



# Anas SpA

Direzione Centrale Progettazione

## SISTEMA TANGENZIALE DI LUCCA

Viabilità Est di Lucca comprendente i collegamenti tra Ponte a Moriano ed i caselli dell'autostrada A11 del Frizzone e di Lucca Est

### PROGETTO PRELIMINARE

PROGETTAZIONE: ANAS - DIREZIONE CENTRALE PROGETTAZIONE

**IL PROGETTISTA:**

Dott. Ing. Antonio VALENTE  
Ordine Ing. di Roma n. 20739

**GRUPPO DI PROGETTAZIONE ANAS**

Ing. Giuseppe Danilo MALGERI – Responsabile di Progetto  
Ing. Francesco BEZZI – Impianti  
Ing. Pier Giorgio D'ARMINI – Traffico e Benefici/Costi  
Ing. Gianfranco FUSANI – Strade  
Ing. Gabriele GIOVANNINI – Cartografia  
Ing. Alessandro MITA – Idraulica  
Ing. Enrico MITTIGA – Geotecnica  
Arch. Gianluca BONOLI – Strutture  
Arch. Roberto ROGGI – Sicurezza  
Geom. Stefano SERANGELI – Geologia  
Geom. Emiliano PAIELLA – Computi e Capitolati  
Geom. Carmelo ZEMA – Espropri ed Interferenze

**IL GEOLOGO**

Dott. Geol. Francesca SCIUBBA  
Ordine Geol. del Lazio n. 1371

**I RESPONSABILI DEL S.I.A.**

Dott. Ing. Ginevra BERETTA      Dott. Arch. Francesca Romana IETTO  
Ordine Ing. di Roma n. 20458      Ordine Arch. di Roma n. 15857

**COORDINATORE PER LA SICUREZZA IN FASE DI PROGETTAZIONE**

Geom. Fabio QUONDAM

**VISTO: IL RESPONSABILE DEL PROCEDIMENTO**

Ing. Nicola DINNELLA

**RESPONSABILI DI UNITA' INGEGNERIA:**

Ing. Fulvio Maria SOCCODATO – Ingegneria Territorio  
Ing. Alessandro MICHELI – Ingegneria Geotecnica e Impianti  
Ing. Achille DEVITOFRANCESCHI – Ingegneria Opere Civili  
Geom. Fabio QUONDAM – Ingegneria Computi, Stime e Capitolati

PROTOCOLLO

DATA

### PROGETTO STRADALE

#### ASSE EST-OVEST

#### SEZIONI TRASVERSALI DELL'ASSE PRINCIPALE

| CODICE PROGETTO |                     | NOME FILE               |                  | REVISIONE      | SCALA:              |
|-----------------|---------------------|-------------------------|------------------|----------------|---------------------|
| PROGETTO        | LIV. PROG. N. PROG. | T00_PS01_STD_SZ04_A.DWG |                  |                |                     |
| L0601A          | P 1201              | CODICE ELAB.            | T00PS01STD SZ04  | A              | 1:200               |
| C               |                     |                         |                  |                |                     |
| B               |                     |                         |                  |                |                     |
| A               | EMISSIONE           | 29/11/2012              | ING. F. Primieri | Ing. G. Fusani | Ing. F.M. Soccodato |
| REV.            | DESCRIZIONE         | DATA                    | REDATTO          | VERIFICATO     | APPROVATO           |

PROFILO ASSE EST-OVEST

SEZIONE 1

PROGRESSIVA 0.00

BINDER  
 C1 0.84 mq.  
 BASE  
 D1 2.62 mq.  
 FONDAZIONE  
 E1 2.10 mq.  
 USURA  
 a1 10.50 ml.

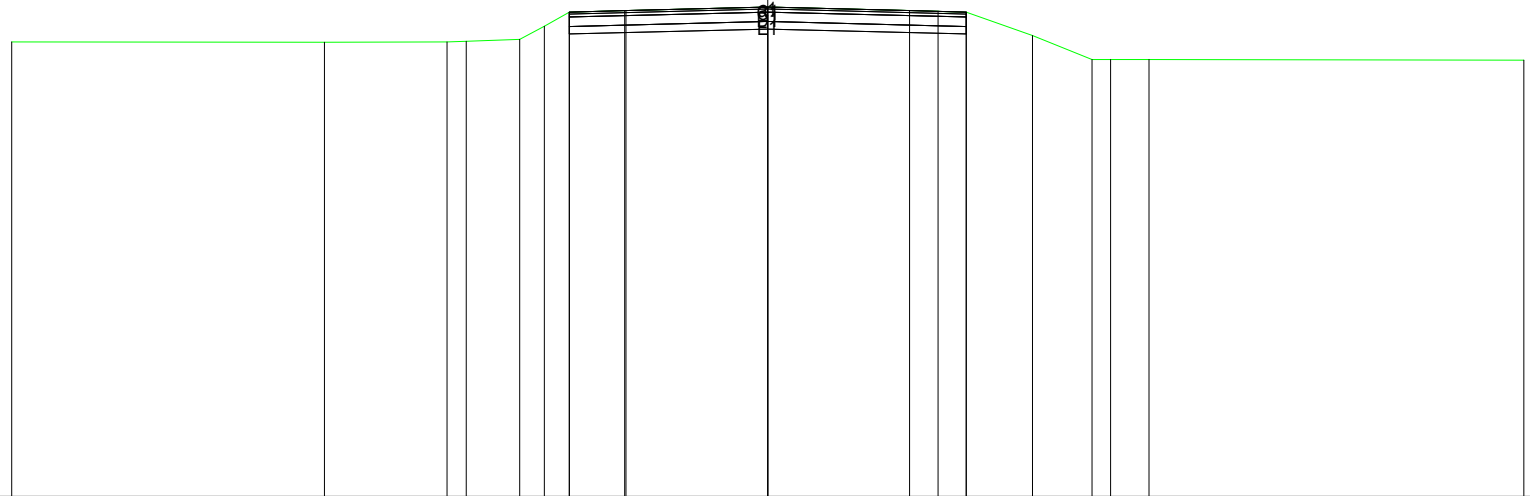

200  
 200

|                      |        |        |       |       |       |       |       |       |       |       |       |       |       |       |       |       |
|----------------------|--------|--------|-------|-------|-------|-------|-------|-------|-------|-------|-------|-------|-------|-------|-------|-------|
| PROGRESSIVE TERRENO  | -20.00 | -11.73 | -8.48 | -7.98 | -6.56 | -5.91 | -5.25 | -3.78 | 0.00  | 4.50  | 5.25  | 7.01  | 8.57  | 9.07  | 10.08 | 20.00 |
| PARZIALI TERRENO     |        | 8.27   | 3.25  | 0.50  | 1.42  | 0.65  | 0.66  | 1.47  | 3.78  | 4.50  | 0.75  | 1.76  | 1.56  | 0.50  | 1.01  | 9.92  |
| QUOTE TERRENO        | 16.02  | 16.02  | 16.02 | 16.04 | 16.09 | 16.43 | 16.81 | 16.85 | 16.94 | 16.83 | 16.81 | 16.19 | 15.56 | 15.56 | 15.56 | 15.54 |
| PROGRESSIVE PROGETTO |        |        |       |       |       |       | -5.25 | -3.75 | 0.00  | 3.75  | 5.25  |       |       |       |       |       |
| PARZIALI PROGETTO    |        |        |       |       |       |       | 1.50  | 3.75  | 3.75  | 1.50  |       |       |       |       |       |       |
| QUOTE PROGETTO       |        |        |       |       |       | 16.81 | 16.85 | 16.94 | 16.85 | 16.81 |       |       |       |       |       |       |

PROFILO ASSE EST-OVEST

SEZIONE 2

PROGRESSIVA 50.00

BINDER  
 C1 0.84 mq.  
 BASE  
 D1 2.62 mq.  
 FONDAZIONE  
 E1 2.10 mq.  
 USURA  
 a1 10.50 ml.

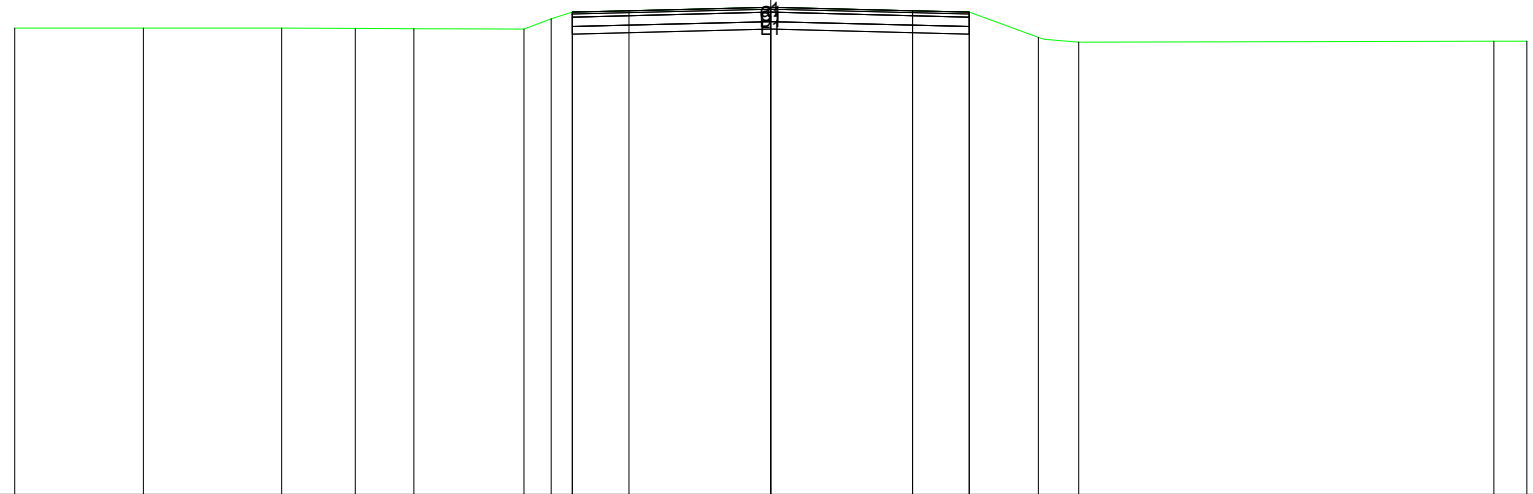

200  
 200

|                      |        |        |        |        |       |       |       |       |       |       |       |       |       |       |       |
|----------------------|--------|--------|--------|--------|-------|-------|-------|-------|-------|-------|-------|-------|-------|-------|-------|
| PROGRESSIVE TERRENO  | -20.00 | -16.60 | -12.94 | -10.99 | -9.45 | -6.53 | -5.81 | -5.25 | 0.00  | 3.75  | 5.25  | 7.08  | 8.15  | 19.12 | 20.00 |
| PARZIALI TERRENO     | 3.40   | 3.66   | 1.95   | 1.54   | 2.92  | 0.72  | 0.56  | 5.25  | 3.75  | 1.50  | 1.83  | 1.07  | 10.97 | 0.88  |       |
| QUOTE TERRENO        | 16.34  | 16.34  | 16.34  | 16.32  | 16.32 | 16.31 | 16.58 | 16.76 | 16.89 | 16.80 | 16.76 | 16.09 | 15.96 | 15.98 | 15.99 |
| PROGRESSIVE PROGETTO |        |        |        |        |       |       | -5.25 | -3.75 | 0.00  | 3.75  | 5.25  |       |       |       |       |
| PARZIALI PROGETTO    |        |        |        |        |       |       | 1.50  | 3.75  | 3.75  | 1.50  |       |       |       |       |       |
| QUOTE PROGETTO       |        |        |        |        |       |       | 16.76 | 16.80 | 16.89 | 16.80 | 16.76 |       |       |       |       |

PROFILO ASSE EST-OVEST

SEZIONE 3

PROGRESSIVA 100.00

BINDER  
 C1 0.84 mq.  
 BASE  
 D1 2.62 mq.  
 FONDAZIONE  
 E1 2.10 mq.  
 USURA  
 a1 10.50 ml.

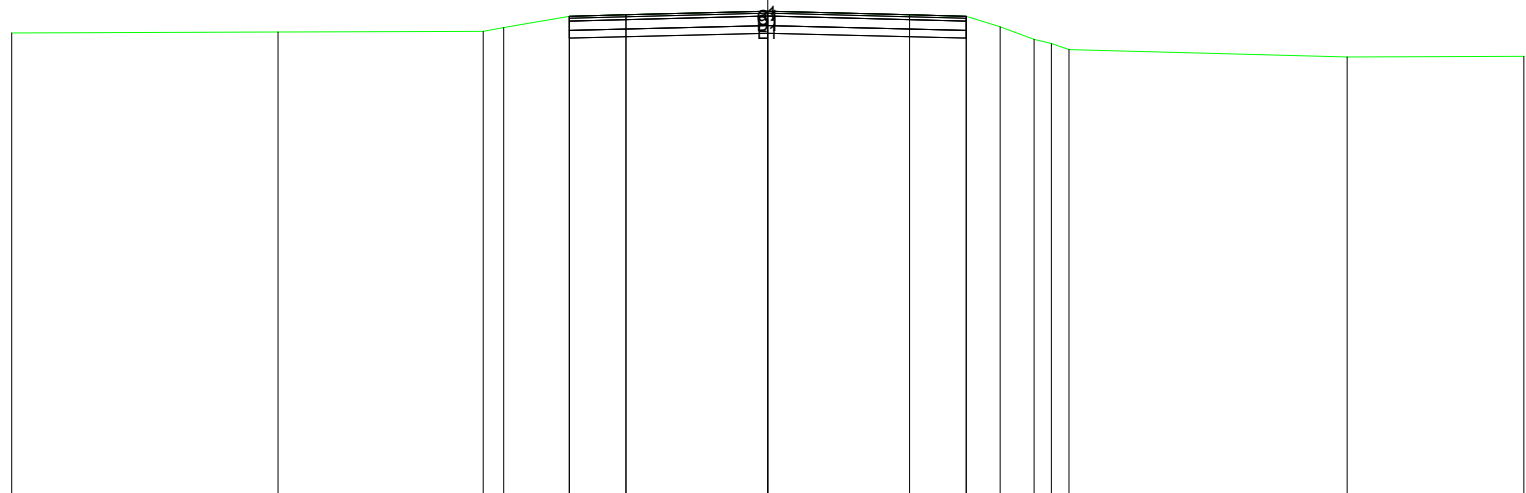

200  
 200

PROGRESSIVE  
 TERRENO

-20.00 -12.96 -7.52 -6.99 -5.25 -3.75 0.00 5.25 6.15 7.04 7.50 7.96 15.32 20.00

PARZIALI  
 TERRENO

7.04 5.44 0.53 1.74 1.50 3.75 5.25 0.90 0.89 0.46 0.46 7.36 4.68

QUOTE  
 TERRENO

16.26 16.29 16.30 16.40 16.70 16.74 16.83 16.70 16.42 16.09 15.98 15.82 15.62 15.64

PROGRESSIVE  
 PROGETTO

-5.25 -3.75 0.00 3.75 5.25

PARZIALI  
 PROGETTO

1.50 3.75 3.75 1.50

QUOTE  
 PROGETTO

16.70 16.74 16.83 16.74 16.70

PROFILO ASSE EST-OVEST

SEZIONE 4

PROGRESSIVA 150.00

BINDER  
 C1 0.84 mq.  
 BASE  
 D1 2.62 mq.  
 FONDAZIONE  
 E1 2.10 mq.  
 USURA  
 a1 10.50 ml.

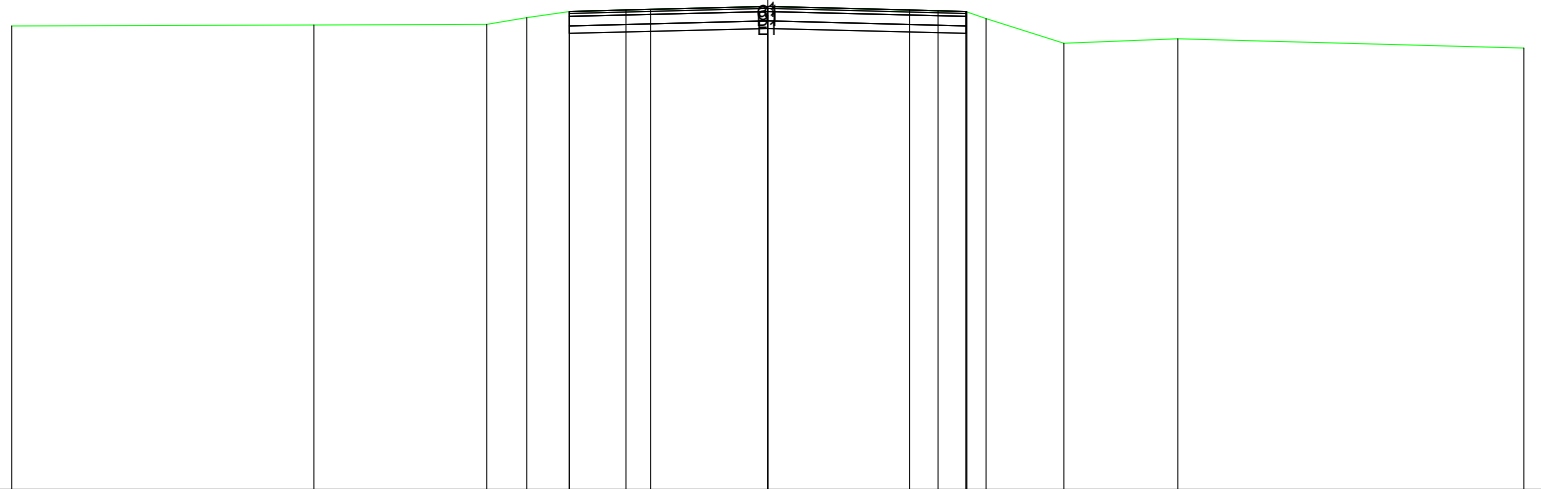

200 200

|                      |        |        |       |       |       |       |       |       |       |       |       |       |       |
|----------------------|--------|--------|-------|-------|-------|-------|-------|-------|-------|-------|-------|-------|-------|
| PROGRESSIVE TERRENO  | -20.00 | -12.01 | -7.44 | -6.38 | -5.25 | -3.10 | 0.00  | 4.50  | 5.24  | 5.77  | 7.83  | 10.84 | 20.00 |
| PARZIALI TERRENO     | 7.99   | 4.57   | 1.06  | 1.13  | 2.15  | 3.10  | 4.50  | 0.74  | 0.53  | 2.06  | 3.01  | 9.16  |       |
| QUOTE TERRENO        | 16.26  | 16.29  | 16.30 | 16.48 | 16.64 | 16.70 | 16.77 | 16.66 | 16.64 | 16.45 | 15.80 | 15.92 | 15.68 |
| PROGRESSIVE PROGETTO |        |        |       |       | -5.25 | -3.75 | 0.00  | 3.75  | 5.25  | 5.26  |       |       |       |
| PARZIALI PROGETTO    |        |        |       |       | 1.50  | 3.75  | 3.75  | 1.50  | 0.01  |       |       |       |       |
| QUOTE PROGETTO       |        |        | 16.64 | 16.68 | 16.77 | 16.68 | 16.64 | 16.63 |       |       |       |       |       |

PROFILO ASSE EST-OVEST

SEZIONE 5

PROGRESSIVA 200.00

BINDER  
 C1 0.84 mq.  
 BASE  
 D1 2.64 mq.  
 FONDAZIONE  
 E1 2.10 mq.  
 USURA  
 a1 10.50 ml.

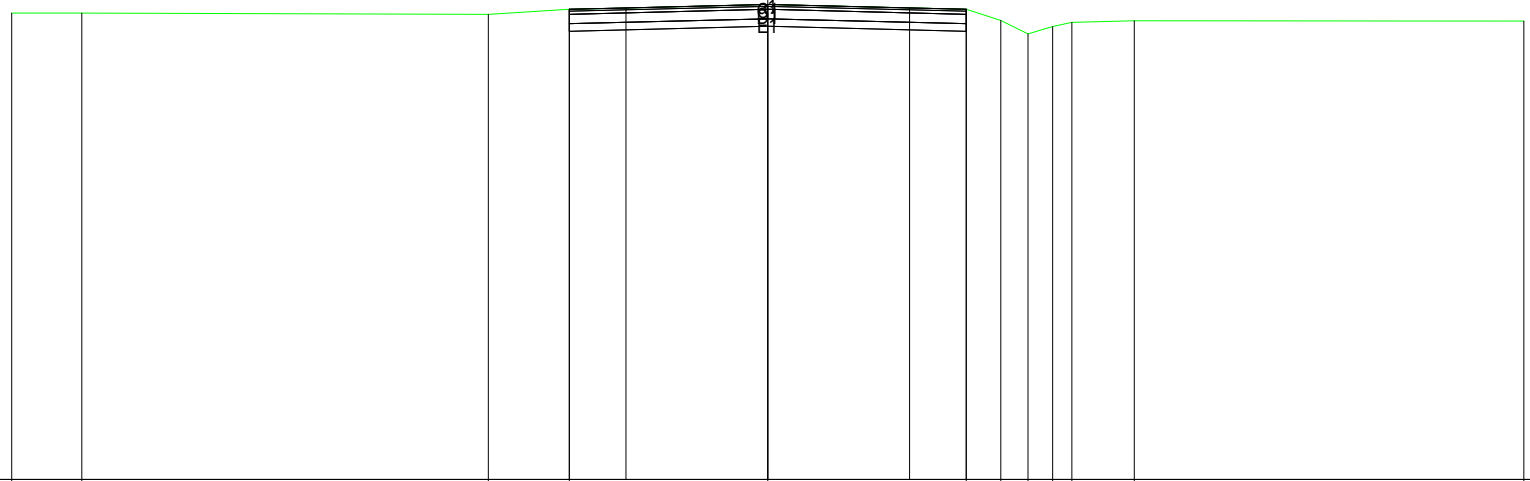

200  
 200

|                      |        |        |       |       |       |       |       |       |       |       |       |       |       |       |
|----------------------|--------|--------|-------|-------|-------|-------|-------|-------|-------|-------|-------|-------|-------|-------|
| PROGRESSIVE TERRENO  | -20.00 | -18.15 |       | -7.39 | -5.25 | 0.00  |       | 5.25  | 6.16  | 6.89  | 7.54  | 8.04  | 9.70  | 20.00 |
| PARZIALI TERRENO     | 1.85   |        | 10.76 | 2.14  | 5.25  | 5.25  | 0.91  | 0.73  | 0.65  | 0.50  | 1.66  |       | 10.30 |       |
| QUOTE TERRENO        | 16.34  | 16.34  |       | 16.30 | 16.43 | 16.56 | 16.43 | 16.14 | 15.79 | 15.98 | 16.09 | 16.13 |       | 16.12 |
| PROGRESSIVE PROGETTO |        |        |       | -5.25 | -3.75 | 0.00  | 3.75  | 5.25  |       |       |       |       |       |       |
| PARZIALI PROGETTO    |        |        |       | 1.50  | 3.75  | 3.75  | 1.50  |       |       |       |       |       |       |       |
| QUOTE PROGETTO       |        |        |       | 16.43 | 16.47 | 16.56 | 16.47 | 16.43 |       |       |       |       |       |       |

PROFILO ASSE EST-OVEST

SEZIONE 6

PROGRESSIVA 250.00

BINDER  
 C1 0.84 mq.  
 BASE  
 D1 2.62 mq.  
 FONDAZIONE  
 E1 2.10 mq.  
 USURA  
 a1 10.50 ml.

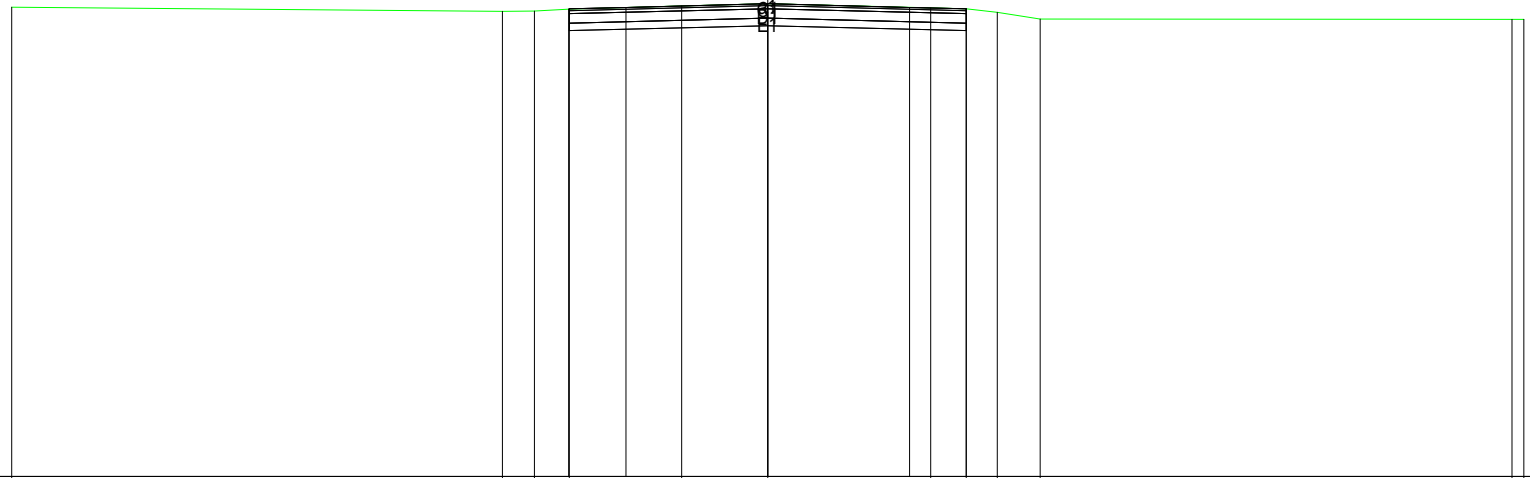

200  
 200

PROGRESSIVE  
 TERRENO

-20.00 -7.02 -6.17 -5.25 -2.28 0.00 4.31 5.25 6.07 7.20 19.68 20.00

PARZIALI  
 TERRENO

12.98 0.85 0.92 2.97 2.28 4.31 0.94 0.82 1.13 12.48 0.32

QUOTE  
 TERRENO

16.41 16.30 16.31 16.36 16.44 16.50 16.39 16.37 16.28 16.10 16.09 16.09

PROGRESSIVE  
 PROGETTO

-5.27 -3.75 0.00 3.75 5.25

PARZIALI  
 PROGETTO

1.52 3.75 3.75 1.50

QUOTE  
 PROGETTO

16.36 16.41 16.50 16.41 16.37

PROFILO ASSE EST-OVEST

SEZIONE 7

PROGRESSIVA 300.00

BINDER  
 C1 0.84 mq.  
 BASE  
 D1 2.62 mq.  
 FONDAZIONE  
 E1 2.10 mq.  
 USURA  
 a1 10.50 ml.

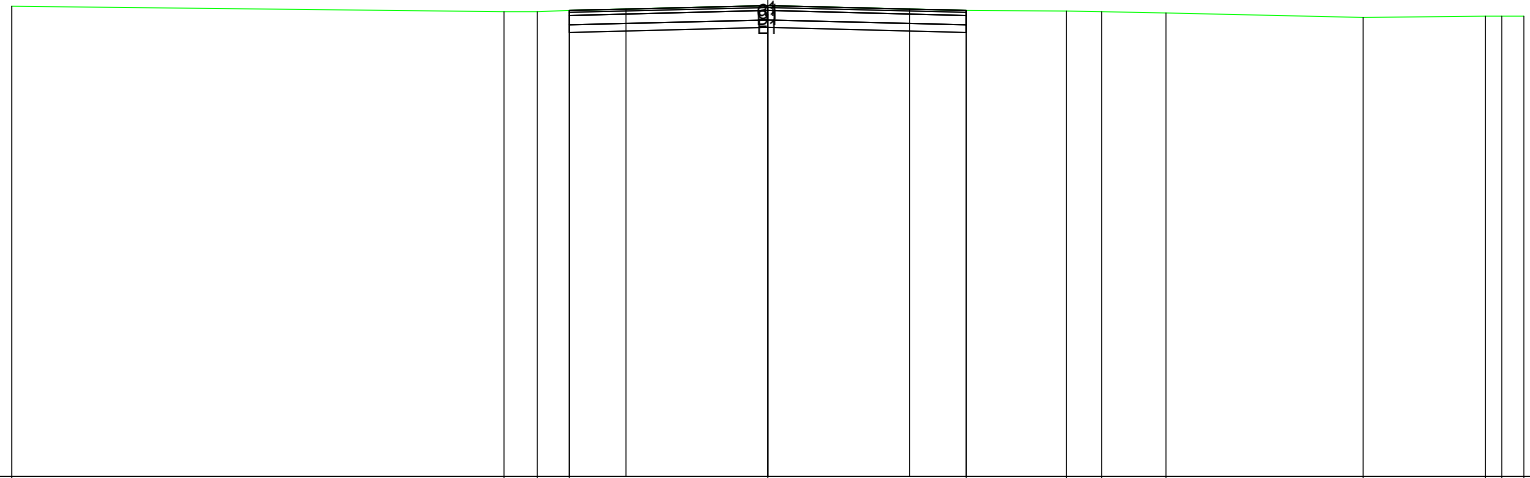

200  
 200

|                      |        |       |       |       |       |       |       |       |       |       |       |       |       |
|----------------------|--------|-------|-------|-------|-------|-------|-------|-------|-------|-------|-------|-------|-------|
| PROGRESSIVE TERRENO  | -20.00 | -6.98 | -6.09 | -5.25 | 0.00  | 5.25  | 7.90  | 8.83  | 10.53 | 15.74 | 18.98 | 19.42 | 20.00 |
| PARZIALI TERRENO     | 13.02  | 0.89  | 0.84  | 5.25  | 5.25  | 2.65  | 0.93  | 1.70  | 5.21  | 3.24  | 0.44  | 0.58  |       |
| QUOTE TERRENO        | 16.43  | 16.30 | 16.29 | 16.32 | 16.46 | 16.32 | 16.31 | 16.29 | 16.26 | 16.14 | 16.17 | 16.18 | 16.18 |
| PROGRESSIVE PROGETTO |        |       | -5.25 | -3.75 | 0.00  | 3.75  | 5.25  |       |       |       |       |       |       |
| PARZIALI PROGETTO    |        |       | 1.50  | 3.75  | 3.75  | 1.50  |       |       |       |       |       |       |       |
| QUOTE PROGETTO       |        | 16.32 | 16.36 | 16.46 | 16.36 | 16.32 |       |       |       |       |       |       |       |



PROFILO ASSE EST-OVEST

SEZIONE 8

PROGRESSIVA 350.00

BINDER  
 C1 0.84 mq.  
 BASE  
 D1 2.62 mq.  
 FONDAZIONE  
 E1 2.10 mq.  
 USURA  
 a1 10.50 ml.

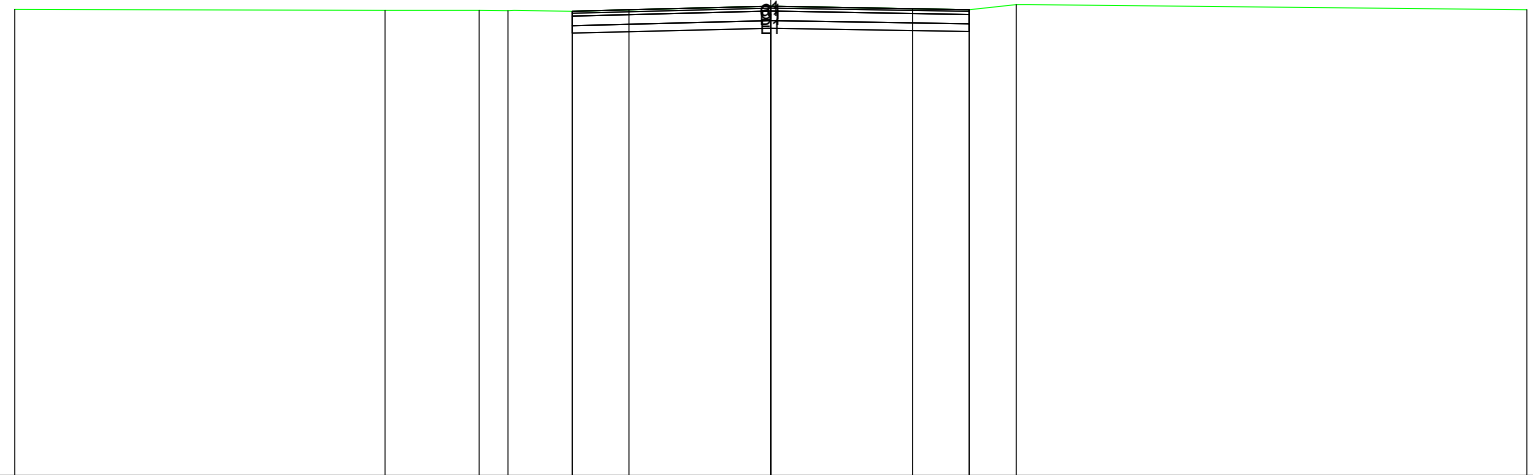

200  
 200

|                      |        |        |       |       |       |       |       |       |       |
|----------------------|--------|--------|-------|-------|-------|-------|-------|-------|-------|
| PROGRESSIVE TERRENO  | -20.00 | -10.20 | -7.71 | -6.95 | -5.25 | 0.00  | 5.25  | 6.49  | 20.00 |
| PARZIALI TERRENO     | 9.80   | 2.49   | 0.76  | 1.70  | 5.25  | 5.25  | 1.24  | 13.51 |       |
| QUOTE TERRENO        | 16.33  | 16.30  | 16.30 | 16.30 | 16.28 | 16.41 | 16.32 | 16.46 | 16.31 |
| PROGRESSIVE PROGETTO |        |        |       |       | -5.25 | -3.75 | 0.00  | 3.75  | 5.25  |
| PARZIALI PROGETTO    |        |        |       |       | 1.50  | 3.75  | 3.75  | 1.50  |       |
| QUOTE PROGETTO       |        |        |       |       | 16.28 | 16.32 | 16.41 | 16.35 | 16.32 |

PROFILO ASSE EST-OVEST

SEZIONE 9

PROGRESSIVA 400.00

BINDER  
C1 0.84 mq.  
BASE  
D1 2.62 mq.  
FONDAZIONE  
E1 2.10 mq.  
USURA  
a1 10.50 ml.

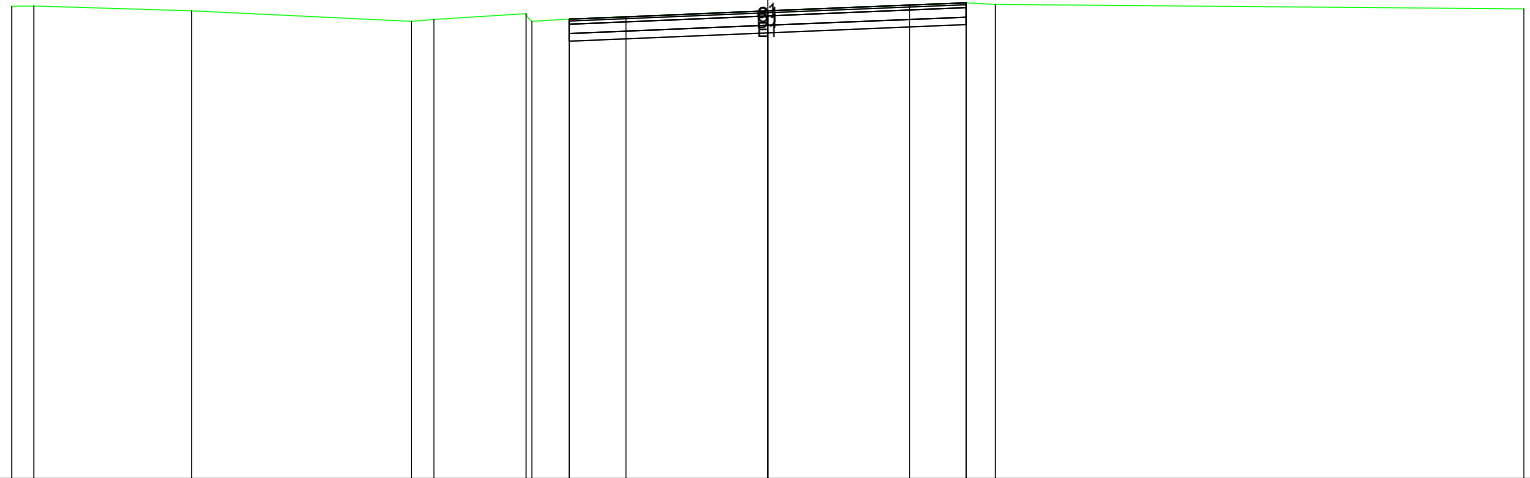

200  
200

|                      |        |        |        |       |       |       |       |       |       |       |       |       |
|----------------------|--------|--------|--------|-------|-------|-------|-------|-------|-------|-------|-------|-------|
| PROGRESSIVE TERRENO  | -20.00 | -19.42 | -15.24 | -9.43 | -8.83 | -6.40 | -6.24 | -5.25 | 0.00  | 5.25  | 6.02  | 20.00 |
| PARZIALI TERRENO     | 0.58   | 4.18   | 5.81   | 0.60  | 2.43  | 0.16  | 0.99  | 5.25  | 5.25  | 0.77  | 13.98 |       |
| QUOTE TERRENO        | 16.49  | 16.50  | 16.37  | 16.09 | 16.14 | 16.30 | 16.09 | 16.15 | 16.37 | 16.58 | 16.54 | 16.42 |
| PROGRESSIVE PROGETTO |        |        |        |       |       |       | -5.25 | -3.75 | 0.00  | 3.75  | 5.25  |       |
| PARZIALI PROGETTO    |        |        |        |       |       |       | 1.50  | 3.75  | 3.75  | 1.50  |       |       |
| QUOTE PROGETTO       |        |        |        |       |       |       | 16.15 | 16.21 | 16.37 | 16.52 | 16.58 |       |

PROFILO ASSE EST-OVEST

SEZIONE 10

PROGRESSIVA 450.00

BINDER  
 C1 0.84 mq.  
 BASE  
 D1 2.63 mq.  
 FONDAZIONE  
 E1 2.10 mq.  
 USURA  
 a1 10.50 ml.

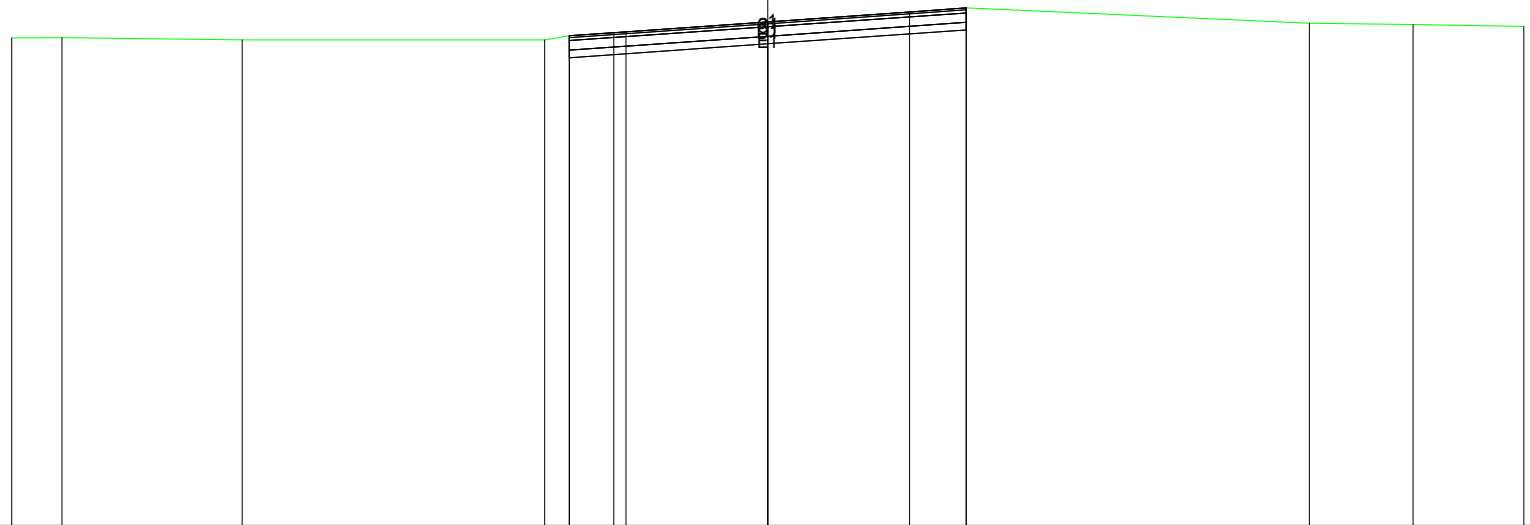

3

200  
 200

|                      |        |        |        |       |       |       |       |       |       |       |       |
|----------------------|--------|--------|--------|-------|-------|-------|-------|-------|-------|-------|-------|
| PROGRESSIVE TERRENO  | -20.00 | -18.67 | -13.91 | -5.91 | -5.25 | -4.07 | 0.00  | 5.25  | 14.33 | 17.07 | 20.00 |
| PARZIALI TERRENO     | 1.33   | 4.76   | 8.00   | 0.66  | 1.18  | 4.07  | 5.25  | 9.08  | 2.74  | 2.93  |       |
| QUOTE TERRENO        | 15.90  | 15.91  | 15.84  | 15.84 | 15.95 | 16.04 | 16.32 | 16.69 | 16.29 | 16.25 | 16.20 |
| PROGRESSIVE PROGETTO |        |        |        | -5.25 | -3.75 | 0.00  | 3.75  | 5.25  |       |       |       |
| PARZIALI PROGETTO    |        |        |        | 1.50  | 3.75  | 3.75  | 1.50  |       |       |       |       |
| QUOTE PROGETTO       |        |        |        | 15.95 | 16.06 | 16.32 | 16.58 | 16.69 |       |       |       |

PROFILO ASSE EST-OVEST

SEZIONE 11

PROGRESSIVA 500.00

BINDER  
 C1 0.84 mq.  
 BASE  
 D1 2.63 mq.  
 FONDAZIONE  
 E1 2.10 mq.  
 USURA  
 a1 10.50 ml.

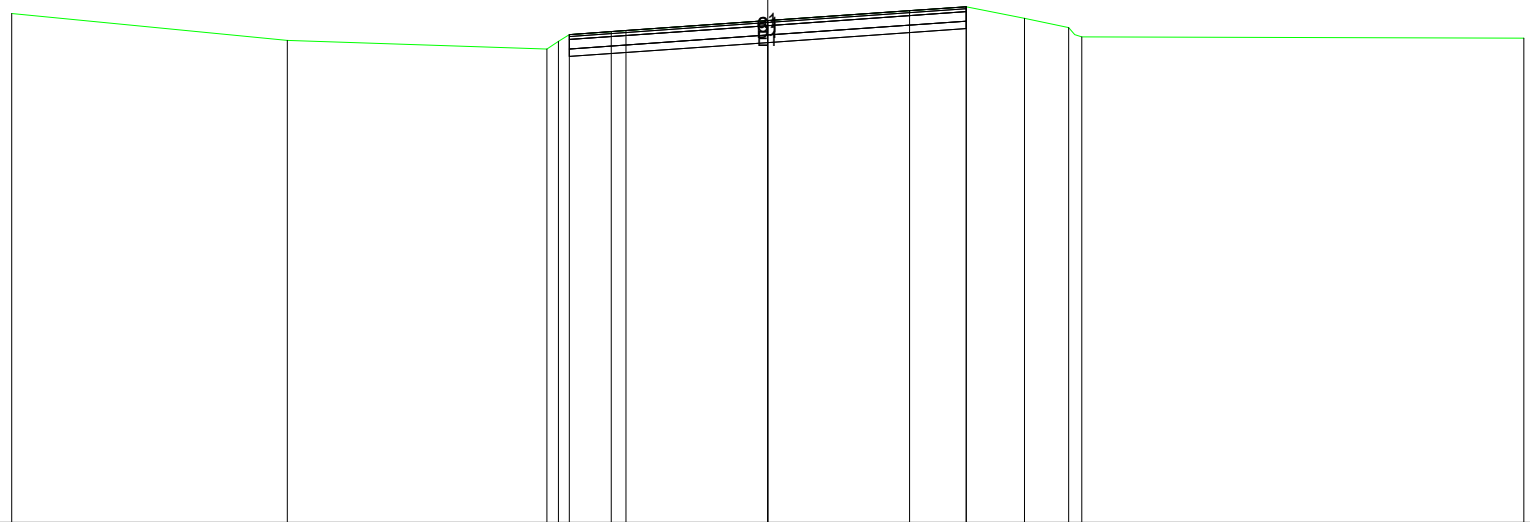

3

200 200

|                      |        |        |       |       |       |       |       |       |       |       |       |
|----------------------|--------|--------|-------|-------|-------|-------|-------|-------|-------|-------|-------|
| PROGRESSIVE TERRENO  | -20.00 | -12.71 | -5.85 | -5.54 | -4.14 | 0.00  | 5.25  | 6.79  | 7.96  | 8.31  | 20.00 |
| PARZIALI TERRENO     |        | 7.29   | 6.86  | 0.31  | 1.40  | 4.14  | 5.25  | 1.54  | 1.17  | 0.35  | 11.69 |
| QUOTE TERRENO        | 16.46  | 15.75  | 15.52 | 15.73 | 15.98 | 16.27 | 16.64 | 16.33 | 16.09 | 15.84 | 15.81 |
| PROGRESSIVE PROGETTO |        |        | -5.25 | -3.75 | 0.00  | 3.75  | 5.25  |       |       |       |       |
| PARZIALI PROGETTO    |        |        | 1.50  | 3.75  | 3.75  | 1.50  |       |       |       |       |       |
| QUOTE PROGETTO       |        |        | 15.91 | 16.01 | 16.27 | 16.54 | 16.64 |       |       |       |       |

PROFILO ASSE EST-OVEST

SEZIONE 12

PROGRESSIVA 550.00

BINDER  
 C1 0.84 mq.  
 BASE  
 D1 2.62 mq.  
 FONDAZIONE  
 E1 2.10 mq.  
 USURA  
 a1 10.50 ml.

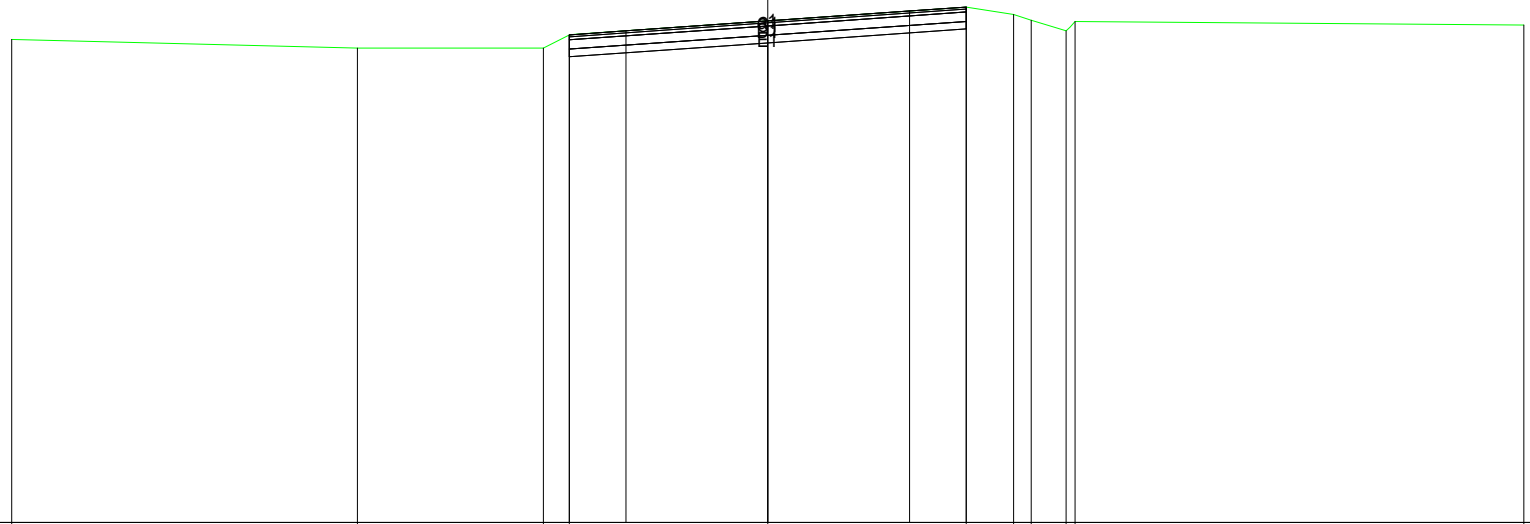

3

200  
 200

|                      |        |        |       |       |       |       |       |       |       |       |       |
|----------------------|--------|--------|-------|-------|-------|-------|-------|-------|-------|-------|-------|
| PROGRESSIVE TERRENO  | -20.00 | -10.86 | -5.94 | -5.25 | 0.00  | 5.25  | 6.50  | 6.97  | 7.89  | 8.13  | 20.00 |
| PARZIALI TERRENO     |        | 9.14   | 4.92  | 0.69  | 5.25  | 5.25  | 1.25  | 0.47  | 0.92  | 0.24  | 11.87 |
| QUOTE TERRENO        | 15.77  | 15.55  | 15.55 | 15.90 | 16.27 | 16.63 | 16.44 | 16.29 | 16.00 | 16.25 | 16.15 |
| PROGRESSIVE PROGETTO |        |        | -5.25 | -3.75 | 0.00  | 3.75  | 5.25  |       |       |       |       |
| PARZIALI PROGETTO    |        |        | 1.50  | 3.75  | 3.75  | 1.50  |       |       |       |       |       |
| QUOTE PROGETTO       |        |        | 15.90 | 16.00 | 16.27 | 16.53 | 16.63 |       |       |       |       |

PROFILO ASSE EST-OVEST

SEZIONE 13

PROGRESSIVA 600.00

BINDER  
 C1 0.84 mq.  
 BASE  
 D1 2.62 mq.  
 FONDAZIONE  
 E1 2.11 mq.  
 USURA  
 a1 10.50 ml.

3

200  
 200

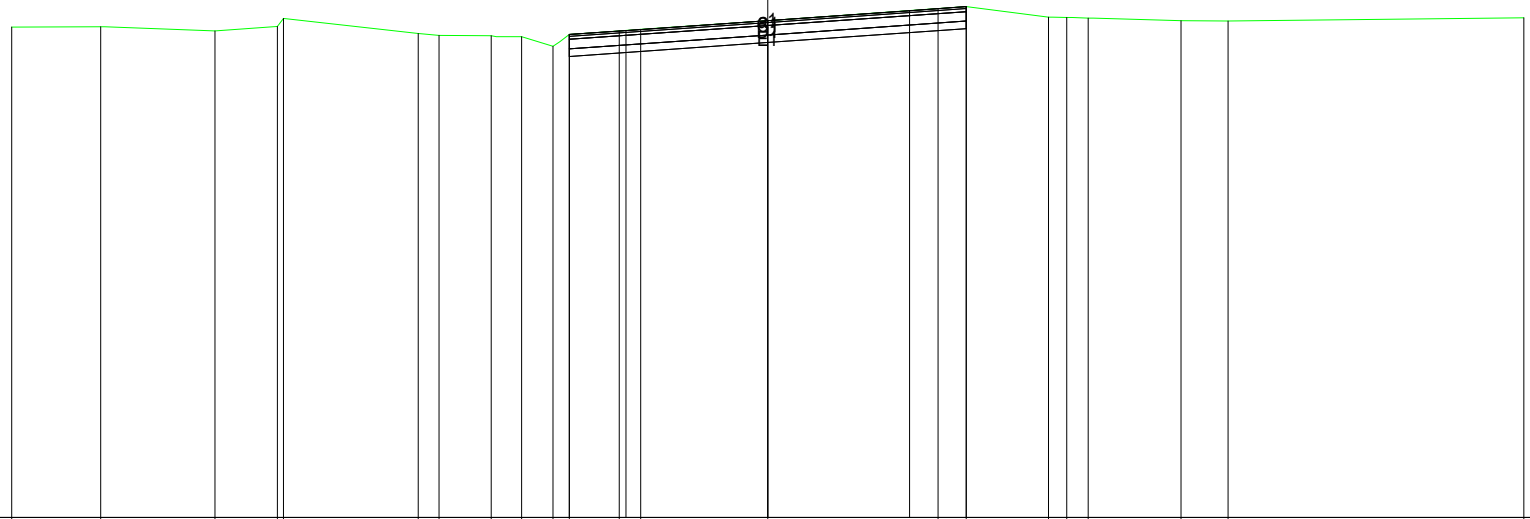

PROGRESSIVE  
 TERRENO

-20.00 -17.64 -14.62 -12.97 -12.81 -9.25 -8.69 -7.32 -6.51 -5.68 -5.25 -3.93 -3.36 0.00 4.50 5.25 7.42 7.91 8.48 10.93 12.17 20.00

PARZIALI  
 TERRENO

2.36 3.02 1.65 0.16 3.56 0.56 1.37 0.81 0.83 0.43 1.32 0.57 3.36 4.50 0.75 2.17 0.49 0.57 2.45 1.24 7.83

QUOTE  
 TERRENO

15.97 15.98 15.87 15.99 16.20 15.80 15.75 15.74 15.72 15.46 15.78 15.87 15.91 16.14 16.46 16.51 16.24 16.22 16.21 16.14 16.14 16.22

PROGRESSIVE  
 PROGETTO

-5.25 -3.75 0.00 3.75 5.25

PARZIALI  
 PROGETTO

1.50 3.75 3.75 1.50

QUOTE  
 PROGETTO

15.78 15.88 16.14 16.41 16.51

PROFILO ASSE EST-OVEST

SEZIONE 14

PROGRESSIVA 650.00

BINDER  
 C1 0.84 mq.  
 BASE  
 D1 2.63 mq.  
 FONDAZIONE  
 E1 2.10 mq.  
 USURA  
 a1 10.50 ml.



200  
 200

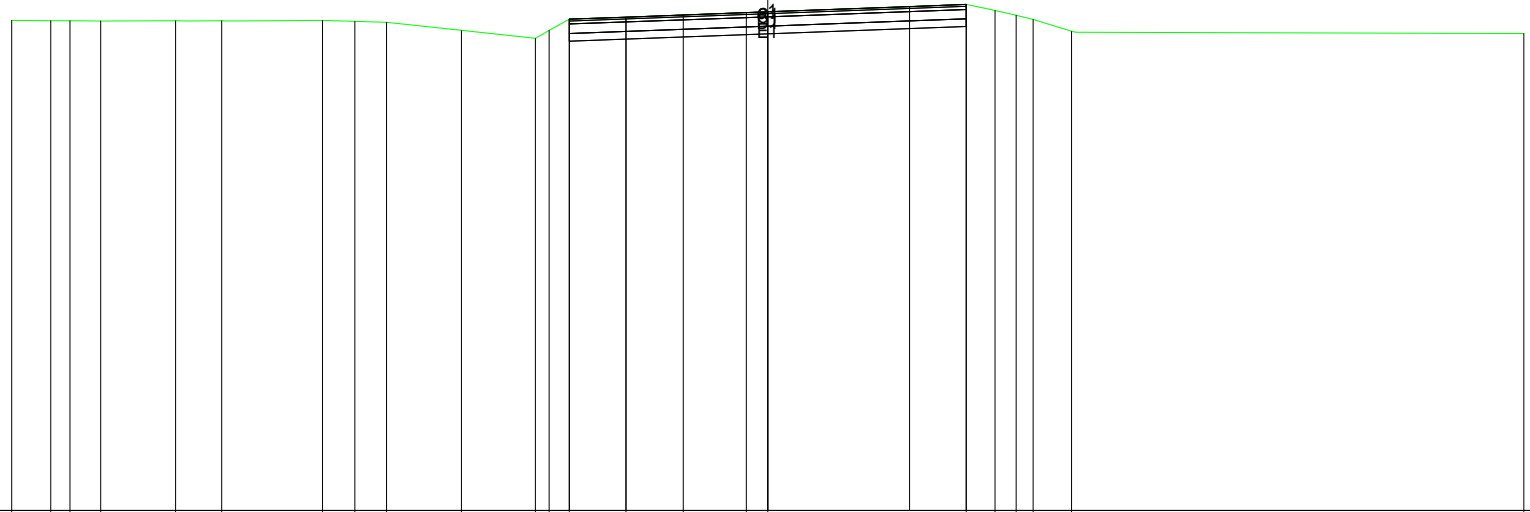

|                      |        |        |        |        |        |        |        |        |        |       |       |       |       |       |       |       |       |       |       |       |       |       |       |
|----------------------|--------|--------|--------|--------|--------|--------|--------|--------|--------|-------|-------|-------|-------|-------|-------|-------|-------|-------|-------|-------|-------|-------|-------|
| PROGRESSIVE TERRENO  | -20.00 | -18.97 | -18.46 | -17.65 | -15.66 | -14.44 | -11.78 | -10.92 | -10.08 | -8.10 | -6.15 | -5.78 | -5.25 | -3.75 | -2.24 | -0.57 | 0.00  | 5.25  | 6.01  | 6.57  | 7.02  | 8.04  | 20.00 |
| PARZIALI TERRENO     | 1.03   | 0.51   | 0.81   | 1.99   | 1.22   | 2.66   | 0.86   | 0.84   | 1.98   | 1.95  | 0.37  | 0.53  | 1.50  | 1.51  | 1.67  | 0.57  | 5.25  | 0.76  | 0.56  | 0.45  | 1.02  | 11.96 |       |
| QUOTE TERRENO        | 15.96  | 15.96  | 15.95  | 15.95  | 15.95  | 15.95  | 15.96  | 15.94  | 15.91  | 15.70 | 15.49 | 15.70 | 16.00 | 16.05 | 16.11 | 16.17 | 16.19 | 16.38 | 16.22 | 16.10 | 15.98 | 15.68 | 15.61 |
| PROGRESSIVE PROGETTO |        |        |        |        |        |        |        |        |        |       |       | -5.25 | -3.75 |       |       | 0.00  |       | 3.75  | 5.25  |       |       |       |       |
| PARZIALI PROGETTO    |        |        |        |        |        |        |        |        |        |       |       | 1.50  |       | 3.75  |       |       | 3.75  | 1.50  |       |       |       |       |       |
| QUOTE PROGETTO       |        |        |        |        |        |        |        |        |        |       | 16.00 | 16.05 | 16.19 | 16.33 | 16.38 |       |       |       |       |       |       |       |       |

PROFILO ASSE EST-OVEST

SEZIONE 15

PROGRESSIVA 700.00

BINDER  
 C1 0.84 mq.  
 BASE  
 D1 2.63 mq.  
 FONDAZIONE  
 E1 2.10 mq.  
 USURA  
 a1 10.50 ml.

3

200 200

|                      |        |        |        |        |        |       |       |       |       |       |       |       |
|----------------------|--------|--------|--------|--------|--------|-------|-------|-------|-------|-------|-------|-------|
| PROGRESSIVE TERRENO  | -20.00 | -18.82 | -17.48 | -15.59 | -15.12 | -5.25 | 0.00  | 5.25  | 6.39  | 6.98  | 11.62 | 20.00 |
| PARZIALI TERRENO     | 1.18   | 1.34   | 1.89   | 0.47   | 9.87   | 5.25  | 5.25  | 1.14  | 0.59  | 4.64  | 8.38  |       |
| QUOTE TERRENO        | 16.71  | 16.79  | 16.78  | 16.74  | 16.75  | 16.11 | 16.24 | 16.13 | 15.87 | 15.72 | 15.71 | 15.70 |
| PROGRESSIVE PROGETTO |        |        |        |        |        | -5.25 | -3.75 | 0.00  | 3.75  | 5.25  |       |       |
| PARZIALI PROGETTO    |        |        |        |        |        | 1.50  | 3.75  | 3.75  | 1.50  |       |       |       |
| QUOTE PROGETTO       |        |        |        |        |        | 16.11 | 16.14 | 16.24 | 16.16 | 16.13 |       |       |





PROFILO ASSE EST-OVEST

SEZIONE 17

PROGRESSIVA 800.00

BINDER  
 C1 0.84 mq.  
 BASE  
 D1 2.62 mq.  
 FONDAZIONE  
 E1 2.10 mq.  
 USURA  
 a1 10.50 ml.

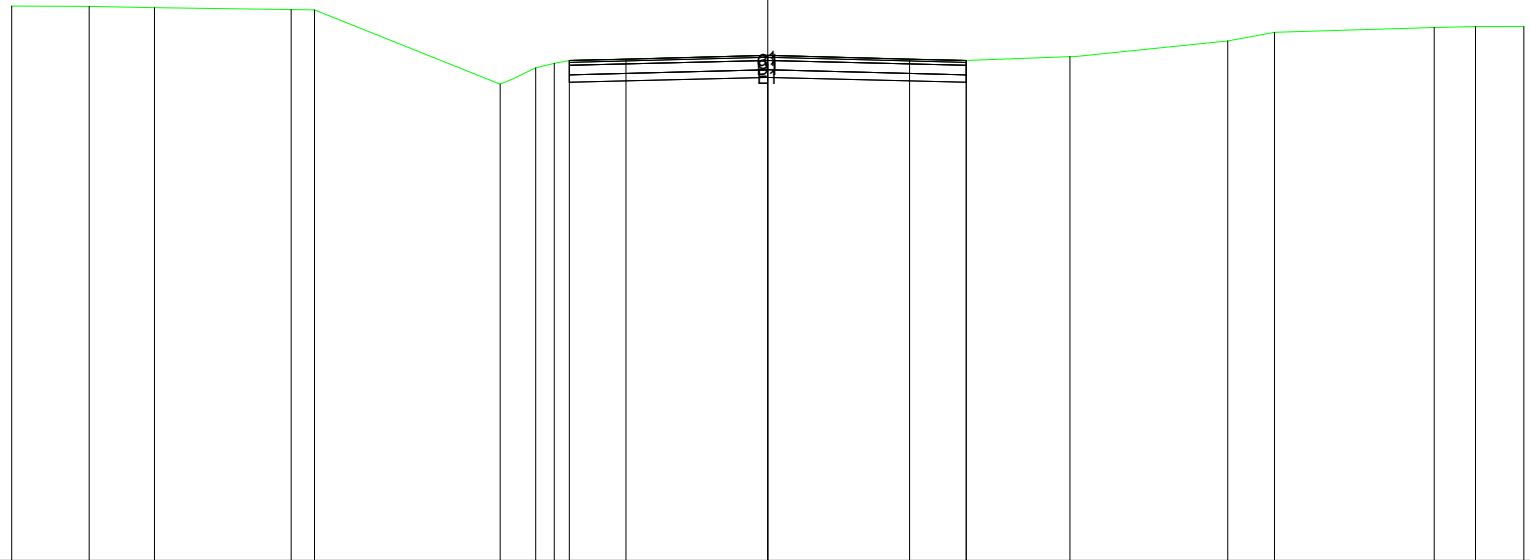

3

200  
200

|                      |        |        |        |        |        |       |       |       |       |       |       |       |       |       |       |       |
|----------------------|--------|--------|--------|--------|--------|-------|-------|-------|-------|-------|-------|-------|-------|-------|-------|-------|
| PROGRESSIVE TERRENO  | -20.00 | -17.95 | -16.22 | -12.61 | -11.99 | -7.08 | -6.14 | -5.65 | 0.00  | 5.25  | 7.99  | 12.17 | 13.40 | 17.63 | 18.72 | 20.00 |
| PARZIALI TERRENO     |        | 2.05   | 1.73   | 3.61   | 0.62   | 4.91  | 0.94  | 0.49  | 5.65  | 5.25  | 2.74  | 4.18  | 1.23  | 4.23  | 1.09  | 1.28  |
| QUOTE TERRENO        | 17.66  | 17.66  | 17.62  | 17.57  | 17.56  | 15.60 | 16.03 | 16.15 | 16.36 | 16.22 | 16.33 | 16.74 | 16.97 | 17.10 | 17.13 | 17.12 |
| PROGRESSIVE PROGETTO |        |        |        |        |        |       | -5.25 | -3.75 | 0.00  | 3.75  | 5.25  |       |       |       |       |       |
| PARZIALI PROGETTO    |        |        |        |        |        |       | 1.50  | 3.75  | 3.75  | 1.50  |       |       |       |       |       |       |
| QUOTE PROGETTO       |        |        |        |        |        |       | 16.22 | 16.26 | 16.36 | 16.26 | 16.22 |       |       |       |       |       |

PROFILO ASSE EST-OVEST

SEZIONE 18

PROGRESSIVA 850.00

BINDER  
 C1 0.84 mq.  
 BASE  
 D1 2.62 mq.  
 FONDAZIONE  
 E1 2.10 mq.  
 USURA  
 a1 10.50 ml.

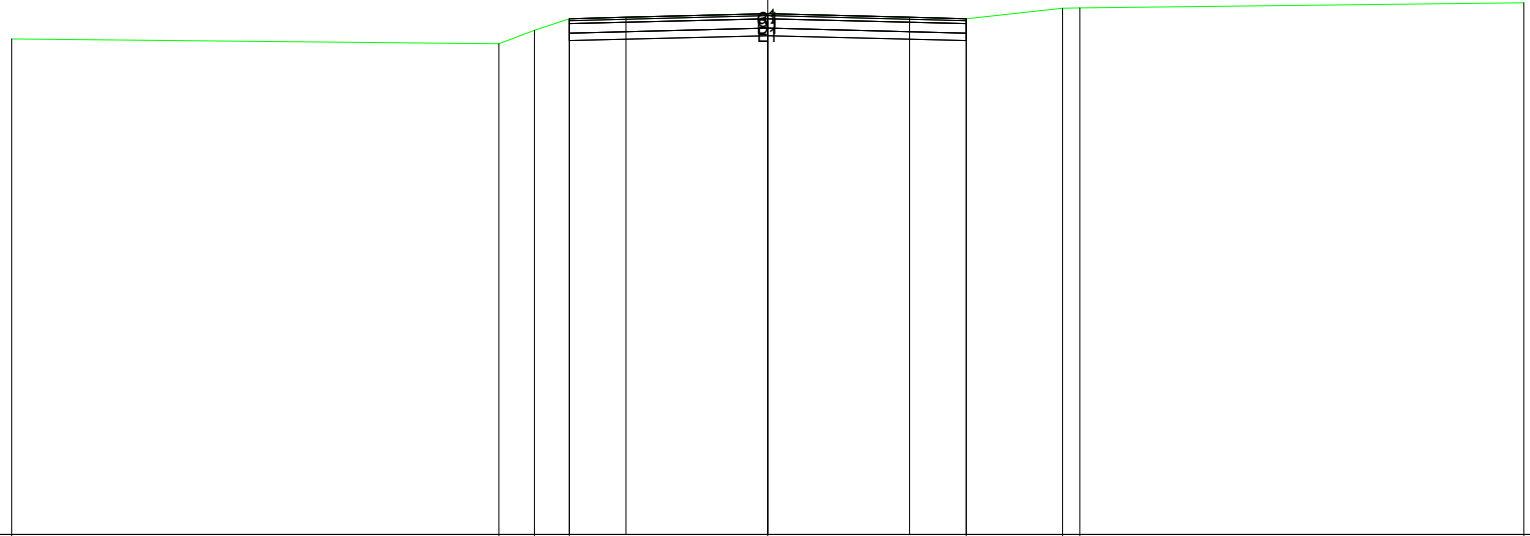

3

200  
 200

|                      |        |       |       |       |       |       |       |       |       |
|----------------------|--------|-------|-------|-------|-------|-------|-------|-------|-------|
| PROGRESSIVE TERRENO  | -20.00 | -7.11 | -6.17 | -5.25 | 0.00  | 5.25  | 7.80  | 8.26  | 20.00 |
| PARZIALI TERRENO     | 12.89  | 0.94  | 0.92  | 5.25  | 5.25  | 2.55  | 0.46  | 11.74 |       |
| QUOTE TERRENO        | 16.11  | 15.98 | 16.34 | 16.64 | 16.77 | 16.64 | 16.92 | 16.93 | 17.06 |
| PROGRESSIVE PROGETTO |        | -5.25 | -3.75 | 0.00  | 3.75  | 5.25  |       |       |       |
| PARZIALI PROGETTO    |        | 1.50  | 3.75  | 3.75  | 1.50  |       |       |       |       |
| QUOTE PROGETTO       |        | 16.64 | 16.68 | 16.77 | 16.68 | 16.64 |       |       |       |

PROFILO ASSE EST-OVEST

SEZIONE 19

PROGRESSIVA 900.00

BINDER  
 C1 0.84 mq.  
 BASE  
 D1 2.62 mq.  
 FONDAZIONE  
 E1 2.10 mq.  
 USURA  
 a1 10.50 ml.

3

200  
 200

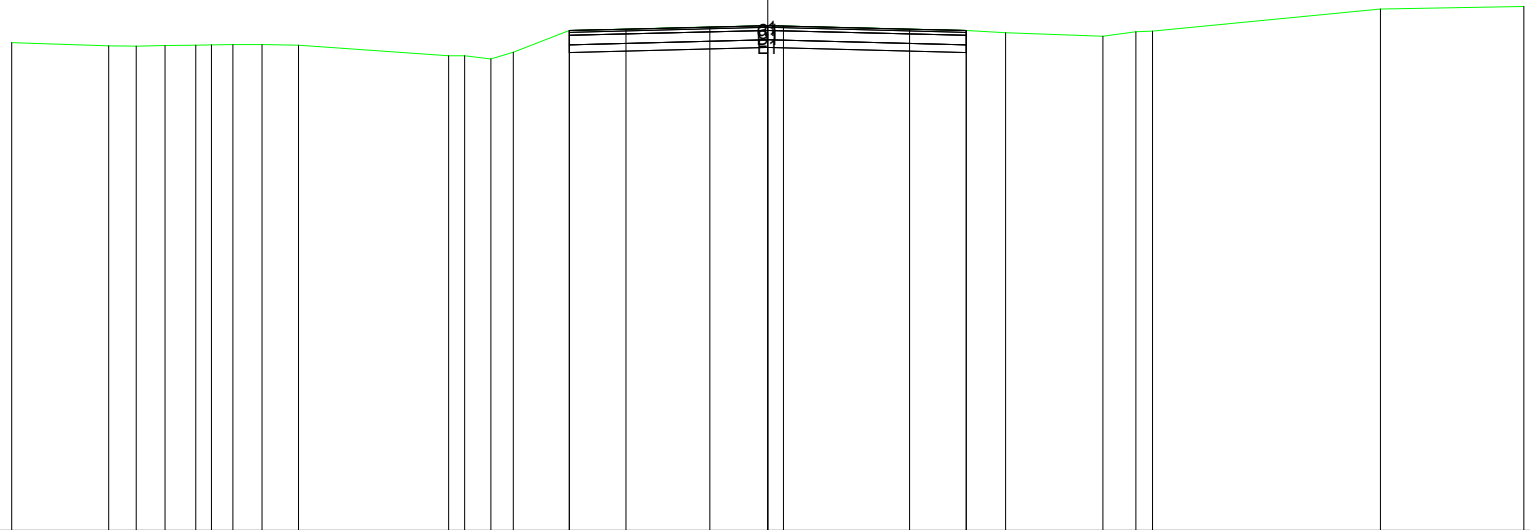

|                      |        |        |        |        |        |        |        |        |        |       |       |       |       |       |       |       |       |       |       |       |       |       |       |       |
|----------------------|--------|--------|--------|--------|--------|--------|--------|--------|--------|-------|-------|-------|-------|-------|-------|-------|-------|-------|-------|-------|-------|-------|-------|-------|
| PROGRESSIVE TERRENO  | -20.00 | -17.43 | -16.71 | -15.94 | -15.13 | -14.71 | -14.15 | -13.37 | -12.42 | -8.45 | -8.02 | -7.32 | -6.73 | -5.25 | -1.53 | 0.00  | 0.41  | 5.25  | 6.29  | 8.86  | 9.73  | 10.17 | 16.20 | 20.00 |
| PARZIALI TERRENO     | 2.57   | 0.72   | 0.77   | 0.81   | 0.42   | 0.56   | 0.78   | 0.95   | 3.97   | 0.43  | 0.70  | 0.59  | 1.48  | 3.72  | 1.53  | 0.41  | 4.84  | 1.04  | 2.57  | 0.87  | 0.44  | 6.03  | 3.80  |       |
| QUOTE TERRENO        | 15.91  | 15.82  | 15.81  | 15.82  | 15.84  | 15.85  | 15.86  | 15.85  | 15.84  | 15.55 | 15.55 | 15.47 | 15.65 | 16.22 | 16.32 | 16.36 | 16.35 | 16.22 | 16.16 | 16.07 | 16.19 | 16.20 | 16.79 | 16.86 |
| PROGRESSIVE PROGETTO |        |        |        |        |        |        |        |        |        | -5.25 | -3.75 |       |       |       |       | 0.00  |       | 3.75  | 5.25  |       |       |       |       |       |
| PARZIALI PROGETTO    |        |        |        |        |        |        |        |        |        | 1.50  | 3.75  |       |       |       |       | 3.75  |       | 1.50  |       |       |       |       |       |       |
| QUOTE PROGETTO       |        |        |        |        |        |        |        |        |        | 16.22 | 16.26 |       |       | 16.22 | 16.26 | 16.22 |       |       |       |       |       |       |       |       |

PROFILO ASSE EST-OVEST

SEZIONE 20

PROGRESSIVA 940.00

BINDER  
 C1 0.84 mq.  
 BASE  
 D1 2.62 mq.  
 FONDAZIONE  
 E1 2.10 mq.  
 USURA  
 a1 10.50 ml.

3

200  
 200

|                      |        |        |        |        |        |      |        |        |       |       |       |       |       |       |       |      |       |       |      |
|----------------------|--------|--------|--------|--------|--------|------|--------|--------|-------|-------|-------|-------|-------|-------|-------|------|-------|-------|------|
| PROGRESSIVE TERRENO  | -20.00 | -19.07 | -18.01 | -17.58 | -16.56 |      | -12.39 | -11.75 | -7.93 | -5.25 |       | 0.00  | 0.48  |       | 5.25  |      | 17.90 | 20.00 |      |
| PARZIALI TERRENO     | 0.93   | 1.06   | 0.43   | 1.02   |        | 4.17 | 0.64   |        | 3.82  |       | 2.68  |       | 5.25  | 0.48  |       | 4.77 |       | 12.65 | 2.10 |
| QUOTE TERRENO        | 15.63  | 15.63  | 15.59  | 15.57  | 15.53  |      | 15.58  | 15.56  | 15.75 | 15.76 |       | 15.89 | 15.87 |       | 15.76 |      | 15.61 | 15.60 |      |
| PROGRESSIVE PROGETTO |        |        |        |        |        |      |        |        |       | -5.25 | -3.75 | 0.00  |       | 3.75  | 5.25  |      |       |       |      |
| PARZIALI PROGETTO    |        |        |        |        |        |      |        |        |       | 1.50  | 3.75  |       | 3.75  | 1.50  |       |      |       |       |      |
| QUOTE PROGETTO       |        |        |        |        |        |      |        |        |       | 15.76 | 15.79 | 15.89 |       | 15.79 | 15.76 |      |       |       |      |

PROFILO ASSE EST-OVEST

SEZIONE 21

PROGRESSIVA 970.00

BINDER  
 C1 0.84 mq.  
 BASE  
 D1 2.62 mq.  
 FONDAZIONE  
 E1 2.10 mq.  
 USURA  
 a1 10.50 ml.

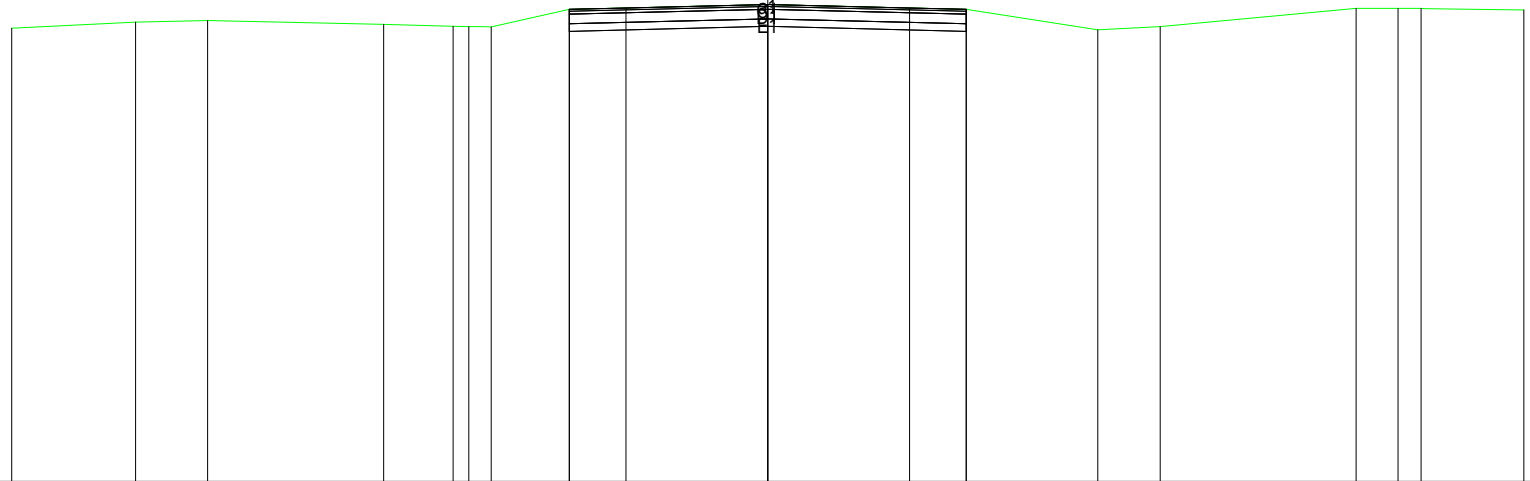

|                      |        |        |        |        |       |       |       |       |       |       |       |       |       |       |       |       |
|----------------------|--------|--------|--------|--------|-------|-------|-------|-------|-------|-------|-------|-------|-------|-------|-------|-------|
| PROGRESSIVE TERRENO  | -20.00 | -16.72 | -14.82 | -10.16 | -8.32 | -7.91 | -7.31 | -5.25 | 0.00  | 5.25  | 8.73  | 10.38 | 15.56 | 16.67 | 17.28 | 20.00 |
| PARZIALI TERRENO     | 3.28   | 1.90   | 4.66   | 1.84   | 0.41  | 0.60  | 2.06  | 5.25  | 5.25  | 3.48  | 1.65  | 5.18  | 1.11  | 0.61  | 2.72  |       |
| QUOTE TERRENO        | 14.99  | 15.15  | 15.19  | 15.09  | 15.04 | 15.03 | 15.02 | 15.49 | 15.62 | 15.49 | 14.94 | 15.03 | 15.51 | 15.52 | 15.51 | 15.47 |
| PROGRESSIVE PROGETTO |        |        |        |        |       |       |       | -5.25 | -3.75 | 0.00  | 3.75  | 5.25  |       |       |       |       |
| PARZIALI PROGETTO    |        |        |        |        |       |       |       | 1.50  | 3.75  | 3.75  | 1.50  |       |       |       |       |       |
| QUOTE PROGETTO       |        |        |        |        |       |       |       | 15.49 | 15.52 | 15.62 | 15.52 | 15.49 |       |       |       |       |

PROFILO ASSE EST-OVEST

SEZIONE 22

PROGRESSIVA 1010

BINDER  
 C1 0.84 mq.  
 BASE  
 D1 2.62 mq.  
 FONDAZIONE  
 E1 2.10 mq.  
 USURA  
 a1 10.50 ml.



200  
 200

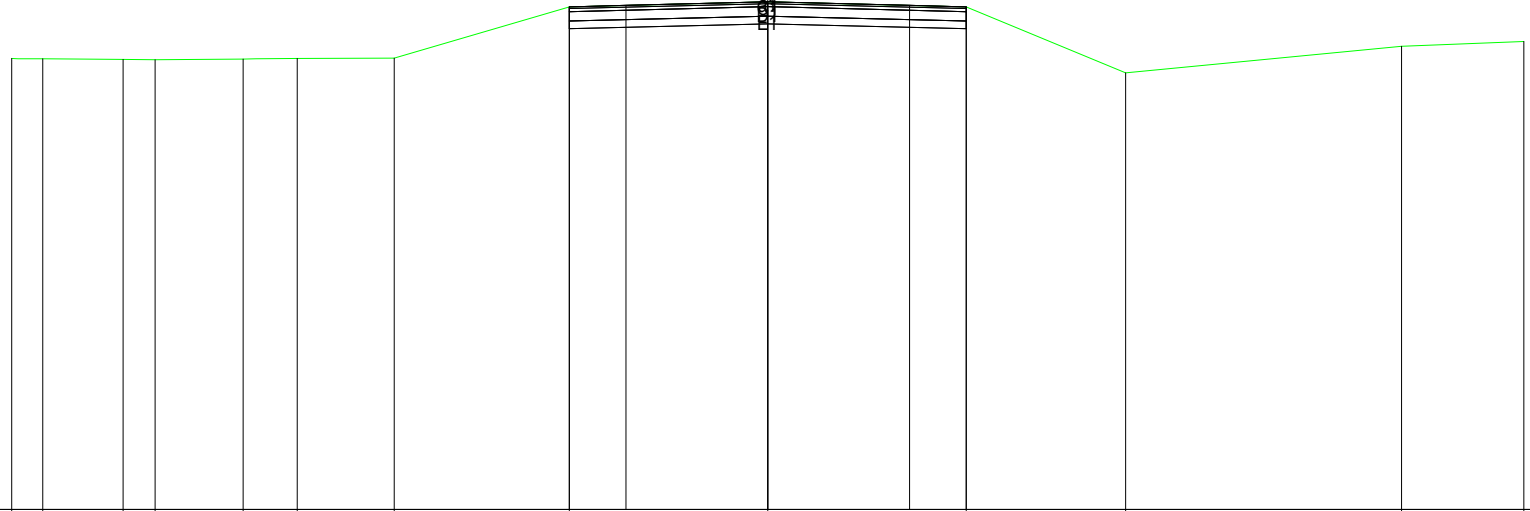

|                      |        |        |        |        |        |        |       |       |       |       |       |       |       |
|----------------------|--------|--------|--------|--------|--------|--------|-------|-------|-------|-------|-------|-------|-------|
| PROGRESSIVE TERRENO  | -20.00 | -19.18 | -17.05 | -16.20 | -13.88 | -12.44 | -9.88 | -5.25 | 0.00  | 5.25  | 9.46  | 16.76 | 20.00 |
| PARZIALI TERRENO     | 0.82   | 2.13   | 0.85   | 2.32   | 1.44   | 2.56   | 4.63  | 5.25  | 5.25  | 4.21  | 7.30  | 3.24  |       |
| QUOTE TERRENO        | 13.93  | 13.92  | 13.90  | 13.90  | 13.91  | 13.93  | 13.94 | 15.30 | 15.43 | 15.30 | 13.55 | 14.26 | 14.38 |
| PROGRESSIVE PROGETTO |        |        |        |        |        |        |       | -5.25 | -3.75 | 0.00  | 3.75  | 5.25  |       |
| PARZIALI PROGETTO    |        |        |        |        |        |        |       | 1.50  | 3.75  | 3.75  | 1.50  |       |       |
| QUOTE PROGETTO       |        |        |        |        |        |        |       | 15.30 | 15.33 | 15.43 | 15.33 | 15.30 |       |

PROFILO ASSE EST-OVEST

SEZIONE 23

PROGRESSIVA 1050

BINDER  
 C1 0.84 mq.  
 BASE  
 D1 2.64 mq.  
 FONDAZIONE  
 E1 2.10 mq.  
 USURA  
 a1 10.50 ml.

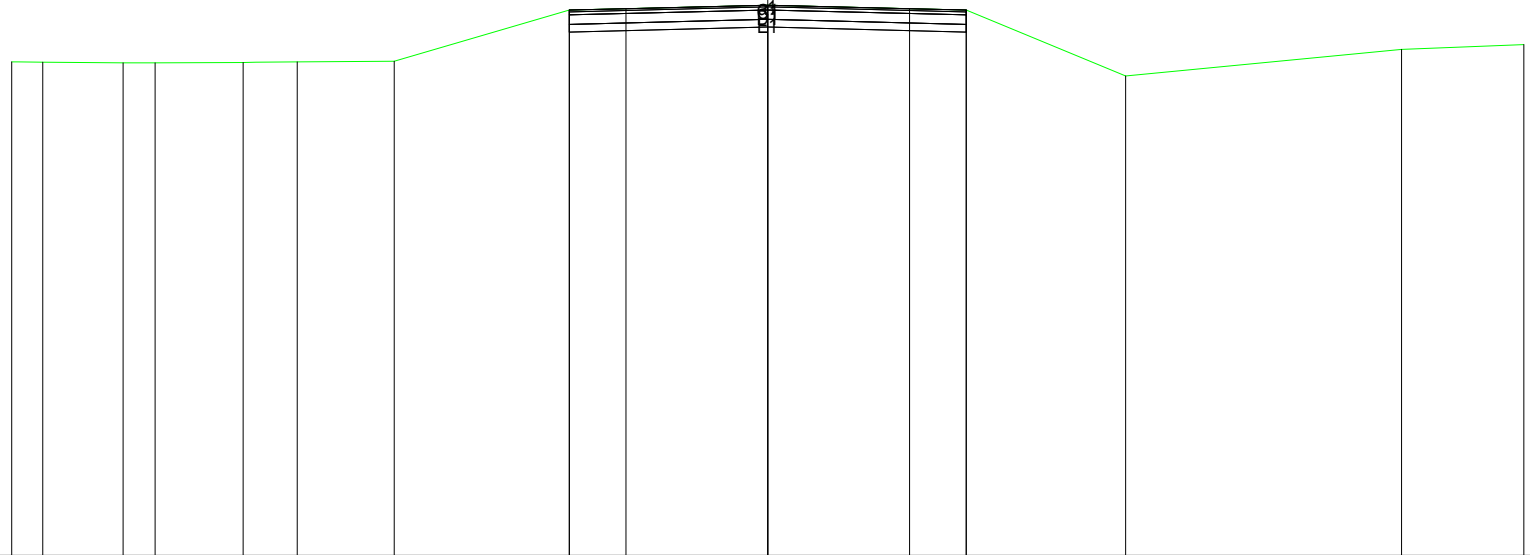

200 200

|                      |        |        |        |        |        |        |       |       |       |       |       |       |       |
|----------------------|--------|--------|--------|--------|--------|--------|-------|-------|-------|-------|-------|-------|-------|
| PROGRESSIVE TERRENO  | -20.00 | -19.18 | -17.05 | -16.20 | -13.88 | -12.44 | -9.88 | -5.25 | 0.00  | 5.25  | 9.46  | 16.76 | 20.00 |
| PARZIALI TERRENO     | 0.82   | 2.13   | 0.85   | 2.32   | 1.44   | 2.56   | 4.63  | 5.25  | 5.25  | 4.21  | 7.30  | 3.24  |       |
| QUOTE TERRENO        | 15.06  | 15.05  | 15.03  | 15.03  | 15.04  | 15.06  | 15.07 | 16.43 | 16.56 | 16.43 | 14.68 | 15.39 | 15.51 |
| PROGRESSIVE PROGETTO |        |        |        |        |        |        |       | -5.25 | -3.75 | 0.00  | 3.75  | 5.25  |       |
| PARZIALI PROGETTO    |        |        |        |        |        |        |       | 1.50  | 3.75  | 3.75  | 1.50  |       |       |
| QUOTE PROGETTO       |        |        |        |        |        |        |       | 16.43 | 16.46 | 16.56 | 16.46 | 16.43 |       |



PROFILO ASSE EST-OVEST

SEZIONE 24

PROGRESSIVA 1100.00

BINDER  
 C1 0.84 mq.  
 BASE  
 D1 2.64 mq.  
 FONDAZIONE  
 E1 2.10 mq.  
 USURA  
 a1 10.50 ml.

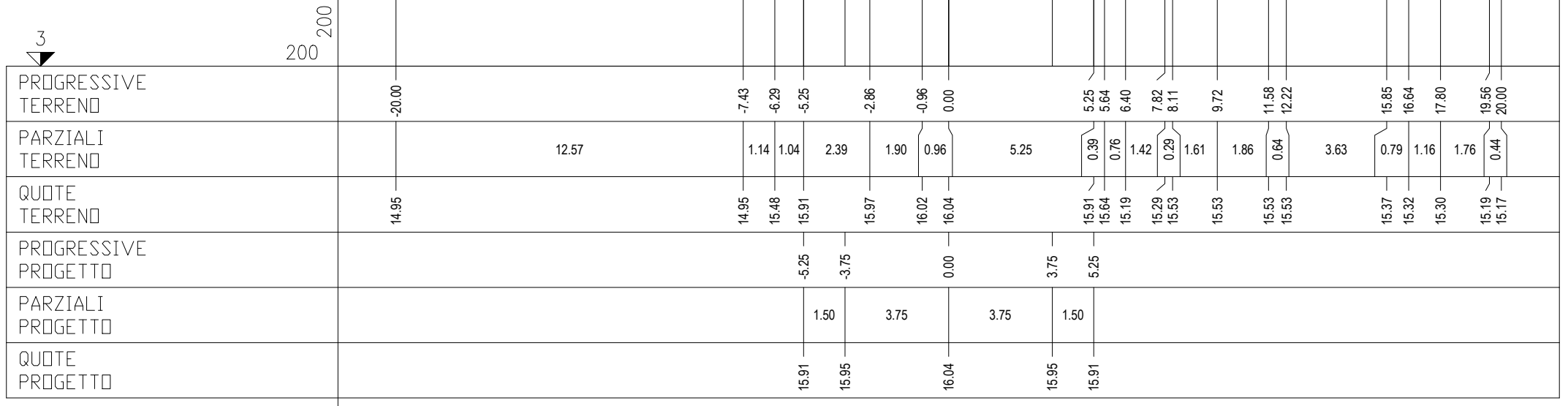





PROFILO ASSE EST-OVEST

SEZIONE 27

PROGRESSIVA 1250.00

BINDER  
 C1 0.84 mq.  
 BASE  
 D1 2.62 mq.  
 FONDAZIONE  
 E1 2.10 mq.  
 USURA  
 a1 10.50 ml.



200  
 200

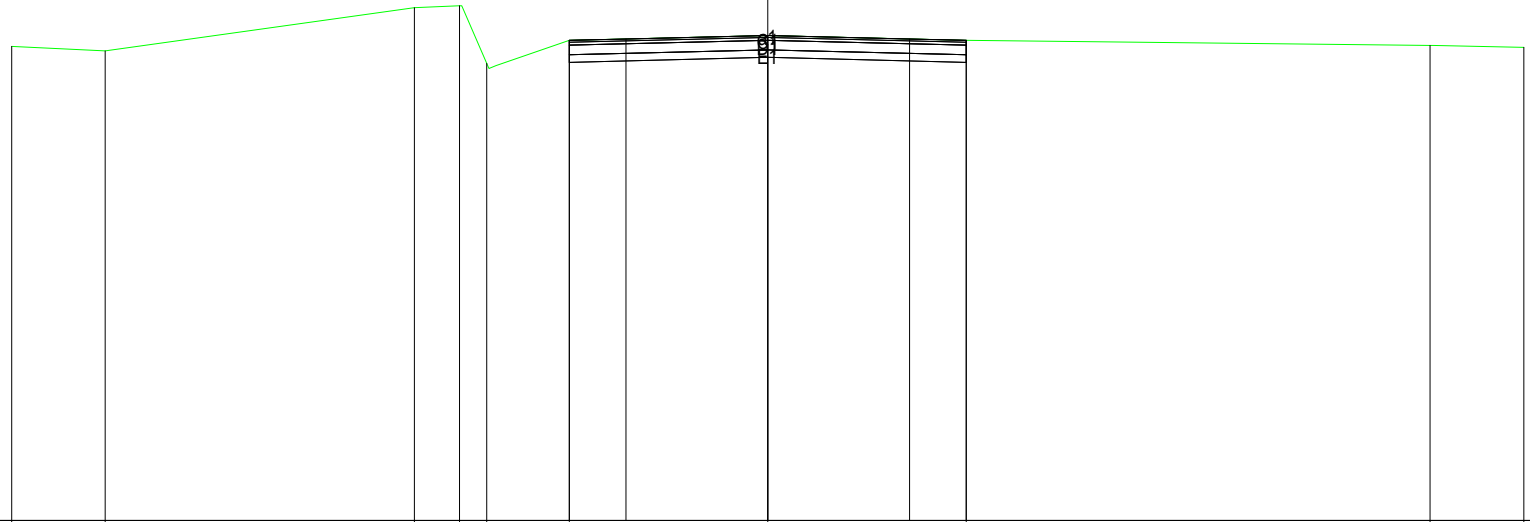

|                      |        |        |       |       |       |       |       |       |       |       |       |
|----------------------|--------|--------|-------|-------|-------|-------|-------|-------|-------|-------|-------|
| PROGRESSIVE TERRENO  | -20.00 | -17.53 |       | -9.35 | -8.16 | -7.43 | -5.25 | 0.00  | 5.25  | 17.51 | 20.00 |
| PARZIALI TERRENO     | 2.47   | 8.18   | 1.19  | 0.73  | 2.18  | 5.25  | 5.25  | 12.26 | 2.49  |       |       |
| QUOTE TERRENO        | 14.54  | 14.42  | 15.56 | 15.62 | 14.09 | 14.70 | 14.83 | 14.70 | 14.56 | 14.51 |       |
| PROGRESSIVE PROGETTO |        |        |       |       |       | -5.25 | -3.75 | 0.00  | 3.75  | 5.25  |       |
| PARZIALI PROGETTO    |        |        |       |       |       | 1.50  | 3.75  | 3.75  | 1.50  |       |       |
| QUOTE PROGETTO       |        |        |       |       |       | 14.70 | 14.74 | 14.83 | 14.74 | 14.70 |       |

PROFILO ASSE EST-OVEST

SEZIONE 28

PROGRESSIVA 1300.00

BINDER  
 C1 0.84 mq.  
 BASE  
 D1 2.62 mq.  
 FONDAZIONE  
 E1 2.10 mq.  
 USURA  
 a1 10.50 ml.



200  
 200

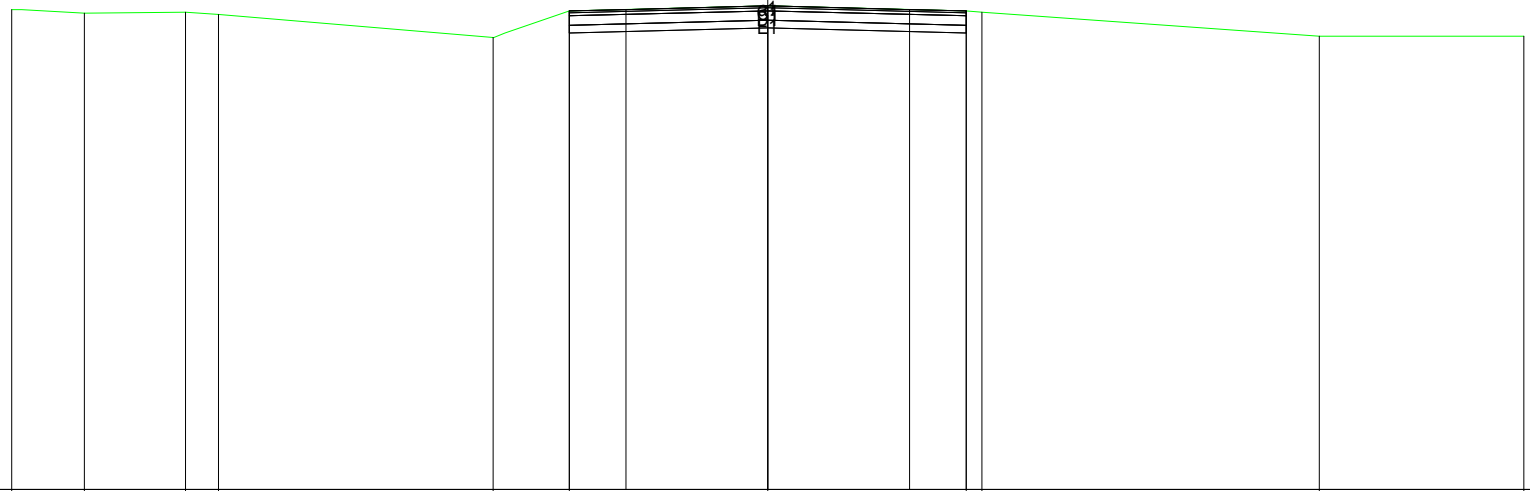

|                      |        |        |        |        |  |       |       |      |       |      |       |       |       |       |       |       |  |       |  |
|----------------------|--------|--------|--------|--------|--|-------|-------|------|-------|------|-------|-------|-------|-------|-------|-------|--|-------|--|
| PROGRESSIVE TERRENO  | -20.00 | -18.08 | -15.40 | -14.53 |  | -7.27 | -5.25 |      | 0.00  |      | 5.25  | 5.66  |       | 14.59 |       | 20.00 |  |       |  |
| PARZIALI TERRENO     |        | 1.92   | 2.68   | 0.87   |  | 7.26  |       | 2.02 |       | 5.25 |       | 5.25  |       | 0.41  |       | 8.93  |  | 5.41  |  |
| QUOTE TERRENO        | 14.69  | 14.60  | 14.62  | 14.57  |  | 13.95 | 14.66 |      | 14.79 |      | 14.66 | 14.63 |       | 13.99 |       | 13.99 |  | 13.99 |  |
| PROGRESSIVE PROGETTO |        |        |        |        |  |       | -5.25 |      | -3.75 |      | 0.00  |       | 3.75  |       | 5.25  |       |  |       |  |
| PARZIALI PROGETTO    |        |        |        |        |  |       | 1.50  |      | 3.75  |      | 3.75  |       | 1.50  |       |       |       |  |       |  |
| QUOTE PROGETTO       |        |        |        |        |  |       | 14.66 |      | 14.70 |      | 14.79 |       | 14.70 |       | 14.66 |       |  |       |  |

PROFILO ASSE EST-OVEST

SEZIONE 29

PROGRESSIVA 1350.00

BINDER  
 C1 0.84 mq.  
 BASE  
 D1 2.62 mq.  
 FONDAZIONE  
 E1 2.10 mq.  
 USURA  
 a1 10.50 ml.

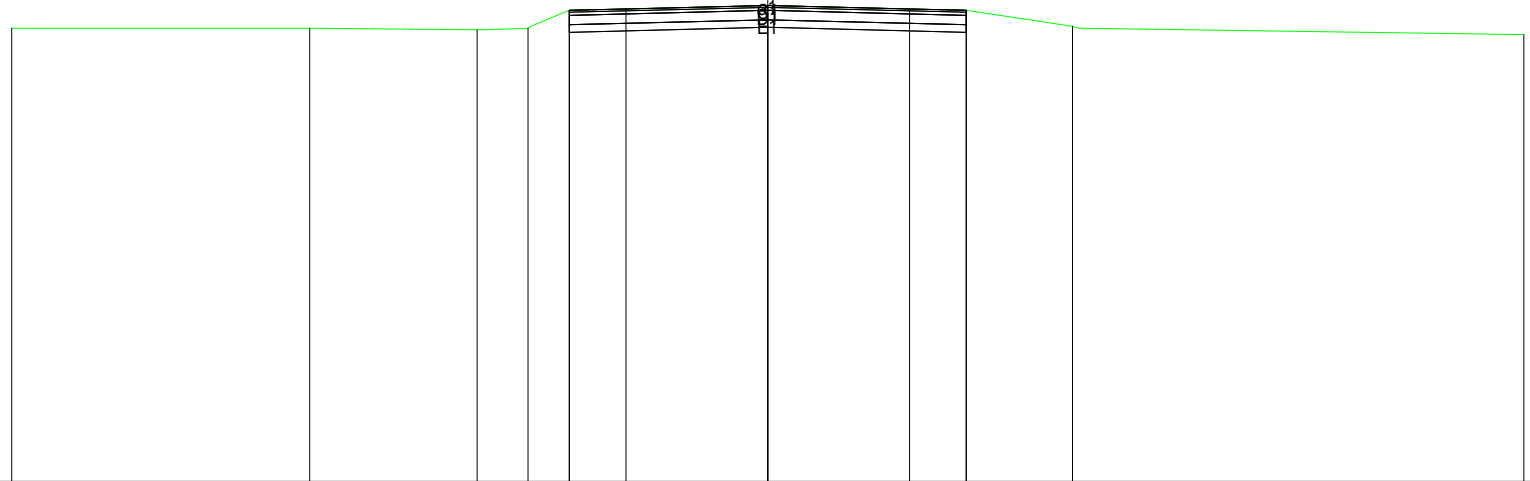

|                      |        |        |       |       |       |       |       |       |       |
|----------------------|--------|--------|-------|-------|-------|-------|-------|-------|-------|
| PROGRESSIVE TERRENO  | -20.00 | -12.12 | -7.69 | -6.34 | -5.25 | 0.00  | 5.25  | 8.06  | 20.00 |
| PARZIALI TERRENO     | 7.88   | 4.43   | 1.35  | 1.09  | 5.25  | 5.25  | 2.81  | 11.94 |       |
| QUOTE TERRENO        | 13.99  | 13.99  | 13.95 | 13.99 | 14.46 | 14.59 | 14.46 | 14.04 | 13.82 |
| PROGRESSIVE PROGETTO |        |        |       |       | -5.25 | -3.75 | 0.00  | 3.75  | 5.25  |
| PARZIALI PROGETTO    |        |        |       |       | 1.50  | 3.75  | 3.75  | 1.50  |       |
| QUOTE PROGETTO       |        |        |       |       | 14.46 | 14.50 | 14.59 | 14.50 | 14.46 |

PROFILO ASSE EST-OVEST

SEZIONE 30

PROGRESSIVA 1400.00

BINDER  
 C1 0.84 mq.  
 BASE  
 D1 2.62 mq.  
 FONDAZIONE  
 E1 2.10 mq.  
 USURA  
 a1 10.50 ml.



200  
 200

|                      |        |        |      |        |        |        |        |        |       |       |       |       |       |       |       |       |       |       |       |      |       |       |
|----------------------|--------|--------|------|--------|--------|--------|--------|--------|-------|-------|-------|-------|-------|-------|-------|-------|-------|-------|-------|------|-------|-------|
| PROGRESSIVE TERRENO  | -20.00 | -18.28 |      | -14.34 | -13.25 | -12.44 | -11.07 | -10.54 |       | -8.41 | -7.57 | -6.72 | -6.27 | -5.25 |       | 0.00  |       | 5.25  | 6.89  | 7.62 |       | 20.00 |
| PARZIALI TERRENO     |        | 1.72   | 3.94 | 1.09   | 0.81   | 1.37   | 0.53   | 2.13   | 0.84  | 0.85  | 0.45  | 1.02  |       | 5.25  |       | 5.25  |       | 1.64  | 0.73  |      | 12.38 |       |
| QUOTE TERRENO        | 14.71  | 14.80  |      | 15.17  | 15.16  | 15.16  | 15.16  | 15.16  | 14.22 | 13.84 | 13.99 | 14.00 | 13.96 |       | 14.10 |       | 13.96 | 14.04 | 13.99 |      |       | 13.90 |
| PROGRESSIVE PROGETTO |        |        |      |        |        |        |        |        |       |       |       |       | -5.25 | -3.75 | 0.00  | 3.75  | 5.25  |       |       |      |       |       |
| PARZIALI PROGETTO    |        |        |      |        |        |        |        |        |       |       |       |       | 1.50  | 3.75  |       | 3.75  | 1.50  |       |       |      |       |       |
| QUOTE PROGETTO       |        |        |      |        |        |        |        |        |       |       |       |       | 13.96 | 13.99 | 14.09 | 13.99 | 13.96 |       |       |      |       |       |

PROFILO ASSE EST-OVEST

SEZIONE 33

PROGRESSIVA 1550.00

BINDER  
 C1 0.84 mq.  
 BASE  
 D1 2.62 mq.  
 FONDAZIONE  
 E1 2.11 mq.  
 USURA  
 a1 10.50 ml.

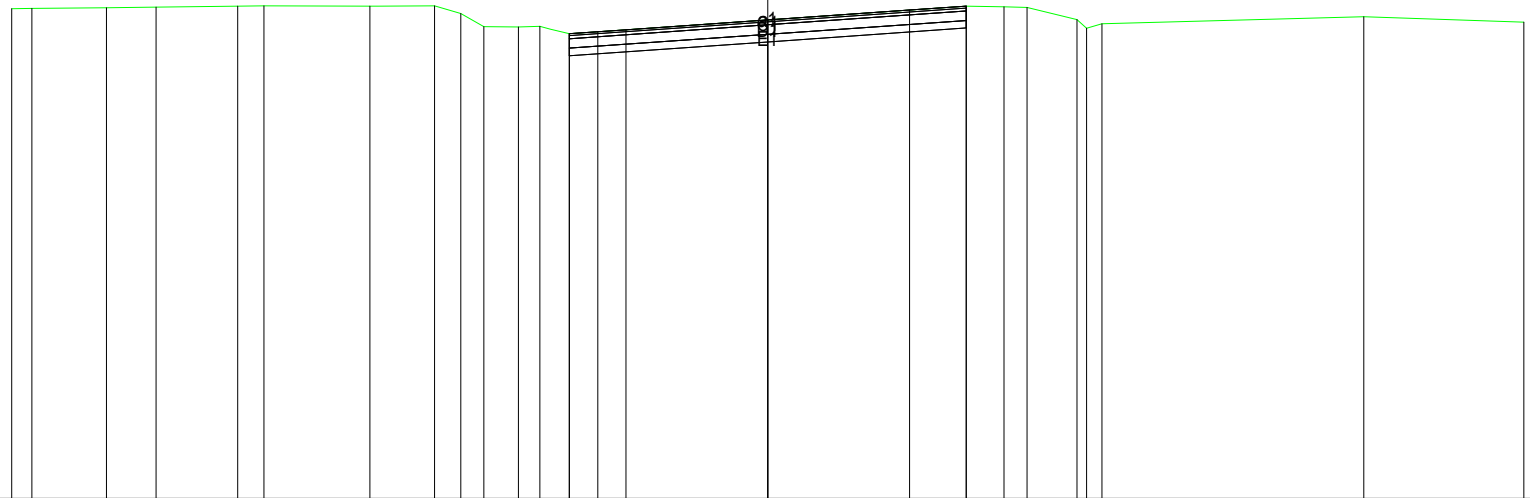

200  
200

|                      |        |        |        |        |        |        |        |       |       |       |       |       |       |       |       |       |       |       |       |       |       |       |       |
|----------------------|--------|--------|--------|--------|--------|--------|--------|-------|-------|-------|-------|-------|-------|-------|-------|-------|-------|-------|-------|-------|-------|-------|-------|
| PROGRESSIVE TERRENO  | -20.00 | -19.46 | -17.49 | -16.18 | -14.03 | -13.33 | -10.52 | -8.82 | -8.12 | -7.51 | -6.60 | -6.03 | -5.25 | -4.50 | 0.00  | 5.25  | 6.25  | 6.86  | 8.18  | 8.43  | 8.84  | 15.76 | 20.00 |
| PARZIALI TERRENO     | 0.54   | 1.97   | 1.31   | 2.15   | 0.70   | 2.81   | 1.70   | 0.70  | 0.61  | 0.91  | 0.57  | 0.78  | 0.75  | 4.50  | 5.25  | 1.00  | 0.61  | 1.32  | 0.25  | 0.41  | 6.92  | 4.24  |       |
| QUOTE TERRENO        | 13.95  | 13.96  | 13.98  | 14.00  | 14.02  | 14.03  | 14.02  | 14.03 | 13.83 | 13.48 | 13.47 | 13.48 | 13.29 | 13.34 | 13.66 | 14.02 | 14.00 | 13.99 | 13.67 | 13.43 | 13.56 | 13.75 | 13.60 |
| PROGRESSIVE PROGETTO |        |        |        |        |        |        |        |       |       |       |       | -5.25 | -3.75 | 0.00  | 3.75  | 5.25  |       |       |       |       |       |       |       |
| PARZIALI PROGETTO    |        |        |        |        |        |        |        |       |       |       |       | 1.50  | 3.75  | 3.75  | 1.50  |       |       |       |       |       |       |       |       |
| QUOTE PROGETTO       |        |        |        |        |        |        |        |       |       |       |       | 13.29 | 13.39 | 13.66 | 13.92 | 14.02 |       |       |       |       |       |       |       |



PROFILO ASSE EST-OVEST

SEZIONE 31

PROGRESSIVA 1450.00

BINDER  
 C1 0.84 mq.  
 BASE  
 D1 2.62 mq.  
 FONDAZIONE  
 E1 2.10 mq.  
 USURA  
 a1 10.50 ml.



200  
 200

|                      |        |      |        |        |        |      |       |       |       |       |       |       |       |       |       |       |       |      |       |      |       |
|----------------------|--------|------|--------|--------|--------|------|-------|-------|-------|-------|-------|-------|-------|-------|-------|-------|-------|------|-------|------|-------|
| PROGRESSIVE TERRENO  | -20.00 |      | -11.62 | -11.14 | -10.63 |      | -7.93 | -7.55 | -6.68 | -6.00 | -5.25 |       | 0.00  |       | 5.25  | 5.93  | 7.30  |      | 13.46 |      | 20.00 |
| PARZIALI TERRENO     |        | 8.38 | 0.48   | 0.51   | 2.70   | 0.38 | 0.87  | 0.68  | 0.75  |       | 5.25  |       | 5.25  |       | 0.68  | 1.37  |       | 6.16 |       | 6.54 |       |
| QUOTE TERRENO        | 14.77  |      | 15.14  | 15.14  | 15.14  |      | 13.74 | 13.54 | 13.66 | 13.68 | 13.77 |       | 13.90 |       | 13.86 | 13.88 | 13.99 |      | 13.73 |      | 13.53 |
| PROGRESSIVE PROGETTO |        |      |        |        |        |      |       |       |       |       | -5.25 |       | -3.75 |       | 0.00  | 3.75  | 5.25  |      |       |      |       |
| PARZIALI PROGETTO    |        |      |        |        |        |      |       |       |       |       | 1.50  |       | 3.75  |       | 3.75  |       | 1.50  |      |       |      |       |
| QUOTE PROGETTO       |        |      |        |        |        |      |       |       |       | 13.77 |       | 13.81 |       | 13.90 |       | 13.87 | 13.86 |      |       |      |       |

PROFILO ASSE EST-OVEST

SEZIONE 32

PROGRESSIVA 1500.00

BINDER  
 C1 0.84 mq.  
 BASE  
 D1 2.63 mq.  
 FONDAZIONE  
 E1 2.10 mq.  
 USURA  
 a1 10.50 ml.

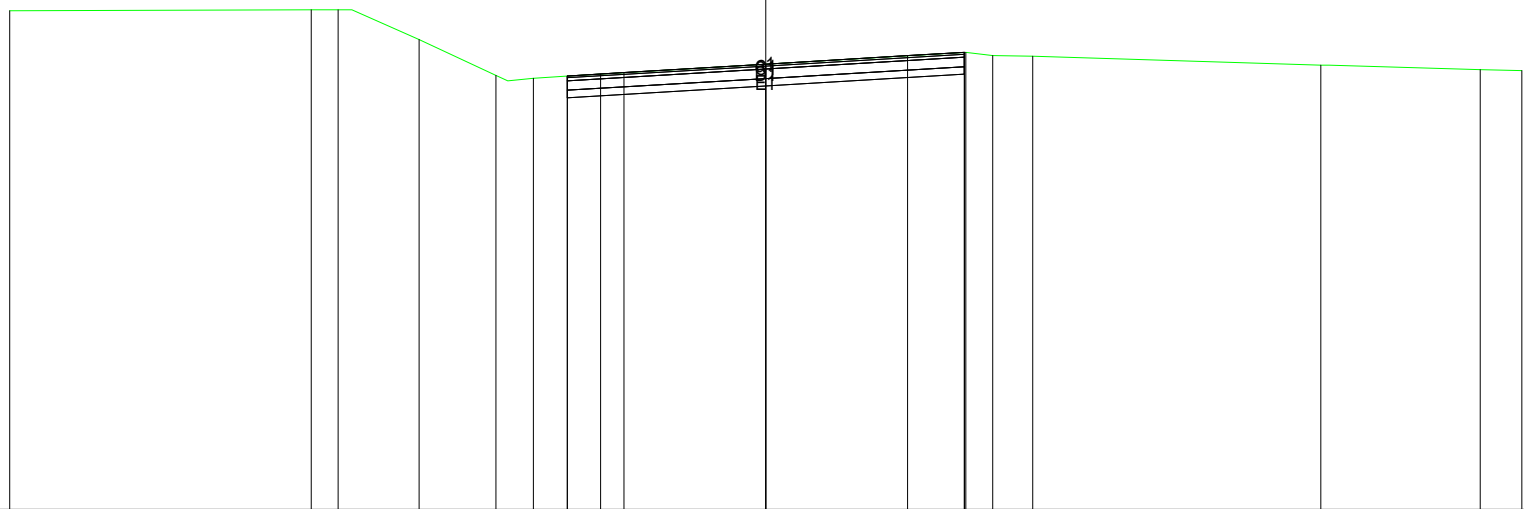

200 200

|                      |        |        |        |       |       |       |       |       |       |       |       |       |       |       |       |
|----------------------|--------|--------|--------|-------|-------|-------|-------|-------|-------|-------|-------|-------|-------|-------|-------|
| PROGRESSIVE TERRENO  | -20.00 | -12.03 | -11.31 | -9.17 | -7.14 | -6.15 | -5.25 | -4.37 | 0.00  | 5.29  | 6.00  | 7.06  | 14.68 | 18.90 | 20.00 |
| PARZIALI TERRENO     | 7.97   | 0.72   | 2.14   | 2.03  | 0.99  | 0.90  | 0.88  | 4.37  | 5.29  | 0.71  | 1.06  | 7.62  | 4.22  | 1.10  |       |
| QUOTE TERRENO        | 15.19  | 15.22  | 15.21  | 14.43 | 13.48 | 13.40 | 13.47 | 13.51 | 13.78 | 14.09 | 14.00 | 13.99 | 13.75 | 13.63 | 13.61 |
| PROGRESSIVE PROGETTO |        |        |        |       |       |       | -5.25 | -3.75 | 0.00  | 3.75  | 5.25  | 5.25  |       |       |       |
| PARZIALI PROGETTO    |        |        |        |       |       |       | 1.50  | 3.75  | 3.75  | 1.50  |       |       |       |       |       |
| QUOTE PROGETTO       |        |        |        |       |       |       | 13.47 | 13.56 | 13.78 | 14.00 | 14.09 | 14.09 |       |       |       |

PROFILO ASSE EST-OVEST

SEZIONE 34

PROGRESSIVA 1600.00

BINDER  
 C1 0.84 mq.  
 BASE  
 D1 2.63 mq.  
 FONDAZIONE  
 E1 2.10 mq.  
 USURA  
 a1 10.50 ml.

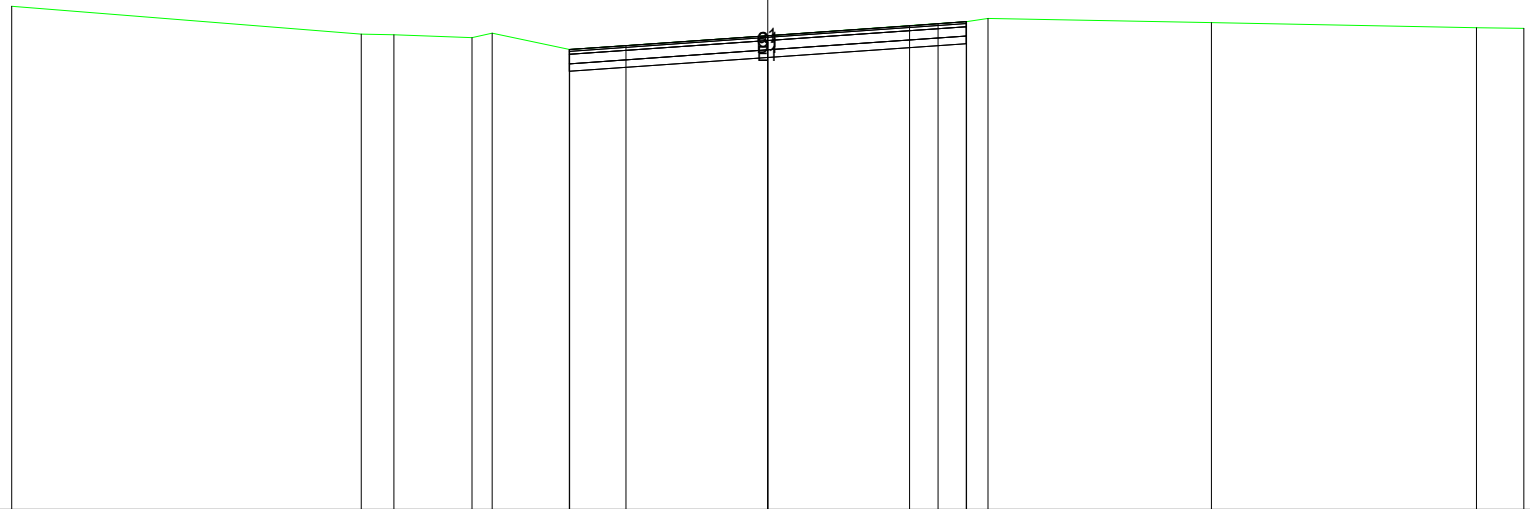

|                      |        |        |       |       |       |       |       |       |       |       |       |       |       |
|----------------------|--------|--------|-------|-------|-------|-------|-------|-------|-------|-------|-------|-------|-------|
| PROGRESSIVE TERRENO  | -20.00 | -10.76 | -9.89 | -7.82 | -7.29 | -5.24 | 0.00  | 4.50  | 5.26  | 5.83  | 11.73 | 18.74 | 20.00 |
| PARZIALI TERRENO     | 9.24   | 0.87   | 2.07  | 0.53  | 2.05  | 5.24  | 4.50  | 0.76  | 0.57  | 5.90  | 7.01  | 1.26  |       |
| QUOTE TERRENO        | 14.31  | 13.57  | 13.56 | 13.48 | 13.60 | 13.17 | 13.53 | 13.85 | 13.90 | 13.99 | 13.87 | 13.74 | 13.73 |
| PROGRESSIVE PROGETTO |        |        |       |       |       | -5.25 | -3.75 | 0.00  | 3.75  | 5.25  |       |       |       |
| PARZIALI PROGETTO    |        |        |       |       |       | 1.50  | 3.75  | 3.75  | 1.50  |       |       |       |       |
| QUOTE PROGETTO       |        |        |       |       |       | 13.17 | 13.27 | 13.53 | 13.80 | 13.90 |       |       |       |

PROFILO ASSE EST-OVEST

SEZIONE 35

PROGRESSIVA 1650.00

BINDER  
 C1 0.84 mq.  
 BASE  
 D1 2.63 mq.  
 FONDAZIONE  
 E1 2.10 mq.  
 USURA  
 a1 10.50 ml.



200  
 200

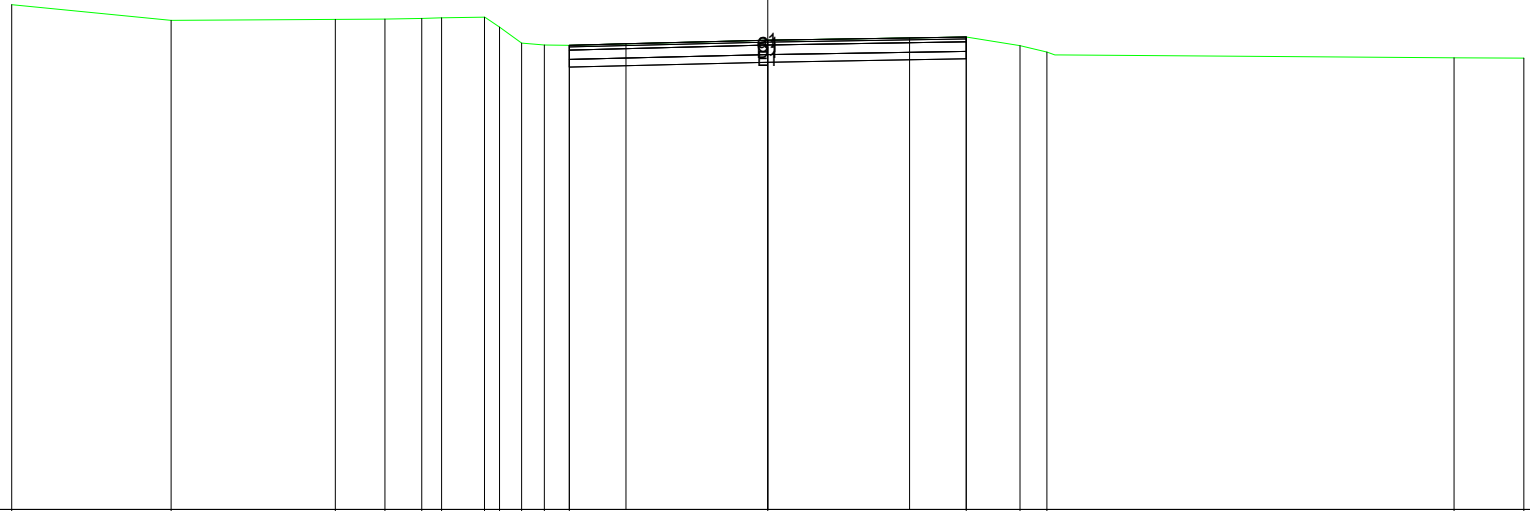

|                      |        |        |        |        |       |       |       |       |       |       |       |       |       |       |       |       |       |
|----------------------|--------|--------|--------|--------|-------|-------|-------|-------|-------|-------|-------|-------|-------|-------|-------|-------|-------|
| PROGRESSIVE TERRENO  | -20.00 | -15.78 | -11.44 | -10.12 | -9.15 | -8.63 | -7.49 | -7.10 | -6.51 | -5.91 | -5.25 | 0.00  | 5.25  | 6.67  | 7.39  | 18.15 | 20.00 |
| PARZIALI TERRENO     |        | 4.22   | 4.34   | 1.32   | 0.97  | 0.52  | 1.14  | 0.39  | 0.59  | 0.60  | 0.66  | 5.25  | 5.25  | 1.42  | 0.72  | 10.76 | 1.85  |
| QUOTE TERRENO        | 14.36  | 13.94  | 13.96  | 13.97  | 13.99 | 14.00 | 14.02 | 13.76 | 13.34 | 13.28 | 13.28 | 13.41 | 13.50 | 13.27 | 13.10 | 12.94 | 12.94 |
| PROGRESSIVE PROGETTO |        |        |        |        |       |       |       |       |       | -5.25 | -3.75 | 0.00  | 3.75  | 5.25  |       |       |       |
| PARZIALI PROGETTO    |        |        |        |        |       |       |       |       |       | 1.50  | 3.75  | 3.75  | 1.50  |       |       |       |       |
| QUOTE PROGETTO       |        |        |        |        |       |       |       |       |       | 13.28 | 13.32 | 13.41 | 13.47 | 13.50 |       |       |       |

PROFILO ASSE EST-OVEST

SEZIONE 36

PROGRESSIVA 1700.00

BINDER  
 C1 0.84 mq.  
 BASE  
 D1 2.62 mq.  
 FONDAZIONE  
 E1 2.10 mq.  
 USURA  
 a1 10.50 ml.



200  
 200

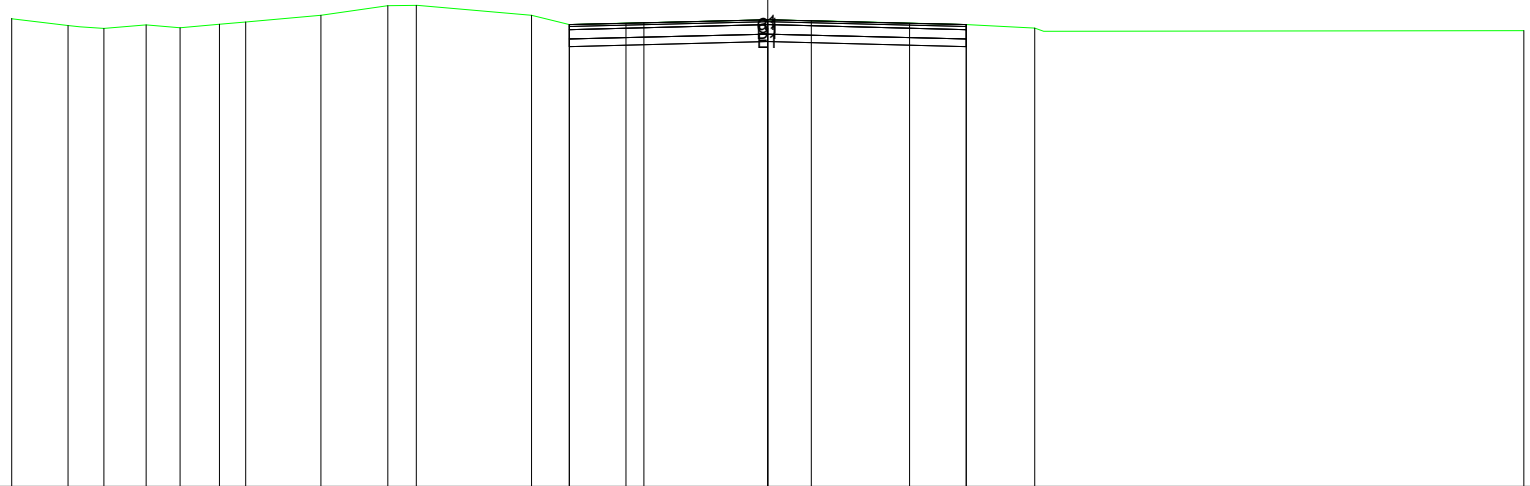

|                      |        |        |        |        |        |        |        |        |        |       |       |       |       |       |       |       |       |       |
|----------------------|--------|--------|--------|--------|--------|--------|--------|--------|--------|-------|-------|-------|-------|-------|-------|-------|-------|-------|
| PROGRESSIVE TERRENO  | -20.00 | -18.51 | -17.56 | -16.45 | -15.55 | -14.51 | -13.81 | -11.82 | -10.05 | -9.30 | -6.25 | -5.25 | -3.28 | 0.00  | 1.15  | 5.25  | 7.06  | 20.00 |
| PARZIALI TERRENO     | 1.49   | 0.95   | 1.11   | 0.90   | 1.04   | 0.70   | 1.99   | 1.77   | 0.75   | 3.05  | 1.00  | 1.97  | 3.28  | 1.15  | 4.10  | 1.81  | 12.94 |       |
| QUOTE TERRENO        | 13.38  | 13.19  | 13.12  | 13.21  | 13.13  | 13.22  | 13.29  | 13.47  | 13.72  | 13.73 | 13.47 | 13.22 | 13.27 | 13.35 | 13.32 | 13.22 | 13.12 | 13.06 |
| PROGRESSIVE PROGETTO |        |        |        |        |        |        |        |        |        |       | -5.25 | -3.75 |       | 0.00  | 3.75  | 5.25  |       |       |
| PARZIALI PROGETTO    |        |        |        |        |        |        |        |        |        |       | 1.50  | 3.75  |       | 3.75  | 1.50  |       |       |       |
| QUOTE PROGETTO       |        |        |        |        |        |        |        |        |        |       | 13.22 | 13.25 |       | 13.35 | 13.25 | 13.22 |       |       |

PROFILO ASSE EST-OVEST

SEZIONE 37

PROGRESSIVA 1716.35

BINDER  
 C1 0.84 mq.  
 BASE  
 D1 2.62 mq.  
 FONDAZIONE  
 E1 2.10 mq.  
 USURA  
 a1 10.50 ml.



200  
 200

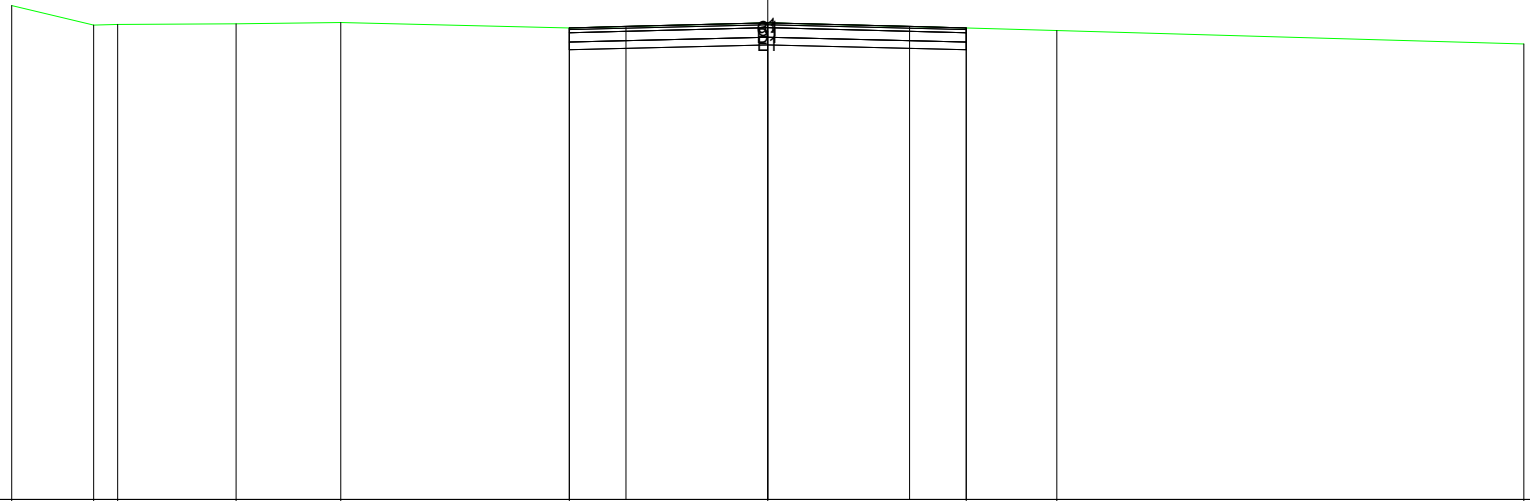

|                      |        |        |        |        |        |       |       |       |       |       |
|----------------------|--------|--------|--------|--------|--------|-------|-------|-------|-------|-------|
| PROGRESSIVE TERRENO  | -20.00 | -17.84 | -17.20 | -14.07 | -11.30 | -5.25 | 0.00  | 5.25  | 7.65  | 20.00 |
| PARZIALI TERRENO     | 2.16   | 0.64   | 3.13   | 2.77   | 6.05   | 5.25  | 5.25  | 2.40  | 12.35 |       |
| QUOTE TERRENO        | 14.06  | 13.55  | 13.56  | 13.58  | 13.62  | 13.48 | 13.61 | 13.48 | 13.40 | 13.05 |
| PROGRESSIVE PROGETTO |        |        |        |        |        | -5.25 | -3.75 | 0.00  | 3.75  | 5.25  |
| PARZIALI PROGETTO    |        |        |        |        |        | 1.50  | 3.75  | 3.75  | 1.50  |       |
| QUOTE PROGETTO       |        |        |        |        |        | 13.48 | 13.51 | 13.61 | 13.51 | 13.48 |

PROFILO ASSE EST-OVEST

SEZIONE 39

PROGRESSIVA 1800.00

BINDER  
 C1 0.84 mq.  
 BASE  
 D1 2.64 mq.  
 FONDAZIONE  
 E1 2.08 mq.  
 USURA  
 a1 10.50 ml.

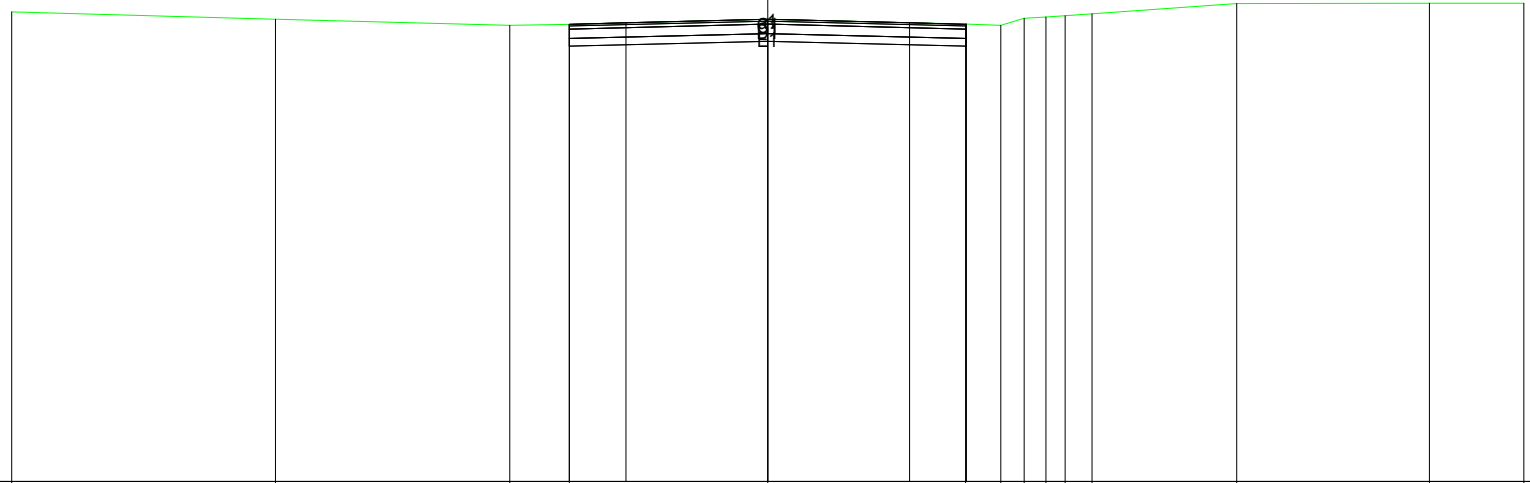

200  
 200

|                      |        |        |       |       |       |       |       |       |       |       |       |       |       |       |
|----------------------|--------|--------|-------|-------|-------|-------|-------|-------|-------|-------|-------|-------|-------|-------|
| PROGRESSIVE TERRENO  | -20.00 | -13.03 | -6.82 | -5.25 | 0.00  | 5.23  | 6.17  | 6.78  | 7.36  | 7.86  | 8.57  | 12.41 | 17.50 | 20.00 |
| PARZIALI TERRENO     | 6.97   | 6.21   | 1.57  | 5.25  | 5.23  | 0.94  | 0.61  | 0.58  | 0.50  | 0.71  | 3.84  | 5.09  | 2.50  |       |
| QUOTE TERRENO        | 13.42  | 13.23  | 13.07 | 13.09 | 13.23 | 13.10 | 13.07 | 13.25 | 13.28 | 13.32 | 13.37 | 13.64 | 13.65 | 13.65 |
| PROGRESSIVE PROGETTO |        |        |       | -5.25 | -3.75 | 0.00  | 3.75  | 5.25  | 5.25  |       |       |       |       |       |
| PARZIALI PROGETTO    |        |        |       | 1.50  | 3.75  | 3.75  | 1.50  |       |       |       |       |       |       |       |
| QUOTE PROGETTO       |        |        | 13.09 | 13.13 | 13.23 | 13.13 | 13.09 | 13.10 |       |       |       |       |       |       |

PROFILO ASSE EST-OVEST

SEZIONE 40

PROGRESSIVA 1850.00

BINDER  
 C1 0.84 mq.  
 BASE  
 D1 2.64 mq.  
 FONDAZIONE  
 E1 2.10 mq.  
 USURA  
 a1 10.50 ml.

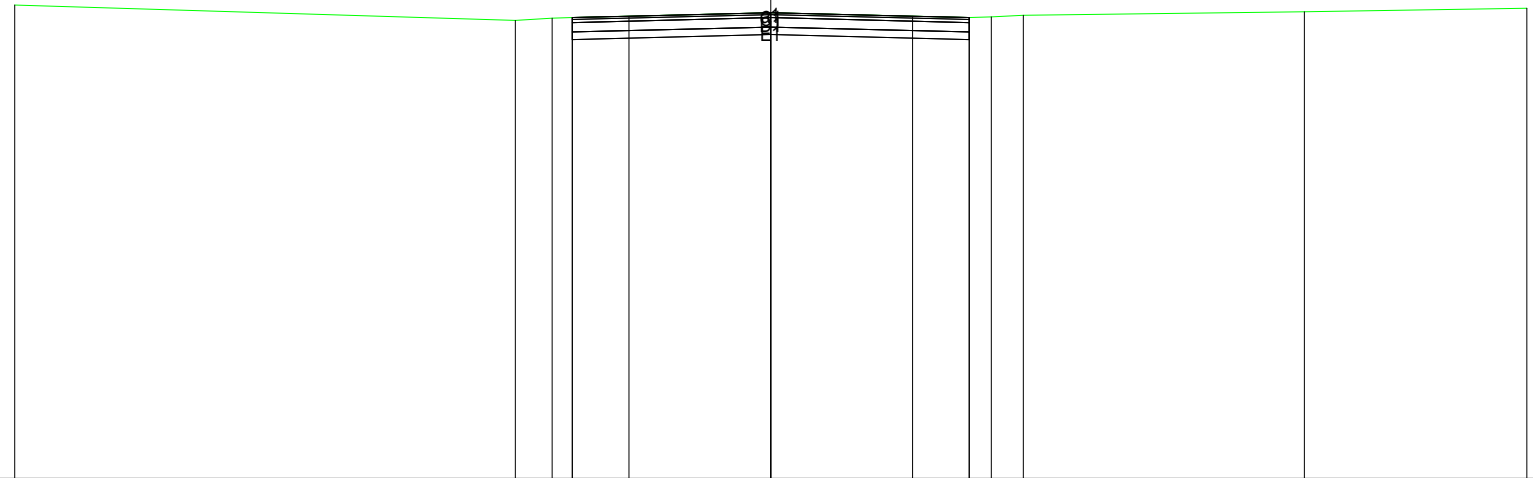

200  
200

|                      |        |       |       |       |       |       |       |       |       |       |
|----------------------|--------|-------|-------|-------|-------|-------|-------|-------|-------|-------|
| PROGRESSIVE TERRENO  | -20.00 | -6.76 | -5.79 | -5.25 | 0.00  | 5.25  | 5.83  | 6.68  | 14.11 | 20.00 |
| PARZIALI TERRENO     | 13.24  | 0.97  | 0.54  | 5.25  | 5.25  | 0.56  | 0.85  | 7.43  | 5.89  |       |
| QUOTE TERRENO        | 13.53  | 13.12 | 13.17 | 13.19 | 13.32 | 13.19 | 13.21 | 13.25 | 13.34 | 13.44 |
| PROGRESSIVE PROGETTO |        |       | -5.25 | -3.75 | 0.00  | 3.75  | 5.25  |       |       |       |
| PARZIALI PROGETTO    |        |       | 1.50  | 3.75  | 3.75  | 1.50  |       |       |       |       |
| QUOTE PROGETTO       |        | 13.19 | 13.23 | 13.32 | 13.23 | 13.19 |       |       |       |       |



PROFILO ASSE EST-OVEST

SEZIONE 41

PROGRESSIVA 1900.00

BINDER  
 C1 0.84 mq.  
 BASE  
 D1 2.62 mq.  
 FONDAZIONE  
 E1 2.10 mq.  
 USURA  
 a1 10.50 ml.

2  
 200 200

|                      |        |        |       |       |       |       |       |       |       |       |       |       |       |       |
|----------------------|--------|--------|-------|-------|-------|-------|-------|-------|-------|-------|-------|-------|-------|-------|
| PROGRESSIVE TERRENO  | -20.00 | -14.19 | -6.81 | -5.77 | -5.25 | 0.00  | 5.25  | 6.48  | 6.65  | 7.63  | 7.72  | 8.63  | 17.77 | 20.00 |
| PARZIALI TERRENO     | 5.81   | 7.38   | 1.04  | 0.52  | 5.25  | 5.25  | 1.23  | 0.17  | 0.98  | 0.09  | 0.91  | 9.14  | 2.23  |       |
| QUOTE TERRENO        | 13.41  | 13.28  | 13.11 | 13.00 | 12.94 | 13.07 | 12.94 | 12.84 | 13.16 | 15.03 | 15.24 | 15.24 | 14.66 | 14.29 |
| PROGRESSIVE PROGETTO |        |        |       | -5.25 | -3.75 | 0.00  | 3.75  | 5.25  |       |       |       |       |       |       |
| PARZIALI PROGETTO    |        |        |       | 1.50  | 3.75  | 3.75  | 1.50  |       |       |       |       |       |       |       |
| QUOTE PROGETTO       |        |        | 12.94 | 12.98 | 13.07 | 12.98 | 12.94 |       |       |       |       |       |       |       |

PROFILO ASSE EST-OVEST

SEZIONE 42

PROGRESSIVA 1950.00

BINDER  
 C1 0.84 mq.  
 BASE  
 D1 2.64 mq.  
 FONDAZIONE  
 E1 2.10 mq.  
 USURA  
 a1 10.50 ml.



200  
 200

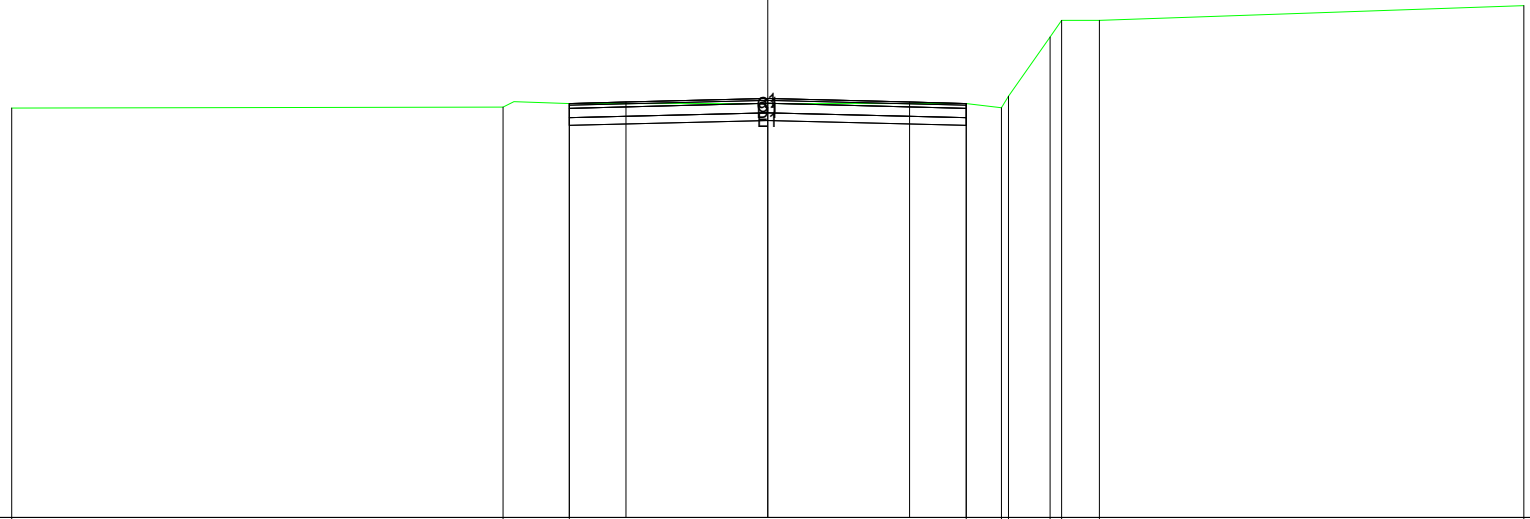

|                      |        |       |       |       |       |       |       |       |       |       |       |       |
|----------------------|--------|-------|-------|-------|-------|-------|-------|-------|-------|-------|-------|-------|
| PROGRESSIVE TERRENO  | -20.00 | -7.00 | -5.25 |       |       | 5.25  | 6.18  | 6.37  | 7.46  | 7.77  | 8.77  | 20.00 |
| PARZIALI TERRENO     |        | 13.00 | 1.75  |       | 10.50 | 0.93  | 0.19  | 1.09  | 0.31  | 1.00  |       | 11.23 |
| QUOTE TERRENO        | 12.83  |       | 12.86 | 12.95 |       | 12.95 | 12.84 | 13.14 | 14.71 | 15.15 | 15.15 | 15.54 |
| PROGRESSIVE PROGETTO |        |       | -5.25 | -3.75 | 0.00  | 3.75  | 5.25  |       |       |       |       |       |
| PARZIALI PROGETTO    |        |       | 1.50  | 3.75  | 3.75  | 1.50  |       |       |       |       |       |       |
| QUOTE PROGETTO       |        |       | 12.95 | 12.99 | 13.08 | 12.99 | 12.95 |       |       |       |       |       |

PROFILO ASSE EST-OVEST

SEZIONE 43

PROGRESSIVA 2000.00

BINDER  
 C1 0.84 mq.  
 BASE  
 D1 2.62 mq.  
 FONDAZIONE  
 E1 2.10 mq.  
 USURA  
 a1 10.50 ml.



200  
 200

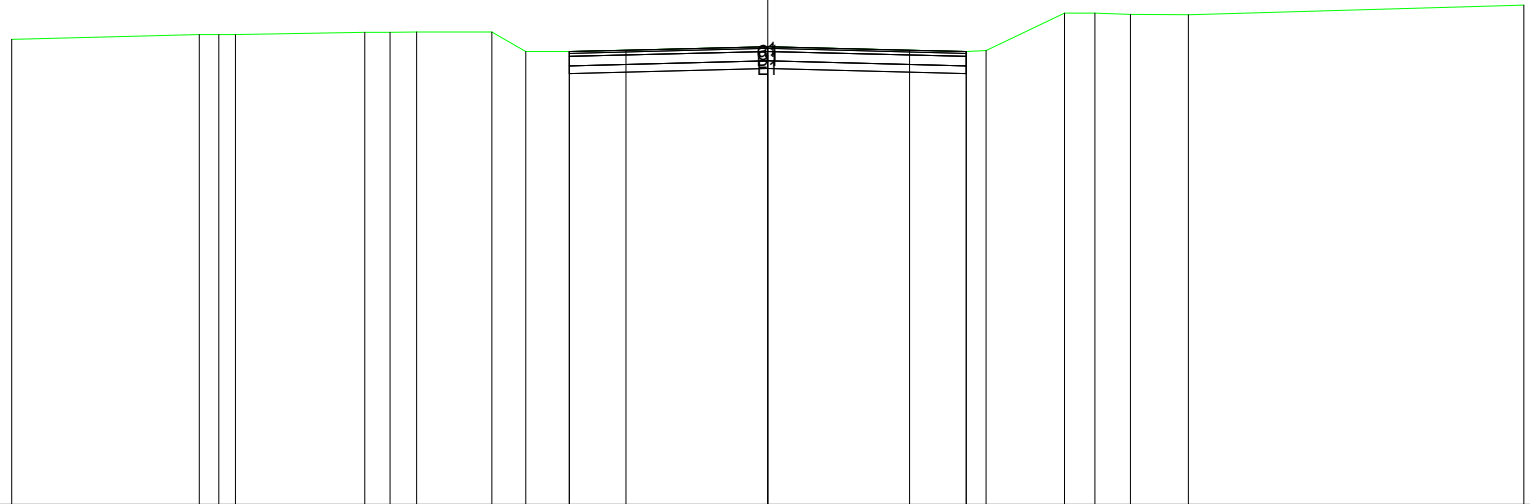

|                      |        |        |        |        |        |       |       |       |       |       |       |       |       |       |       |       |       |       |
|----------------------|--------|--------|--------|--------|--------|-------|-------|-------|-------|-------|-------|-------|-------|-------|-------|-------|-------|-------|
| PROGRESSIVE TERRENO  | -20.00 | -15.04 | -14.52 | -14.09 | -10.66 | -9.99 | -9.29 | -7.30 | -6.40 | -5.25 | 0.00  | 5.25  | 5.77  | 7.85  | 8.65  | 9.59  | 11.13 | 20.00 |
| PARZIALI TERRENO     | 4.96   | 0.52   | 0.43   | 3.43   | 0.67   | 0.70  | 1.99  | 0.90  | 1.15  | 5.25  | 5.25  | 0.52  | 2.08  | 0.80  | 0.94  | 1.54  | 8.87  |       |
| QUOTE TERRENO        | 13.30  | 13.43  | 13.43  | 13.43  | 13.49  | 13.49 | 13.49 | 13.50 | 12.98 | 12.98 | 13.11 | 12.98 | 13.00 | 13.99 | 13.99 | 13.97 | 13.95 | 14.21 |
| PROGRESSIVE PROGETTO |        |        |        |        |        |       |       | -5.25 | -3.75 | 0.00  | 3.75  | 5.25  |       |       |       |       |       |       |
| PARZIALI PROGETTO    |        |        |        |        |        |       |       | 1.50  | 3.75  | 3.75  | 1.50  |       |       |       |       |       |       |       |
| QUOTE PROGETTO       |        |        |        |        |        |       |       | 12.98 | 13.02 | 13.11 | 13.02 | 12.98 |       |       |       |       |       |       |

PROFILO ASSE EST-OVEST

SEZIONE 44

PROGRESSIVA 2050.00

BINDER  
 C1 0.84 mq.  
 BASE  
 D1 2.62 mq.  
 FONDAZIONE  
 E1 2.10 mq.  
 USURA  
 a1 10.50 ml.

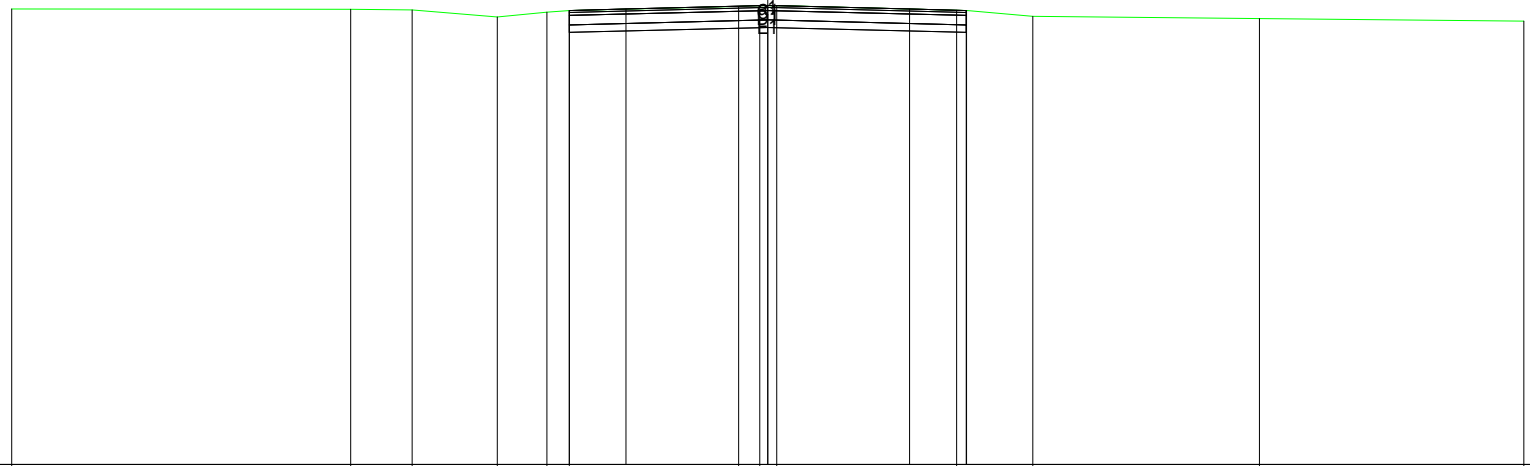

200  
 200

|                      |        |        |       |       |       |       |       |       |       |       |       |       |       |
|----------------------|--------|--------|-------|-------|-------|-------|-------|-------|-------|-------|-------|-------|-------|
| PROGRESSIVE TERRENO  | -20.00 | -11.03 | -9.40 | -7.16 | -5.84 | -5.25 | -0.77 | -0.22 | 0.23  | 5.00  | 7.01  | 13.00 | 20.00 |
| PARZIALI TERRENO     | 8.97   | 1.63   | 2.24  | 1.32  | 0.59  | 4.48  | 0.55  | 0.45  | 4.77  | 2.01  | 5.99  | 7.00  |       |
| QUOTE TERRENO        | 13.04  | 13.04  | 13.02 | 12.84 | 12.96 | 13.01 | 13.12 | 13.13 | 13.13 | 13.01 | 12.85 | 12.79 | 12.73 |
| PROGRESSIVE PROGETTO |        |        |       |       | -5.25 | -3.75 | 0.00  | 3.75  | 5.25  | 5.25  |       |       |       |
| PARZIALI PROGETTO    |        |        |       |       | 1.50  | 3.75  | 3.75  | 1.50  |       |       |       |       |       |
| QUOTE PROGETTO       |        |        |       |       | 13.01 | 13.04 | 13.14 | 13.04 | 13.01 | 13.00 |       |       |       |

PROFILO ASSE EST-OVEST

SEZIONE 45

PROGRESSIVA 2100.00

BINDER  
C1 0.84 mq.  
BASE  
D1 2.62 mq.  
FONDAZIONE  
E1 2.10 mq.  
USURA  
a1 10.50 ml.

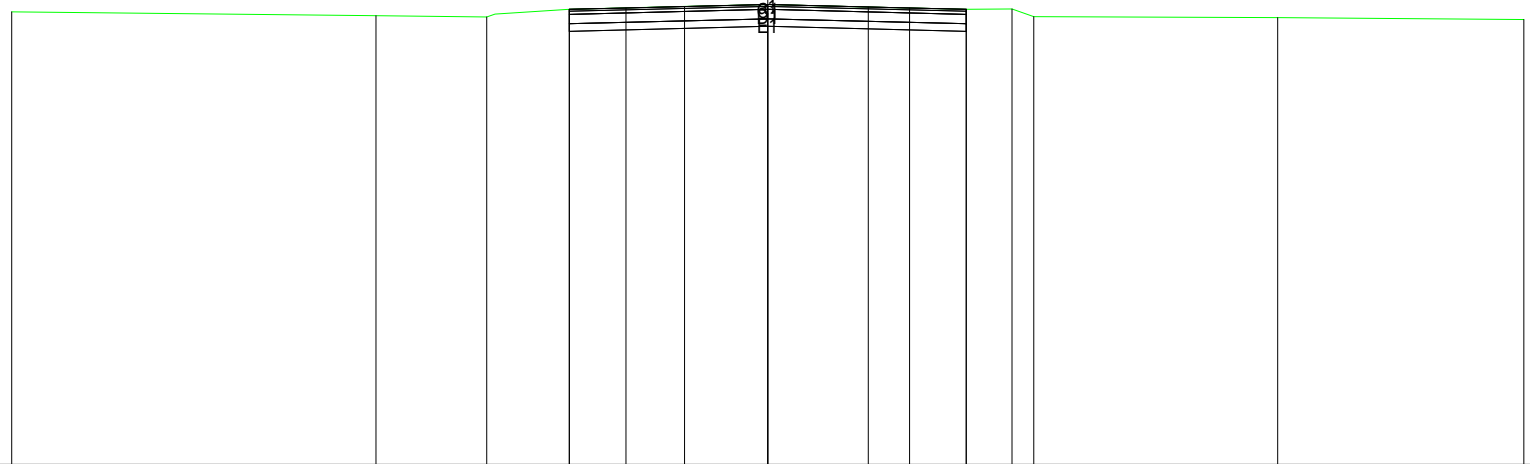

|                      |        |        |       |       |       |       |       |       |       |       |       |       |
|----------------------|--------|--------|-------|-------|-------|-------|-------|-------|-------|-------|-------|-------|
| PROGRESSIVE TERRENO  | -20.00 | -10.36 | -7.44 | -5.25 | -2.20 | 0.00  | 2.65  | 5.25  | 6.46  | 7.03  | 13.48 | 20.00 |
| PARZIALI TERRENO     | 9.64   | 2.92   | 2.19  | 3.05  | 2.20  | 2.65  | 2.60  | 1.21  | 0.57  | 6.45  | 6.52  |       |
| QUOTE TERRENO        | 12.97  | 12.87  | 12.84 | 13.04 | 13.11 | 13.17 | 13.10 | 13.04 | 13.05 | 12.85 | 12.82 | 12.77 |
| PROGRESSIVE PROGETTO |        |        |       | -5.25 | -3.75 | 0.00  | 3.75  | 5.25  |       |       |       |       |
| PARZIALI PROGETTO    |        |        |       | 1.50  | 3.75  |       | 3.75  | 1.50  |       |       |       |       |
| QUOTE PROGETTO       |        |        |       | 13.04 | 13.07 | 13.17 | 13.07 | 13.04 |       |       |       |       |

PROFILO ASSE EST-OVEST

SEZIONE 46

PROGRESSIVA 2150.00

BINDER  
 C1 0.84 mq.  
 BASE  
 D1 2.62 mq.  
 FONDAZIONE  
 E1 2.10 mq.  
 USURA  
 a1 10.50 ml.



200  
 200

|                      |        |       |       |       |       |       |       |       |       |       |       |       |       |       |  |       |       |
|----------------------|--------|-------|-------|-------|-------|-------|-------|-------|-------|-------|-------|-------|-------|-------|--|-------|-------|
| PROGRESSIVE TERRENO  | -20.00 |       | -9.44 | -8.99 | -6.29 | -5.25 | -3.52 | -3.09 | -1.87 | 0.00  | 1.26  |       | 5.05  | 7.03  |  | 17.34 | 20.00 |
| PARZIALI TERRENO     |        | 10.56 | 0.45  | 2.70  | 1.04  | 1.73  | 0.43  | 1.22  | 1.87  | 1.26  | 3.79  | 1.98  |       | 10.31 |  | 2.66  |       |
| QUOTE TERRENO        | 13.43  |       | 13.72 | 13.71 | 13.70 | 13.06 | 13.11 | 13.12 | 13.15 | 13.19 | 13.16 |       | 13.07 | 12.85 |  | 12.89 | 12.93 |
| PROGRESSIVE PROGETTO |        |       |       |       | -5.25 | -3.75 |       |       |       | 0.00  |       | 3.75  | 5.25  |       |  |       |       |
| PARZIALI PROGETTO    |        |       |       |       |       | 1.50  |       | 3.75  |       |       | 3.75  |       | 1.50  |       |  |       |       |
| QUOTE PROGETTO       |        |       |       |       | 13.06 | 13.10 |       |       |       | 13.19 |       | 13.10 | 13.06 |       |  |       |       |

PROFILO ASSE EST-OVEST

SEZIONE 47

PROGRESSIVA 2200.00

BINDER  
 C1 0.84 mq.  
 BASE  
 D1 2.62 mq.  
 FONDAZIONE  
 E1 2.10 mq.  
 USURA  
 a1 10.50 ml.

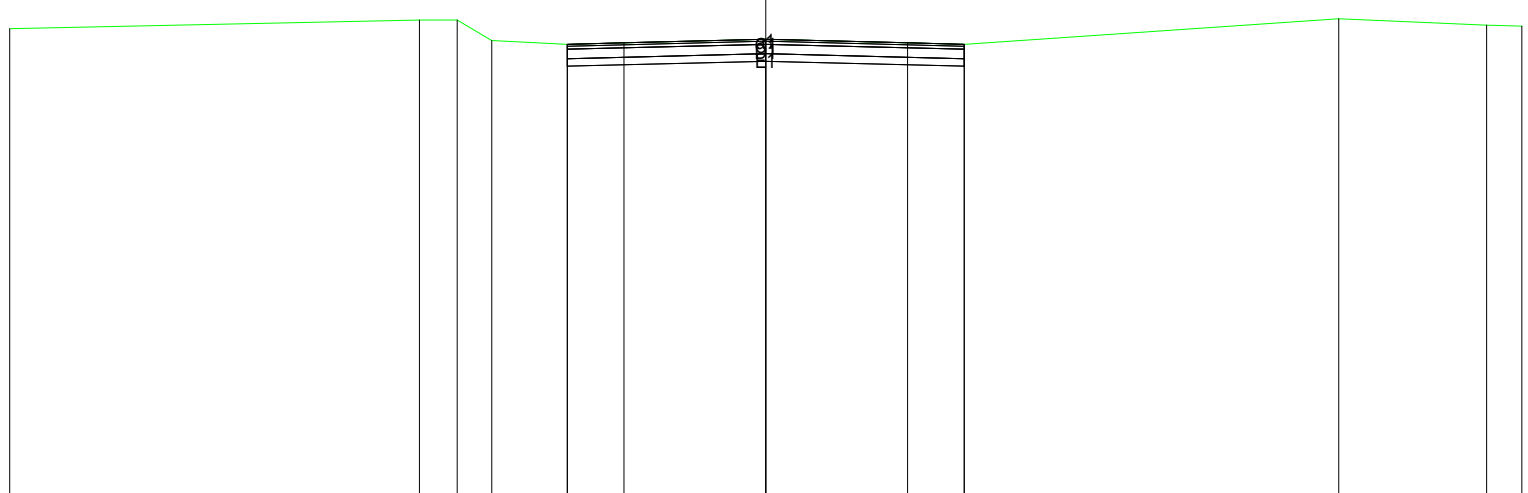

200  
 200

|                      |        |       |  |       |       |       |  |       |  |       |  |       |  |       |       |       |
|----------------------|--------|-------|--|-------|-------|-------|--|-------|--|-------|--|-------|--|-------|-------|-------|
| PROGRESSIVE TERRENO  | -20.00 |       |  | -9.16 | -8.16 | -7.25 |  | -5.25 |  | 0.00  |  | 5.25  |  | 15.16 | 19.07 | 20.00 |
| PARZIALI TERRENO     |        | 10.84 |  | 1.00  | 0.91  | 2.00  |  | 5.25  |  | 5.25  |  | 9.91  |  | 3.91  | 0.93  |       |
| QUOTE TERRENO        | 13.50  |       |  | 13.73 | 13.73 | 13.19 |  | 13.09 |  | 13.22 |  | 13.09 |  | 13.77 | 13.59 | 13.58 |
| PROGRESSIVE PROGETTO |        |       |  |       |       |       |  | -5.25 |  | -3.75 |  | 0.00  |  | 3.75  | 5.25  |       |
| PARZIALI PROGETTO    |        |       |  |       |       |       |  | 1.50  |  | 3.75  |  | 3.75  |  | 1.50  |       |       |
| QUOTE PROGETTO       |        |       |  |       |       |       |  | 13.09 |  | 13.13 |  | 13.22 |  | 13.13 | 13.09 |       |





PROFILO ASSE EST-OVEST

SEZIONE 49

PROGRESSIVA 2300.00

BINDER  
 C1 0.84 mq.  
 BASE  
 D1 2.64 mq.  
 FONDAZIONE  
 E1 2.10 mq.  
 USURA  
 a1 10.50 ml.

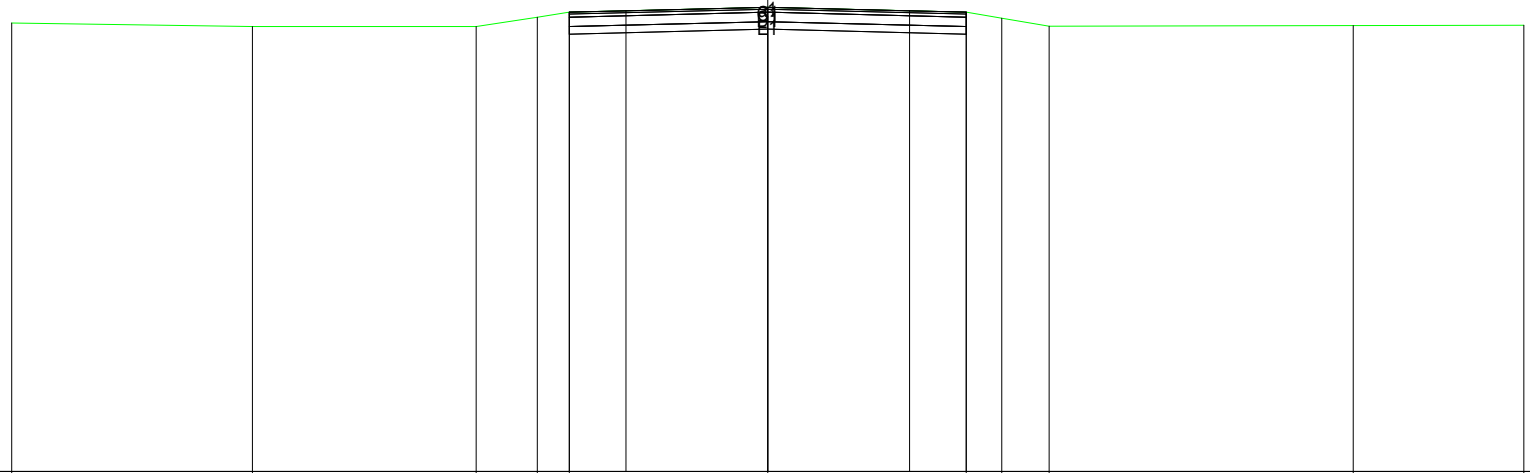

|                      |        |        |       |       |       |       |       |       |       |       |       |
|----------------------|--------|--------|-------|-------|-------|-------|-------|-------|-------|-------|-------|
| PROGRESSIVE TERRENO  | -20.00 | -13.63 | -7.72 | -6.09 | -5.25 | 0.00  | 5.25  | 6.19  | 7.44  | 15.49 | 20.00 |
| PARZIALI TERRENO     | 6.37   | 5.91   | 1.63  | 0.84  | 5.25  | 5.25  | 0.94  | 1.25  | 8.05  | 4.51  |       |
| QUOTE TERRENO        | 12.86  | 12.77  | 12.77 | 13.02 | 13.15 | 13.28 | 13.15 | 12.99 | 12.78 | 12.79 | 12.80 |
| PROGRESSIVE PROGETTO |        |        |       | -5.25 | -3.75 | 0.00  | 3.75  | 5.25  |       |       |       |
| PARZIALI PROGETTO    |        |        |       | 1.50  | 3.75  | 3.75  | 1.50  |       |       |       |       |
| QUOTE PROGETTO       |        |        |       | 13.15 | 13.19 | 13.28 | 13.19 | 13.15 |       |       |       |

PROFILO ASSE EST-OVEST

SEZIONE 50

PROGRESSIVA 2350.00

BINDER  
 C1 0.84 mq.  
 BASE  
 D1 2.62 mq.  
 FONDAZIONE  
 E1 2.10 mq.  
 USURA  
 a1 10.50 ml.

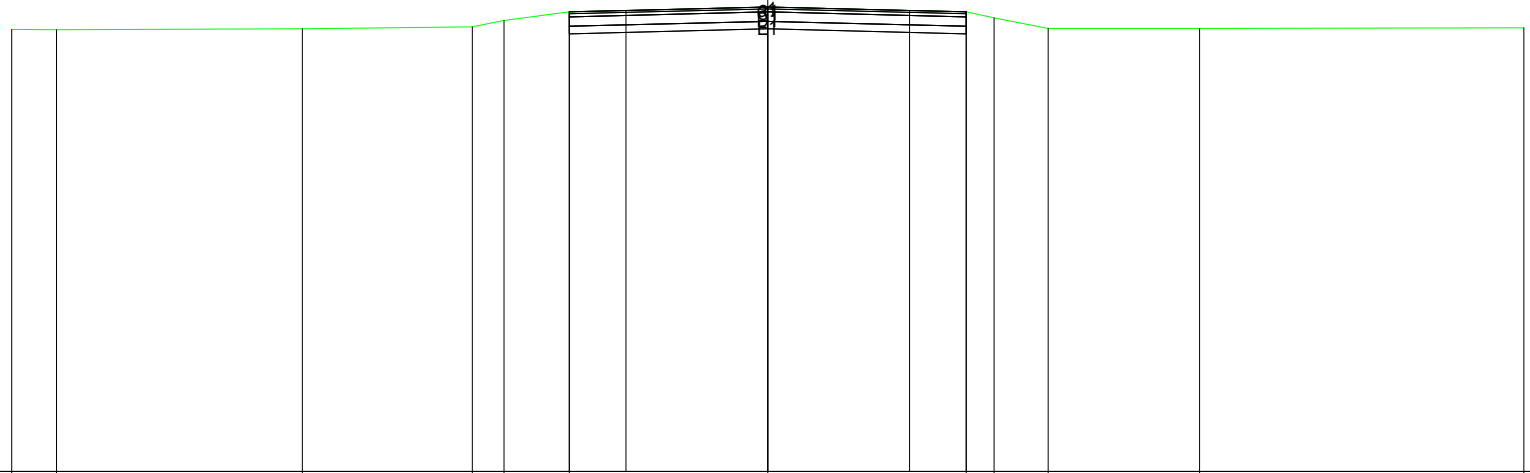

200  
200

|                      |        |        |        |       |       |       |       |       |       |       |       |       |
|----------------------|--------|--------|--------|-------|-------|-------|-------|-------|-------|-------|-------|-------|
| PROGRESSIVE TERRENO  | -20.00 | -18.82 | -12.31 | -7.82 | -6.98 | -5.25 | 0.00  | 5.25  | 5.98  | 7.42  | 11.42 | 20.00 |
| PARZIALI TERRENO     | 1.18   | 6.51   | 4.49   | 0.84  | 1.73  | 5.25  | 5.25  | 0.73  | 1.44  | 4.00  | 8.58  |       |
| QUOTE TERRENO        | 12.69  | 12.69  | 12.71  | 12.76 | 12.93 | 13.16 | 13.29 | 13.16 | 13.00 | 12.72 | 12.72 | 12.73 |
| PROGRESSIVE PROGETTO |        |        |        |       |       | -5.25 | -3.75 | 0.00  | 3.75  | 5.25  |       |       |
| PARZIALI PROGETTO    |        |        |        |       |       | 1.50  | 3.75  | 3.75  | 1.50  |       |       |       |
| QUOTE PROGETTO       |        |        |        |       |       | 13.16 | 13.19 | 13.29 | 13.19 | 13.16 |       |       |

PROFILO ASSE EST-OVEST

SEZIONE 51

PROGRESSIVA 2400.00

BINDER  
 C1 0.84 mq.  
 BASE  
 D1 2.62 mq.  
 FONDAZIONE  
 E1 2.10 mq.  
 USURA  
 a1 10.50 ml.

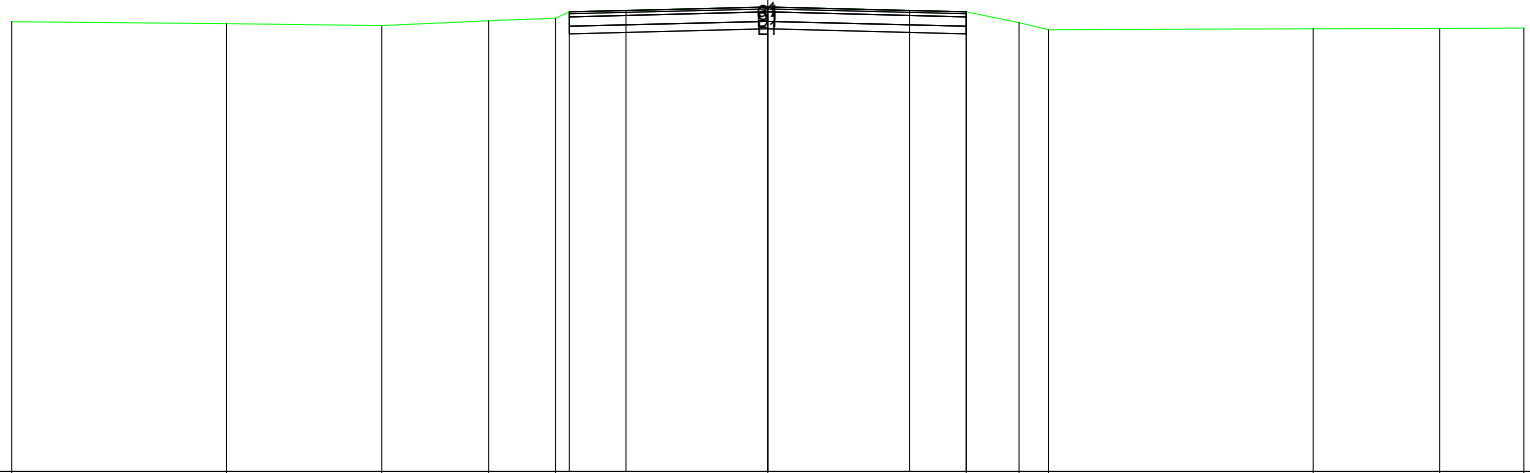

200  
 200

|                      |        |        |        |       |       |       |       |       |       |       |       |       |
|----------------------|--------|--------|--------|-------|-------|-------|-------|-------|-------|-------|-------|-------|
| PROGRESSIVE TERRENO  | -20.00 | -14.32 | -10.22 | -7.38 | -5.62 | 0.00  | 5.25  | 6.64  | 7.42  | 14.43 | 17.77 | 20.00 |
| PARZIALI TERRENO     | 5.68   | 4.10   | 2.84   | 1.76  | 5.62  | 5.25  | 1.39  | 0.78  | 7.01  | 3.34  | 2.23  |       |
| QUOTE TERRENO        | 12.89  | 12.84  | 12.79  | 12.92 | 12.99 | 13.29 | 13.16 | 12.87 | 12.69 | 12.71 | 12.72 | 12.73 |
| PROGRESSIVE PROGETTO |        |        |        |       | -5.25 | -3.75 | 0.00  | 3.75  | 5.25  |       |       |       |
| PARZIALI PROGETTO    |        |        |        |       | 1.50  | 3.75  | 3.75  | 1.50  |       |       |       |       |
| QUOTE PROGETTO       |        |        |        |       | 13.16 | 13.19 | 13.29 | 13.19 | 13.16 |       |       |       |

PROFILO ASSE EST-OVEST

SEZIONE 54

PROGRESSIVA 2550.00

BINDER  
 C1 0.84 mq.  
 BASE  
 D1 2.62 mq.  
 FONDAZIONE  
 E1 2.10 mq.  
 USURA  
 a1 10.50 ml.

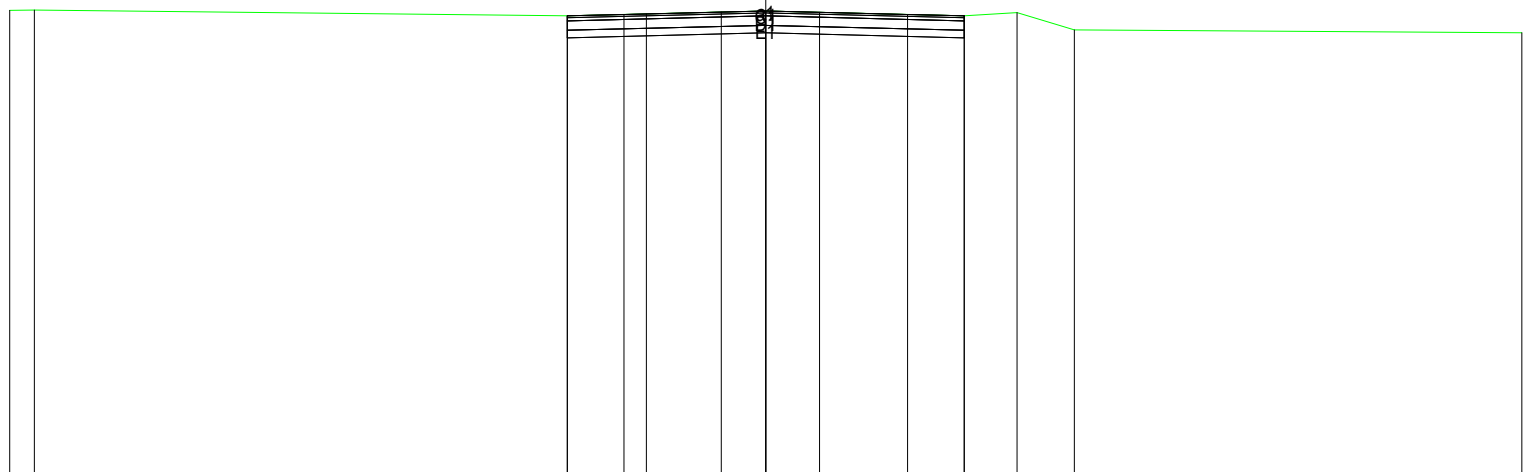

200  
 200

PROGRESSIVE  
 TERRENO

-20.00 -19.35 -5.25 -3.16 -1.18 0.00 1.42 5.25 6.65 8.16 20.00

PARZIALI  
 TERRENO

0.65 14.10 2.09 1.98 1.18 1.42 3.83 1.40 1.51 11.84

QUOTE  
 TERRENO

13.30 13.31 13.16 13.21 13.26 13.29 13.25 13.16 13.25 12.79 12.71

PROGRESSIVE  
 PROGETTO

-5.25 -3.75 0.00 3.75 5.25

PARZIALI  
 PROGETTO

1.50 3.75 3.75 1.50

QUOTE  
 PROGETTO

13.16 13.19 13.29 13.19 13.16

PROFILO ASSE EST-OVEST

SEZIONE 52

PROGRESSIVA 2450.00

BINDER  
 C1 0.84 mq.  
 BASE  
 D1 2.62 mq.  
 FONDAZIONE  
 E1 2.10 mq.  
 USURA  
 a1 10.50 ml.

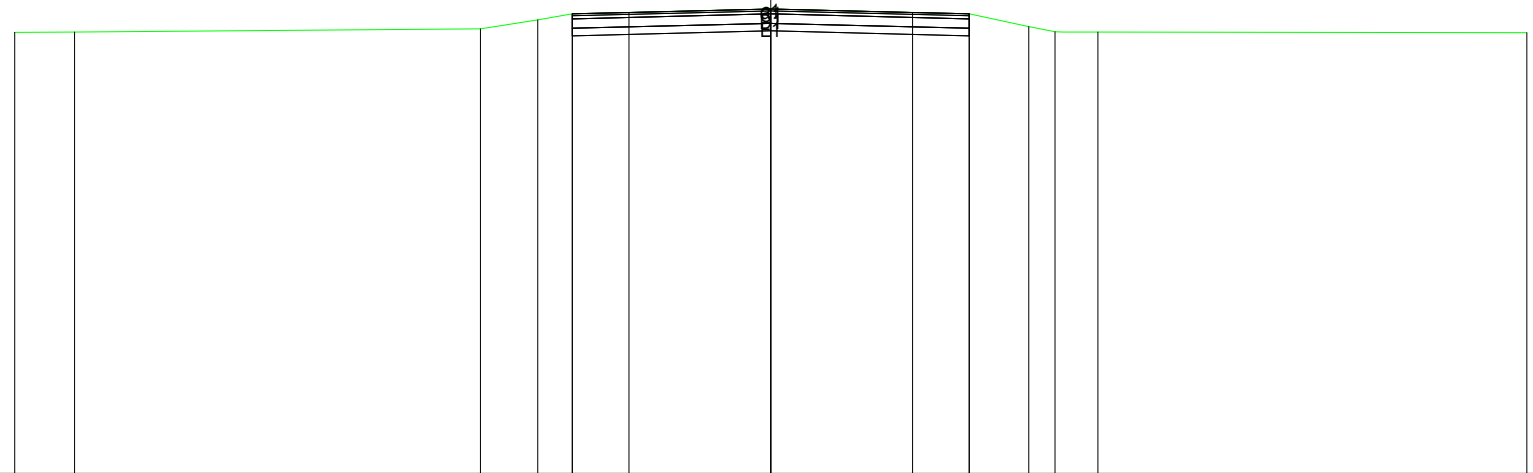

200 200

|                      |        |        |  |       |       |       |  |       |      |       |       |       |       |  |       |
|----------------------|--------|--------|--|-------|-------|-------|--|-------|------|-------|-------|-------|-------|--|-------|
| PROGRESSIVE TERRENO  | -20.00 | -18.41 |  | -7.68 | -6.17 | -5.25 |  | 0.00  |      | 5.25  | 6.82  | 7.52  | 8.65  |  | 20.00 |
| PARZIALI TERRENO     | 1.59   | 10.73  |  | 1.51  | 0.92  | 5.25  |  | 5.25  | 1.57 | 0.70  | 1.13  |       | 11.35 |  |       |
| QUOTE TERRENO        | 12.67  | 12.67  |  | 12.76 | 13.00 | 13.16 |  | 13.29 |      | 13.16 | 12.82 | 12.69 | 12.68 |  | 12.66 |
| PROGRESSIVE PROGETTO |        |        |  |       |       | -5.25 |  | -3.75 |      | 0.00  | 3.75  | 5.25  |       |  |       |
| PARZIALI PROGETTO    |        |        |  |       |       | 1.50  |  | 3.75  |      | 3.75  | 1.50  |       |       |  |       |
| QUOTE PROGETTO       |        |        |  |       |       | 13.16 |  | 13.19 |      | 13.29 | 13.19 | 13.16 |       |  |       |

PROFILO ASSE EST-OVEST

SEZIONE 53

PROGRESSIVA 2500.00

BINDER  
 C1 0.84 mq.  
 BASE  
 D1 2.62 mq.  
 FONDAZIONE  
 E1 2.10 mq.  
 USURA  
 a1 10.50 ml.

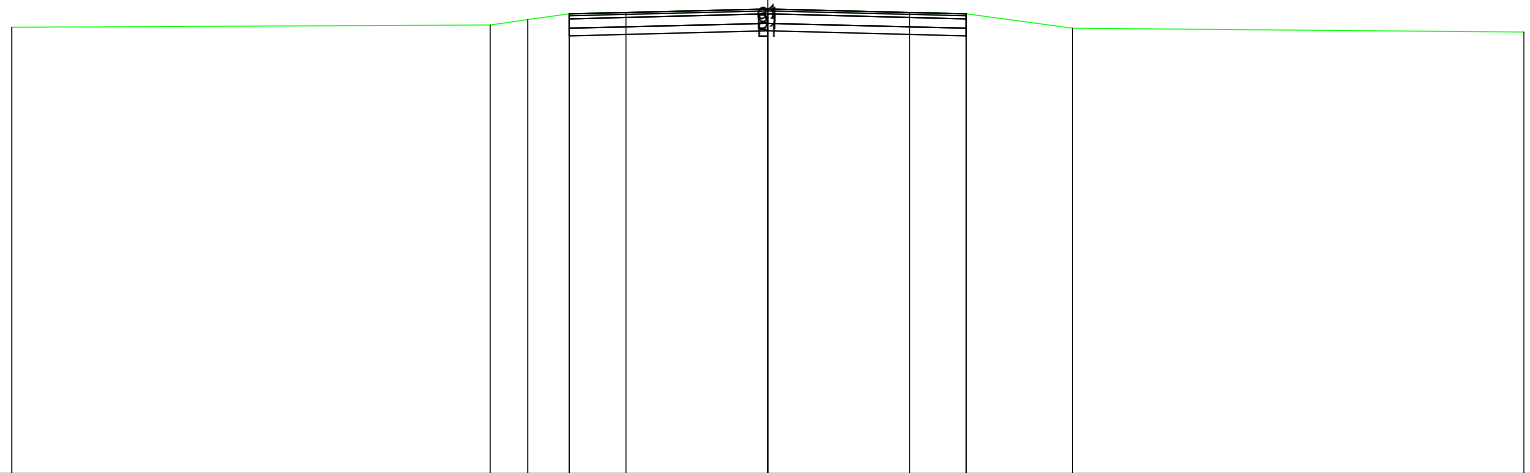

200  
 200

|                      |        |       |       |       |       |       |       |       |       |
|----------------------|--------|-------|-------|-------|-------|-------|-------|-------|-------|
| PROGRESSIVE TERRENO  | -20.00 |       | -7.34 | -6.35 | -5.25 | 0.00  | 5.25  | 8.06  | 20.00 |
| PARZIALI TERRENO     | 12.66  | 0.99  | 1.10  | 5.25  | 5.25  | 2.81  | 11.94 |       |       |
| QUOTE TERRENO        | 12.80  | 12.86 | 13.00 | 13.16 | 13.29 | 13.16 | 12.78 | 12.68 |       |
| PROGRESSIVE PROGETTO |        |       | -5.25 | -3.75 | 0.00  | 3.75  | 5.25  |       |       |
| PARZIALI PROGETTO    |        |       | 1.50  | 3.75  | 3.75  | 1.50  |       |       |       |
| QUOTE PROGETTO       |        | 13.16 | 13.19 | 13.29 | 13.19 | 13.16 |       |       |       |

PROFILO ASSE EST-OVEST

SEZIONE 55

PROGRESSIVA 2600.00

BINDER  
 C1 0.84 mq.  
 BASE  
 D1 2.62 mq.  
 FONDAZIONE  
 E1 2.10 mq.  
 USURA  
 a1 10.50 ml.

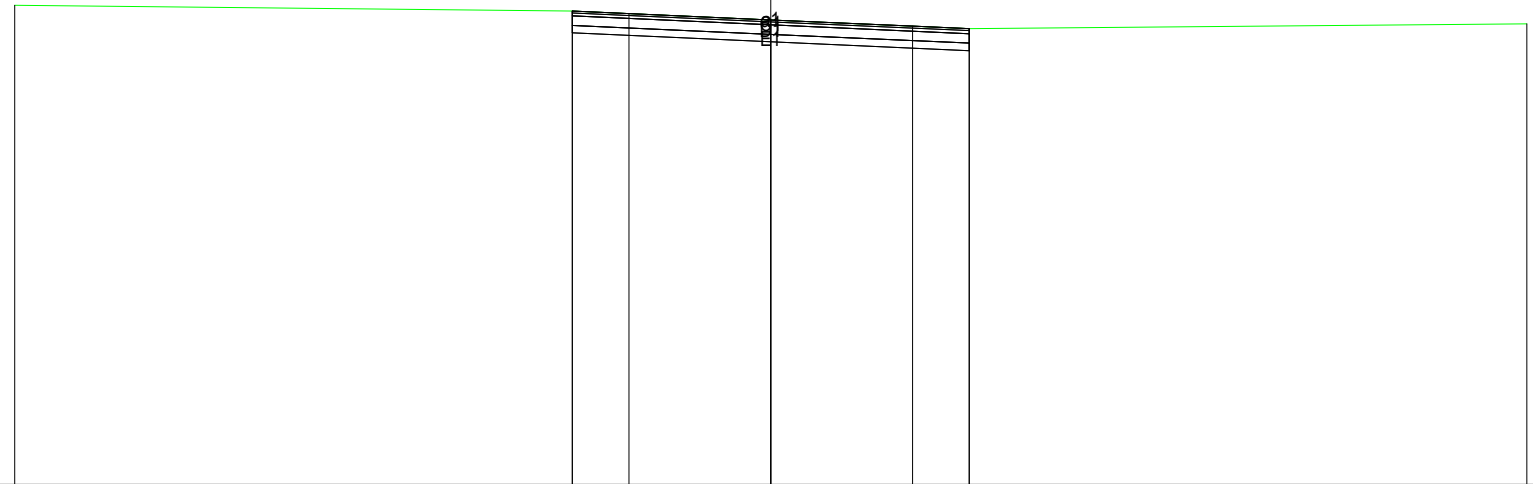

200  
 200

|                      |        |       |       |       |       |       |
|----------------------|--------|-------|-------|-------|-------|-------|
| PROGRESSIVE TERRENO  | -20.00 | -5.25 | 0.00  | 5.25  | 20.00 |       |
| PARZIALI TERRENO     | 14.75  | 5.25  | 5.25  | 14.75 |       |       |
| QUOTE TERRENO        | 13.67  | 13.52 | 13.29 | 13.05 | 13.18 |       |
| PROGRESSIVE PROGETTO |        | -5.25 | -3.75 | 0.00  | 3.75  | 5.25  |
| PARZIALI PROGETTO    |        | 1.50  | 3.75  | 3.75  | 1.50  |       |
| QUOTE PROGETTO       |        | 13.52 | 13.46 | 13.29 | 13.12 | 13.05 |

PROFILO ASSE EST-OVEST

SEZIONE 56

PROGRESSIVA 2650.00

BINDER  
 C1 0.84 mq.  
 BASE  
 D1 2.62 mq.  
 FONDAZIONE  
 E1 2.11 mq.  
 USURA  
 a1 10.50 ml.

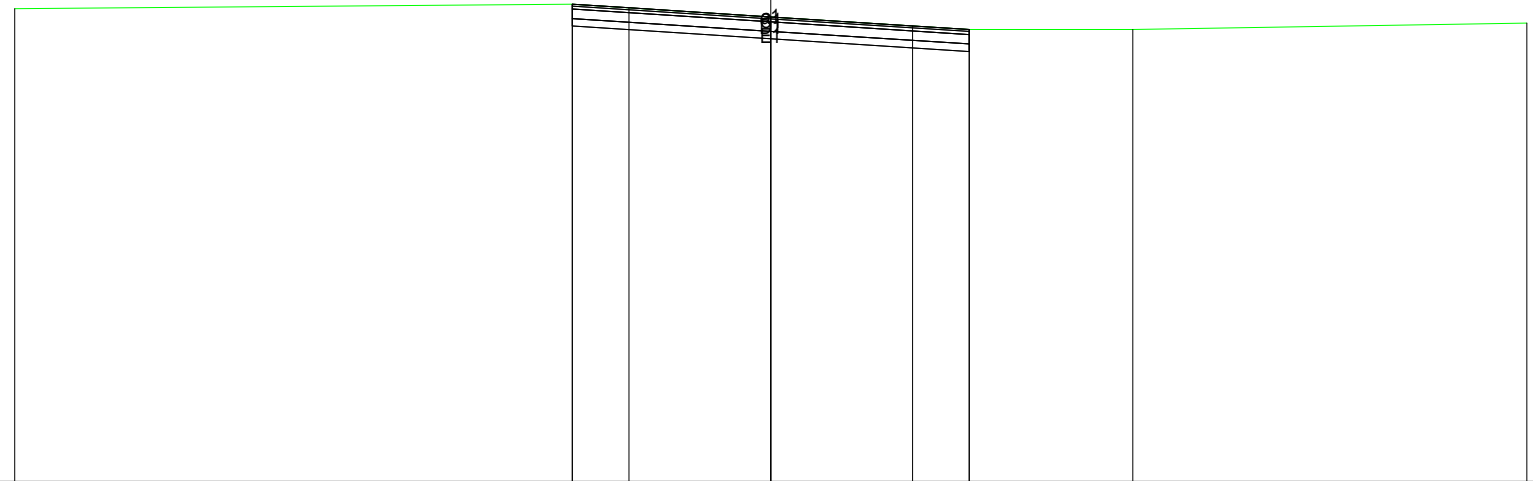

200  
 200

PROGRESSIVE  
 TERRENO

-20.00 -5.25 0.00 5.25 9.58 20.00

PARZIALI  
 TERRENO

14.75 5.25 5.25 4.33 10.42

QUOTE  
 TERRENO

13.50 13.63 13.29 12.95 12.95 13.12

PROGRESSIVE  
 PROGETTO

-5.25 -3.75 0.00 3.75 5.25

PARZIALI  
 PROGETTO

1.50 3.75 3.75 1.50

QUOTE  
 PROGETTO

13.63 13.53 13.29 13.05 12.95



PROFILO ASSE EST-OVEST

SEZIONE 57

PROGRESSIVA 2700.00

BINDER  
 C1 0.84 mq.  
 BASE  
 D1 2.62 mq.  
 FONDAZIONE  
 E1 2.11 mq.  
 USURA  
 a1 10.50 ml.



200  
 200

|                      |        |        |        |        |        |        |       |       |       |       |       |       |       |
|----------------------|--------|--------|--------|--------|--------|--------|-------|-------|-------|-------|-------|-------|-------|
| PROGRESSIVE TERRENO  | -20.00 | -19.22 | -18.96 | -18.64 | -17.82 | -16.92 | -8.58 | -5.25 | 0.00  | 4.58  | 5.25  | 8.01  | 20.00 |
| PARZIALI TERRENO     | 0.78   | 0.26   | 0.32   | 0.82   | 0.90   | 8.34   | 3.33  | 5.25  | 4.58  | 0.67  | 2.76  | 11.99 |       |
| QUOTE TERRENO        | 11.80  | 12.02  | 12.28  | 12.64  | 13.38  | 13.49  | 13.64 | 13.63 | 13.29 | 12.99 | 12.95 | 13.20 | 12.48 |
| PROGRESSIVE PROGETTO |        |        |        |        |        |        |       | -5.25 | -3.75 | 0.00  | 3.75  | 5.25  |       |
| PARZIALI PROGETTO    |        |        |        |        |        |        |       | 1.50  | 3.75  | 3.75  | 1.50  |       |       |
| QUOTE PROGETTO       |        |        |        |        |        |        |       | 13.63 | 13.53 | 13.29 | 13.05 | 12.95 |       |

PROFILO ASSE EST-OVEST

SEZIONE 58

PROGRESSIVA 2750.00

BINDER  
 C1 0.84 mq.  
 BASE  
 D1 2.63 mq.  
 FONDAZIONE  
 E1 2.09 mq.  
 USURA  
 a1 10.50 ml.



200  
 200

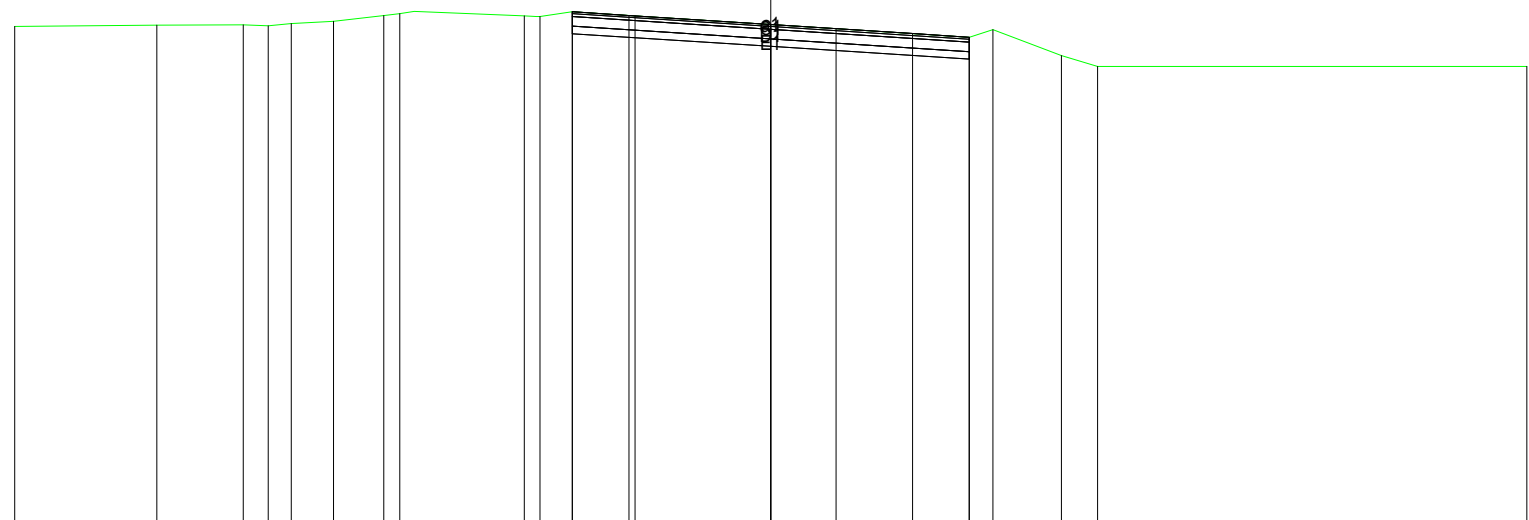

|                      |        |        |        |        |        |        |        |       |       |       |       |       |       |       |       |       |       |       |       |       |  |       |
|----------------------|--------|--------|--------|--------|--------|--------|--------|-------|-------|-------|-------|-------|-------|-------|-------|-------|-------|-------|-------|-------|--|-------|
| PROGRESSIVE TERRENO  | -20.00 | -16.24 | -13.95 | -13.30 | -12.69 | -11.57 | -10.24 | -9.82 |       | -6.52 | -6.11 | -5.25 | -3.59 | 0.00  | 1.72  |       | 5.25  | 5.87  | 7.69  | 8.64  |  | 20.00 |
| PARZIALI TERRENO     |        | 3.76   | 2.29   | 0.65   | 0.61   | 1.12   | 1.33   | 0.42  | 3.30  | 0.41  | 0.86  | 1.66  | 3.59  | 1.72  | 3.53  | 0.62  | 1.82  | 0.95  |       | 11.36 |  |       |
| QUOTE TERRENO        | 13.20  |        | 13.23  | 13.24  | 13.22  | 13.28  | 13.34  | 13.49 | 13.54 | 13.47 | 13.46 | 13.59 | 13.48 | 13.25 | 13.14 |       | 12.91 | 13.11 | 12.43 | 12.14 |  | 12.14 |
| PROGRESSIVE PROGETTO |        |        |        |        |        |        |        |       |       |       | -5.25 | -3.75 |       | 0.00  |       | 3.75  | 5.25  |       |       |       |  |       |
| PARZIALI PROGETTO    |        |        |        |        |        |        |        |       |       |       | 1.50  | 3.75  |       |       | 3.75  |       | 1.50  |       |       |       |  |       |
| QUOTE PROGETTO       |        |        |        |        |        |        |        |       |       | 13.59 | 13.49 |       |       | 13.25 |       | 13.01 | 12.91 |       |       |       |  |       |



PROFILO ASSE EST-OVEST

SEZIONE 60

PROGRESSIVA 2850.00

BINDER 0.84 mq.  
 C1  
 BASE  
 D1 2.62 mq.  
 FONDAZIONE  
 E1 2.10 mq.  
 USURA  
 a1 10.50 ml.

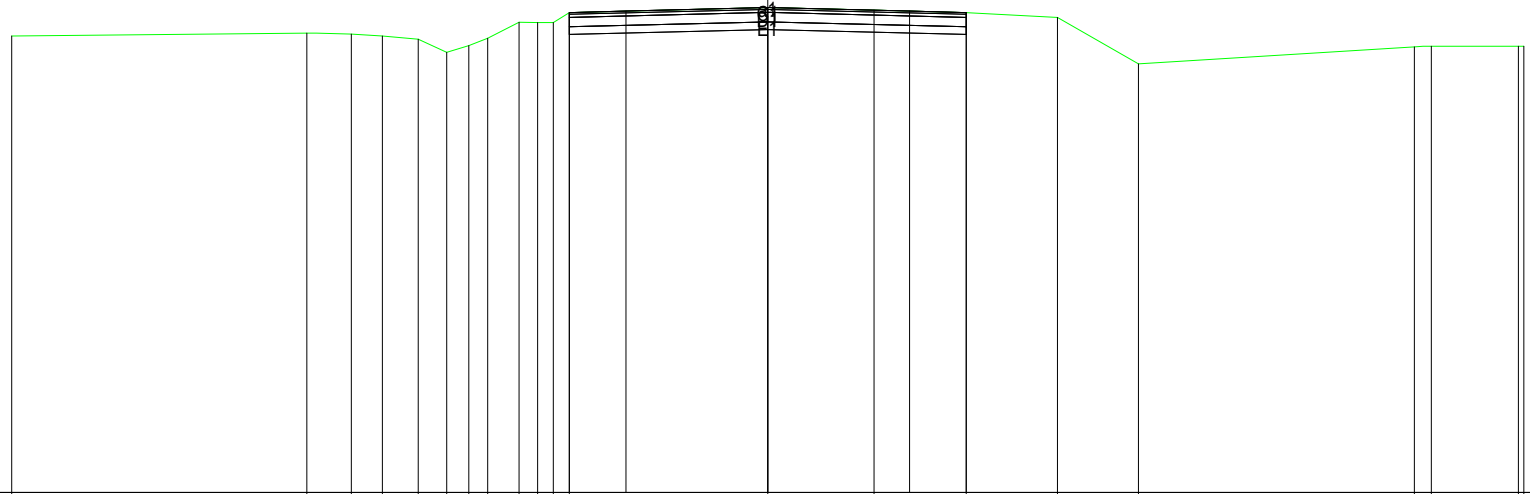

200 200

|                      |        |        |        |        |       |       |       |       |       |       |       |       |       |       |       |       |       |       |       |       |       |
|----------------------|--------|--------|--------|--------|-------|-------|-------|-------|-------|-------|-------|-------|-------|-------|-------|-------|-------|-------|-------|-------|-------|
| PROGRESSIVE TERRENO  | -20.00 | -12.19 | -11.02 | -10.19 | -9.25 | -8.49 | -7.91 | -7.41 | -6.58 | -6.09 | -5.67 | -5.25 | 0.00  | 2.81  | 5.25  | 7.66  | 9.80  | 17.10 | 17.55 | 19.85 | 20.00 |
| PARZIALI TERRENO     | 7.81   | 1.17   | 0.83   | 0.94   | 0.76  | 0.58  | 0.50  | 0.83  | 0.49  | 0.42  | 0.42  | 5.25  | 2.81  | 2.44  | 2.41  | 2.14  | 7.30  | 0.45  | 2.30  | 0.15  |       |
| QUOTE TERRENO        | 12.07  | 12.15  | 12.12  | 12.07  | 11.99 | 11.64 | 11.82 | 12.02 | 12.44 | 12.43 | 12.42 | 12.70 | 12.83 | 12.76 | 12.70 | 12.57 | 11.33 | 11.79 | 11.81 | 11.80 | 11.80 |
| PROGRESSIVE PROGETTO |        |        |        |        |       |       |       |       |       | -5.25 | -3.75 | 0.00  | 3.75  | 5.25  |       |       |       |       |       |       |       |
| PARZIALI PROGETTO    |        |        |        |        |       |       |       |       |       | 1.50  | 3.75  | 3.75  | 1.50  |       |       |       |       |       |       |       |       |
| QUOTE PROGETTO       |        |        |        |        |       |       |       |       |       | 12.70 | 12.73 | 12.83 | 12.73 | 12.70 |       |       |       |       |       |       |       |

PROFILO ASSE EST-OVEST

SEZIONE 61

PROGRESSIVA 2900.00

BINDER  
C1 0.84 mq.  
BASE  
D1 2.62 mq.  
FONDAZIONE  
E1 2.10 mq.  
USURA  
a1 10.50 ml.



200  
200

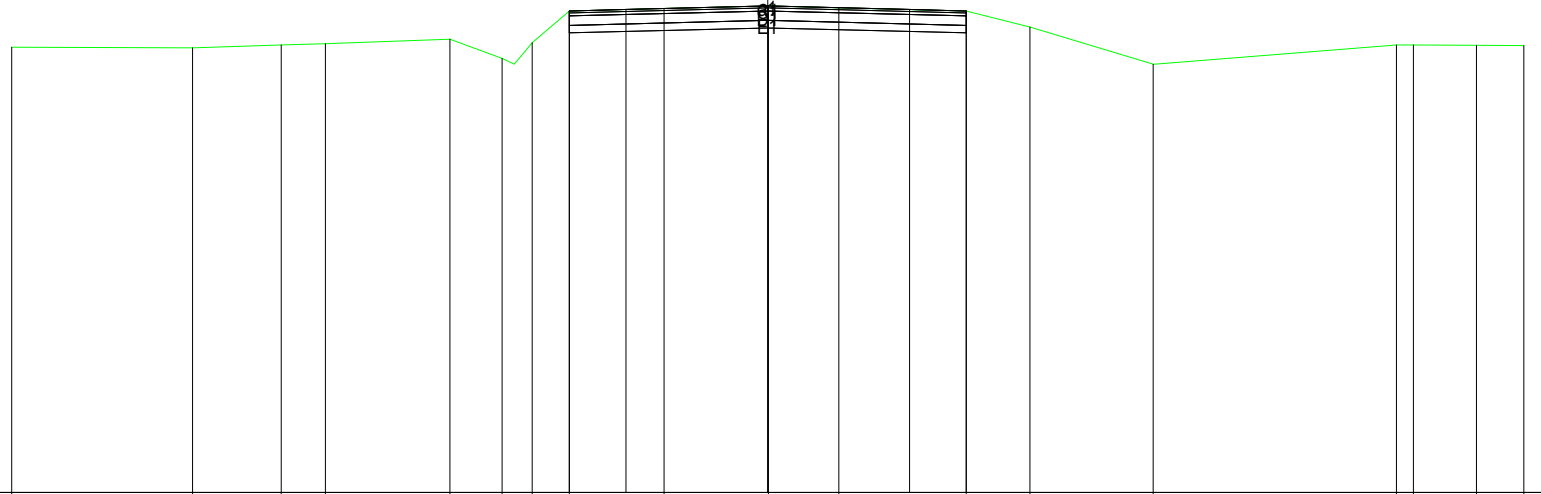

|                      |        |        |        |        |       |       |       |       |       |       |       |       |       |       |       |       |       |       |
|----------------------|--------|--------|--------|--------|-------|-------|-------|-------|-------|-------|-------|-------|-------|-------|-------|-------|-------|-------|
| PROGRESSIVE TERRENO  | -20.00 | -15.21 | -12.87 | -11.70 | -8.40 | -7.03 | -6.23 | -5.25 | -2.75 | 0.02  | 1.88  | 5.25  | 6.93  | 10.19 | 16.63 | 17.08 | 18.74 | 20.00 |
| PARZIALI TERRENO     | 4.79   | 2.34   | 1.17   | 3.30   | 1.37  | 0.80  | 0.98  | 2.50  | 2.77  | 1.86  | 3.37  | 1.68  | 3.26  | 6.44  | 0.45  | 1.66  | 1.26  |       |
| QUOTE TERRENO        | 11.77  | 11.76  | 11.83  | 11.87  | 11.99 | 11.48 | 11.90 | 12.74 | 12.80 | 12.87 | 12.82 | 12.74 | 12.31 | 11.33 | 11.84 | 11.84 | 11.83 | 11.82 |
| PROGRESSIVE PROGETTO |        |        |        |        |       |       | -5.25 | -3.75 |       | 0.00  |       | 3.75  | 5.25  |       |       |       |       |       |
| PARZIALI PROGETTO    |        |        |        |        |       |       | 1.50  | 3.75  |       |       | 3.75  | 1.50  |       |       |       |       |       |       |
| QUOTE PROGETTO       |        |        |        |        |       |       | 12.74 | 12.77 |       | 12.87 |       | 12.77 | 12.74 |       |       |       |       |       |

PROFILO ASSE EST-OVEST

SEZIONE 62

PROGRESSIVA 2950.00

BINDER  
 C1 0.84 mq.  
 BASE  
 D1 2.62 mq.  
 FONDAZIONE  
 E1 2.12 mq.  
 USURA  
 a1 10.50 ml.



200  
 200

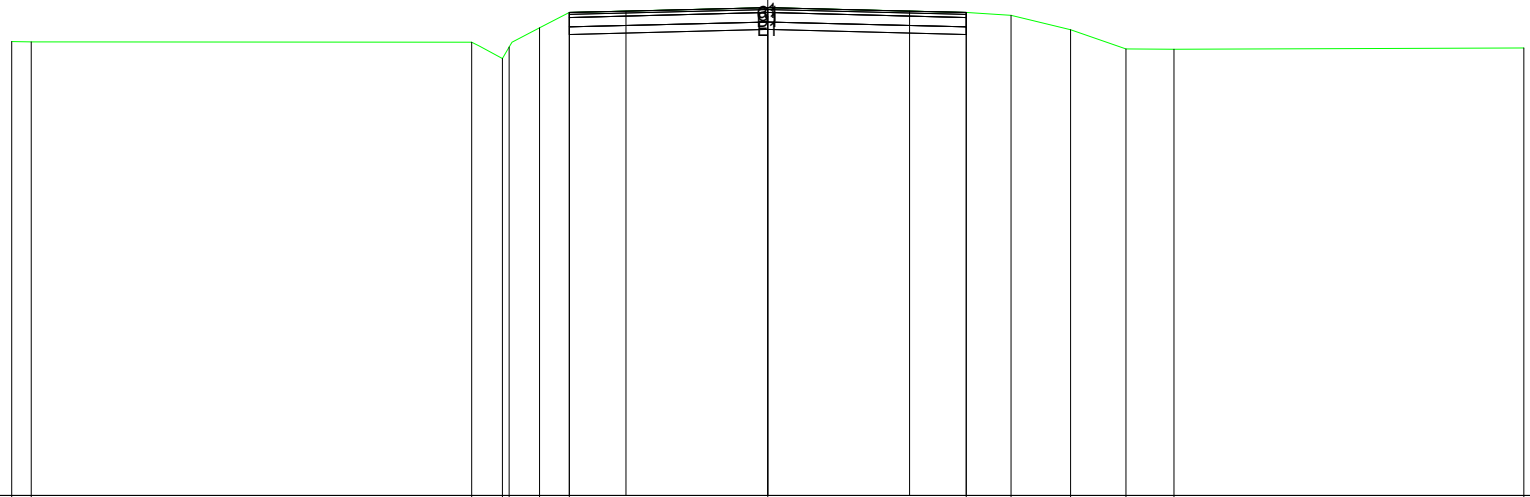

|                      |        |        |       |       |       |       |       |       |      |       |      |       |       |       |       |       |      |       |
|----------------------|--------|--------|-------|-------|-------|-------|-------|-------|------|-------|------|-------|-------|-------|-------|-------|------|-------|
| PROGRESSIVE TERRENO  | -20.00 | -19.49 |       | -7.84 | -7.02 | -6.84 | -6.03 | -5.25 |      | 0.00  |      | 5.25  | 6.44  | 8.01  | 9.47  | 10.74 |      | 20.00 |
| PARZIALI TERRENO     | 0.51   |        | 11.65 | 0.82  | 0.18  | 0.81  | 0.78  |       | 5.25 |       | 5.25 | 1.19  | 1.57  | 1.46  | 1.27  |       | 9.26 |       |
| QUOTE TERRENO        | 12.00  | 11.99  |       | 11.99 | 11.55 | 11.86 | 12.37 | 12.77 |      | 12.91 |      | 12.77 | 12.70 | 12.32 | 11.81 | 11.80 |      | 11.84 |
| PROGRESSIVE PROGETTO |        |        |       |       |       |       | -5.25 | -3.75 |      | 0.00  |      | 3.75  | 5.25  |       |       |       |      |       |
| PARZIALI PROGETTO    |        |        |       |       |       |       |       | 1.50  | 3.75 |       | 3.75 | 1.50  |       |       |       |       |      |       |
| QUOTE PROGETTO       |        |        |       |       |       |       | 12.77 | 12.81 |      | 12.91 |      | 12.81 | 12.77 |       |       |       |      |       |

PROFILO ASSE EST-OVEST

SEZIONE 63

PROGRESSIVA 3000.00

BINDER  
 C1 0.84 mq.  
 BASE  
 D1 2.62 mq.  
 FONDAZIONE  
 E1 2.10 mq.  
 USURA  
 a1 10.50 ml.



200  
 200

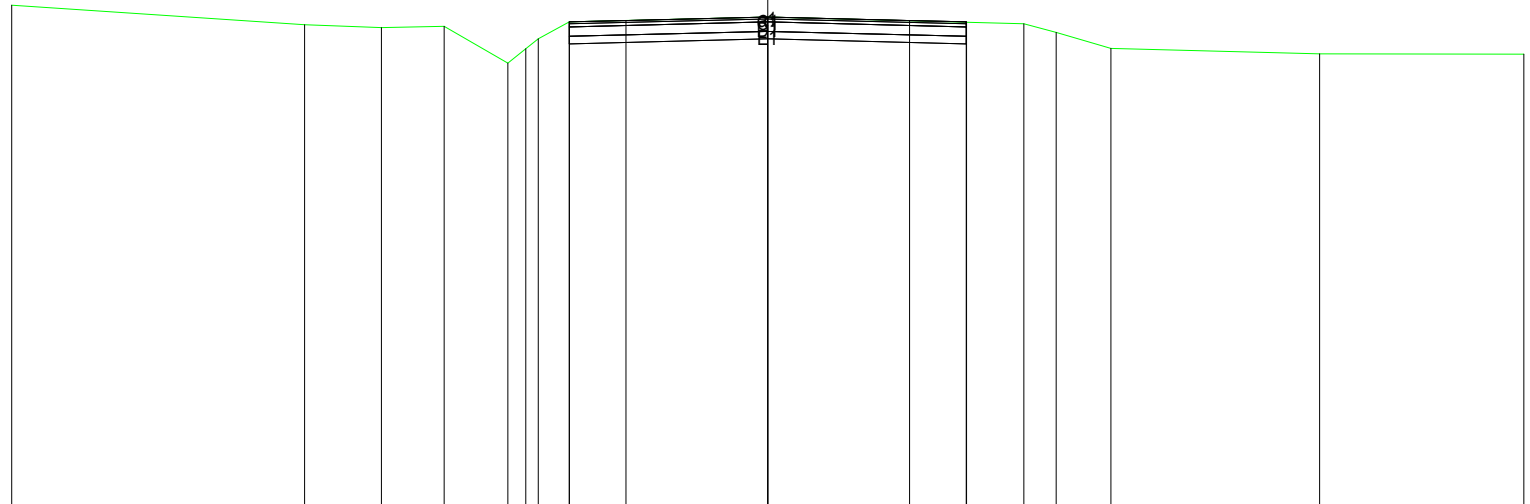

|                      |        |        |        |       |       |       |       |       |       |       |       |       |       |       |
|----------------------|--------|--------|--------|-------|-------|-------|-------|-------|-------|-------|-------|-------|-------|-------|
| PROGRESSIVE TERRENO  | -20.00 | -12.26 | -10.22 | -8.56 | -6.88 | -6.40 | -6.07 | -5.25 | 0.00  | 6.78  | 7.63  | 9.08  | 14.60 | 20.00 |
| PARZIALI TERRENO     | 7.74   | 2.04   | 1.66   | 1.68  | 0.48  | 0.33  | 0.82  | 5.25  | 6.78  | 0.85  | 1.45  | 5.52  | 5.40  |       |
| QUOTE TERRENO        | 13.26  | 12.74  | 12.66  | 12.70 | 11.73 | 12.11 | 12.37 | 12.81 | 12.95 | 12.77 | 12.54 | 12.12 | 11.97 | 11.96 |
| PROGRESSIVE PROGETTO |        |        |        |       |       |       | -5.25 | -3.75 | 0.00  | 3.75  | 5.25  | 5.26  |       |       |
| PARZIALI PROGETTO    |        |        |        |       |       |       | 1.50  | 3.75  | 3.75  | 1.50  | 0.01  |       |       |       |
| QUOTE PROGETTO       |        |        |        |       | 12.81 | 12.85 | 12.95 | 12.85 | 12.81 | 12.81 |       |       |       |       |

PROFILO ASSE EST-OVEST

SEZIONE 64

PROGRESSIVA 3050.00

BINDER  
 C1 0.84 mq.  
 BASE  
 D1 2.64 mq.  
 FONDAZIONE  
 E1 2.10 mq.  
 USURA  
 a1 10.50 ml.



200  
 200

PROGRESSIVE  
 TERRENO

PARZIALI  
 TERRENO

QUOTE  
 TERRENO

PROGRESSIVE  
 PROGETTO

PARZIALI  
 PROGETTO

QUOTE  
 PROGETTO

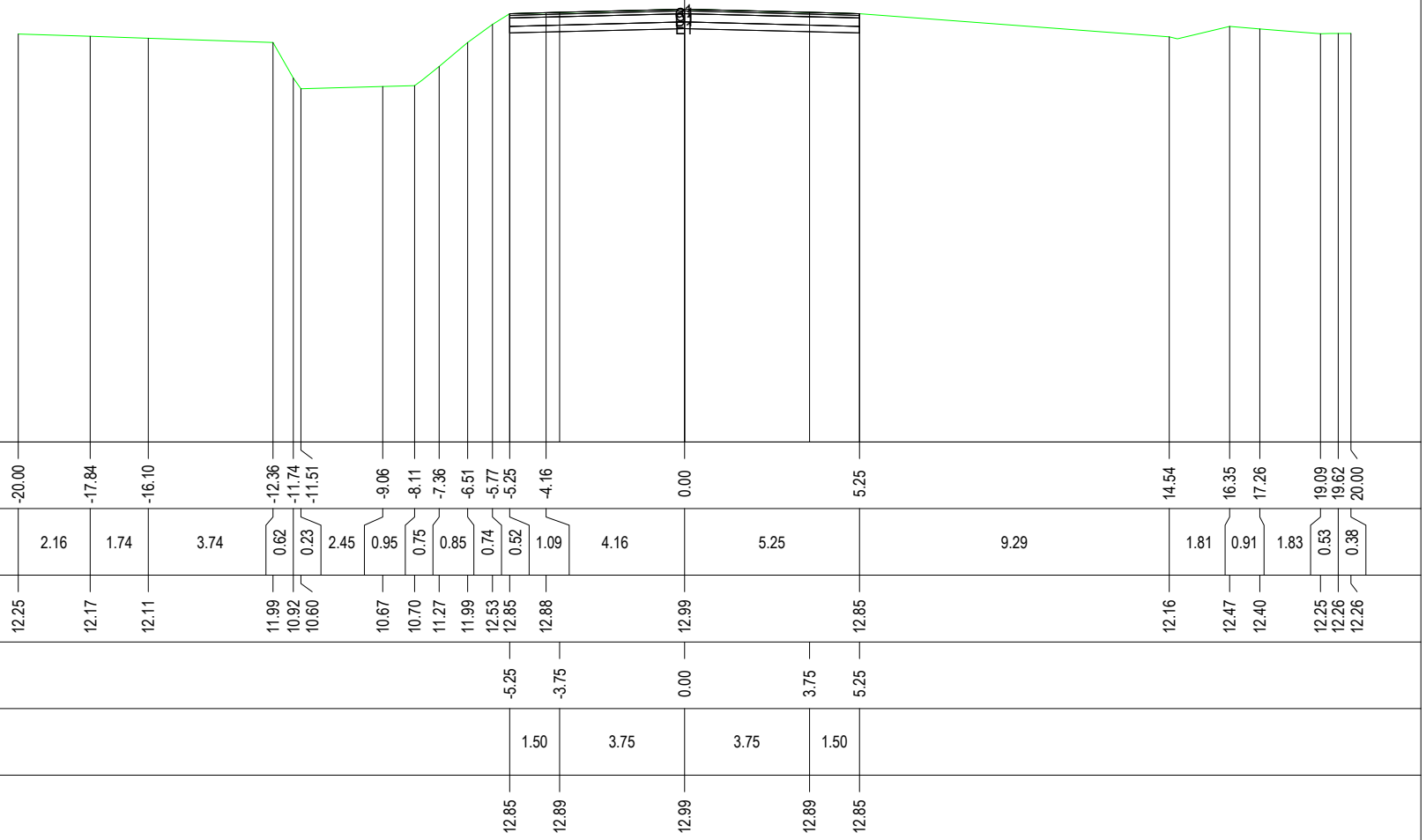



PROFILO ASSE EST-OVEST

SEZIONE 65

PROGRESSIVA 3100.00

BINDER  
 C1 0.84 mq.  
 BASE  
 D1 2.62 mq.  
 FONDAZIONE  
 E1 2.10 mq.  
 USURA  
 a1 10.50 ml.



200  
 200

PROGRESSIVE  
 TERRENO

PARZIALI  
 TERRENO

QUOTE  
 TERRENO

PROGRESSIVE  
 PROGETTO

PARZIALI  
 PROGETTO

QUOTE  
 PROGETTO

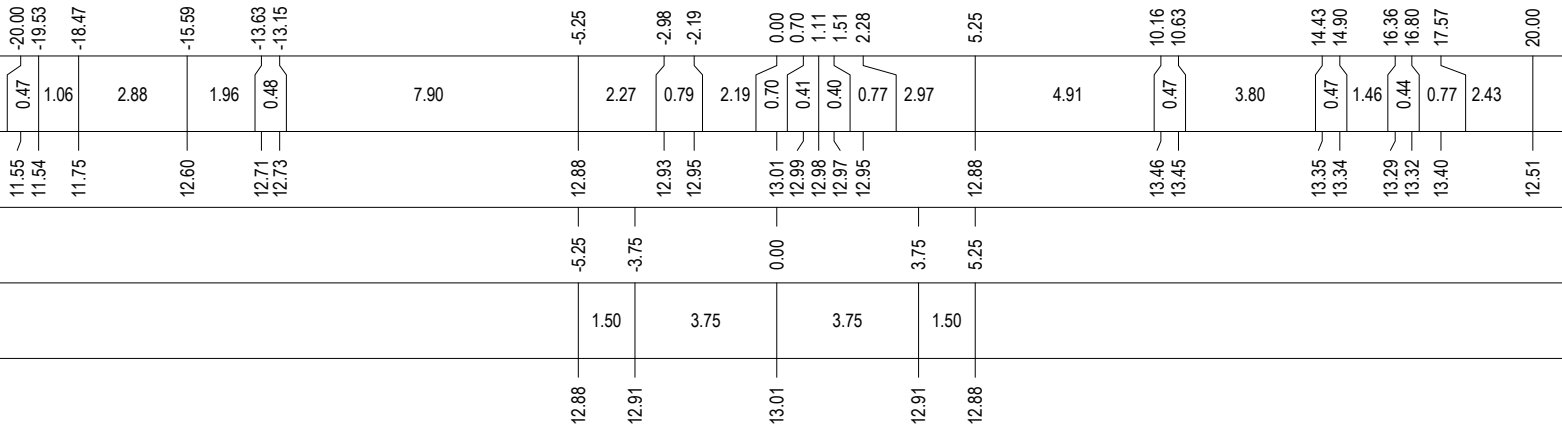





PROFILO ASSE EST-OVEST

SEZIONE 68

PROGRESSIVA 3250.00

BINDER  
 C1 0.89 mq.  
 BASE  
 D1 2.77 mq.  
 FONDAZIONE  
 E1 2.22 mq.  
 USURA  
 a1 11.10 ml.



200  
 200

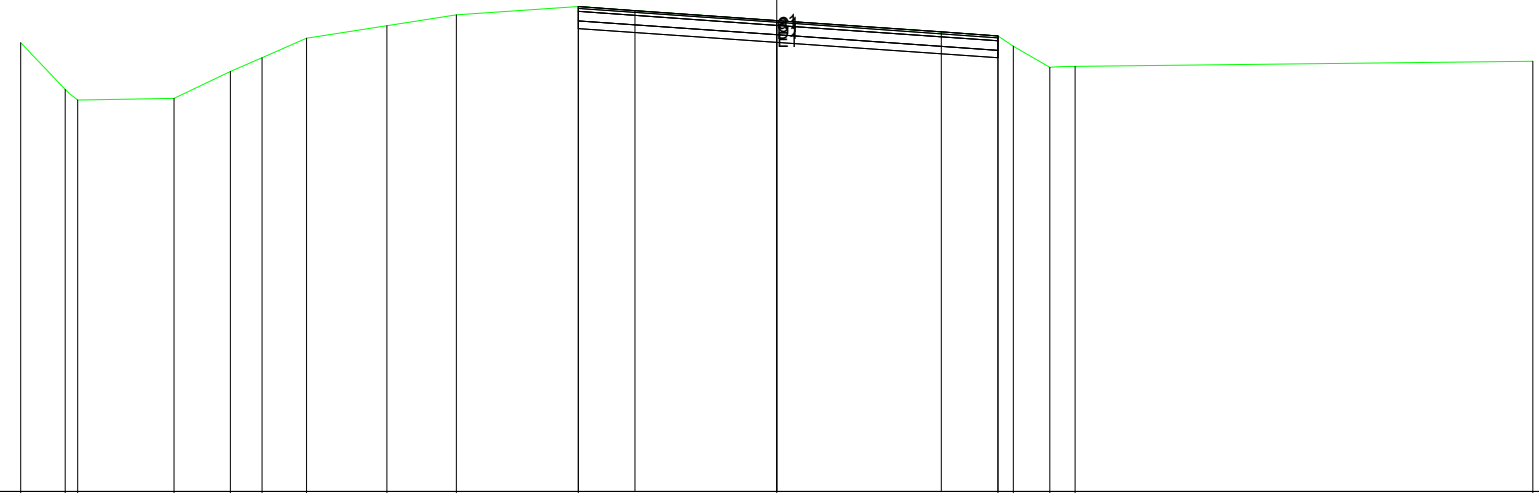

|                      |        |        |        |        |        |        |        |        |       |       |       |       |       |       |       |       |
|----------------------|--------|--------|--------|--------|--------|--------|--------|--------|-------|-------|-------|-------|-------|-------|-------|-------|
| PROGRESSIVE TERRENO  | -20.00 | -18.82 | -18.49 | -15.95 | -14.45 | -13.61 | -12.44 | -10.31 | -8.47 | -5.25 | 0.00  | 5.85  | 6.26  | 7.22  | 7.89  | 20.00 |
| PARZIALI TERRENO     | 1.18   | 0.33   | 2.54   | 1.50   | 0.84   | 1.17   | 2.13   | 1.84   | 3.22  | 5.25  | 5.85  | 0.41  | 0.96  | 0.67  | 12.11 |       |
| QUOTE TERRENO        | 11.87  | 10.63  | 10.36  | 10.40  | 11.10  | 11.48  | 11.99  | 12.32  | 12.60 | 12.83 | 12.46 | 12.05 | 11.77 | 11.22 | 11.25 | 11.38 |
| PROGRESSIVE PROGETTO |        |        |        |        |        |        |        |        |       | -5.25 | -3.75 | 0.00  | 4.35  | 5.85  |       |       |
| PARZIALI PROGETTO    |        |        |        |        |        |        |        |        |       | 1.50  | 3.75  | 4.35  | 1.50  |       |       |       |
| QUOTE PROGETTO       |        |        |        |        |        |        |        |        |       | 12.83 | 12.72 | 12.46 | 12.15 | 12.05 |       |       |

PROFILO ASSE EST-OVEST

SEZIONE 69

PROGRESSIVA 3300.00

BINDER  
 C1 0.84 mq.  
 BASE  
 D1 2.64 mq.  
 FONDAZIONE  
 E1 2.10 mq.  
 USURA  
 a1 10.50 ml.



200  
 200

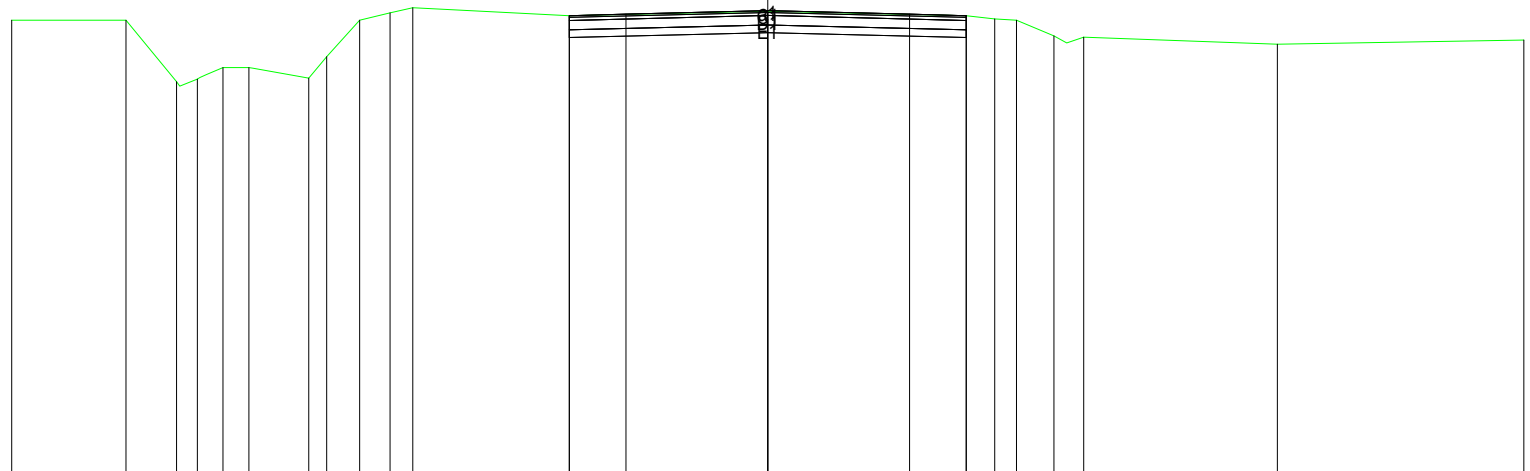

|                      |        |        |        |        |        |        |        |        |        |       |       |       |       |       |       |       |       |       |       |       |
|----------------------|--------|--------|--------|--------|--------|--------|--------|--------|--------|-------|-------|-------|-------|-------|-------|-------|-------|-------|-------|-------|
| PROGRESSIVE TERRENO  | -20.00 | -16.97 | -15.64 | -15.09 | -14.41 | -13.72 | -12.14 | -11.67 | -10.79 | -9.99 | -9.39 | -5.25 | 0.00  | 5.25  | 6.00  | 6.58  | 7.57  | 8.36  | 13.48 | 20.00 |
| PARZIALI TERRENO     | 3.03   | 1.33   | 0.55   | 0.68   | 0.69   | 1.58   | 0.47   | 0.88   | 0.80   | 0.60  | 4.14  | 5.25  | 5.25  | 0.75  | 0.58  | 0.99  | 0.79  | 5.12  | 6.52  |       |
| QUOTE TERRENO        | 11.99  | 11.99  | 10.36  | 10.43  | 10.74  | 10.74  | 10.46  | 11.03  | 11.99  | 12.18 | 12.32 | 12.11 | 12.22 | 12.11 | 12.02 | 11.99 | 11.57 | 11.54 | 11.35 | 11.47 |
| PROGRESSIVE PROGETTO |        |        |        |        |        |        |        |        |        |       |       | -5.25 | -3.75 | 0.00  | 3.75  | 5.25  |       |       |       |       |
| PARZIALI PROGETTO    |        |        |        |        |        |        |        |        |        |       |       | 1.50  | 3.75  | 3.75  | 1.50  |       |       |       |       |       |
| QUOTE PROGETTO       |        |        |        |        |        |        |        |        |        |       |       | 12.11 | 12.15 | 12.24 | 12.15 | 12.11 |       |       |       |       |

PROFILO ASSE EST-OVEST

SEZIONE 70

PROGRESSIVA 3350.00

BINDER  
 C1 0.84 mq.  
 BASE  
 D1 2.62 mq.  
 FONDAZIONE  
 E1 2.10 mq.  
 USURA  
 a1 10.50 ml.



200  
 200

|                      |        |        |        |        |        |        |       |       |       |       |       |       |       |       |       |       |
|----------------------|--------|--------|--------|--------|--------|--------|-------|-------|-------|-------|-------|-------|-------|-------|-------|-------|
| PROGRESSIVE TERRENO  | -20.00 | -16.28 | -15.28 | -12.63 | -11.34 | -10.14 | -8.96 | -7.12 | -5.25 | 0.00  | 5.25  | 5.73  | 6.17  | 7.09  | 8.06  | 20.00 |
| PARZIALI TERRENO     | 3.72   | 1.00   | 2.65   | 1.29   | 1.20   | 1.18   | 1.84  | 1.87  | 5.25  | 5.25  | 0.48  | 0.44  | 0.92  | 0.97  | 11.94 |       |
| QUOTE TERRENO        | 10.88  | 10.82  | 10.34  | 10.45  | 10.50  | 10.54  | 10.91 | 11.39 | 11.98 | 12.11 | 11.98 | 11.72 | 11.48 | 11.12 | 10.75 | 11.37 |
| PROGRESSIVE PROGETTO |        |        |        |        |        |        |       |       | -5.25 | -3.75 | 0.00  | 3.75  | 5.25  |       |       |       |
| PARZIALI PROGETTO    |        |        |        |        |        |        |       |       | 1.50  | 3.75  | 3.75  | 1.50  |       |       |       |       |
| QUOTE PROGETTO       |        |        |        |        |        |        |       |       | 11.98 | 12.02 | 12.11 | 12.02 | 11.98 |       |       |       |

PROFILO ASSE EST-OVEST

SEZIONE 71

PROGRESSIVA 3400.00

BINDER  
 C1 0.84 mq.  
 BASE  
 D1 2.62 mq.  
 FONDAZIONE  
 E1 2.10 mq.  
 USURA  
 a1 10.50 ml.



200  
 200

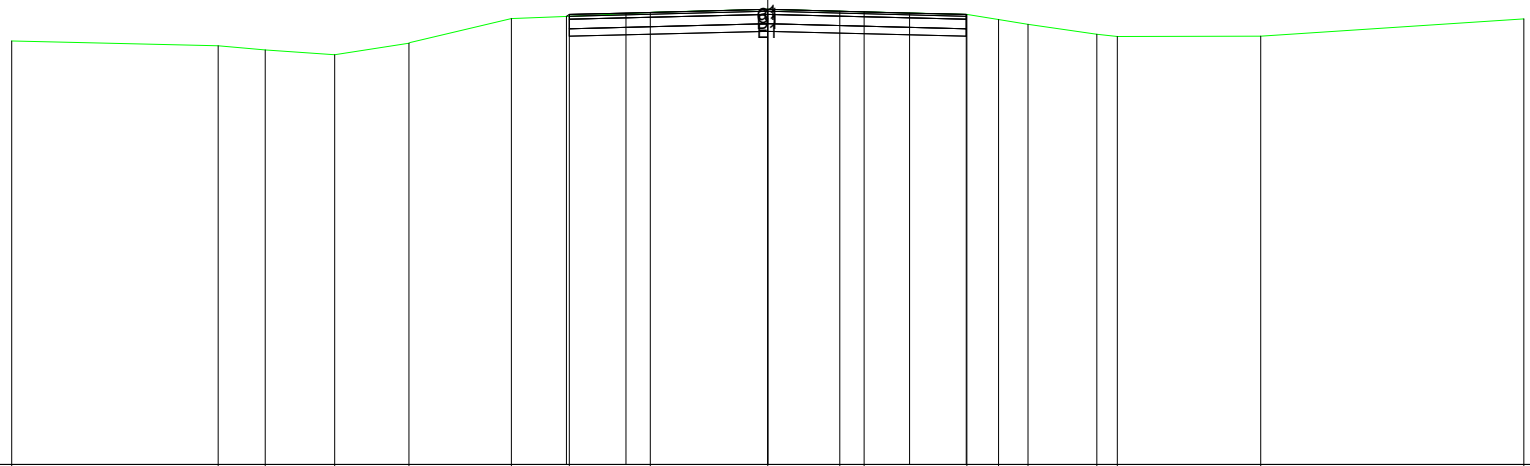

|                      |        |        |        |        |       |       |       |       |       |       |       |       |       |       |       |       |       |       |
|----------------------|--------|--------|--------|--------|-------|-------|-------|-------|-------|-------|-------|-------|-------|-------|-------|-------|-------|-------|
| PROGRESSIVE TERRENO  | -20.00 | -14.54 | -13.30 | -11.46 | -9.49 | -6.78 | -5.25 | -3.11 | 0.00  | 1.91  | 2.55  | 5.26  | 6.11  | 6.88  | 8.70  | 9.25  | 13.04 | 20.00 |
| PARZIALI TERRENO     | 5.46   | 1.24   | 1.84   | 1.97   | 2.71  | 1.53  | 2.14  | 3.11  | 1.91  | 0.64  | 2.71  | 0.85  | 0.77  | 1.82  | 0.55  | 3.79  | 6.96  |       |
| QUOTE TERRENO        | 11.20  | 11.08  | 10.96  | 10.84  | 11.14 | 11.79 | 11.85 | 11.96 | 12.04 | 11.99 | 11.97 | 11.90 | 11.77 | 11.64 | 11.38 | 11.32 | 11.33 | 11.79 |
| PROGRESSIVE PROGETTO |        |        |        |        |       |       | -5.33 | -3.75 | 0.00  |       |       | 3.75  | 5.25  |       |       |       |       |       |
| PARZIALI PROGETTO    |        |        |        |        |       |       | 1.58  | 3.75  |       | 3.75  |       | 1.50  |       |       |       |       |       |       |
| QUOTE PROGETTO       |        |        |        |        |       |       | 11.85 | 11.94 | 12.04 |       | 11.94 | 11.90 |       |       |       |       |       |       |

PROFILO ASSE EST-OVEST

SEZIONE 72

PROGRESSIVA 3450.00

BINDER  
 C1 0.84 mq.  
 BASE  
 D1 2.64 mq.  
 FONDAZIONE  
 E1 2.10 mq.  
 USURA  
 a1 10.50 ml.

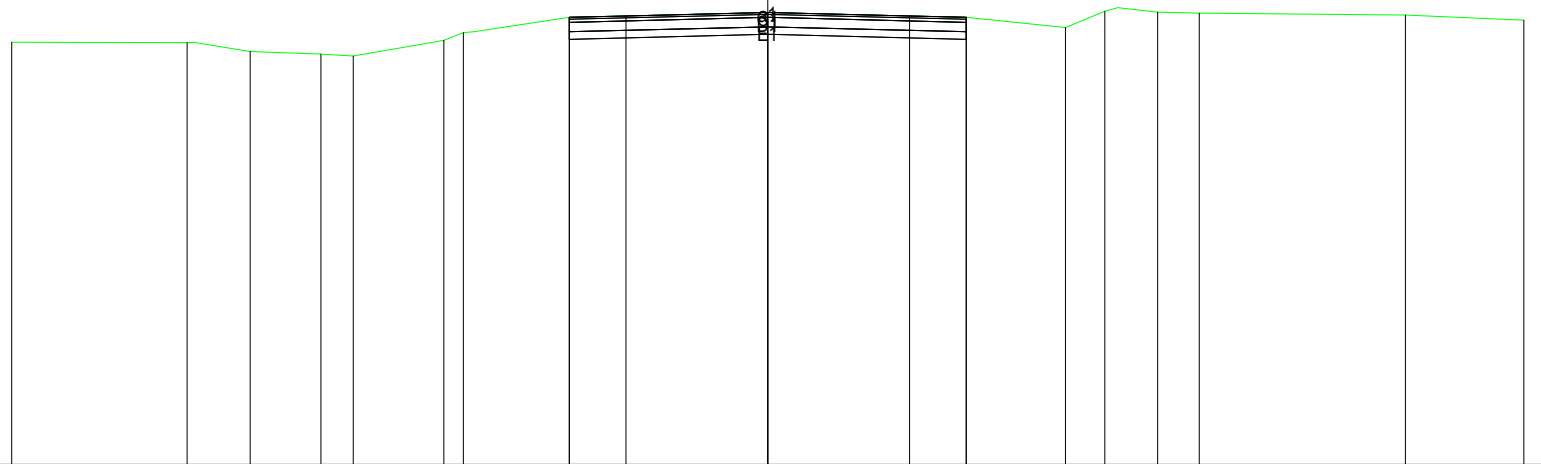

|                      |        |        |        |        |        |       |       |       |       |       |       |       |       |       |       |       |
|----------------------|--------|--------|--------|--------|--------|-------|-------|-------|-------|-------|-------|-------|-------|-------|-------|-------|
| PROGRESSIVE TERRENO  | -20.00 | -15.36 | -13.69 | -11.82 | -10.97 | -8.57 | -8.05 | -5.25 | 0.00  | 5.25  | 7.87  | 8.91  | 10.31 | 11.41 | 16.86 | 20.00 |
| PARZIALI TERRENO     | 4.64   | 1.67   | 1.87   | 0.85   | 2.40   | 0.52  | 2.80  | 5.25  | 5.25  | 2.62  | 1.04  | 1.40  | 1.10  | 5.45  | 3.14  |       |
| QUOTE TERRENO        | 11.17  | 11.16  | 10.92  | 10.86  | 10.81  | 11.22 | 11.42 | 11.83 | 11.96 | 11.83 | 11.55 | 11.99 | 11.96 | 11.94 | 11.89 | 11.75 |
| PROGRESSIVE PROGETTO |        |        |        |        |        |       |       | -5.25 | -3.75 | 0.00  | 3.75  | 5.25  |       |       |       |       |
| PARZIALI PROGETTO    |        |        |        |        |        |       |       | 1.50  | 3.75  | 3.75  | 1.50  |       |       |       |       |       |
| QUOTE PROGETTO       |        |        |        |        |        |       |       | 11.83 | 11.86 | 11.96 | 11.86 | 11.83 |       |       |       |       |





PROFILO ASSE EST-OVEST

SEZIONE 74

PROGRESSIVA 3550.00

BINDER  
 C1 0.84 mq.  
 BASE  
 D1 2.64 mq.  
 FONDAZIONE  
 E1 2.10 mq.  
 USURA  
 a1 10.50 ml.



200  
 200

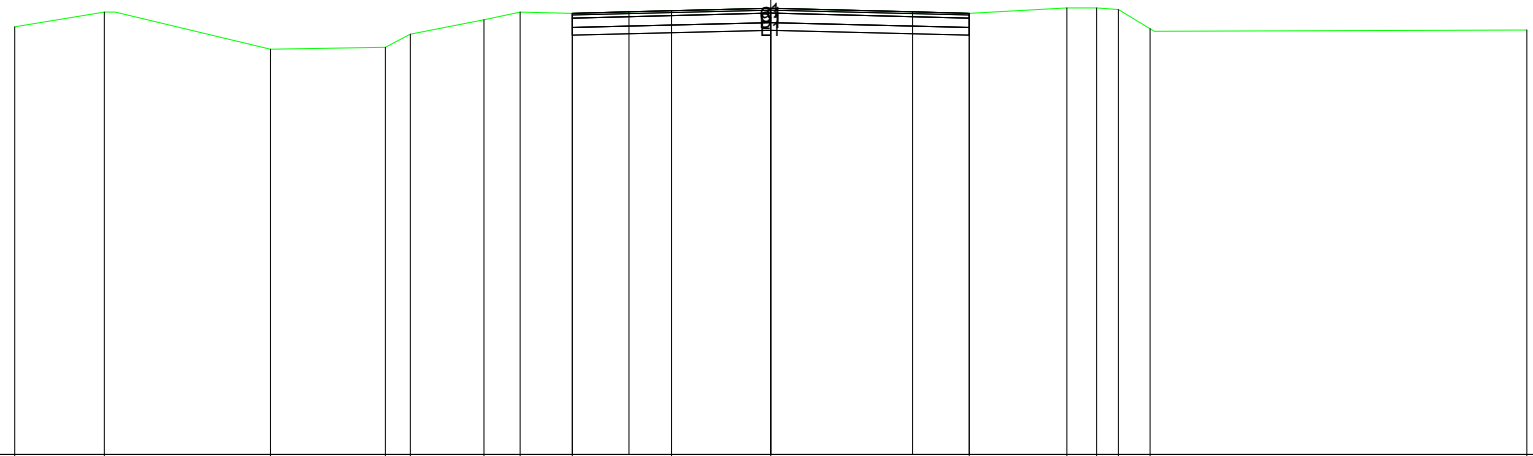

PROGRESSIVE  
 TERRENO

-20.00 -17.63 -13.24 -10.19 -9.53 -7.59 -6.63 -5.25 -2.63 0.00 5.25 7.83 8.62 9.20 10.03 20.00

PARZIALI  
 TERRENO

2.37 4.39 3.05 0.66 1.94 0.96 1.38 2.62 2.63 5.25 2.58 0.79 0.58 0.83 9.97

QUOTE  
 TERRENO

11.31 11.70 10.72 10.77 11.11 11.49 11.70 11.67 11.74 11.80 11.67 11.81 11.81 11.77 11.26 11.23

PROGRESSIVE  
 PROGETTO

-5.25 -3.75 0.00 3.75 5.25

PARZIALI  
 PROGETTO

1.50 3.75 3.75 1.50

QUOTE  
 PROGETTO

11.67 11.71 11.80 11.71 11.67

PROFILO ASSE EST-OVEST

SEZIONE 75

PROGRESSIVA 3600.00

|            |           |
|------------|-----------|
| RILEVATO   |           |
| A1         | 1.39 mq.  |
| A2         | 0.01 mq.  |
| Totale:    | 1.40 mq.  |
| STERRO     |           |
| B1         | 7.67 mq.  |
| BINDER     |           |
| C1         | 0.84 mq.  |
| BASE       |           |
| D1         | 2.62 mq.  |
| FONDAZIONE |           |
| E1         | 2.10 mq.  |
| SCOTICO    |           |
| SC1        | 0.21 mq.  |
| SC2        | 2.11 mq.  |
| Totale:    | 2.32 mq.  |
| USURA      |           |
| a1         | 10.50 ml. |
| VEGETALE   |           |
| b1         | 4.61 ml.  |

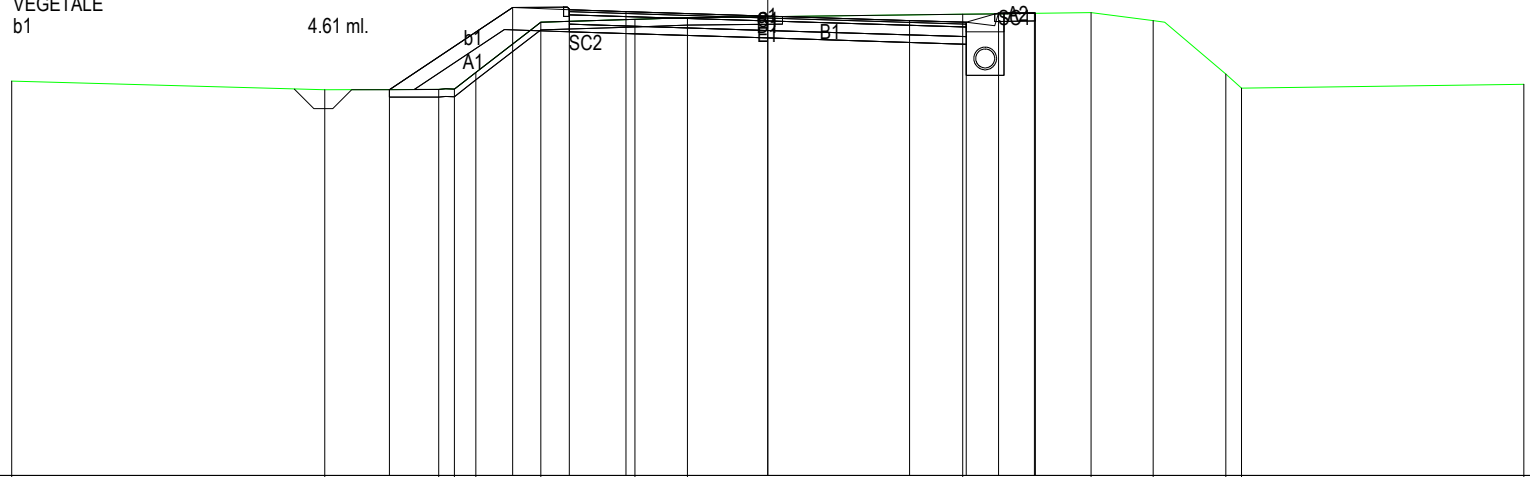

PROGRESSIVE TERRENO

|        |        |       |       |       |       |       |       |      |      |       |       |       |       |
|--------|--------|-------|-------|-------|-------|-------|-------|------|------|-------|-------|-------|-------|
| -20.00 | -11.72 | -8.70 | -8.29 | -7.72 | -6.01 | -3.52 | -2.13 | 5.15 | 8.55 | 10.20 | 12.11 | 12.53 | 20.00 |
|--------|--------|-------|-------|-------|-------|-------|-------|------|------|-------|-------|-------|-------|

PARZIALI TERRENO

|      |      |      |      |      |      |      |      |      |      |      |      |      |
|------|------|------|------|------|------|------|------|------|------|------|------|------|
| 8.28 | 3.02 | 0.41 | 0.57 | 1.71 | 2.49 | 1.39 | 7.28 | 3.40 | 1.65 | 1.91 | 0.42 | 7.47 |
|------|------|------|------|------|------|------|------|------|------|------|------|------|

QUOTE TERRENO

|       |       |       |       |       |       |       |       |       |       |       |       |       |       |
|-------|-------|-------|-------|-------|-------|-------|-------|-------|-------|-------|-------|-------|-------|
| 10.43 | 10.20 | 10.21 | 10.21 | 10.66 | 11.99 | 12.06 | 12.11 | 12.20 | 12.24 | 12.03 | 10.62 | 10.24 | 10.35 |
|-------|-------|-------|-------|-------|-------|-------|-------|-------|-------|-------|-------|-------|-------|

PROGRESSIVE PROGETTO

|        |       |       |       |      |      |      |      |      |      |
|--------|-------|-------|-------|------|------|------|------|------|------|
| -10.01 | -6.75 | -5.25 | -3.75 | 0.00 | 3.75 | 5.25 | 6.10 | 7.05 | 7.07 |
|--------|-------|-------|-------|------|------|------|------|------|------|

PARZIALI PROGETTO

|      |      |      |      |      |      |      |      |      |
|------|------|------|------|------|------|------|------|------|
| 3.26 | 1.50 | 1.50 | 3.75 | 3.75 | 1.50 | 0.85 | 0.95 | 0.02 |
|------|------|------|------|------|------|------|------|------|

QUOTE PROGETTO

|       |       |       |       |       |       |       |       |       |       |
|-------|-------|-------|-------|-------|-------|-------|-------|-------|-------|
| 10.21 | 12.38 | 12.32 | 12.27 | 12.15 | 12.03 | 11.99 | 12.24 | 12.24 | 12.22 |
|-------|-------|-------|-------|-------|-------|-------|-------|-------|-------|

PROFILO ASSE EST-OVEST

SEZIONE 76

PROGRESSIVA 3650.00

|            |           |
|------------|-----------|
| RILEVATO   |           |
| A1         | 0.62 mq.  |
| STERRO     |           |
| B1         | 2.92 mq.  |
| BINDER     |           |
| C1         | 0.84 mq.  |
| BASE       |           |
| D1         | 2.62 mq.  |
| FONDAZIONE |           |
| E1         | 2.10 mq.  |
| SCOTICO    |           |
| SC1        | 3.20 mq.  |
| USURA      |           |
| a1         | 10.50 ml. |
| VEGETALE   |           |
| b1         | 1.59 ml.  |
| b2         | 3.59 ml.  |
| Totale:    | 5.18 ml.  |

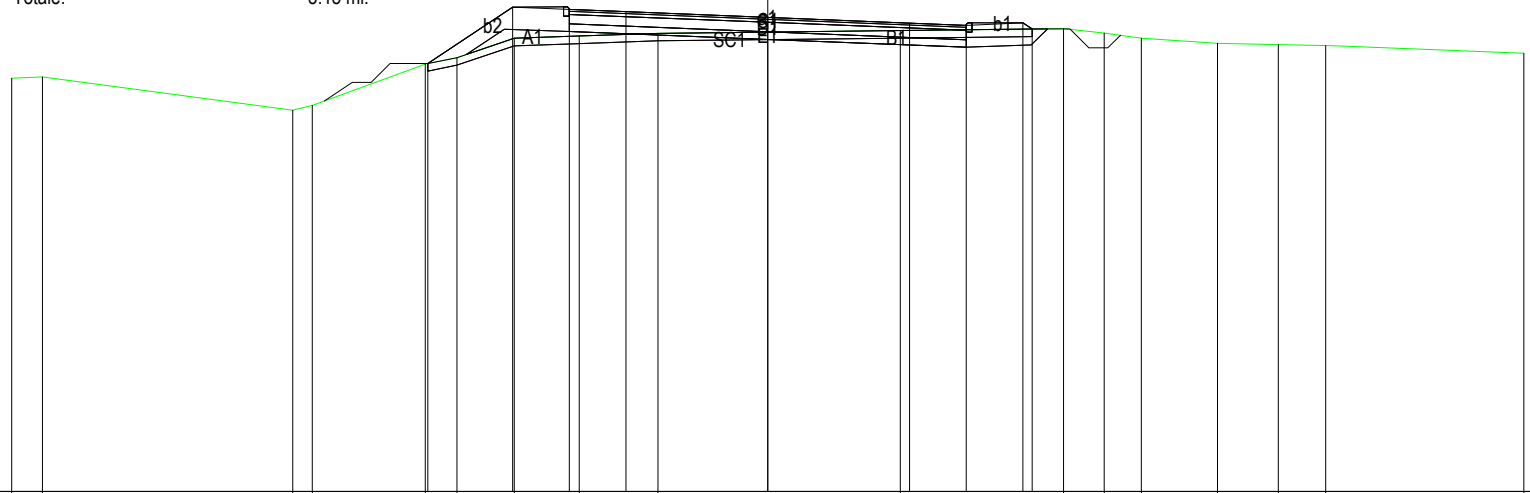

0  
200  
200

|                      |        |        |        |        |       |       |       |       |       |       |       |       |       |       |       |       |       |
|----------------------|--------|--------|--------|--------|-------|-------|-------|-------|-------|-------|-------|-------|-------|-------|-------|-------|-------|
| PROGRESSIVE TERRENO  | -20.00 | -19.19 | -12.57 | -12.05 | -9.06 | -8.22 | -6.70 | -4.99 | -2.90 | 3.50  | 7.82  | 8.90  | 9.88  | 11.89 | 13.51 | 14.76 | 20.00 |
| PARZIALI TERRENO     | 0.81   | 6.62   | 0.52   | 2.99   | 0.84  | 1.52  | 1.71  | 2.09  | 6.40  | 4.32  | 1.08  | 0.98  | 2.01  | 1.62  | 1.25  | 5.24  |       |
| QUOTE TERRENO        | 10.93  | 10.97  | 10.09  | 10.21  | 11.30 | 11.47 | 11.99 | 12.04 | 12.12 | 12.19 | 12.24 | 12.13 | 11.99 | 11.85 | 11.82 | 11.80 | 11.59 |
| PROGRESSIVE PROGETTO |        |        |        |        | -8.99 | -6.75 | -5.25 | -3.75 | 0.00  | 3.75  | 5.25  | 6.75  | 6.99  |       |       |       |       |
| PARZIALI PROGETTO    |        |        |        |        | 2.24  | 1.50  | 1.50  | 3.75  | 3.75  | 1.50  | 1.50  | 0.24  |       |       |       |       |       |
| QUOTE PROGETTO       |        |        |        |        | 11.32 | 12.81 | 12.75 | 12.69 | 12.54 | 12.39 | 12.33 | 12.39 | 12.23 |       |       |       |       |

PROFILO ASSE EST-OVEST

SEZIONE 77

PROGRESSIVA 3700.00

|            |           |
|------------|-----------|
| RILEVATO   |           |
| A1         | 10.78 mq. |
| BINDER     |           |
| C1         | 0.84 mq.  |
| BASE       |           |
| D1         | 2.62 mq.  |
| FONDAZIONE |           |
| E1         | 2.10 mq.  |
| SCOTICO    |           |
| SC1        | 3.60 mq.  |
| USURA      |           |
| a1         | 10.50 ml. |
| VEGETALE   |           |
| b1         | 3.31 ml.  |
| b2         | 3.98 ml.  |
| Totale:    | 7.29 ml.  |

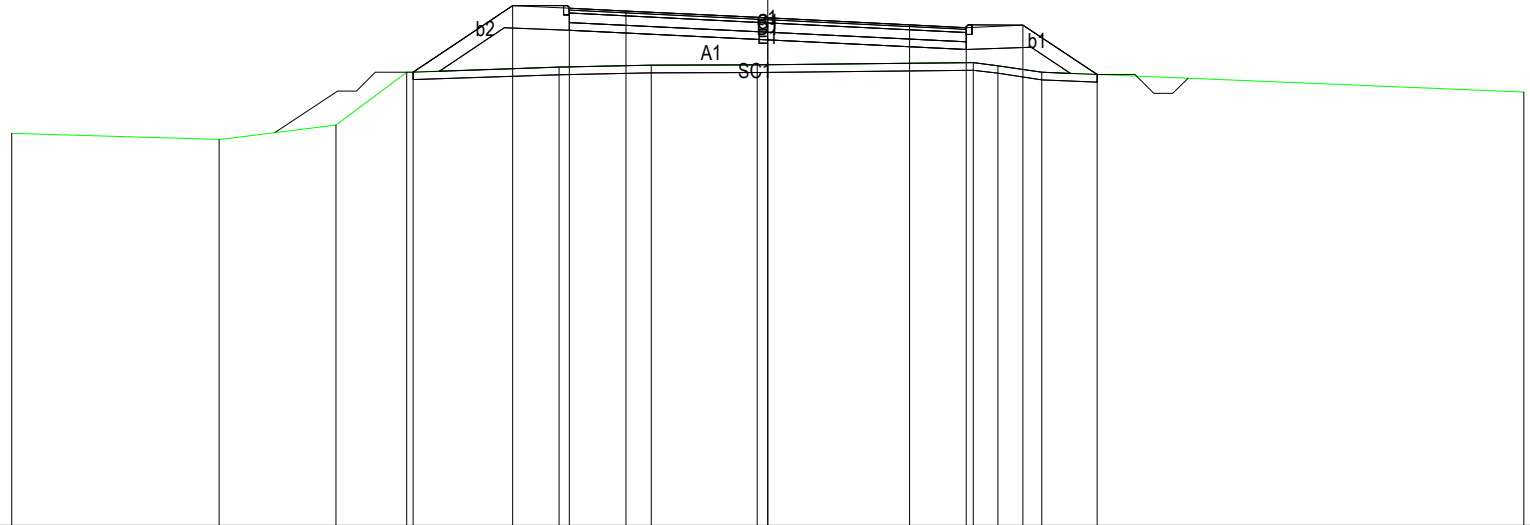

200  
200

|                      |        |        |        |       |       |       |       |       |       |       |       |       |
|----------------------|--------|--------|--------|-------|-------|-------|-------|-------|-------|-------|-------|-------|
| PROGRESSIVE TERRENO  | -20.00 | -14.51 | -11.42 | -9.55 | -5.52 | -3.08 | -0.28 | 5.43  | 6.09  | 7.25  | 20.00 |       |
| PARZIALI TERRENO     |        | 5.49   | 3.09   | 1.87  | 4.03  | 2.44  | 2.80  | 5.71  | 0.66  | 1.16  | 12.75 |       |
| QUOTE TERRENO        | 10.37  | 10.21  | 10.59  | 11.99 | 12.12 | 12.17 | 12.18 | 12.24 | 12.16 | 11.99 | 11.46 |       |
| PROGRESSIVE PROGETTO |        |        |        | -9.38 | -6.75 | -5.25 | -3.75 | 0.00  | 3.75  | 5.25  | 6.75  | 8.71  |
| PARZIALI PROGETTO    |        |        |        |       | 2.63  | 1.50  | 1.50  | 3.75  | 3.75  | 1.50  | 1.50  | 1.96  |
| QUOTE PROGETTO       |        |        |        | 11.99 | 13.75 | 13.68 | 13.61 | 13.43 | 13.24 | 13.17 | 13.23 | 11.93 |

PROFILO ASSE EST-OVEST

SEZIONE 78

PROGRESSIVA 3750.00

|            |           |
|------------|-----------|
| RILEVATO   |           |
| A1         | 41.15 mq. |
| BINDER     |           |
| C1         | 0.84 mq.  |
| BASE       |           |
| D1         | 2.62 mq.  |
| FONDAZIONE |           |
| E1         | 2.11 mq.  |
| SCOTICO    |           |
| SC1        | 4.54 mq.  |
| USURA      |           |
| a1         | 10.50 ml. |
| VEGETALE   |           |
| b1         | 6.82 ml.  |
| b2         | 5.15 ml.  |
| Totale:    | 11.97 ml. |

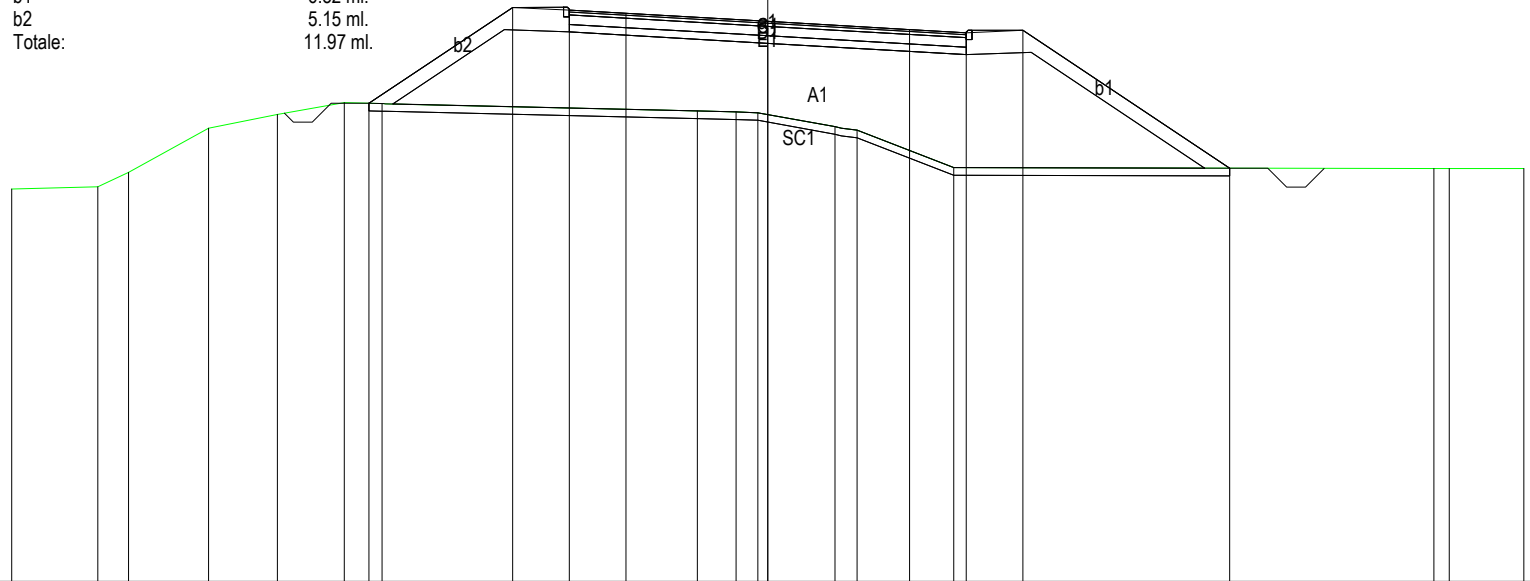

200 200

|                      |        |        |        |        |        |        |        |       |       |       |       |       |       |       |       |       |
|----------------------|--------|--------|--------|--------|--------|--------|--------|-------|-------|-------|-------|-------|-------|-------|-------|-------|
| PROGRESSIVE TERRENO  | -20.00 | -17.72 | -16.91 | -14.80 | -12.97 | -11.20 | -10.21 | -1.87 | -0.84 | -0.27 | 1.77  | 2.36  | 4.92  | 17.62 | 18.02 | 20.00 |
| PARZIALI TERRENO     | 2.28   | 0.81   | 2.11   | 1.83   | 1.77   | 0.99   | 8.34   | 1.03  | 0.57  | 2.04  | 0.59  | 2.56  | 12.70 | 0.40  | 1.98  |       |
| QUOTE TERRENO        | 10.38  | 10.44  | 10.82  | 11.99  | 12.36  | 12.66  | 12.64  | 12.44 | 12.42 | 12.40 | 12.03 | 11.93 | 10.94 | 10.92 | 10.92 | 10.92 |
| PROGRESSIVE PROGETTO |        |        |        |        |        | -10.55 | -6.75  | -5.25 | -3.75 | 0.00  | 3.75  | 5.25  | 6.75  | 12.22 |       |       |
| PARZIALI PROGETTO    |        |        |        |        |        | 3.80   | 1.50   | 1.50  | 3.75  | 3.75  | 1.50  | 1.50  | 5.47  |       |       |       |
| QUOTE PROGETTO       |        |        |        |        |        | 12.65  | 15.18  | 15.11 | 15.03 | 14.81 | 14.60 | 14.51 | 14.58 | 10.93 |       |       |

PROFILO ASSE EST-OVEST

SEZIONE 79

PROGRESSIVA 3800.00

- RILEVATO
- A1 77.31 mq.
- BINDER
- C1 0.84 mq.
- BASE
- D1 2.63 mq.
- FONDAZIONE
- E1 2.10 mq.
- SCOTICO
- SC1 5.33 mq.
- USURA
- a1 10.50 ml.
- VEGETALE
- b1 9.15 ml.
- b2 6.67 ml.
- Totale: 15.82 ml.

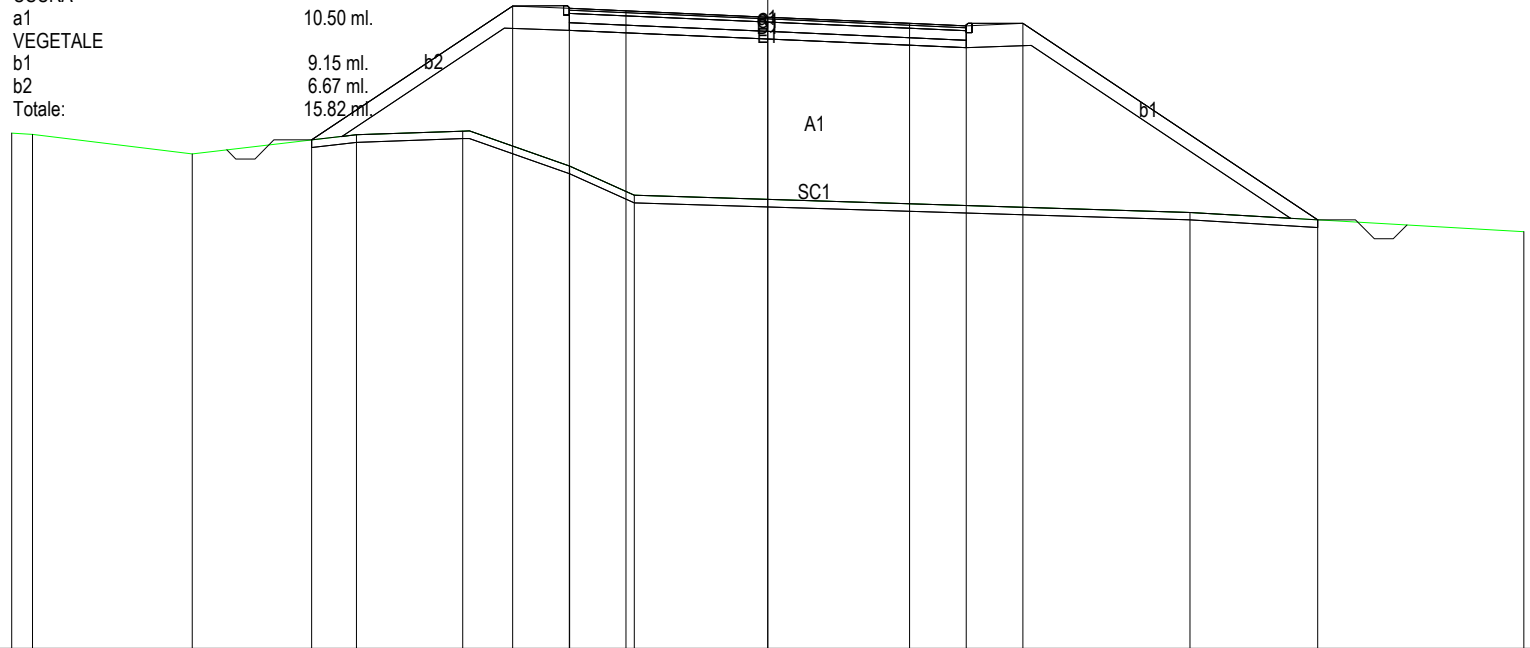

200  
200

PROGRESSIVE  
TERRENO

-20.00 -19.45 -15.23 -10.88 -8.07 -5.24 -3.53 11.17 20.00

PARZIALI  
TERRENO

0.55 4.22 4.35 2.81 2.83 1.71 14.70 8.83

QUOTE  
TERRENO

13.63 13.60 13.08 13.59 13.68 12.76 11.99 11.53 11.02

PROGRESSIVE  
PROGETTO

-12.07 -6.75 -5.25 -3.75 0.00 3.75 5.25 6.75 14.55

PARZIALI  
PROGETTO

5.32 1.50 1.50 3.75 3.75 1.50 1.50 7.80

QUOTE  
PROGETTO

13.45 17.00 16.93 16.86 16.70 16.54 16.47 16.53 11.34





PROFILO ASSE EST-OVEST

SEZIONE 81

PROGRESSIVA 3900.00

USURA  
a1 10.50 ml.  
BINDER  
C1 0.83 mq.

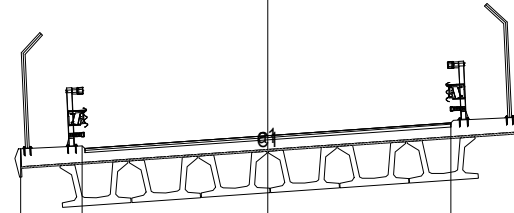

3

200  
200

|                      |        |        |        |        |        |        |       |       |       |       |       |       |       |
|----------------------|--------|--------|--------|--------|--------|--------|-------|-------|-------|-------|-------|-------|-------|
| PROGRESSIVE TERRENO  | -20.00 | -17.87 | -15.95 | -14.04 | -11.82 | -10.06 | -9.18 | -7.51 | -6.00 | -4.72 | 0.36  | 3.57  | 20.00 |
| PARZIALI TERRENO     | 2.13   | 1.92   | 1.91   | 2.22   | 1.76   | 0.88   | 1.67  | 1.51  | 1.28  | 5.08  | 3.21  | 16.43 |       |
| QUOTE TERRENO        | 19.03  | 19.04  | 17.99  | 17.06  | 15.99  | 14.69  | 13.99 | 12.96 | 11.99 | 11.91 | 11.60 | 11.41 | 10.14 |
| PROGRESSIVE PROGETTO |        |        |        |        |        |        |       |       | -6.54 | -4.91 |       | 4.84  | 6.54  |
| PARZIALI PROGETTO    |        |        |        |        |        |        |       |       | 1.63  |       | 9.75  | 1.70  |       |
| QUOTE PROGETTO       |        |        |        |        |        |        |       |       | 20.90 | 20.97 |       | 21.58 | 21.73 |

PROFILO ASSE EST-OVEST

SEZIONE 82

PROGRESSIVA 3950.00

USURA  
a1  
BINDER  
C1

10.50 ml.

0.83 mq.

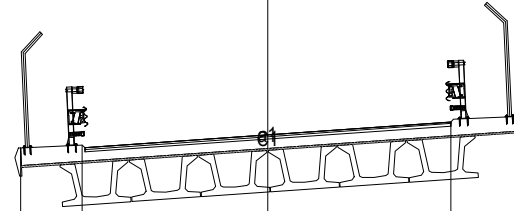

3

200  
200

|                      |        |        |        |        |        |  |        |        |       |       |       |       |  |       |       |       |       |       |       |       |       |  |       |  |       |
|----------------------|--------|--------|--------|--------|--------|--|--------|--------|-------|-------|-------|-------|--|-------|-------|-------|-------|-------|-------|-------|-------|--|-------|--|-------|
| PROGRESSIVE TERRENO  | -20.27 | -19.07 | -17.60 | -17.40 | -16.38 |  | -12.30 | -11.29 | -9.70 | -7.27 | -6.71 | -6.27 |  | -3.05 | -2.26 | -1.34 | -0.07 | 2.73  | 4.92  |       | 9.13  |  | 12.97 |  | 20.00 |
| PARZIALI TERRENO     | 1.20   | 1.47   | 0.20   | 1.02   | 4.08   |  | 1.01   | 1.59   | 2.43  | 0.56  | 0.44  | 3.22  |  | 0.79  | 0.92  | 1.27  | 2.80  | 2.19  | 4.21  |       | 3.84  |  | 7.03  |  |       |
| QUOTE TERRENO        | 21.53  | 21.51  | 13.07  | 11.56  | 11.48  |  | 11.36  | 11.32  | 11.26 | 11.11 | 11.09 | 11.06 |  | 10.96 | 10.92 | 10.90 | 10.87 | 11.49 | 11.99 |       | 12.22 |  | 12.43 |  | 12.93 |
| PROGRESSIVE PROGETTO |        |        |        |        |        |  |        |        |       | -6.54 | -4.91 |       |  |       |       |       |       |       | 4.84  | 6.54  |       |  |       |  |       |
| PARZIALI PROGETTO    |        |        |        |        |        |  |        |        |       | 1.63  |       |       |  | 9.75  |       |       |       |       | 1.70  |       |       |  |       |  |       |
| QUOTE PROGETTO       |        |        |        |        |        |  |        |        |       | 21.88 | 21.95 |       |  |       |       |       |       |       | 22.56 | 22.70 |       |  |       |  |       |

PROFILO ASSE EST-OVEST

SEZIONE 83

PROGRESSIVA 4000.00

USURA  
a1 10.50 ml.  
BINDER  
C1 0.83 mq.

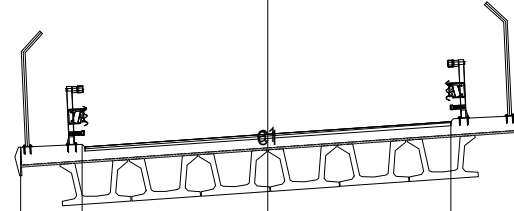

3

200  
200

|                      |        |        |        |        |       |       |       |       |       |       |       |       |       |       |       |
|----------------------|--------|--------|--------|--------|-------|-------|-------|-------|-------|-------|-------|-------|-------|-------|-------|
| PROGRESSIVE TERRENO  | -20.00 | -17.11 | -14.70 | -10.92 | -9.06 | -7.51 | -5.75 | -5.38 | -4.88 | -1.69 | 0.29  | 0.75  | 1.35  | 10.78 | 20.00 |
| PARZIALI TERRENO     | 2.89   | 2.41   | 3.78   | 1.86   | 1.55  | 1.76  | 0.37  | 0.50  | 3.19  | 1.98  | 0.46  | 0.60  | 9.43  | 9.22  |       |
| QUOTE TERRENO        | 21.25  | 21.31  | 19.99  | 17.99  | 16.93 | 15.99 | 14.48 | 14.16 | 13.82 | 11.99 | 10.89 | 10.63 | 10.27 | 10.29 | 10.31 |
| PROGRESSIVE PROGETTO |        |        |        |        |       |       | -6.54 | -4.91 |       |       |       |       | 4.84  | 6.54  |       |
| PARZIALI PROGETTO    |        |        |        |        |       |       | 1.63  |       | 9.75  |       |       |       | 1.70  |       |       |
| QUOTE PROGETTO       |        |        |        |        |       |       | 21.60 | 21.67 |       |       |       |       | 22.28 | 22.43 |       |

PROFILO ASSE EST-OVEST

SEZIONE 84

PROGRESSIVA 4050.00

USURA  
a1 10.50 ml.  
BINDER  
C1 0.83 mq.

2  
200 200

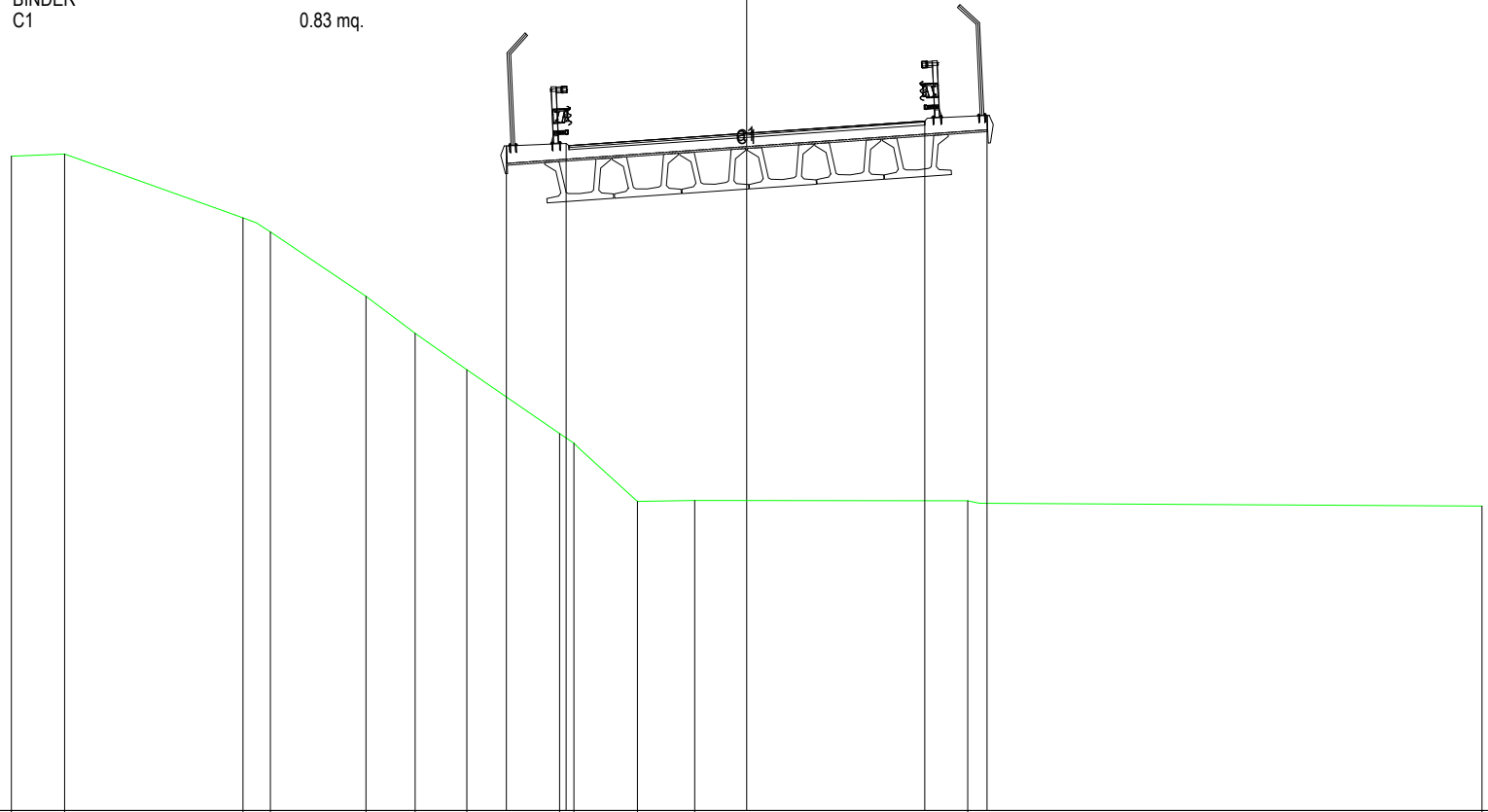

|                      |        |        |        |        |        |       |       |       |       |       |       |       |       |
|----------------------|--------|--------|--------|--------|--------|-------|-------|-------|-------|-------|-------|-------|-------|
| PROGRESSIVE TERRENO  | -20.00 | -18.55 | -13.70 | -12.96 | -10.36 | -9.02 | -7.62 | -5.09 | -4.70 | -2.98 | -1.42 | 6.01  | 20.00 |
| PARZIALI TERRENO     | 1.45   | 4.85   | 0.74   | 2.60   | 1.34   | 1.40  | 2.53  | 0.39  | 1.72  | 1.56  | 7.43  | 13.99 |       |
| QUOTE TERRENO        | 19.80  | 19.85  | 18.12  | 17.74  | 15.99  | 14.98 | 13.99 | 12.25 | 11.99 | 10.41 | 10.44 | 10.42 | 10.28 |
| PROGRESSIVE PROGETTO |        |        |        |        |        |       | -6.54 | -4.91 |       |       | 4.84  | 6.54  |       |
| PARZIALI PROGETTO    |        |        |        |        |        |       | 1.63  | 9.75  |       | 1.70  |       |       |       |
| QUOTE PROGETTO       |        |        |        |        |        |       | 20.08 | 20.15 |       | 20.76 | 20.90 |       |       |

PROFILO ASSE EST-OVEST

SEZIONE 85

PROGRESSIVA 4116.00

|            |           |
|------------|-----------|
| RILEVATO   |           |
| A1         | 95.21 mq. |
| BINDER     |           |
| C1         | 0.84 mq.  |
| BASE       |           |
| D1         | 2.64 mq.  |
| FONDAZIONE |           |
| E1         | 2.10 mq.  |
| SCOTICO    |           |
| SC1        | 2.70 mq.  |
| USURA      |           |
| a1         | 10.50 ml. |
| VEGETALE   |           |
| b1         | 1.35 ml.  |
| b2         | 1.35 ml.  |
| Totale:    | 2.70 ml.  |

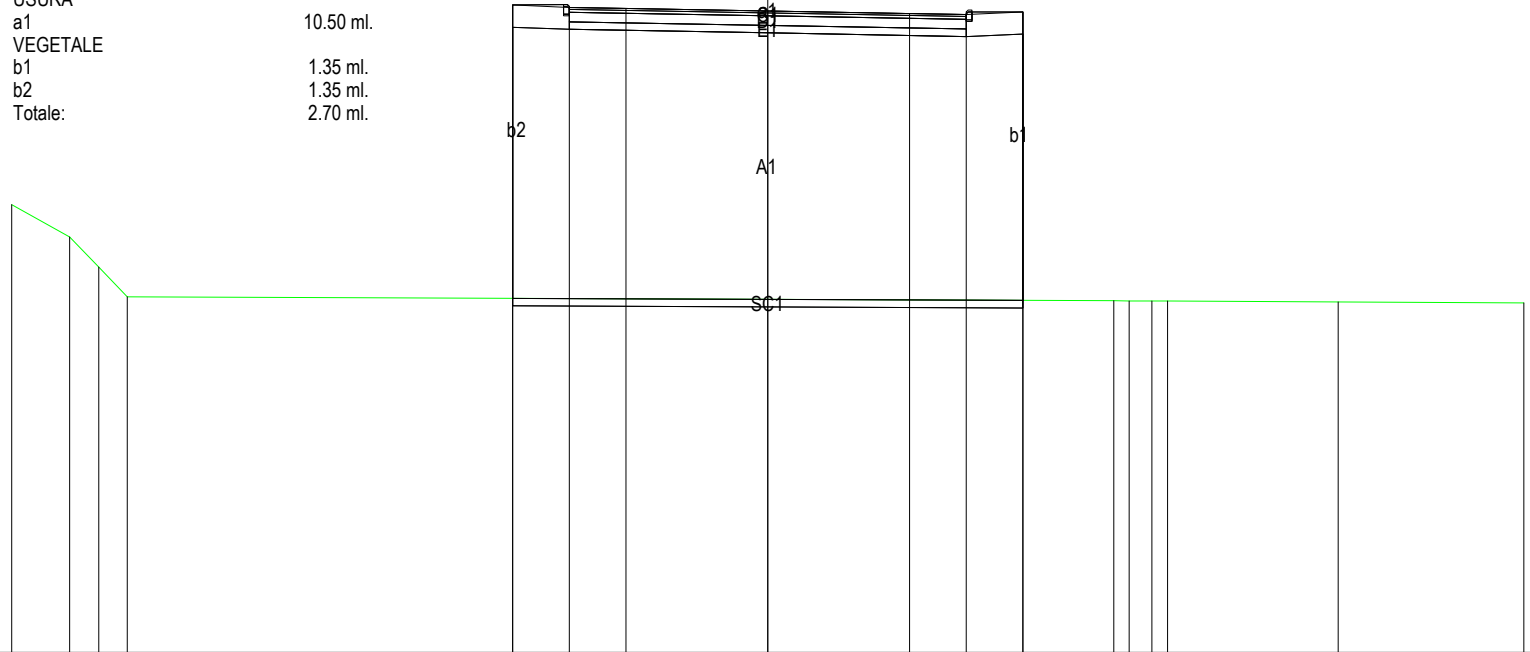

200  
200

|                      |        |        |        |        |       |       |  |       |       |       |       |       |       |       |       |       |
|----------------------|--------|--------|--------|--------|-------|-------|--|-------|-------|-------|-------|-------|-------|-------|-------|-------|
| PROGRESSIVE TERRENO  | -20.00 | -18.47 | -17.70 | -16.95 |       |       |  |       | 9.15  | 9.56  | 10.16 | 10.57 |       | 15.09 |       | 20.00 |
| PARZIALI TERRENO     | 1.53   | 0.77   | 0.75   |        | 26.10 |       |  | 0.41  | 0.60  | 0.41  |       | 4.52  |       | 4.91  |       |       |
| QUOTE TERRENO        | 12.84  | 11.99  | 11.19  | 10.41  |       |       |  | 10.30 | 10.30 | 10.30 | 10.30 |       | 10.27 |       | 10.25 |       |
| PROGRESSIVE PROGETTO |        | -6.75  | -6.75  | -5.25  | -3.75 | 0.00  |  | 3.75  | 5.25  | 6.75  | 6.75  |       |       |       |       |       |
| PARZIALI PROGETTO    |        | 1.50   | 1.50   | 3.75   |       | 3.75  |  | 1.50  | 1.50  |       |       |       |       |       |       |       |
| QUOTE PROGETTO       | 18.13  | 10.37  | 18.06  | 18.04  |       | 17.97 |  | 17.90 | 17.87 | 10.31 | 17.94 |       |       |       |       |       |

PROFILO ASSE EST-OVEST

SEZIONE 86

PROGRESSIVA 4150.00

|            |            |
|------------|------------|
| RILEVATO   |            |
| A1         | 101.40 mq. |
| BINDER     |            |
| C1         | 0.84 mq.   |
| BASE       |            |
| D1         | 2.62 mq.   |
| FONDAZIONE |            |
| E1         | 2.10 mq.   |
| SCOTICO    |            |
| SC1        | 5.94 mq.   |
| USURA      |            |
| a1         | 10.50 ml.  |
| VEGETALE   |            |
| b1         | 9.15 ml.   |
| b2         | 9.76 ml.   |
| Totale:    | 18.91 mb2  |

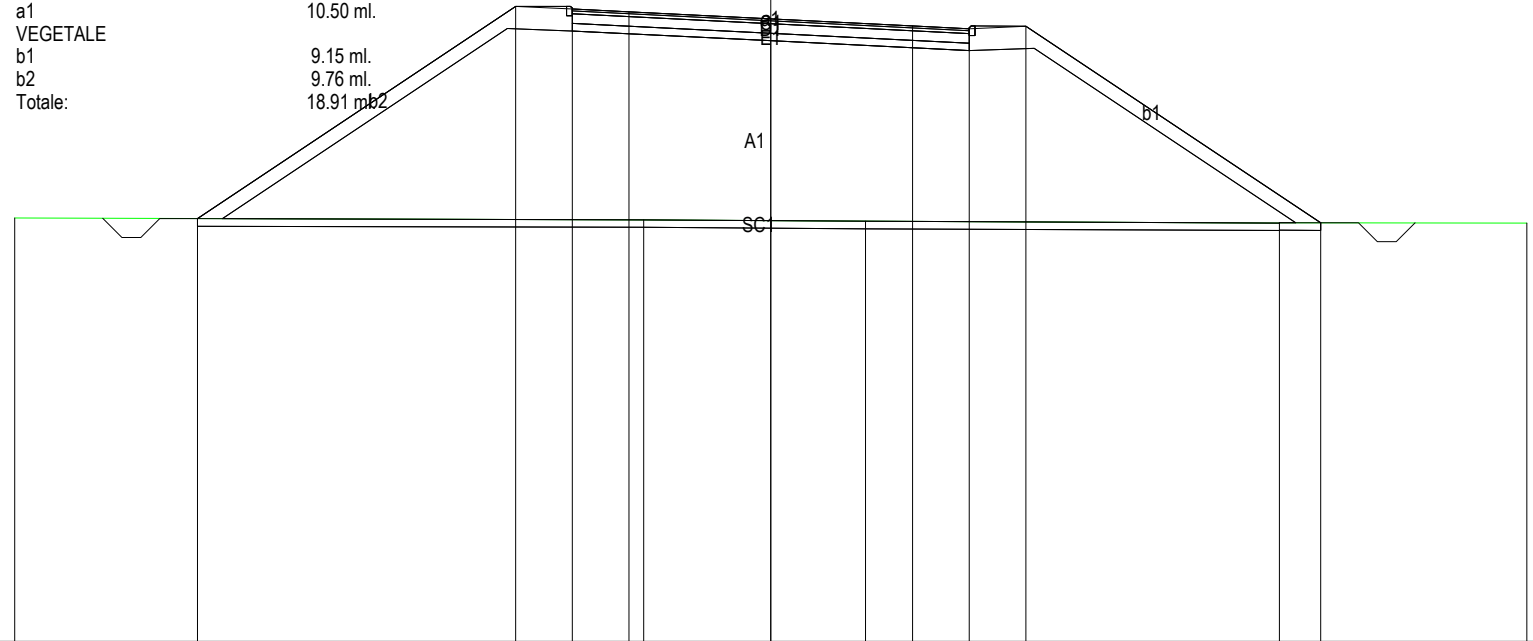

200  
200

|                      |        |        |       |       |       |       |       |       |       |       |       |
|----------------------|--------|--------|-------|-------|-------|-------|-------|-------|-------|-------|-------|
| PROGRESSIVE TERRENO  | -20.00 |        |       | -3.36 |       | 2.51  |       |       | 13.45 |       | 20.00 |
| PARZIALI TERRENO     |        | 16.64  |       |       | 5.87  |       | 10.94 |       |       | 6.55  |       |
| QUOTE TERRENO        | 10.20  |        |       | 10.15 |       | 10.12 |       | 10.07 |       | 10.07 |       |
| PROGRESSIVE PROGETTO |        | -15.16 |       | -6.75 | -5.25 | -3.75 | 0.00  | 3.75  | 5.25  | 6.75  | 14.55 |
| PARZIALI PROGETTO    |        | 8.41   | 1.50  | 1.50  | 3.75  | 3.75  | 1.50  | 1.50  | 7.80  |       |       |
| QUOTE PROGETTO       | 10.18  |        | 15.79 | 15.73 | 15.65 | 15.47 | 15.28 | 15.21 | 15.27 | 10.07 |       |

PROFILO ASSE EST-OVEST

SEZIONE 87

PROGRESSIVA 4200.00

|            |           |
|------------|-----------|
| RILEVATO   |           |
| A1         | 40.59 mq. |
| BINDER     |           |
| C1         | 0.84 mq.  |
| BASE       |           |
| D1         | 2.62 mq.  |
| FONDAZIONE |           |
| E1         | 2.10 mq.  |
| SCOTICO    |           |
| SC1        | 4.49 mq.  |
| USURA      |           |
| a1         | 10.50 ml. |
| VEGETALE   |           |
| b1         | 5.29 ml.  |
| b2         | 6.24 ml.  |
| Totale:    | 11.53 ml. |

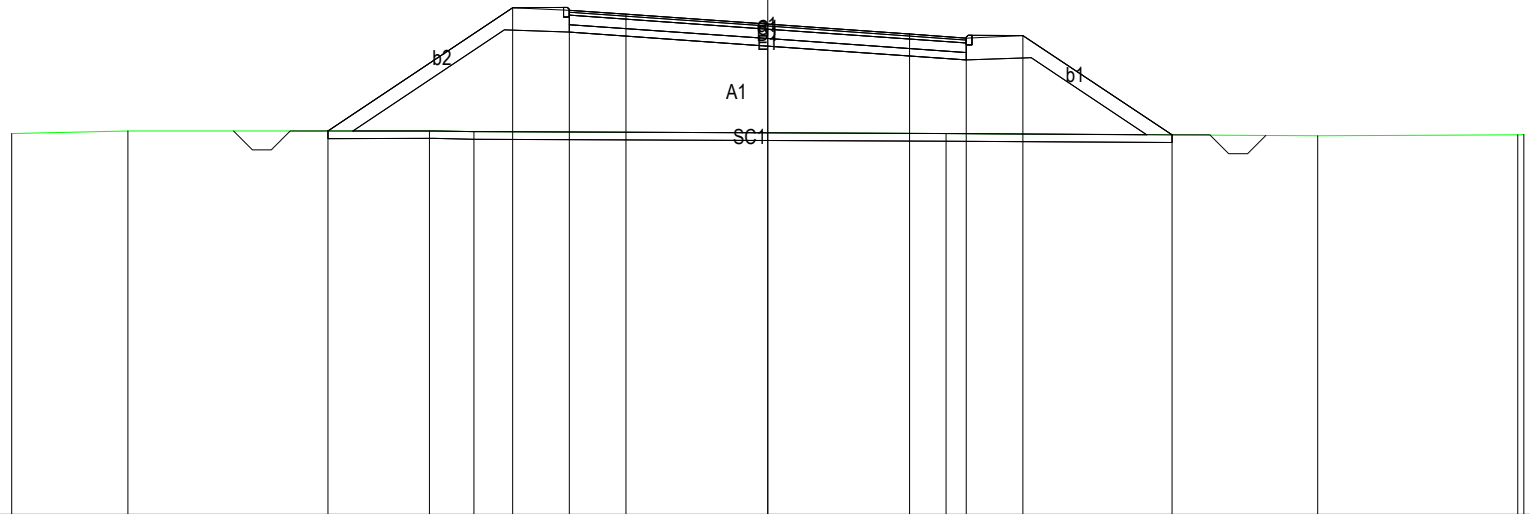

0  
200  
200

|                      |        |        |        |       |       |       |       |       |       |       |       |       |       |
|----------------------|--------|--------|--------|-------|-------|-------|-------|-------|-------|-------|-------|-------|-------|
| PROGRESSIVE TERRENO  | -20.00 | -16.93 |        | -8.95 | -7.77 |       |       |       | 4.72  |       | 14.55 | 19.84 | 20.00 |
| PARZIALI TERRENO     |        | 3.07   | 7.98   | 1.18  |       | 12.49 |       |       |       | 9.83  |       | 5.29  | 0.16  |
| QUOTE TERRENO        | 10.08  | 10.14  |        | 10.15 | 10.13 |       |       |       | 10.07 |       | 10.02 | 10.05 | 10.05 |
| PROGRESSIVE PROGETTO |        |        | -11.64 |       | -6.75 | -5.25 | -3.75 | 0.00  | 3.75  | 5.25  | 6.75  |       | 10.69 |
| PARZIALI PROGETTO    |        |        |        | 4.89  | 1.50  | 1.50  | 3.75  |       | 3.75  | 1.50  | 1.50  | 3.94  |       |
| QUOTE PROGETTO       |        |        | 10.14  |       | 13.40 | 13.34 | 13.23 | 12.97 | 12.71 | 12.60 | 12.67 |       | 10.04 |

PROFILO ASSE EST-OVEST

SEZIONE 88

PROGRESSIVA 4250.00

|            |           |
|------------|-----------|
| RILEVATO   |           |
| A1         | 8.22 mq.  |
| BINDER     |           |
| C1         | 0.84 mq.  |
| BASE       |           |
| D1         | 2.63 mq.  |
| FONDAZIONE |           |
| E1         | 2.10 mq.  |
| SCOTICO    |           |
| SC1        | 3.36 mq.  |
| USURA      |           |
| a1         | 10.50 ml. |
| VEGETALE   |           |
| b1         | 2.85 ml.  |
| b2         | 3.23 ml.  |
| Totale:    | 6.08 ml.  |

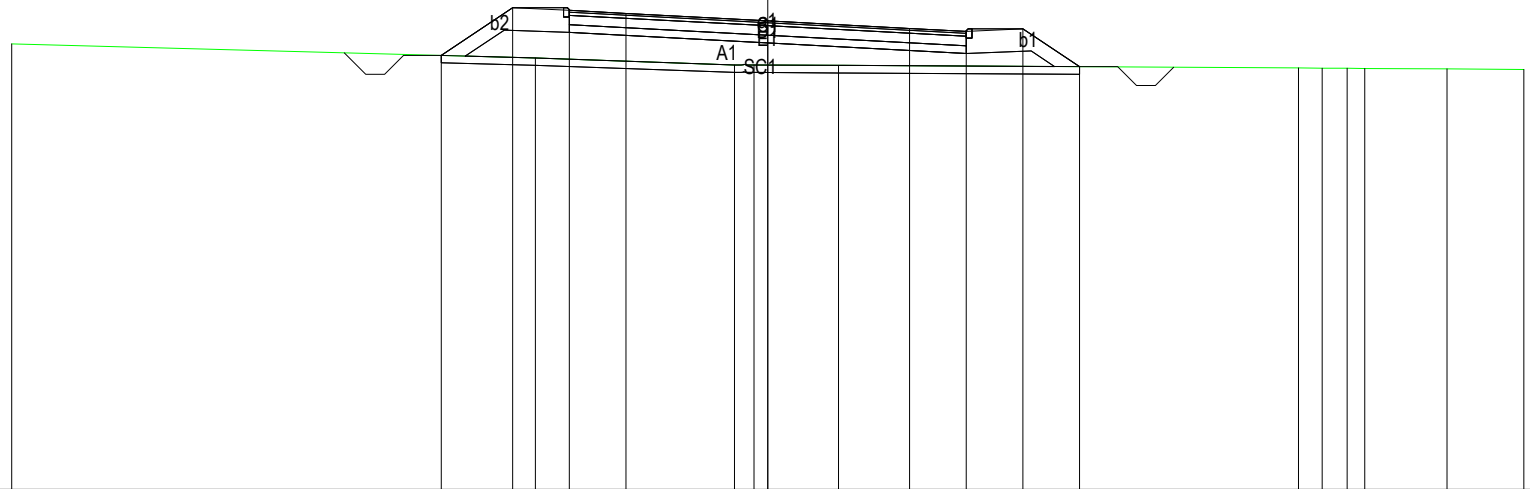

200  
200

|                      |        |       |       |       |       |       |       |       |       |       |       |
|----------------------|--------|-------|-------|-------|-------|-------|-------|-------|-------|-------|-------|
| PROGRESSIVE TERRENO  | -20.00 | -6.15 | -0.88 | -0.36 | 1.87  | 14.04 | 14.66 | 15.32 | 15.79 | 17.97 | 20.00 |
| PARZIALI TERRENO     | 13.85  | 5.27  | 0.52  | 2.23  | 12.17 | 0.62  | 0.66  | 0.47  | 2.18  | 2.03  |       |
| QUOTE TERRENO        | 10.78  | 10.42 | 10.23 | 10.23 | 10.22 | 10.15 | 10.14 | 10.14 | 10.14 | 10.12 | 10.11 |
| PROGRESSIVE PROGETTO |        | -8.63 | -6.75 | -5.25 | -3.75 | 0.00  | 3.75  | 5.25  | 6.75  | 8.25  |       |
| PARZIALI PROGETTO    |        | 1.88  | 1.50  | 1.50  | 3.75  | 3.75  | 1.50  | 1.50  | 1.50  |       |       |
| QUOTE PROGETTO       |        | 10.48 | 11.74 | 11.67 | 11.59 | 11.39 | 11.20 | 11.12 | 11.18 | 10.18 |       |



PROFILO ASSE EST-OVEST

SEZIONE 89

PROGRESSIVA 4300.00

|            |           |
|------------|-----------|
| RILEVATO   |           |
| A1         | 0.15 mq.  |
| STERRO     |           |
| B1         | 6.94 mq.  |
| BINDER     |           |
| C1         | 0.84 mq.  |
| BASE       |           |
| D1         | 2.63 mq.  |
| FONDAZIONE |           |
| E1         | 2.09 mq.  |
| SCOTICO    |           |
| SC1        | 0.35 mq.  |
| SC2        | 2.01 mq.  |
| Totale:    | 2.36 mq.  |
| USURA      |           |
| a1         | 10.50 ml. |
| VEGETALE   |           |
| b1         | 1.89 ml.  |

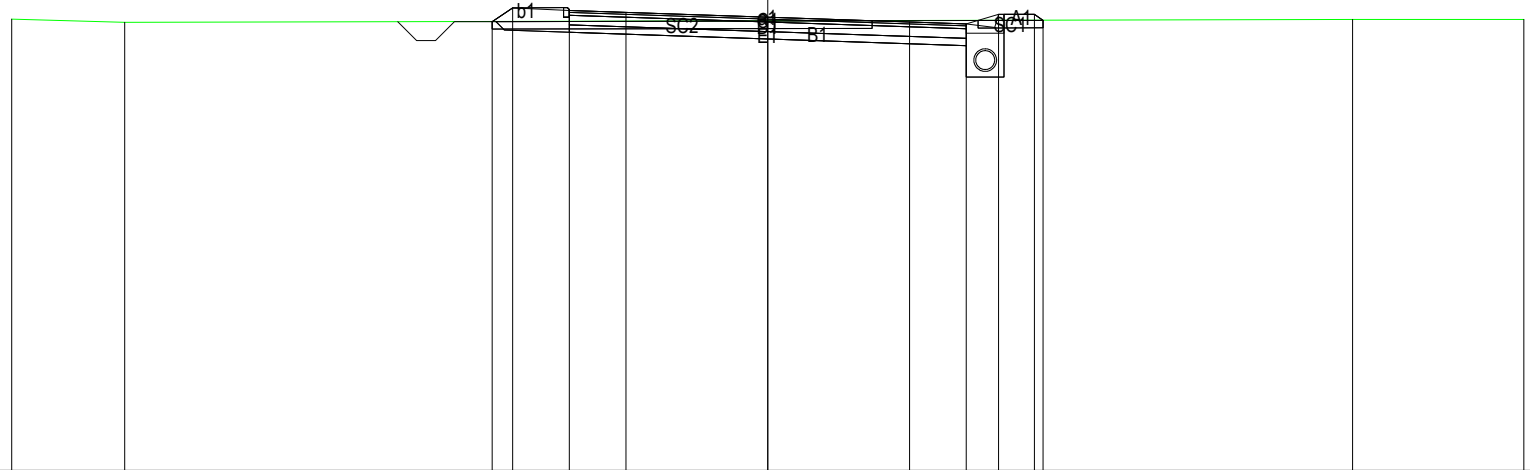

200  
200

|                      |        |        |       |       |       |       |       |       |       |       |       |       |
|----------------------|--------|--------|-------|-------|-------|-------|-------|-------|-------|-------|-------|-------|
| PROGRESSIVE TERRENO  | -20.00 | -17.02 |       |       |       |       |       |       | 15.47 | 20.00 |       |       |
| PARZIALI TERRENO     | 2.98   |        |       |       | 32.49 |       |       |       | 4.53  |       |       |       |
| QUOTE TERRENO        | 10.93  | 10.85  |       |       |       |       |       |       | 10.93 | 10.93 |       |       |
| PROGRESSIVE PROGETTO |        |        | -7.29 | -6.75 | -5.25 | -3.75 | 0.00  | 3.75  | 5.25  | 6.10  | 7.05  | 7.28  |
| PARZIALI PROGETTO    |        |        | 0.54  | 1.50  | 1.50  | 3.75  | 3.75  | 1.50  | 0.85  | 0.95  | 0.23  |       |
| QUOTE PROGETTO       |        |        | 10.87 | 11.23 | 11.17 | 11.12 | 10.99 | 10.86 | 10.81 | 11.06 | 11.06 | 10.91 |

PROFILO ASSE EST-OVEST

SEZIONE 90

PROGRESSIVA 4328.95

|            |           |
|------------|-----------|
| RILEVATO   |           |
| A1         | 0.11 mq.  |
| A2         | 0.09 mq.  |
| Totale:    | 0.20 mq.  |
| STERRO     |           |
| B1         | 9.87 mq.  |
| BINDER     |           |
| C1         | 0.84 mq.  |
| BASE       |           |
| D1         | 2.62 mq.  |
| FONDAZIONE |           |
| E1         | 2.10 mq.  |
| SCOTICO    |           |
| SC1        | 0.29 mq.  |
| SC2        | 0.30 mq.  |
| Totale:    | 0.59 mq.  |
| USURA      |           |
| a1         | 10.50 ml. |

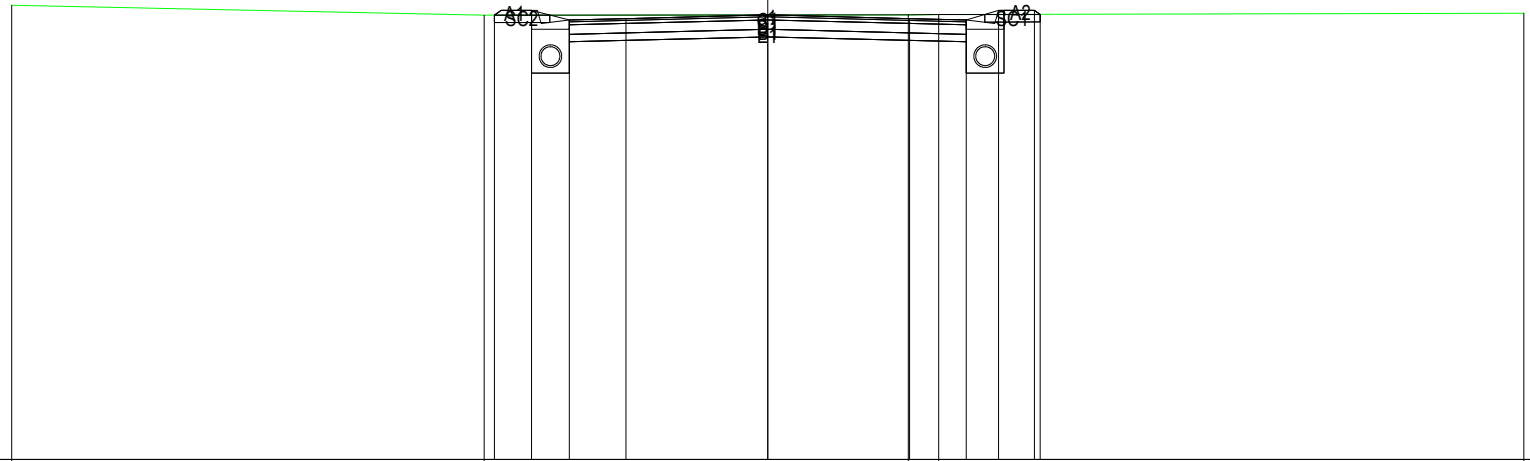

-1

200  
200

|                      |        |       |       |       |       |       |       |       |       |       |       |
|----------------------|--------|-------|-------|-------|-------|-------|-------|-------|-------|-------|-------|
| PROGRESSIVE TERRENO  | -20.00 | -7.50 |       |       |       | 3.71  | 4.52  |       |       | 20.00 |       |
| PARZIALI TERRENO     |        | 12.50 |       | 11.21 |       | 0.81  |       |       | 15.48 |       |       |
| QUOTE TERRENO        | 11.02  | 10.75 |       |       |       | 10.76 | 10.77 |       |       | 10.80 |       |
| PROGRESSIVE PROGETTO |        | -7.23 | -6.25 | -5.25 | -3.75 | 0.00  | 3.75  | 5.25  | 6.10  | 7.05  | 7.20  |
| PARZIALI PROGETTO    |        | 0.98  | 1.00  | 1.50  | 3.75  | 3.75  | 1.50  | 0.85  | 0.95  | 0.15  |       |
| QUOTE PROGETTO       |        | 10.75 | 10.87 | 10.62 | 10.66 | 10.76 | 10.66 | 10.62 | 10.87 | 10.87 | 10.77 |