



# Anas SpA

Direzione Centrale Progettazione

## SISTEMA TANGENZIALE DI LUCCA

Viabilità Est di Lucca comprendente i collegamenti tra Ponte a Moriano ed i caselli dell'autostrada A11 del Frizzone e di Lucca Est

### PROGETTO PRELIMINARE

PROGETTAZIONE: ANAS - DIREZIONE CENTRALE PROGETTAZIONE

**IL PROGETTISTA:**

Dott. Ing. Antonio VALENTE  
Ordine Ing. di Roma n. 20739

**GRUPPO DI PROGETTAZIONE ANAS**

Ing. Giuseppe Danilo MALGERI – Responsabile di Progetto  
Ing. Francesco BEZZI – Impianti  
Ing. Pier Giorgio D'ARMINI – Traffico e Benefici/Costi  
Ing. Gianfranco FUSANI – Strade  
Ing. Gabriele GIOVANNINI – Cartografia  
Ing. Alessandro MITA – Idraulica  
Ing. Enrico MITTIGA – Geotecnica  
Arch. Gianluca BONOLI – Strutture  
Arch. Roberto ROGGI – Sicurezza  
Geom. Stefano SERANGELI – Geologia  
Geom. Emiliano PAIELLA – Computi e Capitolati  
Geom. Carmelo ZEMA – Espropri ed Interferenze

**IL GEOLOGO**

Dott. Geol. Francesca SCIUBBA  
Ordine Geol. del Lazio n. 1371

**I RESPONSABILI DEL S.I.A.**

Dott. Ing. Ginevra BERETTA      Dott. Arch. Francesca Romana IETTO  
Ordine Ing. di Roma n. 20458      Ordine Arch. di Roma n. 15857

**COORDINATORE PER LA SICUREZZA IN FASE DI PROGETTAZIONE**

Geom. Fabio QUONDAM

**VISTO: IL RESPONSABILE DEL PROCEDIMENTO**

Ing. Nicola DINNELLA

**RESPONSABILI DI UNITA' INGEGNERIA:**

Ing. Fulvio Maria SOCCODATO – Ingegneria Territorio  
Ing. Alessandro MICHELI – Ingegneria Geotecnica e Impianti  
Ing. Achille DEVITOFRANCESCHI – Ingegneria Opere Civili  
Geom. Fabio QUONDAM – Ingegneria Computi, Stime e Capitolati

PROTOCOLLO

DATA

## PROGETTO STRADALE

### OPERA CONNESSA

### SEZIONI TRASVERSALI DELL'ASSE PRINCIPALE

CODICE PROGETTO		NOME FILE		REVISIONE	SCALA:
PROGETTO	LIV. PROG.	N. PROG.	T00_PS01_STD_SZ05_A.DWG		
L0601A	P	1201	CODICE ELAB. T00PS01STD SZ05	A	1:200
C					
B					
A	EMISSIONE	29/11/2012	ING. F. Primieri	Ing. G. Fusani	Ing. F.M. Soccodato
REV.	DESCRIZIONE	DATA	REDATTO	VERIFICATO	APPROVATO

PROFILO ASSE OPERA CONNESSA

SEZIONE 1

PROGRESSIVA 0.00

- RILEVATO
- A1 2.02 mq.
- STERRO
- B1 0.95 mq.
- BINDER
- C1 0.84 mq.
- BASE
- D1 2.62 mq.
- FONDAZIONE
- E1 2.10 mq.
- SCOTICO
- SC1 3.23 mq.
- USURA
- a1 10.50 ml.
- VEGETALE
- b1 3.36 ml.
- b2 2.04 ml.
- Totale: 5.40 ml.

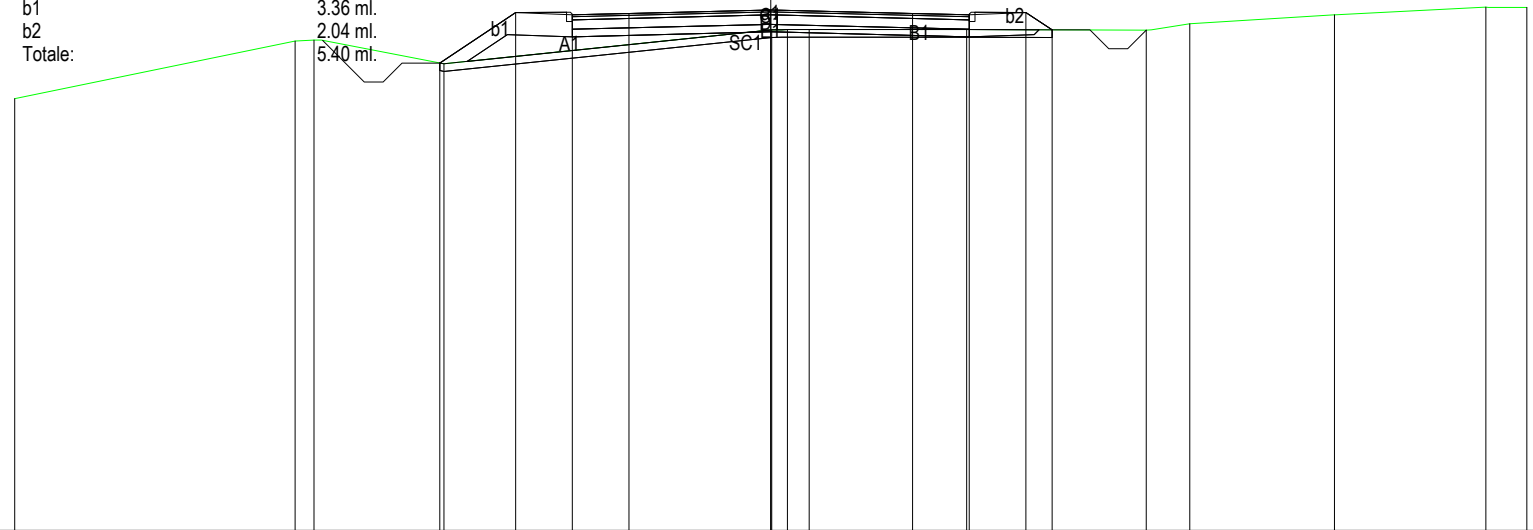

200  
200

PROGRESSIVE TERRENO	-20.00	-12.59	-12.08	-8.64		0.03	0.44	1.02	5.18	9.93	11.08	14.91	18.92	20.00
PARZIALI TERRENO		7.41	0.51	3.44		8.67	0.41	0.58	4.16	4.75	1.15	3.83	4.01	1.08
QUOTE TERRENO	13.42	14.95	14.97	14.34		15.24	15.25	15.25	15.25	15.24	15.40	15.64	15.84	15.83
PROGRESSIVE PROGETTO				-8.76	-6.75	-5.25	-3.75	0.00	3.75	5.25	6.75	7.44		
PARZIALI PROGETTO				2.01	1.50	1.50	3.75		3.75	1.50	1.50	0.69		
QUOTE PROGETTO				14.36	15.70	15.64	15.68	15.77	15.68	15.64	15.70	15.24		

PROFILO ASSE OPERA CONNESSA

SEZIONE 2

PROGRESSIVA 50.00

RILEVATO  
 A1 0.29 mq.  
 STERRO  
 B1 6.47 mq.  
 BINDER  
 C1 0.84 mq.  
 BASE  
 D1 2.62 mq.  
 FONDAZIONE  
 E1 2.10 mq.  
 SCOTICO  
 SC1 0.76 mq.  
 SC2 1.62 mq.  
 Totale: 2.38 mq.  
 USURA  
 a1 10.50 ml.  
 VEGETALE  
 b1 2.31 ml.  
 b2 3.12 ml.  
 Totale: 5.43 ml.

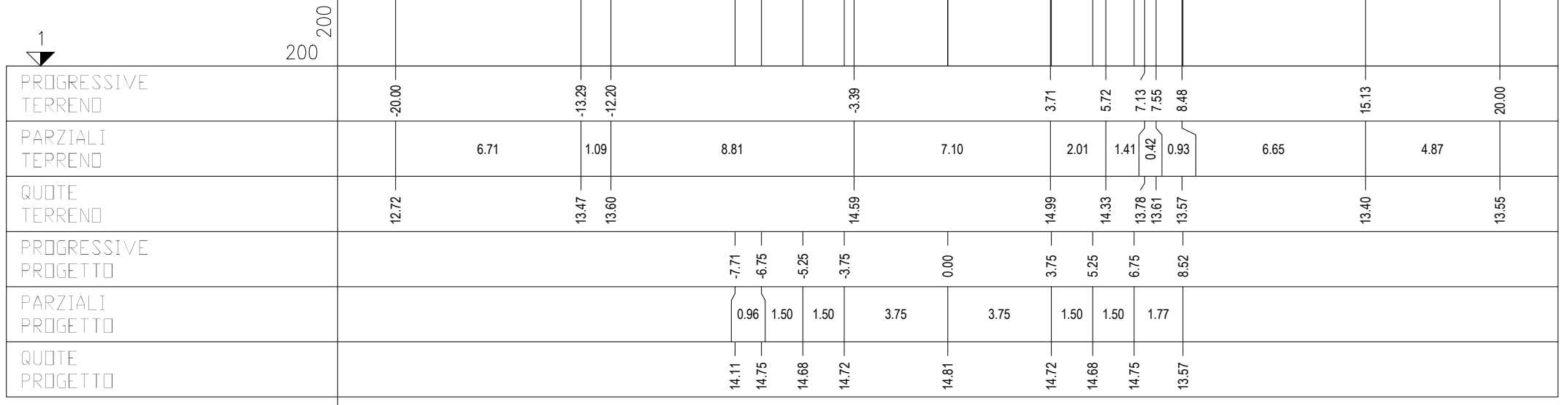

PROFILO ASSE OPERA CONNESSA

SEZIONE 3

PROGRESSIVA 100.00

RILEVATO	
A1	0.02 mq.
A2	0.51 mq.
Totale:	0.53 mq.
STERRO	
B1	3.32 mq.
BINDER	
C1	0.84 mq.
BASE	
D1	2.64 mq.
FONDAZIONE	
E1	2.10 mq.
SCOTICO	
SC1	3.16 mq.
USURA	
a1	10.50 ml.
VEGETALE	
b1	2.43 ml.
b2	2.52 ml.
Totale:	4.95 ml.

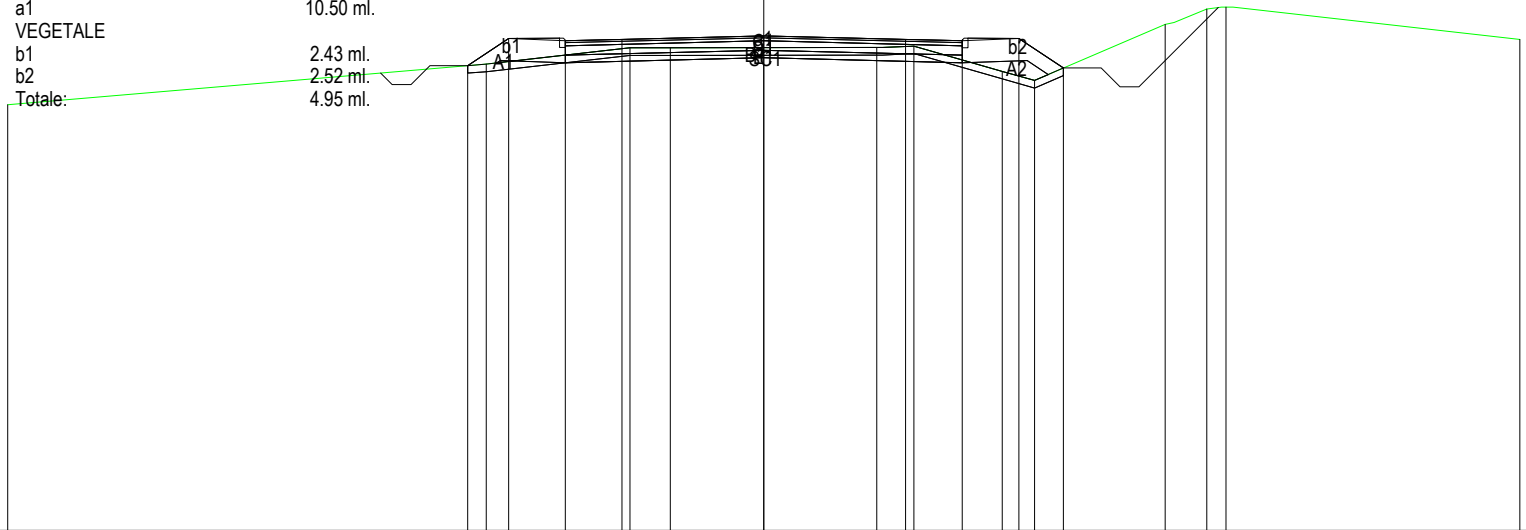

200  
200

PROGRESSIVE TERRENO	-20.00	-7.34	-3.54	-2.47	0.00	2.99	3.97	6.31	7.16	10.61	11.71	12.23	20.00
PARZIALI TERRENO		12.66	3.80	1.07	5.46	0.98	2.34	0.85	3.45	1.10	0.52	7.77	
QUOTE TERRENO	12.26	13.34	13.77	13.76		13.77	13.81	13.14	12.90	14.38	14.79	14.84	13.98
PROGRESSIVE PROGETTO		-7.83	-6.75	-5.25	-3.75	0.00	3.75	5.25	6.75	7.92			
PARZIALI PROGETTO		1.08	1.50	1.50	3.75	3.75	1.50	1.50	1.17				
QUOTE PROGETTO		13.29	14.02	13.95	13.99	14.08	13.99	13.95	14.02	13.23			

PROFILO ASSE OPERA CONNESSA

SEZIONE 4

PROGRESSIVA 150.00

RILEVATO	
A1	2.29 mq.
STERRO	
B1	0.25 mq.
BINDER	
C1	0.84 mq.
BASE	
D1	2.64 mq.
FONDAZIONE	
E1	2.10 mq.
SCOTICO	
SC1	3.42 mq.
USURA	
a1	10.50 ml.
VEGETALE	
b1	4.07 ml.
b2	2.18 ml.
Totale:	6.25 ml.

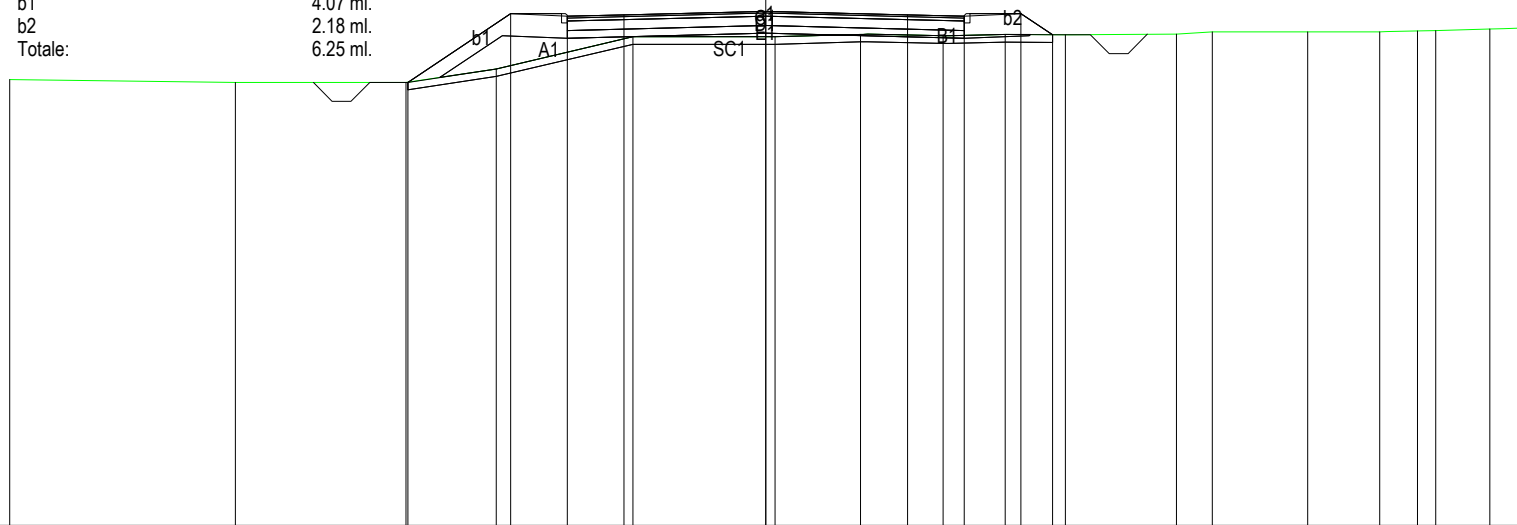

200  
200

PROGRESSIVE TERRENO	-20.00	-14.03	-9.52	-7.13	-3.51	0.24	2.50	4.69	6.33	7.92	10.86	11.81	14.34	16.24	17.24	17.72	19.16	20.00
PARZIALI TERRENO		5.97	4.51	2.39	3.62	3.75	2.26	2.19	1.64	1.59	2.94	0.95	2.53	1.90	1.00	0.48	1.44	0.84
QUOTE TERRENO	11.80	11.72	11.71	12.08	12.93	12.93	12.99	12.95	12.99	12.98	13.00	13.05	13.05	13.06	13.08	13.09	13.14	13.16
PROGRESSIVE PROGETTO			-9.47	-6.75	-5.25	-3.75	0.00	3.75	5.25	6.75	7.58							
PARZIALI PROGETTO				2.72	1.50	1.50	3.75	3.75	1.50	1.50	0.83							
QUOTE PROGETTO			11.72	13.54	13.47	13.51	13.60	13.51	13.47	13.54	12.98							

PROFILO ASSE OPERA CONNESSA

SEZIONE 5

PROGRESSIVA 200.00

RILEVATO	
A1	0.18 mq.
A2	0.76 mq.
Totale:	0.94 mq.
STERRO	
B1	1.97 mq.
BINDER	
C1	0.84 mq.
BASE	
D1	2.62 mq.
FONDAZIONE	
E1	2.10 mq.
SCOTICO	
SC1	3.20 mq.
USURA	
a1	10.50 ml.
VEGETALE	
b1	2.58 ml.
b2	2.56 ml.
Totale:	5.14 ml.

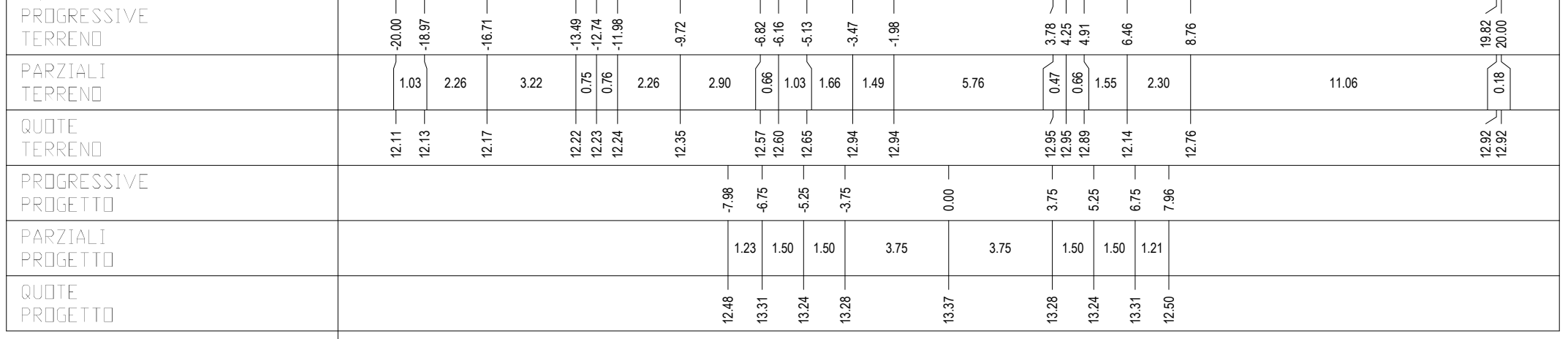

PROFILO ASSE OPERA CONNESSA

SEZIONE 6

PROGRESSIVA 250.00

RILEVATO	
A1	0.05 mq.
A2	0.23 mq.
Totale:	0.28 mq.
STERRO	
B1	3.27 mq.
B2	0.75 mq.
Totale:	4.02 mq.
BINDER	
C1	0.84 mq.
BASE	
D1	2.62 mq.
FONDAZIONE	
E1	2.10 mq.
SCOTICO	
SC1	2.90 mq.
USURA	
a1	10.50 ml.
VEGETALE	
b1	2.59 ml.
b2	1.55 ml.
Totale:	4.14 ml.



PROGRESSIVE TERRENO	-20.00	-18.96	-18.41	-10.00	-7.06	-6.52	-3.52	-3.06	4.18	5.98	6.60	15.97	20.00
PARZIALI TERRENO	1.04	0.55	8.41	2.94	0.54	3.00	0.46	7.24	1.80	0.62	9.37	4.03	
QUOTE TERRENO	11.94	11.96	11.96	12.25	12.62	12.68	13.09	13.09	13.09	12.29	13.49	13.53	13.51
PROGRESSIVE PROGETTO					-7.99	-6.75	-5.25	-3.75	0.00	3.75	5.25	6.75	6.95
PARZIALI PROGETTO					1.24	1.50	1.50	3.75	3.75	1.50	1.50	0.20	
QUOTE PROGETTO					12.50	13.33	13.26	13.30	13.39	13.30	13.26	13.33	13.53

PROFILO ASSE OPERA CONNESSA

SEZIONE 7

PROGRESSIVA 300.00

RILEVATO	
A1	0.02 mq.
STERRO	
B1	3.41 mq.
BINDER	
C1	0.84 mq.
BASE	
D1	2.62 mq.
FONDAZIONE	
E1	2.10 mq.
SCOTICO	
SC1	3.07 mq.
USURA	
a1	10.50 ml.
VEGETALE	
b1	2.62 ml.
b2	1.91 ml.
Totale:	4.53 ml.

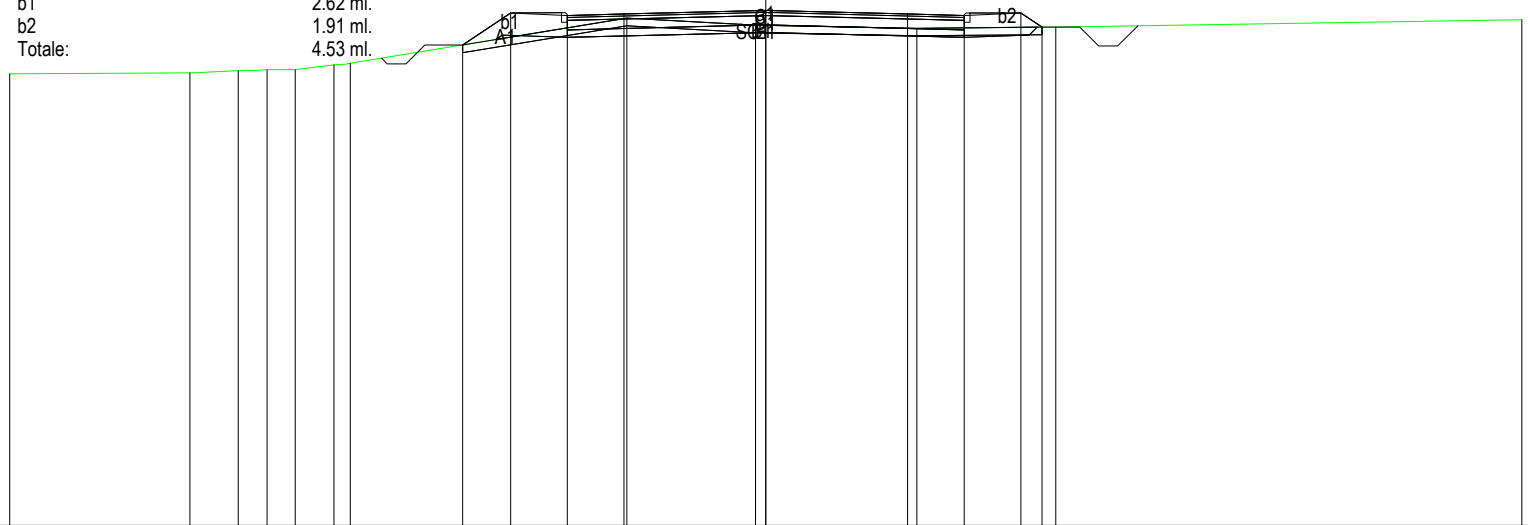

200  
200

PROGRESSIVE TERRENO	-20.00	-15.23	-13.96	-13.19	-12.44	-11.42	-10.99	-3.68	-0.27	3.99	7.67	20.00				
PARZIALI TERRENO	4.77	1.27	0.77	0.75	1.02	0.43	7.31	3.41	4.26	3.68	12.33					
QUOTE TERRENO	11.95	11.97	12.03	12.06	12.06	12.18	12.22	13.42	13.23	13.15	13.19	13.37				
PROGRESSIVE PROGETTO								-8.02	-6.75	-5.25	-3.75	0.00	3.75	5.25	6.75	7.31
PARZIALI PROGETTO								1.27	1.50	1.50	3.75	3.75	1.50	1.50	0.56	
QUOTE PROGETTO								12.71	13.55	13.49	13.53	13.62	13.53	13.49	13.55	13.18



PROFILO ASSE OPERA CONNESSA

SEZIONE 8

PROGRESSIVA 350.00

RILEVATO	
A1	1.37 mq.
STERRO	
B1	6.73 mq.
BINDER	
C1	0.84 mq.
BASE	
D1	2.62 mq.
FONDAZIONE	
E1	2.10 mq.
SCOTICO	
SC1	3.10 mq.
USURA	
a1	10.50 ml.
VEGETALE	
b1	3.85 ml.
b2	2.14 ml.
Totale:	5.99 ml.

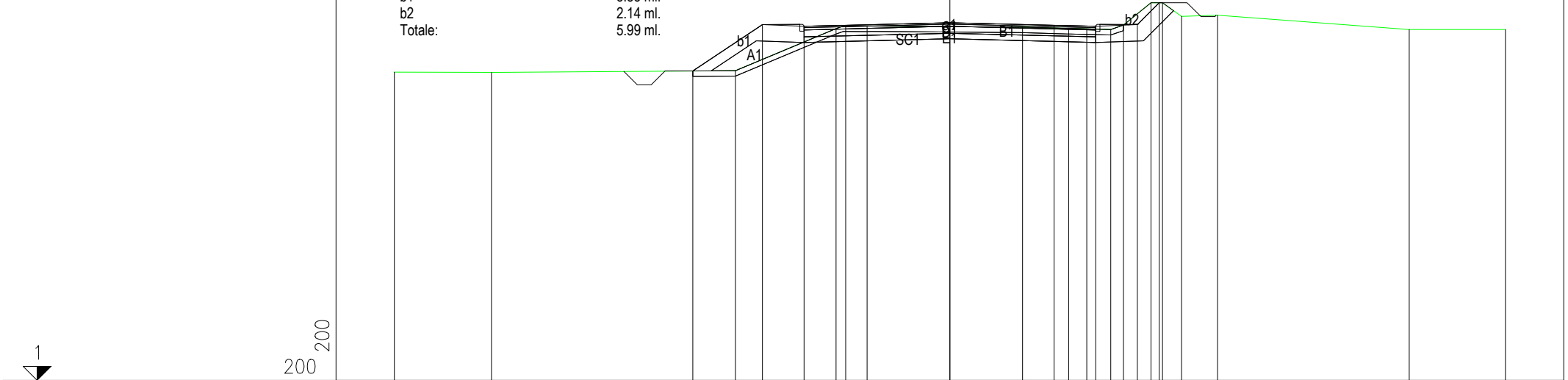

PROGRESSIVE TERRENO	-20.00	-16.50	-7.72	-4.10	-2.99	2.61	4.27	4.93	5.79	6.25	7.23	7.65	8.34	9.63	16.54	20.00
PARZIALI TERRENO		3.50	8.78	3.62	1.11	5.60	1.66	0.66	0.86	0.46	0.98	0.42	0.69	1.29	6.91	3.46
QUOTE TERRENO	12.09	12.09	12.15	13.66	13.75	13.71	13.66	13.65	13.63	13.78	14.59	14.59	14.10	14.14	13.63	13.63
PROGRESSIVE PROGETTO			-9.25	-6.75	-5.25	-3.75	0.00	3.75	5.25	6.75	7.54					
PARZIALI PROGETTO			2.50	1.50	1.50	3.75	3.75	1.50	1.50	0.79						
QUOTE PROGETTO			12.14	13.80	13.74	13.78	13.87	13.78	13.74	13.80	14.59					

PROFILO ASSE OPERA CONNESSA

SEZIONE 9

PROGRESSIVA 400.00

RILEVATO	
A1	1.25 mq.
A2	0.14 mq.
Totale:	1.39 mq.
STERRO	
B1	7.22 mq.
BINDER	
C1	0.84 mq.
BASE	
D1	2.63 mq.
FONDAZIONE	
E1	2.10 mq.
SCOTICO	
SC1	0.35 mq.
SC2	2.31 mq.
Totale:	2.66 mq.
USURA	
a1	10.50 ml.
VEGETALE	
b1	4.60 ml.

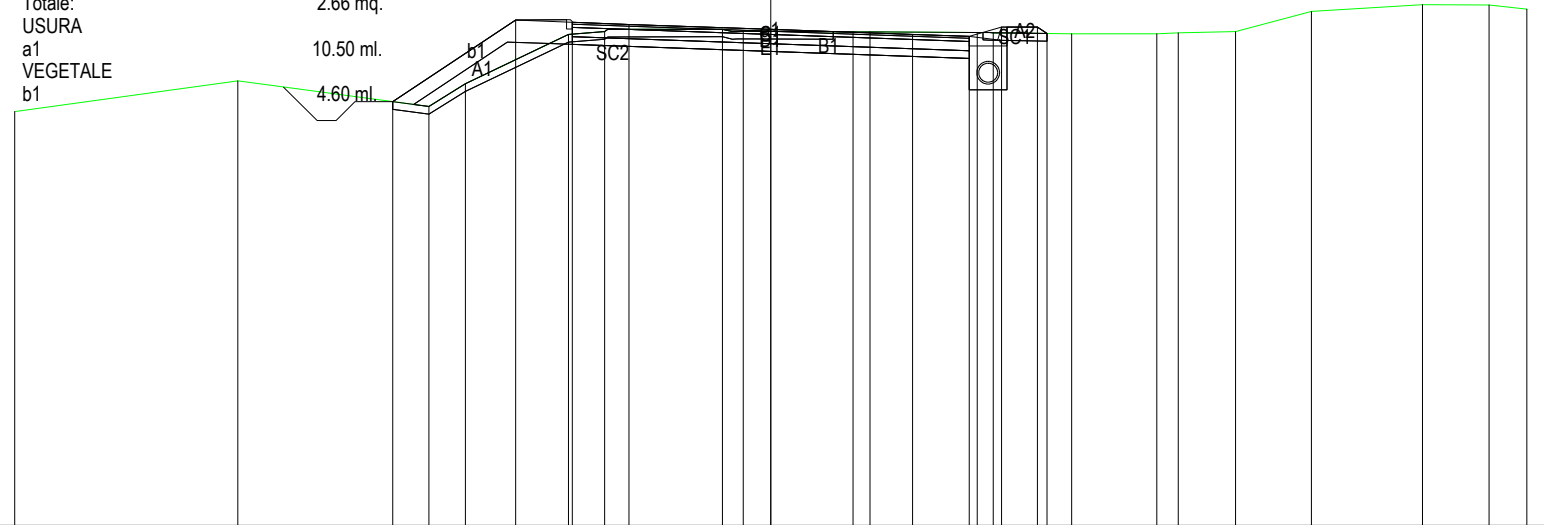

PROGRESSIVE TERRENO	-20.00	-14.10	-9.04	-8.08	-5.35	-4.40	-1.28	-0.73	2.18	2.62	5.46	5.88	7.95	10.21	10.77	12.30	14.30	17.23	19.00	20.00
PARZIALI TERRENO	5.90	5.06	0.96	2.73	0.95	3.12	0.55	2.91	0.44	2.84	0.42	2.07	2.26	0.56	1.53	2.00	2.93	1.77	1.00	
QUOTE TERRENO	11.95	12.76	12.08	12.68	13.99	14.06	14.12	14.07	14.06	14.06	14.04	14.03	14.00	14.01	14.03	14.06	14.60	14.77	14.77	14.66
PROGRESSIVE PROGETTO			-10.00	-6.75	-5.25	-3.75	0.00		3.75	5.25	6.10	7.05	7.30							
PARZIALI PROGETTO			3.25	1.50	1.50	3.75		3.75	1.50	0.85	0.95	0.25								
QUOTE PROGETTO			12.21	14.37	14.31	14.25	14.12		13.99	13.93	14.18	14.18	14.01							



PROFILO ASSE OPERA CONNESSA

SEZIONE 11

PROGRESSIVA 500.00

STERRO	
B1	33.23 mq.
BINDER	
C1	0.83 mq.
BASE	
D1	2.63 mq.
FONDAZIONE	
E1	2.10 mq.
SCOTICO	
SC1	0.54 mq.
USURA	
a1	10.50 ml.
VEGETALE	
b1	2.02 ml.

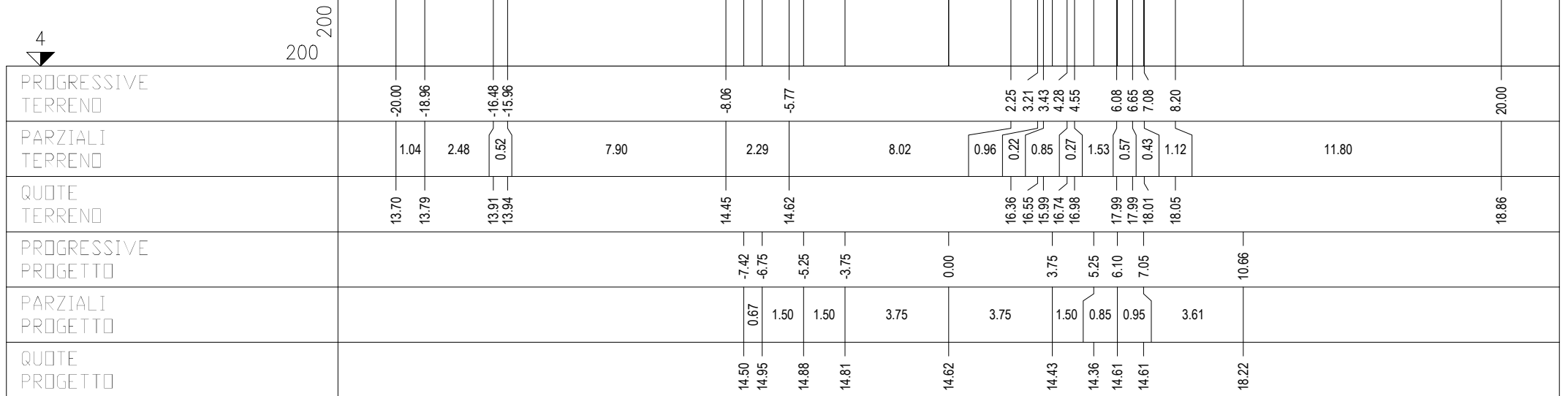



PROFILO ASSE OPERA CONNESSA

SEZIONE 13

PROGRESSIVA 600.00

RILEVATO	
A1	0.01 mq.
A2	0.04 mq.
Totale:	0.05 mq.
STERRO	
B1	6.86 mq.
BINDER	
C1	0.84 mq.
BASE	
D1	2.64 mq.
FONDAZIONE	
E1	2.10 mq.
SCOTICO	
SC1	0.25 mq.
SC2	1.92 mq.
Totale:	2.17 mq.
USURA	
a1	10.50 ml.
VEGETALE	
b1	2.49 ml.

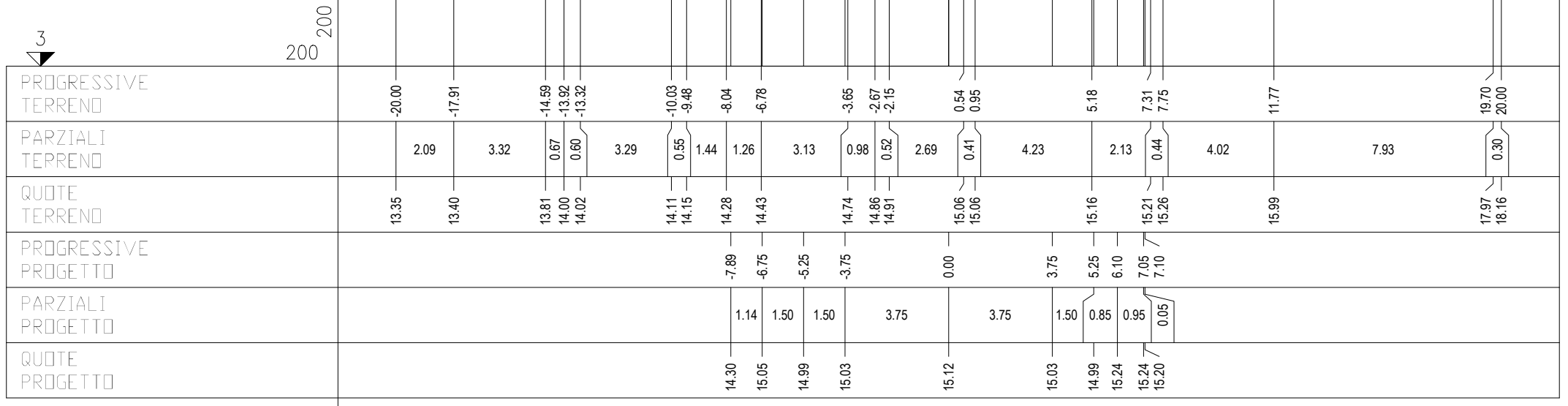

PROFILO ASSE OPERA CONNESSA

SEZIONE 14

PROGRESSIVA 650.00

RILEVATO	
A1	0.08 mq.
STERRO	
B1	14.34 mq.
BINDER	
C1	0.84 mq.
BASE	
D1	2.62 mq.
FONDAZIONE	
E1	2.10 mq.
SCOTICO	
SC1	0.25 mq.
USURA	
a1	10.50 ml.

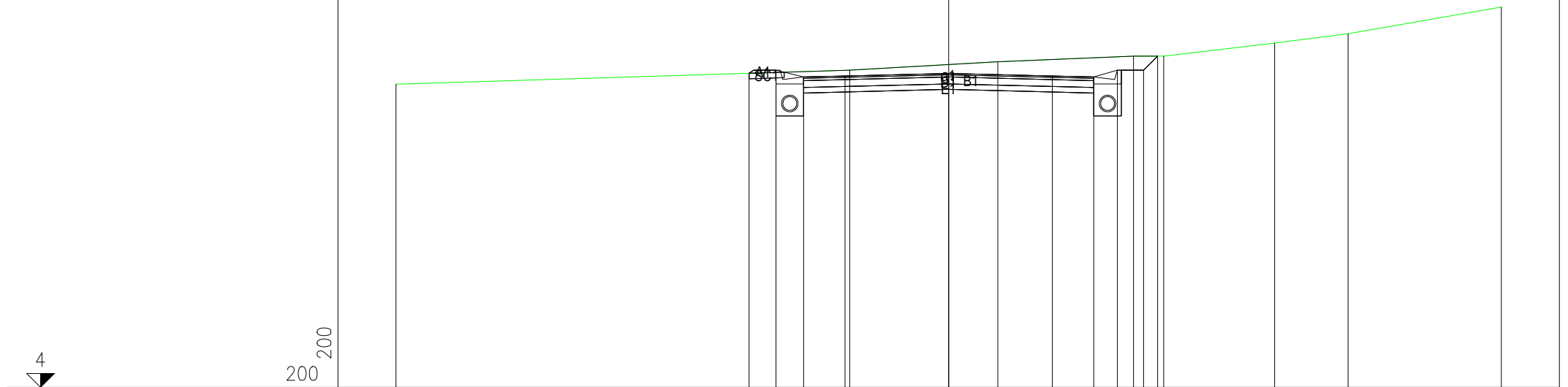

200  
200

PROGRESSIVE TERRENO	-20.00			-3.58		1.77		6.69	7.78		11.79	14.45		20.00
PARZIALI TERRENO		16.42			5.35		4.92	1.09	4.01	2.66		5.55		
QUOTE TERRENO	14.98			15.49		15.79		16.00	16.00		16.47	16.81		17.77
PROGRESSIVE PROGETTO			-7.22	-6.25	-5.25	-3.75	0.00	3.75	5.25	6.10	7.05	7.56		
PARZIALI PROGETTO			0.97	1.00	1.50	3.75	3.75	1.50	0.85	0.95	0.51			
QUOTE PROGETTO			15.38	15.49	15.24	15.28	15.37	15.28	15.24	15.49	15.49	16.00		

PROFILO ASSE OPERA CONNESSA

SEZIONE 15

PROGRESSIVA 710.35

STERRO  
 B1 17.59 mq.  
 BINDER  
 C1 0.84 mq.  
 BASE  
 D1 2.62 mq.  
 FONDAZIONE  
 E1 2.10 mq.  
 USURA  
 a1 10.50 ml.

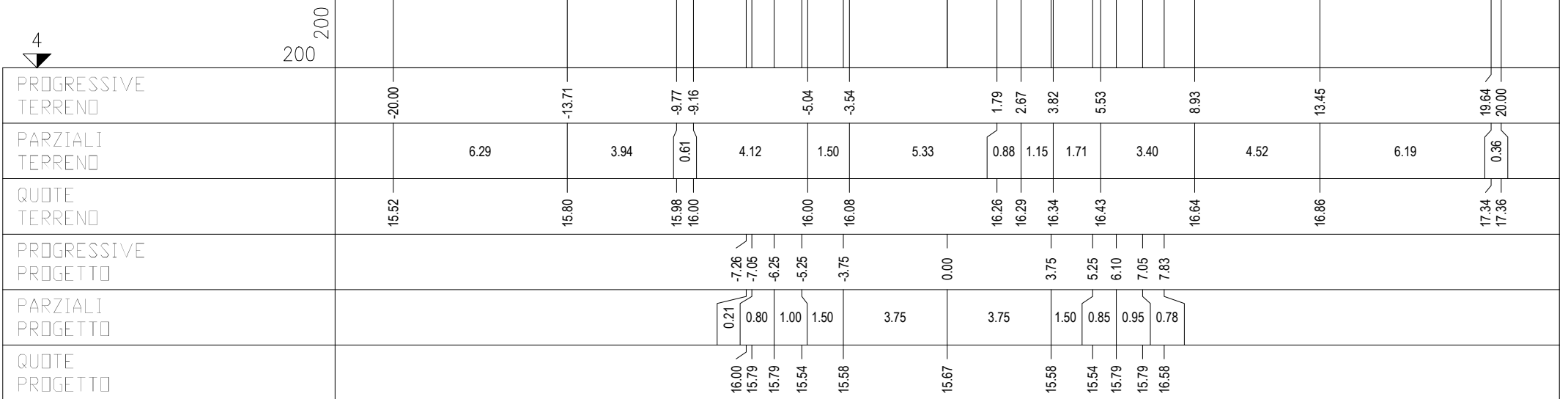



PROFILO ASSE OPERA CONNESSA

SEZIONE 16

PROGRESSIVA 750.35

RILEVATO	
A1	8.43 mq.
BINDER	
C1	0.84 mq.
BASE	
D1	2.64 mq.
FONDAZIONE	
E1	2.10 mq.
SCOTICO	
SC1	3.38 mq.
USURA	
a1	10.50 ml.
VEGETALE	
b1	3.03 ml.
b2	3.04 ml.
Totale:	6.07 ml.

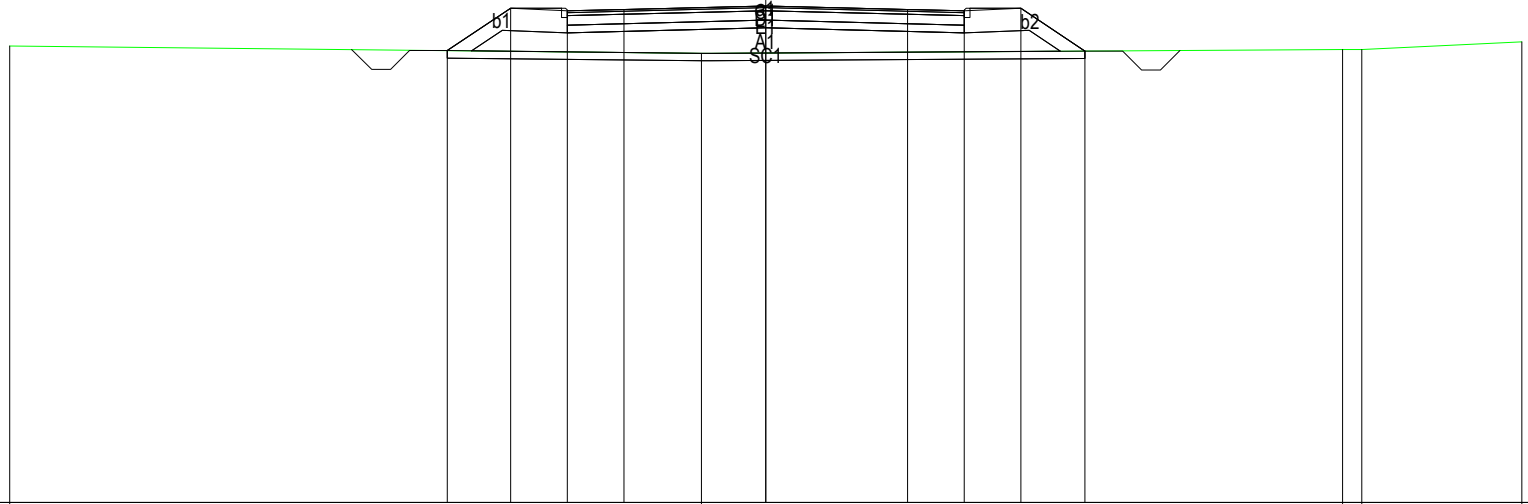

3

200  
200

PROGRESSIVE TERRENO	-20.00	-1.70	15.25	15.76	20.00				
PARZIALI TERRENO	18.30	16.95	0.51	4.24					
QUOTE TERRENO	15.07	14.88	14.98	14.98	15.18				
PROGRESSIVE PROGETTO	-8.43	-6.75	-5.25	-3.75	0.00	3.75	5.25	6.75	8.44
PARZIALI PROGETTO	1.68	1.50	1.50	3.75	3.75	1.50	1.50	1.69	
QUOTE PROGETTO	14.95	16.07	16.00	16.04	16.14	16.04	16.00	16.07	14.94

PROFILO ASSE OPERA CONNESSA

SEZIONE 17

PROGRESSIVA 800.27

RILEVATO	
A1	8.74 mq.
BINDER	
C1	0.84 mq.
BASE	
D1	2.63 mq.
FONDAZIONE	
E1	2.10 mq.
SCOTICO	
SC1	3.43 mq.
USURA	
a1	10.50 ml.
VEGETALE	
b1	4.04 ml.
b2	2.31 ml.
Totale:	6.35 ml.

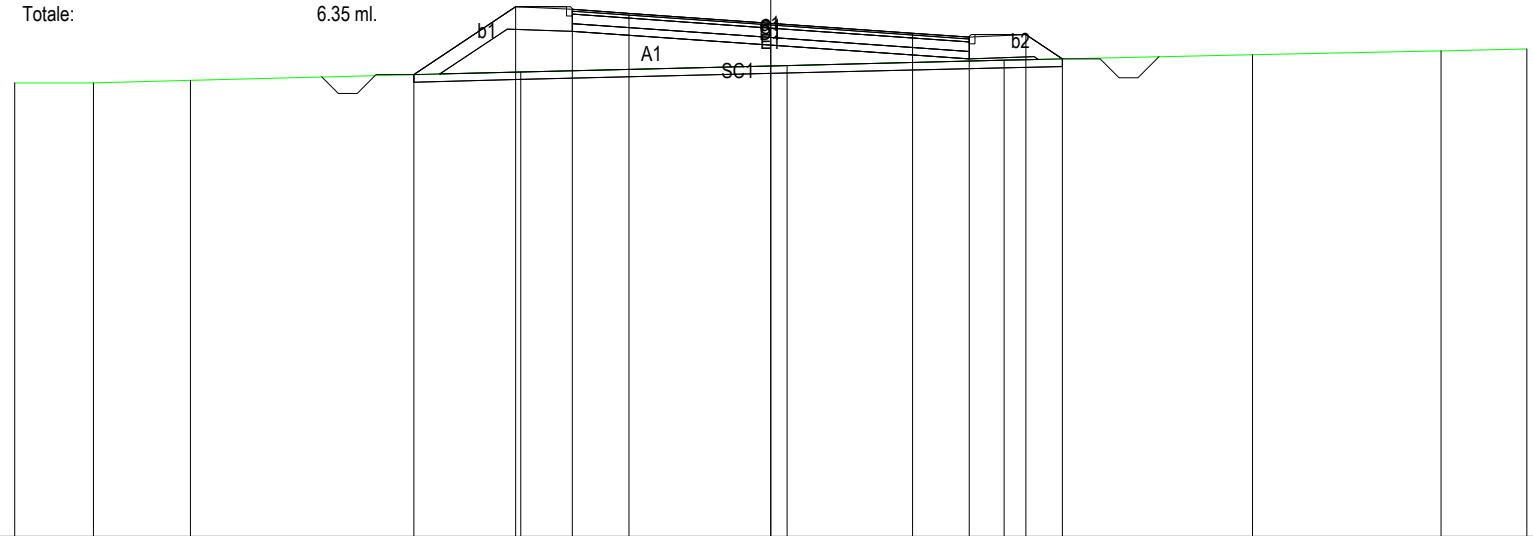

200  
200

PROGRESSIVE TERRENO	-20.00	-17.91	-15.35	-6.61	0.43	6.17	12.74	17.73	20.00			
PARZIALI TERRENO	2.09	2.56	8.74	7.04	5.74	6.57	4.99	2.27				
QUOTE TERRENO	14.00	14.00	14.07	14.29	14.46	14.60	14.75	14.85	14.90			
PROGRESSIVE PROGETTO				-9.44	-6.75	-5.25	-3.75	0.00	3.75	5.25	6.75	7.71
PARZIALI PROGETTO				2.69	1.50	1.50	3.75	3.75	1.50	1.50	0.96	
QUOTE PROGETTO				14.22	16.01	15.94	15.84	15.58	15.31	15.21	15.27	14.63

PROFILO ASSE OPERA CONNESSA

SEZIONE 18

PROGRESSIVA 851.58

RILEVATO	
A1	13.29 mq.
BINDER	
C1	0.83 mq.
BASE	
D1	2.63 mq.
FONDAZIONE	
E1	2.10 mq.
SCOTICO	
SC1	3.59 mq.
USURA	
a1	10.50 ml.
VEGETALE	
b1	3.90 ml.
b2	3.20 ml.
Totale:	7.10 ml.

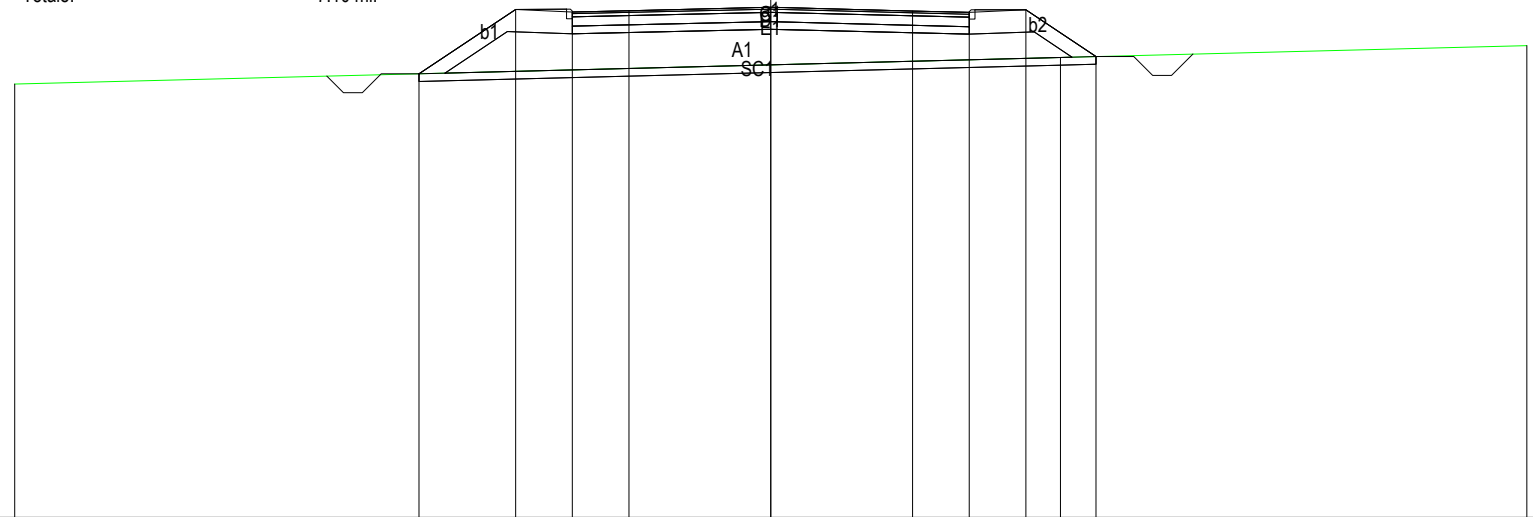

PROGRESSIVE TERRENO	-20.00									7.66		20.00
PARZIALI TERRENO		27.66							12.34			
QUOTE TERRENO	13.46									14.17		14.48
PROGRESSIVE PROGETTO		-9.30	-6.75	-5.25	-3.75	0.00	3.75	5.25	6.75	8.60		
PARZIALI PROGETTO		2.55	1.50	1.50	3.75	3.75	1.50	1.50	1.85			
QUOTE PROGETTO		13.74	15.44	15.37	15.41	15.49	15.40	15.36	15.43	14.19		

PROFILO ASSE OPERA CONNESSA

SEZIONE 19

PROGRESSIVA 901.58

RILEVATO	
A1	11.74 mq.
BINDER	
C1	0.84 mq.
BASE	
D1	2.62 mq.
FONDAZIONE	
E1	2.10 mq.
SCOTICO	
SC1	3.52 mq.
USURA	
a1	10.50 ml.
VEGETALE	
b1	3.40 ml.
b2	3.39 ml.
Totale:	6.79 ml.

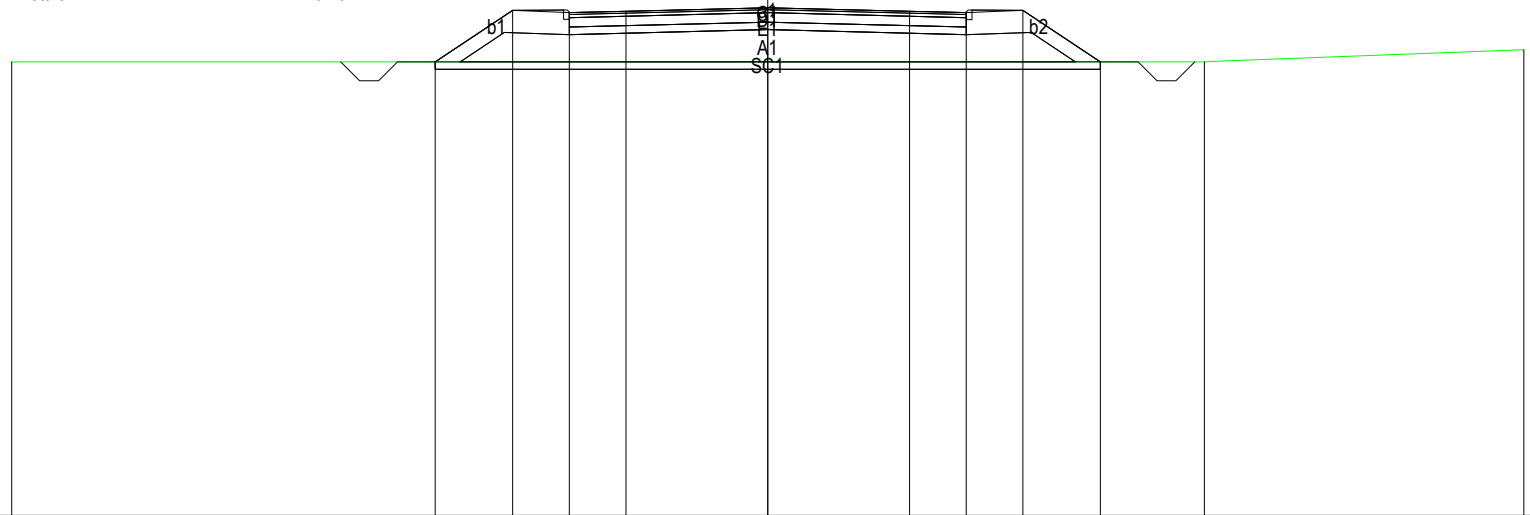

200  
200

PROGRESSIVE TERRENO	-20.00											11.55		20.00
PARZIALI TERRENO		31.55										8.45		
QUOTE TERRENO	14.00											14.00		14.32
PROGRESSIVE PROGETTO		-8.80	-6.75	-5.25	-3.75	0.00		3.75	5.25	6.75	8.79			
PARZIALI PROGETTO		2.05	1.50	1.50	3.75	3.75	1.50	1.50	2.04					
QUOTE PROGETTO		14.00	15.36	15.30	15.34	15.43	15.34	15.30	15.36	14.00				

PROFILO ASSE OPERA CONNESSA

SEZIONE 20

PROGRESSIVA 951.59

RILEVATO	
A1	12.46 mq.
BINDER	
C1	0.84 mq.
BASE	
D1	2.62 mq.
FONDAZIONE	
E1	2.10 mq.
SCOTICO	
SC1	3.50 mq.
USURA	
a1	10.50 ml.
VEGETALE	
b1	3.52 ml.
b2	3.13 ml.
Totale:	6.65 ml.

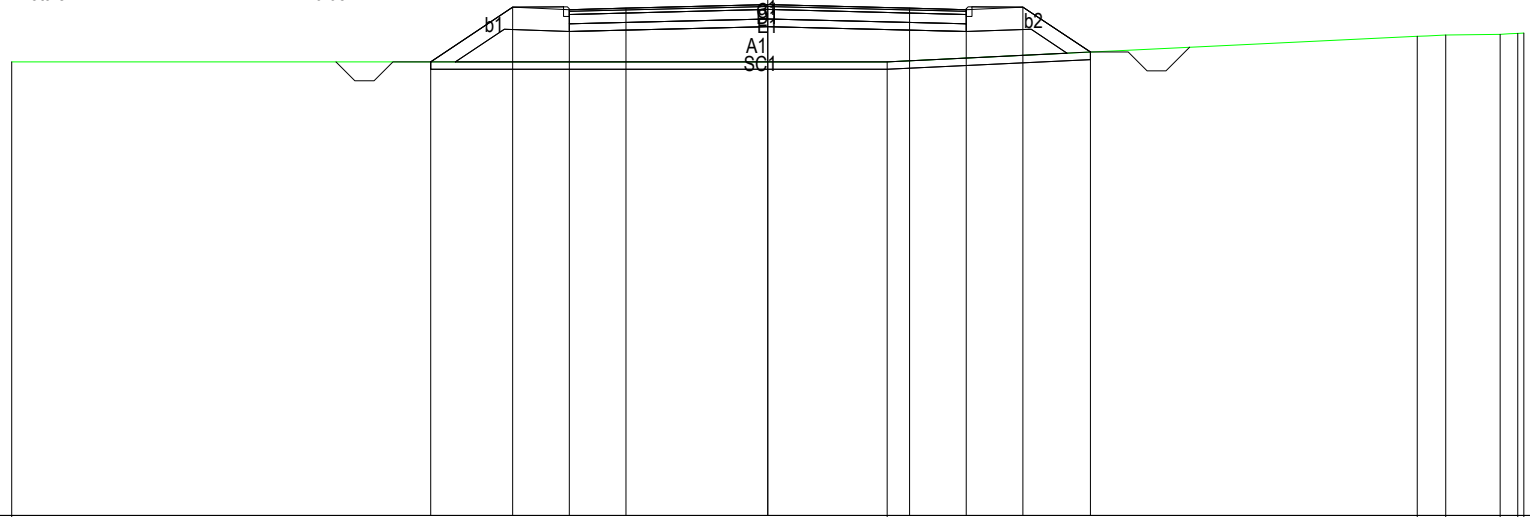

200  
200

PROGRESSIVE TERRENO	-20.00						3.16					17.18	17.93	19.37	19.84	20.00
PARZIALI TERRENO		23.16						14.02				0.75	1.44	0.47	0.16	
QUOTE TERRENO	14.00						14.00					14.67	14.71	14.73	14.75	14.76
PROGRESSIVE PROGETTO		-8.92	-6.75	-5.25	-3.75	0.00	3.75	5.25	6.75	8.53						
PARZIALI PROGETTO		2.17	1.50	1.50	3.75	3.75	1.50	1.50	1.78							
QUOTE PROGETTO		14.00	15.45	15.38	15.42	15.51	15.42	15.38	15.45	14.26						



PROFILO ASSE OPERA CONNESSA

SEZIONE 22

PROGRESSIVA 1051.59

RILEVATO	
A1	4.54 mq.
BINDER	
C1	0.84 mq.
BASE	
D1	2.64 mq.
FONDAZIONE	
E1	2.10 mq.
SCOTICO	
SC1	3.30 mq.
USURA	
a1	10.50 ml.
VEGETALE	
b1	2.51 ml.
b2	3.22 ml.
Totale:	5.73 ml.

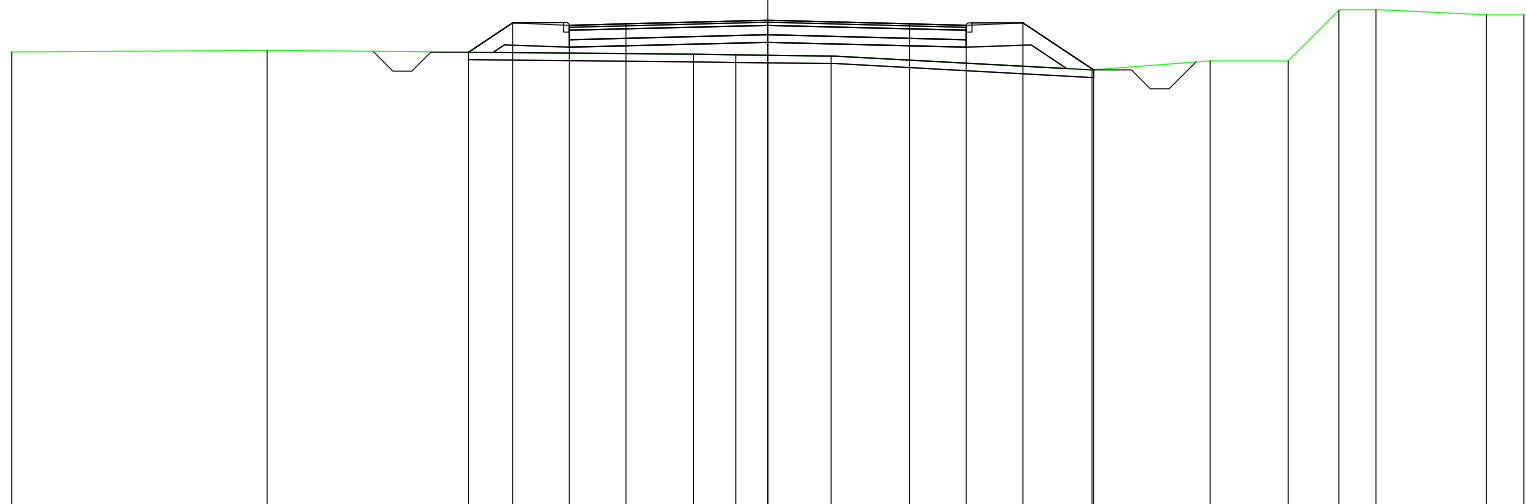

3

200  
200

PROGRESSIVE TERRENO	-20.00	-13.24				-1.97	-0.85	1.68				8.57	11.70	13.77	15.11	16.09	19.01	20.00
PARZIALI TERRENO		6.76		11.27		1.12	2.53		6.89		3.13	2.07	1.34	0.98	2.92	0.99		
QUOTE TERRENO	15.05	15.09				14.99	14.97	14.94				14.57	14.82	14.82	16.15	16.16	16.03	16.03
PROGRESSIVE PROGETTO				-7.91	-6.75	-5.25	-3.75	0.00	3.75	5.25	6.75	8.62						
PARZIALI PROGETTO				1.16	1.50	1.50	3.75	3.75	1.50	1.50	1.87							
QUOTE PROGETTO				15.04	15.82	15.75	15.79	15.88	15.79	15.75	15.82	14.57						

PROFILO ASSE OPERA CONNESSA

SEZIONE 23

PROGRESSIVA 1101.60

- RILEVATO
- A1 1.67 mq.
- STERRO
- B1 0.06 mq.
- BINDER
- C1 0.84 mq.
- BASE
- D1 2.62 mq.
- FONDAZIONE
- E1 2.10 mq.
- SCOTICO
- SC1 3.12 mq.
- USURA
- a1 10.50 ml.
- VEGETALE
- b1 2.61 ml.
- b2 2.19 ml.
- Totale: 4.80 ml.

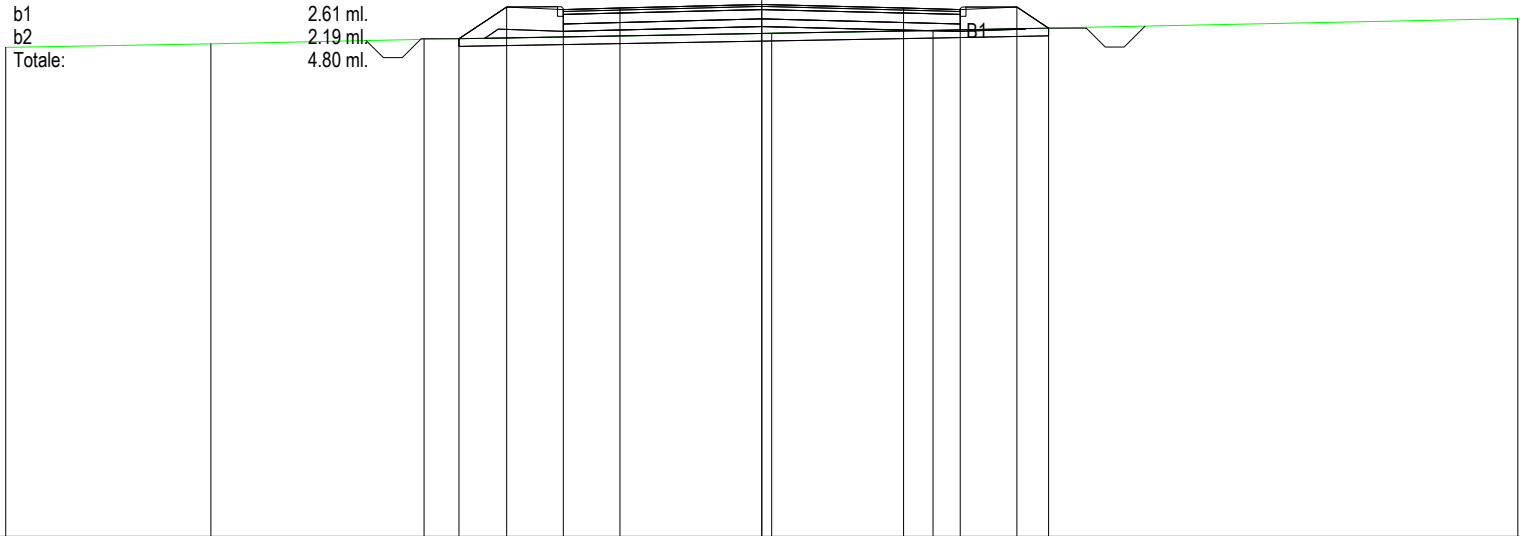

200  
200

PROGRESSIVE TERRENO	-20.00	-14.58	-8.94		0.27	4.53		20.00				
PARZIALI TERRENO		5.42	5.64		9.21	4.26		15.47				
QUOTE TERRENO	14.94	15.03	15.15		15.31	15.38		15.70				
PROGRESSIVE PROGETTO				-8.01	-6.75	-5.25	-3.75	0.00	3.75	5.25	6.75	7.59
PARZIALI PROGETTO				1.26	1.50	1.50	3.75		3.75	1.50	1.50	0.84
QUOTE PROGETTO				15.16	16.00	15.94	15.98	16.07	15.98	15.94	16.00	15.45



PROFILO ASSE OPERA CONNESSA

SEZIONE 24

PROGRESSIVA 1151.60

RILEVATO	
A1	12.89 mq.
BINDER	
C1	0.84 mq.
BASE	
D1	2.64 mq.
FONDAZIONE	
E1	2.10 mq.
SCOTICO	
SC1	3.56 mq.
USURA	
a1	10.50 ml.
VEGETALE	
b1	3.51 ml.
b2	3.50 ml.
Totale:	7.01 ml.

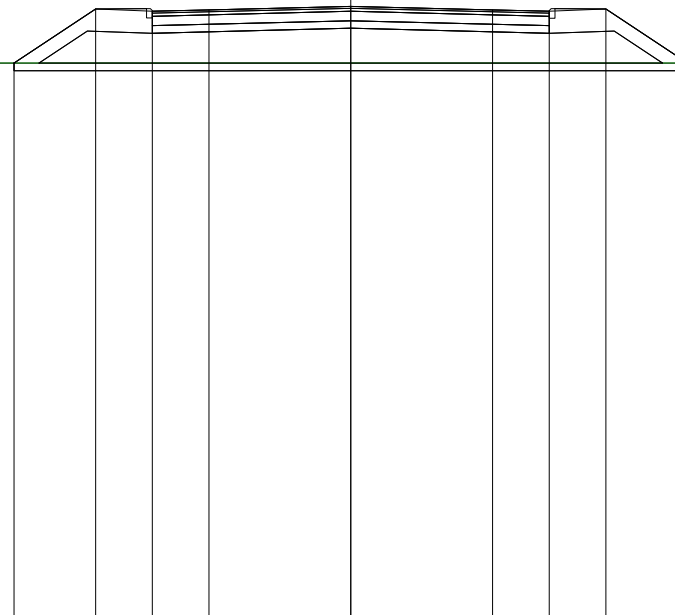

200 200

PROGRESSIVE TERRENO	-20.00												20.00
PARZIALI TERRENO		40.00											
QUOTE TERRENO	14.66												14.66
PROGRESSIVE PROGETTO		-8.91	-6.75	-5.25	-3.75	0.00	3.75	5.25	6.75	8.90			
PARZIALI PROGETTO		2.16	1.50	1.50	3.75	3.75	1.50	1.50	2.15				
QUOTE PROGETTO		14.66	16.10	16.03	16.07	16.16	16.07	16.03	16.10	14.66			

PROFILO ASSE OPERA CONNESSA

SEZIONE 25

PROGRESSIVA 1201.61

RILEVATO	
A1	23.16 mq.
BINDER	
C1	0.84 mq.
BASE	
D1	2.62 mq.
FONDAZIONE	
E1	2.10 mq.
SCOTICO	
SC1	3.92 mq.
USURA	
a1	10.50 ml.
VEGETALE	
b1	4.39 ml.
b2	4.39 ml.
Totale:	8.78 ml.

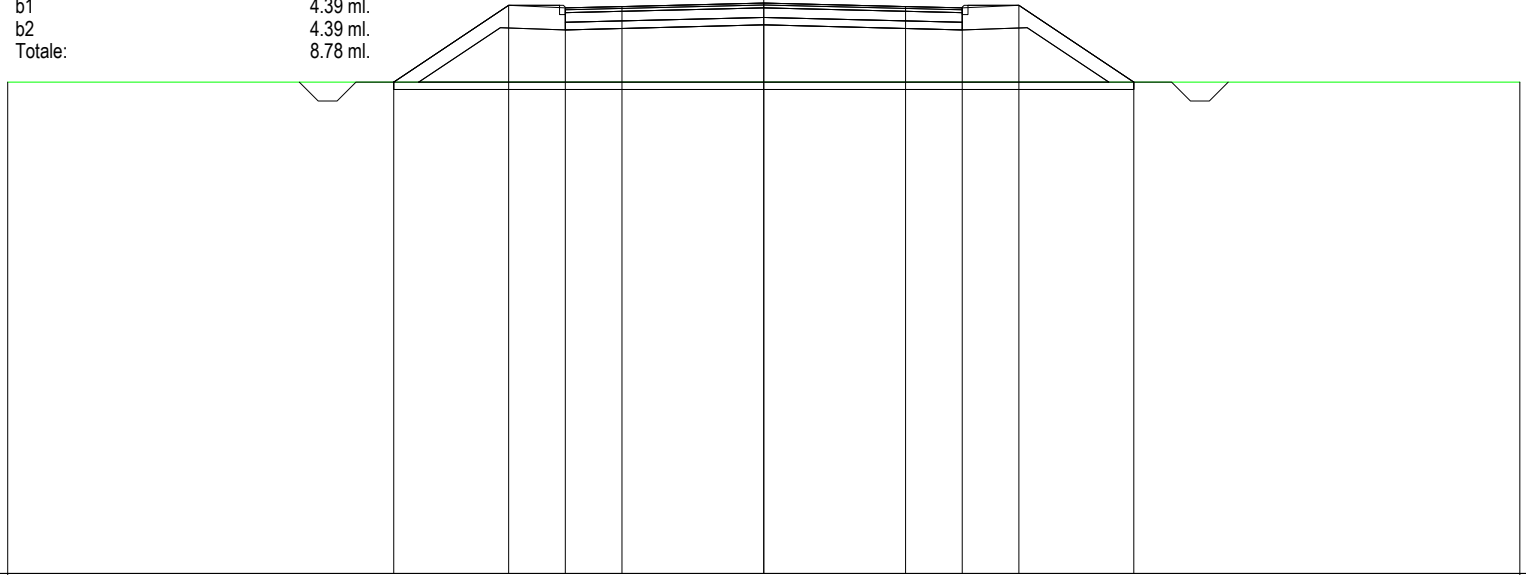

200  
200

PROGRESSIVE TERRENO	-20.00																	20.00
PARZIALI TERRENO								40.00										
QUOTE TERRENO	14.00																	14.00
PROGRESSIVE PROGETTO		-9.79	-6.75	-5.25	-3.75	0.00			3.75	5.25	6.75	9.79						
PARZIALI PROGETTO		3.04	1.50	1.50	3.75		3.75		1.50	1.50	3.04							
QUOTE PROGETTO		14.00	16.02	15.96	16.00	16.09		16.00	15.96	16.02	14.00							

PROFILO ASSE OPERA CONNESSA

SEZIONE 26

PROGRESSIVA 1251.61

RILEVATO	
A1	19.02 mq.
BINDER	
C1	0.84 mq.
BASE	
D1	2.62 mq.
FONDAZIONE	
E1	2.10 mq.
SCOTICO	
SC1	3.78 mq.
USURA	
a1	10.50 ml.
VEGETALE	
b1	4.04 ml.
b2	4.04 ml.
Totale:	8.08 ml.

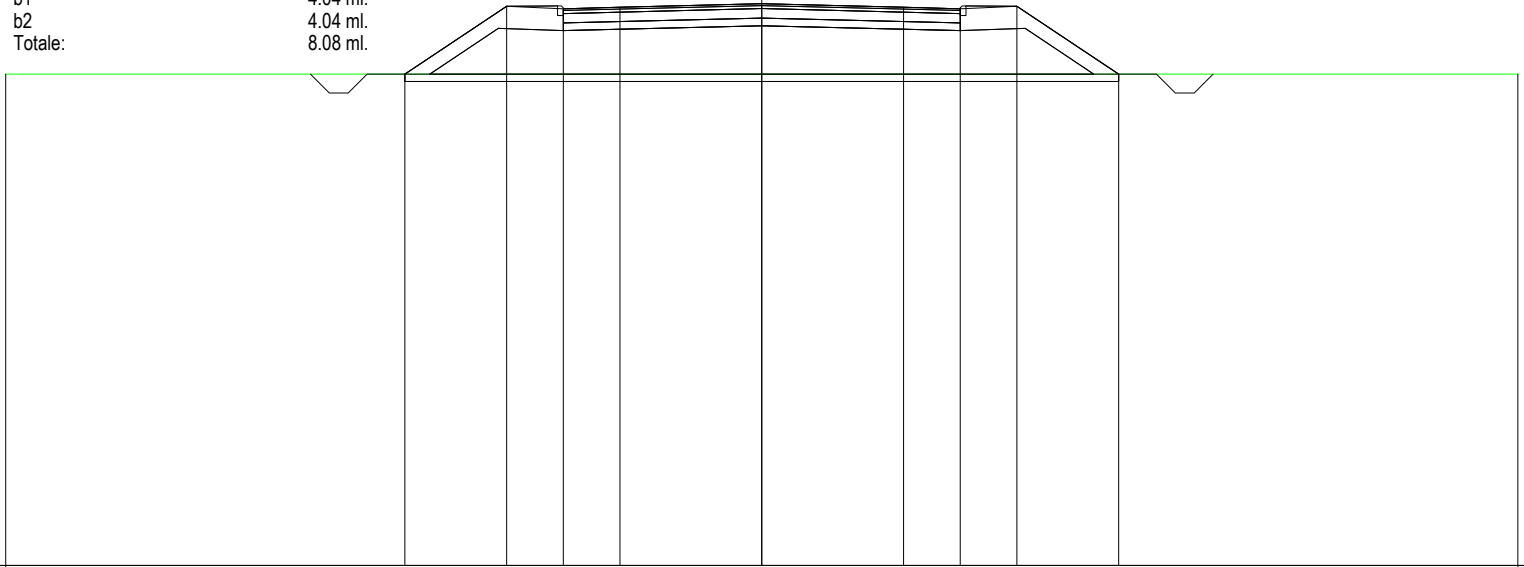

200  
200

PROGRESSIVE TERRENO	-20.00															20.00
PARZIALI TERRENO								40.00								
QUOTE TERRENO	14.00															14.00
PROGRESSIVE PROGETTO		-9.44	-6.75	-5.25	-3.75	0.00			3.75	5.25	6.75	9.44				
PARZIALI PROGETTO			2.69	1.50	1.50	3.75			3.75	1.50	1.50	2.69				
QUOTE PROGETTO		14.00	15.79	15.73	15.76	15.86			15.76	15.73	15.79	14.00				

PROFILO ASSE OPERA CONNESSA

SEZIONE 27

PROGRESSIVA 1300.00

RILEVATO	
A1	16.01 mq.
BINDER	
C1	0.84 mq.
BASE	
D1	2.62 mq.
FONDAZIONE	
E1	2.10 mq.
SCOTICO	
SC1	3.70 mq.
USURA	
a1	10.50 ml.
VEGETALE	
b1	3.57 ml.
b2	4.11 ml.
Totale:	7.68 ml.

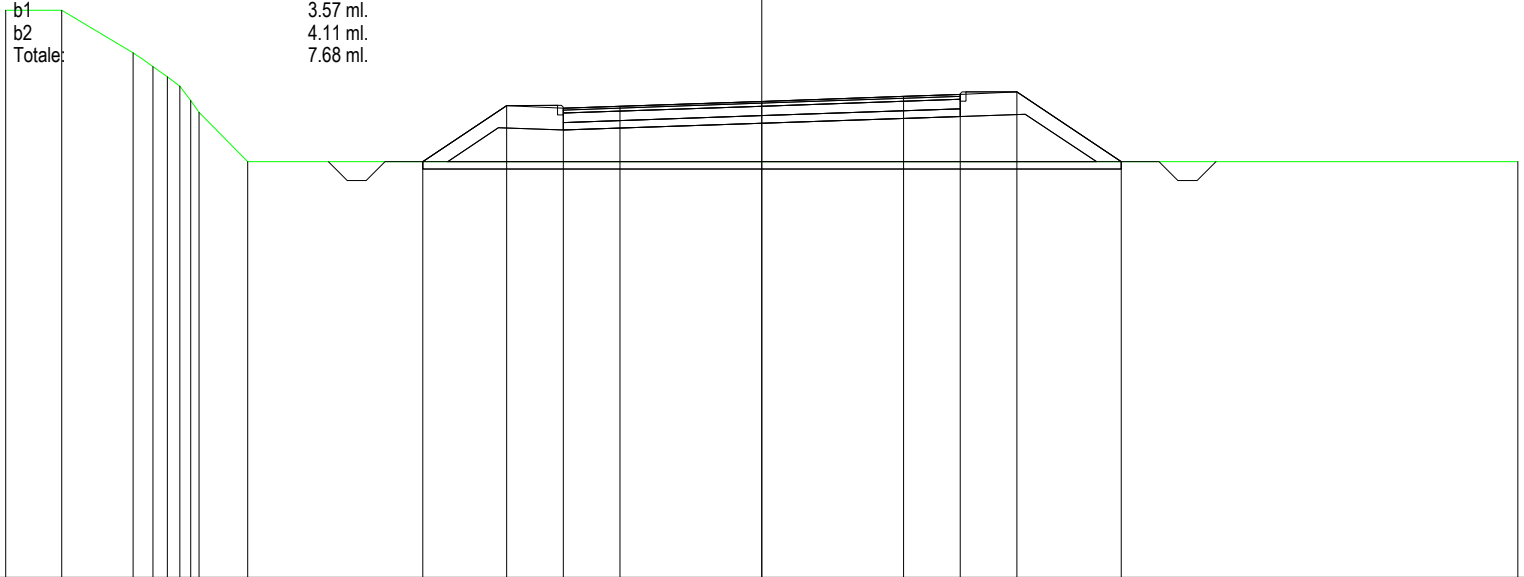

3

200  
200

PROGRESSIVE TERRENO	-20.00	-18.52	-16.63	-16.11	-15.73	-15.39	-15.11	-14.89	-13.60												20.00	
PARZIALI TERRENO	1.48	1.89	0.52	0.38	0.34	0.28	0.22	1.29														
QUOTE TERRENO	18.00	18.00	16.88	16.51	16.24	16.00	15.62	15.30	14.00													14.00
PROGRESSIVE PROGETTO										-8.97	-6.75	-5.25	-3.75	0.00	3.75	5.25	6.75	9.51				
PARZIALI PROGETTO											2.22	1.50	1.50	3.75		3.75	1.50	1.50	2.76			
QUOTE PROGETTO										14.00	15.48	15.41	15.46	15.59	15.72	15.78	15.84	14.00				

PROFILO ASSE OPERA CONNESSA

SEZIONE 28

PROGRESSIVA 1350.00

- RILEVATO
- A1 11.50 mq.
- BINDER
- C1 0.84 mq.
- BASE
- D1 2.63 mq.
- FONDAZIONE
- E1 2.10 mq.
- SCOTICO
- SC1 3.53 mq.
- USURA
- a1 10.50 ml.
- VEGETALE
- b1 2.99 ml.
- b2 3.87 ml.
- Totale: 6.86 ml.

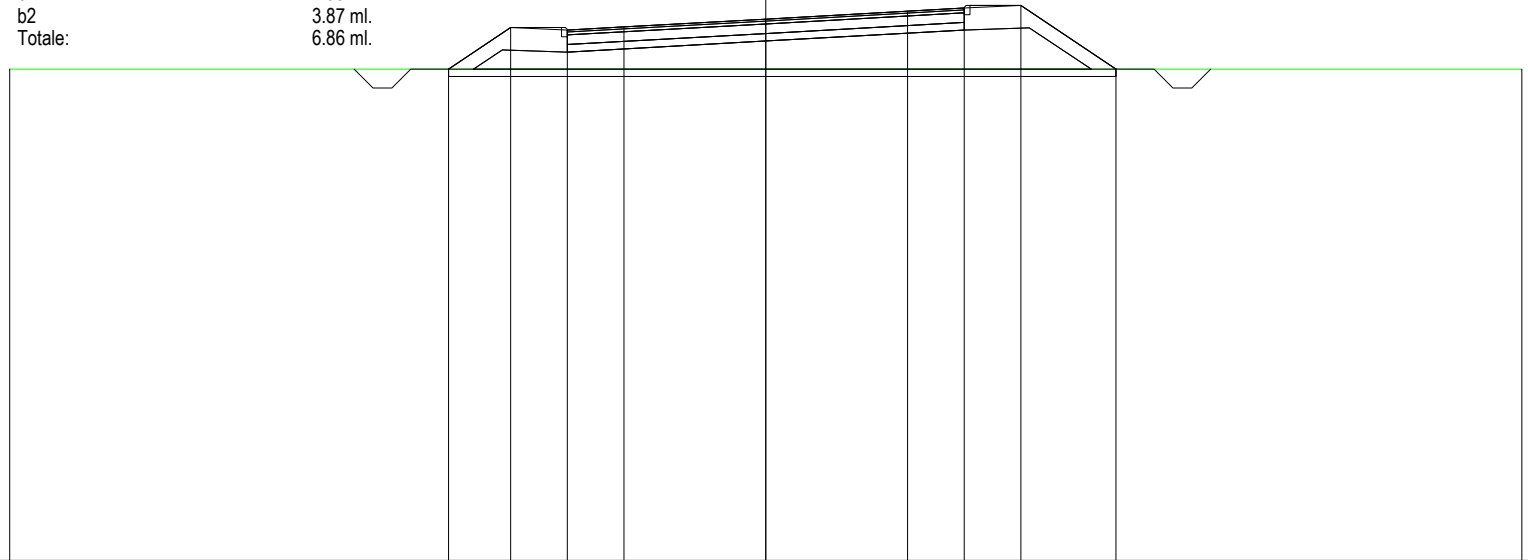

200  
200

PROGRESSIVE  
TERRENO

-20.00

20.00

PARZIALI  
TERRENO

40.00

QUOTE  
TERRENO

14.00

14.00

PROGRESSIVE  
PROGETTO

-8.39

-6.75

-5.25

-3.75

0.00

3.75

5.25

6.75

9.27

PARZIALI  
PROGETTO

1.64

1.50

1.50

3.75

3.75

1.50

1.50

2.52

QUOTE  
PROGETTO

14.00

15.09

15.03

15.11

15.32

15.53

15.61

15.68

14.00

PROFILO ASSE OPERA CONNESSA

SEZIONE 29

PROGRESSIVA 1400.00

RILEVATO	
A1	7.23 mq.
BINDER	
C1	0.84 mq.
BASE	
D1	2.62 mq.
FONDAZIONE	
E1	2.10 mq.
SCOTICO	
SC1	3.37 mq.
USURA	
a1	10.50 ml.
VEGETALE	
b1	2.47 ml.
b2	3.57 ml.
Totale:	6.04 ml.

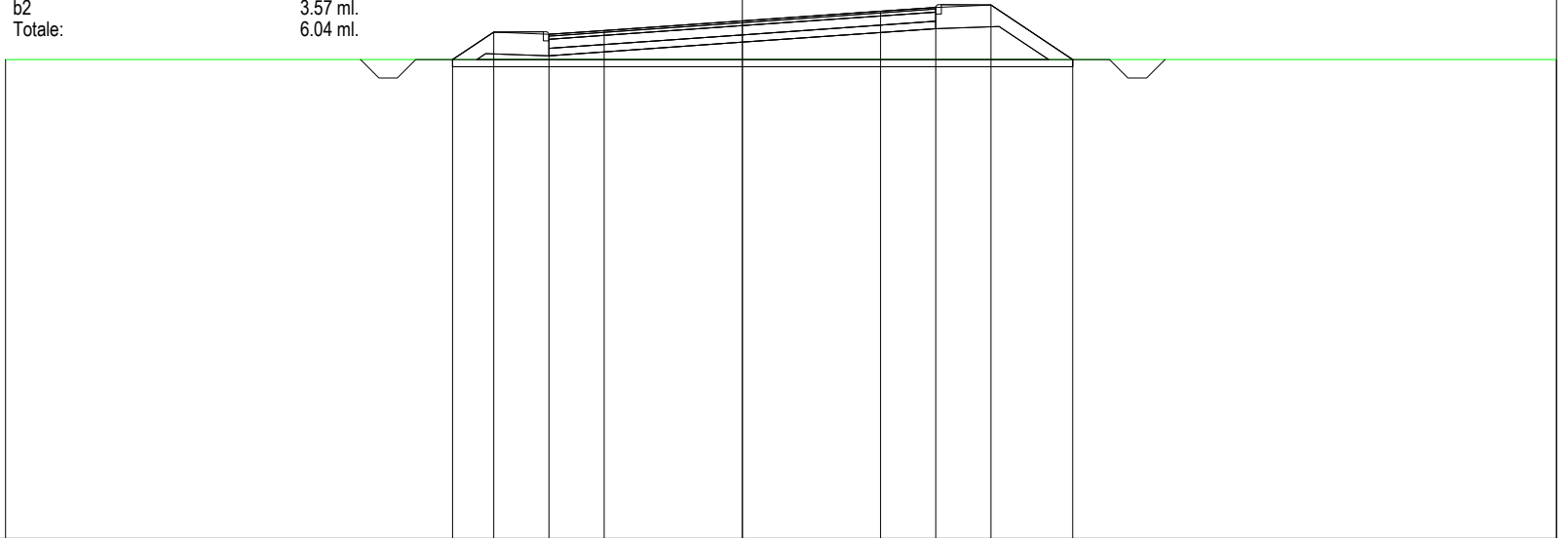

200  
200

PROGRESSIVE TERRENO	-20.00															22.10
PARZIALI TERRENO									42.10							
QUOTE TERRENO	14.00															14.00
PROGRESSIVE PROGETTO		-7.87	-6.75	-5.25	-3.75	0.00		3.75	5.25	6.75	8.97					
PARZIALI PROGETTO		1.12	1.50	1.50	3.75		3.75	1.50	1.50	2.22						
QUOTE PROGETTO		14.00	14.74	14.68	14.78	15.05		15.31	15.41	15.48	14.00					

PROFILO ASSE OPERA CONNESSA

SEZIONE 30

PROGRESSIVA 1450.00

RILEVATO	
A1	3.53 mq.
STERRO	
B1	0.46 mq.
BINDER	
C1	0.83 mq.
BASE	
D1	2.63 mq.
FONDAZIONE	
E1	2.10 mq.
SCOTICO	
SC1	3.20 mq.
USURA	
a1	10.50 ml.
VEGETALE	
b1	2.06 ml.
b2	3.16 ml.
Totale:	5.22 ml.

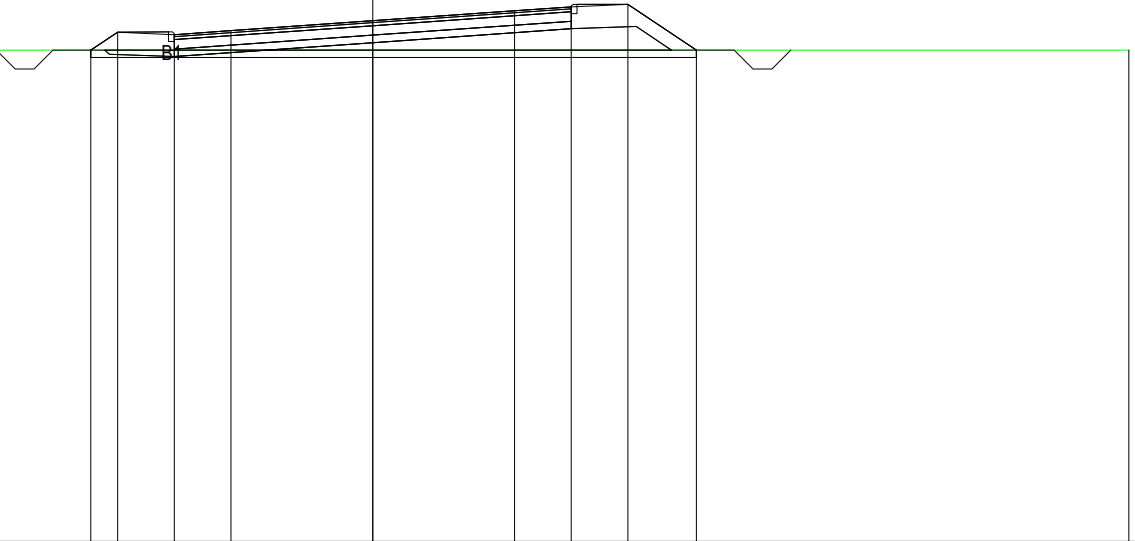

200  
200

PROGRESSIVE TERRENO	-20.00											20.00
PARZIALI TERRENO	40.00											
QUOTE TERRENO	14.00											14.00
PROGRESSIVE PROGETTO		-7.46	-6.75	-5.25	-3.75	0.00		3.75	5.25	6.75	8.56	
PARZIALI PROGETTO		0.71	1.50	1.50	3.75		3.75	1.50	1.50	1.81		
QUOTE PROGETTO		14.00	14.47	14.41	14.51	14.77		15.04	15.14	15.21	14.00	





PROFILO ASSE OPERA CONNESSA

SEZIONE 32

PROGRESSIVA 1550.00

RILEVATO	
A1	0.10 mq.
A2	0.07 mq.
Totale:	0.17 mq.
STERRO	
B1	5.25 mq.
BINDER	
C1	0.84 mq.
BASE	
D1	2.62 mq.
FONDAZIONE	
E1	2.10 mq.
SCOTICO	
SC1	2.19 mq.
SC2	0.28 mq.
Totale:	2.47 mq.
USURA	
a1	10.50 ml.
VEGETALE	
b1	2.34 ml.

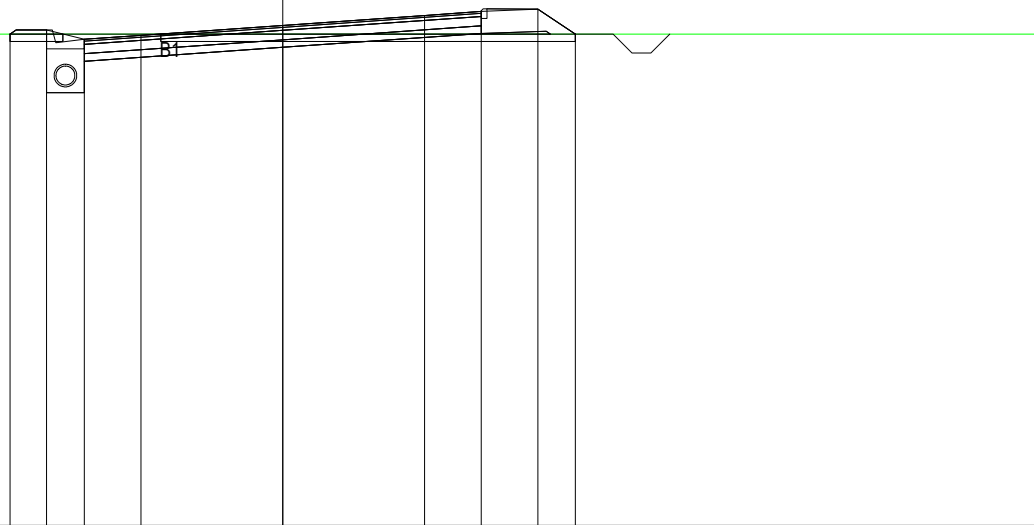

200  
200

PROGRESSIVE TERRENO

-20.00

20.00

PARZIALI TERRENO

40.00

QUOTE TERRENO

14.00

14.00

PROGRESSIVE PROGETTO

-7.21

-6.25

-5.25

-3.75

0.00

3.75

5.25

6.75

7.74

PARZIALI PROGETTO

0.96

1.00

1.50

3.75

3.75

1.50

1.50

0.99

QUOTE PROGETTO

14.00

14.11

13.86

13.96

14.23

14.49

14.59

14.66

14.00

PROFILO ASSE OPERA CONNESSA

SEZIONE 33

PROGRESSIVA 1600.00

RILEVATO	
A1	0.09 mq.
A2	0.05 mq.
Totale:	0.14 mq.
STERRO	
B1	5.44 mq.
BINDER	
C1	0.84 mq.
BASE	
D1	2.63 mq.
FONDAZIONE	
E1	2.10 mq.
SCOTICO	
SC1	2.15 mq.
SC2	0.27 mq.
Totale:	2.42 mq.
USURA	
a1	10.50 ml.
VEGETALE	
b1	2.32 ml.

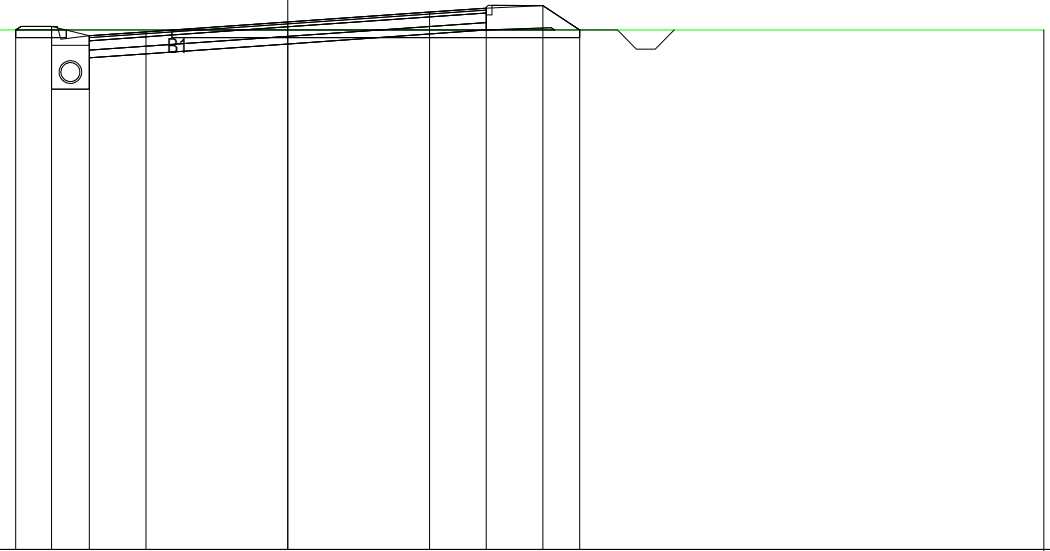

200  
200

PROGRESSIVE  
TERRENO

-20.00

20.00

PARZIALI  
TERRENO

40.00

QUOTE  
TERRENO

13.74

13.74

PROGRESSIVE  
PROGETTO

-7.20	-6.25	-5.25	-3.75	0.00	3.75	5.25	6.75	7.72
0.95	1.00	1.50	3.75	3.75	1.50	1.50	0.97	
13.74	13.83	13.88	13.69	13.95	14.21	14.32	14.38	13.74

PARZIALI  
PROGETTO

QUOTE  
PROGETTO

PROFILO ASSE OPERA CONNESSA

SEZIONE 34

PROGRESSIVA 1650.00

- RILEVATO
- A1 0.07 mq.
- STERRO
- B1 5.71 mq.
- BINDER
- C1 0.84 mq.
- BASE
- D1 2.62 mq.
- FONDAZIONE
- E1 2.10 mq.
- SCOTICO
- SC1 2.11 mq.
- SC2 0.27 mq.
- Totale: 2.38 mq.
- USURA
- a1 10.50 ml.
- VEGETALE
- b1 2.25 ml.

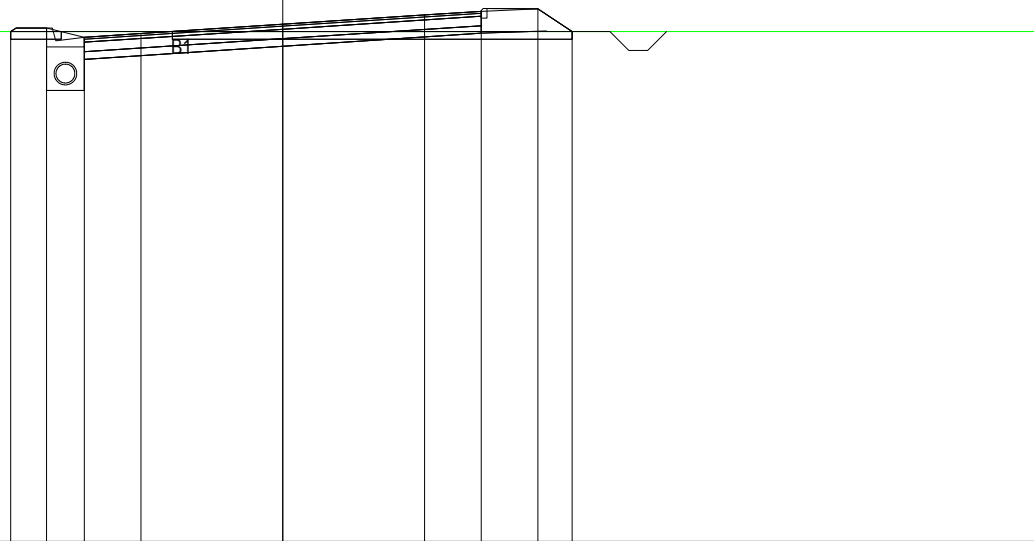

200  
200

PROGRESSIVE TERRENO

-20.00

20.00

PARZIALI TERRENO

40.00

QUOTE TERRENO

13.49

13.49

PROGRESSIVE PROGETTO

-7.20 -6.25 -5.25 -3.75 0.00 3.75 5.25 6.75 7.65

PARZIALI PROGETTO

0.95 1.00 1.50 3.75 3.75 1.50 1.50 0.90

QUOTE PROGETTO

13.49 13.58 13.33 13.43 13.68 13.93 14.02 14.09 13.49

PROFILO ASSE OPERA CONNESSA

SEZIONE 35

PROGRESSIVA 1700.00

- RILEVATO
- A1 0.21 mq.
- STERRO
- B1 5.55 mq.
- BINDER
- C1 0.84 mq.
- BASE
- D1 2.62 mq.
- FONDAZIONE
- E1 2.10 mq.
- SCOTICO
- SC1 2.41 mq.
- SC2 0.40 mq.
- Totale: 2.81 mq.
- USURA
- a1 10.50 ml.
- VEGETALE
- b1 2.10 ml.



0  
200  
200

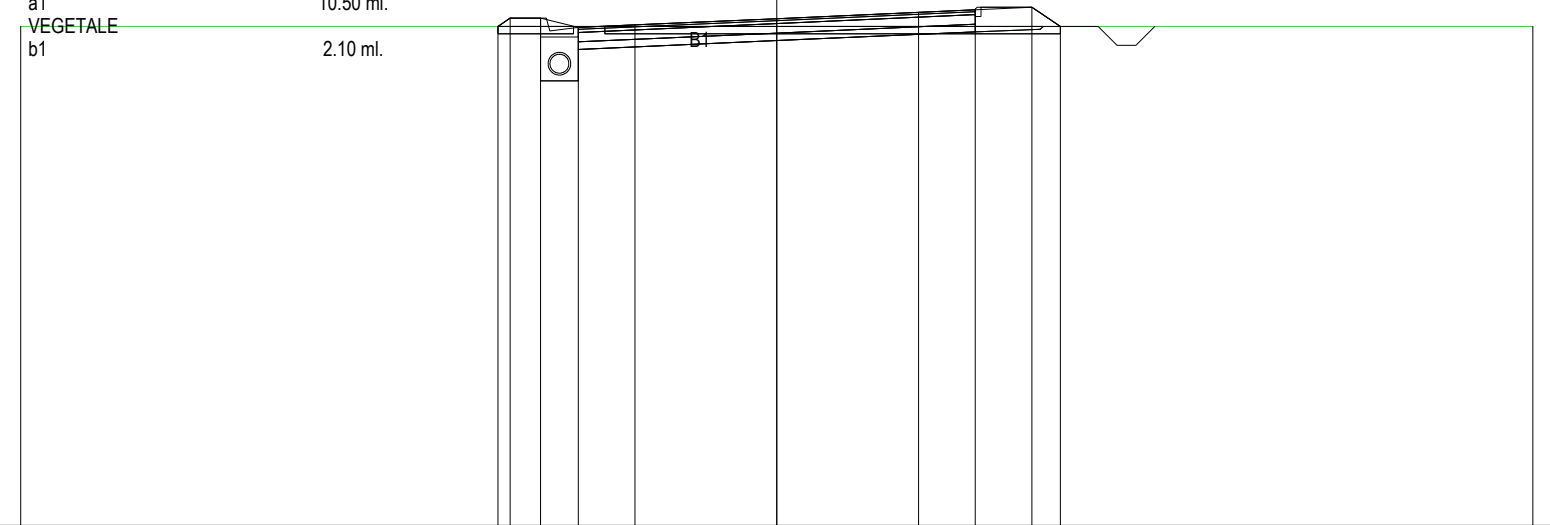

PROGRESSIVE TERRENO

-20.00

20.00

PARZIALI TERRENO

40.00

QUOTE TERRENO

13.20

13.20

PROGRESSIVE PROGETTO

-7.38  
-7.05  
-6.25  
-5.25  
-3.75  
0.00  
3.75  
5.25  
6.75  
7.50

PARZIALI PROGETTO

0.33  
0.80  
1.00  
1.50  
3.75  
3.75  
1.50  
1.50  
0.75

QUOTE PROGETTO

13.20  
13.42  
13.42  
13.17  
13.24  
13.41  
13.57  
13.64  
13.70  
13.20

PROFILO ASSE OPERA CONNESSA

SEZIONE 36

PROGRESSIVA 1750.00

STERRO	
B1	6.37 mq.
BINDER	
C1	0.84 mq.
BASE	
D1	2.62 mq.
FONDAZIONE	
E1	2.10 mq.
SCOTICO	
SC1	2.78 mq.
USURA	
a1	10.50 ml.
VEGETALE	
b1	1.57 ml.
b2	1.57 ml.
Totale:	3.14 ml.

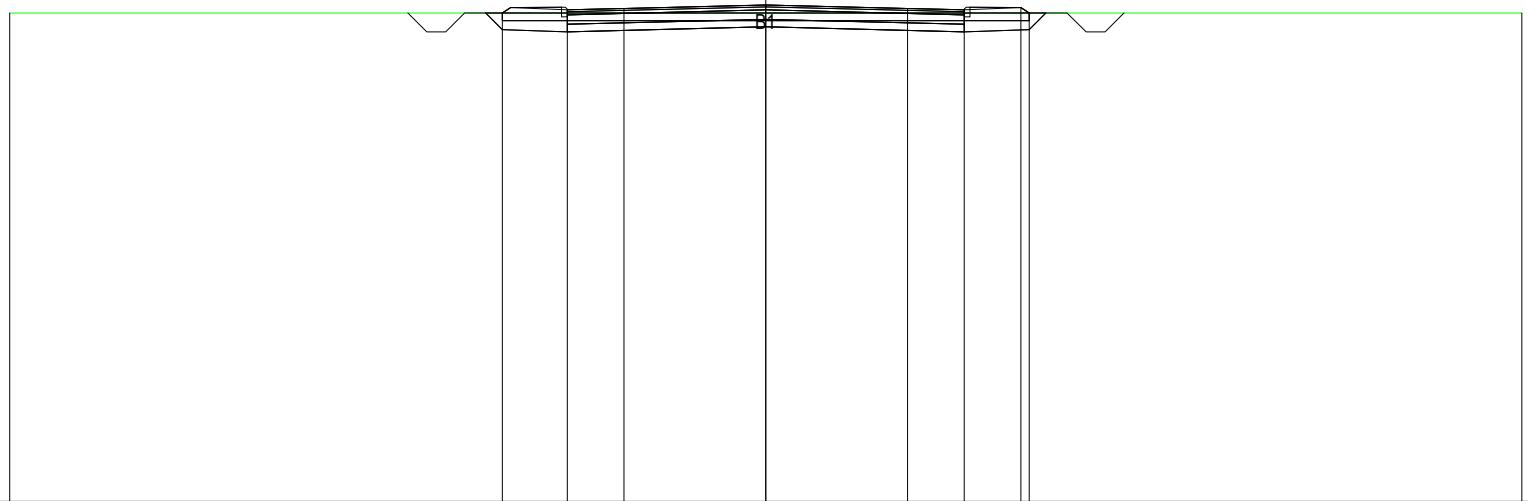

200  
200

PROGRESSIVE TERRENO	-20.00											20.00
PARZIALI TERRENO	40.00											
QUOTE TERRENO	12.92											12.92
PROGRESSIVE PROGETTO		-6.97	-5.25	-3.75	0.00	3.75	5.25	6.75	6.97			
PARZIALI PROGETTO		1.72	1.50	3.75	3.75	1.50	1.50	0.22				
QUOTE PROGETTO		12.92	13.00	13.04	13.13	13.04	13.00	13.07	12.92			

PROFILO ASSE OPERA CONNESSA

SEZIONE 37

PROGRESSIVA 1800.00

STERRO	
B1	6.22 mq.
BINDER	
C1	0.84 mq.
BASE	
D1	2.62 mq.
FONDAZIONE	
E1	2.10 mq.
SCOTICO	
SC1	2.79 mq.
USURA	
a1	10.50 ml.
VEGETALE	
b1	1.57 ml.
b2	1.57 ml.
Totale:	3.14 ml.

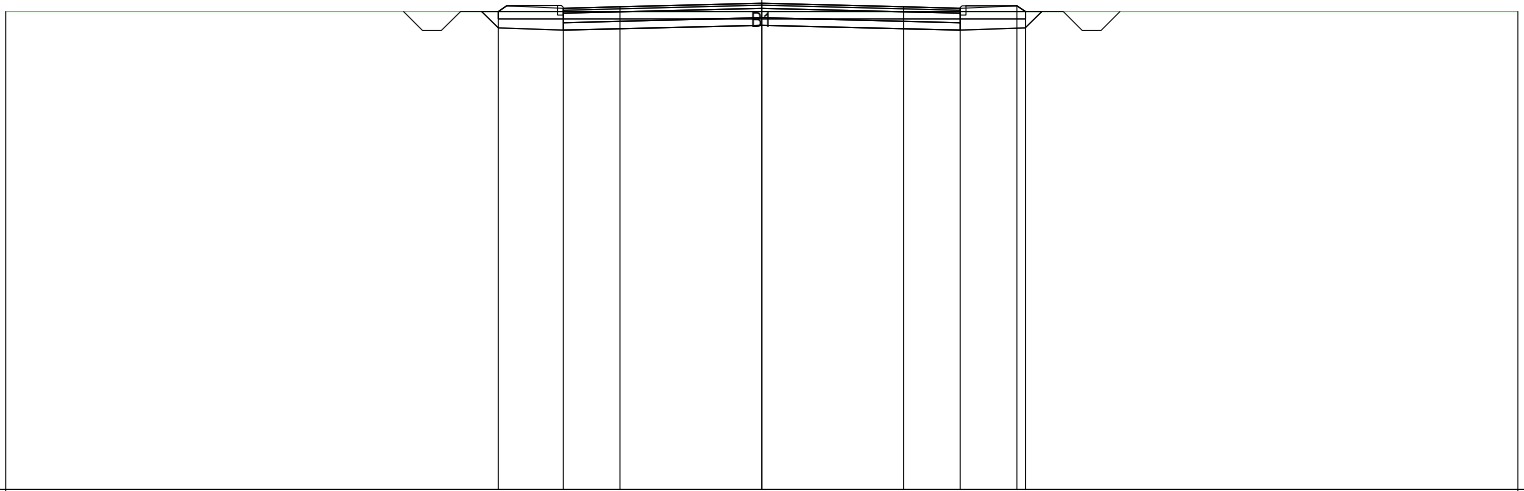

0  
200  
200

PROGRESSIVE TERRENO	-20.00												20.00
PARZIALI TERRENO		40.00											
QUOTE TERRENO	12.64												12.64
PROGRESSIVE PROGETTO		-6.97	-5.25	-3.75	0.00		3.75	5.25	6.75	6.97			
PARZIALI PROGETTO		1.72	1.50	3.75	3.75	1.50	1.50	0.22					
QUOTE PROGETTO		12.64	12.73	12.76	12.86	12.76	12.73	12.79	12.64				

PROFILO ASSE OPERA CONNESSA

SEZIONE 38

PROGRESSIVA 1850.00

STERRO	
B1	0.50 mq.
B2	0.50 mq.
Totale:	1.00 mq.
BINDER	
C1	0.84 mq.
BASE	
D1	2.62 mq.
FONDAZIONE	
E1	2.10 mq.
SCOTICO	
SC1	3.01 mq.
USURA	
a1	10.50 ml.
VEGETALE	
b1	2.13 ml.
b2	2.13 ml.
Totale:	4.26 ml.

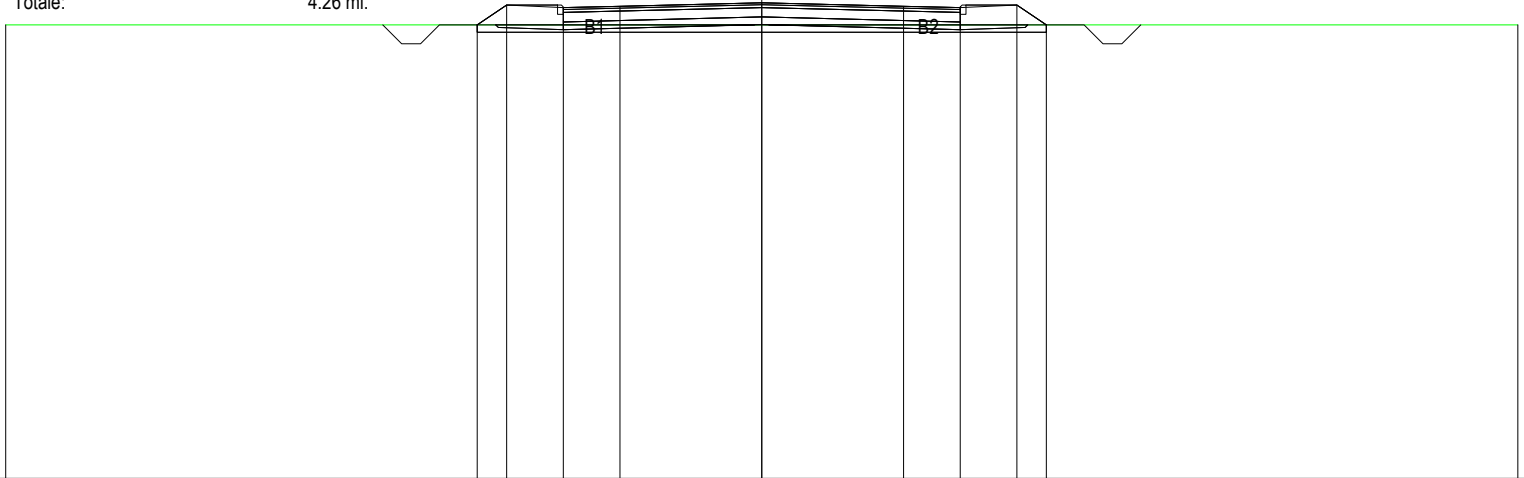

0  
200  
200

PROGRESSIVE TERRENO	-20.00											20.00
PARZIALI TERRENO	40.00											
QUOTE TERRENO	12.00											12.00
PROGRESSIVE PROGETTO		-7.53	-6.75	-5.25	-3.75	0.00		3.75	5.25	6.75	7.53	
PARZIALI PROGETTO		0.78	1.50	1.50	3.75		3.75	1.50	1.50	0.78		
QUOTE PROGETTO		12.00	12.52	12.45	12.49	12.58		12.49	12.45	12.52	12.00	

PROFILO ASSE OPERA CONNESSA

SEZIONE 39

PROGRESSIVA 1900.00

STERRO	
B1	4.92 mq.
BINDER	
C1	0.84 mq.
BASE	
D1	2.62 mq.
FONDAZIONE	
E1	2.10 mq.
SCOTICO	
SC1	2.85 mq.
USURA	
a1	10.50 ml.
VEGETALE	
b1	1.72 ml.
b2	1.72 ml.
Totale:	3.44 ml.

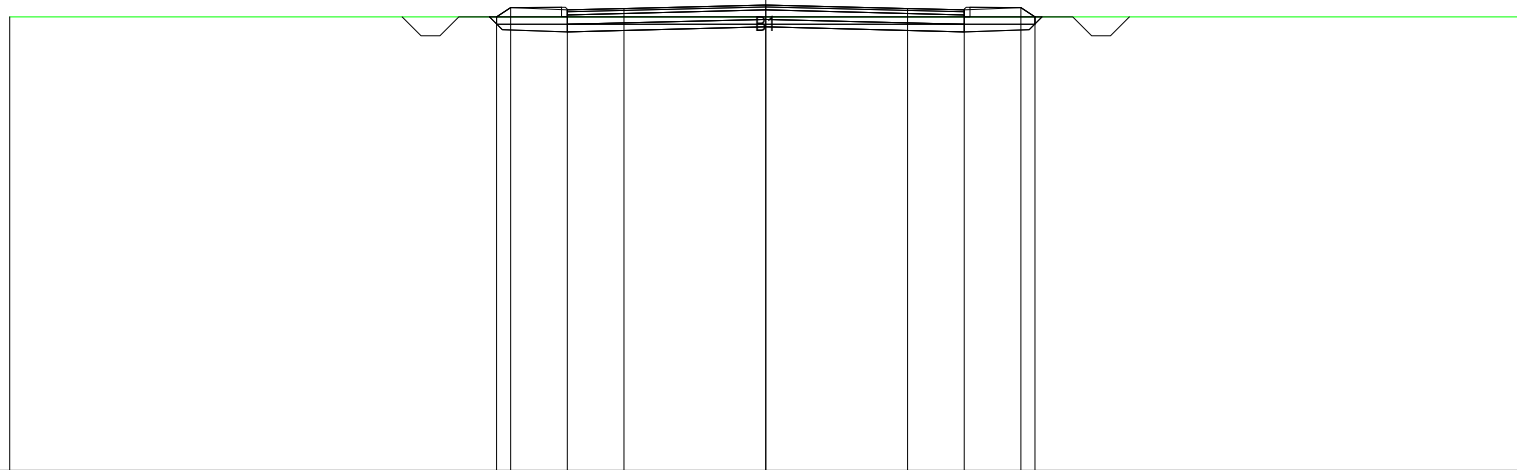

0  
200 200

PROGRESSIVE TERRENO	-20.00													20.00
PARZIALI TERRENO	40.00													
QUOTE TERRENO	12.00													12.00
PROGRESSIVE PROGETTO		-7.12	-6.75	-5.25	-3.75	0.00			3.75	5.25	6.75	7.12		
PARZIALI PROGETTO		0.37	1.50	1.50	3.75	3.75			1.50	1.50	0.37			
QUOTE PROGETTO		12.00	12.24	12.18	12.22	12.31			12.22	12.18	12.24	12.00		



PROFILO ASSE OPERA CONNESSA

SEZIONE 40

PROGRESSIVA 1950.00

RILEVATO  
 A1 0.16 mq.  
 A2 0.16 mq.  
 Totale: 0.32 mq.  
 STERRO  
 B1 9.16 mq.  
 BINDER  
 C1 0.82 mq.  
 BASE  
 D1 2.64 mq.  
 FONDAZIONE  
 E1 2.10 mq.  
 SCOTICO  
 SC1 0.36 mq.  
 SC2 0.88 mq.  
 SC3 0.35 mq.  
 Totale: 1.59 mq.  
 USURA  
 a1 10.50 ml.

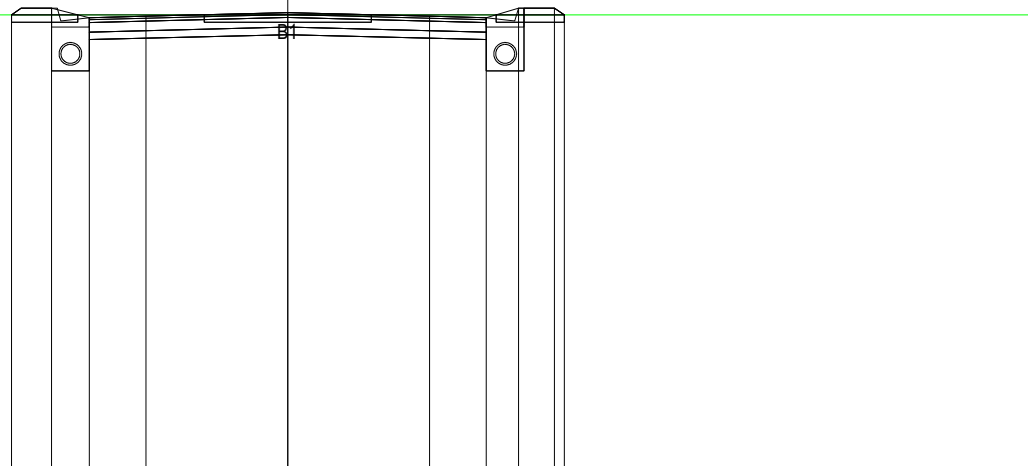

200  
200

PROGRESSIVE  
TERRENO

-20.00

20.00

PARZIALI  
TERRENO

40.00

QUOTE  
TERRENO

12.00

12.00

PROGRESSIVE  
PROGETTO

-7.31

-6.25

-5.25

-3.75

0.00

3.75

5.25

6.10

7.05

7.31

PARZIALI  
PROGETTO

1.06

1.50

3.75

3.75

1.50

0.85

0.95

0.26

QUOTE  
PROGETTO

12.00

12.17

11.92

11.96

12.06

11.96

11.92

12.17

12.17

12.00

PROFILO ASSE OPERA CONNESSA

SEZIONE 41

PROGRESSIVA 2200.00

RILEVATO	
A1	0.08 mq.
STERRO	
B1	7.25 mq.
BINDER	
C1	0.84 mq.
BASE	
D1	2.63 mq.
FONDAZIONE	
E1	2.10 mq.
SCOTICO	
SC1	1.77 mq.
USURA	
a1	10.50 ml.
VEGETALE	
b1	2.63 ml.



200  
200

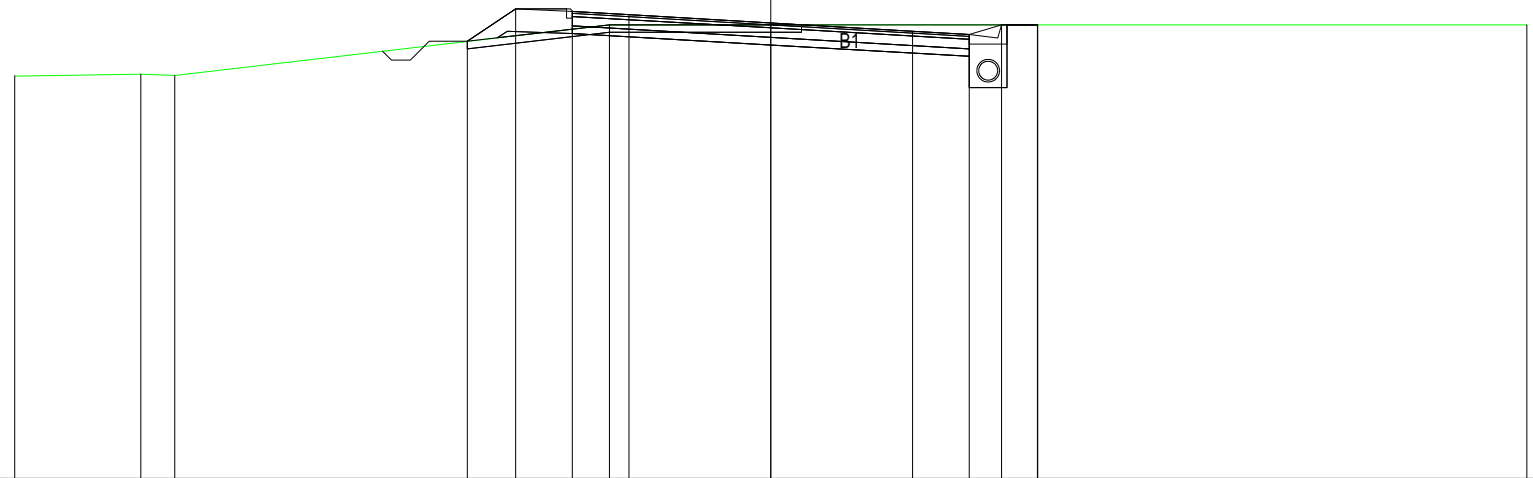

PROGRESSIVE  
TERRENO

-20.00	-16.66	-15.76	-4.27	12.00	20.00
--------	--------	--------	-------	-------	-------

PARZIALI  
TERRENO

3.34	0.90	11.49	24.27
------	------	-------	-------

QUOTE  
TERRENO

10.65	10.69	10.66	12.00	12.00
-------	-------	-------	-------	-------

PROGRESSIVE  
PROGETTO

-8.03	-6.75	-5.25	-3.75	0.00	3.75	5.25	6.10	7.05	7.06
-------	-------	-------	-------	------	------	------	------	------	------

PARZIALI  
PROGETTO

1.28	1.50	1.50	3.75	3.75	1.50	0.85	0.95	0.01
------	------	------	------	------	------	------	------	------

QUOTE  
PROGETTO

11.56	12.42	12.35	12.26	12.05	11.83	11.74	11.99	11.99	12.00
-------	-------	-------	-------	-------	-------	-------	-------	-------	-------

PROFILO ASSE OPERA CONNESSA

SEZIONE 42

PROGRESSIVA 2250.00

- RILEVATO
- A1 0.34 mq.
- STERRO
- B1 2.38 mq.
- BINDER
- C1 0.84 mq.
- BASE
- D1 2.62 mq.
- FONDAZIONE
- E1 2.10 mq.
- SCOTICO
- SC1 3.00 mq.
- USURA
- a1 10.50 ml.
- VEGETALE
- b1 2.47 ml.
- b2 1.71 ml.
- Totale: 4.18 ml.

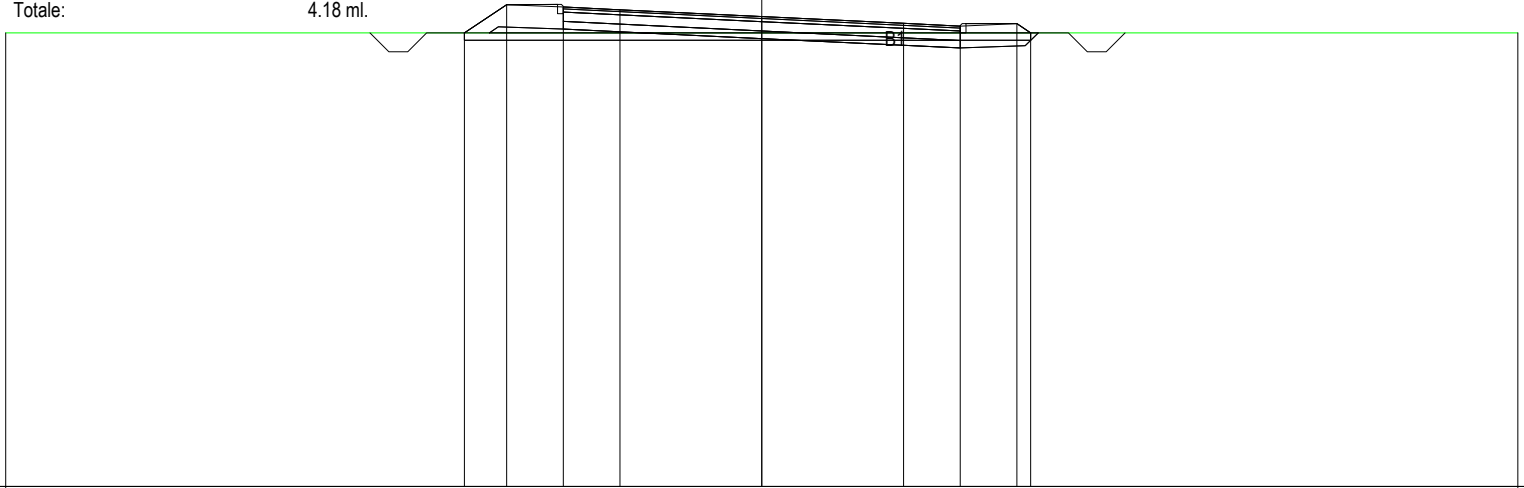

0  
200  
200

PROGRESSIVE TERRENO	-20.00																				20.00
PARZIALI TERRENO		40.00																			
QUOTE TERRENO	12.00																				12.00
PROGRESSIVE PROGETTO				-7.87	-6.75	-5.25	-3.75		0.00					3.75	5.25	6.75	7.11				
PARZIALI PROGETTO				1.12	1.50	1.50		3.75		3.75				1.50	1.50	0.36					
QUOTE PROGETTO				12.00	12.74	12.68	12.61		12.43					12.25	12.18	12.24	12.00				

PROFILO ASSE OPERA CONNESSA

SEZIONE 43

PROGRESSIVA 2300.00

RILEVATO	
A1	1.50 mq.
BINDER	
C1	0.84 mq.
BASE	
D1	2.64 mq.
FONDAZIONE	
E1	2.10 mq.
SCOTICO	
SC1	3.12 mq.
USURA	
a1	10.50 ml.
VEGETALE	
b1	2.39 ml.
b2	2.39 ml.
Totale:	4.78 ml.

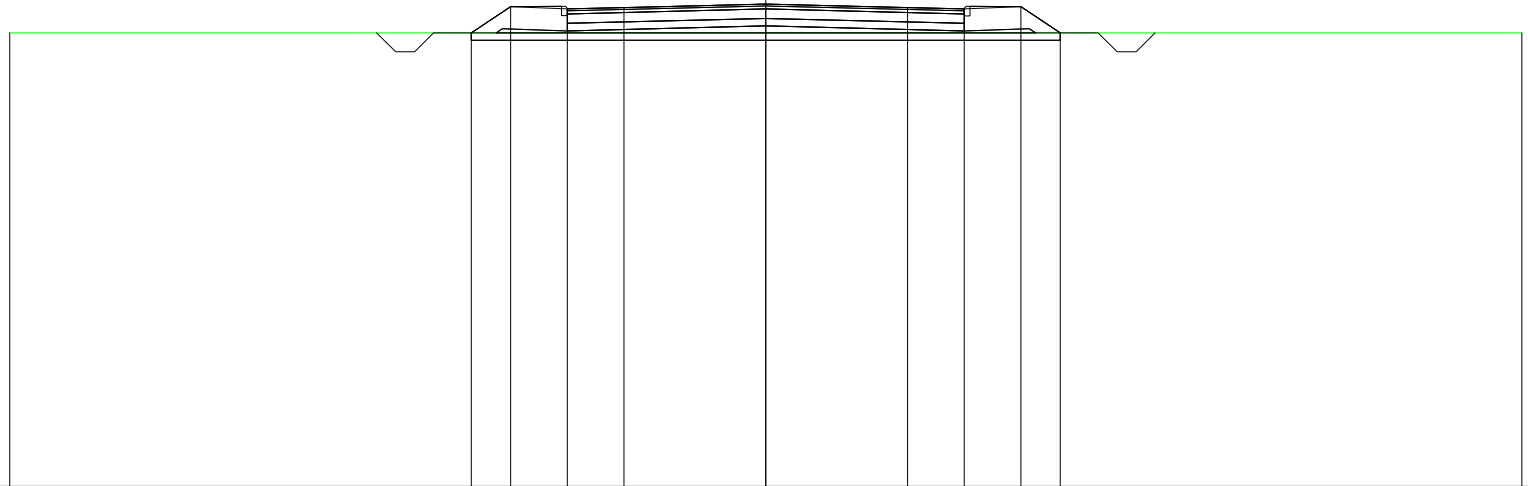

200  
200

PROGRESSIVE  
TERRENO

-20.00

20.00

PARZIALI  
TERRENO

40.00

QUOTE  
TERRENO

12.00

12.00

PROGRESSIVE  
PROGETTO

-7.79

-6.75

-5.25

-3.75

0.00

3.75

5.25

6.75

7.79

PARZIALI  
PROGETTO

1.04

1.50

1.50

3.75

3.75

1.50

1.50

1.04

QUOTE  
PROGETTO

12.00

12.69

12.63

12.67

12.76

12.67

12.63

12.70

12.00

PROFILO ASSE OPERA CONNESSA

SEZIONE 44

PROGRESSIVA 2350.00

RILEVATO	
A1	3.32 mq.
BINDER	
C1	0.84 mq.
BASE	
D1	2.62 mq.
FONDAZIONE	
E1	2.10 mq.
SCOTICO	
SC1	3.22 mq.
USURA	
a1	10.50 ml.
VEGETALE	
b1	2.42 ml.
b2	2.87 ml.
Totale:	5.29 ml.

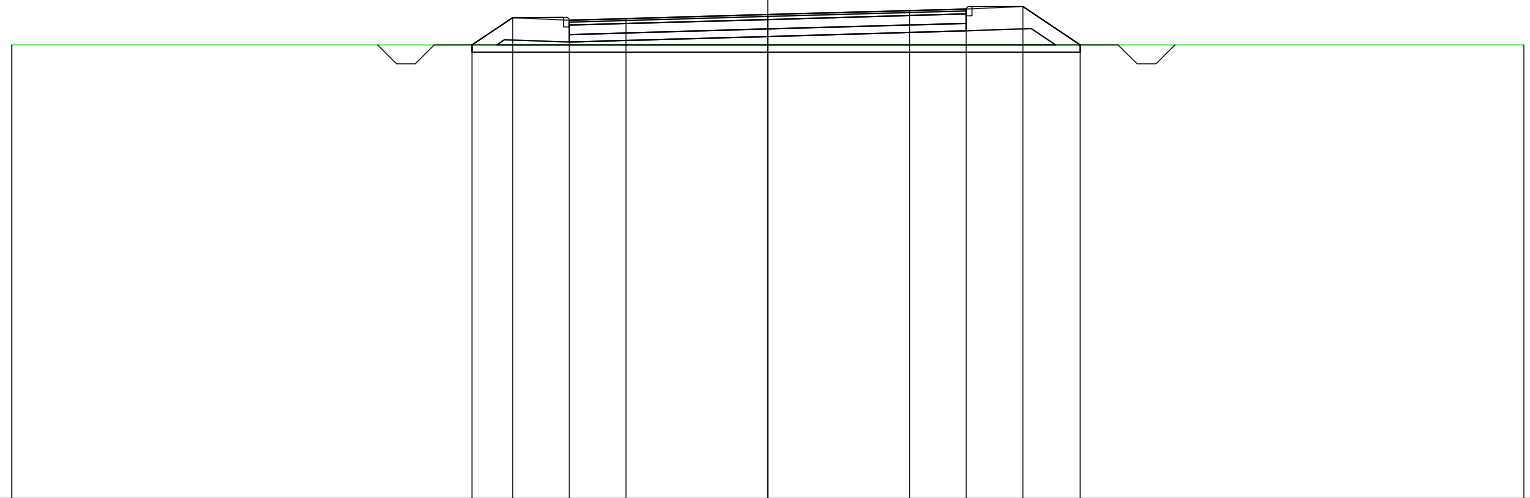

0  
200  
200

PROGRESSIVE  
TERRENO

-20.00

20.00

PARZIALI  
TERRENO

40.00

QUOTE  
TERRENO

12.00

12.00

PROGRESSIVE  
PROGETTO

-7.82

-6.75

-5.25

-3.75

0.00

3.75

5.25

6.75

8.27

PARZIALI  
PROGETTO

1.07

1.50

1.50

3.75

3.75

1.50

1.50

1.52

QUOTE  
PROGETTO

12.00

12.72

12.65

12.69

12.80

12.90

12.95

13.01

12.00

PROFILO ASSE OPERA CONNESSA

SEZIONE 45

PROGRESSIVA 2400.00

RILEVATO	
A1	2.72 mq.
STERRO	
B1	0.22 mq.
BINDER	
C1	0.85 mq.
BASE	
D1	2.62 mq.
FONDAZIONE	
E1	2.10 mq.
SCOTICO	
SC1	3.18 mq.
USURA	
a1	10.50 ml.
VEGETALE	
b1	2.17 ml.
b2	2.95 ml.
Totale:	5.12 ml.

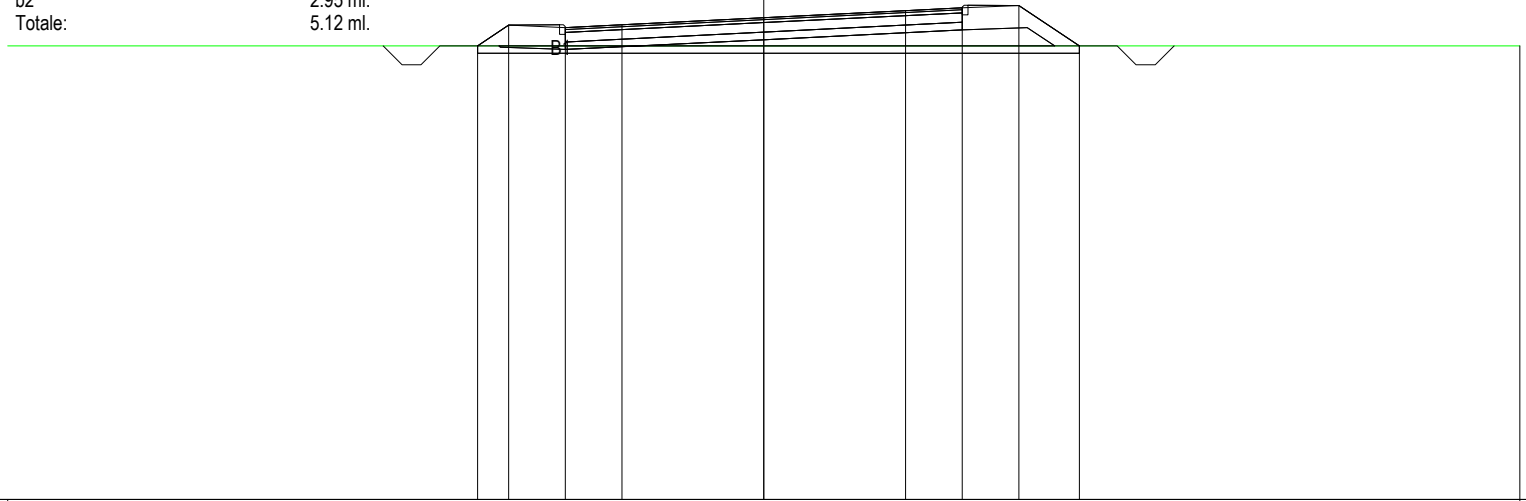

0  
200  
200

PROGRESSIVE TERRENO	-20.00											20.00
PARZIALI TERRENO	40.00											
QUOTE TERRENO	12.00											12.00
PROGRESSIVE PROGETTO			-6.75	-5.25	-3.75	0.00		3.75	5.25	6.75	8.35	
PARZIALI PROGETTO		1.50	1.50	3.75			1.50	1.50	1.60			
QUOTE PROGETTO	12.00	12.55	12.48	12.56	12.74	12.93	13.00	13.07	12.00			

PROFILO ASSE OPERA CONNESSA

SEZIONE 46

PROGRESSIVA 2450.00

RILEVATO	
A1	2.67 mq.
STERRO	
B1	0.91 mq.
BINDER	
C1	0.84 mq.
BASE	
D1	2.63 mq.
FONDAZIONE	
E1	2.10 mq.
SCOTICO	
SC1	3.15 mq.
USURA	
a1	10.50 ml.
VEGETALE	
b1	1.93 ml.
b2	3.03 ml.
Totale:	4.96 ml.

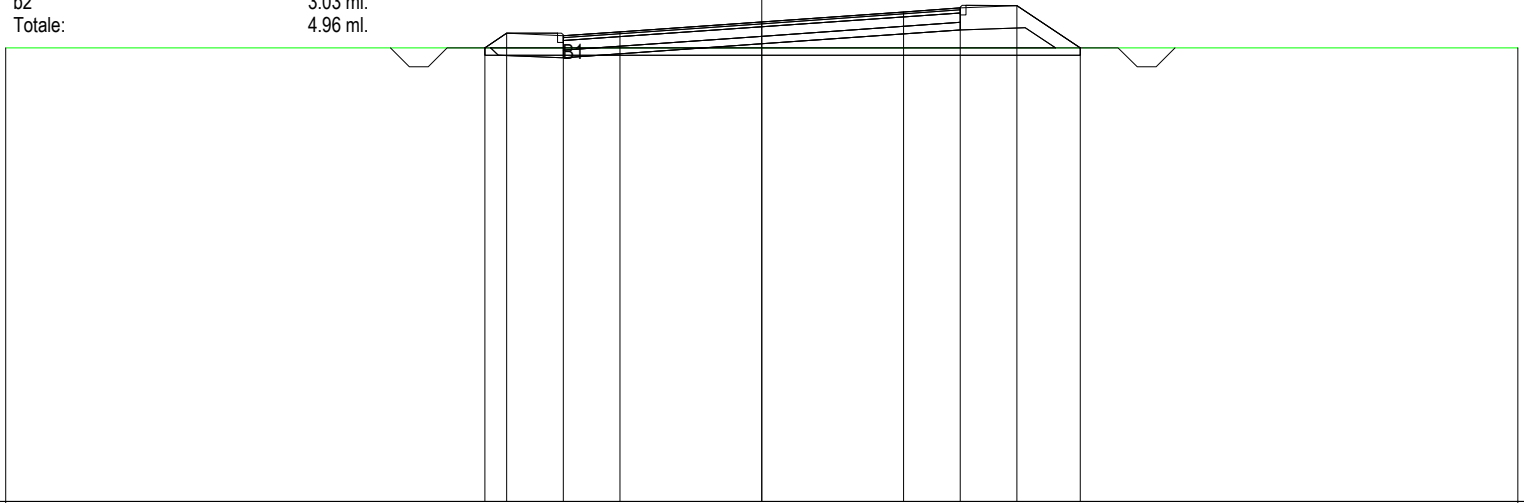

0  
200  
200

PROGRESSIVE  
TERRENO

-20.00

20.00

PARZIALI  
TERRENO

40.00

QUOTE  
TERRENO

12.00

12.00

PROGRESSIVE  
PROGETTO

-7.33

-6.75

-5.25

-3.75

0.00

5.25

6.75

8.43

PARZIALI  
PROGETTO

0.58

1.50

1.50

3.75

3.75

1.50

1.50

1.68

QUOTE  
PROGETTO

12.00

12.38

12.32

12.42

12.69

12.95

13.05

13.12

12.00





PROFILO ASSE OPERA CONNESSA

SEZIONE 48

PROGRESSIVA 2550.00

RILEVATO	
A1	1.73 mq.
STERRO	
B1	1.63 mq.
BINDER	
C1	0.84 mq.
BASE	
D1	2.62 mq.
FONDAZIONE	
E1	2.10 mq.
SCOTICO	
SC1	3.08 mq.
USURA	
a1	10.50 ml.
VEGETALE	
b1	2.86 ml.
b2	1.76 ml.
Totale:	4.62 ml.

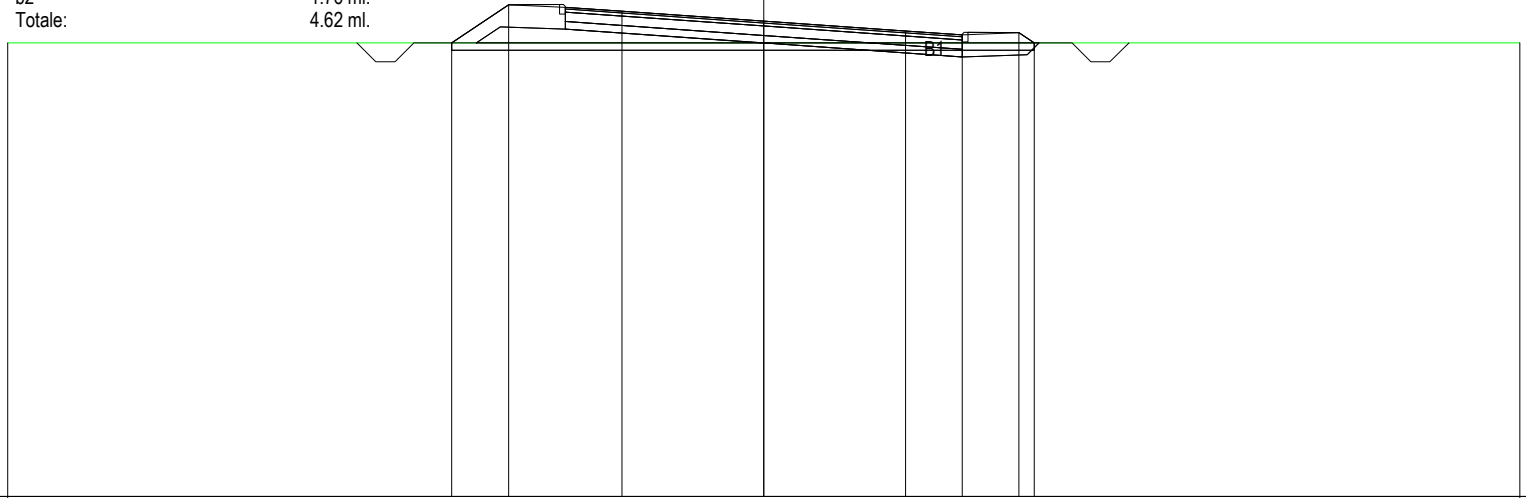

PROGRESSIVE TERRENO

-20.00

20.00

PARZIALI TERRENO

40.00

QUOTE TERRENO

12.00

12.00

PROGRESSIVE PROGETTO

-8.26

-6.75

-5.25

-3.75

0.00

3.75

5.25

6.75

7.16

PARZIALI PROGETTO

1.51

1.50

1.50

3.75

3.75

1.50

1.50

0.41

QUOTE PROGETTO

12.00

13.01

12.94

12.84

12.57

12.31

12.21

12.27

12.00

PROFILO ASSE OPERA CONNESSA

SEZIONE 49

PROGRESSIVA 2600.00

STERRO	
B1	1.75 mq.
BINDER	
C1	0.84 mq.
BASE	
D1	2.63 mq.
FONDAZIONE	
E1	2.10 mq.
SCOTICO	
SC1	2.98 mq.
USURA	
a1	10.50 ml.
VEGETALE	
b1	2.07 ml.
b2	2.03 ml.
Totale:	4.10 ml.

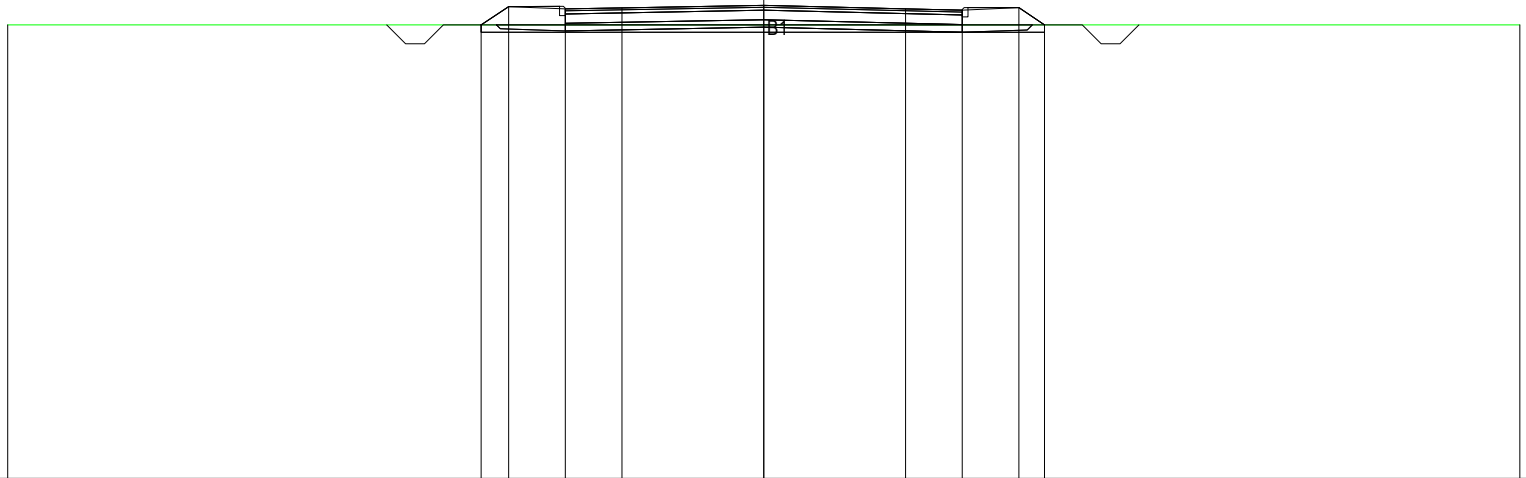

200  
200

PROGRESSIVE  
TERRENO

-20.00

20.00

PARZIALI  
TERRENO

40.00

QUOTE  
TERRENO

12.00

12.00

PROGRESSIVE  
PROGETTO

-7.47

-6.75

-5.25

-3.75

0.00

3.75

5.25

6.75

7.43

PARZIALI  
PROGETTO

0.72

1.50

1.50

3.75

3.75

1.50

1.50

0.68

QUOTE  
PROGETTO

12.00

12.48

12.42

12.45

12.52

12.42

12.39

12.45

12.00

PROFILO ASSE OPERA CONNESSA

SEZIONE 50

PROGRESSIVA 2649.58

STERRO	
B1	2.54 mq.
BINDER	
C1	0.84 mq.
BASE	
D1	2.62 mq.
FONDAZIONE	
E1	2.10 mq.
SCOTICO	
SC1	2.95 mq.
USURA	
a1	10.50 ml.
VEGETALE	
b1	1.97 ml.
b2	1.96 ml.
Totale:	3.93 ml.

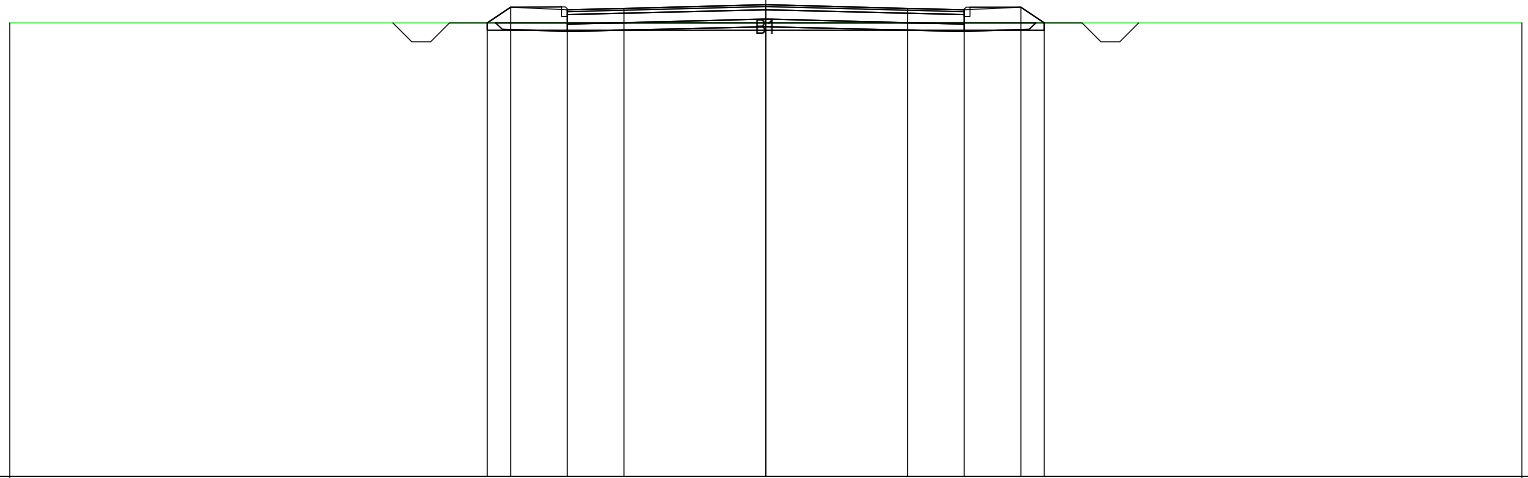

200 200

PROGRESSIVE  
TERRENO

-20.00

20.00

PARZIALI  
TERRENO

40.00

QUOTE  
TERRENO

12.00

12.00

PROGRESSIVE  
PROGETTO

-7.37

-6.75

-5.25

-3.75

0.00

3.75

5.25

6.75

7.36

PARZIALI  
PROGETTO

0.62

1.50

1.50

3.75

3.75

1.50

1.50

0.61

QUOTE  
PROGETTO

12.00

12.41

12.34

12.38

12.48

12.38

12.34

12.41

12.00

PROFILO ASSE OPERA CONNESSA

SEZIONE 52

PROGRESSIVA 2750.00

RILEVATO	
A1	2.00 mq.
BINDER	
C1	0.84 mq.
BASE	
D1	2.62 mq.
FONDAZIONE	
E1	2.10 mq.
SCOTICO	
SC1	3.13 mq.
USURA	
a1	10.50 ml.
VEGETALE	
b1	2.50 ml.
b2	2.35 ml.
Totale:	4.85 ml.

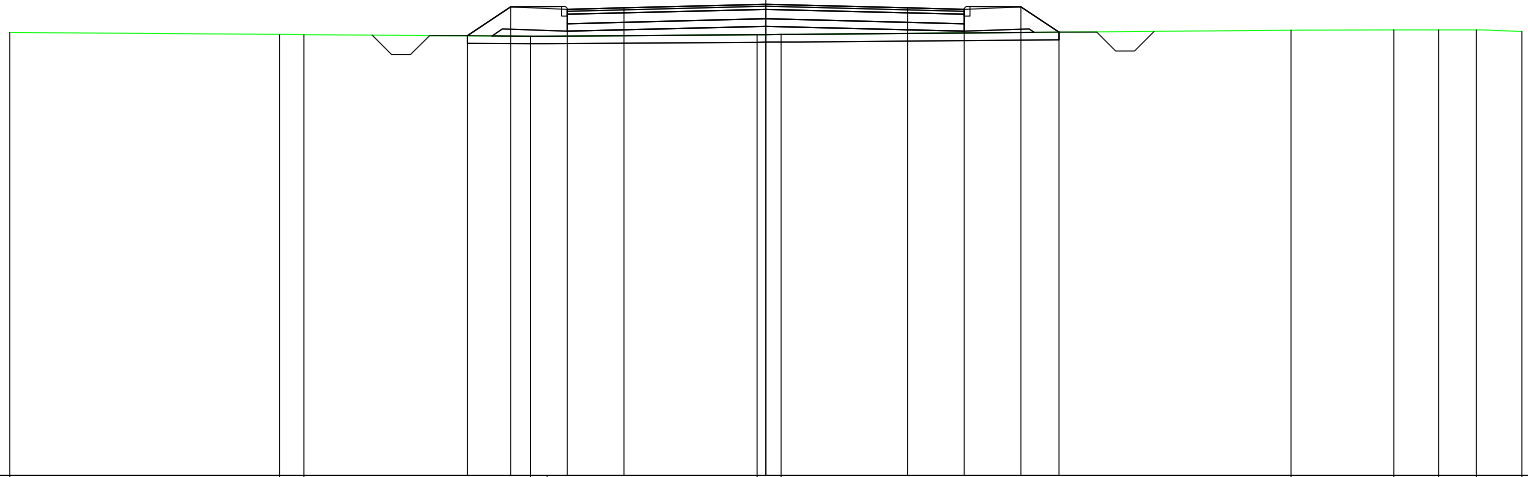

200  
200

PROGRESSIVE TERRENO	-20.00	-12.86	-12.22	-6.22	-5.79	-0.23	0.41	13.89	16.61	17.80	18.80	20.00
PARZIALI TERRENO	7.14	0.64	6.00	0.43	5.56	0.64	13.48	2.72	1.19	1.00	1.20	
QUOTE TERRENO	11.71	11.67	11.66	11.62	11.62	11.66	11.66	11.78	11.78	11.78	11.79	11.74
PROGRESSIVE PROGETTO				-7.90	-6.75	-5.25	-3.75	0.00	3.75	5.25	6.75	7.75
PARZIALI PROGETTO				1.15	1.50	1.50	3.75	3.75	1.50	1.50	1.00	
QUOTE PROGETTO				11.63	12.39	12.33	12.37	12.46	12.37	12.33	12.39	11.73

PROFILO ASSE OPERA CONNESSA

SEZIONE 51

PROGRESSIVA 2689.58

STERRO	
B1	2.16 mq.
BINDER	
C1	0.84 mq.
BASE	
D1	2.62 mq.
FONDAZIONE	
E1	2.10 mq.
SCOTICO	
SC1	2.96 mq.
USURA	
a1	10.50 ml.
VEGETALE	
b1	2.01 ml.
b2	2.01 ml.
Totale:	4.02 ml.

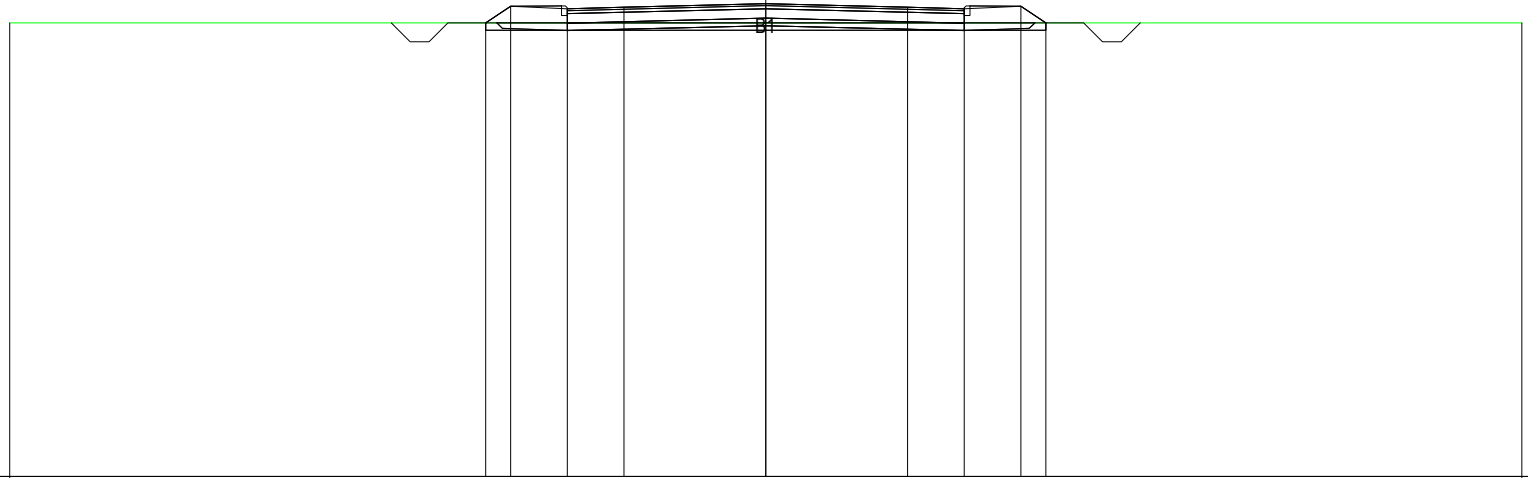

200  
200

PROGRESSIVE TERRENO	-20.00											20.00
PARZIALI TERRENO	40.00											
QUOTE TERRENO	12.00											12.00
PROGRESSIVE PROGETTO		-7.41	-6.75	-5.25	-3.75	0.00	3.75	5.25	6.75	7.41		
PARZIALI PROGETTO		0.66	1.50	1.50	3.75	3.75	1.50	1.50	0.66			
QUOTE PROGETTO		12.00	12.44	12.37	12.41	12.50	12.41	12.37	12.44	12.00		

PROFILO ASSE OPERA CONNESSA

SEZIONE 53

PROGRESSIVA 2800.00

RILEVATO	
A1	7.90 mq.
BINDER	
C1	0.84 mq.
BASE	
D1	2.62 mq.
FONDAZIONE	
E1	2.10 mq.
SCOTICO	
SC1	3.37 mq.
USURA	
a1	10.50 ml.
VEGETALE	
b1	2.95 ml.
b2	3.12 ml.
Totale:	6.07 ml.

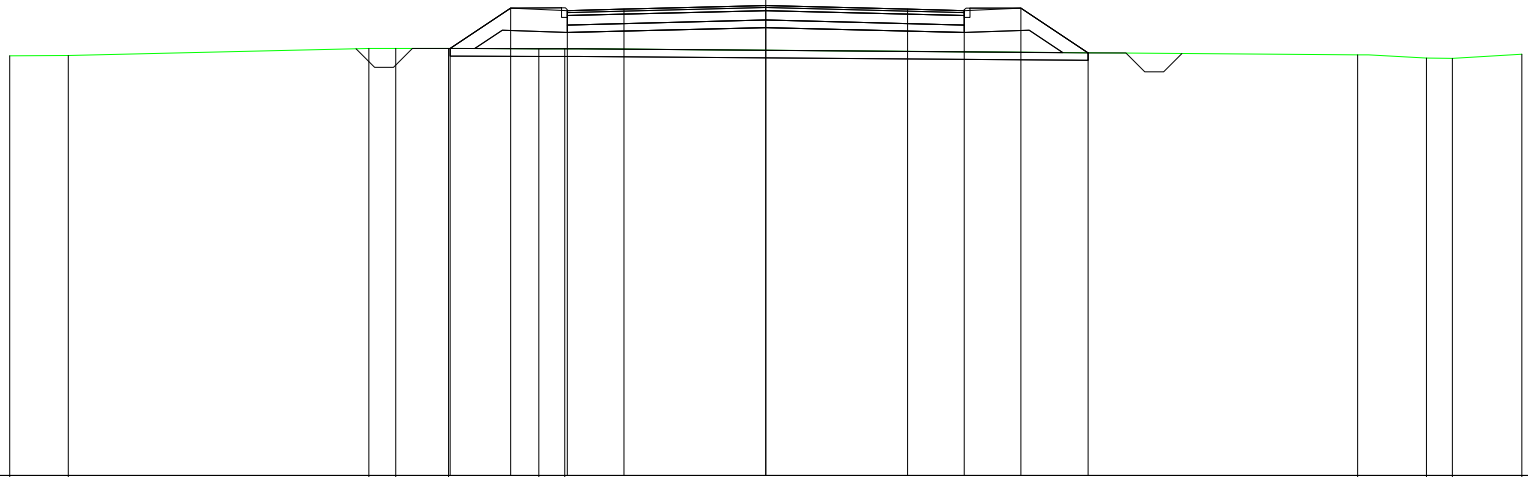

PROGRESSIVE TERRENO

-20.00 -18.45 -10.50 -9.79 -8.39 -6.01 -5.32 15.66 17.48 18.16 20.00

PARZIALI TERRENO

1.55 7.95 0.71 1.40 2.38 0.69 20.98 1.82 0.68 1.84

QUOTE TERRENO

11.10 11.11 11.30 11.30 11.29 11.29 11.28 11.12 11.04 11.03 11.15

PROGRESSIVE PROGETTO

-8.35 -6.75 -5.25 -3.75 0.00 3.75 5.25 6.75 8.52

PARZIALI PROGETTO

1.60 1.50 1.50 3.75 3.75 1.50 1.50 1.77

QUOTE PROGETTO

11.29 12.36 12.30 12.33 12.43 12.33 12.30 12.36 11.18

PROFILO ASSE OPERA CONNESSA

SEZIONE 54

PROGRESSIVA 2850.00

RILEVATO	
A1	7.27 mq.
BINDER	
C1	0.84 mq.
BASE	
D1	2.62 mq.
FONDAZIONE	
E1	2.10 mq.
SCOTICO	
SC1	3.36 mq.
USURA	
a1	10.50 ml.
VEGETALE	
b1	2.95 ml.
b2	3.03 ml.
Totale:	5.98 ml.

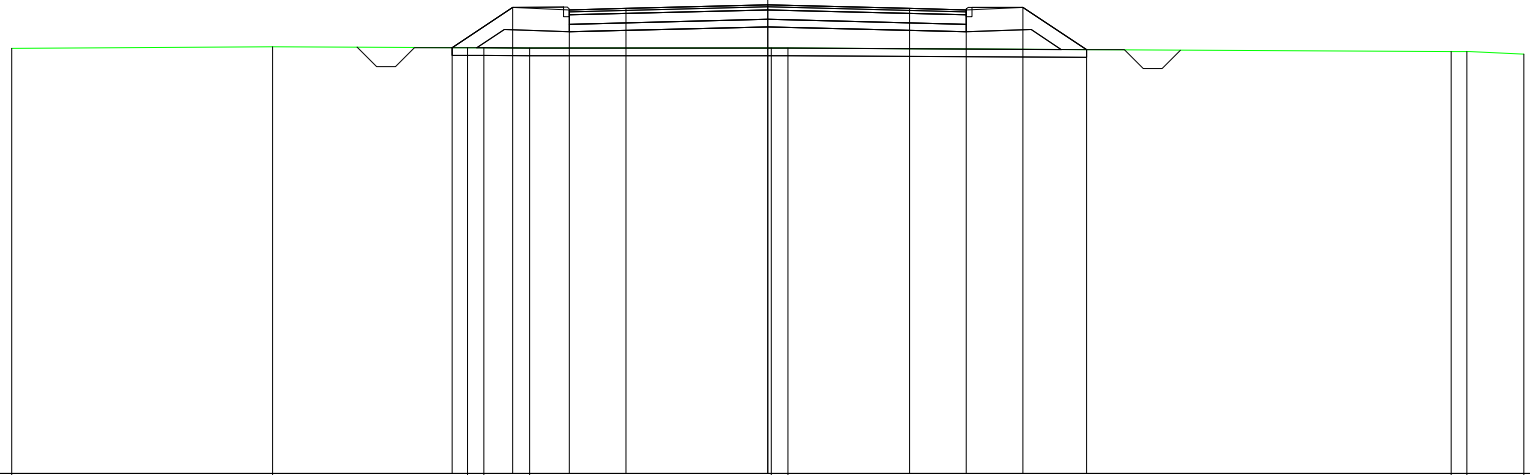

200  
200

PROGRESSIVE TERRENO	-20.00	-13.10	-7.94	-7.51	-6.30	0.09	0.53	18.08	18.49	20.00	
PARZIALI TERRENO	6.90	5.16	0.43	1.21	6.39	0.44	17.55	0.41	1.51		
QUOTE TERRENO	11.25	11.29	11.26	11.26	11.25	11.25	11.25	11.16	11.16	11.09	
PROGRESSIVE PROGETTO			-8.35	-6.75	-5.25	-3.75	0.00	3.75	5.25	6.75	8.43
PARZIALI PROGETTO			1.60	1.50	1.50	3.75	3.75	1.50	1.50	1.68	
QUOTE PROGETTO			11.26	12.33	12.26	12.30	12.39	12.30	12.26	12.33	11.21

PROFILO ASSE OPERA CONNESSA

SEZIONE 55

PROGRESSIVA 2900.00

RILEVATO	
A1	9.31 mq.
BINDER	
C1	0.84 mq.
BASE	
D1	2.64 mq.
FONDAZIONE	
E1	2.10 mq.
SCOTICO	
SC1	3.42 mq.
USURA	
a1	10.50 ml.
VEGETALE	
b1	3.17 ml.
b2	3.17 ml.
Totale:	6.34 ml.

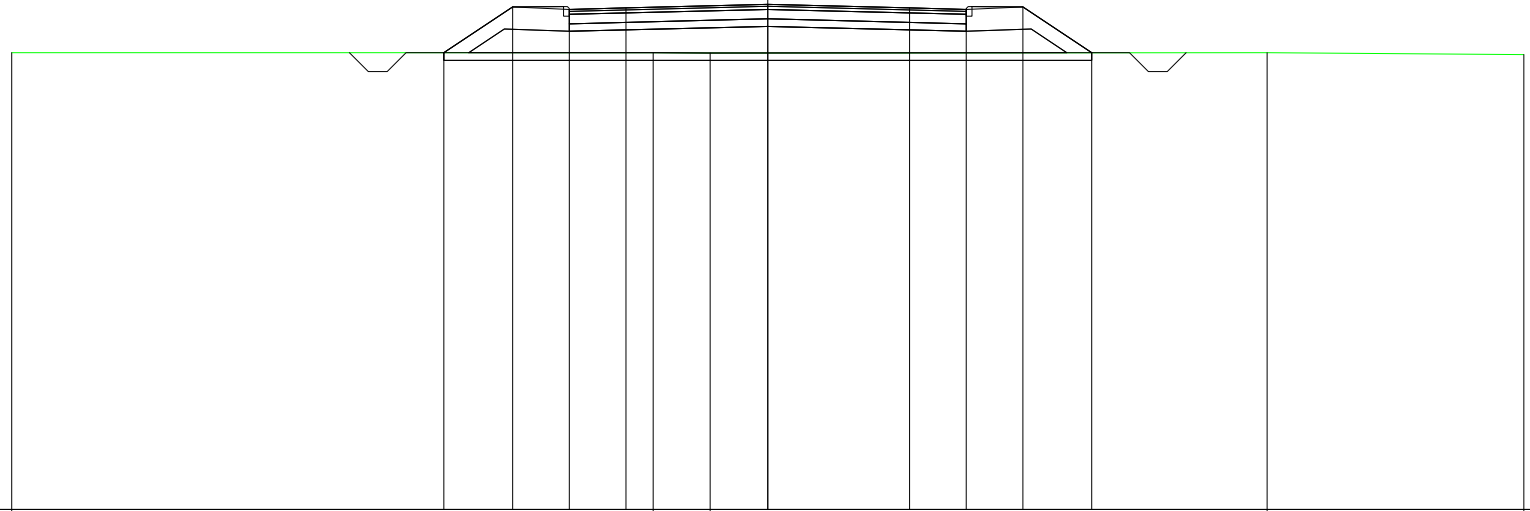

200  
200

PROGRESSIVE TERRENO	-20.00				-3.03	-1.53					13.21	20.00
PARZIALI TERRENO		16.97			1.50		14.74				6.79	
QUOTE TERRENO	11.08				11.08	11.08					11.08	11.03
PROGRESSIVE PROGETTO		-8.57	-6.75	-5.25	-3.75	0.00	3.75	5.25	6.75	8.57		
PARZIALI PROGETTO		1.82	1.50	1.50	3.75	3.75	1.50	1.50	1.82			
QUOTE PROGETTO		11.08	12.29	12.23	12.26	12.36	12.26	12.23	12.29	11.08		



PROFILO ASSE OPERA CONNESSA

SEZIONE 56

PROGRESSIVA 2932.38

RILEVATO	
A1	11.71 mq.
BINDER	
C1	0.84 mq.
BASE	
D1	2.63 mq.
FONDAZIONE	
E1	2.10 mq.
SCOTICO	
SC1	3.55 mq.
USURA	
a1	10.50 ml.
VEGETALE	
b1	3.18 ml.
b2	3.72 ml.
Totale:	6.90 ml.

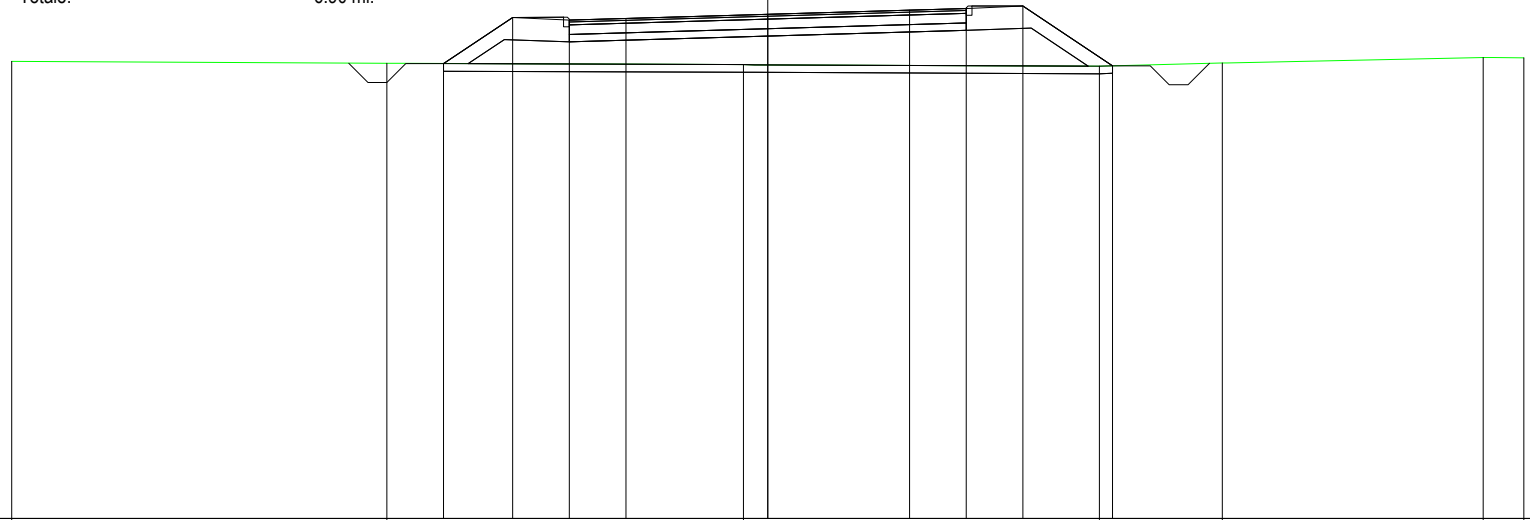

200  
200

PROGRESSIVE TERRENO	-20.00	-10.07				-0.64				8.77	12.02	18.93	20.00
PARZIALI TERRENO		9.93		9.43				9.41		3.25		6.91	1.07
QUOTE TERRENO	11.09		11.04			11.00				10.96	11.05	11.19	11.19
PROGRESSIVE PROGETTO				-8.58	-6.75	-5.25	-3.75	0.00		3.75	5.25	6.75	9.12
PARZIALI PROGETTO				1.83	1.50	1.50	3.75		3.75	1.50	1.50	2.37	
QUOTE PROGETTO				11.03	12.25	12.18	12.23	12.34		12.44		12.55	10.97

PROFILO ASSE OPERA CONNESSA

SEZIONE 57

PROGRESSIVA 2982.38

RILEVATO	
A1	7.99 mq.
BINDER	
C1	0.84 mq.
BASE	
D1	2.62 mq.
FONDAZIONE	
E1	2.10 mq.
SCOTICO	
SC1	3.38 mq.
USURA	
a1	10.50 ml.
VEGETALE	
b1	2.58 ml.
b2	3.50 ml.
Totale:	6.08 ml.

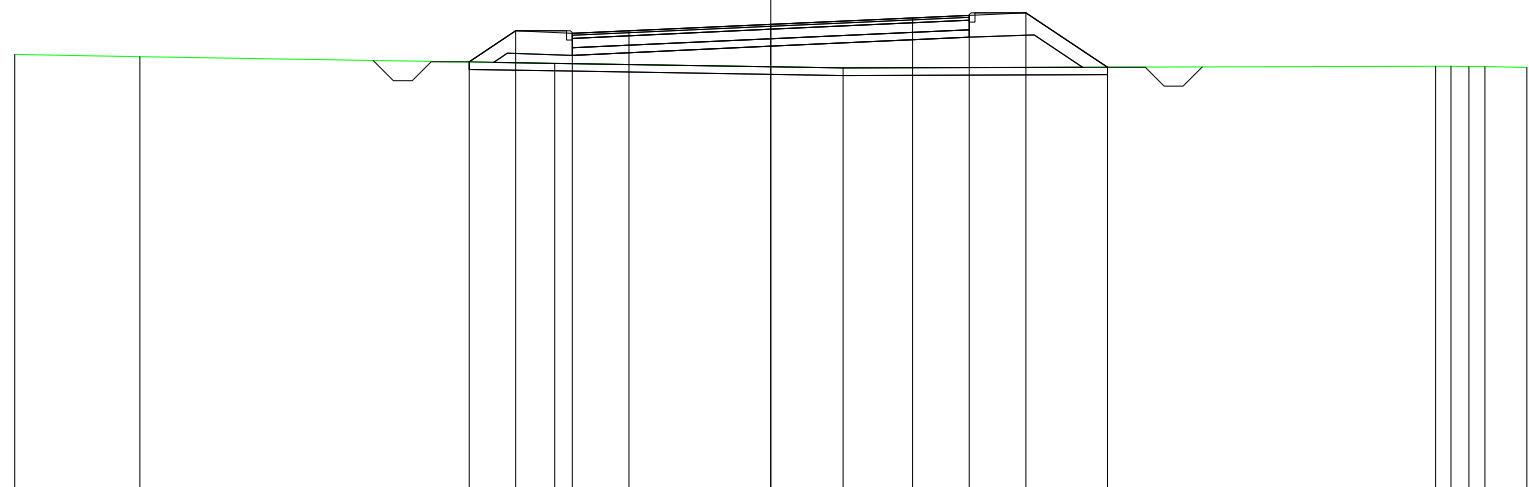

0  
100  
200

PROGRESSIVE TERRENO	-20.00	-16.69	-5.71	1.91	17.58	17.99	18.47	18.89	20.00		
PARZIALI TERRENO	3.31	10.98	7.62	15.67	0.41	0.48	0.42	1.11			
QUOTE TERRENO	11.50	11.45	11.27	11.15	11.19	11.19	11.19	11.16			
PROGRESSIVE PROGETTO			-7.98	-6.75	-5.25	-3.75	0.00	3.75	5.25	6.75	8.90
PARZIALI PROGETTO			1.23	1.50	1.50	3.75	3.75	1.50	1.50	2.15	
QUOTE PROGETTO			11.31	12.13	12.06	12.13	12.30	12.47	12.54	12.61	11.17

PROFILO ASSE OPERA CONNESSA

SEZIONE 58

PROGRESSIVA 3050.00

RILEVATO	
A1	0.07 mq.
A2	5.21 mq.
Totale:	5.28 mq.
BINDER	
C1	0.84 mq.
BASE	
D1	2.63 mq.
FONDAZIONE	
E1	2.09 mq.
SCOTICO	
SC1	3.31 mq.
USURA	
a1	10.50 ml.
VEGETALE	
b1	2.35 ml.
b2	3.46 ml.
Totale:	5.81 ml.

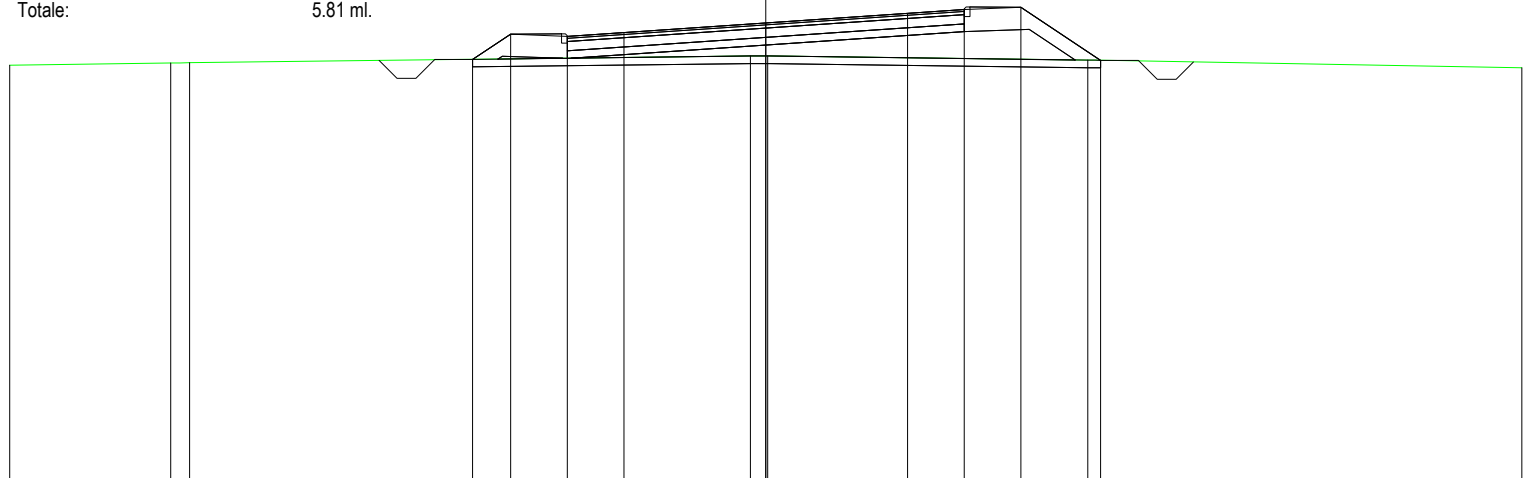

200  
200

PROGRESSIVE TERRENO	-20.00	-15.74	-15.24		-0.41	0.05		8.52		20.00		
PARZIALI TERRENO	4.26	0.50		14.83	0.46		8.47		11.48			
QUOTE TERRENO	11.14	11.20	11.21		11.38	11.38		11.28		11.07		
PROGRESSIVE PROGETTO				-7.75	-6.75	-5.25	-3.75	0.00	3.75	5.25	6.75	8.86
PARZIALI PROGETTO				1.00	1.50	1.50	3.75		3.75	1.50	1.50	2.11
QUOTE PROGETTO				11.30	11.97	11.90	12.00	12.26	12.51	12.61	12.68	11.27

PROFILO ASSE OPERA CONNESSA

SEZIONE 59

PROGRESSIVA 3100.00

RILEVATO	
A1	5.57 mq.
BINDER	
C1	0.84 mq.
BASE	
D1	2.62 mq.
FONDAZIONE	
E1	2.10 mq.
SCOTICO	
SC1	3.29 mq.
USURA	
a1	10.50 ml.
VEGETALE	
b1	2.47 ml.
b2	3.25 ml.
Totale:	5.72 ml.

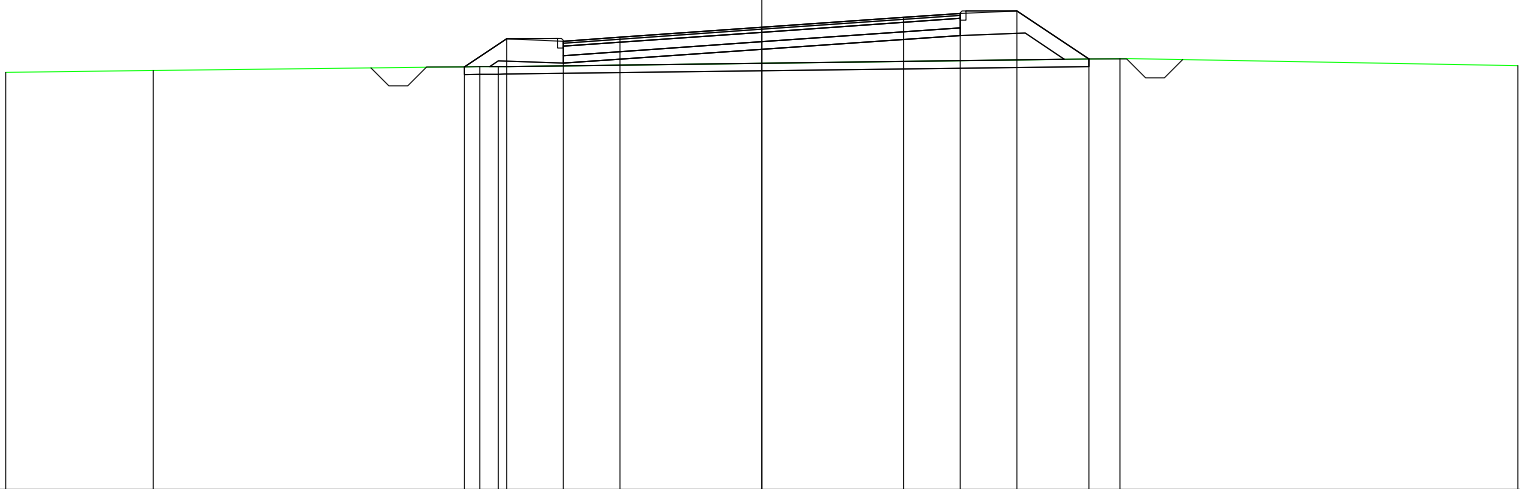

200  
200

PROGRESSIVE TERRENO	-20.00	-16.10	-7.46	-6.97					9.47	20.00		
PARZIALI TERRENO		3.90	8.64	0.49		16.44			10.53			
QUOTE TERRENO	11.03	11.08	11.18	11.18					11.40	11.21		
PROGRESSIVE PROGETTO			-7.87	-6.75	-5.25	-3.75			3.75	5.25	6.75	8.65
PARZIALI PROGETTO			1.12	1.50	1.50	3.75		3.75	1.50	1.50	1.90	
QUOTE PROGETTO			11.18	11.92	11.85	11.96		12.22	12.48	12.59	12.65	11.39

PROFILO ASSE OPERA CONNESSA

SEZIONE 60

PROGRESSIVA 3150.00

RILEVATO	
A1	6.86 mq.
BINDER	
C1	0.84 mq.
BASE	
D1	2.63 mq.
FONDAZIONE	
E1	2.10 mq.
SCOTICO	
SC1	3.34 mq.
USURA	
a1	10.50 ml.
VEGETALE	
b1	2.58 ml.
b2	3.34 ml.
Totale:	5.92 ml.

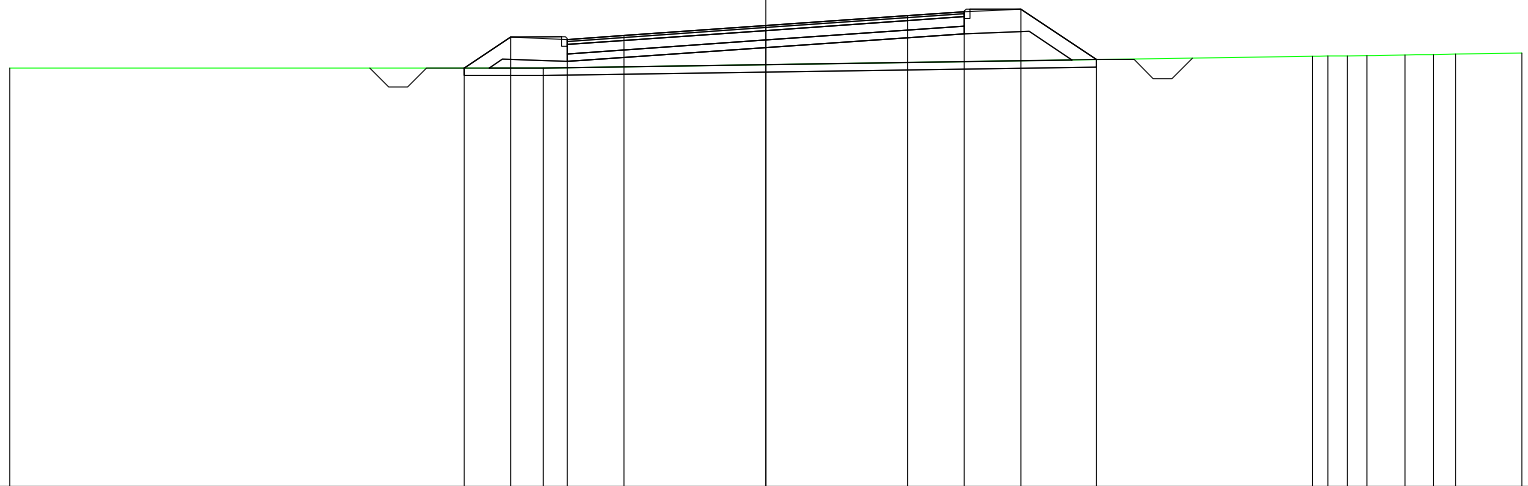

200  
200

PROGRESSIVE TERRENO	-20.00	-5.89	14.46	14.87	15.39	15.90	16.91	17.66	18.24	20.00			
PARZIALI TERRENO		14.11		20.35		0.41	0.52	0.51	1.01	0.75	0.58	1.76	
QUOTE TERRENO	11.07		11.07			11.38	11.38	11.39	11.40	11.41	11.42	11.44	11.47
PROGRESSIVE PROGETTO		-7.98	-6.75	-5.25	-3.75	0.00	3.75	5.25	6.75	8.74			
PARZIALI PROGETTO			1.23	1.50	1.50	3.75		3.75	1.50	1.50	1.99		
QUOTE PROGETTO		11.07	11.89	11.82	11.93	12.19	12.45	12.56	12.62	11.29			

PROFILO ASSE OPERA CONNESSA

SEZIONE 61

PROGRESSIVA 3200.00

RILEVATO	
A1	6.30 mq.
BINDER	
C1	0.84 mq.
BASE	
D1	2.63 mq.
FONDAZIONE	
E1	2.10 mq.
SCOTICO	
SC1	3.28 mq.
USURA	
a1	10.50 ml.
VEGETALE	
b1	2.32 ml.
b2	3.31 ml.
Totale:	5.63 ml.

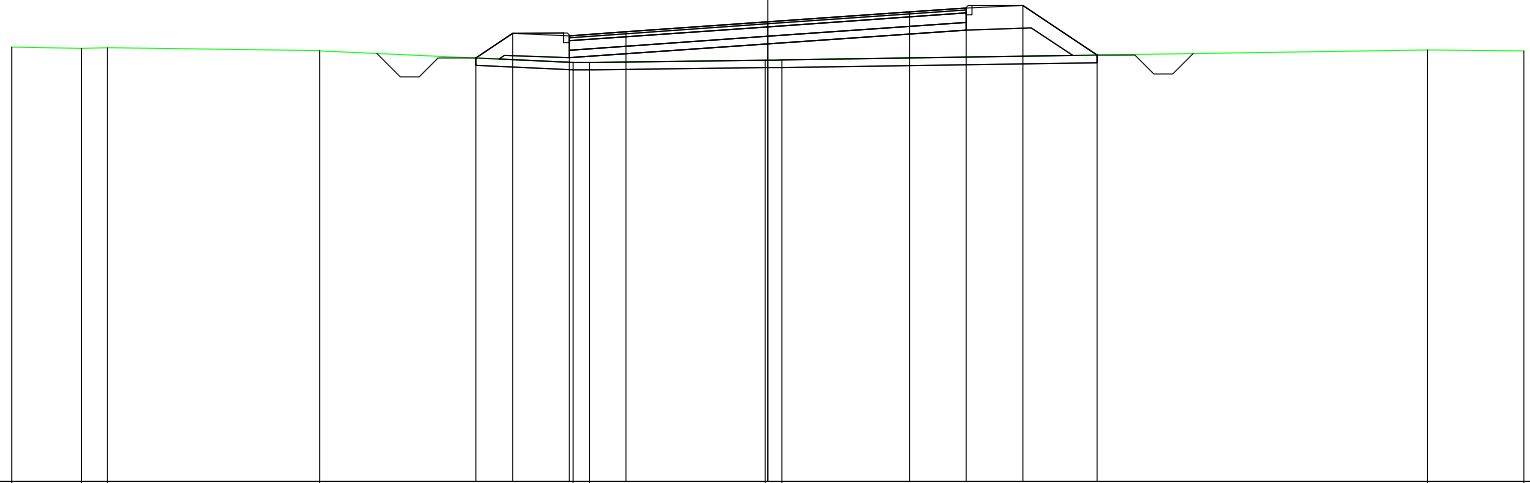

0  
200  
200

PROGRESSIVE TERRENO	-20.00	-18.15	-17.46		-11.86		-5.15	-4.72		-0.07	0.37			17.45	20.00			
PARZIALI TERRENO	1.85	0.69		5.60		6.71	0.43		4.65	0.44		17.08		2.55				
QUOTE TERRENO	11.49	11.46	11.47		11.39		11.09	11.09		11.14	11.15			11.41	11.39			
PROGRESSIVE PROGETTO							-7.72	-6.75		-5.25	-3.75		0.00		3.75	5.25	6.75	8.71
PARZIALI PROGETTO							0.97	1.50	1.50	3.75		3.75		1.50	1.50	1.96		
QUOTE PROGETTO							11.20	11.85	11.79	11.89		12.15		12.42	12.52	12.59	11.28	

PROFILO ASSE OPERA CONNESSA

SEZIONE 62

PROGRESSIVA 3250.00

- RILEVATO
- A1 0.92 mq.
- A2 0.05 mq.
- Totale: 0.97 mq.
- STERRO
- B1 2.49 mq.
- B2 0.83 mq.
- Totale: 3.32 mq.
- BINDER
- C1 0.84 mq.
- BASE
- D1 2.62 mq.
- FONDAZIONE
- E1 2.10 mq.
- SCOTICO
- SC1 2.58 mq.
- USURA
- a1 10.50 ml.
- VEGETALE
- b1 2.36 ml.



PROGRESSIVE TERRENO	-20.00	-13.05	-12.47	-5.74	-4.33	-3.59	-1.54	-0.28	1.74	8.36	18.38	20.00	
PARZIALI TERRENO	6.95	0.58	6.73	1.41	0.74	2.05	1.26	2.02	6.62	10.02	1.62		
QUOTE TERRENO	11.75	12.31	12.65	12.65	10.78	11.01	11.58	11.66	11.78	11.65	11.49	11.42	
PROGRESSIVE PROGETTO				-7.48	-7.05	-6.25	-5.25	-3.75	0.00	3.75	5.25	6.75	7.76
PARZIALI PROGETTO				0.43	0.80	1.00	1.50	3.75	3.75	1.50	1.50	1.01	
QUOTE PROGETTO				12.65	12.22	12.22	11.97	12.01	12.12	12.23	12.27	12.33	11.66

PROFILO ASSE OPERA CONNESSA

SEZIONE 63

PROGRESSIVA 3300.00

STERRO	
B1	4.84 mq.
BINDER	
C1	0.84 mq.
BASE	
D1	2.62 mq.
FONDAZIONE	
E1	2.10 mq.
SCOTICO	
SC1	2.96 mq.
USURA	
a1	10.50 ml.
VEGETALE	
b1	1.99 ml.
b2	2.07 ml.
Totale:	4.06 ml.

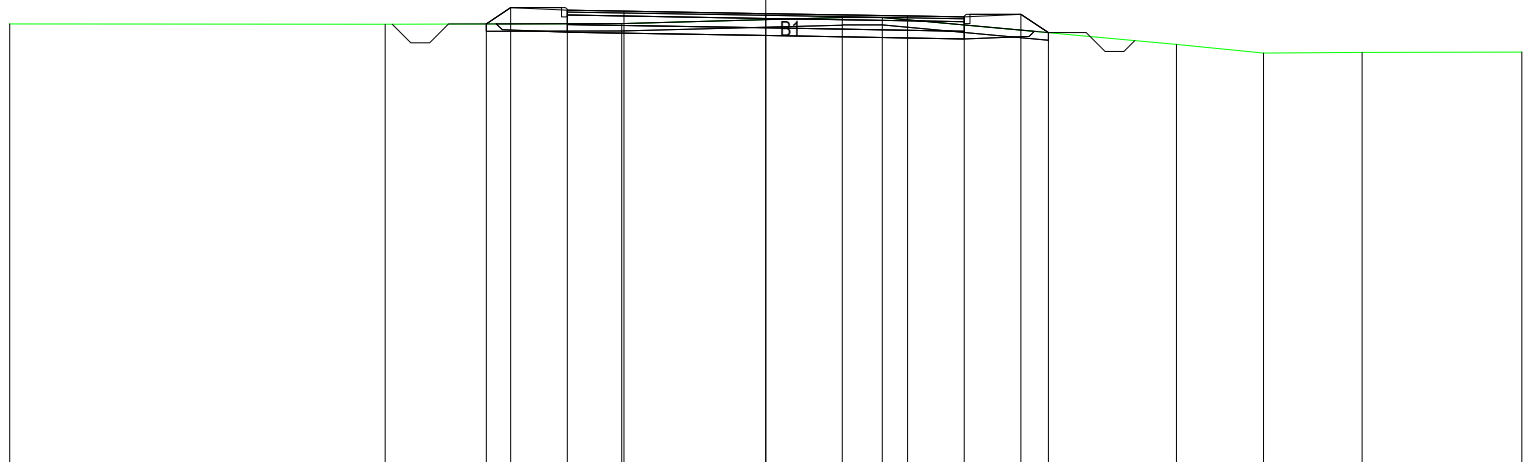

0  
200  
200

PROGRESSIVE TERRENO	-20.00	-10.07	-3.82	2.02	3.08	10.87	13.16	15.77	20.00		
PARZIALI TERRENO		9.93	6.25	5.84	1.06	7.79	2.29	2.61	4.23		
QUOTE TERRENO	11.81	11.80	11.82	11.98	11.98	11.27	11.04	11.06	11.06		
PROGRESSIVE PROGETTO			-7.39	-6.75	-5.25	-3.75	0.00	3.75	5.25	6.75	7.47
PARZIALI PROGETTO			0.64	1.50	1.50	3.75	3.75	1.50	1.50	0.72	
QUOTE PROGETTO			11.81	12.24	12.17	12.15	12.09	12.02	12.00	12.06	11.58



PROFILO ASSE OPERA CONNESSA

SEZIONE 64

PROGRESSIVA 3350.00

RILEVATO	
A1	0.10 mq.
STERRO	
B1	6.94 mq.
BINDER	
C1	0.84 mq.
BASE	
D1	2.62 mq.
FONDAZIONE	
E1	2.10 mq.
SCOTICO	
SC1	1.77 mq.
USURA	
a1	10.50 ml.
VEGETALE	
b1	2.35 ml.

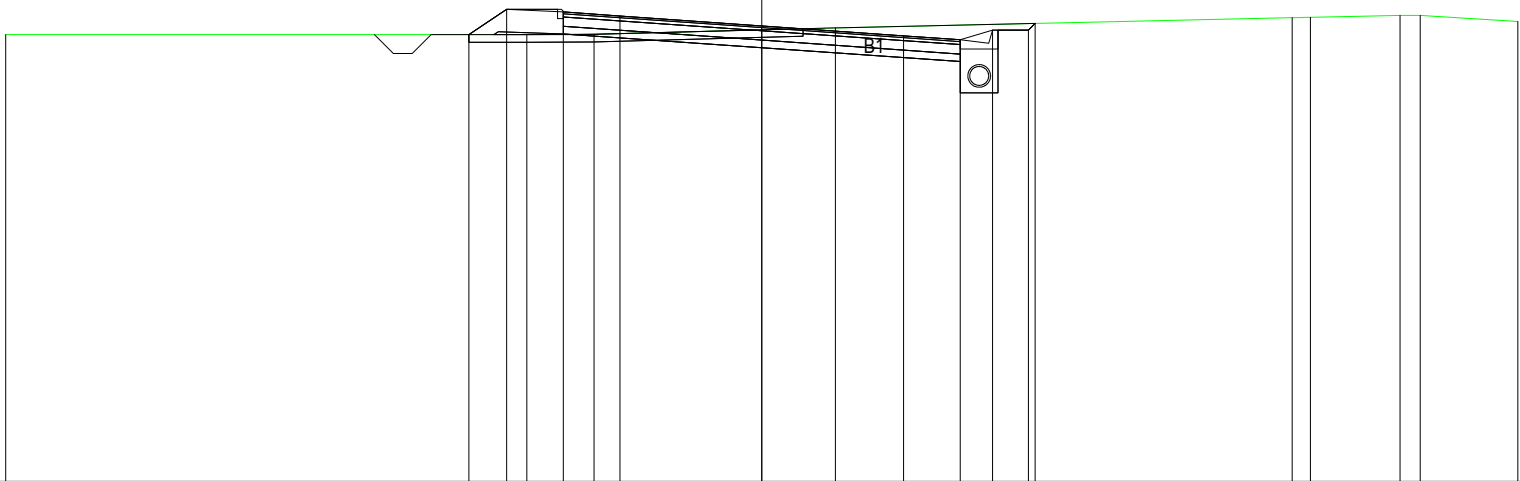

0  
200  
200

PROGRESSIVE TERRENO	-20.00			-6.22	-4.43		1.94			14.03	14.51	16.88	17.41	20.00
PARZIALI TERRENO		13.78		1.79		6.37		12.09		0.48	2.37	0.53	2.59	
QUOTE TERRENO	11.82			11.82	11.82		12.00			12.27	12.28	12.33	12.33	12.17
PROGRESSIVE PROGETTO			-7.75	-6.75	-5.25	-3.75	0.00	3.75	5.25	6.10	7.05	7.23		
PARZIALI PROGETTO			1.00	1.50	1.50	3.75	3.75	1.50	0.85	0.95	0.18			
QUOTE PROGETTO			11.82	12.48	12.42	12.31	12.05	11.79	11.68	11.93	11.93	12.12		

PROFILO ASSE OPERA CONNESSA

SEZIONE 65

PROGRESSIVA 3400.00

- STERRO
- B1 6.99 mq.
- BINDER
- C1 0.84 mq.
- BASE
- D1 2.62 mq.
- FONDAZIONE
- E1 2.10 mq.
- SCOTICO
- SC1 1.75 mq.
- USURA
- a1 10.50 ml.
- VEGETALE
- b1 2.24 ml.

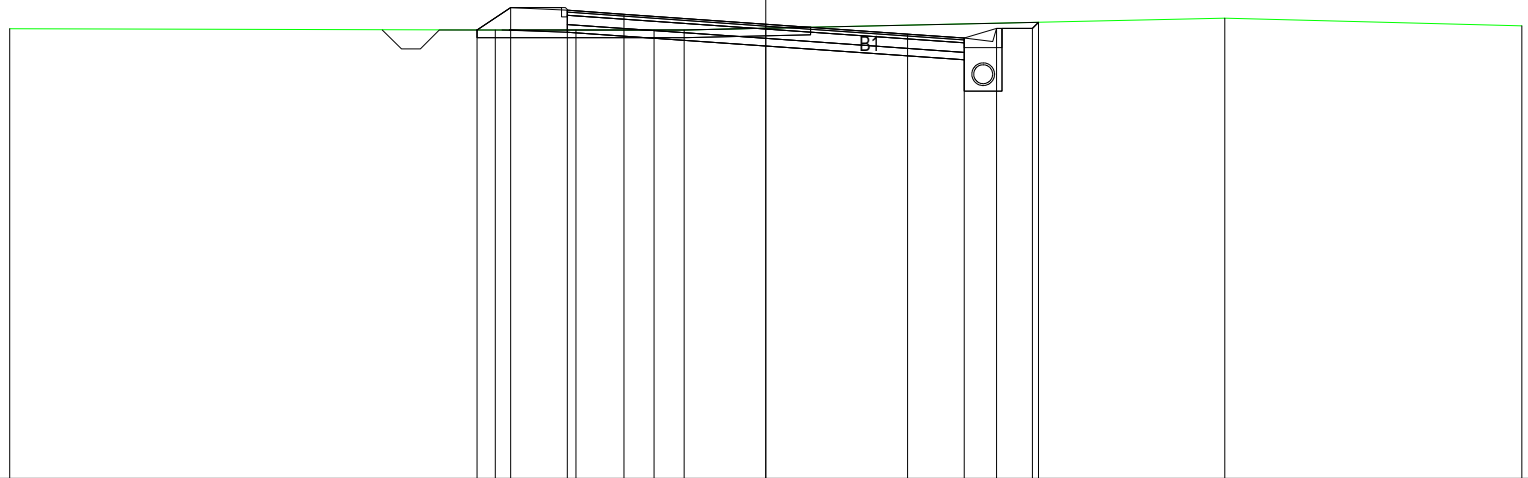

PROGRESSIVE TERRENO	-20.00	-7.16	-5.03	-2.96	-2.16		12.14	20.00			
PARZIALI TERRENO		12.84	2.13	2.07	0.80		14.30	7.86			
QUOTE TERRENO	11.89	11.86	11.86	11.86	11.86		12.17	11.97			
PROGRESSIVE PROGETTO		-7.64	-6.75	-5.25	-3.75	0.00	3.75	5.25	6.10	7.05	7.22
PARZIALI PROGETTO		0.89	1.50	1.50	3.75	3.75	1.50	0.85	0.95	0.17	
QUOTE PROGETTO		11.86	12.45	12.39	12.28	12.02	11.75	11.65	11.90	11.90	12.07

PROFILO ASSE OPERA CONNESSA

SEZIONE 66

PROGRESSIVA 3450.00

RILEVATO	
A1	0.12 mq.
STERRO	
B1	5.65 mq.
BINDER	
C1	0.84 mq.
BASE	
D1	2.63 mq.
FONDAZIONE	
E1	2.10 mq.
SCOTICO	
SC1	2.05 mq.
USURA	
a1	10.50 ml.
VEGETALE	
b1	2.33 ml.

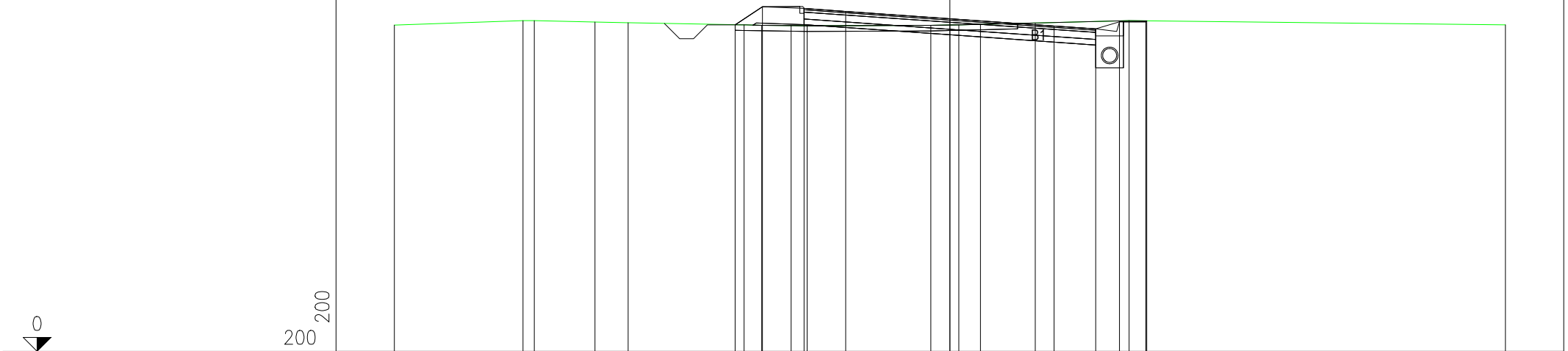

PROGRESSIVE TERRENO	-20.00	-15.37	-14.96	-12.78	-11.58	-7.41	-6.77	-5.71	-5.14	-0.69	0.32	1.10	3.07	6.45	20.00		
PARZIALI TERRENO	4.63	0.41	2.18	1.20	4.17	0.64	1.06	0.57	4.45	1.01	0.78	1.97	3.38	13.55			
QUOTE TERRENO	11.75	11.91	11.91	11.86	11.84	11.76	11.75	11.73	11.73	11.74	11.76	11.78	11.83	11.91	11.76		
PROGRESSIVE PROGETTO						-7.73	-6.75	-5.25	-3.75	0.00			3.75	5.25	6.10	7.05	7.09
PARZIALI PROGETTO						0.98	1.50	1.50	3.75		3.75	1.50	0.85	0.95	0.04		
QUOTE PROGETTO						11.76	12.42	12.35	12.25	11.98			11.72	11.62	11.87	11.87	11.91

PROFILO ASSE OPERA CONNESSA

SEZIONE 67

PROGRESSIVA 3500.00

STERRO  
 B1 7.70 mq.  
 BINDER  
 C1 0.84 mq.  
 BASE  
 D1 2.63 mq.  
 FONDAZIONE  
 E1 2.10 mq.  
 SCOTICO  
 SC1 0.07 mq.  
 SC2 1.54 mq.  
 Totale: 1.61 mq.  
 USURA  
 a1 10.50 ml.  
 VEGETALE  
 b1 2.04 ml.

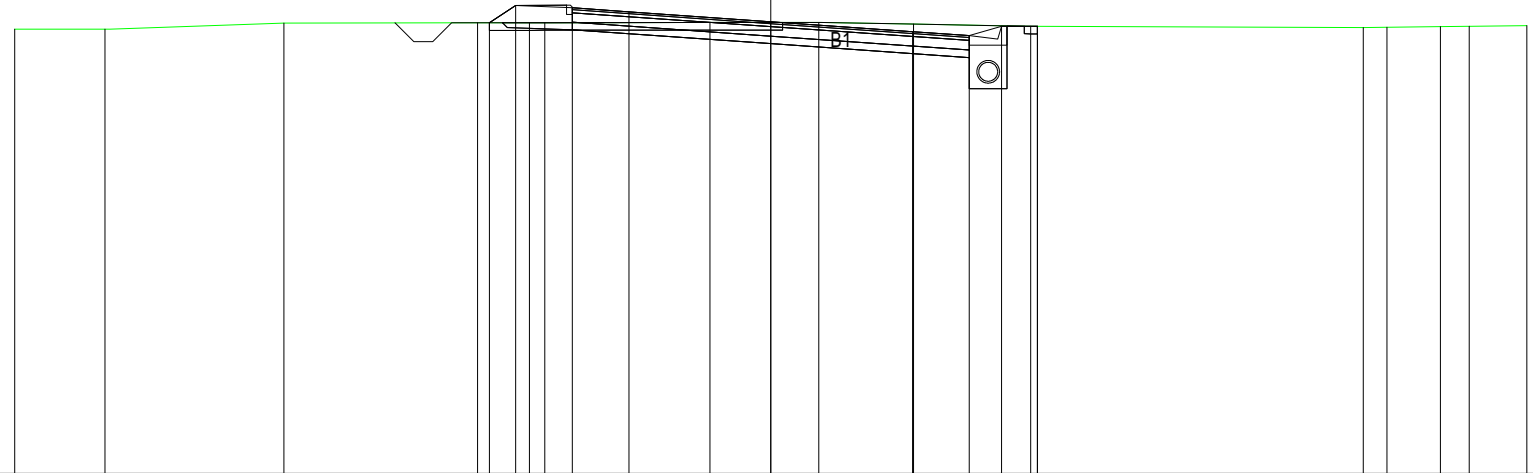

0  
 200 200

PROGRESSIVE TERRENO	-20.00	-17.61	-12.88	-7.76	-6.39	-5.98	-1.61	1.27	3.77	6.87	15.67	16.30	17.72	18.47	20.00
PARZIALI TERRENO		2.39	4.73	5.12	1.37	0.41	4.37	2.88	2.50	3.10	8.80	0.63	1.42	0.75	1.53
QUOTE TERRENO	11.75	11.75	11.91	11.92	11.92	11.92	11.93	11.93	11.89	11.83	11.79	11.80	11.82	11.83	11.84
PROGRESSIVE PROGETTO				-7.44	-6.75	-5.25	-3.75	0.00	3.75	5.25	6.10	7.05	7.06		
PARZIALI PROGETTO				0.69	1.50	1.50	3.75	3.75	1.50	0.85	0.95	0.01			
QUOTE PROGETTO				11.92	12.38	12.32	12.21	11.95	11.69	11.58	11.83	11.83	11.83		

PROFILO ASSE OPERA CONNESSA

SEZIONE 68

PROGRESSIVA 3550.00

STERRO  
B1 4.21 mq.  
BINDER  
C1 0.84 mq.  
BASE  
D1 2.63 mq.  
FONDAZIONE  
E1 2.09 mq.  
SCOTICO  
SC1 2.86 mq.  
USURA  
a1 10.50 ml.  
VEGETALE  
b1 1.71 ml.  
b2 1.83 ml.  
Totale: 3.54 ml.

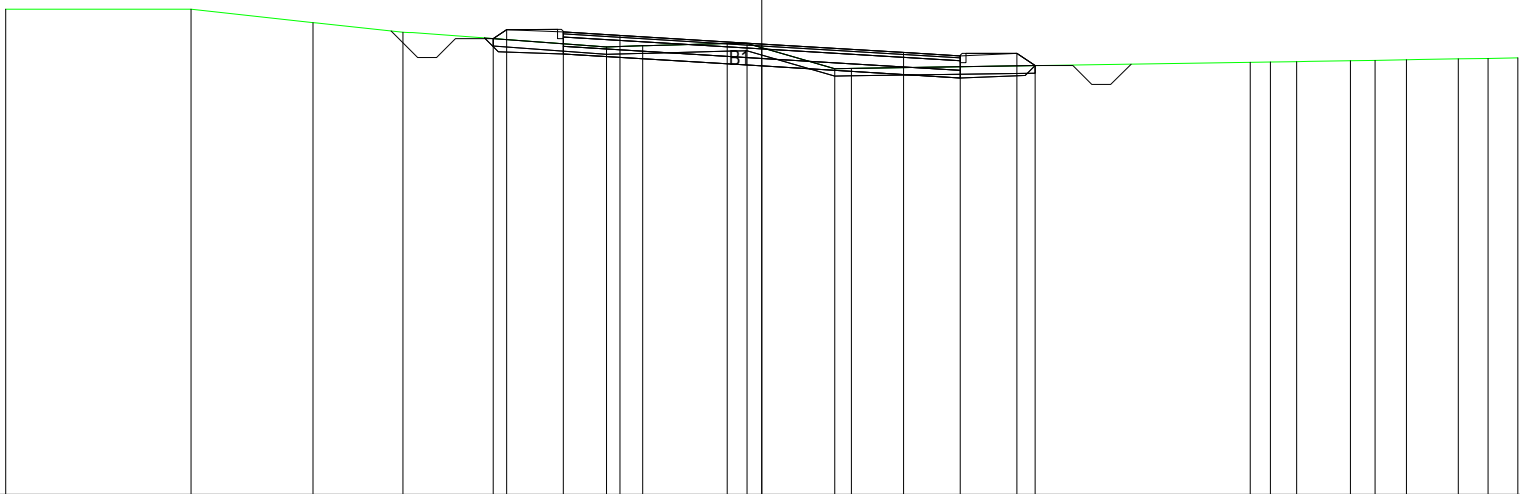

200  
200

PROGRESSIVE TERRENO	-20.00	-15.10	-11.87	-9.49		-4.11	-3.15	-0.92	-0.39	1.93	2.37		12.92	13.45	14.15	15.57	16.22	17.05	18.42	19.21	20.00
PARZIALI TERRENO		4.90	3.23	2.38	5.38	0.96	2.23	0.53	2.32	0.44		10.55	0.53	0.70	1.42	0.65	0.83	1.37	0.79	0.79	
QUOTE TERRENO	12.84	12.84	12.48	12.23		11.84	11.87	11.93	11.93	11.26	11.27		11.43	11.44	11.45	11.47	11.48	11.50	11.52	11.54	11.55
PROGRESSIVE PROGETTO					-7.11	-6.75	-5.25	-3.75	0.00	3.75	5.25	6.75	7.23								
PARZIALI PROGETTO					0.36	1.50	1.50	3.75		3.75	1.50	1.50	0.48								
QUOTE PROGETTO					12.06	12.30	12.23	12.14	11.92	11.69	11.60	11.66	11.34								

PROFILO ASSE OPERA CONNESSA

SEZIONE 69

PROGRESSIVA 3600.00

RILEVATO	
A1	0.01 mq.
STERRO	
B1	14.74 mq.
BINDER	
C1	0.84 mq.
BASE	
D1	2.62 mq.
FONDAZIONE	
E1	2.10 mq.
SCOTICO	
SC1	0.07 mq.
SC2	0.52 mq.
Totale:	0.59 mq.
USURA	
a1	10.50 ml.
VEGETALE	
b1	1.76 ml.

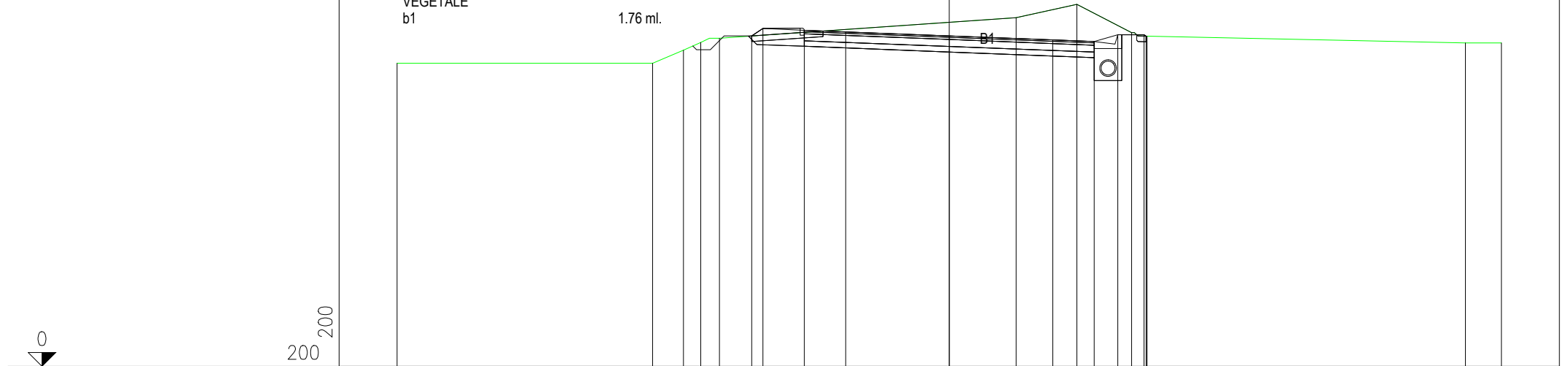

0  
200  
200

PROGRESSIVE TERRENO	-20.00	-10.74	-9.63	-9.00	-8.33			2.42	4.62	6.60	7.16			18.69	20.00	
PARZIALI TERRENO		9.26	1.11	0.63	0.67		10.75		2.20	1.98	0.56		11.53		1.31	
QUOTE TERRENO	10.98	10.98	11.45	11.73	11.88			12.63	13.11	12.08	11.95			11.71	11.71	
PROGRESSIVE PROGETTO						-7.16	-6.75	-5.25	-3.75	0.00		3.75	5.25	6.10	7.05	7.13
PARZIALI PROGETTO						0.41	1.50	1.50	3.75		3.75	1.50	0.85	0.95	0.08	
QUOTE PROGETTO			11.96	12.23		12.17	12.11		11.96		11.82	11.76	12.01	12.01	11.96	

PROFILO ASSE OPERA CONNESSA

SEZIONE 70

PROGRESSIVA 3650.00

STERRO  
 B1 3.07 mq.  
 BINDER  
 C1 0.84 mq.  
 BASE  
 D1 2.62 mq.  
 FONDAZIONE  
 E1 2.10 mq.  
 SCOTICO  
 SC1 2.96 mq.  
 USURA  
 a1 10.50 ml.  
 VEGETALE  
 b1 2.24 ml.  
 b2 1.80 ml.  
 Totale: 4.04 ml.

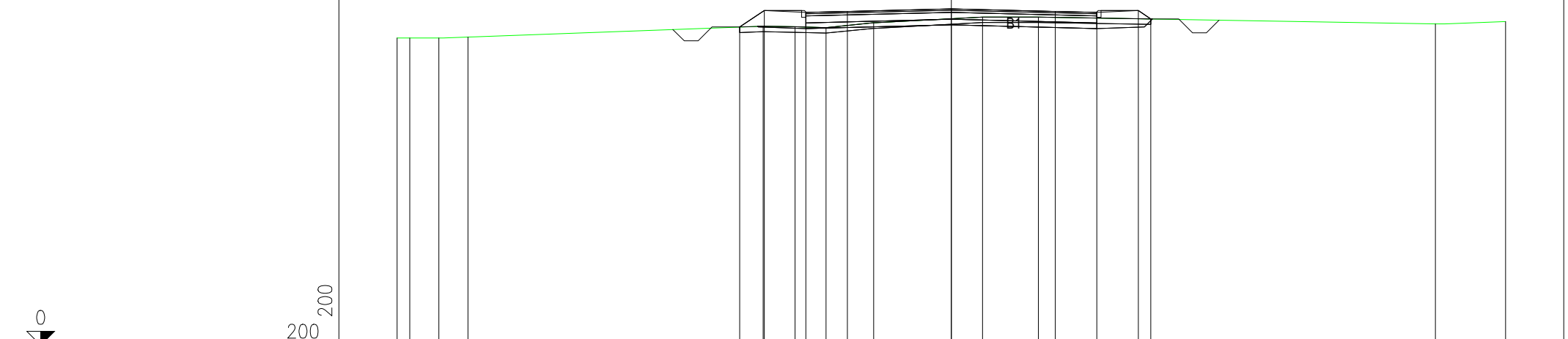

PROGRESSIVE TERRENO	-20.00	-19.54	-18.50	-17.44	-6.79	-5.64	-4.52	-2.80	1.13	3.14	17.47	20.00	
PARZIALI TERRENO	0.46	1.04	1.06	10.65	1.15	1.12	1.72	3.93	2.01	14.33	2.53		
QUOTE TERRENO	11.07	11.07	11.07	11.11	11.50	11.48	11.45	11.62	11.83	11.83	11.58	11.67	
PROGRESSIVE PROGETTO					-7.64	-6.75	-5.25	-3.75	0.00	3.75	5.25	6.75	7.20
PARZIALI PROGETTO					0.89	1.50	1.50	3.75	3.75	1.50	1.50	0.45	
QUOTE PROGETTO					11.47	12.06	12.00	12.03	12.13	12.03	12.00	12.06	11.76

PROFILO ASSE OPERA CONNESSA

SEZIONE 71

PROGRESSIVA 3700.00

RILEVATO	
A1	0.25 mq.
STERRO	
B1	4.70 mq.
BINDER	
C1	0.84 mq.
BASE	
D1	2.62 mq.
FONDAZIONE	
E1	2.10 mq.
SCOTICO	
SC1	3.22 mq.
USURA	
a1	10.50 ml.
VEGETALE	
b1	3.12 ml.
b2	2.19 ml.
Totale:	5.31 ml.



200  
200

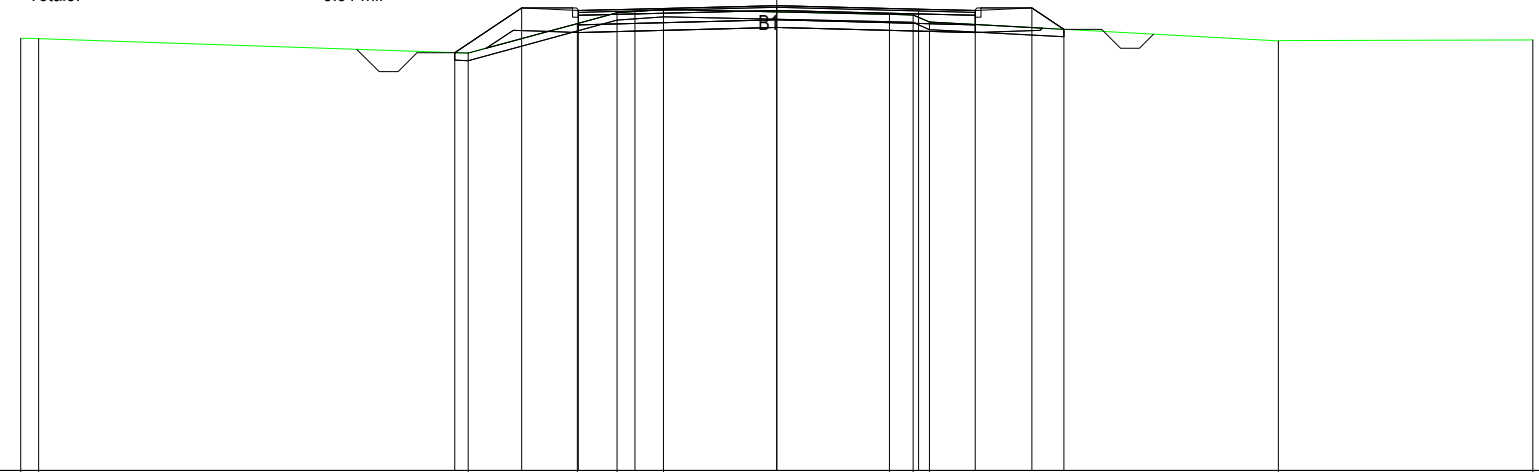

PROGRESSIVE TERRENO	-20.00	-19.52	-8.16	-5.27	-4.22	-3.00	2.98	3.60	4.03	13.26	20.00
PARZIALI TERRENO	0.48	11.36	2.89	1.05	1.22	5.98	0.62	0.43	9.23	6.74	
QUOTE TERRENO	11.43	11.42	11.04	11.82	12.11	12.19	12.07	12.05	11.86	11.37	11.39
PROGRESSIVE PROGETTO			-8.52	-6.75	-5.25	-3.75	0.00	3.75	5.25	6.75	7.59
PARZIALI PROGETTO			1.77	1.50	1.50	3.75	3.75	1.50	1.50	0.84	
QUOTE PROGETTO			11.05	12.23	12.17	12.20	12.30	12.20	12.17	12.23	11.67



PROFILO ASSE OPERA CONNESSA

SEZIONE 72

PROGRESSIVA 3717.68

- RILEVATO
- A1 0.19 mq.
- STERRO
- B1 9.14 mq.
- BINDER
- C1 0.84 mq.
- BASE
- D1 2.64 mq.
- FONDAZIONE
- E1 2.10 mq.
- SCOTICO
- SC1 1.41 mq.
- USURA
- a1 10.50 ml.
- VEGETALE
- b1 3.09 ml.

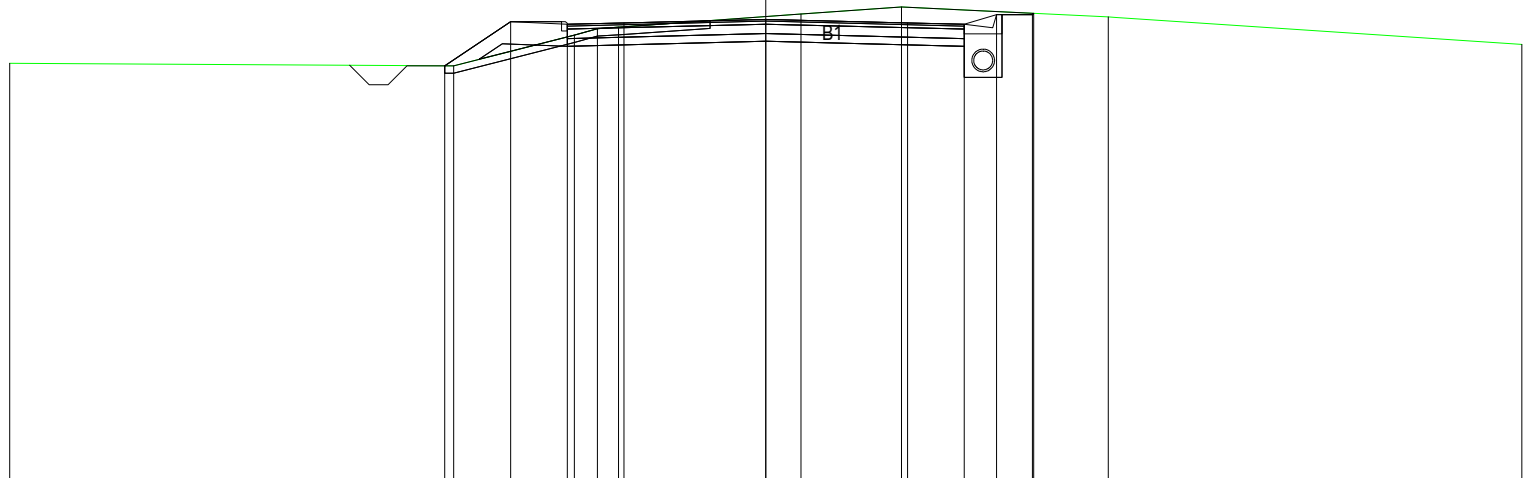

0  
200  
200

PROGRESSIVE TERRENO	-20.00	-8.26	-5.07	-4.45	-3.89	0.93	3.59	9.06	20.00		
PARZIALI TERRENO		11.74	3.19	0.62	0.56	4.82	2.66	5.47	10.94		
QUOTE TERRENO	11.19	11.13	11.94	12.11	12.15	12.49	12.68	12.42	11.69		
PROGRESSIVE PROGETTO		-8.49	-6.75	-5.25	-3.75	0.00	3.75	5.25	6.10	7.05	7.09
PARZIALI PROGETTO		1.74	1.50	1.50	3.75	3.75	1.50	0.85	0.95	0.04	
QUOTE PROGETTO		11.13	12.29	12.23	12.26	12.36	12.26	12.23	12.48	12.48	12.51

PROFILO ASSE OPERA CONNESSA

SEZIONE 73

PROGRESSIVA 3757.68

RILEVATO	
A1	0.45 mq.
STERRO	
B1	7.83 mq.
BINDER	
C1	0.84 mq.
BASE	
D1	2.62 mq.
FONDAZIONE	
E1	2.10 mq.
SCOTICO	
SC1	1.02 mq.
SC2	0.47 mq.
Totale:	1.49 mq.
USURA	
a1	10.50 ml.
VEGETALE	
b1	2.15 ml.
b2	3.74 ml.
Totale:	5.89 ml.

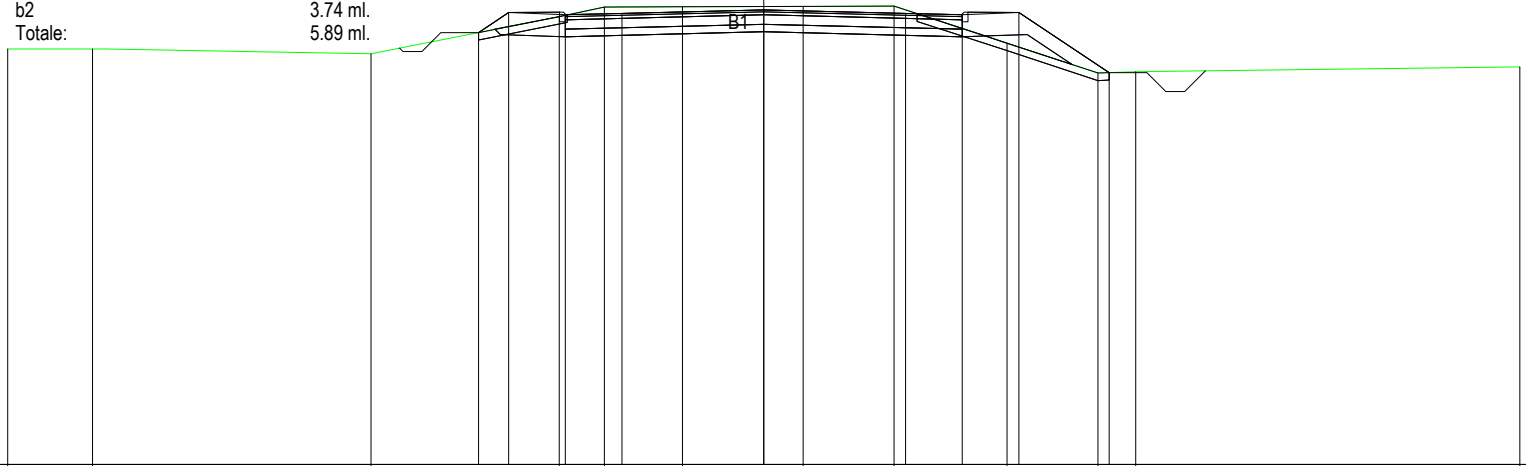

200  
200

PROGRESSIVE TERRENO	-20.00	-17.76	-10.39	-5.41	-4.21	-2.15	1.04	3.44	6.43	8.84	9.84	20.00
PARZIALI TERRENO		2.24	7.37	4.98	1.20	2.06	3.19	2.40	2.99	2.41	1.00	10.16
QUOTE TERRENO	10.99	10.99	10.86	11.85	12.10	12.11	12.12	12.12	11.15	10.35	10.39	10.52
PROGRESSIVE PROGETTO				-7.55	-6.75	-5.25	-3.75	0.00	3.75	5.25	6.75	9.14
PARZIALI PROGETTO				0.80	1.50	1.50	3.75	3.75	1.50	1.50	2.39	
QUOTE PROGETTO				11.43	11.96	11.89	11.93	12.02	11.93	11.89	11.96	10.37

PROFILO ASSE OPERA CONNESSA

SEZIONE 74

PROGRESSIVA 3800.00

RILEVATO	
A1	1.86 mq.
STERRO	
B1	5.89 mq.
BINDER	
C1	0.84 mq.
BASE	
D1	2.64 mq.
FONDAZIONE	
E1	2.10 mq.
SCOTICO	
SC1	1.24 mq.
SC2	0.58 mq.
SC3	0.66 mq.
Totale:	2.48 mq.
USURA	
a1	10.50 ml.
VEGETALE	
b1	2.20 ml.
b2	4.07 ml.
Totale:	6.27 ml.



PROGRESSIVE TERRENO	-20.00	-18.87	-18.17	-17.66	-17.00	-16.53	-9.52	-6.14	-4.20	-2.72	2.11	3.13	7.27	8.13	9.67	20.00
PARZIALI TERRENO	1.13	0.70	0.51	0.66	0.47	7.01	3.38	1.94	1.48	4.83	1.02	4.14	0.86	1.54	10.33	
QUOTE TERRENO	10.85	10.84	10.84	10.84	10.84	10.84	10.86	11.40	11.71	11.76	11.77	11.77	10.18	9.87	9.93	10.33
PROGRESSIVE PROGETTO								-7.60	-6.75	-5.25	-3.75	0.00	3.75	5.25	6.75	9.47
PARZIALI PROGETTO								0.85	1.50	1.50	3.75	3.75	1.50	1.50	2.72	
QUOTE PROGETTO								11.17	11.73	11.67	11.71	11.80	11.71	11.67	11.73	9.92

PROFILO ASSE OPERA CONNESSA

SEZIONE 75

PROGRESSIVA 3850.00

STERRO	
B1	5.57 mq.
BINDER	
C1	0.84 mq.
BASE	
D1	2.62 mq.
FONDAZIONE	
E1	2.10 mq.
SCOTICO	
SC1	3.07 mq.
USURA	
a1	10.50 ml.
VEGETALE	
b1	2.39 ml.
b2	2.00 ml.
Totale:	4.39 ml.

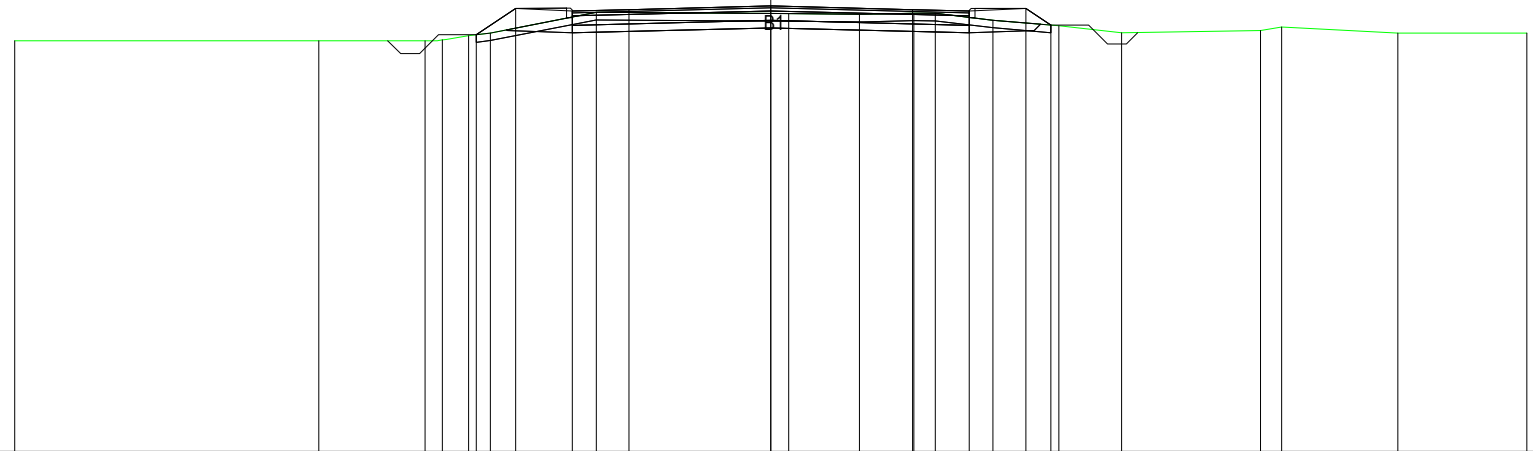

0  
100  
200

PROGRESSIVE TERRENO	-20.00	-11.96	-9.15	-8.69	-7.99	-7.42	-4.61	0.47	2.34	3.78	4.35	5.87	7.62	9.28	12.96	13.52	16.59	20.00
PARZIALI TERRENO	8.04	2.81	0.46	0.70	0.57	2.81	5.08	1.87	1.44	0.57	1.52	1.75	1.66	3.68	0.56	3.07	3.41	
QUOTE TERRENO	10.86	10.86	10.86	10.89	11.00	11.07	11.61	11.58	11.56	11.59	11.59	11.41	11.26	11.07	11.13	11.23	11.06	11.07
PROGRESSIVE PROGETTO					-7.79	-6.75	-5.25	-3.75	0.00	3.75	5.25	6.75	7.41					
PARZIALI PROGETTO					1.04	1.50	1.50	3.75	3.75	1.50	1.50	0.66						
QUOTE PROGETTO					11.02	11.72	11.65	11.69	11.78	11.69	11.65	11.72	11.28					

PROFILO ASSE OPERA CONNESSA

SEZIONE 76

PROGRESSIVA 3900.00

RILEVATO  
 A1 0.02 mq.  
 A2 0.68 mq.  
 Totale: 0.70 mq.  
 STERRO  
 B1 4.02 mq.  
 BINDER  
 C1 0.84 mq.  
 BASE  
 D1 2.64 mq.  
 FONDAZIONE  
 E1 2.10 mq.  
 SCOTICO  
 SC1 3.30 mq.  
 USURA  
 a1 10.50 ml.  
 VEGETALE  
 b1 2.73 ml.  
 b2 2.94 ml.  
 Totale: 5.67 ml.

-1  
 200 200

PROGRESSIVE TERRENO	-20.00	-11.06	-8.46	-7.61	-4.53	-3.78	-2.20	2.69	4.75	6.95	18.34	20.00
PARZIALI TERRENO	8.94	2.60	0.85	3.08	0.75	1.58	4.89	2.06	2.20	11.39	1.66	
QUOTE TERRENO	10.78	10.79	10.70	10.90	11.57	11.54	11.54	11.54	11.10	10.61	10.78	10.75
PROGRESSIVE PROGETTO			-8.13	-6.75	-5.25	-3.75	0.00	3.75	5.25	6.75	8.34	
PARZIALI PROGETTO			1.38	1.50	1.50	3.75	3.75	1.50	1.50	1.59		
QUOTE PROGETTO			10.78	11.70	11.63	11.67	11.76	11.67	11.63	11.70	10.63	

PROFILO ASSE OPERA CONNESSA

SEZIONE 77

PROGRESSIVA 3950.00

RILEVATO	
A1	0.42 mq.
A2	0.85 mq.
Totale:	1.27 mq.
STERRO	
B1	1.90 mq.
BINDER	
C1	0.84 mq.
BASE	
D1	2.63 mq.
FONDAZIONE	
E1	2.10 mq.
SCOTICO	
SC1	3.39 mq.
USURA	
a1	10.50 ml.
VEGETALE	
b1	3.27 ml.
b2	2.85 ml.
Totale:	6.12 ml.



PROGRESSIVE TERRENO	-20.00	-18.19		-8.55	-5.38	-4.61	-3.13		2.85	3.90	6.18		18.63	20.00
PARZIALI TERRENO	1.81		9.64	3.17	0.77	1.48		5.98	1.05	2.28		12.45	1.37	
QUOTE TERRENO	10.68	10.68		10.70	11.36	11.52	11.48		11.31	11.07	10.61		10.75	10.77
PROGRESSIVE PROGETTO				-8.67	-6.75	-5.25	-3.75	0.00	3.75	5.25	6.75	8.25		
PARZIALI PROGETTO				1.92	1.50	1.50	3.75		3.75	1.50	1.50	1.50		
QUOTE PROGETTO				10.70	11.98	11.92	11.87	11.74	11.62	11.57	11.63	10.63		

PROFILO ASSE OPERA CONNESSA

SEZIONE 78

PROGRESSIVA 4000.00

RILEVATO	
A1	0.33 mq.
A2	0.73 mq.
Totale:	1.06 mq.
STERRO	
B1	1.74 mq.
BINDER	
C1	0.84 mq.
BASE	
D1	2.62 mq.
FONDAZIONE	
E1	2.10 mq.
SCOTICO	
SC1	3.32 mq.
USURA	
a1	10.50 ml.
VEGETALE	
b1	3.13 ml.
b2	2.65 ml.
Totale:	5.78 ml.



PROGRESSIVE TERRENO	-20.00	-11.52	-9.47	-6.22	-5.12	-4.65	-1.33	2.45	5.18	8.13	20.00
PARZIALI TERRENO	8.48	2.05	3.25	1.10	0.47	3.32	3.78	2.73	2.95	11.87	
QUOTE TERRENO	10.69	10.70	10.70	11.30	11.52	11.49	11.41	11.31	10.61	10.65	10.74
PROGRESSIVE PROGETTO			-8.53	-6.75	-5.25	-3.75	0.00	3.75	5.25	6.75	8.05
PARZIALI PROGETTO			1.78	1.50	1.50	3.75	3.75	1.50	1.50	1.30	
QUOTE PROGETTO			10.88	12.06	12.00	11.92	11.72	11.53	11.45	11.51	10.65

PROFILO ASSE OPERA CONNESSA

SEZIONE 79

PROGRESSIVA 4050.00

- RILEVATO
- A1 1.46 mq.
- A2 0.18 mq.
- Totale: 1.64 mq.
- STERRO
- B1 3.48 mq.
- BINDER
- C1 0.84 mq.
- BASE
- D1 2.63 mq.
- FONDAZIONE
- E1 2.10 mq.
- SCOTICO
- SC1 0.85 mq.
- SC2 2.40 mq.
- Totale: 3.25 mq.
- USURA
- a1 10.50 ml.
- VEGETALE
- b1 3.61 ml.
- b2 2.51 ml.
- Totale: 6.12 ml.



PROGRESSIVE TERRENO	-20.00	-16.22	-15.76	-13.51	-13.07		-7.72	-6.47		-4.22	-3.03		1.92	3.50		6.76	8.30		20.00
PARZIALI TERRENO		3.78	0.46	2.25	0.44		5.35	1.25	2.25	1.19		4.95	1.58	3.26		1.54		11.70	
QUOTE TERRENO	10.72	10.64	10.63	10.63	10.63		10.63	10.97		11.48	11.49		11.49	11.50		10.57	10.65		10.83
PROGRESSIVE PROGETTO							-9.01	-6.75	-5.25	-3.75		0.00		3.75	5.25	6.75	7.91		
PARZIALI PROGETTO							2.26	1.50	1.50		3.75		3.75	1.50	1.50	1.16			
QUOTE PROGETTO							10.63	12.14	12.07	11.97		11.70		11.44	11.34	11.40	10.63		



PROFILO ASSE OPERA CONNESSA

SEZIONE 80

PROGRESSIVA 4100.00

- RILEVATO
- A1 0.88 mq.
- A2 0.16 mq.
- Totale: 1.04 mq.
- STERRO
- B1 4.04 mq.
- BINDER
- C1 0.84 mq.
- BASE
- D1 2.62 mq.
- FONDAZIONE
- E1 2.10 mq.
- SCOTICO
- SC1 0.81 mq.
- SC2 2.14 mq.
- Totale: 2.95 mq.
- USURA
- a1 10.50 ml.
- VEGETALE
- b1 3.12 ml.
- b2 2.74 ml.
- Totale: 5.86 ml.

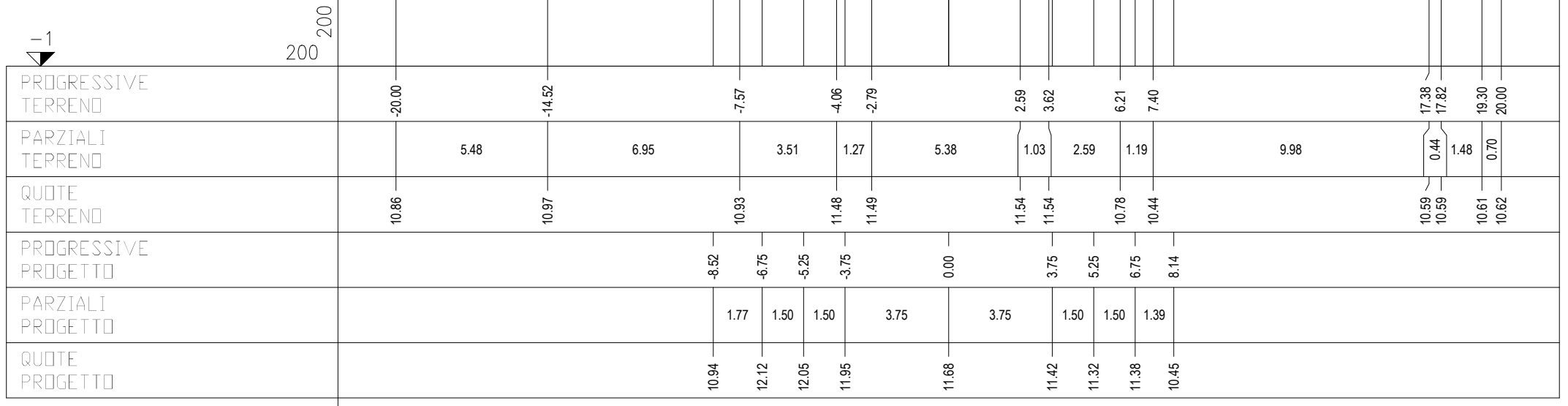

PROFILO ASSE OPERA CONNESSA

SEZIONE 81

PROGRESSIVA 4150.00

- RILEVATO
- A1 0.77 mq.
- A2 0.27 mq.
- Totale: 1.04 mq.
- STERRO
- B1 5.16 mq.
- BINDER
- C1 0.84 mq.
- BASE
- D1 2.62 mq.
- FONDAZIONE
- E1 2.10 mq.
- SCOTICO
- SC1 0.41 mq.
- SC2 2.42 mq.
- Totale: 2.83 mq.
- USURA
- a1 10.50 ml.
- VEGETALE
- b1 3.56 ml.



PROGRESSIVE TERRENO	-20.00			-6.52	-5.90	-4.51		-1.44	-0.82	-0.04		3.18	4.31		20.00
PARZIALI TERRENO		13.48		0.62	1.39	3.07		0.62	0.78		3.22	1.13		15.69	
QUOTE TERRENO	8.39			11.12	11.23	11.46		11.45	11.45	11.45		11.45	11.40		10.71
PROGRESSIVE PROGETTO		-8.96		-6.75	-5.25	-3.75		0.00				3.75	5.25	6.10	7.05
PARZIALI PROGETTO			2.21	1.50	1.50		3.75		3.75		1.50	0.85	0.95	0.44	
QUOTE PROGETTO		10.63		12.10	12.03	11.93		11.67			11.40	11.30	11.55	11.55	11.26

PROFILO ASSE OPERA CONNESSA

SEZIONE 82

PROGRESSIVA 4200.00

RILEVATO	
A1	4.08 mq.
STERRO	
B1	1.81 mq.
BINDER	
C1	0.84 mq.
BASE	
D1	2.62 mq.
FONDAZIONE	
E1	2.10 mq.
SCOTICO	
SC1	3.18 mq.
USURA	
a1	10.50 ml.
VEGETALE	
b1	1.86 ml.
b2	3.24 ml.
Totale:	5.10 ml.

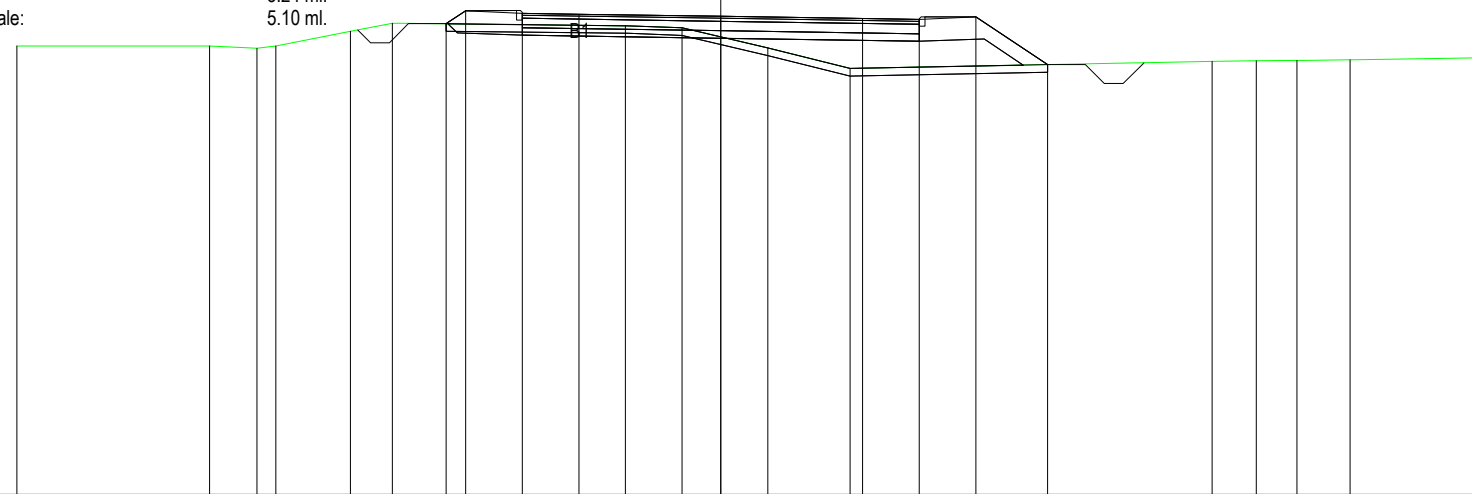

200  
200

PROGRESSIVE TERRENO	-18.62	-13.52	-12.27	-11.77	-9.80	-8.69		-2.53	-1.02	1.24	3.42		12.99	14.16	15.24	16.65	20.00
PARZIALI TERRENO		5.10	1.25	0.50	1.97	1.11		6.16	1.51	2.26	2.18		9.57	1.17	1.08	1.41	3.35
QUOTE TERRENO	10.87	10.87	10.81	10.87	11.25	11.46		11.40	11.34	10.81	10.27		10.45	10.47	10.48	10.50	10.55
PROGRESSIVE PROGETTO								-7.26	-6.75	-5.25	-3.75		0.00	3.75	5.25	6.75	8.64
PARZIALI PROGETTO								0.51	1.50	1.50	3.75		3.75	1.50	1.50	1.89	
QUOTE PROGETTO								11.45	11.79	11.73	11.70		11.65	11.59	11.57	11.63	10.37

PROFILO ASSE OPERA CONNESSA

SEZIONE 83

PROGRESSIVA 4250.00

RILEVATO	
A1	4.09 mq.
STERRO	
B1	2.43 mq.
BINDER	
C1	0.84 mq.
BASE	
D1	2.62 mq.
FONDAZIONE	
E1	2.10 mq.
SCOTICO	
SC1	3.16 mq.
USURA	
a1	10.50 ml.
VEGETALE	
b1	1.35 ml.
b2	3.68 ml.
Totale:	5.03 ml.

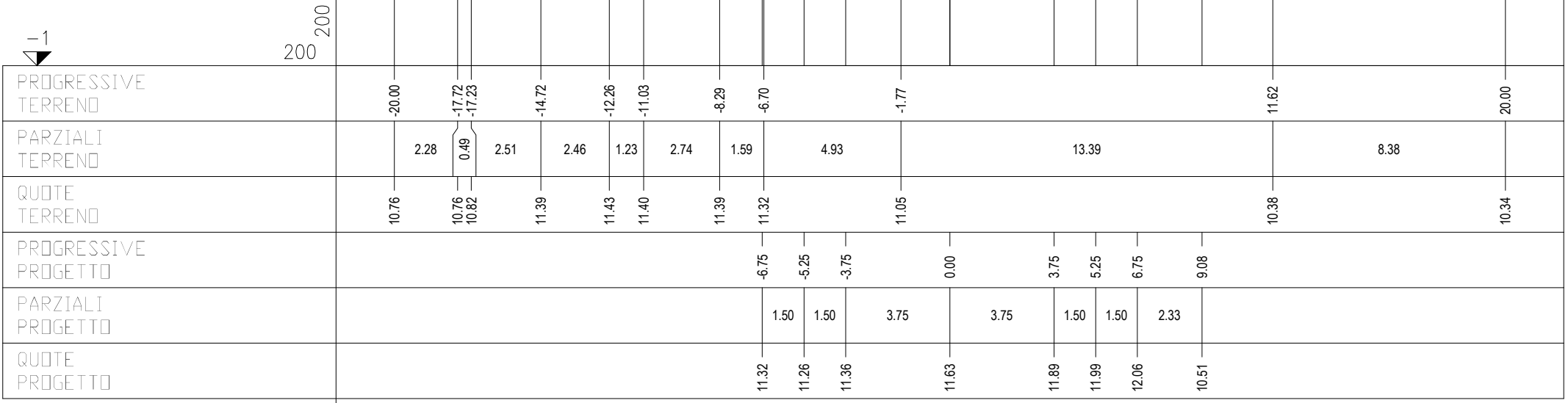

PROFILO ASSE OPERA CONNESSA

SEZIONE 84

PROGRESSIVA 4300.00

RILEVATO	
A1	4.77 mq.
STERRO	
B1	2.11 mq.
BINDER	
C1	0.83 mq.
BASE	
D1	2.63 mq.
FONDAZIONE	
E1	2.10 mq.
SCOTICO	
SC1	3.13 mq.
USURA	
a1	10.50 ml.
VEGETALE	
b1	1.39 ml.
b2	3.43 ml.
Totale:	4.82 ml.



PROGRESSIVE TERRENO	-20.00	-19.35	-17.99	-16.26	-15.08	-14.02	-10.72	-7.16	1.52	6.01	6.59	8.44	20.00	
PARZIALI TERRENO	0.65	1.36	1.73	1.18	1.06	3.30	3.56	8.68	4.49	0.58	1.85	11.56		
QUOTE TERRENO	10.80	10.77	10.71	11.05	11.28	11.30	11.30	11.30	10.75	10.55	10.55	10.65	10.81	
PROGRESSIVE PROGETTO							-6.79	-5.25	-3.75	0.00	3.75	5.25	6.75	8.83
PARZIALI PROGETTO							1.54	1.50	3.75	3.75	1.50	1.50	2.08	
QUOTE PROGETTO							11.28	11.24	11.34	11.61	11.87	11.97	12.04	10.66

PROFILO ASSE OPERA CONNESSA

SEZIONE 85

PROGRESSIVA 4350.00

- RILEVATO
- A1 0.25 mq.
- STERRO
- B1 3.89 mq.
- BINDER
- C1 0.84 mq.
- BASE
- D1 2.63 mq.
- FONDAZIONE
- E1 2.10 mq.
- SCOTICO
- SC1 2.62 mq.
- SC2 0.32 mq.
- Totale: 2.94 mq.
- USURA
- a1 10.50 ml.
- VEGETALE
- b1 1.47 ml.
- b2 2.47 ml.
- Totale: 3.94 ml.



PROGRESSIVE TERRENO	-20.00	-17.76	-15.43	-13.87	-13.40	-10.10	-9.54	-8.85	-4.29	-1.69	2.89	3.70	4.64	9.30	15.32	15.73	18.63	19.32	19.82	20.00
PARZIALI TERRENO		2.24	2.33	1.56	0.47	3.30	0.56	0.69	4.56	2.60	4.58	0.81	0.94	4.66	6.02	0.41	2.90	0.69	0.50	0.16
QUOTE TERRENO	10.84	10.85	10.85	10.62	10.55	11.14	11.24	11.25	11.30	11.30	11.25	11.24	11.23	11.19	11.13	11.14	11.22	11.24	11.10	11.04
PROGRESSIVE PROGETTO									-6.87	-5.25	-3.75	0.00	3.75	5.25	6.75	7.87				
PARZIALI PROGETTO									1.62	1.50	3.75	3.75	1.50	1.50	1.12					
QUOTE PROGETTO									11.27	11.29	11.38	11.59	11.80	11.88	11.95	11.20				

PROFILO ASSE OPERA CONNESSA

SEZIONE 86

PROGRESSIVA 4400.00

RILEVATO	
A1	0.06 mq.
STERRO	
B1	3.57 mq.
BINDER	
C1	0.84 mq.
BASE	
D1	2.62 mq.
FONDAZIONE	
E1	2.10 mq.
SCOTICO	
SC1	2.58 mq.
USURA	
a1	10.50 ml.
VEGETALE	
b1	1.74 ml.
b2	0.35 ml.
Totale:	2.09 ml.



PROGRESSIVE TERRENO	-20.00			-6.21	-5.67				4.42		7.77		10.19		11.63		13.60		20.00
PARZIALI TERRENO		13.79		0.54		10.09		3.35		2.42	1.44	1.97		6.40					
QUOTE TERRENO	11.38			11.14	11.15			11.38		10.56	9.99	9.22		8.30					8.30
PROGRESSIVE PROGETTO				-7.14	-6.75				0.00		3.75	5.25	6.75		9.18				
PARZIALI PROGETTO				0.39	1.50	1.50	3.75		3.75		1.50	1.50	2.43						
QUOTE PROGETTO				11.16	11.42				11.57		11.72	11.78	11.84		10.23				

PROFILO ASSE OPERA CONNESSA

SEZIONE 87

PROGRESSIVA 4450.00

RILEVATO	
A1	0.63 mq.
STERRO	
B1	4.25 mq.
BINDER	
C1	0.84 mq.
BASE	
D1	2.62 mq.
FONDAZIONE	
E1	2.10 mq.
USURA	
a1	10.50 ml.
VEGETALE	
b1	1.89 ml.
b2	0.35 ml.
Totale:	2.24 ml.

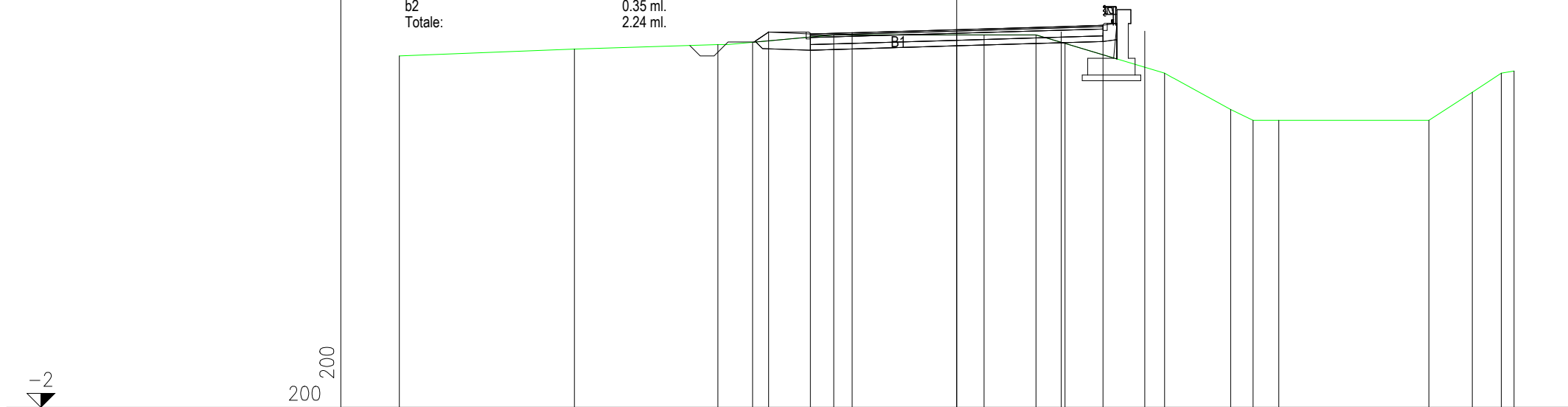

200  
200

PROGRESSIVE TERRENO	-20.00	-13.72	-8.57	-4.41	0.98	2.84	3.88	7.46	9.83	10.63	16.94	18.50	19.54	20.00
PARZIALI TERRENO	6.28	5.15	4.16	5.39	1.86	1.04	3.58	2.37	0.80	6.31	1.56	1.04	0.46	
QUOTE TERRENO	10.60	10.85	11.01	11.36	11.36	11.36	11.06	9.99	8.68	8.30	8.30	9.31	9.99	10.06
PROGRESSIVE PROGETTO			-7.33	-6.75	-5.25	-3.75	0.00	3.75	5.25	6.75	11.56			
PARZIALI PROGETTO			0.58	1.50	1.50	3.75	3.75	1.50	1.50	4.81				
QUOTE PROGETTO			11.10	11.48	11.42	11.46	11.55	11.47	11.43	11.50	8.30			



PROFILO ASSE OPERA CONNESSA

SEZIONE 88

PROGRESSIVA 4500.00

RILEVATO	
A1	0.46 mq.
A2	0.21 mq.
Totale:	0.67 mq.
STERRO	
B1	6.85 mq.
BINDER	
C1	0.84 mq.
BASE	
D1	2.62 mq.
FONDAZIONE	
E1	2.10 mq.
SCOTICO	
SC1	0.53 mq.
SC2	0.45 mq.
SC3	0.50 mq.
Totale:	1.48 mq.
USURA	
a1	10.50 ml.
VEGETALE	
b1	0.35 ml.



PROGRESSIVE TERRENO	-20.00	-14.12	-8.48	-4.23		1.28	2.97	3.45		6.87	8.21	10.32		17.58	18.79	20.00
PARZIALI TERRENO		5.88	5.64	4.25	5.51	1.69	0.48	3.42	1.34	2.11	7.26	1.21	1.21			
QUOTE TERRENO	10.72	10.75	11.11	11.50	11.50	11.50	11.50	11.32	9.99	9.46	8.30	8.30	8.94	9.67		
PROGRESSIVE PROGETTO			-7.78	-7.05	-6.25	-5.25	-3.75	0.00	3.75	5.25	6.75	11.50				
PARZIALI PROGETTO			0.73	0.80	1.00	1.50	3.75	3.75	1.50	1.50	4.75					
QUOTE PROGETTO			11.16	11.65	11.65	11.40	11.44	11.53	11.44	11.40	11.46	8.30				

PROFILO ASSE OPERA CONNESSA

SEZIONE 89

PROGRESSIVA 4550.00

RILEVATO	
A1	0.26 mq.
A2	0.12 mq.
Totale:	0.38 mq.
STERRO	
B1	7.25 mq.
BINDER	
C1	0.84 mq.
BASE	
D1	2.62 mq.
FONDAZIONE	
E1	2.10 mq.
SCOTICO	
SC1	0.51 mq.
SC2	0.18 mq.
SC3	0.40 mq.
Totale:	1.09 mq.
USURA	
a1	10.50 ml.
VEGETALE	
b1	0.35 ml.



PROGRESSIVE TERRENO	-20.00	-19.55	-11.94	-7.53	-4.21	-3.59	2.99	4.04	7.16	8.98	12.92	18.48	19.81	20.00
PARZIALI TERRENO	0.45	7.61	4.41	3.32	0.62	6.58	1.05	3.12	1.82	3.94	5.56	1.33	0.19	
QUOTE TERRENO	10.76	10.75	11.13	11.34	11.50	11.50	11.50	11.17	9.99	9.43	8.30	8.30	9.57	9.58
PROGRESSIVE PROGETTO				-7.49	-7.05	-6.25	-5.25	-3.75	0.00	3.75	5.25	6.75	10.37	
PARZIALI PROGETTO				0.44	0.80	1.00	1.50	3.75	3.75	1.50	1.50	3.62		
QUOTE PROGETTO				11.34	11.63	11.63	11.38	11.42	11.51	11.42	11.38	11.44	9.03	

PROFILO ASSE OPERA CONNESSA

SEZIONE 90

PROGRESSIVA 4600.00

RILEVATO	
A1	0.19 mq.
A2	0.04 mq.
Totale:	0.23 mq.
STERRO	
B1	7.26 mq.
BINDER	
C1	0.84 mq.
BASE	
D1	2.62 mq.
FONDAZIONE	
E1	2.10 mq.
SCOTICO	
SC1	0.52 mq.
SC2	0.37 mq.
SC3	0.37 mq.
Totale:	1.26 mq.
USURA	
a1	10.50 ml.
VEGETALE	
b1	0.35 ml.

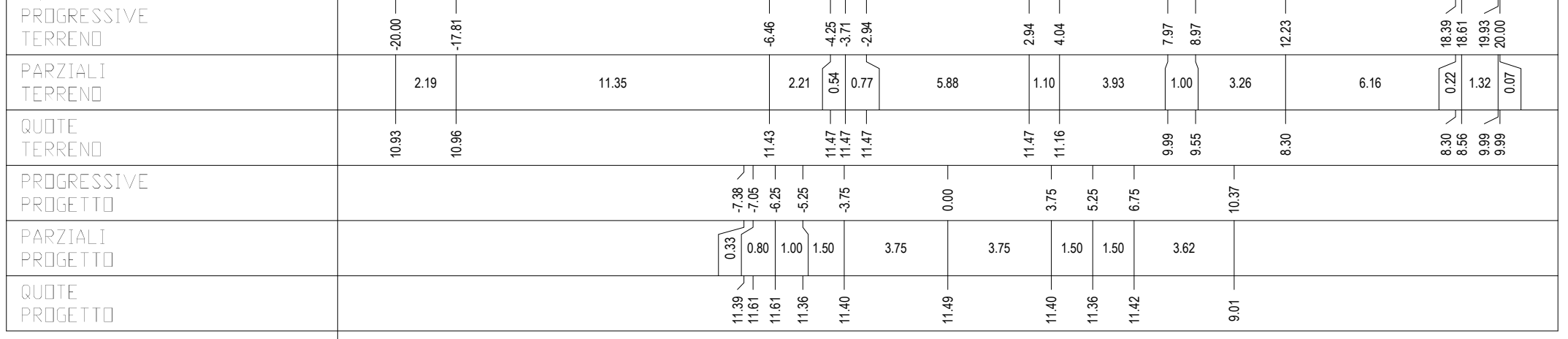

PROFILO ASSE OPERA CONNESSA

SEZIONE 91

PROGRESSIVA 4650.00

RILEVATO  
 A1 0.13 mq.  
 STERRO  
 B1 7.25 mq.  
 BINDER  
 C1 0.84 mq.  
 BASE  
 D1 2.62 mq.  
 FONDAZIONE  
 E1 2.10 mq.  
 SCOTICO  
 SC1 0.53 mq.  
 SC2 0.29 mq.  
 SC3 0.31 mq.  
 Totale: 1.13 mq.  
 USURA

a1 10.50 ml.  
 VEGETALE  
 b1 0.35 ml.

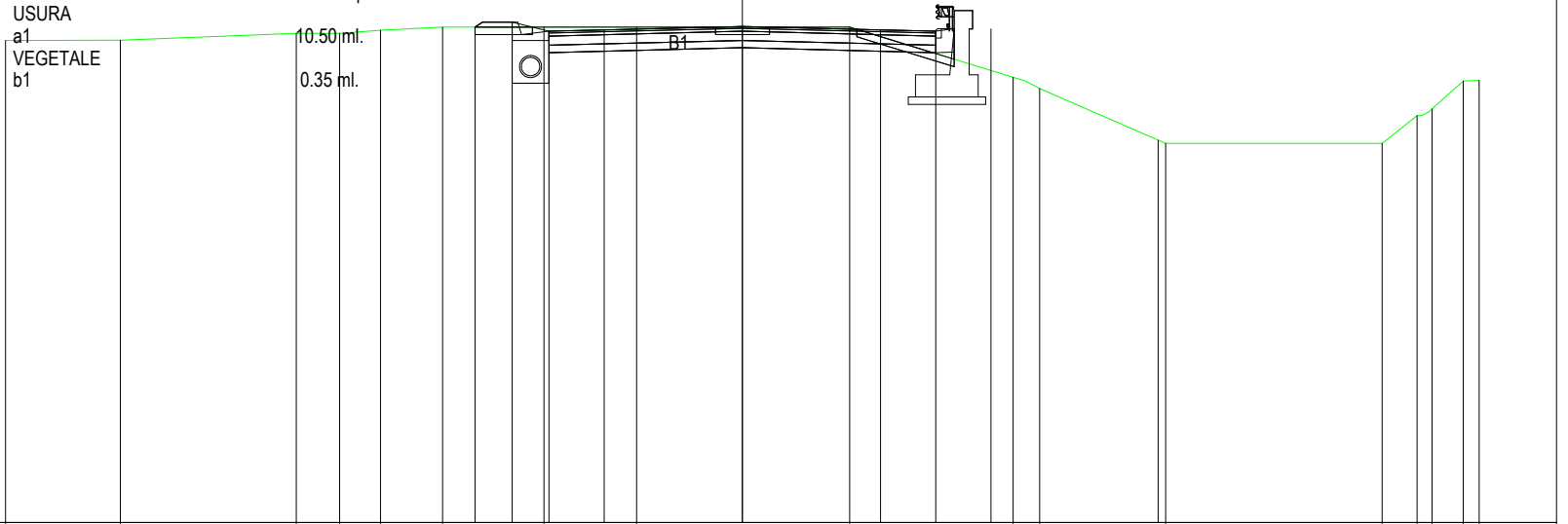

PROGRESSIVE TERRENO	-20.00	-16.89	-12.10	-10.93	-9.82	-8.14	-5.39	-2.87	2.91	7.35	8.07	11.49	17.36	18.31	18.72	19.56	20.00
PARZIALI TERRENO		3.11	4.79	1.17	1.11	1.68	2.75	2.52	5.78	4.44	0.72	3.42	5.87	0.95	0.41	0.84	0.44
QUOTE TERRENO	11.09	11.09	11.28	11.28	11.37	11.45	11.45	11.45	11.45	10.09	9.78	8.30	8.30	9.05	9.23	9.99	10.00
PROGRESSIVE PROGETTO						-7.26	-6.25	-5.25	-3.75	0.00	3.75	5.25	6.75	11.28			
PARZIALI PROGETTO						1.01	1.00	1.50	3.75	3.75	1.50	1.50	4.53				
QUOTE PROGETTO						11.45	11.59	11.34	11.38	11.47	11.38	11.34	11.41	8.38			

PROFILO ASSE OPERA CONNESSA

SEZIONE 92

PROGRESSIVA 4700.00

RILEVATO	
A1	0.02 mq.
A2	0.12 mq.
Totale:	0.14 mq.
STERRO	
B1	5.92 mq.
BINDER	
C1	0.84 mq.
BASE	
D1	2.62 mq.
FONDAZIONE	
E1	2.10 mq.
SCOTICO	
SC1	0.50 mq.
SC2	0.10 mq.
SC3	0.63 mq.
Totale:	1.23 mq.
USURA	
a1	10.50 ml.
VEGETALE	
b1	2.27 ml.
b2	0.35 ml.
Totale:	2.62 ml.



PROGRESSIVE TERRENO	-20.00	-17.35	-15.71	-11.44	-6.47	-4.98	-4.18		3.02	6.96	10.06		16.22	19.86	20.00
PARZIALI TERRENO		2.65	1.64	4.27		4.97	1.49	0.80	7.20	3.94	3.10	6.16		3.64	0.14
QUOTE TERRENO	10.88	10.85	10.84	10.80		10.76	11.21	11.45		11.45	10.01	8.30		8.30	9.71 9.76
PROGRESSIVE PROGETTO						-7.67	-6.75	-5.25	-3.75	0.00	3.75	5.25	6.75	11.39	
PARZIALI PROGETTO						0.92	1.50	1.50	3.75	3.75	1.50	1.50	4.64		
QUOTE PROGETTO						10.77	11.39	11.32	11.36	11.45	11.36	11.32	11.39	8.30	

PROFILO ASSE OPERA CONNESSA

SEZIONE 93

PROGRESSIVA 4750.00

RILEVATO	
A1	0.11 mq.
STERRO	
B1	4.75 mq.
BINDER	
C1	0.84 mq.
BASE	
D1	2.62 mq.
FONDAZIONE	
E1	2.10 mq.
SCOTICO	
SC1	2.68 mq.
USURA	
a1	10.50 ml.
VEGETALE	
b1	2.22 ml.
b2	0.35 ml.
Totale:	2.57 ml.



PROGRESSIVE TERRENO	-20.00	-19.48	-18.00		-8.50	-6.40	-5.54	-3.99		-0.63	-0.03	3.20	5.63	7.21	7.75	10.56	16.83	19.65	20.00
PARZIALI TERRENO	0.52	1.48		9.50	2.10	0.86	1.55	3.36	0.60	3.23	2.43	1.58	0.54	2.81		6.27	2.82	0.35	
QUOTE TERRENO	10.77	10.77	10.79		10.79	10.78	10.96	11.30		11.30	11.30	11.30	10.51	9.99	9.68	8.18	8.18	9.94	10.02
PROGRESSIVE PROGETTO					-7.62	-6.75	-5.25	-3.75		0.00	3.75	5.25	6.75			11.53			
PARZIALI PROGETTO					0.87	1.50	1.50	3.75		3.75	1.50	1.50	4.78						
QUOTE PROGETTO					10.78	11.37	11.30	11.34		11.43	11.34	11.30	11.37			8.18			

PROFILO ASSE OPERA CONNESSA

SEZIONE 94

PROGRESSIVA 4800.00

RILEVATO	
A1	0.28 mq.
STERRO	
B1	5.19 mq.
BINDER	
C1	0.84 mq.
BASE	
D1	2.62 mq.
FONDAZIONE	
E1	2.10 mq.
SCOTICO	
SC1	2.56 mq.
USURA	
a1	10.50 ml.
VEGETALE	
b1	1.61 ml.
b2	0.35 ml.
Totale:	1.96 ml.



PROGRESSIVE TERRENO	-20.00	-19.47	-10.19	-4.88	0.97	3.05	5.25	6.60	8.60	9.78	16.73	19.07	20.00
PARZIALI TERRENO	0.53	9.28	5.31	5.85	2.08	2.20	1.35	2.00	1.18	6.95	2.34	0.93	
QUOTE TERRENO	10.58	10.58	11.07	11.25	11.25	11.25	10.44	9.99	8.94	8.18	8.18	9.09	9.42
PROGRESSIVE PROGETTO			-7.01	-5.25	-3.75	0.00	3.75	5.25	6.75	11.50			
PARZIALI PROGETTO			1.76	1.50	3.75	3.75	1.50	1.50	4.75				
QUOTE PROGETTO			11.17	11.28	11.32	11.41	11.32	11.28	11.35	8.18			

PROFILO ASSE OPERA CONNESSA

SEZIONE 95

PROGRESSIVA 4850.00

RILEVATO	
A1	0.02 mq.
A2	0.09 mq.
Totale:	0.11 mq.
STERRO	
B1	5.19 mq.
BINDER	
C1	0.84 mq.
BASE	
D1	2.62 mq.
FONDAZIONE	
E1	2.10 mq.
SCOTICO	
SC1	2.78 mq.
USURA	
a1	10.50 ml.
VEGETALE	
b1	2.77 ml.
b2	0.35 ml.
Totale:	3.12 ml.



PROGRESSIVE TERRENO	-20.00	-14.79	-8.16	-6.97	-5.75		-0.07	3.13	5.62	7.24	9.82	10.69		16.32	20.00
PARZIALI TERRENO		5.21	6.63	1.19	1.22	5.68	3.20	2.49	1.62	2.58	0.87	5.63	3.68		
QUOTE TERRENO	10.87	10.92	10.38	10.65	11.25		11.25	11.25	10.49	9.99	8.63	8.18		8.18	9.35
PROGRESSIVE PROGETTO			-8.17	-6.75	-5.25	-3.75	0.00	3.75	5.25	6.75		11.47			
PARZIALI PROGETTO			1.42	1.50	1.50	3.75	3.75	1.50	1.50	4.72					
QUOTE PROGETTO			10.38	11.33	11.26	11.30	11.39	11.30	11.26	11.33		8.18			



PROFILO ASSE OPERA CONNESSA

SEZIONE 96

PROGRESSIVA 4900.00

RILEVATO	
A1	0.39 mq.
A2	0.03 mq.
Totale:	0.42 mq.
STERRO	
B1	4.54 mq.
BINDER	
C1	0.84 mq.
BASE	
D1	2.62 mq.
FONDAZIONE	
E1	2.10 mq.
SCOTICO	
SC1	2.78 mq.
USURA	
a1	10.50 ml.
VEGETALE	
b1	2.73 ml.
b2	0.35 ml.
Totale:	3.08 ml.

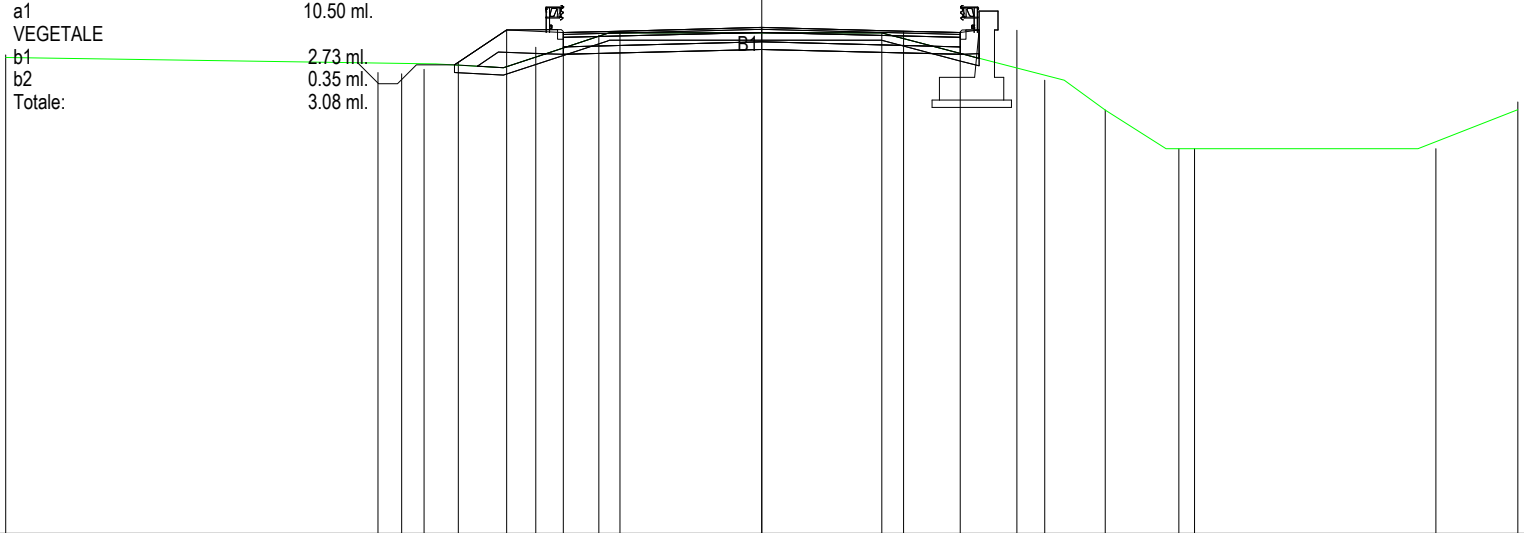

200  
200

PROGRESSIVE TERRENO	-20.00	-10.15	-9.52	-8.93	-5.98	-4.31	3.17	7.48	9.08	11.04	17.83	20.00
PARZIALI TERRENO	9.85	0.63	0.59	2.95	1.67	7.48	4.31	1.60	1.96	6.79	2.17	
QUOTE TERRENO	10.66	10.19	10.16	10.28	10.86	11.18	11.24	9.99	9.20	8.18	8.18	9.42
PROGRESSIVE PROGETTO				-8.03	-6.75	-5.25	-3.75	0.00	3.75	5.25	6.75	11.45
PARZIALI PROGETTO				1.28	1.50	1.50	3.75	3.75	1.50	1.50	4.70	
QUOTE PROGETTO		10.45	11.31	11.24	11.28	11.37	11.28	11.24	11.31	8.18		

PROFILO ASSE OPERA CONNESSA

SEZIONE 97

PROGRESSIVA 4950.00

RILEVATO	
A1	0.03 mq.
A2	0.04 mq.
Totale:	0.07 mq.
STERRO	
B1	4.97 mq.
BINDER	
C1	0.84 mq.
BASE	
D1	2.64 mq.
FONDAZIONE	
E1	2.10 mq.
SCOTICO	
SC1	2.78 mq.
USURA	
a1	10.50 ml.
VEGETALE	
b1	2.74 ml.
b2	0.35 ml.
Totale:	3.09 ml.

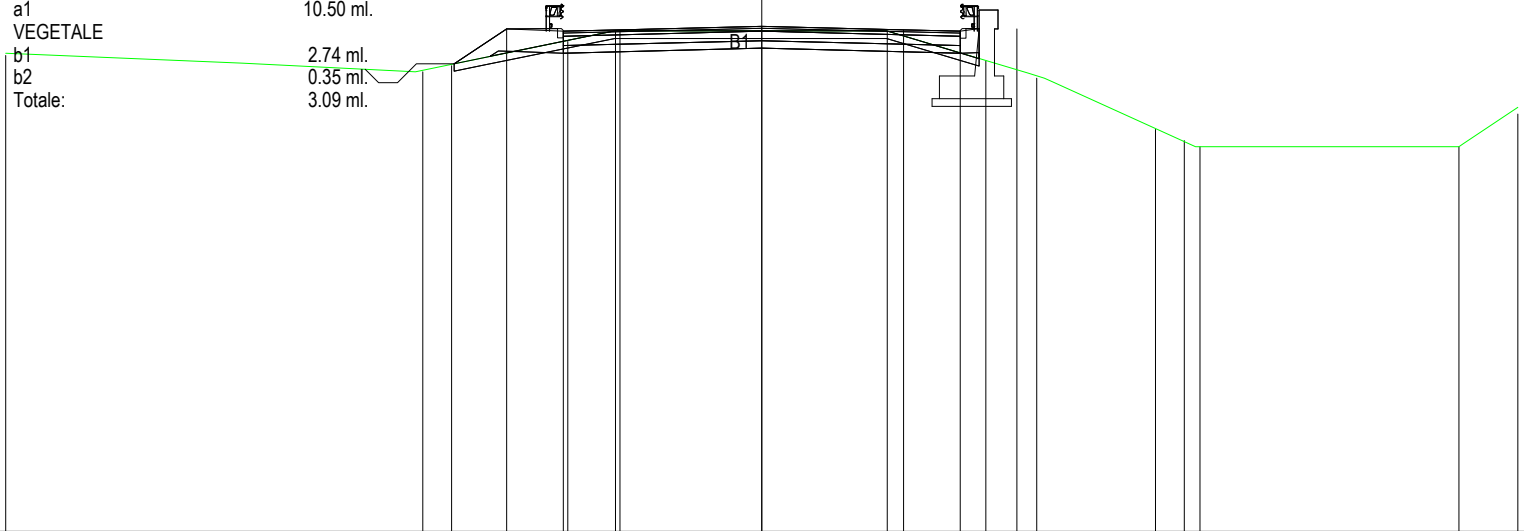

200  
200

PROGRESSIVE TERRENO	-20.00	-8.97	-5.13	-3.87		3.32	5.93	7.27	10.41	11.59		18.44	20.00
PARZIALI TERRENO		11.03	3.84	1.26	7.19	2.61	1.34	3.14	1.18	6.85	1.56		
QUOTE TERRENO	10.59	10.16	10.96	11.23		11.23	10.45	9.99	8.64	8.18		8.18	9.04
PROGRESSIVE PROGETTO		-8.20	-6.75	-5.25	-3.75	0.00	3.75	5.25	6.75	11.18			
PARZIALI PROGETTO			1.45	1.50	1.50	3.75	3.75	1.50	1.50	4.43			
QUOTE PROGETTO		10.32	11.29	11.22	11.26	11.36	11.26	11.22	11.29	8.34			

PROFILO ASSE OPERA CONNESSA

SEZIONE 98

PROGRESSIVA 5000.00

RILEVATO	
A1	0.10 mq.
A2	0.05 mq.
Totale:	0.15 mq.
STERRO	
B1	4.66 mq.
BINDER	
C1	0.84 mq.
BASE	
D1	2.62 mq.
FONDAZIONE	
E1	2.10 mq.
SCOTICO	
SC1	2.82 mq.
USURA	
a1	10.50 ml.
VEGETALE	
b1	2.94 ml.
b2	0.35 ml.
Totale:	3.29 ml.



PROGRESSIVE TERRENO	-20.00	-19.04	-18.49	-17.80	-17.29	-16.61	-15.87	-4.60	-3.70	3.49	6.39	7.40	10.63	16.83	20.00
PARZIALI TERRENO	0.96	0.55	0.69	0.51	0.68	0.74	11.27	0.90	7.19	2.90	1.01	3.23	6.20	3.17	
QUOTE TERRENO	10.48	10.52	10.52	10.53	10.54	10.56	10.59	11.15	11.20	11.20	10.30	9.99	8.30	8.18	9.73
PROGRESSIVE PROGETTO		-7.12	-6.75	-5.25	-3.75	0.00	3.75	5.25	6.75	11.39					
PARZIALI PROGETTO		0.37	1.50	1.50	3.75	3.75	1.50	1.50	4.64						
QUOTE PROGETTO		11.02	11.27	11.20	11.24	11.34	11.24	11.20	11.27	8.18					

PROFILO ASSE OPERA CONNESSA

SEZIONE 99

PROGRESSIVA 5050.00

RILEVATO	
A1	0.04 mq.
STERRO	
B1	5.59 mq.
BINDER	
C1	0.84 mq.
BASE	
D1	2.64 mq.
FONDAZIONE	
E1	2.10 mq.
SCOTICO	
SC1	2.62 mq.
USURA	
a1	10.50 ml.
VEGETALE	
b1	1.92 ml.
b2	0.35 ml.
Totale:	2.27 ml.

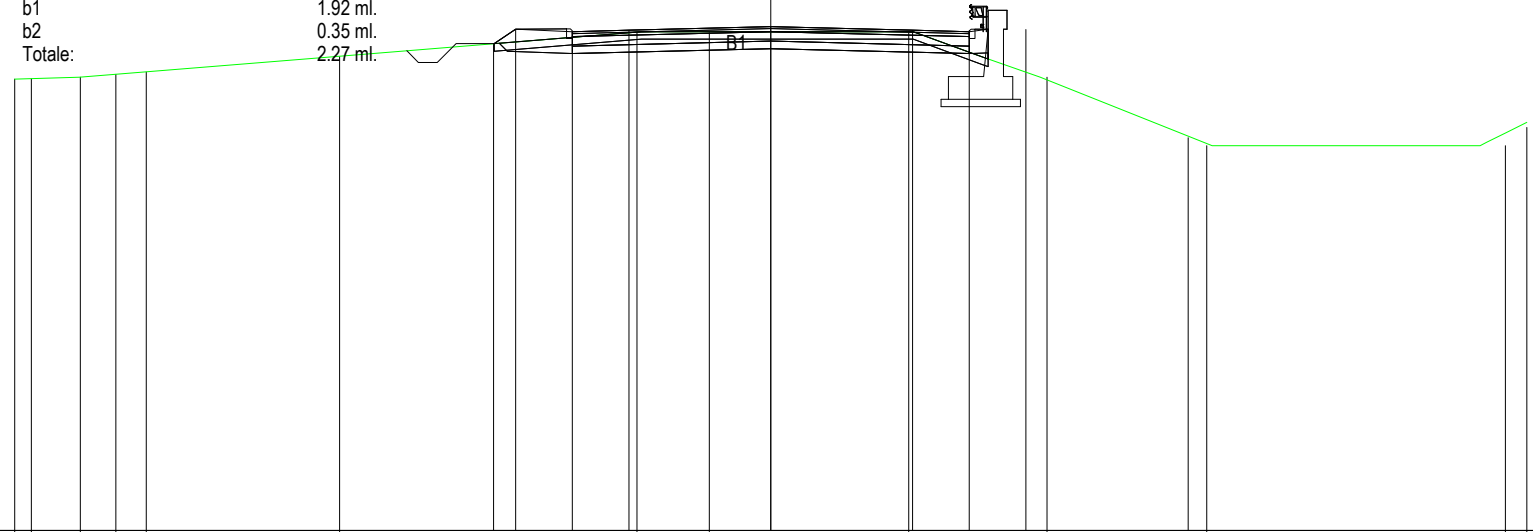

PROGRESSIVE TERRENO	-20.00	-19.56	-18.27	-17.33	-16.52	-11.41	-3.54	-1.62	3.65	7.30	11.53	19.43	20.00		
PARZIALI TERRENO	0.44	1.29	0.94	0.81	5.11	7.87	1.92	5.27	3.65	4.23	7.90	0.57			
QUOTE TERRENO	9.94	9.95	9.99	10.06	10.13	10.53	11.17	11.16	11.17	9.99	8.18	8.18	8.66		
PROGRESSIVE PROGETTO							-7.34	-6.75	-5.25	-3.75	0.00	3.75	5.25	6.75	11.04
PARZIALI PROGETTO							0.59	1.50	1.50	3.75	3.75	1.50	1.50	4.29	
QUOTE PROGETTO							10.86	11.25	11.19	11.22	11.32	11.22	11.19	11.25	8.39

PROFILO ASSE OPERA CONNESSA

SEZIONE 100

PROGRESSIVA 5100.00

- RILEVATO
- A1 0.05 mq.
- STERRO
- B1 5.08 mq.
- BINDER
- C1 0.84 mq.
- BASE
- D1 2.62 mq.
- FONDAZIONE
- E1 2.10 mq.
- SCOTICO
- SC1 2.61 mq.
- USURA
- a1 10.50 ml.
- VEGETALE
- b1 1.93 ml.
- b2 0.35 ml.
- Totale: 2.28 ml.



PROGRESSIVE TERRENO	-20.00	-18.43	-14.77	-10.54	-8.94	-6.94	-3.71		3.48	5.53	7.46	9.44	11.34		19.36	20.00
PARZIALI TERRENO	1.57	3.66	4.23	1.60	2.00	3.23		7.19	2.05	1.93	1.98	1.90		8.02	0.64	
QUOTE TERRENO	9.97	9.99	10.28	10.61	10.71	10.82	11.14		11.14	10.58	9.99	9.09	8.18		8.18	8.59
PROGRESSIVE PROGETTO						-7.41	-6.75	-5.25	-3.75	0.00	3.75	5.25	6.75	11.31		
PARZIALI PROGETTO						0.66	1.50	1.50	3.75	3.75	1.50	1.50	4.56			
QUOTE PROGETTO						10.79	11.23	11.17	11.20	11.30	11.20	11.17	11.23	8.19		

PROFILO ASSE OPERA CONNESSA

SEZIONE 101

PROGRESSIVA 5150.00

RILEVATO	
A1	0.09 mq.
STERRO	
B1	5.25 mq.
BINDER	
C1	0.84 mq.
BASE	
D1	2.64 mq.
FONDAZIONE	
E1	2.10 mq.
SCOTICO	
SC1	2.62 mq.
USURA	
a1	10.50 ml.
VEGETALE	
b1	1.94 ml.
b2	0.35 ml.
Totale:	2.29 ml.

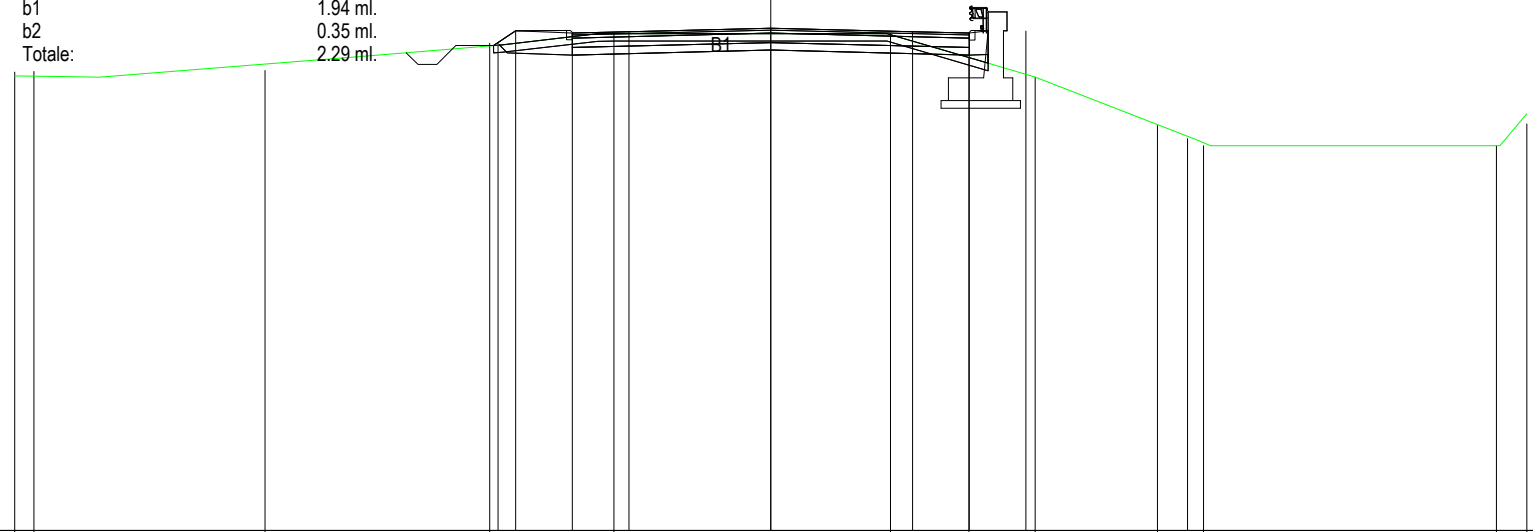

PROGRESSIVE TERRENO	-20.00	-19.49		-13.38		-7.44	-4.15		3.16	5.24	6.99	10.23	11.44	19.19	20.00
PARZIALI TERRENO	0.51	6.11	5.94	3.29	7.31	2.08	1.75	3.24	1.21	7.75	0.81				
QUOTE TERRENO	10.12	10.14	10.16	10.89	11.14	11.14	10.52	9.99	8.71	8.18	8.18	8.18	8.18	8.18	8.75
PROGRESSIVE PROGETTO				-7.21	-6.75	-5.25	-3.75	0.00	3.75	5.25	6.75	11.02			
PARZIALI PROGETTO				0.46	1.50	1.50	3.75	3.75	1.50	1.50	4.27				
QUOTE PROGETTO	10.90	11.21	11.15	11.18	11.28	11.18	11.15	11.21	8.36						

PROFILO ASSE OPERA CONNESSA

SEZIONE 102

PROGRESSIVA 5200.00

RILEVATO	
A1	0.14 mq.
A2	0.10 mq.
Totale:	0.24 mq.
STERRO	
B1	4.65 mq.
BINDER	
C1	0.84 mq.
BASE	
D1	2.63 mq.
FONDAZIONE	
E1	2.10 mq.
SCOTICO	
SC1	2.87 mq.
USURA	
a1	10.50 ml.
VEGETALE	
b1	3.21 ml.
b2	0.35 ml.
Totale:	3.56 ml.



PROGRESSIVE TERRENO	-20.00	-9.11	-4.35	3.86	4.81	7.76	9.84	10.51	17.46	17.89	20.00
PARZIALI TERRENO		10.89	4.76	8.21	0.95	2.95	2.08	0.67	6.95	0.43	2.11
QUOTE TERRENO	10.17	10.85	11.05	11.14	10.86	9.99	8.65	8.18	8.18	8.28	8.88
PROGRESSIVE PROGETTO			-7.14	-6.75	-5.25	-3.75	0.00	3.75	5.25	6.75	11.64
PARZIALI PROGETTO			0.39	1.50	1.50	3.75	3.75	1.50	1.50	4.89	
QUOTE PROGETTO			10.93	11.19	11.13	11.16	11.26	11.34	11.37	11.44	8.18

PROFILO ASSE OPERA CONNESSA

SEZIONE 103

PROGRESSIVA 5250.00

- RILEVATO
- A1 0.06 mq.
- STERRO
- B1 5.46 mq.
- BINDER
- C1 0.84 mq.
- BASE
- D1 2.62 mq.
- FONDAZIONE
- E1 2.10 mq.
- SCOTICO
- SC1 1.50 mq.
- SC2 0.46 mq.
- Totale: 1.96 mq.
- USURA
- a1 10.50 ml.
- VEGETALE
- b1 1.82 ml.
- b2 0.35 ml.
- Totale: 2.17 ml.



PROGRESSIVE TERRENO	-20.00	-16.93	-13.18	-7.65	-2.43	0.85	2.35	5.41	9.36	13.34	20.00		
PARZIALI TERRENO		3.07	3.75	5.53	5.22	3.28	1.50	3.06	3.95	3.98	6.66		
QUOTE TERRENO	10.20	10.32	10.50	10.79	11.10	11.09	11.09	11.10	10.02	8.18	8.18		
PROGRESSIVE PROGETTO				-7.62	-7.05	-6.25	-5.25	-3.75	0.00	3.75	5.25	6.75	9.01
PARZIALI PROGETTO				0.57	0.80	1.00	1.50	3.75	3.75	1.50	1.50	2.26	
QUOTE PROGETTO				10.79	11.17	11.17	10.92	11.01	11.24	11.47	11.56	11.63	10.12



PROFILO ASSE OPERA CONNESSA

SEZIONE 104

PROGRESSIVA 5300.00

- RILEVATO
- A1 0.29 mq.
- A2 0.10 mq.
- Totale: 0.39 mq.
- STERRO
- B1 5.21 mq.
- BINDER
- C1 0.83 mq.
- BASE
- D1 2.63 mq.
- FONDAZIONE
- E1 2.10 mq.
- SCOTICO
- SC1 1.88 mq.
- SC2 0.43 mq.
- Totale: 2.31 mq.
- USURA
- a1 10.50 ml.
- VEGETALE
- b1 0.35 ml.

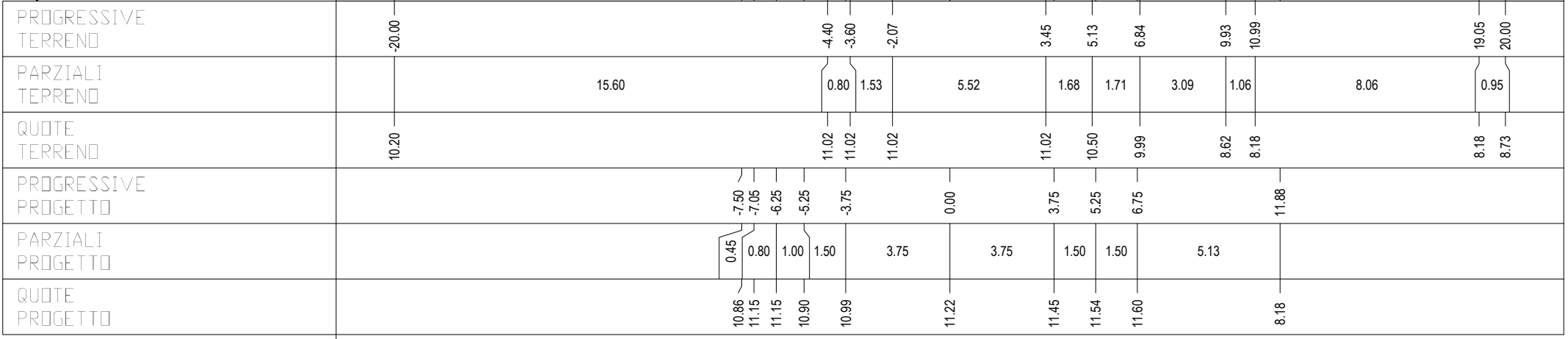

PROFILO ASSE OPERA CONNESSA

SEZIONE 105

PROGRESSIVA 5350.00

RILEVATO	
A1	1.16 mq.
STERRO	
B1	4.07 mq.
BINDER	
C1	0.84 mq.
BASE	
D1	2.62 mq.
FONDAZIONE	
E1	2.10 mq.
SCOTICO	
SC1	2.54 mq.
USURA	
a1	10.50 ml.
VEGETALE	
b1	1.63 ml.
b2	0.35 ml.
Totale:	1.98 ml.

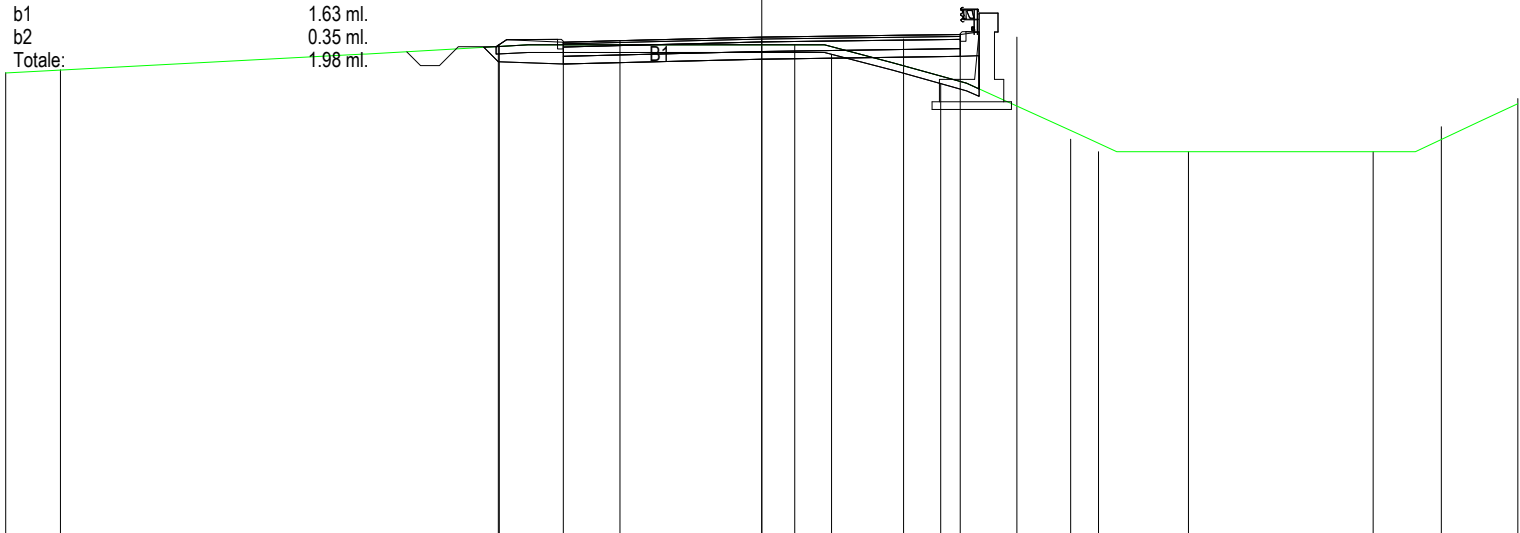

200  
200

PROGRESSIVE TERRENO	-20.00	-18.56		-6.97		0.87	1.84	4.73	8.17	8.91		16.17	17.97	20.00
PARZIALI TERRENO	1.44		11.59		7.84	0.97	2.89	3.44	0.74		7.26	1.80	2.03	
QUOTE TERRENO	10.27	10.34		11.01		11.01	10.75	9.99	8.51	8.18		8.18	8.84	9.58
PROGRESSIVE PROGETTO				-6.94	-5.25	-3.75	0.00	3.75	5.25	6.75		11.29		
PARZIALI PROGETTO				1.69	1.50	3.75		3.75	1.50	1.50	4.54			
QUOTE PROGETTO				11.01	11.07	11.11	11.20	11.16	11.14	11.20		8.18		

PROFILO ASSE OPERA CONNESSA

SEZIONE 106

PROGRESSIVA 5400.00

RILEVATO	
A1	2.29 mq.
STERRO	
B1	3.62 mq.
BINDER	
C1	0.84 mq.
BASE	
D1	2.62 mq.
FONDAZIONE	
E1	2.10 mq.
SCOTICO	
SC1	2.55 mq.
USURA	
a1	10.50 ml.
VEGETALE	
b1	1.53 ml.
b2	0.35 ml.
Totale:	1.88 ml.

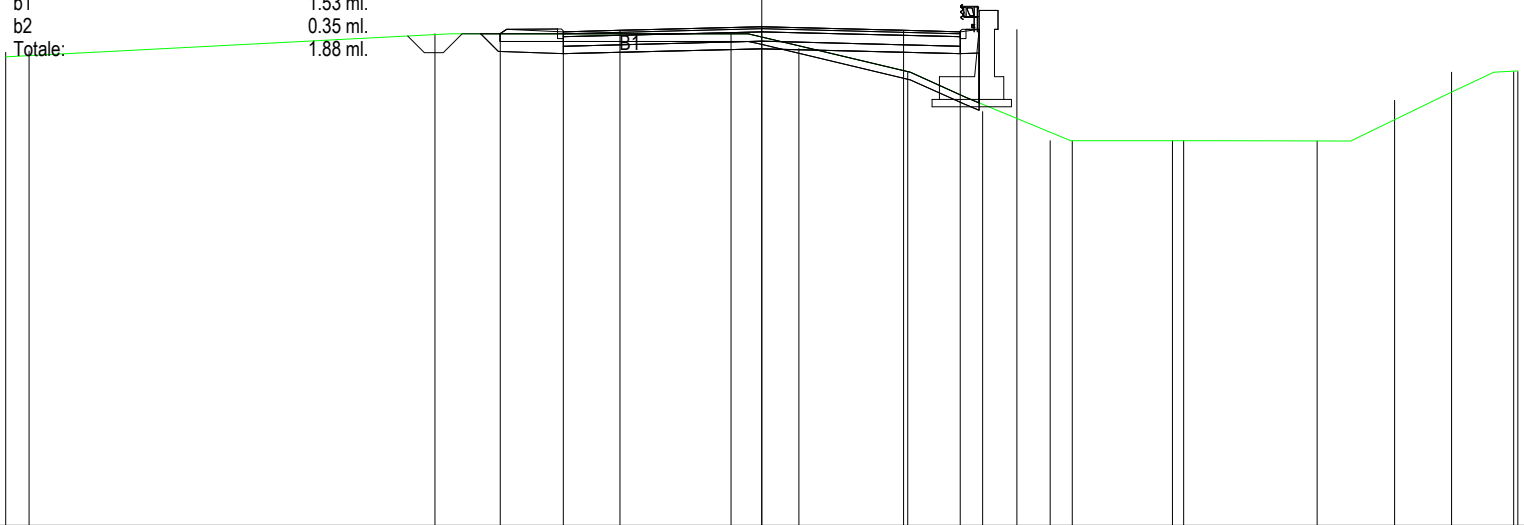

200  
200

PROGRESSIVE TERRENO	-20.00	-19.38	-8.65	-0.81	0.98	3.86	5.84	7.63	8.21	10.86	14.69	16.74	18.25	19.89	20.00
PARZIALI TERRENO	0.62	10.73	7.84	1.79	2.88	1.98	1.79	0.58	2.65	3.83	2.05	1.51	1.64	0.11	
QUOTE TERRENO	10.52	10.55	11.01	11.01	10.61	9.99	8.94	8.18	8.18	8.17	8.17	9.24	9.99	10.00	10.00
PROGRESSIVE PROGETTO			-6.92	-5.25	-3.75	0.00	3.75	5.25	6.75	11.16					
PARZIALI PROGETTO			1.67	1.50	3.75	3.75	1.50	1.50	4.41						
QUOTE PROGETTO			11.01	11.05	11.09	11.18	11.09	11.05	11.11	8.17					

PROFILO ASSE OPERA CONNESSA

SEZIONE 107

PROGRESSIVA 5450.00

RILEVATO	
A1	4.86 mq.
STERRO	
B1	3.23 mq.
BINDER	
C1	0.84 mq.
BASE	
D1	2.62 mq.
FONDAZIONE	
E1	2.10 mq.
SCOTICO	
SC1	2.52 mq.
USURA	
a1	10.50 ml.
VEGETALE	
b1	1.49 ml.
b2	0.35 ml.
Totale:	1.84 ml.

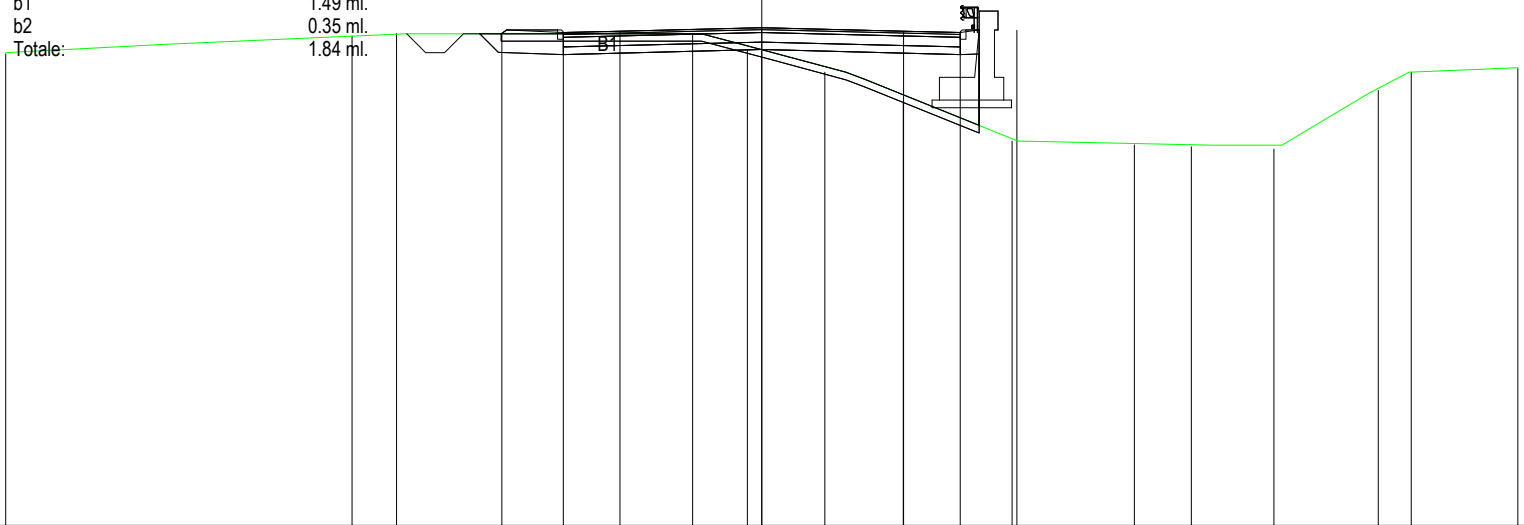

200 200

PROGRESSIVE TERRENO	-20.00	-10.84	-9.66		-1.83	-0.38	1.67	3.74	6.62	9.85	13.54	16.30	17.18	20.00
PARZIALI TERRENO		9.16	1.18	7.83	1.45	2.05	2.07	2.88	3.23	3.69	2.76	0.88	2.82	
QUOTE TERRENO	10.47	10.95	11.01		11.01	10.58	9.99	9.20	8.17	8.06	7.96	9.51	9.99	10.09
PROGRESSIVE PROGETTO				-6.88	-5.25	-3.75	0.00	3.75	5.25	6.75	11.36			
PARZIALI PROGETTO				1.63	1.50	3.75	3.75	1.50	1.50	4.61				
QUOTE PROGETTO				11.01	11.03	11.07	11.16	11.07	11.03	11.10	8.02			

PROFILO ASSE OPERA CONNESSA

SEZIONE 108

PROGRESSIVA 5500.00

RILEVATO	
A1	4.29 mq.
STERRO	
B1	3.67 mq.
BINDER	
C1	0.84 mq.
BASE	
D1	2.62 mq.
FONDAZIONE	
E1	2.10 mq.
SCOTICO	
SC1	2.51 mq.
USURA	
a1	10.50 ml.
VEGETALE	
b1	1.46 ml.
b2	0.35 ml.
Totale:	1.81 ml.

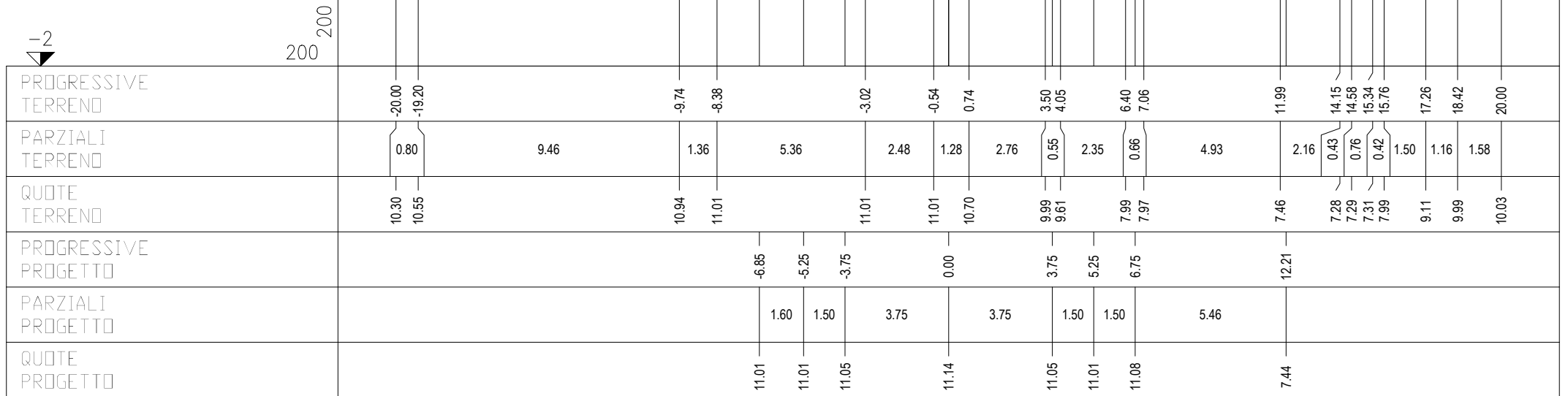

PROFILO ASSE OPERA CONNESSA

SEZIONE 109

PROGRESSIVA 5550.00

RILEVATO	
A1	0.25 mq.
A2	2.57 mq.
Totale:	2.82 mq.
STERRO	
B1	4.82 mq.
BINDER	
C1	0.84 mq.
BASE	
D1	2.62 mq.
FONDAZIONE	
E1	2.10 mq.
SCOTICO	
SC1	2.03 mq.
SC2	0.42 mq.
Totale:	2.45 mq.
USURA	
a1	10.50 ml.
VEGETALE	
b1	0.35 ml.



PROGRESSIVE TERRENO	-20.00	-18.92	-15.89	-15.32	-14.66	-13.56	-9.83	-8.56	-2.21	0.86	1.29	3.24	3.91	4.08	6.42	7.80	8.92	16.20	17.87	19.14	20.00
PARZIALI TERRENO	1.08	3.03	0.57	0.66	1.08	3.75	1.27	6.35	3.07	0.43	1.95	0.67	0.17	2.34	1.38	1.12	7.28	1.67	1.27	0.86	
QUOTE TERRENO	10.30	10.43	10.64	10.68	10.68	10.68	10.78	10.79	10.90	10.97	11.01	11.08	11.12	9.99	7.99	7.34	6.81	6.73	7.99	8.89	9.48
PROGRESSIVE PROGETTO										-7.12	-6.75	-5.25	-3.75	0.00	3.75	5.25	6.75	13.19			
PARZIALI PROGETTO										0.37	1.50	1.50	3.75	3.75	1.50	1.50	6.44				
QUOTE PROGETTO										10.81	11.06	10.99	11.03	11.12	11.03	10.99	11.06	6.76			

PROFILO ASSE OPERA CONNESSA

SEZIONE 110

PROGRESSIVA 5600.00

- RILEVATO
- A1 0.42 mq.
- STERRO
- B1 9.65 mq.
- BINDER
- C1 0.84 mq.
- BASE
- D1 2.62 mq.
- FONDAZIONE
- E1 2.10 mq.
- SCOTICO
- SC1 1.15 mq.
- USURA
- a1 10.50 ml.
- VEGETALE
- b1 0.35 ml.

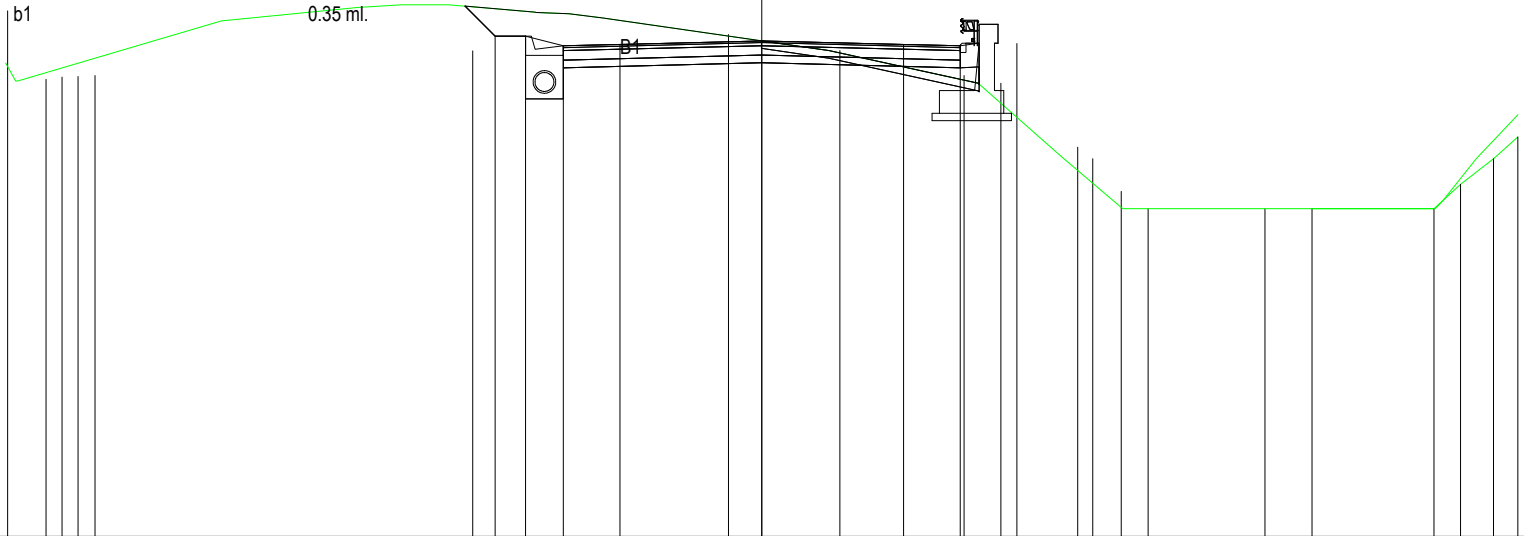

200  
200

PROGRESSIVE TERRENO	-19.95	-18.94	-18.51	-18.09	-17.64		-0.88	2.07		5.35	6.32	8.35	8.75	9.50	10.22		14.55		17.78	18.48	19.35	20.00	
PARZIALI TERRENO	1.01	0.43	0.42	0.45		16.76		2.95		3.28	0.97	2.03	0.40	0.75	0.72		4.33		3.23	0.70	0.87	0.65	
QUOTE TERRENO	11.90	10.09	10.15	10.16	10.19		11.28	10.85		10.19	9.99	8.29	7.99	7.13	6.67		6.67		6.67	6.67	7.32	7.99	8.57
PROGRESSIVE PROGETTO									0.00		3.75	5.25	6.75				13.31						
PARZIALI PROGETTO		0.59	0.80	1.00	1.50		3.75		3.75		1.50	1.50		6.56									
QUOTE PROGETTO		10.84	11.24	11.24	10.99	11.02		11.10		11.01	10.97	11.04					6.67						

PROFILO ASSE OPERA CONNESSA

SEZIONE 111

PROGRESSIVA 5650.00

STERRO	
B1	3.17 mq.
BINDER	
C1	0.84 mq.
BASE	
D1	2.62 mq.
FONDAZIONE	
E1	2.10 mq.
USURA	
a1	10.50 ml.
VEGETALE	
b1	1.81 ml.
b2	0.35 ml.
Totale:	2.16 ml.



200  
200

PROGRESSIVE TERRENO	-18.92	-17.62	-12.79	-6.15	-3.92	-0.72	2.19	6.11	9.75	11.39	17.18	17.87	19.39	20.00
PARZIALI TERRENO	1.30	4.83	6.64	2.23	3.20	2.91	3.92	3.64	1.64	5.79	0.69	1.52	0.61	
QUOTE TERRENO	9.94	9.93	10.38	11.04	11.04	10.87	10.54	9.99	8.00	6.67	6.67	7.14	7.99	8.60
PROGRESSIVE PROGETTO				-7.47	-6.75	-5.25	-3.75	0.00	3.75	5.25	6.75	13.12		
PARZIALI PROGETTO				0.72	1.50	1.50	3.75	3.75	1.50	1.50	6.37			
QUOTE PROGETTO				10.91	11.39	11.32	11.26	11.08	10.91	10.84	10.91	6.67		



PROFILO ASSE OPERA CONNESSA

SEZIONE 112

PROGRESSIVA 5700.00

RILEVATO	
A1	0.04 mq.
A2	0.04 mq.
Totale:	0.08 mq.
STERRO	
B1	2.49 mq.
BINDER	
C1	0.84 mq.
BASE	
D1	2.63 mq.
FONDAZIONE	
E1	2.10 mq.
SCOTICO	
SC1	2.75 mq.
USURA	
a1	10.50 ml.
VEGETALE	
b1	2.53 ml.
b2	0.35 ml.
Totale:	2.88 ml.



PROGRESSIVE TERRENO	-20.00			-6.81	-5.09	-3.11				3.27		5.79	6.44	6.84	8.36	9.89	10.30	11.86			20.00
PARZIALI TERRENO		13.19		1.72	1.98		6.38		2.52	0.65	0.40	1.52	1.53	0.41	1.56		8.14				
QUOTE TERRENO	9.87			10.77	10.96	10.85			10.53	10.01	9.99	9.76	8.98	7.99	7.72	6.67					6.67
PROGRESSIVE PROGETTO				-7.85	-6.75	-5.25	-3.75	0.00	3.75	5.25	6.75					12.98					
PARZIALI PROGETTO				1.10	1.50	1.50	3.75	3.75	1.50	1.50			6.23								
QUOTE PROGETTO				10.70	11.44	11.37	11.28	11.06	10.85	10.76	10.82					6.67					

PROFILO ASSE OPERA CONNESSA

SEZIONE 113

PROGRESSIVA 5750.00

RILEVATO	
A1	11.70 mq.
STERRO	
B1	3.12 mq.
BINDER	
C1	0.84 mq.
BASE	
D1	2.62 mq.
FONDAZIONE	
E1	2.10 mq.
SCOTICO	
SC1	3.51 mq.
USURA	
a1	10.50 ml.
VEGETALE	
b1	5.08 ml.
b2	1.71 ml.
Totale:	6.79 ml.

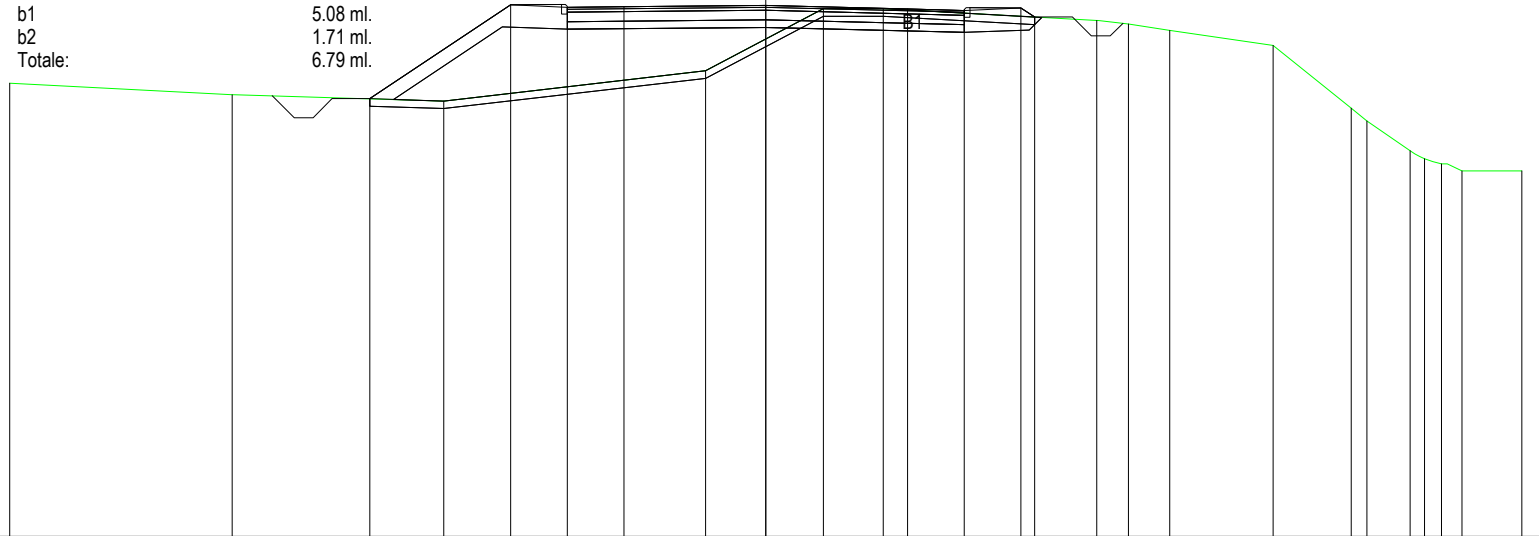

200  
200

PROGRESSIVE TERRENO	-20.00	-14.12	-8.52	-1.60	1.52	3.10	8.75	9.59	10.69	13.42	15.49	15.90	17.04	17.42	17.87	18.42	20.00
PARZIALI TERRENO		5.88	5.60	6.92	3.12	1.58	5.65	0.84	1.10	2.73	2.07	0.41	1.14	0.38	0.45	0.55	1.58
QUOTE TERRENO	8.99	8.69	8.52	9.31	10.96	10.96	10.65	10.56	10.39	9.99	8.33	7.99	7.20	6.99	6.85	6.67	6.67
PROGRESSIVE PROGETTO			-10.48	-6.75	-5.25	-3.75	0.00	3.75	5.25	6.75	7.11						
PARZIALI PROGETTO			3.73	1.50	1.50	3.75	3.75	1.50	1.50	0.36							
QUOTE PROGETTO			8.58	11.06	11.00	11.01	11.05	10.95	10.91	10.98	10.74						

PROFILO ASSE OPERA CONNESSA

SEZIONE 114

PROGRESSIVA 5800.00

RILEVATO	
A1	19.73 mq.
BINDER	
C1	0.84 mq.
BASE	
D1	2.62 mq.
FONDAZIONE	
E1	2.12 mq.
SCOTICO	
SC1	3.76 mq.
USURA	
a1	10.50 ml.
VEGETALE	
b1	5.19 ml.
b2	2.82 ml.
Totale:	8.01 ml.

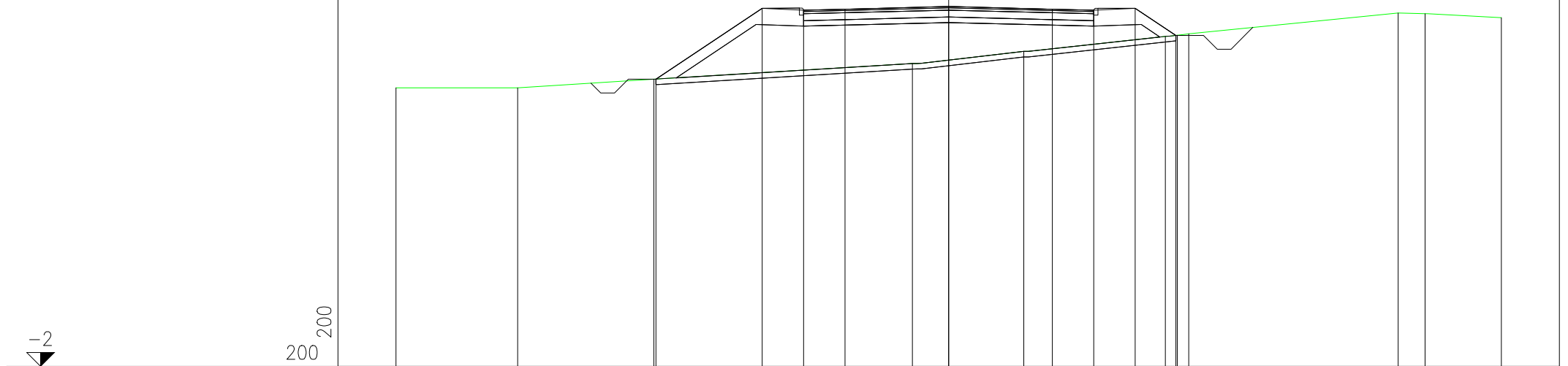

PROGRESSIVE TERRENO	-20.00	-15.60	-10.67		-1.31	2.72	7.84	8.27	8.69	16.27	17.24	20.00
PARZIALI TERRENO	4.40	4.93	9.36	4.03	5.12	0.43	0.42	7.58	0.97	2.76		
QUOTE TERRENO	8.09	8.09	8.39	8.96	9.40	9.95	9.99	10.04	10.79	10.77	10.62	
PROGRESSIVE PROGETTO			-10.59	-6.75	-5.25	-3.75	0.00	3.75	5.25	6.75	8.22	
PARZIALI PROGETTO		3.84	1.50	1.50	3.75	3.75	1.50	1.50	1.47			
QUOTE PROGETTO		8.40	10.96	10.89	10.93	11.03	10.93	10.89	10.96	9.98		

PROFILO ASSE OPERA CONNESSA

SEZIONE 115

PROGRESSIVA 5839.48

RILEVATO	
A1	25.30 mq.
BINDER	
C1	0.84 mq.
BASE	
D1	2.62 mq.
FONDAZIONE	
E1	2.10 mq.
SCOTICO	
SC1	3.98 mq.
USURA	
a1	10.50 ml.
VEGETALE	
b1	5.58 ml.
b2	3.49 ml.
Totale:	9.07 ml.

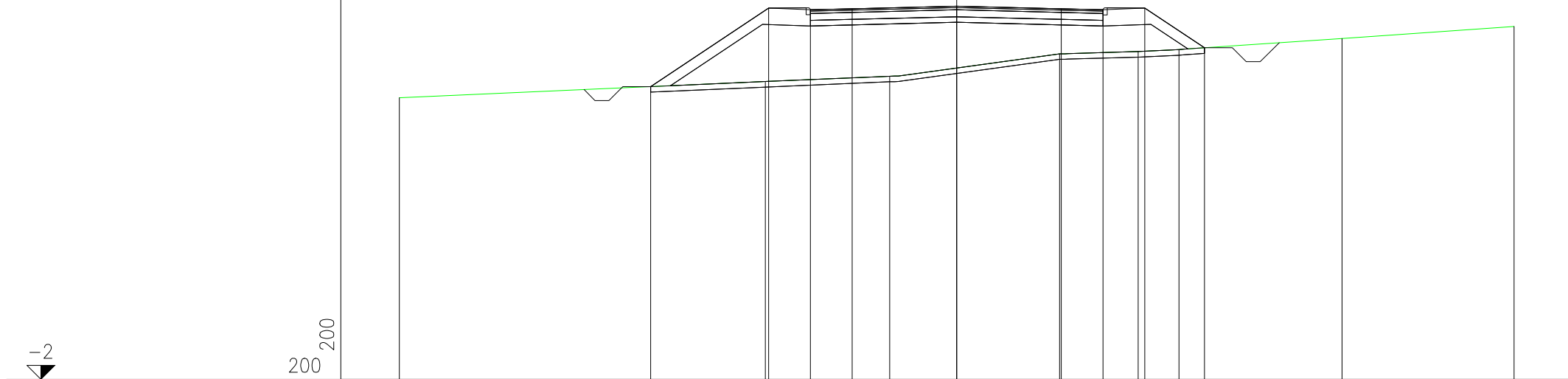

200 200

PROGRESSIVE TERRENO	-20.00		-6.87		-2.41		3.69		6.51	7.98		13.83		20.00
PARZIALI TERRENO		13.13		4.46		6.10		2.82	1.47		5.85		6.17	
QUOTE TERRENO	8.10		8.68		8.87		9.68		9.76	9.83		10.22		10.66
PROGRESSIVE PROGETTO		-10.98		-6.75	-5.25	-3.75	0.00		3.75	5.25	6.75		8.89	
PARZIALI PROGETTO			4.23		1.50	1.50	3.75		3.75	1.50	1.50		2.14	
QUOTE PROGETTO		8.50		11.32	11.26	11.29	11.39		11.29	11.26	11.32		9.89	

PROFILO ASSE OPERA CONNESSA

SEZIONE 116

PROGRESSIVA 5859.48

RILEVATO	
A1	4.63 mq.
BINDER	
C1	0.84 mq.
BASE	
D1	2.62 mq.
FONDAZIONE	
E1	2.10 mq.
SCOTICO	
SC1	3.26 mq.
USURA	
a1	10.50 ml.
VEGETALE	
b1	2.68 ml.
b2	2.78 ml.
Totale:	5.46 ml.

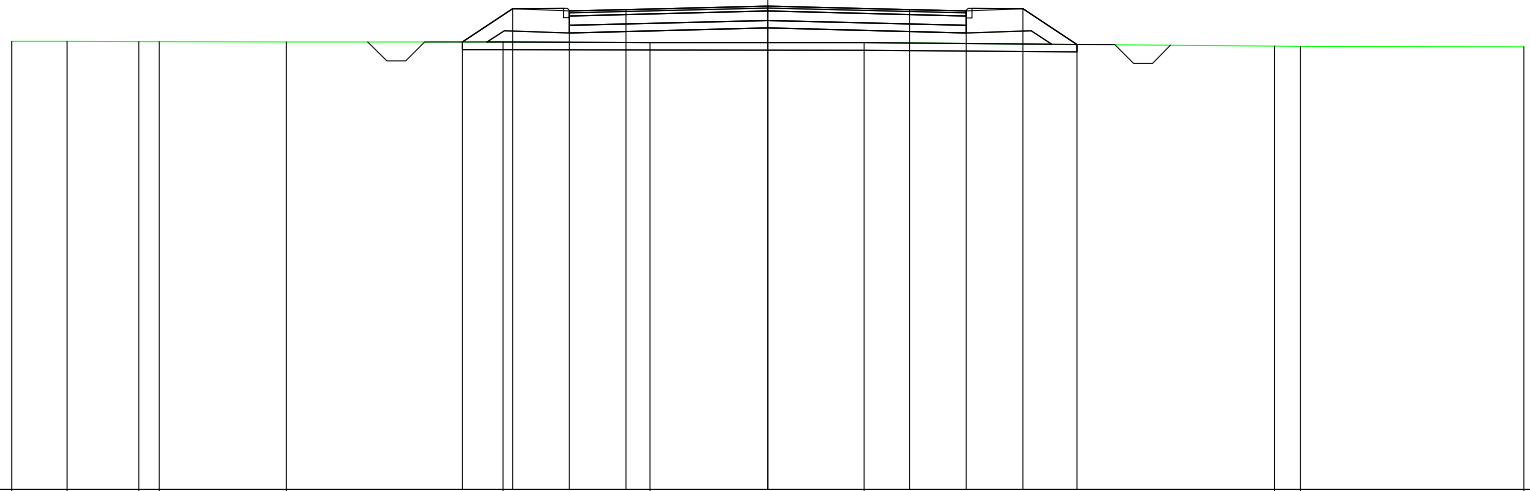

200  
200

PROGRESSIVE TERRENO	-20.00	-18.54	-16.64	-16.10	-12.74	-7.01	-3.12	2.55	13.40	14.09	20.00			
PARZIALI TERRENO	1.46	1.90	0.54	3.36	5.73	3.89	5.67	10.85	0.69	5.91				
QUOTE TERRENO	10.85	10.85	10.85	10.85	10.84	10.83	10.82	10.82	10.72	10.72	10.71			
PROGRESSIVE PROGETTO						-8.08	-6.75	-5.25	-3.75	0.00	3.75	5.25	6.75	8.18
PARZIALI PROGETTO						1.33	1.50	1.50	3.75	3.75	1.50	1.50	1.43	
QUOTE PROGETTO						10.83	11.72	11.66	11.69	11.79	11.69	11.66	11.72	10.77