



Anas SpA

Direzione Centrale Progettazione

SISTEMA TANGENZIALE DI LUCCA

Viabilità Est di Lucca comprendente i collegamenti tra Ponte a Moriano ed i caselli dell'autostrada A11 del Frizzone e di Lucca Est

PROGETTO PRELIMINARE

PROGETTAZIONE: ANAS - DIREZIONE CENTRALE PROGETTAZIONE

IL PROGETTISTA:

Dott. Ing. Antonio VALENTE
Ordine Ing. di Roma n. 20739

GRUPPO DI PROGETTAZIONE ANAS

Ing. Giuseppe Danilo MALGERI – Responsabile di Progetto
Ing. Francesco BEZZI – Impianti
Ing. Pier Giorgio D'ARMINI – Traffico e Benefici/Costi
Ing. Gianfranco FUSANI – Strade
Ing. Gabriele GIOVANNINI – Cartografia
Ing. Alessandro MITA – Idraulica
Ing. Enrico MITTIGA – Geotecnica
Arch. Gianluca BONOLI – Strutture
Arch. Roberto ROGGI – Sicurezza
Geom. Stefano SERANGELI – Geologia
Geom. Emiliano PAIELLA – Computi e Capitolati
Geom. Carmelo ZEMA – Espropri ed Interferenze

IL GEOLOGO

Dott. Geol. Francesca SCIUBBA
Ordine Geol. del Lazio n. 1371

I RESPONSABILI DEL S.I.A.

Dott. Ing. Ginevra BERETTA Dott. Arch. Francesca Romana IETTO
Ordine Ing. di Roma n. 20458 Ordine Arch. di Roma n. 15857

COORDINATORE PER LA SICUREZZA IN FASE DI PROGETTAZIONE

Geom. Fabio QUONDAM

VISTO: IL RESPONSABILE DEL PROCEDIMENTO

Ing. Nicola DINNELLA

RESPONSABILI DI UNITA' INGEGNERIA:

Ing. Fulvio Maria SOCCODATO – Ingegneria Territorio
Ing. Alessandro MICHELI – Ingegneria Geotecnica e Impianti
Ing. Achille DEVITOFRANCESCHI – Ingegneria Opere Civili
Geom. Fabio QUONDAM – Ingegneria Computi, Stime e Capitolati

PROTOCOLLO

DATA

PROGETTO STRADALE

INTERSEZIONE DI ANTRACCOLI

SEZIONI TRASVERSALI ROTATORIA E RAMPE

CODICE PROGETTO

PROGETTO

LIV. PROG.

N. PROG.

L0601A P 1201

NOME FILE

T00_SV01_STD_SZ08_A.DWG

CODICE ELAB.

T00SV01STD SZ08

REVISIONE

A

SCALA:

1:200

C					
B					
A	EMISSIONE	29/11/2012	ING. F. Primieri	Ing. G. Fusani	Ing. F.M. Soccodato
REV.	DESCRIZIONE	DATA	REDATTO	VERIFICATO	APPROVATO

PROFILO ASSE NORD

SEZIONE 1

PROGRESSIVA 0.00

B	STERRO	mq	6.53
C	BINDER	mq	0.84
D	BASE	mq	2.62
E	FONDAZIONE	mq	2.10
SC	SCOTICO	mq	2.71
a	USURA	m	10.50
b	VEGETALE	m	3.82

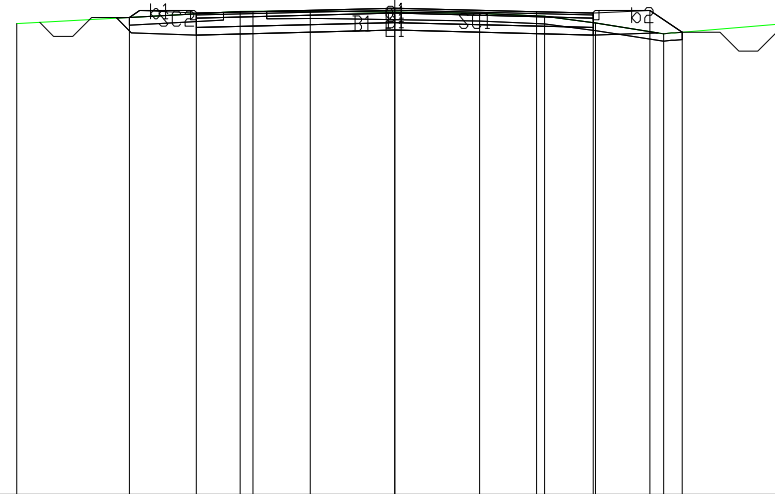

5

200
200

PROGRESSIVE TERRENO		-10.00		-4.09	-2.24		2.24	3.96	5.30	7.11		10.33
PARZIALI TERRENO			5.91	1.85		4.48	1.72	1.34	1.81		3.22	
QUOTE TERRENO		17.45		17.77	17.79		17.72	17.65	17.47	17.19		17.45
PROGRESSIVE PROGETTO			-7.02	-5.25	-3.75		0.00	3.75	5.25	6.75	7.60	
PARZIALI PROGETTO			1.77	1.50		3.75	3.75	1.50	1.50	0.85		
QUOTE PROGETTO			17.62	17.73	17.77		17.86	17.77	17.73	17.80	17.23	

PROFILO ASSE NORD

SEZIONE 2

PROGRESSIVA 50.00

A	RILEVATO	m ^q	0,57
B	STERRO	m ^q	7,18
C	BINDER	m ^q	0,84
D	BASE	m ^q	2,62
E	FONDAZIONE	m ^q	2,10
SC	SCOTICO	m ^q	2,37
a	USURA	m	10,50
b	VEGETALE	m	2,47

200
200

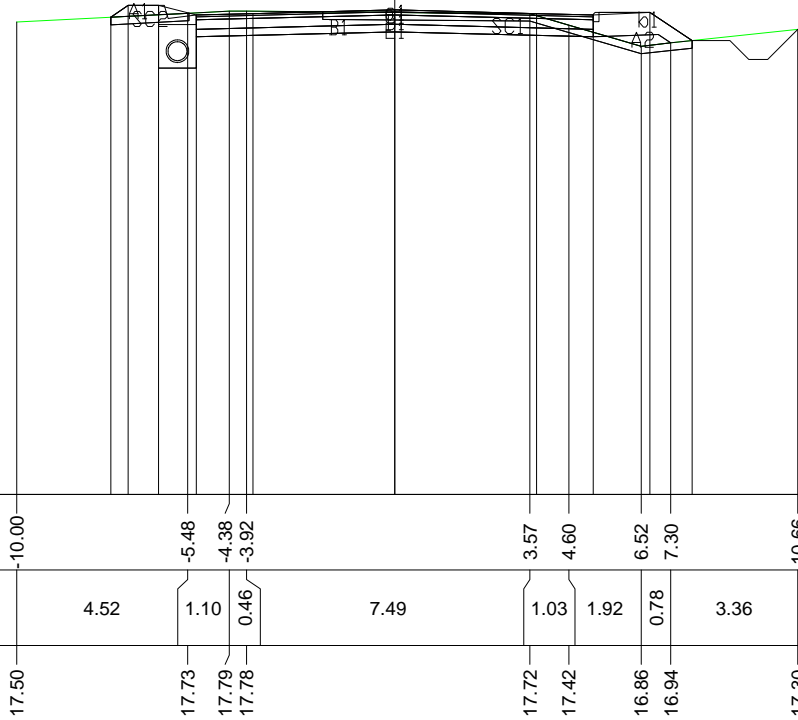

PROGRESSIVE TERRENO	-10.00		-5.48	-4.38	-3.92		3.57	4.60	6.52	7.30	10.66		
PARZIALI TERRENO		4.52	1.10	0.46		7.49	1.03	1.92	0.78	3.36			
QUOTE TERRENO	17.50		17.73	17.79	17.78		17.72	17.42	16.86	16.94	17.30		
PROGRESSIVE PROGETTO			-7.51	-7.05	-6.25	-5.25	-3.75		0.00				
PARZIALI PROGETTO		0.46	0.80	1.00	1.50	3.75	3.75	1.50	1.50	1.12			
QUOTE PROGETTO		17.62	17.93	17.93	17.68	17.72		17.81		17.72	17.68	17.75	17.00

PROFILO ASSE NORD

SEZIONE 3

PROGRESSIVA 100.00

A	RILEVATO	mq	0.30
B	STERRO	mq	6.17
C	BINDER	mq	0.84
D	BASE	mq	2.62
E	FONDAZIONE	mq	2.10
SC	SCOTICO	mq	1.99
a	USURA	m	10.50
b	VEGETALE	m	4.36

5

200
200

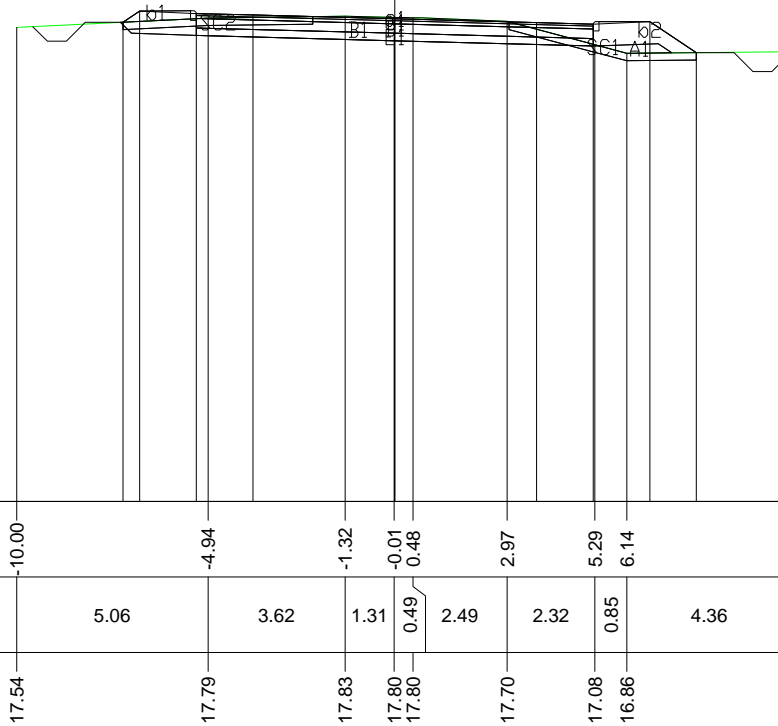

PROGRESSIVE TERRENO		-10.00		-4.94		-1.32		-0.01	0.48		2.97		5.29	6.14		10.50
PARZIALI TERRENO			5.06		3.62		1.31	0.49	2.49		2.32		0.85		4.36	
QUOTE TERRENO		17.54		17.79		17.83		17.80	17.80		17.70		17.08	16.86		16.90
PROGRESSIVE PROGETTO			-7.19	-6.75	-5.25	-3.75		0.00			3.75		5.25	6.75		7.97
PARZIALI PROGETTO			0.44	1.50	1.50		3.75		3.75		1.50		1.50	1.22		
QUOTE PROGETTO		17.68	17.97	17.91	17.87		17.76				17.66		17.62	17.69		16.87

PROFILO ASSE NORD

SEZIONE 4

PROGRESSIVA 150.00

A	RILEVATO	mq	0.44
B	STERRO	mq	7.08
C	BINDER	mq	0.84
D	BASE	mq	2.63
E	FONDAZIONE	mq	2.10
SC	SCOTICO	mq	1.46
a	USURA	m	10.50
b	VEGETALE	m	2.39

5

200
200

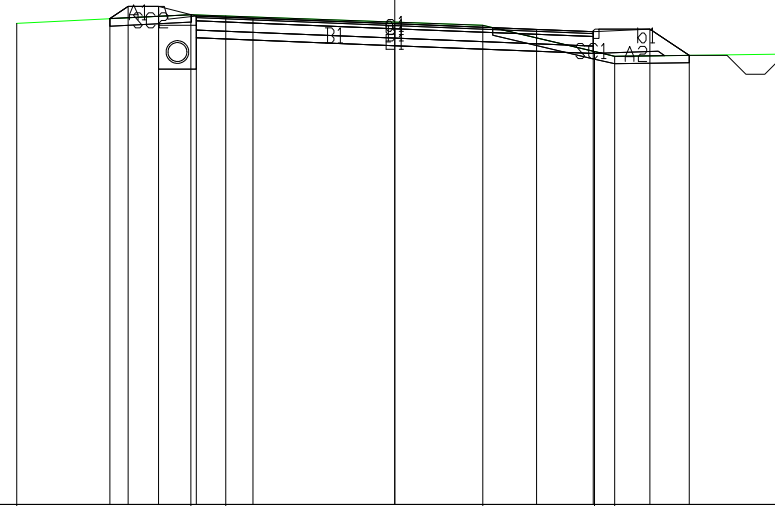

PROGRESSIVE TERRENO		-10.00		-5.39	-4.47		2.33		5.28	5.82		10.32		
PARZIALI TERRENO			4.61	0.92		6.80		2.95	0.54		4.50			
QUOTE TERRENO		17.73		17.96	17.92		17.67		16.98	16.86		16.91		
PROGRESSIVE PROGETTO			-7.54	-7.05	-6.25	-5.25	-3.75		0.00		3.75	5.25	6.75	7.79
PARZIALI PROGETTO			0.49	0.80	1.00	1.50	3.75		3.75	1.50	1.50	1.04		
QUOTE PROGETTO		17.85	18.17	18.17	17.92	17.86		17.72		17.57	17.51	17.57	16.88	

PROFILO ASSE SUD

SEZIONE 1

PROGRESSIVA 0.00

A	RILEVATO	mq	2.21
B	STERRO	mq	8.56
C	BINDER	mq	0.84
D	BASE	mq	2.62
E	FONDAZIONE	mq	2.10
SC	SCOTICO	mq	2.50
a	USURA	m	10.50



200
200

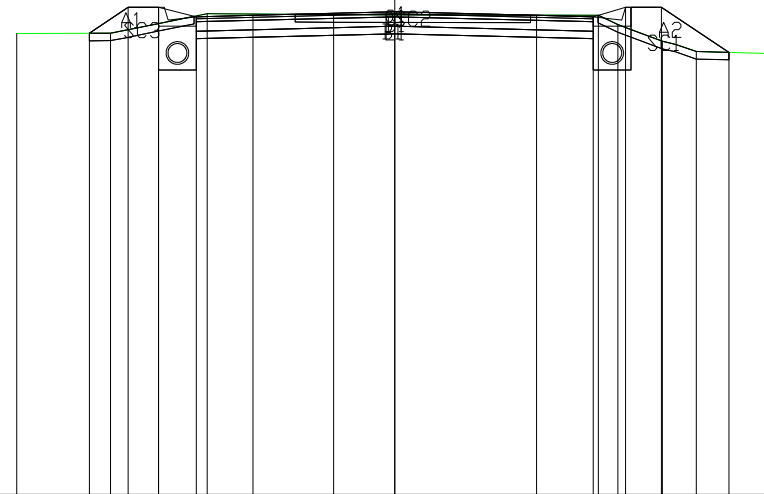

PROGRESSIVE TERRENO		-10.00	-7.52	-6.25	-4.96		-1.62				5.38	5.90	7.08	7.97	10.00
PARZIALI TERRENO			2.48	1.27	1.29		3.34		7.00		0.52	1.18	0.89		2.03
QUOTE TERRENO		16.19	16.20	16.46	16.72		16.69				16.67	16.43	15.99	15.72	15.66
PROGRESSIVE PROGETTO			-8.08	-7.05	-6.25	-5.25	-3.75		0.00		3.75	5.25	6.10	7.05	8.84
PARZIALI PROGETTO			1.03	0.80	1.00	1.50		3.75		3.75	1.50	0.85	0.95	1.79	
QUOTE PROGETTO			16.20	16.88	16.88	16.63	16.67		16.77		16.67	16.63	16.88	16.88	15.69

PROFILO ASSE SUD

SEZIONE 2

PROGRESSIVA 50.00

A	RILEVATO	mq	0.21
B	STERRO	mq	4.39
C	BINDER	mq	0.84
D	BASE	mq	2.64
E	FONDAZIONE	mq	2.10
SC	SCOTICO	mq	3.24
a	USURA	m	10.50
b	VEGETALE	m	5.49

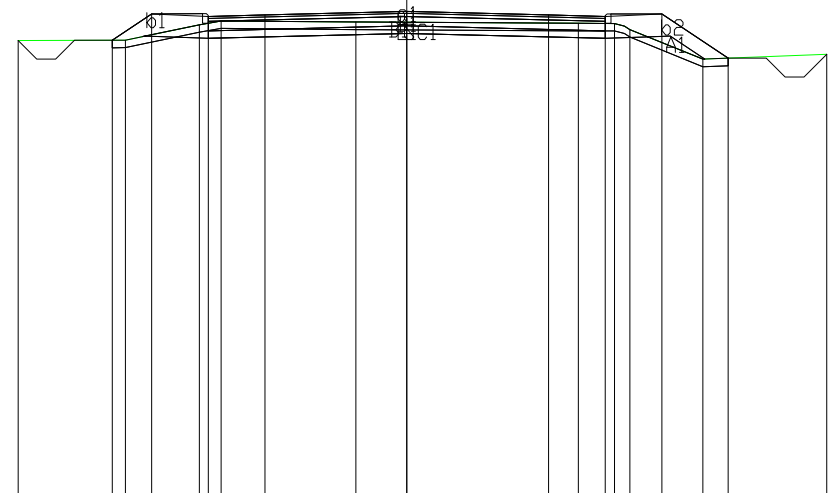

200
200

PROGRESSIVE TERRENO		-10.28	-7.45	-5.49	-4.91		-1.34		4.54	5.49	5.90	7.83		11.11
PARZIALI TERRENO			2.83	1.96	0.58	3.57		5.88	0.95	0.41	1.93		3.28	
QUOTE TERRENO		16.19	16.20	16.61	16.71		16.68		16.65	16.64	16.48	15.70		15.83
PROGRESSIVE PROGETTO			-7.79	-6.75	-5.25	-3.75		0.00	3.75	5.25	6.75	8.50		
PARZIALI PROGETTO			1.04	1.50	1.50	3.75		3.75	1.50	1.50	1.75			
QUOTE PROGETTO			16.20	16.89	16.83	16.87		16.96	16.87	16.83	16.89	15.72		

PROFILO ASSE SUD

SEZIONE 3

PROGRESSIVA 101.06

A	RILEVATO	mq	0.56
B	STERRO	mq	1.78
C	BINDER	mq	0.84
D	BASE	mq	2.62
E	FONDAZIONE	mq	2.10
SC	SCOTICO	mq	3.16
a	USURA	m	10.50
b	VEGETALE	m	5.04

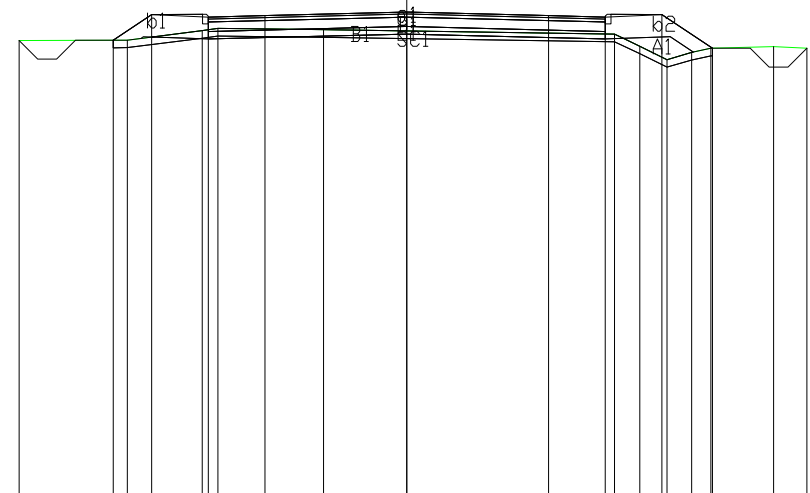

4

200
200

PROGRESSIVE TERRENO		-10.25	-7.39	-5.41	-5.00	-2.20		5.50	6.16	6.89	7.54	8.04	9.70	10.58
PARZIALI TERRENO			2.86	1.98	0.41	2.80	7.70	0.66	0.73	0.65	0.50	1.66	0.88	
QUOTE TERRENO		16.20	16.20	16.45	16.51	16.48		16.36	16.04	15.69	15.88	15.99	16.03	15.99
PROGRESSIVE PROGETTO			-7.76	-6.75	-5.25	-3.75	0.00	3.75	5.25	6.75	8.08			
PARZIALI PROGETTO			1.01	1.50	1.50	3.75	3.75	1.50	1.50	1.33				
QUOTE PROGETTO		16.20	16.88	16.81	16.85	16.94	16.85	16.81	16.88	15.99				

PROFILO CAPPIO OVEST

SEZIONE 2

PROGRESSIVA 50.00

A	RILEVATO	m	0.05
B	STERRO	m	5.21
C	BINDER	m	0.54
D	BASE	m	1.69
E	FONDAZIONE	m	1.34
SC	SCOTICO	m	1.63
a	USURA	m	6.75
b	VEGETALE	m	1.99



200
200

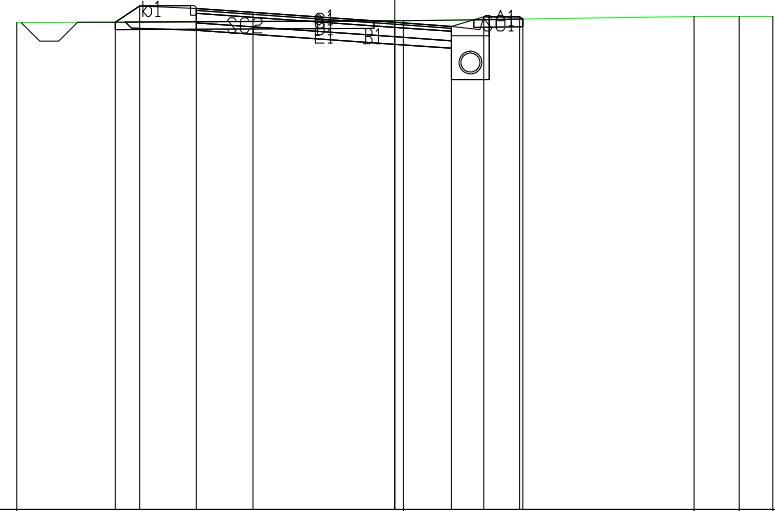

PROGRESSIVE TERRENO		-10.00			0.23			7.92	9.11	10.00
PARZIALI TERRENO			10.23			7.69		1.19	0.89	
QUOTE TERRENO		16.88			16.93			17.04	17.04	17.04
PROGRESSIVE PROGETTO			-7.39	-6.75	-5.25	-3.75	0.00	1.50	2.35	3.30
PARZIALI PROGETTO			0.64	1.50	1.50	3.75	1.50	0.85	0.95	0.09
QUOTE PROGETTO		16.89	17.32	17.25	17.15	16.88	16.78	17.03	17.03	16.97

PROFILO CAPPIO OVEST

SEZIONE 3

PROGRESSIVA 70.44

A	RILEVATO	m	0.21
B	STERRO	m	7.88
C	BINDER	m	0.55
D	BASE	m	1.69
E	FONDAZIONE	m	1.35
SC	SCOTICO	m	0.61
α	USURA	m	6.75

4

200
200

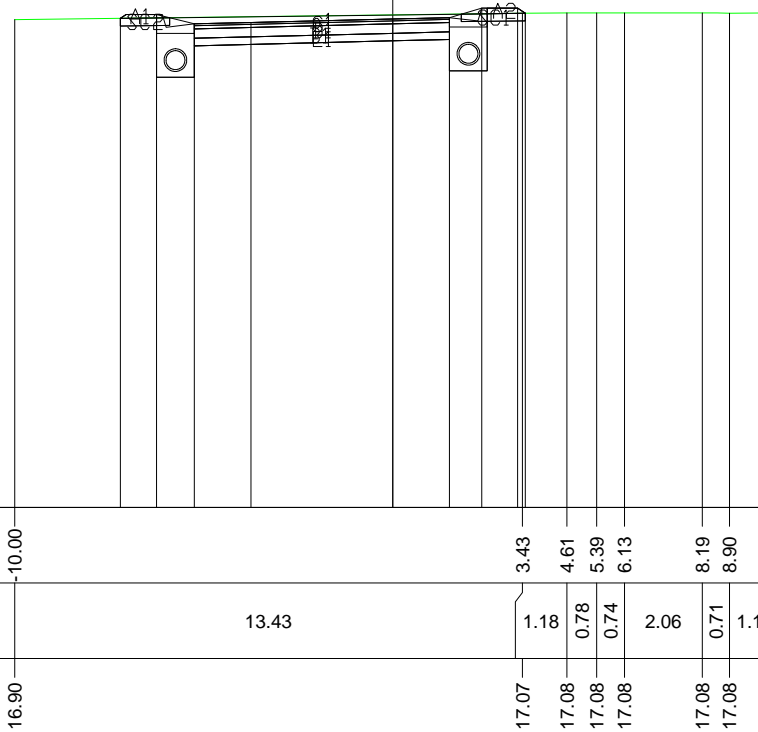

PROGRESSIVE
TERRENO

-10.00
3.43
4.61
5.39
6.13
8.19
8.90
10.00

PARZIALI
TERRENO

13.43
1.18
0.78
0.74
2.06
0.71
1.10

QUOTE
TERRENO

16.90
17.07
17.08
17.08
17.08
17.08
17.08
17.08

PROGRESSIVE
PROGETTO

-7.20
-6.25
-5.25
-3.75
0.00
1.50
2.35
3.30
3.51

PARZIALI
PROGETTO

0.95
1.00
1.50
3.75
1.50
0.85
0.95
0.21

QUOTE
PROGETTO

16.94
17.04
16.79
16.83
16.92
16.96
17.21
17.21
17.07

PROFILO DIRETTA OVEST

SEZIONE 1

PROGRESSIVA 0.00

A	RILEVATO	mq	0.26
B	STERRO	mq	7.93
C	BINDER	mq	0.54
D	BASE	mq	1.68
E	FONDAZIONE	mq	1.36
SC	SCOTICO	mq	0.43
α	USURA	m	6.75



200
200

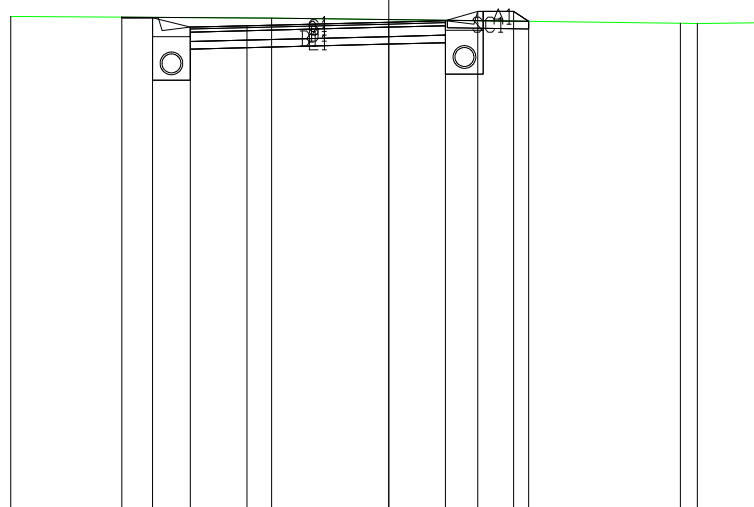

PROGRESSIVE TERRENO	-10.00	-3.10	7.71	8.16	10.00				
PARZIALI TERRENO	6.90	10.81	0.45	1.84					
QUOTE TERRENO	17.04	17.00	16.86	16.85	16.88				
PROGRESSIVE PROGETTO	-7.07	-6.25	-5.25	-3.75	0.00	1.50	2.35	3.30	3.70
PARZIALI PROGETTO	0.82	1.00	1.50	3.75	1.50	0.85	0.95	0.40	
QUOTE PROGETTO	17.02	17.01	16.76	16.79	16.89	16.93	17.18	17.18	16.91

PROFILO DIRETTA OVEST

SEZIONE 2

PROGRESSIVA 50.00

A	RILEVATO	mq	0.18
B	STERRO	mq	4.86
C	BINDER	mq	0.53
D	BASE	mq	1.70
E	FONDAZIONE	mq	1.35
SC	SCOTICO	mq	1.94
a	USURA	m	6.75
b	VEGETALE	m	1.89



200
200

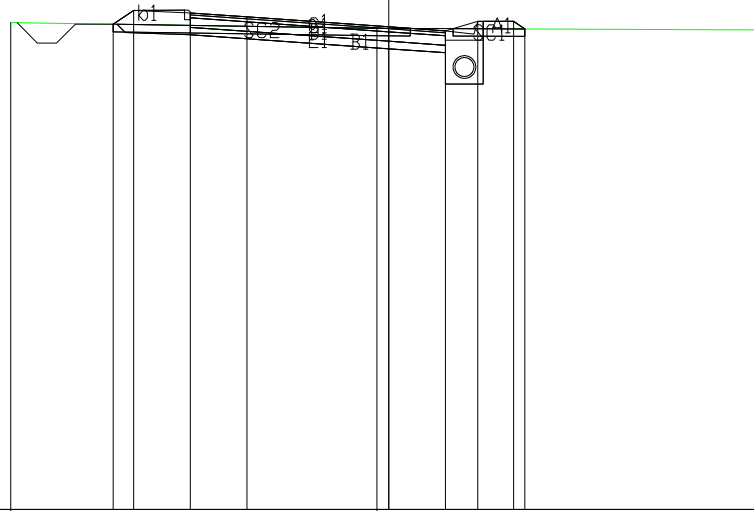

PROGRESSIVE TERRENO		-10.00		-0.31		10.00					
PARZIALI TERRENO			9.69		10.31						
QUOTE TERRENO		16.88		16.73		16.68					
PROGRESSIVE PROGETTO			-7.29	-6.75	-5.25	-3.75	0.00	1.50	2.35	3.30	3.60
PARZIALI PROGETTO			0.54	1.50	1.50	3.75	1.50	0.85	0.95	0.30	
QUOTE PROGETTO		16.83	17.20	17.13	17.03	16.77	16.66	16.91	16.91	16.71	

PROFILO DIRETTA OVEST

SEZIONE 3

PROGRESSIVA 96.14

A	RILEVATO	mq	10.23
B	STERRO	mq	0.07
C	BINDER	mq	0.54
D	BASE	mq	1.70
E	FONDAZIONE	mq	1.35
SC	SCOTICO	mq	2.45
a	USURA	m	6.75
b	VEGETALE	m	5.10

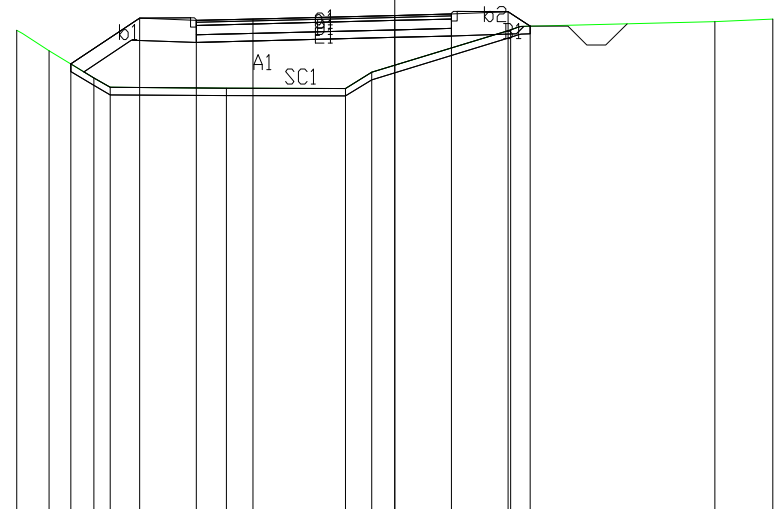

3

200
200

PROGRESSIVE TERRENO		-10.00	-9.14	-7.96	-7.53		-4.45		-1.30	-0.61		3.06		8.47	10.00
PARZIALI TERRENO		0.86	1.18	0.43		3.08		3.15	0.69		3.67		5.41	1.53	
QUOTE TERRENO		15.89	15.35	14.63	14.38		14.36		14.35	14.78		15.90		16.11	16.18
PROGRESSIVE PROGETTO			-8.57		-6.75		-5.25		-3.75		0.00	1.50		3.00	3.58
PARZIALI PROGETTO				1.82	1.50	1.50		3.75		1.50	1.50	0.58			
QUOTE PROGETTO			15.00		16.21		16.15		16.18		16.28	16.32		16.38	15.99

PROFILO IMMISIONE IN ASSE NORD

SEZIONE 1

PROGRESSIVA 0.00

B	STERRO	mq	7.23
C	BINDER	m ²	0.54
D	BASE	m ²	1.69
E	FONDAZIONE	m ²	1.35
SC	SCOTICO	m ²	0.54
a	USURA	m	6.75
b	VEGETALE	m	1.56

4

200
200

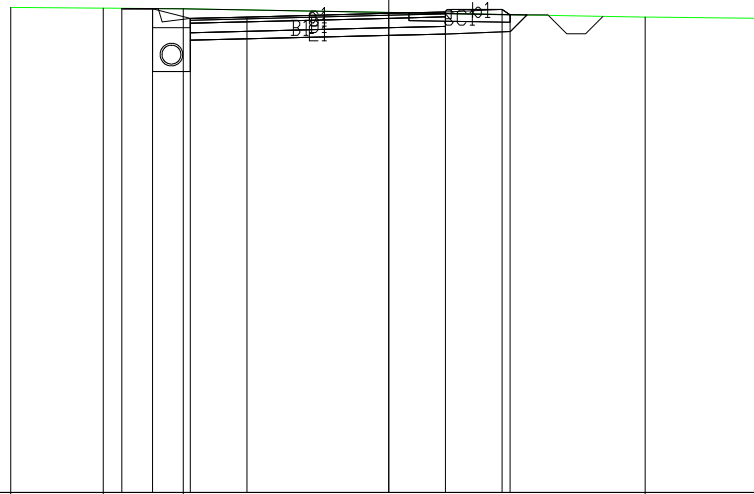

PROGRESSIVE TERRENO		-10.00	-7.56	-5.44		6.78	10.00			
PARZIALI TERRENO		2.44	2.12		12.22	3.22				
QUOTE TERRENO		16.83	16.81	16.79		16.57	16.54			
PROGRESSIVE PROGETTO			-7.06	-6.25	-5.25	-3.75	0.00	1.50	3.00	3.21
PARZIALI PROGETTO			0.81	1.00	1.50	3.75	1.50	1.50	0.21	
QUOTE PROGETTO			16.80	16.79	16.54	16.58	16.67	16.71	16.77	16.64

PROFILO IMMISIONE IN ASSE NORD

SEZIONE 2

PROGRESSIVA 50.00

A	RILEVATO	mq	0.14
B	STERRO	m ²	6.30
C	BINDER	m ²	0.54
D	BASE	m ²	1.69
E	FONDAZIONE	m ²	1.35
SC	SCOTICO	m ²	1.40
a	USURA	m	6.75
b	VEGETALE	m	1.61



200
200

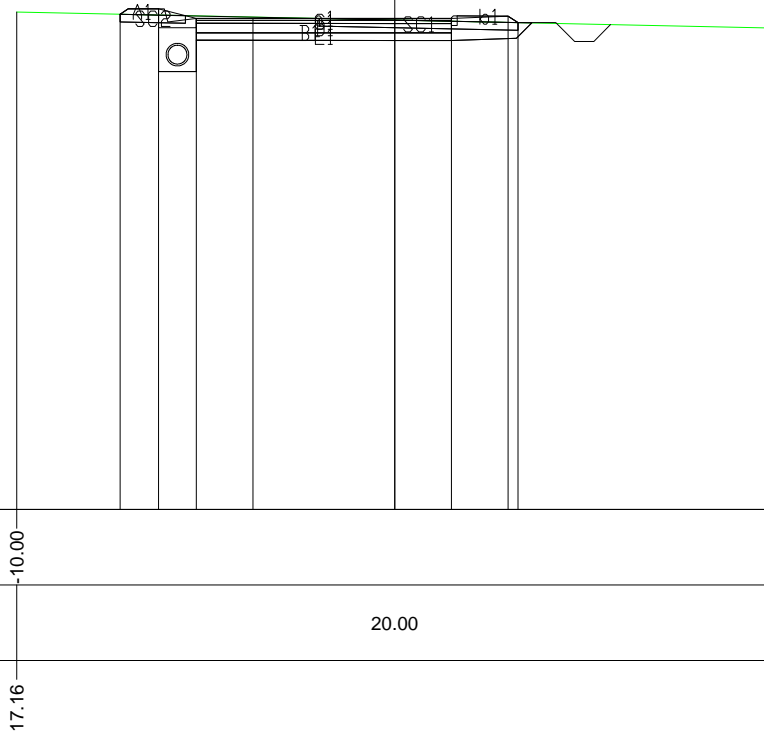

PROGRESSIVE TERRENO	-10.00	10.00
PARZIALI TERRENO	20.00	
QUOTE TERRENO	17.16	16.73
PROGRESSIVE PROGETTO	-7.26 -6.25 -5.25 -3.75	0.00 1.50 3.00 3.26
PARZIALI PROGETTO	1.01 1.00 1.50	3.75 1.50 1.50 0.26
QUOTE PROGETTO	17.10 17.24 16.99 16.99	16.98 16.98 17.05 16.87

PROFILO IMMISIONE IN ASSE NORD

SEZIONE 3

PROGRESSIVA 100.00

A	RILEVATO	mq	0.14
B	STERRO	mq	5.95
C	BINDER	mq	0.54
D	BASE	mq	1.68
E	FONDAZIONE	mq	1.35
SC	SCOTICO	mq	1.49
a	USURA	m	6.75
b	VEGETALE	m	1.64

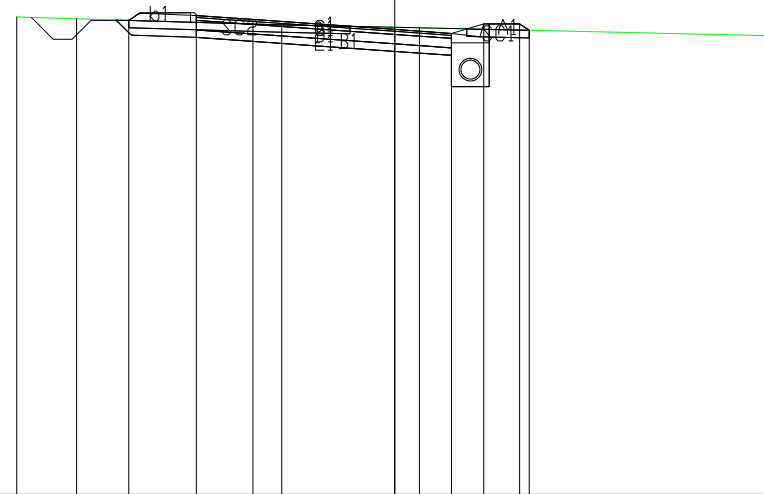

200
200

PROGRESSIVE TERRENO	-10.00	-8.41		-2.99	0.65		10.00		
PARZIALI TERRENO		1.59	5.42		3.64		9.35		
QUOTE TERRENO	17.63	17.58		17.42	17.34		17.13		
PROGRESSIVE PROGETTO		-7.04	-5.25	-3.75	0.00	1.50	2.35	3.30	3.55
PARZIALI PROGETTO			1.79	1.50	3.75	1.50	0.85	0.95	0.25
QUOTE PROGETTO		17.54	17.67	17.56	17.30	17.19	17.44	17.44	17.28

PROFILO IMMISIONE IN ASSE NORD

SEZIONE 4

PROGRESSIVA 131.10

A	RILEVATO	m	0.32
B	STERRO	m	7.92
C	BINDER	m	0.54
D	BASE	m	1.68
E	FONDAZIONE	m	1.35
SC	SCOTICO	m	0.66
α	USURA	m	6.75

5

200
200

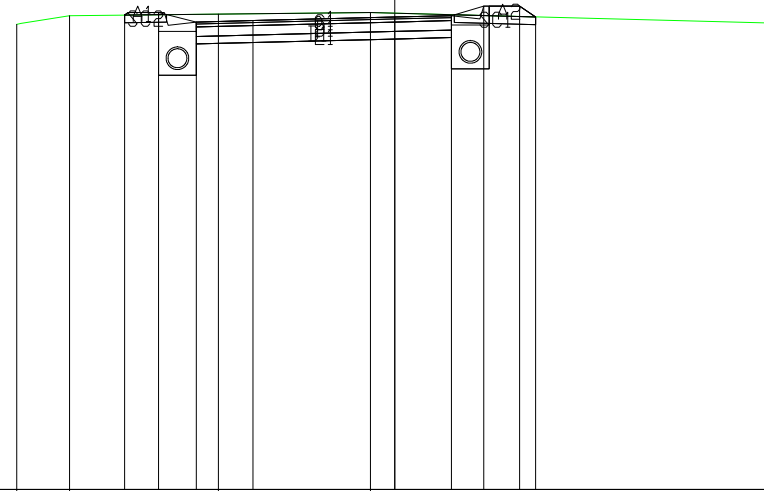

PROGRESSIVE TERRENO	-10.00	-8.61	-4.67	-0.64	10.00					
PARZIALI TERRENO	1.39	3.94	4.03	10.64						
QUOTE TERRENO	17.31	17.53	17.58	17.61	17.33					
PROGRESSIVE PROGETTO		-7.15	-6.25	-5.25	-3.75	0.00	1.50	2.35	3.30	3.73
PARZIALI PROGETTO		0.90	1.00	1.50	3.75	1.50	0.85	0.95	0.43	
QUOTE PROGETTO		17.55	17.61	17.36	17.40	17.49	17.53	17.78	17.78	17.50

PROFILO IMMISSIONE ASSE SUD

SEZIONE 1

PROGRESSIVA 0.00

A	RILEVATO	mq	0.11
B	STERRO	mq	6.78
C	BINDER	mq	0.54
D	BASE	mq	1.70
E	FONDAZIONE	mq	1.35
SC	SCOTICO	mq	0.91
a	USURA	m	6.75
b	VEGETALE	m	1.50

3

200
200

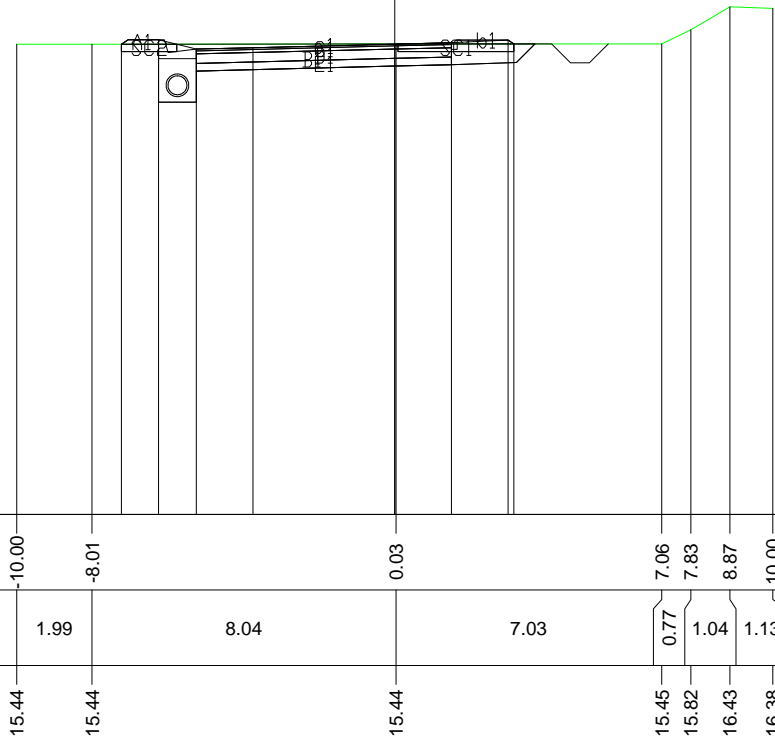

PROGRESSIVE TERRENO	-10.00	-8.01			0.03			7.06	7.83	8.87	10.00
PARZIALI TERRENO		1.99		8.04		7.03		0.77	1.04	1.13	
QUOTE TERRENO	15.44	15.44			15.44			15.45	15.82	16.43	16.38
PROGRESSIVE PROGETTO			-7.23	-6.25	-5.25	-3.75	0.00	1.50	3.00	3.15	
PARZIALI PROGETTO		0.98	1.00	1.50	3.75	1.50	1.50	0.15			
QUOTE PROGETTO		15.44	15.56	15.31	15.35		15.44	15.48	15.54	15.44	

PROFILO IMMISSIONE ASSE SUD

SEZIONE 2

PROGRESSIVA 50.00

B	STERRO	mq	3.53
C	BINDER	mq	0.53
D	BASE	mq	1.70
E	FONDAZIONE	mq	1.35
SC	SCOTICO	mq	2.13
a	USURA	m	6.75
b	VEGETALE	m	3.55

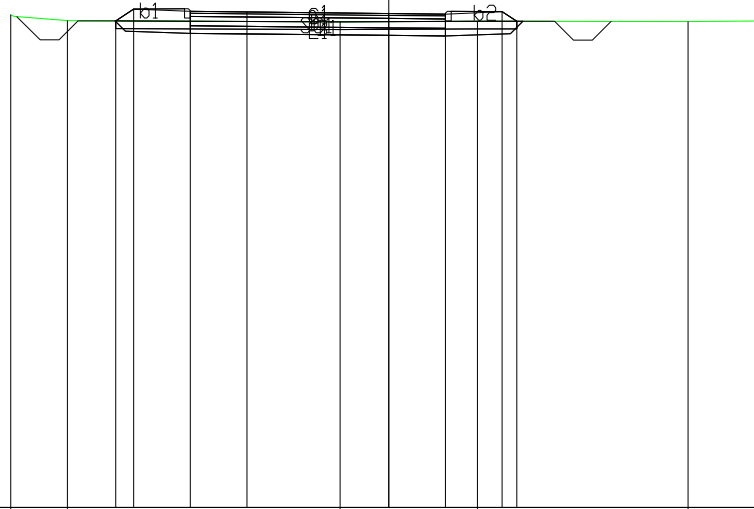

3

200
200

PROGRESSIVE TERRENO	-10.00	-8.50			-1.28	2.35		7.91	10.00	
PARZIALI TERRENO		1.50		7.22		3.63		5.56	2.09	
QUOTE TERRENO	16.03	15.88			15.84	15.86		15.85	15.87	
PROGRESSIVE PROGETTO			-7.22	-6.75	-5.25	-3.75	0.00	1.50	3.00	3.38
PARZIALI PROGETTO		0.47	1.50	1.50	3.75	1.50	1.50	0.38		
QUOTE PROGETTO		15.87	16.19	16.12	16.11	16.07	16.05	16.12	15.86	

PROFILO IMMISSIONE ASSE SUD

SEZIONE 3

PROGRESSIVA 98.01

A	RILEVATO	mq	0.13
B	STERRO	mq	6.19
C	BINDER	mq	0.54
D	BASE	mq	1.69
E	FONDAZIONE	mq	1.35
SC	SCOTICO	mq	1.19
a	USURA	m	6.75
b	VEGETALE	m	2.96



200
200

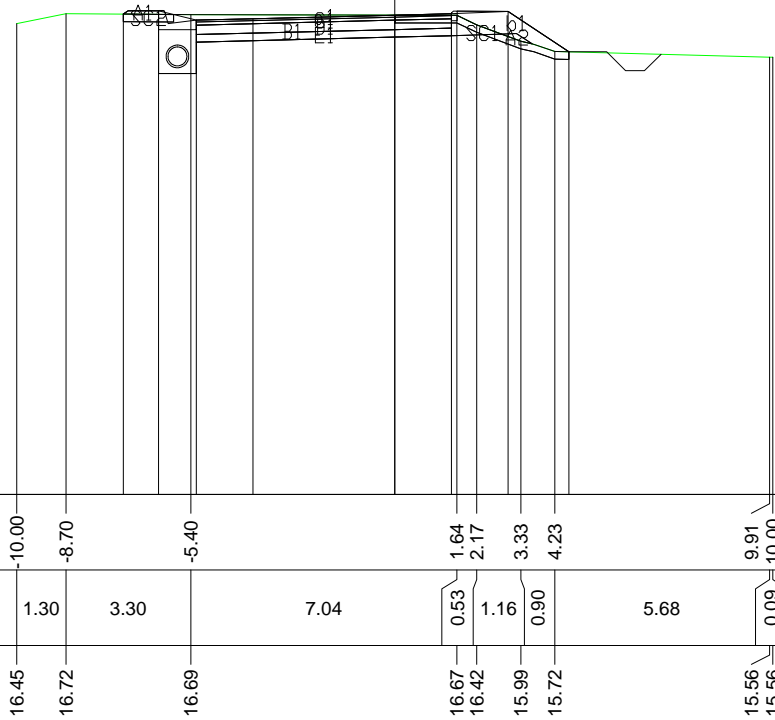

PROGRESSIVE TERRENO		-10.00	-8.70	-5.40		1.64	2.17	3.33	4.23		9.91	10.00
PARZIALI TERRENO		1.30	3.30		7.04	0.53	1.16	0.90		5.68	0.09	
QUOTE TERRENO		16.45	16.72	16.69		16.67	16.42	15.99	15.72		15.56	15.56
PROGRESSIVE PROGETTO			-7.18	-6.25	-5.25	-3.75		0.00	1.50	3.00	4.61	
PARZIALI PROGETTO			0.93	1.00	1.50	3.75		1.50	1.50	1.61		
QUOTE PROGETTO			16.71	16.79	16.54	16.58		16.68	16.71	16.78	15.71	

PROFILO INNESTO EST ROT.

SEZIONE 1

PROGRESSIVA 0.00

200
200



PROGRESSIVE
TERRENO

-10.00 -8.57 -8.12 -3.55 -2.87 -0.60 10.00

PARZIALI
TERRENO

1.43 0.45 4.57 0.68 2.27 10.60

QUOTE
TERRENO

16.99 17.00 17.01 17.07 17.07 17.03 16.80

PROGRESSIVE
PROGETTO

PARZIALI
PROGETTO

QUOTE
PROGETTO

PROFILO INNESTO EST ROT.

SEZIONE 2

PROGRESSIVA 25.00

B	STERRO	mq	3.74
C	BINDER	mq	0.84
D	BASE	mq	2.62
E	FONDAZIONE	mq	2.10
SC	SCOTICO	mq	2.92
a	USURA	m	10.50
b	VEGETALE	m	3.72

4

200
200

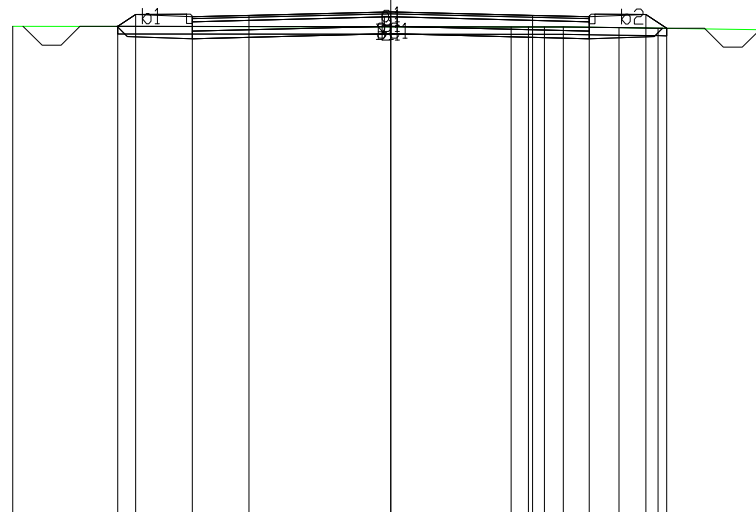

PROGRESSIVE
TERRENO

-10.00 3.18 3.64 4.06 4.56 6.04 7.07 10.00

PARZIALI
TERRENO

13.18 0.46 0.42 0.50 1.48 1.03 2.93

QUOTE
TERRENO

16.91 16.90 16.90 16.90 16.88 16.86 16.82

PROGRESSIVE
PROGETTO

-7.22 -6.75 -5.25 -3.75 0.00 3.75 5.25 6.75 7.30

PARZIALI
PROGETTO

0.47 1.50 1.50 3.75 3.75 1.50 1.50 0.55

QUOTE
PROGETTO

16.91 17.23 17.16 17.20 17.29 17.20 17.16 17.23 16.86

PROFILO INNESTO EST ROT.

SEZIONE 2

PROGRESSIVA 25.00

B	STERRO	mq	3.74
C	BINDER	mq	0.84
D	BASE	mq	2.62
E	FONDAZIONE	mq	2.10
SC	SCOTICO	mq	2.92
a	USURA	m	10.50
b	VEGETALE	m	3.72

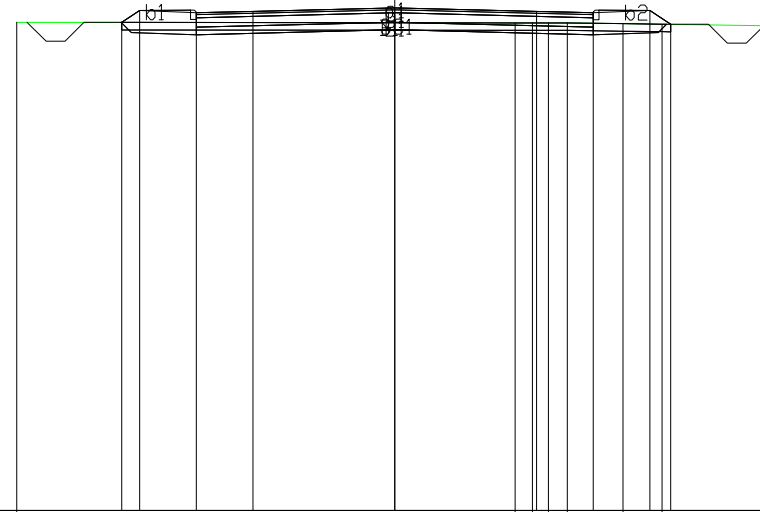

200
200

PROGRESSIVE TERRENO		-10.00							3.18	3.64	4.06	4.56	6.04	7.07	10.00
PARZIALI TERRENO			13.18						0.46	0.42	0.50	1.48	1.03	2.93	
QUOTE TERRENO		16.91							16.90	16.90	16.90	16.90	16.88	16.86	16.82
PROGRESSIVE PROGETTO			-7.22	-6.75	-5.25	-3.75	0.00			3.75	5.25	6.75	7.30		
PARZIALI PROGETTO			0.47	1.50	1.50	3.75		3.75		1.50	1.50	0.55			
QUOTE PROGETTO		16.91	17.23	17.16	17.20		17.29		17.20	17.16		17.23	16.86		

PROFILO INNESTO EST ROT.

SEZIONE 3

PROGRESSIVA 56.55

A	RILEVATO	mq	0.22
B	STERRO	mq	9.85
C	BINDER	mq	0.84
D	BASE	mq	2.62
E	FONDAZIONE	mq	2.10
SC	SCOTICO	mq	0.59
α	USURA	m	10.50

4
▼

200
200

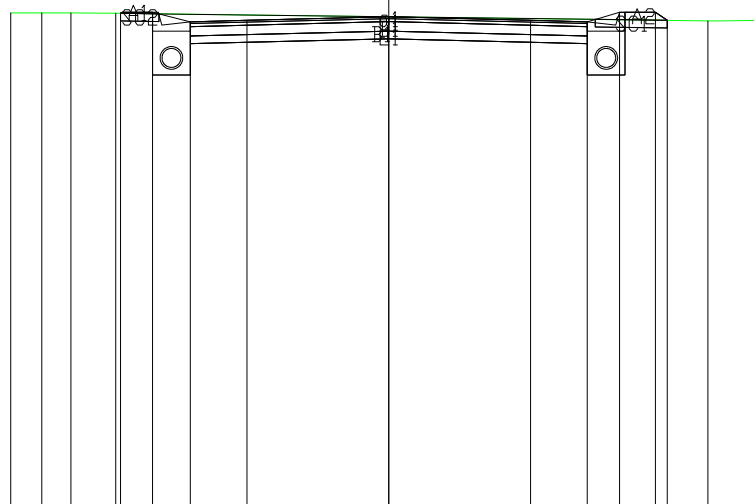

PROGRESSIVE
TERRENO

-10.00 -9.18 -8.41 -7.22 8.44 10.00

PARZIALI
TERRENO

0.82 0.77 1.19 15.66 1.56

QUOTE
TERRENO

17.08 17.07 16.87 16.89

PROGRESSIVE
PROGETTO

-7.10 -6.25 -5.25 -3.75 0.00 3.75 5.25 6.10 7.05 7.37

PARZIALI
PROGETTO

0.85 1.00 1.50 3.75 3.75 1.50 0.85 0.95 0.32

QUOTE
PROGETTO

17.07 17.10 16.85 16.89 16.98 16.89 16.85 17.10 17.10 16.89

PROFILO NUOVO ASSE MADONNINA

SEZIONE 1

PROGRESSIVA 0.00

A	RILEVATO	mq	11.25
C	BINDER	mq	0.84
D	BASE	mq	2.62
E	FONDAZIONE	mq	2.10
SC	SCOTICO	mq	3.48
a	USURA	m	10.50
b	VEGETALE	m	6.66

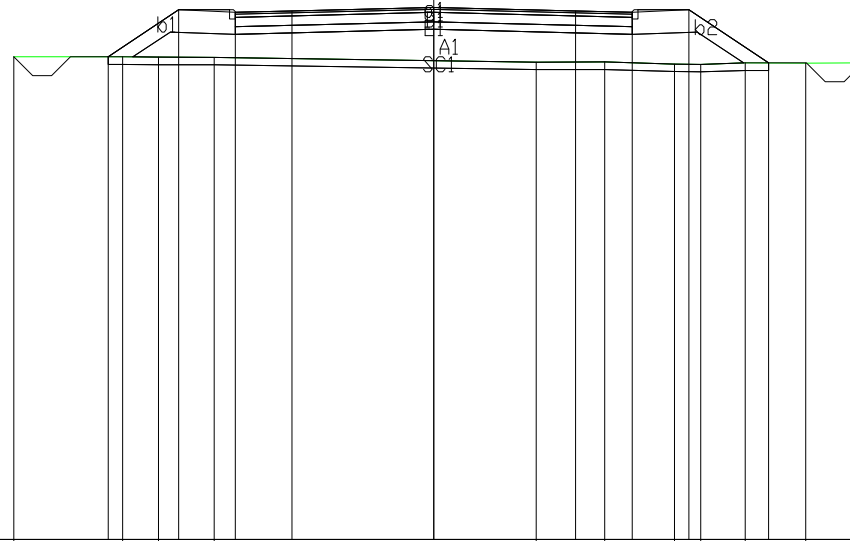

200 200

PROGRESSIVE TERRENO		-11.11	-8.23	-7.28	-5.81		2.70	4.52	6.37	7.06	8.24	9.84	11.35
PARZIALI TERRENO		2.88	0.95	1.47		8.51	1.82	1.85	0.69	1.18	1.60	1.51	
QUOTE TERRENO		16.77	16.77	16.76	16.75		16.63	16.63	16.58	16.57	16.61	16.60	16.61
PROGRESSIVE PROGETTO			-8.61	-6.75	-5.25	-3.75	0.00	3.75	5.25	6.75	8.85		
PARZIALI PROGETTO			1.86	1.50	1.50	3.75	3.75	1.50	1.50	2.10			
QUOTE PROGETTO			16.77	18.01	17.94	17.98	18.07	17.98	17.94	18.01	16.61		

PROFILO NUOVO ASSE MADONNINA

SEZIONE 2

PROGRESSIVA 56.55

A	RILEVATO	mq	0,37
B	STERRO	mq	2,99
C	BINDER	mq	0,84
D	BASE	mq	2,62
E	FONDAZIONE	mq	2,10
SC	SCOTICO	mq	3,03
a	USURA	m	10,50
b	VEGETALE	m	4,35

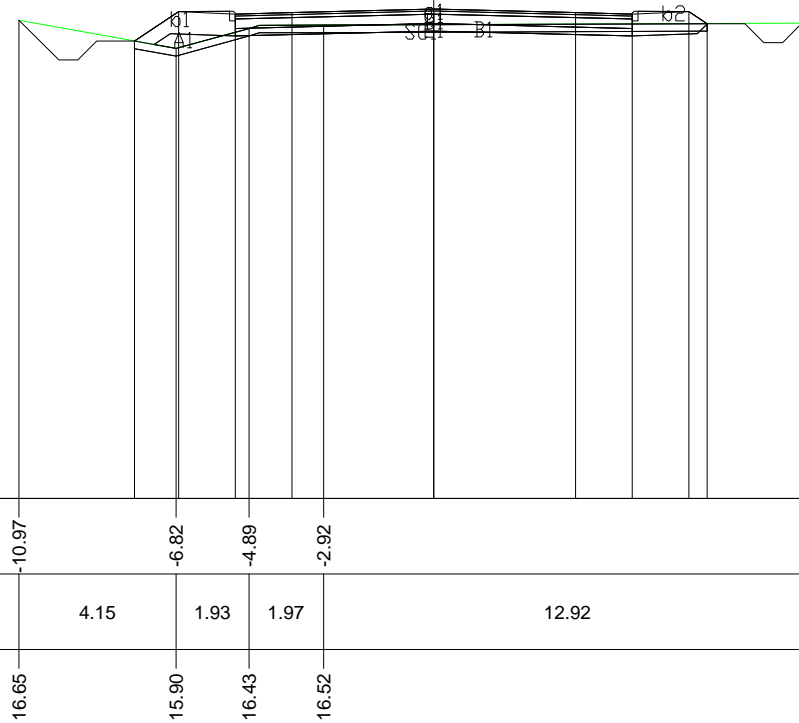

200
200

PROGRESSIVE TERRENO		-10.97	-6.82	-4.89	-2.92					10.00	
PARZIALI TERRENO			4.15	1.93	1.97		12.92				
QUOTE TERRENO		16.65	15.90	16.43	16.52					16.57	
PROGRESSIVE PROGETTO			-7.92	-6.75	-5.25	-3.75	0.00	3.75	5.25	6.75	7.23
PARZIALI PROGETTO			1.17	1.50	1.50	3.75	3.75	1.50	1.50	0.48	
QUOTE PROGETTO			16.10	16.88	16.81	16.85	16.94	16.85	16.81	16.88	16.56

PROFILO NUOVO ASSE ROMANA

SEZIONE 1

PROGRESSIVA 0.00

A	RILEVATO	m	0.66
B	STERRO	m	9.76
C	BINDER	m	0.84
D	BASE	m	2.62
E	FONDAZIONE	m	2.10
SC	SCOTICO	m	0.55
a	USURA	m	10.50



200
200

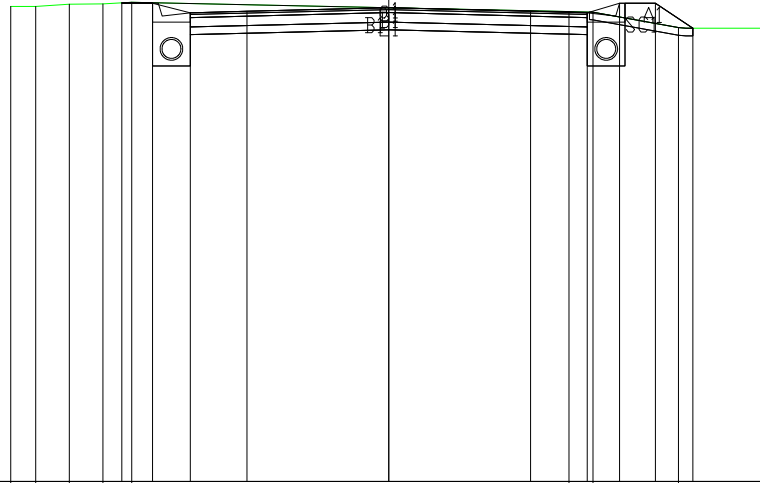

PROGRESSIVE TERRENO	-10.00	-9.34	-8.45	-7.56	-6.80							4.77	5.40		7.66	10.00
PARZIALI TERRENO	0.66	0.89	0.89	0.76			11.57					0.63	2.26		2.34	
QUOTE TERRENO	16.56	16.56	16.62	16.63	16.67							16.43	16.41		16.00	15.99
PROGRESSIVE PROGETTO				-7.06	-6.25	-5.25	-3.75		0.00			3.75	5.25	6.10	7.05	8.04
PARZIALI PROGETTO				0.81	1.00	1.50	3.75		3.75			1.50	0.85	0.95	0.99	
QUOTE PROGETTO				16.66	16.65	16.40	16.44		16.53			16.44	16.40	16.65	16.65	15.99

PROFILO NUOVO ASSE ROMANA

SEZIONE 2

PROGRESSIVA 50.00

A	RILEVATO	m	0.05
B	STERRO	m	6.52
C	BINDER	m	0.86
D	BASE	m	2.72
E	FONDAZIONE	m	2.17
SC	SCOTICO	m	2.11
a	USURA	m	10.83
b	VEGETALE	m	4.55

3

200
200

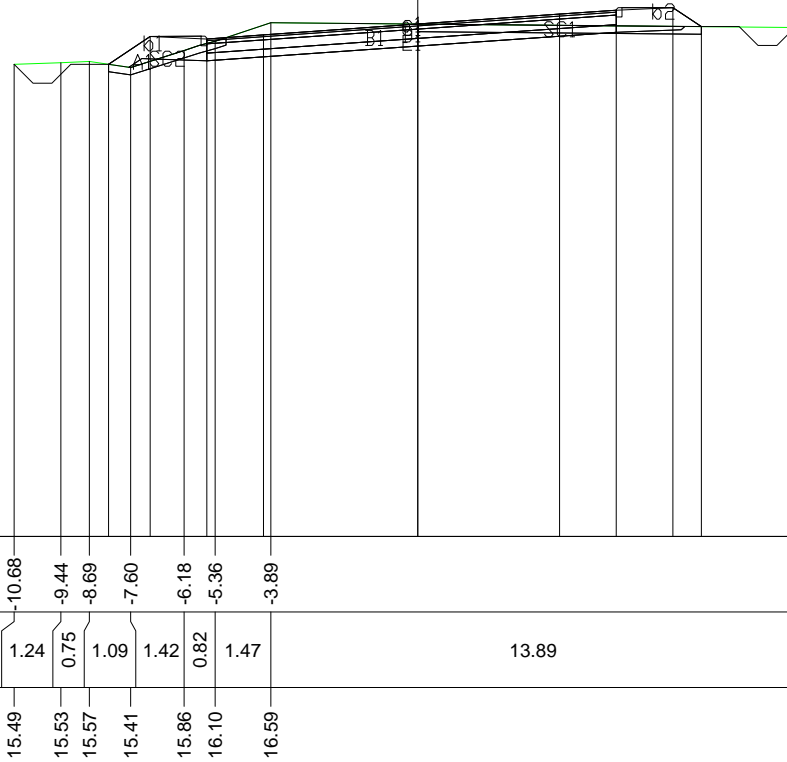

PROGRESSIVE
TERRENO

PARZIALI
TERRENO

QUOTE
TERRENO

PROGRESSIVE
PROGETTO

PARZIALI
PROGETTO

QUOTE
PROGETTO

10.68	9.44	8.69	7.60	6.18	5.36	3.89								10.00
1.24	0.75	1.09	1.42	0.82	1.47		13.89							
15.49	15.53	15.57	15.41	15.86	16.10	16.59								16.46
			-8.18	-7.08	-5.58	-4.08	0.00		3.75	5.25	6.75	7.50		
			1.10	1.50	1.50		4.08		3.75	1.50	1.50	0.75		
			15.49	16.23	16.16	16.27		16.55		16.81	16.92	16.98	16.48	

PROFILO NUOVO A. ROMANA OVEST

SEZIONE 3

PROGRESSIVA 100.00

B	STERRO	mq	6.86
C	BINDER	mq	0.85
D	BASE	mq	2.62
E	FONDAZIONE	mq	2.10
SC	SCOTICO	mq	2.27
α	USURA	m	10.50
b	VEGETALE	m	1.77



200
200

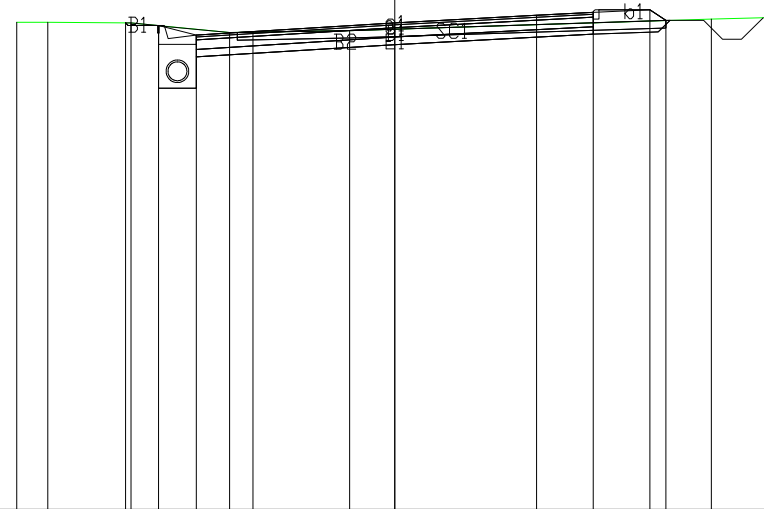

PROGRESSIVE TERRENO			-10.00	-9.18	-6.98	-4.37	-1.20			8.38	10.00		
PARZIALI TERRENO			0.82	2.20	2.61	3.17		9.58		1.62			
QUOTE TERRENO			16.89	16.89	16.87	16.61	16.67			16.97	17.01		
PROGRESSIVE PROGETTO					-7.12	-6.25	-5.25	-3.75	0.00	3.75	5.25	6.75	7.17
PARZIALI PROGETTO					0.87	1.00	1.50	3.75	3.75	1.50	1.50	0.42	
QUOTE PROGETTO					16.87	16.80	16.55	16.64	16.87	17.07	17.15	17.22	16.93

PROFILO ROTATORIA ANTRACCOLI

SEZIONE 1

PROGRESSIVA 0.00

A	RILEVATO	mq	22.92
C	BINDER	mq	0.67
D	BASE	mq	1.14
E	FONDAZIONE	mq	2.47
SC	SCOTICID	mq	5.79
a	USURA	m	9.50
b	VEGETALE	m	19.32

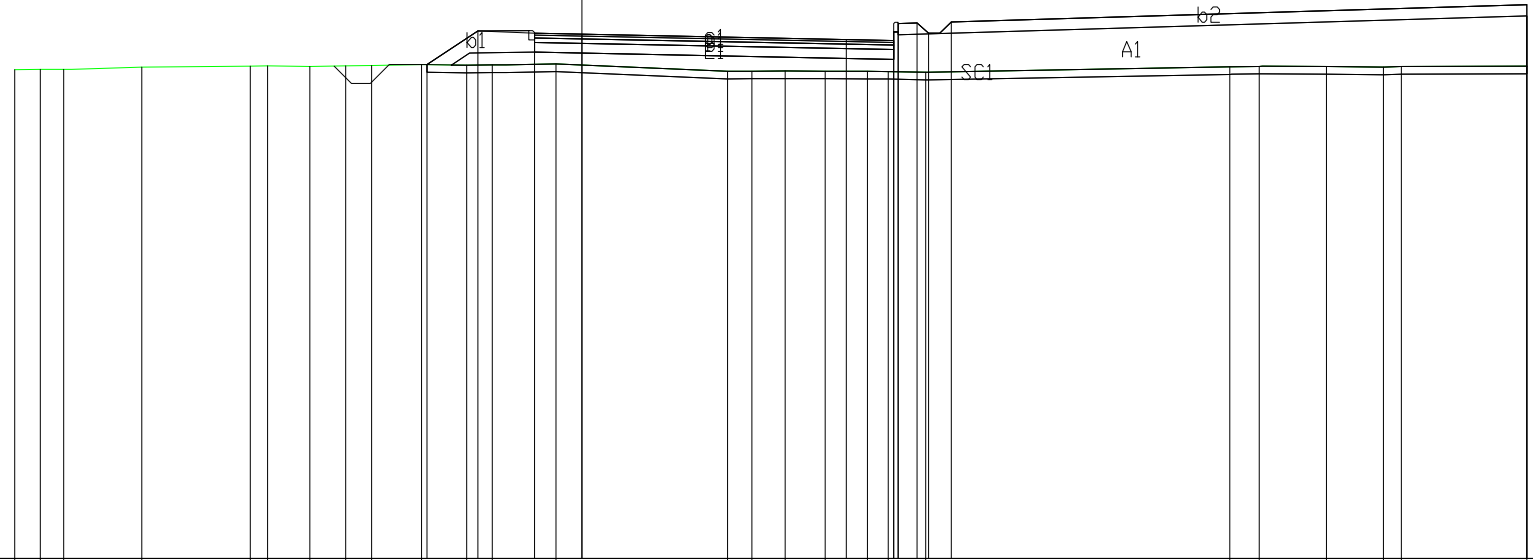

200
200

PROGRESSIVE TERRENO	15.00	14.32	13.71	11.64	8.77	8.31	7.19	6.25	5.56	4.24	3.04	2.37	0.68	3.85	4.50	5.38	6.44	7.56	8.10	9.10	17.14	17.92	19.70	21.20	21.68	25.00	
PARZIALI TERRENO	0.68	0.61	2.07	2.87	0.46	1.12	0.94	0.69	1.32	1.20	0.67	1.69	4.53	0.65	0.88	1.06	1.12	0.54	1.00	8.04	0.78	1.78	1.50	0.48	3.32		
QUOTE TERRENO	16.93	16.93	16.94	16.99	17.03	17.03	17.01	17.03	17.04	17.06	17.04	17.06	17.08	16.88	16.89	16.89	16.89	16.88	16.88	16.86	17.01	17.02	17.01	17.00	17.01	17.02	
PROGRESSIVE PROGETTO										-4.09	-2.75	-1.25	0.00	7.00	1.25	0.12	0.50	0.87	9.17	9.77	25.00	25.00					
PARZIALI PROGETTO										1.34	1.50	1.25	7.00	1.25	0.12	0.50	0.30	0.60	15.23								
QUOTE PROGETTO										17.06	17.96	17.89	17.87	17.73	17.70	17.93	18.15	17.93	18.17	17.89	18.19	18.65	17.02				

PROFILO ROTATORIA ANTRACCOLI

SEZIONE 2

PROGRESSIVA 37.00

A	RILEVATO	mq	6.59
B	STERRO	mq	2.11
C	BINDER	mq	0.66
D	BASE	mq	1.14
E	FONDAZIONE	mq	2.47
SC	SCOTICO	m ³	5.71
a	USURA	m	9.50
b	VEGETALE	m	18.66

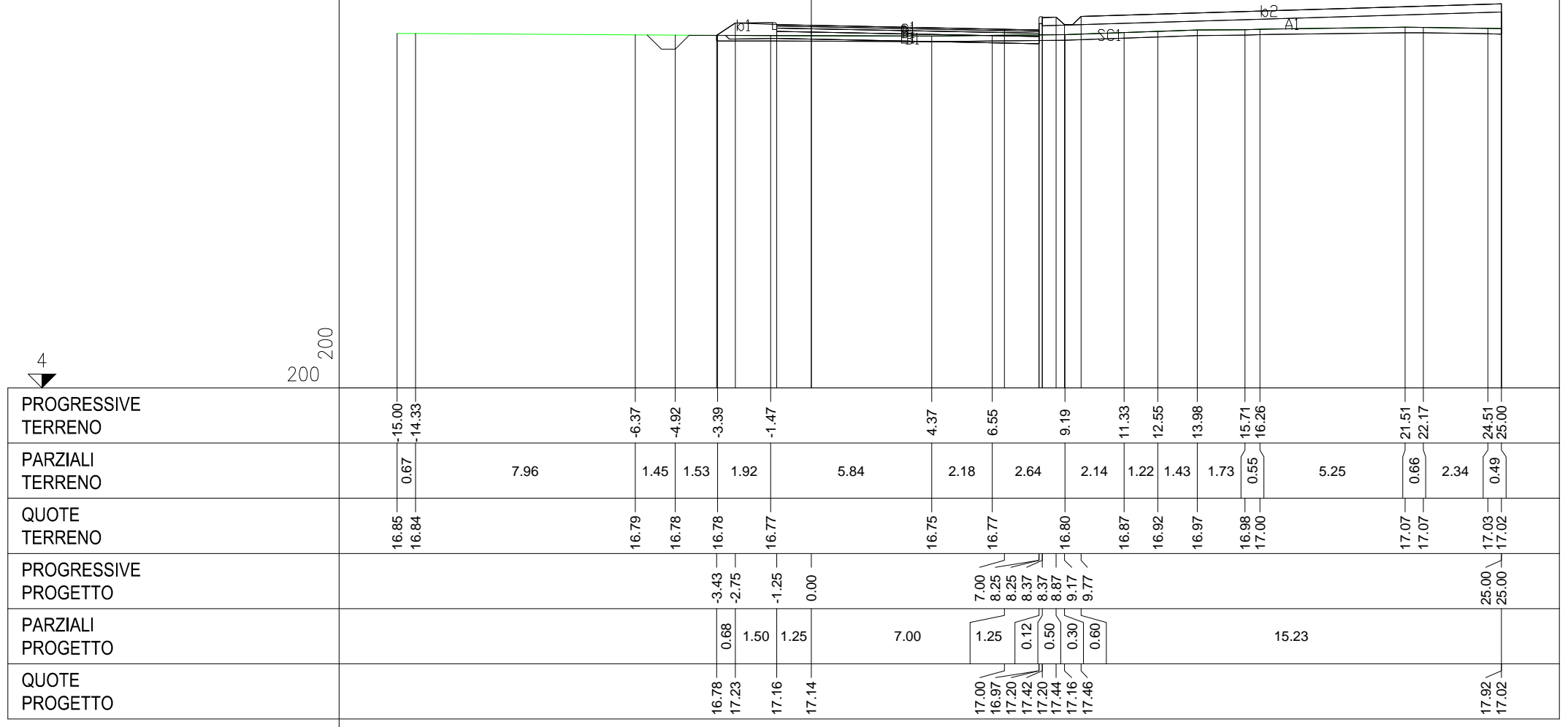

PROFILO ROTATORIA ANTRACCOLI

SEZIONE 3

PROGRESSIVA 75.45

A	RILEVATO	mq	9.02
B	STERRO	mq	1.88
C	BINDER	mq	0.66
D	BASE	mq	1.14
E	FONDAZIONE	mq	2.47
SC	SCOTICO	mq	5.69
a	USURA	m	9.50
b	VEGETALE	m	18.67

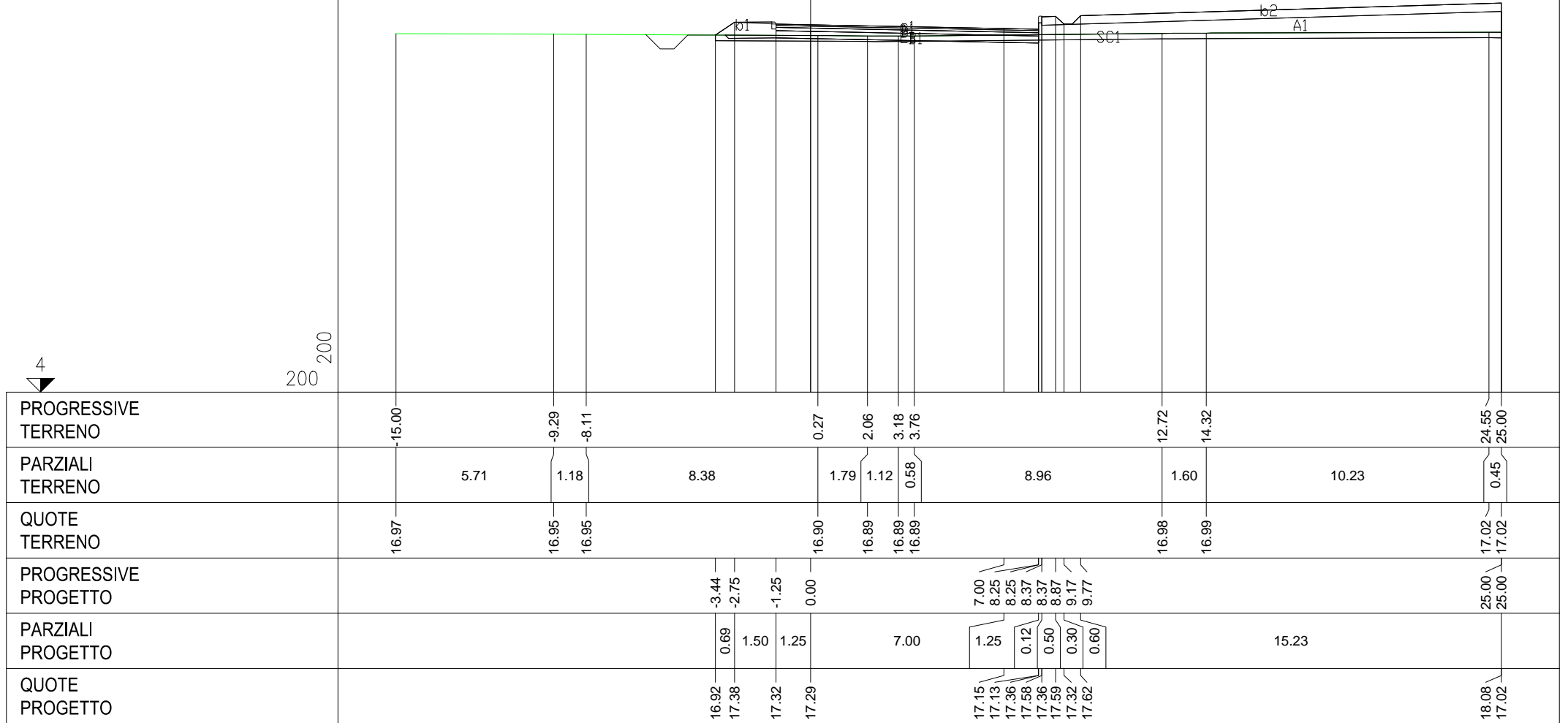

PROFILO ROTATORIA ANTRACCOLI

SEZIONE 4

PROGRESSIVA 115.00

A	RILEVATO	mq	36.18
C	BINDER	mq	0.66
D	BASE	mq	1.14
E	FONDAZIONE	mq	2.47
SC	SCOTICO	mq	6.04
a	USURA	m	9.50
b	VEGETALE	m	20.43

200
200

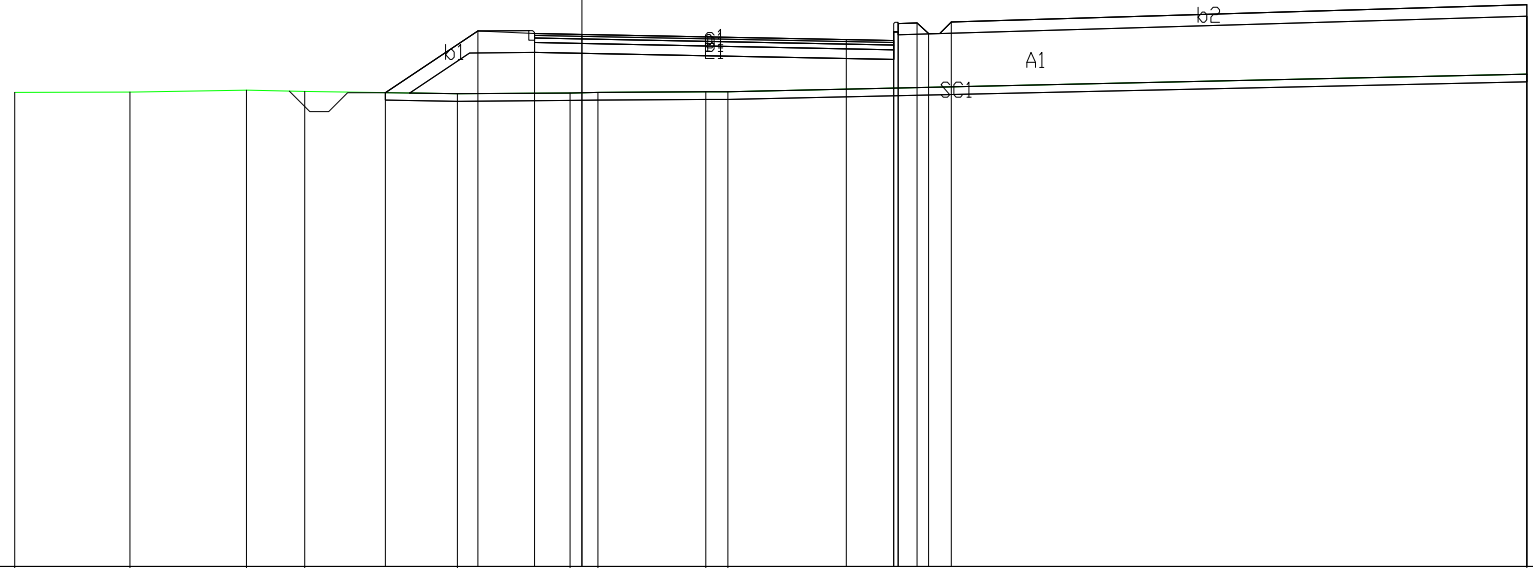

PROGRESSIVE TERRENO	-15.00	-11.95	-8.87	-7.33	-3.29	-0.31	0.43	3.28	3.86	25.00								
PARZIALI TERRENO		3.05	3.08	1.54	4.04	2.98	0.74	2.85	0.58	21.14								
QUOTE TERRENO	16.54	16.55	16.60	16.57	16.51	16.53	16.54	16.56	16.56	17.02								
PROGRESSIVE PROGETTO					-5.20	-2.75	-1.25	0.00		7.00	25.00							
PARZIALI PROGETTO					2.45	1.50	1.25		7.00	1.25	0.12	0.50	0.30	0.60	15.23			
QUOTE PROGETTO					16.53	18.16	18.10	18.07		17.93	17.91	18.14	18.36	18.14	18.37	18.10	18.40	17.02

PROFILO ROTATORIA ANTRACCOLI

SEZIONE 5

PROGRESSIVA 157.07

A	RILEVATO	mq	22.92
C	BINDER	mq	0.67
D	BASE	mq	1.14
E	FONDAZIONE	mq	2.47
SC	SCOTICID	mq	5.79
a	USURA	m	9.50
b	VEGETALE	m	19.32

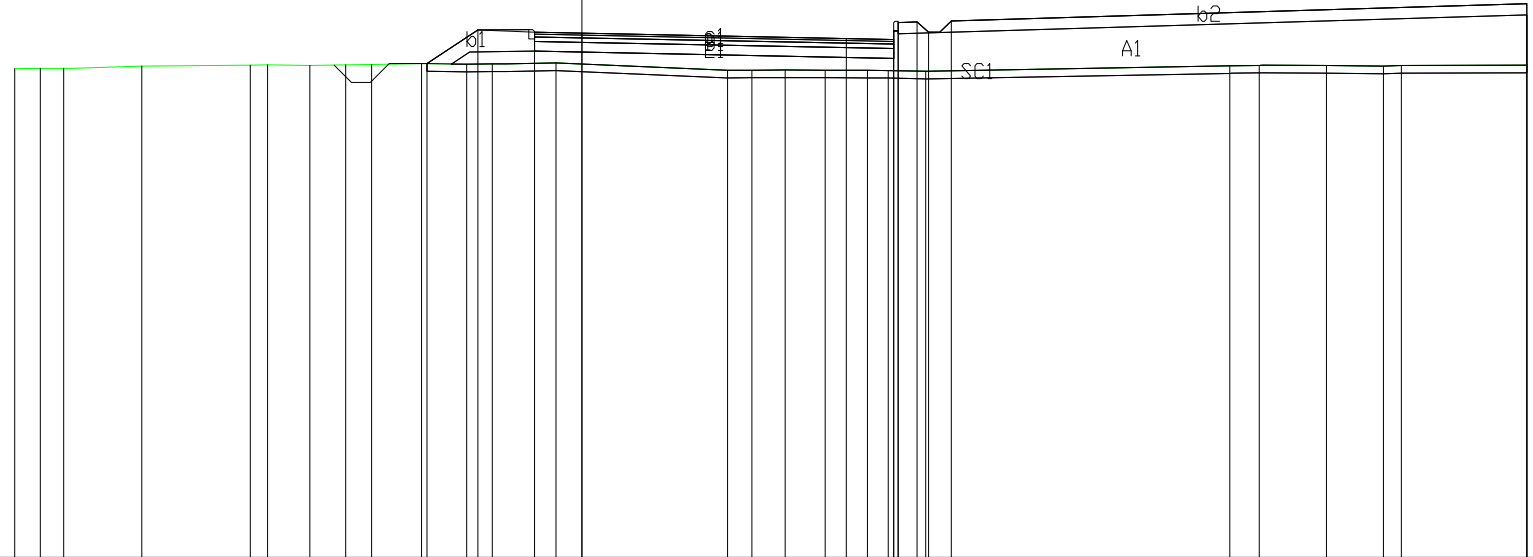

200
200

PROGRESSIVE TERRENO	15.00	14.32	13.71	11.64	8.77	8.31	7.19	6.25	5.56	4.24	3.04	2.37	0.68	3.85	4.50	5.38	6.44	7.56	8.10	9.10	17.14	17.92	19.70	21.20	21.68	25.00	
PARZIALI TERRENO	0.68	0.61	2.07	2.87	0.46	1.12	0.94	0.69	1.32	1.20	0.67	1.69	4.53	0.65	0.88	1.06	1.12	0.54	1.00	8.04	0.78	1.78	1.50	0.48	3.32		
QUOTE TERRENO	16.93	16.93	16.94	16.99	17.03	17.03	17.01	17.03	17.04	17.06	17.04	17.06	17.08	16.88	16.89	16.89	16.89	16.88	16.88	16.86	17.01	17.02	17.01	17.00	17.01	17.02	
PROGRESSIVE PROGETTO										-4.09	-2.75	-1.25	0.00	7.00	1.25	0.12	0.50	0.87	9.17	9.77						25.00	25.00
PARZIALI PROGETTO										1.34	1.50	1.25	7.00	1.25	0.12	0.50	0.30	0.60	15.23								
QUOTE PROGETTO										17.06	17.96	17.89	17.87	17.73	17.70	17.93	18.15	17.93	18.17	17.89	18.19					18.65	17.02

PROFILO TORNA INDIETRO NORD

SEZIONE 1

PROGRESSIVA 0.00

A	RILEVATO	mq	0.01
B	STERRO	mq	7.27
C	BINDER	mq	0.59
D	BASE	mq	1.82
E	FONDAZIONE	mq	1.47
SC	SCOTICO	mq	0.92
a	USURA	m	7.31
b	VEGETALE	m	1.61

4

200
200

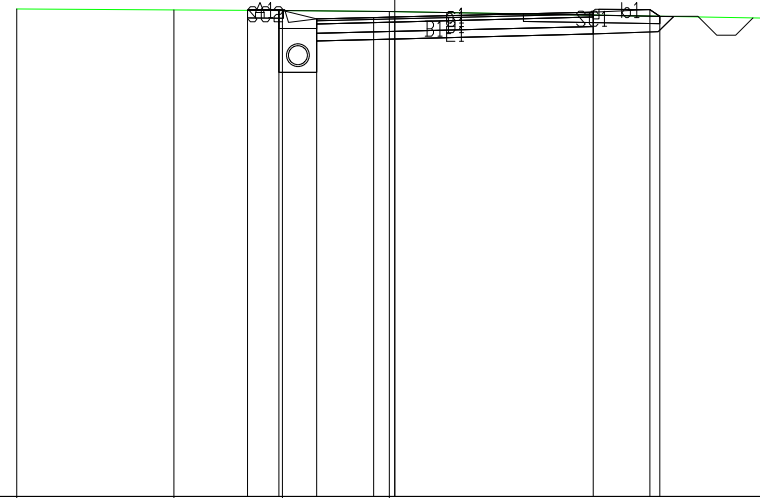

PROGRESSIVE TERRENO	-10.00	-5.84	-2.97	-0.14	10.00					
PARZIALI TERRENO	4.16	2.87	2.83	10.14						
QUOTE TERRENO	16.90	16.87	16.85	16.83	16.65					
PROGRESSIVE PROGETTO			-3.90	-3.06	-2.06	-0.56	0.00	5.25	6.75	7.01
PARZIALI PROGETTO			0.84	1.00	1.50	0.56	5.25	1.50	0.26	
QUOTE PROGETTO			16.86	16.88	16.63	16.67	16.68	16.81	16.88	16.70

PROFILO TORNA INDIETRO SUD

SEZIONE 1

PROGRESSIVA 0.00

A	RILEVATO	mq	0.08
B	STERRO	mq	7.37
C	BINDER	mq	0.58
D	BASE	mq	1.82
E	FONDAZIONE	mq	1.46
SC	SCOTICO	mq	0.72
a	USURA	m	7.30
b	VEGETALE	m	1.47

3

200
200

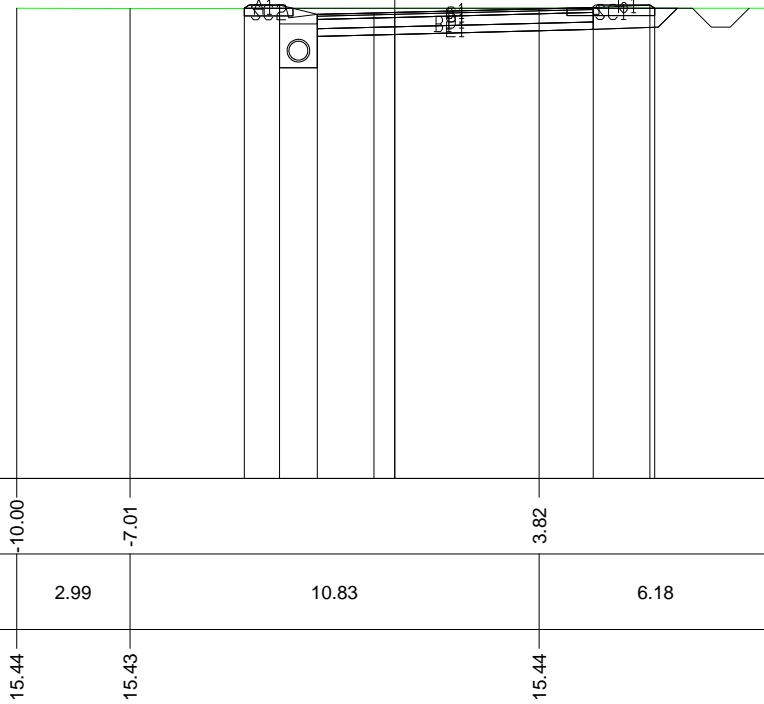

PROGRESSIVE
TERRENO

-10.00 -7.01 3.82 10.00

PARZIALI
TERRENO

2.99 10.83 6.18

QUOTE
TERRENO

15.44 15.43 15.44 15.44

PROGRESSIVE
PROGETTO

-3.98 -3.05 -2.05 -0.55 0.00 5.25 6.75 6.87

PARZIALI
PROGETTO

0.93 1.00 1.50 0.55 5.25 1.50 0.12

QUOTE
PROGETTO

15.43 15.52 15.27 15.31 15.32 15.46 15.52 15.44

PROFILO TORNA INDIETRO SUD

SEZIONE 2

PROGRESSIVA 47.16

A	RILEVATO	mq	0.26
B	STERRO	mq	4.95
C	BINDER	mq	0.57
D	BASE	mq	1.79
E	FONDAZIONE	mq	1.43
SC	SCOTICO	mq	2.23
a	USURA	m	7.15
b	VEGETALE	m	5.16

4

200
200

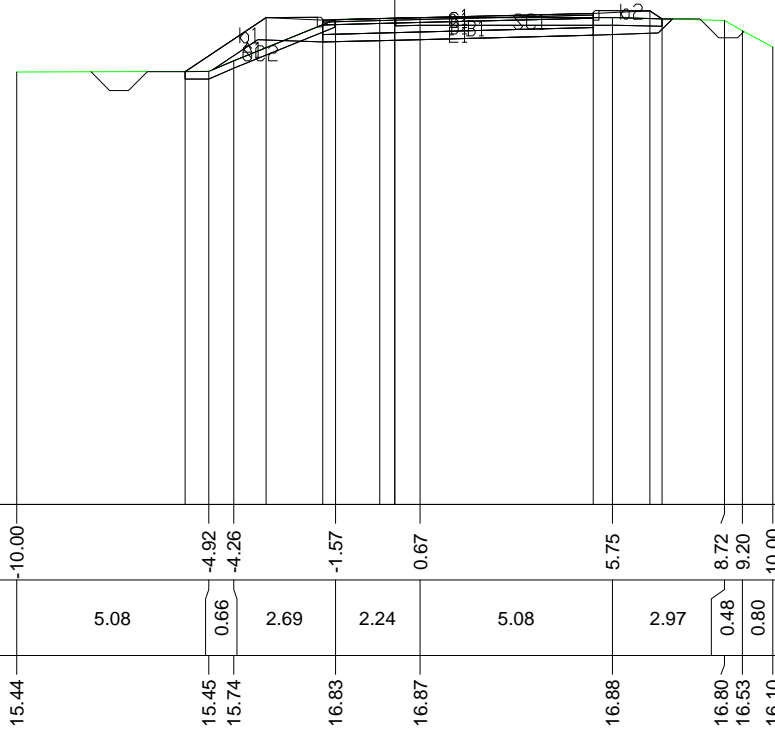

PROGRESSIVE TERRENO		-10.00		-4.92	-4.26		-1.57		0.67		5.75		8.72	9.20	10.00
PARZIALI TERRENO			5.08	0.66	2.69		2.24		5.08		2.97		0.48	0.80	
QUOTE TERRENO		15.44		15.45	15.74		16.83		16.87		16.88		16.80	16.53	16.10
PROGRESSIVE PROGETTO			-5.54		-3.40		-1.90		-0.40	0.00		5.25		6.75	7.07
PARZIALI PROGETTO				2.14	1.50		1.50		0.40		5.25		1.50		0.32
QUOTE PROGETTO			15.45		16.88		16.81		16.85	16.86		16.99		17.06	16.85

PROFILO TRONCO DI SCAMBIO EST

SEZIONE 1

PROGRESSIVA 0.00

A	RILEVATO	mq	1.94
B	STERRO	mq	8.26
C	BINDER	mq	0.84
D	BASE	mq	2.62
E	FONDAZIONE	mq	2.10
SC	SCOTICO	mq	1.38
α	USURA	m	10.50
b	VEGETALE	m	2.65



200
200

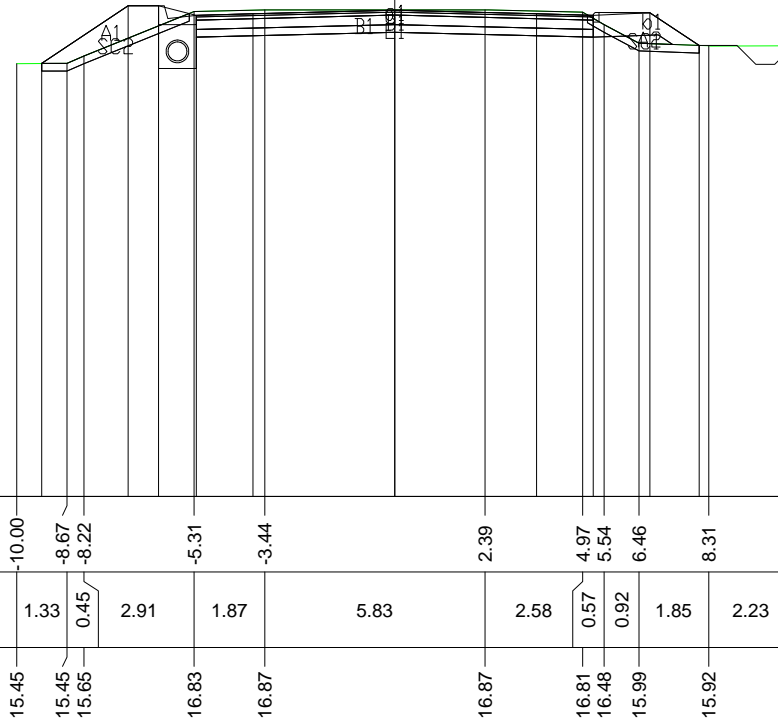

PROGRESSIVE TERRENO		-10.00	-8.67	-8.22		-5.31	-3.44		2.39	4.97	5.54	6.46	8.31	10.54
PARZIALI TERRENO		1.33	0.45	2.91	1.87	5.83	2.58	0.57	0.92	1.85	2.23			
QUOTE TERRENO		15.45	15.45	15.65	16.83	16.87	16.87	16.81	16.48	15.99	15.92	15.92		
PROGRESSIVE PROGETTO		-9.34	-7.05	-6.25	-5.25	-3.75	0.00	3.75	5.25	6.75	8.05			
PARZIALI PROGETTO		2.29	0.80	1.00	1.50	3.75	3.75	1.50	1.50	1.30				
QUOTE PROGETTO		15.45	16.98	16.98	16.73	16.77	16.86	16.77	16.73	16.79	15.93			

PROFILO TRONCO DI SCAMBIO EST

SEZIONE 2

PROGRESSIVA 50.00

B	STERRO	mq	4,14
C	BINDER	mq	0,84
D	BASE	mq	2,62
E	FONDAZIONE	mq	2,10
SC	SCOTICO	mq	2,87
a	USURA	m	10,50
b	VEGETALE	m	3,56

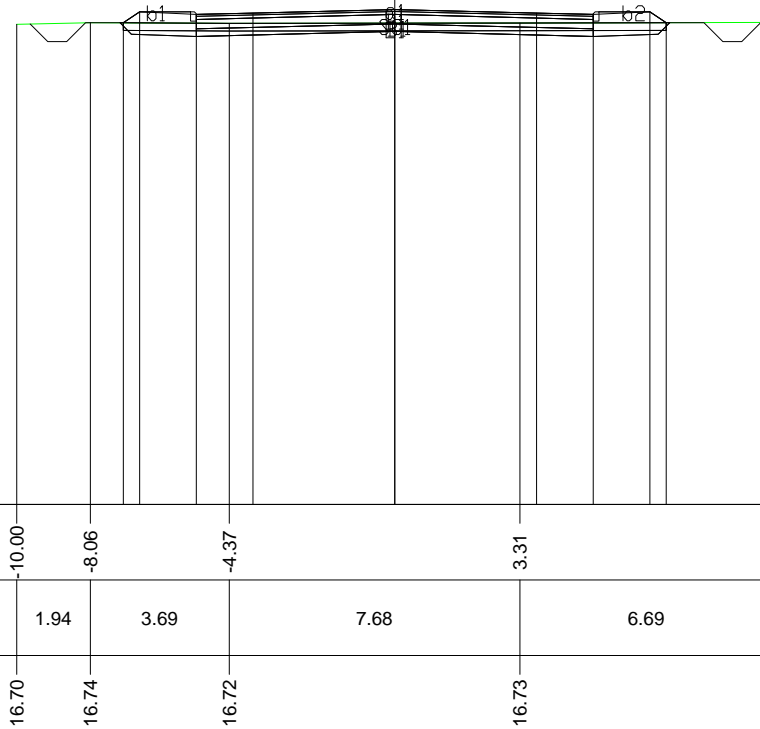

200
200

PROGRESSIVE
TERRENO

PARZIALI
TERRENO

QUOTE
TERRENO

PROGRESSIVE
PROGETTO

PARZIALI
PROGETTO

QUOTE
PROGETTO

-10.00	-8.06	-4.37	3.31	10.00
1.94	3.69	7.68	6.69	
16.70	16.74	16.72	16.73	16.75
	-7.18	-6.75	-5.25	-3.75
	0.43	1.50	1.50	3.75
16.74	17.03	16.96	17.00	17.09
	16.96	17.00	16.96	17.00
	17.03	16.74	16.74	16.74

PROFILO TRONCO DI SCAMBIO EST

SEZIONE 3

PROGRESSIVA 100.00

A	RILEVATO	mq	0.06
B	STERRO	mq	7.34
C	BINDER	mq	0.84
D	BASE	mq	2.64
E	FONDAZIONE	mq	2.10
SC	SCOTICO	mq	2.13
a	USURA	m	10.50
b	VEGETALE	m	1.96



200
200

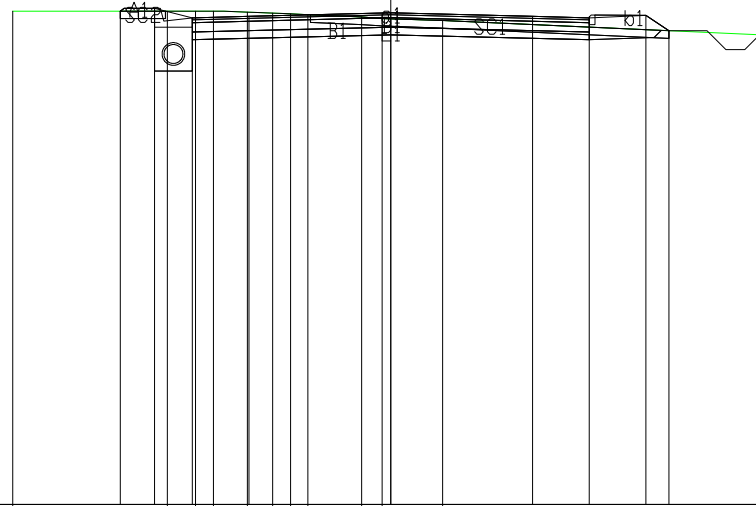

PROGRESSIVE TERRENO	-10.00	-5.91	-5.17	-4.69	-3.80	-3.12	-2.65	-2.20	-0.77	-0.23	1.37	10.00		
PARZIALI TERRENO		4.09	0.74	0.48	0.89	0.68	0.47	0.45	1.43	0.54	1.60	8.63		
QUOTE TERRENO	17.05	17.05	17.05	17.05	17.02	17.00	16.98	16.95	16.89	16.86	16.80	16.41		
PROGRESSIVE PROGETTO		-7.16	-6.25	-5.25	-3.75				0.00		3.75	5.25	6.75	7.36
PARZIALI PROGETTO		0.91	1.00	1.50		3.75			3.75		1.50	1.50	0.61	
QUOTE PROGETTO	17.05	17.12	16.87	16.91	17.00	16.91	16.53	16.87	16.94	16.53	16.91	16.87	16.94	16.53

PROFILO TRONCO DI SCAMBIO EST

SEZIONE 4

PROGRESSIVA 150.00

A	RILEVATO	mq	0.11
B	STERRO	mq	6.57
C	BINDER	mq	0.90
D	BASE	mq	2.81
E	FONDAZIONE	mq	2.25
SC	SCOTICO	mq	2.46
α	USURA	m	11.25
b	VEGETALE	m	2.05

4

200
200

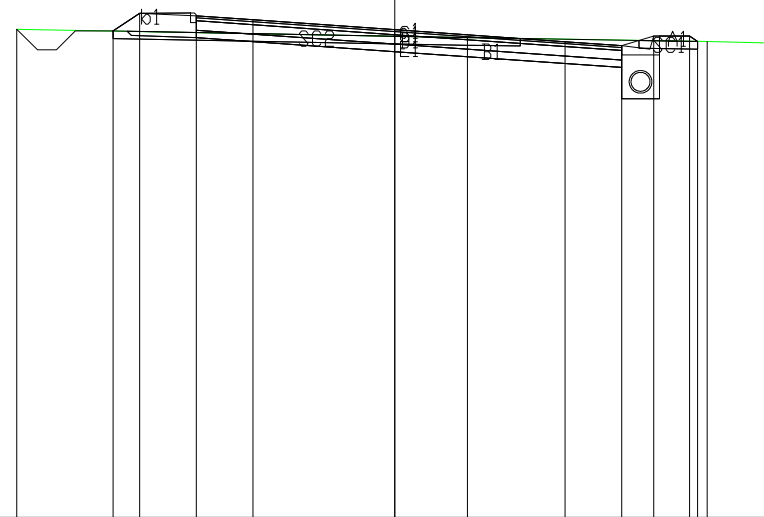

PROGRESSIVE TERRENO	-10.00					1.92		8.26	10.00		
PARZIALI TERRENO			11.92				6.34		1.74		
QUOTE TERRENO	16.91					16.69		16.59	16.55		
PROGRESSIVE PROGETTO		-7.45	-6.75	-5.25	-3.75	0.00	4.50	6.00	6.85	7.80	8.01
PARZIALI PROGETTO		0.70	1.50	1.50	3.75		4.50	1.50	0.85	0.95	0.21
QUOTE PROGETTO	16.87	17.33	17.27	17.16		16.90	16.59	16.48	16.73	16.73	16.59

PROFILO TRONCO DI SCAMBIO EST

SEZIONE 5

PROGRESSIVA 200.00

A	RILEVATO	mq	0.04
B	STERRO	mq	8.22
C	BINDER	mq	0.89
D	BASE	mq	2.77
E	FONDAZIONE	mq	2.22
SC	SCOTICO	mq	1.88
α	USURA	m	11.10
b	VEGETALE	m	1.82

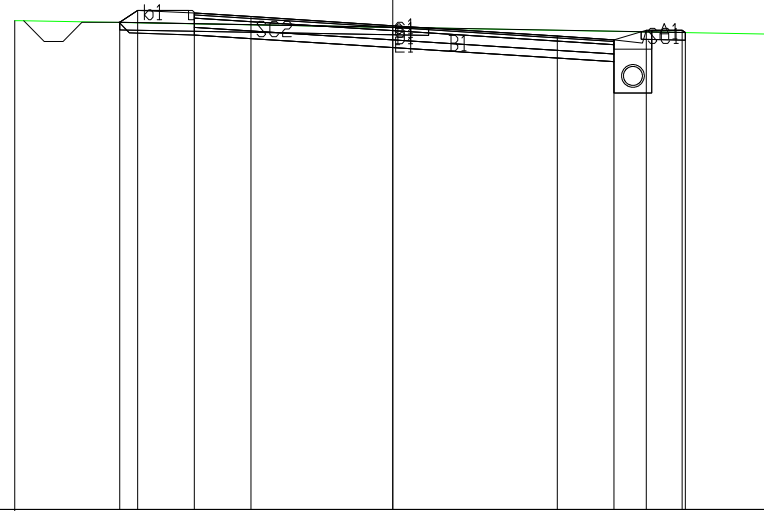

200
200

PROGRESSIVE
TERRENO

-10.00

10.00

PARZIALI
TERRENO

20.00

QUOTE
TERRENO

16.93

16.58

PROGRESSIVE
PROGETTO

-7.22

-6.75

-5.25

-3.75

0.00

4.35

5.85

6.70

7.65

7.74

PARZIALI
PROGETTO

0.47

1.50

1.50

3.75

4.35

1.50

0.85

0.95

0.09

QUOTE
PROGETTO

16.88

17.20

17.13

17.03

16.80

16.52

16.42

16.67

16.67

16.62

PROFILO TRONCO DI SCAMBIO EST

SEZIONE 6

PROGRESSIVA 217.36

A	RILEVATO	mq	0,27
B	STERRO	mq	9,76
C	BINDER	mq	0,84
D	BASE	mq	2,63
E	FONDAZIONE	mq	2,11
SC	SCOTICO	mq	0,63
α	USURA	m	10,51



200
200

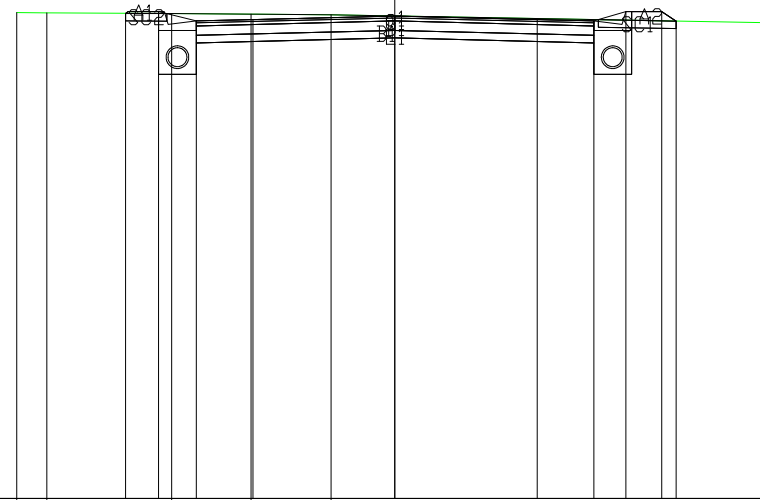

PROGRESSIVE TERRENO			-10.00	-9.21	-5.90	-3.81	-1.69			10.00				
PARZIALI TERRENO			0.79	3.31	2.09	2.12		11.69						
QUOTE TERRENO			16.85	16.84	16.82	16.81	16.79			16.58				
PROGRESSIVE PROGETTO					-7.12	-6.25	-5.25	-3.75	0.00	3.76	5.26	6.11	7.06	7.44
PARZIALI PROGETTO					0.87	1.00	1.50	3.75	3.76	1.50	0.85	0.95	0.38	
QUOTE PROGETTO					16.83	16.88	16.63	16.67	16.76	16.67	16.63	16.88	16.88	16.63

PROFILO TRONCO SCAMBIO OVEST

SEZIONE 1

PROGRESSIVA 0.00

A	RILEVATO	m	0.23
B	STERRO	m	9.47
C	BINDER	m	0.87
D	BASE	m	2.71
E	FONDAZIONE	m	2.17
SC	SCOTICO	m	1.57
a	USURA	m	10.83

5

200
200

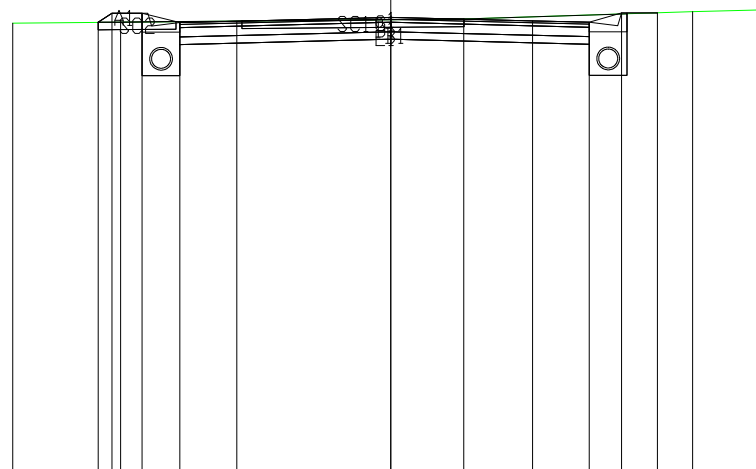

PROGRESSIVE TERRENO	-10.00	-7.15	1.93	7.98	10.00						
PARZIALI TERRENO	2.85	9.08	6.05	2.02							
QUOTE TERRENO	16.96	16.99	17.07	17.27	17.32						
PROGRESSIVE PROGETTO		-7.74	-7.38	-6.58	-5.58	-4.08	0.00	3.75	5.25	6.10	7.05
PARZIALI PROGETTO		0.36	0.80	1.00	1.50	4.08	3.75	1.50	0.85	0.95	
QUOTE PROGETTO		16.99	17.23	17.23	16.98	17.02	17.12	17.02	16.99	17.24	17.24

PROFILO TRONCO SCAMBIO OVEST

SEZIONE 2

PROGRESSIVA 54.76

A	RILEVATO	m	0.36
B	STERRO	m	9.75
C	BINDER	m	0.85
D	BASE	m	2.65
E	FONDAZIONE	m	2.13
SC	SCOTICO	m	0.71
a	USURA	m	10.62

4

200
200

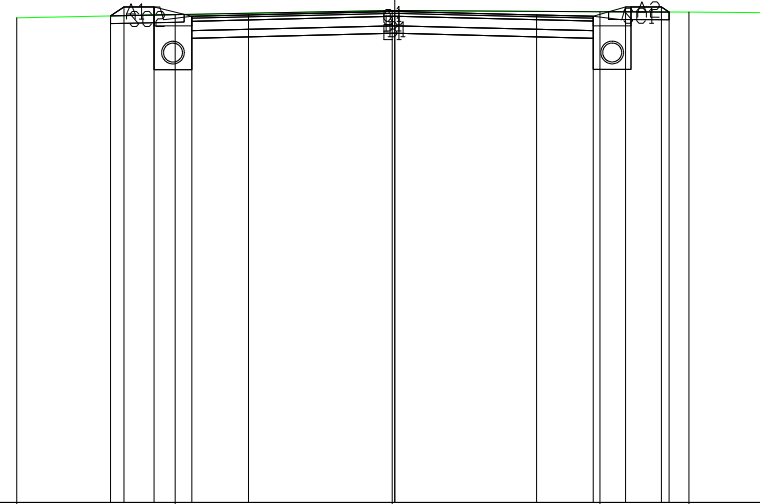

PROGRESSIVE TERRENO	-10.00	-5.81	-0.07	5.43	7.78	10.00					
PARZIALI TERRENO		4.19	5.74	5.50	2.35	2.22					
QUOTE TERRENO	16.82	16.90	17.02	16.98	16.97	16.95					
PROGRESSIVE PROGETTO		-7.52	-6.37	-5.37	-3.87	0.00	3.75	5.25	6.10	7.05	7.26
PARZIALI PROGETTO		0.35	0.80	1.00	1.50	3.87	3.75	1.50	0.85	0.95	0.21
QUOTE PROGETTO		16.87	17.11	17.11	16.86	16.89	16.99	16.90	16.86	17.11	16.97

PROFILO TRONCO SCAMBIO OVEST

SEZIONE 3

PROGRESSIVA 100.00

B	STERRO	m	11,48
C	BINDER	m	0,87
D	BASE	m	2,74
E	FONDAZIONE	m	2,19
SC	SCOTICO	m	0,88
a	USURA	m	10,95
b	VEGETALE	m	1,79

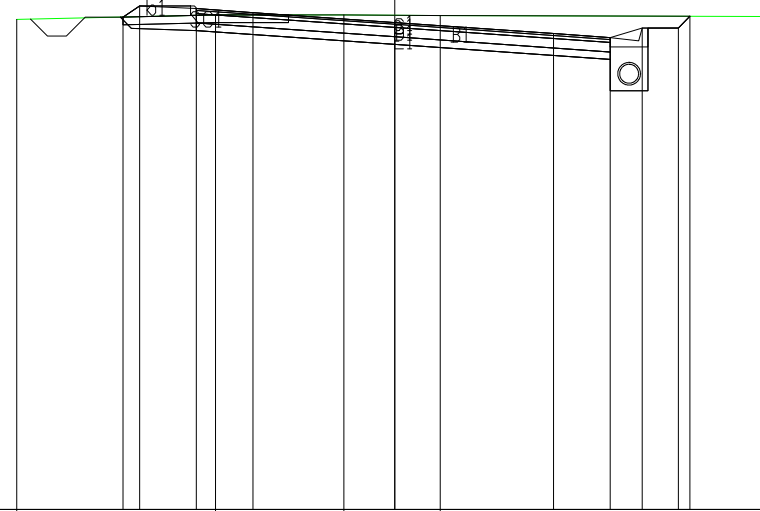

200
200

PROGRESSIVE TERRENO		-10.00		-4.75		-1.35		1.20		10.00										
PARZIALI TERRENO			5.25		3.40		2.55		8.80											
QUOTE TERRENO		16.96		17.08		17.08		17.06		17.04										
PROGRESSIVE PROGETTO			-7.19		-5.25		-3.75		0.00		4.20		5.70		6.55		7.50		7.81	
PARZIALI PROGETTO			0.44		1.50		1.50		3.75		4.20		1.50		0.85		0.95		0.31	
QUOTE PROGETTO		17.02		17.31		17.25		17.14		16.88		16.59		16.48		16.73		16.73		17.04

PROFILO TRONCO SCAMBIO OVEST

SEZIONE 4

PROGRESSIVA 157.13

A	RILEVATO	m	11.06
B	STERRO	m	0.87
C	BINDER	m	0.84
D	BASE	m	2.64
E	FONDAZIONE	m	2.10
SC	SCOTICO	m	2.79
a	USURA	m	10.51
b	VEGETALE	m	3.12

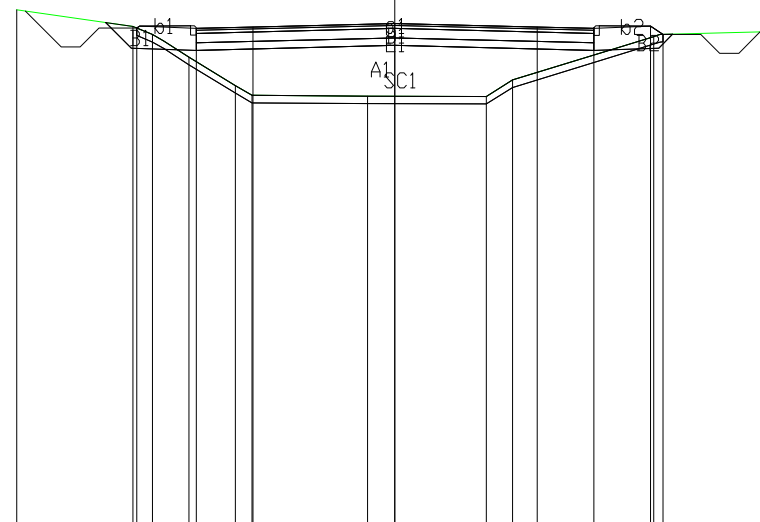

3

200
200

PROGRESSIVE TERRENO		-10.00		-6.92	-6.41	-5.44	-4.22	-3.77		-0.72		2.42	3.11		6.85	10.00
PARZIALI TERRENO			3.08	0.51	0.97	1.22	0.45	3.05		3.14		0.69	3.74		3.15	
QUOTE TERRENO		16.64		16.20	15.99	15.38	14.63	14.38		14.36		14.35	14.78		15.93	16.06
PROGRESSIVE PROGETTO				-6.83	-5.25	-3.75		0.00		3.76		5.26		6.76	7.10	
PARZIALI PROGETTO				1.58	1.50	3.75		3.76		1.50	1.50	0.34				
QUOTE PROGETTO				16.16	16.15	16.18		16.28		16.18	16.15	16.21	15.99			

PROFILO TRONCO SCAMBIO OVEST

SEZIONE 5

PROGRESSIVA 200.00

A	RILEVATO	m	0.29
B	STERRO	m	5.50
C	BINDER	m	0.93
D	BASE	m	2.91
E	FONDAZIONE	m	2.33
SC	SCOTICO	m	2.66
a	USURA	m	11.62
b	VEGETALE	m	2.41

200
200

3

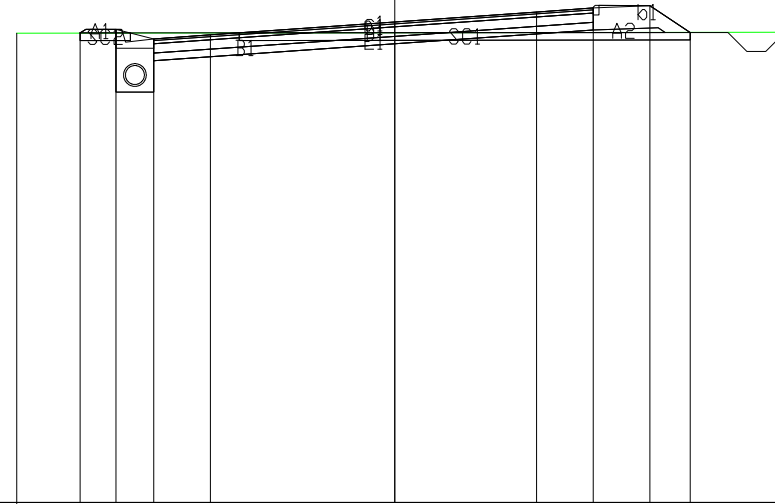

PROGRESSIVE TERRENO	-10.00												10.32
PARZIALI TERRENO						20.32							
QUOTE TERRENO	15.42												15.44
PROGRESSIVE PROGETTO		-8.32	-7.37	-6.37	-4.87	0.00		3.75	5.25	6.75	7.81		
PARZIALI PROGETTO		0.95	1.00	1.50	4.87		3.75	1.50	1.50	1.06			
QUOTE PROGETTO	15.42	15.51	15.26	15.37		15.71		15.97	16.08	16.14	15.43		

PROFILO TRONCO SCAMBIO OVEST

SEZIONE 6

PROGRESSIVA 237.71

A	RILEVATO	m	0.14
B	STERRO	m	9.94
C	BINDER	m	0.85
D	BASE	m	2.63
E	FONDAZIONE	m	2.12
SC	SCOTICO	m	0.47
a	USURA	m	10.56

3

200
200

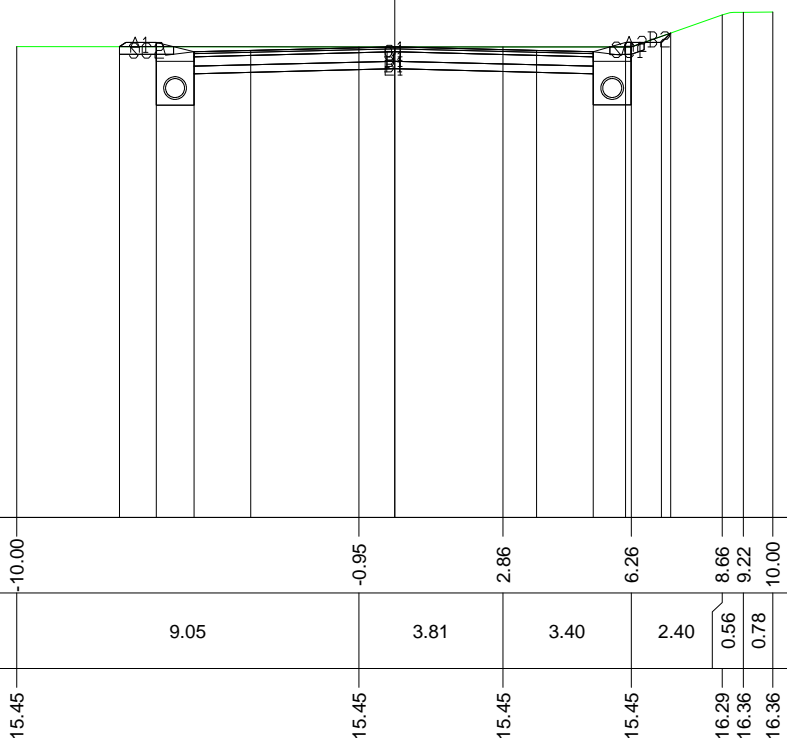

PROGRESSIVE TERRENO	-10.00			-0.95	2.86	6.26	8.66	9.22	10.00
PARZIALI TERRENO		9.05		3.81	3.40	2.40	0.56	0.78	
QUOTE TERRENO	15.45			15.45	15.45	15.45	16.29	16.36	16.36
PROGRESSIVE PROGETTO		-7.29	-6.31	-5.31	-3.81	0.00	3.75	5.25	6.10
PARZIALI PROGETTO		0.98	1.00	1.50	3.81	3.75	1.50	0.85	0.95
QUOTE PROGETTO		15.45	15.57	15.32	15.35	15.45	15.35	15.32	15.57

PROFILO USCITA ASSE SUD

SEZIONE 1

PROGRESSIVA 0.00

A	RILEVATO	mq	0.33
B	STERRO	mq	4.56
C	BINDER	mq	0.53
D	BASE	mq	1.69
E	FONDAZIONE	mq	1.35
SC	SCOTICO	mq	2.33
a	USURA	m	6.75
b	VEGETALE	m	4.43



200
200

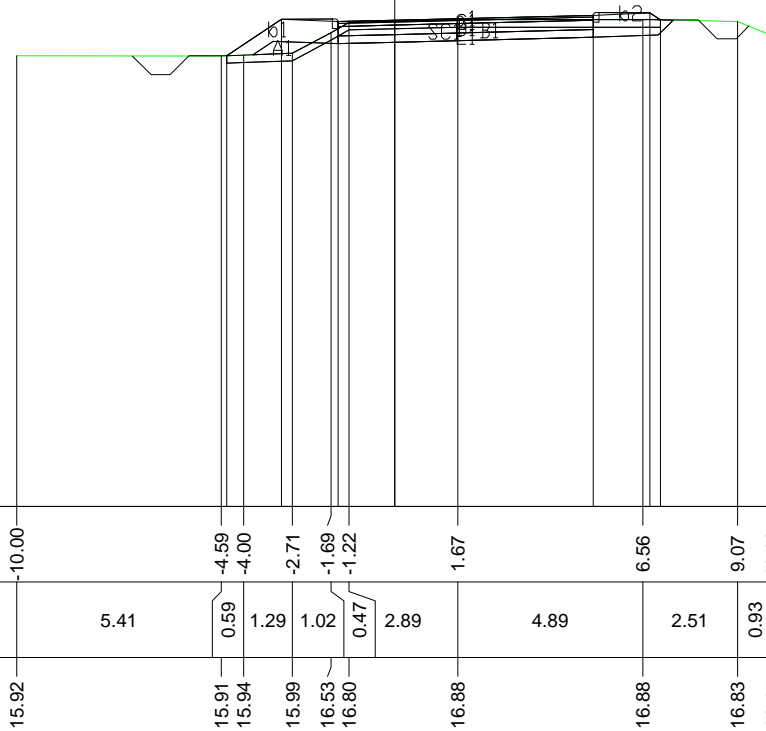

PROGRESSIVE TERRENO	-10.00	-4.59	-4.00	-2.71	-1.69	-1.22	1.67	6.56	9.07	10.00
PARZIALI TERRENO	5.41	0.59	1.29	1.02	0.47	2.89	4.89	2.51	0.93	
QUOTE TERRENO	15.92	15.91	15.94	15.99	16.53	16.80	16.88	16.88	16.83	16.45
PROGRESSIVE PROGETTO		-4.45	-3.00	-1.50	0.00			5.25	6.75	7.03
PARZIALI PROGETTO		1.45	1.50	1.50	5.25	1.50	0.28			
QUOTE PROGETTO		15.92	16.89	16.82	16.86			16.99	17.06	16.87

PROFILO USCITA ASSE SUD

SEZIONE 2

PROGRESSIVA 50.00

A	RILEVATO	mq	0.01
B	STERRO	mq	4.53
C	BINDER	mq	0.53
D	BASE	mq	1.69
E	FONDAZIONE	mq	1.35
SC	SCOTICO	mq	2.02
a	USURA	m	6.75
b	VEGETALE	m	4.10



200
200

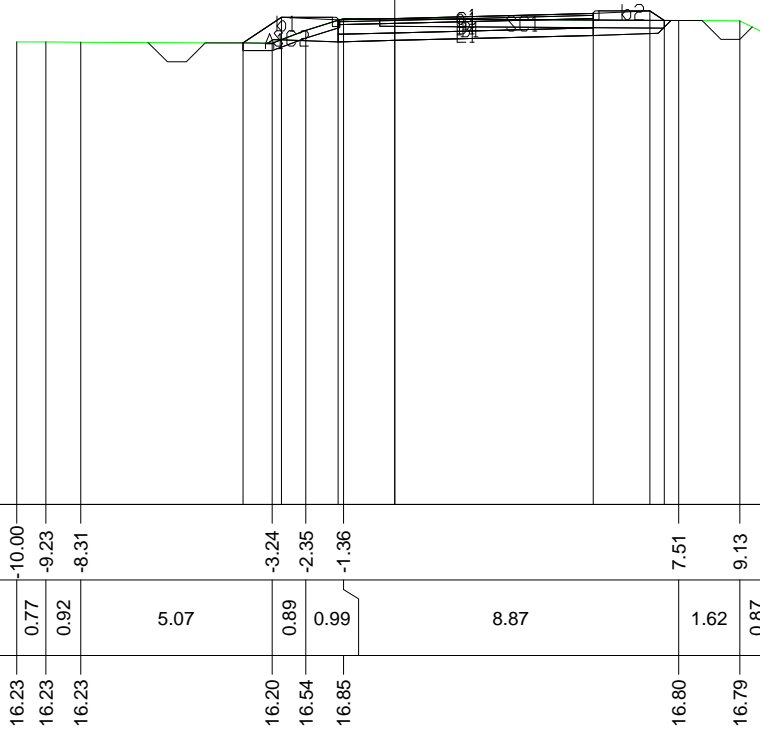

PROGRESSIVE TERRENO

-10.00 -9.23 -8.31 -3.24 -2.35 -1.36 7.51 9.13 10.00

PARZIALI TERRENO

0.77 0.92 5.07 0.89 0.99 8.87 1.62 0.87

QUOTE TERRENO

16.23 16.23 16.23 16.20 16.54 16.85 16.80 16.79 16.36

PROGRESSIVE PROGETTO

-4.02 -3.00 -1.50 0.00 5.25 6.75 7.13

PARZIALI PROGETTO

1.02 1.50 1.50 5.25 1.50 0.38

QUOTE PROGETTO

16.21 16.88 16.82 16.86 16.99 17.05 16.80

PROFILO USCITA ASSE SUD

SEZIONE 3

PROGRESSIVA 101.15

A	RILEVATO	mq	0.75
B	STERRO	mq	5.83
C	BINDER	mq	0.53
D	BASE	mq	1.69
E	FONDAZIONE	mq	1.35
SC	SCOTICO	mq	1.75
a	USURA	m	6.75
b	VEGETALE	m	1.64

4

200
200

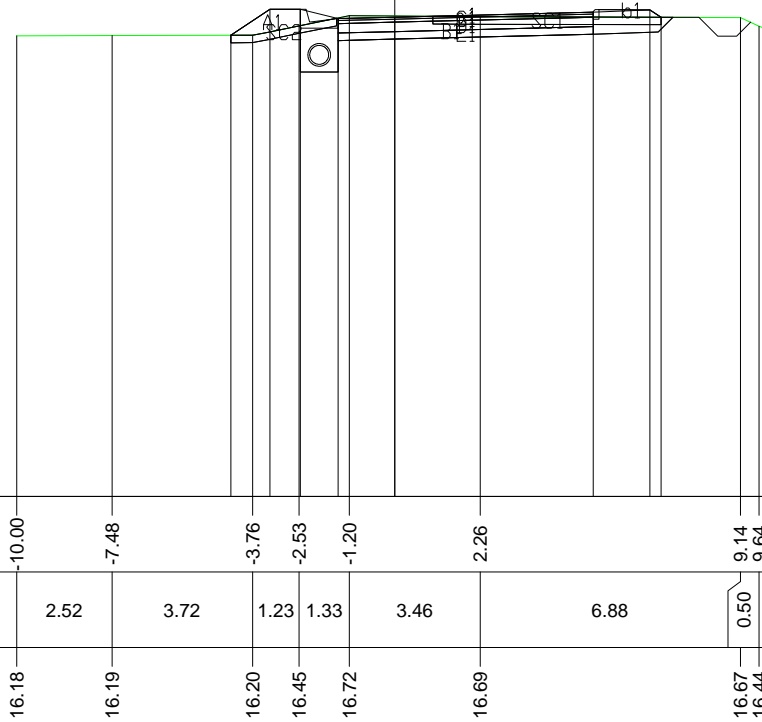

PROGRESSIVE TERRENO	-10.00	-7.48	-3.76	-2.53	-1.20	2.26	9.14	9.64	10.00	
PARZIALI TERRENO		2.52	3.72	1.23	1.33	3.46	6.88	0.50	0.36	
QUOTE TERRENO	16.18	16.19	16.20	16.45	16.72	16.69	16.67	16.44	16.30	
PROGRESSIVE PROGETTO			-4.33	-3.30	-2.50	-1.50	0.00	5.25	6.75	7.04
PARZIALI PROGETTO			1.03	0.80	1.00	1.50	5.25	1.50	0.29	
QUOTE PROGETTO			16.20	16.89	16.89	16.64	16.68	16.81	16.87	16.68

PROFILO USCITA ASSE NORD

SEZIONE 1

PROGRESSIVA 0.00

B	STERRO	m	6.97
C	BINDER	m ²	0.54
D	BASE	m ²	1.68
E	FONDAZIONE	m ²	1.35
SC	SCOTICO	m ²	0.70
a	USURA	m	6.75
b	VEGETALE	m	2.16

5

200
200

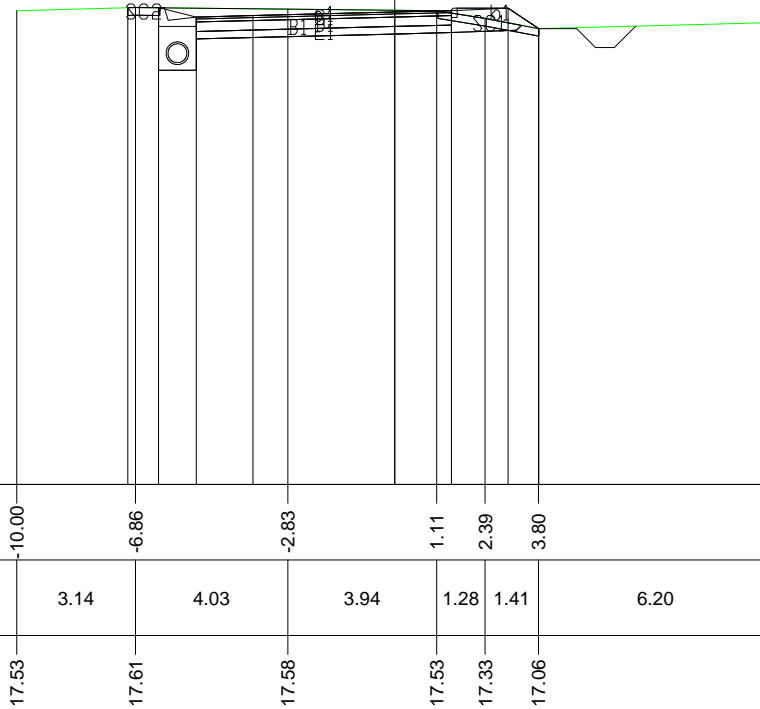

PROGRESSIVE TERRENO		-10.00	-6.86	-2.83	1.11	2.39	3.80	10.00		
PARZIALI TERRENO		3.14	4.03	3.94	1.28	1.41	6.20			
QUOTE TERRENO		17.53	17.61	17.58	17.53	17.33	17.06	17.22		
PROGRESSIVE PROGETTO			-7.06	-6.25	-5.25	-3.75	0.00	1.50	3.00	3.81
PARZIALI PROGETTO			0.81	1.00	1.50	3.75	1.50	1.50	0.81	
QUOTE PROGETTO			17.61	17.61	17.36	17.40	17.49	17.53	17.60	17.06

PROFILO USCITA ASSE NORD

SEZIONE 2

PROGRESSIVA 50.00

A	RILEVATO	m	0.06
B	STERRO	m ^q	9.47
C	BINDER	m ^q	0.54
D	BASE	m ^q	1.69
E	FONDAZIONE	m ^q	1.36
SC	SCOTICO	m ^q	0.24
a	USURA	m	6.75

5

200 200

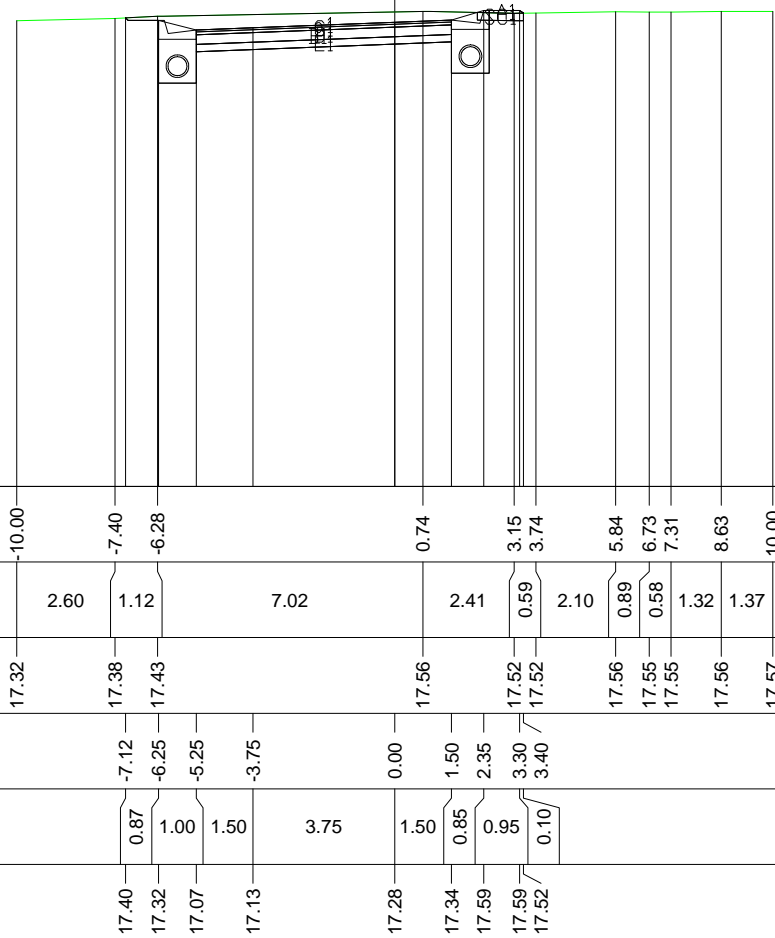

PROGRESSIVE TERRENO		-10.00	-7.40	-6.28		0.74	3.15	3.74	5.84	6.73	7.31	8.63	10.00
PARZIALI TERRENO		2.60	1.12		7.02	2.41	0.59	2.10	0.89	0.58	1.32	1.37	
QUOTE TERRENO		17.32	17.38	17.43		17.56	17.52	17.52	17.56	17.55	17.55	17.56	17.57
PROGRESSIVE PROGETTO			-7.12	-6.25	-5.25	-3.75	0.00	1.50	2.35	3.30	3.40		
PARZIALI PROGETTO			0.87	1.00	1.50	3.75	1.50	0.85	0.95	0.10			
QUOTE PROGETTO			17.40	17.32	17.07	17.13	17.28	17.34	17.59	17.59	17.52		

PROFILO USCITA ASSE NORD

SEZIONE 3

PROGRESSIVA 100.00

A	RILEVATO	m	0.06
B	STERRO	m	10.52
C	BINDER	m	0.54
D	BASE	m	1.69
E	FONDAZIONE	m	1.35
SC	SCOTICO	m	0.21
a	USURA	m	6.75

5

200 200

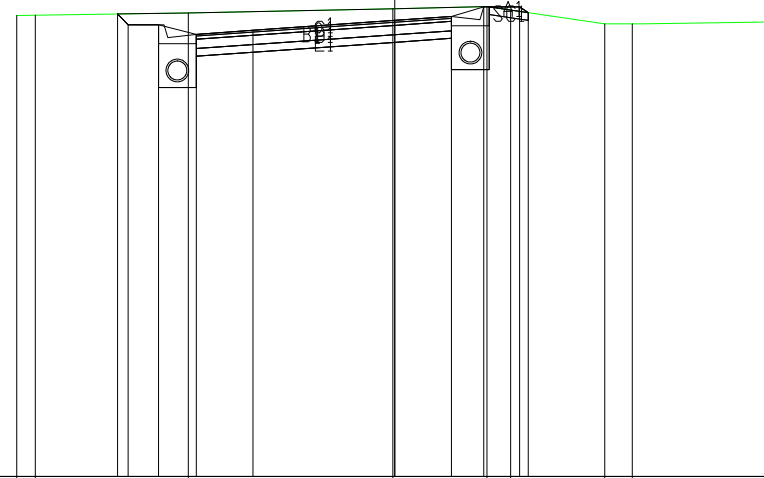

PROGRESSIVE
TERRENO

PARZIALI
TERRENO

QUOTE
TERRENO

PROGRESSIVE
PROGETTO

PARZIALI
PROGETTO

QUOTE
PROGETTO

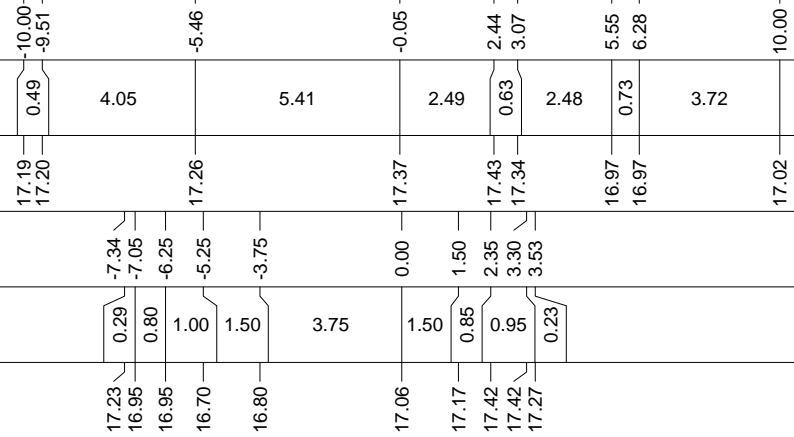

PROFILO USCITA ASSE NORD

SEZIONE 4

PROGRESSIVA 147.07

B	STERRO	m	9,29
C	BINDER	m ^q	0,53
D	BASE	m ^q	1,69
E	FONDAZIONE	m ^q	1,35
α	USURA	m	6,75

5

200
200

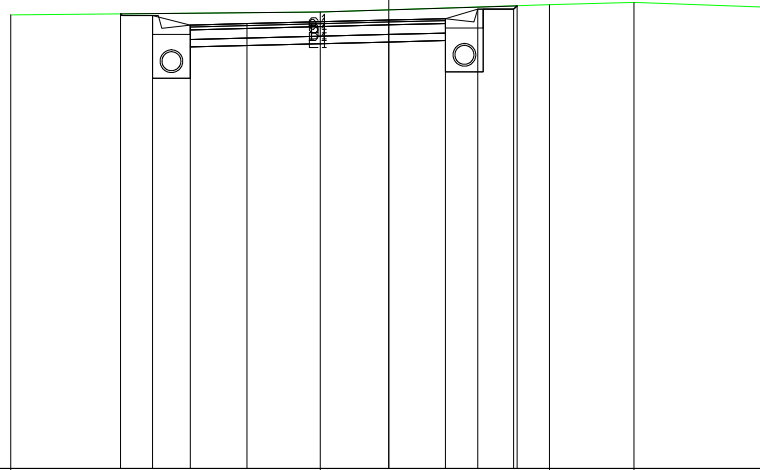

PROGRESSIVE
TERRENO

-10.00	-1.81	4.25	6.48	10.00
--------	-------	------	------	-------

PARZIALI
TERRENO

8.19	6.06	2.23	3.52
------	------	------	------

QUOTE
TERRENO

17.00	17.07	17.27	17.33	17.20
-------	-------	-------	-------	-------

PROGRESSIVE
PROGETTO

-7.10	-6.25	-5.25	-3.75	0.00	1.50	2.35	3.30	3.39
-------	-------	-------	-------	------	------	------	------	------

PARZIALI
PROGETTO

0.85	1.00	1.50	3.75	1.50	0.85	0.95	0.09
------	------	------	------	------	------	------	------

QUOTE
PROGETTO

17.02	16.98	16.73	16.77	16.86	16.90	17.15	17.15	17.24
-------	-------	-------	-------	-------	-------	-------	-------	-------