

# IMPIANTO DI RETE PER LA CONNESSIONE DI UN IMPIANTO DI PRODUZIONE DA FONTE SOLARE FOTOVOLTAICA AVENTE POTENZA PARI A 55'860 kW

UBICATO NEL COMUNE DI BRINDISI (BR), FG. n. 155 - 168 - 169 - 170 -  
171 - 177

## PIANO TECNICO

### DOCUMENTAZIONE GENERALE CABINA DI RACCORDO CAMPO FV-STALLO

#### IDENTIFICAZIONE ELABORATO

Livello Prog.	Codice Rintracciabilità	Tipo Doc.	N° Elaborato	N° Foglio	Tot. Fogli	NOME FILE	DATA	SCALA
PD	201900555	EG	PT05	1	2	AEPV-C03_PT05	NOV 20	N/A

#### REVISIONI

REV	DATA	DESCRIZIONE	ESEGUITO	VERIFICATO	APPROVATO
00	11/2020	PIANO TECNICO (Rif. AEPV-C03)	IVC	N/A	N/A

PROGETTAZIONE



**MAYA ENGINEERING SRLS**  
C.F./P.IVA 08365980724  
**Dott. Ing. Vito Calio**  
Amministratore Unico  
4, Via San Girolamo  
70017 Putignano (BA)  
PEC: vito.calio@ingpec.eu

**MAYA ENGINEERING SRLS**  
4, Via San Girolamo  
70017 Putignano (BA)  
C.F./P.IVA 08365980724  
*Vito Calio*

(TIMBRO E FIRMA PER BENESTARE)

TECNICO SPECIALISTA

**Dott. Ing. Vito Calio**  
4, Via San Girolamo  
70017 Putignano (BA)  
M.: +39 328 4819015  
E.: v.calio@maya-eng.com  
PEC: vito.calio@ingpec.eu



(TIMBRO E FIRMA PER BENESTARE)

GESTORE RETE ELETTRICA

(TIMBRO E FIRMA PER BENESTARE)

RICHIEDENTE

**Brindisi Solar 3 s.r.l.**  
Via Antonio Francavilla 6  
San Vito dei Normanni BR  
P.IVA 02611120748

(TIMBRO E FIRMA PER BENESTARE)

# CABINA DI RACCORDO CAMPO FV STALLO

PIANTA

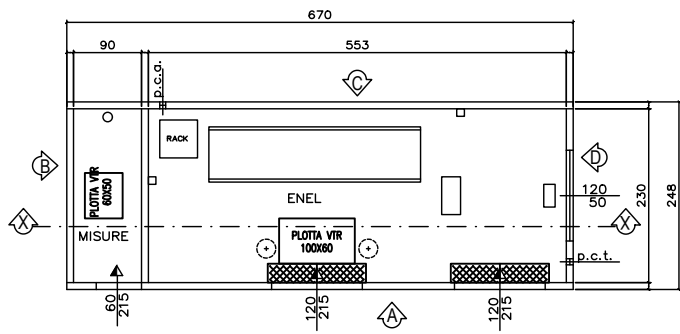

sezione X-X

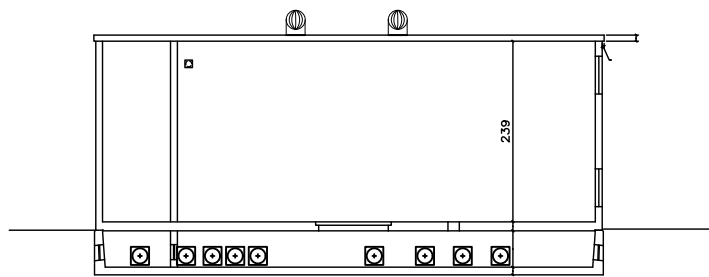

PIANTA COPERTURA SP. CM. 9

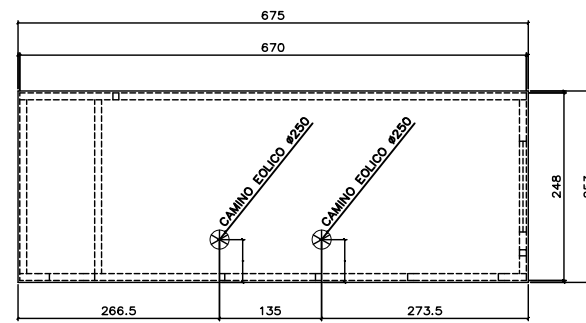

VISTA LATO A

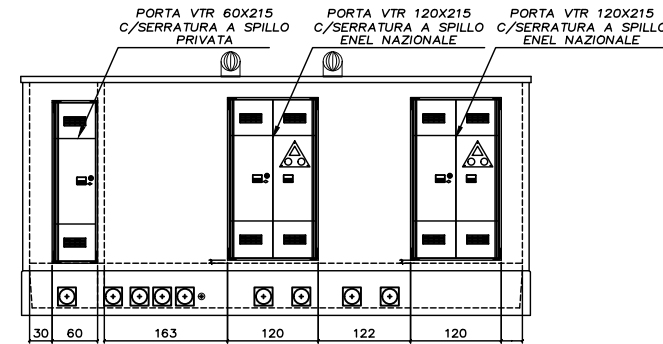

VISTA LATO C

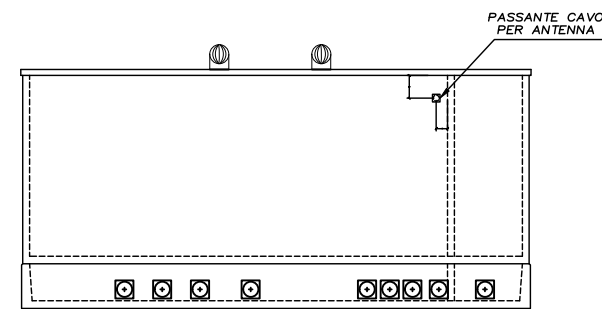

VISTA LATO B

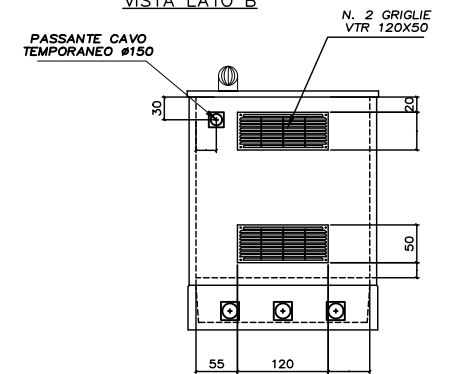

VISTA LATO D

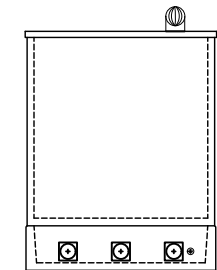

LEGENDA:

- PREFRATTURA  $\varnothing 200$
- CONNETTORE DI TERRA

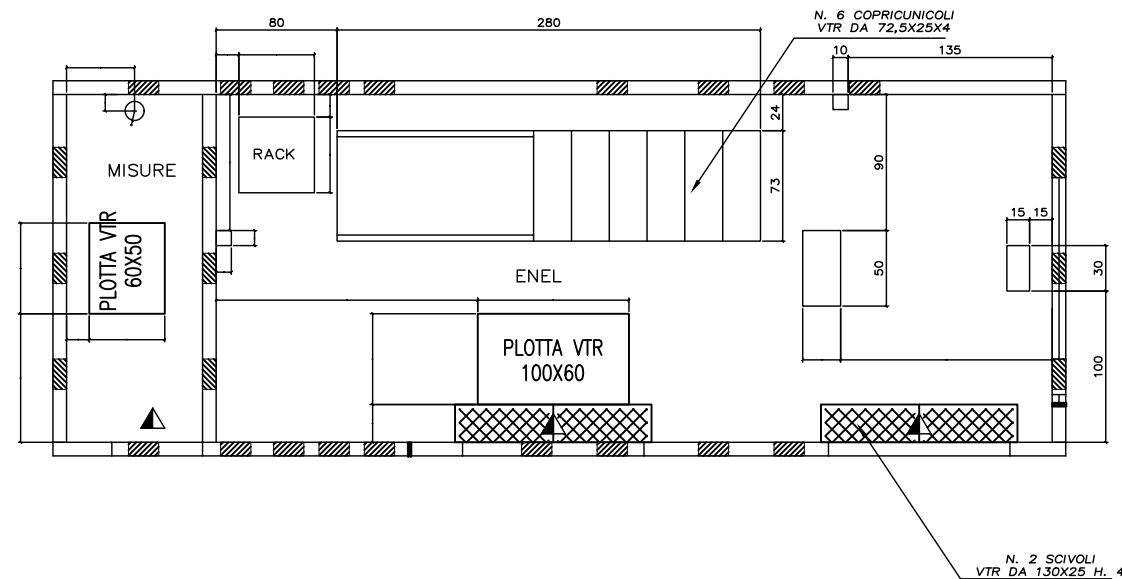

Rev No	Revision note	Date	Signature	Checked	Designe By
01	Piano tecnico	11.2020	IVC	N/A	N/A

**Vito Calio'**  
 Director  
 M: +39 328 4819015  
 E: [v.calio@maya-eng.com](mailto:v.calio@maya-eng.com)

TITLE/SUBJECT  
**PROGETTO DI STAZIONE UTENTE (SU) 150 KV  
 E OPERE DI CONNESSIONE ALLA  
 SE TERNA "BRINDISI SUD" 150/380 KV  
 Cod. Rint. 201900555  
 CABINA DI RACCORDO CAMPO FV - STALLO**

Date	Scale
11.2020	1:100
Version	Sheet
01	02
Maya Engineering Srls	