

NOTA
- Le sezioni si intendono rappresentate in direzione Gela.

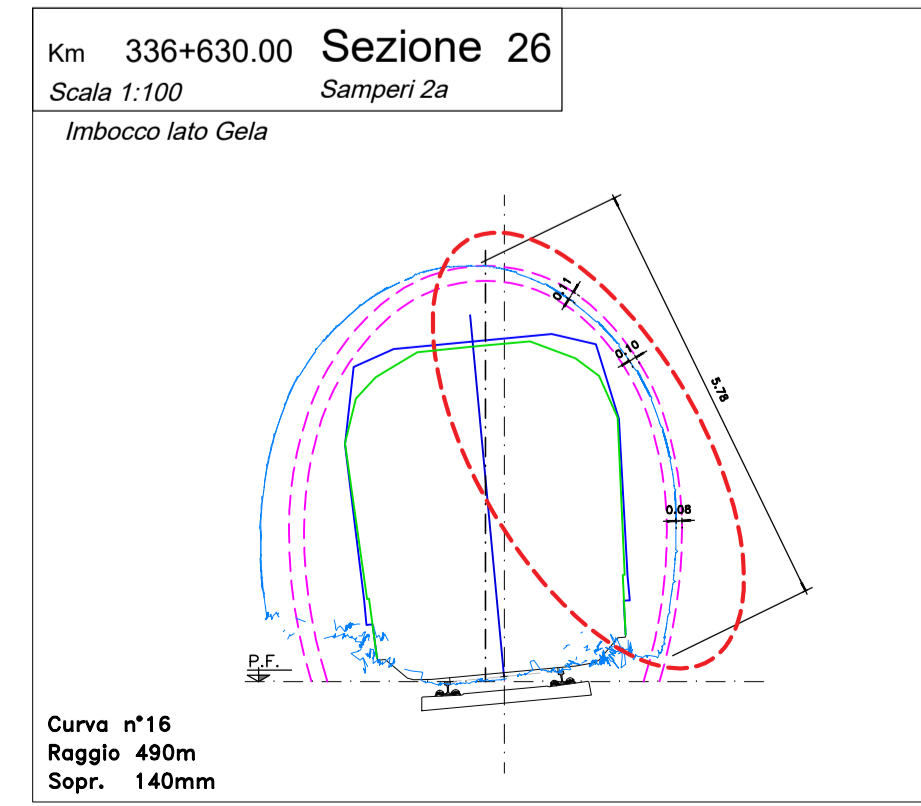
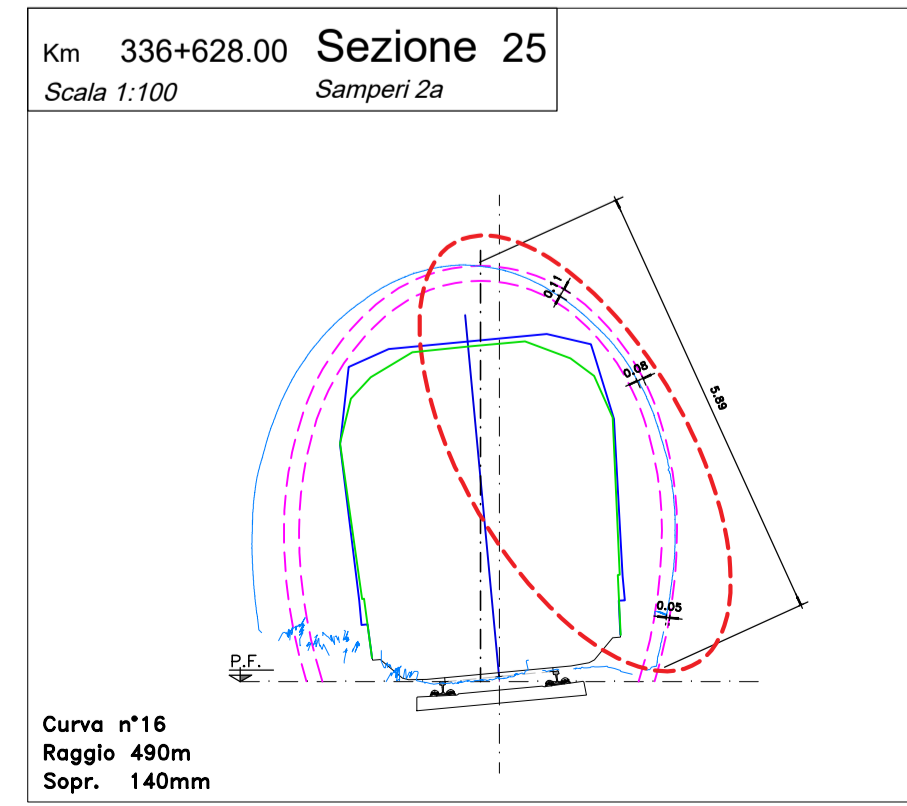
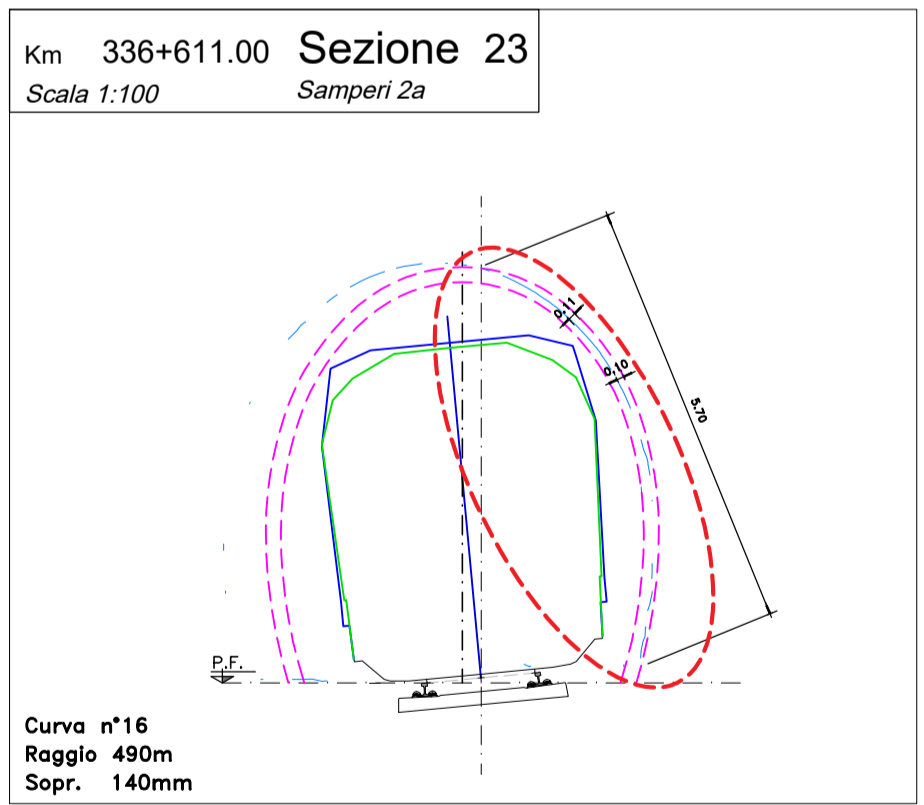
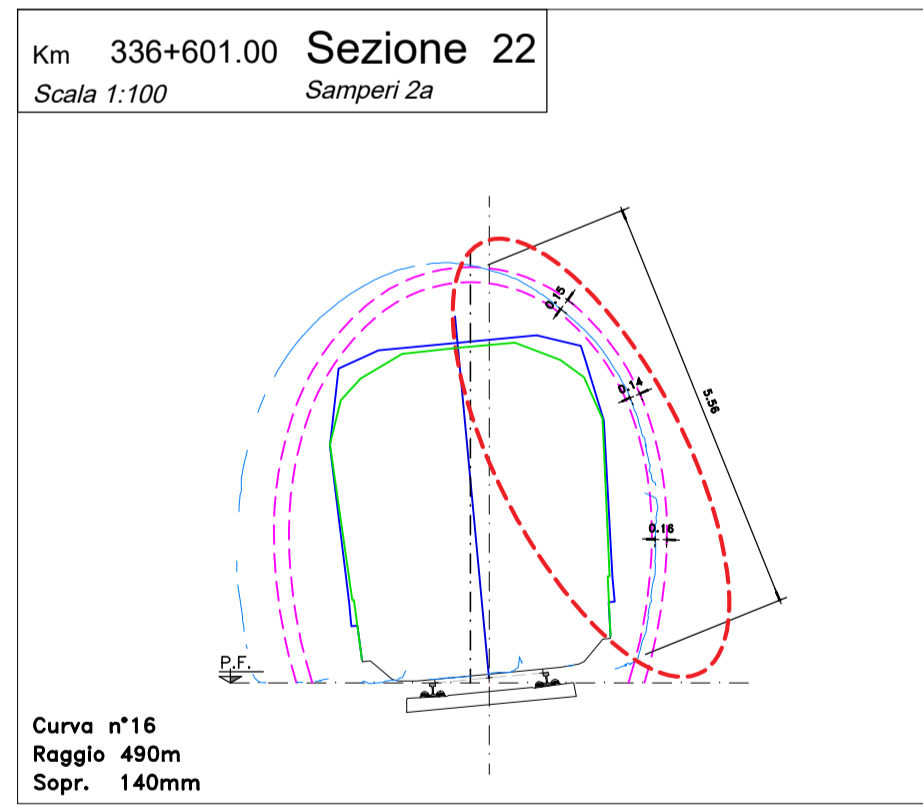
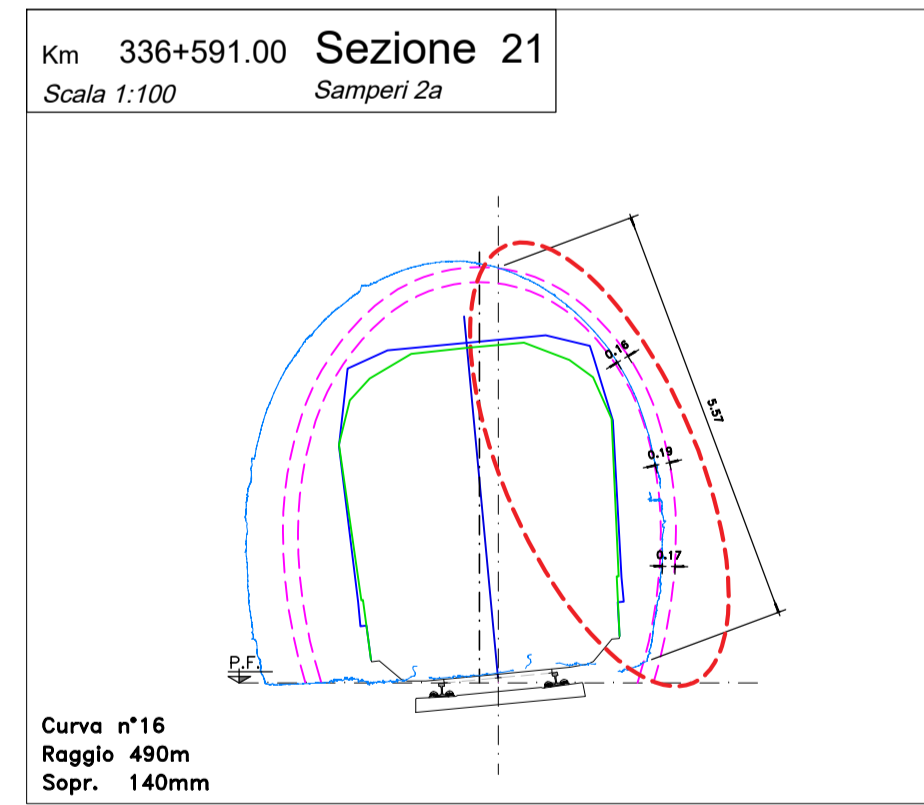
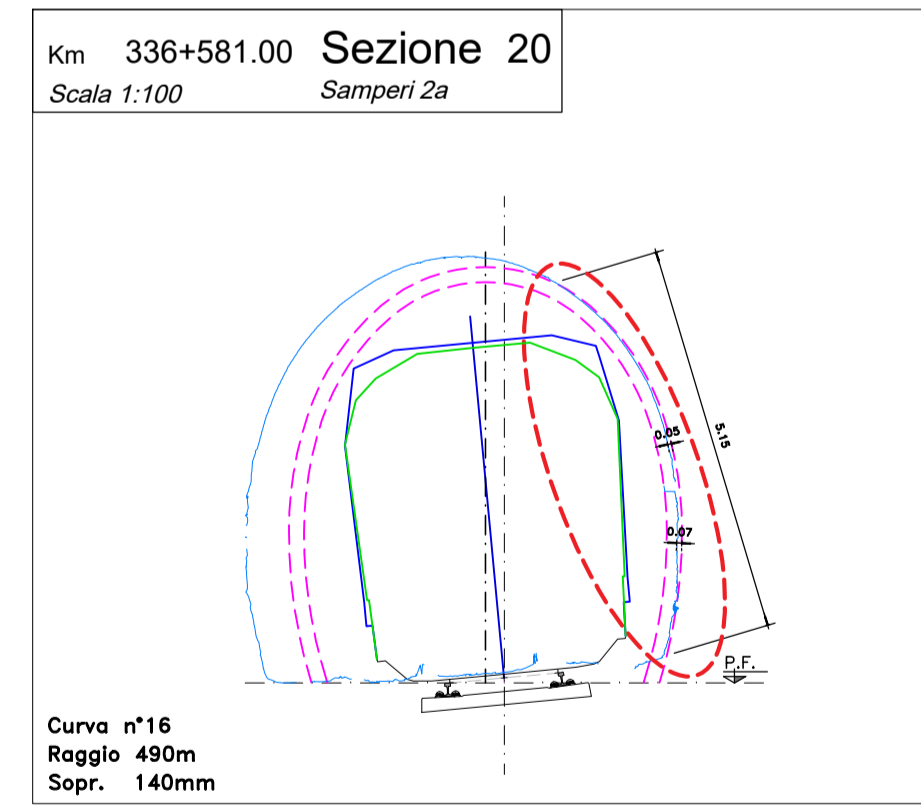
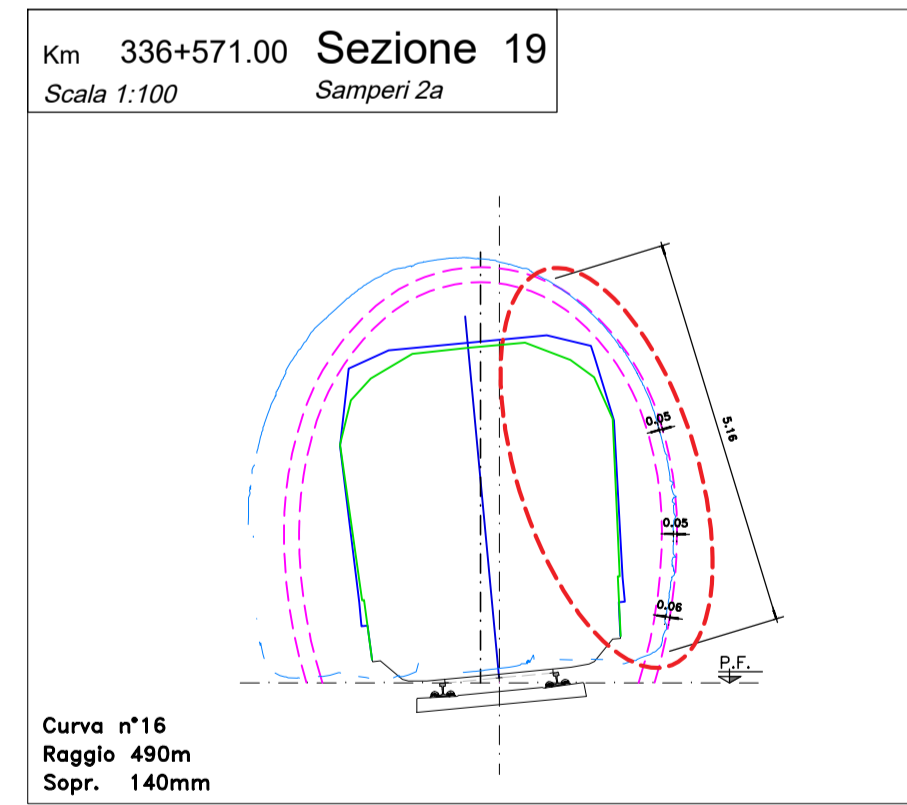
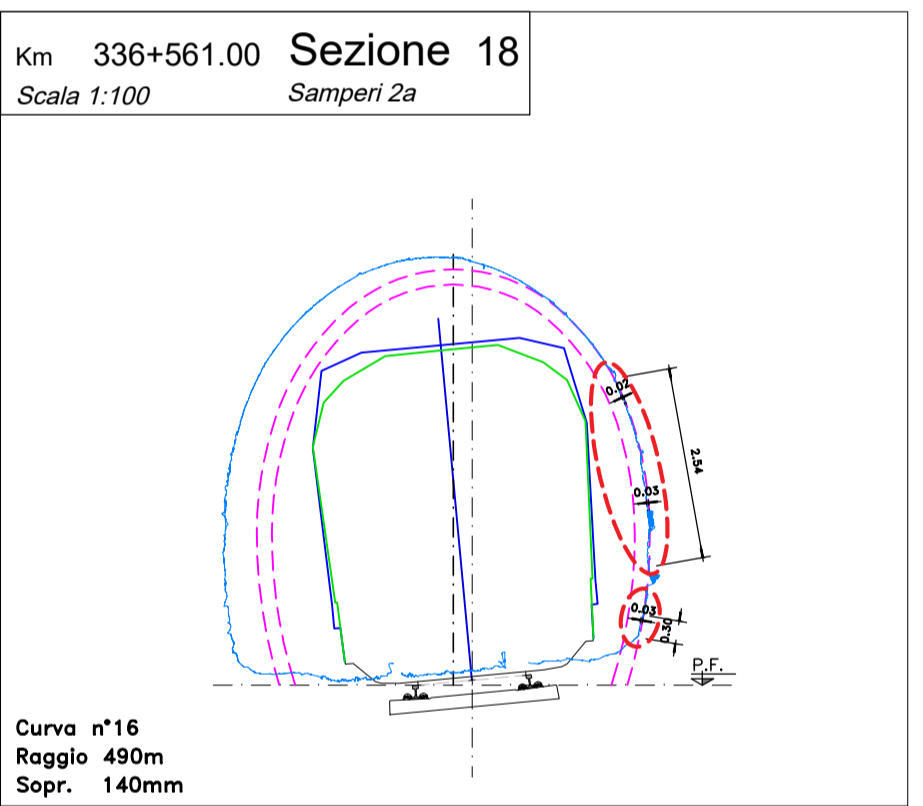
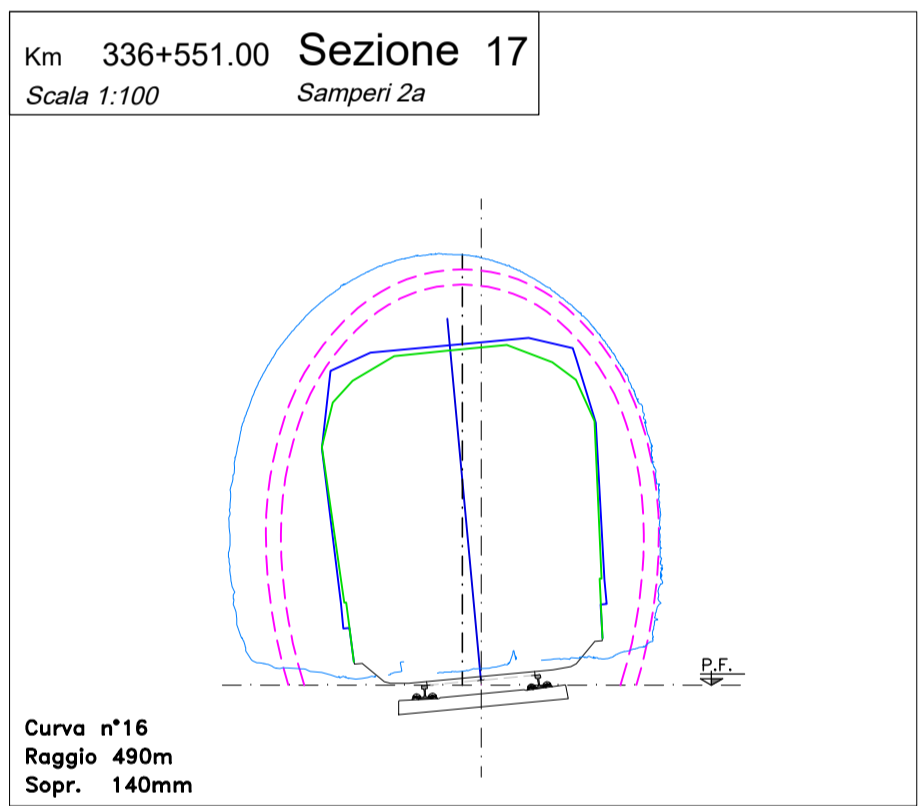
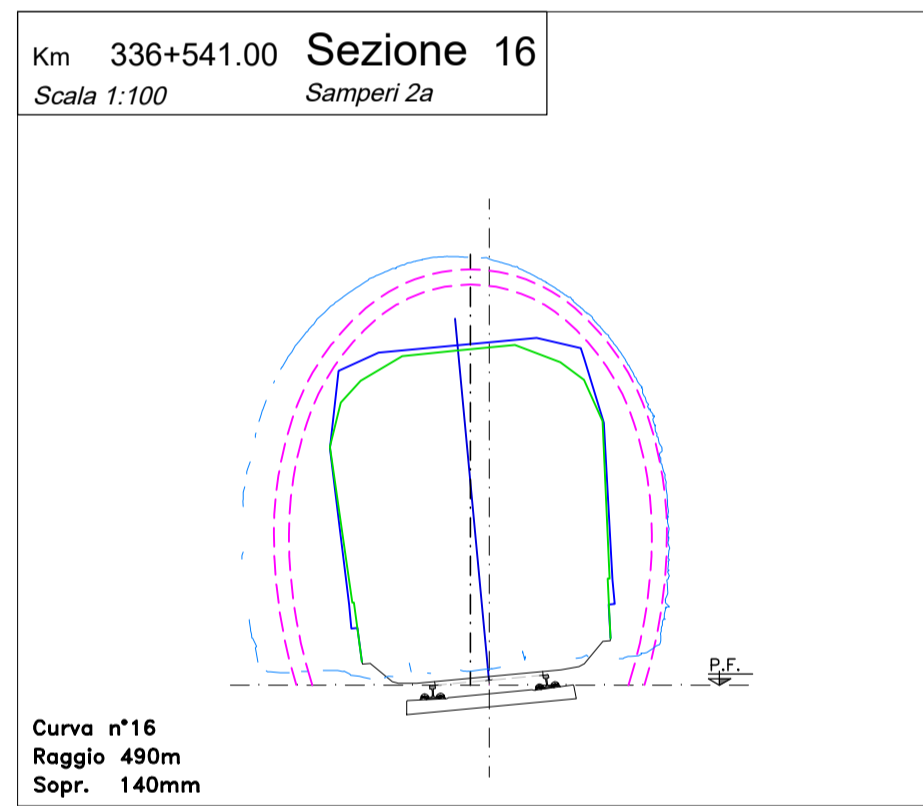
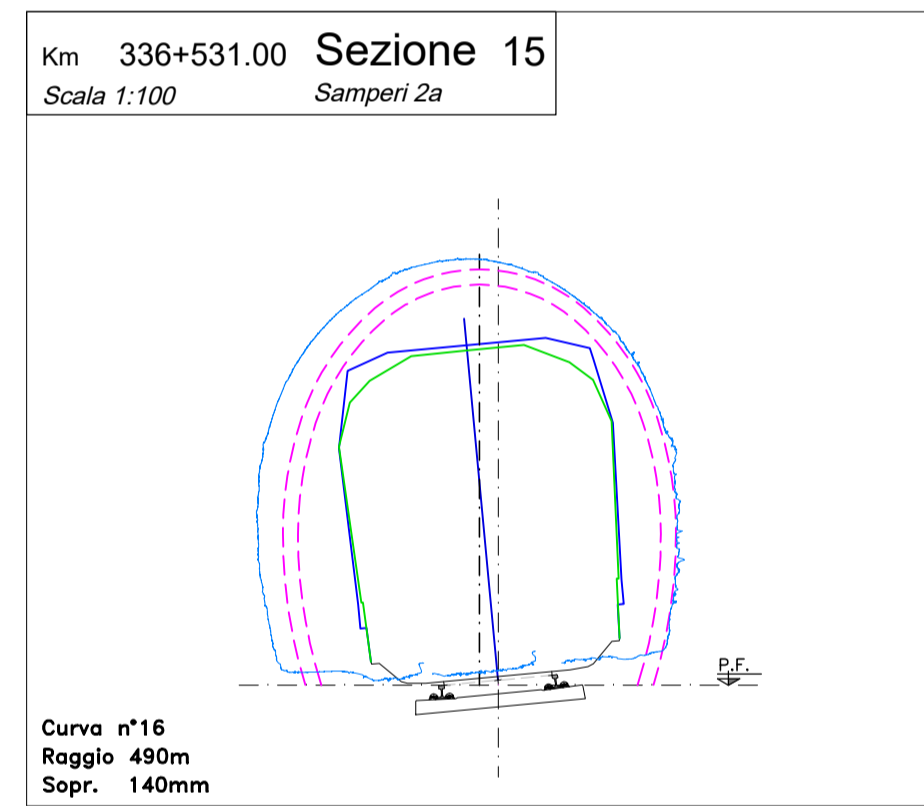
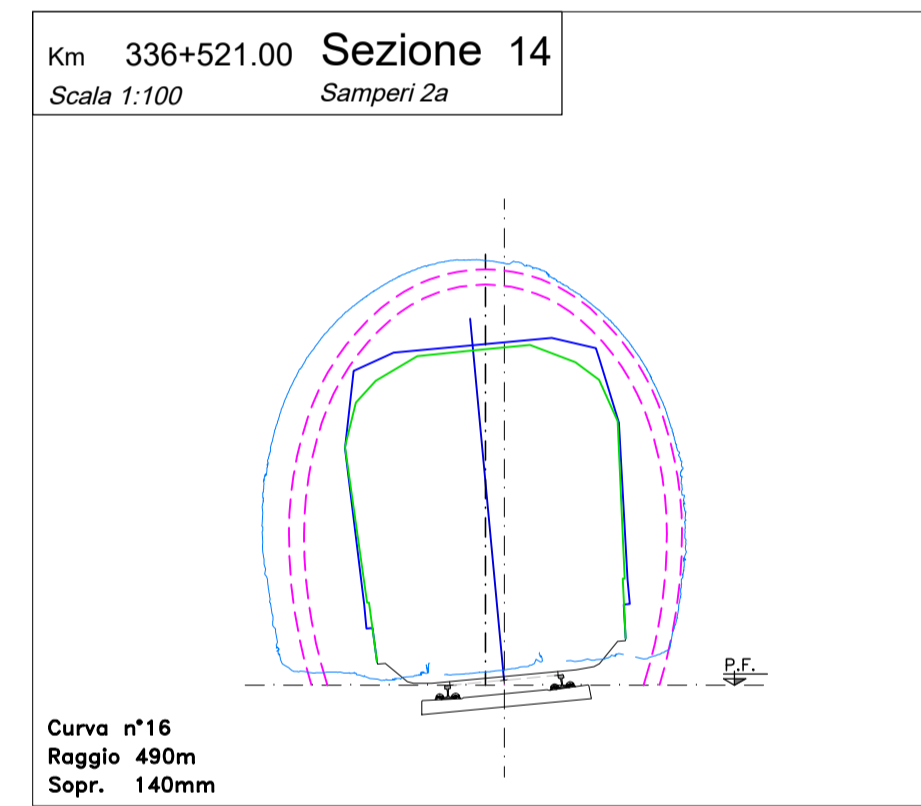
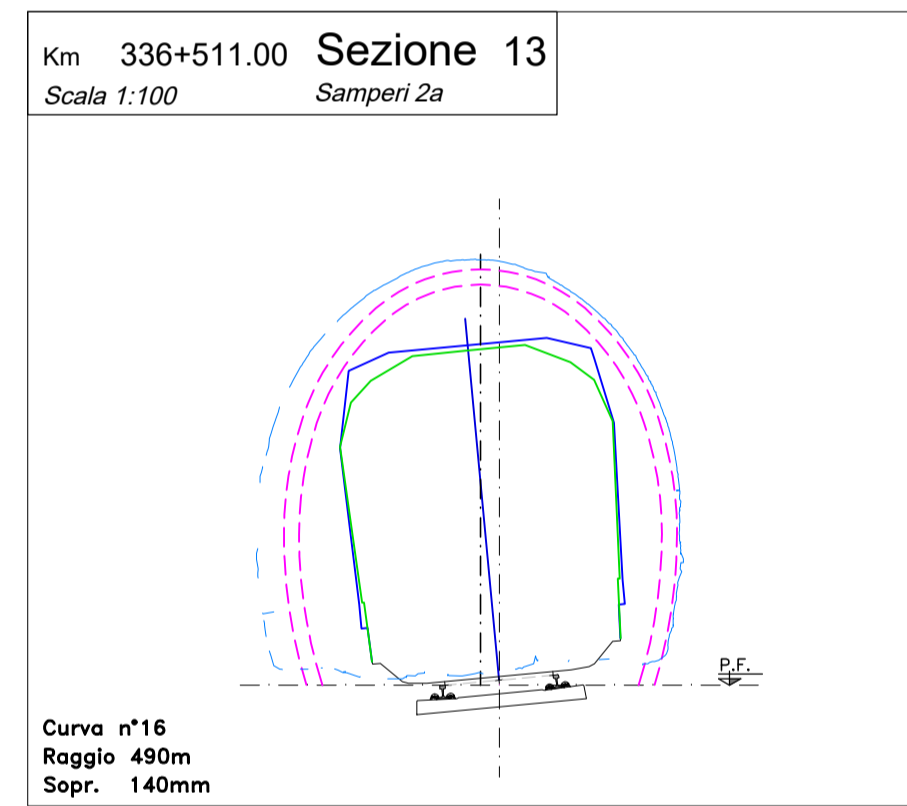
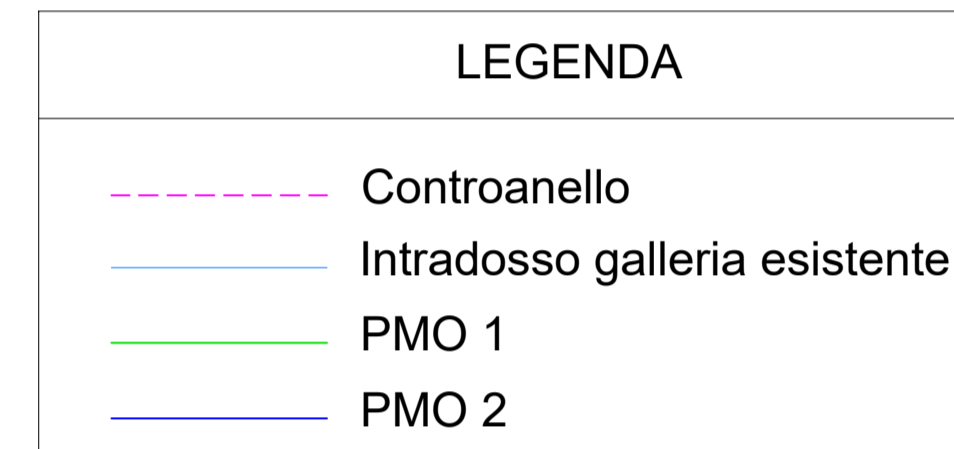

NOTA BENE
Le progressive associate a ciascuna sezione trasversale rappresentata sono relative alla progressiva storica del portale lato Caltagirone della galleria Samperi 2a, Pk 336+398.01 che corrisponde alla progressiva di progetto 336+378.724

COMMITTENTE:

PROGETTAZIONE:

LINEA FERROVIARIA CATANIA C.LE - GELA
TRATTA FERROVIARIA CALTAGIRONE - GELA
PROGETTO DI FATTIBILITA' TECNICO ECONOMICA
S. O. GALLERIE
RIPRISTINO TRATTA CALTAGIRONE - GELA
LOTTO 2: RIPRISTINO TRATTA NISCEMI - GELA

STUDIO INTERFERENZE
Galleria Samperi 2a

SCALA: 1:100

COMMESSA LOTTO FASE ENTE TIPO DOC. OPERA/DISCIPLINA PROGR. REV.
RS6K 00 R 07 WA GN0100 001 A

| Rev. | Descrizione | Redatto | Data | Verificato | Data | Approvato | Data | Autorizzato Data |
|------|----------------------|----------|-----------|------------|-----------|-----------|-----------|--------------------------|
| A | Emissione definitiva | M. Ricci | Agg. 2022 | M. Ricci | Agg. 2022 | P. Nigro | Agg. 2022 | A. Scuffi Agosto 2022 |

File: RS6K00R07WAGN0100001A.dwg n. Elab.: