



EGP CODE  
GRE.EEC.R.73.IT.W.15235.12.025.01

PAGE  
1 di/of 527

TITLE: RELAZIONE DI CALCOLO PRELIMINARE DELLE OPERE EDILI

AVAILABLE LANGUAGE: IT

**IMPIANTO EOLICO  
"ACQUAVIVA COLLECROCE"**  
Comuni di Acquaviva Collecroce (CB), San Felice del Molise (CB),  
Castelmauro (CB), Palata (CB), Tavenna (CB) e Montecilfone (CB)

**RELAZIONE DI CALCOLO PRELIMINARE DELLE OPERE EDILI**

Il Tecnico  
Ing. Leonardo Sblendido

File:GRE.EEC.R.73.IT.W.15235.12.025.01\_Relazione di calcolo preliminare delle opere edili.pdf

REV.	DATE	DESCRIPTION	PREPARED	VERIFIED	APPROVED
01	12/11/2021	EMISSIONE PER ITER AUTORIZZATIVO	G.Mattei	E.Speranza	L.Sblendido
00	01/06/2021	Prima Emissione	G.Mattei	E.Speranza	L.Sblendido

**EGP VALIDATION**

<i>Marco Porcellini/Alessio Provasi</i>	<i>Paolo Operti</i>	<i>Luciano Iacofano</i>
COLLABORATORS	VERIFIED BY	VALIDATED BY

PROJECT / PLANT ACQUAVIVA COLLECROCE EO	<b>EGP CODE</b>																		
	GROUP	FUNCION	TYPE	ISSUER	COUNTRY	TEC	PLANT	SYSTEM	PROGRESSIVE	REVISION									
	<b>GRE</b>	<b>EEC</b>	<b>R</b>	<b>7</b>	<b>3</b>	<b>I</b>	<b>T</b>	<b>W</b>	<b>1</b>	<b>5</b>	<b>2</b>	<b>3</b>	<b>5</b>	<b>1</b>	<b>2</b>	<b>0</b>	<b>2</b>	<b>4</b>	<b>0</b>
CLASSIFICATION					UTILIZATION SCOPE														

This document is property of Enel Green Power SPA. It is strictly forbidden to reproduce this document, in whole or in part, and to provide to others any related information without the previous written consent by Enel Green Power SPA.

## INDICE

1. PREMESSA .....	4
1.1. Descrizione generale dell'opera .....	4
1.2. Quadro normativo di riferimento adottato .....	5
1.3. Azioni di progetto sulla costruzione.....	5
1.4. Modello numerico .....	6
1.4.1. Informazioni sul codice di calcolo .....	6
1.5. Modellazione delle azioni .....	7
1.6. Combinazioni e/o percorsi di carico .....	7
1.7. Verifiche agli stati limite ultimi .....	8
1.8. Verifiche agli stati limite di esercizio .....	8
1.9. RELAZIONE SUI MATERIALI .....	8
2. NORMATIVA DI RIFERIMENTO .....	9
3. CARATTERISTICHE MATERIALI UTILIZZATI .....	14
3.1. LEGENDA TABELLA DATI MATERIALI.....	14
4. MODELLAZIONE DELLE SEZIONI .....	21
4.1. LEGENDA TABELLA DATI SEZIONI .....	21
5. MODELLAZIONE STRUTTURA: NODI .....	23
5.1. LEGENDA TABELLA DATI NODI .....	23
5.1.1. TABELLA DATI NODI .....	23
6. MODELLAZIONE STRUTTURA: ELEMENTI TRAVE.....	30
6.1. TABELLA DATI TRAVI.....	30
7. MODELLAZIONE STRUTTURA: ELEMENTI SHELL .....	34
7.1. LEGENDA TABELLA DATI SHELL .....	34
8. MODELLAZIONE DELLA STRUTTURA: ELEMENTI SOLAIO-PANNELLO .....	51
8.1. LEGENDA TABELLA DATI SOLAI-PANNELLI .....	51
9. MODELLAZIONE DELLE AZIONI.....	55
9.1. LEGENDA TABELLA DATI AZIONI.....	55
10. SCHEMATIZZAZIONE DEI CASI DI CARICO .....	58
10.1. LEGENDA TABELLA CASI DI CARICO.....	58
11. DEFINIZIONE DELLE COMBINAZIONI .....	66
11.1. LEGENDA TABELLA COMBINAZIONI DI CARICO.....	66
12. AZIONE SISMICA.....	70
12.1. VALUTAZIONE DELL' AZIONE SISMICA .....	70
12.1.1. Parametri della struttura .....	70
13. RISULTATI ANALISI SISMICHE .....	71
13.1. LEGENDA TABELLA ANALISI SISMICHE .....	71
14. RISULTATI NODALI.....	82
14.1. LEGENDA RISULTATI NODALI .....	82
15. RISULTATI OPERE DI FONDAZIONE .....	257
15.1. LEGENDA RISULTATI OPERE DI FONDAZIONE.....	257
16. RISULTATI ELEMENTI TIPO TRAVE .....	279



EGP CODE

GRE.EEC.R.73.IT.W.15235.12.024.01

PAGE

3 di/of 527

16.1.	LEGENDA RISULTATI ELEMENTI TIPO TRAVE .....	279
17.	RISULTATI ELEMENTI TIPO SHELL .....	330
17.1.	LEGENDA RISULTATI ELEMENTI TIPO SHELL .....	330
18.	VERIFICHE ELEMENTI TRAVE E/O PILASTRO IN C.A. ....	458
18.1.	LEGENDA TABELLA VERIFICHE ELEMENTI TRAVE E/O PILASTRO IN C.A. ....	458
18.2.	PROGETTAZIONE DELLE FONDAZIONI .....	459
19.	VERIFICHE ELEMENTI PARETE E/O GUSCIO IN C.A. ....	472
19.1.	LEGENDA TABELLA VERIFICHE ELEMENTI PARETE E GUSCIO IN C.A. ....	472
19.2.	PROGETTAZIONE DELLE FONDAZIONI .....	475
20.	STATI LIMITE D' ESERCIZIO .....	510
20.1.	LEGENDA TABELLA STATI LIMITE D' ESERCIZIO .....	510
21.	CONCLUSIONI.....	527

## 1. Premessa

La presente relazione preliminare di calcolo strutturale, in conformità al §10.1 del DM 17/01/18, è comprensiva di una descrizione generale dell'opera e dei criteri generali di analisi e verifica. Segue inoltre le indicazioni fornite al §10.2 del DM stesso per quanto concerne analisi e verifiche svolte con l'ausilio di codici di calcolo.

Nella presente parte sono riportati i principali elementi di inquadramento del progetto definitivo riguardante le strutture ed alle prestazioni attese dalla struttura.

### 1.1. Descrizione generale dell'opera

L'opera oggetto delle verifiche strutturali di questa relazione, è l'edificio di stazione annesso all'impianto Eolico "Acquaviva Collecroce" proposto da Enel Green Power S.p.A., nei Comuni di Acquaviva Collecroce, Castelmauro, Palata, San Felice del Molise e Montecilfone, tutti in provincia di Campobasso (CB). La Stazione 150/33 kV sarà ubicata nel Comune di Montecilfone. L'edificio in esame è costituito da una struttura monopiano a telaio in cemento armato gettato in opera. Il solaio di copertura è di tipo laterocemento mentre le tamponature sono in blocchi di laterizio.



Figura 1:Pianta Edificio di stazione.



### Descrizione generale dell'opera

Fabbricato ad uso	
Ubicazione	Comune di MONTECILFONE (CB) (Regione MOLISE) Località MONTECILFONE (CB)

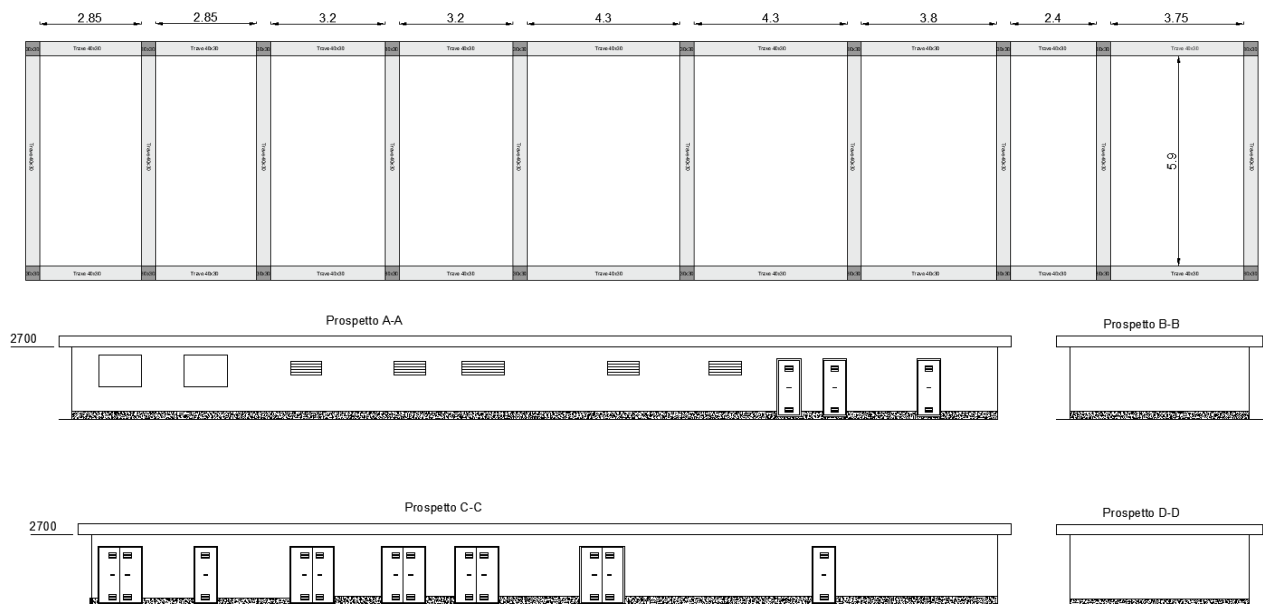
### Principali caratteristiche della struttura

Struttura regolare in pianta	
Struttura regolare in altezza	
Classe di duttilità	
Travi: ricalate o in spessore	
Pilastr	
Pilastr in falso	
Tipo di fondazione	
Condizioni per cui è necessario considerare la componente verticale del sisma	

### Parametri della struttura

Classe d'uso	Vita Vn [anni]	Coeff. Uso	Periodo Vr [anni]
II	50.0	1.0	50.0

### Fattore di struttura/comportamento

Edificio in Elevazione:

qSLU x=3.3

qSLU y=3.3

Fondazione:

q=1

### 1.2. Quadro normativo di riferimento adottato

Le norme ed i documenti assunti quale riferimento per la progettazione strutturale vengono indicati di seguito. Nel capitolo "normativa di riferimento" è comunque presente l'elenco completo delle normative disponibili.

### Progetto-verifica degli elementi

Progetto cemento armato	D.M. 17-01-2018
Progetto acciaio	D.M. 17-01-2018
Progetto legno	D.M. 17-01-2018
Progetto muratura	D.M. 17-01-2018
<b>Azione sismica</b>	
Norma applicata per l' azione sismica	D.M. 17-01-2018

### 1.3. Azioni di progetto sulla costruzione

Nei capitoli "modellazione delle azioni" e "schematizzazione dei casi di carico" sono indicate le azioni sulla costruzioni.

Nel prosieguo si indicano tipo di analisi strutturale condotta (statico,dinamico, lineare o non lineare) e il metodo adottato per la risoluzione del problema strutturale nonché le metodologie seguite per la verifica o per il progetto-verifica delle sezioni. Si riportano le combinazioni di carico adottate e, nel caso di calcoli non lineari, i percorsi di carico seguiti; le configurazioni studiate per la struttura in esame *sono risultate effettivamente esaustive per la progettazione-verifica.*

La verifica della sicurezza degli elementi strutturali avviene con i metodi della scienza delle costruzioni. L'analisi strutturale è condotta con il metodo degli spostamenti per la valutazione dello stato tensodeformativo indotto da carichi statici. L'analisi strutturale è condotta con il metodo dell'analisi modale e dello spettro di risposta in termini di accelerazione per la valutazione dello stato tensodeformativo indotto da carichi dinamici (tra cui quelli di tipo sismico).

L'analisi strutturale viene effettuata con il metodo degli elementi finiti. Il metodo sopraindicato si basa sulla schematizzazione della struttura in elementi connessi solo in corrispondenza di un numero prefissato di punti denominati nodi. I nodi sono definiti dalle tre coordinate cartesiane in un sistema di riferimento globale. Le incognite del problema (nell'ambito del metodo degli spostamenti) sono le componenti di spostamento dei nodi riferite al sistema di riferimento globale (traslazioni secondo X, Y, Z, rotazioni attorno X, Y, Z). La soluzione del problema si ottiene con un sistema di equazioni algebriche lineari i cui termini noti sono costituiti dai carichi agenti sulla struttura opportunamente concentrati ai nodi:

$$\mathbf{K} * \mathbf{u} = \mathbf{F}$$

dove  $\mathbf{K}$  = matrice di rigidezza  
 $\mathbf{u}$  = vettore spostamenti nodali  
 $\mathbf{F}$  = vettore forze nodali

Dagli spostamenti ottenuti con la risoluzione del sistema vengono quindi dedotte le sollecitazioni e/o le tensioni di ogni elemento, riferite generalmente ad una terna locale all'elemento stesso.

Il sistema di riferimento utilizzato è costituito da una terna cartesiana destrorsa XYZ. Si assume l'asse Z verticale ed orientato verso l'alto. Gli elementi utilizzati per la modellazione dello schema statico della struttura sono i seguenti:

- Elemento tipo **TRUSS** (biella-D2)
- Elemento tipo **BEAM** (trave-D2)
- Elemento tipo **MEMBRANE** (membrana-D3)
- Elemento tipo **PLATE** (piastra-guscio-D3)
- Elemento tipo **BOUNDARY** (molla)

Elemento tipo **STIFFNESS** (matrice di rigidezza)  
 Elemento tipo **BRICK** (elemento solido)  
 Elemento tipo **SOLAIO** (macro elemento composto da più membrane)

#### 1.4. Modello numerico

In questa parte viene descritto il modello numerico utilizzato (o i modelli numerici utilizzati) per l'analisi della struttura. La presentazione delle informazioni deve essere, coerentemente con le prescrizioni del paragrafo 10.2 e relativi sottoparagrafi delle NTC-18, tale da garantirne la leggibilità, la corretta interpretazione e la riproducibilità

##### Tipo di analisi strutturale

Carichi verticali	SI
Statica non lineare	NO
Sismica statica lineare	NO
Sismica dinamica lineare	SI
Sismica statica non lineare (prop. masse)	NO
Sismica statica non lineare (prop. modo)	NO
Sismica statica non lineare (triangolare)	NO
Non linearità geometriche (fattore P delta)	NO

Di seguito si indicano l'origine e le caratteristiche dei codici di calcolo utilizzati riportando titolo, produttore e distributore, versione, estremi della licenza d'uso:

##### 1.4.1. Informazioni sul codice di calcolo

Titolo:	PRO_SAP PROfessional Structural Analysis Program
Versione:	PROFESSIONAL (build 2020-01-187)
Produttore-Distributore:	2S.I. Software e Servizi per l'Ingegneria s.r.l., Ferrara
Codice Licenza:	Licenza dsi5451

Un attento esame preliminare della documentazione a corredo del software **ha consentito di valutarne l'affidabilità e soprattutto l'idoneità al caso specifico**. La documentazione, fornita dal produttore e distributore del software, contiene una esauriente descrizione delle basi teoriche e degli algoritmi impiegati, l'individuazione dei campi d'impiego, nonché casi prova interamente risolti e commentati, corredati dei file di input necessari a riprodurre l'elaborazione:

##### Affidabilità dei codici utilizzati

2S.I. ha verificato l'affidabilità e la robustezza del codice di calcolo attraverso un numero significativo di casi prova in cui i risultati dell'analisi numerica sono stati confrontati con soluzioni teoriche.

E' possibile reperire la documentazione contenente alcuni dei più significativi casi trattati al seguente link:  
<https://www.2si.it/it/prodotti/affidabilita/>

##### Modellazione della geometria e proprietà meccaniche:

nodi	1222
elementi D2 (per aste, travi, pilastri...)	50
elementi D3 (per pareti, platee, gusci...)	1110
elementi solaio	29
elementi solidi	0

##### Dimensione del modello strutturale [cm]:

X min =	-50.00
Xmax =	3475.79
Ymin =	-50.00
Ymax =	680.00
Zmin =	0.00
Zmax =	300.00

##### Strutture verticali:

Elementi di tipo asta	NO
Pilastri	SI
Pareti	NO
Setti (a comportamento membranale)	NO

##### Strutture non verticali:

Elementi di tipo asta	NO
Travi	SI

Gusci	NO
Membrane	NO
<b>Orizzontamenti:</b>	
Solai con la proprietà piano rigido	NO
Solai senza la proprietà piano rigido	SI
<b>Tipo di vincoli:</b>	
Nodi vincolati rigidamente	NO
Nodi vincolati elasticamente	NO
Nodi con isolatori sismici	NO
Fondazioni puntuali (plinti/plinti su palo)	NO
Fondazioni di tipo trave	NO
Fondazioni di tipo platea	SI
Fondazioni con elementi solidi	NO

### 1.5. Modellazione delle azioni

Si veda il capitolo **“Schematizzazione dei casi di carico”** per le informazioni necessarie alla comprensione ed alla ricostruzione delle azioni applicate al modello numerico, coerentemente con quanto indicato nella parte **“2.6. Azioni di progetto sulla costruzione”**.

### 1.6. Combinazioni e/o percorsi di carico

Si veda il capitolo **“Definizione delle combinazioni”** in cui sono indicate le combinazioni di carico adottate e, nel caso di calcoli non lineari, i percorsi di carico seguiti.

#### Combinazioni dei casi di carico

APPROCCIO PROGETTUALE	Approccio 2
Tensioni ammissibili	NO
SLU	SI
SLV (SLU con sisma)	SI
SLC	NO
SLD	SI
SLO	NO
SLU GEO A2 (per approccio 1)	NO
SLU EQU	NO
Combinazione caratteristica (rara)	SI
Combinazione frequente	SI
Combinazione quasi permanente (SLE)	SI
SLA (accidentale quale incendio)	NO

#### Principali risultati

I risultati devono costituire una sintesi completa ed efficace, presentata in modo da riassumere il comportamento della struttura, per ogni tipo di analisi svolta.

Nella presente relazione di calcolo sono riportati i seguenti risultati che il progettista ritiene di interesse per la descrizione e la comprensione del/i modello/i e del comportamento della struttura:

per l'analisi modale:

- periodi dei modi di vibrare della struttura
- masse eccitate dai singoli modi
- massa eccitata totale

deformate e sollecitazioni:

- spostamenti e rotazioni dei singoli nodi della struttura
- reazioni vincolari (nel caso siano presenti nodi vincolati rigidamente)
- pressioni sul terreno (nel caso siano presenti elementi di fondazione)
- sollecitazioni sugli elementi d2 nelle combinazioni di calcolo più significative
- tensioni sugli elementi d3 nelle combinazioni di calcolo più significative
- sollecitazioni sui macroelementi da elementi d3 nelle combinazioni di calcolo più significative

La presente relazione, oltre ad illustrare in modo esaustivo i dati in ingresso ed i risultati delle analisi in forma tabellare, riporta una serie di immagini:

per i dati in ingresso:

- modello solido della struttura
- numerazione di nodi e ed elementi
- configurazioni di carico statiche
- configurazioni di carico sismiche con baricentri delle masse e eccentricità

per le combinazioni più significative (statisticamente più gravose per la struttura):

- configurazioni deformate
- diagrammi e involuppi delle azioni interne

- mappe delle tensioni
- reazioni vincolari
- mappe delle pressioni sul terreno

per il progetto-verifica degli elementi:

- diagrammi di armatura
- percentuali di sfruttamento
- mappe delle verifiche più significative per i vari stati limite

#### **Informazioni generali sull'elaborazione e giudizio motivato di accettabilità dei risultati.**

Il programma prevede una serie di controlli automatici (check) che consentono l'individuazione di errori di modellazione. Al termine dell'analisi un controllo automatico identifica la presenza di spostamenti o rotazioni abnormi. Si può pertanto asserire che l'elaborazione sia corretta e completa. I risultati delle elaborazioni sono stati sottoposti a controlli che ne comprovano l'attendibilità. Tale valutazione ha compreso il confronto con i risultati di semplici calcoli, eseguiti con metodi tradizionali e adottati, anche in fase di primo proporzionamento della struttura. Inoltre, sulla base di considerazioni riguardanti gli stati tensionali e deformativi determinati, si è valutata la validità delle scelte operate in sede di schematizzazione e di modellazione della struttura e delle azioni. Si allega al termine della presente relazione elenco sintetico dei controlli svolti (verifiche di equilibrio tra reazioni vincolari e carichi applicati, comparazioni tra i risultati delle analisi e quelli di valutazioni semplificate, etc.) .

#### **1.7. Verifiche agli stati limite ultimi**

Nel capitolo relativo alla progettazione degli elementi strutturali agli SLU vengono indicate, con riferimento alla normativa adottata, le modalità ed i criteri seguiti per valutare la sicurezza della struttura nei confronti delle possibili situazioni di crisi ed i risultati delle valutazioni svolte. In via generale, oltre alle verifiche di resistenza e di spostamento, devono essere prese in considerazione verifiche nei confronti dei fenomeni di instabilità, locale e globale, di fatica, di duttilità, di degrado.

#### **1.8. Verifiche agli stati limite di esercizio**

Nel capitolo relativo alla progettazione degli elementi strutturali agli SLE vengono indicate, con riferimento alla normativa adottata, le modalità seguite per valutare l'affidabilità della struttura nei confronti delle possibili situazioni di perdita di funzionalità (per eccessive deformazioni, fessurazioni, vibrazioni, etc.) ed i risultati delle valutazioni svolte.

#### **1.9. RELAZIONE SUI MATERIALI**

Il capitolo Materiali riporta informazioni esaustive relative all'elenco dei materiali impiegati e loro modalità di posa in opera e ai valori di calcolo.

## 2. NORMATIVA DI RIFERIMENTO

1. D.Min. Infrastrutture Min. Interni e Prot. Civile 17 Gennaio 2018 e allegate "Norme tecniche per le costruzioni".
2. Circolare 21/01/19, n. 7 C.S.LL.PP "Istruzioni per l'applicazione dell'aggiornamento delle Norme Tecniche delle Costruzioni di cui al decreto ministeriale 17 gennaio 2018"
3. D.Min. Infrastrutture e trasporti 14 Settembre 2005 e allegate "Norme tecniche per le costruzioni".
4. D.M. LL.PP. 9 Gennaio 1996 "Norme tecniche per il calcolo, l'esecuzione ed il collaudo delle strutture in cemento armato, normale e precompresso e per le strutture metalliche".
5. D.M. LL.PP. 16 Gennaio 1996 "Norme tecniche relative ai <<Criteri generali per la verifica di sicurezza delle costruzioni e dei carichi e sovraccarichi>>".
6. D.M. LL.PP. 16 Gennaio 1996 "Norme tecniche per le costruzioni in zone sismiche".
7. Circolare 4/07/96, n.156AA.GG./STC. istruzioni per l'applicazione delle "Norme tecniche relative ai <<Criteri generali per la verifica di sicurezza delle costruzioni e dei carichi e sovraccarichi>>" di cui al D.M. 16/01/96.
8. Circolare 10/04/97, n.65AA.GG. istruzioni per l'applicazione delle "Norme tecniche per le costruzioni in zone sismiche" di cui al D.M. 16/01/96.
9. D.M. LL.PP. 20 Novembre 1987 "Norme tecniche per la progettazione, esecuzione e collaudo degli edifici in muratura e per il loro consolidamento".
10. Circolare 4 Gennaio 1989 n. 30787 "Istruzioni in merito alle norme tecniche per la progettazione, esecuzione e collaudo degli edifici in muratura e per il loro consolidamento".
11. D.M. LL.PP. 11 Marzo 1988 "Norme tecniche riguardanti le indagini sui terreni e sulle rocce, la stabilità dei pendii naturali e delle scarpate, i criteri generali e le prescrizioni per la progettazione, l'esecuzione e il collaudo delle opere di sostegno delle terre e delle opere di fondazione".
12. D.M. LL.PP. 3 Dicembre 1987 "Norme tecniche per la progettazione, esecuzione e collaudo delle costruzioni prefabbricate".
13. UNI 9502 - Procedimento analitico per valutare la resistenza al fuoco degli elementi costruttivi di conglomerato cementizio armato, normale e precompresso - edizione maggio 2001
14. Ordinanza del Presidente del Consiglio dei Ministri n. 3274 del 20 marzo 2003 "Primi elementi in materia di criteri generali per la classificazione sismica del territorio nazionale e di normative tecniche per le costruzioni in zona sismica" e successive modificazioni e integrazioni.
15. UNI EN 1990:2006 13/04/2006 Eurocodice 0 - Criteri generali di progettazione strutturale.
16. UNI EN 1991-1-1:2004 01/08/2004 Eurocodice 1 - Azioni sulle strutture - Parte 1-1: Azioni in generale - Pesi per unità di volume, pesi propri e sovraccarichi per gli edifici.
17. UNI EN 1991-2:2005 01/03/2005 Eurocodice 1 - Azioni sulle strutture - Parte 2: Carichi da traffico sui ponti.
18. UNI EN 1991-1-3:2004 01/10/2004 Eurocodice 1 - Azioni sulle strutture - Parte 1-3: Azioni in generale - Carichi da neve.
19. UNI EN 1991-1-4:2005 01/07/2005 Eurocodice 1 - Azioni sulle strutture - Parte 1-4: Azioni in generale - Azioni del vento.
20. UNI EN 1991-1-5:2004 01/10/2004 Eurocodice 1 - Azioni sulle strutture - Parte 1-5: Azioni in generale - Azioni termiche.
21. UNI EN 1992-1-1:2005 24/11/2005 Eurocodice 2 - Progettazione delle strutture di calcestruzzo - Parte 1-1: Regole generali e regole per gli edifici.
22. UNI EN 1992-1-2:2005 01/04/2005 Eurocodice 2 - Progettazione delle strutture di calcestruzzo - Parte 1-2: Regole generali - Progettazione strutturale contro l'incendio.
23. UNI EN 1993-1-1:2005 01/08/2005 Eurocodice 3 - Progettazione delle strutture di acciaio - Parte 1-1: Regole generali e regole per gli edifici.
24. UNI EN 1993-1-8:2005 01/08/2005 Eurocodice 3 - Progettazione delle strutture di acciaio - Parte 1-8: Progettazione dei collegamenti.
25. UNI EN 1994-1-1:2005 01/03/2005 Eurocodice 4 - Progettazione delle strutture composte acciaio-calcestruzzo - Parte 1-1: Regole generali e regole per gli edifici.
26. UNI EN 1994-2:2006 12/01/2006 Eurocodice 4 - Progettazione delle strutture composte acciaio-calcestruzzo - Parte 2: Regole generali e regole per i ponti.
27. UNI EN 1995-1-1:2005 01/02/2005 Eurocodice 5 - Progettazione delle strutture di legno - Parte 1-1: Regole generali - Regole comuni e regole per gli edifici.
28. UNI EN 1995-2:2005 01/01/2005 Eurocodice 5 - Progettazione delle strutture di legno - Parte 2: Ponti.
29. UNI EN 1996-1-1:2006 26/01/2006 Eurocodice 6 - Progettazione delle strutture di muratura - Parte 1-1: Regole generali per strutture di muratura armata e non armata.
30. UNI EN 1996-3:2006 09/03/2006 Eurocodice 6 - Progettazione delle strutture di muratura - Parte 3: Metodi di calcolo semplificato per strutture di muratura non armata.



- 31. UNI EN 1997-1:2005 01/02/2005 Eurocodice 7 - Progettazione geotecnica - Parte 1: Regole generali.
- 32. UNI EN 1998-1:2005 01/03/2005 Eurocodice 8 - Progettazione delle strutture per la resistenza sismica - Parte 1: Regole generali, azioni sismiche e regole per gli edifici.
- 33. UNI EN 1998-3:2005 01/08/2005 Eurocodice 8 - Progettazione delle strutture per la resistenza sismica - Parte 3: Valutazione e adeguamento degli edifici.
- 34. UNI EN 1998-5:2005 01/01/2005 Eurocodice 8 - Progettazione delle strutture per la resistenza sismica - Parte 5: Fondazioni, strutture di contenimento ed aspetti geotecnici.

**NOTA il capitolo "normativa di riferimento": riporta l'elenco delle normative implementate nel software. Le norme utilizzate per la struttura oggetto della presente relazione sono indicate nel precedente capitolo "RELAZIONE DI CALCOLO STRUTTURALE" "ANALISI E VERIFICHE SVOLTE CON L'AUSILIO DI CODICI DI CALCOLO".** Laddove nei capitoli successivi vengano richiamate norme antecedenti al DM 17.01.18 è dovuto a o a progettazione simulata di edificio esistente.

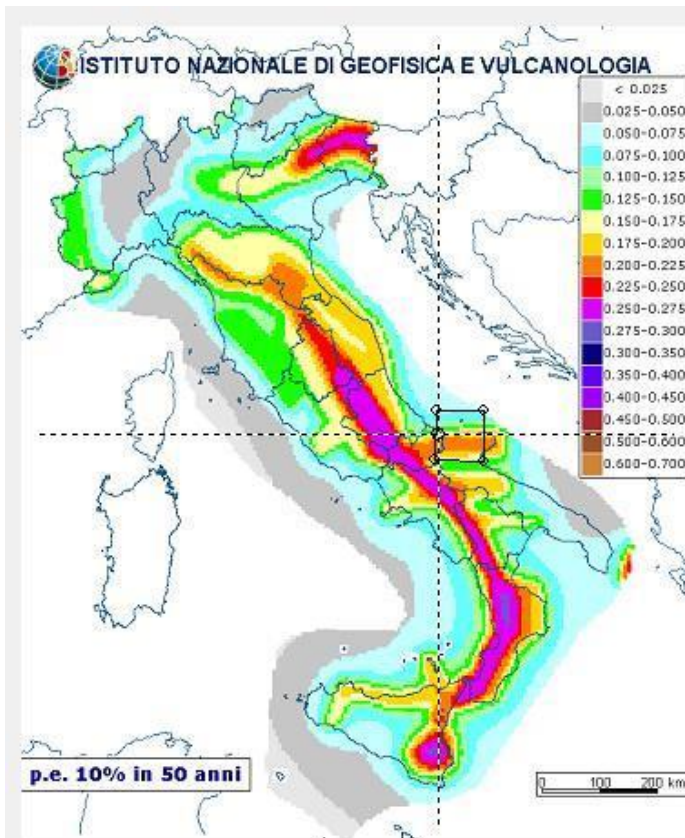

Nota: per il calcolo dei parametri sismici  
 1) inserire le coordinate geografiche 2) introdurre Vn e Cu

Per le isole è possibile utilizzare come località: gruppo isole N  
 [con N = 1,2,3,4,5]

Vertici della maglia elementare			
Id nodo	Longitudine	Latitudine	Distanza [km]
28547	14.833	41.877	2.900
28548	14.900	41.876	5.998
28326	14.902	41.926	5.936
28325	14.834	41.927	2.671

Coordinate geografiche

Località:

Longitudine:  Latitudine:

Parametri per le forme spettrali					
	Pver	Tr	ag [g]	Fo	T*c
SLO	81	60	0.063	2.480	0.330
SLD	63	101	0.080	2.520	0.340
SLV	10	949	0.186	2.550	0.390
SLC	5	1950	0.239	2.520	0.400

Periodo di riferimento per l'azione sismica			
Vita Vn [anni]	Coefficiente uso Cu	Periodo Vr [anni]	Livello di sicurezza per esistenti %
<input type="text" value="50"/>	<input type="text" value="2"/>	<input type="text" value="100"/>	<input type="text" value="100"/>

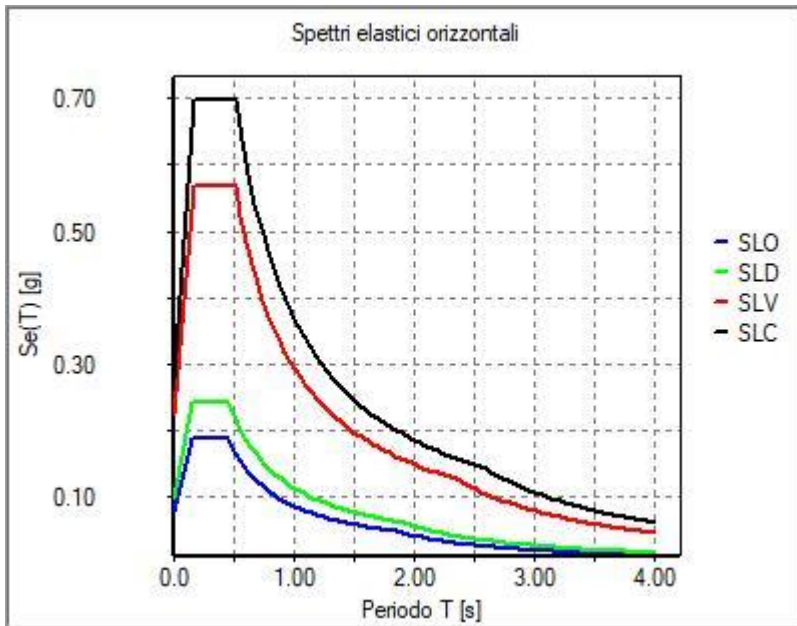

01\_INT\_SPETTRI\_ELASTICI\_O

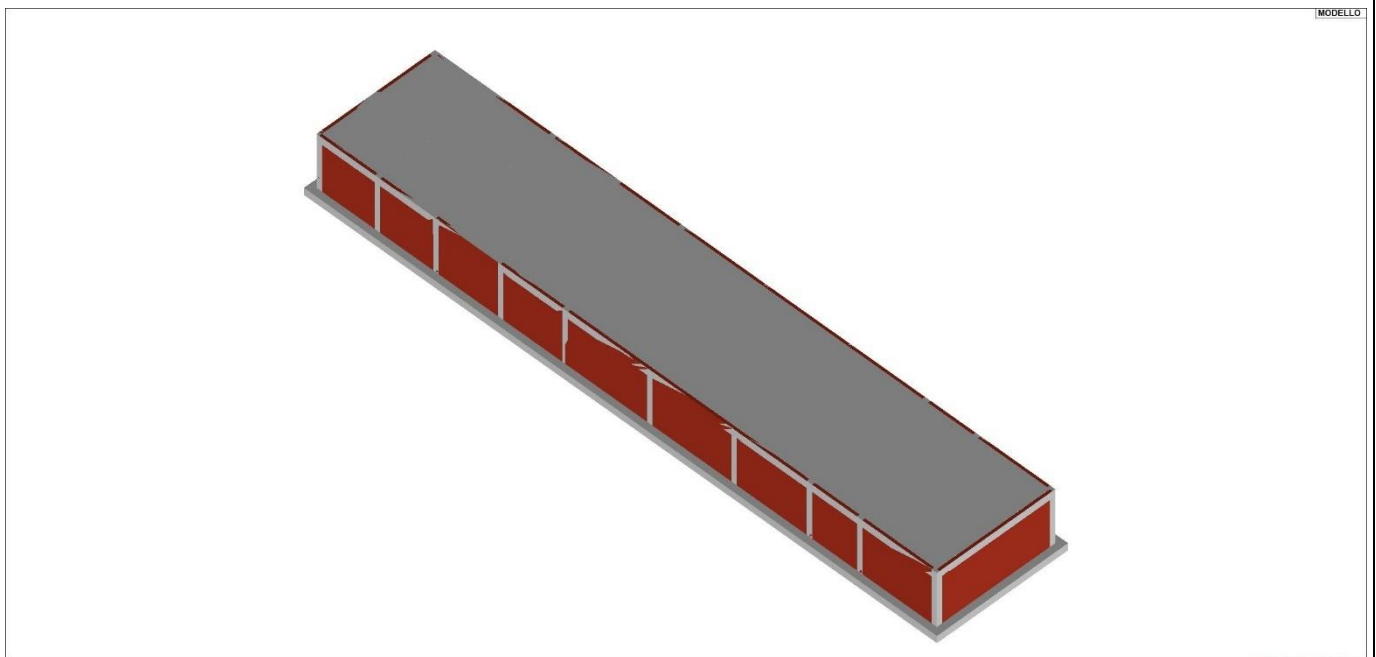

01\_INT\_VISTA\_SOLIDATA\_001

MODELLO

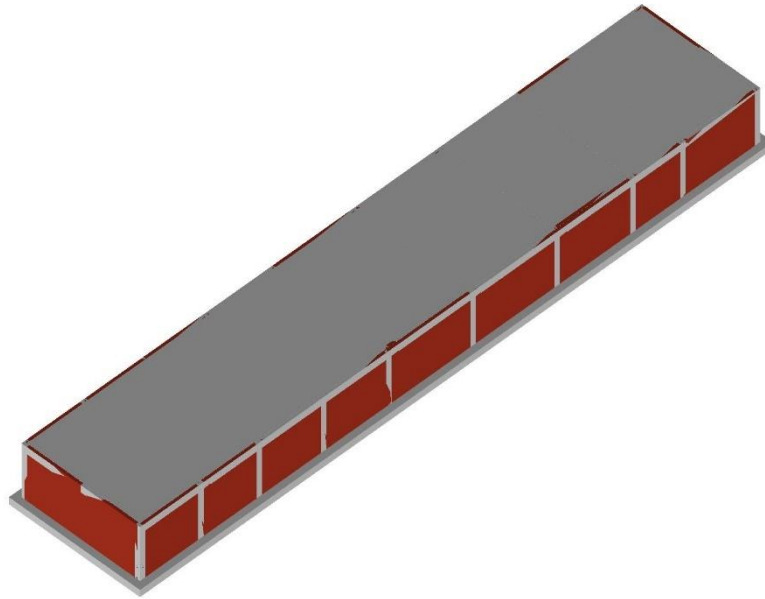

Edificio 33E\_CIVITA'PSP

01\_INT\_VISTA\_SOLIDATA\_002

MODELLO

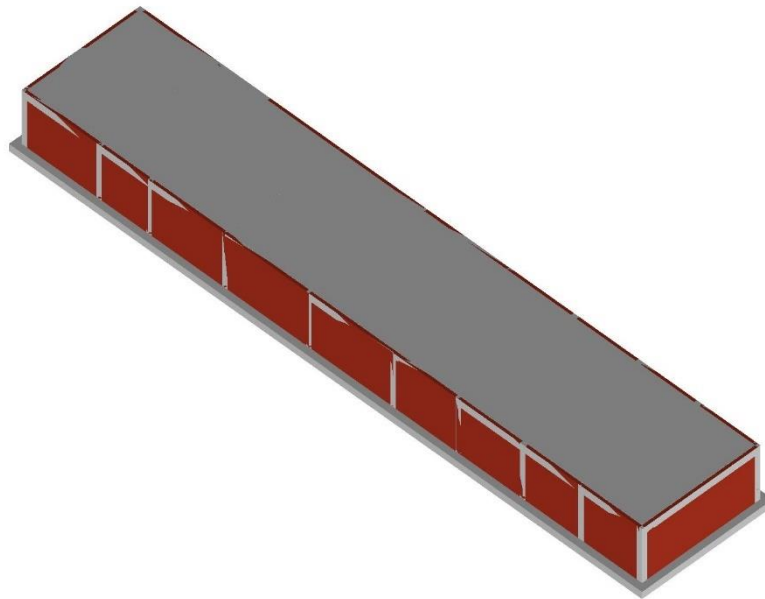

Edificio 33E\_CIVITA'PSP

01\_INT\_VISTA\_SOLIDATA\_003



MODELLO

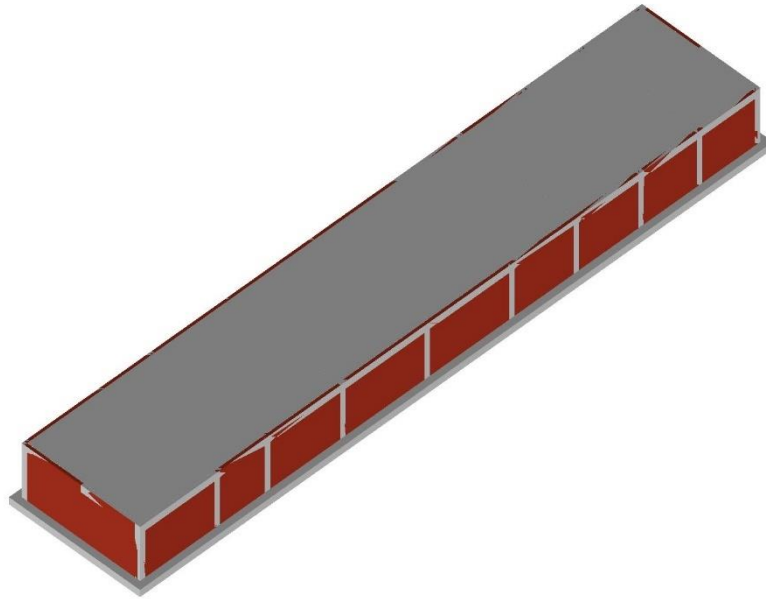

Edificio SSE CIVITA' P&P

01\_INT\_VISTA\_SOLIDATA\_004

### 3. CARATTERISTICHE MATERIALI UTILIZZATI

#### 3.1. LEGENDA TABELLA DATI MATERIALI

Il programma consente l'uso di materiali diversi. Sono previsti i seguenti tipi di materiale:

1	materiale tipo cemento armato
2	materiale tipo acciaio
3	materiale tipo muratura
4	materiale tipo legno
5	materiale tipo generico

I materiali utilizzati nella modellazione sono individuati da una sigla identificativa ed un codice numerico (gli elementi strutturali richiamano quest'ultimo nella propria descrizione). Per ogni materiale vengono riportati in tabella i seguenti dati:

Young	modulo di elasticità normale E
Poisson	coefficiente di contrazione trasversale ni
G	modulo di elasticità tangenziale
Gamma	peso specifico
Alfa	coefficiente di dilatazione termica
Fattore di confidenza FC m	Fattore di confidenza specifico per materiale; (è riportato solo se diverso da quello globale della struttura)
Fattore di confidenza FC a	Fattore di confidenza specifico per l'armatura (è riportato solo se diverso da quello globale della struttura)
Elasto-plastico	Materiale elastico perfettamente plastico per aste non lineari
Massima compressione	Massima tensione di compressione per aste non lineari
Massima trazione	Massima tensione di trazione per aste non lineari
Fattore attrito	Coefficiente di attrito per aste non lineari
Rapporto HRDb	Rapporto di hardening a flessione
Rapporto HRDv	Rapporto di hardening a taglio

I dati soprariportati vengono utilizzati per la modellazione dello schema statico e per la determinazione dei carichi inerziali e termici. In relazione al tipo di materiale vengono riportati inoltre:

1	cemento o armato	Resistenza Rc	resistenza a compressione cubica
		Resistenza fctm	resistenza media a trazione semplice
		Coefficiente ksb	Coefficiente di riduzione della resistenza a compressione da utilizzare nello stress block
2	acciaio	Tensione ft	Valore della tensione di rottura
		Tensione fy	Valore della tensione di snervamento
		Resistenza fd	Resistenza di calcolo per SL CNR-UNI 10011
		Resistenza fd (>40)	Resistenza di calcolo per SL CNR-UNI 10011 per spessori > 40mm
		Tensione ammissibile	Tensione ammissibile CNR-UNI 10011
		Tensione ammissibile (>40)	Tensione ammissibile CNR-UNI 10011 per spessori > 40mm
3	muratura	Muratura consolidata	Muratura per la quale si prevedono interventi di rinforzo"
		Incremento resistenza	Incremento conseguito in termini di resistenza
		Incremento rigidezza	Incremento conseguito in termini di rigidezza
		Resistenza f	Valore della resistenza a compressione
		Resistenza fv0	Valore della resistenza a taglio in assenza di tensioni normali

Resistenza fh	Valore della resistenza a compressione orizzontale
Resistenza fb	Valore della resistenza a compressione dei blocchi
Resistenza fbh	Valore della resistenza a compressione dei blocchi in direzione orizzontale
Resistenza fv0h	Valore della resistenza a taglio in assenza di tensioni normali per le travi
Resistenza ft	Valore della resistenza a trazione per fessurazione diagonale
Resistenza fvlim	Valore della massima resistenza a taglio
Resistenza fbt	Valore della resistenza a trazione dei blocchi
Coefficiente mu	Coefficiente d'attrito utilizzato per la resistenza a taglio (tipicamente 0.4)
Coefficiente fi	Coefficiente d'ingranamento utilizzato per la resistenza a taglio
Coefficiente ksb	Coefficiente di riduzione della resistenza a compressione da utilizzare nello stress block

## 4 legno

E0,05	Modulo di elasticità corrispondente ad un frattile del 5%
Resistenza fc0	Valore della resistenza a compressione parallela
Resistenza ft0	Valore della resistenza a trazione parallela
Resistenza fm	Valore della resistenza a flessione
Resistenza fv	Valore della resistenza a taglio
Resist. ft0k	Resistenza caratteristica (tensione amm. per REGLES) per trazione
Resist. fmk	Resistenza caratteristica (tensione amm. per REGLES) per flessione
Resist. fvk	Resistenza caratteristica (tensione amm. per REGLES) per taglio
Modulo E0,05	Modulo elastico parallelo caratteristico
Lamellare	lamellare o massiccio

Nel tabulato si riportano sia i valori caratteristici che medi utilizzando gli uni e/o gli altri in relazione alle richieste di normativa ed alla tipologia di verifica. (Cap.7 NTC18 per materiali nuovi, Cap.8 NTC18 e relativa circolare 21/01/2019 per materiali esistenti, Linee Guida Reluis per incamiciatura CAM, CNR-DT 200 per interventi con FRP)

Vengono inoltre riportate le tabelle contenenti il riassunto delle informazioni assegnate nei criteri di progetto in uso.

Con riferimento al **Documento di Affidabilità** "Test di validazione del software di calcolo PRO\_SAP e dei moduli aggiuntivi PRO\_SAP Modulo Geotecnico, PRO\_CAD nodi acciaio e PRO\_MST" - versione Maggio 2011, disponibile per il download sul sito [www.2si.it](http://www.2si.it), si segnalano i seguenti esempi applicativi:

Modellazione di strutture in c.a.

Test N°	Titolo
41	GERARCHIA DELLE RESISTENZE PER TRAVI IN C.A.
42	GERARCHIA DELLE RESISTENZE PER PILASTRI IN C.A.
43	VERIFICA ALLE TA DI STRUTTURE IN C.A.
44	VERIFICA AGLI SLU DI STRUTTURE IN C.A.
45	VERIFICA A PUNZONAMENTO ALLO SLU DI PIASTRE IN C.A.
46	VERIFICA A PUNZONAMENTO ALLO SLU DI TRAVI IN C.A.
47	PROGETTAZIONE A TAGLIO DI STRUTTURE IN C.A. SECONDO IL D.M. 9/1/96
48	PROGETTAZIONE A TAGLIO DI STRUTTURE IN C.A. SECONDO IL D.M. 14/1/2008
49	VERIFICA ALLO SLE (TENSIONI E FESSURAZIONE) DI STRUTTURE IN C.A.
50	VERIFICA ALLO SLE (DEFORMAZIONE) DI STRUTTURE IN C.A.
51	FATTORE DI STRUTTURA
52	SOVRARESISTENZE
53	DETTAGLI COSTRUTTIVI C.A.: LIMITI D'ARMATURA PILASTRI E NODI TRAVE-PILASTRO
54	PARETI IN C.A. SNELLE IN ZONA SISMICA
80	ANALISI PUSHOVER DI UN EDIFICIO IN C.A.
120	PROGETTO E VERIFICA DI TRAVI PREM

## Modellazione di strutture in acciaio

Test N°	Titolo
55	VERIFICA DI STABILITA' DI ASTE COMPRESSE IN ACCIAIO – METODO OMEGA
56	LUCE LIBERA DI TRAVI E ASTE IN ACCIAIO
57	LUCE LIBERA DI COLONNE IN ACCIAIO
58	SVERGOLAMENTO DI TRAVI IN ACCIAIO
59	FATTORE DI STRUTTURA
60	ACCIAIO D.M.2008
61	ACCIAIO EC3
62	GERARCHIA RESISTENZE STRUTTURE IN ACCIAIO
63	STABILITA' DI ASTE COMPOSTE IN ACCIAIO
73	COLLEGAMENTI IN ACCIAIO: NODO TRAVE COLONNA FLANGIATO CON PRESENZA IRRIGIDIMENTI TRASVERSALI
74	COLLEGAMENTI IN ACCIAIO: NODO TRAVE COLONNA FLANGIATO CON PRESENZA DI UN PIATTO DI RINFORZO SALDATO ALL'ANIMA DELLA COLONNA
75	COLLEGAMENTI IN ACCIAIO: NODO TRAVE COLONNA FLANGIATO CON PRESENZA DI DUE PIATTI DI RINFORZO SALDATI ALL'ANIMA DELLA COLONNA
76	COLLEGAMENTI IN ACCIAIO: NODO TRAVE COLONNA FLANGIATO A DUE VIE SU ALI COLONNA
77	COLLEGAMENTI IN ACCIAIO: NODO TRAVE COLONNA FLANGIATO A UNA VIA CON DUE COMBINAZIONI DI CARICO
78	COLLEGAMENTI IN ACCIAIO: NODO TRAVE COLONNA FLANGIATO SU ANIMA SENZA RINFORZI A QUATTRO FILE DI BULLONI DI CUI UNA SU PIASTRA INFERIORE E UNA SU PIASTRA SUPERIORE
79	VERIFICA DELLA PIASTRA NODO TRAVE COLONNA
85	TELAIO ACCIAIO: CONTROVENTI CONCENTRICI

## Modellazione di strutture in muratura

Test N°	Titolo
81	ANALISI PUSHOVER DI UNA STRUTTURA IN MURATURA
84	ANALISI ELASTO PLASTICA INCREMENTALE, PARETE IN MURATURA
86	VERIFICA NON SISMICA DELLE MURATURE (D.M. 87 TA)
87	VERIFICA NON SISMICA DELLE MURATURE (D.M. 2005 SL)
88	FATTORE DI STRUTTURA

## Modellazione di strutture in legno

Test N°	Titolo
17	SOLAIO: MISTO LEGNO-CALCESTRUZZO
89	VERIFICA ALLO SLU DI STRUTTURE IN LEGNO SECONDO EC5
90	VERIFICA ALLO SLE DI STRUTTURE IN LEGNO SECONDO EC5
91	FATTORE DI STRUTTURA
92	VERIFICHE EC5
93	SNELLEZZE EC5
94	VERIFICA AL FUOCO DI STRUTTURE IN LEGNO SECONDO EC5
117	PROGETTO E VERIFICA DI GUSCI IN MATERIALE XLAM
118	PROGETTO E VERIFICA DI PARETI IN MATERIALE XLAM E RELATIVI COLLEGAMENTI

119

PROGETTO E VERIFICA DI SOLAI IN MATERIALE XLAM

Id	Tipo / Note	V. caratt.	V. medio	Young	Poisson	G	Gamma	Alfa	Altri
		daN/cm <sup>2</sup>	daN/cm <sup>2</sup>	daN/cm <sup>2</sup>		daN/cm <sup>2</sup>	daN/cm <sup>3</sup>		
1	Calcestruzzo Classe C25/30			3.145e+05	0.20	1.310e+05	2.50e-03	1.00e-05	
	Resistenza Rc	300.0							
	Resistenza fctm		25.6						
	Rapporto Rfessurata								1.00
	Coefficiente ksb								0.85
	Rapporto HRDb								1.00e-05
	Rapporto HRDv								1.00e-05
5	Calcestruzzo Classe C32/40			3.360e+05	0.20	1.400e+05	2.50e-03	1.00e-05	
	Resistenza Rc	400.0							
	Resistenza fctm		31.0						
	Rapporto Rfessurata								1.00
	Coefficiente ksb								0.85
	Rapporto HRDb								1.00e-05
	Rapporto HRDv								1.00e-05
25	Danesi - Isomuro 30.19.25 (25.19.20) e malta di classe M10-muratura E = 6.530e+04			6.530e+04	0.0	1.612e+04	9.00e-04	1.00e-05	
	Resistenza f	65.3							
	Resistenza fh	32.6							
	Resistenza fv0	3.0							
	Resistenza fv0h	3.0							
	Resistenza tau0	1.5							
	Resistenza fvlim	9.4							
	Resistenza fb	144.0							
	Resistenza fbh	32.0							
	Resistenza fbt	10.0							
	Rapporto Rfessurata								1.00
	Coefficiente ksb								0.85
	Coefficiente mu (tilda)								0.40
	Coefficiente fi								0.50
	Rapporto HRDb								1.00e-05
	Rapporto HRDv								1.00e-05

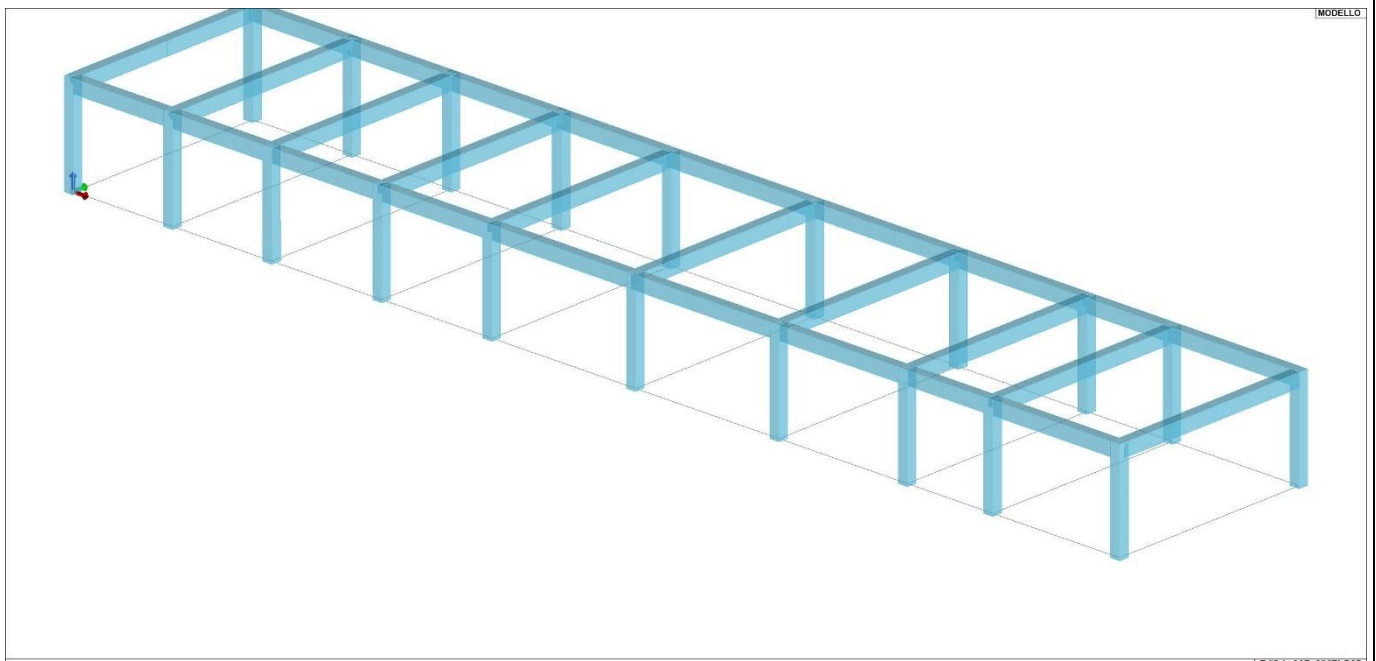

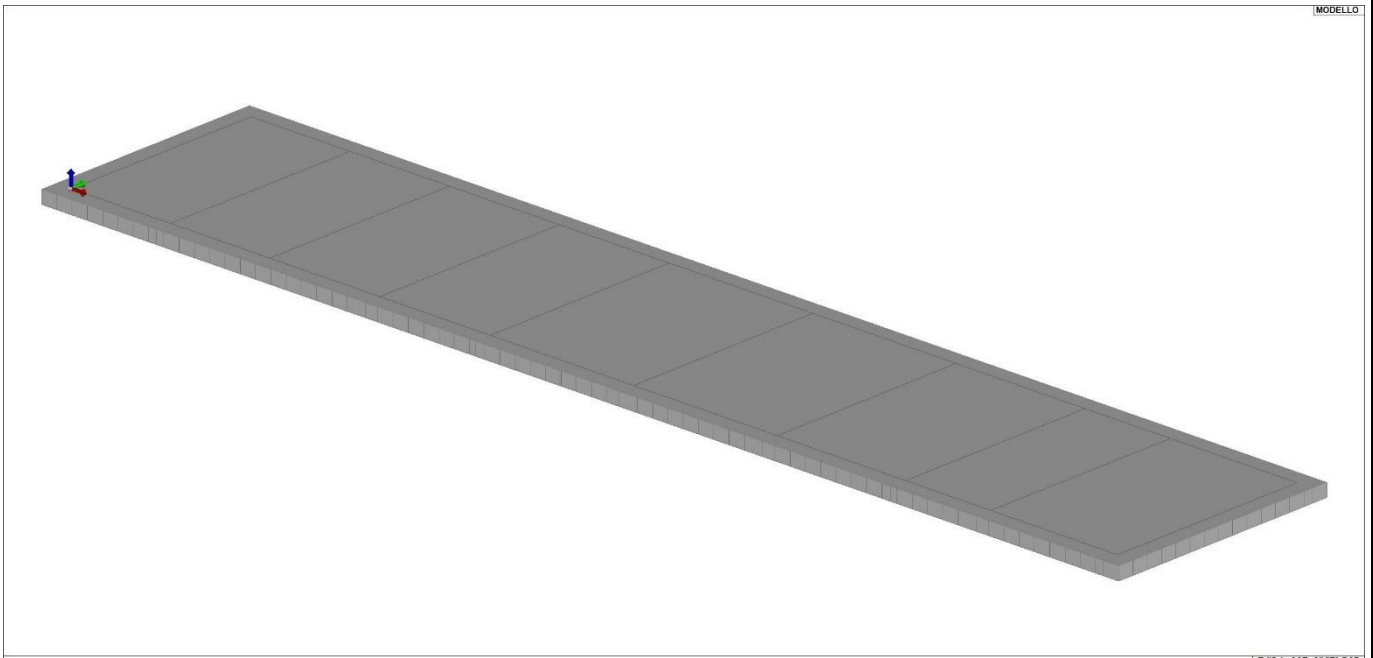

MODELLO Edificio 33E\_CIVITA'PSP

11\_MOD\_MATERIALI\_D3

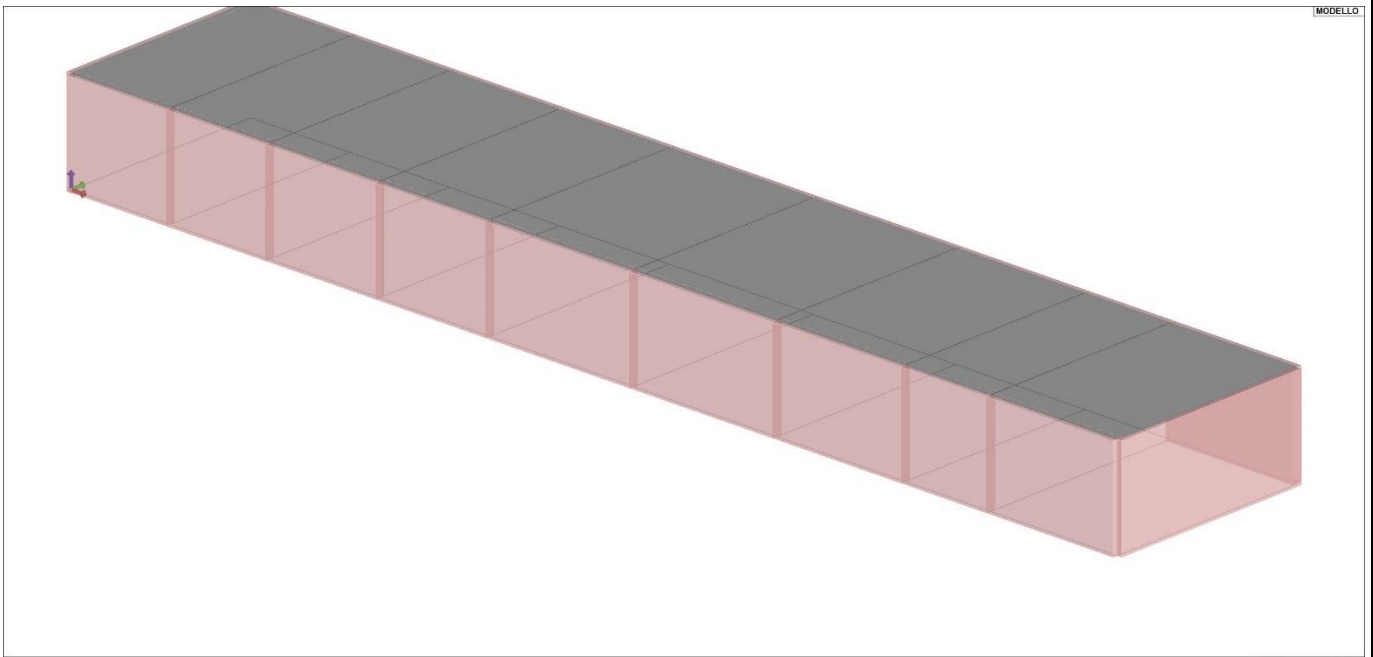

MODELLO Edificio 33E\_CIVITA'PSP

11\_MOD\_MATERIALI\_SOLAI

Gusci c.a.	1/7/..	2/8/..	3/9/..	4/10/..	5/11/..	6/12/..
<b>Armatura</b>						
Inclinazione Ax [ gradi ]	0.0	0.0				
Angolo Ax-Ay [ gradi ]	90.00	90.00				
Minima tesa	0.31	0.10				
Massima tesa	0.78	0.78				
Maglia unica centrale	No	No				
Copriferro [ cm ]	2.00	3.00				
<b>Maglia x</b>						
diametro	10	12				
passo	20	20				
diametro aggiuntivi	12	12				
<b>Maglia y</b>						
diametro	10	12				
passo	20	20				
diametro aggiuntivi	12	12				

Gusci c.a.	1/7/..	2/8/..	3/9/..	4/10/..	5/11/..	6/12/..
<b>Stati limite ultimi</b>						
Tensione fy [daN/cm <sup>2</sup> ]	4500.00	4500.00				
Tipo acciaio	tipo C	tipo C				
Coefficiente gamma s	1.15	1.15				
Coefficiente gamma c	1.50	1.50				
Verifiche con N costante	Si	Si				
Applica SLU da DIN	No	No				
<b>Tensioni ammissibili</b>						
Tensione amm. cls [daN/cm <sup>2</sup> ]	97.50	97.50				
Tensione amm. acciaio [daN/cm <sup>2</sup> ]	2600.00	2600.00				
Rapporto omogeneizzazione N	15.00	15.00				
Massimo rapporto area compressa/tesa	1.00	1.00				
<b>Resistenza al fuoco</b>						
3- intradosso	No	No				
3+ estradosso	No	No				
Tempo di esposizione R	15	15				

Travi c.a.	1/7/..	2/8/..	3/9/..	4/10/..	5/11/..	6/12/..
<b>Generalità</b>						
Progetta a filo	No	No				
Af inf: da q*L*L /	0.0	0.0				
<b>Armatura</b>						
Minima tesa	0.31	0.20				
Minima compressa	0.31	0.20				
Massima tesa	0.78	0.78				
Da sezione	Si	Si				
Usa armatura teorica	No	No				
<b>Stati limite ultimi</b>						
Tensione fy [daN/cm <sup>2</sup> ]	4500.00	4500.00				
Tensione fy staffe [daN/cm <sup>2</sup> ]	4500.00	4500.00				
Tipo acciaio	tipo C	tipo C				
Coefficiente gamma s	1.15	1.15				
Coefficiente gamma c	1.50	1.50				
Verifiche con N costante	Si	Si				
Fattore di redistribuzione	0.0	0.0				
<b>Modello per il confinamento</b>						
Relazione tensio-deformativa	Mander	Mander				
Incrudimento acciaio	5.000e-03	5.000e-03				
Fattore lambda	1.00	1.00				
epsilon max,s	4.000e-02	4.000e-02				
epsilon cu2	4.500e-03	4.500e-03				
epsilon c2	0.0	0.0				
epsilon cy	0.0	0.0				
<b>Tensioni ammissibili</b>						
Tensione amm. cls [daN/cm <sup>2</sup> ]	97.50	97.50				
Tensione amm. acciaio [daN/cm <sup>2</sup> ]	2600.00	2600.00				
Rapporto omogeneizzazione N	15.00	15.00				
Massimo rapporto area compressa/tesa	1.00	1.00				
<b>Staffe</b>						
Diametro staffe	0.0	0.0				
Passo minimo [ cm ]	4.00	4.00				
Passo massimo [ cm ]	30.00	30.00				
Passo raffittito [ cm ]	15.00	15.00				
Lunghezza zona raffittita [ cm ]	50.00	50.00				
Ctg(Teta) Max	2.50	2.50				
Percentuale sagomati	0.0	0.0				
Luce di taglio per GR [ cm ]	1.00	1.00				
Adotta scorrimento medio	No	No				
Torsione non essenziale inclusa	Si	Si				

Pilastrì c.a.	1/7/..	2/8/..	3/9/..	4/10/..	5/11/..	6/12/..
<b>Generalità</b>						
Progetto armatura	Privilegia lati	Privilegia lati				
Progetta a filo	No	No				
Effetti del 2 ordine	Si	Si				
Beta per 2-2	1.00	1.00				
Beta per 3-3	1.00	1.00				
<b>Armatura</b>						
Massima tesa	4.00	4.00				
Minima tesa	1.00	1.00				



Pilastrici c.a.	1/7/..	2/8/..	3/9/..	4/10/..	5/11/..	6/12/..
<b>Stati limite ultimi</b>						
Tensione fy [daN/cm <sup>2</sup> ]	4500.00	4500.00				
Tensione fy staffe [daN/cm <sup>2</sup> ]	4500.00	4500.00				
Tipo acciaio	tipo C	tipo C				
Coefficiente gamma s	1.15	1.15				
Coefficiente gamma c	1.50	1.50				
Verifiche con N costante	Si	Si				
<b>Modello per il confinamento</b>						
Relazione tensio-deformativa	Mander	Mander				
Incrudimento acciaio	5.000e-03	5.000e-03				
Fattore lambda	1.00	1.00				
epsilon max,s	4.000e-02	4.000e-02				
epsilon cu2	4.500e-03	4.500e-03				
epsilon c2	0.0	0.0				
epsilon cy	0.0	0.0				
<b>Tensioni ammissibili</b>						
Tensione amm. cls [daN/cm <sup>2</sup> ]	97.50	97.50				
Tensione amm. acciaio [daN/cm <sup>2</sup> ]	2600.00	2600.00				
Rapporto omogeneizzazione N	15.00	15.00				
<b>Staffe</b>						
Diametro staffe	0.0	0.0				
Passo minimo [ cm ]	5.00	5.00				
Passo massimo [ cm ]	25.00	25.00				
Passo raffittito [ cm ]	15.00	15.00				
Lunghezza zona raffittita [ cm ]	45.00	45.00				
Ctg(Teta) Max	2.50	2.50				
Luce di taglio per GR [ cm ]	1.00	1.00				
Massimizza gerarchia	Si	Si				

Solai e pannelli	1/7/..	2/8/..	3/9/..	4/10/..	5/11/..	6/12/..
<b>Generalità</b>						
Usa tensioni ammissibili	No	No				
Af inf: da traliccio	Si	Si				
Consenti armatura a taglio	No	No				
Incrementa armatura longitudinale per taglio	Si	Si				
Af inf: da q*L*L /	20.00	20.00				
Incremento fascia piena [ cm ]	5.00	5.00				
<b>Armatura</b>						
Minima tesa	0.15	0.15				
Massima tesa	3.00	3.00				
Minima compressa	0.0	0.0				
Af/h [ cm ]	7.000e-02	7.000e-02				
<b>Stati limite ultimi</b>						
Tensione fy [daN/cm <sup>2</sup> ]	4500.00	4500.00				
Tipo acciaio	tipo C	tipo C				
Coefficiente gamma s	1.15	1.15				
Coefficiente gamma c	1.50	1.50				
Fattore di redistribuzione	0.0	0.0				
<b>Tensioni ammissibili</b>						
Tensione amm. cls [daN/cm <sup>2</sup> ]	85.00	85.00				
Tensione amm. acciaio [daN/cm <sup>2</sup> ]	2600.00	2600.00				
Rapporto omogeneizzazione N	15.00	15.00				
Massimo rapporto area compressa/tesa	1.00	1.00				
<b>Verifica freccia</b>						
Infinita	250.00	250.00				
Istantanea	500.00	500.00				
Fattore viscosità	3.00	3.00				
Usa J non fessurato	No	No				
<b>Elementi non strutturali</b>						
Tamponatura antiespulsione	No	No				
Tamponatura con armatura	No	No				
Fattore di struttura/comportamento	2.00	2.00				
Coefficiente gamma m	0.0	0.0				
Periodo Ta	0.0	0.0				
Altezza pannello	0.0	0.0				



## 4. MODELLAZIONE DELLE SEZIONI

### 4.1. LEGENDA TABELLA DATI SEZIONI

Il programma consente l'uso di sezioni diverse. Sono previsti i seguenti tipi di sezione:

1. sezione di tipo generico
2. profilati semplici
3. profilati accoppiati e speciali

Le sezioni utilizzate nella modellazione sono individuate da una sigla identificativa ed un codice numerico (gli elementi strutturali richiamano quest'ultimo nella propria descrizione). Per ogni sezione vengono riportati in tabella i seguenti dati:

<b>Area</b>	area della sezione
<b>A V2</b>	area della sezione/fattore di taglio (per il taglio in direzione 2)
<b>A V3</b>	area della sezione/fattore di taglio (per il taglio in direzione 3)
<b>Jt</b>	fattore torsionale di rigidezza
<b>J2-2</b>	momento d'inerzia della sezione riferito all'asse 2
<b>J3-3</b>	momento d'inerzia della sezione riferito all'asse 3
<b>W2-2</b>	modulo di resistenza della sezione riferito all'asse 2
<b>W3-3</b>	modulo di resistenza della sezione riferito all'asse 3
<b>Wp2-2</b>	modulo di resistenza plastico della sezione riferito all'asse 2
<b>Wp3-3</b>	modulo di resistenza plastico della sezione riferito all'asse 3

I dati sopra riportati vengono utilizzati per la determinazione dei carichi inerziali e per la definizione delle rigidità degli elementi strutturali; qualora il valore di Area V2 (e/o Area V3) sia nullo la deformabilità per taglio V2 (e/o V3) è trascurata. La valutazione delle caratteristiche inerziali delle sezioni è condotta nel riferimento 2-3 dell'elemento.

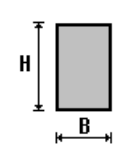
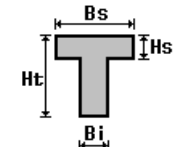
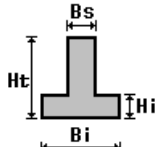
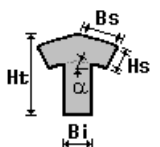
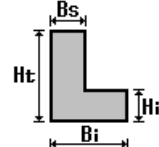
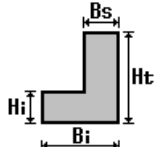
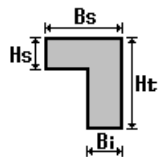
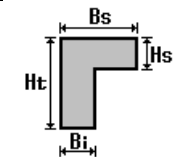
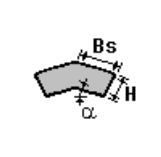
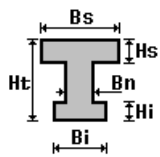
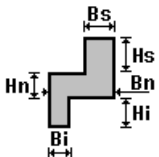
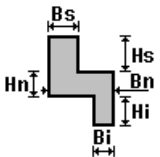
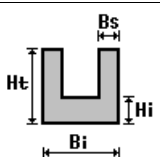
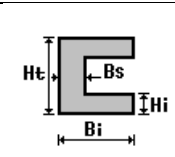
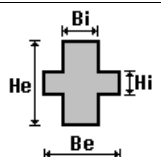
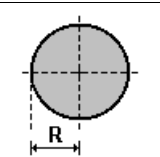
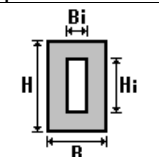
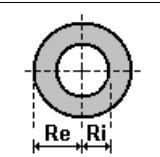
					
rettangolare	a T	a T rovescia	a T di colmo	a L	a L specchiata
					
a L specchiata rovescia	a L rovescia	a L di colmo	a doppio T	a quattro specchiata	a quattro
					
a U	a C	a croce	circolare	rettangolare cava	circolare cava

Per quanto concerne i profilati semplici ed accoppiati l'asse 2 del riferimento coincide con l'asse x riportato nei più diffusi profilatari.

Per quanto concerne le sezioni di tipo generico (tipo 1.):  
i valori dimensionali con prefisso B sono riferiti all'asse 2  
i valori dimensionali con prefisso H sono riferiti all'asse 3

Con riferimento al Documento di Affidabilità "Test di validazione del software di calcolo PRO\_SAP e dei moduli aggiuntivi PRO\_SAP Modulo Geotecnico, PRO\_CAD nodi acciaio e PRO\_MST" - versione Settembre 2014, disponibile per il download sul sito [www.2si.it](http://www.2si.it), si segnalano i seguenti esempi applicativi:

Test N°	Titolo
1	CARATTERISTICHE GEOMETRICHE E INERZIALI
45	VERIFICA AGLI SLU DI STRUTTURE IN C.A.
48	PROGETTAZIONE A TAGLIO DI STRUTTURE IN C.A. SECONDO IL D.M. 9/1/96
49	PROGETTAZIONE A TAGLIO DI STRUTTURE IN C.A. SECONDO IL D.M. 14/1/2008
50	VERIFICA ALLO SLE (TENSIONI E FESSURAZIONE) DI STRUTTURE IN C.A.
51	VERIFICA ALLO SLE (DEFORMAZIONE) DI STRUTTURE IN C.A.
104	ANALISI DI RESISTENZA AL FUOCO

Id	Tipo	Area	A V2	A V3	Jt	J 2-2	J 3-3	W 2-2	W 3-3	Wp 2-2	Wp 3-3
		cm2	cm2	cm2	cm4	cm4	cm4	cm3	cm3	cm3	cm3
1	Rettangolare: b=30.00 h =30.00	900.00	750.00	750.00	1.139e+05	6.750e+04	6.750e+04	4500.00	4500.00	6750.00	6750.00
2	Rettangolare: b=30 h=40	1200.00	1000.00	1000.00	1.946e+05	9.000e+04	1.600e+05	6000.00	8000.00	9000.00	1.200e+04

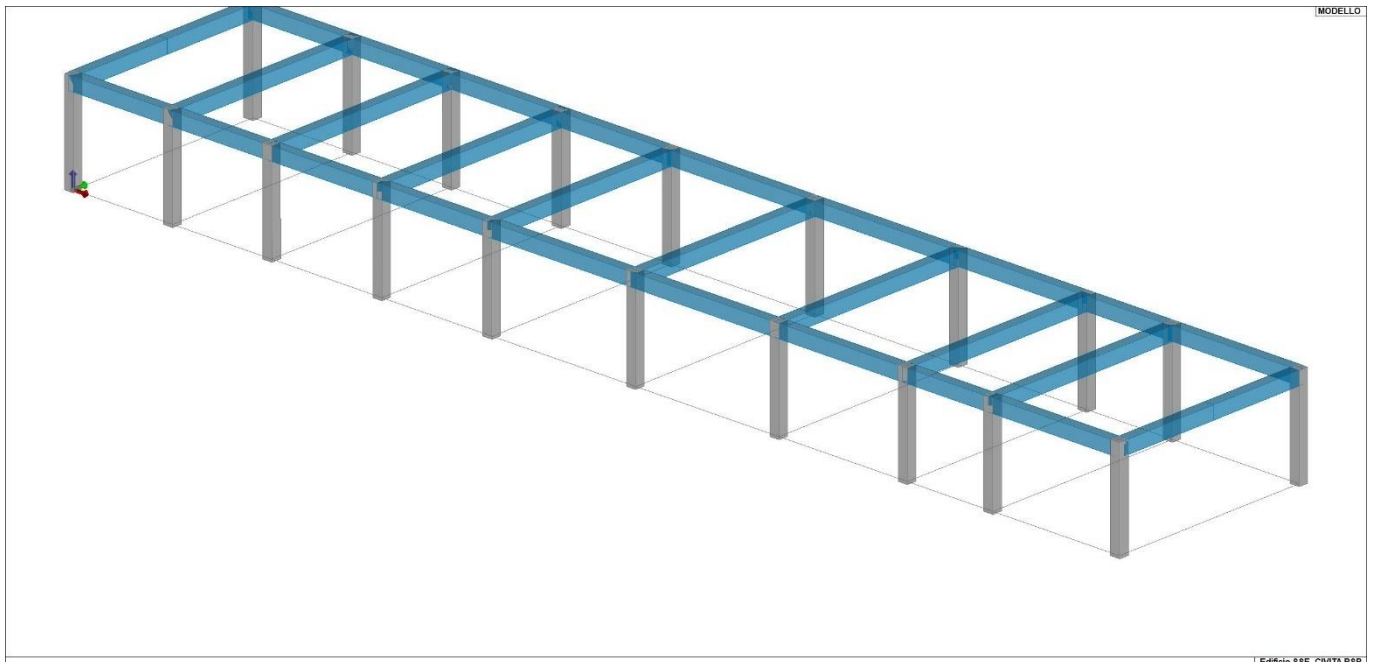

13\_MOD\_SEZIONI

## 5. MODELLAZIONE STRUTTURA: NODI

### 5.1. LEGENDA TABELLA DATI NODI

Il programma utilizza per la modellazione nodi strutturali.

Ogni nodo è individuato dalle coordinate cartesiane nel sistema di riferimento globale (X Y Z).

Ad ogni nodo è eventualmente associato un codice di vincolamento rigido, un codice di fondazione speciale, ed un set di sei molle (tre per le traslazioni, tre per le rotazioni). Le tabelle sottoriportate riflettono le succitate possibilità. In particolare per ogni nodo viene indicato in tabella:

<b>Nodo</b>	numero del nodo.
<b>X</b>	valore della coordinata X
<b>Y</b>	valore della coordinata Y
<b>Z</b>	valore della coordinata Z

Per i nodi ai quali sia associato un codice di vincolamento rigido, un codice di fondazione speciale o un set di molle viene indicato in tabella:

<b>Nodo</b>	numero del nodo.
<b>X</b>	valore della coordinata X
<b>Y</b>	valore della coordinata Y
<b>Z</b>	valore della coordinata Z
<b>Note</b>	eventuale codice di vincolo (es. v=110010 sei valori relativi ai sei gradi di libertà previsti per il nodo TxTyTzRxRyRz, il valore 1 indica che lo spostamento o rotazione relativo è impedito, il valore 0 indica che lo spostamento o rotazione relativo è libero).
<b>Note</b>	(FS = 1, 2,...) eventuale codice del tipo di fondazione speciale (1, 2,... fanno riferimento alle tipologie: plinto, palo, plinto su pali,...) che è collegato al nodo. (ISO = "id SIGLA") indice e sigla identificativa dell' eventuale isolatore sismico assegnato al nodo
<b>Rig. TX</b>	valore della rigidezza dei vincoli elastici eventualmente applicati al nodo, nello specifico TX (idem per TY, TZ, RX, RY, RZ).

Per strutture sismicamente isolate viene inoltre inserita la tabella delle caratteristiche per gli isolatori utilizzati; le caratteristiche sono indicate in conformità al cap. 7.10 del D.M. 17/01/18

#### 5.1.1. TABELLA DATI NODI

Nodo	X	YZ	Nodo	X	Y	Z	Nodo	X	Y	Z	
	cm	cm	cm		cm	cm	cm		cm	cm	
1	0.0	0.0	0.0	2	0.0	0.0	300.0	3	0.0	630.0	0.0
4	0.0	630.0	300.0	5	324.8	630.0	0.0	6	324.8	630.0	300.0
7	650.0	630.0	0.0	8	649.6	630.0	300.0	9	1009.9	630.0	0.0
10	1009.9	630.0	300.0	11	1370.2	630.0	0.0	12	1370.2	630.0	300.0
13	1840.0	630.0	0.0	14	1840.0	630.0	300.0	15	2309.8	630.0	0.0
16	2309.8	630.0	300.0	17	2729.9	630.0	0.0	18	2729.9	630.0	300.0
19	3009.8	630.0	0.0	20	3009.8	630.0	300.0	21	3424.9	630.0	0.0
22	3424.9	630.0	300.0	23	324.8	0.0	0.0	24	324.8	0.0	300.0
25	650.0	0.0	0.0	26	649.6	0.0	300.0	27	1009.9	0.0	0.0
28	1009.9	0.0	300.0	29	1370.2	0.0	0.0	30	1370.2	0.0	300.0
31	1840.0	0.0	0.0	32	1840.0	0.0	300.0	33	2309.8	0.0	0.0
34	2309.8	0.0	300.0	35	2729.9	0.0	0.0	36	2729.9	0.0	300.0
37	3009.8	0.0	0.0	38	3009.8	0.0	300.0	39	3424.9	0.0	0.0
40	3424.9	0.0	300.0	41	50.0	0.0	0.0	42	50.0	50.0	0.0
43	0.0	50.0	0.0	44	50.0	100.0	0.0	45	0.0	100.0	0.0
46	50.0	150.0	0.0	47	0.0	150.0	0.0	48	50.0	200.0	0.0
49	0.0	200.0	0.0	50	50.0	250.0	0.0	51	0.0	250.0	0.0
52	50.0	300.0	0.0	53	0.0	300.0	0.0	54	50.0	350.0	0.0
55	0.0	350.0	0.0	56	50.0	400.0	0.0	57	0.0	400.0	0.0
58	50.0	450.0	0.0	59	0.0	450.0	0.0	60	50.0	500.0	0.0
61	0.0	500.0	0.0	62	50.0	550.0	0.0	63	0.0	550.0	0.0
64	50.0	600.0	0.0	65	0.0	600.0	0.0	66	50.0	630.0	0.0
67	100.0	0.0	0.0	68	100.0	50.0	0.0	69	100.0	100.0	0.0
70	100.0	150.0	0.0	71	100.0	200.0	0.0	72	100.0	250.0	0.0
73	100.0	300.0	0.0	74	100.0	350.0	0.0	75	100.0	400.0	0.0
76	100.0	450.0	0.0	77	100.0	500.0	0.0	78	100.0	550.0	0.0
79	100.0	600.0	0.0	80	100.0	630.0	0.0	81	150.0	0.0	0.0
82	150.0	50.0	0.0	83	150.0	100.0	0.0	84	150.0	150.0	0.0



EGP CODE

GRE.EEC.R.73.IT.W.15235.12.024.01

PAGE

24 di/of 527

85	150.0	200.0	0.0	86	150.0	250.0	0.0	87	150.0	300.0	0.0
88	150.0	350.0	0.0	89	150.0	400.0	0.0	90	150.0	450.0	0.0
91	150.0	500.0	0.0	92	150.0	550.0	0.0	93	150.0	600.0	0.0
94	150.0	630.0	0.0	95	200.0	0.0	0.0	96	200.0	50.0	0.0
97	200.0	100.0	0.0	98	200.0	150.0	0.0	99	200.0	200.0	0.0
100	200.0	250.0	0.0	101	200.0	300.0	0.0	102	200.0	350.0	0.0
103	200.0	400.0	0.0	104	200.0	450.0	0.0	105	200.0	500.0	0.0
106	200.0	550.0	0.0	107	200.0	600.0	0.0	108	200.0	630.0	0.0
109	250.0	0.0	0.0	110	250.0	50.0	0.0	111	250.0	100.0	0.0
112	250.0	150.0	0.0	113	250.0	200.0	0.0	114	250.0	250.0	0.0
115	250.0	300.0	0.0	116	250.0	350.0	0.0	117	250.0	400.0	0.0
118	250.0	450.0	0.0	119	250.0	500.0	0.0	120	250.0	550.0	0.0
121	250.0	600.0	0.0	122	250.0	630.0	0.0	123	300.0	0.0	0.0
124	300.0	50.0	0.0	125	300.0	100.0	0.0	126	300.0	150.0	0.0
127	300.0	200.0	0.0	128	300.0	250.0	0.0	129	300.0	300.0	0.0
130	300.0	350.0	0.0	131	300.0	400.0	0.0	132	300.0	450.0	0.0
133	300.0	500.0	0.0	134	300.0	550.0	0.0	135	300.0	600.0	0.0
136	300.0	630.0	0.0	137	324.8	50.0	0.0	138	324.8	100.0	0.0
139	324.8	150.0	0.0	140	324.8	200.0	0.0	141	324.8	250.0	0.0
142	324.8	300.0	0.0	143	324.8	350.0	0.0	144	324.8	400.0	0.0
145	324.8	450.0	0.0	146	324.8	500.0	0.0	147	324.8	550.0	0.0
148	324.8	600.0	0.0	149	350.0	0.0	0.0	150	350.0	50.0	0.0
151	350.0	100.0	0.0	152	350.0	150.0	0.0	153	350.0	200.0	0.0
154	350.0	250.0	0.0	155	350.0	300.0	0.0	156	350.0	350.0	0.0
157	350.0	400.0	0.0	158	350.0	450.0	0.0	159	350.0	500.0	0.0
160	350.0	550.0	0.0	161	350.0	600.0	0.0	162	350.0	630.0	0.0
163	400.0	0.0	0.0	164	400.0	50.0	0.0	165	400.0	100.0	0.0
166	400.0	150.0	0.0	167	400.0	200.0	0.0	168	400.0	250.0	0.0
169	400.0	300.0	0.0	170	400.0	350.0	0.0	171	400.0	400.0	0.0
172	400.0	450.0	0.0	173	400.0	500.0	0.0	174	400.0	550.0	0.0
175	400.0	600.0	0.0	176	400.0	630.0	0.0	177	450.0	0.0	0.0
178	450.0	50.0	0.0	179	450.0	100.0	0.0	180	450.0	150.0	0.0
181	450.0	200.0	0.0	182	450.0	250.0	0.0	183	450.0	300.0	0.0
184	450.0	350.0	0.0	185	450.0	400.0	0.0	186	450.0	450.0	0.0
187	450.0	500.0	0.0	188	450.0	550.0	0.0	189	450.0	600.0	0.0
190	450.0	630.0	0.0	191	500.0	0.0	0.0	192	500.0	50.0	0.0
193	500.0	100.0	0.0	194	500.0	150.0	0.0	195	500.0	200.0	0.0
196	500.0	250.0	0.0	197	500.0	300.0	0.0	198	500.0	350.0	0.0
199	500.0	400.0	0.0	200	500.0	450.0	0.0	201	500.0	500.0	0.0
202	500.0	550.0	0.0	203	500.0	600.0	0.0	204	500.0	630.0	0.0
205	550.0	0.0	0.0	206	550.0	50.0	0.0	207	550.0	100.0	0.0
208	550.0	150.0	0.0	209	550.0	200.0	0.0	210	550.0	250.0	0.0
211	550.0	300.0	0.0	212	550.0	350.0	0.0	213	550.0	400.0	0.0
214	550.0	450.0	0.0	215	550.0	500.0	0.0	216	550.0	550.0	0.0
217	550.0	600.0	0.0	218	550.0	630.0	0.0	219	600.0	0.0	0.0
220	600.0	50.0	0.0	221	600.0	100.0	0.0	222	600.0	150.0	0.0
223	600.0	200.0	0.0	224	600.0	250.0	0.0	225	600.0	300.0	0.0
226	600.0	350.0	0.0	227	600.0	400.0	0.0	228	600.0	450.0	0.0
229	600.0	500.0	0.0	230	600.0	550.0	0.0	231	600.0	600.0	0.0
232	600.0	630.0	0.0	233	2550.0	-50.0	0.0	234	650.0	50.0	0.0
235	650.0	100.0	0.0	236	650.0	150.0	0.0	237	650.0	200.0	0.0
238	650.0	250.0	0.0	239	650.0	300.0	0.0	240	650.0	350.0	0.0
241	650.0	400.0	0.0	242	650.0	450.0	0.0	243	650.0	500.0	0.0
244	650.0	550.0	0.0	245	650.0	600.0	0.0	246	3350.0	150.0	0.0
247	700.0	0.0	0.0	248	700.0	50.0	0.0	249	700.0	100.0	0.0
250	700.0	150.0	0.0	251	700.0	200.0	0.0	252	700.0	250.0	0.0
253	700.0	300.0	0.0	254	700.0	350.0	0.0	255	700.0	400.0	0.0
256	700.0	450.0	0.0	257	700.0	500.0	0.0	258	700.0	550.0	0.0
259	700.0	600.0	0.0	260	700.0	630.0	0.0	261	750.0	0.0	0.0
262	750.0	50.0	0.0	263	750.0	100.0	0.0	264	750.0	150.0	0.0
265	750.0	200.0	0.0	266	750.0	250.0	0.0	267	750.0	300.0	0.0
268	750.0	350.0	0.0	269	750.0	400.0	0.0	270	750.0	450.0	0.0
271	750.0	500.0	0.0	272	750.0	550.0	0.0	273	750.0	600.0	0.0
274	750.0	630.0	0.0	275	800.0	0.0	0.0	276	800.0	50.0	0.0
277	800.0	100.0	0.0	278	800.0	150.0	0.0	279	800.0	200.0	0.0
280	800.0	250.0	0.0	281	800.0	300.0	0.0	282	800.0	350.0	0.0
283	800.0	400.0	0.0	284	800.0	450.0	0.0	285	800.0	500.0	0.0
286	800.0	550.0	0.0	287	800.0	600.0	0.0	288	800.0	630.0	0.0
289	850.0	0.0	0.0	290	850.0	50.0	0.0	291	850.0	100.0	0.0
292	850.0	150.0	0.0	293	850.0	200.0	0.0	294	850.0	250.0	0.0
295	850.0	300.0	0.0	296	850.0	350.0	0.0	297	850.0	400.0	0.0
298	850.0	450.0	0.0	299	850.0	500.0	0.0	300	850.0	550.0	0.0
301	850.0	600.0	0.0	302	850.0	630.0	0.0	303	900.0	0.0	0.0
304	900.0	50.0	0.0	305	900.0	100.0	0.0	306	900.0	150.0	0.0
307	900.0	200.0	0.0	308	900.0	250.0	0.0	309	900.0	300.0	0.0
310	900.0	350.0	0.0	311	900.0	400.0	0.0	312	900.0	450.0	0.0



EGP CODE

GRE.EEC.R.73.IT.W.15235.12.024.01

PAGE

25 di/of 527

313	900.0	500.0	0.0	314	900.0	550.0	0.0	315	900.0	600.0	0.0
316	900.0	630.0	0.0	317	950.0	0.0	0.0	318	950.0	50.0	0.0
319	950.0	100.0	0.0	320	950.0	150.0	0.0	321	950.0	200.0	0.0
322	950.0	250.0	0.0	323	950.0	300.0	0.0	324	950.0	350.0	0.0
325	950.0	400.0	0.0	326	950.0	450.0	0.0	327	950.0	500.0	0.0
328	950.0	550.0	0.0	329	950.0	600.0	0.0	330	950.0	630.0	0.0
331	2650.0	-50.0	0.0	332	1009.9	50.0	0.0	333	1009.9	100.0	0.0
334	1009.9	150.0	0.0	335	1009.9	200.0	0.0	336	1009.9	250.0	0.0
337	1009.9	300.0	0.0	338	1009.9	350.0	0.0	339	1009.9	400.0	0.0
340	1009.9	450.0	0.0	341	1009.9	500.0	0.0	342	1009.9	550.0	0.0
343	1009.9	600.0	0.0	344	2700.0	-50.0	0.0	345	2750.0	-50.0	0.0
346	2800.0	-50.0	0.0	347	2850.0	-50.0	0.0	348	2900.0	-50.0	0.0
349	2950.0	-50.0	0.0	350	3399.8	-50.0	0.0	351	3050.0	-50.0	0.0
352	3100.0	-50.0	0.0	353	3150.0	-50.0	0.0	354	3200.0	-50.0	0.0
355	3250.0	-50.0	0.0	356	3300.0	-50.0	0.0	357	1050.0	0.0	0.0
358	1050.0	50.0	0.0	359	1050.0	100.0	0.0	360	1050.0	150.0	0.0
361	1050.0	200.0	0.0	362	1050.0	250.0	0.0	363	1050.0	300.0	0.0
364	1050.0	350.0	0.0	365	1050.0	400.0	0.0	366	1050.0	450.0	0.0
367	1050.0	500.0	0.0	368	1050.0	550.0	0.0	369	1050.0	600.0	0.0
370	1050.0	630.0	0.0	371	1100.0	0.0	0.0	372	1100.0	50.0	0.0
373	1100.0	100.0	0.0	374	1100.0	150.0	0.0	375	1100.0	200.0	0.0
376	1100.0	250.0	0.0	377	1100.0	300.0	0.0	378	1100.0	350.0	0.0
379	1100.0	400.0	0.0	380	1100.0	450.0	0.0	381	1100.0	500.0	0.0
382	1100.0	550.0	0.0	383	1100.0	600.0	0.0	384	1100.0	630.0	0.0
385	1150.0	0.0	0.0	386	1150.0	50.0	0.0	387	1150.0	100.0	0.0
388	1150.0	150.0	0.0	389	1150.0	200.0	0.0	390	1150.0	250.0	0.0
391	1150.0	300.0	0.0	392	1150.0	350.0	0.0	393	1150.0	400.0	0.0
394	1150.0	450.0	0.0	395	1150.0	500.0	0.0	396	1150.0	550.0	0.0
397	1150.0	600.0	0.0	398	1150.0	630.0	0.0	399	1200.0	0.0	0.0
400	1200.0	50.0	0.0	401	1200.0	100.0	0.0	402	1200.0	150.0	0.0
403	1200.0	200.0	0.0	404	1200.0	250.0	0.0	405	1200.0	300.0	0.0
406	1200.0	350.0	0.0	407	1200.0	400.0	0.0	408	1200.0	450.0	0.0
409	1200.0	500.0	0.0	410	1200.0	550.0	0.0	411	1200.0	600.0	0.0
412	1200.0	630.0	0.0	413	1250.0	0.0	0.0	414	1250.0	50.0	0.0
415	1250.0	100.0	0.0	416	1250.0	150.0	0.0	417	1250.0	200.0	0.0
418	1250.0	250.0	0.0	419	1250.0	300.0	0.0	420	1250.0	350.0	0.0
421	1250.0	400.0	0.0	422	1250.0	450.0	0.0	423	1250.0	500.0	0.0
424	1250.0	550.0	0.0	425	1250.0	600.0	0.0	426	1250.0	630.0	0.0
427	1300.0	0.0	0.0	428	1300.0	50.0	0.0	429	1300.0	100.0	0.0
430	1300.0	150.0	0.0	431	1300.0	200.0	0.0	432	1300.0	250.0	0.0
433	1300.0	300.0	0.0	434	1300.0	350.0	0.0	435	1300.0	400.0	0.0
436	1300.0	450.0	0.0	437	1300.0	500.0	0.0	438	1300.0	550.0	0.0
439	1300.0	600.0	0.0	440	1300.0	630.0	0.0	441	1350.0	0.0	0.0
442	1350.0	50.0	0.0	443	1350.0	100.0	0.0	444	1350.0	150.0	0.0
445	1350.0	200.0	0.0	446	1350.0	250.0	0.0	447	1350.0	300.0	0.0
448	1350.0	350.0	0.0	449	1350.0	400.0	0.0	450	1350.0	450.0	0.0
451	1350.0	500.0	0.0	452	1350.0	550.0	0.0	453	1350.0	600.0	0.0
454	1350.0	630.0	0.0	455	1370.2	50.0	0.0	456	1370.2	100.0	0.0
457	1370.2	150.0	0.0	458	1370.2	200.0	0.0	459	1370.2	250.0	0.0
460	1370.2	300.0	0.0	461	1370.2	350.0	0.0	462	1370.2	400.0	0.0
463	1370.2	450.0	0.0	464	1370.2	500.0	0.0	465	1370.2	550.0	0.0
466	1370.2	600.0	0.0	467	1400.0	0.0	0.0	468	1400.0	50.0	0.0
469	1400.0	100.0	0.0	470	1400.0	150.0	0.0	471	1400.0	200.0	0.0
472	1400.0	250.0	0.0	473	1400.0	300.0	0.0	474	1400.0	350.0	0.0
475	1400.0	400.0	0.0	476	1400.0	450.0	0.0	477	1400.0	500.0	0.0
478	1400.0	550.0	0.0	479	1400.0	600.0	0.0	480	1400.0	630.0	0.0
481	1450.0	0.0	0.0	482	1450.0	50.0	0.0	483	1450.0	100.0	0.0
484	1450.0	150.0	0.0	485	1450.0	200.0	0.0	486	1450.0	250.0	0.0
487	1450.0	300.0	0.0	488	1450.0	350.0	0.0	489	1450.0	400.0	0.0
490	1450.0	450.0	0.0	491	1450.0	500.0	0.0	492	1450.0	550.0	0.0
493	1450.0	600.0	0.0	494	1450.0	630.0	0.0	495	1500.0	0.0	0.0
496	1500.0	50.0	0.0	497	1500.0	100.0	0.0	498	1500.0	150.0	0.0
499	1500.0	200.0	0.0	500	1500.0	250.0	0.0	501	1500.0	300.0	0.0
502	1500.0	350.0	0.0	503	1500.0	400.0	0.0	504	1500.0	450.0	0.0
505	1500.0	500.0	0.0	506	1500.0	550.0	0.0	507	1500.0	600.0	0.0
508	1500.0	630.0	0.0	509	1550.0	0.0	0.0	510	1550.0	50.0	0.0
511	1550.0	100.0	0.0	512	1550.0	150.0	0.0	513	1550.0	200.0	0.0
514	1550.0	250.0	0.0	515	1550.0	300.0	0.0	516	1550.0	350.0	0.0
517	1550.0	400.0	0.0	518	1550.0	450.0	0.0	519	1550.0	500.0	0.0
520	1550.0	550.0	0.0	521	1550.0	600.0	0.0	522	1550.0	630.0	0.0
523	1600.0	0.0	0.0	524	1600.0	50.0	0.0	525	1600.0	100.0	0.0
526	1600.0	150.0	0.0	527	1600.0	200.0	0.0	528	1600.0	250.0	0.0
529	1600.0	300.0	0.0	530	1600.0	350.0	0.0	531	1600.0	400.0	0.0
532	1600.0	450.0	0.0	533	1600.0	500.0	0.0	534	1600.0	550.0	0.0
535	1600.0	600.0	0.0	536	1600.0	630.0	0.0	537	1650.0	0.0	0.0
538	1650.0	50.0	0.0	539	1650.0	100.0	0.0	540	1650.0	150.0	0.0



EGP CODE

GRE.EEC.R.73.IT.W.15235.12.024.01

PAGE

26 di/of 527

541	1650.0	200.0	0.0	542	1650.0	250.0	0.0	543	1650.0	300.0	0.0
544	1650.0	350.0	0.0	545	1650.0	400.0	0.0	546	1650.0	450.0	0.0
547	1650.0	500.0	0.0	548	1650.0	550.0	0.0	549	1650.0	600.0	0.0
550	1650.0	630.0	0.0	551	1700.0	0.0	0.0	552	1700.0	50.0	0.0
553	1700.0	100.0	0.0	554	1700.0	150.0	0.0	555	1700.0	200.0	0.0
556	1700.0	250.0	0.0	557	1700.0	300.0	0.0	558	1700.0	350.0	0.0
559	1700.0	400.0	0.0	560	1700.0	450.0	0.0	561	1700.0	500.0	0.0
562	1700.0	550.0	0.0	563	1700.0	600.0	0.0	564	1700.0	630.0	0.0
565	1750.0	0.0	0.0	566	1750.0	50.0	0.0	567	1750.0	100.0	0.0
568	1750.0	150.0	0.0	569	1750.0	200.0	0.0	570	1750.0	250.0	0.0
571	1750.0	300.0	0.0	572	1750.0	350.0	0.0	573	1750.0	400.0	0.0
574	1750.0	450.0	0.0	575	1750.0	500.0	0.0	576	1750.0	550.0	0.0
577	1750.0	600.0	0.0	578	1750.0	630.0	0.0	579	1800.0	0.0	0.0
580	1800.0	50.0	0.0	581	1800.0	100.0	0.0	582	1800.0	150.0	0.0
583	1800.0	200.0	0.0	584	1800.0	250.0	0.0	585	1800.0	300.0	0.0
586	1800.0	350.0	0.0	587	1800.0	400.0	0.0	588	1800.0	450.0	0.0
589	1800.0	500.0	0.0	590	1800.0	550.0	0.0	591	1800.0	600.0	0.0
592	1800.0	630.0	0.0	593	1840.0	50.0	0.0	594	1840.0	100.0	0.0
595	1840.0	150.0	0.0	596	1840.0	200.0	0.0	597	1840.0	250.0	0.0
598	1840.0	300.0	0.0	599	1840.0	350.0	0.0	600	1840.0	400.0	0.0
601	1840.0	450.0	0.0	602	1840.0	500.0	0.0	603	1840.0	550.0	0.0
604	1840.0	600.0	0.0	605	3350.0	-50.0	0.0	606	1800.0	-50.0	0.0
607	3475.8	630.0	0.0	608	3475.8	0.0	0.0	609	3475.8	50.0	0.0
610	3475.8	100.0	0.0	611	3475.8	150.0	0.0	612	3475.8	200.0	0.0
613	3475.8	250.0	0.0	614	3475.8	300.0	0.0	615	3475.8	350.0	0.0
616	3475.8	400.0	0.0	617	3475.8	450.0	0.0	618	3475.8	500.0	0.0
619	1900.0	0.0	0.0	620	1900.0	50.0	0.0	621	1900.0	100.0	0.0
622	1900.0	150.0	0.0	623	1900.0	200.0	0.0	624	1900.0	250.0	0.0
625	1900.0	300.0	0.0	626	1900.0	350.0	0.0	627	1900.0	400.0	0.0
628	1900.0	450.0	0.0	629	1900.0	500.0	0.0	630	1900.0	550.0	0.0
631	1900.0	600.0	0.0	632	1900.0	630.0	0.0	633	1950.0	0.0	0.0
634	1950.0	50.0	0.0	635	1950.0	100.0	0.0	636	1950.0	150.0	0.0
637	1950.0	200.0	0.0	638	1950.0	250.0	0.0	639	1950.0	300.0	0.0
640	1950.0	350.0	0.0	641	1950.0	400.0	0.0	642	1950.0	450.0	0.0
643	1950.0	500.0	0.0	644	1950.0	550.0	0.0	645	1950.0	600.0	0.0
646	1950.0	630.0	0.0	647	2000.0	0.0	0.0	648	2000.0	50.0	0.0
649	2000.0	100.0	0.0	650	2000.0	150.0	0.0	651	2000.0	200.0	0.0
652	2000.0	250.0	0.0	653	2000.0	300.0	0.0	654	2000.0	350.0	0.0
655	2000.0	400.0	0.0	656	2000.0	450.0	0.0	657	2000.0	500.0	0.0
658	2000.0	550.0	0.0	659	2000.0	600.0	0.0	660	2000.0	630.0	0.0
661	2050.0	0.0	0.0	662	2050.0	50.0	0.0	663	2050.0	100.0	0.0
664	2050.0	150.0	0.0	665	2050.0	200.0	0.0	666	2050.0	250.0	0.0
667	2050.0	300.0	0.0	668	2050.0	350.0	0.0	669	2050.0	400.0	0.0
670	2050.0	450.0	0.0	671	2050.0	500.0	0.0	672	2050.0	550.0	0.0
673	2050.0	600.0	0.0	674	2050.0	630.0	0.0	675	2100.0	0.0	0.0
676	2100.0	50.0	0.0	677	2100.0	100.0	0.0	678	2100.0	150.0	0.0
679	2100.0	200.0	0.0	680	2100.0	250.0	0.0	681	2100.0	300.0	0.0
682	2100.0	350.0	0.0	683	2100.0	400.0	0.0	684	2100.0	450.0	0.0
685	2100.0	500.0	0.0	686	2100.0	550.0	0.0	687	2100.0	600.0	0.0
688	2100.0	630.0	0.0	689	2150.0	0.0	0.0	690	2150.0	50.0	0.0
691	2150.0	100.0	0.0	692	2150.0	150.0	0.0	693	2150.0	200.0	0.0
694	2150.0	250.0	0.0	695	2150.0	300.0	0.0	696	2150.0	350.0	0.0
697	2150.0	400.0	0.0	698	2150.0	450.0	0.0	699	2150.0	500.0	0.0
700	2150.0	550.0	0.0	701	2150.0	600.0	0.0	702	2150.0	630.0	0.0
703	2200.0	0.0	0.0	704	2200.0	50.0	0.0	705	2200.0	100.0	0.0
706	2200.0	150.0	0.0	707	2200.0	200.0	0.0	708	2200.0	250.0	0.0
709	2200.0	300.0	0.0	710	2200.0	350.0	0.0	711	2200.0	400.0	0.0
712	2200.0	450.0	0.0	713	2200.0	500.0	0.0	714	2200.0	550.0	0.0
715	2200.0	600.0	0.0	716	2200.0	630.0	0.0	717	2250.0	0.0	0.0
718	2250.0	50.0	0.0	719	2250.0	100.0	0.0	720	2250.0	150.0	0.0
721	2250.0	200.0	0.0	722	2250.0	250.0	0.0	723	2250.0	300.0	0.0
724	2250.0	350.0	0.0	725	2250.0	400.0	0.0	726	2250.0	450.0	0.0
727	2250.0	500.0	0.0	728	2250.0	550.0	0.0	729	2250.0	600.0	0.0
730	2250.0	630.0	0.0	731	3475.8	550.0	0.0	732	2309.8	50.0	0.0
733	2309.8	100.0	0.0	734	2309.8	150.0	0.0	735	2309.8	200.0	0.0
736	2309.8	250.0	0.0	737	2309.8	300.0	0.0	738	2309.8	350.0	0.0
739	2309.8	400.0	0.0	740	2309.8	450.0	0.0	741	2309.8	500.0	0.0
742	2309.8	550.0	0.0	743	2309.8	600.0	0.0	744	3475.8	600.0	0.0
745	3475.8	680.0	0.0	746	3475.8	-50.0	0.0	747	-50.0	0.0	0.0
748	-50.0	630.0	0.0	749	-50.0	50.0	0.0	750	-50.0	100.0	0.0
751	-50.0	150.0	0.0	752	-50.0	200.0	0.0	753	-50.0	250.0	0.0
754	-50.0	300.0	0.0	755	-50.0	350.0	0.0	756	-50.0	400.0	0.0
757	2350.0	0.0	0.0	758	2350.0	50.0	0.0	759	2350.0	100.0	0.0
760	2350.0	150.0	0.0	761	2350.0	200.0	0.0	762	2350.0	250.0	0.0
763	2350.0	300.0	0.0	764	2350.0	350.0	0.0	765	2350.0	400.0	0.0
766	2350.0	450.0	0.0	767	2350.0	500.0	0.0	768	2350.0	550.0	0.0





EGP CODE

GRE.EEC.R.73.IT.W.15235.12.024.01

PAGE

27 di/of 527

769	2350.0	600.0	0.0	770	2350.0	630.0	0.0	771	2400.0	0.0	0.0
772	2400.0	50.0	0.0	773	2400.0	100.0	0.0	774	2400.0	150.0	0.0
775	2400.0	200.0	0.0	776	2400.0	250.0	0.0	777	2400.0	300.0	0.0
778	2400.0	350.0	0.0	779	2400.0	400.0	0.0	780	2400.0	450.0	0.0
781	2400.0	500.0	0.0	782	2400.0	550.0	0.0	783	2400.0	600.0	0.0
784	2400.0	630.0	0.0	785	2450.0	0.0	0.0	786	2450.0	50.0	0.0
787	2450.0	100.0	0.0	788	2450.0	150.0	0.0	789	2450.0	200.0	0.0
790	2450.0	250.0	0.0	791	2450.0	300.0	0.0	792	2450.0	350.0	0.0
793	2450.0	400.0	0.0	794	2450.0	450.0	0.0	795	2450.0	500.0	0.0
796	2450.0	550.0	0.0	797	2450.0	600.0	0.0	798	2450.0	630.0	0.0
799	2500.0	0.0	0.0	800	2500.0	50.0	0.0	801	2500.0	100.0	0.0
802	2500.0	150.0	0.0	803	2500.0	200.0	0.0	804	2500.0	250.0	0.0
805	2500.0	300.0	0.0	806	2500.0	350.0	0.0	807	2500.0	400.0	0.0
808	2500.0	450.0	0.0	809	2500.0	500.0	0.0	810	2500.0	550.0	0.0
811	2500.0	600.0	0.0	812	2500.0	630.0	0.0	813	2550.0	0.0	0.0
814	2550.0	50.0	0.0	815	2550.0	100.0	0.0	816	2550.0	150.0	0.0
817	2550.0	200.0	0.0	818	2550.0	250.0	0.0	819	2550.0	300.0	0.0
820	2550.0	350.0	0.0	821	2550.0	400.0	0.0	822	2550.0	450.0	0.0
823	2550.0	500.0	0.0	824	2550.0	550.0	0.0	825	2550.0	600.0	0.0
826	2550.0	630.0	0.0	827	2600.0	0.0	0.0	828	2600.0	50.0	0.0
829	2600.0	100.0	0.0	830	2600.0	150.0	0.0	831	2600.0	200.0	0.0
832	2600.0	250.0	0.0	833	2600.0	300.0	0.0	834	2600.0	350.0	0.0
835	2600.0	400.0	0.0	836	2600.0	450.0	0.0	837	2600.0	500.0	0.0
838	2600.0	550.0	0.0	839	2600.0	600.0	0.0	840	2600.0	630.0	0.0
841	2650.0	0.0	0.0	842	2650.0	50.0	0.0	843	2650.0	100.0	0.0
844	2650.0	150.0	0.0	845	2650.0	200.0	0.0	846	2650.0	250.0	0.0
847	2650.0	300.0	0.0	848	2650.0	350.0	0.0	849	2650.0	400.0	0.0
850	2650.0	450.0	0.0	851	2650.0	500.0	0.0	852	2650.0	550.0	0.0
853	2650.0	600.0	0.0	854	2650.0	630.0	0.0	855	2700.0	0.0	0.0
856	2700.0	50.0	0.0	857	2700.0	100.0	0.0	858	2700.0	150.0	0.0
859	2700.0	200.0	0.0	860	2700.0	250.0	0.0	861	2700.0	300.0	0.0
862	2700.0	350.0	0.0	863	2700.0	400.0	0.0	864	2700.0	450.0	0.0
865	2700.0	500.0	0.0	866	2700.0	550.0	0.0	867	2700.0	600.0	0.0
868	2700.0	630.0	0.0	869	2729.9	50.0	0.0	870	2729.9	100.0	0.0
871	2729.9	150.0	0.0	872	2729.9	200.0	0.0	873	2729.9	250.0	0.0
874	2729.9	300.0	0.0	875	2729.9	350.0	0.0	876	2729.9	400.0	0.0
877	2729.9	450.0	0.0	878	2729.9	500.0	0.0	879	2729.9	550.0	0.0
880	2729.9	600.0	0.0	881	2750.0	0.0	0.0	882	2750.0	50.0	0.0
883	2750.0	100.0	0.0	884	2750.0	150.0	0.0	885	2750.0	200.0	0.0
886	2750.0	250.0	0.0	887	2750.0	300.0	0.0	888	2750.0	350.0	0.0
889	2750.0	400.0	0.0	890	2750.0	450.0	0.0	891	2750.0	500.0	0.0
892	2750.0	550.0	0.0	893	2750.0	600.0	0.0	894	2750.0	630.0	0.0
895	2800.0	0.0	0.0	896	2800.0	50.0	0.0	897	2800.0	100.0	0.0
898	2800.0	150.0	0.0	899	2800.0	200.0	0.0	900	2800.0	250.0	0.0
901	2800.0	300.0	0.0	902	2800.0	350.0	0.0	903	2800.0	400.0	0.0
904	2800.0	450.0	0.0	905	2800.0	500.0	0.0	906	2800.0	550.0	0.0
907	2800.0	600.0	0.0	908	2800.0	630.0	0.0	909	2850.0	0.0	0.0
910	2850.0	50.0	0.0	911	2850.0	100.0	0.0	912	2850.0	150.0	0.0
913	2850.0	200.0	0.0	914	2850.0	250.0	0.0	915	2850.0	300.0	0.0
916	2850.0	350.0	0.0	917	2850.0	400.0	0.0	918	2850.0	450.0	0.0
919	2850.0	500.0	0.0	920	2850.0	550.0	0.0	921	2850.0	600.0	0.0
922	2850.0	630.0	0.0	923	2900.0	0.0	0.0	924	2900.0	50.0	0.0
925	2900.0	100.0	0.0	926	2900.0	150.0	0.0	927	2900.0	200.0	0.0
928	2900.0	250.0	0.0	929	2900.0	300.0	0.0	930	2900.0	350.0	0.0
931	2900.0	400.0	0.0	932	2900.0	450.0	0.0	933	2900.0	500.0	0.0
934	2900.0	550.0	0.0	935	2900.0	600.0	0.0	936	2900.0	630.0	0.0
937	2950.0	0.0	0.0	938	2950.0	50.0	0.0	939	2950.0	100.0	0.0
940	2950.0	150.0	0.0	941	2950.0	200.0	0.0	942	2950.0	250.0	0.0
943	2950.0	300.0	0.0	944	2950.0	350.0	0.0	945	2950.0	400.0	0.0
946	2950.0	450.0	0.0	947	2950.0	500.0	0.0	948	2950.0	550.0	0.0
949	2950.0	600.0	0.0	950	2950.0	630.0	0.0	951	-50.0	450.0	0.0
952	3009.8	50.0	0.0	953	3009.8	100.0	0.0	954	3009.8	150.0	0.0
955	3009.8	200.0	0.0	956	3009.8	250.0	0.0	957	3009.8	300.0	0.0
958	3009.8	350.0	0.0	959	3009.8	400.0	0.0	960	3009.8	450.0	0.0
961	3009.8	500.0	0.0	962	3009.8	550.0	0.0	963	3009.8	600.0	0.0
964	-50.0	500.0	0.0	965	-50.0	550.0	0.0	966	-50.0	600.0	0.0
967	-50.0	680.0	0.0	968	-50.0	-50.0	0.0	969	3399.8	630.0	0.0
970	3399.8	0.0	0.0	971	3399.8	50.0	0.0	972	3399.8	100.0	0.0
973	3399.8	150.0	0.0	974	3399.8	200.0	0.0	975	3399.8	250.0	0.0
976	3399.8	300.0	0.0	977	3050.0	0.0	0.0	978	3050.0	50.0	0.0
979	3050.0	100.0	0.0	980	3050.0	150.0	0.0	981	3050.0	200.0	0.0
982	3050.0	250.0	0.0	983	3050.0	300.0	0.0	984	3050.0	350.0	0.0
985	3050.0	400.0	0.0	986	3050.0	450.0	0.0	987	3050.0	500.0	0.0
988	3050.0	550.0	0.0	989	3050.0	600.0	0.0	990	3050.0	630.0	0.0
991	3100.0	0.0	0.0	992	3100.0	50.0	0.0	993	3100.0	100.0	0.0
994	3100.0	150.0	0.0	995	3100.0	200.0	0.0	996	3100.0	250.0	0.0





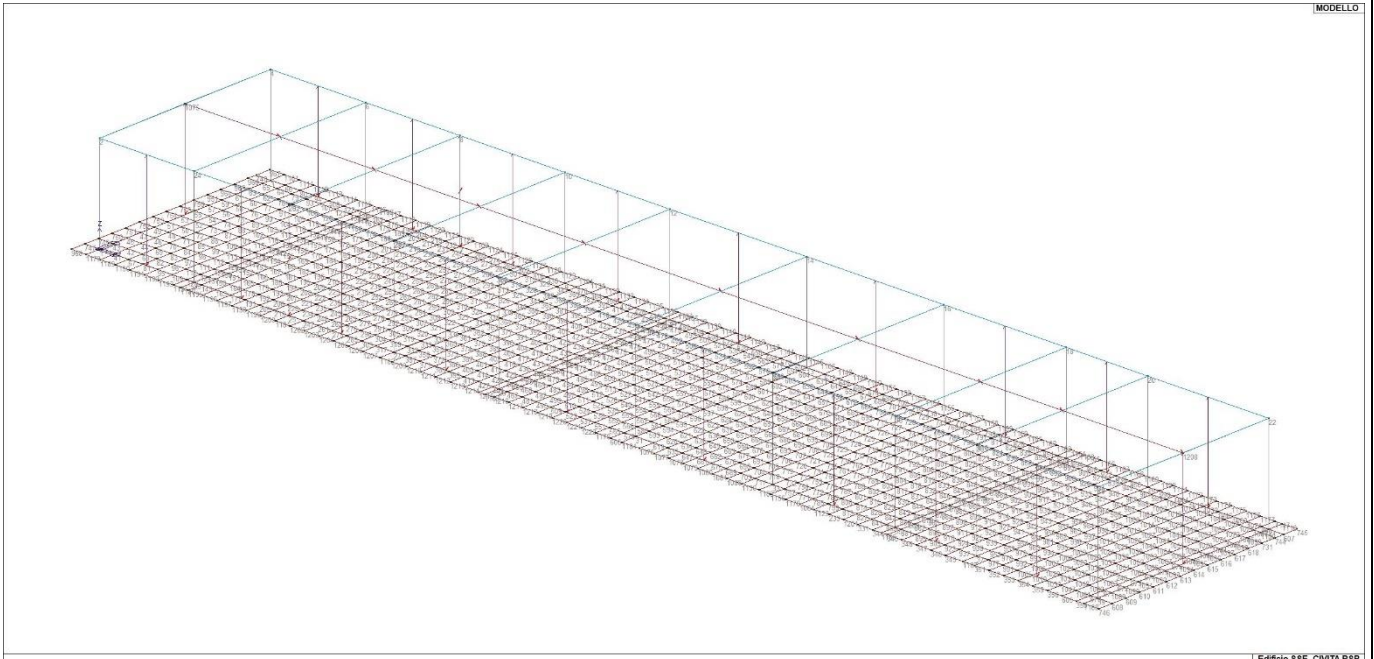

Edificio 38E CIVITA' PISP

14\_MOD\_NUMERAZIONE\_NODI

## 6. MODELLAZIONE STRUTTURA: ELEMENTI TRAVE

### 6.1. TABELLA DATI TRAVI

Il programma utilizza per la modellazione elementi a due nodi denominati in generale travi.

Ogni elemento trave è individuato dal nodo iniziale e dal nodo finale.

Ogni elemento è caratterizzato da un insieme di proprietà riportate in tabella che ne completano la modellazione.

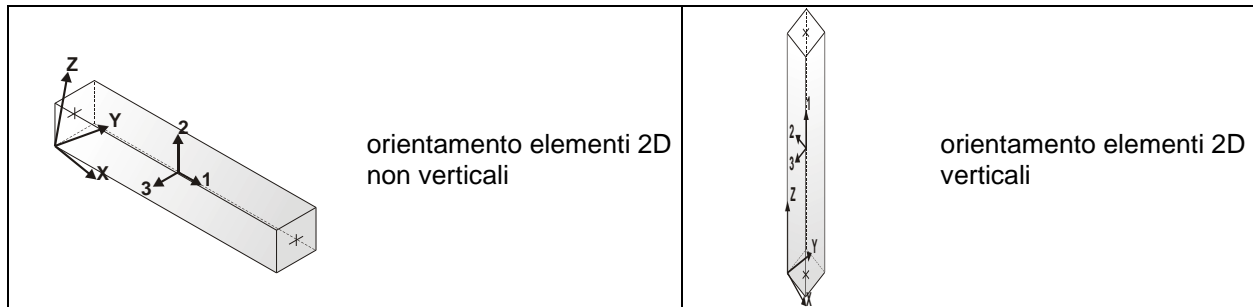

In particolare per ogni elemento viene indicato in tabella:

<b>Elem.</b>	numero dell'elemento
<b>Note</b>	codice di comportamento: trave, trave di fondazione, pilastro, asta, asta tesa, asta compressa,
<b>Nodo I (J)</b>	numero del nodo iniziale (finale)
<b>Mat.</b>	codice del materiale assegnato all'elemento
<b>Sez.</b>	codice della sezione assegnata all'elemento
<b>Rotaz.</b>	valore della rotazione dell'elemento, attorno al proprio asse, nel caso in cui l'orientamento di default non sia adottabile; l'orientamento di default prevede per gli elementi non verticali l'asse 2 contenuto nel piano verticale e l'asse 3 orizzontale, per gli elementi verticali l'asse 2 diretto secondo X negativo e l'asse 3 diretto secondo Y negativo
<b>Svincolo I (J)</b>	codici di svincolo per le azioni interne; i primi sei codici si riferiscono al nodo iniziale, i restanti sei al nodo finale (il valore 1 indica che la relativa azione interna non è attiva)
<b>Wink V</b>	costante di sottofondo (coefficiente di Winkler) per la modellazione della trave su suolo elastico
<b>Wink O</b>	costante di sottofondo (coefficiente di Winkler) per la modellazione del suolo elastico orizzontale

Con riferimento al **Documento di Affidabilità** "Test di validazione del software di calcolo PRO\_SAP e dei moduli aggiuntivi PRO\_SAP Modulo Geotecnico, PRO\_CAD nodi acciaio e PRO\_MST" - versione Settembre 2014, disponibile per il download sul sito [www.2si.it](http://www.2si.it), si segnalano i seguenti esempi applicativi:

Test N°	Titolo
2	TRAVI A UNA CAMPATA
3	TRAVE A PIU' CAMPATE
4	TRAVE A UNA CAMPATA SU TERRENO ALLA WINKLER
5	TRAVI SU TERRENO ALLA WINKLER CON CARICO TRASVERSALE
6	TELAI PIANI CON CERNIERE ALLA BASE
7	TELAI PIANI CON INCASTRI ALLA BASE
11	STRUTTURE SOGGETTE A VARIAZIONI TERMICHE
12	STRUTTURE SU TERRENO ALLA WINKLER SOTTOPOSTE A CARICHI DISTRIBUITI TRIANGOLARI
21	DRILLING
24	TENSIONI E ROTAZIONI RISPETTO ALLA CORDA DI ELEMENTI TRAVE
27	FRECCIA DI ELEMENTI TRAVE
42	GERARCHIA DELLE RESISTENZE PER TRAVI IN C.A.
43	GERARCHIA DELLE RESISTENZE PER PILASTRI IN C.A.
44	VERIFICA ALLE TA DI STRUTTURE IN C.A.
45	VERIFICA AGLI SLU DI STRUTTURE IN C.A.
47	VERIFICA A PUNZONAMENTO ALLO SLU DI TRAVI IN C.A.
48	PROGETTAZIONE A TAGLIO DI STRUTTURE IN C.A. SECONDO IL D.M. 9/1/96
49	PROGETTAZIONE A TAGLIO DI STRUTTURE IN C.A. SECONDO IL D.M. 14/1/2008
50	VERIFICA ALLO SLE (TENSIONI E FESSURAZIONE) DI STRUTTURE IN C.A.
51	VERIFICA ALLO SLE (DEFORMAZIONE) DI STRUTTURE IN C.A.
52	FATTORE DI STRUTTURA
53	SOVRARESISTENZE
54	DETTAGLI COSTRUTTIVI C.A.: LIMITI D'ARMATURA PILASTRI E NODI TRAVE-PILASTRO
56	VERIFICA DI STABILITA' DI ASTE COMPRESSE IN ACCIAIO – METODO OMEGA
57	LUCE LIBERA DI TRAVI E ASTE IN ACCIAIO
58	LUCE LIBERA DI COLONNE IN ACCIAIO
59	SVERGOLAMENTO DI TRAVI IN ACCIAIO
64	STABILITA' DI ASTE COMPOSTE IN ACCIAIO
73	VALUTAZIONE EFFETTO P- $\delta$ SU PILASTRATA
74	VALUTAZIONE EFFETTO P- $\delta$ SU TELAIO 3D
85	ANALISI PUSHOVER DI UN EDIFICIO IN C.A.
87	ANALISI ELASTO PLASTICA INCREMENTALE
88	ANALISI ELASTO PLASTICA INCREMENTALE
98	VERIFICA ALLO SLU DI STRUTTURE IN LEGNO SECONDO EC5
99	VERIFICA ALLO SLE DI STRUTTURE IN LEGNO SECONDO EC5
102	SNELLEZZE EC5
130	PROGETTO E VERIFICA DI TRAVI PREM

Elem.	Note	Nodo I	Nodo J	Mat.	Sez. gradi	Rotaz.	Svincolo I	Svincolo J daN/cm3	Wink V daN/cm3	Wink O
1	Pilas.	1	2	5	1					
2	Pilas.	3	4	5	1					
3	Pilas.	5	6	5	1					
4	Pilas.	7	8	5	1					
5	Pilas.	9	10	5	1					
6	Pilas.	11	12	5	1					
7	Pilas.	13	14	5	1					
8	Pilas.	15	16	5	1					

9	Pilas.	17	18	5	1
10	Pilas.	19	20	5	1
11	Pilas.	21	22	5	1
12	Pilas.	23	24	5	1
13	Pilas.	25	26	5	1
14	Pilas.	27	28	5	1
15	Pilas.	29	30	5	1
16	Pilas.	31	32	5	1
17	Pilas.	33	34	5	1
18	Pilas.	35	36	5	1
19	Pilas.	37	38	5	1
20	Pilas.	39	40	5	1
21	Trave	38	40	5	2
22	Trave	2	24	5	2
23	Trave	4	6	5	2
24	Trave	40	1208	5	2
25	Trave	2	1075	5	2
26	Trave	24	26	5	2
27	Trave	6	8	5	2
28	Trave	26	28	5	2
29	Trave	8	10	5	2
30	Trave	28	30	5	2
31	Trave	10	12	5	2
32	Trave	30	32	5	2
33	Trave	12	14	5	2
34	Trave	32	34	5	2
35	Trave	14	16	5	2
36	Trave	34	36	5	2
37	Trave	16	18	5	2
38	Trave	36	38	5	2
39	Trave	18	20	5	2
40	Trave	20	22	5	2
41	Trave	24	6	5	2
42	Trave	26	8	5	2
43	Trave	28	10	5	2
44	Trave	30	12	5	2
45	Trave	32	14	5	2
46	Trave	34	16	5	2
47	Trave	36	18	5	2
48	Trave	38	20	5	2
49	Trave	1208	22	5	2
50	Trave	1075	4	5	2

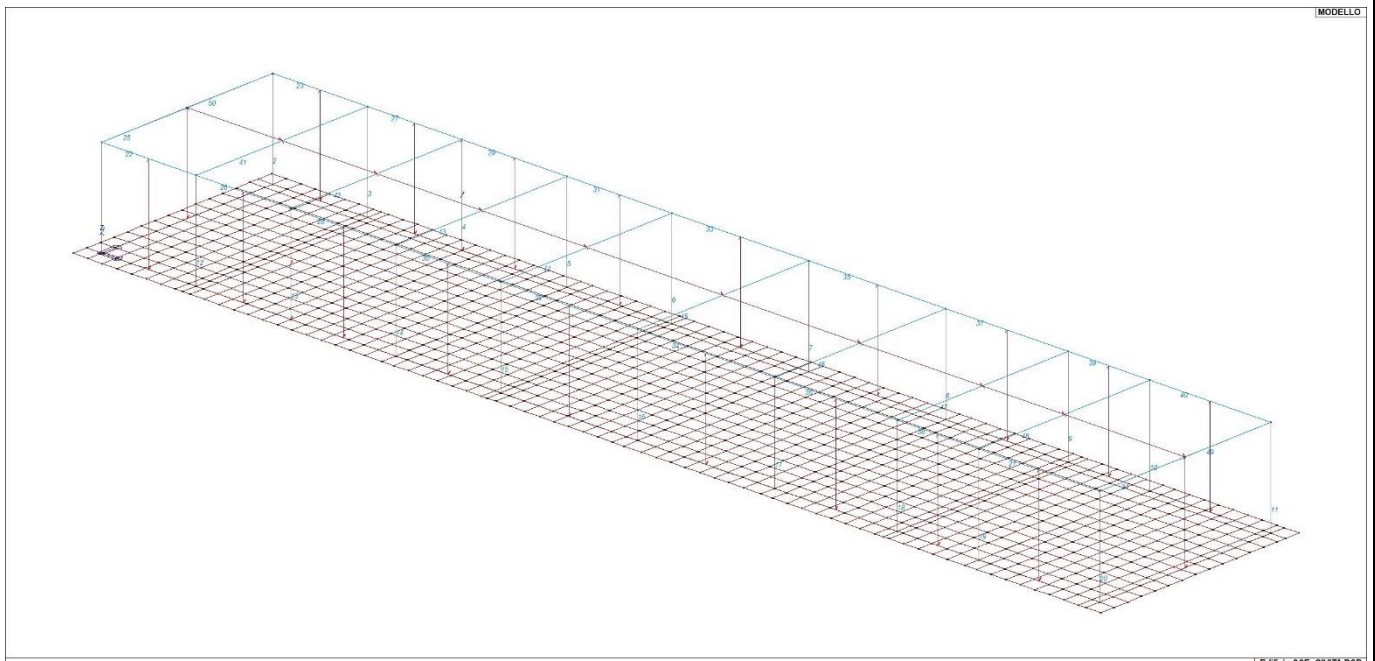

15\_MOD\_NUMERAZIONE\_D2

MODELLO

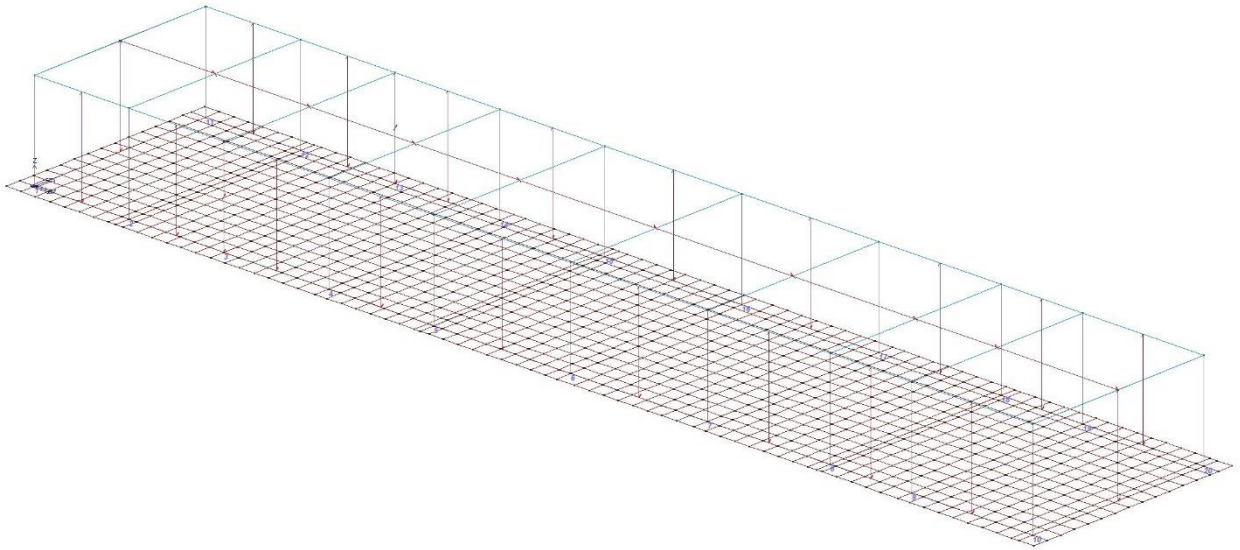

Edificio 33E\_CIVITA'PSP

15\_MOD\_NUMERAZIONE\_D2\_PILASTRATE

MODELLO

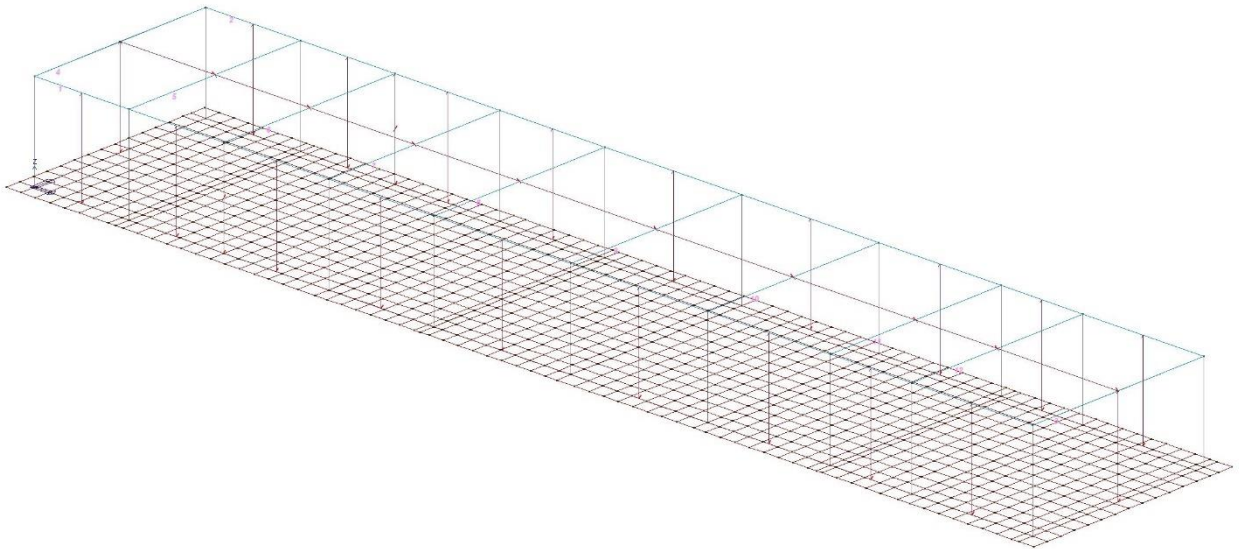

Edificio 33E\_CIVITA'PSP

15\_MOD\_NUMERAZIONE\_D2\_TRAVATE



## 7. MODELLAZIONE STRUTTURA: ELEMENTI SHELL

### 7.1. LEGENDA TABELLA DATI SHELL

Il programma utilizza per la modellazione elementi a tre o quattro nodi denominati in generale shell.

Ogni elemento shell è individuato dai nodi I, J, K, L (L=I per gli elementi a tre nodi).

Ogni elemento è caratterizzato da un insieme di proprietà riportate in tabella che ne completano la modellazione.

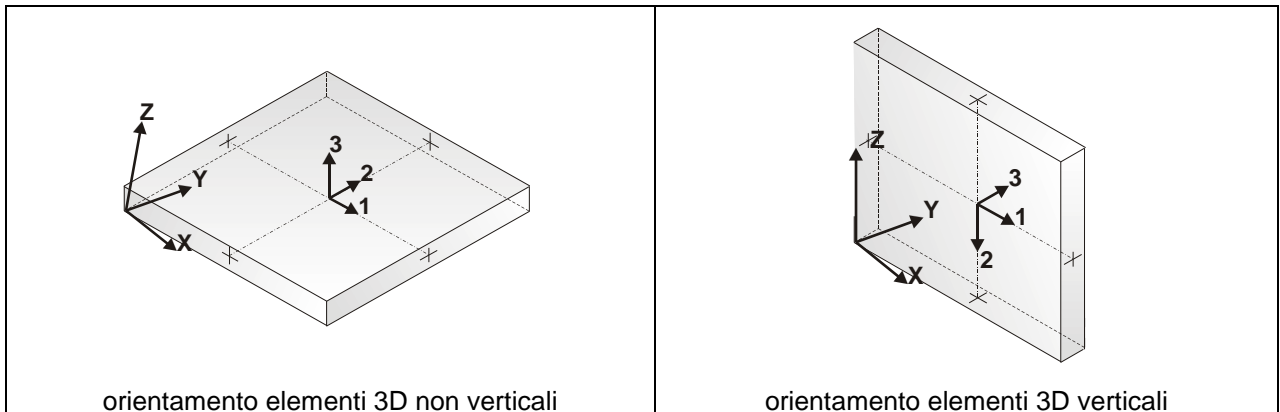

In particolare per ogni elemento viene indicato in tabella:

<b>Elem.</b>	numero dell'elemento
<b>Note</b>	codice di comportamento: <i>Guscio</i> (elemento guscio in elevazione non verticale) <i>Guscio fond.</i> (elemento guscio su suolo elastico) <i>Setto</i> (elemento guscio in elevazione verticale) <i>Membrana</i> (elemento guscio con comportamento membranale)
<b>Nodo I (J, K, L)</b>	numero del nodo I (J, K, L)
<b>Mat.</b>	codice del materiale assegnato all'elemento
<b>Spessore</b>	spessore dell'elemento (costante)
<b>Wink V</b>	costante di sottofondo (coefficiente di Winkler) per la modellazione del suolo elastico verticale
<b>Wink O</b>	costante di sottofondo (coefficiente di Winkler) per la modellazione del suolo elastico orizzontale

Con riferimento al **Documento di Affidabilità** "Test di validazione del software di calcolo PRO\_SAP e dei moduli aggiuntivi PRO\_SAP Modulo Geotecnico, PRO\_CAD nodi acciaio e PRO\_MST" - versione Maggio 2011, disponibile per il download sul sito [www.2si.it](http://www.2si.it), si segnalano i seguenti esempi applicativi:

Test N°	Titolo
8	MENSOLE CON ELEMENTI PLATE E MATERIALE ORTOTROPO
10	PIASTRA CON ELEMENTI PLATE E MATERIALE ORTOTROPO
21	DRILLING
25	TENSIONI DI ELEMENTI PLATE
31	REALIZZAZIONE DI MESH PIANA SU GEOMETRIA CON PUNTI FISSI IMPORTATA DA FILE .DXF
32	REALIZZAZIONE DI MESH PIANA SU GEOMETRIA CON SEGMENTI E FORI INTERNI IMPORTATA DA FILE .DXF
33	REALIZZAZIONE DI MESH PIANE SU GEOMETRIE COSTRUITE IN PRO_SAP
34	ANALISI DI BUCKLING DI PIASTRA ISOTROPA
35	ANALISI DI BUCKLING DI UN CILINDRO COMPRESSO INCASTRATO ALLA BASE
36	ANALISI DI PARETI FORATE
37	BIMETALLIC STRIP (NAFEMS EXERCISE 6)
38	ANALISI ELASTICA DI PIASTRA CON INTAGLIO CIRCOLARE (FLAT BAR WITH EDGE NOTCHES-NAFEMS EXERCISE 9)
39	PLATEA NERVATA
45	VERIFICA A PUNZONAMENTO ALLO SLU DI PIASTRE IN C.A.
117	PROGETTO E VERIFICA DI GUSCI IN MATERIALE XLAM
118	PROGETTO E VERIFICA DI PARETI IN MATERIALE XLAM E RELATIVI COLLEGAMENTI

Elem.	Note	Nodo I	Nodo J	Nodo K	Nodo L	Mat.	Spessore	Svincolo	Wink V	Wink O
					cm		daN/cm <sup>3</sup>	daN/cm <sup>3</sup>		
1	Guscio fond.	1 41	42	43	1	40.0		10.00	5.00	
2	Guscio fond.	43 42	44	45	1	40.0		10.00	5.00	
3	Guscio fond.	45 44	46	47	1	40.0		10.00	5.00	
4	Guscio fond.	47 46	48	49	1	40.0		10.00	5.00	
5	Guscio fond.	49 48	50	51	1	40.0		10.00	5.00	
6	Guscio fond.	51 50	52	53	1	40.0		10.00	5.00	
7	Guscio fond.	53 52	54	55	1	40.0		10.00	5.00	
8	Guscio fond.	55 54	56	57	1	40.0		10.00	5.00	
9	Guscio fond.	57 56	58	59	1	40.0		10.00	5.00	
10	Guscio fond.	59 58	60	61	1	40.0		10.00	5.00	
11	Guscio fond.	61 60	62	63	1	40.0		10.00	5.00	
12	Guscio fond.	63 62	64	65	1	40.0		10.00	5.00	
13	Guscio fond.	65 64	66	3	1	40.0		10.00	5.00	
14	Guscio fond.	41 67	68	42	1	40.0		10.00	5.00	
15	Guscio fond.	42 68	69	44	1	40.0		10.00	5.00	
16	Guscio fond.	44 69	70	46	1	40.0		10.00	5.00	
17	Guscio fond.	46 70	71	48	1	40.0		10.00	5.00	
18	Guscio fond.	48 71	72	50	1	40.0		10.00	5.00	
19	Guscio fond.	50 72	73	52	1	40.0		10.00	5.00	
20	Guscio fond.	52 73	74	54	1	40.0		10.00	5.00	
21	Guscio fond.	54 74	75	56	1	40.0		10.00	5.00	
22	Guscio fond.	56 75	76	58	1	40.0		10.00	5.00	
23	Guscio fond.	58 76	77	60	1	40.0		10.00	5.00	
24	Guscio fond.	60 77	78	62	1	40.0		10.00	5.00	
25	Guscio fond.	62 78	79	64	1	40.0		10.00	5.00	
26	Guscio fond.	64 79	80	66	1	40.0		10.00	5.00	
27	Guscio fond.	67 81	82	68	1	40.0		10.00	5.00	
28	Guscio fond.	68 82	83	69	1	40.0		10.00	5.00	
29	Guscio fond.	69 83	84	70	1	40.0		10.00	5.00	
30	Guscio fond.	70 84	85	71	1	40.0		10.00	5.00	
31	Guscio fond.	71 85	86	72	1	40.0		10.00	5.00	
32	Guscio fond.	72 86	87	73	1	40.0		10.00	5.00	
33	Guscio fond.	73 87	88	74	1	40.0		10.00	5.00	
34	Guscio fond.	74 88	89	75	1	40.0		10.00	5.00	
35	Guscio fond.	75 89	90	76	1	40.0		10.00	5.00	
36	Guscio fond.	76 90	91	77	1	40.0		10.00	5.00	
37	Guscio fond.	77 91	92	78	1	40.0		10.00	5.00	



EGP CODE

GRE.EEC.R.73.IT.W.15235.12.024.01

PAGE

36 di/of 527

38Guscio fond.	78 92	93	79	1	40.0	10.00	5.00
39Guscio fond.	79 93	94	80	1	40.0	10.00	5.00
40Guscio fond.	81 95	96	82	1	40.0	10.00	5.00
41Guscio fond.	82 96	97	83	1	40.0	10.00	5.00
42Guscio fond.	83 97	98	84	1	40.0	10.00	5.00
43Guscio fond.	84 98	99	85	1	40.0	10.00	5.00
44Guscio fond.	85 99	100	86	1	40.0	10.00	5.00
45Guscio fond.	86100	101	87	1	40.0	10.00	5.00
46Guscio fond.	87101	102	88	1	40.0	10.00	5.00
47Guscio fond.	88102	103	89	1	40.0	10.00	5.00
48Guscio fond.	89103	104	90	1	40.0	10.00	5.00
49Guscio fond.	90104	105	91	1	40.0	10.00	5.00
50Guscio fond.	91105	106	92	1	40.0	10.00	5.00
51Guscio fond.	92106	107	93	1	40.0	10.00	5.00
52Guscio fond.	93107	108	94	1	40.0	10.00	5.00
53Guscio fond.	95109	110	96	1	40.0	10.00	5.00
54Guscio fond.	96110	111	97	1	40.0	10.00	5.00
55Guscio fond.	97111	112	98	1	40.0	10.00	5.00
56Guscio fond.	98112	113	99	1	40.0	10.00	5.00
57Guscio fond.	99113	114	100	1	40.0	10.00	5.00
58Guscio fond.	100114	115	101	1	40.0	10.00	5.00
59Guscio fond.	101115	116	102	1	40.0	10.00	5.00
60Guscio fond.	102116	117	103	1	40.0	10.00	5.00
61Guscio fond.	103117	118	104	1	40.0	10.00	5.00
62Guscio fond.	104118	119	105	1	40.0	10.00	5.00
63Guscio fond.	105119	120	106	1	40.0	10.00	5.00
64Guscio fond.	106120	121	107	1	40.0	10.00	5.00
65Guscio fond.	107121	122	108	1	40.0	10.00	5.00
66Guscio fond.	109123	124	110	1	40.0	10.00	5.00
67Guscio fond.	110124	125	111	1	40.0	10.00	5.00
68Guscio fond.	111125	126	112	1	40.0	10.00	5.00
69Guscio fond.	112126	127	113	1	40.0	10.00	5.00
70Guscio fond.	113127	128	114	1	40.0	10.00	5.00
71Guscio fond.	114128	129	115	1	40.0	10.00	5.00
72Guscio fond.	115129	130	116	1	40.0	10.00	5.00
73Guscio fond.	116130	131	117	1	40.0	10.00	5.00
74Guscio fond.	117131	132	118	1	40.0	10.00	5.00
75Guscio fond.	118132	133	119	1	40.0	10.00	5.00
76Guscio fond.	119133	134	120	1	40.0	10.00	5.00
77Guscio fond.	120134	135	121	1	40.0	10.00	5.00
78Guscio fond.	121135	136	122	1	40.0	10.00	5.00
79Guscio fond.	12323	137	124	1	40.0	10.00	5.00
80Guscio fond.	124137	138	125	1	40.0	10.00	5.00
81Guscio fond.	125138	139	126	1	40.0	10.00	5.00
82Guscio fond.	126139	140	127	1	40.0	10.00	5.00
83Guscio fond.	127140	141	128	1	40.0	10.00	5.00
84Guscio fond.	128141	142	129	1	40.0	10.00	5.00
85Guscio fond.	129142	143	130	1	40.0	10.00	5.00
86Guscio fond.	130143	144	131	1	40.0	10.00	5.00
87Guscio fond.	131144	145	132	1	40.0	10.00	5.00
88Guscio fond.	132145	146	133	1	40.0	10.00	5.00
89Guscio fond.	133146	147	134	1	40.0	10.00	5.00
90Guscio fond.	134147	148	135	1	40.0	10.00	5.00
91Guscio fond.	135148	5	136	1	40.0	10.00	5.00
92Guscio fond.	23149	150	137	1	40.0	10.00	5.00
93Guscio fond.	137150	151	138	1	40.0	10.00	5.00
94Guscio fond.	138151	152	139	1	40.0	10.00	5.00
95Guscio fond.	139152	153	140	1	40.0	10.00	5.00
96Guscio fond.	140153	154	141	1	40.0	10.00	5.00
97Guscio fond.	141154	155	142	1	40.0	10.00	5.00
98Guscio fond.	142155	156	143	1	40.0	10.00	5.00
99Guscio fond.	143156	157	144	1	40.0	10.00	5.00
100Guscio fond.	144157	158	145	1	40.0	10.00	5.00
101Guscio fond.	145158	159	146	1	40.0	10.00	5.00
102Guscio fond.	146159	160	147	1	40.0	10.00	5.00
103Guscio fond.	147160	161	148	1	40.0	10.00	5.00
104Guscio fond.	148161	162	5	1	40.0	10.00	5.00
105Guscio fond.	149163	164	150	1	40.0	10.00	5.00
106Guscio fond.	150164	165	151	1	40.0	10.00	5.00
107Guscio fond.	151165	166	152	1	40.0	10.00	5.00
108Guscio fond.	152166	167	153	1	40.0	10.00	5.00
109Guscio fond.	153167	168	154	1	40.0	10.00	5.00
110Guscio fond.	154168	169	155	1	40.0	10.00	5.00
111Guscio fond.	155169	170	156	1	40.0	10.00	5.00
112Guscio fond.	156170	171	157	1	40.0	10.00	5.00
113Guscio fond.	157171	172	158	1	40.0	10.00	5.00





EGP CODE

GRE.EEC.R.73.IT.W.15235.12.024.01

PAGE

37 di/of 527

114	Guscio fond.	158172	173	159	1	40.0	10.00	5.00
115	Guscio fond.	159173	174	160	1	40.0	10.00	5.00
116	Guscio fond.	160174	175	161	1	40.0	10.00	5.00
117	Guscio fond.	161175	176	162	1	40.0	10.00	5.00
118	Guscio fond.	163177	178	164	1	40.0	10.00	5.00
119	Guscio fond.	164178	179	165	1	40.0	10.00	5.00
120	Guscio fond.	165179	180	166	1	40.0	10.00	5.00
121	Guscio fond.	166180	181	167	1	40.0	10.00	5.00
122	Guscio fond.	167181	182	168	1	40.0	10.00	5.00
123	Guscio fond.	168182	183	169	1	40.0	10.00	5.00
124	Guscio fond.	169183	184	170	1	40.0	10.00	5.00
125	Guscio fond.	170184	185	171	1	40.0	10.00	5.00
126	Guscio fond.	171185	186	172	1	40.0	10.00	5.00
127	Guscio fond.	172186	187	173	1	40.0	10.00	5.00
128	Guscio fond.	173187	188	174	1	40.0	10.00	5.00
129	Guscio fond.	174188	189	175	1	40.0	10.00	5.00
130	Guscio fond.	175189	190	176	1	40.0	10.00	5.00
131	Guscio fond.	177191	192	178	1	40.0	10.00	5.00
132	Guscio fond.	178192	193	179	1	40.0	10.00	5.00
133	Guscio fond.	179193	194	180	1	40.0	10.00	5.00
134	Guscio fond.	180194	195	181	1	40.0	10.00	5.00
135	Guscio fond.	181195	196	182	1	40.0	10.00	5.00
136	Guscio fond.	182196	197	183	1	40.0	10.00	5.00
137	Guscio fond.	183197	198	184	1	40.0	10.00	5.00
138	Guscio fond.	184198	199	185	1	40.0	10.00	5.00
139	Guscio fond.	185199	200	186	1	40.0	10.00	5.00
140	Guscio fond.	186200	201	187	1	40.0	10.00	5.00
141	Guscio fond.	187201	202	188	1	40.0	10.00	5.00
142	Guscio fond.	188202	203	189	1	40.0	10.00	5.00
143	Guscio fond.	189203	204	190	1	40.0	10.00	5.00
144	Guscio fond.	191205	206	192	1	40.0	10.00	5.00
145	Guscio fond.	192206	207	193	1	40.0	10.00	5.00
146	Guscio fond.	193207	208	194	1	40.0	10.00	5.00
147	Guscio fond.	194208	209	195	1	40.0	10.00	5.00
148	Guscio fond.	195209	210	196	1	40.0	10.00	5.00
149	Guscio fond.	196210	211	197	1	40.0	10.00	5.00
150	Guscio fond.	197211	212	198	1	40.0	10.00	5.00
151	Guscio fond.	198212	213	199	1	40.0	10.00	5.00
152	Guscio fond.	199213	214	200	1	40.0	10.00	5.00
153	Guscio fond.	200214	215	201	1	40.0	10.00	5.00
154	Guscio fond.	201215	216	202	1	40.0	10.00	5.00
155	Guscio fond.	202216	217	203	1	40.0	10.00	5.00
156	Guscio fond.	203217	218	204	1	40.0	10.00	5.00
157	Guscio fond.	205219	220	206	1	40.0	10.00	5.00
158	Guscio fond.	206220	221	207	1	40.0	10.00	5.00
159	Guscio fond.	207221	222	208	1	40.0	10.00	5.00
160	Guscio fond.	208222	223	209	1	40.0	10.00	5.00
161	Guscio fond.	209223	224	210	1	40.0	10.00	5.00
162	Guscio fond.	210224	225	211	1	40.0	10.00	5.00
163	Guscio fond.	211225	226	212	1	40.0	10.00	5.00
164	Guscio fond.	212226	227	213	1	40.0	10.00	5.00
165	Guscio fond.	213227	228	214	1	40.0	10.00	5.00
166	Guscio fond.	214228	229	215	1	40.0	10.00	5.00
167	Guscio fond.	215229	230	216	1	40.0	10.00	5.00
168	Guscio fond.	216230	231	217	1	40.0	10.00	5.00
169	Guscio fond.	217231	232	218	1	40.0	10.00	5.00
170	Guscio fond.	21925	234	220	1	40.0	10.00	5.00
171	Guscio fond.	220234	235	221	1	40.0	10.00	5.00
172	Guscio fond.	221235	236	222	1	40.0	10.00	5.00
173	Guscio fond.	222236	237	223	1	40.0	10.00	5.00
174	Guscio fond.	223237	238	224	1	40.0	10.00	5.00
175	Guscio fond.	224238	239	225	1	40.0	10.00	5.00
176	Guscio fond.	225239	240	226	1	40.0	10.00	5.00
177	Guscio fond.	226240	241	227	1	40.0	10.00	5.00
178	Guscio fond.	227241	242	228	1	40.0	10.00	5.00
179	Guscio fond.	228242	243	229	1	40.0	10.00	5.00
180	Guscio fond.	229243	244	230	1	40.0	10.00	5.00
181	Guscio fond.	230244	245	231	1	40.0	10.00	5.00
182	Guscio fond.	231245	7	232	1	40.0	10.00	5.00
183	Guscio fond.	25247	248	234	1	40.0	10.00	5.00
184	Guscio fond.	234248	249	235	1	40.0	10.00	5.00
185	Guscio fond.	235249	250	236	1	40.0	10.00	5.00
186	Guscio fond.	236250	251	237	1	40.0	10.00	5.00
187	Guscio fond.	237251	252	238	1	40.0	10.00	5.00
188	Guscio fond.	238252	253	239	1	40.0	10.00	5.00
189	Guscio fond.	239253	254	240	1	40.0	10.00	5.00



EGP CODE

GRE.EEC.R.73.IT.W.15235.12.024.01

PAGE

38 di/of 527

190	Guscio fond.	240254	255	241	1	40.0	10.00	5.00
191	Guscio fond.	241255	256	242	1	40.0	10.00	5.00
192	Guscio fond.	242256	257	243	1	40.0	10.00	5.00
193	Guscio fond.	243257	258	244	1	40.0	10.00	5.00
194	Guscio fond.	244258	259	245	1	40.0	10.00	5.00
195	Guscio fond.	245259	260	7	1	40.0	10.00	5.00
196	Guscio fond.	247261	262	248	1	40.0	10.00	5.00
197	Guscio fond.	248262	263	249	1	40.0	10.00	5.00
198	Guscio fond.	249263	264	250	1	40.0	10.00	5.00
199	Guscio fond.	250264	265	251	1	40.0	10.00	5.00
200	Guscio fond.	251265	266	252	1	40.0	10.00	5.00
201	Guscio fond.	252266	267	253	1	40.0	10.00	5.00
202	Guscio fond.	253267	268	254	1	40.0	10.00	5.00
203	Guscio fond.	254268	269	255	1	40.0	10.00	5.00
204	Guscio fond.	255269	270	256	1	40.0	10.00	5.00
205	Guscio fond.	256270	271	257	1	40.0	10.00	5.00
206	Guscio fond.	257271	272	258	1	40.0	10.00	5.00
207	Guscio fond.	258272	273	259	1	40.0	10.00	5.00
208	Guscio fond.	259273	274	260	1	40.0	10.00	5.00
209	Guscio fond.	261275	276	262	1	40.0	10.00	5.00
210	Guscio fond.	262276	277	263	1	40.0	10.00	5.00
211	Guscio fond.	263277	278	264	1	40.0	10.00	5.00
212	Guscio fond.	264278	279	265	1	40.0	10.00	5.00
213	Guscio fond.	265279	280	266	1	40.0	10.00	5.00
214	Guscio fond.	266280	281	267	1	40.0	10.00	5.00
215	Guscio fond.	267281	282	268	1	40.0	10.00	5.00
216	Guscio fond.	268282	283	269	1	40.0	10.00	5.00
217	Guscio fond.	269283	284	270	1	40.0	10.00	5.00
218	Guscio fond.	270284	285	271	1	40.0	10.00	5.00
219	Guscio fond.	271285	286	272	1	40.0	10.00	5.00
220	Guscio fond.	272286	287	273	1	40.0	10.00	5.00
221	Guscio fond.	273287	288	274	1	40.0	10.00	5.00
222	Guscio fond.	275289	290	276	1	40.0	10.00	5.00
223	Guscio fond.	276290	291	277	1	40.0	10.00	5.00
224	Guscio fond.	277291	292	278	1	40.0	10.00	5.00
225	Guscio fond.	278292	293	279	1	40.0	10.00	5.00
226	Guscio fond.	279293	294	280	1	40.0	10.00	5.00
227	Guscio fond.	280294	295	281	1	40.0	10.00	5.00
228	Guscio fond.	281295	296	282	1	40.0	10.00	5.00
229	Guscio fond.	282296	297	283	1	40.0	10.00	5.00
230	Guscio fond.	283297	298	284	1	40.0	10.00	5.00
231	Guscio fond.	284298	299	285	1	40.0	10.00	5.00
232	Guscio fond.	285299	300	286	1	40.0	10.00	5.00
233	Guscio fond.	286300	301	287	1	40.0	10.00	5.00
234	Guscio fond.	287301	302	288	1	40.0	10.00	5.00
235	Guscio fond.	289303	304	290	1	40.0	10.00	5.00
236	Guscio fond.	290304	305	291	1	40.0	10.00	5.00
237	Guscio fond.	291305	306	292	1	40.0	10.00	5.00
238	Guscio fond.	292306	307	293	1	40.0	10.00	5.00
239	Guscio fond.	293307	308	294	1	40.0	10.00	5.00
240	Guscio fond.	294308	309	295	1	40.0	10.00	5.00
241	Guscio fond.	295309	310	296	1	40.0	10.00	5.00
242	Guscio fond.	296310	311	297	1	40.0	10.00	5.00
243	Guscio fond.	297311	312	298	1	40.0	10.00	5.00
244	Guscio fond.	298312	313	299	1	40.0	10.00	5.00
245	Guscio fond.	299313	314	300	1	40.0	10.00	5.00
246	Guscio fond.	300314	315	301	1	40.0	10.00	5.00
247	Guscio fond.	301315	316	302	1	40.0	10.00	5.00
248	Guscio fond.	303317	318	304	1	40.0	10.00	5.00
249	Guscio fond.	304318	319	305	1	40.0	10.00	5.00
250	Guscio fond.	305319	320	306	1	40.0	10.00	5.00
251	Guscio fond.	306320	321	307	1	40.0	10.00	5.00
252	Guscio fond.	307321	322	308	1	40.0	10.00	5.00
253	Guscio fond.	308322	323	309	1	40.0	10.00	5.00
254	Guscio fond.	309323	324	310	1	40.0	10.00	5.00
255	Guscio fond.	310324	325	311	1	40.0	10.00	5.00
256	Guscio fond.	311325	326	312	1	40.0	10.00	5.00
257	Guscio fond.	312326	327	313	1	40.0	10.00	5.00
258	Guscio fond.	313327	328	314	1	40.0	10.00	5.00
259	Guscio fond.	314328	329	315	1	40.0	10.00	5.00
260	Guscio fond.	315329	330	316	1	40.0	10.00	5.00
261	Guscio fond.	31727	332	318	1	40.0	10.00	5.00
262	Guscio fond.	318332	333	319	1	40.0	10.00	5.00
263	Guscio fond.	319333	334	320	1	40.0	10.00	5.00
264	Guscio fond.	320334	335	321	1	40.0	10.00	5.00
265	Guscio fond.	321335	336	322	1	40.0	10.00	5.00



EGP CODE

GRE.EEC.R.73.IT.W.15235.12.024.01

PAGE

39 di/of 527

266Guscio fond.	322336	337	323	1	40.0	10.00	5.00
267Guscio fond.	323337	338	324	1	40.0	10.00	5.00
268Guscio fond.	324338	339	325	1	40.0	10.00	5.00
269Guscio fond.	325339	340	326	1	40.0	10.00	5.00
270Guscio fond.	326340	341	327	1	40.0	10.00	5.00
271Guscio fond.	327341	342	328	1	40.0	10.00	5.00
272Guscio fond.	328342	343	329	1	40.0	10.00	5.00
273Guscio fond.	329343	9	330	1	40.0	10.00	5.00
274Guscio fond.	1065974	975	1066	1	40.0	10.00	5.00
275Guscio fond.	1066975	976	1067	1	40.0	10.00	5.00
276Guscio fond.	1067976	1082	1068	1	40.0	10.00	5.00
277Guscio fond.	10681082	1083	1069	1	40.0	10.00	5.00
278Guscio fond.	10691083	1084	1070	1	40.0	10.00	5.00
279Guscio fond.	10701084	1085	1071	1	40.0	10.00	5.00
280Guscio fond.	10711085	1086	1072	1	40.0	10.00	5.00
281Guscio fond.	10721086	1087	1073	1	40.0	10.00	5.00
282Guscio fond.	10731087	969	1074	1	40.0	10.00	5.00
283Guscio fond.	1074969	1147	1177	1	40.0	10.00	5.00
284Guscio fond.	1061970	971	1062	1	40.0	10.00	5.00
285Guscio fond.	1062971	972	1063	1	40.0	10.00	5.00
286Guscio fond.	1063972	973	246	1	40.0	10.00	5.00
287Guscio fond.	27357	358	332	1	40.0	10.00	5.00
288Guscio fond.	332358	359	333	1	40.0	10.00	5.00
289Guscio fond.	333359	360	334	1	40.0	10.00	5.00
290Guscio fond.	334360	361	335	1	40.0	10.00	5.00
291Guscio fond.	335361	362	336	1	40.0	10.00	5.00
292Guscio fond.	336362	363	337	1	40.0	10.00	5.00
293Guscio fond.	337363	364	338	1	40.0	10.00	5.00
294Guscio fond.	338364	365	339	1	40.0	10.00	5.00
295Guscio fond.	339365	366	340	1	40.0	10.00	5.00
296Guscio fond.	340366	367	341	1	40.0	10.00	5.00
297Guscio fond.	341367	368	342	1	40.0	10.00	5.00
298Guscio fond.	342368	369	343	1	40.0	10.00	5.00
299Guscio fond.	343369	370	9	1	40.0	10.00	5.00
300Guscio fond.	357371	372	358	1	40.0	10.00	5.00
301Guscio fond.	358372	373	359	1	40.0	10.00	5.00
302Guscio fond.	359373	374	360	1	40.0	10.00	5.00
303Guscio fond.	360374	375	361	1	40.0	10.00	5.00
304Guscio fond.	361375	376	362	1	40.0	10.00	5.00
305Guscio fond.	362376	377	363	1	40.0	10.00	5.00
306Guscio fond.	363377	378	364	1	40.0	10.00	5.00
307Guscio fond.	364378	379	365	1	40.0	10.00	5.00
308Guscio fond.	365379	380	366	1	40.0	10.00	5.00
309Guscio fond.	366380	381	367	1	40.0	10.00	5.00
310Guscio fond.	367381	382	368	1	40.0	10.00	5.00
311Guscio fond.	368382	383	369	1	40.0	10.00	5.00
312Guscio fond.	369383	384	370	1	40.0	10.00	5.00
313Guscio fond.	371385	386	372	1	40.0	10.00	5.00
314Guscio fond.	372386	387	373	1	40.0	10.00	5.00
315Guscio fond.	373387	388	374	1	40.0	10.00	5.00
316Guscio fond.	374388	389	375	1	40.0	10.00	5.00
317Guscio fond.	375389	390	376	1	40.0	10.00	5.00
318Guscio fond.	376390	391	377	1	40.0	10.00	5.00
319Guscio fond.	377391	392	378	1	40.0	10.00	5.00
320Guscio fond.	378392	393	379	1	40.0	10.00	5.00
321Guscio fond.	379393	394	380	1	40.0	10.00	5.00
322Guscio fond.	380394	395	381	1	40.0	10.00	5.00
323Guscio fond.	381395	396	382	1	40.0	10.00	5.00
324Guscio fond.	382396	397	383	1	40.0	10.00	5.00
325Guscio fond.	383397	398	384	1	40.0	10.00	5.00
326Guscio fond.	385399	400	386	1	40.0	10.00	5.00
327Guscio fond.	386400	401	387	1	40.0	10.00	5.00
328Guscio fond.	387401	402	388	1	40.0	10.00	5.00
329Guscio fond.	388402	403	389	1	40.0	10.00	5.00
330Guscio fond.	389403	404	390	1	40.0	10.00	5.00
331Guscio fond.	390404	405	391	1	40.0	10.00	5.00
332Guscio fond.	391405	406	392	1	40.0	10.00	5.00
333Guscio fond.	392406	407	393	1	40.0	10.00	5.00
334Guscio fond.	393407	408	394	1	40.0	10.00	5.00
335Guscio fond.	394408	409	395	1	40.0	10.00	5.00
336Guscio fond.	395409	410	396	1	40.0	10.00	5.00
337Guscio fond.	396410	411	397	1	40.0	10.00	5.00
338Guscio fond.	397411	412	398	1	40.0	10.00	5.00
339Guscio fond.	399413	414	400	1	40.0	10.00	5.00
340Guscio fond.	400414	415	401	1	40.0	10.00	5.00
341Guscio fond.	401415	416	402	1	40.0	10.00	5.00



EGP CODE

GRE.EEC.R.73.IT.W.15235.12.024.01

PAGE

40 di/of 527

342Guscio fond.	402416	417	403	1	40.0	10.00	5.00
343Guscio fond.	403417	418	404	1	40.0	10.00	5.00
344Guscio fond.	404418	419	405	1	40.0	10.00	5.00
345Guscio fond.	405419	420	406	1	40.0	10.00	5.00
346Guscio fond.	406420	421	407	1	40.0	10.00	5.00
347Guscio fond.	407421	422	408	1	40.0	10.00	5.00
348Guscio fond.	408422	423	409	1	40.0	10.00	5.00
349Guscio fond.	409423	424	410	1	40.0	10.00	5.00
350Guscio fond.	410424	425	411	1	40.0	10.00	5.00
351Guscio fond.	411425	426	412	1	40.0	10.00	5.00
352Guscio fond.	413427	428	414	1	40.0	10.00	5.00
353Guscio fond.	414428	429	415	1	40.0	10.00	5.00
354Guscio fond.	415429	430	416	1	40.0	10.00	5.00
355Guscio fond.	416430	431	417	1	40.0	10.00	5.00
356Guscio fond.	417431	432	418	1	40.0	10.00	5.00
357Guscio fond.	418432	433	419	1	40.0	10.00	5.00
358Guscio fond.	419433	434	420	1	40.0	10.00	5.00
359Guscio fond.	420434	435	421	1	40.0	10.00	5.00
360Guscio fond.	421435	436	422	1	40.0	10.00	5.00
361Guscio fond.	422436	437	423	1	40.0	10.00	5.00
362Guscio fond.	423437	438	424	1	40.0	10.00	5.00
363Guscio fond.	424438	439	425	1	40.0	10.00	5.00
364Guscio fond.	425439	440	426	1	40.0	10.00	5.00
365Guscio fond.	427441	442	428	1	40.0	10.00	5.00
366Guscio fond.	428442	443	429	1	40.0	10.00	5.00
367Guscio fond.	429443	444	430	1	40.0	10.00	5.00
368Guscio fond.	430444	445	431	1	40.0	10.00	5.00
369Guscio fond.	431445	446	432	1	40.0	10.00	5.00
370Guscio fond.	432446	447	433	1	40.0	10.00	5.00
371Guscio fond.	433447	448	434	1	40.0	10.00	5.00
372Guscio fond.	434448	449	435	1	40.0	10.00	5.00
373Guscio fond.	435449	450	436	1	40.0	10.00	5.00
374Guscio fond.	436450	451	437	1	40.0	10.00	5.00
375Guscio fond.	437451	452	438	1	40.0	10.00	5.00
376Guscio fond.	438452	453	439	1	40.0	10.00	5.00
377Guscio fond.	439453	454	440	1	40.0	10.00	5.00
378Guscio fond.	44129	455	442	1	40.0	10.00	5.00
379Guscio fond.	442455	456	443	1	40.0	10.00	5.00
380Guscio fond.	443456	457	444	1	40.0	10.00	5.00
381Guscio fond.	444457	458	445	1	40.0	10.00	5.00
382Guscio fond.	445458	459	446	1	40.0	10.00	5.00
383Guscio fond.	446459	460	447	1	40.0	10.00	5.00
384Guscio fond.	447460	461	448	1	40.0	10.00	5.00
385Guscio fond.	448461	462	449	1	40.0	10.00	5.00
386Guscio fond.	449462	463	450	1	40.0	10.00	5.00
387Guscio fond.	450463	464	451	1	40.0	10.00	5.00
388Guscio fond.	451464	465	452	1	40.0	10.00	5.00
389Guscio fond.	452465	466	453	1	40.0	10.00	5.00
390Guscio fond.	453466	11	454	1	40.0	10.00	5.00
391Guscio fond.	29467	468	455	1	40.0	10.00	5.00
392Guscio fond.	455468	469	456	1	40.0	10.00	5.00
393Guscio fond.	456469	470	457	1	40.0	10.00	5.00
394Guscio fond.	457470	471	458	1	40.0	10.00	5.00
395Guscio fond.	458471	472	459	1	40.0	10.00	5.00
396Guscio fond.	459472	473	460	1	40.0	10.00	5.00
397Guscio fond.	460473	474	461	1	40.0	10.00	5.00
398Guscio fond.	461474	475	462	1	40.0	10.00	5.00
399Guscio fond.	462475	476	463	1	40.0	10.00	5.00
400Guscio fond.	463476	477	464	1	40.0	10.00	5.00
401Guscio fond.	464477	478	465	1	40.0	10.00	5.00
402Guscio fond.	465478	479	466	1	40.0	10.00	5.00
403Guscio fond.	466479	480	11	1	40.0	10.00	5.00
404Guscio fond.	467481	482	468	1	40.0	10.00	5.00
405Guscio fond.	468482	483	469	1	40.0	10.00	5.00
406Guscio fond.	469483	484	470	1	40.0	10.00	5.00
407Guscio fond.	470484	485	471	1	40.0	10.00	5.00
408Guscio fond.	471485	486	472	1	40.0	10.00	5.00
409Guscio fond.	472486	487	473	1	40.0	10.00	5.00
410Guscio fond.	473487	488	474	1	40.0	10.00	5.00
411Guscio fond.	474488	489	475	1	40.0	10.00	5.00
412Guscio fond.	475489	490	476	1	40.0	10.00	5.00
413Guscio fond.	476490	491	477	1	40.0	10.00	5.00
414Guscio fond.	477491	492	478	1	40.0	10.00	5.00
415Guscio fond.	478492	493	479	1	40.0	10.00	5.00
416Guscio fond.	479493	494	480	1	40.0	10.00	5.00
417Guscio fond.	481495	496	482	1	40.0	10.00	5.00



EGP CODE

GRE.EEC.R.73.IT.W.15235.12.024.01

PAGE

41 di/of 527

418	Guscio fond.	482496	497	483	1	40.0	10.00	5.00
419	Guscio fond.	483497	498	484	1	40.0	10.00	5.00
420	Guscio fond.	484498	499	485	1	40.0	10.00	5.00
421	Guscio fond.	485499	500	486	1	40.0	10.00	5.00
422	Guscio fond.	486500	501	487	1	40.0	10.00	5.00
423	Guscio fond.	487501	502	488	1	40.0	10.00	5.00
424	Guscio fond.	488502	503	489	1	40.0	10.00	5.00
425	Guscio fond.	489503	504	490	1	40.0	10.00	5.00
426	Guscio fond.	490504	505	491	1	40.0	10.00	5.00
427	Guscio fond.	491505	506	492	1	40.0	10.00	5.00
428	Guscio fond.	492506	507	493	1	40.0	10.00	5.00
429	Guscio fond.	493507	508	494	1	40.0	10.00	5.00
430	Guscio fond.	495509	510	496	1	40.0	10.00	5.00
431	Guscio fond.	496510	511	497	1	40.0	10.00	5.00
432	Guscio fond.	497511	512	498	1	40.0	10.00	5.00
433	Guscio fond.	498512	513	499	1	40.0	10.00	5.00
434	Guscio fond.	499513	514	500	1	40.0	10.00	5.00
435	Guscio fond.	500514	515	501	1	40.0	10.00	5.00
436	Guscio fond.	501515	516	502	1	40.0	10.00	5.00
437	Guscio fond.	502516	517	503	1	40.0	10.00	5.00
438	Guscio fond.	503517	518	504	1	40.0	10.00	5.00
439	Guscio fond.	504518	519	505	1	40.0	10.00	5.00
440	Guscio fond.	505519	520	506	1	40.0	10.00	5.00
441	Guscio fond.	506520	521	507	1	40.0	10.00	5.00
442	Guscio fond.	507521	522	508	1	40.0	10.00	5.00
443	Guscio fond.	509523	524	510	1	40.0	10.00	5.00
444	Guscio fond.	510524	525	511	1	40.0	10.00	5.00
445	Guscio fond.	511525	526	512	1	40.0	10.00	5.00
446	Guscio fond.	512526	527	513	1	40.0	10.00	5.00
447	Guscio fond.	513527	528	514	1	40.0	10.00	5.00
448	Guscio fond.	514528	529	515	1	40.0	10.00	5.00
449	Guscio fond.	515529	530	516	1	40.0	10.00	5.00
450	Guscio fond.	516530	531	517	1	40.0	10.00	5.00
451	Guscio fond.	517531	532	518	1	40.0	10.00	5.00
452	Guscio fond.	518532	533	519	1	40.0	10.00	5.00
453	Guscio fond.	519533	534	520	1	40.0	10.00	5.00
454	Guscio fond.	520534	535	521	1	40.0	10.00	5.00
455	Guscio fond.	521535	536	522	1	40.0	10.00	5.00
456	Guscio fond.	523537	538	524	1	40.0	10.00	5.00
457	Guscio fond.	524538	539	525	1	40.0	10.00	5.00
458	Guscio fond.	525539	540	526	1	40.0	10.00	5.00
459	Guscio fond.	526540	541	527	1	40.0	10.00	5.00
460	Guscio fond.	527541	542	528	1	40.0	10.00	5.00
461	Guscio fond.	528542	543	529	1	40.0	10.00	5.00
462	Guscio fond.	529543	544	530	1	40.0	10.00	5.00
463	Guscio fond.	530544	545	531	1	40.0	10.00	5.00
464	Guscio fond.	531545	546	532	1	40.0	10.00	5.00
465	Guscio fond.	532546	547	533	1	40.0	10.00	5.00
466	Guscio fond.	533547	548	534	1	40.0	10.00	5.00
467	Guscio fond.	534548	549	535	1	40.0	10.00	5.00
468	Guscio fond.	535549	550	536	1	40.0	10.00	5.00
469	Guscio fond.	537551	552	538	1	40.0	10.00	5.00
470	Guscio fond.	538552	553	539	1	40.0	10.00	5.00
471	Guscio fond.	539553	554	540	1	40.0	10.00	5.00
472	Guscio fond.	540554	555	541	1	40.0	10.00	5.00
473	Guscio fond.	541555	556	542	1	40.0	10.00	5.00
474	Guscio fond.	542556	557	543	1	40.0	10.00	5.00
475	Guscio fond.	543557	558	544	1	40.0	10.00	5.00
476	Guscio fond.	544558	559	545	1	40.0	10.00	5.00
477	Guscio fond.	545559	560	546	1	40.0	10.00	5.00
478	Guscio fond.	546560	561	547	1	40.0	10.00	5.00
479	Guscio fond.	547561	562	548	1	40.0	10.00	5.00
480	Guscio fond.	548562	563	549	1	40.0	10.00	5.00
481	Guscio fond.	549563	564	550	1	40.0	10.00	5.00
482	Guscio fond.	551565	566	552	1	40.0	10.00	5.00
483	Guscio fond.	552566	567	553	1	40.0	10.00	5.00
484	Guscio fond.	553567	568	554	1	40.0	10.00	5.00
485	Guscio fond.	554568	569	555	1	40.0	10.00	5.00
486	Guscio fond.	555569	570	556	1	40.0	10.00	5.00
487	Guscio fond.	556570	571	557	1	40.0	10.00	5.00
488	Guscio fond.	557571	572	558	1	40.0	10.00	5.00
489	Guscio fond.	558572	573	559	1	40.0	10.00	5.00
490	Guscio fond.	559573	574	560	1	40.0	10.00	5.00
491	Guscio fond.	560574	575	561	1	40.0	10.00	5.00
492	Guscio fond.	561575	576	562	1	40.0	10.00	5.00
493	Guscio fond.	562576	577	563	1	40.0	10.00	5.00





EGP CODE

GRE.EEC.R.73.IT.W.15235.12.024.01

PAGE

42 di/of 527

494Guscio fond.	563577	578	564	1	40.0	10.00	5.00
495Guscio fond.	565579	580	566	1	40.0	10.00	5.00
496Guscio fond.	566580	581	567	1	40.0	10.00	5.00
497Guscio fond.	567581	582	568	1	40.0	10.00	5.00
498Guscio fond.	568582	583	569	1	40.0	10.00	5.00
499Guscio fond.	569583	584	570	1	40.0	10.00	5.00
500Guscio fond.	570584	585	571	1	40.0	10.00	5.00
501Guscio fond.	571585	586	572	1	40.0	10.00	5.00
502Guscio fond.	572586	587	573	1	40.0	10.00	5.00
503Guscio fond.	573587	588	574	1	40.0	10.00	5.00
504Guscio fond.	574588	589	575	1	40.0	10.00	5.00
505Guscio fond.	575589	590	576	1	40.0	10.00	5.00
506Guscio fond.	576590	591	577	1	40.0	10.00	5.00
507Guscio fond.	577591	592	578	1	40.0	10.00	5.00
508Guscio fond.	57931	593	580	1	40.0	10.00	5.00
509Guscio fond.	580593	594	581	1	40.0	10.00	5.00
510Guscio fond.	581594	595	582	1	40.0	10.00	5.00
511Guscio fond.	582595	596	583	1	40.0	10.00	5.00
512Guscio fond.	583596	597	584	1	40.0	10.00	5.00
513Guscio fond.	584597	598	585	1	40.0	10.00	5.00
514Guscio fond.	585598	599	586	1	40.0	10.00	5.00
515Guscio fond.	586599	600	587	1	40.0	10.00	5.00
516Guscio fond.	587600	601	588	1	40.0	10.00	5.00
517Guscio fond.	588601	602	589	1	40.0	10.00	5.00
518Guscio fond.	589602	603	590	1	40.0	10.00	5.00
519Guscio fond.	590603	604	591	1	40.0	10.00	5.00
520Guscio fond.	591604	13	592	1	40.0	10.00	5.00
521Guscio fond.	747 1	43	749	1	40.0	10.00	5.00
522Guscio fond.	74943	45	750	1	40.0	10.00	5.00
523Guscio fond.	75045	47	751	1	40.0	10.00	5.00
524Guscio fond.	75147	49	752	1	40.0	10.00	5.00
525Guscio fond.	75249	51	753	1	40.0	10.00	5.00
526Guscio fond.	75351	53	754	1	40.0	10.00	5.00
527Guscio fond.	75453	55	755	1	40.0	10.00	5.00
528Guscio fond.	75555	57	756	1	40.0	10.00	5.00
529Guscio fond.	75657	59	951	1	40.0	10.00	5.00
530Guscio fond.	95159	61	964	1	40.0	10.00	5.00
531Guscio fond.	96461	63	965	1	40.0	10.00	5.00
532Guscio fond.	96563	65	966	1	40.0	10.00	5.00
533Guscio fond.	96665	3	748	1	40.0	10.00	5.00
534Guscio fond.	31619	620	593	1	40.0	10.00	5.00
535Guscio fond.	593620	621	594	1	40.0	10.00	5.00
536Guscio fond.	594621	622	595	1	40.0	10.00	5.00
537Guscio fond.	595622	623	596	1	40.0	10.00	5.00
538Guscio fond.	596623	624	597	1	40.0	10.00	5.00
539Guscio fond.	597624	625	598	1	40.0	10.00	5.00
540Guscio fond.	598625	626	599	1	40.0	10.00	5.00
541Guscio fond.	599626	627	600	1	40.0	10.00	5.00
542Guscio fond.	600627	628	601	1	40.0	10.00	5.00
543Guscio fond.	601628	629	602	1	40.0	10.00	5.00
544Guscio fond.	602629	630	603	1	40.0	10.00	5.00
545Guscio fond.	603630	631	604	1	40.0	10.00	5.00
546Guscio fond.	604631	632	13	1	40.0	10.00	5.00
547Guscio fond.	619633	634	620	1	40.0	10.00	5.00
548Guscio fond.	620634	635	621	1	40.0	10.00	5.00
549Guscio fond.	621635	636	622	1	40.0	10.00	5.00
550Guscio fond.	622636	637	623	1	40.0	10.00	5.00
551Guscio fond.	623637	638	624	1	40.0	10.00	5.00
552Guscio fond.	624638	639	625	1	40.0	10.00	5.00
553Guscio fond.	625639	640	626	1	40.0	10.00	5.00
554Guscio fond.	626640	641	627	1	40.0	10.00	5.00
555Guscio fond.	627641	642	628	1	40.0	10.00	5.00
556Guscio fond.	628642	643	629	1	40.0	10.00	5.00
557Guscio fond.	629643	644	630	1	40.0	10.00	5.00
558Guscio fond.	630644	645	631	1	40.0	10.00	5.00
559Guscio fond.	631645	646	632	1	40.0	10.00	5.00
560Guscio fond.	633647	648	634	1	40.0	10.00	5.00
561Guscio fond.	634648	649	635	1	40.0	10.00	5.00
562Guscio fond.	635649	650	636	1	40.0	10.00	5.00
563Guscio fond.	636650	651	637	1	40.0	10.00	5.00
564Guscio fond.	637651	652	638	1	40.0	10.00	5.00
565Guscio fond.	638652	653	639	1	40.0	10.00	5.00
566Guscio fond.	639653	654	640	1	40.0	10.00	5.00
567Guscio fond.	640654	655	641	1	40.0	10.00	5.00
568Guscio fond.	641655	656	642	1	40.0	10.00	5.00
569Guscio fond.	642656	657	643	1	40.0	10.00	5.00





EGP CODE

GRE.EEC.R.73.IT.W.15235.12.024.01

PAGE

43 di/of 527

570Guscio fond.	643657	658	644	1	40.0	10.00	5.00
571Guscio fond.	644658	659	645	1	40.0	10.00	5.00
572Guscio fond.	645659	660	646	1	40.0	10.00	5.00
573Guscio fond.	647661	662	648	1	40.0	10.00	5.00
574Guscio fond.	648662	663	649	1	40.0	10.00	5.00
575Guscio fond.	649663	664	650	1	40.0	10.00	5.00
576Guscio fond.	650664	665	651	1	40.0	10.00	5.00
577Guscio fond.	651665	666	652	1	40.0	10.00	5.00
578Guscio fond.	652666	667	653	1	40.0	10.00	5.00
579Guscio fond.	653667	668	654	1	40.0	10.00	5.00
580Guscio fond.	654668	669	655	1	40.0	10.00	5.00
581Guscio fond.	655669	670	656	1	40.0	10.00	5.00
582Guscio fond.	656670	671	657	1	40.0	10.00	5.00
583Guscio fond.	657671	672	658	1	40.0	10.00	5.00
584Guscio fond.	658672	673	659	1	40.0	10.00	5.00
585Guscio fond.	659673	674	660	1	40.0	10.00	5.00
586Guscio fond.	661675	676	662	1	40.0	10.00	5.00
587Guscio fond.	662676	677	663	1	40.0	10.00	5.00
588Guscio fond.	663677	678	664	1	40.0	10.00	5.00
589Guscio fond.	664678	679	665	1	40.0	10.00	5.00
590Guscio fond.	665679	680	666	1	40.0	10.00	5.00
591Guscio fond.	666680	681	667	1	40.0	10.00	5.00
592Guscio fond.	667681	682	668	1	40.0	10.00	5.00
593Guscio fond.	668682	683	669	1	40.0	10.00	5.00
594Guscio fond.	669683	684	670	1	40.0	10.00	5.00
595Guscio fond.	670684	685	671	1	40.0	10.00	5.00
596Guscio fond.	671685	686	672	1	40.0	10.00	5.00
597Guscio fond.	672686	687	673	1	40.0	10.00	5.00
598Guscio fond.	673687	688	674	1	40.0	10.00	5.00
599Guscio fond.	675689	690	676	1	40.0	10.00	5.00
600Guscio fond.	676690	691	677	1	40.0	10.00	5.00
601Guscio fond.	677691	692	678	1	40.0	10.00	5.00
602Guscio fond.	678692	693	679	1	40.0	10.00	5.00
603Guscio fond.	679693	694	680	1	40.0	10.00	5.00
604Guscio fond.	680694	695	681	1	40.0	10.00	5.00
605Guscio fond.	681695	696	682	1	40.0	10.00	5.00
606Guscio fond.	682696	697	683	1	40.0	10.00	5.00
607Guscio fond.	683697	698	684	1	40.0	10.00	5.00
608Guscio fond.	684698	699	685	1	40.0	10.00	5.00
609Guscio fond.	685699	700	686	1	40.0	10.00	5.00
610Guscio fond.	686700	701	687	1	40.0	10.00	5.00
611Guscio fond.	687701	702	688	1	40.0	10.00	5.00
612Guscio fond.	689703	704	690	1	40.0	10.00	5.00
613Guscio fond.	690704	705	691	1	40.0	10.00	5.00
614Guscio fond.	691705	706	692	1	40.0	10.00	5.00
615Guscio fond.	692706	707	693	1	40.0	10.00	5.00
616Guscio fond.	693707	708	694	1	40.0	10.00	5.00
617Guscio fond.	694708	709	695	1	40.0	10.00	5.00
618Guscio fond.	695709	710	696	1	40.0	10.00	5.00
619Guscio fond.	696710	711	697	1	40.0	10.00	5.00
620Guscio fond.	697711	712	698	1	40.0	10.00	5.00
621Guscio fond.	698712	713	699	1	40.0	10.00	5.00
622Guscio fond.	699713	714	700	1	40.0	10.00	5.00
623Guscio fond.	700714	715	701	1	40.0	10.00	5.00
624Guscio fond.	701715	716	702	1	40.0	10.00	5.00
625Guscio fond.	703717	718	704	1	40.0	10.00	5.00
626Guscio fond.	704718	719	705	1	40.0	10.00	5.00
627Guscio fond.	705719	720	706	1	40.0	10.00	5.00
628Guscio fond.	706720	721	707	1	40.0	10.00	5.00
629Guscio fond.	707721	722	708	1	40.0	10.00	5.00
630Guscio fond.	708722	723	709	1	40.0	10.00	5.00
631Guscio fond.	709723	724	710	1	40.0	10.00	5.00
632Guscio fond.	710724	725	711	1	40.0	10.00	5.00
633Guscio fond.	711725	726	712	1	40.0	10.00	5.00
634Guscio fond.	712726	727	713	1	40.0	10.00	5.00
635Guscio fond.	713727	728	714	1	40.0	10.00	5.00
636Guscio fond.	714728	729	715	1	40.0	10.00	5.00
637Guscio fond.	715729	730	716	1	40.0	10.00	5.00
638Guscio fond.	71733	732	718	1	40.0	10.00	5.00
639Guscio fond.	718732	733	719	1	40.0	10.00	5.00
640Guscio fond.	719733	734	720	1	40.0	10.00	5.00
641Guscio fond.	720734	735	721	1	40.0	10.00	5.00
642Guscio fond.	721735	736	722	1	40.0	10.00	5.00
643Guscio fond.	722736	737	723	1	40.0	10.00	5.00
644Guscio fond.	723737	738	724	1	40.0	10.00	5.00
645Guscio fond.	724738	739	725	1	40.0	10.00	5.00



EGP CODE

GRE.EEC.R.73.IT.W.15235.12.024.01

PAGE

44 di/of 527

646	Guscio fond.	725739	740	726	1	40.0	10.00	5.00
647	Guscio fond.	726740	741	727	1	40.0	10.00	5.00
648	Guscio fond.	727741	742	728	1	40.0	10.00	5.00
649	Guscio fond.	728742	743	729	1	40.0	10.00	5.00
650	Guscio fond.	729743	15	730	1	40.0	10.00	5.00
651	Guscio fond.	39608	609	1089	1	40.0	10.00	5.00
652	Guscio fond.	1089609	610	1090	1	40.0	10.00	5.00
653	Guscio fond.	1090610	611	1091	1	40.0	10.00	5.00
654	Guscio fond.	1091611	612	1092	1	40.0	10.00	5.00
655	Guscio fond.	1092612	613	1093	1	40.0	10.00	5.00
656	Guscio fond.	1093613	614	1094	1	40.0	10.00	5.00
657	Guscio fond.	1094614	615	1095	1	40.0	10.00	5.00
658	Guscio fond.	1095615	616	1096	1	40.0	10.00	5.00
659	Guscio fond.	1096616	617	1097	1	40.0	10.00	5.00
660	Guscio fond.	1097617	618	1098	1	40.0	10.00	5.00
661	Guscio fond.	1098618	731	1099	1	40.0	10.00	5.00
662	Guscio fond.	1099731	744	1100	1	40.0	10.00	5.00
663	Guscio fond.	1100744	607	21	1	40.0	10.00	5.00
664	Guscio fond.	33757	758	732	1	40.0	10.00	5.00
665	Guscio fond.	732758	759	733	1	40.0	10.00	5.00
666	Guscio fond.	733759	760	734	1	40.0	10.00	5.00
667	Guscio fond.	734760	761	735	1	40.0	10.00	5.00
668	Guscio fond.	735761	762	736	1	40.0	10.00	5.00
669	Guscio fond.	736762	763	737	1	40.0	10.00	5.00
670	Guscio fond.	737763	764	738	1	40.0	10.00	5.00
671	Guscio fond.	738764	765	739	1	40.0	10.00	5.00
672	Guscio fond.	739765	766	740	1	40.0	10.00	5.00
673	Guscio fond.	740766	767	741	1	40.0	10.00	5.00
674	Guscio fond.	741767	768	742	1	40.0	10.00	5.00
675	Guscio fond.	742768	769	743	1	40.0	10.00	5.00
676	Guscio fond.	743769	770	15	1	40.0	10.00	5.00
677	Guscio fond.	757771	772	758	1	40.0	10.00	5.00
678	Guscio fond.	758772	773	759	1	40.0	10.00	5.00
679	Guscio fond.	759773	774	760	1	40.0	10.00	5.00
680	Guscio fond.	760774	775	761	1	40.0	10.00	5.00
681	Guscio fond.	761775	776	762	1	40.0	10.00	5.00
682	Guscio fond.	762776	777	763	1	40.0	10.00	5.00
683	Guscio fond.	763777	778	764	1	40.0	10.00	5.00
684	Guscio fond.	764778	779	765	1	40.0	10.00	5.00
685	Guscio fond.	765779	780	766	1	40.0	10.00	5.00
686	Guscio fond.	766780	781	767	1	40.0	10.00	5.00
687	Guscio fond.	767781	782	768	1	40.0	10.00	5.00
688	Guscio fond.	768782	783	769	1	40.0	10.00	5.00
689	Guscio fond.	769783	784	770	1	40.0	10.00	5.00
690	Guscio fond.	771785	786	772	1	40.0	10.00	5.00
691	Guscio fond.	772786	787	773	1	40.0	10.00	5.00
692	Guscio fond.	773787	788	774	1	40.0	10.00	5.00
693	Guscio fond.	774788	789	775	1	40.0	10.00	5.00
694	Guscio fond.	775789	790	776	1	40.0	10.00	5.00
695	Guscio fond.	776790	791	777	1	40.0	10.00	5.00
696	Guscio fond.	777791	792	778	1	40.0	10.00	5.00
697	Guscio fond.	778792	793	779	1	40.0	10.00	5.00
698	Guscio fond.	779793	794	780	1	40.0	10.00	5.00
699	Guscio fond.	780794	795	781	1	40.0	10.00	5.00
700	Guscio fond.	781795	796	782	1	40.0	10.00	5.00
701	Guscio fond.	782796	797	783	1	40.0	10.00	5.00
702	Guscio fond.	783797	798	784	1	40.0	10.00	5.00
703	Guscio fond.	785799	800	786	1	40.0	10.00	5.00
704	Guscio fond.	786800	801	787	1	40.0	10.00	5.00
705	Guscio fond.	787801	802	788	1	40.0	10.00	5.00
706	Guscio fond.	788802	803	789	1	40.0	10.00	5.00
707	Guscio fond.	789803	804	790	1	40.0	10.00	5.00
708	Guscio fond.	790804	805	791	1	40.0	10.00	5.00
709	Guscio fond.	791805	806	792	1	40.0	10.00	5.00
710	Guscio fond.	792806	807	793	1	40.0	10.00	5.00
711	Guscio fond.	793807	808	794	1	40.0	10.00	5.00
712	Guscio fond.	794808	809	795	1	40.0	10.00	5.00
713	Guscio fond.	795809	810	796	1	40.0	10.00	5.00
714	Guscio fond.	796810	811	797	1	40.0	10.00	5.00
715	Guscio fond.	797811	812	798	1	40.0	10.00	5.00
716	Guscio fond.	799813	814	800	1	40.0	10.00	5.00
717	Guscio fond.	800814	815	801	1	40.0	10.00	5.00
718	Guscio fond.	801815	816	802	1	40.0	10.00	5.00
719	Guscio fond.	802816	817	803	1	40.0	10.00	5.00
720	Guscio fond.	803817	818	804	1	40.0	10.00	5.00
721	Guscio fond.	804818	819	805	1	40.0	10.00	5.00



EGP CODE

GRE.EEC.R.73.IT.W.15235.12.024.01

PAGE

45 di/of 527

722Guscio fond.	805819	820	806	1	40.0	10.00	5.00
723Guscio fond.	806820	821	807	1	40.0	10.00	5.00
724Guscio fond.	807821	822	808	1	40.0	10.00	5.00
725Guscio fond.	808822	823	809	1	40.0	10.00	5.00
726Guscio fond.	809823	824	810	1	40.0	10.00	5.00
727Guscio fond.	810824	825	811	1	40.0	10.00	5.00
728Guscio fond.	811825	826	812	1	40.0	10.00	5.00
729Guscio fond.	813827	828	814	1	40.0	10.00	5.00
730Guscio fond.	814828	829	815	1	40.0	10.00	5.00
731Guscio fond.	815829	830	816	1	40.0	10.00	5.00
732Guscio fond.	816830	831	817	1	40.0	10.00	5.00
733Guscio fond.	817831	832	818	1	40.0	10.00	5.00
734Guscio fond.	818832	833	819	1	40.0	10.00	5.00
735Guscio fond.	819833	834	820	1	40.0	10.00	5.00
736Guscio fond.	820834	835	821	1	40.0	10.00	5.00
737Guscio fond.	821835	836	822	1	40.0	10.00	5.00
738Guscio fond.	822836	837	823	1	40.0	10.00	5.00
739Guscio fond.	823837	838	824	1	40.0	10.00	5.00
740Guscio fond.	824838	839	825	1	40.0	10.00	5.00
741Guscio fond.	825839	840	826	1	40.0	10.00	5.00
742Guscio fond.	827841	842	828	1	40.0	10.00	5.00
743Guscio fond.	828842	843	829	1	40.0	10.00	5.00
744Guscio fond.	829843	844	830	1	40.0	10.00	5.00
745Guscio fond.	830844	845	831	1	40.0	10.00	5.00
746Guscio fond.	831845	846	832	1	40.0	10.00	5.00
747Guscio fond.	832846	847	833	1	40.0	10.00	5.00
748Guscio fond.	833847	848	834	1	40.0	10.00	5.00
749Guscio fond.	834848	849	835	1	40.0	10.00	5.00
750Guscio fond.	835849	850	836	1	40.0	10.00	5.00
751Guscio fond.	836850	851	837	1	40.0	10.00	5.00
752Guscio fond.	837851	852	838	1	40.0	10.00	5.00
753Guscio fond.	838852	853	839	1	40.0	10.00	5.00
754Guscio fond.	839853	854	840	1	40.0	10.00	5.00
755Guscio fond.	841855	856	842	1	40.0	10.00	5.00
756Guscio fond.	842856	857	843	1	40.0	10.00	5.00
757Guscio fond.	843857	858	844	1	40.0	10.00	5.00
758Guscio fond.	844858	859	845	1	40.0	10.00	5.00
759Guscio fond.	845859	860	846	1	40.0	10.00	5.00
760Guscio fond.	846860	861	847	1	40.0	10.00	5.00
761Guscio fond.	847861	862	848	1	40.0	10.00	5.00
762Guscio fond.	848862	863	849	1	40.0	10.00	5.00
763Guscio fond.	849863	864	850	1	40.0	10.00	5.00
764Guscio fond.	850864	865	851	1	40.0	10.00	5.00
765Guscio fond.	851865	866	852	1	40.0	10.00	5.00
766Guscio fond.	852866	867	853	1	40.0	10.00	5.00
767Guscio fond.	853867	868	854	1	40.0	10.00	5.00
768Guscio fond.	85535	869	856	1	40.0	10.00	5.00
769Guscio fond.	856869	870	857	1	40.0	10.00	5.00
770Guscio fond.	857870	871	858	1	40.0	10.00	5.00
771Guscio fond.	858871	872	859	1	40.0	10.00	5.00
772Guscio fond.	859872	873	860	1	40.0	10.00	5.00
773Guscio fond.	860873	874	861	1	40.0	10.00	5.00
774Guscio fond.	861874	875	862	1	40.0	10.00	5.00
775Guscio fond.	862875	876	863	1	40.0	10.00	5.00
776Guscio fond.	863876	877	864	1	40.0	10.00	5.00
777Guscio fond.	864877	878	865	1	40.0	10.00	5.00
778Guscio fond.	865878	879	866	1	40.0	10.00	5.00
779Guscio fond.	866879	880	867	1	40.0	10.00	5.00
780Guscio fond.	867880	17	868	1	40.0	10.00	5.00
781Guscio fond.	35881	882	869	1	40.0	10.00	5.00
782Guscio fond.	869882	883	870	1	40.0	10.00	5.00
783Guscio fond.	870883	884	871	1	40.0	10.00	5.00
784Guscio fond.	871884	885	872	1	40.0	10.00	5.00
785Guscio fond.	872885	886	873	1	40.0	10.00	5.00
786Guscio fond.	873886	887	874	1	40.0	10.00	5.00
787Guscio fond.	874887	888	875	1	40.0	10.00	5.00
788Guscio fond.	875888	889	876	1	40.0	10.00	5.00
789Guscio fond.	876889	890	877	1	40.0	10.00	5.00
790Guscio fond.	877890	891	878	1	40.0	10.00	5.00
791Guscio fond.	878891	892	879	1	40.0	10.00	5.00
792Guscio fond.	879892	893	880	1	40.0	10.00	5.00
793Guscio fond.	880893	894	17	1	40.0	10.00	5.00
794Guscio fond.	881895	896	882	1	40.0	10.00	5.00
795Guscio fond.	882896	897	883	1	40.0	10.00	5.00
796Guscio fond.	883897	898	884	1	40.0	10.00	5.00
797Guscio fond.	884898	899	885	1	40.0	10.00	5.00



EGP CODE

GRE.EEC.R.73.IT.W.15235.12.024.01

PAGE

46 di/of 527

798Guscio fond.	885899	900	886	1	40.0	10.00	5.00
799Guscio fond.	886900	901	887	1	40.0	10.00	5.00
800Guscio fond.	887901	902	888	1	40.0	10.00	5.00
801Guscio fond.	888902	903	889	1	40.0	10.00	5.00
802Guscio fond.	889903	904	890	1	40.0	10.00	5.00
803Guscio fond.	890904	905	891	1	40.0	10.00	5.00
804Guscio fond.	891905	906	892	1	40.0	10.00	5.00
805Guscio fond.	892906	907	893	1	40.0	10.00	5.00
806Guscio fond.	893907	908	894	1	40.0	10.00	5.00
807Guscio fond.	895909	910	896	1	40.0	10.00	5.00
808Guscio fond.	896910	911	897	1	40.0	10.00	5.00
809Guscio fond.	897911	912	898	1	40.0	10.00	5.00
810Guscio fond.	898912	913	899	1	40.0	10.00	5.00
811Guscio fond.	899913	914	900	1	40.0	10.00	5.00
812Guscio fond.	900914	915	901	1	40.0	10.00	5.00
813Guscio fond.	901915	916	902	1	40.0	10.00	5.00
814Guscio fond.	902916	917	903	1	40.0	10.00	5.00
815Guscio fond.	903917	918	904	1	40.0	10.00	5.00
816Guscio fond.	904918	919	905	1	40.0	10.00	5.00
817Guscio fond.	905919	920	906	1	40.0	10.00	5.00
818Guscio fond.	906920	921	907	1	40.0	10.00	5.00
819Guscio fond.	907921	922	908	1	40.0	10.00	5.00
820Guscio fond.	909923	924	910	1	40.0	10.00	5.00
821Guscio fond.	910924	925	911	1	40.0	10.00	5.00
822Guscio fond.	911925	926	912	1	40.0	10.00	5.00
823Guscio fond.	912926	927	913	1	40.0	10.00	5.00
824Guscio fond.	913927	928	914	1	40.0	10.00	5.00
825Guscio fond.	914928	929	915	1	40.0	10.00	5.00
826Guscio fond.	915929	930	916	1	40.0	10.00	5.00
827Guscio fond.	916930	931	917	1	40.0	10.00	5.00
828Guscio fond.	917931	932	918	1	40.0	10.00	5.00
829Guscio fond.	918932	933	919	1	40.0	10.00	5.00
830Guscio fond.	919933	934	920	1	40.0	10.00	5.00
831Guscio fond.	920934	935	921	1	40.0	10.00	5.00
832Guscio fond.	921935	936	922	1	40.0	10.00	5.00
833Guscio fond.	923937	938	924	1	40.0	10.00	5.00
834Guscio fond.	924938	939	925	1	40.0	10.00	5.00
835Guscio fond.	925939	940	926	1	40.0	10.00	5.00
836Guscio fond.	926940	941	927	1	40.0	10.00	5.00
837Guscio fond.	927941	942	928	1	40.0	10.00	5.00
838Guscio fond.	928942	943	929	1	40.0	10.00	5.00
839Guscio fond.	929943	944	930	1	40.0	10.00	5.00
840Guscio fond.	930944	945	931	1	40.0	10.00	5.00
841Guscio fond.	931945	946	932	1	40.0	10.00	5.00
842Guscio fond.	932946	947	933	1	40.0	10.00	5.00
843Guscio fond.	933947	948	934	1	40.0	10.00	5.00
844Guscio fond.	934948	949	935	1	40.0	10.00	5.00
845Guscio fond.	935949	950	936	1	40.0	10.00	5.00
846Guscio fond.	93737	952	938	1	40.0	10.00	5.00
847Guscio fond.	938952	953	939	1	40.0	10.00	5.00
848Guscio fond.	939953	954	940	1	40.0	10.00	5.00
849Guscio fond.	940954	955	941	1	40.0	10.00	5.00
850Guscio fond.	941955	956	942	1	40.0	10.00	5.00
851Guscio fond.	942956	957	943	1	40.0	10.00	5.00
852Guscio fond.	943957	958	944	1	40.0	10.00	5.00
853Guscio fond.	944958	959	945	1	40.0	10.00	5.00
854Guscio fond.	945959	960	946	1	40.0	10.00	5.00
855Guscio fond.	946960	961	947	1	40.0	10.00	5.00
856Guscio fond.	947961	962	948	1	40.0	10.00	5.00
857Guscio fond.	948962	963	949	1	40.0	10.00	5.00
858Guscio fond.	949963	19	950	1	40.0	10.00	5.00
859Guscio fond.	345346	895	881	1	40.0	10.00	5.00
860Guscio fond.	346347	909	895	1	40.0	10.00	5.00
861Guscio fond.	347348	923	909	1	40.0	10.00	5.00
862Guscio fond.	348349	937	923	1	40.0	10.00	5.00
863Guscio fond.	3491187	37	937	1	40.0	10.00	5.00
864Guscio fond.	3501188	39	970	1	40.0	10.00	5.00
865Guscio fond.	1187351	977	37	1	40.0	10.00	5.00
866Guscio fond.	351352	991	977	1	40.0	10.00	5.00
867Guscio fond.	352353	1005	991	1	40.0	10.00	5.00
868Guscio fond.	353354	1019	1005	1	40.0	10.00	5.00
869Guscio fond.	354355	1033	1019	1	40.0	10.00	5.00
870Guscio fond.	355356	1047	1033	1	40.0	10.00	5.00
871Guscio fond.	356605	1061	1047	1	40.0	10.00	5.00
872Guscio fond.	37977	978	952	1	40.0	10.00	5.00
873Guscio fond.	952978	979	953	1	40.0	10.00	5.00



EGP CODE

GRE.EEC.R.73.IT.W.15235.12.024.01

PAGE

47 di/of 527

874Guscio fond.	953979	980	954	1	40.0	10.00	5.00
875Guscio fond.	954980	981	955	1	40.0	10.00	5.00
876Guscio fond.	955981	982	956	1	40.0	10.00	5.00
877Guscio fond.	956982	983	957	1	40.0	10.00	5.00
878Guscio fond.	957983	984	958	1	40.0	10.00	5.00
879Guscio fond.	958984	985	959	1	40.0	10.00	5.00
880Guscio fond.	959985	986	960	1	40.0	10.00	5.00
881Guscio fond.	960986	987	961	1	40.0	10.00	5.00
882Guscio fond.	961987	988	962	1	40.0	10.00	5.00
883Guscio fond.	962988	989	963	1	40.0	10.00	5.00
884Guscio fond.	963989	990	19	1	40.0	10.00	5.00
885Guscio fond.	977991	992	978	1	40.0	10.00	5.00
886Guscio fond.	978992	993	979	1	40.0	10.00	5.00
887Guscio fond.	979993	994	980	1	40.0	10.00	5.00
888Guscio fond.	980994	995	981	1	40.0	10.00	5.00
889Guscio fond.	981995	996	982	1	40.0	10.00	5.00
890Guscio fond.	982996	997	983	1	40.0	10.00	5.00
891Guscio fond.	983997	998	984	1	40.0	10.00	5.00
892Guscio fond.	984998	999	985	1	40.0	10.00	5.00
893Guscio fond.	985999	1000	986	1	40.0	10.00	5.00
894Guscio fond.	9861000	1001	987	1	40.0	10.00	5.00
895Guscio fond.	9871001	1002	988	1	40.0	10.00	5.00
896Guscio fond.	9881002	1003	989	1	40.0	10.00	5.00
897Guscio fond.	9891003	1004	990	1	40.0	10.00	5.00
898Guscio fond.	9911005	1006	992	1	40.0	10.00	5.00
899Guscio fond.	9921006	1007	993	1	40.0	10.00	5.00
900Guscio fond.	9931007	1008	994	1	40.0	10.00	5.00
901Guscio fond.	9941008	1009	995	1	40.0	10.00	5.00
902Guscio fond.	9951009	1010	996	1	40.0	10.00	5.00
903Guscio fond.	9961010	1011	997	1	40.0	10.00	5.00
904Guscio fond.	9971011	1012	998	1	40.0	10.00	5.00
905Guscio fond.	9981012	1013	999	1	40.0	10.00	5.00
906Guscio fond.	9991013	1014	1000	1	40.0	10.00	5.00
907Guscio fond.	10001014	1015	1001	1	40.0	10.00	5.00
908Guscio fond.	10011015	1016	1002	1	40.0	10.00	5.00
909Guscio fond.	10021016	1017	1003	1	40.0	10.00	5.00
910Guscio fond.	10031017	1018	1004	1	40.0	10.00	5.00
911Guscio fond.	10051019	1020	1006	1	40.0	10.00	5.00
912Guscio fond.	10061020	1021	1007	1	40.0	10.00	5.00
913Guscio fond.	10071021	1022	1008	1	40.0	10.00	5.00
914Guscio fond.	10081022	1023	1009	1	40.0	10.00	5.00
915Guscio fond.	10091023	1024	1010	1	40.0	10.00	5.00
916Guscio fond.	10101024	1025	1011	1	40.0	10.00	5.00
917Guscio fond.	10111025	1026	1012	1	40.0	10.00	5.00
918Guscio fond.	10121026	1027	1013	1	40.0	10.00	5.00
919Guscio fond.	10131027	1028	1014	1	40.0	10.00	5.00
920Guscio fond.	10141028	1029	1015	1	40.0	10.00	5.00
921Guscio fond.	10151029	1030	1016	1	40.0	10.00	5.00
922Guscio fond.	10161030	1031	1017	1	40.0	10.00	5.00
923Guscio fond.	10171031	1032	1018	1	40.0	10.00	5.00
924Guscio fond.	10191033	1034	1020	1	40.0	10.00	5.00
925Guscio fond.	10201034	1035	1021	1	40.0	10.00	5.00
926Guscio fond.	10211035	1036	1022	1	40.0	10.00	5.00
927Guscio fond.	10221036	1037	1023	1	40.0	10.00	5.00
928Guscio fond.	10231037	1038	1024	1	40.0	10.00	5.00
929Guscio fond.	10241038	1039	1025	1	40.0	10.00	5.00
930Guscio fond.	10251039	1040	1026	1	40.0	10.00	5.00
931Guscio fond.	10261040	1041	1027	1	40.0	10.00	5.00
932Guscio fond.	10271041	1042	1028	1	40.0	10.00	5.00
933Guscio fond.	10281042	1043	1029	1	40.0	10.00	5.00
934Guscio fond.	10291043	1044	1030	1	40.0	10.00	5.00
935Guscio fond.	10301044	1045	1031	1	40.0	10.00	5.00
936Guscio fond.	10311045	1046	1032	1	40.0	10.00	5.00
937Guscio fond.	10331047	1048	1034	1	40.0	10.00	5.00
938Guscio fond.	10341048	1049	1035	1	40.0	10.00	5.00
939Guscio fond.	10351049	1050	1036	1	40.0	10.00	5.00
940Guscio fond.	10361050	1051	1037	1	40.0	10.00	5.00
941Guscio fond.	10371051	1052	1038	1	40.0	10.00	5.00
942Guscio fond.	10381052	1053	1039	1	40.0	10.00	5.00
943Guscio fond.	10391053	1054	1040	1	40.0	10.00	5.00
944Guscio fond.	10401054	1055	1041	1	40.0	10.00	5.00
945Guscio fond.	10411055	1056	1042	1	40.0	10.00	5.00
946Guscio fond.	10421056	1057	1043	1	40.0	10.00	5.00
947Guscio fond.	10431057	1058	1044	1	40.0	10.00	5.00
948Guscio fond.	10441058	1059	1045	1	40.0	10.00	5.00
949Guscio fond.	10451059	1060	1046	1	40.0	10.00	5.00





EGP CODE

GRE.EEC.R.73.IT.W.15235.12.024.01

PAGE

48 di/of 527

950Guscio fond.	10471061	1062	1048	1	40.0	10.00	5.00
951Guscio fond.	10481062	1063	1049	1	40.0	10.00	5.00
952Guscio fond.	10491063	246	1050	1	40.0	10.00	5.00
953Guscio fond.	1050246	1065	1051	1	40.0	10.00	5.00
954Guscio fond.	10511065	1066	1052	1	40.0	10.00	5.00
955Guscio fond.	10521066	1067	1053	1	40.0	10.00	5.00
956Guscio fond.	10531067	1068	1054	1	40.0	10.00	5.00
957Guscio fond.	10541068	1069	1055	1	40.0	10.00	5.00
958Guscio fond.	10551069	1070	1056	1	40.0	10.00	5.00
959Guscio fond.	10561070	1071	1057	1	40.0	10.00	5.00
960Guscio fond.	10571071	1072	1058	1	40.0	10.00	5.00
961Guscio fond.	10581072	1073	1059	1	40.0	10.00	5.00
962Guscio fond.	10591073	1074	1060	1	40.0	10.00	5.00
963Guscio fond.	3441186	35	855	1	40.0	10.00	5.00
964Guscio fond.	331344	855	841	1	40.0	10.00	5.00
965Guscio fond.	1201331	841	827	1	40.0	10.00	5.00
966Guscio fond.	2331201	827	813	1	40.0	10.00	5.00
967Guscio fond.	1123233	813	799	1	40.0	10.00	5.00
968Guscio fond.	10641123	799	785	1	40.0	10.00	5.00
969Guscio fond.	11701064	785	771	1	40.0	10.00	5.00
970Guscio fond.	11561170	771	757	1	40.0	10.00	5.00
971Guscio fond.	11851156	757	33	1	40.0	10.00	5.00
972Guscio fond.	1188746	608	39	1	40.0	10.00	5.00
973Guscio fond.	11301185	33	717	1	40.0	10.00	5.00
974Guscio fond.	10881130	717	703	1	40.0	10.00	5.00
975Guscio fond.	10811088	703	689	1	40.0	10.00	5.00
976Guscio fond.	97039	1089	971	1	40.0	10.00	5.00
977Guscio fond.	9711089	1090	972	1	40.0	10.00	5.00
978Guscio fond.	9721090	1091	973	1	40.0	10.00	5.00
979Guscio fond.	9731091	1092	974	1	40.0	10.00	5.00
980Guscio fond.	9741092	1093	975	1	40.0	10.00	5.00
981Guscio fond.	9751093	1094	976	1	40.0	10.00	5.00
982Guscio fond.	9761094	1095	1082	1	40.0	10.00	5.00
983Guscio fond.	10821095	1096	1083	1	40.0	10.00	5.00
984Guscio fond.	10831096	1097	1084	1	40.0	10.00	5.00
985Guscio fond.	10841097	1098	1085	1	40.0	10.00	5.00
986Guscio fond.	10851098	1099	1086	1	40.0	10.00	5.00
987Guscio fond.	10861099	1100	1087	1	40.0	10.00	5.00
988Guscio fond.	10871100	21	969	1	40.0	10.00	5.00
989Guscio fond.	3 66	1111	1101	1	40.0	10.00	5.00
990Guscio fond.	66 80	1112	1111	1	40.0	10.00	5.00
991Guscio fond.	80 94	1113	1112	1	40.0	10.00	5.00
992Guscio fond.	94108	1114	1113	1	40.0	10.00	5.00
993Guscio fond.	108122	1115	1114	1	40.0	10.00	5.00
994Guscio fond.	122136	1116	1115	1	40.0	10.00	5.00
995Guscio fond.	136 5	1102	1116	1	40.0	10.00	5.00
996Guscio fond.	5 162	1117	1102	1	40.0	10.00	5.00
997Guscio fond.	162176	1118	1117	1	40.0	10.00	5.00
998Guscio fond.	176190	1119	1118	1	40.0	10.00	5.00
999Guscio fond.	190204	1120	1119	1	40.0	10.00	5.00
1000Guscio fond.	204218	1121	1120	1	40.0	10.00	5.00
1001Guscio fond.	218232	1122	1121	1	40.0	10.00	5.00
1002Guscio fond.	232 7	1103	1122	1	40.0	10.00	5.00
1003Guscio fond.	7 260	1124	1103	1	40.0	10.00	5.00
1004Guscio fond.	260274	1125	1124	1	40.0	10.00	5.00
1005Guscio fond.	274288	1126	1125	1	40.0	10.00	5.00
1006Guscio fond.	288302	1127	1126	1	40.0	10.00	5.00
1007Guscio fond.	302316	1128	1127	1	40.0	10.00	5.00
1008Guscio fond.	316330	1129	1128	1	40.0	10.00	5.00
1009Guscio fond.	330 9	1104	1129	1	40.0	10.00	5.00
1010Guscio fond.	246973	974	1065	1	40.0	10.00	5.00
1011Guscio fond.	9 370	1131	1104	1	40.0	10.00	5.00
1012Guscio fond.	370384	1132	1131	1	40.0	10.00	5.00
1013Guscio fond.	384398	1133	1132	1	40.0	10.00	5.00
1014Guscio fond.	398412	1134	1133	1	40.0	10.00	5.00
1015Guscio fond.	412426	1135	1134	1	40.0	10.00	5.00
1016Guscio fond.	426440	1136	1135	1	40.0	10.00	5.00
1017Guscio fond.	440454	1137	1136	1	40.0	10.00	5.00
1018Guscio fond.	45411	1105	1137	1	40.0	10.00	5.00
1019Guscio fond.	11480	1138	1105	1	40.0	10.00	5.00
1020Guscio fond.	480494	1139	1138	1	40.0	10.00	5.00
1021Guscio fond.	494508	1140	1139	1	40.0	10.00	5.00
1022Guscio fond.	508522	1141	1140	1	40.0	10.00	5.00
1023Guscio fond.	522536	1142	1141	1	40.0	10.00	5.00
1024Guscio fond.	536550	1143	1142	1	40.0	10.00	5.00
1025Guscio fond.	550564	1144	1143	1	40.0	10.00	5.00





EGP CODE

GRE.EEC.R.73.IT.W.15235.12.024.01

PAGE

49 di/of 527

1026Guscio fond.	564578	1145	1144	1	40.0	10.00	5.00
1027Guscio fond.	578592	1146	1145	1	40.0	10.00	5.00
1028Guscio fond.	59213	1106	1146	1	40.0	10.00	5.00
1029Guscio fond.	748 3	1101	967	1	40.0	10.00	5.00
1030Guscio fond.	13632	1148	1106	1	40.0	10.00	5.00
1031Guscio fond.	632646	1149	1148	1	40.0	10.00	5.00
1032Guscio fond.	646660	1150	1149	1	40.0	10.00	5.00
1033Guscio fond.	660674	1151	1150	1	40.0	10.00	5.00
1034Guscio fond.	674688	1152	1151	1	40.0	10.00	5.00
1035Guscio fond.	688702	1153	1152	1	40.0	10.00	5.00
1036Guscio fond.	702716	1154	1153	1	40.0	10.00	5.00
1037Guscio fond.	716730	1155	1154	1	40.0	10.00	5.00
1038Guscio fond.	73015	1107	1155	1	40.0	10.00	5.00
1039Guscio fond.	21607	745	1110	1	40.0	10.00	5.00
1040Guscio fond.	15770	1157	1107	1	40.0	10.00	5.00
1041Guscio fond.	770784	1158	1157	1	40.0	10.00	5.00
1042Guscio fond.	784798	1159	1158	1	40.0	10.00	5.00
1043Guscio fond.	798812	1160	1159	1	40.0	10.00	5.00
1044Guscio fond.	812826	1161	1160	1	40.0	10.00	5.00
1045Guscio fond.	826840	1162	1161	1	40.0	10.00	5.00
1046Guscio fond.	840854	1163	1162	1	40.0	10.00	5.00
1047Guscio fond.	854868	1164	1163	1	40.0	10.00	5.00
1048Guscio fond.	86817	1108	1164	1	40.0	10.00	5.00
1049Guscio fond.	17894	1165	1108	1	40.0	10.00	5.00
1050Guscio fond.	894908	1166	1165	1	40.0	10.00	5.00
1051Guscio fond.	908922	1167	1166	1	40.0	10.00	5.00
1052Guscio fond.	922936	1168	1167	1	40.0	10.00	5.00
1053Guscio fond.	936950	1169	1168	1	40.0	10.00	5.00
1054Guscio fond.	95019	1109	1169	1	40.0	10.00	5.00
1055Guscio fond.	1186345	881	35	1	40.0	10.00	5.00
1056Guscio fond.	19990	1171	1109	1	40.0	10.00	5.00
1057Guscio fond.	9901004	1172	1171	1	40.0	10.00	5.00
1058Guscio fond.	10041018	1173	1172	1	40.0	10.00	5.00
1059Guscio fond.	10181032	1174	1173	1	40.0	10.00	5.00
1060Guscio fond.	10321046	1175	1174	1	40.0	10.00	5.00
1061Guscio fond.	10461060	1176	1175	1	40.0	10.00	5.00
1062Guscio fond.	10601074	1177	1176	1	40.0	10.00	5.00
1063Guscio fond.	10801081	689	675	1	40.0	10.00	5.00
1064Guscio fond.	96921	1110	1147	1	40.0	10.00	5.00
1065Guscio fond.	11791189	41	1	1	40.0	10.00	5.00
1066Guscio fond.	11891190	67	41	1	40.0	10.00	5.00
1067Guscio fond.	11901191	81	67	1	40.0	10.00	5.00
1068Guscio fond.	11911192	95	81	1	40.0	10.00	5.00
1069Guscio fond.	11921193	109	95	1	40.0	10.00	5.00
1070Guscio fond.	11931194	123	109	1	40.0	10.00	5.00
1071Guscio fond.	11941180	23	123	1	40.0	10.00	5.00
1072Guscio fond.	11801195	149	23	1	40.0	10.00	5.00
1073Guscio fond.	11951196	163	149	1	40.0	10.00	5.00
1074Guscio fond.	11961197	177	163	1	40.0	10.00	5.00
1075Guscio fond.	11971198	191	177	1	40.0	10.00	5.00
1076Guscio fond.	11981199	205	191	1	40.0	10.00	5.00
1077Guscio fond.	11991200	219	205	1	40.0	10.00	5.00
1078Guscio fond.	12001181	25	219	1	40.0	10.00	5.00
1079Guscio fond.	11811202	247	25	1	40.0	10.00	5.00
1080Guscio fond.	12021203	261	247	1	40.0	10.00	5.00
1081Guscio fond.	12031204	275	261	1	40.0	10.00	5.00
1082Guscio fond.	12041205	289	275	1	40.0	10.00	5.00
1083Guscio fond.	12051206	303	289	1	40.0	10.00	5.00
1084Guscio fond.	12061207	317	303	1	40.0	10.00	5.00
1085Guscio fond.	12071182	27	317	1	40.0	10.00	5.00
1086Guscio fond.	605350	970	1061	1	40.0	10.00	5.00
1087Guscio fond.	11821209	357	27	1	40.0	10.00	5.00
1088Guscio fond.	12091210	371	357	1	40.0	10.00	5.00
1089Guscio fond.	12101211	385	371	1	40.0	10.00	5.00
1090Guscio fond.	12111212	399	385	1	40.0	10.00	5.00
1091Guscio fond.	12121213	413	399	1	40.0	10.00	5.00
1092Guscio fond.	12131214	427	413	1	40.0	10.00	5.00
1093Guscio fond.	12141215	441	427	1	40.0	10.00	5.00
1094Guscio fond.	12151183	29	441	1	40.0	10.00	5.00
1095Guscio fond.	11831216	467	29	1	40.0	10.00	5.00
1096Guscio fond.	12161217	481	467	1	40.0	10.00	5.00
1097Guscio fond.	12171218	495	481	1	40.0	10.00	5.00
1098Guscio fond.	12181219	509	495	1	40.0	10.00	5.00
1099Guscio fond.	12191220	523	509	1	40.0	10.00	5.00
1100Guscio fond.	12201221	537	523	1	40.0	10.00	5.00
1101Guscio fond.	12211222	551	537	1	40.0	10.00	5.00

1102	Guscio fond.	12221178	565	551	1	40.0	10.00	5.00
1103	Guscio fond.	1178606	579	565	1	40.0	10.00	5.00
1104	Guscio fond.	6061184	31	579	1	40.0	10.00	5.00
1105	Guscio fond.	9681179	1	747	1	40.0	10.00	5.00
1106	Guscio fond.	11841076	619	31	1	40.0	10.00	5.00
1107	Guscio fond.	10761077	633	619	1	40.0	10.00	5.00
1108	Guscio fond.	10771078	647	633	1	40.0	10.00	5.00
1109	Guscio fond.	10781079	661	647	1	40.0	10.00	5.00
1110	Guscio fond.	10791080	675	661	1	40.0	10.00	5.00

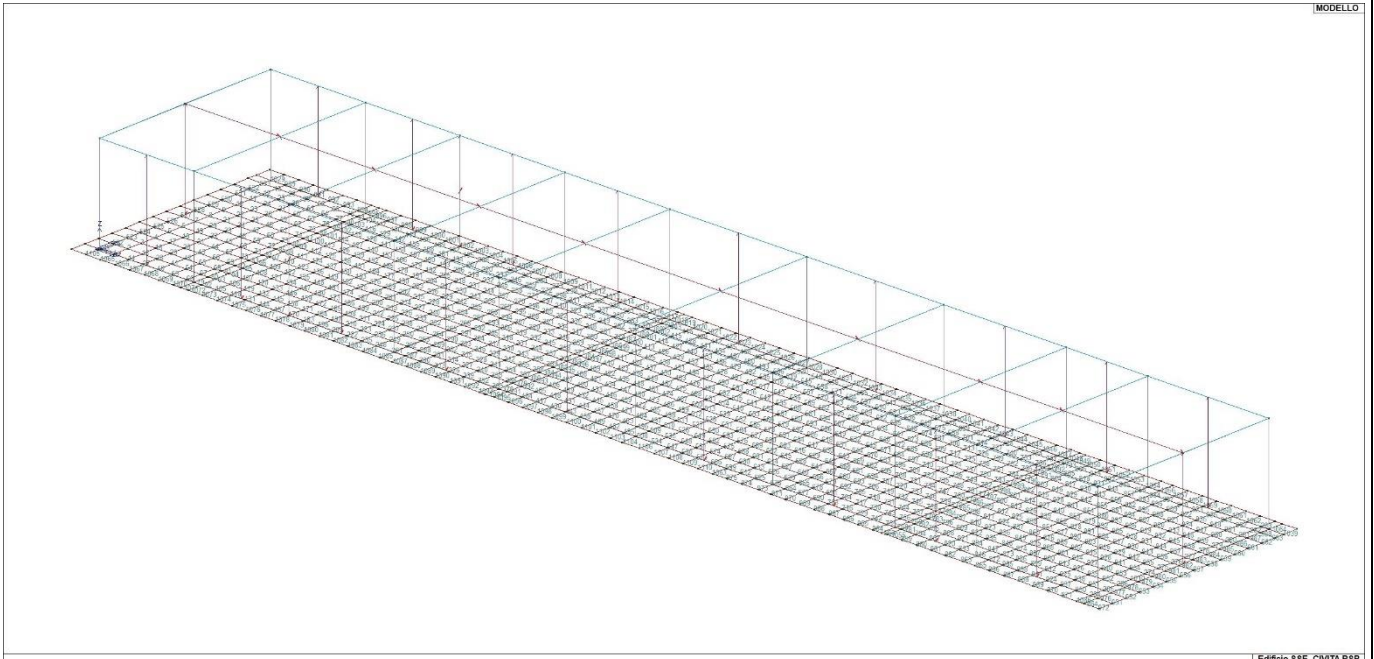

Edificio SSE\_CIVITA\_PSP

16\_MOD\_NUMERAZIONE\_D3

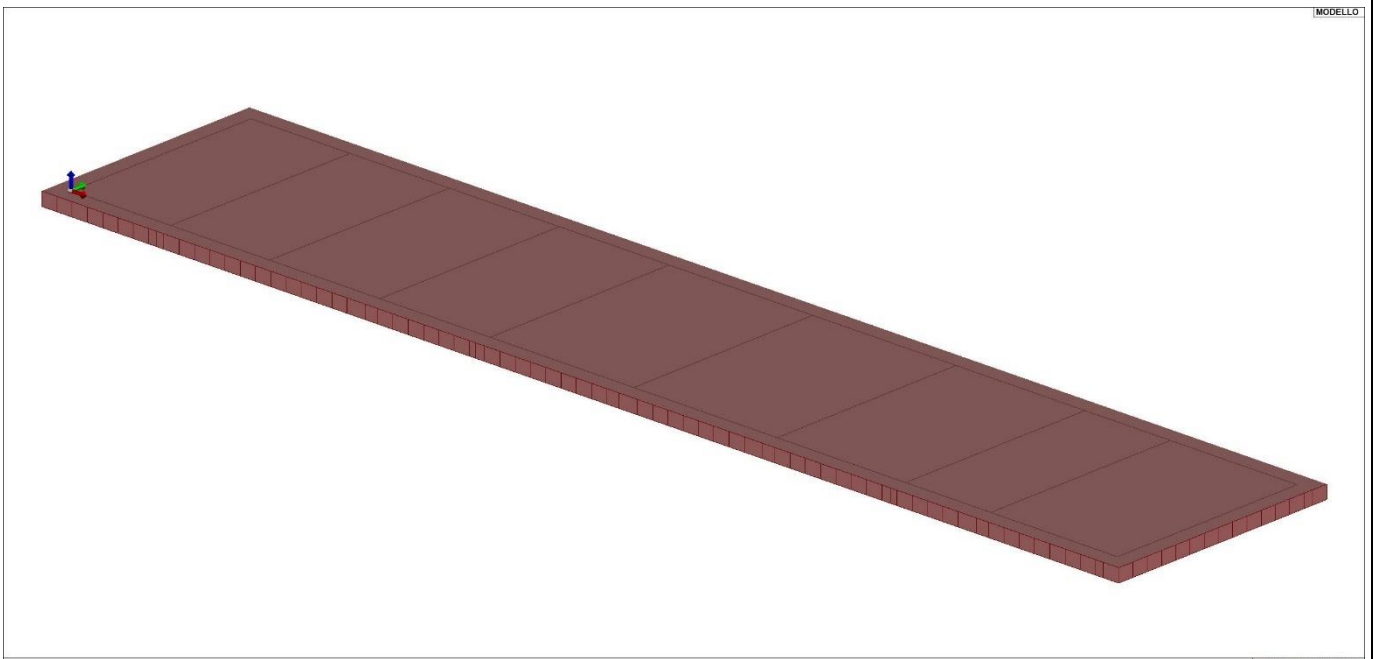

Edificio SSE\_CIVITA\_PSP

16\_MOD\_SPESSORI\_D3

## 8. MODELLAZIONE DELLA STRUTTURA: ELEMENTI SOLAIO-PANNELLO

### 8.1. LEGENDA TABELLA DATI SOLAI-PANNELLI

Il programma utilizza per la modellazione elementi a tre o più nodi denominati in generale solaio o pannello.

Ogni elemento solaio-pannello è individuato da una poligonale di nodi 1,2, ..., N.

L'elemento solaio è utilizzato in primo luogo per la modellazione dei carichi agenti sugli elementi strutturali. In secondo luogo può essere utilizzato per la corretta ripartizione delle forze orizzontali agenti nel proprio piano. L'elemento balcone è derivato dall'elemento solaio.

I carichi agenti sugli elementi solaio, raccolti in un archivio, sono direttamente assegnati agli elementi utilizzando le informazioni raccolte nell' archivio (es. i coefficienti combinatori). La tabella seguente riporta i dati utilizzati per la definizione dei carichi e delle masse.

L'elemento pannello è utilizzato solo per l'applicazione dei carichi, quali pesi delle tamponature o spinte dovute al vento o terre. In questo caso i carichi sono applicati in analogia agli altri elementi strutturali (si veda il cap. SCHEMATIZZAZIONE DEI CASI DI CARICO).

<b>Id.Arch.</b>	Identificativo dell' archivio
<b>Tipo</b>	Tipo di carico <b>Variab.</b> Carico variabile generico <b>Var. rid.</b> Carico variabile generico con riduzione in funzione dell' area (c.5.5. ...) <b>Neve</b> Carico di neve
<b>G1k</b>	carico permanente (comprensivo del peso proprio)
<b>G2k</b>	carico permanente non strutturale e non compiutamente definito
<b>Qk</b>	carico variabile
<b>Fatt. A</b>	fattore di riduzione del carico variabile (0.5 o 0.75) per tipo "Var.rid."
<b>S sis.</b>	fattore di riduzione del carico variabile per la definizione delle masse sismiche per D.M. 96 (vedi NOTA sul capitolo "normativa di riferimento")
<b>Psi 0</b>	Coefficiente combinatorio dei valori caratteristici delle azioni variabili: <b>per valore raro</b>
<b>Psi 1</b>	Coefficiente combinatorio dei valori caratteristici delle azioni variabili: <b>per valore frequente</b>
<b>Psi 2</b>	Coefficiente combinatorio dei valori caratteristici delle azioni variabili: <b>per valore quasi permanente</b>
<b>Psi S 2</b>	Coefficiente di combinazione che fornisce il valore quasi-permanente dell'azione variabile: <b>per la definizione delle masse sismiche</b>
<b>Fatt. Fi</b>	Coefficiente di correlazione dei carichi per edifici

Ogni elemento è caratterizzato da un insieme di proprietà riportate in tabella che ne completano la modellazione. In particolare per ogni elemento viene indicato in tabella:

<b>Elem</b>	numero dell'elemento
<b>Tipo</b>	codice di comportamento <b>S</b> elemento utilizzato solo per scarico <b>C</b> elemento utilizzato per scarico e per modellazione piano rigido <b>P</b> elemento utilizzato come pannello <b>M</b> scarico monodirezionale <b>B</b> scarico bidirezionale
<b>Id.Arch.</b>	Identificativo dell' archivio
<b>Mat</b>	codice del materiale assegnato all'elemento
<b>Spessore</b>	spessore dell'elemento (costante)
<b>Orditura</b>	angolo (rispetto all'asse X) della direzione dei travetti principali
<b>Gk</b>	carico permanente solaio (comprensivo del peso proprio)
<b>Qk</b>	carico variabile solaio
<b>Nodi</b>	numero dei nodi che definiscono l'elemento (5 per riga)

Nel caso in cui si sia proceduto alla progettazione dei solai con le tensioni ammissibili vengono riportate le massime tensioni nell'elemento (massima compressione nel calcestruzzo, massima tensione nell'acciaio, massima tensione tangenziale); nel caso in cui si sia proceduto alla progettazione con il metodo degli stati limite vengono riportati il rapporto  $x/d$  e le verifiche per sollecitazioni proporzionali nonché le verifiche in esercizio.

In particolare i simboli utilizzati in tabella assumono il seguente significato:

<b>Elem.</b>	numero identificativo dell'elemento
<b>Stato</b>	Codici di verifica relativi alle tensioni normali e alle tensioni tangenziali
<b>Note</b>	Viene riportato il codice relativo alla sezione(s) e relativo al materiale(m);
<b>Pos.</b>	Ascissa del punto di verifica
<b>F ist, F infi</b>	Frecce istantanee e a tempo infinito
<b>Momento</b>	Momento flettente
<b>Taglio</b>	Sollecitazione di taglio
<b>Af inf.</b>	Area di armatura longitudinale posta all'intradosso della trave
<b>Af sup.</b>	Area di armatura longitudinale posta all'estradosso della trave
<b>AfV</b>	Area dell'armatura atta ad assorbire le azioni di taglio
<b>Beff</b>	Base della sezione di cls per l'assorbimento del taglio
<b>simboli utilizzati con il metodo delle tensioni ammissibili:</b>	
<b>sc max</b>	Massima tensione di compressione del calcestruzzo
<b>sf max</b>	Massima tensione nell'acciaio
<b>tau max</b>	Massima tensione tangenziale nel cls
<b>simboli utilizzati con il metodo degli stati limite:</b>	
<b>x/d</b>	rapporto tra posizione dell'asse neutro e altezza utile alla rottura della sezione (per sola flessione)
<b>verif.</b>	rapporto Sd/Su con sollecitazioni ultime proporzionali: valore minore o uguale a 1 per verifica positiva
<b>Verif.V</b>	rapporto Sd/Su con sollecitazioni taglianti proporzionali valore minore o uguale a 1 per verifica positiva
<b>rRfck</b>	rapporto tra la massima compressione nel calcestruzzo e la tensione fck in combinazioni rare [normalizzato a 1]
<b>rFfck</b>	rapporto tra la massima compressione nel calcestruzzo e la tensione fck in combinazioni frequenti [normalizzato a 1]
<b>rPfck</b>	rapporto tra la massima compressione nel calcestruzzo e la tensione fck in combinazioni quasi permanenti [normalizzato a 1]
<b>rRfyk</b>	rapporto tra la massima tensione nell'acciaio e la tensione fyk in combinazioni frequenti [normalizzato a 1]
<b>rFyk</b>	rapporto tra la massima tensione nell'acciaio e la tensione fyk in combinazioni rare [normalizzato a 1]
<b>rPfyk</b>	rapporto tra la massima tensione nell'acciaio e la tensione fyk in combinazioni quasi permanenti [normalizzato a 1]
<b>wR</b>	apertura caratteristica delle fessure in combinazioni rare [mm]
<b>wF</b>	apertura caratteristica delle fessure in combinazioni frequenti [mm]
<b>wP</b>	apertura caratteristica delle fessure in combinazioni quasi permanenti [mm]

Nel caso in cui si sia proceduto alla verifica delle tamponature secondo il D.M. 17.01.2018 - §7.2.3 viene riportata una tabella riassuntiva delle verifiche degli elementi pannello. La verifica confronta i momenti sollecitanti indotti dal sisma con i momenti resistenti, secondo tre ipotesi, due basate sulla resistenza a pressoflessione della tamponatura ed una basata sul cinematicismo a seguito della formazione di tre cerniere plastiche sulla tamponatura (rif. Ufficio di Vigilanza sulle Costruzioni, Provincia di Terni).

Qualora la tamponatura sia di tipo antiespulsione (nelle due possibili varianti ordinaria o armata) viene condotta una verifica con meccanismo ad arco con degrado di resistenza. La verifica confronta le pressioni sollecitanti indotte dal sisma con le pressioni resistenti che la tamponatura sviluppa attraverso il meccanismo ad arco. La verifica considera anche il degrado di resistenza dovuto al danneggiamento nel piano della tamponatura.

Per quest'ultima tamponatura sono disponibili, in funzione del materiale impiegato (materiale [52] o materiale [53]):

- **Tamponatura Antiespulsione ordinaria Poroton® Cis Edil** sp.30 cm; con metodo di verifica per meccanismo ad arco con degrado di resistenza, sviluppato attraverso i risultati di un progetto di ricerca sperimentale condotto dall'Università degli Studi di Padova.  
Utilizzabile per il materiale [52].
- **Tamponatura Antiespulsione armata Poroton® Cis Edil** sp.30 cm; con metodo di verifica per meccanismo ad arco con degrado di resistenza, sviluppato attraverso i risultati di un progetto di ricerca sperimentale condotto dall'Università degli Studi di Padova.  
Utilizzabile per il materiale [53].

La verifica è stata calibrata sulla base di prove sperimentali sul sistema di Tamponatura Antiespulsione anche in presenza di aperture.

(rif. Rapporti di Prova redatti dal Dipartimento ICEA - Università degli Studi di Padova di test sperimentali condotti sul sistema Tamponatura Antiespulsione di Cis Edil)

In particolare i simboli utilizzati in tabella assumono il seguente significato:

<b>Elem.</b>	Numero identificativo dell'elemento
<b>Stato</b>	Codice di verifica
<b>Ver. c.c.</b>	Verifica nell'ipotesi di trave appoggiata con carico concentrato in mezzzeria
<b>Ver. c.d.</b>	Verifica nell'ipotesi di trave appoggiata con carico distribuito
<b>Ver. c.cin.</b>	Verifica nell'ipotesi di cinematismo con formazione di cerniere plastiche in appoggio e mezzzeria
<b>Ver. CIS</b>	Rapporto pa/pr (valore minore o uguale a 1 per verifica positiva)
<b>Z</b>	Quota del baricentro dell'elemento
<b>T1</b>	Periodo proprio dell'edificio nella direzione di interesse (ortogonale al pannello)
<b>Ta</b>	Periodo proprio della parete
<b>Sa</b>	Accelerazione massima, adimensionalizzata allo SLV
<b>pa</b>	Pressione sulla parete causata dall'azione sismica
<b>pr</b>	Pressione resistente del meccanismo ad arco
<b>Drift</b>	Spostamento relativo interpiano allo SLV valutato secondo il D.M. 14.01.2018 - § 7.3.3.3
<b>Beta a</b>	Coef. riduttivo per tener conto del danneggiamento del piano dipendente dallo spostamento, ottenuto sperimentalmente

Con riferimento al **Documento di Affidabilità "Test di validazione del software di calcolo PRO\_SAP e dei moduli aggiuntivi PRO\_SAP Modulo Geotecnico, PRO\_CAD nodi acciaio e PRO\_MST"** - versione Maggio 2011, disponibile per il download sul sito [www.2si.it](http://www.2si.it), si segnalano i seguenti esempi applicativi:

Test N°	Titolo
<b>14</b>	<b>ANALISI DEI CARICHI PER UN SOLAIO DI COPERTURA</b>
<b>15</b>	<b>EFFETTI DELLO SPESSORE SULLA RIGIDEZZA DEI SOLAI</b>
<b>16</b>	<b>SOLAIO: CONFRONTO FRA RIGIDO E DEFORMABILE</b>
<b>17</b>	<b>SOLAIO: MISTO LEGNO-CALCESTRUZZO</b>
<b>28</b>	<b>FRECCIA DI SOLAI IN C.A.</b>
<b>119</b>	<b>PROGETTO E VERIFICA DI SOLAI IN MATERIALE XLAM</b>

ID Arch.	Tipo	G1k	G2k	Qk	Fatt. A	s sis.	Psi 0	Psi 1	Psi 2	Psi S 2	Fatt. Fi
1	Neve	daN/cm2	daN/cm2	daN/cm2		1.00	0.50	0.20	0.0	0.0	1.00
		2.87e-023.60e-04	1.10e-02								

Elem.	TipolD Arch.	Mat.	Spessore	Orditura	G1k	G2k	Qk	Nodo 1/6..	Nodo 2/7..	Nodo 3/8..	Nodo..	Nodo..
			daN/cm2	daN/cm2	daN/cm2							
1	SM	1	m=1	1.00.02.87e-023.60e-04	1.10e-02		24	6	4	2		
2	SM	1	m=1	1.00.02.87e-023.60e-04	1.10e-02		26	8	6	24		
3	SM	1	m=1	1.00.02.87e-023.60e-04	1.10e-02		28	10	8	26		
4	SM	1	m=1	1.00.02.87e-023.60e-04	1.10e-02		30	12	10	28		
5	SM	1	m=1	1.00.02.87e-023.60e-04	1.10e-02		32	14	12	30		
6	SM	1	m=1	1.00.02.87e-023.60e-04	1.10e-02		34	16	14	32		
7	SM	1	m=1	1.00.02.87e-023.60e-04	1.10e-02		36	18	16	34		
8	SM	1	m=1	1.00.02.87e-023.60e-04	1.10e-02		38	20	18	36		
9	SM	1	m=1	1.00.02.87e-023.60e-04	1.10e-02		40	22	20	38		
10	PM		m=25	30.0	90.0			1	2	24	23	
11	PM		m=25	30.0	90.0			24	26	25	23	
12	PM		m=25	30.0	90.0			26	28	27	25	
13	PM		m=25	30.0	90.0			28	30	29	27	
14	PM		m=25	30.0	90.0			30	32	31	29	
15	PM		m=25	30.0	90.0			32	34	33	31	
16	PM		m=25	30.0	90.0			34	36	35	33	
17	PM		m=25	30.0	90.0			36	38	37	35	
18	PM		m=25	30.0	90.0			38	40	39	37	
19	PM		m=25	30.0	90.0			3	4	2	1	
20	PM		m=25	30.0	90.0			21	19	20	22	
21	PM		m=25	30.0	90.0			22	40	39	21	
22	PM		m=25	30.0	90.0			5	3	4	6	
23	PM		m=25	30.0	90.0			7	5	6	8	
24	PM		m=25	30.0	90.0			9	7	8	10	
25	PM		m=25	30.0	90.0			11	9	10	12	
26	PM		m=25	30.0	90.0			13	11	12	14	



27 PM	m=25	30.0	90.0	15	13	14	16
28 PM	m=25	30.0	90.0	17	15	16	18
29 PM	m=25	30.0	90.0	19	17	18	20

Elem.	Stato	Ver. c.c.	Ver. c.d.	Ver. cin.	Ver. CIS	Z	T1	Ta	Sa	pa	pr	Drift	Beta a
					cm	sec	sec	g	daN/cm2	daN/cm2	%		
10	NV	L1.16	0.58	1.08	0.0	150.0	0.19	0.025	0.46	0.006	0.0	0.42	0.0
11	NV	L1.16	0.58	1.08	0.0	150.0	0.19	0.025	0.46	0.006	0.0	0.42	0.0
12	NV	L1.16	0.58	1.08	0.0	150.0	0.19	0.025	0.46	0.006	0.0	0.42	0.0
13	NV	L1.16	0.58	1.08	0.0	150.0	0.19	0.025	0.46	0.006	0.0	0.42	0.0
14	NV	L1.16	0.58	1.08	0.0	150.0	0.19	0.025	0.46	0.006	0.0	0.42	0.0
15	NV	L1.16	0.58	1.08	0.0	150.0	0.19	0.025	0.46	0.006	0.0	0.42	0.0
16	NV	L1.16	0.58	1.08	0.0	150.0	0.19	0.025	0.46	0.006	0.0	0.42	0.0
17	NV	L1.16	0.58	1.08	0.0	150.0	0.19	0.025	0.46	0.006	0.0	0.42	0.0
18	NV	L1.16	0.58	1.08	0.0	150.0	0.19	0.025	0.46	0.006	0.0	0.43	0.0
19	NV	L1.16	0.58	1.08	0.0	150.0	0.19	0.025	0.46	0.006	0.0	0.35	0.0
20	NV	L1.16	0.58	1.08	0.0	150.0	0.19	0.025	0.46	0.006	0.0	0.43	0.0
21	NV	L1.16	0.58	1.08	0.0	150.0	0.19	0.025	0.46	0.006	0.0	0.39	0.0
22	NV	L1.16	0.58	1.08	0.0	150.0	0.19	0.025	0.46	0.006	0.0	0.42	0.0
23	NV	L1.16	0.58	1.08	0.0	150.0	0.19	0.025	0.46	0.006	0.0	0.42	0.0
24	NV	L1.16	0.58	1.08	0.0	150.0	0.19	0.025	0.46	0.006	0.0	0.42	0.0
25	NV	L1.16	0.58	1.08	0.0	150.0	0.19	0.025	0.46	0.006	0.0	0.42	0.0
26	NV	L1.16	0.58	1.08	0.0	150.0	0.19	0.025	0.46	0.006	0.0	0.42	0.0
27	NV	L1.16	0.58	1.08	0.0	150.0	0.19	0.025	0.46	0.006	0.0	0.42	0.0
28	NV	L1.16	0.58	1.08	0.0	150.0	0.19	0.025	0.46	0.006	0.0	0.42	0.0
29	NV	L1.16	0.58	1.08	0.0	150.0	0.19	0.025	0.46	0.006	0.0	0.42	0.0

Elem.	Ver. c.c.	Ver. c.d.	Ver. cin.	Ver. CIS	Drift
	1.16	0.58	1.08	0.0	0.35
	1.16	0.58	1.08	0.0	0.43

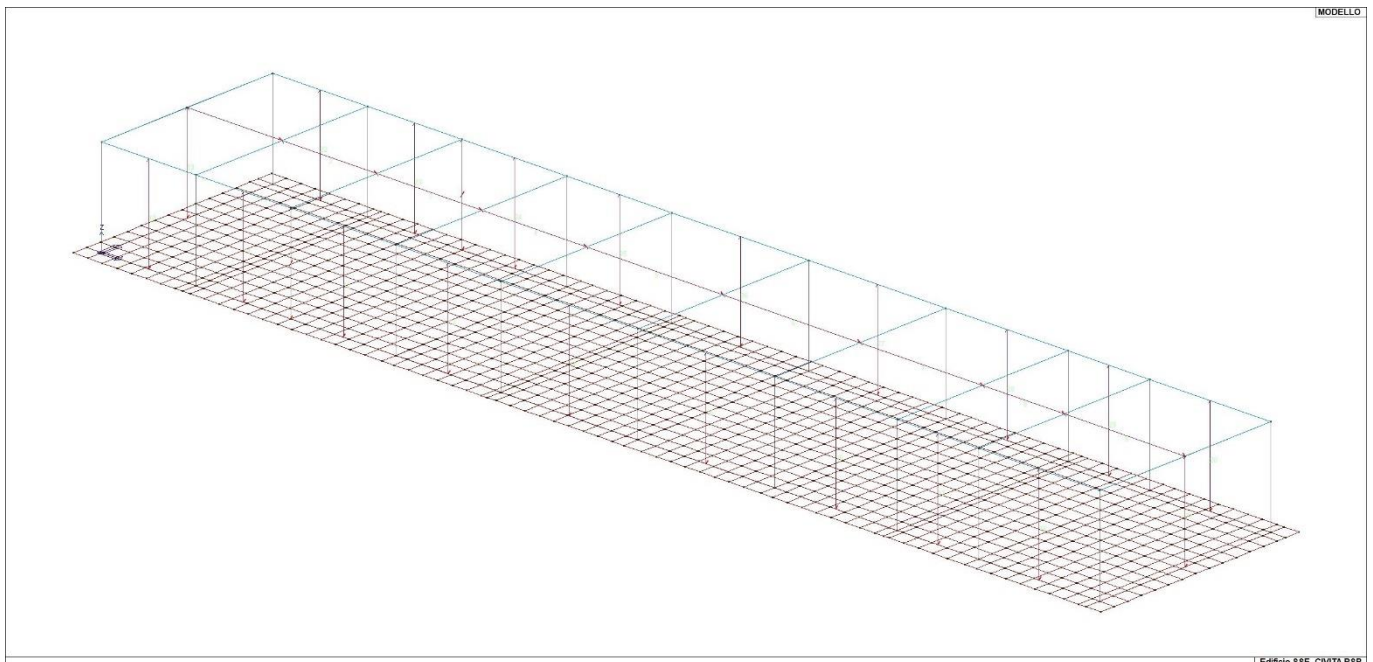

17\_MOD\_NUMERAZIONE\_SOLAI



## 9. MODELLAZIONE DELLE AZIONI

### 9.1. LEGENDA TABELLA DATI AZIONI

Il programma consente l'uso di diverse tipologie di carico (azioni). Le azioni utilizzate nella modellazione sono individuate da una sigla identificativa ed un codice numerico (gli elementi strutturali richiamano quest'ultimo nella propria descrizione). Per ogni azione applicata alla struttura viene di riportato il codice, il tipo e la sigla identificativa. Le tabelle successive dettagliano i valori caratteristici di ogni azione in relazione al tipo. Le tabelle riportano infatti i seguenti dati in relazione al tipo:

<b>1</b>	<b>carico concentrato nodale</b> 6 dati (forza $F_x, F_y, F_z$ , momento $M_x, M_y, M_z$ )
<b>2</b>	<b>spostamento nodale impresso</b> 6 dati (spostamento $T_x, T_y, T_z$ , rotazione $R_x, R_y, R_z$ )
<b>3</b>	<b>carico distribuito globale su elemento tipo trave</b> 7 dati ( $f_x, f_y, f_z, m_x, m_y, m_z$ , ascissa di inizio carico) 7 dati ( $f_x, f_y, f_z, m_x, m_y, m_z$ , ascissa di fine carico)
<b>4</b>	<b>carico distribuito locale su elemento tipo trave</b> 7 dati ( $f_1, f_2, f_3, m_1, m_2, m_3$ , ascissa di inizio carico) 7 dati ( $f_1, f_2, f_3, m_1, m_2, m_3$ , ascissa di fine carico)
<b>5</b>	<b>carico concentrato globale su elemento tipo trave</b> 7 dati ( $F_x, F_y, F_z, M_x, M_y, M_z$ , ascissa di carico)
<b>6</b>	<b>carico concentrato locale su elemento tipo trave</b> 7 dati ( $F_1, F_2, F_3, M_1, M_2, M_3$ , ascissa di carico)
<b>7</b>	<b>variazione termica applicata ad elemento tipo trave</b> 7 dati (variazioni termiche: uniforme, media e differenza in altezza e larghezza al nodo iniziale e finale)
<b>8</b>	<b>carico di pressione uniforme su elemento tipo piastra</b> 1 dato (pressione)
<b>9</b>	<b>carico di pressione variabile su elemento tipo piastra</b> 4 dati (pressione, quota, pressione, quota)
<b>10</b>	<b>variazione termica applicata ad elemento tipo piastra</b> 2 dati (variazioni termiche: media e differenza nello spessore)
<b>11</b>	<b>carico variabile generale su elementi tipo trave e piastra</b> 1 dato descrizione della tipologia 4 dati per segmento (posizione, valore, posizione, valore) la tipologia precisa l'ascissa di definizione, la direzione del carico, la modalità di carico e la larghezza d'influenza per gli elementi tipo trave
<b>12</b>	<b>gruppo di carichi con impronta su piastra</b> 9 dati (numero di ripetizioni in direzione X e Y, valore di ciascun carico, posizione centrale del primo, dimensioni dell'impronta, interasse tra i carichi)

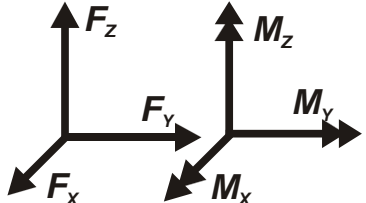
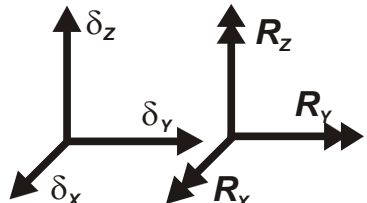
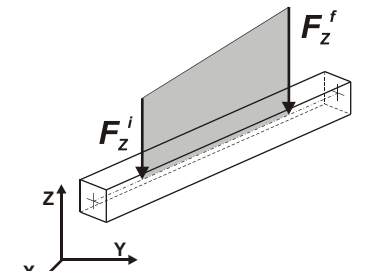
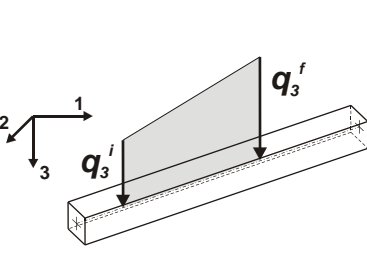
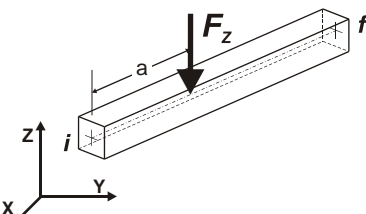
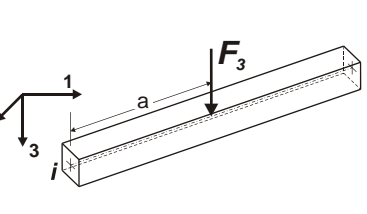
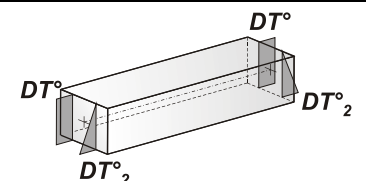
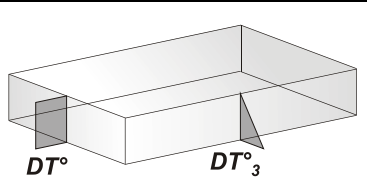
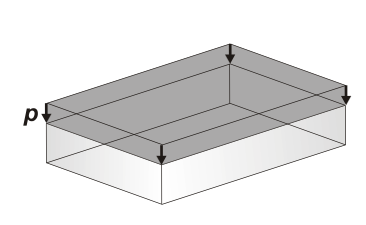
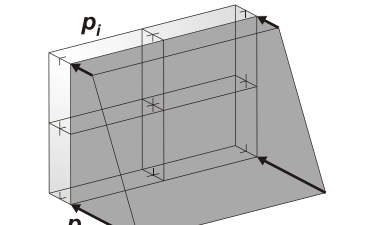
 <p>Carico concentrato nodale</p>	 <p>Spostamento impresso</p>
 <p>Carico distribuito globale</p>	 <p>Carico distribuito locale</p>
 <p>Carico concentrato globale</p>	 <p>Carico concentrato locale</p>
 <p>Carico termico 2D</p>	 <p>Carico termico 3D</p>
 <p>Carico pressione uniforme</p>	 <p>Carico pressione variabile</p>

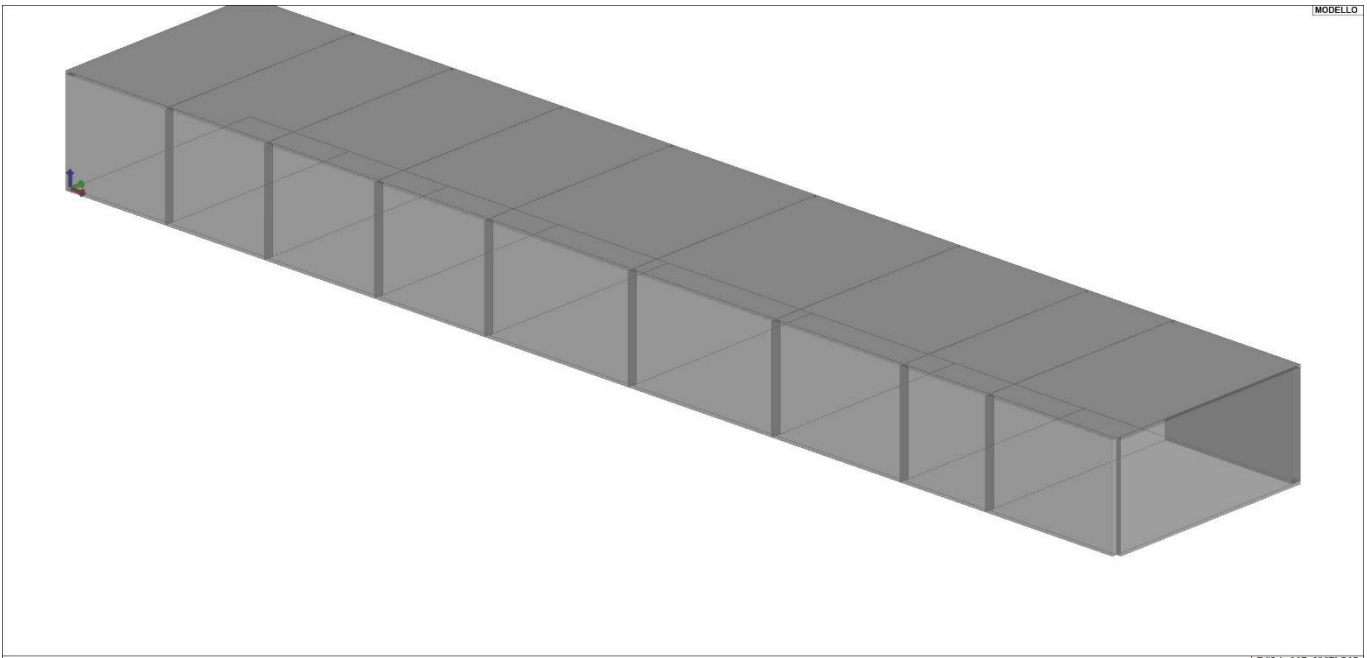

Edificio SSE CIVITA' P&P

21\_CAR\_CARICHI\_SOLAI

## 10. SCHEMATIZZAZIONE DEI CASI DI CARICO

### 10.1. LEGENDA TABELLA CASI DI CARICO

Il programma consente l'applicazione di diverse tipologie di casi di carico.

Sono previsti i seguenti 11 tipi di casi di carico:

	<b>Sigla</b>	<b>Tipo</b>	<b>Descrizione</b>
1	<b>Ggk</b>	A	caso di carico comprensivo del peso proprio struttura
2	<b>Gk</b>	NA	caso di carico con azioni permanenti
3	<b>Qk</b>	NA	caso di carico con azioni variabili
4	<b>Gsk</b>	A	caso di carico comprensivo dei carichi permanenti sui solai e sulle coperture
5	<b>Qsk</b>	A	caso di carico comprensivo dei carichi variabili sui solai
6	<b>Qnk</b>	A	caso di carico comprensivo dei carichi di neve sulle coperture
7	<b>Qtk</b>	SA	caso di carico comprensivo di una variazione termica agente sulla struttura
8	<b>Qvk</b>	NA	caso di carico comprensivo di azioni da vento sulla struttura
9	<b>Esk</b>	SA	caso di carico sismico con analisi statica equivalente
10	<b>Edk</b>	SA	caso di carico sismico con analisi dinamica
11	<b>Etk</b>	NA	caso di carico comprensivo di azioni derivanti dall' incremento di spinta delle terre in condizione sismica
12	<b>Pk</b>	NA	caso di carico comprensivo di azioni derivanti da coazioni, cedimenti e precompressioni

Sono di tipo automatico A (ossia non prevedono introduzione dati da parte dell'utente) i seguenti casi di carico: 1-Ggk; 4-Gsk; 5-Qsk; 6-Qnk.

Sono di tipo semi-automatico SA (ossia prevedono una minima introduzione dati da parte dell'utente) i seguenti casi di carico:

7-Qtk, in quanto richiede solo il valore della variazione termica;

9-Esk e 10-Edk, in quanto richiedono il valore dell'angolo di ingresso del sisma e l'individuazione dei casi di carico partecipanti alla definizione delle masse.

Sono di tipo non automatico NA ossia prevedono la diretta applicazione di carichi generici agli elementi strutturali (si veda il precedente punto Modellazione delle Azioni) i restanti casi di carico.

Nella tabella successiva vengono riportati i casi di carico agenti sulla struttura, con l'indicazione dei dati relativi al caso di carico stesso:

*Numero Tipo e Sigla identificativa, Valore di riferimento del caso di carico (se previsto).*

In successione, per i casi di carico non automatici, viene riportato l'elenco di nodi ed elementi direttamente caricati con la sigla identificativa del carico.

Per i casi di carico di tipo sismico (9-Esk e 10-Edk), viene riportata la tabella di definizione delle masse: per ogni caso di carico partecipante alla definizione delle masse viene indicata la relativa aliquota (partecipazione) considerata. Si precisa che per i caso di carico 5-Qsk e 6-Qnk la partecipazione è prevista localmente per ogni elemento solaio o copertura presente nel modello (si confronti il valore Sksol nel capitolo relativo agli elementi solaio) e pertanto la loro partecipazione è di norma pari a uno.

CDC	Tipo	Sigla Id	Note
1	Ggk	CDC=Ggk (peso proprio della struttura)	
2	Gsk	CDC=G1sk (permanente solai-coperture)	
3	Gsk	CDC=G2sk (permanente solai-coperture n.c.d.)	
4	Gsk	CDC=G2pk (permanente pannelli n.c.d.)	
5	Qnk	CDC=Qnk (carico da neve)	
6	Edk	CDC=Ed (dinamico SLU) alfa=0.0 (ecc. +)	partecipazione:1.00 per 1 CDC=Ggk (peso proprio della struttura)
			partecipazione:1.00 per 2 CDC=G1sk (permanente solai-coperture)
			partecipazione:1.00 per 3 CDC=G2sk (permanente solai-coperture n.c.d.)
			partecipazione:1.00 per 4 CDC=G2pk (permanente pannelli n.c.d.)
			partecipazione:1.00 per 5 CDC=Qnk (carico da neve)
7	Edk	CDC=Ed (dinamico SLU) alfa=0.0 (ecc. -)	come precedente CDC sismico
8	Edk	CDC=Ed (dinamico SLU) alfa=90.00 (ecc. +)	come precedente CDC sismico
9	Edk	CDC=Ed (dinamico SLU) alfa=90.00 (ecc. -)	come precedente CDC sismico
10	Edk	CDC=Ed (dinamico SLD) alfa=0.0 (ecc. +)	come precedente CDC sismico
11	Edk	CDC=Ed (dinamico SLD) alfa=0.0 (ecc. -)	come precedente CDC sismico
12	Edk	CDC=Ed (dinamico SLD) alfa=90.00 (ecc. +)	come precedente CDC sismico

CDC	Tipo	Sigla Id	Note
13	Edk	CDC=Ed (dinamico SLD) alfa=90.00 (ecc. -)	come precedente CDC sismico

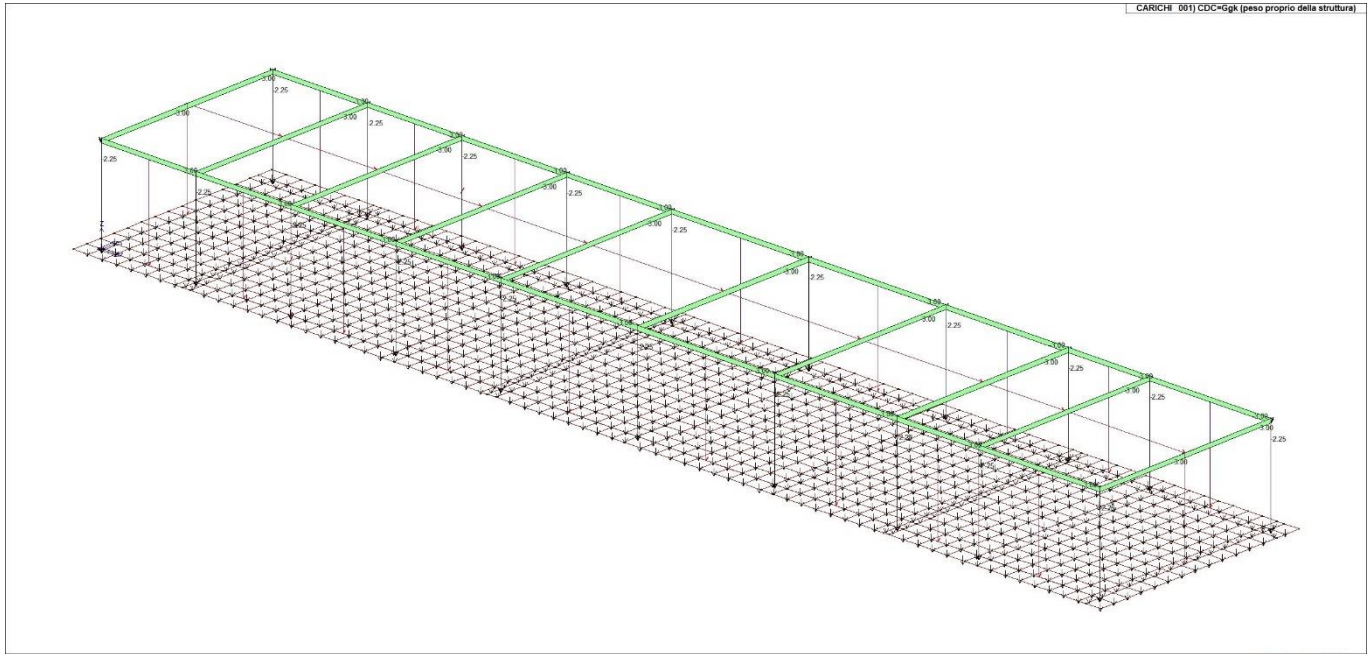

22\_CDC\_001\_CDC=Ggk (peso proprio della struttura)

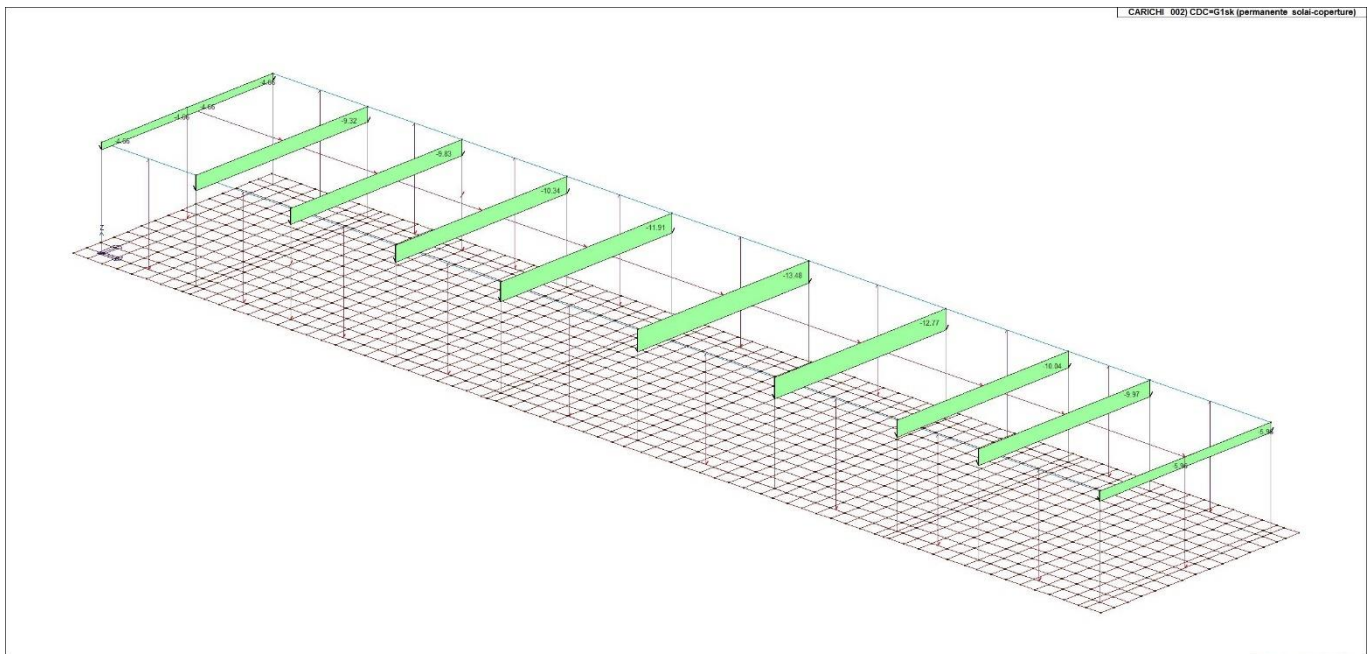

22\_CDC\_002\_CDC=G1sk (permanente solai-coperture)







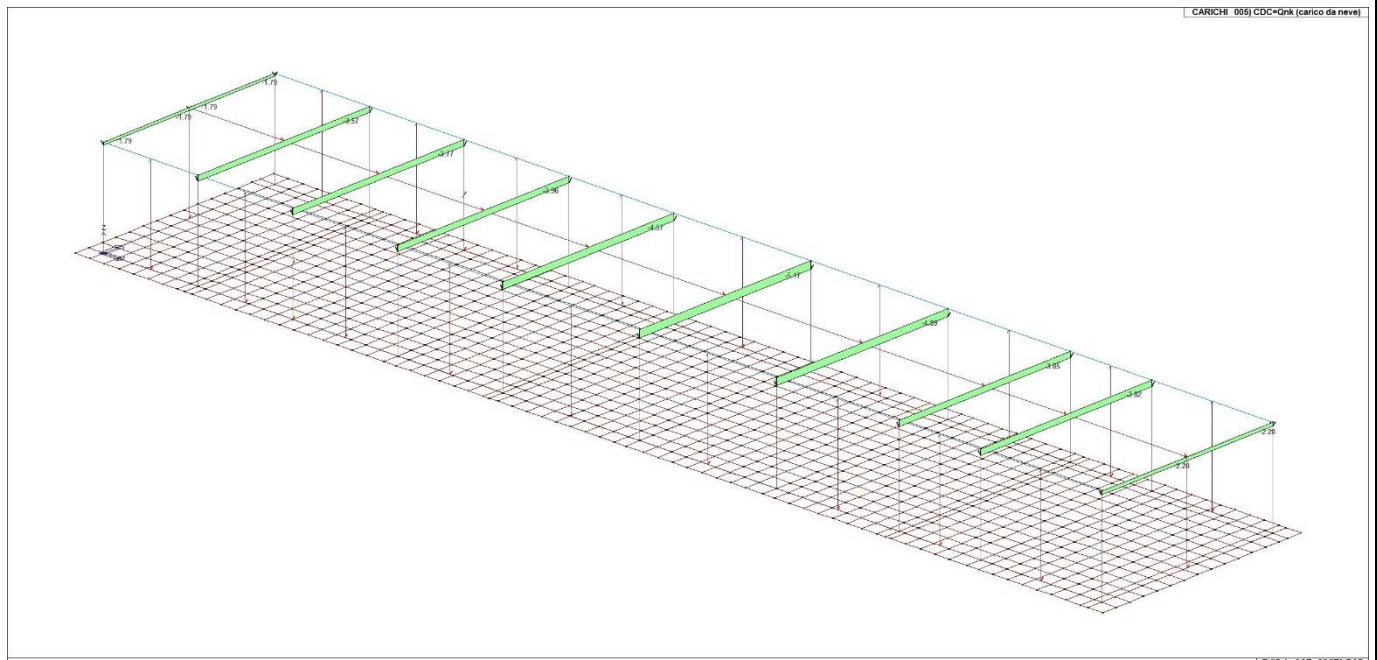

22\_CDC\_005\_CDC=Qnk (carico da neve)

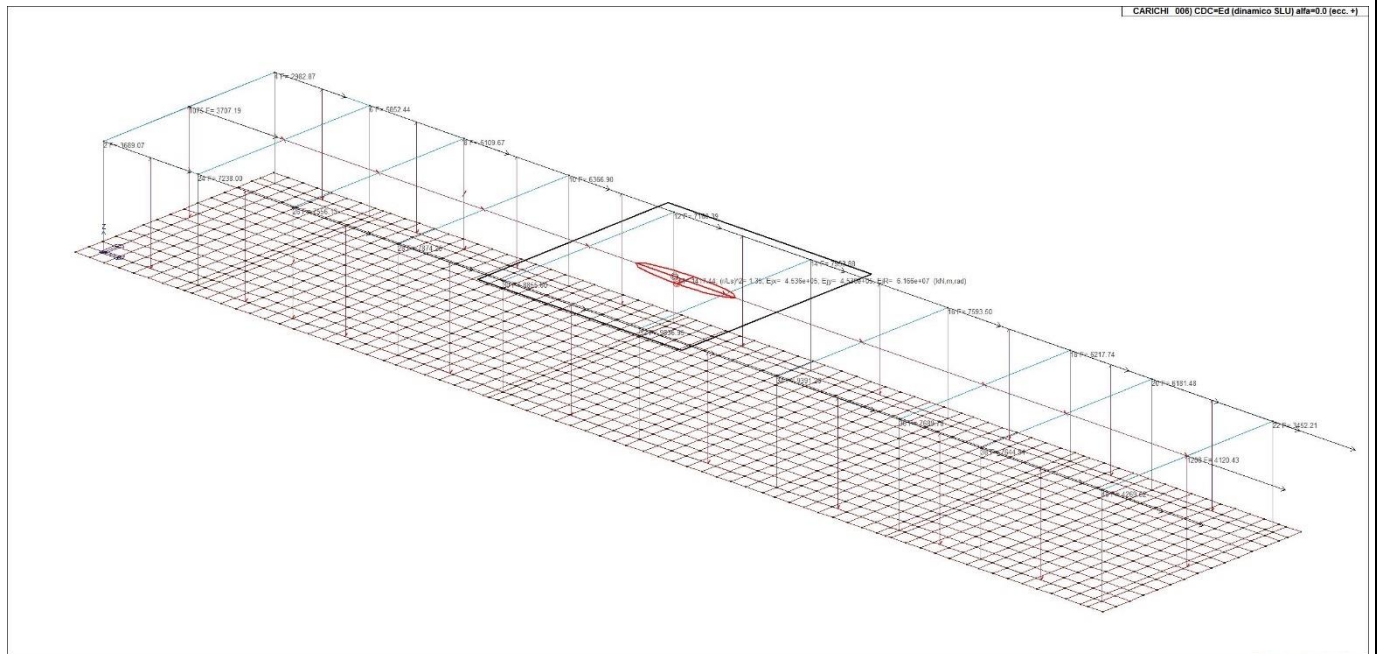

22\_CDC\_006\_CDC=Ed (dinamico SLU) alfa=0.0 (ecc. +)

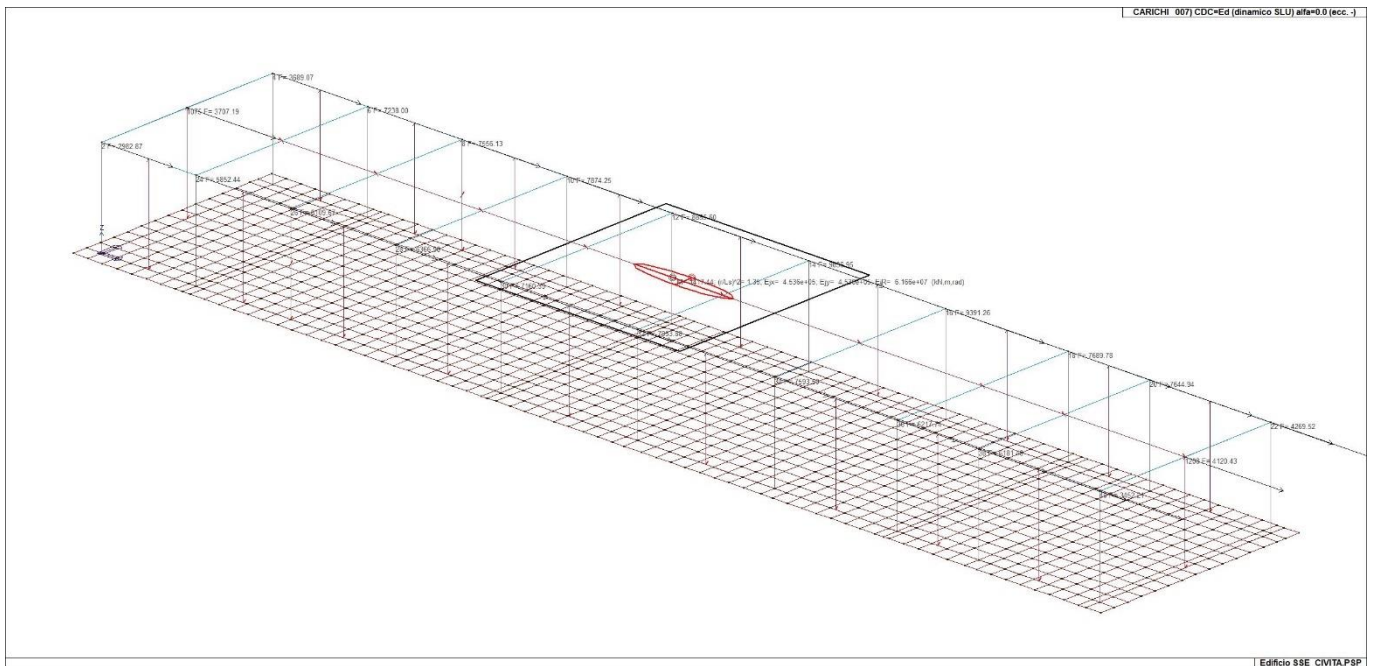

22\_CDC\_007\_CDC=Ed (dinamico SLU) alfa=0.0 (ecc. -)

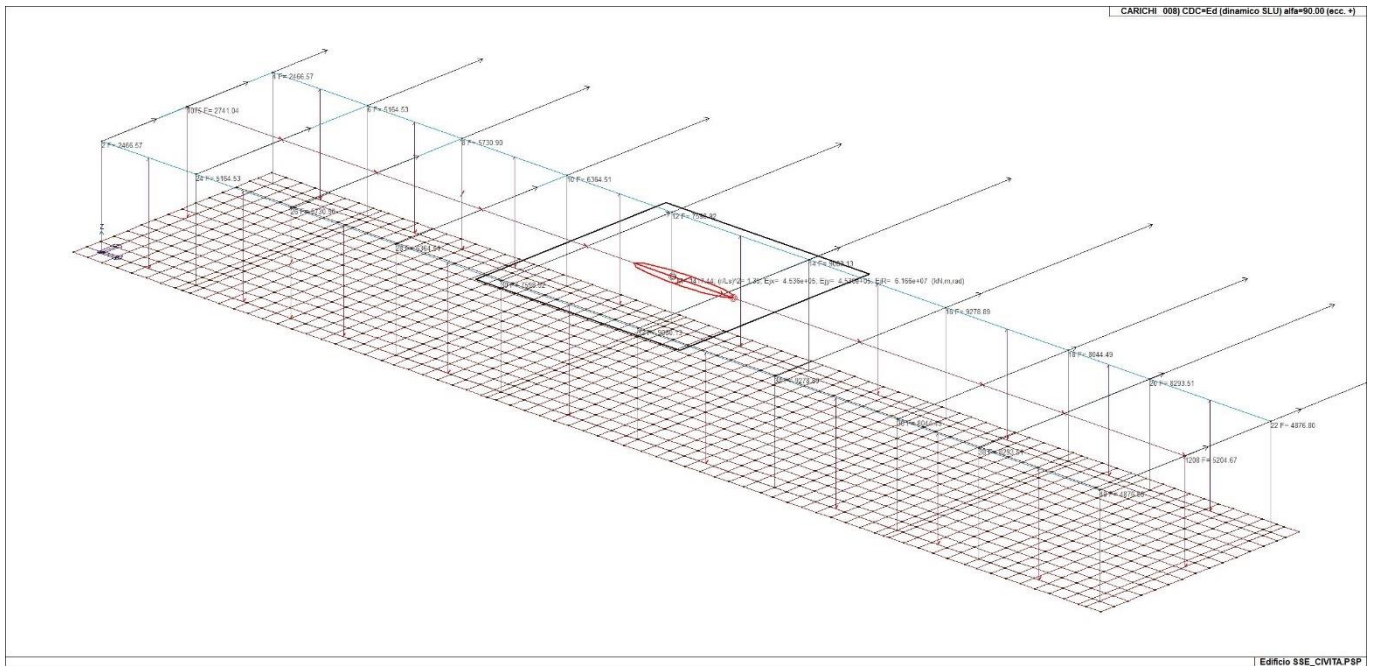

22\_CDC\_008\_CDC=Ed (dinamico SLU) alfa=90.00 (ecc. +)

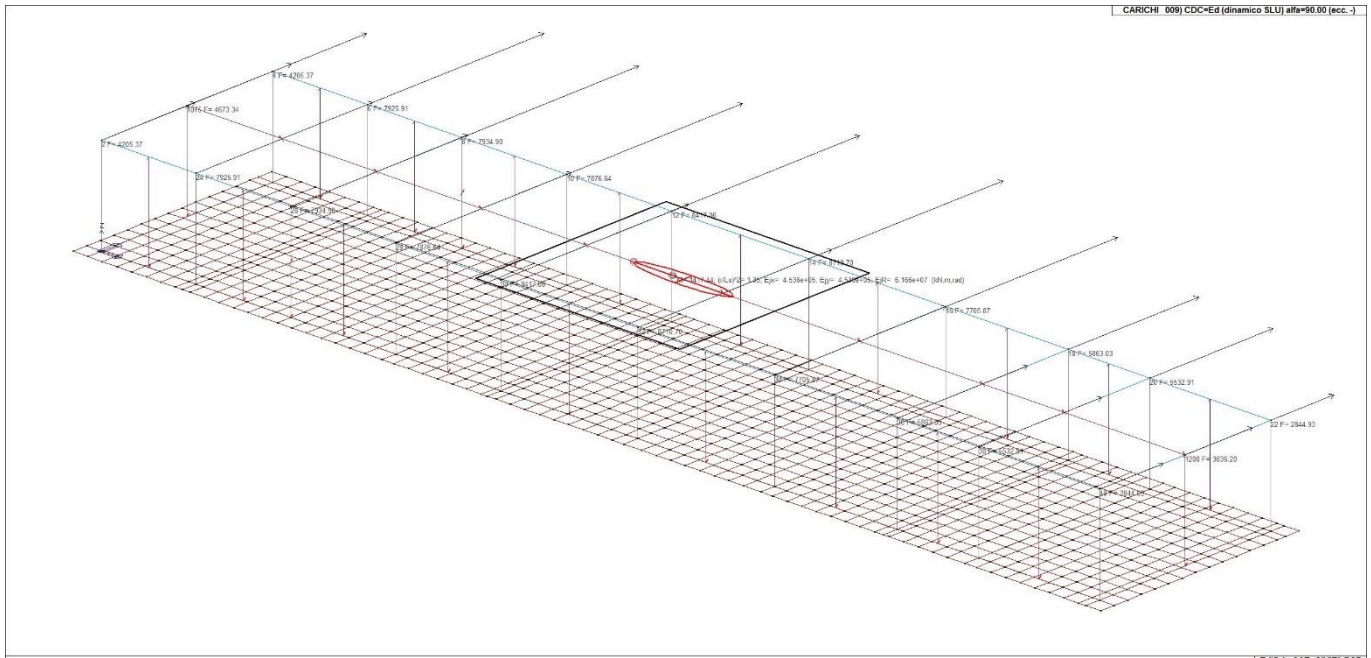

22\_CDC\_009\_CDC=Ed (dinamico SLU) alfa=90.00 (ecc. -)

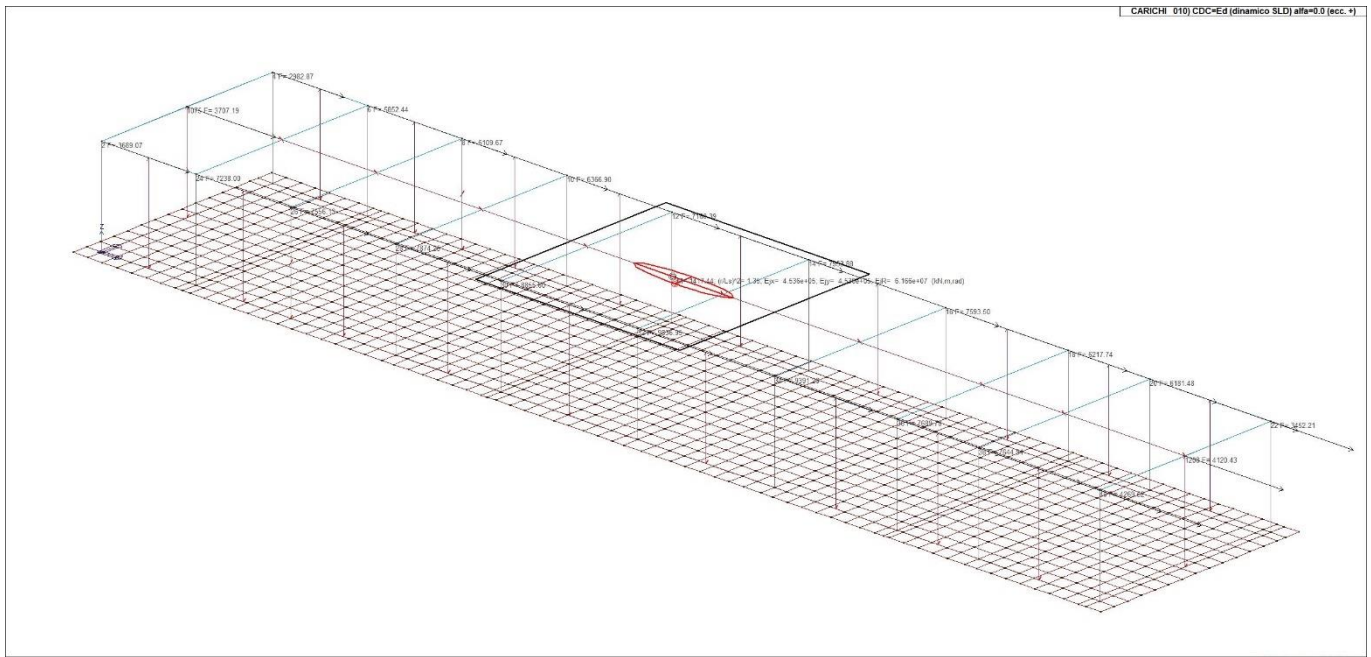

22\_CDC\_010\_CDC=Ed (dinamico SLD) alfa=0.0 (ecc. +)



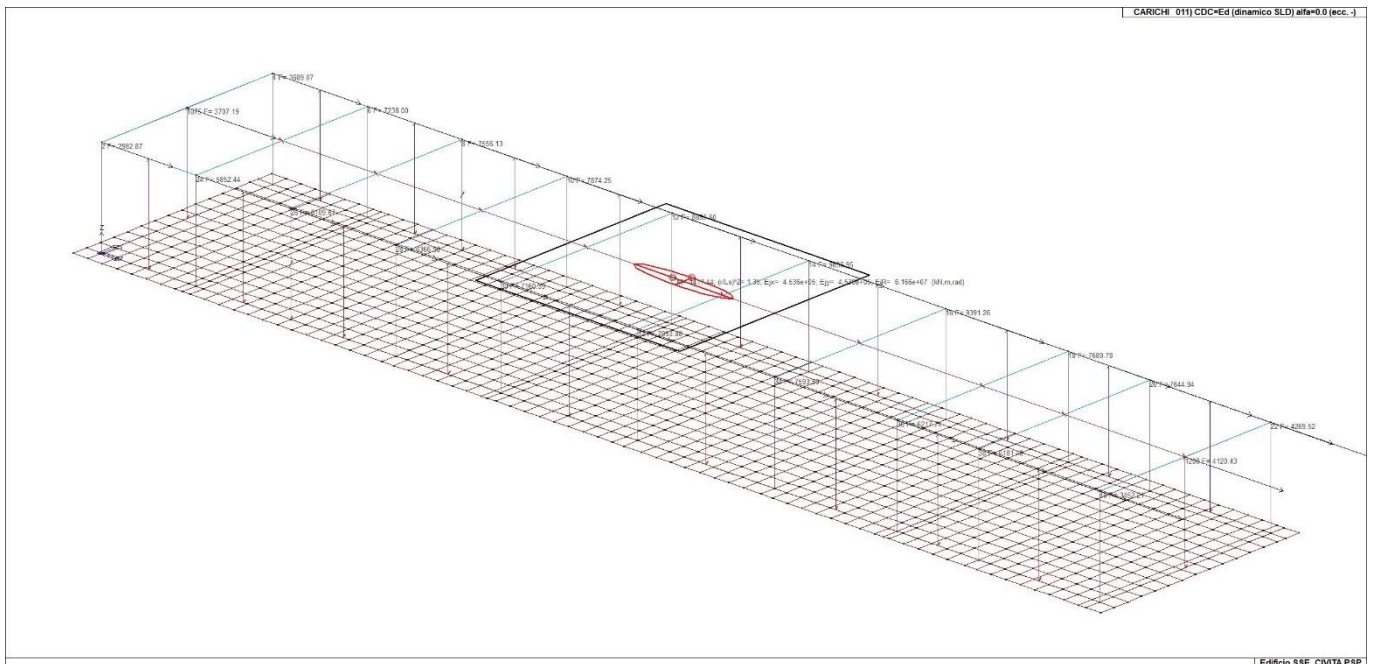

22\_CDC\_011\_CDC=Ed (dinamico SLD) alfa=0.0 (ecc. -)

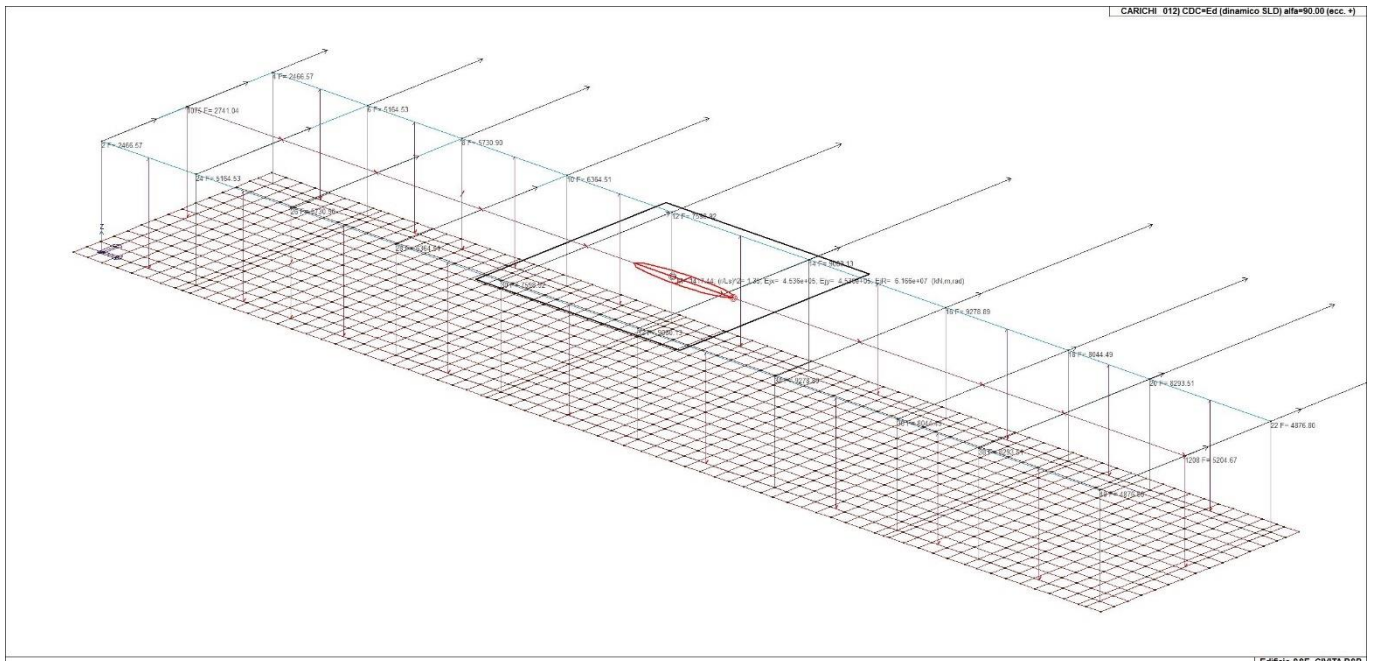

22\_CDC\_012\_CDC=Ed (dinamico SLD) alfa=90.00 (ecc. +)



## 11. DEFINIZIONE DELLE COMBINAZIONI

### 11.1. LEGENDA TABELLA COMBINAZIONI DI CARICO

Il programma combina i diversi tipi di casi di carico (CDC) secondo le regole previste dalla normativa vigente. Le combinazioni previste sono destinate al controllo di sicurezza della struttura ed alla verifica degli spostamenti e delle sollecitazioni.

La prima tabella delle combinazioni riportata di seguito comprende le seguenti informazioni: Numero, Tipo, Sigla identificativa. Una seconda tabella riporta il peso nella combinazione assunto per ogni caso di carico.

Ai fini delle verifiche degli stati limite si definiscono le seguenti combinazioni delle azioni:

#### Combinazione fondamentale SLU

$$\gamma G1 \cdot G1 + \gamma G2 \cdot G2 + \gamma P \cdot P + \gamma Q1 \cdot Qk1 + \gamma Q2 \cdot \psi 02 \cdot Qk2 + \gamma Q3 \cdot \psi 03 \cdot Qk3 + \dots$$

#### Combinazione caratteristica (rara) SLE

$$G1 + G2 + P + Qk1 + \psi 02 \cdot Qk2 + \psi 03 \cdot Qk3 + \dots$$

#### Combinazione frequente SLE

$$G1 + G2 + P + \psi 11 \cdot Qk1 + \psi 22 \cdot Qk2 + \psi 23 \cdot Qk3 + \dots$$

#### Combinazione quasi permanente SLE

$$G1 + G2 + P + \psi 21 \cdot Qk1 + \psi 22 \cdot Qk2 + \psi 23 \cdot Qk3 + \dots$$

#### Combinazione sismica, impiegata per gli stati limite ultimi e di esercizio connessi all'azione sismica E

$$E + G1 + G2 + P + \psi 21 \cdot Qk1 + \psi 22 \cdot Qk2 + \dots$$

#### Combinazione eccezionale, impiegata per gli stati limite connessi alle azioni eccezionali

$$G1 + G2 + Ad + P + \psi 21 \cdot Qk1 + \psi 22 \cdot Qk2 + \dots$$

Dove:

NTC 2018 Tabella 2.5.I

Destinazione d'uso/azione	$\psi 0$	$\psi 1$	$\psi 2$
Categoria A residenziali	0,70	0,50	0,30
Categoria B uffici	0,70	0,50	0,30
Categoria C ambienti suscettibili di affollamento	0,70	0,70	0,60
Categoria D ambienti ad uso commerciale	0,70	0,70	0,60
Categoria E biblioteche, archivi, magazzini, ...	1,00	0,90	0,80
Categoria F Rimesse e parcheggi (autoveicoli $\leq 30kN$ )	0,70	0,70	0,60
Categoria G Rimesse e parcheggi (autoveicoli $> 30kN$ )	0,70	0,50	0,30
Categoria H Coperture	0,00	0,00	0,00
Vento	0,60	0,20	0,00
Neve a quota $\leq 1000$ m	0,50	0,20	0,00
Neve a quota $> 1000$ m	0,70	0,50	0,20
Variazioni Termiche	0,60	0,50	0,00

Nelle verifiche possono essere adottati in alternativa due diversi approcci progettuali:

- per l'approccio 1 si considerano due diverse combinazioni di gruppi di coefficienti di sicurezza parziali per le azioni, per i materiali e per la resistenza globale (combinazione 1 con coefficienti A1 e combinazione 2 con coefficienti A2),

- per l'approccio 2 si definisce un'unica combinazione per le azioni, per la resistenza dei materiali e per la resistenza globale (con coefficienti A1).

NTC 2018 Tabella 2.6.I

		Coefficiente $\gamma f$	<b>EQU</b>	<b>A1</b>	<b>A2</b>
Carichi permanenti	Favorevoli	$\gamma G1$	0,9	1,0	1,0
	Sfavorevoli		1,1	1,3	1,0
Carichi permanenti non strutturali (Non compiutamente definiti)	Favorevoli	$\gamma G2$	0,8	0,8	0,8
	Sfavorevoli		1,5	1,5	1,3
Carichi variabili	Favorevoli	$\gamma Qi$	0,0	0,0	0,0
	Sfavorevoli		1,5	1,5	1,3



Cmb	Tipo	Sigla Id	effetto P-delta
1	SLU	Comb. SLU A1 1	
2	SLU	Comb. SLU A1 2	
3	SLU	Comb. SLU A1 3	
4	SLU	Comb. SLU A1 4	
5	SLU	Comb. SLU A1 (SLV sism.) 5	
6	SLU	Comb. SLU A1 (SLV sism.) 6	
7	SLU	Comb. SLU A1 (SLV sism.) 7	
8	SLU	Comb. SLU A1 (SLV sism.) 8	
9	SLU	Comb. SLU A1 (SLV sism.) 9	
10	SLU	Comb. SLU A1 (SLV sism.) 10	
11	SLU	Comb. SLU A1 (SLV sism.) 11	
12	SLU	Comb. SLU A1 (SLV sism.) 12	
13	SLU	Comb. SLU A1 (SLV sism.) 13	
14	SLU	Comb. SLU A1 (SLV sism.) 14	
15	SLU	Comb. SLU A1 (SLV sism.) 15	
16	SLU	Comb. SLU A1 (SLV sism.) 16	
17	SLU	Comb. SLU A1 (SLV sism.) 17	
18	SLU	Comb. SLU A1 (SLV sism.) 18	
19	SLU	Comb. SLU A1 (SLV sism.) 19	
20	SLU	Comb. SLU A1 (SLV sism.) 20	
21	SLU	Comb. SLU A1 (SLV sism.) 21	
22	SLU	Comb. SLU A1 (SLV sism.) 22	
23	SLU	Comb. SLU A1 (SLV sism.) 23	
24	SLU	Comb. SLU A1 (SLV sism.) 24	
25	SLU	Comb. SLU A1 (SLV sism.) 25	
26	SLU	Comb. SLU A1 (SLV sism.) 26	
27	SLU	Comb. SLU A1 (SLV sism.) 27	
28	SLU	Comb. SLU A1 (SLV sism.) 28	
29	SLU	Comb. SLU A1 (SLV sism.) 29	
30	SLU	Comb. SLU A1 (SLV sism.) 30	
31	SLU	Comb. SLU A1 (SLV sism.) 31	
32	SLU	Comb. SLU A1 (SLV sism.) 32	
33	SLU	Comb. SLU A1 (SLV sism.) 33	
34	SLU	Comb. SLU A1 (SLV sism.) 34	
35	SLU	Comb. SLU A1 (SLV sism.) 35	
36	SLU	Comb. SLU A1 (SLV sism.) 36	
37	SLD(sis)	Comb. SLE (SLD Danno sism.) 37	
38	SLD(sis)	Comb. SLE (SLD Danno sism.) 38	
39	SLD(sis)	Comb. SLE (SLD Danno sism.) 39	
40	SLD(sis)	Comb. SLE (SLD Danno sism.) 40	
41	SLD(sis)	Comb. SLE (SLD Danno sism.) 41	
42	SLD(sis)	Comb. SLE (SLD Danno sism.) 42	
43	SLD(sis)	Comb. SLE (SLD Danno sism.) 43	
44	SLD(sis)	Comb. SLE (SLD Danno sism.) 44	
45	SLD(sis)	Comb. SLE (SLD Danno sism.) 45	
46	SLD(sis)	Comb. SLE (SLD Danno sism.) 46	
47	SLD(sis)	Comb. SLE (SLD Danno sism.) 47	
48	SLD(sis)	Comb. SLE (SLD Danno sism.) 48	
49	SLD(sis)	Comb. SLE (SLD Danno sism.) 49	
50	SLD(sis)	Comb. SLE (SLD Danno sism.) 50	
51	SLD(sis)	Comb. SLE (SLD Danno sism.) 51	
52	SLD(sis)	Comb. SLE (SLD Danno sism.) 52	
53	SLD(sis)	Comb. SLE (SLD Danno sism.) 53	
54	SLD(sis)	Comb. SLE (SLD Danno sism.) 54	
55	SLD(sis)	Comb. SLE (SLD Danno sism.) 55	
56	SLD(sis)	Comb. SLE (SLD Danno sism.) 56	
57	SLD(sis)	Comb. SLE (SLD Danno sism.) 57	
58	SLD(sis)	Comb. SLE (SLD Danno sism.) 58	
59	SLD(sis)	Comb. SLE (SLD Danno sism.) 59	
60	SLD(sis)	Comb. SLE (SLD Danno sism.) 60	
61	SLD(sis)	Comb. SLE (SLD Danno sism.) 61	
62	SLD(sis)	Comb. SLE (SLD Danno sism.) 62	
63	SLD(sis)	Comb. SLE (SLD Danno sism.) 63	
64	SLD(sis)	Comb. SLE (SLD Danno sism.) 64	
65	SLD(sis)	Comb. SLE (SLD Danno sism.) 65	
66	SLD(sis)	Comb. SLE (SLD Danno sism.) 66	
67	SLD(sis)	Comb. SLE (SLD Danno sism.) 67	
68	SLD(sis)	Comb. SLE (SLD Danno sism.) 68	
69	SLE(r)	Comb. SLE(rara) 69	
70	SLE(r)	Comb. SLE(rara) 70	
71	SLE(f)	Comb. SLE(freq.) 71	
72	SLE(f)	Comb. SLE(freq.) 72	



EGP CODE

GRE.EEC.R.73.IT.W.15235.12.024.01

PAGE

68 di/of 527

Cmb	Tipo	Sigla Id	effetto P-delta
73	SLE(p)	Comb. SLE(perme.) 73	

Cmb	CDC 1/15...	CDC 2/16...	CDC 3/17...	CDC 4/18...	CDC 5/19...	CDC 6/20...	CDC 7/21...	CDC 8/22...	CDC 9/23...	CDC 10/24...	CDC 11/25...	CDC 12/26...	CDC 13/27...	CDC 14/28...
1	1.30	1.30	1.50	1.50	0.0	0.0	0.0	0.0	0.0	0.0	0.0	0.0	0.0	
2	1.30	1.30	1.50	1.50	1.50	0.0	0.0	0.0	0.0	0.0	0.0	0.0	0.0	
3	1.00	1.00	0.80	0.80	0.0	0.0	0.0	0.0	0.0	0.0	0.0	0.0	0.0	
4	1.00	1.00	0.80	0.80	1.50	0.0	0.0	0.0	0.0	0.0	0.0	0.0	0.0	
5	1.00	1.00	1.00	1.00	0.0	-1.00	0.0	-0.30	0.0	0.0	0.0	0.0	0.0	
6	1.00	1.00	1.00	1.00	0.0	-1.00	0.0	0.30	0.0	0.0	0.0	0.0	0.0	
7	1.00	1.00	1.00	1.00	0.0	1.00	0.0	-0.30	0.0	0.0	0.0	0.0	0.0	
8	1.00	1.00	1.00	1.00	0.0	1.00	0.0	0.30	0.0	0.0	0.0	0.0	0.0	
9	1.00	1.00	1.00	1.00	0.0	-1.00	0.0	0.0	-0.30	0.0	0.0	0.0	0.0	
10	1.00	1.00	1.00	1.00	0.0	-1.00	0.0	0.0	0.30	0.0	0.0	0.0	0.0	
11	1.00	1.00	1.00	1.00	0.0	1.00	0.0	0.0	-0.30	0.0	0.0	0.0	0.0	
12	1.00	1.00	1.00	1.00	0.0	1.00	0.0	0.0	0.30	0.0	0.0	0.0	0.0	
13	1.00	1.00	1.00	1.00	0.0	0.0	-1.00	-0.30	0.0	0.0	0.0	0.0	0.0	
14	1.00	1.00	1.00	1.00	0.0	0.0	-1.00	0.30	0.0	0.0	0.0	0.0	0.0	
15	1.00	1.00	1.00	1.00	0.0	0.0	1.00	-0.30	0.0	0.0	0.0	0.0	0.0	
16	1.00	1.00	1.00	1.00	0.0	0.0	1.00	0.30	0.0	0.0	0.0	0.0	0.0	
17	1.00	1.00	1.00	1.00	0.0	0.0	-1.00	0.0	-0.30	0.0	0.0	0.0	0.0	
18	1.00	1.00	1.00	1.00	0.0	0.0	-1.00	0.0	0.30	0.0	0.0	0.0	0.0	
19	1.00	1.00	1.00	1.00	0.0	0.0	1.00	0.0	-0.30	0.0	0.0	0.0	0.0	
20	1.00	1.00	1.00	1.00	0.0	0.0	1.00	0.0	0.30	0.0	0.0	0.0	0.0	
21	1.00	1.00	1.00	1.00	0.0	-0.30	0.0	-1.00	0.0	0.0	0.0	0.0	0.0	
22	1.00	1.00	1.00	1.00	0.0	-0.30	0.0	1.00	0.0	0.0	0.0	0.0	0.0	
23	1.00	1.00	1.00	1.00	0.0	0.30	0.0	-1.00	0.0	0.0	0.0	0.0	0.0	
24	1.00	1.00	1.00	1.00	0.0	0.30	0.0	1.00	0.0	0.0	0.0	0.0	0.0	
25	1.00	1.00	1.00	1.00	0.0	0.0	-0.30	-1.00	0.0	0.0	0.0	0.0	0.0	
26	1.00	1.00	1.00	1.00	0.0	0.0	-0.30	1.00	0.0	0.0	0.0	0.0	0.0	
27	1.00	1.00	1.00	1.00	0.0	0.0	0.30	-1.00	0.0	0.0	0.0	0.0	0.0	
28	1.00	1.00	1.00	1.00	0.0	0.0	0.30	1.00	0.0	0.0	0.0	0.0	0.0	
29	1.00	1.00	1.00	1.00	0.0	-0.30	0.0	0.0	-1.00	0.0	0.0	0.0	0.0	
30	1.00	1.00	1.00	1.00	0.0	-0.30	0.0	0.0	1.00	0.0	0.0	0.0	0.0	
31	1.00	1.00	1.00	1.00	0.0	0.30	0.0	0.0	-1.00	0.0	0.0	0.0	0.0	
32	1.00	1.00	1.00	1.00	0.0	0.30	0.0	0.0	1.00	0.0	0.0	0.0	0.0	
33	1.00	1.00	1.00	1.00	0.0	0.0	-0.30	0.0	-1.00	0.0	0.0	0.0	0.0	
34	1.00	1.00	1.00	1.00	0.0	0.0	-0.30	0.0	1.00	0.0	0.0	0.0	0.0	
35	1.00	1.00	1.00	1.00	0.0	0.0	0.30	0.0	-1.00	0.0	0.0	0.0	0.0	
36	1.00	1.00	1.00	1.00	0.0	0.0	0.30	0.0	1.00	0.0	0.0	0.0	0.0	
37	1.00	1.00	1.00	1.00	0.0	0.0	0.0	0.0	0.0	-1.00	0.0	-0.30	0.0	
38	1.00	1.00	1.00	1.00	0.0	0.0	0.0	0.0	0.0	-1.00	0.0	0.30	0.0	
39	1.00	1.00	1.00	1.00	0.0	0.0	0.0	0.0	0.0	1.00	0.0	-0.30	0.0	
40	1.00	1.00	1.00	1.00	0.0	0.0	0.0	0.0	0.0	1.00	0.0	0.30	0.0	
41	1.00	1.00	1.00	1.00	0.0	0.0	0.0	0.0	0.0	-1.00	0.0	0.0	-0.30	
42	1.00	1.00	1.00	1.00	0.0	0.0	0.0	0.0	0.0	-1.00	0.0	0.0	0.30	
43	1.00	1.00	1.00	1.00	0.0	0.0	0.0	0.0	0.0	1.00	0.0	0.0	-0.30	
44	1.00	1.00	1.00	1.00	0.0	0.0	0.0	0.0	0.0	1.00	0.0	0.0	0.30	
45	1.00	1.00	1.00	1.00	0.0	0.0	0.0	0.0	0.0	0.0	-1.00	-0.30	0.0	
46	1.00	1.00	1.00	1.00	0.0	0.0	0.0	0.0	0.0	0.0	-1.00	0.30	0.0	
47	1.00	1.00	1.00	1.00	0.0	0.0	0.0	0.0	0.0	0.0	1.00	-0.30	0.0	
48	1.00	1.00	1.00	1.00	0.0	0.0	0.0	0.0	0.0	0.0	1.00	0.30	0.0	
49	1.00	1.00	1.00	1.00	0.0	0.0	0.0	0.0	0.0	0.0	-1.00	0.0	-0.30	
50	1.00	1.00	1.00	1.00	0.0	0.0	0.0	0.0	0.0	0.0	-1.00	0.0	0.30	
51	1.00	1.00	1.00	1.00	0.0	0.0	0.0	0.0	0.0	0.0	1.00	0.0	-0.30	
52	1.00	1.00	1.00	1.00	0.0	0.0	0.0	0.0	0.0	0.0	1.00	0.0	0.30	
53	1.00	1.00	1.00	1.00	0.0	0.0	0.0	0.0	0.0	-0.30	0.0	-1.00	0.0	
54	1.00	1.00	1.00	1.00	0.0	0.0	0.0	0.0	0.0	-0.30	0.0	1.00	0.0	
55	1.00	1.00	1.00	1.00	0.0	0.0	0.0	0.0	0.0	0.30	0.0	-1.00	0.0	
56	1.00	1.00	1.00	1.00	0.0	0.0	0.0	0.0	0.0	0.30	0.0	1.00	0.0	
57	1.00	1.00	1.00	1.00	0.0	0.0	0.0	0.0	0.0	0.0	-0.30	-1.00	0.0	
58	1.00	1.00	1.00	1.00	0.0	0.0	0.0	0.0	0.0	0.0	-0.30	1.00	0.0	
59	1.00	1.00	1.00	1.00	0.0	0.0	0.0	0.0	0.0	0.0	0.30	-1.00	0.0	
60	1.00	1.00	1.00	1.00	0.0	0.0	0.0	0.0	0.0	0.0	0.30	1.00	0.0	
61	1.00	1.00	1.00	1.00	0.0	0.0	0.0	0.0	0.0	-0.30	0.0	0.0	-1.00	
62	1.00	1.00	1.00	1.00	0.0	0.0	0.0	0.0	0.0	-0.30	0.0	0.0	1.00	
63	1.00	1.00	1.00	1.00	0.0	0.0	0.0	0.0	0.0	0.30	0.0	0.0	-1.00	
64	1.00	1.00	1.00	1.00	0.0	0.0	0.0	0.0	0.0	0.30	0.0	0.0	1.00	
65	1.00	1.00	1.00	1.00	0.0	0.0	0.0	0.0	0.0	0.0	-0.30	0.0	-1.00	
66	1.00	1.00	1.00	1.00	0.0	0.0	0.0	0.0	0.0	0.0	-0.30	0.0	1.00	
67	1.00	1.00	1.00	1.00	0.0	0.0	0.0	0.0	0.0	0.0	0.30	0.0	-1.00	
68	1.00	1.00	1.00	1.00	0.0	0.0	0.0	0.0	0.0	0.0	0.30	0.0	1.00	



## 12. AZIONE SISMICA

### 12.1. VALUTAZIONE DELL' AZIONE SISMICA

L'azione sismica sulle costruzioni è valutata a partire dalla "pericolosità sismica di base", in condizioni ideali di sito di riferimento rigido con superficie topografica orizzontale.

Allo stato attuale, la pericolosità sismica su reticolo di riferimento nell'intervallo di riferimento è fornita dai dati pubblicati sul sito <http://esse1.mi.ingv.it/>. Per punti non coincidenti con il reticolo di riferimento e periodi di ritorno non contemplati direttamente si opera come indicato nell' allegato alle NTC (rispettivamente media pesata e interpolazione).

L' azione sismica viene definita in relazione ad un periodo di riferimento  $V_r$  che si ricava, per ciascun tipo di costruzione, moltiplicandone la vita nominale per il coefficiente d'uso (vedi tabella Parametri della struttura). Fissato il periodo di riferimento  $V_r$  e la probabilità di superamento  $P_{ver}$  associata a ciascuno degli stati limite considerati, si ottiene il periodo di ritorno  $T_r$  e i relativi parametri di pericolosità sismica (vedi tabella successiva):

$a_g$ : accelerazione orizzontale massima del terreno;

$F_o$ : valore massimo del fattore di amplificazione dello spettro in accelerazione orizzontale;

$T^*c$ : periodo di inizio del tratto a velocità costante dello spettro in accelerazione orizzontale;

12.1.1. Parametri della struttura					
Classe d'uso	Vita $V_n$ [anni]	Coeff. Uso	Periodo $V_r$ [anni]	Tipo di suolo	Categoria topografica
II	50.0	2.0	100.0	B	T1

Individuati su reticolo di riferimento i parametri di pericolosità sismica si valutano i parametri spettrali riportati in tabella:

$S$  è il coefficiente che tiene conto della categoria di sottosuolo e delle condizioni topografiche mediante la relazione seguente  $S = S_s \cdot S_t$  (3.2.3)

$F_o$  è il fattore che quantifica l'amplificazione spettrale massima, su sito di riferimento rigido orizzontale

$F_v$  è il fattore che quantifica l'amplificazione spettrale massima verticale, in termini di accelerazione orizzontale massima del terreno  $a_g$  su sito di riferimento rigido orizzontale

$T_b$  è il periodo corrispondente all'inizio del tratto dello spettro ad accelerazione costante.

$T_c$  è il periodo corrispondente all'inizio del tratto dello spettro a velocità costante.

$T_d$  è il periodo corrispondente all'inizio del tratto dello spettro a spostamento costante.

Id nodo	Longitudine	Latitudine	Distanza
			Km
Loc.	14.837	41.903	
28547	14.833	41.877	2.900
28548	14.900	41.876	5.998
28326	14.902	41.926	5.936
28325	14.834	41.927	2.671

SL	$P_{ver}$	$T_r$	$a_g$	$F_o$	$T^*c$
		Anni	g		sec
SLO	81.0	60.0	0.063	2.480	0.330
SLD	63.0	101.0	0.080	2.520	0.340
SLV	10.0	949.0	0.186	2.550	0.390
SLC	5.0	1950.0	0.239	2.520	0.400

SL	$a_g$	$S$	$F_o$	$F_v$	$T_b$	$T_c$	$T_d$
	g				sec	sec	sec
SLO	0.063	1.200	2.480	0.839	0.151	0.453	1.851
SLD	0.080	1.200	2.520	0.962	0.155	0.464	1.920
SLV	0.186	1.200	2.550	1.485	0.173	0.518	2.344
SLC	0.239	1.159	2.520	1.664	0.176	0.528	2.556

### 13. RISULTATI ANALISI SISMICHE

#### 13.1. LEGENDA TABELLA ANALISI SISMICHE

Il programma consente l'analisi di diverse configurazioni sismiche.

Sono previsti, infatti, i seguenti casi di carico:

- 9. Esk** caso di carico sismico con analisi statica equivalente  
**10. Edk** caso di carico sismico con analisi dinamica

Ciascun caso di carico è caratterizzato da un angolo di ingresso e da una configurazione di masse determinante la forza sismica complessiva (si rimanda al capitolo relativo ai casi di carico per chiarimenti inerenti questo aspetto).

Nella colonna Note, in funzione della norma in uso sono riportati i parametri fondamentali che caratterizzano l'azione sismica: in particolare possono essere presenti i seguenti valori:

<b>Angolo di ingresso</b>	Angolo di ingresso dell'azione sismica orizzontale
<b>Fattore di importanza</b>	Fattore di importanza dell'edificio, in base alla categoria di appartenenza
<b>Zona sismica</b>	Zona sismica
<b>Accelerazione ag</b>	Accelerazione orizzontale massima sul suolo
<b>Categoria suolo</b>	Categoria di profilo stratigrafico del suolo di fondazione
<b>Fattore q</b>	Fattore di struttura/di comportamento. Dipendente dalla tipologia strutturale
<b>Fattore di sito S</b>	Fattore dipendente dalla stratigrafia e dal profilo topografico
<b>Classe di duttilità CD</b>	Classe di duttilità della struttura – "A" duttilità alta, "B" duttilità bassa
<b>Fattore riduz. SLD</b>	Fattore di riduzione dello spettro elastico per lo stato limite di danno
<b>Periodo proprio T1</b>	Periodo proprio di vibrazione della struttura
<b>Coefficiente Lambda</b>	Coefficiente dipendente dal periodo proprio T1 e dal numero di piani della struttura
<b>Ordinata spettro Sd(T1)</b>	Valore delle ordinate dello spettro di progetto per lo stato limite ultimo, componente orizzontale (verticale Svd)
<b>Ordinata spettro Se(T1)</b>	Valore delle ordinate dello spettro elastico ridotta del fattore SLD per lo stato limite di danno, componente orizzontale (verticale Sve)
<b>Ordinata spettro S (Tb-Tc)</b>	Valore dell' ordinata dello spettro in uso nel tratto costante
<b>numero di modi considerati</b>	Numero di modi di vibrare della struttura considerati nell'analisi dinamica

Per ciascun caso di carico sismico viene riportato l'insieme di dati sotto riportati (le masse sono espresse in unità di forza):

- a) **analisi sismica statica equivalente:**
- quota, posizione del centro di applicazione e azione orizzontale risultante, posizione del baricentro delle rigidezze, rapporto  $r/L_s$  (per strutture a nucleo), indici di regolarità  $e/r$  secondo EC8 4.2.3.2
  - azione sismica complessiva
- b) **analisi sismica dinamica con spettro di risposta:**
- quota, posizione del centro di massa e massa risultante, posizione del baricentro delle rigidezze, rapporto  $r/L_s$  (per strutture a nucleo) , indici di regolarità  $e/r$  secondo EC8 4.2.3.2
  - frequenza, periodo, accelerazione spettrale, massa eccitata nelle tre direzioni globali per tutti i modi
  - massa complessiva ed aliquota di massa complessiva eccitata.

Per ciascuna combinazione sismica definita SLD o SLO viene riportato il livello di deformazione  $\eta_T$  (dr) degli elementi strutturali verticali. Per semplicità di consultazione il livello è espresso anche in unità  $1000 \cdot \eta_T/h$  da confrontare direttamente con i valori forniti nella norma (es. 5 per edifici con tamponamenti collegati rigidamente alla struttura, 10.0 per edifici con tamponamenti collegati elasticamente, 3 per edifici in muratura ordinaria, 4 per

edifici in muratura armata).

Qualora si applichi il D.M. 96 (vedi NOTA sul capitolo "normativa di riferimento") l'analisi sismica dinamica può essere comprensiva di sollecitazione verticale contemporanea a quella orizzontale, nel qual caso è effettuata una sovrapposizione degli effetti in ragione della radice dei quadrati degli effetti stessi. Per ciascuna combinazione sismica - analisi effettuate con il D.M. 96 (vedi NOTA sul capitolo "normativa di riferimento") - viene riportato il livello di deformazione  $\eta_T$ ,  $\eta_P$  e  $\eta_D$  degli elementi strutturali verticali. Per semplicità di consultazione il livello è espresso in unità  $1000 \cdot \eta_T/h$  da confrontare direttamente con il valore 2 o 4 per la verifica.

Per gli edifici sismicamente isolati si riportano di seguito le verifiche condotte sui dispositivi di isolamento. Le verifiche sono effettuate secondo la circolare n.7/2019 del C.S.LL.PP nelle combinazioni in SLC come previsto dal DM 17-01-2018. Per ogni combinazione è riportato il codice di verifica ed i valori utilizzati per la verifica: spostamento  $d_E$ , area ridotta e dimensione  $A_2$ , azione verticale, deformazioni di taglio dell'elastomero e tensioni nell'acciaio.

Qualora si applichi l'Ordinanza 3274 e s.m.i. le verifiche sono eseguite in accordo con l'allegato 10.A. In particolare la tabella, per ogni combinazione di calcolo, riporta:

<b>Nodo</b>	Nodo di appoggio dell' isolatore
<b>Cmb</b>	Combinazione oggetto della verifica
<b>Verif.</b>	Codice di verifica ok – verifica positiva , NV – verifica negativa, ND – verifica non completata
<b>dE</b>	Spostamento relativo tra le due facce (amplificato del 20% per Ordinanza 3274 e smi) combinato con la regola del 30%
<b>Ang fi</b>	Angolo utilizzato per il calcolo dell' area ridotta $A_r$ (per dispositivi circolari)
<b>V</b>	Azione verticale agente
<b>Ar</b>	Area ridotta efficace
<b>Dim A2</b>	Dimensione utile per il calcolo della deformazione per rotazione
<b>Sig s</b>	Tensione nell' inserto in acciaio
<b>Gam c(a,s,t)</b>	Deformazioni di taglio dell' elastomero
<b>Vcr</b>	Carico critico per instabilità

Affinché la verifica sia positiva deve essere:

- 1)  $V > 0$
- 2)  $\text{Sig } s < f_{yk}$
- 3)  $\text{Gam } t < 5$
- 4)  $\text{Gam } s < \text{Gam}^*$  (caratteristica dell' elastomero)
- 5)  $\text{Gam } s < 2$
- 6)  $V < 0.5 V_{cr}$

Con riferimento al **Documento di Affidabilità** "Test di validazione del software di calcolo PRO\_SAP e dei moduli aggiuntivi PRO\_SAP Modulo Geotecnico, PRO\_CAD nodi acciaio e PRO\_MST" - versione Maggio 2011, disponibile per il download sul sito [www.2si.it](http://www.2si.it), si segnalano i seguenti esempi applicativi:

Test N°	Titolo
23	DM 2008: SPETTRO
29	SISMICA 1000/H, SOMMA V, EFFETTO P- $\delta$
30	ANALISI DI UN EDIFICIO CON ISOLATORI SISMICI
70	MASSE SISMICHE
75	PROGETTO DI ISOLATORI ELASTOMERICI
76	VERIFICA DI ISOLATORI ELASTOMERICI
77	VERIFICA DI ISOLATORI FRICTION PENDULUM



**Calcolo dei fattori di comportamento secondo il D.M. 17/01/2018**

La costruzione, nuova, è caratterizzata da regolarità sia in pianta sia in altezza ed è progettata in classe di duttilità media (CD"B").

**Parametri fattore in direzione x e y**

Sistema costruttivo: calcestruzzo  
 Tipologia strutturale: strutture a telaio, a pareti accoppiate, miste  
 Definizione rapporto  $\alpha_w/\alpha_1$ : valore come da normativa  
 Riferimento normativo  $\alpha_w/\alpha_1$ : strutture a telaio di un piano  
 Valore rapporto  $\alpha_w/\alpha_1 = 1.100$   
 Valore base fattore  $q_0 = 3.000 \alpha_w/\alpha_1 = 3.300$   
 Fattore pareti  $K_w = 1.000$   
 Fattore di regolarità  $K_R = 1.0$   
 Fattore dissipativo  $q_D = q_0 \cdot K_w \cdot K_R = 3.300$

**Fattori di comportamento utilizzati**

Dissipativi

q SLU x 3.300  
 q SLU y 3.300  
 q SLU z 1.500

CDC	Tipo	Sigla Id	Note
6	Edk	CDC=Ed (dinamico SLU) alfa=0.0 (ecc. +)	
			categoria suolo: B
			fattore di sito S = 1.200
			ordinata spettro (tratto Tb-Tc) = 0.172 g
			angolo di ingresso:0.0
			eccentricità aggiuntiva: positiva
			periodo proprio T1: 0.195 sec.
			fattore q: 3.300
			fattore per spost. mu d: 7.125
			classe di duttilità CD: B
			numero di modi considerati: 9
			combinaz. modale: CQC

Quota	M Sismica x g	Pos. GX	Pos. GY	E agg. X-X	E agg. Y-Y	Pos. KX	Pos. KY	(r/Ls)^2	rapp. ex/rx	rapp. ey/ry
cm	daN	cm	cm	cm	cm	cm	cm			
300.00	1.417e+05	1704.20	314.99	0.0	-31.50	1666.93	314.99	1.345	0.032	0.0
Risulta	1.417e+05									

Modo	Frequenza	Periodo	Acc. Spettrale	M efficace X x g	%	M efficace Y x g	%	M efficace Z x g	%	Energia	Energia x v
	Hz	sec	g	daN		daN		daN			
1	4.554	0.220	0.172	1.18	8.30e-04	9.797e+04	69.1	1.98e-04	0.0	0.0	0.0
2	5.141	0.195	0.172	1.310e+05	92.4	5.99	4.23e-03	2.90e-03	2.04e-06	0.0	0.0
3	5.213	0.192	0.172	66.50	4.69e-02	4.295e+04	30.3	3.08e-04	0.0	0.0	0.0
4	5.976	0.167	0.174	8441.61	6.0	33.40	2.36e-02	5.73e-04	0.0	0.0	0.0
5	6.917	0.145	0.181	4.98	3.51e-03	711.38	0.5	8.11e-04	0.0	0.0	0.0
6	9.079	0.110	0.191	2140.61	1.5	0.02	1.66e-05	0.04	2.87e-05	0.0	0.0
7	10.468	0.096	0.195	5.26	3.71e-03	5.05e-03	3.56e-06	6232.65	4.4	0.0	0.0
8	11.256	0.089	0.197	13.56	9.57e-03	2.59e-03	1.83e-06	3147.00	2.2	0.0	0.0
9	33.289	0.030	0.214	0.02	1.29e-05	8.29e-04	0.0	1.310e+05	92.4	0.0	0.0
Risulta				1.417e+05		1.417e+05		1.404e+05			
In percentuale				99.97		99.95		99.06			

CDC	Tipo	Sigla Id	Note
7	Edk	CDC=Ed (dinamico SLU) alfa=0.0 (ecc. -)	
			categoria suolo: B
			fattore di sito S = 1.200
			ordinata spettro (tratto Tb-Tc) = 0.172 g
			angolo di ingresso:0.0
			eccentricità aggiuntiva: negativa
			periodo proprio T1: 0.195 sec.
			fattore q: 3.300
			fattore per spost. mu d: 7.121
			classe di duttilità CD: B
			numero di modi considerati: 9
			combinaz. modale: CQC

Quota	M Sismica x g	Pos. GX	Pos. GY	E agg. X-X	E agg. Y-Y	Pos. KX	Pos. KY	(r/Ls)^2	rapp. ex/rx	rapp. ey/ry
cm	daN	cm	cm	cm	cm	cm	cm			
300.00	1.417e+05	1704.20	314.99	0.0	31.50	1666.93	314.99	1.345	0.032	0.0
Risulta	1.417e+05									

Modo	Frequenza	Periodo	Acc. Spettrale	M efficace X x g	%	M efficace Y x g	%	M efficace Z x g	%	Energia	Energia x v
	Hz	sec	g	daN		daN		daN			
1	4.554	0.220	0.172	1.21	8.57e-04	9.797e+04	69.1	1.93e-04	0.0	0.0	0.0
2	5.138	0.195	0.172	1.307e+05	92.2	6.23	4.39e-03	2.82e-03	1.99e-06	0.0	0.0
3	5.213	0.192	0.172	68.54	4.84e-02	4.295e+04	30.3	3.99e-04	0.0	0.0	0.0
4	5.985	0.167	0.174	8759.29	6.2	33.84	2.39e-02	4.12e-04	0.0	0.0	0.0
5	6.917	0.145	0.181	6.77	4.77e-03	710.84	0.5	8.83e-04	0.0	0.0	0.0
6	9.061	0.110	0.191	2160.97	1.5	0.02	1.11e-05	0.01	8.65e-06	0.0	0.0
7	10.467	0.096	0.195	6.27	4.42e-03	4.37e-03	3.08e-06	6226.69	4.4	0.0	0.0
8	11.255	0.089	0.197	15.36	1.08e-02	1.98e-03	1.40e-06	3152.94	2.2	0.0	0.0
9	33.289	0.030	0.214	0.02	1.46e-05	8.06e-04	0.0	1.310e+05	92.4	0.0	0.0
Risulta				1.417e+05		1.417e+05		1.404e+05			
In percentuale				99.97		99.95		99.06			

CDC	Tipo	Sigla Id	Note
8	Edk	CDC=Ed (dinamico SLU) alfa=90.00 (ecc. +)	
			categoria suolo: B
			fattore di sito S = 1.200
			ordinata spettro (tratto Tb-Tc) = 0.172 g
			angolo di ingresso:90.00
			eccentricità aggiuntiva: positiva
			periodo proprio T1: 0.227 sec.
			fattore q: 3.300
			fattore per spost. mu d: 6.257
			classe di duttilità CD: B
			numero di modi considerati: 9
			combinaz. modale: CQC

Quota	M Sismica x g	Pos. GX	Pos. GY	E agg. X-X	E agg. Y-Y	Pos. KX	Pos. KY	(r/Ls)^2	rapp. ex/rx	rapp. ey/ry
cm	daN	cm	cm	cm	cm	cm	cm			
300.00	1.417e+05	1704.20	314.99	171.24	0.0	1666.93	314.99	1.345	0.032	0.0
Risulta	1.417e+05									

Modo	Frequenza	Periodo	Acc. Spettrale	M efficace X x g	%	M efficace Y x g	%	M efficace Z x g	%	Energia	Energia x v
	Hz	sec	g	daN		daN		daN			
1	4.412	0.227	0.172	5.13e-04	0.0	1.007e+05	71.1	2.07e-04	0.0	0.0	0.0
2	5.206	0.192	0.172	1.400e+05	98.7	0.04	2.91e-05	3.31e-03	2.33e-06	0.0	0.0
3	5.348	0.187	0.172	0.22	1.58e-04	3.327e+04	23.5	1.87e-04	0.0	0.0	0.0
4	6.436	0.155	0.178	0.14	9.68e-05	7672.30	5.4	3.96e-04	0.0	0.0	0.0
5	8.895	0.112	0.190	736.24	0.5	2.63	1.86e-03	0.05	3.59e-05	0.0	0.0
6	9.868	0.101	0.193	1010.05	0.7	0.89	6.24e-04	3.30e-04	0.0	0.0	0.0
7	10.448	0.096	0.195	6.43	4.53e-03	5.94e-05	0.0	6015.12	4.2	0.0	0.0
8	11.238	0.089	0.197	14.33	1.01e-02	3.13e-03	2.21e-06	3360.69	2.4	0.0	0.0
9	33.287	0.030	0.214	0.02	1.41e-05	5.48e-04	0.0	1.310e+05	92.4	0.0	0.0
Risulta				1.417e+05		1.417e+05		1.404e+05			
In percentuale				99.98		99.94		99.06			

CDC	Tipo	Sigla Id	Note
9	Edk	CDC=Ed (dinamico SLU) alfa=90.00 (ecc. -)	
			categoria suolo: B
			fattore di sito S = 1.200
			ordinata spettro (tratto Tb-Tc) = 0.172 g
			angolo di ingresso:90.00
			eccentricità aggiuntiva: negativa
			periodo proprio T1: 0.221 sec.
			fattore q: 3.300
			fattore per spost. mu d: 6.398
			classe di duttilità CD: B

CDC	Tipo	Sigla Id	Note
			numero di modi considerati: 9
			combinaz. modale: CQC

Quota	M Sismica x g	Pos. GX	Pos. GY	E agg. X-X	E agg. Y-Y	Pos. KX	Pos. KY	(r/Ls)^2	rapp. ex/rx	rapp. ey/ry
cm	daN	cm	cm	cm	cm	cm	cm			
300.00	1.417e+05	1704.20	314.99	-171.24	0.0	1666.93	314.99	1.345	0.032	0.0
Risulta	1.417e+05									

Modo	Frequenza	Periodo	Acc. Spettrale	M efficace X %	M efficace Y %	M efficace Z %	Energia	Energia x v			
	Hz	sec	g	x g	x g	x g					
				daN	daN	daN					
1	4.531	0.221	0.172	2.04e-03	1.44e-06	1.105e+05	78.0	2.49e-04	0.0	0.0	0.0
2	5.206	0.192	0.172	1.400e+05	98.7	0.01	7.49e-06	3.27e-03	2.31e-06	0.0	0.0
3	5.360	0.187	0.172	0.04	2.93e-05	2.519e+04	17.8	3.10e-04	0.0	0.0	0.0
4	6.362	0.157	0.177	0.05	3.34e-05	5929.72	4.2	1.40e-05	0.0	0.0	0.0
5	8.889	0.112	0.190	727.01	0.5	0.88	6.18e-04	0.06	3.91e-05	0.0	0.0
6	9.864	0.101	0.193	1020.51	0.7	0.35	2.47e-04	9.42e-03	6.64e-06	0.0	0.0
7	10.476	0.095	0.195	5.53	3.90e-03	0.01	8.95e-06	6222.35	4.4	0.0	0.0
8	11.233	0.089	0.197	14.07	9.92e-03	0.06	3.91e-05	3156.60	2.2	0.0	0.0
9	33.287	0.030	0.214	0.02	1.28e-05	5.64e-05	0.0	1.310e+05	92.4	0.0	0.0
Risulta				1.417e+05		1.417e+05		1.404e+05			
In percentuale				99.98		99.95		99.06			

CDC	Tipo	Sigla Id	Note
10	Edk	CDC=Ed (dinamico SLD) alfa=0.0 (ecc. +)	
			categoria suolo: B
			fattore di sito S = 1.200
			ordinata spettro (tratto Tb-Tc) = 0.242 g
			angolo di ingresso:0.0
			eccentricità aggiuntiva: positiva
			periodo proprio T1: 0.195 sec.
			numero di modi considerati: 9
			combinaz. modale: CQC

Quota	M Sismica x g	Pos. GX	Pos. GY	E agg. X-X	E agg. Y-Y	Pos. KX	Pos. KY	(r/Ls)^2	rapp. ex/rx	rapp. ey/ry
cm	daN	cm	cm	cm	cm	cm	cm			
300.00	1.417e+05	1704.20	314.99	0.0	-31.50	1666.93	314.99	1.345	0.032	0.0
Risulta	1.417e+05									

Modo	Frequenza	Periodo	Acc. Spettrale	M efficace X %	M efficace Y %	M efficace Z %	Energia	Energia x v			
	Hz	sec	g	x g	x g	x g					
				daN	daN	daN					
1	4.554	0.220	0.242	1.18	8.30e-04	9.797e+04	69.1	1.98e-04	0.0	0.0	0.0
2	5.141	0.195	0.242	1.310e+05	92.4	5.99	4.23e-03	2.90e-03	2.04e-06	0.0	0.0
3	5.213	0.192	0.242	66.50	4.69e-02	4.295e+04	30.3	3.08e-04	0.0	0.0	0.0
4	5.976	0.167	0.242	8441.61	6.0	33.40	2.36e-02	5.73e-04	0.0	0.0	0.0
5	6.917	0.145	0.232	4.98	3.51e-03	711.38	0.5	8.11e-04	0.0	0.0	0.0
6	9.079	0.110	0.199	2140.61	1.5	0.02	1.66e-05	0.04	2.87e-05	0.0	0.0
7	10.468	0.096	0.186	5.26	3.71e-03	5.05e-03	3.56e-06	6232.65	4.4	0.0	0.0
8	11.256	0.089	0.179	13.56	9.57e-03	2.59e-03	1.83e-06	3147.00	2.2	0.0	0.0
9	33.289	0.030	0.124	0.02	1.29e-05	8.29e-04	0.0	1.310e+05	92.4	0.0	0.0
Risulta				1.417e+05		1.417e+05		1.404e+05			
In percentuale				99.97		99.95		99.06			

CDC	Tipo	Sigla Id	Note
11	Edk	CDC=Ed (dinamico SLD) alfa=0.0 (ecc. -)	
			categoria suolo: B
			fattore di sito S = 1.200
			ordinata spettro (tratto Tb-Tc) = 0.242 g
			angolo di ingresso:0.0
			eccentricità aggiuntiva: negativa
			periodo proprio T1: 0.195 sec.
			numero di modi considerati: 9

CDC	Tipo	Sigla Id	Note
			combinaz. modale: CQC

Quota	M Sismica x g	Pos. GX	Pos. GY	E agg. X-X	E agg. Y-Y	Pos. KX	Pos. KY	(r/Ls)^2	rapp. ex/rx	rapp. ey/ry
cm	daN	cm	cm	cm	cm	cm	cm			
300.00	1.417e+05	1704.20	314.99	0.0	31.50	1666.93	314.99	1.345	0.032	0.0
Risulta	1.417e+05									

Modo	Frequenza	Periodo	Acc. Spettrale	M efficace X x g	%	M efficace Y x g	%	M efficace Z x g	%	Energia	Energia x v
	Hz	sec	g	daN		daN		daN			
1	4.554	0.220	0.242	1.21	8.57e-04	9.797e+04	69.1	1.93e-04	0.0	0.0	0.0
2	5.138	0.195	0.242	1.307e+05	92.2	6.23	4.39e-03	2.82e-03	1.99e-06	0.0	0.0
3	5.213	0.192	0.242	68.54	4.84e-02	4.295e+04	30.3	3.99e-04	0.0	0.0	0.0
4	5.985	0.167	0.242	8759.29	6.2	33.84	2.39e-02	4.12e-04	0.0	0.0	0.0
5	6.917	0.145	0.232	6.77	4.77e-03	710.84	0.5	8.83e-04	0.0	0.0	0.0
6	9.061	0.110	0.200	2160.97	1.5	0.02	1.11e-05	0.01	8.65e-06	0.0	0.0
7	10.467	0.096	0.186	6.27	4.42e-03	4.37e-03	3.08e-06	6226.69	4.4	0.0	0.0
8	11.255	0.089	0.179	15.36	1.08e-02	1.98e-03	1.40e-06	3152.94	2.2	0.0	0.0
9	33.289	0.030	0.124	0.02	1.46e-05	8.06e-04	0.0	1.310e+05	92.4	0.0	0.0
Risulta				1.417e+05		1.417e+05		1.404e+05			
In percentuale				99.97		99.95		99.06			

CDC	Tipo	Sigla Id	Note
12	Edk	CDC=Ed (dinamico SLD) alfa=90.00 (ecc. +)	
			categoria suolo: B
			fattore di sito S = 1.200
			ordinata spettro (tratto Tb-Tc) = 0.242 g
			angolo di ingresso:90.00
			eccentricità aggiuntiva: positiva
			periodo proprio T1: 0.227 sec.
			numero di modi considerati: 9
			combinaz. modale: CQC

Quota	M Sismica x g	Pos. GX	Pos. GY	E agg. X-X	E agg. Y-Y	Pos. KX	Pos. KY	(r/Ls)^2	rapp. ex/rx	rapp. ey/ry
cm	daN	cm	cm	cm	cm	cm	cm			
300.00	1.417e+05	1704.20	314.99	171.24	0.0	1666.93	314.99	1.345	0.032	0.0
Risulta	1.417e+05									

Modo	Frequenza	Periodo	Acc. Spettrale	M efficace X x g	%	M efficace Y x g	%	M efficace Z x g	%	Energia	Energia x v
	Hz	sec	g	daN		daN		daN			
1	4.412	0.227	0.242	5.13e-04	0.0	1.007e+05	71.1	2.07e-04	0.0	0.0	0.0
2	5.206	0.192	0.242	1.400e+05	98.7	0.04	2.91e-05	3.31e-03	2.33e-06	0.0	0.0
3	5.348	0.187	0.242	0.22	1.58e-04	3.327e+04	23.5	1.87e-04	0.0	0.0	0.0
4	6.436	0.155	0.242	0.14	9.68e-05	7672.30	5.4	3.96e-04	0.0	0.0	0.0
5	8.895	0.112	0.202	736.24	0.5	2.63	1.86e-03	0.05	3.59e-05	0.0	0.0
6	9.868	0.101	0.191	1010.05	0.7	0.89	6.24e-04	3.30e-04	0.0	0.0	0.0
7	10.448	0.096	0.186	6.43	4.53e-03	5.94e-05	0.0	6015.12	4.2	0.0	0.0
8	11.238	0.089	0.180	14.33	1.01e-02	3.13e-03	2.21e-06	3360.69	2.4	0.0	0.0
9	33.287	0.030	0.124	0.02	1.41e-05	5.48e-04	0.0	1.310e+05	92.4	0.0	0.0
Risulta				1.417e+05		1.417e+05		1.404e+05			
In percentuale				99.98		99.94		99.06			

CDC	Tipo	Sigla Id	Note
13	Edk	CDC=Ed (dinamico SLD) alfa=90.00 (ecc. -)	
			categoria suolo: B
			fattore di sito S = 1.200
			ordinata spettro (tratto Tb-Tc) = 0.242 g
			angolo di ingresso:90.00
			eccentricità aggiuntiva: negativa
			periodo proprio T1: 0.221 sec.
			numero di modi considerati: 9
			combinaz. modale: CQC



EGP CODE

GRE.EEC.R.73.IT.W.15235.12.024.01

PAGE

77 di/of 527

Quota	M Sismica x g	Pos. GX	Pos. GY	E agg. X-X	E agg. Y-Y	Pos. KX	Pos. KY	(r/Ls)^2	rapp. ex/rx	rapp. ey/ry
cm	daN	cm	cm	cm	cm	cm	cm			
300.00	1.417e+05	1704.20	314.99	-171.24	0.0	1666.93	314.99	1.345	0.032	0.0
Risulta	1.417e+05									

Modo	Frequenza	Periodo	Acc. Spettrale	M efficace X	%	M efficace Y	%	M efficace Z	%	Energia	Energia x v
	Hz	sec	g	x g		x g		x g			
				daN		daN		daN			
1	4.531	0.221	0.242	2.04e-03	1.44e-06	1.105e+05	78.0	2.49e-04	0.0	0.0	0.0
2	5.206	0.192	0.242	1.400e+05	98.7	0.01	7.49e-06	3.27e-03	2.31e-06	0.0	0.0
3	5.360	0.187	0.242	0.04	2.93e-05	2.519e+04	17.8	3.10e-04	0.0	0.0	0.0
4	6.362	0.157	0.242	0.05	3.34e-05	5929.72	4.2	1.40e-05	0.0	0.0	0.0
5	8.889	0.112	0.202	727.01	0.5	0.88	6.18e-04	0.06	3.91e-05	0.0	0.0
6	9.864	0.101	0.191	1020.51	0.7	0.35	2.47e-04	9.42e-03	6.64e-06	0.0	0.0
7	10.476	0.095	0.186	5.53	3.90e-03	0.01	8.95e-06	6222.35	4.4	0.0	0.0
8	11.233	0.089	0.180	14.07	9.92e-03	0.06	3.91e-05	3156.60	2.2	0.0	0.0
9	33.287	0.030	0.124	0.02	1.28e-05	5.64e-05	0.0	1.310e+05	92.4	0.0	0.0
Risulta				1.417e+05		1.417e+05		1.404e+05			
In percentuale				99.98		99.95		99.06			

Cmb etaT	Pilas. inter. h	1000 etaT/h		etaT	inter. h	Pilas.1000 etaT/h		etaT	inter. h	Pilas.1000		etaT/h
		cm	cm			cm	cm			cm	cm	
37	1	0.83	0.25	300.0	2	0.54	0.16	300.0	3	0.53	0.16	300.0
	4	0.54	0.16	300.0	5	0.55	0.16	300.0	6	0.56	0.17	300.0
	7	0.59	0.18	300.0	8	0.59	0.18	300.0	9	0.58	0.17	300.0
	10	0.59	0.18	300.0	11	0.63	0.19	300.0	12	0.83	0.25	300.0
	13	0.86	0.26	300.0	14	0.87	0.26	300.0	15	0.90	0.27	300.0
	16	0.94	0.28	300.0	17	0.94	0.28	300.0	18	0.91	0.27	300.0
38	19	0.92	0.28	300.0	20	0.94	0.28	300.0				
	1	0.84	0.25	300.0	2	0.64	0.19	300.0	3	0.61	0.18	300.0
	4	0.60	0.18	300.0	5	0.61	0.18	300.0	6	0.62	0.19	300.0
	7	0.70	0.21	300.0	8	0.76	0.23	300.0	9	0.68	0.21	300.0
	10	0.63	0.19	300.0	11	0.57	0.17	300.0	12	0.81	0.24	300.0
	13	0.81	0.24	300.0	14	0.81	0.24	300.0	15	0.82	0.25	300.0
39	16	0.85	0.25	300.0	17	0.88	0.26	300.0	18	0.85	0.25	300.0
	19	0.83	0.25	300.0	20	0.82	0.24	300.0				
	1	0.86	0.26	300.0	2	0.58	0.18	300.0	3	0.56	0.17	300.0
	4	0.55	0.17	300.0	5	0.56	0.17	300.0	6	0.56	0.17	300.0
	7	0.60	0.18	300.0	8	0.64	0.19	300.0	9	0.60	0.18	300.0
	10	0.57	0.17	300.0	11	0.57	0.17	300.0	12	0.85	0.25	300.0
40	13	0.84	0.25	300.0	14	0.85	0.26	300.0	15	0.86	0.26	300.0
	16	0.92	0.28	300.0	17	0.97	0.29	300.0	18	0.91	0.27	300.0
	19	0.87	0.26	300.0	20	0.85	0.25	300.0				
	1	0.82	0.25	300.0	2	0.53	0.16	300.0	3	0.55	0.17	300.0
	4	0.59	0.18	300.0	5	0.61	0.18	300.0	6	0.64	0.19	300.0
	7	0.70	0.21	300.0	8	0.70	0.21	300.0	9	0.66	0.20	300.0
41	10	0.67	0.20	300.0	11	0.71	0.21	300.0	12	0.82	0.24	300.0
	13	0.83	0.25	300.0	14	0.83	0.25	300.0	15	0.84	0.25	300.0
	16	0.87	0.26	300.0	17	0.87	0.26	300.0	18	0.86	0.26	300.0
	19	0.86	0.26	300.0	20	0.91	0.27	300.0				
	1	0.83	0.25	300.0	2	0.55	0.17	300.0	3	0.55	0.17	300.0
	4	0.58	0.17	300.0	5	0.60	0.18	300.0	6	0.62	0.19	300.0
42	7	0.60	0.18	300.0	8	0.56	0.17	300.0	9	0.55	0.17	300.0
	10	0.56	0.17	300.0	11	0.59	0.18	300.0	12	0.84	0.25	300.0
	13	0.89	0.27	300.0	14	0.91	0.27	300.0	15	0.94	0.28	300.0
	16	0.93	0.28	300.0	17	0.87	0.26	300.0	18	0.85	0.25	300.0
	19	0.86	0.26	300.0	20	0.88	0.26	300.0				
	1	0.88	0.26	300.0	2	0.68	0.20	300.0	3	0.66	0.20	300.0
43	4	0.64	0.19	300.0	5	0.66	0.20	300.0	6	0.68	0.20	300.0
	7	0.69	0.21	300.0	8	0.65	0.20	300.0	9	0.60	0.18	300.0
	10	0.57	0.17	300.0	11	0.54	0.16	300.0	12	0.84	0.25	300.0
	13	0.84	0.25	300.0	14	0.85	0.25	300.0	15	0.86	0.26	300.0
	16	0.86	0.26	300.0	17	0.85	0.25	300.0	18	0.83	0.25	300.0
	19	0.83	0.25	300.0	20	0.83	0.25	300.0				
43	1	0.91	0.27	300.0	2	0.61	0.18	300.0	3	0.58	0.18	300.0
	4	0.57	0.17	300.0	5	0.58	0.17	300.0	6	0.59	0.18	300.0
	7	0.59	0.18	300.0	8	0.57	0.17	300.0	9	0.55	0.17	300.0
	10	0.53	0.16	300.0	11	0.56	0.17	300.0	12	0.90	0.27	300.0



EGP CODE

GRE.EEC.R.73.IT.W.15235.12.024.01

PAGE

78 di/of 527

	13	0.89	0.27	300.0	14	0.90	0.27	300.0	15	0.92	0.28	300.0
	16	0.93	0.28	300.0	17	0.91	0.27	300.0	18	0.87	0.26	300.0
	19	0.84	0.25	300.0	20	0.85	0.25	300.0				
44	1	0.81	0.24	300.0	2	0.56	0.17	300.0	3	0.60	0.18	300.0
	4	0.65	0.20	300.0	5	0.69	0.21	300.0	6	0.72	0.22	300.0
	7	0.71	0.21	300.0	8	0.62	0.19	300.0	9	0.60	0.18	300.0
	10	0.61	0.18	300.0	11	0.66	0.20	300.0	12	0.81	0.24	300.0
	13	0.84	0.25	300.0	14	0.85	0.25	300.0	15	0.86	0.26	300.0
	16	0.86	0.26	300.0	17	0.83	0.25	300.0	18	0.82	0.25	300.0
	19	0.82	0.25	300.0	20	0.86	0.26	300.0				
45	1	0.64	0.19	300.0	2	0.84	0.25	300.0	3	0.81	0.24	300.0
	4	0.81	0.24	300.0	5	0.82	0.24	300.0	6	0.82	0.25	300.0
	7	0.85	0.26	300.0	8	0.88	0.26	300.0	9	0.85	0.25	300.0
	10	0.83	0.25	300.0	11	0.82	0.25	300.0	12	0.60	0.18	300.0
	13	0.59	0.18	300.0	14	0.60	0.18	300.0	15	0.62	0.19	300.0
	16	0.70	0.21	300.0	17	0.76	0.23	300.0	18	0.68	0.20	300.0
	19	0.63	0.19	300.0	20	0.57	0.17	300.0				
46	1	0.54	0.16	300.0	2	0.83	0.25	300.0	3	0.83	0.25	300.0
	4	0.86	0.26	300.0	5	0.88	0.26	300.0	6	0.90	0.27	300.0
	7	0.95	0.28	300.0	8	0.94	0.28	300.0	9	0.91	0.27	300.0
	10	0.92	0.28	300.0	11	0.94	0.28	300.0	12	0.52	0.16	300.0
	13	0.54	0.16	300.0	14	0.55	0.16	300.0	15	0.56	0.17	300.0
	16	0.59	0.18	300.0	17	0.59	0.18	300.0	18	0.57	0.17	300.0
	19	0.59	0.18	300.0	20	0.62	0.19	300.0				
47	1	0.53	0.16	300.0	2	0.82	0.25	300.0	3	0.82	0.25	300.0
	4	0.83	0.25	300.0	5	0.84	0.25	300.0	6	0.84	0.25	300.0
	7	0.87	0.26	300.0	8	0.87	0.26	300.0	9	0.86	0.26	300.0
	10	0.86	0.26	300.0	11	0.91	0.27	300.0	12	0.55	0.16	300.0
	13	0.59	0.18	300.0	14	0.61	0.18	300.0	15	0.64	0.19	300.0
	16	0.70	0.21	300.0	17	0.69	0.21	300.0	18	0.66	0.20	300.0
	19	0.67	0.20	300.0	20	0.71	0.21	300.0				
48	1	0.58	0.17	300.0	2	0.87	0.26	300.0	3	0.85	0.26	300.0
	4	0.84	0.25	300.0	5	0.85	0.26	300.0	6	0.86	0.26	300.0
	7	0.93	0.28	300.0	8	0.97	0.29	300.0	9	0.92	0.27	300.0
	10	0.87	0.26	300.0	11	0.85	0.26	300.0	12	0.56	0.17	300.0
	13	0.55	0.16	300.0	14	0.55	0.17	300.0	15	0.55	0.17	300.0
	16	0.60	0.18	300.0	17	0.64	0.19	300.0	18	0.60	0.18	300.0
	19	0.56	0.17	300.0	20	0.57	0.17	300.0				
49	1	0.68	0.20	300.0	2	0.88	0.26	300.0	3	0.85	0.25	300.0
	4	0.84	0.25	300.0	5	0.85	0.25	300.0	6	0.86	0.26	300.0
	7	0.86	0.26	300.0	8	0.85	0.25	300.0	9	0.83	0.25	300.0
	10	0.83	0.25	300.0	11	0.83	0.25	300.0	12	0.65	0.20	300.0
	13	0.64	0.19	300.0	14	0.65	0.20	300.0	15	0.68	0.20	300.0
	16	0.68	0.21	300.0	17	0.65	0.20	300.0	18	0.60	0.18	300.0
	19	0.57	0.17	300.0	20	0.54	0.16	300.0				
50	1	0.55	0.16	300.0	2	0.83	0.25	300.0	3	0.85	0.25	300.0
	4	0.89	0.27	300.0	5	0.91	0.27	300.0	6	0.95	0.28	300.0
	7	0.93	0.28	300.0	8	0.87	0.26	300.0	9	0.85	0.25	300.0
	10	0.86	0.26	300.0	11	0.88	0.26	300.0	12	0.55	0.16	300.0
	13	0.58	0.17	300.0	14	0.59	0.18	300.0	15	0.62	0.19	300.0
	16	0.60	0.18	300.0	17	0.55	0.17	300.0	18	0.55	0.16	300.0
	19	0.56	0.17	300.0	20	0.58	0.17	300.0				
51	1	0.55	0.17	300.0	2	0.81	0.24	300.0	3	0.82	0.25	300.0
	4	0.84	0.25	300.0	5	0.85	0.26	300.0	6	0.87	0.26	300.0
	7	0.86	0.26	300.0	8	0.83	0.25	300.0	9	0.82	0.25	300.0
	10	0.82	0.25	300.0	11	0.86	0.26	300.0	12	0.60	0.18	300.0
	13	0.65	0.20	300.0	14	0.68	0.20	300.0	15	0.72	0.22	300.0
	16	0.70	0.21	300.0	17	0.62	0.19	300.0	18	0.60	0.18	300.0
	19	0.61	0.18	300.0	20	0.65	0.20	300.0				
52	1	0.61	0.18	300.0	2	0.91	0.27	300.0	3	0.90	0.27	300.0
	4	0.89	0.27	300.0	5	0.91	0.27	300.0	6	0.92	0.28	300.0
	7	0.93	0.28	300.0	8	0.91	0.27	300.0	9	0.87	0.26	300.0
	10	0.84	0.25	300.0	11	0.85	0.25	300.0	12	0.58	0.17	300.0
	13	0.56	0.17	300.0	14	0.57	0.17	300.0	15	0.58	0.17	300.0
	16	0.58	0.18	300.0	17	0.57	0.17	300.0	18	0.55	0.16	300.0
	19	0.53	0.16	300.0	20	0.56	0.17	300.0				
53	1	0.51	0.15	300.0	2	0.35	0.11	300.0	3	0.42	0.13	300.0
	4	0.54	0.16	300.0	5	0.62	0.19	300.0	6	0.72	0.22	300.0
	7	1.06	0.32	300.0	8	1.19	0.36	300.0	9	0.97	0.29	300.0
	10	0.89	0.27	300.0	11	0.80	0.24	300.0	12	0.61	0.18	300.0
	13	0.74	0.22	300.0	14	0.82	0.25	300.0	15	0.94	0.28	300.0
	16	1.29	0.39	300.0	17	1.41	0.42	300.0	18	1.17	0.35	300.0
	19	1.08	0.32	300.0	20	0.96	0.29	300.0				
54	1	0.46	0.14	300.0	2	0.55	0.16	300.0	3	0.61	0.18	300.0
	4	0.71	0.21	300.0	5	0.79	0.24	300.0	6	0.90	0.27	300.0
	7	1.27	0.38	300.0	8	1.42	0.43	300.0	9	1.16	0.35	300.0





EGP CODE

GRE.EEC.R.73.IT.W.15235.12.024.01

PAGE

79 di/of 527

	10	1.03	0.31	300.0	11	0.85	0.26	300.0	12	0.48	0.14	300.0
	13	0.56	0.17	300.0	14	0.63	0.19	300.0	15	0.72	0.22	300.0
	16	1.07	0.32	300.0	17	1.23	0.37	300.0	18	1.00	0.30	300.0
	19	0.88	0.26	300.0	20	0.74	0.22	300.0				
55	1	0.56	0.17	300.0	2	0.44	0.13	300.0	3	0.47	0.14	300.0
	4	0.55	0.17	300.0	5	0.62	0.19	300.0	6	0.71	0.21	300.0
	7	1.06	0.32	300.0	8	1.22	0.37	300.0	9	0.99	0.30	300.0
	10	0.87	0.26	300.0	11	0.73	0.22	300.0	12	0.62	0.19	300.0
	13	0.72	0.22	300.0	14	0.80	0.24	300.0	15	0.91	0.27	300.0
	16	1.27	0.38	300.0	17	1.43	0.43	300.0	18	1.17	0.35	300.0
	19	1.04	0.31	300.0	20	0.86	0.26	300.0				
56	1	0.41	0.12	300.0	2	0.45	0.14	300.0	3	0.57	0.17	300.0
	4	0.71	0.21	300.0	5	0.79	0.24	300.0	6	0.91	0.27	300.0
	7	1.27	0.38	300.0	8	1.39	0.42	300.0	9	1.15	0.34	300.0
	10	1.05	0.32	300.0	11	0.93	0.28	300.0	12	0.48	0.14	300.0
	13	0.59	0.18	300.0	14	0.66	0.20	300.0	15	0.75	0.23	300.0
	16	1.08	0.33	300.0	17	1.21	0.36	300.0	18	1.00	0.30	300.0
	19	0.92	0.27	300.0	20	0.84	0.25	300.0				
57	1	0.55	0.17	300.0	2	0.46	0.14	300.0	3	0.48	0.14	300.0
	4	0.57	0.17	300.0	5	0.63	0.19	300.0	6	0.72	0.22	300.0
	7	1.07	0.32	300.0	8	1.23	0.37	300.0	9	1.00	0.30	300.0
	10	0.88	0.26	300.0	11	0.74	0.22	300.0	12	0.61	0.18	300.0
	13	0.71	0.21	300.0	14	0.79	0.24	300.0	15	0.90	0.27	300.0
	16	1.27	0.38	300.0	17	1.42	0.43	300.0	18	1.16	0.35	300.0
	19	1.03	0.31	300.0	20	0.85	0.26	300.0				
58	1	0.35	0.10	300.0	2	0.51	0.15	300.0	3	0.61	0.18	300.0
	4	0.74	0.22	300.0	5	0.82	0.25	300.0	6	0.94	0.28	300.0
	7	1.29	0.39	300.0	8	1.41	0.42	300.0	9	1.17	0.35	300.0
	10	1.08	0.32	300.0	11	0.96	0.29	300.0	12	0.42	0.12	300.0
	13	0.54	0.16	300.0	14	0.62	0.19	300.0	15	0.72	0.21	300.0
	16	1.06	0.32	300.0	17	1.19	0.36	300.0	18	0.97	0.29	300.0
	19	0.89	0.27	300.0	20	0.80	0.24	300.0				
59	1	0.45	0.14	300.0	2	0.41	0.12	300.0	3	0.48	0.14	300.0
	4	0.59	0.18	300.0	5	0.66	0.20	300.0	6	0.75	0.23	300.0
	7	1.08	0.33	300.0	8	1.22	0.36	300.0	9	1.00	0.30	300.0
	10	0.92	0.27	300.0	11	0.84	0.25	300.0	12	0.57	0.17	300.0
	13	0.71	0.21	300.0	14	0.79	0.24	300.0	15	0.91	0.27	300.0
	16	1.27	0.38	300.0	17	1.39	0.42	300.0	18	1.15	0.34	300.0
	19	1.05	0.32	300.0	20	0.93	0.28	300.0				
60	1	0.44	0.13	300.0	2	0.56	0.17	300.0	3	0.62	0.19	300.0
	4	0.72	0.22	300.0	5	0.80	0.24	300.0	6	0.90	0.27	300.0
	7	1.27	0.38	300.0	8	1.43	0.43	300.0	9	1.17	0.35	300.0
	10	1.04	0.31	300.0	11	0.86	0.26	300.0	12	0.47	0.14	300.0
	13	0.55	0.17	300.0	14	0.62	0.19	300.0	15	0.71	0.21	300.0
	16	1.06	0.32	300.0	17	1.22	0.37	300.0	18	0.99	0.30	300.0
	19	0.87	0.26	300.0	20	0.73	0.22	300.0				
61	1	0.76	0.23	300.0	2	0.63	0.19	300.0	3	0.77	0.23	300.0
	4	0.88	0.26	300.0	5	1.00	0.30	300.0	6	1.12	0.34	300.0
	7	1.05	0.32	300.0	8	0.72	0.21	300.0	9	0.54	0.16	300.0
	10	0.50	0.15	300.0	11	0.45	0.13	300.0	12	0.93	0.28	300.0
	13	1.05	0.32	300.0	14	1.18	0.35	300.0	15	1.32	0.40	300.0
	16	1.27	0.38	300.0	17	0.92	0.28	300.0	18	0.72	0.22	300.0
	19	0.67	0.20	300.0	20	0.59	0.18	300.0				
62	1	0.74	0.22	300.0	2	0.82	0.25	300.0	3	0.95	0.29	300.0
	4	1.03	0.31	300.0	5	1.16	0.35	300.0	6	1.29	0.39	300.0
	7	1.25	0.37	300.0	8	0.93	0.28	300.0	9	0.71	0.21	300.0
	10	0.62	0.19	300.0	11	0.48	0.14	300.0	12	0.82	0.25	300.0
	13	0.89	0.27	300.0	14	1.01	0.30	300.0	15	1.12	0.34	300.0
	16	1.06	0.32	300.0	17	0.76	0.23	300.0	18	0.58	0.17	300.0
	19	0.51	0.15	300.0	20	0.42	0.12	300.0				
63	1	0.85	0.25	300.0	2	0.71	0.21	300.0	3	0.80	0.24	300.0
	4	0.87	0.26	300.0	5	0.99	0.30	300.0	6	1.10	0.33	300.0
	7	1.04	0.31	300.0	8	0.73	0.22	300.0	9	0.54	0.16	300.0
	10	0.46	0.14	300.0	11	0.36	0.11	300.0	12	0.97	0.29	300.0
	13	1.05	0.32	300.0	14	1.18	0.35	300.0	15	1.31	0.39	300.0
	16	1.27	0.38	300.0	17	0.95	0.29	300.0	18	0.74	0.22	300.0
	19	0.66	0.20	300.0	20	0.53	0.16	300.0				
64	1	0.65	0.19	300.0	2	0.74	0.22	300.0	3	0.92	0.28	300.0
	4	1.04	0.31	300.0	5	1.17	0.35	300.0	6	1.31	0.39	300.0
	7	1.26	0.38	300.0	8	0.91	0.27	300.0	9	0.71	0.21	300.0
	10	0.66	0.20	300.0	11	0.57	0.17	300.0	12	0.78	0.24	300.0
	13	0.89	0.27	300.0	14	1.01	0.30	300.0	15	1.13	0.34	300.0
	16	1.06	0.32	300.0	17	0.73	0.22	300.0	18	0.56	0.17	300.0
	19	0.52	0.16	300.0	20	0.48	0.14	300.0				
65	1	0.82	0.25	300.0	2	0.74	0.22	300.0	3	0.82	0.25	300.0
	4	0.89	0.27	300.0	5	1.01	0.30	300.0	6	1.12	0.34	300.0

	7	1.06	0.32	300.0	8	0.76	0.23	300.0	9	0.58	0.18	300.0
	10	0.52	0.15	300.0	11	0.42	0.12	300.0	12	0.95	0.29	300.0
	13	1.03	0.31	300.0	14	1.16	0.35	300.0	15	1.29	0.39	300.0
	16	1.25	0.37	300.0	17	0.93	0.28	300.0	18	0.71	0.21	300.0
66	19	0.62	0.19	300.0	20	0.48	0.14	300.0				
	1	0.63	0.19	300.0	2	0.76	0.23	300.0	3	0.93	0.28	300.0
	4	1.05	0.32	300.0	5	1.18	0.35	300.0	6	1.32	0.40	300.0
	7	1.27	0.38	300.0	8	0.92	0.28	300.0	9	0.72	0.22	300.0
	10	0.67	0.20	300.0	11	0.59	0.18	300.0	12	0.77	0.23	300.0
	13	0.88	0.26	300.0	14	1.00	0.30	300.0	15	1.12	0.34	300.0
	16	1.05	0.32	300.0	17	0.72	0.21	300.0	18	0.54	0.16	300.0
	19	0.50	0.15	300.0	20	0.45	0.13	300.0				
67	1	0.74	0.22	300.0	2	0.65	0.19	300.0	3	0.79	0.24	300.0
	4	0.89	0.27	300.0	5	1.01	0.30	300.0	6	1.14	0.34	300.0
	7	1.06	0.32	300.0	8	0.73	0.22	300.0	9	0.56	0.17	300.0
	10	0.52	0.16	300.0	11	0.48	0.14	300.0	12	0.92	0.28	300.0
	13	1.04	0.31	300.0	14	1.17	0.35	300.0	15	1.32	0.39	300.0
	16	1.26	0.38	300.0	17	0.91	0.27	300.0	18	0.71	0.21	300.0
	19	0.66	0.20	300.0	20	0.57	0.17	300.0				
68	1	0.71	0.21	300.0	2	0.85	0.25	300.0	3	0.97	0.29	300.0
	4	1.05	0.32	300.0	5	1.18	0.35	300.0	6	1.31	0.39	300.0
	7	1.27	0.38	300.0	8	0.95	0.29	300.0	9	0.74	0.22	300.0
	10	0.66	0.20	300.0	11	0.53	0.16	300.0	12	0.80	0.24	300.0
	13	0.87	0.26	300.0	14	0.98	0.30	300.0	15	1.10	0.33	300.0
	16	1.04	0.31	300.0	17	0.73	0.22	300.0	18	0.54	0.16	300.0
	19	0.46	0.14	300.0	20	0.36	0.11	300.0				

Cmb

1000 etaT/h

1.43

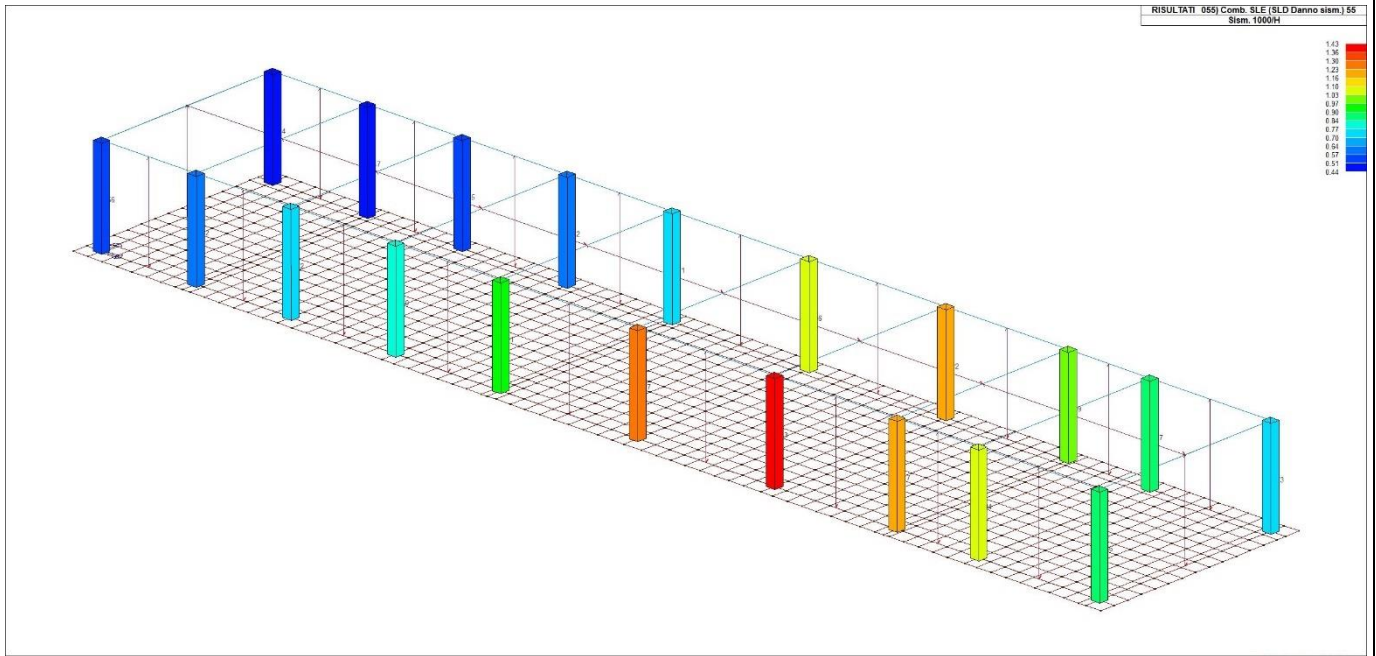

31\_RIS\_SLE\_055\_Comb. SLE (SLD Danno sism.) 55

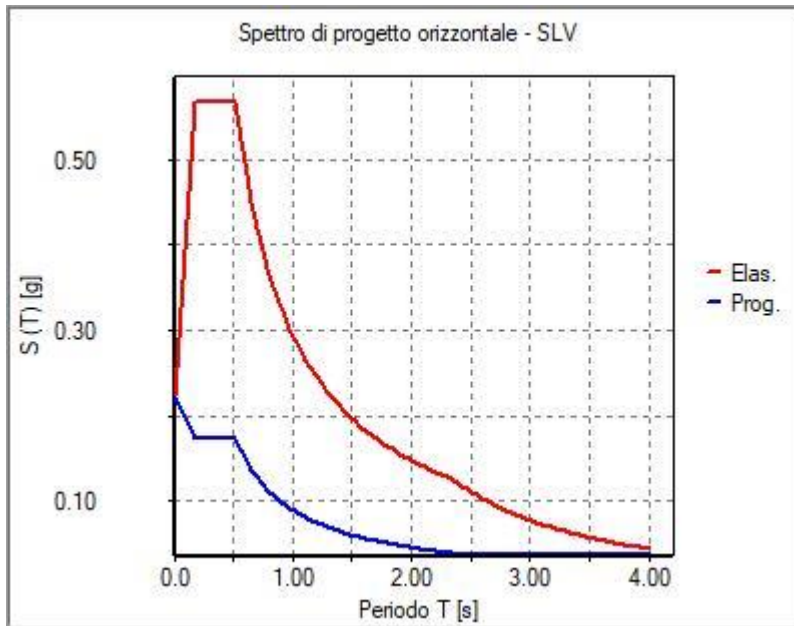

31\_RIS\_SPETTRI\_PROGETTO\_SLV\_O

## 14. RISULTATI NODALI

### 14.1. LEGENDA RISULTATI NODALI

Il controllo dei risultati delle analisi condotte, per quanto concerne i nodi strutturali, è possibile in relazione alle tabelle sottoriportate.

Una prima tabella riporta infatti per ogni nodo e per ogni combinazione (o caso di carico) gli spostamenti nodali.

Una seconda tabella riporta per ogni nodo a cui sia associato un vincolo rigido e/o elastico o una fondazione speciale e per ogni combinazione (o caso di carico) i valori delle azioni esercitate dalla struttura sui vincoli (reazioni vincolari cambiate di segno).

Una terza tabella, infine riassume per ogni nodo le sei combinazioni in cui si attingono i valori minimi e massimi della reazione Fz, della reazione Mx e della reazione My.

Nodo	Cmb	Traslazione X	Traslazione Y	Traslazione Z	Rotazione X	Rotazione Y	Rotazione Z
	cm	cm	cm				
1 2	-1.04e-03	-3.46e-03	-0.05	1.74e-04	-5.50e-05	1.88e-06	
1 8	-4.28e-03	-3.47e-03	-0.04	1.40e-04	-1.19e-04	-1.11e-06	
1 12	-4.15e-03	-3.88e-03	-0.04	1.50e-04	-1.20e-04	-1.14e-06	
1 36	-1.38e-03	-5.78e-03	-0.04	1.90e-04	-5.99e-05	2.38e-06	
1 40	-5.72e-03	-3.97e-03	-0.04	1.52e-04	-1.52e-04	-2.02e-06	
1 44	-5.54e-03	-4.55e-03	-0.04	1.66e-04	-1.53e-04	-2.04e-06	
1 68	-1.66e-03	-7.23e-03	-0.04	2.22e-04	-6.91e-05	2.90e-06	
1 70	-7.60e-04	-2.56e-03	-0.03	1.29e-04	-4.02e-05	1.40e-06	
1 72	-7.09e-04	-2.25e-03	-0.03	1.13e-04	-3.76e-05	1.18e-06	
1 73	-6.96e-04	-2.17e-03	-0.03	1.09e-04	-3.69e-05	1.12e-06	
2 2	7.65e-04	0.03	-0.05	-1.19e-03	5.13e-05	1.39e-06	
2 5	0.18	0.01	-0.03	-7.13e-04	2.87e-04	-9.69e-05	
2 12	-0.18	-7.76e-04	-0.04	-6.90e-04	-2.13e-04	1.06e-04	
2 33	0.03	0.18	-0.03	-9.71e-04	9.22e-05	6.99e-06	
2 37	0.25	0.01	-0.02	-7.11e-04	3.87e-04	-1.29e-04	
2 44	-0.25	-7.44e-03	-0.05	-6.78e-04	-3.13e-04	1.41e-04	
2 65	0.05	0.24	-0.03	-1.07e-03	1.14e-04	1.01e-05	
2 70	6.08e-04	0.02	-0.04	-8.90e-04	3.97e-05	1.02e-06	
2 72	5.11e-04	0.02	-0.04	-7.52e-04	3.72e-05	0.0	
2 73	4.86e-04	0.02	-0.04	-7.18e-04	3.65e-05	0.0	
3 2	-1.06e-03	3.51e-03	-0.05	-1.76e-04	-5.58e-05	-2.78e-06	
3 15	-4.40e-03	3.52e-03	-0.04	-1.43e-04	-1.24e-04	0.0	
3 19	-4.27e-03	3.92e-03	-0.04	-1.52e-04	-1.25e-04	0.0	
3 31	-1.43e-03	5.86e-03	-0.04	-1.93e-04	-6.21e-05	-4.41e-06	
3 47	-5.87e-03	4.02e-03	-0.04	-1.56e-04	-1.58e-04	0.0	
3 51	-5.70e-03	4.60e-03	-0.04	-1.69e-04	-1.60e-04	0.0	
3 63	-1.72e-03	7.32e-03	-0.04	-2.26e-04	-7.20e-05	-5.51e-06	
3 70	-7.82e-04	2.60e-03	-0.03	-1.31e-04	-4.09e-05	-2.11e-06	
3 72	-7.27e-04	2.28e-03	-0.03	-1.15e-04	-3.81e-05	-1.76e-06	
3 73	-7.13e-04	2.20e-03	-0.03	-1.11e-04	-3.75e-05	-1.67e-06	
4 2	7.68e-04	-0.02	-0.05	1.19e-03	5.15e-05	-1.74e-06	
4 14	0.18	-0.01	-0.03	7.12e-04	2.88e-04	9.29e-05	
4 19	-0.18	8.59e-04	-0.04	6.90e-04	-2.13e-04	-1.08e-04	
4 36	-0.06	-0.18	-0.03	9.99e-04	-3.40e-05	-9.95e-05	
4 46	0.25	-0.01	-0.02	7.10e-04	3.88e-04	1.23e-04	
4 51	-0.25	7.47e-03	-0.05	6.78e-04	-3.14e-04	-1.44e-04	
4 68	-0.08	-0.24	-0.03	1.11e-03	-6.24e-05	-1.36e-04	
4 70	6.10e-04	-0.02	-0.04	8.90e-04	3.99e-05	-1.30e-06	
4 72	5.12e-04	-0.02	-0.04	7.52e-04	3.73e-05	-1.02e-06	
4 73	4.87e-04	-0.01	-0.04	7.17e-04	3.66e-05	0.0	
5 2	1.05e-04	4.07e-03	-0.04	-2.10e-04	4.47e-06	0.0	
5 14	2.83e-03	2.44e-03	-0.03	-1.11e-04	4.76e-05	-2.11e-06	
5 31	-4.30e-04	5.82e-03	-0.03	-2.05e-04	-8.38e-06	0.0	
5 33	1.01e-03	5.82e-03	-0.03	-2.02e-04	1.40e-05	-1.23e-06	
5 46	3.94e-03	2.42e-03	-0.03	-1.04e-04	6.57e-05	-2.90e-06	
5 63	-6.25e-04	7.15e-03	-0.03	-2.35e-04	-1.27e-05	0.0	
5 65	1.39e-03	7.14e-03	-0.03	-2.31e-04	1.86e-05	-1.67e-06	
5 70	7.62e-05	2.98e-03	-0.03	-1.54e-04	3.41e-06	0.0	
5 72	6.32e-05	2.60e-03	-0.03	-1.34e-04	2.56e-06	0.0	
5 73	6.00e-05	2.51e-03	-0.03	-1.29e-04	2.35e-06	0.0	
6 1	-6.06e-04	-0.03	-0.05	1.31e-03	-1.37e-05	0.0	
6 2	-4.73e-04	-0.04	-0.05	1.73e-03	-1.15e-05	0.0	
6 15	-0.18	-1.56e-03	-0.03	9.70e-04	-1.07e-04	1.13e-04	



EGP CODE

GRE.EEC.R.73.IT.W.15235.12.024.01

PAGE

83 di/of 527

6 30	0.03	-0.21	-0.03	1.32e-03	1.18e-05	-9.64e-05
6 33	0.05	0.17	-0.04	6.70e-04	1.59e-05	5.76e-05
6 47	-0.25	6.13e-03	-0.03	9.56e-04	-1.47e-04	1.58e-04
6 62	0.05	-0.28	-0.03	1.45e-03	2.05e-05	-1.34e-04
6 65	0.08	0.24	-0.04	5.37e-04	2.63e-05	8.08e-05
6 69	-4.36e-04	-0.02	-0.03	1.00e-03	-1.01e-05	0.0
6 70	-3.47e-04	-0.03	-0.04	1.28e-03	-8.58e-06	0.0
6 71	-4.36e-04	-0.02	-0.03	1.00e-03	-1.01e-05	0.0
6 72	-4.18e-04	-0.02	-0.04	1.06e-03	-9.76e-06	0.0
6 73	-4.36e-04	-0.02	-0.03	1.00e-03	-1.01e-05	0.0
7 2	-6.47e-05	4.09e-03	-0.04	-2.14e-04	-3.62e-06	0.0
7 4	-6.60e-05	3.12e-03	-0.03	-1.64e-04	-3.10e-06	0.0
7 15	-2.66e-03	2.84e-03	-0.03	-1.44e-04	-4.22e-05	0.0
7 33	8.38e-04	5.64e-03	-0.03	-2.04e-04	7.35e-06	0.0
7 47	-3.72e-03	2.97e-03	-0.03	-1.49e-04	-5.81e-05	0.0
7 65	1.19e-03	6.89e-03	-0.03	-2.34e-04	1.13e-05	0.0
7 70	-5.30e-05	2.99e-03	-0.03	-1.57e-04	-2.80e-06	0.0
7 72	-4.30e-05	2.61e-03	-0.03	-1.37e-04	-2.48e-06	0.0
7 73	-4.05e-05	2.51e-03	-0.03	-1.31e-04	-2.39e-06	0.0
8 1	-7.82e-05	-0.03	-0.05	1.41e-03	1.15e-05	0.0
8 2	1.91e-05	-0.04	-0.05	1.88e-03	1.20e-05	0.0
8 15	-0.18	0.02	-0.04	1.01e-03	-1.11e-04	6.84e-05
8 32	-0.04	-0.23	-0.03	1.45e-03	-1.92e-05	-1.28e-04
8 33	0.06	0.18	-0.04	7.20e-04	4.84e-05	1.01e-04
8 47	-0.25	0.04	-0.04	9.78e-04	-1.59e-04	9.51e-05
8 64	-0.05	-0.31	-0.03	1.59e-03	-3.03e-05	-1.78e-04
8 65	0.08	0.26	-0.04	5.75e-04	6.44e-05	1.41e-04
8 69	-4.57e-05	-0.02	-0.03	1.08e-03	8.68e-06	0.0
8 70	1.92e-05	-0.03	-0.04	1.39e-03	9.00e-06	0.0
8 71	-4.57e-05	-0.02	-0.03	1.08e-03	8.68e-06	0.0
8 72	-3.27e-05	-0.02	-0.04	1.14e-03	8.74e-06	0.0
8 73	-4.57e-05	-0.02	-0.03	1.08e-03	8.68e-06	0.0
9 1	1.71e-05	3.44e-03	-0.04	-1.80e-04	1.08e-06	1.08e-06
9 2	1.55e-05	4.19e-03	-0.04	-2.20e-04	1.40e-06	1.45e-06
9 14	2.61e-03	2.01e-03	-0.03	-1.17e-04	4.30e-05	0.0
9 31	-5.28e-04	5.74e-03	-0.03	-2.14e-04	-9.15e-06	1.67e-06
9 35	-6.46e-04	5.72e-03	-0.03	-2.15e-04	-1.34e-05	1.71e-06
9 46	3.65e-03	1.79e-03	-0.03	-1.10e-04	5.99e-05	0.0
9 63	-7.43e-04	7.01e-03	-0.04	-2.46e-04	-1.31e-05	2.00e-06
9 67	-9.09e-04	6.99e-03	-0.04	-2.47e-04	-1.91e-05	2.07e-06
9 69	1.08e-05	2.56e-03	-0.03	-1.34e-04	0.0	0.0
9 70	9.67e-06	3.06e-03	-0.03	-1.61e-04	1.03e-06	1.08e-06
9 71	1.08e-05	2.56e-03	-0.03	-1.34e-04	0.0	0.0
9 72	1.05e-05	2.66e-03	-0.03	-1.39e-04	0.0	0.0
9 73	1.08e-05	2.56e-03	-0.03	-1.34e-04	0.0	0.0
10 1	-3.78e-04	-0.03	-0.05	1.49e-03	-4.73e-06	0.0
10 2	-2.67e-04	-0.04	-0.05	1.98e-03	-3.65e-06	0.0
1015	-0.18	0.02	-0.04	1.05e-03	-1.26e-04	7.16e-05
1034	0.05	-0.26	-0.03	1.55e-03	2.92e-05	-1.08e-04
1035	-0.05	0.21	-0.04	7.27e-04	-3.64e-05	1.08e-04
1047	-0.25	0.04	-0.04	1.02e-03	-1.75e-04	1.00e-04
1066	0.07	-0.35	-0.03	1.72e-03	4.23e-05	-1.51e-04
1067	-0.07	0.30	-0.04	5.61e-04	-4.96e-05	1.51e-04
1069	-2.76e-04	-0.02	-0.04	1.14e-03	-3.62e-06	0.0
1070	-2.02e-04	-0.03	-0.04	1.47e-03	-2.90e-06	0.0
1071	-2.76e-04	-0.02	-0.04	1.14e-03	-3.62e-06	0.0
1072	-2.61e-04	-0.03	-0.04	1.21e-03	-3.48e-06	0.0
1073	-2.76e-04	-0.02	-0.04	1.14e-03	-3.62e-06	0.0
11 2	-2.47e-04	4.55e-03	-0.05	-2.36e-04	-1.19e-05	-1.54e-06
1115	-2.74e-03	3.39e-03	-0.03	-1.59e-04	-5.38e-05	0.0
1129	5.89e-04	6.15e-03	-0.03	-2.40e-04	0.0	-2.80e-06
1133	6.93e-04	6.14e-03	-0.03	-2.40e-04	4.75e-06	-2.93e-06
1147	-3.77e-03	3.64e-03	-0.03	-1.66e-04	-7.23e-05	0.0
1161	8.86e-04	7.51e-03	-0.04	-2.79e-04	3.14e-06	-3.59e-06
1165	1.03e-03	7.50e-03	-0.04	-2.79e-04	9.69e-06	-3.76e-06
1170	-1.86e-04	3.33e-03	-0.03	-1.73e-04	-8.93e-06	-1.14e-06
1172	-1.62e-04	2.87e-03	-0.03	-1.49e-04	-7.82e-06	0.0
1173	-1.55e-04	2.76e-03	-0.03	-1.43e-04	-7.54e-06	0.0
12 2	4.95e-04	-0.05	-0.06	2.20e-03	3.31e-05	0.0
1214	0.18	-0.08	-0.04	1.36e-03	1.63e-04	-8.64e-05
1233	0.06	0.23	-0.04	8.01e-04	6.82e-05	2.09e-05
1234	0.05	-0.29	-0.03	1.72e-03	6.30e-05	-3.88e-05
1246	0.25	-0.11	-0.04	1.40e-03	2.19e-04	-1.21e-04
1265	0.08	0.34	-0.04	6.19e-04	8.60e-05	2.93e-05
1266	0.07	-0.39	-0.03	1.90e-03	7.87e-05	-5.39e-05
1270	3.79e-04	-0.03	-0.04	1.63e-03	2.52e-05	0.0



EGP CODE

GRE.EEC.R.73.IT.W.15235.12.024.01

PAGE

84 di/of 527

1272	3.10e-04	-0.03	-0.04	1.33e-03	2.42e-05	0.0
1273	2.92e-04	-0.03	-0.04	1.26e-03	2.39e-05	0.0
13 2	5.12e-05	4.49e-03	-0.05	-2.37e-04	2.62e-06	-1.83e-06
1314	2.57e-03	1.89e-03	-0.03	-1.20e-04	4.68e-05	0.0
1323	-8.70e-04	5.52e-03	-0.03	-2.24e-04	-6.94e-06	-1.83e-06
1325	5.11e-04	5.53e-03	-0.03	-2.25e-04	1.57e-05	-1.71e-06
1346	3.59e-03	1.56e-03	-0.03	-1.10e-04	6.50e-05	0.0
1355	-1.23e-03	6.65e-03	-0.04	-2.57e-04	-1.03e-05	-2.14e-06
1357	7.05e-04	6.66e-03	-0.04	-2.57e-04	2.14e-05	-1.98e-06
1370	3.86e-05	3.28e-03	-0.03	-1.74e-04	1.96e-06	-1.36e-06
1372	3.11e-05	2.83e-03	-0.03	-1.49e-04	1.61e-06	-1.11e-06
1373	2.92e-05	2.71e-03	-0.03	-1.43e-04	1.52e-06	-1.05e-06
14 1	-3.36e-04	-0.04	-0.05	1.78e-03	-4.08e-06	0.0
14 2	-2.37e-04	-0.05	-0.06	2.41e-03	-3.88e-06	0.0
1415	-0.18	0.05	-0.04	1.23e-03	-1.65e-04	7.21e-05
1423	-0.04	0.22	-0.04	9.26e-04	-3.72e-05	1.58e-04
1424	-0.03	-0.28	-0.03	1.80e-03	-3.33e-05	-1.72e-04
1447	-0.25	0.08	-0.04	1.18e-03	-2.30e-04	1.01e-04
1455	-0.06	0.32	-0.04	7.50e-04	-5.07e-05	2.21e-04
1456	-0.04	-0.38	-0.03	1.98e-03	-4.53e-05	-2.40e-04
1469	-2.50e-04	-0.03	-0.04	1.37e-03	-3.14e-06	0.0
1470	-1.84e-04	-0.04	-0.04	1.78e-03	-3.00e-06	0.0
1471	-2.50e-04	-0.03	-0.04	1.37e-03	-3.14e-06	0.0
1472	-2.37e-04	-0.03	-0.04	1.45e-03	-3.11e-06	0.0
1473	-2.50e-04	-0.03	-0.04	1.37e-03	-3.14e-06	0.0
15 2	-1.93e-05	4.39e-03	-0.05	-2.32e-04	0.0	1.83e-06
1520	-2.58e-03	2.07e-03	-0.03	-1.25e-04	-4.41e-05	0.0
1523	-8.23e-04	5.95e-03	-0.04	-2.34e-04	-9.40e-06	2.53e-06
1552	-3.60e-03	1.83e-03	-0.03	-1.19e-04	-6.20e-05	0.0
1555	-1.15e-03	7.26e-03	-0.04	-2.71e-04	-1.34e-05	3.12e-06
1570	-1.27e-05	3.21e-03	-0.03	-1.70e-04	0.0	1.36e-06
1572	-1.11e-05	2.77e-03	-0.03	-1.46e-04	0.0	1.12e-06
1573	-1.06e-05	2.66e-03	-0.03	-1.40e-04	0.0	1.06e-06
16 1	-4.17e-04	-0.04	-0.05	1.71e-03	-8.28e-06	0.0
16 2	-3.43e-04	-0.05	-0.06	2.30e-03	-9.49e-06	0.0
1615	-0.18	0.05	-0.04	1.18e-03	-1.60e-04	2.32e-05
1623	-0.04	0.26	-0.04	8.10e-04	-4.05e-05	-3.86e-05
1628	-0.05	-0.31	-0.03	1.81e-03	-4.81e-05	4.02e-05
1647	-0.25	0.08	-0.04	1.12e-03	-2.21e-04	3.22e-05
1655	-0.06	0.37	-0.04	6.11e-04	-5.40e-05	-5.42e-05
1660	-0.07	-0.42	-0.03	2.01e-03	-6.49e-05	5.61e-05
1669	-3.16e-04	-0.03	-0.04	1.31e-03	-6.37e-06	0.0
1670	-2.67e-04	-0.04	-0.04	1.70e-03	-7.18e-06	0.0
1671	-3.16e-04	-0.03	-0.04	1.31e-03	-6.37e-06	0.0
1672	-3.06e-04	-0.03	-0.04	1.39e-03	-6.54e-06	0.0
1673	-3.16e-04	-0.03	-0.04	1.31e-03	-6.37e-06	0.0
17 2	3.80e-04	4.42e-03	-0.05	-2.28e-04	2.07e-05	1.32e-06
1717	2.85e-03	3.07e-03	-0.03	-1.51e-04	5.74e-05	0.0
1727	-5.82e-04	6.20e-03	-0.03	-2.30e-04	2.68e-06	2.55e-06
1749	3.89e-03	3.21e-03	-0.03	-1.56e-04	7.52e-05	0.0
1759	-9.10e-04	7.60e-03	-0.04	-2.66e-04	-1.48e-06	3.27e-06
1770	2.89e-04	3.23e-03	-0.03	-1.67e-04	1.56e-05	0.0
1772	2.48e-04	2.80e-03	-0.03	-1.44e-04	1.36e-05	0.0
1773	2.38e-04	2.70e-03	-0.03	-1.39e-04	1.31e-05	0.0
18 1	-9.93e-04	-0.03	-0.05	1.47e-03	-3.76e-05	0.0
18 2	-9.21e-04	-0.04	-0.05	1.95e-03	-3.92e-05	0.0
1815	-0.18	0.04	-0.04	1.01e-03	-1.50e-04	1.23e-05
1827	-0.06	0.20	-0.04	7.18e-04	-6.97e-05	-1.02e-04
1828	-0.05	-0.25	-0.03	1.53e-03	-5.94e-05	1.30e-04
1847	-0.25	0.07	-0.04	9.61e-04	-1.98e-04	1.65e-05
1859	-0.08	0.30	-0.04	5.56e-04	-8.62e-05	-1.43e-04
1860	-0.07	-0.35	-0.03	1.70e-03	-7.17e-05	1.82e-04
1869	-7.59e-04	-0.02	-0.04	1.12e-03	-2.88e-05	0.0
1870	-7.11e-04	-0.03	-0.04	1.45e-03	-2.98e-05	0.0
1871	-7.59e-04	-0.02	-0.04	1.12e-03	-2.88e-05	0.0
1872	-7.50e-04	-0.02	-0.04	1.19e-03	-2.90e-05	0.0
1873	-7.59e-04	-0.02	-0.04	1.12e-03	-2.88e-05	0.0
19 2	-6.14e-04	4.13e-03	-0.04	-2.15e-04	-2.86e-05	0.0
1919	-3.05e-03	3.36e-03	-0.03	-1.42e-04	-6.15e-05	0.0
1921	3.10e-05	5.86e-03	-0.03	-2.08e-04	-1.46e-05	1.10e-06
1925	1.85e-04	5.66e-03	-0.03	-2.08e-04	-1.04e-05	1.05e-06
1951	-4.11e-03	3.68e-03	-0.03	-1.46e-04	-7.90e-05	0.0
1953	1.96e-04	7.19e-03	-0.04	-2.38e-04	-1.33e-05	1.51e-06
1957	4.12e-04	6.91e-03	-0.04	-2.38e-04	-7.38e-06	1.44e-06
1970	-4.55e-04	3.02e-03	-0.03	-1.58e-04	-2.14e-05	0.0
1972	-3.98e-04	2.64e-03	-0.03	-1.37e-04	-1.85e-05	0.0





EGP CODE

GRE.EEC.R.73.IT.W.15235.12.024.01

PAGE

85 di/of 527

1973	-3.83e-04	2.54e-03	-0.03	-1.32e-04	-1.78e-05	0.0
20 2	8.84e-04	-0.04	-0.05	1.85e-03	5.01e-05	0.0
2014	0.18	-0.09	-0.03	1.20e-03	1.36e-04	-5.56e-05
2024	-0.03	-0.23	-0.03	1.43e-03	1.50e-05	-1.15e-04
2025	0.05	0.18	-0.04	7.10e-04	7.19e-05	-1.24e-04
2046	0.25	-0.12	-0.03	1.25e-03	1.75e-04	-7.77e-05
2056	-0.04	-0.31	-0.03	1.58e-03	5.71e-06	1.60e-04
2057	0.07	0.26	-0.04	5.65e-04	8.54e-05	-1.73e-04
2070	6.62e-04	-0.03	-0.04	1.38e-03	3.82e-05	0.0
2072	6.07e-04	-0.02	-0.04	1.13e-03	3.83e-05	0.0
2073	5.94e-04	-0.02	-0.04	1.07e-03	3.83e-05	0.0
21 2	1.67e-03	3.75e-03	-0.05	-1.87e-04	8.74e-05	0.0
2113	4.55e-03	4.10e-03	-0.04	-1.59e-04	1.43e-04	-1.21e-06
2117	4.62e-03	3.60e-03	-0.04	-1.47e-04	1.41e-04	-1.05e-06
2121	1.94e-03	6.26e-03	-0.04	-2.09e-04	8.49e-05	0.0
2145	5.93e-03	4.80e-03	-0.04	-1.76e-04	1.77e-04	-1.87e-06
2149	6.03e-03	4.08e-03	-0.04	-1.59e-04	1.75e-04	-1.65e-06
2153	2.28e-03	7.83e-03	-0.04	-2.46e-04	9.60e-05	1.01e-06
2170	1.24e-03	2.78e-03	-0.04	-1.39e-04	6.45e-05	0.0
2172	1.12e-03	2.42e-03	-0.03	-1.21e-04	5.84e-05	0.0
2173	1.09e-03	2.33e-03	-0.03	-1.16e-04	5.69e-05	0.0
22 1	-2.23e-03	-0.02	-0.05	1.05e-03	-1.00e-04	0.0
22 2	-2.20e-03	-0.03	-0.05	1.36e-03	-1.05e-04	1.00e-06
2213	0.18	5.24e-03	-0.04	7.70e-04	2.10e-04	1.55e-04
2215	-0.18	0.07	-0.03	6.65e-04	-3.69e-04	-1.83e-04
2226	0.06	-0.20	-0.03	1.13e-03	1.67e-05	9.93e-05
2245	0.25	0.01	-0.05	7.54e-04	3.25e-04	2.06e-04
2247	-0.26	0.10	-0.03	6.08e-04	-4.87e-04	-2.45e-04
2256	-0.05	-0.28	-0.03	1.22e-03	-1.53e-04	-3.85e-05
2269	-1.73e-03	-0.02	-0.04	8.08e-04	-7.75e-05	0.0
2270	-1.70e-03	-0.02	-0.04	1.02e-03	-8.04e-05	0.0
2271	-1.73e-03	-0.02	-0.04	8.08e-04	-7.75e-05	0.0
2272	-1.72e-03	-0.02	-0.04	8.50e-04	-7.81e-05	0.0
2273	-1.73e-03	-0.02	-0.04	8.08e-04	-7.75e-05	0.0
23 2	9.07e-05	-4.09e-03	-0.04	2.09e-04	4.26e-06	0.0
23 5	2.78e-03	-2.45e-03	-0.03	1.10e-04	4.47e-05	3.58e-06
2330	9.87e-04	-5.85e-03	-0.03	2.01e-04	1.32e-05	1.70e-06
2336	-4.25e-04	-5.85e-03	-0.03	2.04e-04	-7.78e-06	0.0
2337	3.87e-03	-2.43e-03	-0.03	1.03e-04	6.17e-05	4.92e-06
2362	1.36e-03	-7.18e-03	-0.03	2.30e-04	1.76e-05	2.28e-06
2368	-6.15e-04	-7.18e-03	-0.03	2.34e-04	-1.18e-05	0.0
2370	6.58e-05	-2.99e-03	-0.03	1.53e-04	3.26e-06	0.0
2372	5.41e-05	-2.62e-03	-0.03	1.34e-04	2.43e-06	0.0
2373	5.12e-05	-2.52e-03	-0.03	1.29e-04	2.22e-06	0.0
24 1	-6.05e-04	0.03	-0.05	-1.31e-03	-1.37e-05	0.0
24 2	-4.72e-04	0.04	-0.05	-1.73e-03	-1.15e-05	0.0
24 8	-0.18	1.89e-03	-0.03	-9.70e-04	-1.07e-04	-1.13e-04
2430	0.05	-0.17	-0.04	-6.70e-04	1.56e-05	-5.83e-05
2431	-0.06	0.21	-0.03	-1.34e-03	-3.57e-05	5.90e-05
2440	-0.25	-5.71e-03	-0.03	-9.57e-04	-1.46e-04	-1.58e-04
2462	0.08	-0.24	-0.04	-5.37e-04	2.59e-05	-8.18e-05
2463	-0.08	0.28	-0.03	-1.47e-03	-4.60e-05	8.25e-05
2469	-4.35e-04	0.02	-0.03	-1.00e-03	-1.00e-05	0.0
2470	-3.46e-04	0.03	-0.04	-1.28e-03	-8.56e-06	0.0
2471	-4.35e-04	0.02	-0.03	-1.00e-03	-1.00e-05	0.0
2472	-4.17e-04	0.02	-0.04	-1.06e-03	-9.74e-06	0.0
2473	-4.35e-04	0.02	-0.03	-1.00e-03	-1.00e-05	0.0
25 2	-6.59e-05	-4.08e-03	-0.04	2.13e-04	-3.46e-06	0.0
25 4	-6.68e-05	-3.11e-03	-0.03	1.63e-04	-2.96e-06	0.0
25 8	-2.60e-03	-2.83e-03	-0.03	1.43e-04	-3.92e-05	-1.74e-06
2530	8.18e-04	-5.62e-03	-0.03	2.03e-04	6.72e-06	1.10e-06
2540	-3.62e-03	-2.96e-03	-0.03	1.48e-04	-5.39e-05	-2.44e-06
2562	1.16e-03	-6.88e-03	-0.03	2.32e-04	1.03e-05	1.54e-06
2570	-5.38e-05	-2.98e-03	-0.03	1.56e-04	-2.68e-06	0.0
2572	-4.35e-05	-2.60e-03	-0.03	1.36e-04	-2.37e-06	0.0
2573	-4.09e-05	-2.50e-03	-0.03	1.31e-04	-2.29e-06	0.0
26 1	-7.84e-05	0.03	-0.05	-1.41e-03	1.14e-05	0.0
26 2	1.87e-05	0.04	-0.05	-1.88e-03	1.19e-05	0.0
26 8	-0.18	-0.02	-0.04	-1.01e-03	-1.11e-04	-6.77e-05
2629	0.05	0.23	-0.03	-1.45e-03	4.00e-05	1.25e-04
2630	0.06	-0.18	-0.04	-7.20e-04	4.85e-05	-1.00e-04
2640	-0.25	-0.04	-0.04	-9.78e-04	-1.59e-04	-9.41e-05
2661	0.07	0.31	-0.03	-1.59e-03	5.25e-05	1.75e-04
2662	0.08	-0.26	-0.04	-5.75e-04	6.45e-05	-1.41e-04
2669	-4.54e-05	0.02	-0.03	-1.08e-03	8.65e-06	0.0
2670	1.93e-05	0.03	-0.04	-1.39e-03	8.97e-06	0.0



EGP CODE

GRE.EEC.R.73.IT.W.15235.12.024.01

PAGE

86 di/of 527

2671	-4.54e-05	0.02	-0.03	-1.08e-03	8.65e-06	0.0
2672	-3.25e-05	0.02	-0.04	-1.14e-03	8.71e-06	0.0
2673	-4.54e-05	0.02	-0.03	-1.08e-03	8.65e-06	0.0
27 1	1.39e-05	-3.43e-03	-0.04	1.79e-04	0.0	-1.03e-06
27 2	1.13e-05	-4.18e-03	-0.04	2.18e-04	1.28e-06	-1.38e-06
27 5	2.54e-03	-1.96e-03	-0.03	1.16e-04	4.00e-05	0.0
2732	-6.30e-04	-5.72e-03	-0.03	2.13e-04	-1.24e-05	-1.99e-06
2736	-5.16e-04	-5.72e-03	-0.03	2.13e-04	-8.38e-06	-1.80e-06
2737	3.55e-03	-1.72e-03	-0.03	1.09e-04	5.57e-05	1.51e-06
2764	-8.86e-04	-6.99e-03	-0.04	2.45e-04	-1.76e-05	-2.47e-06
2768	-7.25e-04	-6.99e-03	-0.04	2.45e-04	-1.20e-05	-2.20e-06
2769	8.33e-06	-2.56e-03	-0.03	1.33e-04	0.0	0.0
2770	6.60e-06	-3.05e-03	-0.03	1.60e-04	0.0	-1.03e-06
2771	8.33e-06	-2.56e-03	-0.03	1.33e-04	0.0	0.0
2772	7.98e-06	-2.66e-03	-0.03	1.38e-04	0.0	0.0
2773	8.33e-06	-2.56e-03	-0.03	1.33e-04	0.0	0.0
28 1	-3.77e-04	0.03	-0.05	-1.49e-03	-4.71e-06	0.0
28 2	-2.66e-04	0.04	-0.05	-1.98e-03	-3.62e-06	0.0
28 8	-0.18	-0.02	-0.04	-1.06e-03	-1.25e-04	-7.11e-05
2832	-0.05	-0.21	-0.04	-7.27e-04	-3.63e-05	-1.08e-04
2835	-0.04	0.26	-0.03	-1.55e-03	-3.15e-05	1.08e-04
2840	-0.25	-0.04	-0.04	-1.02e-03	-1.74e-04	-9.93e-05
2864	-0.07	-0.30	-0.04	-5.62e-04	-4.94e-05	-1.51e-04
2867	-0.05	0.35	-0.03	-1.72e-03	-4.26e-05	1.50e-04
2869	-2.75e-04	0.02	-0.04	-1.14e-03	-3.60e-06	0.0
2870	-2.01e-04	0.03	-0.04	-1.47e-03	-2.88e-06	0.0
2871	-2.75e-04	0.02	-0.04	-1.14e-03	-3.60e-06	0.0
2872	-2.60e-04	0.03	-0.04	-1.21e-03	-3.46e-06	0.0
2873	-2.75e-04	0.02	-0.04	-1.14e-03	-3.60e-06	0.0
29 2	-2.39e-04	-4.59e-03	-0.05	2.35e-04	-1.17e-05	1.09e-06
29 8	-2.69e-03	-3.41e-03	-0.03	1.59e-04	-5.09e-05	-1.40e-06
2930	6.92e-04	-6.19e-03	-0.03	2.39e-04	4.24e-06	2.87e-06
2934	5.90e-04	-6.20e-03	-0.03	2.39e-04	0.0	2.59e-06
2940	-3.70e-03	-3.66e-03	-0.03	1.66e-04	-6.84e-05	-2.19e-06
2962	1.03e-03	-7.56e-03	-0.04	2.78e-04	8.92e-06	3.78e-06
2966	8.87e-04	-7.56e-03	-0.04	2.78e-04	2.72e-06	3.40e-06
2970	-1.80e-04	-3.36e-03	-0.03	1.72e-04	-8.80e-06	0.0
2972	-1.57e-04	-2.90e-03	-0.03	1.48e-04	-7.70e-06	0.0
2973	-1.51e-04	-2.78e-03	-0.03	1.43e-04	-7.43e-06	0.0
30 2	4.94e-04	0.05	-0.06	-2.20e-03	3.30e-05	0.0
30 5	0.18	0.08	-0.04	-1.36e-03	1.63e-04	8.57e-05
3030	0.06	-0.23	-0.04	-8.01e-04	6.81e-05	-2.12e-05
3035	-0.04	0.29	-0.03	-1.72e-03	-6.09e-06	3.88e-05
3037	0.25	0.11	-0.04	-1.40e-03	2.19e-04	1.20e-04
3062	0.08	-0.34	-0.04	-6.19e-04	8.57e-05	-2.96e-05
3067	-0.05	0.39	-0.03	-1.90e-03	-1.80e-05	5.40e-05
3070	3.79e-04	0.03	-0.04	-1.63e-03	2.52e-05	0.0
3072	3.09e-04	0.03	-0.04	-1.33e-03	2.42e-05	0.0
3073	2.92e-04	0.03	-0.04	-1.26e-03	2.39e-05	0.0
31 2	5.03e-05	-4.48e-03	-0.05	2.36e-04	2.64e-06	1.82e-06
3110	2.50e-03	-3.57e-03	-0.03	1.67e-04	4.42e-05	2.59e-06
3122	4.88e-04	-5.53e-03	-0.03	2.23e-04	1.48e-05	2.04e-06
3128	-8.56e-04	-5.51e-03	-0.03	2.23e-04	-6.32e-06	1.54e-06
3142	3.49e-03	-3.92e-03	-0.03	1.77e-04	6.13e-05	3.22e-06
3154	6.72e-04	-6.66e-03	-0.04	2.56e-04	2.01e-05	2.43e-06
3160	-1.21e-03	-6.64e-03	-0.04	2.55e-04	-9.45e-06	1.74e-06
3170	3.79e-05	-3.28e-03	-0.03	1.73e-04	1.97e-06	1.35e-06
3172	3.05e-05	-2.82e-03	-0.03	1.48e-04	1.62e-06	1.11e-06
3173	2.87e-05	-2.71e-03	-0.03	1.42e-04	1.54e-06	1.05e-06
32 1	-3.37e-04	0.04	-0.05	-1.78e-03	-4.10e-06	0.0
32 2	-2.38e-04	0.05	-0.06	-2.41e-03	-3.90e-06	0.0
32 8	-0.18	-0.05	-0.04	-1.23e-03	-1.65e-04	-7.15e-05
3221	0.06	0.28	-0.03	-1.81e-03	4.77e-05	1.72e-04
3228	-0.04	-0.22	-0.04	-9.26e-04	-3.76e-05	-1.58e-04
3240	-0.25	-0.08	-0.04	-1.18e-03	-2.30e-04	-1.00e-04
3253	0.08	0.38	-0.03	-1.98e-03	6.80e-05	2.40e-04
3260	-0.06	-0.32	-0.04	-7.50e-04	-5.12e-05	-2.21e-04
3269	-2.51e-04	0.03	-0.04	-1.37e-03	-3.15e-06	0.0
3270	-1.85e-04	0.04	-0.04	-1.78e-03	-3.02e-06	0.0
3271	-2.51e-04	0.03	-0.04	-1.37e-03	-3.15e-06	0.0
3272	-2.37e-04	0.03	-0.04	-1.45e-03	-3.12e-06	0.0
3273	-2.51e-04	0.03	-0.04	-1.37e-03	-3.15e-06	0.0
33 2	-2.12e-05	-4.39e-03	-0.05	2.31e-04	0.0	-1.73e-06
3311	-2.51e-03	-2.07e-03	-0.03	1.25e-04	-4.08e-05	-1.76e-06
3328	-8.11e-04	-5.94e-03	-0.03	2.32e-04	-8.90e-06	-2.68e-06
3343	-3.51e-03	-1.83e-03	-0.03	1.18e-04	-5.74e-05	-2.06e-06



EGP CODE

GRE.EEC.R.73.IT.W.15235.12.024.01

PAGE

87 di/of 527

3360	-1.13e-03	-7.25e-03	-0.04	2.70e-04	-1.26e-05	-3.35e-06
3370	-1.42e-05	-3.21e-03	-0.03	1.69e-04	0.0	-1.29e-06
3372	-1.23e-05	-2.77e-03	-0.03	1.45e-04	0.0	-1.06e-06
3373	-1.18e-05	-2.66e-03	-0.03	1.40e-04	0.0	-1.00e-06
34 1	-4.17e-04	0.04	-0.05	-1.71e-03	-8.25e-06	0.0
34 2	-3.43e-04	0.05	-0.06	-2.30e-03	-9.45e-06	0.0
34 8	-0.18	-0.05	-0.04	-1.18e-03	-1.59e-04	-2.28e-05
3425	0.04	0.31	-0.03	-1.81e-03	2.75e-05	-3.96e-05
3428	-0.04	-0.26	-0.04	-8.10e-04	-4.02e-05	3.88e-05
3440	-0.25	-0.08	-0.04	-1.12e-03	-2.21e-04	-3.17e-05
3457	0.06	0.42	-0.03	-2.01e-03	4.10e-05	-5.51e-05
3460	-0.06	-0.37	-0.04	-6.11e-04	-5.37e-05	5.43e-05
3469	-3.16e-04	0.03	-0.04	-1.31e-03	-6.35e-06	0.0
3470	-2.67e-04	0.04	-0.04	-1.71e-03	-7.15e-06	0.0
3471	-3.16e-04	0.03	-0.04	-1.31e-03	-6.35e-06	0.0
3472	-3.06e-04	0.03	-0.04	-1.39e-03	-6.51e-06	0.0
3473	-3.16e-04	0.03	-0.04	-1.31e-03	-6.35e-06	0.0
35 2	3.68e-04	-4.44e-03	-0.05	2.27e-04	2.03e-05	0.0
3510	2.79e-03	-3.08e-03	-0.03	1.51e-04	5.45e-05	1.85e-06
3524	-5.82e-04	-6.23e-03	-0.03	2.29e-04	3.02e-06	-2.36e-06
3542	3.82e-03	-3.23e-03	-0.03	1.55e-04	7.12e-05	2.73e-06
3556	-9.07e-04	-7.64e-03	-0.04	2.65e-04	0.0	-3.16e-06
3570	2.80e-04	-3.25e-03	-0.03	1.66e-04	1.53e-05	0.0
3572	2.40e-04	-2.82e-03	-0.03	1.44e-04	1.33e-05	0.0
3573	2.31e-04	-2.71e-03	-0.03	1.38e-04	1.28e-05	0.0
36 1	-9.93e-04	0.03	-0.05	-1.47e-03	-3.75e-05	0.0
36 2	-9.22e-04	0.04	-0.05	-1.95e-03	-3.91e-05	0.0
36 8	-0.18	-0.04	-0.04	-1.01e-03	-1.49e-04	-1.14e-05
3624	-0.06	-0.20	-0.04	-7.18e-04	-6.96e-05	1.03e-04
3625	0.04	0.25	-0.03	-1.53e-03	0.0	-1.33e-04
3640	-0.25	-0.07	-0.04	-9.60e-04	-1.98e-04	-1.53e-05
3656	-0.08	-0.30	-0.04	-5.56e-04	-8.61e-05	1.44e-04
3657	0.06	0.35	-0.03	-1.69e-03	1.18e-05	-1.87e-04
3669	-7.59e-04	0.02	-0.04	-1.12e-03	-2.87e-05	0.0
3670	-7.12e-04	0.03	-0.04	-1.45e-03	-2.98e-05	0.0
3671	-7.59e-04	0.02	-0.04	-1.12e-03	-2.87e-05	0.0
3672	-7.50e-04	0.02	-0.04	-1.19e-03	-2.89e-05	0.0
3673	-7.59e-04	0.02	-0.04	-1.12e-03	-2.87e-05	0.0
37 2	-5.79e-04	-4.12e-03	-0.04	2.14e-04	-2.77e-05	0.0
3712	-2.95e-03	-3.36e-03	-0.03	1.41e-04	-5.78e-05	-2.46e-06
3722	1.92e-04	-5.64e-03	-0.03	2.06e-04	-1.04e-05	0.0
3726	4.31e-05	-5.84e-03	-0.03	2.06e-04	-1.43e-05	-1.10e-06
3744	-3.99e-03	-3.68e-03	-0.03	1.45e-04	-7.41e-05	-3.26e-06
3754	4.15e-04	-6.89e-03	-0.04	2.36e-04	-7.62e-06	0.0
3758	2.04e-04	-7.17e-03	-0.04	2.37e-04	-1.32e-05	-1.37e-06
3770	-4.29e-04	-3.02e-03	-0.03	1.57e-04	-2.07e-05	0.0
3772	-3.75e-04	-2.63e-03	-0.03	1.36e-04	-1.79e-05	0.0
3773	-3.62e-04	-2.53e-03	-0.03	1.31e-04	-1.72e-05	0.0
38 2	8.79e-04	0.04	-0.05	-1.85e-03	4.99e-05	0.0
38 5	0.18	0.09	-0.03	-1.20e-03	1.35e-04	5.57e-05
3821	0.06	0.23	-0.03	-1.44e-03	6.37e-05	-7.14e-05
3822	0.05	-0.18	-0.04	-7.10e-04	7.17e-05	1.22e-04
3837	0.25	0.12	-0.03	-1.25e-03	1.74e-04	7.77e-05
3853	0.08	0.32	-0.03	-1.59e-03	7.39e-05	-1.00e-04
3854	0.07	-0.26	-0.04	-5.65e-04	8.51e-05	1.71e-04
3870	6.59e-04	0.03	-0.04	-1.38e-03	3.81e-05	0.0
3872	6.05e-04	0.02	-0.04	-1.13e-03	3.82e-05	0.0
3873	5.91e-04	0.02	-0.04	-1.07e-03	3.82e-05	0.0
39 2	1.63e-03	-3.72e-03	-0.05	1.86e-04	8.63e-05	0.0
39 6	4.45e-03	-4.08e-03	-0.04	1.57e-04	1.39e-04	3.84e-06
3910	4.52e-03	-3.58e-03	-0.04	1.45e-04	1.37e-04	4.03e-06
3926	1.89e-03	-6.22e-03	-0.04	2.06e-04	8.26e-05	1.17e-06
3938	5.80e-03	-4.78e-03	-0.04	1.73e-04	1.72e-04	5.24e-06
3942	5.91e-03	-4.07e-03	-0.04	1.57e-04	1.70e-04	5.52e-06
3958	2.21e-03	-7.79e-03	-0.04	2.43e-04	9.31e-05	1.50e-06
3970	1.21e-03	-2.76e-03	-0.04	1.37e-04	6.36e-05	0.0
3972	1.09e-03	-2.40e-03	-0.03	1.20e-04	5.76e-05	0.0
3973	1.06e-03	-2.31e-03	-0.03	1.15e-04	5.61e-05	0.0
40 1	-2.22e-03	0.02	-0.05	-1.05e-03	-9.99e-05	0.0
40 2	-2.19e-03	0.03	-0.05	-1.36e-03	-1.04e-04	0.0
40 6	0.18	-4.98e-03	-0.04	-7.70e-04	2.10e-04	-1.53e-04
40 8	-0.18	-0.07	-0.03	-6.65e-04	-3.69e-04	1.86e-04
4021	0.06	0.20	-0.03	-1.13e-03	1.67e-05	-1.07e-04
4038	0.25	-0.01	-0.05	-7.54e-04	3.25e-04	-2.03e-04
4040	-0.26	-0.10	-0.03	-6.08e-04	-4.86e-04	2.50e-04
4053	0.08	0.28	-0.03	-1.26e-03	5.44e-05	-1.47e-04



EGP CODE

GRE.EEC.R.73.IT.W.15235.12.024.01

PAGE

88 di/of 527

4069	-1.72e-03	0.02	-0.04	-8.09e-04	-7.73e-05	0.0
4070	-1.70e-03	0.02	-0.04	-1.02e-03	-8.02e-05	0.0
4071	-1.72e-03	0.02	-0.04	-8.09e-04	-7.73e-05	0.0
4072	-1.72e-03	0.02	-0.04	-8.50e-04	-7.79e-05	0.0
4073	-1.72e-03	0.02	-0.04	-8.09e-04	-7.73e-05	0.0
41 2	-1.20e-03	-3.31e-03	-0.04	1.59e-04	-6.31e-05	0.0
41 8	-3.76e-03	-3.26e-03	-0.03	1.26e-04	-8.54e-05	0.0
4132	-1.79e-03	-5.41e-03	-0.03	1.59e-04	-6.41e-05	0.0
4136	-1.60e-03	-5.51e-03	-0.03	1.60e-04	-6.07e-05	0.0
4140	-4.94e-03	-3.71e-03	-0.04	1.35e-04	-1.03e-04	0.0
4164	-2.18e-03	-6.74e-03	-0.04	1.83e-04	-7.29e-05	0.0
4168	-1.92e-03	-6.89e-03	-0.04	1.84e-04	-6.80e-05	0.0
4170	-8.83e-04	-2.45e-03	-0.03	1.18e-04	-4.62e-05	0.0
4172	-8.19e-04	-2.16e-03	-0.03	1.04e-04	-4.30e-05	0.0
4173	-8.04e-04	-2.08e-03	-0.03	1.00e-04	-4.22e-05	0.0
42 2	-9.72e-04	-3.04e-03	-0.04	1.47e-04	-5.14e-05	0.0
42 7	-3.61e-03	-2.09e-03	-0.03	9.75e-05	-7.58e-05	0.0
4212	-3.47e-03	-3.42e-03	-0.03	1.16e-04	-7.48e-05	0.0
4236	-1.18e-03	-4.97e-03	-0.03	1.37e-04	-4.14e-05	0.0
4239	-4.79e-03	-2.16e-03	-0.03	9.90e-05	-9.21e-05	0.0
4244	-4.60e-03	-4.02e-03	-0.03	1.25e-04	-9.09e-05	0.0
4268	-1.38e-03	-6.19e-03	-0.03	1.54e-04	-4.40e-05	0.0
4270	-7.03e-04	-2.24e-03	-0.03	1.09e-04	-3.70e-05	0.0
4272	-6.69e-04	-1.99e-03	-0.02	9.67e-05	-3.53e-05	0.0
4273	-6.60e-04	-1.92e-03	-0.02	9.37e-05	-3.49e-05	0.0
43 2	-1.11e-03	-3.14e-03	-0.04	1.54e-04	-5.49e-05	0.0
43 8	-4.07e-03	-3.06e-03	-0.03	1.30e-04	-9.46e-05	0.0
4312	-4.02e-03	-3.40e-03	-0.03	1.35e-04	-9.51e-05	0.0
4336	-1.60e-03	-5.05e-03	-0.03	1.44e-04	-5.28e-05	0.0
4340	-5.40e-03	-3.47e-03	-0.03	1.42e-04	-1.18e-04	0.0
4344	-5.33e-03	-3.95e-03	-0.03	1.49e-04	-1.19e-04	0.0
4368	-1.94e-03	-6.27e-03	-0.03	1.62e-04	-5.92e-05	0.0
4370	-8.17e-04	-2.32e-03	-0.03	1.14e-04	-3.99e-05	0.0
4372	-7.57e-04	-2.06e-03	-0.03	1.01e-04	-3.75e-05	0.0
4373	-7.42e-04	-1.99e-03	-0.03	9.80e-05	-3.68e-05	0.0
44 2	-9.18e-04	-2.45e-03	-0.03	1.20e-04	-4.66e-05	0.0
44 8	-3.25e-03	-2.54e-03	-0.02	9.38e-05	-6.09e-05	0.0
4412	-3.15e-03	-2.83e-03	-0.02	9.65e-05	-6.08e-05	0.0
4436	-1.15e-03	-4.20e-03	-0.02	1.01e-04	-3.61e-05	0.0
4440	-4.30e-03	-2.91e-03	-0.02	1.00e-04	-7.27e-05	0.0
4444	-4.16e-03	-3.33e-03	-0.02	1.04e-04	-7.26e-05	0.0
4468	-1.36e-03	-5.25e-03	-0.02	1.10e-04	-3.79e-05	0.0
4470	-6.53e-04	-1.81e-03	-0.02	8.84e-05	-3.29e-05	0.0
4472	-6.25e-04	-1.61e-03	-0.02	7.92e-05	-3.18e-05	0.0
4473	-6.18e-04	-1.57e-03	-0.02	7.69e-05	-3.15e-05	0.0
45 2	-9.25e-04	-2.59e-03	-0.03	1.26e-04	-4.63e-05	0.0
45 8	-3.41e-03	-2.62e-03	-0.03	1.09e-04	-6.88e-05	0.0
4512	-3.32e-03	-2.92e-03	-0.03	1.12e-04	-6.87e-05	0.0
4536	-1.20e-03	-4.39e-03	-0.02	1.09e-04	-3.75e-05	0.0
4540	-4.53e-03	-3.00e-03	-0.03	1.20e-04	-8.39e-05	0.0
4544	-4.40e-03	-3.42e-03	-0.03	1.25e-04	-8.38e-05	0.0
4568	-1.43e-03	-5.49e-03	-0.02	1.21e-04	-4.00e-05	0.0
4570	-6.62e-04	-1.91e-03	-0.02	9.33e-05	-3.29e-05	0.0
4572	-6.29e-04	-1.70e-03	-0.02	8.33e-05	-3.16e-05	0.0
4573	-6.21e-04	-1.65e-03	-0.02	8.08e-05	-3.13e-05	0.0
46 2	-8.36e-04	-1.84e-03	-0.02	9.05e-05	-4.25e-05	0.0
46 8	-2.96e-03	-2.07e-03	-0.02	7.24e-05	-5.04e-05	0.0
4611	-2.93e-03	-1.04e-03	-0.02	6.84e-05	-5.14e-05	0.0
4636	-1.07e-03	-3.55e-03	-0.02	6.94e-05	-3.15e-05	0.0
4640	-3.91e-03	-2.42e-03	-0.02	7.81e-05	-5.91e-05	0.0
4643	-3.87e-03	-9.85e-04	-0.02	7.25e-05	-6.05e-05	0.0
4668	-1.28e-03	-4.50e-03	-0.02	7.40e-05	-3.26e-05	0.0
4670	-5.85e-04	-1.36e-03	-0.02	6.65e-05	-2.95e-05	0.0
4672	-5.68e-04	-1.22e-03	-0.02	5.98e-05	-2.89e-05	0.0
4673	-5.63e-04	-1.18e-03	-0.02	5.81e-05	-2.88e-05	0.0
47 2	-8.05e-04	-1.92e-03	-0.03	9.41e-05	-4.09e-05	0.0
47 7	-3.05e-03	-1.33e-03	-0.02	8.10e-05	-5.56e-05	0.0
4711	-3.02e-03	-1.07e-03	-0.02	7.98e-05	-5.58e-05	0.0
4736	-1.07e-03	-3.65e-03	-0.02	7.37e-05	-3.10e-05	0.0
4739	-4.05e-03	-1.37e-03	-0.02	8.92e-05	-6.67e-05	0.0
4743	-4.01e-03	-9.99e-04	-0.02	8.76e-05	-6.70e-05	0.0
4768	-1.28e-03	-4.62e-03	-0.02	7.90e-05	-3.23e-05	0.0
4770	-5.64e-04	-1.42e-03	-0.02	6.95e-05	-2.85e-05	0.0
4772	-5.48e-04	-1.27e-03	-0.02	6.23e-05	-2.79e-05	0.0
4773	-5.43e-04	-1.23e-03	-0.02	6.05e-05	-2.78e-05	0.0
48 1	-7.66e-04	-1.07e-03	-0.02	5.26e-05	-3.96e-05	0.0



EGP CODE

GRE.EEC.R.73.IT.W.15235.12.024.01

PAGE

89 di/of 527

48 2	-7.85e-04	-1.24e-03	-0.02	6.09e-05	-4.01e-05	0.0
48 7	-2.73e-03	-9.44e-04	-0.02	5.03e-05	-4.35e-05	0.0
4811	-2.71e-03	-7.06e-04	-0.02	5.03e-05	-4.36e-05	0.0
4836	-1.04e-03	-2.97e-03	-0.01	4.00e-05	-2.91e-05	0.0
4839	-3.61e-03	-1.01e-03	-0.02	5.47e-05	-5.00e-05	0.0
4843	-3.58e-03	-6.65e-04	-0.02	5.47e-05	-5.02e-05	0.0
4868	-1.24e-03	-3.85e-03	-0.01	4.03e-05	-2.98e-05	0.0
4869	-5.28e-04	-7.97e-04	-0.01	3.92e-05	-2.71e-05	0.0
4870	-5.41e-04	-9.13e-04	-0.01	4.48e-05	-2.75e-05	0.0
4871	-5.28e-04	-7.97e-04	-0.01	3.92e-05	-2.71e-05	0.0
4872	-5.31e-04	-8.20e-04	-0.01	4.03e-05	-2.72e-05	0.0
4873	-5.28e-04	-7.97e-04	-0.01	3.92e-05	-2.71e-05	0.0
49 1	-7.22e-04	-1.10e-03	-0.02	5.41e-05	-3.75e-05	0.0
49 2	-7.37e-04	-1.28e-03	-0.02	6.29e-05	-3.78e-05	0.0
49 7	-2.76e-03	-9.51e-04	-0.02	5.79e-05	-4.52e-05	0.0
4911	-2.74e-03	-7.18e-04	-0.02	5.79e-05	-4.54e-05	0.0
4936	-1.01e-03	-3.02e-03	-0.02	4.21e-05	-2.76e-05	0.0
4939	-3.67e-03	-1.00e-03	-0.02	6.49e-05	-5.30e-05	0.0
4943	-3.64e-03	-6.69e-04	-0.02	6.49e-05	-5.33e-05	0.0
4968	-1.22e-03	-3.91e-03	-0.02	4.26e-05	-2.84e-05	0.0
4969	-4.98e-04	-8.26e-04	-0.02	4.06e-05	-2.57e-05	0.0
4970	-5.08e-04	-9.49e-04	-0.02	4.65e-05	-2.59e-05	0.0
4971	-4.98e-04	-8.26e-04	-0.02	4.06e-05	-2.57e-05	0.0
4972	-5.00e-04	-8.51e-04	-0.02	4.18e-05	-2.57e-05	0.0
4973	-4.98e-04	-8.26e-04	-0.02	4.06e-05	-2.57e-05	0.0
50 1	-7.46e-04	-5.86e-04	-0.02	2.89e-05	-3.87e-05	0.0
50 2	-7.57e-04	-6.80e-04	-0.02	3.34e-05	-3.89e-05	0.0
50 7	-2.56e-03	4.16e-04	-0.01	3.01e-05	-3.84e-05	0.0
5011	-2.55e-03	6.41e-04	-0.01	3.07e-05	-3.84e-05	0.0
5036	-1.04e-03	-2.49e-03	-0.01	1.74e-05	-2.82e-05	0.0
5039	-3.39e-03	7.49e-04	-0.01	3.35e-05	-4.32e-05	0.0
5043	-3.37e-03	1.07e-03	-0.01	3.43e-05	-4.33e-05	0.0
5068	-1.25e-03	-3.31e-03	-0.01	1.57e-05	-2.90e-05	0.0
5069	-5.10e-04	-4.37e-04	-0.01	2.15e-05	-2.63e-05	0.0
5070	-5.17e-04	-4.99e-04	-0.01	2.45e-05	-2.64e-05	0.0
5071	-5.10e-04	-4.37e-04	-0.01	2.15e-05	-2.63e-05	0.0
5072	-5.11e-04	-4.50e-04	-0.01	2.21e-05	-2.63e-05	0.0
5073	-5.10e-04	-4.37e-04	-0.01	2.15e-05	-2.63e-05	0.0
51 1	-6.96e-04	-6.01e-04	-0.02	2.96e-05	-3.63e-05	0.0
51 2	-7.01e-04	-6.99e-04	-0.02	3.43e-05	-3.62e-05	0.0
51 7	-2.57e-03	-6.22e-04	-0.02	3.48e-05	-3.87e-05	0.0
5111	-2.56e-03	-4.04e-04	-0.02	3.54e-05	-3.88e-05	0.0
5136	-1.01e-03	-2.51e-03	-0.01	1.77e-05	-2.65e-05	0.0
5139	-3.41e-03	-6.93e-04	-0.02	3.98e-05	-4.44e-05	0.0
5143	-3.40e-03	-3.81e-04	-0.02	4.07e-05	-4.46e-05	0.0
5168	-1.22e-03	-3.34e-03	-0.01	1.58e-05	-2.73e-05	0.0
5169	-4.74e-04	-4.51e-04	-0.01	2.22e-05	-2.46e-05	0.0
5170	-4.78e-04	-5.16e-04	-0.01	2.53e-05	-2.45e-05	0.0
5171	-4.74e-04	-4.51e-04	-0.01	2.22e-05	-2.46e-05	0.0
5172	-4.75e-04	-4.64e-04	-0.01	2.28e-05	-2.46e-05	0.0
5173	-4.74e-04	-4.51e-04	-0.01	2.22e-05	-2.46e-05	0.0
52 1	-7.38e-04	-1.34e-04	-0.02	6.61e-06	-3.84e-05	0.0
52 2	-7.46e-04	-1.55e-04	-0.02	7.63e-06	-3.84e-05	0.0
52 8	-2.46e-03	1.22e-04	-0.01	7.89e-06	-3.54e-05	0.0
5211	-2.45e-03	9.96e-04	-0.01	1.15e-05	-3.56e-05	0.0
5236	-1.07e-03	-2.09e-03	-0.01	-1.67e-06	-2.84e-05	0.0
5240	-3.24e-03	2.13e-04	-0.01	9.11e-06	-3.92e-05	0.0
5243	-3.24e-03	1.43e-03	-0.01	1.41e-05	-3.94e-05	0.0
5268	-1.30e-03	-2.89e-03	-0.01	-4.32e-06	-2.94e-05	0.0
5269	-5.02e-04	-9.99e-05	-0.01	4.93e-06	-2.59e-05	0.0
5270	-5.07e-04	-1.14e-04	-0.01	5.61e-06	-2.60e-05	0.0
5271	-5.02e-04	-9.99e-05	-0.01	4.93e-06	-2.59e-05	0.0
5272	-5.03e-04	-1.03e-04	-0.01	5.06e-06	-2.59e-05	0.0
5273	-5.02e-04	-9.99e-05	-0.01	4.93e-06	-2.59e-05	0.0
53 1	-6.86e-04	-1.37e-04	-0.02	6.77e-06	-3.59e-05	0.0
53 2	-6.87e-04	-1.59e-04	-0.02	7.85e-06	-3.56e-05	0.0
53 8	-2.45e-03	1.25e-04	-0.01	9.82e-06	-3.51e-05	0.0
5311	-2.45e-03	1.00e-03	-0.01	1.39e-05	-3.53e-05	0.0
5336	-1.04e-03	-2.10e-03	-0.01	-2.15e-06	-2.69e-05	0.0
5340	-3.24e-03	2.19e-04	-0.01	1.18e-05	-3.95e-05	0.0
5343	-3.24e-03	1.44e-03	-0.01	1.74e-05	-3.97e-05	0.0
5368	-1.27e-03	-2.90e-03	-0.01	-5.05e-06	-2.80e-05	0.0
5369	-4.65e-04	-1.03e-04	-0.01	5.08e-06	-2.41e-05	0.0
5370	-4.66e-04	-1.17e-04	-0.01	5.79e-06	-2.40e-05	0.0
5371	-4.65e-04	-1.03e-04	-0.01	5.08e-06	-2.41e-05	0.0
5372	-4.65e-04	-1.06e-04	-0.01	5.22e-06	-2.41e-05	0.0





EGP CODE

GRE.EEC.R.73.IT.W.15235.12.024.01

PAGE

90 di/of 527

5373	-4.65e-04	-1.03e-04	-0.01	5.08e-06	-2.41e-05	0.0
54 1	-7.39e-04	3.10e-04	-0.02	-1.53e-05	-3.85e-05	0.0
54 2	-7.48e-04	3.60e-04	-0.02	-1.76e-05	-3.85e-05	0.0
5416	-2.49e-03	-6.39e-04	-0.01	-1.81e-05	-3.63e-05	0.0
5420	-2.48e-03	-8.59e-04	-0.01	-1.89e-05	-3.63e-05	0.0
5431	-1.05e-03	2.24e-03	-0.01	-5.26e-06	-2.81e-05	0.0
5448	-3.28e-03	-9.79e-04	-0.01	-2.08e-05	-4.04e-05	0.0
5452	-3.27e-03	-1.29e-03	-0.01	-2.20e-05	-4.05e-05	0.0
5463	-1.27e-03	3.05e-03	-0.01	-2.80e-06	-2.90e-05	0.0
5469	-5.03e-04	2.31e-04	-0.01	-1.14e-05	-2.60e-05	0.0
5470	-5.09e-04	2.64e-04	-0.01	-1.29e-05	-2.61e-05	0.0
5471	-5.03e-04	2.31e-04	-0.01	-1.14e-05	-2.60e-05	0.0
5472	-5.04e-04	2.38e-04	-0.01	-1.17e-05	-2.60e-05	0.0
5473	-5.03e-04	2.31e-04	-0.01	-1.14e-05	-2.60e-05	0.0
55 1	-6.87e-04	3.18e-04	-0.02	-1.56e-05	-3.59e-05	0.0
55 2	-6.89e-04	3.70e-04	-0.02	-1.81e-05	-3.57e-05	0.0
5516	-2.48e-03	-6.41e-04	-0.01	-2.12e-05	-3.61e-05	0.0
5520	-2.48e-03	-8.54e-04	-0.01	-2.21e-05	-3.62e-05	0.0
5531	-1.02e-03	2.25e-03	-0.01	-4.92e-06	-2.65e-05	0.0
5548	-3.29e-03	-9.83e-04	-0.02	-2.49e-05	-4.08e-05	0.0
5552	-3.28e-03	-1.29e-03	-0.02	-2.63e-05	-4.10e-05	0.0
5563	-1.24e-03	3.06e-03	-0.01	-2.20e-06	-2.74e-05	0.0
5569	-4.66e-04	2.38e-04	-0.01	-1.17e-05	-2.42e-05	0.0
5570	-4.67e-04	2.73e-04	-0.01	-1.33e-05	-2.41e-05	0.0
5571	-4.66e-04	2.38e-04	-0.01	-1.17e-05	-2.42e-05	0.0
5572	-4.66e-04	2.45e-04	-0.01	-1.20e-05	-2.42e-05	0.0
5573	-4.66e-04	2.38e-04	-0.01	-1.17e-05	-2.42e-05	0.0
56 1	-7.49e-04	7.72e-04	-0.02	-3.81e-05	-3.90e-05	0.0
56 2	-7.62e-04	8.97e-04	-0.02	-4.40e-05	-3.92e-05	0.0
5616	-2.61e-03	-2.79e-04	-0.01	-3.79e-05	-3.98e-05	0.0
5620	-2.60e-03	-5.07e-04	-0.01	-3.84e-05	-4.00e-05	0.0
5631	-1.03e-03	2.67e-03	-0.01	-2.61e-05	-2.83e-05	0.0
5648	-3.45e-03	-6.11e-04	-0.01	-4.17e-05	-4.51e-05	0.0
5652	-3.43e-03	-9.38e-04	-0.01	-4.24e-05	-4.53e-05	0.0
5663	-1.24e-03	3.51e-03	-0.01	-2.52e-05	-2.90e-05	0.0
5669	-5.13e-04	5.76e-04	-0.01	-2.84e-05	-2.65e-05	0.0
5670	-5.22e-04	6.60e-04	-0.01	-3.23e-05	-2.67e-05	0.0
5671	-5.13e-04	5.76e-04	-0.01	-2.84e-05	-2.65e-05	0.0
5672	-5.15e-04	5.93e-04	-0.01	-2.92e-05	-2.65e-05	0.0
5673	-5.13e-04	5.76e-04	-0.01	-2.84e-05	-2.65e-05	0.0
57 1	-7.00e-04	7.94e-04	-0.02	-3.90e-05	-3.66e-05	0.0
57 2	-7.08e-04	9.25e-04	-0.02	-4.53e-05	-3.66e-05	0.0
5716	-2.62e-03	7.52e-04	-0.02	-4.35e-05	-4.05e-05	0.0
5720	-2.61e-03	5.30e-04	-0.02	-4.41e-05	-4.07e-05	0.0
5731	-9.98e-04	2.70e-03	-0.01	-2.68e-05	-2.65e-05	0.0
5748	-3.48e-03	8.17e-04	-0.02	-4.92e-05	-4.68e-05	0.0
5752	-3.47e-03	4.98e-04	-0.02	-5.00e-05	-4.71e-05	0.0
5763	-1.21e-03	3.54e-03	-0.01	-2.58e-05	-2.72e-05	0.0
5769	-4.79e-04	5.96e-04	-0.01	-2.93e-05	-2.49e-05	0.0
5770	-4.84e-04	6.83e-04	-0.01	-3.34e-05	-2.49e-05	0.0
5771	-4.79e-04	5.96e-04	-0.01	-2.93e-05	-2.49e-05	0.0
5772	-4.80e-04	6.13e-04	-0.01	-3.01e-05	-2.49e-05	0.0
5773	-4.79e-04	5.96e-04	-0.01	-2.93e-05	-2.49e-05	0.0
58 2	-7.96e-04	1.48e-03	-0.02	-7.25e-05	-4.08e-05	0.0
5816	-2.79e-03	1.09e-03	-0.02	-5.80e-05	-4.58e-05	0.0
5820	-2.77e-03	8.40e-04	-0.02	-5.75e-05	-4.60e-05	0.0
5831	-1.04e-03	3.19e-03	-0.01	-5.26e-05	-2.96e-05	0.0
5848	-3.70e-03	1.14e-03	-0.02	-6.26e-05	-5.31e-05	0.0
5852	-3.67e-03	7.92e-04	-0.02	-6.18e-05	-5.34e-05	0.0
5863	-1.24e-03	4.09e-03	-0.01	-5.49e-05	-3.04e-05	0.0
5870	-5.51e-04	1.09e-03	-0.02	-5.33e-05	-2.81e-05	0.0
5872	-5.39e-04	9.76e-04	-0.02	-4.80e-05	-2.77e-05	0.0
5873	-5.36e-04	9.48e-04	-0.02	-4.66e-05	-2.76e-05	0.0
59 2	-7.50e-04	1.53e-03	-0.02	-7.50e-05	-3.86e-05	0.0
5916	-2.84e-03	1.10e-03	-0.02	-6.69e-05	-4.82e-05	0.0
5920	-2.82e-03	8.59e-04	-0.02	-6.63e-05	-4.85e-05	0.0
5931	-1.01e-03	3.26e-03	-0.02	-5.54e-05	-2.82e-05	0.0
5948	-3.77e-03	1.15e-03	-0.02	-7.44e-05	-5.70e-05	0.0
5952	-3.75e-03	8.02e-04	-0.02	-7.36e-05	-5.74e-05	0.0
5963	-1.22e-03	4.17e-03	-0.02	-5.82e-05	-2.90e-05	0.0
5970	-5.20e-04	1.13e-03	-0.02	-5.54e-05	-2.66e-05	0.0
5972	-5.10e-04	1.01e-03	-0.02	-4.98e-05	-2.63e-05	0.0
5973	-5.08e-04	9.85e-04	-0.02	-4.84e-05	-2.62e-05	0.0
60 2	-8.58e-04	2.09e-03	-0.03	-1.03e-04	-4.38e-05	0.0
6016	-3.05e-03	1.46e-03	-0.02	-7.72e-05	-5.47e-05	0.0
6020	-3.02e-03	1.19e-03	-0.02	-7.55e-05	-5.50e-05	0.0



EGP CODE

GRE.EEC.R.73.IT.W.15235.12.024.01

PAGE

91 di/of 527

6031	-1.09e-03	3.81e-03	-0.02	-8.21e-05	-3.27e-05	0.0
6048	-4.04e-03	1.51e-03	-0.02	-8.18e-05	-6.48e-05	0.0
6052	-3.99e-03	1.12e-03	-0.02	-7.93e-05	-6.51e-05	0.0
6063	-1.30e-03	4.79e-03	-0.02	-8.86e-05	-3.39e-05	0.0
6070	-6.04e-04	1.54e-03	-0.02	-7.55e-05	-3.06e-05	0.0
6072	-5.84e-04	1.38e-03	-0.02	-6.77e-05	-2.99e-05	0.0
6073	-5.79e-04	1.34e-03	-0.02	-6.58e-05	-2.97e-05	0.0
61 2	-8.29e-04	2.19e-03	-0.03	-1.07e-04	-4.23e-05	0.0
6116	-3.16e-03	1.49e-03	-0.02	-9.03e-05	-6.03e-05	0.0
6120	-3.13e-03	1.22e-03	-0.02	-8.84e-05	-6.06e-05	0.0
6131	-1.09e-03	3.93e-03	-0.02	-8.75e-05	-3.24e-05	0.0
6148	-4.20e-03	1.53e-03	-0.02	-9.89e-05	-7.29e-05	0.0
6152	-4.16e-03	1.14e-03	-0.02	-9.63e-05	-7.34e-05	0.0
6163	-1.31e-03	4.94e-03	-0.02	-9.51e-05	-3.39e-05	0.0
6170	-5.85e-04	1.62e-03	-0.02	-7.91e-05	-2.96e-05	0.0
6172	-5.65e-04	1.45e-03	-0.02	-7.08e-05	-2.89e-05	0.0
6173	-5.60e-04	1.40e-03	-0.02	-6.87e-05	-2.87e-05	0.0
62 2	-9.59e-04	2.68e-03	-0.03	-1.31e-04	-4.91e-05	0.0
6215	-3.37e-03	2.73e-03	-0.02	-1.02e-04	-6.60e-05	0.0
6219	-3.27e-03	3.04e-03	-0.02	-1.06e-04	-6.58e-05	0.0
6231	-1.19e-03	4.48e-03	-0.02	-1.14e-04	-3.83e-05	0.0
6247	-4.47e-03	3.12e-03	-0.03	-1.09e-04	-7.91e-05	0.0
6251	-4.32e-03	3.56e-03	-0.03	-1.14e-04	-7.89e-05	0.0
6263	-1.41e-03	5.59e-03	-0.02	-1.27e-04	-4.03e-05	0.0
6270	-6.88e-04	1.98e-03	-0.02	-9.67e-05	-3.49e-05	0.0
6272	-6.54e-04	1.76e-03	-0.02	-8.65e-05	-3.35e-05	0.0
6273	-6.46e-04	1.71e-03	-0.02	-8.39e-05	-3.32e-05	0.0
63 2	-9.58e-04	2.84e-03	-0.03	-1.38e-04	-4.83e-05	0.0
6315	-3.55e-03	2.83e-03	-0.03	-1.19e-04	-7.43e-05	0.0
6319	-3.45e-03	3.15e-03	-0.03	-1.23e-04	-7.41e-05	0.0
6331	-1.24e-03	4.70e-03	-0.03	-1.25e-04	-3.93e-05	0.0
6347	-4.71e-03	3.22e-03	-0.03	-1.31e-04	-9.10e-05	0.0
6351	-4.57e-03	3.67e-03	-0.03	-1.37e-04	-9.07e-05	0.0
6363	-1.47e-03	5.86e-03	-0.03	-1.39e-04	-4.20e-05	0.0
6370	-6.90e-04	2.10e-03	-0.02	-1.02e-04	-3.45e-05	0.0
6372	-6.52e-04	1.87e-03	-0.02	-9.13e-05	-3.30e-05	0.0
6373	-6.43e-04	1.81e-03	-0.02	-8.85e-05	-3.26e-05	0.0
64 2	-1.05e-03	3.21e-03	-0.04	-1.55e-04	-5.59e-05	0.0
6415	-3.73e-03	1.85e-03	-0.03	-1.17e-04	-8.12e-05	0.0
6419	-3.60e-03	2.21e-03	-0.03	-1.23e-04	-8.15e-05	0.0
6431	-1.28e-03	5.27e-03	-0.03	-1.50e-04	-4.95e-05	0.0
6447	-4.94e-03	1.77e-03	-0.03	-1.24e-04	-9.87e-05	0.0
6451	-4.76e-03	2.30e-03	-0.03	-1.33e-04	-9.90e-05	0.0
6463	-1.50e-03	6.57e-03	-0.03	-1.71e-04	-5.41e-05	0.0
6470	-7.67e-04	2.37e-03	-0.03	-1.14e-04	-4.05e-05	0.0
6472	-7.23e-04	2.10e-03	-0.03	-1.02e-04	-3.83e-05	0.0
6473	-7.12e-04	2.03e-03	-0.03	-9.83e-05	-3.77e-05	0.0
65 2	-1.14e-03	3.33e-03	-0.04	-1.64e-04	-5.71e-05	0.0
6515	-4.35e-03	3.25e-03	-0.03	-1.37e-04	-1.08e-04	0.0
6519	-4.31e-03	3.61e-03	-0.04	-1.43e-04	-1.09e-04	0.0
6531	-1.68e-03	5.37e-03	-0.03	-1.62e-04	-5.88e-05	0.0
6547	-5.79e-03	3.69e-03	-0.04	-1.50e-04	-1.36e-04	0.0
6551	-5.73e-03	4.21e-03	-0.04	-1.59e-04	-1.37e-04	0.0
6563	-2.05e-03	6.68e-03	-0.03	-1.85e-04	-6.71e-05	0.0
6570	-8.41e-04	2.47e-03	-0.03	-1.21e-04	-4.18e-05	0.0
6572	-7.76e-04	2.18e-03	-0.03	-1.07e-04	-3.90e-05	0.0
6573	-7.60e-04	2.11e-03	-0.03	-1.04e-04	-3.82e-05	0.0
66 2	-1.20e-03	3.32e-03	-0.04	-1.60e-04	-6.32e-05	0.0
6615	-3.81e-03	3.30e-03	-0.03	-1.26e-04	-8.66e-05	0.0
6631	-1.60e-03	5.53e-03	-0.03	-1.61e-04	-6.10e-05	0.0
6635	-1.79e-03	5.44e-03	-0.03	-1.60e-04	-6.45e-05	0.0
6647	-5.01e-03	3.76e-03	-0.04	-1.35e-04	-1.04e-04	0.0
6663	-1.92e-03	6.91e-03	-0.04	-1.85e-04	-6.84e-05	0.0
6667	-2.19e-03	6.78e-03	-0.04	-1.84e-04	-7.34e-05	0.0
6670	-8.82e-04	2.46e-03	-0.03	-1.18e-04	-4.63e-05	0.0
6672	-8.18e-04	2.17e-03	-0.03	-1.05e-04	-4.31e-05	0.0
6673	-8.02e-04	2.09e-03	-0.03	-1.01e-04	-4.23e-05	0.0
67 2	-8.37e-04	-2.93e-03	-0.04	1.44e-04	-4.41e-05	0.0
67 8	-3.20e-03	-2.93e-03	-0.03	1.08e-04	-5.52e-05	0.0
6732	-1.22e-03	-4.84e-03	-0.03	1.36e-04	-4.46e-05	0.0
6736	-1.06e-03	-4.90e-03	-0.03	1.37e-04	-4.29e-05	0.0
6740	-4.26e-03	-3.34e-03	-0.03	1.14e-04	-6.52e-05	0.0
6764	-1.48e-03	-6.03e-03	-0.03	1.54e-04	-5.04e-05	0.0
6768	-1.26e-03	-6.12e-03	-0.03	1.55e-04	-4.80e-05	0.0
6770	-6.12e-04	-2.16e-03	-0.03	1.06e-04	-3.21e-05	0.0
6772	-5.78e-04	-1.91e-03	-0.03	9.42e-05	-3.05e-05	0.0



EGP CODE

GRE.EEC.R.73.IT.W.15235.12.024.01

PAGE

92 di/of 527

6773	-5.70e-04	-1.85e-03	-0.03	9.13e-05	-3.01e-05	0.0
68 2	-7.66e-04	-2.79e-03	-0.03	1.37e-04	-3.97e-05	0.0
68 8	-3.03e-03	-2.80e-03	-0.02	1.01e-04	-4.76e-05	0.0
6832	-1.14e-03	-4.57e-03	-0.02	1.23e-04	-3.50e-05	0.0
6836	-1.00e-03	-4.62e-03	-0.02	1.23e-04	-3.33e-05	0.0
6840	-4.03e-03	-3.20e-03	-0.03	1.07e-04	-5.58e-05	0.0
6864	-1.38e-03	-5.69e-03	-0.03	1.37e-04	-3.81e-05	0.0
6868	-1.19e-03	-5.77e-03	-0.03	1.38e-04	-3.57e-05	0.0
6870	-5.51e-04	-2.04e-03	-0.02	1.01e-04	-2.84e-05	0.0
6872	-5.28e-04	-1.82e-03	-0.02	9.00e-05	-2.74e-05	0.0
6873	-5.22e-04	-1.77e-03	-0.02	8.73e-05	-2.72e-05	0.0
69 2	-7.14e-04	-2.35e-03	-0.03	1.16e-04	-3.65e-05	0.0
69 8	-2.88e-03	-2.46e-03	-0.02	8.50e-05	-4.29e-05	0.0
6912	-2.77e-03	-2.75e-03	-0.02	8.76e-05	-4.28e-05	0.0
6936	-9.53e-04	-4.07e-03	-0.02	9.65e-05	-2.74e-05	0.0
6940	-3.84e-03	-2.83e-03	-0.02	8.92e-05	-5.01e-05	0.0
6944	-3.69e-03	-3.25e-03	-0.02	9.30e-05	-5.00e-05	0.0
6968	-1.14e-03	-5.11e-03	-0.02	1.06e-04	-2.84e-05	0.0
6970	-5.04e-04	-1.72e-03	-0.02	8.49e-05	-2.56e-05	0.0
6972	-4.89e-04	-1.54e-03	-0.02	7.62e-05	-2.51e-05	0.0
6973	-4.85e-04	-1.50e-03	-0.02	7.40e-05	-2.49e-05	0.0
70 2	-6.84e-04	-1.79e-03	-0.02	8.83e-05	-3.49e-05	0.0
70 8	-2.71e-03	-2.03e-03	-0.02	6.56e-05	-3.81e-05	0.0
7011	-2.68e-03	-1.02e-03	-0.02	6.15e-05	-3.89e-05	0.0
7036	-9.42e-04	-3.47e-03	-0.02	6.71e-05	-2.55e-05	0.0
7040	-3.61e-03	-2.38e-03	-0.02	6.92e-05	-4.39e-05	0.0
7043	-3.57e-03	-9.62e-04	-0.02	6.34e-05	-4.50e-05	0.0
7068	-1.13e-03	-4.41e-03	-0.02	7.13e-05	-2.61e-05	0.0
7070	-4.76e-04	-1.31e-03	-0.02	6.46e-05	-2.41e-05	0.0
7072	-4.65e-04	-1.18e-03	-0.02	5.82e-05	-2.38e-05	0.0
7073	-4.63e-04	-1.14e-03	-0.02	5.66e-05	-2.37e-05	0.0
71 1	-6.56e-04	-1.05e-03	-0.02	5.19e-05	-3.41e-05	0.0
71 2	-6.70e-04	-1.22e-03	-0.02	5.99e-05	-3.43e-05	0.0
71 8	-2.56e-03	-6.24e-04	-0.01	4.54e-05	-3.42e-05	0.0
7131	-1.13e-03	1.34e-03	-0.01	3.93e-05	-2.76e-05	0.0
7136	-9.47e-04	-2.93e-03	-0.01	4.09e-05	-2.47e-05	0.0
7140	-3.40e-03	-5.60e-04	-0.01	4.82e-05	-3.86e-05	0.0
7163	-1.41e-03	2.19e-03	-0.01	3.96e-05	-2.93e-05	0.0
7168	-1.15e-03	-3.79e-03	-0.01	4.19e-05	-2.53e-05	0.0
7169	-4.51e-04	-7.78e-04	-0.01	3.84e-05	-2.32e-05	0.0
7170	-4.60e-04	-8.89e-04	-0.01	4.38e-05	-2.34e-05	0.0
7171	-4.51e-04	-7.78e-04	-0.01	3.84e-05	-2.32e-05	0.0
7172	-4.53e-04	-8.00e-04	-0.01	3.95e-05	-2.33e-05	0.0
7173	-4.51e-04	-7.78e-04	-0.01	3.84e-05	-2.32e-05	0.0
72 1	-6.52e-04	-5.78e-04	-0.02	2.86e-05	-3.40e-05	0.0
72 2	-6.63e-04	-6.68e-04	-0.02	3.29e-05	-3.41e-05	0.0
72 8	-2.44e-03	-2.49e-04	-0.01	2.51e-05	-3.14e-05	0.0
7231	-1.07e-03	1.59e-03	-0.01	2.74e-05	-2.61e-05	0.0
7236	-9.65e-04	-2.47e-03	-0.01	1.72e-05	-2.45e-05	0.0
7240	-3.23e-03	-1.75e-04	-0.01	2.67e-05	-3.48e-05	0.0
7263	-1.32e-03	2.40e-03	-0.01	2.99e-05	-2.74e-05	0.0
7268	-1.17e-03	-3.28e-03	-0.01	1.56e-05	-2.51e-05	0.0
7269	-4.45e-04	-4.29e-04	-0.01	2.12e-05	-2.30e-05	0.0
7270	-4.52e-04	-4.89e-04	-0.01	2.41e-05	-2.31e-05	0.0
7271	-4.45e-04	-4.29e-04	-0.01	2.12e-05	-2.30e-05	0.0
7272	-4.47e-04	-4.41e-04	-0.01	2.17e-05	-2.30e-05	0.0
7273	-4.45e-04	-4.29e-04	-0.01	2.12e-05	-2.30e-05	0.0
73 1	-6.51e-04	-1.33e-04	-0.01	6.55e-06	-3.40e-05	0.0
73 2	-6.60e-04	-1.53e-04	-0.01	7.53e-06	-3.41e-05	0.0
73 8	-2.35e-03	1.09e-04	-0.01	6.47e-06	-2.99e-05	0.0
7331	-1.02e-03	1.88e-03	-0.01	1.26e-05	-2.52e-05	0.0
7336	-9.96e-04	-2.08e-03	-0.01	-1.46e-06	-2.47e-05	0.0
7340	-3.11e-03	1.95e-04	-0.01	7.15e-06	-3.26e-05	0.0
7363	-1.25e-03	2.67e-03	-0.01	1.57e-05	-2.61e-05	0.0
7368	-1.22e-03	-2.88e-03	-0.01	-3.99e-06	-2.55e-05	0.0
7369	-4.43e-04	-9.83e-05	-0.01	4.85e-06	-2.29e-05	0.0
7370	-4.49e-04	-1.12e-04	-0.01	5.51e-06	-2.30e-05	0.0
7371	-4.43e-04	-9.83e-05	-0.01	4.85e-06	-2.29e-05	0.0
7372	-4.44e-04	-1.01e-04	-0.01	4.98e-06	-2.29e-05	0.0
7373	-4.43e-04	-9.83e-05	-0.01	4.85e-06	-2.29e-05	0.0
74 1	-6.50e-04	3.06e-04	-0.01	-1.51e-05	-3.40e-05	0.0
74 2	-6.60e-04	3.53e-04	-0.01	-1.74e-05	-3.41e-05	0.0
7416	-2.37e-03	-6.23e-04	-0.01	-1.59e-05	-3.04e-05	0.0
7431	-9.81e-04	2.22e-03	-0.01	-5.39e-06	-2.46e-05	0.0
7436	-1.04e-03	-1.76e-03	-0.01	-1.87e-05	-2.55e-05	0.0
7448	-3.14e-03	-9.55e-04	-0.01	-1.78e-05	-3.34e-05	0.0



EGP CODE

GRE.EEC.R.73.IT.W.15235.12.024.01

PAGE

93 di/of 527

7463	-1.20e-03	3.02e-03	-0.01	-3.06e-06	-2.52e-05	0.0
7468	-1.28e-03	-2.56e-03	-0.01	-2.16e-05	-2.65e-05	0.0
7469	-4.43e-04	2.27e-04	-0.01	-1.12e-05	-2.29e-05	0.0
7470	-4.49e-04	2.59e-04	-0.01	-1.27e-05	-2.30e-05	0.0
7471	-4.43e-04	2.27e-04	-0.01	-1.12e-05	-2.29e-05	0.0
7472	-4.44e-04	2.33e-04	-0.01	-1.15e-05	-2.30e-05	0.0
7473	-4.43e-04	2.27e-04	-0.01	-1.12e-05	-2.29e-05	0.0
75 1	-6.51e-04	7.60e-04	-0.02	-3.76e-05	-3.40e-05	0.0
75 2	-6.63e-04	8.80e-04	-0.02	-4.34e-05	-3.42e-05	0.0
7516	-2.47e-03	-2.80e-04	-0.01	-3.41e-05	-3.27e-05	0.0
7531	-9.54e-04	2.64e-03	-0.01	-2.56e-05	-2.45e-05	0.0
7536	-1.09e-03	-1.49e-03	-0.01	-3.28e-05	-2.66e-05	0.0
7548	-3.28e-03	-6.10e-04	-0.01	-3.66e-05	-3.65e-05	0.0
7563	-1.16e-03	3.47e-03	-0.01	-2.47e-05	-2.50e-05	0.0
7568	-1.35e-03	-2.31e-03	-0.01	-3.48e-05	-2.81e-05	0.0
7569	-4.45e-04	5.64e-04	-0.01	-2.79e-05	-2.31e-05	0.0
7570	-4.53e-04	6.44e-04	-0.01	-3.17e-05	-2.32e-05	0.0
7571	-4.45e-04	5.64e-04	-0.01	-2.79e-05	-2.31e-05	0.0
7572	-4.47e-04	5.80e-04	-0.01	-2.86e-05	-2.31e-05	0.0
7573	-4.45e-04	5.64e-04	-0.01	-2.79e-05	-2.31e-05	0.0
76 2	-6.71e-04	1.44e-03	-0.02	-7.11e-05	-3.45e-05	0.0
7616	-2.60e-03	5.85e-05	-0.01	-5.23e-05	-3.61e-05	0.0
7620	-2.58e-03	-1.91e-04	-0.01	-5.18e-05	-3.62e-05	0.0
7631	-9.42e-04	3.14e-03	-0.01	-5.08e-05	-2.49e-05	0.0
7648	-3.46e-03	-2.77e-04	-0.01	-5.50e-05	-4.12e-05	0.0
7652	-3.43e-03	-6.34e-04	-0.02	-5.43e-05	-4.13e-05	0.0
7663	-1.14e-03	4.02e-03	-0.01	-5.29e-05	-2.55e-05	0.0
7670	-4.62e-04	1.06e-03	-0.01	-5.20e-05	-2.36e-05	0.0
7672	-4.54e-04	9.49e-04	-0.01	-4.69e-05	-2.34e-05	0.0
7673	-4.52e-04	9.23e-04	-0.01	-4.56e-05	-2.34e-05	0.0
77 2	-6.90e-04	2.02e-03	-0.02	-9.98e-05	-3.54e-05	0.0
7715	-2.76e-03	2.21e-03	-0.02	-7.40e-05	-4.01e-05	0.0
7720	-2.74e-03	1.15e-03	-0.02	-6.79e-05	-4.08e-05	0.0
7731	-9.46e-04	3.71e-03	-0.02	-7.89e-05	-2.60e-05	0.0
7747	-3.68e-03	2.56e-03	-0.02	-7.80e-05	-4.65e-05	0.0
7752	-3.64e-03	1.09e-03	-0.02	-6.95e-05	-4.74e-05	0.0
7763	-1.14e-03	4.68e-03	-0.02	-8.49e-05	-2.68e-05	0.0
7770	-4.82e-04	1.48e-03	-0.02	-7.30e-05	-2.46e-05	0.0
7772	-4.70e-04	1.33e-03	-0.02	-6.57e-05	-2.42e-05	0.0
7773	-4.67e-04	1.29e-03	-0.02	-6.38e-05	-2.41e-05	0.0
78 2	-7.30e-04	2.55e-03	-0.03	-1.26e-04	-3.76e-05	0.0
7815	-2.94e-03	2.63e-03	-0.02	-9.24e-05	-4.50e-05	0.0
7819	-2.83e-03	2.94e-03	-0.02	-9.57e-05	-4.49e-05	0.0
7831	-9.76e-04	4.32e-03	-0.02	-1.08e-04	-2.85e-05	0.0
7847	-3.92e-03	3.02e-03	-0.02	-9.70e-05	-5.27e-05	0.0
7851	-3.77e-03	3.46e-03	-0.02	-1.02e-04	-5.26e-05	0.0
7863	-1.17e-03	5.39e-03	-0.02	-1.20e-04	-2.96e-05	0.0
7870	-5.19e-04	1.87e-03	-0.02	-9.22e-05	-2.65e-05	0.0
7872	-5.01e-04	1.67e-03	-0.02	-8.27e-05	-2.59e-05	0.0
7873	-4.96e-04	1.62e-03	-0.02	-8.03e-05	-2.57e-05	0.0
79 2	-7.90e-04	2.90e-03	-0.04	-1.43e-04	-4.14e-05	0.0
7915	-3.09e-03	2.90e-03	-0.03	-1.06e-04	-5.06e-05	0.0
7931	-1.04e-03	4.79e-03	-0.03	-1.31e-04	-3.69e-05	0.0
7935	-1.18e-03	4.74e-03	-0.03	-1.31e-04	-3.86e-05	0.0
7947	-4.11e-03	3.31e-03	-0.03	-1.12e-04	-5.94e-05	0.0
7963	-1.24e-03	5.97e-03	-0.03	-1.48e-04	-4.04e-05	0.0
7967	-1.44e-03	5.90e-03	-0.03	-1.47e-04	-4.28e-05	0.0
7970	-5.72e-04	2.13e-03	-0.03	-1.05e-04	-2.98e-05	0.0
7972	-5.45e-04	1.90e-03	-0.02	-9.36e-05	-2.86e-05	0.0
7973	-5.39e-04	1.84e-03	-0.02	-9.08e-05	-2.83e-05	0.0
80 2	-8.32e-04	2.96e-03	-0.04	-1.46e-04	-4.42e-05	0.0
8015	-3.22e-03	2.97e-03	-0.03	-1.09e-04	-5.58e-05	0.0
8031	-1.08e-03	4.93e-03	-0.03	-1.38e-04	-4.32e-05	0.0
8035	-1.23e-03	4.87e-03	-0.03	-1.38e-04	-4.49e-05	0.0
8047	-4.28e-03	3.39e-03	-0.03	-1.15e-04	-6.60e-05	0.0
8063	-1.28e-03	6.15e-03	-0.03	-1.57e-04	-4.84e-05	0.0
8067	-1.50e-03	6.08e-03	-0.03	-1.56e-04	-5.08e-05	0.0
8070	-6.08e-04	2.18e-03	-0.03	-1.07e-04	-3.21e-05	0.0
8072	-5.74e-04	1.93e-03	-0.03	-9.52e-05	-3.05e-05	0.0
8073	-5.66e-04	1.87e-03	-0.03	-9.22e-05	-3.01e-05	0.0
81 1	-2.88e-04	-2.45e-03	-0.04	1.22e-04	-1.62e-05	0.0
81 2	-2.65e-04	-2.88e-03	-0.04	1.43e-04	-1.47e-05	0.0
81 8	-2.54e-03	-2.83e-03	-0.03	1.04e-04	-2.26e-05	0.0
8132	-7.51e-04	-4.68e-03	-0.03	1.30e-04	-1.82e-05	0.0
8136	-6.25e-04	-4.73e-03	-0.03	1.31e-04	-1.77e-05	0.0
8140	-3.48e-03	-3.22e-03	-0.03	1.09e-04	-2.71e-05	0.0



EGP CODE

GRE.EEC.R.73.IT.W.15235.12.024.01

PAGE

94 di/of 527

8164	-9.70e-04	-5.83e-03	-0.03	1.46e-04	-2.09e-05	0.0
8168	-7.94e-04	-5.89e-03	-0.03	1.47e-04	-2.03e-05	0.0
8169	-2.03e-04	-1.82e-03	-0.03	9.03e-05	-1.13e-05	0.0
8170	-1.87e-04	-2.11e-03	-0.03	1.04e-04	-1.02e-05	0.0
8171	-2.03e-04	-1.82e-03	-0.03	9.03e-05	-1.13e-05	0.0
8172	-2.00e-04	-1.88e-03	-0.03	9.31e-05	-1.10e-05	0.0
8173	-2.03e-04	-1.82e-03	-0.03	9.03e-05	-1.13e-05	0.0
82 1	-3.47e-04	-2.35e-03	-0.03	1.17e-04	-1.89e-05	0.0
82 2	-3.34e-04	-2.75e-03	-0.03	1.36e-04	-1.78e-05	0.0
82 8	-2.52e-03	-2.71e-03	-0.02	9.84e-05	-2.29e-05	0.0
8232	-7.82e-04	-4.45e-03	-0.02	1.19e-04	-1.73e-05	0.0
8236	-6.69e-04	-4.49e-03	-0.02	1.19e-04	-1.67e-05	0.0
8240	-3.43e-03	-3.09e-03	-0.02	1.03e-04	-2.68e-05	0.0
8264	-9.99e-04	-5.53e-03	-0.02	1.32e-04	-1.91e-05	0.0
8268	-8.40e-04	-5.60e-03	-0.02	1.32e-04	-1.81e-05	0.0
8269	-2.42e-04	-1.74e-03	-0.02	8.66e-05	-1.29e-05	0.0
8270	-2.32e-04	-2.01e-03	-0.02	9.96e-05	-1.22e-05	0.0
8271	-2.42e-04	-1.74e-03	-0.02	8.66e-05	-1.29e-05	0.0
8272	-2.40e-04	-1.80e-03	-0.02	8.92e-05	-1.28e-05	0.0
8273	-2.42e-04	-1.74e-03	-0.02	8.66e-05	-1.29e-05	0.0
83 1	-4.02e-04	-2.01e-03	-0.02	9.99e-05	-2.14e-05	0.0
83 2	-3.97e-04	-2.34e-03	-0.02	1.16e-04	-2.07e-05	0.0
83 8	-2.48e-03	-1.39e-03	-0.02	8.30e-05	-2.36e-05	0.0
8312	-2.38e-03	-1.68e-03	-0.02	8.55e-05	-2.37e-05	0.0
8336	-7.18e-04	-4.01e-03	-0.02	9.51e-05	-1.68e-05	0.0
8340	-3.36e-03	-1.34e-03	-0.02	8.66e-05	-2.73e-05	0.0
8344	-3.22e-03	-1.76e-03	-0.02	9.02e-05	-2.73e-05	0.0
8368	-8.93e-04	-5.02e-03	-0.02	1.04e-04	-1.77e-05	0.0
8369	-2.77e-04	-1.49e-03	-0.02	7.39e-05	-1.46e-05	0.0
8370	-2.74e-04	-1.71e-03	-0.02	8.47e-05	-1.41e-05	0.0
8371	-2.77e-04	-1.49e-03	-0.02	7.39e-05	-1.46e-05	0.0
8372	-2.76e-04	-1.53e-03	-0.02	7.60e-05	-1.45e-05	0.0
8373	-2.77e-04	-1.49e-03	-0.02	7.39e-05	-1.46e-05	0.0
84 2	-4.47e-04	-1.80e-03	-0.02	8.89e-05	-2.31e-05	0.0
84 8	-2.42e-03	-1.02e-03	-0.01	6.34e-05	-2.39e-05	0.0
8431	-1.01e-03	1.12e-03	-0.01	4.94e-05	-1.87e-05	0.0
8436	-7.64e-04	-3.44e-03	-0.01	6.69e-05	-1.74e-05	0.0
8440	-3.26e-03	-9.68e-04	-0.01	6.60e-05	-2.72e-05	0.0
8463	-1.29e-03	2.03e-03	-0.02	4.65e-05	-1.97e-05	0.0
8468	-9.47e-04	-4.36e-03	-0.01	7.10e-05	-1.79e-05	0.0
8470	-3.06e-04	-1.31e-03	-0.01	6.48e-05	-1.57e-05	0.0
8472	-3.05e-04	-1.18e-03	-0.01	5.83e-05	-1.59e-05	0.0
8473	-3.05e-04	-1.14e-03	-0.01	5.67e-05	-1.59e-05	0.0
85 1	-4.75e-04	-1.06e-03	-0.02	5.24e-05	-2.50e-05	0.0
85 2	-4.80e-04	-1.22e-03	-0.02	6.04e-05	-2.49e-05	0.0
85 8	-2.34e-03	-6.35e-04	-0.01	4.32e-05	-2.35e-05	0.0
8533	1.57e-04	1.34e-03	-0.01	3.65e-05	-1.57e-05	0.0
8536	-8.05e-04	-2.90e-03	-0.01	4.08e-05	-1.80e-05	0.0
8540	-3.15e-03	-5.75e-04	-0.01	4.50e-05	-2.61e-05	0.0
8565	3.50e-04	2.20e-03	-0.01	3.57e-05	-1.53e-05	0.0
8568	-9.97e-04	-3.76e-03	-0.01	4.16e-05	-1.85e-05	0.0
8569	-3.24e-04	-7.80e-04	-0.01	3.86e-05	-1.69e-05	0.0
8570	-3.27e-04	-8.91e-04	-0.01	4.40e-05	-1.68e-05	0.0
8571	-3.24e-04	-7.80e-04	-0.01	3.86e-05	-1.69e-05	0.0
8572	-3.25e-04	-8.02e-04	-0.01	3.97e-05	-1.69e-05	0.0
8573	-3.24e-04	-7.80e-04	-0.01	3.86e-05	-1.69e-05	0.0
86 1	-4.92e-04	-5.83e-04	-0.01	2.89e-05	-2.59e-05	0.0
86 2	-4.99e-04	-6.73e-04	-0.01	3.32e-05	-2.59e-05	0.0
86 8	-2.26e-03	-2.64e-04	-0.01	2.35e-05	-2.27e-05	0.0
8633	1.73e-04	1.59e-03	-0.01	2.53e-05	-1.64e-05	0.0
8636	-8.42e-04	-2.45e-03	-0.01	1.73e-05	-1.85e-05	0.0
8640	-3.03e-03	-1.95e-04	-0.01	2.45e-05	-2.47e-05	0.0
8665	3.76e-04	2.39e-03	-0.01	2.69e-05	-1.60e-05	0.0
8668	-1.04e-03	-3.25e-03	-9.93e-03	1.57e-05	-1.89e-05	0.0
8669	-3.35e-04	-4.30e-04	-0.01	2.13e-05	-1.75e-05	0.0
8670	-3.39e-04	-4.91e-04	-0.01	2.42e-05	-1.74e-05	0.0
8671	-3.35e-04	-4.30e-04	-0.01	2.13e-05	-1.75e-05	0.0
8672	-3.35e-04	-4.42e-04	-0.01	2.19e-05	-1.75e-05	0.0
8673	-3.35e-04	-4.30e-04	-0.01	2.13e-05	-1.75e-05	0.0
87 1	-4.99e-04	-1.34e-04	-0.01	6.62e-06	-2.63e-05	0.0
87 2	-5.06e-04	-1.55e-04	-0.01	7.61e-06	-2.63e-05	0.0
87 8	-2.19e-03	8.77e-05	-9.69e-03	5.54e-06	-2.20e-05	0.0
8717	1.48e-03	9.62e-04	-0.01	5.57e-06	-1.37e-05	0.0
8736	-8.78e-04	-2.07e-03	-9.77e-03	-1.33e-06	-1.88e-05	0.0
8740	-2.94e-03	1.65e-04	-9.58e-03	5.83e-06	-2.37e-05	0.0
8749	2.21e-03	1.39e-03	-0.01	5.86e-06	-1.21e-05	0.0





EGP CODE

GRE.EEC.R.73.IT.W.15235.12.024.01

PAGE

95 di/of 527

8768	-1.09e-03	-2.85e-03-9.70e-03	-3.82e-06	-1.93e-05	0.0
8769	-3.39e-04	-9.89e-05-9.95e-03	4.88e-06	-1.77e-05	0.0
8770	-3.44e-04	-1.13e-04-9.61e-03	5.54e-06	-1.77e-05	0.0
8771	-3.39e-04	-9.89e-05-9.95e-03	4.88e-06	-1.77e-05	0.0
8772	-3.40e-04	-1.02e-04-9.89e-03	5.01e-06	-1.77e-05	0.0
8773	-3.39e-04	-9.89e-05-9.95e-03	4.88e-06	-1.77e-05	0.0
88 1	-4.97e-04	3.08e-04 -0.01	-1.53e-05	-2.62e-05	0.0
88 2	-5.04e-04	3.55e-04 -0.01	-1.76e-05	-2.62e-05	0.0
8810	1.47e-03	-8.41e-04 -0.01	-1.18e-05	-1.37e-05	0.0
8815	-2.21e-03	4.46e-05-9.85e-03	-1.25e-05	-2.22e-05	0.0
8831	-8.63e-04	2.21e-03-9.80e-03	-5.57e-06	-1.87e-05	0.0
8842	2.20e-03	-1.27e-03 -0.01	-1.21e-05	-1.21e-05	0.0
8847	-2.96e-03	-3.11e-05-9.75e-03	-1.30e-05	-2.41e-05	0.0
8863	-1.07e-03	3.00e-03-9.67e-03	-3.28e-06	-1.91e-05	0.0
8869	-3.37e-04	2.27e-04 -0.01	-1.13e-05	-1.76e-05	0.0
8870	-3.42e-04	2.59e-04-9.79e-03	-1.28e-05	-1.76e-05	0.0
8871	-3.37e-04	2.27e-04 -0.01	-1.13e-05	-1.76e-05	0.0
8872	-3.38e-04	2.34e-04 -0.01	-1.16e-05	-1.76e-05	0.0
8873	-3.37e-04	2.27e-04 -0.01	-1.13e-05	-1.76e-05	0.0
89 1	-4.85e-04	7.65e-04 -0.01	-3.80e-05	-2.57e-05	0.0
89 2	-4.91e-04	8.85e-04 -0.01	-4.37e-05	-2.56e-05	0.0
8915	-2.28e-03	4.04e-04 -0.01	-3.11e-05	-2.31e-05	0.0
8930	1.67e-04	-1.49e-03 -0.01	-3.03e-05	-1.63e-05	0.0
8931	-8.26e-04	2.62e-03 -0.01	-2.57e-05	-1.83e-05	0.0
8947	-3.07e-03	3.37e-04 -0.01	-3.24e-05	-2.54e-05	0.0
8962	3.65e-04	-2.31e-03 -0.01	-3.13e-05	-1.59e-05	0.0
8963	-1.02e-03	3.44e-03 -0.01	-2.48e-05	-1.87e-05	0.0
8969	-3.30e-04	5.65e-04 -0.01	-2.80e-05	-1.73e-05	0.0
8970	-3.34e-04	6.45e-04 -0.01	-3.19e-05	-1.72e-05	0.0
8971	-3.30e-04	5.65e-04 -0.01	-2.80e-05	-1.73e-05	0.0
8972	-3.31e-04	5.81e-04 -0.01	-2.88e-05	-1.73e-05	0.0
8973	-3.30e-04	5.65e-04 -0.01	-2.80e-05	-1.73e-05	0.0
90 2	-4.66e-04	1.45e-03 -0.02	-7.16e-05	-2.43e-05	0.0
9015	-2.37e-03	7.85e-04 -0.01	-5.12e-05	-2.39e-05	0.0
9031	-7.89e-04	3.11e-03 -0.01	-5.07e-05	-1.78e-05	0.0
9036	-9.86e-04	-1.24e-03 -0.01	-4.35e-05	-1.92e-05	0.0
9047	-3.19e-03	7.27e-04 -0.01	-5.33e-05	-2.69e-05	0.0
9063	-9.79e-04	3.98e-03 -0.01	-5.26e-05	-1.82e-05	0.0
9068	-1.25e-03	-2.10e-03 -0.01	-4.26e-05	-2.02e-05	0.0
9070	-3.18e-04	1.06e-03 -0.01	-5.22e-05	-1.64e-05	0.0
9072	-3.16e-04	9.50e-04 -0.01	-4.71e-05	-1.65e-05	0.0
9073	-3.16e-04	9.24e-04 -0.01	-4.58e-05	-1.66e-05	0.0
91 1	-4.27e-04	1.74e-03 -0.02	-8.65e-05	-2.28e-05	0.0
91 2	-4.25e-04	2.02e-03 -0.02	-1.00e-04	-2.23e-05	0.0
9115	-2.44e-03	1.17e-03 -0.02	-7.17e-05	-2.44e-05	0.0
9120	-2.41e-03	1.27e-04 -0.02	-6.56e-05	-2.44e-05	0.0
9131	-7.48e-04	3.67e-03 -0.02	-7.84e-05	-1.68e-05	0.0
9147	-3.30e-03	1.12e-03 -0.02	-7.47e-05	-2.79e-05	0.0
9152	-3.26e-03	-3.34e-04 -0.02	-6.62e-05	-2.80e-05	0.0
9163	-9.30e-04	4.62e-03 -0.02	-8.42e-05	-1.74e-05	0.0
9169	-2.93e-04	1.29e-03 -0.02	-6.39e-05	-1.55e-05	0.0
9170	-2.92e-04	1.48e-03 -0.02	-7.31e-05	-1.51e-05	0.0
9171	-2.93e-04	1.29e-03 -0.02	-6.39e-05	-1.55e-05	0.0
9172	-2.93e-04	1.33e-03 -0.02	-6.58e-05	-1.54e-05	0.0
9173	-2.93e-04	1.29e-03 -0.02	-6.39e-05	-1.55e-05	0.0
92 1	-3.78e-04	2.17e-03 -0.03	-1.08e-04	-2.05e-05	0.0
92 2	-3.69e-04	2.54e-03 -0.03	-1.26e-04	-1.96e-05	0.0
9215	-2.49e-03	2.55e-03 -0.02	-9.03e-05	-2.38e-05	0.0
9231	-7.03e-04	4.23e-03 -0.02	-1.06e-04	-1.69e-05	0.0
9235	-8.04e-04	4.19e-03 -0.02	-1.06e-04	-1.77e-05	0.0
9247	-3.39e-03	2.92e-03 -0.02	-9.43e-05	-2.77e-05	0.0
9263	-8.79e-04	5.27e-03 -0.02	-1.17e-04	-1.81e-05	0.0
9267	-1.02e-03	5.22e-03 -0.02	-1.16e-04	-1.92e-05	0.0
9269	-2.61e-04	1.61e-03 -0.02	-8.00e-05	-1.40e-05	0.0
9270	-2.55e-04	1.85e-03 -0.02	-9.18e-05	-1.34e-05	0.0
9271	-2.61e-04	1.61e-03 -0.02	-8.00e-05	-1.40e-05	0.0
9272	-2.60e-04	1.66e-03 -0.02	-8.23e-05	-1.38e-05	0.0
9273	-2.61e-04	1.61e-03 -0.02	-8.00e-05	-1.40e-05	0.0
93 1	-3.20e-04	2.44e-03 -0.03	-1.21e-04	-1.78e-05	0.0
93 2	-3.02e-04	2.86e-03 -0.03	-1.42e-04	-1.66e-05	0.0
9315	-2.53e-03	2.81e-03 -0.02	-1.03e-04	-2.31e-05	0.0
9331	-6.60e-04	4.64e-03 -0.03	-1.27e-04	-1.71e-05	0.0
9335	-7.76e-04	4.60e-03 -0.03	-1.26e-04	-1.77e-05	0.0
9347	-3.46e-03	3.19e-03 -0.03	-1.07e-04	-2.74e-05	0.0
9363	-8.34e-04	5.78e-03 -0.03	-1.41e-04	-1.90e-05	0.0
9367	-9.98e-04	5.72e-03 -0.03	-1.41e-04	-1.98e-05	0.0





EGP CODE

GRE.EEC.R.73.IT.W.15235.12.024.01

PAGE

96 di/of 527

9369	-2.23e-04	1.81e-03	-0.02	-8.99e-05	-1.23e-05	0.0
9370	-2.11e-04	2.09e-03	-0.03	-1.04e-04	-1.14e-05	0.0
9371	-2.23e-04	1.81e-03	-0.02	-8.99e-05	-1.23e-05	0.0
9372	-2.21e-04	1.87e-03	-0.02	-9.26e-05	-1.21e-05	0.0
9373	-2.23e-04	1.81e-03	-0.02	-8.99e-05	-1.23e-05	0.0
94 1	-2.84e-04	2.47e-03	-0.04	-1.23e-04	-1.63e-05	0.0
94 2	-2.60e-04	2.91e-03	-0.04	-1.44e-04	-1.47e-05	0.0
9415	-2.54e-03	2.86e-03	-0.03	-1.05e-04	-2.28e-05	0.0
9431	-6.37e-04	4.75e-03	-0.03	-1.32e-04	-1.80e-05	0.0
9435	-7.60e-04	4.71e-03	-0.03	-1.32e-04	-1.84e-05	0.0
9447	-3.48e-03	3.25e-03	-0.03	-1.10e-04	-2.73e-05	0.0
9463	-8.11e-04	5.92e-03	-0.03	-1.49e-04	-2.06e-05	0.0
9467	-9.84e-04	5.87e-03	-0.03	-1.48e-04	-2.12e-05	0.0
9469	-2.00e-04	1.84e-03	-0.03	-9.12e-05	-1.13e-05	0.0
9470	-1.84e-04	2.13e-03	-0.03	-1.06e-04	-1.03e-05	0.0
9471	-2.00e-04	1.84e-03	-0.03	-9.12e-05	-1.13e-05	0.0
9472	-1.97e-04	1.90e-03	-0.03	-9.41e-05	-1.11e-05	0.0
9473	-2.00e-04	1.84e-03	-0.03	-9.12e-05	-1.13e-05	0.0
95 2	2.98e-04	-3.04e-03	-0.04	1.50e-04	1.42e-05	0.0
95 6	2.38e-03	-2.87e-03	-0.03	9.50e-05	1.33e-05	0.0
9532	-3.05e-04	-4.45e-03	-0.03	1.34e-04	3.70e-06	0.0
9536	-1.90e-04	-4.79e-03	-0.03	1.35e-04	3.80e-06	0.0
9538	3.27e-03	-3.25e-03	-0.03	9.51e-05	1.56e-05	0.0
9564	-4.91e-04	-5.48e-03	-0.03	1.50e-04	2.33e-06	0.0
9568	-3.29e-04	-5.94e-03	-0.03	1.51e-04	2.46e-06	0.0
9570	2.29e-04	-2.22e-03	-0.03	1.10e-04	1.12e-05	0.0
9572	1.72e-04	-1.97e-03	-0.03	9.76e-05	8.04e-06	0.0
9573	1.58e-04	-1.91e-03	-0.03	9.46e-05	7.26e-06	0.0
96 2	8.62e-05	-2.89e-03	-0.03	1.43e-04	3.53e-06	0.0
96 4	1.20e-04	-2.16e-03	-0.02	1.07e-04	6.17e-06	0.0
96 5	2.20e-03	-9.13e-04	-0.02	7.93e-05	6.03e-06	0.0
9632	-4.70e-04	-4.50e-03	-0.02	1.23e-04	-1.83e-06	0.0
9636	-3.69e-04	-4.54e-03	-0.02	1.23e-04	-1.58e-06	0.0
9637	3.07e-03	-5.57e-04	-0.02	7.49e-05	8.03e-06	0.0
9664	-6.71e-04	-5.57e-03	-0.02	1.35e-04	-2.89e-06	0.0
9668	-5.28e-04	-5.62e-03	-0.02	1.36e-04	-2.55e-06	0.0
9670	7.60e-05	-2.11e-03	-0.02	1.04e-04	3.44e-06	0.0
9672	4.04e-05	-1.88e-03	-0.02	9.34e-05	1.41e-06	0.0
9673	3.15e-05	-1.83e-03	-0.02	9.06e-05	0.0	0.0
97 1	-1.29e-04	-2.10e-03	-0.02	1.04e-04	-7.74e-06	0.0
97 2	-9.45e-05	-2.45e-03	-0.02	1.21e-04	-5.58e-06	0.0
97 8	-2.19e-03	-1.49e-03	-0.02	8.58e-05	-9.56e-06	0.0
9732	-5.92e-04	-3.72e-03	-0.02	9.77e-05	-7.50e-06	0.0
9736	-5.06e-04	-4.03e-03	-0.02	9.77e-05	-7.12e-06	0.0
9740	-3.03e-03	-1.46e-03	-0.02	8.92e-05	-1.15e-05	0.0
9764	-7.98e-04	-4.59e-03	-0.02	1.06e-04	-8.66e-06	0.0
9768	-6.77e-04	-5.03e-03	-0.02	1.06e-04	-8.13e-06	0.0
9769	-7.78e-05	-1.55e-03	-0.02	7.70e-05	-4.59e-06	0.0
9770	-5.47e-05	-1.79e-03	-0.02	8.84e-05	-3.15e-06	0.0
9771	-7.78e-05	-1.55e-03	-0.02	7.70e-05	-4.59e-06	0.0
9772	-7.32e-05	-1.60e-03	-0.02	7.93e-05	-4.30e-06	0.0
9773	-7.78e-05	-1.55e-03	-0.02	7.70e-05	-4.59e-06	0.0
98 1	-2.31e-04	-1.61e-03	-0.02	7.98e-05	-1.29e-05	0.0
98 2	-2.17e-04	-1.87e-03	-0.02	9.24e-05	-1.18e-05	0.0
98 8	-2.19e-03	-1.09e-03	-0.01	6.45e-05	-1.30e-05	0.0
9833	2.97e-04	1.07e-03	-0.01	4.93e-05	-6.43e-06	0.0
9836	-6.02e-04	-3.44e-03	-0.01	6.84e-05	-1.02e-05	0.0
9840	-3.00e-03	-1.05e-03	-0.01	6.68e-05	-1.49e-05	0.0
9865	4.77e-04	1.98e-03	-0.01	4.55e-05	-5.67e-06	0.0
9868	-7.81e-04	-4.35e-03	-0.01	7.22e-05	-1.10e-05	0.0
9869	-1.52e-04	-1.19e-03	-0.01	5.88e-05	-8.33e-06	0.0
9870	-1.43e-04	-1.36e-03	-0.01	6.72e-05	-7.59e-06	0.0
9871	-1.52e-04	-1.19e-03	-0.01	5.88e-05	-8.33e-06	0.0
9872	-1.50e-04	-1.22e-03	-0.01	6.05e-05	-8.18e-06	0.0
9873	-1.52e-04	-1.19e-03	-0.01	5.88e-05	-8.33e-06	0.0
99 1	-2.93e-04	-1.09e-03	-0.02	5.41e-05	-1.59e-05	0.0
99 2	-2.90e-04	-1.26e-03	-0.02	6.25e-05	-1.54e-05	0.0
99 8	-2.15e-03	-6.81e-04	-0.01	4.31e-05	-1.44e-05	0.0
9933	2.74e-04	1.29e-03	-0.01	3.81e-05	-9.40e-06	0.0
9936	-6.67e-04	-2.90e-03	-0.01	4.17e-05	-1.17e-05	0.0
9940	-2.93e-03	-6.29e-04	-0.01	4.44e-05	-1.60e-05	0.0
9965	4.62e-04	2.13e-03	-0.01	3.74e-05	-8.94e-06	0.0
9968	-8.55e-04	-3.74e-03	-0.01	4.24e-05	-1.21e-05	0.0
9969	-1.97e-04	-8.05e-04	-0.01	3.99e-05	-1.05e-05	0.0
9970	-1.95e-04	-9.20e-04	-0.01	4.54e-05	-1.02e-05	0.0
9971	-1.97e-04	-8.05e-04	-0.01	3.99e-05	-1.05e-05	0.0



EGP CODE

GRE.EEC.R.73.IT.W.15235.12.024.01

PAGE

97 di/of 527

9972	-1.96e-04	-8.28e-04	-0.01	4.10e-05	-1.05e-05	0.0
9973	-1.97e-04	-8.05e-04	-0.01	3.99e-05	-1.05e-05	0.0
1001	-3.26e-04	-6.01e-04	-0.01	2.98e-05	-1.76e-05	0.0
1002	-3.29e-04	-6.94e-04	-0.01	3.42e-05	-1.74e-05	0.0
1008	-2.10e-03	-2.97e-04-9.46e-03		2.31e-05	-1.46e-05	0.0
10017	1.53e-03	6.06e-04	-0.01	2.20e-05	-9.65e-06	0.0
10036	-7.16e-04	-2.43e-03-9.36e-03		1.78e-05	-1.25e-05	0.0
10040	-2.85e-03	-2.37e-04-9.30e-03		2.35e-05	-1.58e-05	0.0
10049	2.23e-03	1.02e-03	-0.01	2.21e-05	-8.82e-06	0.0
10068	-9.15e-04	-3.23e-03-9.16e-03		1.61e-05	-1.28e-05	0.0
10069	-2.20e-04	-4.43e-04-9.87e-03		2.19e-05	-1.17e-05	0.0
10070	-2.22e-04	-5.05e-04-9.62e-03		2.49e-05	-1.16e-05	0.0
10071	-2.20e-04	-4.43e-04-9.87e-03		2.19e-05	-1.17e-05	0.0
10072	-2.20e-04	-4.55e-04-9.82e-03		2.25e-05	-1.17e-05	0.0
10073	-2.20e-04	-4.43e-04-9.87e-03		2.19e-05	-1.17e-05	0.0
1011	-3.39e-04	-1.38e-04	-0.01	6.81e-06	-1.83e-05	0.0
1012	-3.44e-04	-1.59e-04	-0.01	7.83e-06	-1.81e-05	0.0
1018	-2.04e-03	5.92e-05-8.79e-03		5.02e-06	-1.44e-05	0.0
10117	1.55e-03	9.20e-04-9.65e-03		6.14e-06	-1.03e-05	0.0
10136	-7.57e-04	-2.05e-03-8.99e-03		-1.27e-06	-1.27e-05	0.0
10140	-2.77e-03	1.26e-04-8.63e-03		5.04e-06	-1.52e-05	0.0
10149	2.26e-03	1.33e-03-9.83e-03		6.60e-06	-9.51e-06	0.0
10168	-9.68e-04	-2.83e-03-8.90e-03		-3.80e-06	-1.29e-05	0.0
10169	-2.29e-04	-1.02e-04-9.21e-03		5.01e-06	-1.22e-05	0.0
10170	-2.32e-04	-1.16e-04-8.87e-03		5.69e-06	-1.21e-05	0.0
10171	-2.29e-04	-1.02e-04-9.21e-03		5.01e-06	-1.22e-05	0.0
10172	-2.30e-04	-1.05e-04-9.14e-03		5.15e-06	-1.22e-05	0.0
10173	-2.29e-04	-1.02e-04-9.21e-03		5.01e-06	-1.22e-05	0.0
1021	-3.35e-04	3.16e-04	-0.01	-1.57e-05	-1.81e-05	0.0
1022	-3.39e-04	3.65e-04	-0.01	-1.81e-05	-1.80e-05	0.0
10210	1.54e-03	-7.94e-04-9.85e-03		-1.25e-05	-1.01e-05	0.0
10215	-2.06e-03	7.43e-05-8.95e-03		-1.19e-05	-1.44e-05	0.0
10231	-7.40e-04	2.19e-03-9.01e-03		-5.79e-06	-1.28e-05	0.0
10242	2.25e-03	-1.20e-03	-0.01	-1.29e-05	-9.32e-06	0.0
10247	-2.79e-03	8.47e-06-8.78e-03		-1.21e-05	-1.54e-05	0.0
10263	-9.46e-04	2.97e-03-8.87e-03		-3.47e-06	-1.30e-05	0.0
10269	-2.26e-04	2.33e-04-9.37e-03		-1.16e-05	-1.21e-05	0.0
10270	-2.29e-04	2.66e-04-9.05e-03		-1.31e-05	-1.20e-05	0.0
10271	-2.26e-04	2.33e-04-9.37e-03		-1.16e-05	-1.21e-05	0.0
10272	-2.27e-04	2.40e-04-9.31e-03		-1.19e-05	-1.21e-05	0.0
10273	-2.26e-04	2.33e-04-9.37e-03		-1.16e-05	-1.21e-05	0.0
1031	-3.14e-04	7.89e-04	-0.01	-3.92e-05	-1.71e-05	0.0
1032	-3.14e-04	9.13e-04	-0.01	-4.51e-05	-1.68e-05	0.0
10315	-2.11e-03	4.41e-04-9.98e-03		-3.06e-05	-1.46e-05	0.0
10330	2.74e-04	-1.44e-03	-0.01	-3.14e-05	-1.04e-05	0.0
10331	-6.97e-04	2.60e-03-9.78e-03		-2.63e-05	-1.23e-05	0.0
10347	-2.87e-03	3.82e-04-9.83e-03		-3.14e-05	-1.59e-05	0.0
10362	4.68e-04	-2.25e-03	-0.01	-3.25e-05	-1.00e-05	0.0
10363	-8.91e-04	3.41e-03-9.54e-03		-2.53e-05	-1.27e-05	0.0
10369	-2.11e-04	5.82e-04	-0.01	-2.89e-05	-1.14e-05	0.0
10370	-2.12e-04	6.64e-04	-0.01	-3.28e-05	-1.11e-05	0.0
10371	-2.11e-04	5.82e-04	-0.01	-2.89e-05	-1.14e-05	0.0
10372	-2.11e-04	5.98e-04	-0.01	-2.97e-05	-1.13e-05	0.0
10373	-2.11e-04	5.82e-04	-0.01	-2.89e-05	-1.14e-05	0.0
1041	-2.70e-04	1.29e-03	-0.02	-6.43e-05	-1.49e-05	0.0
1042	-2.63e-04	1.50e-03	-0.02	-7.42e-05	-1.42e-05	0.0
10415	-2.16e-03	8.38e-04	-0.01	-5.14e-05	-1.41e-05	0.0
10430	2.83e-04	-1.20e-03	-0.01	-4.31e-05	-8.31e-06	0.0
10431	-6.43e-04	3.10e-03	-0.01	-5.16e-05	-1.13e-05	0.0
10447	-2.96e-03	7.90e-04	-0.01	-5.30e-05	-1.59e-05	0.0
10462	4.68e-04	-2.06e-03	-0.01	-4.14e-05	-7.71e-06	0.0
10463	-8.28e-04	3.97e-03	-0.01	-5.33e-05	-1.19e-05	0.0
10469	-1.80e-04	9.54e-04	-0.01	-4.73e-05	-9.82e-06	0.0
10470	-1.75e-04	1.09e-03	-0.01	-5.40e-05	-9.34e-06	0.0
10471	-1.80e-04	9.54e-04	-0.01	-4.73e-05	-9.82e-06	0.0
10472	-1.79e-04	9.82e-04	-0.01	-4.87e-05	-9.73e-06	0.0
10473	-1.80e-04	9.54e-04	-0.01	-4.73e-05	-9.82e-06	0.0
1051	-1.93e-04	1.81e-03	-0.02	-9.00e-05	-1.11e-05	0.0
1052	-1.71e-04	2.11e-03	-0.02	-1.04e-04	-9.69e-06	0.0
10515	-2.19e-03	1.25e-03	-0.02	-7.33e-05	-1.22e-05	0.0
10530	3.21e-04	-1.00e-03	-0.02	-5.26e-05	-4.75e-06	0.0
10531	-5.69e-04	3.68e-03	-0.01	-8.02e-05	-9.40e-06	0.0
10547	-3.02e-03	1.22e-03	-0.02	-7.61e-05	-1.43e-05	0.0
10562	4.98e-04	-1.94e-03	-0.02	-4.71e-05	-3.82e-06	0.0
10563	-7.46e-04	4.62e-03	-0.01	-8.57e-05	-1.03e-05	0.0
10569	-1.24e-04	1.34e-03	-0.02	-6.64e-05	-7.08e-06	0.0



EGP CODE

GRE.EEC.R.73.IT.W.15235.12.024.01

PAGE

98 di/of 527

10570	-1.10e-04	1.54e-03	-0.02	-7.60e-05	-6.11e-06	0.0
10571	-1.24e-04	1.34e-03	-0.02	-6.64e-05	-7.08e-06	0.0
10572	-1.21e-04	1.38e-03	-0.02	-6.83e-05	-6.88e-06	0.0
10573	-1.24e-04	1.34e-03	-0.02	-6.64e-05	-7.08e-06	0.0
1061	-7.13e-05	2.27e-03	-0.03	-1.13e-04	-5.08e-06	0.0
1062	-2.46e-05	2.66e-03	-0.03	-1.32e-04	-2.35e-06	0.0
10615	-2.17e-03	2.56e-03	-0.02	-9.36e-05	-7.99e-06	0.0
10631	-4.59e-04	4.26e-03	-0.02	-1.09e-04	-5.37e-06	0.0
10635	-5.50e-04	4.22e-03	-0.02	-1.09e-04	-5.71e-06	0.0
10647	-3.03e-03	2.90e-03	-0.02	-9.75e-05	-1.01e-05	0.0
10663	-6.29e-04	5.29e-03	-0.02	-1.19e-04	-6.45e-06	0.0
10667	-7.56e-04	5.24e-03	-0.02	-1.19e-04	-6.93e-06	0.0
10669	-3.53e-05	1.68e-03	-0.02	-8.35e-05	-2.64e-06	0.0
10670	-4.20e-06	1.94e-03	-0.02	-9.60e-05	0.0	0.0
10671	-3.53e-05	1.68e-03	-0.02	-8.35e-05	-2.64e-06	0.0
10672	-2.91e-05	1.73e-03	-0.02	-8.60e-05	-2.27e-06	0.0
10673	-3.53e-05	1.68e-03	-0.02	-8.35e-05	-2.64e-06	0.0
1072	1.74e-04	3.01e-03	-0.03	-1.49e-04	7.73e-06	0.0
1074	1.86e-04	2.25e-03	-0.03	-1.11e-04	9.33e-06	0.0
10714	2.28e-03	9.59e-04	-0.02	-8.18e-05	9.00e-06	0.0
10731	-3.09e-04	4.69e-03	-0.03	-1.31e-04	1.07e-06	0.0
10735	-4.14e-04	4.65e-03	-0.03	-1.30e-04	0.0	0.0
10746	3.16e-03	5.96e-04	-0.02	-7.70e-05	1.12e-05	0.0
10763	-4.65e-04	5.81e-03	-0.03	-1.45e-04	0.0	0.0
10767	-6.13e-04	5.76e-03	-0.03	-1.45e-04	0.0	0.0
10770	1.40e-04	2.20e-03	-0.03	-1.09e-04	6.48e-06	0.0
10772	9.56e-05	1.95e-03	-0.02	-9.70e-05	4.03e-06	0.0
10773	8.46e-05	1.89e-03	-0.02	-9.41e-05	3.42e-06	0.0
1082	3.00e-04	3.06e-03	-0.04	-1.52e-04	1.41e-05	0.0
10813	2.39e-03	1.89e-03	-0.03	-9.59e-05	1.33e-05	0.0
10831	-1.98e-04	4.81e-03	-0.03	-1.36e-04	3.99e-06	0.0
10835	-3.11e-04	4.78e-03	-0.03	-1.36e-04	3.92e-06	0.0
10845	3.28e-03	1.87e-03	-0.03	-9.60e-05	1.56e-05	0.0
10863	-3.41e-04	5.97e-03	-0.03	-1.53e-04	2.74e-06	0.0
10867	-5.00e-04	5.92e-03	-0.03	-1.52e-04	2.65e-06	0.0
10870	2.31e-04	2.24e-03	-0.03	-1.11e-04	1.11e-05	0.0
10872	1.74e-04	1.99e-03	-0.03	-9.85e-05	7.99e-06	0.0
10873	1.60e-04	1.92e-03	-0.03	-9.55e-05	7.22e-06	0.0
1092	6.32e-04	-3.37e-03	-0.04	1.65e-04	3.16e-05	0.0
1096	2.64e-03	-3.05e-03	-0.03	1.05e-04	2.71e-05	0.0
10932	-7.01e-05	-4.72e-03	-0.03	1.46e-04	2.04e-05	0.0
10936	4.99e-05	-5.02e-03	-0.03	1.47e-04	2.09e-05	0.0
10938	3.55e-03	-3.42e-03	-0.03	1.06e-04	3.05e-05	0.0
10964	-2.49e-04	-5.77e-03	-0.03	1.63e-04	2.12e-05	0.0
10968	-8.02e-05	-6.19e-03	-0.03	1.64e-04	2.18e-05	0.0
10970	4.75e-04	-2.46e-03	-0.03	1.21e-04	2.40e-05	0.0
10972	3.96e-04	-2.18e-03	-0.03	1.07e-04	1.97e-05	0.0
10973	3.77e-04	-2.11e-03	-0.03	1.04e-04	1.86e-05	0.0
1102	3.16e-04	-3.19e-03	-0.03	1.57e-04	1.56e-05	0.0
1105	2.37e-03	-1.13e-03	-0.02	8.79e-05	1.53e-05	0.0
11032	-3.24e-04	-4.71e-03	-0.02	1.33e-04	5.68e-06	0.0
11036	-2.21e-04	-4.74e-03	-0.02	1.33e-04	6.10e-06	0.0
11037	3.25e-03	-7.84e-04	-0.02	8.36e-05	1.78e-05	0.0
11064	-5.29e-04	-5.79e-03	-0.02	1.46e-04	4.39e-06	0.0
11068	-3.83e-04	-5.84e-03	-0.02	1.46e-04	4.98e-06	0.0
11070	2.42e-04	-2.33e-03	-0.02	1.14e-04	1.22e-05	0.0
11072	1.97e-04	-2.07e-03	-0.02	1.02e-04	9.60e-06	0.0
11073	1.85e-04	-2.01e-03	-0.02	9.89e-05	8.95e-06	0.0
1112	7.49e-05	-2.65e-03	-0.02	1.30e-04	3.00e-06	0.0
1114	9.52e-05	-1.97e-03	-0.02	9.67e-05	4.92e-06	0.0
1115	2.15e-03	-1.70e-03	-0.02	7.45e-05	6.78e-06	0.0
11134	6.64e-04	-3.80e-03	-0.02	9.97e-05	0.0	0.0
11136	-3.95e-04	-4.11e-03	-0.02	1.03e-04	-2.47e-06	0.0
11137	3.00e-03	-1.71e-03	-0.02	7.14e-05	8.98e-06	0.0
11166	9.14e-04	-4.66e-03	-0.02	1.07e-04	0.0	0.0
11168	-5.68e-04	-5.09e-03	-0.02	1.11e-04	-3.95e-06	0.0
11170	6.54e-05	-1.93e-03	-0.02	9.50e-05	2.92e-06	0.0
11172	4.28e-05	-1.72e-03	-0.02	8.51e-05	1.57e-06	0.0
11173	3.71e-05	-1.67e-03	-0.02	8.26e-05	1.23e-06	0.0
1121	-8.71e-05	-1.70e-03	-0.02	8.42e-05	-5.63e-06	0.0
1122	-6.87e-05	-1.98e-03	-0.02	9.77e-05	-4.34e-06	0.0
1128	-2.06e-03	-1.18e-03	-0.01	6.66e-05	-6.99e-06	0.0
11233	3.94e-04	9.58e-04	-0.01	5.37e-05	-1.19e-06	0.0
11236	-4.98e-04	-3.47e-03	-0.01	7.04e-05	-5.40e-06	0.0
11240	-2.87e-03	-1.15e-03	-0.01	6.84e-05	-8.47e-06	0.0
11265	5.72e-04	1.85e-03	-0.01	5.04e-05	0.0	0.0



EGP CODE

GRE.EEC.R.73.IT.W.15235.12.024.01

PAGE

99 di/of 527

11268	-6.76e-04	-4.36e-03	-0.01	7.38e-05	-6.24e-06	0.0
11269	-5.17e-05	-1.26e-03	-0.01	6.21e-05	-3.29e-06	0.0
11270	-3.94e-05	-1.44e-03	-0.01	7.11e-05	-2.43e-06	0.0
11271	-5.17e-05	-1.26e-03	-0.01	6.21e-05	-3.29e-06	0.0
11272	-4.92e-05	-1.29e-03	-0.01	6.39e-05	-3.12e-06	0.0
11273	-5.17e-05	-1.26e-03	-0.01	6.21e-05	-3.29e-06	0.0
1131	-1.55e-04	-1.14e-03	-0.01	5.66e-05	-9.00e-06	0.0
1132	-1.50e-04	-1.33e-03	-0.01	6.54e-05	-8.36e-06	0.0
1138	-2.02e-03	-7.41e-04	-0.01	4.33e-05	-8.02e-06	0.0
11333	3.62e-04	1.21e-03	-0.01	4.22e-05	-4.78e-06	0.0
11336	-5.65e-04	-2.90e-03	-0.01	4.11e-05	-6.76e-06	0.0
11340	-2.79e-03	-6.98e-04	-0.01	4.39e-05	-8.92e-06	0.0
11365	5.48e-04	2.04e-03	-0.01	4.25e-05	-4.38e-06	0.0
11368	-7.51e-04	-3.72e-03	-0.01	4.08e-05	-7.16e-06	0.0
11369	-1.02e-04	-8.42e-04	-0.01	4.17e-05	-5.77e-06	0.0
11370	-9.78e-05	-9.64e-04	-0.01	4.75e-05	-5.34e-06	0.0
11371	-1.02e-04	-8.42e-04	-0.01	4.17e-05	-5.77e-06	0.0
11372	-1.01e-04	-8.67e-04	-0.01	4.28e-05	-5.68e-06	0.0
11373	-1.02e-04	-8.42e-04	-0.01	4.17e-05	-5.77e-06	0.0
1141	-1.91e-04	-6.25e-04	-0.01	3.09e-05	-1.08e-05	0.0
1142	-1.92e-04	-7.24e-04	-0.01	3.56e-05	-1.05e-05	0.0
1148	-1.97e-03	-3.40e-04-8.92e-03		2.31e-05	-8.27e-06	0.0
11417	1.60e-03	5.41e-04-9.98e-03		2.33e-05	-6.33e-06	0.0
11436	-6.16e-04	-2.42e-03-8.88e-03		1.83e-05	-7.47e-06	0.0
11440	-2.71e-03	-2.89e-04-8.72e-03		2.32e-05	-8.75e-06	0.0
11449	2.29e-03	9.40e-04 -0.01		2.36e-05	-6.05e-06	0.0
11468	-8.11e-04	-3.21e-03-8.66e-03		1.65e-05	-7.64e-06	0.0
11469	-1.27e-04	-4.60e-04-9.41e-03		2.28e-05	-7.05e-06	0.0
11470	-1.28e-04	-5.26e-04-9.17e-03		2.59e-05	-6.84e-06	0.0
11471	-1.27e-04	-4.60e-04-9.41e-03		2.28e-05	-7.05e-06	0.0
11472	-1.27e-04	-4.74e-04-9.37e-03		2.34e-05	-7.01e-06	0.0
11473	-1.27e-04	-4.60e-04-9.41e-03		2.28e-05	-7.05e-06	0.0
1151	-2.04e-04	-1.44e-04 -0.01		7.07e-06	-1.15e-05	0.0
1152	-2.08e-04	-1.66e-04 -0.01		8.13e-06	-1.13e-05	0.0
1158	-1.92e-03	2.67e-05-8.25e-03		4.74e-06	-8.14e-06	0.0
11517	1.61e-03	8.74e-04-9.22e-03		6.63e-06	-7.13e-06	0.0
11536	-6.57e-04	-2.03e-03-8.49e-03		-1.26e-06	-7.64e-06	0.0
11540	-2.63e-03	8.19e-05-8.06e-03		4.58e-06	-8.38e-06	0.0
11549	2.31e-03	1.26e-03-9.42e-03		7.22e-06	-6.96e-06	0.0
11568	-8.64e-04	-2.79e-03-8.39e-03		-3.85e-06	-7.68e-06	0.0
11569	-1.37e-04	-1.06e-04-8.73e-03		5.20e-06	-7.55e-06	0.0
11570	-1.40e-04	-1.21e-04-8.39e-03		5.91e-06	-7.43e-06	0.0
11571	-1.37e-04	-1.06e-04-8.73e-03		5.20e-06	-7.55e-06	0.0
11572	-1.38e-04	-1.09e-04-8.66e-03		5.34e-06	-7.53e-06	0.0
11573	-1.37e-04	-1.06e-04-8.73e-03		5.20e-06	-7.55e-06	0.0
1161	-2.00e-04	3.28e-04 -0.01		-1.63e-05	-1.13e-05	0.0
1162	-2.03e-04	3.80e-04 -0.01		-1.88e-05	-1.11e-05	0.0
11610	1.61e-03	-7.42e-04-9.43e-03		-1.33e-05	-6.92e-06	0.0
11615	-1.93e-03	1.10e-04-8.40e-03		-1.18e-05	-8.19e-06	0.0
11631	-6.40e-04	2.17e-03-8.52e-03		-6.03e-06	-7.71e-06	0.0
11642	2.31e-03	-1.13e-03-9.64e-03		-1.38e-05	-6.71e-06	0.0
11647	-2.65e-03	5.54e-05-8.20e-03		-1.17e-05	-8.49e-06	0.0
11663	-8.42e-04	2.94e-03-8.37e-03		-3.63e-06	-7.82e-06	0.0
11669	-1.34e-04	2.42e-04-8.89e-03		-1.20e-05	-7.43e-06	0.0
11670	-1.36e-04	2.76e-04-8.58e-03		-1.36e-05	-7.29e-06	0.0
11671	-1.34e-04	2.42e-04-8.89e-03		-1.20e-05	-7.43e-06	0.0
11672	-1.35e-04	2.49e-04-8.83e-03		-1.23e-05	-7.41e-06	0.0
11673	-1.34e-04	2.42e-04-8.89e-03		-1.20e-05	-7.43e-06	0.0
1171	-1.78e-04	8.22e-04 -0.01		-4.08e-05	-1.02e-05	0.0
1172	-1.76e-04	9.53e-04 -0.01		-4.71e-05	-9.80e-06	0.0
11715	-1.98e-03	4.89e-04-9.44e-03		-3.08e-05	-8.20e-06	0.0
11730	3.59e-04	-1.39e-03 -0.01		-3.30e-05	-6.02e-06	0.0
11731	-5.95e-04	2.60e-03-9.31e-03		-2.70e-05	-7.28e-06	0.0
11747	-2.73e-03	4.40e-04-9.24e-03		-3.11e-05	-8.82e-06	0.0
11762	5.50e-04	-2.18e-03 -0.01		-3.42e-05	-5.77e-06	0.0
11763	-7.86e-04	3.40e-03-9.06e-03		-2.58e-05	-7.53e-06	0.0
11769	-1.18e-04	6.06e-04-9.93e-03		-3.00e-05	-6.65e-06	0.0
11770	-1.17e-04	6.93e-04-9.76e-03		-3.42e-05	-6.38e-06	0.0
11771	-1.18e-04	6.06e-04-9.93e-03		-3.00e-05	-6.65e-06	0.0
11772	-1.18e-04	6.23e-04-9.89e-03		-3.09e-05	-6.60e-06	0.0
11773	-1.18e-04	6.06e-04-9.93e-03		-3.00e-05	-6.65e-06	0.0
1181	-1.30e-04	1.36e-03 -0.02		-6.74e-05	-7.89e-06	0.0
1182	-1.19e-04	1.58e-03 -0.02		-7.80e-05	-7.03e-06	0.0
11815	-2.03e-03	9.09e-04 -0.01		-5.24e-05	-7.71e-06	0.0
11830	3.73e-04	-1.11e-03 -0.01		-4.62e-05	-3.58e-06	0.0
11831	-5.39e-04	3.11e-03 -0.01		-5.30e-05	-6.33e-06	0.0



EGP CODE

GRE.EEC.R.73.IT.W.15235.12.024.01

PAGE

100 di/of 527

11847	-2.81e-03	8.69e-04	-0.01	-5.35e-05	-8.82e-06	0.0
11862	5.55e-04	-1.95e-03	-0.01	-4.49e-05	-3.03e-06	0.0
11863	-7.21e-04	3.96e-03	-0.01	-5.44e-05	-6.87e-06	0.0
11869	-8.28e-05	1.00e-03	-0.01	-4.96e-05	-4.95e-06	0.0
11870	-7.58e-05	1.15e-03	-0.01	-5.67e-05	-4.38e-06	0.0
11871	-8.28e-05	1.00e-03	-0.01	-4.96e-05	-4.95e-06	0.0
11872	-8.14e-05	1.03e-03	-0.01	-5.10e-05	-4.84e-06	0.0
11873	-8.28e-05	1.00e-03	-0.01	-4.96e-05	-4.95e-06	0.0
1191	-4.22e-05	1.93e-03	-0.02	-9.55e-05	-3.60e-06	0.0
1192	-1.46e-05	2.25e-03	-0.02	-1.11e-04	-1.89e-06	0.0
11915	-2.07e-03	1.37e-03	-0.01	-7.62e-05	-6.25e-06	0.0
11930	4.23e-04	-8.74e-04	-0.02	-5.79e-05	0.0	0.0
11931	-4.60e-04	3.72e-03	-0.01	-8.29e-05	-4.50e-06	0.0
11947	-2.89e-03	1.34e-03	-0.01	-7.85e-05	-8.03e-06	0.0
11962	6.00e-04	-1.79e-03	-0.02	-5.29e-05	2.00e-06	0.0
11963	-6.36e-04	4.64e-03	-0.01	-8.80e-05	-5.58e-06	0.0
11969	-1.83e-05	1.42e-03	-0.01	-7.04e-05	-1.79e-06	0.0
11970	0.0	1.64e-03	-0.02	-8.08e-05	0.0	0.0
11971	-1.83e-05	1.42e-03	-0.01	-7.04e-05	-1.79e-06	0.0
11972	-1.46e-05	1.47e-03	-0.02	-7.25e-05	-1.56e-06	0.0
11973	-1.83e-05	1.42e-03	-0.01	-7.04e-05	-1.79e-06	0.0
1202	1.66e-04	2.89e-03	-0.03	-1.43e-04	7.29e-06	0.0
12014	2.25e-03	9.90e-04	-0.02	-8.04e-05	1.03e-05	0.0
12031	-3.37e-04	4.39e-03	-0.02	-1.16e-04	0.0	0.0
12035	-4.29e-04	4.35e-03	-0.02	-1.16e-04	0.0	0.0
12046	3.11e-03	6.66e-04	-0.02	-7.66e-05	1.29e-05	0.0
12063	-5.09e-04	5.41e-03	-0.02	-1.26e-04	-1.73e-06	0.0
12067	-6.38e-04	5.36e-03	-0.02	-1.26e-04	-2.41e-06	0.0
12070	1.32e-04	2.11e-03	-0.02	-1.04e-04	6.07e-06	0.0
12072	1.01e-04	1.88e-03	-0.02	-9.29e-05	4.31e-06	0.0
12073	9.34e-05	1.82e-03	-0.02	-9.01e-05	3.86e-06	0.0
1212	4.41e-04	3.33e-03	-0.03	-1.64e-04	2.19e-05	0.0
12114	2.48e-03	1.18e-03	-0.02	-9.11e-05	1.96e-05	0.0
12131	-1.27e-04	4.92e-03	-0.03	-1.42e-04	1.04e-05	0.0
12135	-2.35e-04	4.88e-03	-0.03	-1.41e-04	1.00e-05	0.0
12146	3.37e-03	8.31e-04	-0.02	-8.64e-05	2.22e-05	0.0
12163	-2.82e-04	6.05e-03	-0.03	-1.57e-04	9.52e-06	0.0
12167	-4.34e-04	6.01e-03	-0.03	-1.57e-04	8.98e-06	0.0
12170	3.34e-04	2.43e-03	-0.03	-1.19e-04	1.68e-05	0.0
12172	2.76e-04	2.16e-03	-0.02	-1.06e-04	1.36e-05	0.0
12173	2.62e-04	2.09e-03	-0.02	-1.03e-04	1.28e-05	0.0
1222	6.29e-04	3.39e-03	-0.04	-1.66e-04	3.15e-05	0.0
12213	2.66e-03	3.06e-03	-0.03	-1.06e-04	2.71e-05	0.0
12231	2.95e-05	5.05e-03	-0.03	-1.48e-04	2.04e-05	0.0
12235	-9.00e-05	4.74e-03	-0.03	-1.48e-04	1.99e-05	0.0
12245	3.57e-03	3.42e-03	-0.03	-1.07e-04	3.05e-05	0.0
12263	-1.08e-04	6.22e-03	-0.03	-1.65e-04	2.11e-05	0.0
12267	-2.76e-04	5.80e-03	-0.03	-1.65e-04	2.05e-05	0.0
12270	4.73e-04	2.48e-03	-0.03	-1.22e-04	2.39e-05	0.0
12272	3.94e-04	2.19e-03	-0.03	-1.08e-04	1.96e-05	0.0
12273	3.75e-04	2.12e-03	-0.03	-1.04e-04	1.85e-05	0.0
1232	5.13e-04	-4.07e-03	-0.04	1.94e-04	2.58e-05	0.0
1236	2.75e-03	-3.59e-03	-0.03	1.27e-04	3.73e-05	0.0
12330	1.21e-03	-5.83e-03	-0.03	1.78e-04	2.52e-05	0.0
12336	-5.65e-05	-5.82e-03	-0.03	1.81e-04	1.47e-05	0.0
12338	3.73e-03	-4.01e-03	-0.03	1.29e-04	4.61e-05	0.0
12362	1.57e-03	-7.16e-03	-0.03	2.02e-04	2.90e-05	0.0
12368	-2.03e-04	-7.14e-03	-0.03	2.05e-04	1.43e-05	0.0
12370	3.83e-04	-2.98e-03	-0.03	1.42e-04	1.94e-05	0.0
12372	3.26e-04	-2.61e-03	-0.03	1.25e-04	1.63e-05	0.0
12373	3.12e-04	-2.51e-03	-0.03	1.20e-04	1.55e-05	0.0
1241	1.49e-05	-3.07e-03	-0.03	1.49e-04	2.34e-06	0.0
1242	1.16e-05	-3.65e-03	-0.03	1.77e-04	3.58e-06	0.0
1245	2.42e-03	-2.24e-03	-0.02	1.01e-04	1.79e-05	0.0
12430	5.83e-04	-5.03e-03	-0.02	1.45e-04	2.04e-06	0.0
12436	-6.93e-04	-5.06e-03	-0.02	1.47e-04	-5.58e-06	0.0
12437	3.38e-03	-2.22e-03	-0.02	9.77e-05	2.42e-05	0.0
12462	8.12e-04	-6.14e-03	-0.02	1.59e-04	2.02e-06	0.0
12468	-9.75e-04	-6.17e-03	-0.02	1.62e-04	-8.65e-06	0.0
12469	1.14e-05	-2.28e-03	-0.02	1.11e-04	2.10e-06	0.0
12470	9.20e-06	-2.67e-03	-0.02	1.29e-04	2.92e-06	0.0
12471	1.14e-05	-2.28e-03	-0.02	1.11e-04	2.10e-06	0.0
12472	1.10e-05	-2.36e-03	-0.02	1.15e-04	2.27e-06	0.0
12473	1.14e-05	-2.28e-03	-0.02	1.11e-04	2.10e-06	0.0
1252	4.67e-05	-2.84e-03	-0.02	1.39e-04	1.83e-06	0.0
1254	5.20e-05	-2.12e-03	-0.02	1.03e-04	2.93e-06	0.0





EGP CODE

GRE.EEC.R.73.IT.W.15235.12.024.01

PAGE

101 di/of 527

1255	2.17e-03	-1.82e-03	-0.02	8.29e-05	7.39e-06	0.0
12510	2.14e-03	-2.88e-03	-0.02	9.09e-05	6.80e-06	0.0
12536	-4.10e-04	-4.18e-03	-0.02	1.05e-04	-1.66e-06	0.0
12537	3.03e-03	-1.83e-03	-0.02	8.10e-05	1.00e-05	0.0
12542	2.98e-03	-3.31e-03	-0.02	9.22e-05	9.22e-06	0.0
12568	-5.83e-04	-5.14e-03	-0.02	1.12e-04	-2.64e-06	0.0
12570	3.88e-05	-2.07e-03	-0.02	1.01e-04	1.77e-06	0.0
12572	2.81e-05	-1.85e-03	-0.02	9.05e-05	0.0	0.0
12573	2.54e-05	-1.79e-03	-0.02	8.78e-05	0.0	0.0
1261	-3.50e-05	-1.78e-03	-0.02	8.80e-05	-2.86e-06	0.0
1262	-2.53e-05	-2.08e-03	-0.02	1.02e-04	-1.99e-06	0.0
1268	-2.02e-03	-1.26e-03	-0.01	6.72e-05	-4.98e-06	0.0
12629	4.89e-04	6.06e-04	-0.01	5.79e-05	0.0	0.0
12636	-4.62e-04	-3.49e-03	-0.01	7.19e-05	-2.90e-06	0.0
12640	-2.83e-03	-1.23e-03	-0.01	6.81e-05	-6.35e-06	0.0
12661	6.93e-04	1.38e-03	-0.01	5.51e-05	0.0	0.0
12668	-6.39e-04	-4.36e-03	-0.01	7.48e-05	-3.44e-06	0.0
12669	-1.95e-05	-1.32e-03	-0.01	6.49e-05	-1.57e-06	0.0
12670	-1.30e-05	-1.52e-03	-0.01	7.43e-05	0.0	0.0
12671	-1.95e-05	-1.32e-03	-0.01	6.49e-05	-1.57e-06	0.0
12672	-1.82e-05	-1.36e-03	-0.01	6.68e-05	-1.46e-06	0.0
12673	-1.95e-05	-1.32e-03	-0.01	6.49e-05	-1.57e-06	0.0
1271	-7.58e-05	-1.19e-03	-0.01	5.87e-05	-4.90e-06	0.0
1272	-7.39e-05	-1.38e-03	-0.01	6.78e-05	-4.43e-06	0.0
1278	-1.95e-03	-7.93e-04	-0.01	4.34e-05	-4.32e-06	0.0
12729	4.53e-04	9.03e-04	-0.01	4.42e-05	-2.41e-06	0.0
12736	-5.07e-04	-2.90e-03	-0.01	4.22e-05	-3.52e-06	0.0
12740	-2.71e-03	-7.58e-04	-0.01	4.35e-05	-4.82e-06	0.0
12761	6.55e-04	1.62e-03	-0.01	4.46e-05	-2.15e-06	0.0
12768	-6.90e-04	-3.71e-03	-9.82e-03	4.18e-05	-3.71e-06	0.0
12769	-4.92e-05	-8.75e-04	-0.01	4.32e-05	-3.06e-06	0.0
12770	-4.80e-05	-1.00e-03	-0.01	4.93e-05	-2.74e-06	0.0
12771	-4.92e-05	-8.75e-04	-0.01	4.32e-05	-3.06e-06	0.0
12772	-4.90e-05	-9.01e-04	-0.01	4.44e-05	-3.00e-06	0.0
12773	-4.92e-05	-8.75e-04	-0.01	4.32e-05	-3.06e-06	0.0
1281	-9.85e-05	-6.47e-04	-0.01	3.20e-05	-6.04e-06	0.0
1282	-1.01e-04	-7.50e-04	-0.01	3.68e-05	-5.80e-06	0.0
1288	-1.89e-03	-3.81e-04	-8.64e-03	2.30e-05	-3.77e-06	0.0
12817	1.64e-03	4.78e-04	-9.72e-03	2.46e-05	-4.27e-06	0.0
12836	-5.48e-04	-2.41e-03	-8.61e-03	1.87e-05	-3.90e-06	0.0
12840	-2.62e-03	-3.40e-04	-8.43e-03	2.29e-05	-3.73e-06	0.0
12849	2.32e-03	8.59e-04	-9.95e-03	2.50e-05	-4.42e-06	0.0
12868	-7.41e-04	-3.19e-03	-8.39e-03	1.68e-05	-3.91e-06	0.0
12869	-6.57e-05	-4.76e-04	-9.15e-03	2.35e-05	-3.89e-06	0.0
12870	-6.74e-05	-5.45e-04	-8.92e-03	2.68e-05	-3.73e-06	0.0
12871	-6.57e-05	-4.76e-04	-9.15e-03	2.35e-05	-3.89e-06	0.0
12872	-6.60e-05	-4.90e-04	-9.11e-03	2.41e-05	-3.85e-06	0.0
12873	-6.57e-05	-4.76e-04	-9.15e-03	2.35e-05	-3.89e-06	0.0
1291	-1.07e-04	-1.49e-04	-0.01	7.29e-06	-6.51e-06	0.0
1292	-1.12e-04	-1.72e-04	-0.01	8.40e-06	-6.36e-06	0.0
1298	-1.84e-03	-6.86e-06	-7.97e-03	4.59e-06	-3.77e-06	0.0
12917	1.66e-03	8.29e-04	-8.93e-03	7.01e-06	-4.80e-06	0.0
12936	-5.86e-04	-2.01e-03	-8.21e-03	-1.24e-06	-4.02e-06	0.0
12940	-2.54e-03	3.60e-05	-7.78e-03	4.30e-06	-3.59e-06	0.0
12949	2.35e-03	1.20e-03	-9.13e-03	7.68e-06	-5.04e-06	0.0
12968	-7.92e-04	-2.76e-03	-8.11e-03	-3.89e-06	-3.94e-06	0.0
12969	-7.22e-05	-1.09e-04	-8.44e-03	5.36e-06	-4.23e-06	0.0
12970	-7.50e-05	-1.25e-04	-8.11e-03	6.10e-06	-4.13e-06	0.0
12971	-7.22e-05	-1.09e-04	-8.44e-03	5.36e-06	-4.23e-06	0.0
12972	-7.27e-05	-1.13e-04	-8.38e-03	5.51e-06	-4.21e-06	0.0
12973	-7.22e-05	-1.09e-04	-8.44e-03	5.36e-06	-4.23e-06	0.0
1301	-1.05e-04	3.39e-04	-0.01	-1.69e-05	-6.40e-06	0.0
1302	-1.08e-04	3.92e-04	-0.01	-1.94e-05	-6.23e-06	0.0
13010	1.65e-03	-6.91e-04	-9.15e-03	-1.39e-05	-4.67e-06	0.0
13015	-1.85e-03	1.46e-04	-8.12e-03	-1.17e-05	-3.83e-06	0.0
13031	-5.69e-04	2.15e-03	-8.24e-03	-6.22e-06	-4.07e-06	0.0
13042	2.34e-03	-1.07e-03	-9.36e-03	-1.45e-05	-4.88e-06	0.0
13047	-2.56e-03	1.03e-04	-7.92e-03	-1.14e-05	-3.70e-06	0.0
13063	-7.69e-04	2.92e-03	-8.09e-03	-3.75e-06	-4.04e-06	0.0
13069	-7.01e-05	2.49e-04	-8.62e-03	-1.24e-05	-4.15e-06	0.0
13070	-7.26e-05	2.85e-04	-8.31e-03	-1.41e-05	-4.04e-06	0.0
13071	-7.01e-05	2.49e-04	-8.62e-03	-1.24e-05	-4.15e-06	0.0
13072	-7.06e-05	2.56e-04	-8.55e-03	-1.27e-05	-4.13e-06	0.0
13073	-7.01e-05	2.49e-04	-8.62e-03	-1.24e-05	-4.15e-06	0.0
1311	-8.96e-05	8.51e-04	-0.01	-4.22e-05	-5.69e-06	0.0
1312	-9.03e-05	9.88e-04	-0.01	-4.87e-05	-5.37e-06	0.0



EGP CODE

GRE.EEC.R.73.IT.W.15235.12.024.01

PAGE

102 di/of 527

13115	-1.90e-03	5.33e-04-9.16e-03	-3.08e-05	-4.13e-06	0.0
13130	4.11e-04	-1.34e-03 -0.01	-3.45e-05	-3.52e-06	0.0
13131	-5.29e-04	2.59e-03-9.05e-03	-2.76e-05	-3.74e-06	0.0
13147	-2.64e-03	4.94e-04-8.95e-03	-3.08e-05	-4.32e-06	0.0
13162	5.99e-04	-2.12e-03 -0.01	-3.58e-05	-3.48e-06	0.0
13163	-7.17e-04	3.38e-03-8.79e-03	-2.63e-05	-3.79e-06	0.0
13169	-5.92e-05	6.27e-04-9.69e-03	-3.10e-05	-3.63e-06	0.0
13170	-5.97e-05	7.18e-04-9.53e-03	-3.54e-05	-3.42e-06	0.0
13171	-5.92e-05	6.27e-04-9.69e-03	-3.10e-05	-3.63e-06	0.0
13172	-5.93e-05	6.45e-04-9.65e-03	-3.19e-05	-3.59e-06	0.0
13173	-5.92e-05	6.27e-04-9.69e-03	-3.10e-05	-3.63e-06	0.0
1321	-5.91e-05	1.42e-03 -0.02	-7.01e-05	-4.22e-06	0.0
1322	-5.38e-05	1.65e-03 -0.02	-8.11e-05	-3.61e-06	0.0
13215	-1.97e-03	9.67e-04 -0.01	-5.27e-05	-4.39e-06	0.0
13231	-4.85e-04	3.12e-03 -0.01	-5.42e-05	-3.25e-06	0.0
13234	4.61e-04	-7.84e-04 -0.01	-4.91e-05	-1.63e-06	0.0
13247	-2.74e-03	9.34e-04 -0.01	-5.32e-05	-5.12e-06	0.0
13263	-6.65e-04	3.95e-03 -0.01	-5.52e-05	-3.52e-06	0.0
13266	6.61e-04	-1.52e-03 -0.01	-4.81e-05	-1.25e-06	0.0
13269	-3.70e-05	1.04e-03 -0.01	-5.16e-05	-2.56e-06	0.0
13270	-3.35e-05	1.20e-03 -0.01	-5.90e-05	-2.16e-06	0.0
13271	-3.70e-05	1.04e-03 -0.01	-5.16e-05	-2.56e-06	0.0
13272	-3.63e-05	1.07e-03 -0.01	-5.31e-05	-2.48e-06	0.0
13273	-3.70e-05	1.04e-03 -0.01	-5.16e-05	-2.56e-06	0.0
1332	8.61e-06	2.38e-03 -0.02	-1.17e-04	0.0	0.0
1334	2.53e-05	1.77e-03 -0.02	-8.64e-05	1.20e-06	0.0
13314	2.05e-03	1.55e-03 -0.02	-7.07e-05	3.81e-06	0.0
13318	1.97e-03	1.27e-03 -0.02	-6.95e-05	3.93e-06	0.0
13331	-4.37e-04	3.75e-03 -0.01	-8.49e-05	-2.56e-06	0.0
13346	2.87e-03	1.57e-03 -0.02	-6.95e-05	5.61e-06	0.0
13350	2.76e-03	1.18e-03 -0.02	-6.77e-05	5.79e-06	0.0
13363	-6.12e-04	4.66e-03 -0.01	-8.93e-05	-3.31e-06	0.0
13370	1.16e-05	1.73e-03 -0.02	-8.50e-05	0.0	0.0
13372	3.34e-06	1.55e-03 -0.01	-7.62e-05	0.0	0.0
13373	1.28e-06	1.50e-03 -0.01	-7.40e-05	0.0	0.0
1342	1.04e-04	3.14e-03 -0.03	-1.54e-04	4.45e-06	0.0
13414	2.26e-03	1.99e-03 -0.02	-9.07e-05	1.06e-05	0.0
13431	-3.72e-04	4.48e-03 -0.02	-1.20e-04	0.0	0.0
13433	8.10e-04	4.47e-03 -0.02	-1.19e-04	3.54e-06	0.0
13446	3.14e-03	2.00e-03 -0.02	-8.83e-05	1.39e-05	0.0
13463	-5.45e-04	5.49e-03 -0.02	-1.29e-04	-1.54e-06	0.0
13465	1.11e-03	5.47e-03 -0.02	-1.27e-04	4.00e-06	0.0
13470	8.06e-05	2.29e-03 -0.02	-1.12e-04	3.68e-06	0.0
13472	6.47e-05	2.04e-03 -0.02	-9.99e-05	2.66e-06	0.0
13473	6.07e-05	1.97e-03 -0.02	-9.69e-05	2.40e-06	0.0
1352	1.02e-04	3.94e-03 -0.04	-1.90e-04	8.66e-06	0.0
13514	2.59e-03	1.56e-03 -0.02	-1.06e-04	2.57e-05	0.0
13531	-6.60e-04	5.48e-03 -0.03	-1.67e-04	-3.17e-06	0.0
13533	6.70e-04	5.21e-03 -0.03	-1.64e-04	6.78e-06	0.0
13546	3.60e-03	1.21e-03 -0.02	-1.01e-04	3.39e-05	0.0
13563	-9.51e-04	6.70e-03 -0.03	-1.86e-04	-6.54e-06	0.0
13565	9.11e-04	6.31e-03 -0.03	-1.82e-04	7.39e-06	0.0
13570	7.57e-05	2.89e-03 -0.03	-1.39e-04	6.67e-06	0.0
13572	7.03e-05	2.54e-03 -0.03	-1.23e-04	5.55e-06	0.0
13573	6.89e-05	2.45e-03 -0.02	-1.19e-04	5.27e-06	0.0
1362	5.06e-04	4.05e-03 -0.04	-1.94e-04	2.53e-05	0.0
13613	2.78e-03	3.55e-03 -0.03	-1.27e-04	3.76e-05	0.0
13631	-8.71e-05	5.80e-03 -0.03	-1.80e-04	1.35e-05	0.0
13633	1.20e-03	5.80e-03 -0.03	-1.78e-04	2.44e-05	0.0
13645	3.78e-03	3.96e-03 -0.03	-1.29e-04	4.66e-05	0.0
13663	-2.44e-04	7.12e-03 -0.03	-2.04e-04	1.29e-05	0.0
13665	1.56e-03	7.12e-03 -0.03	-2.01e-04	2.80e-05	0.0
13670	3.77e-04	2.97e-03 -0.03	-1.42e-04	1.91e-05	0.0
13672	3.21e-04	2.60e-03 -0.03	-1.25e-04	1.60e-05	0.0
13673	3.07e-04	2.50e-03 -0.03	-1.20e-04	1.52e-05	0.0
1372	6.82e-05	-3.61e-03 -0.03	1.77e-04	2.69e-06	0.0
1375	2.52e-03	-2.26e-03 -0.02	1.08e-04	1.73e-05	0.0
13730	8.79e-04	-4.95e-03 -0.02	1.43e-04	4.95e-06	0.0
13737	3.51e-03	-2.27e-03 -0.02	1.07e-04	2.38e-05	0.0
13762	1.22e-03	-6.03e-03 -0.02	1.56e-04	6.43e-06	0.0
13770	4.99e-05	-2.64e-03 -0.02	1.29e-04	2.17e-06	0.0
13772	4.00e-05	-2.33e-03 -0.02	1.14e-04	1.44e-06	0.0
13773	3.75e-05	-2.26e-03 -0.02	1.11e-04	1.26e-06	0.0
1382	1.15e-05	-2.88e-03 -0.02	1.41e-04	0.0	0.0
1384	1.67e-05	-2.15e-03 -0.02	1.05e-04	1.07e-06	0.0
1385	2.14e-03	-1.85e-03 -0.02	8.74e-05	6.16e-06	0.0



EGP CODE

GRE.EEC.R.73.IT.W.15235.12.024.01

PAGE

103 di/of 527

13810	2.11e-03	-2.92e-03	-0.02	9.57e-05	5.93e-06	0.0
13830	7.30e-04	-4.21e-03	-0.02	1.07e-04	1.27e-06	0.0
13837	2.99e-03	-1.87e-03	-0.02	8.67e-05	8.77e-06	0.0
13842	2.95e-03	-3.36e-03	-0.02	9.84e-05	8.45e-06	0.0
13862	1.02e-03	-5.17e-03	-0.02	1.14e-04	1.92e-06	0.0
13870	1.02e-05	-2.10e-03	-0.02	1.03e-04	0.0	0.0
13872	4.92e-06	-1.87e-03	-0.02	9.17e-05	0.0	0.0
13873	3.59e-06	-1.81e-03	-0.02	8.89e-05	0.0	0.0
1391	-3.06e-05	-1.81e-03	-0.02	8.90e-05	-2.53e-06	0.0
1392	-2.71e-05	-2.11e-03	-0.02	1.03e-04	-1.95e-06	0.0
1398	-2.01e-03	-1.28e-03	-0.01	6.61e-05	-4.29e-06	0.0
13929	4.81e-04	5.80e-04	-0.01	5.95e-05	0.0	0.0
13936	-4.55e-04	-3.49e-03	-0.01	7.22e-05	-2.01e-06	0.0
13940	-2.81e-03	-1.25e-03	-0.01	6.63e-05	-5.42e-06	0.0
13961	6.82e-04	1.35e-03	-0.01	5.70e-05	0.0	0.0
13968	-6.29e-04	-4.35e-03	-0.01	7.48e-05	-2.22e-06	0.0
13969	-1.92e-05	-1.33e-03	-0.01	6.56e-05	-1.48e-06	0.0
13970	-1.69e-05	-1.54e-03	-0.01	7.52e-05	-1.09e-06	0.0
13971	-1.92e-05	-1.33e-03	-0.01	6.56e-05	-1.48e-06	0.0
13972	-1.88e-05	-1.37e-03	-0.01	6.75e-05	-1.40e-06	0.0
13973	-1.92e-05	-1.33e-03	-0.01	6.56e-05	-1.48e-06	0.0
1402	-5.48e-05	-1.40e-03	-0.01	6.86e-05	-3.37e-06	0.0
1408	-1.93e-03	-8.12e-04	-0.01	4.31e-05	-3.12e-06	0.0
14029	4.62e-04	8.91e-04	-0.01	4.49e-05	-2.23e-06	0.0
14036	-4.89e-04	-2.90e-03	-0.01	4.25e-05	-2.28e-06	0.0
14040	-2.68e-03	-7.81e-04-9.98e-03		4.29e-05	-3.44e-06	0.0
14061	6.61e-04	1.60e-03	-0.01	4.54e-05	-2.20e-06	0.0
14068	-6.70e-04	-3.70e-03-9.76e-03		4.20e-05	-2.27e-06	0.0
14070	-3.64e-05	-1.02e-03	-0.01	4.98e-05	-2.09e-06	0.0
14072	-3.58e-05	-9.11e-04	-0.01	4.49e-05	-2.27e-06	0.0
14073	-3.56e-05	-8.85e-04	-0.01	4.36e-05	-2.31e-06	0.0
1411	-6.79e-05	-6.54e-04	-0.01	3.23e-05	-4.44e-06	0.0
1412	-7.21e-05	-7.58e-04	-0.01	3.73e-05	-4.28e-06	0.0
1418	-1.86e-03	-3.98e-04-8.56e-03		2.27e-05	-2.48e-06	0.0
1419	1.74e-03	-3.26e-04-9.64e-03		2.54e-05	-3.30e-06	0.0
14136	-5.26e-04	-2.40e-03-8.53e-03		1.89e-05	-2.50e-06	0.0
14140	-2.59e-03	-3.64e-04-8.36e-03		2.24e-05	-2.34e-06	0.0
14141	2.45e-03	-2.62e-04-9.86e-03		2.60e-05	-3.49e-06	0.0
14168	-7.18e-04	-3.17e-03-8.32e-03		1.69e-05	-2.36e-06	0.0
14169	-4.58e-05	-4.81e-04-9.07e-03		2.37e-05	-2.84e-06	0.0
14170	-4.86e-05	-5.51e-04-8.84e-03		2.70e-05	-2.73e-06	0.0
14171	-4.58e-05	-4.81e-04-9.07e-03		2.37e-05	-2.84e-06	0.0
14172	-4.64e-05	-4.95e-04-9.03e-03		2.44e-05	-2.82e-06	0.0
14173	-4.58e-05	-4.81e-04-9.07e-03		2.37e-05	-2.84e-06	0.0
1421	-7.40e-05	-1.51e-04	-0.01	7.37e-06	-4.77e-06	0.0
1422	-7.94e-05	-1.74e-04	-0.01	8.49e-06	-4.68e-06	0.0
1428	-1.81e-03	-2.33e-05-7.90e-03		3.99e-06	-2.22e-06	0.0
1429	1.70e-03	3.54e-05-8.82e-03		7.72e-06	-3.93e-06	0.0
14236	-5.62e-04	-2.00e-03-8.12e-03		-1.22e-06	-2.77e-06	0.0
14240	-2.51e-03	1.34e-05-7.72e-03		3.45e-06	-1.88e-06	0.0
14241	2.40e-03	9.58e-05-9.01e-03		8.63e-06	-4.27e-06	0.0
14268	-7.67e-04	-2.75e-03-8.03e-03		-3.89e-06	-2.65e-06	0.0
14269	-5.01e-05	-1.11e-04-8.36e-03		5.41e-06	-3.08e-06	0.0
14270	-5.37e-05	-1.27e-04-8.03e-03		6.16e-06	-3.02e-06	0.0
14271	-5.01e-05	-1.11e-04-8.36e-03		5.41e-06	-3.08e-06	0.0
14272	-5.08e-05	-1.14e-04-8.29e-03		5.56e-06	-3.07e-06	0.0
14273	-5.01e-05	-1.11e-04-8.36e-03		5.41e-06	-3.08e-06	0.0
1431	-7.19e-05	3.42e-04	-0.01	-1.70e-05	-4.70e-06	0.0
1432	-7.68e-05	3.96e-04	-0.01	-1.96e-05	-4.59e-06	0.0
14315	-1.82e-03	1.63e-04-8.05e-03		-1.12e-05	-2.34e-06	0.0
14318	1.71e-03	1.06e-04-9.04e-03		-1.46e-05	-3.78e-06	0.0
14333	5.00e-04	2.15e-03-8.42e-03		-6.30e-06	-3.17e-06	0.0
14347	-2.53e-03	1.26e-04-7.86e-03		-1.07e-05	-2.06e-06	0.0
14350	2.41e-03	4.49e-05-9.25e-03		-1.55e-05	-4.09e-06	0.0
14365	7.20e-04	2.90e-03-8.38e-03		-3.81e-06	-3.23e-06	0.0
14369	-4.86e-05	2.52e-04-8.53e-03		-1.25e-05	-3.03e-06	0.0
14370	-5.19e-05	2.88e-04-8.22e-03		-1.42e-05	-2.96e-06	0.0
14371	-4.86e-05	2.52e-04-8.53e-03		-1.25e-05	-3.03e-06	0.0
14372	-4.92e-05	2.59e-04-8.47e-03		-1.29e-05	-3.01e-06	0.0
14373	-4.86e-05	2.52e-04-8.53e-03		-1.25e-05	-3.03e-06	0.0
1441	-6.17e-05	8.60e-04	-0.01	-4.27e-05	-4.22e-06	0.0
1442	-6.45e-05	9.98e-04	-0.01	-4.93e-05	-4.01e-06	0.0
14415	-1.88e-03	5.52e-04-9.08e-03		-3.07e-05	-2.52e-06	0.0
14433	5.48e-04	2.59e-03-9.24e-03		-2.78e-05	-2.62e-06	0.0
14434	4.55e-04	-1.08e-03	-0.01	-3.50e-05	-2.90e-06	0.0
14447	-2.61e-03	5.17e-04-8.87e-03		-3.04e-05	-2.45e-06	0.0



EGP CODE

GRE.EEC.R.73.IT.W.15235.12.024.01

PAGE

104 di/of 527

14465	7.85e-04	3.37e-03-9.09e-03	-2.64e-05	-2.59e-06	0.0
14466	6.53e-04	-1.77e-03 -0.01	-3.64e-05	-2.98e-06	0.0
14469	-4.13e-05	6.33e-04-9.61e-03	-3.14e-05	-2.68e-06	0.0
14470	-4.32e-05	7.26e-04-9.45e-03	-3.58e-05	-2.54e-06	0.0
14471	-4.13e-05	6.33e-04-9.61e-03	-3.14e-05	-2.68e-06	0.0
14472	-4.17e-05	6.52e-04-9.58e-03	-3.22e-05	-2.66e-06	0.0
14473	-4.13e-05	6.33e-04-9.61e-03	-3.14e-05	-2.68e-06	0.0
1451	-4.32e-05	1.43e-03 -0.02	-7.08e-05	-3.32e-06	0.0
1452	-4.22e-05	1.67e-03 -0.02	-8.21e-05	-2.91e-06	0.0
14515	-1.95e-03	9.86e-04 -0.01	-5.23e-05	-3.35e-06	0.0
14533	6.07e-04	3.12e-03 -0.01	-5.45e-05	-1.57e-06	0.0
14534	4.64e-04	-7.70e-04 -0.01	-5.00e-05	-1.76e-06	0.0
14547	-2.72e-03	9.56e-04 -0.01	-5.23e-05	-3.87e-06	0.0
14565	8.62e-04	3.95e-03 -0.01	-5.55e-05	-1.38e-06	0.0
14566	6.60e-04	-1.50e-03 -0.01	-4.91e-05	-1.65e-06	0.0
14569	-2.80e-05	1.06e-03 -0.01	-5.22e-05	-2.04e-06	0.0
14570	-2.74e-05	1.21e-03 -0.01	-5.97e-05	-1.77e-06	0.0
14571	-2.80e-05	1.06e-03 -0.01	-5.22e-05	-2.04e-06	0.0
14572	-2.79e-05	1.09e-03 -0.01	-5.37e-05	-1.99e-06	0.0
14573	-2.80e-05	1.06e-03 -0.01	-5.22e-05	-2.04e-06	0.0
1461	-1.60e-05	2.06e-03 -0.02	-1.02e-04	-2.00e-06	0.0
1462	-9.42e-06	2.41e-03 -0.02	-1.18e-04	-1.30e-06	0.0
14615	-2.05e-03	1.47e-03 -0.01	-7.58e-05	-5.11e-06	0.0
14618	1.95e-03	1.30e-03 -0.02	-7.29e-05	2.86e-06	0.0
14633	6.81e-04	3.75e-03 -0.01	-8.52e-05	0.0	0.0
14647	-2.86e-03	1.45e-03 -0.01	-7.62e-05	-6.72e-06	0.0
14650	2.73e-03	1.21e-03 -0.02	-7.20e-05	4.45e-06	0.0
14665	9.58e-04	4.65e-03 -0.01	-8.93e-05	0.0	0.0
14669	-8.69e-06	1.52e-03 -0.01	-7.49e-05	-1.10e-06	0.0
14670	-4.30e-06	1.76e-03 -0.02	-8.61e-05	0.0	0.0
14671	-8.69e-06	1.52e-03 -0.01	-7.49e-05	-1.10e-06	0.0
14672	-7.81e-06	1.57e-03 -0.01	-7.72e-05	-1.01e-06	0.0
14673	-8.69e-06	1.52e-03 -0.01	-7.49e-05	-1.10e-06	0.0
1472	3.42e-05	3.19e-03 -0.03	-1.56e-04	0.0	0.0
14714	2.20e-03	2.03e-03 -0.02	-9.62e-05	7.70e-06	0.0
14733	7.66e-04	4.53e-03 -0.02	-1.22e-04	1.86e-06	0.0
14746	3.07e-03	2.04e-03 -0.02	-9.53e-05	1.07e-05	0.0
14765	1.07e-03	5.54e-03 -0.02	-1.31e-04	2.54e-06	0.0
14770	2.64e-05	2.33e-03 -0.02	-1.14e-04	0.0	0.0
14772	1.90e-05	2.07e-03 -0.02	-1.01e-04	0.0	0.0
14773	1.72e-05	2.01e-03 -0.02	-9.83e-05	0.0	0.0
1482	9.80e-05	3.86e-03 -0.04	-1.89e-04	3.81e-06	0.0
14814	2.74e-03	2.39e-03 -0.03	-1.14e-04	2.67e-05	0.0
14833	9.63e-04	5.31e-03 -0.03	-1.63e-04	7.75e-06	0.0
14846	3.81e-03	2.38e-03 -0.03	-1.12e-04	3.66e-05	0.0
14865	1.33e-03	6.47e-03 -0.03	-1.81e-04	1.01e-05	0.0
14870	7.11e-05	2.82e-03 -0.03	-1.38e-04	2.95e-06	0.0
14872	5.86e-05	2.49e-03 -0.03	-1.22e-04	2.13e-06	0.0
14873	5.55e-05	2.41e-03 -0.02	-1.18e-04	1.93e-06	0.0
1492	-3.21e-04	-4.06e-03 -0.04	1.95e-04	-1.69e-05	0.0
1498	-2.54e-03	-2.62e-03 -0.03	1.27e-04	-2.80e-05	0.0
14930	5.83e-04	-5.78e-03 -0.03	1.81e-04	-1.01e-05	0.0
14936	-6.40e-04	-5.80e-03 -0.03	1.81e-04	-1.83e-05	0.0
14940	-3.48e-03	-2.67e-03 -0.03	1.29e-04	-3.48e-05	0.0
14962	8.98e-04	-7.09e-03 -0.03	2.05e-04	-9.72e-06	0.0
14968	-8.13e-04	-7.11e-03 -0.03	2.05e-04	-2.13e-05	0.0
14970	-2.43e-04	-2.97e-03 -0.03	1.42e-04	-1.27e-05	0.0
14972	-2.13e-04	-2.60e-03 -0.03	1.25e-04	-1.13e-05	0.0
14973	-2.05e-04	-2.50e-03 -0.03	1.21e-04	-1.10e-05	0.0
1502	9.82e-05	-3.70e-03 -0.03	1.79e-04	0.0	0.0
1506	2.44e-03	-3.26e-03 -0.02	1.25e-04	1.39e-05	0.0
15030	9.67e-04	-5.08e-03 -0.02	1.49e-04	8.23e-06	0.0
15038	3.39e-03	-3.63e-03 -0.02	1.30e-04	1.96e-05	0.0
15062	1.34e-03	-6.19e-03 -0.02	1.64e-04	1.17e-05	0.0
15070	7.21e-05	-2.70e-03 -0.02	1.31e-04	0.0	0.0
15072	5.21e-05	-2.39e-03 -0.02	1.16e-04	0.0	0.0
15073	4.71e-05	-2.31e-03 -0.02	1.12e-04	0.0	0.0
1512	-3.36e-05	-2.88e-03 -0.02	1.41e-04	-2.32e-06	0.0
1518	-2.13e-03	-1.77e-03 -0.02	8.88e-05	-5.96e-06	0.0
15110	2.05e-03	-2.91e-03 -0.02	9.74e-05	2.97e-06	0.0
15130	6.99e-04	-4.19e-03 -0.02	1.07e-04	0.0	0.0
15140	-2.97e-03	-1.75e-03 -0.02	8.87e-05	-7.64e-06	0.0
15142	2.88e-03	-3.35e-03 -0.02	1.01e-04	4.88e-06	0.0
15162	9.89e-04	-5.14e-03 -0.02	1.14e-04	1.67e-06	0.0
15170	-2.52e-05	-2.10e-03 -0.02	1.03e-04	-1.55e-06	0.0
15172	-2.48e-05	-1.87e-03 -0.02	9.18e-05	-1.74e-06	0.0



EGP CODE

GRE.EEC.R.73.IT.W.15235.12.024.01

PAGE

105 di/of 527

15173	-2.47e-05	-1.81e-03	-0.02	8.90e-05	-1.79e-06	0.0
1522	-3.68e-05	-2.12e-03	-0.02	1.04e-04	-2.29e-06	0.0
1528	-2.00e-03	-1.28e-03	-0.01	6.53e-05	-3.44e-06	0.0
1529	1.87e-03	-1.12e-03	-0.01	6.56e-05	0.0	0.0
15230	6.43e-04	-3.49e-03	-0.01	7.30e-05	0.0	0.0
15240	-2.79e-03	-1.26e-03	-0.01	6.51e-05	-4.16e-06	0.0
15241	2.63e-03	-1.04e-03	-0.01	6.55e-05	0.0	0.0
15262	9.11e-04	-4.35e-03	-0.01	7.58e-05	0.0	0.0
15270	-2.62e-05	-1.54e-03	-0.01	7.55e-05	-1.46e-06	0.0
15272	-2.47e-05	-1.38e-03	-0.01	6.78e-05	-1.61e-06	0.0
15273	-2.43e-05	-1.34e-03	-0.01	6.58e-05	-1.64e-06	0.0
1532	-4.32e-05	-1.40e-03	-0.01	6.90e-05	-2.68e-06	0.0
1538	-1.90e-03	-8.26e-04	-0.01	4.27e-05	-1.44e-06	0.0
15329	4.64e-04	8.86e-04	-0.01	4.53e-05	-2.24e-06	0.0
15330	5.87e-04	-2.89e-03	-0.01	4.29e-05	-1.55e-06	0.0
15340	-2.66e-03	-7.99e-04-9.92e-03		4.23e-05	-1.30e-06	0.0
15361	6.61e-04	1.60e-03	-0.01	4.59e-05	-2.42e-06	0.0
15362	8.33e-04	-3.69e-03	-0.01	4.25e-05	-1.44e-06	0.0
15370	-3.00e-05	-1.02e-03	-0.01	5.01e-05	-1.69e-06	0.0
15372	-2.75e-05	-9.15e-04	-0.01	4.51e-05	-1.79e-06	0.0
15373	-2.69e-05	-8.89e-04	-0.01	4.39e-05	-1.81e-06	0.0
1541	-4.44e-05	-6.58e-04	-0.01	3.25e-05	-3.20e-06	0.0
1542	-5.04e-05	-7.63e-04	-0.01	3.75e-05	-3.11e-06	0.0
1548	-1.84e-03	-4.15e-04-8.52e-03		2.27e-05	-1.18e-06	0.0
1549	1.74e-03	-3.15e-04-9.56e-03		2.57e-05	-2.89e-06	0.0
15430	5.39e-04	-2.40e-03-8.74e-03		1.91e-05	-2.09e-06	0.0
15440	-2.56e-03	-3.85e-04-8.32e-03		2.22e-05	0.0	0.0
15441	2.46e-03	-2.45e-04-9.78e-03		2.64e-05	-3.24e-06	0.0
15462	7.67e-04	-3.16e-03-8.62e-03		1.72e-05	-2.11e-06	0.0
15469	-3.08e-05	-4.84e-04-9.01e-03		2.39e-05	-2.04e-06	0.0
15470	-3.47e-05	-5.54e-04-8.79e-03		2.72e-05	-1.99e-06	0.0
15471	-3.08e-05	-4.84e-04-9.01e-03		2.39e-05	-2.04e-06	0.0
15472	-3.16e-05	-4.98e-04-8.97e-03		2.45e-05	-2.03e-06	0.0
15473	-3.08e-05	-4.84e-04-9.01e-03		2.39e-05	-2.04e-06	0.0
1551	-4.74e-05	-1.52e-04	-0.01	7.42e-06	-3.38e-06	0.0
1552	-5.41e-05	-1.76e-04	-0.01	8.56e-06	-3.35e-06	0.0
1558	-1.78e-03	-3.97e-05-7.86e-03		4.06e-06	-1.01e-06	0.0
1559	1.71e-03	5.08e-05-8.74e-03		7.72e-06	-3.33e-06	0.0
15536	-5.43e-04	-1.99e-03-8.07e-03		-1.19e-06	-1.77e-06	0.0
15540	-2.48e-03	-9.43e-06-7.69e-03		3.53e-06	0.0	0.0
15541	2.41e-03	1.18e-04-8.91e-03		8.61e-06	-3.80e-06	0.0
15568	-7.47e-04	-2.74e-03-7.98e-03		-3.85e-06	-1.61e-06	0.0
15569	-3.27e-05	-1.12e-04-8.29e-03		5.45e-06	-2.17e-06	0.0
15570	-3.72e-05	-1.27e-04-7.97e-03		6.21e-06	-2.15e-06	0.0
15571	-3.27e-05	-1.12e-04-8.29e-03		5.45e-06	-2.17e-06	0.0
15572	-3.36e-05	-1.15e-04-8.23e-03		5.60e-06	-2.17e-06	0.0
15573	-3.27e-05	-1.12e-04-8.29e-03		5.45e-06	-2.17e-06	0.0
1561	-4.61e-05	3.44e-04	-0.01	-1.71e-05	-3.35e-06	0.0
1562	-5.24e-05	3.98e-04	-0.01	-1.97e-05	-3.30e-06	0.0
15616	-1.80e-03	-4.14e-04-8.09e-03		-1.34e-05	-1.13e-06	0.0
15618	1.72e-03	9.10e-05-8.96e-03		-1.47e-05	-3.24e-06	0.0
15633	5.16e-04	2.14e-03-8.35e-03		-6.40e-06	-2.36e-06	0.0
15648	-2.50e-03	-6.76e-04-7.94e-03		-1.37e-05	0.0	0.0
15650	2.42e-03	2.43e-05-9.15e-03		-1.56e-05	-3.67e-06	0.0
15665	7.35e-04	2.89e-03-8.31e-03		-3.92e-06	-2.45e-06	0.0
15669	-3.18e-05	2.53e-04-8.47e-03		-1.26e-05	-2.15e-06	0.0
15670	-3.61e-05	2.89e-04-8.16e-03		-1.43e-05	-2.12e-06	0.0
15671	-3.18e-05	2.53e-04-8.47e-03		-1.26e-05	-2.15e-06	0.0
15672	-3.27e-05	2.60e-04-8.41e-03		-1.29e-05	-2.14e-06	0.0
15673	-3.18e-05	2.53e-04-8.47e-03		-1.26e-05	-2.15e-06	0.0
1571	-4.09e-05	8.64e-04	-0.01	-4.29e-05	-3.10e-06	0.0
1572	-4.60e-05	1.00e-03	-0.01	-4.96e-05	-2.99e-06	0.0
15715	-1.85e-03	5.67e-04-9.03e-03		-3.04e-05	-1.31e-06	0.0
15733	5.60e-04	2.58e-03-9.18e-03		-2.81e-05	-1.92e-06	0.0
15734	4.63e-04	-1.08e-03	-0.01	-3.52e-05	-2.39e-06	0.0
15747	-2.59e-03	5.38e-04-8.83e-03		-3.00e-05	-1.05e-06	0.0
15765	7.96e-04	3.36e-03-9.03e-03		-2.68e-05	-1.90e-06	0.0
15766	6.60e-04	-1.77e-03	-0.01	-3.67e-05	-2.55e-06	0.0
15769	-2.83e-05	6.36e-04-9.56e-03		-3.15e-05	-1.98e-06	0.0
15770	-3.17e-05	7.29e-04-9.40e-03		-3.60e-05	-1.91e-06	0.0
15771	-2.83e-05	6.36e-04-9.56e-03		-3.15e-05	-1.98e-06	0.0
15772	-2.89e-05	6.55e-04-9.52e-03		-3.24e-05	-1.97e-06	0.0
15773	-2.83e-05	6.36e-04-9.56e-03		-3.15e-05	-1.98e-06	0.0
1582	-3.79e-05	1.67e-03	-0.02	-8.25e-05	-2.58e-06	0.0
15815	-1.93e-03	9.98e-04	-0.01	-5.18e-05	-2.29e-06	0.0
15833	6.11e-04	3.12e-03	-0.01	-5.50e-05	-1.19e-06	0.0





EGP CODE

GRE.EEC.R.73.IT.W.15235.12.024.01

PAGE

106 di/of 527

15834	4.59e-04	-7.65e-04	-0.01	-5.04e-05	-1.99e-06	0.0
15847	-2.69e-03	9.71e-04	-0.01	-5.16e-05	-2.50e-06	0.0
15865	8.65e-04	3.94e-03	-0.01	-5.60e-05	0.0	0.0
15866	6.53e-04	-1.50e-03	-0.01	-4.96e-05	-2.08e-06	0.0
15870	-2.64e-05	1.22e-03	-0.01	-5.99e-05	-1.64e-06	0.0
15872	-2.46e-05	1.09e-03	-0.01	-5.39e-05	-1.75e-06	0.0
15873	-2.41e-05	1.06e-03	-0.01	-5.24e-05	-1.77e-06	0.0
1592	-3.54e-05	2.41e-03	-0.02	-1.19e-04	-2.45e-06	0.0
15916	-2.04e-03	7.54e-04	-0.01	-7.09e-05	-4.74e-06	0.0
15918	1.90e-03	1.30e-03	-0.02	-7.43e-05	0.0	0.0
15933	6.69e-04	3.76e-03	-0.01	-8.61e-05	0.0	0.0
15948	-2.84e-03	4.52e-04	-0.01	-6.92e-05	-5.93e-06	0.0
15950	2.67e-03	1.21e-03	-0.02	-7.39e-05	1.69e-06	0.0
15965	9.46e-04	4.65e-03	-0.01	-9.05e-05	0.0	0.0
15970	-2.58e-05	1.76e-03	-0.02	-8.63e-05	-1.60e-06	0.0
15972	-2.44e-05	1.57e-03	-0.01	-7.73e-05	-1.74e-06	0.0
15973	-2.41e-05	1.52e-03	-0.01	-7.51e-05	-1.78e-06	0.0
1602	-4.69e-05	3.18e-03	-0.03	-1.56e-04	-3.32e-06	0.0
16015	-2.18e-03	1.96e-03	-0.02	-9.84e-05	-7.77e-06	0.0
16017	2.08e-03	3.15e-03	-0.02	-1.09e-04	3.51e-06	0.0
16033	7.14e-04	4.49e-03	-0.02	-1.22e-04	0.0	0.0
16047	-3.04e-03	1.95e-03	-0.02	-9.85e-05	-9.91e-06	0.0
16049	2.93e-03	3.60e-03	-0.02	-1.13e-04	5.90e-06	0.0
16065	1.01e-03	5.49e-03	-0.02	-1.31e-04	1.51e-06	0.0
16070	-3.59e-05	2.32e-03	-0.02	-1.14e-04	-2.33e-06	0.0
16072	-3.44e-05	2.06e-03	-0.02	-1.01e-04	-2.43e-06	0.0
16073	-3.40e-05	2.00e-03	-0.02	-9.82e-05	-2.45e-06	0.0
1612	5.40e-05	3.98e-03	-0.04	-1.92e-04	-2.66e-06	0.0
16113	2.52e-03	3.52e-03	-0.03	-1.36e-04	1.59e-05	0.0
16133	9.82e-04	5.51e-03	-0.03	-1.69e-04	7.08e-06	0.0
16145	3.52e-03	3.93e-03	-0.03	-1.43e-04	2.33e-05	0.0
16165	1.37e-03	6.73e-03	-0.03	-1.88e-04	1.09e-05	0.0
16170	3.84e-05	2.92e-03	-0.03	-1.41e-04	-1.91e-06	0.0
16172	2.16e-05	2.56e-03	-0.03	-1.24e-04	-2.33e-06	0.0
16173	1.74e-05	2.48e-03	-0.02	-1.20e-04	-2.43e-06	0.0
1622	-2.93e-04	4.05e-03	-0.04	-1.95e-04	-1.63e-05	0.0
16215	-2.57e-03	2.59e-03	-0.03	-1.27e-04	-2.82e-05	0.0
16231	-6.31e-04	5.77e-03	-0.03	-1.78e-04	-1.76e-05	0.0
16233	6.15e-04	5.77e-03	-0.03	-1.80e-04	-9.01e-06	0.0
16247	-3.52e-03	2.63e-03	-0.03	-1.29e-04	-3.53e-05	0.0
16263	-8.07e-04	7.09e-03	-0.03	-2.01e-04	-2.04e-05	0.0
16265	9.37e-04	7.08e-03	-0.03	-2.04e-04	-8.36e-06	0.0
16270	-2.23e-04	2.96e-03	-0.03	-1.43e-04	-1.22e-05	0.0
16272	-1.95e-04	2.59e-03	-0.03	-1.25e-04	-1.09e-05	0.0
16273	-1.89e-04	2.50e-03	-0.03	-1.21e-04	-1.06e-05	0.0
1632	-4.73e-04	-3.53e-03	-0.04	1.73e-04	-2.46e-05	0.0
1638	-2.33e-03	-2.25e-03	-0.03	1.09e-04	-1.36e-05	0.0
16330	3.94e-04	-5.05e-03	-0.03	1.51e-04	-2.14e-05	0.0
16340	-3.15e-03	-2.26e-03	-0.03	1.10e-04	-1.28e-05	0.0
16362	6.71e-04	-6.19e-03	-0.03	1.68e-04	-2.37e-05	0.0
16370	-3.59e-04	-2.58e-03	-0.03	1.26e-04	-1.85e-05	0.0
16372	-3.09e-04	-2.27e-03	-0.03	1.12e-04	-1.62e-05	0.0
16373	-2.97e-04	-2.20e-03	-0.03	1.08e-04	-1.56e-05	0.0
1642	-2.62e-04	-3.34e-03	-0.03	1.64e-04	-1.40e-05	0.0
1647	-2.18e-03	-1.23e-03	-0.02	9.10e-05	-7.26e-06	0.0
16430	5.48e-04	-4.76e-03	-0.02	1.37e-04	-8.25e-06	0.0
16439	-2.99e-03	-8.83e-04	-0.02	8.62e-05	-6.53e-06	0.0
16462	8.35e-04	-5.83e-03	-0.02	1.50e-04	-7.93e-06	0.0
16470	-2.00e-04	-2.43e-03	-0.02	1.20e-04	-1.05e-05	0.0
16472	-1.74e-04	-2.16e-03	-0.02	1.06e-04	-9.36e-06	0.0
16473	-1.67e-04	-2.09e-03	-0.02	1.03e-04	-9.07e-06	0.0
1652	-1.19e-04	-2.77e-03	-0.02	1.37e-04	-6.30e-06	0.0
1657	-2.07e-03	-9.46e-04	-0.02	7.75e-05	-3.89e-06	0.0
16510	1.89e-03	-2.84e-03	-0.02	9.72e-05	-4.17e-06	0.0
16530	6.37e-04	-4.13e-03	-0.02	1.06e-04	-1.98e-06	0.0
16539	-2.86e-03	-6.31e-04	-0.02	7.40e-05	-3.77e-06	0.0
16542	2.67e-03	-3.28e-03	-0.02	1.02e-04	-4.16e-06	0.0
16562	9.22e-04	-5.08e-03	-0.02	1.14e-04	-1.10e-06	0.0
16570	-9.14e-05	-2.02e-03	-0.02	9.95e-05	-4.66e-06	0.0
16572	-7.90e-05	-1.80e-03	-0.02	8.90e-05	-4.27e-06	0.0
16573	-7.58e-05	-1.74e-03	-0.02	8.63e-05	-4.17e-06	0.0
1662	-5.27e-05	-2.08e-03	-0.02	1.03e-04	-2.90e-06	0.0
1667	-1.95e-03	-5.93e-04	-0.01	6.04e-05	-1.18e-06	0.0
1669	1.80e-03	-1.08e-03	-0.01	6.60e-05	-3.34e-06	0.0
16630	6.24e-04	-3.46e-03	-0.01	7.33e-05	0.0	0.0
16639	-2.72e-03	-3.09e-04	-0.01	5.86e-05	0.0	0.0



EGP CODE

GRE.EEC.R.73.IT.W.15235.12.024.01

PAGE

107 di/of 527

16641	2.54e-03	-9.86e-04	-0.01	6.64e-05	-3.90e-06	0.0
16662	8.86e-04	-4.32e-03	-0.01	7.66e-05	0.0	0.0
16670	-4.11e-05	-1.51e-03	-0.01	7.46e-05	-2.07e-06	0.0
16672	-3.43e-05	-1.35e-03	-0.01	6.69e-05	-1.96e-06	0.0
16673	-3.26e-05	-1.31e-03	-0.01	6.50e-05	-1.94e-06	0.0
1672	-2.77e-05	-1.40e-03	-0.01	6.88e-05	-1.75e-06	0.0
1678	-1.87e-03	-8.46e-04	-0.01	4.18e-05	0.0	0.0
16729	4.64e-04	8.97e-04	-0.01	4.52e-05	-2.16e-06	0.0
16730	5.93e-04	-2.87e-03	-0.01	4.31e-05	0.0	0.0
16740	-2.61e-03	-8.30e-04-9.90e-03		4.11e-05	0.0	0.0
16761	6.56e-04	1.61e-03	-0.01	4.58e-05	-2.57e-06	0.0
16762	8.37e-04	-3.67e-03	-0.01	4.29e-05	0.0	0.0
16770	-2.17e-05	-1.01e-03	-0.01	5.00e-05	-1.17e-06	0.0
16772	-1.66e-05	-9.09e-04	-0.01	4.49e-05	-1.14e-06	0.0
16773	-1.54e-05	-8.83e-04	-0.01	4.37e-05	-1.14e-06	0.0
1681	-1.12e-05	-6.58e-04	-0.01	3.25e-05	-1.42e-06	0.0
1682	-1.98e-05	-7.63e-04	-0.01	3.76e-05	-1.46e-06	0.0
1688	-1.80e-03	-4.44e-04-8.51e-03		2.24e-05	0.0	0.0
16829	4.87e-04	1.21e-03-9.46e-03		2.88e-05	-1.63e-06	0.0
16830	5.57e-04	-2.38e-03-8.66e-03		1.94e-05	-1.07e-06	0.0
16840	-2.52e-03	-4.26e-04-8.34e-03		2.18e-05	1.28e-06	0.0
16861	6.85e-04	1.89e-03-9.66e-03		3.08e-05	-1.93e-06	0.0
16862	7.84e-04	-3.14e-03-8.54e-03		1.76e-05	-1.13e-06	0.0
16869	-9.58e-06	-4.84e-04-8.95e-03		2.39e-05	0.0	0.0
16870	-1.53e-05	-5.54e-04-8.72e-03		2.73e-05	0.0	0.0
16871	-9.58e-06	-4.84e-04-8.95e-03		2.39e-05	0.0	0.0
16872	-1.07e-05	-4.98e-04-8.90e-03		2.46e-05	0.0	0.0
16873	-9.58e-06	-4.84e-04-8.95e-03		2.39e-05	0.0	0.0
1691	-9.23e-06	-1.52e-04	-0.01	7.45e-06	-1.37e-06	0.0
1692	-1.77e-05	-1.77e-04	-0.01	8.60e-06	-1.42e-06	0.0
1698	-1.75e-03	-7.17e-05-7.87e-03		4.08e-06	0.0	0.0
1699	1.73e-03	8.31e-05-8.60e-03		7.73e-06	-2.46e-06	0.0
16930	5.20e-04	-1.97e-03-8.23e-03		-1.07e-06	-1.28e-06	0.0
16940	-2.45e-03	-5.44e-05-7.72e-03		3.55e-06	1.37e-06	0.0
16941	2.42e-03	1.63e-04-8.75e-03		8.62e-06	-3.10e-06	0.0
16962	7.31e-04	-2.71e-03-8.23e-03		-3.69e-06	-1.45e-06	0.0
16969	-7.91e-06	-1.12e-04-8.23e-03		5.47e-06	0.0	0.0
16970	-1.35e-05	-1.28e-04-7.90e-03		6.23e-06	0.0	0.0
16971	-7.91e-06	-1.12e-04-8.23e-03		5.47e-06	0.0	0.0
16972	-9.04e-06	-1.15e-04-8.16e-03		5.62e-06	0.0	0.0
16973	-7.91e-06	-1.12e-04-8.23e-03		5.47e-06	0.0	0.0
1701	-9.02e-06	3.43e-04	-0.01	-1.72e-05	-1.39e-06	0.0
1702	-1.73e-05	3.98e-04	-0.01	-1.98e-05	-1.44e-06	0.0
17016	-1.76e-03	-3.77e-04-8.09e-03		-1.32e-05	0.0	0.0
17018	1.73e-03	5.85e-05-8.82e-03		-1.49e-05	-2.47e-06	0.0
17033	5.38e-04	2.12e-03-8.27e-03		-6.56e-06	-1.18e-06	0.0
17048	-2.47e-03	-6.24e-04-7.97e-03		-1.35e-05	1.22e-06	0.0
17050	2.43e-03	-2.10e-05-8.99e-03		-1.58e-05	-3.11e-06	0.0
17065	7.56e-04	2.87e-03-8.21e-03		-4.14e-06	-1.30e-06	0.0
17069	-7.80e-06	2.52e-04-8.40e-03		-1.26e-05	0.0	0.0
17070	-1.33e-05	2.89e-04-8.10e-03		-1.44e-05	0.0	0.0
17071	-7.80e-06	2.52e-04-8.40e-03		-1.26e-05	0.0	0.0
17072	-8.90e-06	2.60e-04-8.34e-03		-1.29e-05	0.0	0.0
17073	-7.80e-06	2.52e-04-8.40e-03		-1.26e-05	0.0	0.0
1711	-1.15e-05	8.62e-04	-0.01	-4.29e-05	-1.51e-06	0.0
1712	-1.98e-05	1.00e-03	-0.01	-4.96e-05	-1.56e-06	0.0
17116	-1.82e-03	-1.48e-05-9.19e-03		-3.11e-05	0.0	0.0
17133	5.75e-04	2.56e-03-9.11e-03		-2.84e-05	-1.00e-06	0.0
17134	4.74e-04	-1.09e-03	-0.01	-3.51e-05	-1.81e-06	0.0
17148	-2.54e-03	-2.70e-04-9.06e-03		-3.09e-05	0.0	0.0
17165	8.10e-04	3.33e-03-8.96e-03		-2.72e-05	-1.01e-06	0.0
17166	6.68e-04	-1.78e-03	-0.01	-3.66e-05	-2.14e-06	0.0
17169	-9.92e-06	6.34e-04-9.49e-03		-3.15e-05	0.0	0.0
17170	-1.55e-05	7.27e-04-9.33e-03		-3.60e-05	-1.01e-06	0.0
17171	-9.92e-06	6.34e-04-9.49e-03		-3.15e-05	0.0	0.0
17172	-1.10e-05	6.53e-04-9.46e-03		-3.24e-05	0.0	0.0
17173	-9.92e-06	6.34e-04-9.49e-03		-3.15e-05	0.0	0.0
1722	-3.20e-05	1.66e-03	-0.02	-8.20e-05	-2.12e-06	0.0
17216	-1.89e-03	3.62e-04	-0.01	-4.94e-05	0.0	0.0
17233	6.10e-04	3.10e-03	-0.01	-5.52e-05	0.0	0.0
17234	4.49e-04	-7.82e-04	-0.01	-4.99e-05	-2.58e-06	0.0
17248	-2.64e-03	9.11e-05	-0.01	-4.84e-05	0.0	0.0
17265	8.62e-04	3.92e-03	-0.01	-5.65e-05	0.0	0.0
17266	6.37e-04	-1.52e-03	-0.01	-4.91e-05	-3.05e-06	0.0
17270	-2.52e-05	1.20e-03	-0.01	-5.95e-05	-1.46e-06	0.0
17272	-2.00e-05	1.08e-03	-0.01	-5.35e-05	-1.41e-06	0.0



EGP CODE

GRE.EEC.R.73.IT.W.15235.12.024.01

PAGE

108 di/of 527

17273	-1.86e-05	1.05e-03	-0.01	-5.20e-05	-1.40e-06	0.0
1732	-6.98e-05	2.36e-03	-0.02	-1.17e-04	-3.98e-06	0.0
17316	-1.98e-03	7.37e-04	-0.01	-6.77e-05	-2.11e-06	0.0
17318	1.80e-03	1.25e-03	-0.02	-7.42e-05	-3.99e-06	0.0
17333	6.35e-04	3.72e-03	-0.01	-8.61e-05	-1.22e-06	0.0
17348	-2.76e-03	4.41e-04	-0.01	-6.53e-05	-1.89e-06	0.0
17350	2.55e-03	1.15e-03	-0.02	-7.44e-05	-4.53e-06	0.0
17365	9.07e-04	4.62e-03	-0.01	-9.10e-05	0.0	0.0
17370	-5.43e-05	1.72e-03	-0.02	-8.47e-05	-2.89e-06	0.0
17372	-4.61e-05	1.53e-03	-0.01	-7.59e-05	-2.70e-06	0.0
17373	-4.40e-05	1.49e-03	-0.01	-7.37e-05	-2.65e-06	0.0
1742	-1.63e-04	3.03e-03	-0.03	-1.50e-04	-8.83e-06	0.0
17416	-2.12e-03	1.06e-03	-0.02	-8.35e-05	-5.57e-06	0.0
17417	1.88e-03	3.05e-03	-0.02	-1.08e-04	-5.74e-06	0.0
17433	6.25e-04	4.41e-03	-0.02	-1.20e-04	-3.57e-06	0.0
17448	-2.92e-03	7.30e-04	-0.02	-7.93e-05	-5.48e-06	0.0
17449	2.67e-03	3.51e-03	-0.02	-1.13e-04	-5.71e-06	0.0
17465	9.17e-04	5.41e-03	-0.02	-1.30e-04	-2.68e-06	0.0
17470	-1.25e-04	2.21e-03	-0.02	-1.09e-04	-6.58e-06	0.0
17472	-1.08e-04	1.96e-03	-0.02	-9.71e-05	-5.95e-06	0.0
17473	-1.04e-04	1.90e-03	-0.02	-9.42e-05	-5.79e-06	0.0
1752	-3.31e-04	3.49e-03	-0.04	-1.72e-04	-1.82e-05	0.0
17515	-2.23e-03	2.19e-03	-0.02	-1.08e-04	-9.03e-06	0.0
17533	4.94e-04	4.94e-03	-0.03	-1.46e-04	-1.44e-05	0.0
17547	-3.04e-03	2.19e-03	-0.02	-1.08e-04	-7.96e-06	0.0
17565	7.76e-04	6.05e-03	-0.03	-1.61e-04	-1.55e-05	0.0
17570	-2.52e-04	2.54e-03	-0.03	-1.25e-04	-1.36e-05	0.0
17572	-2.19e-04	2.25e-03	-0.02	-1.11e-04	-1.20e-05	0.0
17573	-2.11e-04	2.18e-03	-0.02	-1.08e-04	-1.16e-05	0.0
1762	-4.54e-04	3.55e-03	-0.04	-1.75e-04	-2.44e-05	0.0
17615	-2.34e-03	2.25e-03	-0.03	-1.10e-04	-1.34e-05	0.0
17633	4.14e-04	5.08e-03	-0.03	-1.52e-04	-2.10e-05	0.0
17647	-3.17e-03	2.26e-03	-0.03	-1.11e-04	-1.26e-05	0.0
17665	6.94e-04	6.22e-03	-0.03	-1.70e-04	-2.32e-05	0.0
17670	-3.45e-04	2.59e-03	-0.03	-1.27e-04	-1.84e-05	0.0
17672	-2.97e-04	2.29e-03	-0.03	-1.13e-04	-1.60e-05	0.0
17673	-2.85e-04	2.21e-03	-0.03	-1.09e-04	-1.55e-05	0.0
1772	-2.31e-04	-3.33e-03	-0.04	1.64e-04	-1.19e-05	0.0
1778	-1.99e-03	-2.16e-03	-0.03	1.05e-04	3.17e-06	0.0
17730	4.86e-04	-4.83e-03	-0.03	1.42e-04	-1.47e-05	0.0
17740	-2.73e-03	-2.19e-03	-0.03	1.06e-04	7.53e-06	0.0
17762	7.38e-04	-5.94e-03	-0.03	1.57e-04	-1.75e-05	0.0
17770	-1.79e-04	-2.42e-03	-0.03	1.20e-04	-9.02e-06	0.0
17772	-1.52e-04	-2.15e-03	-0.03	1.06e-04	-7.89e-06	0.0
17773	-1.45e-04	-2.08e-03	-0.03	1.03e-04	-7.61e-06	0.0
1782	-1.39e-04	-3.16e-03	-0.03	1.56e-04	-7.15e-06	0.0
1788	-1.96e-03	-2.03e-03	-0.02	9.91e-05	4.30e-06	0.0
17830	5.71e-04	-4.57e-03	-0.02	1.29e-04	-8.42e-06	0.0
17840	-2.71e-03	-2.05e-03	-0.02	9.95e-05	7.89e-06	0.0
17862	8.34e-04	-5.60e-03	-0.02	1.41e-04	-9.92e-06	0.0
17870	-1.09e-04	-2.30e-03	-0.02	1.13e-04	-5.43e-06	0.0
17872	-9.17e-05	-2.04e-03	-0.02	1.01e-04	-4.81e-06	0.0
17873	-8.74e-05	-1.98e-03	-0.02	9.81e-05	-4.66e-06	0.0
1792	-6.33e-05	-2.67e-03	-0.02	1.32e-04	-3.32e-06	0.0
1794	-6.34e-05	-1.98e-03	-0.02	9.75e-05	-2.68e-06	0.0
1797	-1.92e-03	-9.43e-04	-0.02	7.62e-05	3.25e-06	0.0
17910	1.81e-03	-2.71e-03	-0.02	9.28e-05	-7.53e-06	0.0
17930	6.18e-04	-4.04e-03	-0.02	1.03e-04	-2.87e-06	0.0
17939	-2.67e-03	-6.52e-04	-0.02	7.33e-05	5.44e-06	0.0
17942	2.55e-03	-3.13e-03	-0.02	9.65e-05	-9.67e-06	0.0
17962	8.82e-04	-4.99e-03	-0.02	1.11e-04	-3.14e-06	0.0
17970	-5.14e-05	-1.94e-03	-0.02	9.61e-05	-2.51e-06	0.0
17972	-4.15e-05	-1.73e-03	-0.02	8.60e-05	-2.26e-06	0.0
17973	-3.90e-05	-1.68e-03	-0.02	8.34e-05	-2.20e-06	0.0
1802	-2.16e-05	-2.04e-03	-0.02	1.01e-04	-1.28e-06	0.0
1804	-2.88e-05	-1.50e-03	-0.01	7.40e-05	0.0	0.0
1808	-1.87e-03	-1.29e-03	-0.01	6.29e-05	2.74e-06	0.0
1809	1.77e-03	-1.01e-03	-0.01	6.38e-05	-4.51e-06	0.0
18030	6.23e-04	-3.43e-03	-0.01	7.26e-05	-1.09e-06	0.0
18040	-2.62e-03	-1.30e-03	-0.01	6.25e-05	4.17e-06	0.0
18041	2.49e-03	-8.94e-04	-0.01	6.39e-05	-5.98e-06	0.0
18062	8.77e-04	-4.28e-03	-0.01	7.62e-05	-1.19e-06	0.0
18070	-1.95e-05	-1.48e-03	-0.01	7.32e-05	0.0	0.0
18072	-1.30e-05	-1.32e-03	-0.01	6.57e-05	0.0	0.0
18073	-1.14e-05	-1.29e-03	-0.01	6.38e-05	0.0	0.0
1812	-3.64e-06	-1.38e-03	-0.01	6.82e-05	0.0	0.0



EGP CODE

GRE.EEC.R.73.IT.W.15235.12.024.01

PAGE

109 di/of 527

1814	-1.38e-05	-1.01e-03	-0.01	4.99e-05	0.0	0.0
1815	1.83e-03	-8.74e-04	-0.01	4.50e-05	-2.74e-06	0.0
18129	4.76e-04	9.17e-04	-0.01	4.48e-05	-1.42e-06	0.0
18130	6.00e-04	-2.85e-03	-0.01	4.26e-05	0.0	0.0
18137	2.56e-03	-8.75e-04	-0.01	4.56e-05	-3.72e-06	0.0
18161	6.66e-04	1.64e-03	-0.01	4.53e-05	-1.88e-06	0.0
18162	8.41e-04	-3.64e-03	-9.99e-03	4.23e-05	0.0	0.0
18170	-5.57e-06	-1.00e-03	-0.01	4.95e-05	0.0	0.0
18171	1.04e-06	-8.73e-04	-0.01	4.33e-05	0.0	0.0
18172	0.0	-8.99e-04	-0.01	4.45e-05	0.0	0.0
18173	1.04e-06	-8.73e-04	-0.01	4.33e-05	0.0	0.0
1821	1.24e-05	-6.54e-04	-0.01	3.24e-05	0.0	0.0
1822	3.10e-06	-7.59e-04	-0.01	3.74e-05	0.0	0.0
1825	1.79e-03	-4.88e-04	-9.28e-03	2.52e-05	-2.06e-06	0.0
18229	5.00e-04	1.22e-03	-9.40e-03	2.85e-05	0.0	0.0
18230	5.69e-04	-2.36e-03	-8.62e-03	1.94e-05	0.0	0.0
18237	2.50e-03	-4.92e-04	-9.41e-03	2.57e-05	-2.85e-06	0.0
18261	6.98e-04	1.90e-03	-9.59e-03	3.04e-05	-1.22e-06	0.0
18262	7.94e-04	-3.11e-03	-8.50e-03	1.76e-05	0.0	0.0
18269	5.97e-06	-4.81e-04	-8.93e-03	2.38e-05	0.0	0.0
18270	0.0	-5.51e-04	-8.70e-03	2.71e-05	0.0	0.0
18271	5.97e-06	-4.81e-04	-8.93e-03	2.38e-05	0.0	0.0
18272	4.73e-06	-4.95e-04	-8.88e-03	2.44e-05	0.0	0.0
18273	5.97e-06	-4.81e-04	-8.93e-03	2.38e-05	0.0	0.0
1831	1.46e-05	-1.52e-04	-0.01	7.43e-06	0.0	0.0
1832	5.46e-06	-1.76e-04	-0.01	8.58e-06	0.0	0.0
1835	1.75e-03	-1.20e-04	-8.48e-03	6.80e-06	-1.77e-06	0.0
1839	1.74e-03	1.16e-04	-8.50e-03	7.66e-06	-1.80e-06	0.0
18330	5.35e-04	-1.95e-03	-8.19e-03	-1.01e-06	0.0	0.0
18337	2.44e-03	-1.24e-04	-8.60e-03	7.32e-06	-2.46e-06	0.0
18341	2.43e-03	2.09e-04	-8.61e-03	8.54e-06	-2.50e-06	0.0
18362	7.45e-04	-2.69e-03	-8.18e-03	-3.61e-06	0.0	0.0
18369	7.73e-06	-1.12e-04	-8.21e-03	5.45e-06	0.0	0.0
18370	1.62e-06	-1.28e-04	-7.88e-03	6.22e-06	0.0	0.0
18371	7.73e-06	-1.12e-04	-8.21e-03	5.45e-06	0.0	0.0
18372	6.50e-06	-1.15e-04	-8.14e-03	5.60e-06	0.0	0.0
18373	7.73e-06	-1.12e-04	-8.21e-03	5.45e-06	0.0	0.0
1841	1.50e-05	3.41e-04	-0.01	-1.71e-05	0.0	0.0
1842	5.98e-06	3.96e-04	-0.01	-1.97e-05	0.0	0.0
18414	1.76e-03	2.61e-04	-8.69e-03	-1.40e-05	-1.86e-06	0.0
18418	1.74e-03	2.36e-05	-8.72e-03	-1.48e-05	-1.85e-06	0.0
18433	5.52e-04	2.10e-03	-8.23e-03	-6.60e-06	0.0	0.0
18446	2.46e-03	2.66e-04	-8.81e-03	-1.45e-05	-2.59e-06	0.0
18450	2.44e-03	-6.90e-05	-8.85e-03	-1.56e-05	-2.58e-06	0.0
18465	7.69e-04	2.84e-03	-8.17e-03	-4.22e-06	0.0	0.0
18469	7.96e-06	2.51e-04	-8.38e-03	-1.25e-05	0.0	0.0
18470	1.97e-06	2.87e-04	-8.07e-03	-1.43e-05	0.0	0.0
18471	7.96e-06	2.51e-04	-8.38e-03	-1.25e-05	0.0	0.0
18472	6.76e-06	2.58e-04	-8.32e-03	-1.29e-05	0.0	0.0
18473	7.96e-06	2.51e-04	-8.38e-03	-1.25e-05	0.0	0.0
1851	1.29e-05	8.54e-04	-0.01	-4.26e-05	0.0	0.0
1852	4.01e-06	9.93e-04	-0.01	-4.93e-05	0.0	0.0
18514	1.80e-03	6.34e-04	-9.84e-03	-3.27e-05	-2.21e-06	0.0
18533	5.87e-04	2.54e-03	-9.07e-03	-2.84e-05	0.0	0.0
18534	4.88e-04	-1.10e-03	-0.01	-3.47e-05	-1.08e-06	0.0
18546	2.52e-03	6.38e-04	-9.99e-03	-3.32e-05	-3.04e-06	0.0
18565	8.19e-04	3.31e-03	-8.92e-03	-2.73e-05	0.0	0.0
18566	6.80e-04	-1.79e-03	-0.01	-3.60e-05	-1.46e-06	0.0
18569	6.25e-06	6.28e-04	-9.46e-03	-3.13e-05	0.0	0.0
18570	0.0	7.20e-04	-9.31e-03	-3.57e-05	0.0	0.0
18571	6.25e-06	6.28e-04	-9.46e-03	-3.13e-05	0.0	0.0
18572	5.07e-06	6.46e-04	-9.43e-03	-3.22e-05	0.0	0.0
18573	6.25e-06	6.28e-04	-9.46e-03	-3.13e-05	0.0	0.0
1862	-4.57e-06	1.63e-03	-0.02	-8.10e-05	0.0	0.0
1864	-1.48e-05	1.20e-03	-0.01	-5.93e-05	0.0	0.0
18615	-1.84e-03	1.03e-03	-0.01	-5.03e-05	2.25e-06	0.0
18633	6.17e-04	3.07e-03	-0.01	-5.50e-05	0.0	0.0
18634	4.62e-04	-8.11e-04	-0.01	-4.87e-05	-1.78e-06	0.0
18647	-2.58e-03	1.03e-03	-0.01	-4.99e-05	3.32e-06	0.0
18665	8.64e-04	3.88e-03	-0.01	-5.64e-05	0.0	0.0
18666	6.46e-04	-1.55e-03	-0.01	-4.77e-05	-2.32e-06	0.0
18670	-6.46e-06	1.19e-03	-0.01	-5.88e-05	0.0	0.0
18672	-1.33e-06	1.06e-03	-0.01	-5.28e-05	0.0	0.0
18673	0.0	1.03e-03	-0.01	-5.13e-05	0.0	0.0
1872	-2.88e-05	2.30e-03	-0.02	-1.14e-04	-1.90e-06	0.0
1874	-3.50e-05	1.69e-03	-0.02	-8.37e-05	-1.50e-06	0.0



EGP CODE

GRE.EEC.R.73.IT.W.15235.12.024.01

PAGE

110 di/of 527

18716	-1.89e-03	7.45e-04	-0.01	-6.67e-05	2.52e-06	0.0
18718	1.77e-03	1.15e-03	-0.02	-7.13e-05	-5.47e-06	0.0
18733	6.33e-04	3.67e-03	-0.01	-8.48e-05	-1.51e-06	0.0
18748	-2.64e-03	4.69e-04	-0.01	-6.46e-05	4.03e-06	0.0
18750	2.48e-03	1.04e-03	-0.02	-7.10e-05	-7.16e-06	0.0
18765	8.94e-04	4.56e-03	-0.01	-9.00e-05	-1.61e-06	0.0
18770	-2.51e-05	1.67e-03	-0.02	-8.27e-05	-1.43e-06	0.0
18772	-1.83e-05	1.49e-03	-0.01	-7.41e-05	-1.29e-06	0.0
18773	-1.66e-05	1.45e-03	-0.01	-7.19e-05	-1.26e-06	0.0
1882	-8.16e-05	2.90e-03	-0.03	-1.44e-04	-4.61e-06	0.0
18816	-1.93e-03	1.05e-03	-0.02	-8.20e-05	3.33e-06	0.0
18833	6.15e-04	4.28e-03	-0.02	-1.15e-04	-3.98e-06	0.0
18848	-2.68e-03	7.53e-04	-0.02	-7.86e-05	5.89e-06	0.0
18865	8.82e-04	5.26e-03	-0.02	-1.25e-04	-4.36e-06	0.0
18870	-6.55e-05	2.11e-03	-0.02	-1.04e-04	-3.50e-06	0.0
18872	-5.41e-05	1.88e-03	-0.02	-9.32e-05	-3.13e-06	0.0
18873	-5.13e-05	1.82e-03	-0.02	-9.05e-05	-3.04e-06	0.0
1892	-1.65e-04	3.29e-03	-0.03	-1.63e-04	-9.00e-06	0.0
18915	-1.97e-03	2.12e-03	-0.02	-1.04e-04	3.59e-06	0.0
18933	5.52e-04	4.73e-03	-0.03	-1.37e-04	-1.05e-05	0.0
18947	-2.72e-03	2.14e-03	-0.02	-1.04e-04	7.38e-06	0.0
18965	8.15e-04	5.80e-03	-0.03	-1.51e-04	-1.24e-05	0.0
18970	-1.29e-04	2.39e-03	-0.03	-1.18e-04	-6.83e-06	0.0
18972	-1.09e-04	2.12e-03	-0.02	-1.05e-04	-6.03e-06	0.0
18973	-1.05e-04	2.05e-03	-0.02	-1.02e-04	-5.83e-06	0.0
1902	-2.18e-04	3.36e-03	-0.04	-1.66e-04	-1.17e-05	0.0
19015	-1.98e-03	2.17e-03	-0.03	-1.06e-04	3.68e-06	0.0
19033	4.97e-04	4.86e-03	-0.03	-1.43e-04	-1.47e-05	0.0
19047	-2.72e-03	2.20e-03	-0.03	-1.07e-04	8.21e-06	0.0
19065	7.52e-04	5.97e-03	-0.03	-1.59e-04	-1.76e-05	0.0
19070	-1.69e-04	2.44e-03	-0.03	-1.21e-04	-8.92e-06	0.0
19072	-1.44e-04	2.16e-03	-0.03	-1.07e-04	-7.82e-06	0.0
19073	-1.38e-04	2.09e-03	-0.03	-1.04e-04	-7.54e-06	0.0
1912	1.72e-04	-3.31e-03	-0.04	1.63e-04	8.94e-06	0.0
1916	1.91e-03	-2.82e-03	-0.03	1.11e-04	-6.53e-06	0.0
19130	7.59e-04	-4.78e-03	-0.03	1.39e-04	4.32e-06	0.0
19138	2.63e-03	-3.12e-03	-0.03	1.15e-04	-1.13e-05	0.0
19162	1.02e-03	-5.87e-03	-0.03	1.54e-04	3.93e-06	0.0
19170	1.23e-04	-2.41e-03	-0.03	1.19e-04	6.55e-06	0.0
19172	1.08e-04	-2.13e-03	-0.03	1.06e-04	5.55e-06	0.0
19173	1.05e-04	-2.07e-03	-0.03	1.02e-04	5.30e-06	0.0
1922	1.11e-04	-3.14e-03	-0.03	1.55e-04	5.88e-06	0.0
1925	1.91e-03	-1.84e-03	-0.02	9.34e-05	-6.49e-06	0.0
19230	7.13e-04	-4.52e-03	-0.02	1.27e-04	0.0	0.0
19237	2.64e-03	-1.79e-03	-0.02	9.17e-05	-1.05e-05	0.0
19262	9.71e-04	-5.55e-03	-0.02	1.39e-04	-1.82e-06	0.0
19270	7.82e-05	-2.28e-03	-0.02	1.13e-04	4.30e-06	0.0
19272	7.16e-05	-2.03e-03	-0.02	1.01e-04	3.69e-06	0.0
19273	7.00e-05	-1.97e-03	-0.02	9.75e-05	3.54e-06	0.0
1932	6.50e-05	-2.66e-03	-0.02	1.32e-04	3.30e-06	0.0
1935	1.89e-03	-1.58e-03	-0.02	8.04e-05	-4.31e-06	0.0
19330	6.78e-04	-4.01e-03	-0.02	1.02e-04	0.0	0.0
19337	2.64e-03	-1.54e-03	-0.02	7.94e-05	-6.86e-06	0.0
19362	9.32e-04	-4.94e-03	-0.02	1.09e-04	-1.56e-06	0.0
19370	4.41e-05	-1.93e-03	-0.02	9.57e-05	2.41e-06	0.0
19372	4.33e-05	-1.73e-03	-0.02	8.56e-05	2.11e-06	0.0
19373	4.30e-05	-1.67e-03	-0.02	8.30e-05	2.04e-06	0.0
1941	4.29e-05	-1.74e-03	-0.02	8.66e-05	1.54e-06	0.0
1942	3.85e-05	-2.04e-03	-0.02	1.01e-04	1.74e-06	0.0
1945	1.88e-03	-1.22e-03	-0.01	6.27e-05	-2.59e-06	0.0
19429	4.88e-04	6.71e-04	-0.01	5.56e-05	0.0	0.0
19430	6.47e-04	-3.40e-03	-0.01	7.21e-05	0.0	0.0
19437	2.61e-03	-1.19e-03	-0.01	6.23e-05	-4.08e-06	0.0
19461	6.72e-04	1.45e-03	-0.01	5.24e-05	0.0	0.0
19462	8.95e-04	-4.25e-03	-0.01	7.54e-05	-1.43e-06	0.0
19469	2.77e-05	-1.28e-03	-0.01	6.36e-05	1.13e-06	0.0
19470	2.47e-05	-1.48e-03	-0.01	7.31e-05	1.26e-06	0.0
19471	2.77e-05	-1.28e-03	-0.01	6.36e-05	1.13e-06	0.0
19472	2.71e-05	-1.32e-03	-0.01	6.55e-05	1.16e-06	0.0
19473	2.77e-05	-1.28e-03	-0.01	6.36e-05	1.13e-06	0.0
1951	3.33e-05	-1.19e-03	-0.01	5.89e-05	0.0	0.0
1952	2.59e-05	-1.38e-03	-0.01	6.83e-05	0.0	0.0
1955	1.84e-03	-8.32e-04	-0.01	4.35e-05	-1.60e-06	0.0
19529	4.99e-04	9.24e-04	-0.01	4.23e-05	0.0	0.0
19530	6.14e-04	-2.83e-03	-0.01	4.45e-05	0.0	0.0
19537	2.57e-03	-8.17e-04	-0.01	4.36e-05	-2.51e-06	0.0





EGP CODE

GRE.EEC.R.73.IT.W.15235.12.024.01

PAGE

111 di/of 527

19561	6.90e-04	1.64e-03	-0.01	4.19e-05	0.0	0.0
19562	8.51e-04	-3.62e-03	-9.95e-03	4.50e-05	-1.03e-06	0.0
19569	2.05e-05	-8.72e-04	-0.01	4.32e-05	0.0	0.0
19570	1.56e-05	-1.00e-03	-0.01	4.95e-05	0.0	0.0
19571	2.05e-05	-8.72e-04	-0.01	4.32e-05	0.0	0.0
19572	1.95e-05	-8.98e-04	-0.01	4.45e-05	0.0	0.0
19573	2.05e-05	-8.72e-04	-0.01	4.32e-05	0.0	0.0
1961	2.94e-05	-6.55e-04	-0.01	3.24e-05	0.0	0.0
1962	2.07e-05	-7.61e-04	-0.01	3.75e-05	0.0	0.0
1965	1.80e-03	-4.54e-04	-9.20e-03	2.49e-05	-1.22e-06	0.0
19629	5.14e-04	1.22e-03	-9.39e-03	2.85e-05	0.0	0.0
19630	5.79e-04	-2.34e-03	-8.60e-03	1.93e-05	0.0	0.0
19637	2.51e-03	-4.44e-04	-9.30e-03	2.53e-05	-1.91e-06	0.0
19661	7.12e-04	1.90e-03	-9.57e-03	3.04e-05	0.0	0.0
19662	8.03e-04	-3.09e-03	-8.47e-03	1.75e-05	0.0	0.0
19669	1.77e-05	-4.81e-04	-8.94e-03	2.38e-05	0.0	0.0
19670	1.19e-05	-5.52e-04	-8.71e-03	2.72e-05	0.0	0.0
19671	1.77e-05	-4.81e-04	-8.94e-03	2.38e-05	0.0	0.0
19672	1.65e-05	-4.95e-04	-8.89e-03	2.44e-05	0.0	0.0
19673	1.77e-05	-4.81e-04	-8.94e-03	2.38e-05	0.0	0.0
1971	2.86e-05	-1.53e-04	-0.01	7.43e-06	0.0	0.0
1972	1.95e-05	-1.77e-04	-0.01	8.58e-06	0.0	0.0
1975	1.76e-03	-8.92e-05	-8.42e-03	6.74e-06	-1.13e-06	0.0
1979	1.75e-03	1.47e-04	-8.43e-03	7.60e-06	-1.12e-06	0.0
19736	-4.92e-04	-1.93e-03	-8.07e-03	-1.09e-06	0.0	0.0
19737	2.45e-03	-8.09e-05	-8.49e-03	7.24e-06	-1.76e-06	0.0
19741	2.45e-03	2.52e-04	-8.51e-03	8.45e-06	-1.75e-06	0.0
19762	7.55e-04	-2.66e-03	-8.16e-03	-3.70e-06	0.0	0.0
19769	1.71e-05	-1.12e-04	-8.22e-03	5.45e-06	0.0	0.0
19770	1.10e-05	-1.28e-04	-7.89e-03	6.22e-06	0.0	0.0
19771	1.71e-05	-1.12e-04	-8.22e-03	5.45e-06	0.0	0.0
19772	1.59e-05	-1.15e-04	-8.16e-03	5.60e-06	0.0	0.0
19773	1.71e-05	-1.12e-04	-8.22e-03	5.45e-06	0.0	0.0
1981	2.98e-05	3.41e-04	-0.01	-1.71e-05	0.0	0.0
1982	2.11e-05	3.96e-04	-0.01	-1.98e-05	0.0	0.0
19814	1.77e-03	2.28e-04	-8.62e-03	-1.39e-05	-1.08e-06	0.0
19833	5.61e-04	2.08e-03	-8.22e-03	-6.55e-06	0.0	0.0
19834	5.20e-04	-1.42e-03	-8.69e-03	-1.87e-05	0.0	0.0
19846	2.47e-03	2.20e-04	-8.71e-03	-1.44e-05	-1.71e-06	0.0
19865	7.79e-04	2.81e-03	-8.15e-03	-4.14e-06	0.0	0.0
19866	7.21e-04	-2.09e-03	-8.80e-03	-2.12e-05	0.0	0.0
19869	1.80e-05	2.50e-04	-8.40e-03	-1.26e-05	0.0	0.0
19870	1.22e-05	2.87e-04	-8.09e-03	-1.43e-05	0.0	0.0
19871	1.80e-05	2.50e-04	-8.40e-03	-1.26e-05	0.0	0.0
19872	1.69e-05	2.58e-04	-8.33e-03	-1.29e-05	0.0	0.0
19873	1.80e-05	2.50e-04	-8.40e-03	-1.26e-05	0.0	0.0
1991	3.35e-05	8.54e-04	-0.01	-4.26e-05	0.0	0.0
1992	2.60e-05	9.93e-04	-0.01	-4.93e-05	0.0	0.0
19914	1.82e-03	5.98e-04	-9.76e-03	-3.23e-05	-1.20e-06	0.0
19933	5.98e-04	2.52e-03	-9.06e-03	-2.83e-05	0.0	0.0
19934	5.05e-04	-1.10e-03	-0.01	-3.46e-05	0.0	0.0
19946	2.53e-03	5.86e-04	-9.87e-03	-3.27e-05	-1.92e-06	0.0
19965	8.29e-04	3.28e-03	-8.89e-03	-2.71e-05	0.0	0.0
19966	6.98e-04	-1.80e-03	-0.01	-3.59e-05	0.0	0.0
19969	2.08e-05	6.27e-04	-9.48e-03	-3.13e-05	0.0	0.0
19970	1.58e-05	7.20e-04	-9.32e-03	-3.58e-05	0.0	0.0
19971	2.08e-05	6.27e-04	-9.48e-03	-3.13e-05	0.0	0.0
19972	1.98e-05	6.46e-04	-9.45e-03	-3.22e-05	0.0	0.0
19973	2.08e-05	6.27e-04	-9.48e-03	-3.13e-05	0.0	0.0
2001	4.13e-05	1.40e-03	-0.02	-6.98e-05	1.22e-06	0.0
2002	3.62e-05	1.63e-03	-0.02	-8.10e-05	1.32e-06	0.0
20014	1.86e-03	9.81e-04	-0.01	-5.12e-05	-1.68e-06	0.0
20033	6.34e-04	3.04e-03	-0.01	-5.46e-05	0.0	0.0
20034	4.93e-04	-8.22e-04	-0.01	-4.82e-05	0.0	0.0
20046	2.59e-03	9.63e-04	-0.01	-5.12e-05	-2.71e-06	0.0
20065	8.78e-04	3.85e-03	-0.01	-5.60e-05	0.0	0.0
20066	6.79e-04	-1.56e-03	-0.01	-4.70e-05	0.0	0.0
20069	2.65e-05	1.03e-03	-0.01	-5.12e-05	0.0	0.0
20070	2.32e-05	1.18e-03	-0.01	-5.87e-05	0.0	0.0
20071	2.65e-05	1.03e-03	-0.01	-5.12e-05	0.0	0.0
20072	2.59e-05	1.06e-03	-0.01	-5.27e-05	0.0	0.0
20073	2.65e-05	1.03e-03	-0.01	-5.12e-05	0.0	0.0
2011	5.65e-05	1.96e-03	-0.02	-9.75e-05	2.00e-06	0.0
2012	5.60e-05	2.29e-03	-0.02	-1.14e-04	2.33e-06	0.0
20114	1.89e-03	1.36e-03	-0.01	-7.01e-05	-2.92e-06	0.0
20118	1.81e-03	1.08e-03	-0.01	-6.89e-05	-2.87e-06	0.0



EGP CODE

GRE.EEC.R.73.IT.W.15235.12.024.01

PAGE

112 di/of 527

20133	6.69e-04	3.64e-03	-0.01	-8.40e-05	0.0	0.0
20146	2.63e-03	1.33e-03	-0.02	-6.94e-05	-4.68e-06	0.0
20150	2.52e-03	9.39e-04	-0.02	-6.77e-05	-4.62e-06	0.0
20165	9.21e-04	4.52e-03	-0.01	-8.89e-05	-1.28e-06	0.0
20169	3.80e-05	1.44e-03	-0.01	-7.17e-05	1.48e-06	0.0
20170	3.76e-05	1.66e-03	-0.02	-8.24e-05	1.70e-06	0.0
20171	3.80e-05	1.44e-03	-0.01	-7.17e-05	1.48e-06	0.0
20172	3.79e-05	1.48e-03	-0.01	-7.38e-05	1.52e-06	0.0
20173	3.80e-05	1.44e-03	-0.01	-7.17e-05	1.48e-06	0.0
2022	9.19e-05	2.88e-03	-0.03	-1.43e-04	4.23e-06	0.0
20214	1.91e-03	1.70e-03	-0.02	-8.65e-05	-4.80e-06	0.0
20233	7.02e-04	4.24e-03	-0.02	-1.13e-04	0.0	0.0
20246	2.65e-03	1.65e-03	-0.02	-8.52e-05	-7.77e-06	0.0
20265	9.60e-04	5.21e-03	-0.02	-1.23e-04	-1.41e-06	0.0
20270	6.39e-05	2.09e-03	-0.02	-1.04e-04	3.09e-06	0.0
20272	5.99e-05	1.87e-03	-0.02	-9.27e-05	2.68e-06	0.0
20273	5.89e-05	1.81e-03	-0.02	-9.00e-05	2.58e-06	0.0
2032	1.46e-04	3.27e-03	-0.03	-1.62e-04	7.14e-06	0.0
20314	1.92e-03	1.90e-03	-0.02	-9.66e-05	-7.31e-06	0.0
20333	7.44e-04	4.68e-03	-0.03	-1.35e-04	0.0	0.0
20346	2.66e-03	1.84e-03	-0.02	-9.46e-05	-1.19e-05	0.0
20365	1.01e-03	5.74e-03	-0.03	-1.48e-04	-2.44e-06	0.0
20370	1.04e-04	2.38e-03	-0.03	-1.18e-04	5.23e-06	0.0
20372	9.31e-05	2.11e-03	-0.02	-1.05e-04	4.46e-06	0.0
20373	9.04e-05	2.04e-03	-0.02	-1.01e-04	4.27e-06	0.0
2042	1.83e-04	3.34e-03	-0.04	-1.65e-04	9.05e-06	0.0
20413	1.92e-03	2.84e-03	-0.03	-1.12e-04	-6.91e-06	0.0
20433	7.74e-04	4.81e-03	-0.03	-1.41e-04	4.30e-06	0.0
20445	2.65e-03	3.13e-03	-0.03	-1.15e-04	-1.18e-05	0.0
20465	1.04e-03	5.90e-03	-0.03	-1.56e-04	3.88e-06	0.0
20470	1.31e-04	2.43e-03	-0.03	-1.20e-04	6.63e-06	0.0
20472	1.15e-04	2.15e-03	-0.03	-1.07e-04	5.62e-06	0.0
20473	1.11e-04	2.08e-03	-0.03	-1.03e-04	5.37e-06	0.0
2052	4.97e-04	-3.49e-03	-0.04	1.71e-04	2.60e-05	0.0
2056	2.22e-03	-2.90e-03	-0.03	1.13e-04	9.77e-06	0.0
20530	1.03e-03	-4.95e-03	-0.03	1.46e-04	1.82e-05	0.0
20532	-7.04e-05	-4.79e-03	-0.03	1.47e-04	2.27e-05	0.0
20538	2.99e-03	-3.19e-03	-0.03	1.16e-04	7.31e-06	0.0
20562	1.31e-03	-6.06e-03	-0.03	1.62e-04	1.92e-05	0.0
20564	-2.21e-04	-5.84e-03	-0.03	1.63e-04	2.55e-05	0.0
20570	3.66e-04	-2.54e-03	-0.03	1.25e-04	1.93e-05	0.0
20572	3.19e-04	-2.24e-03	-0.03	1.10e-04	1.66e-05	0.0
20573	3.07e-04	-2.17e-03	-0.03	1.07e-04	1.59e-05	0.0
2062	2.93e-04	-3.31e-03	-0.03	1.63e-04	1.59e-05	0.0
2065	2.09e-03	-1.87e-03	-0.02	9.39e-05	4.27e-06	0.0
20632	-2.54e-04	-4.50e-03	-0.02	1.33e-04	1.08e-05	0.0
20636	-1.88e-04	-4.65e-03	-0.02	1.33e-04	1.02e-05	0.0
20637	2.85e-03	-1.79e-03	-0.02	9.08e-05	2.03e-06	0.0
20664	-4.30e-04	-5.48e-03	-0.02	1.46e-04	1.12e-05	0.0
20668	-3.37e-04	-5.69e-03	-0.02	1.46e-04	1.04e-05	0.0
20670	2.14e-04	-2.41e-03	-0.02	1.18e-04	1.18e-05	0.0
20672	1.91e-04	-2.13e-03	-0.02	1.05e-04	1.02e-05	0.0
20673	1.85e-04	-2.06e-03	-0.02	1.02e-04	9.84e-06	0.0
2072	1.53e-04	-2.76e-03	-0.02	1.36e-04	7.93e-06	0.0
2075	2.01e-03	-1.57e-03	-0.02	8.01e-05	2.20e-06	0.0
20734	6.89e-04	-3.90e-03	-0.02	1.04e-04	2.15e-06	0.0
20736	-3.02e-04	-4.05e-03	-0.02	1.05e-04	3.51e-06	0.0
20737	2.77e-03	-1.50e-03	-0.02	7.79e-05	1.07e-06	0.0
20766	9.25e-04	-4.77e-03	-0.02	1.11e-04	1.00e-06	0.0
20768	-4.62e-04	-4.99e-03	-0.02	1.12e-04	2.91e-06	0.0
20770	1.10e-04	-2.01e-03	-0.02	9.89e-05	5.86e-06	0.0
20772	1.02e-04	-1.79e-03	-0.02	8.83e-05	5.18e-06	0.0
20773	9.95e-05	-1.73e-03	-0.02	8.57e-05	5.01e-06	0.0
2082	7.57e-05	-2.08e-03	-0.02	1.03e-04	3.62e-06	0.0
2085	1.93e-03	-1.20e-03	-0.01	6.26e-05	0.0	0.0
20829	5.26e-04	6.39e-04	-0.01	5.71e-05	3.32e-06	0.0
20836	-3.75e-04	-3.40e-03	-0.01	7.27e-05	1.27e-06	0.0
20837	2.68e-03	-1.16e-03	-0.01	6.16e-05	0.0	0.0
20861	7.16e-04	1.42e-03	-0.01	5.40e-05	3.70e-06	0.0
20868	-5.46e-04	-4.24e-03	-0.01	7.58e-05	0.0	0.0
20870	5.24e-05	-1.51e-03	-0.01	7.46e-05	2.65e-06	0.0
20872	5.19e-05	-1.35e-03	-0.01	6.68e-05	2.42e-06	0.0
20873	5.18e-05	-1.31e-03	-0.01	6.49e-05	2.36e-06	0.0
2091	4.64e-05	-1.20e-03	-0.01	5.96e-05	1.63e-06	0.0
2092	4.07e-05	-1.40e-03	-0.01	6.92e-05	1.71e-06	0.0
2095	1.86e-03	-8.09e-04	-0.01	4.40e-05	0.0	0.0



EGP CODE

GRE.EEC.R.73.IT.W.15235.12.024.01

PAGE

113 di/of 527

20929	5.16e-04	9.08e-04	-0.01	4.49e-05	1.57e-06	0.0
20936	-4.22e-04	-2.82e-03	-0.01	4.26e-05	0.0	0.0
20937	2.60e-03	-7.80e-04	-0.01	4.41e-05	0.0	0.0
20961	7.11e-04	1.63e-03	-0.01	4.54e-05	1.72e-06	0.0
20968	-6.03e-04	-3.59e-03-9.82e-03		4.22e-05	0.0	0.0
20969	3.02e-05	-8.85e-04	-0.01	4.38e-05	1.18e-06	0.0
20970	2.64e-05	-1.02e-03	-0.01	5.02e-05	1.23e-06	0.0
20971	3.02e-05	-8.85e-04	-0.01	4.38e-05	1.18e-06	0.0
20972	2.94e-05	-9.12e-04	-0.01	4.50e-05	1.19e-06	0.0
20973	3.02e-05	-8.85e-04	-0.01	4.38e-05	1.18e-06	0.0
2101	3.51e-05	-6.62e-04	-0.01	3.27e-05	1.02e-06	0.0
2102	2.68e-05	-7.70e-04	-0.01	3.78e-05	0.0	0.0
2105	1.81e-03	-4.28e-04-9.16e-03		2.49e-05	0.0	0.0
21029	5.22e-04	1.21e-03-9.42e-03		2.88e-05	0.0	0.0
21030	5.83e-04	-2.33e-03-8.60e-03		1.92e-05	0.0	0.0
21037	2.53e-03	-4.06e-04-9.23e-03		2.53e-05	0.0	0.0
21061	7.22e-04	1.90e-03-9.60e-03		3.08e-05	0.0	0.0
21062	8.08e-04	-3.06e-03-8.45e-03		1.73e-05	0.0	0.0
21069	2.16e-05	-4.86e-04-8.98e-03		2.40e-05	0.0	0.0
21070	1.60e-05	-5.58e-04-8.74e-03		2.74e-05	0.0	0.0
21071	2.16e-05	-4.86e-04-8.98e-03		2.40e-05	0.0	0.0
21072	2.05e-05	-5.01e-04-8.93e-03		2.47e-05	0.0	0.0
21073	2.16e-05	-4.86e-04-8.98e-03		2.40e-05	0.0	0.0
2111	3.20e-05	-1.54e-04	-0.01	7.46e-06	0.0	0.0
2112	2.29e-05	-1.79e-04	-0.01	8.63e-06	0.0	0.0
2115	1.77e-03	-6.14e-05-8.38e-03		6.76e-06	0.0	0.0
2119	1.76e-03	1.74e-04-8.39e-03		7.62e-06	0.0	0.0
21136	-4.92e-04	-1.91e-03-8.12e-03		-1.24e-06	0.0	0.0
21137	2.47e-03	-4.11e-05-8.43e-03		7.25e-06	-1.06e-06	0.0
21141	2.46e-03	2.91e-04-8.45e-03		8.48e-06	-1.04e-06	0.0
21168	-6.96e-04	-2.64e-03-8.06e-03		-3.93e-06	0.0	0.0
21169	1.92e-05	-1.13e-04-8.25e-03		5.47e-06	0.0	0.0
21170	1.32e-05	-1.30e-04-7.91e-03		6.25e-06	0.0	0.0
21171	1.92e-05	-1.13e-04-8.25e-03		5.47e-06	0.0	0.0
21172	1.80e-05	-1.17e-04-8.18e-03		5.63e-06	0.0	0.0
21173	1.92e-05	-1.13e-04-8.25e-03		5.47e-06	0.0	0.0
2121	3.39e-05	3.44e-04	-0.01	-1.73e-05	0.0	0.0
2122	2.53e-05	4.00e-04	-0.01	-2.00e-05	0.0	0.0
21214	1.78e-03	2.00e-04-8.58e-03		-1.39e-05	0.0	0.0
21233	5.65e-04	2.06e-03-8.22e-03		-6.46e-06	0.0	0.0
21234	5.26e-04	-1.42e-03-8.70e-03		-1.90e-05	0.0	0.0
21246	2.48e-03	1.80e-04-8.64e-03		-1.44e-05	0.0	0.0
21265	7.82e-04	2.79e-03-8.14e-03		-3.97e-06	0.0	0.0
21266	7.28e-04	-2.09e-03-8.81e-03		-2.15e-05	0.0	0.0
21269	2.07e-05	2.53e-04-8.43e-03		-1.27e-05	0.0	0.0
21270	1.49e-05	2.90e-04-8.11e-03		-1.45e-05	0.0	0.0
21271	2.07e-05	2.53e-04-8.43e-03		-1.27e-05	0.0	0.0
21272	1.95e-05	2.60e-04-8.37e-03		-1.30e-05	0.0	0.0
21273	2.07e-05	2.53e-04-8.43e-03		-1.27e-05	0.0	0.0
2131	4.17e-05	8.63e-04	-0.01	-4.31e-05	1.29e-06	0.0
2132	3.51e-05	1.01e-03	-0.01	-4.99e-05	1.28e-06	0.0
21314	1.83e-03	5.72e-04-9.72e-03		-3.23e-05	0.0	0.0
21333	6.03e-04	2.51e-03-9.06e-03		-2.83e-05	0.0	0.0
21334	5.16e-04	-1.10e-03	-0.01	-3.51e-05	1.01e-06	0.0
21346	2.55e-03	5.48e-04-9.81e-03		-3.26e-05	0.0	0.0
21365	8.34e-04	3.26e-03-8.87e-03		-2.69e-05	0.0	0.0
21366	7.12e-04	-1.79e-03	-0.01	-3.65e-05	1.05e-06	0.0
21369	2.66e-05	6.35e-04-9.52e-03		-3.16e-05	0.0	0.0
21370	2.22e-05	7.29e-04-9.36e-03		-3.62e-05	0.0	0.0
21371	2.66e-05	6.35e-04-9.52e-03		-3.16e-05	0.0	0.0
21372	2.58e-05	6.54e-04-9.49e-03		-3.25e-05	0.0	0.0
21373	2.66e-05	6.35e-04-9.52e-03		-3.16e-05	0.0	0.0
2141	6.13e-05	1.42e-03	-0.02	-7.08e-05	2.26e-06	0.0
2142	5.93e-05	1.66e-03	-0.02	-8.23e-05	2.48e-06	0.0
21414	1.89e-03	9.60e-04	-0.01	-5.12e-05	0.0	0.0
21431	-3.98e-04	3.04e-03	-0.01	-5.49e-05	1.13e-06	0.0
21434	5.18e-04	-8.01e-04	-0.01	-4.92e-05	2.11e-06	0.0
21446	2.63e-03	9.25e-04	-0.01	-5.09e-05	0.0	0.0
21463	-5.74e-04	3.83e-03	-0.01	-5.60e-05	0.0	0.0
21466	7.09e-04	-1.54e-03	-0.01	-4.81e-05	2.30e-06	0.0
21469	4.15e-05	1.05e-03	-0.01	-5.20e-05	1.66e-06	0.0
21470	4.02e-05	1.21e-03	-0.01	-5.97e-05	1.81e-06	0.0
21471	4.15e-05	1.05e-03	-0.01	-5.20e-05	1.66e-06	0.0
21472	4.12e-05	1.08e-03	-0.01	-5.36e-05	1.69e-06	0.0
21473	4.15e-05	1.05e-03	-0.01	-5.20e-05	1.66e-06	0.0
2152	1.13e-04	2.35e-03	-0.02	-1.16e-04	5.22e-06	0.0



EGP CODE

GRE.EEC.R.73.IT.W.15235.12.024.01

PAGE

114 di/of 527

21514	1.97e-03	1.35e-03	-0.01	-7.00e-05	1.40e-06	0.0
21531	-3.41e-04	3.65e-03	-0.01	-8.52e-05	2.19e-06	0.0
21534	5.40e-04	-5.55e-04	-0.02	-6.16e-05	4.34e-06	0.0
21546	2.72e-03	1.30e-03	-0.01	-6.86e-05	0.0	0.0
21563	-5.08e-04	4.52e-03	-0.01	-8.99e-05	1.73e-06	0.0
21566	7.27e-04	-1.37e-03	-0.02	-5.68e-05	4.74e-06	0.0
21570	8.00e-05	1.71e-03	-0.02	-8.45e-05	3.85e-06	0.0
21572	7.57e-05	1.52e-03	-0.01	-7.56e-05	3.44e-06	0.0
21573	7.46e-05	1.48e-03	-0.01	-7.34e-05	3.34e-06	0.0
2162	2.20e-04	3.00e-03	-0.03	-1.48e-04	1.09e-05	0.0
21614	2.05e-03	1.27e-03	-0.02	-8.61e-05	3.29e-06	0.0
21631	-2.51e-04	4.32e-03	-0.02	-1.18e-04	5.76e-06	0.0
21635	-3.11e-04	4.30e-03	-0.02	-1.18e-04	6.11e-06	0.0
21646	2.82e-03	1.02e-03	-0.02	-8.33e-05	1.88e-06	0.0
21663	-4.08e-04	5.29e-03	-0.02	-1.27e-04	5.35e-06	0.0
21667	-4.93e-04	5.27e-03	-0.02	-1.27e-04	5.84e-06	0.0
21670	1.60e-04	2.18e-03	-0.02	-1.08e-04	8.05e-06	0.0
21672	1.45e-04	1.94e-03	-0.02	-9.60e-05	7.05e-06	0.0
21673	1.41e-04	1.88e-03	-0.02	-9.31e-05	6.80e-06	0.0
2172	3.86e-04	3.45e-03	-0.04	-1.70e-04	2.00e-05	0.0
21714	2.15e-03	1.93e-03	-0.02	-9.72e-05	4.65e-06	0.0
21731	-1.09e-04	4.83e-03	-0.03	-1.42e-04	1.53e-05	0.0
21735	-1.75e-04	4.68e-03	-0.03	-1.42e-04	1.60e-05	0.0
21746	2.91e-03	1.84e-03	-0.02	-9.37e-05	1.57e-06	0.0
21763	-2.48e-04	5.91e-03	-0.03	-1.56e-04	1.64e-05	0.0
21767	-3.42e-04	5.70e-03	-0.03	-1.56e-04	1.74e-05	0.0
21770	2.83e-04	2.51e-03	-0.03	-1.23e-04	1.49e-05	0.0
21772	2.49e-04	2.22e-03	-0.02	-1.10e-04	1.28e-05	0.0
21773	2.41e-04	2.15e-03	-0.02	-1.06e-04	1.23e-05	0.0
2182	5.04e-04	3.52e-03	-0.04	-1.73e-04	2.61e-05	0.0
21813	2.24e-03	2.90e-03	-0.03	-1.14e-04	9.72e-06	0.0
21831	6.17e-06	4.98e-03	-0.03	-1.49e-04	2.20e-05	0.0
21835	-6.73e-05	4.83e-03	-0.03	-1.49e-04	2.28e-05	0.0
21845	3.01e-03	3.18e-03	-0.03	-1.17e-04	7.22e-06	0.0
21863	-1.15e-04	6.10e-03	-0.03	-1.65e-04	2.45e-05	0.0
21867	-2.19e-04	5.89e-03	-0.03	-1.65e-04	2.56e-05	0.0
21870	3.71e-04	2.57e-03	-0.03	-1.26e-04	1.94e-05	0.0
21872	3.23e-04	2.27e-03	-0.03	-1.12e-04	1.66e-05	0.0
21873	3.11e-04	2.19e-03	-0.03	-1.08e-04	1.59e-05	0.0
2192	5.17e-04	-4.01e-03	-0.04	1.93e-04	2.70e-05	0.0
2196	2.38e-03	-3.25e-03	-0.03	1.30e-04	2.01e-05	0.0
21930	1.09e-03	-5.51e-03	-0.03	1.70e-04	2.23e-05	0.0
21932	-8.75e-05	-5.35e-03	-0.03	1.70e-04	2.10e-05	0.0
21938	3.20e-03	-3.57e-03	-0.03	1.34e-04	2.14e-05	0.0
21962	1.40e-03	-6.73e-03	-0.03	1.91e-04	2.45e-05	0.0
21964	-2.51e-04	-6.51e-03	-0.03	1.90e-04	2.27e-05	0.0
21970	3.82e-04	-2.93e-03	-0.03	1.41e-04	2.01e-05	0.0
21972	3.33e-04	-2.56e-03	-0.03	1.24e-04	1.73e-05	0.0
21973	3.21e-04	-2.46e-03	-0.03	1.19e-04	1.66e-05	0.0
2201	6.81e-05	-3.15e-03	-0.03	1.53e-04	6.92e-06	0.0
2202	5.40e-05	-3.77e-03	-0.03	1.82e-04	7.90e-06	0.0
2205	2.18e-03	-1.72e-03	-0.02	1.02e-04	1.13e-05	0.0
22032	-7.11e-04	-5.02e-03	-0.02	1.51e-04	0.0	0.0
22036	-6.24e-04	-5.05e-03	-0.02	1.51e-04	0.0	0.0
22037	3.04e-03	-1.48e-03	-0.02	9.79e-05	1.38e-05	0.0
22064	-1.01e-03	-6.09e-03	-0.02	1.66e-04	-2.73e-06	0.0
22068	-8.92e-04	-6.13e-03	-0.02	1.66e-04	-1.98e-06	0.0
22069	4.56e-05	-2.34e-03	-0.02	1.13e-04	5.19e-06	0.0
22070	3.63e-05	-2.75e-03	-0.02	1.33e-04	5.84e-06	0.0
22071	4.56e-05	-2.34e-03	-0.02	1.13e-04	5.19e-06	0.0
22072	4.38e-05	-2.42e-03	-0.02	1.17e-04	5.32e-06	0.0
22073	4.56e-05	-2.34e-03	-0.02	1.13e-04	5.19e-06	0.0
2212	1.01e-04	-2.91e-03	-0.02	1.43e-04	5.73e-06	0.0
2215	2.08e-03	-1.64e-03	-0.02	8.44e-05	6.00e-06	0.0
22132	-4.31e-04	-3.98e-03	-0.02	1.08e-04	1.11e-06	0.0
22136	-3.63e-04	-4.11e-03	-0.02	1.07e-04	1.35e-06	0.0
22137	2.89e-03	-1.56e-03	-0.02	8.23e-05	6.92e-06	0.0
22164	-6.30e-04	-4.85e-03	-0.02	1.15e-04	0.0	0.0
22168	-5.35e-04	-5.02e-03	-0.02	1.15e-04	0.0	0.0
22170	7.14e-05	-2.12e-03	-0.02	1.04e-04	4.22e-06	0.0
22172	6.88e-05	-1.88e-03	-0.02	9.25e-05	3.78e-06	0.0
22173	6.82e-05	-1.82e-03	-0.02	8.97e-05	3.67e-06	0.0
2221	5.42e-05	-1.83e-03	-0.02	9.05e-05	2.21e-06	0.0
2222	5.09e-05	-2.15e-03	-0.02	1.06e-04	2.42e-06	0.0
2225	1.96e-03	-1.22e-03	-0.01	6.46e-05	2.52e-06	0.0
22229	5.29e-04	5.85e-04	-0.01	5.98e-05	3.09e-06	0.0



EGP CODE

GRE.EEC.R.73.IT.W.15235.12.024.01

PAGE

115 di/of 527

22236	-4.06e-04	-3.41e-03	-0.01	7.34e-05	0.0	0.0
22237	2.73e-03	-1.16e-03	-0.01	6.39e-05	2.88e-06	0.0
22261	7.26e-04	1.36e-03	-0.01	5.71e-05	3.68e-06	0.0
22268	-5.83e-04	-4.24e-03	-0.01	7.61e-05	0.0	0.0
22269	3.62e-05	-1.35e-03	-0.01	6.66e-05	1.61e-06	0.0
22270	3.40e-05	-1.56e-03	-0.01	7.67e-05	1.75e-06	0.0
22271	3.62e-05	-1.35e-03	-0.01	6.66e-05	1.61e-06	0.0
22272	3.57e-05	-1.39e-03	-0.01	6.86e-05	1.64e-06	0.0
22273	3.62e-05	-1.35e-03	-0.01	6.66e-05	1.61e-06	0.0
2231	3.36e-05	-1.23e-03	-0.01	6.05e-05	1.05e-06	0.0
2232	2.57e-05	-1.43e-03	-0.01	7.03e-05	0.0	0.0
2235	1.87e-03	-8.01e-04	-0.01	4.48e-05	0.0	0.0
22329	5.15e-04	8.85e-04	-0.01	4.58e-05	1.30e-06	0.0
22330	6.17e-04	-2.81e-03	-0.01	4.31e-05	0.0	0.0
22337	2.62e-03	-7.61e-04	-0.01	4.49e-05	0.0	0.0
22361	7.14e-04	1.60e-03	-0.01	4.64e-05	1.53e-06	0.0
22362	8.56e-04	-3.58e-03	-9.90e-03	4.26e-05	0.0	0.0
22369	2.05e-05	-9.02e-04	-0.01	4.45e-05	0.0	0.0
22370	1.52e-05	-1.04e-03	-0.01	5.10e-05	0.0	0.0
22371	2.05e-05	-9.02e-04	-0.01	4.45e-05	0.0	0.0
22372	1.94e-05	-9.29e-04	-0.01	4.58e-05	0.0	0.0
22373	2.05e-05	-9.02e-04	-0.01	4.45e-05	0.0	0.0
2241	2.62e-05	-6.70e-04	-0.01	3.30e-05	0.0	0.0
2242	1.66e-05	-7.80e-04	-0.01	3.82e-05	0.0	0.0
2245	1.81e-03	-4.09e-04	-9.15e-03	2.52e-05	0.0	0.0
22429	5.19e-04	1.21e-03	-9.46e-03	2.94e-05	0.0	0.0
22430	5.78e-04	-2.31e-03	-8.60e-03	1.91e-05	0.0	0.0
22437	2.53e-03	-3.75e-04	-9.21e-03	2.56e-05	0.0	0.0
22461	7.21e-04	1.89e-03	-9.64e-03	3.15e-05	0.0	0.0
22462	8.03e-04	-3.04e-03	-8.44e-03	1.71e-05	0.0	0.0
22469	1.49e-05	-4.92e-04	-9.01e-03	2.42e-05	0.0	0.0
22470	8.47e-06	-5.66e-04	-8.77e-03	2.77e-05	0.0	0.0
22471	1.49e-05	-4.92e-04	-9.01e-03	2.42e-05	0.0	0.0
22472	1.36e-05	-5.07e-04	-8.96e-03	2.49e-05	0.0	0.0
22473	1.49e-05	-4.92e-04	-9.01e-03	2.42e-05	0.0	0.0
2251	2.46e-05	-1.56e-04	-0.01	7.50e-06	0.0	0.0
2252	1.46e-05	-1.81e-04	-0.01	8.67e-06	0.0	0.0
2255	1.77e-03	-3.62e-05	-8.36e-03	6.81e-06	0.0	0.0
22529	5.33e-04	1.55e-03	-8.40e-03	1.25e-05	0.0	0.0
22536	-5.00e-04	-1.90e-03	-8.15e-03	-1.41e-06	0.0	0.0
22537	2.47e-03	-5.17e-06	-8.39e-03	7.32e-06	0.0	0.0
22561	7.40e-04	2.21e-03	-8.46e-03	1.53e-05	0.0	0.0
22562	7.56e-04	-2.61e-03	-8.15e-03	-4.17e-06	0.0	0.0
22569	1.36e-05	-1.15e-04	-8.28e-03	5.50e-06	0.0	0.0
22570	6.96e-06	-1.32e-04	-7.93e-03	6.28e-06	0.0	0.0
22571	1.36e-05	-1.15e-04	-8.28e-03	5.50e-06	0.0	0.0
22572	1.23e-05	-1.18e-04	-8.21e-03	5.66e-06	0.0	0.0
22573	1.36e-05	-1.15e-04	-8.28e-03	5.50e-06	0.0	0.0
2261	2.59e-05	3.47e-04	-0.01	-1.75e-05	0.0	0.0
2262	1.62e-05	4.04e-04	-0.01	-2.02e-05	0.0	0.0
22614	1.78e-03	1.77e-04	-8.57e-03	-1.41e-05	0.0	0.0
22633	5.60e-04	2.05e-03	-8.23e-03	-6.39e-06	0.0	0.0
22634	5.22e-04	-1.41e-03	-8.72e-03	-1.93e-05	0.0	0.0
22646	2.49e-03	1.45e-04	-8.61e-03	-1.46e-05	0.0	0.0
22665	7.78e-04	2.77e-03	-8.14e-03	-3.82e-06	0.0	0.0
22666	7.26e-04	-2.08e-03	-8.83e-03	-2.20e-05	0.0	0.0
22669	1.46e-05	2.55e-04	-8.46e-03	-1.28e-05	0.0	0.0
22670	8.17e-06	2.93e-04	-8.14e-03	-1.46e-05	0.0	0.0
22671	1.46e-05	2.55e-04	-8.46e-03	-1.28e-05	0.0	0.0
22672	1.33e-05	2.63e-04	-8.39e-03	-1.32e-05	0.0	0.0
22673	1.46e-05	2.55e-04	-8.46e-03	-1.28e-05	0.0	0.0
2271	3.10e-05	8.75e-04	-0.01	-4.36e-05	0.0	0.0
2272	2.26e-05	1.02e-03	-0.01	-5.06e-05	0.0	0.0
22714	1.83e-03	5.55e-04	-9.73e-03	-3.29e-05	0.0	0.0
22733	5.97e-04	2.49e-03	-9.07e-03	-2.84e-05	0.0	0.0
22734	5.13e-04	-1.08e-03	-0.01	-3.59e-05	0.0	0.0
22746	2.56e-03	5.20e-04	-9.79e-03	-3.32e-05	0.0	0.0
22765	8.28e-04	3.24e-03	-8.87e-03	-2.69e-05	0.0	0.0
22766	7.11e-04	-1.78e-03	-0.01	-3.74e-05	0.0	0.0
22769	1.85e-05	6.44e-04	-9.56e-03	-3.21e-05	0.0	0.0
22770	1.29e-05	7.40e-04	-9.40e-03	-3.67e-05	0.0	0.0
22771	1.85e-05	6.44e-04	-9.56e-03	-3.21e-05	0.0	0.0
22772	1.74e-05	6.63e-04	-9.53e-03	-3.30e-05	0.0	0.0
22773	1.85e-05	6.44e-04	-9.56e-03	-3.21e-05	0.0	0.0
2281	4.52e-05	1.45e-03	-0.02	-7.22e-05	1.53e-06	0.0
2282	4.02e-05	1.70e-03	-0.02	-8.41e-05	1.60e-06	0.0





EGP CODE

GRE.EEC.R.73.IT.W.15235.12.024.01

PAGE

116 di/of 527

22814	1.90e-03	9.59e-04	-0.01	-5.25e-05	1.08e-06	0.0
22831	-4.20e-04	3.03e-03	-0.01	-5.54e-05	0.0	0.0
22834	5.17e-04	-7.69e-04	-0.01	-5.08e-05	1.79e-06	0.0
22846	2.65e-03	9.15e-04	-0.01	-5.22e-05	1.08e-06	0.0
22863	-6.00e-04	3.82e-03	-0.01	-5.63e-05	0.0	0.0
22866	7.12e-04	-1.51e-03	-0.01	-4.99e-05	2.07e-06	0.0
22869	2.93e-05	1.07e-03	-0.01	-5.31e-05	1.09e-06	0.0
22870	2.60e-05	1.23e-03	-0.01	-6.10e-05	1.14e-06	0.0
22871	2.93e-05	1.07e-03	-0.01	-5.31e-05	1.09e-06	0.0
22872	2.87e-05	1.10e-03	-0.01	-5.47e-05	1.10e-06	0.0
22873	2.93e-05	1.07e-03	-0.01	-5.31e-05	1.09e-06	0.0
2292	8.30e-05	2.44e-03	-0.02	-1.20e-04	3.86e-06	0.0
22914	2.00e-03	1.38e-03	-0.01	-7.28e-05	3.74e-06	0.0
22931	-3.78e-04	3.67e-03	-0.01	-8.66e-05	0.0	0.0
22934	5.44e-04	-4.85e-04	-0.02	-6.51e-05	4.23e-06	0.0
22946	2.78e-03	1.32e-03	-0.02	-7.16e-05	4.24e-06	0.0
22963	-5.52e-04	4.53e-03	-0.01	-9.10e-05	0.0	0.0
22966	7.39e-04	-1.29e-03	-0.02	-6.07e-05	4.92e-06	0.0
22970	5.79e-05	1.77e-03	-0.02	-8.75e-05	2.82e-06	0.0
22972	5.63e-05	1.58e-03	-0.02	-7.82e-05	2.56e-06	0.0
22973	5.60e-05	1.53e-03	-0.01	-7.59e-05	2.49e-06	0.0
2302	1.71e-04	3.19e-03	-0.03	-1.57e-04	8.99e-06	0.0
23014	2.16e-03	1.41e-03	-0.02	-9.16e-05	8.79e-06	0.0
23031	-3.16e-04	4.40e-03	-0.02	-1.22e-04	3.37e-06	0.0
23035	-3.88e-04	4.39e-03	-0.02	-1.22e-04	3.06e-06	0.0
23046	2.98e-03	1.18e-03	-0.02	-8.89e-05	1.00e-05	0.0
23063	-4.86e-04	5.36e-03	-0.02	-1.32e-04	2.45e-06	0.0
23067	-5.88e-04	5.34e-03	-0.02	-1.32e-04	2.02e-06	0.0
23070	1.24e-04	2.32e-03	-0.02	-1.14e-04	6.65e-06	0.0
23072	1.14e-04	2.06e-03	-0.02	-1.02e-04	5.87e-06	0.0
23073	1.11e-04	2.00e-03	-0.02	-9.85e-05	5.67e-06	0.0
2312	2.17e-04	4.01e-03	-0.04	-1.93e-04	1.50e-05	0.0
23114	2.30e-03	1.83e-03	-0.02	-1.06e-04	1.56e-05	0.0
23131	-2.70e-04	5.39e-03	-0.03	-1.66e-04	6.29e-06	0.0
23135	-3.59e-04	5.36e-03	-0.03	-1.66e-04	5.75e-06	0.0
23146	3.16e-03	1.58e-03	-0.02	-1.01e-04	1.80e-05	0.0
23163	-4.35e-04	6.56e-03	-0.03	-1.84e-04	5.01e-06	0.0
23167	-5.61e-04	6.51e-03	-0.03	-1.85e-04	4.24e-06	0.0
23170	1.58e-04	2.93e-03	-0.03	-1.41e-04	1.11e-05	0.0
23172	1.47e-04	2.57e-03	-0.03	-1.24e-04	9.83e-06	0.0
23173	1.45e-04	2.48e-03	-0.02	-1.20e-04	9.50e-06	0.0
2322	5.19e-04	4.03e-03	-0.04	-1.95e-04	2.70e-05	0.0
23213	2.42e-03	3.23e-03	-0.03	-1.29e-04	2.02e-05	0.0
23233	1.10e-03	5.53e-03	-0.03	-1.71e-04	2.19e-05	0.0
23235	-1.05e-04	5.40e-03	-0.03	-1.72e-04	2.05e-05	0.0
23245	3.25e-03	3.53e-03	-0.03	-1.33e-04	2.16e-05	0.0
23265	1.41e-03	6.76e-03	-0.03	-1.91e-04	2.40e-05	0.0
23267	-2.75e-04	6.57e-03	-0.03	-1.92e-04	2.20e-05	0.0
23270	3.84e-04	2.95e-03	-0.03	-1.42e-04	2.01e-05	0.0
23272	3.34e-04	2.58e-03	-0.03	-1.25e-04	1.73e-05	0.0
23273	3.22e-04	2.48e-03	-0.03	-1.20e-04	1.66e-05	0.0
2332	2.48e-04	-2.82e-03	-0.04	1.40e-04	1.39e-05	0.0
23310	1.73e-03	-2.05e-03	-0.03	8.94e-05	-6.14e-06	0.0
23324	-3.53e-04	-4.32e-03	-0.03	1.22e-04	1.88e-05	0.0
23342	2.36e-03	-2.17e-03	-0.03	9.03e-05	-1.22e-05	0.0
23356	-5.57e-04	-5.35e-03	-0.04	1.36e-04	2.27e-05	0.0
23370	1.89e-04	-2.04e-03	-0.03	1.01e-04	1.05e-05	0.0
23372	1.63e-04	-1.81e-03	-0.03	9.00e-05	9.16e-06	0.0
23373	1.57e-04	-1.75e-03	-0.03	8.72e-05	8.83e-06	0.0
2342	-6.49e-05	-3.68e-03	-0.03	1.83e-04	-3.13e-06	0.0
2344	-6.62e-05	-2.77e-03	-0.02	1.37e-04	-2.72e-06	0.0
2348	-2.41e-03	-2.51e-03	-0.02	1.19e-04	-1.62e-05	0.0
23430	7.42e-04	-4.81e-03	-0.02	1.47e-04	0.0	0.0
23440	-3.36e-03	-2.59e-03	-0.02	1.21e-04	-2.18e-05	0.0
23462	1.06e-03	-5.82e-03	-0.02	1.60e-04	1.67e-06	0.0
23470	-5.31e-05	-2.69e-03	-0.02	1.33e-04	-2.42e-06	0.0
23472	-4.27e-05	-2.37e-03	-0.02	1.18e-04	-2.11e-06	0.0
23473	-4.01e-05	-2.29e-03	-0.02	1.14e-04	-2.03e-06	0.0
2352	-3.93e-05	-2.97e-03	-0.02	1.46e-04	-2.05e-06	0.0
2354	-4.56e-05	-2.21e-03	-0.02	1.08e-04	-1.85e-06	0.0
2358	-2.08e-03	-2.03e-03	-0.02	9.36e-05	-5.93e-06	0.0
23530	6.64e-04	-4.13e-03	-0.02	1.09e-04	0.0	0.0
23540	-2.90e-03	-2.10e-03	-0.02	9.44e-05	-7.79e-06	0.0
23562	9.38e-04	-5.04e-03	-0.02	1.16e-04	0.0	0.0
23570	-3.35e-05	-2.16e-03	-0.02	1.06e-04	-1.60e-06	0.0
23572	-2.46e-05	-1.92e-03	-0.02	9.43e-05	-1.35e-06	0.0



EGP CODE

GRE.EEC.R.73.IT.W.15235.12.024.01

PAGE

117 di/of 527

23573	-2.24e-05	-1.86e-03	-0.02	9.14e-05	-1.28e-06	0.0
2362	-2.39e-05	-2.17e-03	-0.02	1.07e-04	-1.36e-06	0.0
2364	-3.30e-05	-1.61e-03	-0.01	7.86e-05	-1.29e-06	0.0
2368	-1.96e-03	-1.50e-03	-0.01	6.75e-05	-2.83e-06	0.0
23629	4.85e-04	5.61e-04	-0.01	6.13e-05	0.0	0.0
23630	6.28e-04	-3.41e-03	-0.01	7.38e-05	0.0	0.0
23640	-2.74e-03	-1.56e-03	-0.01	6.76e-05	-3.64e-06	0.0
23661	6.85e-04	1.33e-03	-0.01	5.89e-05	0.0	0.0
23662	8.84e-04	-4.23e-03	-0.01	7.64e-05	0.0	0.0
23670	-2.18e-05	-1.58e-03	-0.01	7.74e-05	-1.07e-06	0.0
23672	-1.40e-05	-1.41e-03	-0.01	6.92e-05	0.0	0.0
23673	-1.20e-05	-1.37e-03	-0.01	6.72e-05	0.0	0.0
2371	0.0	-1.23e-03	-0.01	6.07e-05	0.0	0.0
2372	-1.24e-05	-1.44e-03	-0.01	7.05e-05	0.0	0.0
2374	-2.37e-05	-1.06e-03	-0.01	5.17e-05	0.0	0.0
2378	-1.87e-03	-1.02e-03	-0.01	4.36e-05	-1.02e-06	0.0
23729	4.92e-04	8.77e-04	-0.01	4.63e-05	0.0	0.0
23730	5.96e-04	-2.80e-03	-0.01	4.34e-05	0.0	0.0
23740	-2.61e-03	-1.07e-03	-0.01	4.32e-05	-1.24e-06	0.0
23761	6.91e-04	1.59e-03	-0.01	4.69e-05	0.0	0.0
23762	8.36e-04	-3.56e-03	-9.89e-03	4.29e-05	0.0	0.0
23769	-4.30e-06	-9.06e-04	-0.01	4.46e-05	0.0	0.0
23770	-1.30e-05	-1.04e-03	-0.01	5.12e-05	0.0	0.0
23771	-4.30e-06	-9.06e-04	-0.01	4.46e-05	0.0	0.0
23772	-6.04e-06	-9.34e-04	-0.01	4.59e-05	0.0	0.0
23773	-4.30e-06	-9.06e-04	-0.01	4.46e-05	0.0	0.0
2381	7.36e-06	-6.71e-04	-0.01	3.30e-05	0.0	0.0
2382	-4.70e-06	-7.82e-04	-0.01	3.82e-05	0.0	0.0
2384	-1.76e-05	-5.74e-04	-8.66e-03	2.80e-05	0.0	0.0
2385	1.80e-03	-3.88e-04	-9.14e-03	2.55e-05	0.0	0.0
23829	5.06e-04	1.20e-03	-9.46e-03	2.96e-05	0.0	0.0
23830	5.65e-04	-2.30e-03	-8.59e-03	1.91e-05	0.0	0.0
23837	2.53e-03	-3.46e-04	-9.19e-03	2.61e-05	0.0	0.0
23861	7.09e-04	1.89e-03	-9.64e-03	3.18e-05	0.0	0.0
23862	7.91e-04	-3.03e-03	-8.43e-03	1.70e-05	0.0	0.0
23869	0.0	-4.94e-04	-9.01e-03	2.42e-05	0.0	0.0
23870	-7.24e-06	-5.67e-04	-8.77e-03	2.77e-05	0.0	0.0
23871	0.0	-4.94e-04	-9.01e-03	2.42e-05	0.0	0.0
23872	0.0	-5.08e-04	-8.96e-03	2.49e-05	0.0	0.0
23873	0.0	-4.94e-04	-9.01e-03	2.42e-05	0.0	0.0
2391	1.05e-05	-1.56e-04	-0.01	7.49e-06	0.0	0.0
2392	-1.03e-06	-1.82e-04	-0.01	8.66e-06	0.0	0.0
2394	-1.46e-05	-1.34e-04	-7.82e-03	6.32e-06	0.0	0.0
2395	1.76e-03	-1.21e-05	-8.34e-03	6.87e-06	0.0	0.0
23929	5.23e-04	1.55e-03	-8.40e-03	1.26e-05	0.0	0.0
23930	5.35e-04	-1.88e-03	-8.18e-03	-1.49e-06	0.0	0.0
23937	2.46e-03	2.89e-05	-8.36e-03	7.42e-06	0.0	0.0
23961	7.31e-04	2.21e-03	-8.45e-03	1.54e-05	0.0	0.0
23962	7.47e-04	-2.59e-03	-8.15e-03	-4.28e-06	0.0	0.0
23969	3.23e-06	-1.15e-04	-8.28e-03	5.49e-06	0.0	0.0
23970	-4.47e-06	-1.32e-04	-7.93e-03	6.28e-06	0.0	0.0
23971	3.23e-06	-1.15e-04	-8.28e-03	5.49e-06	0.0	0.0
23972	1.69e-06	-1.18e-04	-8.21e-03	5.65e-06	0.0	0.0
23973	3.23e-06	-1.15e-04	-8.28e-03	5.49e-06	0.0	0.0
2401	1.02e-05	3.47e-04	-0.01	-1.75e-05	0.0	0.0
2402	-1.38e-06	4.04e-04	-0.01	-2.02e-05	0.0	0.0
2404	-1.49e-05	2.96e-04	-8.03e-03	-1.48e-05	0.0	0.0
24014	1.77e-03	1.53e-04	-8.55e-03	-1.42e-05	0.0	0.0
24033	5.49e-04	2.03e-03	-8.23e-03	-6.33e-06	0.0	0.0
24034	5.12e-04	-1.42e-03	-8.72e-03	-1.95e-05	0.0	0.0
24046	2.48e-03	1.12e-04	-8.58e-03	-1.48e-05	0.0	0.0
24065	7.68e-04	2.75e-03	-8.14e-03	-3.73e-06	0.0	0.0
24066	7.15e-04	-2.09e-03	-8.83e-03	-2.21e-05	0.0	0.0
24069	2.98e-06	2.55e-04	-8.46e-03	-1.28e-05	0.0	0.0
24070	-4.74e-06	2.93e-04	-8.14e-03	-1.47e-05	0.0	0.0
24071	2.98e-06	2.55e-04	-8.46e-03	-1.28e-05	0.0	0.0
24072	1.43e-06	2.63e-04	-8.40e-03	-1.32e-05	0.0	0.0
24073	2.98e-06	2.55e-04	-8.46e-03	-1.28e-05	0.0	0.0
2411	6.39e-06	8.77e-04	-0.01	-4.37e-05	0.0	0.0
2412	-5.75e-06	1.02e-03	-0.01	-5.07e-05	0.0	0.0
2414	-1.84e-05	7.52e-04	-9.31e-03	-3.71e-05	0.0	0.0
24114	1.82e-03	5.37e-04	-9.72e-03	-3.33e-05	0.0	0.0
24133	5.80e-04	2.48e-03	-9.06e-03	-2.84e-05	0.0	0.0
24134	4.96e-04	-1.08e-03	-0.01	-3.62e-05	0.0	0.0
24146	2.55e-03	4.93e-04	-9.79e-03	-3.38e-05	0.0	0.0
24165	8.12e-04	3.22e-03	-8.86e-03	-2.69e-05	0.0	0.0



EGP CODE

GRE.EEC.R.73.IT.W.15235.12.024.01

PAGE

118 di/of 527

24166	6.94e-04	-1.77e-03	-0.01	-3.78e-05	0.0	0.0
24169	0.0	6.45e-04-9.57e-03		-3.21e-05	0.0	0.0
24170	-8.06e-06	7.42e-04-9.40e-03		-3.68e-05	0.0	0.0
24171	0.0	6.45e-04-9.57e-03		-3.21e-05	0.0	0.0
24172	-1.58e-06	6.65e-04-9.54e-03		-3.30e-05	0.0	0.0
24173	0.0	6.45e-04-9.57e-03		-3.21e-05	0.0	0.0
2422	-1.41e-05	1.71e-03	-0.02	-8.46e-05	-1.04e-06	0.0
2424	-2.52e-05	1.26e-03	-0.01	-6.22e-05	-1.03e-06	0.0
24215	-1.89e-03	1.20e-03	-0.01	-5.31e-05	-1.41e-06	0.0
24233	6.11e-04	3.02e-03	-0.01	-5.57e-05	0.0	0.0
24234	4.83e-04	-7.56e-04	-0.01	-5.17e-05	0.0	0.0
24247	-2.64e-03	1.25e-03	-0.01	-5.29e-05	-1.74e-06	0.0
24265	8.57e-04	3.80e-03	-0.01	-5.66e-05	0.0	0.0
24266	6.79e-04	-1.49e-03	-0.01	-5.10e-05	0.0	0.0
24270	-1.44e-05	1.24e-03	-0.01	-6.14e-05	0.0	0.0
24272	-7.32e-06	1.11e-03	-0.01	-5.50e-05	0.0	0.0
24273	-5.56e-06	1.08e-03	-0.01	-5.34e-05	0.0	0.0
2432	-2.61e-05	2.47e-03	-0.02	-1.22e-04	-1.63e-06	0.0
2434	-3.49e-05	1.83e-03	-0.02	-9.02e-05	-1.51e-06	0.0
24315	-1.99e-03	1.70e-03	-0.01	-7.78e-05	-3.80e-06	0.0
24333	6.45e-04	3.67e-03	-0.01	-8.73e-05	0.0	0.0
24334	4.81e-04	-4.49e-04	-0.02	-6.72e-05	0.0	0.0
24347	-2.78e-03	1.76e-03	-0.01	-7.81e-05	-4.92e-06	0.0
24365	9.09e-04	4.52e-03	-0.01	-9.15e-05	0.0	0.0
24366	6.80e-04	-1.25e-03	-0.02	-6.33e-05	0.0	0.0
24370	-2.35e-05	1.80e-03	-0.02	-8.87e-05	-1.28e-06	0.0
24372	-1.56e-05	1.60e-03	-0.02	-7.92e-05	-1.05e-06	0.0
24373	-1.37e-05	1.55e-03	-0.01	-7.69e-05	0.0	0.0
2442	-4.17e-05	3.27e-03	-0.03	-1.61e-04	-2.38e-06	0.0
2444	-4.77e-05	2.44e-03	-0.02	-1.20e-04	-2.12e-06	0.0
24415	-2.11e-03	2.23e-03	-0.02	-1.04e-04	-6.73e-06	0.0
24433	6.79e-04	4.42e-03	-0.02	-1.25e-04	0.0	0.0
24447	-2.94e-03	2.31e-03	-0.02	-1.06e-04	-8.83e-06	0.0
24465	9.60e-04	5.38e-03	-0.02	-1.34e-04	0.0	0.0
24470	-3.54e-05	2.38e-03	-0.02	-1.17e-04	-1.85e-06	0.0
24472	-2.65e-05	2.11e-03	-0.02	-1.04e-04	-1.58e-06	0.0
24473	-2.42e-05	2.04e-03	-0.02	-1.01e-04	-1.51e-06	0.0
2452	-6.77e-05	3.91e-03	-0.04	-1.96e-04	-3.51e-06	0.0
2454	-6.85e-05	2.95e-03	-0.03	-1.48e-04	-3.03e-06	0.0
24515	-2.60e-03	2.68e-03	-0.03	-1.29e-04	-2.50e-05	0.0
24533	8.02e-04	5.14e-03	-0.03	-1.67e-04	2.52e-06	0.0
24547	-3.63e-03	2.78e-03	-0.03	-1.32e-04	-3.41e-05	0.0
24565	1.14e-03	6.22e-03	-0.03	-1.85e-04	4.45e-06	0.0
24570	-5.53e-05	2.85e-03	-0.03	-1.43e-04	-2.72e-06	0.0
24572	-4.49e-05	2.51e-03	-0.03	-1.26e-04	-2.38e-06	0.0
24573	-4.24e-05	2.43e-03	-0.03	-1.22e-04	-2.29e-06	0.0
2462	1.05e-03	-1.76e-03	-0.02	8.67e-05	5.46e-05	0.0
2465	2.86e-03	2.84e-05	-0.02	5.96e-05	5.32e-05	0.0
2469	2.89e-03	-2.88e-04	-0.02	6.06e-05	5.29e-05	0.0
24626	1.16e-03	-3.52e-03	-0.02	6.51e-05	3.74e-05	0.0
24637	3.73e-03	4.85e-04	-0.02	6.13e-05	6.00e-05	0.0
24641	3.76e-03	3.70e-05	-0.02	6.28e-05	5.97e-05	0.0
24658	1.35e-03	-4.48e-03	-0.02	6.91e-05	3.79e-05	0.0
24670	7.49e-04	-1.29e-03	-0.02	6.35e-05	3.87e-05	0.0
24672	7.06e-04	-1.16e-03	-0.02	5.69e-05	3.66e-05	0.0
24673	6.96e-04	-1.12e-03	-0.02	5.52e-05	3.61e-05	0.0
2472	-6.50e-04	-4.00e-03	-0.04	1.92e-04	-3.37e-05	0.0
2478	-2.44e-03	-2.82e-03	-0.03	1.26e-04	-2.45e-05	0.0
24730	2.77e-04	-5.46e-03	-0.03	1.70e-04	-2.58e-05	0.0
24736	-8.13e-04	-5.47e-03	-0.03	1.69e-04	-2.70e-05	0.0
24740	-3.25e-03	-2.96e-03	-0.03	1.29e-04	-2.59e-05	0.0
24762	5.49e-04	-6.67e-03	-0.03	1.91e-04	-2.77e-05	0.0
24768	-9.78e-04	-6.67e-03	-0.03	1.89e-04	-2.94e-05	0.0
24770	-4.91e-04	-2.92e-03	-0.03	1.40e-04	-2.53e-05	0.0
24772	-4.20e-04	-2.55e-03	-0.03	1.23e-04	-2.18e-05	0.0
24773	-4.02e-04	-2.46e-03	-0.03	1.19e-04	-2.10e-05	0.0
2482	-1.60e-04	-3.74e-03	-0.03	1.80e-04	-1.32e-05	0.0
2487	-2.24e-03	-1.57e-03	-0.02	9.78e-05	-1.53e-05	0.0
24830	7.13e-04	-5.03e-03	-0.02	1.51e-04	-2.47e-06	0.0
24839	-3.10e-03	-1.27e-03	-0.02	9.20e-05	-1.79e-05	0.0
24862	1.04e-03	-6.12e-03	-0.02	1.67e-04	0.0	0.0
24870	-1.24e-04	-2.73e-03	-0.02	1.31e-04	-9.99e-06	0.0
24872	-1.12e-04	-2.40e-03	-0.02	1.16e-04	-8.90e-06	0.0
24873	-1.09e-04	-2.32e-03	-0.02	1.12e-04	-8.62e-06	0.0
2492	-1.74e-04	-2.88e-03	-0.02	1.41e-04	-9.52e-06	0.0
2496	1.90e-03	-2.41e-03	-0.02	9.69e-05	-3.33e-06	0.0



EGP CODE

GRE.EEC.R.73.IT.W.15235.12.024.01

PAGE

119 di/of 527

2497	-2.12e-03	-1.20e-03	-0.02	8.06e-05	-8.77e-06	0.0
24930	5.88e-04	-4.08e-03	-0.02	1.07e-04	-3.17e-06	0.0
24938	2.70e-03	-2.65e-03	-0.02	1.00e-04	-2.24e-06	0.0
24939	-2.92e-03	-9.65e-04	-0.02	7.73e-05	-9.85e-06	0.0
24962	8.67e-04	-4.99e-03	-0.02	1.15e-04	-2.02e-06	0.0
24970	-1.34e-04	-2.10e-03	-0.02	1.03e-04	-7.19e-06	0.0
24972	-1.14e-04	-1.86e-03	-0.02	9.15e-05	-6.28e-06	0.0
24973	-1.09e-04	-1.81e-03	-0.02	8.87e-05	-6.05e-06	0.0
2502	-9.44e-05	-2.13e-03	-0.02	1.04e-04	-4.93e-06	0.0
2507	-1.98e-03	-8.08e-04	-0.01	6.16e-05	-4.36e-06	0.0
25029	4.18e-04	5.95e-04	-0.01	6.00e-05	-4.16e-06	0.0
25030	5.88e-04	-3.38e-03	-0.01	7.32e-05	-1.45e-06	0.0
25039	-2.74e-03	-5.99e-04	-0.01	5.99e-05	-4.87e-06	0.0
25061	6.08e-04	1.37e-03	-0.01	5.77e-05	-4.59e-06	0.0
25062	8.47e-04	-4.20e-03	-0.01	7.62e-05	0.0	0.0
25070	-7.43e-05	-1.54e-03	-0.01	7.58e-05	-3.74e-06	0.0
25072	-6.09e-05	-1.38e-03	-0.01	6.78e-05	-3.23e-06	0.0
25073	-5.76e-05	-1.34e-03	-0.01	6.58e-05	-3.11e-06	0.0
2511	-2.96e-05	-1.21e-03	-0.01	5.98e-05	-1.96e-06	0.0
2512	-4.71e-05	-1.41e-03	-0.01	6.94e-05	-2.51e-06	0.0
2514	-5.01e-05	-1.04e-03	-0.01	5.09e-05	-2.16e-06	0.0
2518	-1.88e-03	-1.02e-03	-0.01	4.21e-05	-1.60e-06	0.0
25129	4.61e-04	8.98e-04	-0.01	4.55e-05	-2.17e-06	0.0
25130	5.75e-04	-2.78e-03	-0.01	4.31e-05	0.0	0.0
25140	-2.62e-03	-1.08e-03	-0.01	4.14e-05	-1.61e-06	0.0
25161	6.56e-04	1.61e-03	-0.01	4.62e-05	-2.42e-06	0.0
25162	8.16e-04	-3.54e-03-9.86e-03		4.28e-05	0.0	0.0
25169	-2.70e-05	-8.91e-04	-0.01	4.39e-05	-1.55e-06	0.0
25170	-3.87e-05	-1.03e-03	-0.01	5.03e-05	-1.92e-06	0.0
25171	-2.70e-05	-8.91e-04	-0.01	4.39e-05	-1.55e-06	0.0
25172	-2.94e-05	-9.18e-04	-0.01	4.52e-05	-1.63e-06	0.0
25173	-2.70e-05	-8.91e-04	-0.01	4.39e-05	-1.55e-06	0.0
2521	-9.47e-06	-6.62e-04	-0.01	3.26e-05	0.0	0.0
2522	-2.33e-05	-7.71e-04	-0.01	3.77e-05	-1.36e-06	0.0
2524	-3.11e-05	-5.66e-04-8.62e-03		2.75e-05	-1.24e-06	0.0
2528	-1.81e-03	-6.14e-04-8.87e-03		2.23e-05	0.0	0.0
25229	4.91e-04	1.22e-03-9.43e-03		2.92e-05	-1.19e-06	0.0
25230	5.53e-04	-2.29e-03-8.57e-03		1.90e-05	0.0	0.0
25240	-2.53e-03	-6.64e-04-8.82e-03		2.17e-05	0.0	0.0
25261	6.92e-04	1.90e-03-9.61e-03		3.14e-05	-1.35e-06	0.0
25262	7.79e-04	-3.01e-03-8.41e-03		1.70e-05	0.0	0.0
25269	-1.16e-05	-4.87e-04-8.99e-03		2.39e-05	0.0	0.0
25270	-2.09e-05	-5.59e-04-8.73e-03		2.73e-05	-1.06e-06	0.0
25271	-1.16e-05	-4.87e-04-8.99e-03		2.39e-05	0.0	0.0
25272	-1.35e-05	-5.01e-04-8.93e-03		2.46e-05	0.0	0.0
25273	-1.16e-05	-4.87e-04-8.99e-03		2.39e-05	0.0	0.0
2531	-1.79e-06	-1.55e-04	-0.01	7.40e-06	0.0	0.0
2532	-1.43e-05	-1.80e-04	-0.01	8.56e-06	0.0	0.0
2534	-2.39e-05	-1.32e-04-7.79e-03		6.24e-06	0.0	0.0
2538	-1.76e-03	-2.40e-04-8.23e-03		3.98e-06	0.0	0.0
25329	5.13e-04	1.55e-03-8.38e-03		1.25e-05	0.0	0.0
25330	5.26e-04	-1.87e-03-8.16e-03		-1.46e-06	0.0	0.0
25340	-2.46e-03	-2.91e-04-8.21e-03		3.41e-06	0.0	0.0
25361	7.21e-04	2.22e-03-8.43e-03		1.53e-05	0.0	0.0
25362	7.38e-04	-2.58e-03-8.12e-03		-4.22e-06	0.0	0.0
25369	-5.72e-06	-1.14e-04-8.27e-03		5.43e-06	0.0	0.0
25370	-1.41e-05	-1.31e-04-7.90e-03		6.20e-06	0.0	0.0
25371	-5.72e-06	-1.14e-04-8.27e-03		5.43e-06	0.0	0.0
25372	-7.39e-06	-1.17e-04-8.19e-03		5.58e-06	0.0	0.0
25373	-5.72e-06	-1.14e-04-8.27e-03		5.43e-06	0.0	0.0
2541	-3.64e-06	3.42e-04	-0.01	-1.72e-05	0.0	0.0
2542	-1.65e-05	3.98e-04	-0.01	-1.99e-05	-1.08e-06	0.0
2544	-2.57e-05	2.91e-04-7.99e-03		-1.46e-05	-1.02e-06	0.0
25415	-1.77e-03	3.76e-04-8.37e-03		-1.11e-05	0.0	0.0
25433	5.39e-04	2.02e-03-8.21e-03		-6.25e-06	0.0	0.0
25434	5.00e-04	-1.42e-03-8.70e-03		-1.93e-05	0.0	0.0
25447	-2.48e-03	4.26e-04-8.34e-03		-1.05e-05	0.0	0.0
25465	7.57e-04	2.73e-03-8.11e-03		-3.70e-06	0.0	0.0
25466	7.04e-04	-2.10e-03-8.80e-03		-2.19e-05	0.0	0.0
25469	-7.15e-06	2.51e-04-8.44e-03		-1.26e-05	0.0	0.0
25470	-1.57e-05	2.88e-04-8.11e-03		-1.44e-05	0.0	0.0
25471	-7.15e-06	2.51e-04-8.44e-03		-1.26e-05	0.0	0.0
25472	-8.86e-06	2.59e-04-8.38e-03		-1.30e-05	0.0	0.0
25473	-7.15e-06	2.51e-04-8.44e-03		-1.26e-05	0.0	0.0
2551	-1.60e-05	8.64e-04	-0.01	-4.31e-05	-1.36e-06	0.0
2552	-3.11e-05	1.01e-03	-0.01	-5.00e-05	-1.81e-06	0.0



EGP CODE

GRE.EEC.R.73.IT.W.15235.12.024.01

PAGE

120 di/of 527

2554	-3.74e-05	7.39e-04-9.25e-03	-3.65e-05	-1.61e-06	0.0
25515	-1.83e-03	7.63e-04-9.38e-03	-3.01e-05	0.0	0.0
25533	5.63e-04	2.46e-03-9.03e-03	-2.82e-05	0.0	0.0
25534	4.75e-04	-1.10e-03 -0.01	-3.56e-05	-1.54e-06	0.0
25547	-2.55e-03	8.14e-04-9.32e-03	-2.95e-05	0.0	0.0
25565	7.95e-04	3.20e-03-8.83e-03	-2.68e-05	0.0	0.0
25566	6.72e-04	-1.79e-03 -0.01	-3.72e-05	-1.72e-06	0.0
25569	-1.66e-05	6.35e-04-9.53e-03	-3.16e-05	-1.09e-06	0.0
25570	-2.67e-05	7.30e-04-9.35e-03	-3.62e-05	-1.40e-06	0.0
25571	-1.66e-05	6.35e-04-9.53e-03	-3.16e-05	-1.09e-06	0.0
25572	-1.86e-05	6.54e-04-9.50e-03	-3.25e-05	-1.15e-06	0.0
25573	-1.66e-05	6.35e-04-9.53e-03	-3.16e-05	-1.09e-06	0.0
2562	-6.46e-05	1.68e-03 -0.02	-8.31e-05	-3.49e-06	0.0
25616	-1.91e-03	5.60e-04 -0.01	-5.00e-05	-2.63e-06	0.0
25633	5.79e-04	3.00e-03 -0.01	-5.51e-05	-1.32e-06	0.0
25634	4.41e-04	-7.82e-04 -0.01	-5.09e-05	-2.84e-06	0.0
25648	-2.65e-03	3.62e-04 -0.01	-4.90e-05	-2.80e-06	0.0
25665	8.27e-04	3.78e-03 -0.01	-5.62e-05	0.0	0.0
25666	6.32e-04	-1.52e-03 -0.01	-5.02e-05	-3.11e-06	0.0
25670	-5.18e-05	1.22e-03 -0.01	-6.02e-05	-2.66e-06	0.0
25672	-4.09e-05	1.09e-03 -0.01	-5.40e-05	-2.27e-06	0.0
25673	-3.81e-05	1.06e-03 -0.01	-5.24e-05	-2.17e-06	0.0
2572	-1.31e-04	2.41e-03 -0.02	-1.19e-04	-6.89e-06	0.0
25716	-2.02e-03	9.58e-04 -0.01	-6.94e-05	-5.93e-06	0.0
25733	5.83e-04	3.64e-03 -0.01	-8.65e-05	-2.42e-06	0.0
25734	3.88e-04	-4.92e-04 -0.02	-6.55e-05	-5.47e-06	0.0
25748	-2.80e-03	7.37e-04 -0.01	-6.72e-05	-6.56e-06	0.0
25765	8.48e-04	4.50e-03 -0.01	-9.11e-05	-1.66e-06	0.0
25766	5.75e-04	-1.30e-03 -0.02	-6.17e-05	-5.92e-06	0.0
25770	-1.01e-04	1.75e-03 -0.02	-8.65e-05	-5.21e-06	0.0
25772	-8.46e-05	1.56e-03 -0.01	-7.73e-05	-4.52e-06	0.0
25773	-8.05e-05	1.51e-03 -0.01	-7.50e-05	-4.35e-06	0.0
2582	-2.48e-04	3.16e-03 -0.03	-1.56e-04	-1.34e-05	0.0
25816	-2.20e-03	1.34e-03 -0.02	-8.75e-05	-1.20e-05	0.0
25833	5.56e-04	4.38e-03 -0.02	-1.22e-04	-5.49e-06	0.0
25848	-3.01e-03	1.08e-03 -0.02	-8.36e-05	-1.33e-05	0.0
25865	8.42e-04	5.34e-03 -0.02	-1.32e-04	-4.29e-06	0.0
25870	-1.90e-04	2.30e-03 -0.02	-1.13e-04	-1.01e-05	0.0
25872	-1.62e-04	2.04e-03 -0.02	-1.01e-04	-8.81e-06	0.0
25873	-1.56e-04	1.98e-03 -0.02	-9.74e-05	-8.49e-06	0.0
2592	-3.26e-04	3.98e-03 -0.04	-1.91e-04	-2.10e-05	0.0
25916	-2.36e-03	1.64e-03 -0.02	-1.02e-04	-1.98e-05	0.0
25933	5.79e-04	5.38e-03 -0.03	-1.66e-04	-8.86e-06	0.0
25948	-3.21e-03	1.31e-03 -0.02	-9.46e-05	-2.23e-05	0.0
25965	8.95e-04	6.55e-03 -0.03	-1.85e-04	-7.06e-06	0.0
25970	-2.48e-04	2.91e-03 -0.03	-1.39e-04	-1.58e-05	0.0
25972	-2.18e-04	2.55e-03 -0.02	-1.23e-04	-1.39e-05	0.0
25973	-2.11e-04	2.46e-03 -0.02	-1.19e-04	-1.34e-05	0.0
2602	-6.44e-04	4.02e-03 -0.04	-1.94e-04	-3.39e-05	0.0
26015	-2.47e-03	2.79e-03 -0.03	-1.26e-04	-2.47e-05	0.0
26033	2.87e-04	5.51e-03 -0.03	-1.72e-04	-2.54e-05	0.0
26047	-3.30e-03	2.92e-03 -0.03	-1.28e-04	-2.62e-05	0.0
26065	5.62e-04	6.73e-03 -0.03	-1.93e-04	-2.72e-05	0.0
26070	-4.86e-04	2.94e-03 -0.03	-1.41e-04	-2.55e-05	0.0
26072	-4.16e-04	2.56e-03 -0.03	-1.24e-04	-2.20e-05	0.0
26073	-3.99e-04	2.47e-03 -0.03	-1.20e-04	-2.11e-05	0.0
2612	-6.16e-04	-3.43e-03 -0.04	1.68e-04	-3.19e-05	0.0
2618	-2.26e-03	-2.43e-03 -0.03	1.09e-04	-1.43e-05	0.0
26130	2.40e-04	-4.86e-03 -0.03	1.46e-04	-2.70e-05	0.0
26140	-3.01e-03	-2.54e-03 -0.03	1.10e-04	-1.20e-05	0.0
26162	4.89e-04	-5.95e-03 -0.03	1.62e-04	-2.98e-05	0.0
26170	-4.65e-04	-2.50e-03 -0.03	1.22e-04	-2.40e-05	0.0
26172	-3.97e-04	-2.20e-03 -0.03	1.08e-04	-2.07e-05	0.0
26173	-3.80e-04	-2.13e-03 -0.03	1.05e-04	-1.98e-05	0.0
2622	-3.81e-04	-3.25e-03 -0.03	1.60e-04	-2.03e-05	0.0
2628	-2.11e-03	-2.26e-03 -0.02	1.01e-04	-7.10e-06	0.0
26230	4.09e-04	-4.58e-03 -0.02	1.32e-04	-1.27e-05	0.0
26240	-2.86e-03	-2.35e-03 -0.02	1.01e-04	-4.84e-06	0.0
26262	6.68e-04	-5.60e-03 -0.02	1.45e-04	-1.26e-05	0.0
26270	-2.89e-04	-2.36e-03 -0.02	1.16e-04	-1.53e-05	0.0
26272	-2.48e-04	-2.09e-03 -0.02	1.03e-04	-1.32e-05	0.0
26273	-2.37e-04	-2.03e-03 -0.02	9.97e-05	-1.27e-05	0.0
2632	-2.09e-04	-2.71e-03 -0.02	1.33e-04	-1.09e-05	0.0
2636	1.76e-03	-2.28e-03 -0.02	9.22e-05	-9.09e-06	0.0
2637	-2.02e-03	-1.11e-03 -0.02	7.53e-05	-4.74e-06	0.0
26330	5.36e-04	-3.99e-03 -0.02	1.04e-04	-5.32e-06	0.0





EGP CODE

GRE.EEC.R.73.IT.W.15235.12.024.01

PAGE

121 di/of 527

26338	2.52e-03	-2.51e-03	-0.02	9.57e-05	-9.96e-06	0.0
26339	-2.78e-03	-8.76e-04	-0.02	7.18e-05	-3.87e-06	0.0
26362	8.03e-04	-4.91e-03	-0.02	1.12e-04	-4.68e-06	0.0
26370	-1.60e-04	-1.97e-03	-0.02	9.68e-05	-8.24e-06	0.0
26372	-1.37e-04	-1.75e-03	-0.02	8.64e-05	-7.18e-06	0.0
26373	-1.31e-04	-1.69e-03	-0.02	8.37e-05	-6.92e-06	0.0
2642	-1.06e-04	-2.04e-03	-0.02	1.01e-04	-5.47e-06	0.0
2647	-1.93e-03	-7.69e-04	-0.01	5.87e-05	-2.34e-06	0.0
26429	3.90e-04	6.69e-04	-0.01	5.67e-05	-5.51e-06	0.0
26430	5.68e-04	-3.34e-03	-0.01	7.18e-05	-2.27e-06	0.0
26439	-2.68e-03	-5.65e-04	-0.01	5.68e-05	-1.89e-06	0.0
26461	5.73e-04	1.45e-03	-0.01	5.41e-05	-6.33e-06	0.0
26462	8.21e-04	-4.16e-03	-0.01	7.51e-05	-1.79e-06	0.0
26470	-8.28e-05	-1.48e-03	-0.01	7.29e-05	-4.14e-06	0.0
26472	-6.89e-05	-1.32e-03	-0.01	6.52e-05	-3.60e-06	0.0
26473	-6.54e-05	-1.28e-03	-0.01	6.33e-05	-3.47e-06	0.0
2651	-3.49e-05	-1.18e-03	-0.01	5.82e-05	-2.18e-06	0.0
2652	-5.21e-05	-1.37e-03	-0.01	6.76e-05	-2.73e-06	0.0
2654	-5.28e-05	-1.01e-03	-0.01	4.94e-05	-2.30e-06	0.0
2657	-1.86e-03	-4.04e-04	-0.01	4.14e-05	0.0	0.0
26529	4.48e-04	9.36e-04	-0.01	4.40e-05	-2.80e-06	0.0
26530	5.65e-04	-2.76e-03	-0.01	4.23e-05	-1.16e-06	0.0
26539	-2.59e-03	-2.21e-04	-0.01	4.08e-05	0.0	0.0
26561	6.40e-04	1.66e-03	-0.01	4.46e-05	-3.23e-06	0.0
26562	8.04e-04	-3.52e-03-9.82e-03		4.21e-05	0.0	0.0
26569	-3.07e-05	-8.65e-04	-0.01	4.27e-05	-1.71e-06	0.0
26570	-4.21e-05	-9.96e-04	-0.01	4.89e-05	-2.08e-06	0.0
26571	-3.07e-05	-8.65e-04	-0.01	4.27e-05	-1.71e-06	0.0
26572	-3.29e-05	-8.91e-04	-0.01	4.39e-05	-1.78e-06	0.0
26573	-3.07e-05	-8.65e-04	-0.01	4.27e-05	-1.71e-06	0.0
2661	-1.29e-05	-6.47e-04	-0.01	3.19e-05	-1.10e-06	0.0
2662	-2.60e-05	-7.54e-04	-0.01	3.69e-05	-1.46e-06	0.0
2664	-3.18e-05	-5.52e-04-8.55e-03		2.69e-05	-1.28e-06	0.0
2668	-1.80e-03	-6.26e-04-8.84e-03		2.18e-05	0.0	0.0
26629	4.85e-04	1.24e-03-9.36e-03		2.84e-05	-1.45e-06	0.0
26630	5.48e-04	-2.27e-03-8.54e-03		1.87e-05	0.0	0.0
26640	-2.52e-03	-6.86e-04-8.80e-03		2.12e-05	0.0	0.0
26661	6.84e-04	1.92e-03-9.53e-03		3.05e-05	-1.68e-06	0.0
26662	7.73e-04	-2.99e-03-8.37e-03		1.69e-05	0.0	0.0
26669	-1.37e-05	-4.75e-04-8.94e-03		2.34e-05	0.0	0.0
26670	-2.25e-05	-5.46e-04-8.67e-03		2.67e-05	-1.12e-06	0.0
26671	-1.37e-05	-4.75e-04-8.94e-03		2.34e-05	0.0	0.0
26672	-1.55e-05	-4.89e-04-8.89e-03		2.40e-05	0.0	0.0
26673	-1.37e-05	-4.75e-04-8.94e-03		2.34e-05	0.0	0.0
2671	-4.69e-06	-1.52e-04	-0.01	7.28e-06	0.0	0.0
2672	-1.63e-05	-1.77e-04	-0.01	8.42e-06	-1.01e-06	0.0
2674	-2.41e-05	-1.29e-04-7.74e-03		6.13e-06	0.0	0.0
2678	-1.76e-03	-2.62e-04-8.21e-03		3.92e-06	0.0	0.0
26729	5.10e-04	1.56e-03-8.34e-03		1.22e-05	0.0	0.0
26730	5.22e-04	-1.86e-03-8.13e-03		-1.41e-06	0.0	0.0
26740	-2.46e-03	-3.22e-04-8.21e-03		3.35e-06	0.0	0.0
26761	7.17e-04	2.23e-03-8.38e-03		1.50e-05	0.0	0.0
26762	7.34e-04	-2.57e-03-8.09e-03		-4.11e-06	0.0	0.0
26769	-7.45e-06	-1.12e-04-8.24e-03		5.33e-06	0.0	0.0
26770	-1.52e-05	-1.28e-04-7.86e-03		6.09e-06	0.0	0.0
26771	-7.45e-06	-1.12e-04-8.24e-03		5.33e-06	0.0	0.0
26772	-9.00e-06	-1.15e-04-8.16e-03		5.48e-06	0.0	0.0
26773	-7.45e-06	-1.12e-04-8.24e-03		5.33e-06	0.0	0.0
2681	-6.81e-06	3.34e-04	-0.01	-1.69e-05	0.0	0.0
2682	-1.89e-05	3.88e-04	-0.01	-1.95e-05	-1.15e-06	0.0
2684	-2.61e-05	2.84e-04-7.94e-03		-1.42e-05	-1.03e-06	0.0
26815	-1.77e-03	3.94e-04-8.36e-03		-1.09e-05	0.0	0.0
26833	5.34e-04	2.01e-03-8.17e-03		-6.13e-06	0.0	0.0
26834	4.96e-04	-1.44e-03-8.65e-03		-1.88e-05	-1.01e-06	0.0
26847	-2.47e-03	4.54e-04-8.34e-03		-1.03e-05	0.0	0.0
26865	7.52e-04	2.71e-03-8.08e-03		-3.64e-06	0.0	0.0
26866	6.99e-04	-2.11e-03-8.75e-03		-2.14e-05	-1.15e-06	0.0
26869	-9.08e-06	2.45e-04-8.41e-03		-1.23e-05	0.0	0.0
26870	-1.71e-05	2.81e-04-8.06e-03		-1.41e-05	0.0	0.0
26871	-9.08e-06	2.45e-04-8.41e-03		-1.23e-05	0.0	0.0
26872	-1.07e-05	2.52e-04-8.34e-03		-1.27e-05	0.0	0.0
26873	-9.08e-06	2.45e-04-8.41e-03		-1.23e-05	0.0	0.0
2691	-2.04e-05	8.41e-04	-0.01	-4.20e-05	-1.52e-06	0.0
2692	-3.50e-05	9.80e-04	-0.01	-4.87e-05	-1.95e-06	0.0
2694	-3.91e-05	7.18e-04-9.16e-03		-3.55e-05	-1.68e-06	0.0
26915	-1.82e-03	7.70e-04-9.34e-03		-2.93e-05	0.0	0.0



EGP CODE

GRE.EEC.R.73.IT.W.15235.12.024.01

PAGE

122 di/of 527

26933	5.56e-04	2.44e-03-8.98e-03	-2.77e-05	0.0	0.0
26934	4.67e-04	-1.12e-03-9.98e-03	-3.45e-05	-1.88e-06	0.0
26947	-2.54e-03	8.31e-04-9.29e-03	-2.87e-05	0.0	0.0
26965	7.87e-04	3.18e-03-8.79e-03	-2.65e-05	0.0	0.0
26966	6.62e-04	-1.82e-03 -0.01	-3.60e-05	-2.15e-06	0.0
26969	-1.95e-05	6.18e-04-9.47e-03	-3.08e-05	-1.20e-06	0.0
26970	-2.92e-05	7.10e-04-9.27e-03	-3.53e-05	-1.49e-06	0.0
26971	-1.95e-05	6.18e-04-9.47e-03	-3.08e-05	-1.20e-06	0.0
26972	-2.14e-05	6.36e-04-9.43e-03	-3.17e-05	-1.26e-06	0.0
26973	-1.95e-05	6.18e-04-9.47e-03	-3.08e-05	-1.20e-06	0.0
2702	-7.22e-05	1.62e-03 -0.02	-8.04e-05	-3.81e-06	0.0
27016	-1.88e-03	5.41e-04 -0.01	-4.81e-05	-1.52e-06	0.0
27033	5.66e-04	2.97e-03 -0.01	-5.39e-05	-1.76e-06	0.0
27034	4.24e-04	-8.32e-04 -0.01	-4.87e-05	-3.65e-06	0.0
27048	-2.62e-03	3.50e-04 -0.01	-4.70e-05	-1.17e-06	0.0
27065	8.10e-04	3.75e-03 -0.01	-5.52e-05	-1.51e-06	0.0
27066	6.11e-04	-1.58e-03 -0.01	-4.79e-05	-4.15e-06	0.0
27070	-5.72e-05	1.18e-03 -0.01	-5.83e-05	-2.88e-06	0.0
27072	-4.61e-05	1.05e-03 -0.01	-5.23e-05	-2.49e-06	0.0
27073	-4.34e-05	1.02e-03 -0.01	-5.07e-05	-2.39e-06	0.0
2712	-1.46e-04	2.30e-03 -0.02	-1.14e-04	-7.54e-06	0.0
27116	-1.96e-03	9.02e-04 -0.01	-6.57e-05	-3.39e-06	0.0
27133	5.55e-04	3.58e-03 -0.01	-8.41e-05	-3.50e-06	0.0
27134	3.55e-04	-5.85e-04 -0.01	-6.13e-05	-7.03e-06	0.0
27148	-2.71e-03	6.87e-04 -0.01	-6.33e-05	-2.84e-06	0.0
27165	8.13e-04	4.44e-03 -0.01	-8.91e-05	-3.00e-06	0.0
27166	5.34e-04	-1.40e-03 -0.02	-5.72e-05	-7.94e-06	0.0
27170	-1.13e-04	1.67e-03 -0.02	-8.26e-05	-5.68e-06	0.0
27172	-9.48e-05	1.49e-03 -0.01	-7.38e-05	-4.95e-06	0.0
27173	-9.04e-05	1.44e-03 -0.01	-7.17e-05	-4.76e-06	0.0
2722	-2.80e-04	2.94e-03 -0.03	-1.45e-04	-1.45e-05	0.0
27216	-2.07e-03	1.21e-03 -0.02	-8.09e-05	-6.22e-06	0.0
27233	4.90e-04	4.25e-03 -0.02	-1.16e-04	-7.96e-06	0.0
27248	-2.82e-03	9.66e-04 -0.02	-7.68e-05	-5.06e-06	0.0
27265	7.56e-04	5.21e-03 -0.02	-1.27e-04	-7.50e-06	0.0
27270	-2.13e-04	2.14e-03 -0.02	-1.05e-04	-1.09e-05	0.0
27272	-1.82e-04	1.90e-03 -0.02	-9.40e-05	-9.47e-06	0.0
27273	-1.75e-04	1.84e-03 -0.02	-9.11e-05	-9.11e-06	0.0
2732	-4.76e-04	3.39e-03 -0.03	-1.67e-04	-2.51e-05	0.0
27315	-2.17e-03	2.35e-03 -0.02	-1.06e-04	-9.80e-06	0.0
27333	3.31e-04	4.75e-03 -0.03	-1.41e-04	-2.00e-05	0.0
27347	-2.92e-03	2.45e-03 -0.02	-1.07e-04	-7.43e-06	0.0
27365	5.83e-04	5.81e-03 -0.03	-1.55e-04	-2.17e-05	0.0
27370	-3.60e-04	2.46e-03 -0.03	-1.21e-04	-1.89e-05	0.0
27372	-3.09e-04	2.18e-03 -0.02	-1.07e-04	-1.63e-05	0.0
27373	-2.96e-04	2.11e-03 -0.02	-1.04e-04	-1.57e-05	0.0
2742	-6.12e-04	3.46e-03 -0.04	-1.70e-04	-3.21e-05	0.0
27415	-2.27e-03	2.42e-03 -0.03	-1.09e-04	-1.42e-05	0.0
27433	2.47e-04	4.90e-03 -0.03	-1.48e-04	-2.72e-05	0.0
27447	-3.03e-03	2.53e-03 -0.03	-1.11e-04	-1.19e-05	0.0
27465	4.97e-04	6.00e-03 -0.03	-1.64e-04	-3.01e-05	0.0
27470	-4.62e-04	2.52e-03 -0.03	-1.24e-04	-2.41e-05	0.0
27472	-3.95e-04	2.22e-03 -0.03	-1.09e-04	-2.08e-05	0.0
27473	-3.78e-04	2.15e-03 -0.03	-1.06e-04	-1.99e-05	0.0
2752	-2.54e-04	-3.22e-03 -0.04	1.59e-04	-1.30e-05	0.0
2758	-1.90e-03	-2.32e-03 -0.03	1.04e-04	3.27e-06	0.0
27530	4.15e-04	-4.64e-03 -0.03	1.36e-04	-1.52e-05	0.0
27540	-2.60e-03	-2.44e-03 -0.03	1.06e-04	7.85e-06	0.0
27562	6.44e-04	-5.70e-03 -0.03	1.50e-04	-1.81e-05	0.0
27570	-1.93e-04	-2.34e-03 -0.03	1.15e-04	-9.77e-06	0.0
27572	-1.64e-04	-2.07e-03 -0.03	1.02e-04	-8.46e-06	0.0
27573	-1.57e-04	-2.00e-03 -0.03	9.91e-05	-8.13e-06	0.0
2762	-1.65e-04	-3.06e-03 -0.03	1.51e-04	-8.58e-06	0.0
2768	-1.89e-03	-2.19e-03 -0.02	9.80e-05	4.10e-06	0.0
27630	5.05e-04	-4.39e-03 -0.02	1.24e-04	-9.59e-06	0.0
27640	-2.60e-03	-2.30e-03 -0.02	9.95e-05	7.92e-06	0.0
27662	7.48e-04	-5.39e-03 -0.02	1.36e-04	-1.13e-05	0.0
27670	-1.27e-04	-2.22e-03 -0.02	1.09e-04	-6.47e-06	0.0
27672	-1.07e-04	-1.97e-03 -0.02	9.74e-05	-5.63e-06	0.0
27673	-1.02e-04	-1.91e-03 -0.02	9.44e-05	-5.42e-06	0.0
2772	-9.18e-05	-2.59e-03 -0.02	1.28e-04	-4.82e-06	0.0
2778	-1.87e-03	-1.86e-03 -0.02	8.19e-05	3.14e-06	0.0
27730	5.61e-04	-3.89e-03 -0.02	9.94e-05	-3.95e-06	0.0
27740	-2.59e-03	-1.96e-03 -0.02	8.26e-05	5.62e-06	0.0
27762	8.08e-04	-4.80e-03 -0.02	1.07e-04	-4.31e-06	0.0
27770	-7.17e-05	-1.88e-03 -0.02	9.26e-05	-3.64e-06	0.0



EGP CODE

GRE.EEC.R.73.IT.W.15235.12.024.01

PAGE

123 di/of 527

27772	-5.96e-05	-1.67e-03	-0.02	8.28e-05	-3.18e-06	0.0
27773	-5.66e-05	-1.62e-03	-0.02	8.03e-05	-3.06e-06	0.0
2782	-4.59e-05	-1.98e-03	-0.02	9.76e-05	-2.45e-06	0.0
2784	-4.65e-05	-1.45e-03	-0.01	7.14e-05	-2.04e-06	0.0
2788	-1.85e-03	-1.45e-03	-0.01	6.17e-05	1.94e-06	0.0
27829	4.27e-04	7.32e-04	-0.01	5.37e-05	-3.25e-06	0.0
27830	5.80e-04	-3.29e-03	-0.01	7.02e-05	-1.87e-06	0.0
27840	-2.57e-03	-1.54e-03	-0.01	6.18e-05	3.35e-06	0.0
27861	6.09e-04	1.52e-03	-0.01	5.06e-05	-3.94e-06	0.0
27862	8.23e-04	-4.12e-03	-0.01	7.36e-05	-1.99e-06	0.0
27870	-3.72e-05	-1.43e-03	-0.01	7.07e-05	-1.86e-06	0.0
27872	-2.93e-05	-1.28e-03	-0.01	6.33e-05	-1.61e-06	0.0
27873	-2.73e-05	-1.24e-03	-0.01	6.15e-05	-1.55e-06	0.0
2791	-1.03e-05	-1.15e-03	-0.01	5.70e-05	0.0	0.0
2792	-2.13e-05	-1.34e-03	-0.01	6.61e-05	-1.22e-06	0.0
2794	-2.68e-05	-9.83e-04	-0.01	4.82e-05	-1.05e-06	0.0
2798	-1.82e-03	-1.03e-03	-0.01	4.12e-05	1.12e-06	0.0
27929	4.66e-04	9.71e-04	-0.01	4.11e-05	-1.75e-06	0.0
27930	5.73e-04	-2.73e-03	-9.97e-03	4.29e-05	0.0	0.0
27940	-2.54e-03	-1.11e-03	-0.01	4.10e-05	1.86e-06	0.0
27961	6.57e-04	1.70e-03	-0.01	4.09e-05	-2.15e-06	0.0
27962	8.06e-04	-3.49e-03	-9.76e-03	4.34e-05	0.0	0.0
27969	-1.13e-05	-8.45e-04	-0.01	4.17e-05	0.0	0.0
27970	-1.87e-05	-9.72e-04	-0.01	4.79e-05	0.0	0.0
27971	-1.13e-05	-8.45e-04	-0.01	4.17e-05	0.0	0.0
27972	-1.28e-05	-8.70e-04	-0.01	4.30e-05	0.0	0.0
27973	-1.13e-05	-8.45e-04	-0.01	4.17e-05	0.0	0.0
2801	0.0	-6.36e-04	-0.01	3.14e-05	0.0	0.0
2802	-9.54e-06	-7.40e-04	-0.01	3.63e-05	0.0	0.0
2804	-1.73e-05	-5.41e-04	-8.50e-03	2.64e-05	0.0	0.0
2808	-1.78e-03	-6.44e-04	-8.85e-03	2.18e-05	0.0	0.0
28030	5.53e-04	-2.25e-03	-8.50e-03	1.84e-05	0.0	0.0
28035	-5.45e-04	1.25e-03	-9.32e-03	2.75e-05	0.0	0.0
28040	-2.49e-03	-7.15e-04	-8.82e-03	2.13e-05	1.07e-06	0.0
28062	7.76e-04	-2.97e-03	-8.34e-03	1.66e-05	0.0	0.0
28067	-7.61e-04	1.94e-03	-9.48e-03	2.94e-05	0.0	0.0
28069	-3.57e-06	-4.66e-04	-8.91e-03	2.30e-05	0.0	0.0
28070	-9.80e-06	-5.36e-04	-8.63e-03	2.63e-05	0.0	0.0
28071	-3.57e-06	-4.66e-04	-8.91e-03	2.30e-05	0.0	0.0
28072	-4.82e-06	-4.80e-04	-8.85e-03	2.36e-05	0.0	0.0
28073	-3.57e-06	-4.66e-04	-8.91e-03	2.30e-05	0.0	0.0
2811	3.56e-06	-1.50e-04	-0.01	7.18e-06	0.0	0.0
2812	-5.19e-06	-1.74e-04	-0.01	8.31e-06	0.0	0.0
2814	-1.39e-05	-1.28e-04	-7.70e-03	6.04e-06	0.0	0.0
2818	-1.74e-03	-2.83e-04	-8.22e-03	3.97e-06	0.0	0.0
28130	5.27e-04	-1.85e-03	-8.10e-03	-1.44e-06	0.0	0.0
28135	-5.24e-04	1.57e-03	-8.32e-03	1.20e-05	0.0	0.0
28140	-2.44e-03	-3.53e-04	-8.22e-03	3.45e-06	0.0	0.0
28162	7.38e-04	-2.55e-03	-8.06e-03	-4.12e-06	0.0	0.0
28167	-7.33e-04	2.24e-03	-8.37e-03	1.47e-05	0.0	0.0
28169	0.0	-1.10e-04	-8.21e-03	5.26e-06	0.0	0.0
28170	-6.51e-06	-1.26e-04	-7.83e-03	6.01e-06	0.0	0.0
28171	0.0	-1.10e-04	-8.21e-03	5.26e-06	0.0	0.0
28172	-1.85e-06	-1.13e-04	-8.14e-03	5.41e-06	0.0	0.0
28173	0.0	-1.10e-04	-8.21e-03	5.26e-06	0.0	0.0
2821	2.69e-06	3.28e-04	-0.01	-1.66e-05	0.0	0.0
2822	-6.21e-06	3.81e-04	-0.01	-1.92e-05	0.0	0.0
2824	-1.47e-05	2.78e-04	-7.90e-03	-1.39e-05	0.0	0.0
28215	-1.75e-03	4.14e-04	-8.36e-03	-1.09e-05	0.0	0.0
28232	-5.36e-04	-1.45e-03	-8.63e-03	-1.83e-05	0.0	0.0
28233	5.39e-04	1.99e-03	-8.14e-03	-5.95e-06	0.0	0.0
28247	-2.46e-03	4.84e-04	-8.35e-03	-1.03e-05	0.0	0.0
28264	-7.49e-04	-2.12e-03	-8.72e-03	-2.08e-05	0.0	0.0
28265	7.55e-04	2.70e-03	-8.04e-03	-3.48e-06	0.0	0.0
28269	-1.35e-06	2.40e-04	-8.38e-03	-1.21e-05	0.0	0.0
28270	-7.29e-06	2.76e-04	-8.03e-03	-1.39e-05	0.0	0.0
28271	-1.35e-06	2.40e-04	-8.38e-03	-1.21e-05	0.0	0.0
28272	-2.54e-06	2.47e-04	-8.31e-03	-1.25e-05	0.0	0.0
28273	-1.35e-06	2.40e-04	-8.38e-03	-1.21e-05	0.0	0.0
2831	-3.32e-06	8.24e-04	-0.01	-4.12e-05	0.0	0.0
2832	-1.32e-05	9.60e-04	-0.01	-4.78e-05	0.0	0.0
2834	-2.03e-05	7.01e-04	-9.09e-03	-3.48e-05	0.0	0.0
28315	-1.79e-03	7.86e-04	-9.34e-03	-2.92e-05	0.0	0.0
28332	-5.58e-04	-1.15e-03	-9.92e-03	-3.33e-05	0.0	0.0
28333	5.63e-04	2.42e-03	-8.93e-03	-2.72e-05	0.0	0.0
28347	-2.50e-03	8.58e-04	-9.31e-03	-2.88e-05	1.22e-06	0.0



EGP CODE

GRE.EEC.R.73.IT.W.15235.12.024.01

PAGE

124 di/of 527

28364	-7.79e-04	-1.85e-03	-0.01	-3.45e-05	0.0	0.0
28365	7.90e-04	3.15e-03	-8.74e-03	-2.60e-05	0.0	0.0
28369	-5.98e-06	6.05e-04	-9.42e-03	-3.02e-05	0.0	0.0
28370	-1.26e-05	6.95e-04	-9.22e-03	-3.46e-05	0.0	0.0
28371	-5.98e-06	6.05e-04	-9.42e-03	-3.02e-05	0.0	0.0
28372	-7.30e-06	6.23e-04	-9.38e-03	-3.11e-05	0.0	0.0
28373	-5.98e-06	6.05e-04	-9.42e-03	-3.02e-05	0.0	0.0
2842	-2.97e-05	1.58e-03	-0.02	-7.84e-05	-1.68e-06	0.0
2844	-3.35e-05	1.16e-03	-0.01	-5.72e-05	-1.42e-06	0.0
28415	-1.83e-03	1.19e-03	-0.01	-4.92e-05	1.22e-06	0.0
28433	5.78e-04	2.94e-03	-0.01	-5.29e-05	-1.18e-06	0.0
28434	4.49e-04	-8.77e-04	-0.01	-4.67e-05	-2.20e-06	0.0
28447	-2.55e-03	1.27e-03	-0.01	-4.91e-05	2.12e-06	0.0
28465	8.16e-04	3.72e-03	-0.01	-5.42e-05	-1.24e-06	0.0
28466	6.36e-04	-1.63e-03	-0.01	-4.56e-05	-2.66e-06	0.0
28470	-2.50e-05	1.14e-03	-0.01	-5.68e-05	-1.27e-06	0.0
28472	-1.84e-05	1.02e-03	-0.01	-5.09e-05	-1.09e-06	0.0
28473	-1.67e-05	9.93e-04	-0.01	-4.95e-05	-1.05e-06	0.0
2852	-6.21e-05	2.22e-03	-0.02	-1.10e-04	-3.30e-06	0.0
28515	-1.85e-03	1.61e-03	-0.01	-7.00e-05	2.13e-06	0.0
28533	5.76e-04	3.52e-03	-0.01	-8.18e-05	-2.59e-06	0.0
28534	4.06e-04	-6.61e-04	-0.01	-5.78e-05	-4.05e-06	0.0
28547	-2.58e-03	1.70e-03	-0.01	-7.03e-05	3.82e-06	0.0
28565	8.22e-04	4.38e-03	-0.01	-8.68e-05	-2.79e-06	0.0
28566	5.83e-04	-1.48e-03	-0.01	-5.32e-05	-4.84e-06	0.0
28570	-4.94e-05	1.61e-03	-0.01	-7.97e-05	-2.50e-06	0.0
28572	-4.00e-05	1.43e-03	-0.01	-7.13e-05	-2.18e-06	0.0
28573	-3.76e-05	1.39e-03	-0.01	-6.92e-05	-2.09e-06	0.0
2862	-1.19e-04	2.80e-03	-0.03	-1.39e-04	-6.19e-06	0.0
28615	-1.88e-03	2.00e-03	-0.02	-8.93e-05	3.42e-06	0.0
28633	5.44e-04	4.11e-03	-0.02	-1.11e-04	-5.03e-06	0.0
28647	-2.60e-03	2.10e-03	-0.02	-9.02e-05	6.36e-06	0.0
28665	7.91e-04	5.06e-03	-0.02	-1.20e-04	-5.48e-06	0.0
28670	-9.20e-05	2.03e-03	-0.02	-1.01e-04	-4.67e-06	0.0
28672	-7.72e-05	1.80e-03	-0.02	-8.97e-05	-4.08e-06	0.0
28673	-7.35e-05	1.75e-03	-0.02	-8.70e-05	-3.93e-06	0.0
2872	-2.00e-04	3.18e-03	-0.03	-1.57e-04	-1.04e-05	0.0
28715	-1.90e-03	2.27e-03	-0.02	-1.02e-04	4.53e-06	0.0
28733	4.75e-04	4.55e-03	-0.03	-1.32e-04	-1.17e-05	0.0
28747	-2.61e-03	2.39e-03	-0.02	-1.04e-04	8.96e-06	0.0
28765	7.15e-04	5.58e-03	-0.03	-1.45e-04	-1.38e-05	0.0
28770	-1.53e-04	2.30e-03	-0.02	-1.14e-04	-7.82e-06	0.0
28772	-1.30e-04	2.04e-03	-0.02	-1.01e-04	-6.79e-06	0.0
28773	-1.24e-04	1.98e-03	-0.02	-9.83e-05	-6.53e-06	0.0
2882	-2.52e-04	3.25e-03	-0.04	-1.61e-04	-1.30e-05	0.0
28815	-1.90e-03	2.33e-03	-0.03	-1.05e-04	3.74e-06	0.0
28833	4.18e-04	4.67e-03	-0.03	-1.38e-04	-1.55e-05	0.0
28847	-2.60e-03	2.45e-03	-0.03	-1.07e-04	8.53e-06	0.0
28865	6.47e-04	5.73e-03	-0.03	-1.53e-04	-1.84e-05	0.0
28870	-1.92e-04	2.36e-03	-0.03	-1.17e-04	-9.82e-06	0.0
28872	-1.63e-04	2.09e-03	-0.03	-1.04e-04	-8.50e-06	0.0
28873	-1.56e-04	2.02e-03	-0.03	-1.00e-04	-8.17e-06	0.0
2892	2.28e-04	-3.22e-03	-0.04	1.59e-04	1.19e-05	0.0
2896	1.87e-03	-2.55e-03	-0.03	1.05e-04	-4.17e-06	0.0
28930	7.63e-04	-4.63e-03	-0.03	1.35e-04	7.57e-06	0.0
28932	-2.28e-04	-4.57e-03	-0.03	1.36e-04	1.50e-05	0.0
28938	2.56e-03	-2.77e-03	-0.03	1.08e-04	-8.72e-06	0.0
28962	1.01e-03	-5.68e-03	-0.03	1.50e-04	7.73e-06	0.0
28964	-3.76e-04	-5.60e-03	-0.03	1.50e-04	1.82e-05	0.0
28970	1.67e-04	-2.34e-03	-0.03	1.15e-04	8.83e-06	0.0
28972	1.45e-04	-2.07e-03	-0.03	1.02e-04	7.49e-06	0.0
28973	1.39e-04	-2.00e-03	-0.03	9.89e-05	7.16e-06	0.0
2902	1.51e-04	-3.05e-03	-0.03	1.51e-04	7.80e-06	0.0
2905	1.87e-03	-1.56e-03	-0.02	8.74e-05	-4.88e-06	0.0
29032	-3.27e-04	-4.33e-03	-0.02	1.24e-04	8.70e-06	0.0
29036	-2.88e-04	-4.38e-03	-0.02	1.24e-04	7.74e-06	0.0
29037	2.58e-03	-1.42e-03	-0.02	8.46e-05	-8.75e-06	0.0
29064	-4.95e-04	-5.30e-03	-0.02	1.36e-04	1.03e-05	0.0
29068	-4.40e-04	-5.37e-03	-0.02	1.36e-04	8.93e-06	0.0
29070	1.10e-04	-2.21e-03	-0.02	1.09e-04	5.81e-06	0.0
29072	9.71e-05	-1.97e-03	-0.02	9.72e-05	4.97e-06	0.0
29073	9.39e-05	-1.90e-03	-0.02	9.42e-05	4.76e-06	0.0
2912	8.83e-05	-2.59e-03	-0.02	1.28e-04	4.40e-06	0.0
2915	1.86e-03	-1.31e-03	-0.02	7.53e-05	-3.22e-06	0.0
29124	-6.73e-04	-2.88e-03	-0.02	9.33e-05	4.07e-06	0.0
29136	-3.53e-04	-3.87e-03	-0.02	9.90e-05	3.25e-06	0.0



EGP CODE

GRE.EEC.R.73.IT.W.15235.12.024.01

PAGE

125 di/of 527

29137	2.58e-03	-1.19e-03	-0.02	7.34e-05	-5.61e-06	0.0
29156	-9.63e-04	-3.38e-03	-0.02	9.86e-05	4.62e-06	0.0
29168	-5.17e-04	-4.78e-03	-0.02	1.07e-04	3.46e-06	0.0
29170	6.36e-05	-1.87e-03	-0.02	9.25e-05	3.27e-06	0.0
29172	5.80e-05	-1.67e-03	-0.02	8.26e-05	2.84e-06	0.0
29173	5.66e-05	-1.62e-03	-0.02	8.02e-05	2.73e-06	0.0
2922	4.87e-05	-1.98e-03	-0.02	9.75e-05	2.27e-06	0.0
2925	1.84e-03	-9.79e-04	-0.01	5.89e-05	-1.78e-06	0.0
29231	-5.59e-04	7.97e-04	-0.01	5.33e-05	3.37e-06	0.0
29236	-4.02e-04	-3.28e-03	-0.01	6.98e-05	1.19e-06	0.0
29237	2.57e-03	-8.75e-04	-0.01	5.79e-05	-3.07e-06	0.0
29263	-7.95e-04	1.61e-03	-0.01	5.00e-05	4.15e-06	0.0
29268	-5.75e-04	-4.10e-03	-0.01	7.32e-05	1.09e-06	0.0
29270	3.40e-05	-1.43e-03	-0.01	7.06e-05	1.68e-06	0.0
29272	3.28e-05	-1.28e-03	-0.01	6.32e-05	1.49e-06	0.0
29273	3.25e-05	-1.24e-03	-0.01	6.14e-05	1.44e-06	0.0
2931	2.91e-05	-1.15e-03	-0.01	5.69e-05	1.01e-06	0.0
2932	2.70e-05	-1.34e-03	-0.01	6.61e-05	1.15e-06	0.0
2935	1.82e-03	-6.19e-04	-0.01	4.11e-05	0.0	0.0
29331	-5.56e-04	1.03e-03	-0.01	4.08e-05	1.98e-06	0.0
29336	-4.40e-04	-2.72e-03-9.97e-03		4.27e-05	0.0	0.0
29337	2.54e-03	-5.28e-04	-0.01	4.08e-05	-1.43e-06	0.0
29363	-7.86e-04	1.78e-03	-0.01	4.05e-05	2.47e-06	0.0
29368	-6.23e-04	-3.47e-03-9.76e-03		4.31e-05	0.0	0.0
29369	1.92e-05	-8.44e-04	-0.01	4.17e-05	0.0	0.0
29370	1.79e-05	-9.72e-04	-0.01	4.78e-05	0.0	0.0
29371	1.92e-05	-8.44e-04	-0.01	4.17e-05	0.0	0.0
29372	1.89e-05	-8.70e-04	-0.01	4.29e-05	0.0	0.0
29373	1.92e-05	-8.44e-04	-0.01	4.17e-05	0.0	0.0
2941	2.06e-05	-6.36e-04	-0.01	3.13e-05	0.0	0.0
2942	1.64e-05	-7.40e-04	-0.01	3.63e-05	0.0	0.0
2945	1.79e-03	-2.62e-04-8.92e-03		2.36e-05	0.0	0.0
29431	-5.40e-04	1.31e-03-9.34e-03		2.77e-05	1.11e-06	0.0
29436	-4.72e-04	-2.24e-03-8.51e-03		1.82e-05	0.0	0.0
29437	2.50e-03	-1.80e-04-8.93e-03		2.39e-05	0.0	0.0
29463	-7.61e-04	2.02e-03-9.51e-03		2.97e-05	1.38e-06	0.0
29468	-6.66e-04	-2.95e-03-8.35e-03		1.63e-05	0.0	0.0
29469	1.27e-05	-4.66e-04-8.91e-03		2.29e-05	0.0	0.0
29470	9.95e-06	-5.36e-04-8.62e-03		2.63e-05	0.0	0.0
29471	1.27e-05	-4.66e-04-8.91e-03		2.29e-05	0.0	0.0
29472	1.22e-05	-4.80e-04-8.85e-03		2.36e-05	0.0	0.0
29473	1.27e-05	-4.66e-04-8.91e-03		2.29e-05	0.0	0.0
2951	1.75e-05	-1.50e-04	-0.01	7.18e-06	0.0	0.0
2952	1.26e-05	-1.74e-04	-0.01	8.31e-06	0.0	0.0
2955	1.75e-03	8.54e-05-8.18e-03		6.39e-06	0.0	0.0
29531	-5.16e-04	1.62e-03-8.34e-03		1.21e-05	0.0	0.0
29536	-5.01e-04	-1.84e-03-8.12e-03		-1.57e-06	0.0	0.0
29537	2.45e-03	1.64e-04-8.17e-03		6.84e-06	0.0	0.0
29563	-7.27e-04	2.31e-03-8.38e-03		1.48e-05	0.0	0.0
29568	-7.06e-04	-2.53e-03-8.09e-03		-4.30e-06	0.0	0.0
29569	1.04e-05	-1.10e-04-8.21e-03		5.25e-06	0.0	0.0
29570	7.11e-06	-1.26e-04-7.83e-03		6.01e-06	0.0	0.0
29571	1.04e-05	-1.10e-04-8.21e-03		5.25e-06	0.0	0.0
29572	9.73e-06	-1.13e-04-8.14e-03		5.40e-06	0.0	0.0
29573	1.04e-05	-1.10e-04-8.21e-03		5.25e-06	0.0	0.0
2961	1.86e-05	3.28e-04	-0.01	-1.66e-05	0.0	0.0
2962	1.39e-05	3.81e-04	-0.01	-1.92e-05	0.0	0.0
29614	1.76e-03	4.32e-05-8.37e-03		-1.32e-05	0.0	0.0
29633	5.49e-04	1.98e-03-8.13e-03		-5.77e-06	0.0	0.0
29636	-5.27e-04	-1.50e-03-8.64e-03		-1.85e-05	0.0	0.0
29646	2.46e-03	-3.59e-05-8.37e-03		-1.36e-05	0.0	0.0
29665	7.65e-04	2.68e-03-8.02e-03		-3.22e-06	0.0	0.0
29668	-7.42e-04	-2.20e-03-8.74e-03		-2.10e-05	0.0	0.0
29669	1.12e-05	2.40e-04-8.38e-03		-1.21e-05	0.0	0.0
29670	8.10e-06	2.76e-04-8.02e-03		-1.39e-05	0.0	0.0
29671	1.12e-05	2.40e-04-8.38e-03		-1.21e-05	0.0	0.0
29672	1.06e-05	2.47e-04-8.31e-03		-1.25e-05	0.0	0.0
29673	1.12e-05	2.40e-04-8.38e-03		-1.21e-05	0.0	0.0
2971	2.42e-05	8.24e-04	-0.01	-4.12e-05	0.0	0.0
2972	2.09e-05	9.60e-04	-0.01	-4.78e-05	0.0	0.0
29714	1.80e-03	3.94e-04-9.45e-03		-3.05e-05	0.0	0.0
29731	-4.58e-04	2.41e-03-8.94e-03		-2.69e-05	0.0	0.0
29736	-5.48e-04	-1.20e-03-9.94e-03		-3.35e-05	1.39e-06	0.0
29746	2.51e-03	3.09e-04-9.46e-03		-3.07e-05	0.0	0.0
29763	-6.47e-04	3.13e-03-8.75e-03		-2.57e-05	0.0	0.0
29768	-7.73e-04	-1.93e-03	-0.01	-3.48e-05	1.72e-06	0.0





EGP CODE

GRE.EEC.R.73.IT.W.15235.12.024.01

PAGE

126 di/of 527

29769	1.55e-05	6.04e-04-9.42e-03	-3.02e-05	0.0	0.0
29770	1.33e-05	6.95e-04-9.21e-03	-3.46e-05	0.0	0.0
29771	1.55e-05	6.04e-04-9.42e-03	-3.02e-05	0.0	0.0
29772	1.51e-05	6.22e-04-9.38e-03	-3.11e-05	0.0	0.0
29773	1.55e-05	6.04e-04-9.42e-03	-3.02e-05	0.0	0.0
2981	3.66e-05	1.35e-03 -0.01	-6.74e-05	1.36e-06	0.0
2982	3.65e-05	1.58e-03 -0.02	-7.84e-05	1.61e-06	0.0
29814	1.83e-03	7.55e-04 -0.01	-4.82e-05	0.0	0.0
29831	-4.23e-04	2.92e-03 -0.01	-5.26e-05	0.0	0.0
29836	-5.59e-04	-9.39e-04 -0.01	-4.64e-05	2.41e-06	0.0
29846	2.55e-03	6.59e-04 -0.01	-4.78e-05	-1.74e-06	0.0
29863	-6.02e-04	3.70e-03 -0.01	-5.39e-05	0.0	0.0
29868	-7.93e-04	-1.71e-03 -0.01	-4.52e-05	2.97e-06	0.0
29869	2.50e-05	9.92e-04 -0.01	-4.94e-05	1.03e-06	0.0
29870	2.49e-05	1.14e-03 -0.01	-5.67e-05	1.19e-06	0.0
29871	2.50e-05	9.92e-04 -0.01	-4.94e-05	1.03e-06	0.0
29872	2.50e-05	1.02e-03 -0.01	-5.09e-05	1.06e-06	0.0
29873	2.50e-05	9.92e-04 -0.01	-4.94e-05	1.03e-06	0.0
2992	6.58e-05	2.22e-03 -0.02	-1.10e-04	3.08e-06	0.0
29914	1.85e-03	1.11e-03 -0.01	-6.58e-05	-2.08e-06	0.0
29931	-3.81e-04	3.51e-03 -0.01	-8.14e-05	1.95e-06	0.0
29936	-5.54e-04	-7.28e-04 -0.01	-5.72e-05	3.98e-06	0.0
29946	2.57e-03	9.98e-04 -0.01	-6.44e-05	-3.68e-06	0.0
29963	-5.50e-04	4.36e-03 -0.01	-8.64e-05	1.95e-06	0.0
29968	-7.93e-04	-1.58e-03 -0.01	-5.24e-05	4.81e-06	0.0
29970	4.67e-05	1.61e-03 -0.01	-7.96e-05	2.29e-06	0.0
29972	4.36e-05	1.43e-03 -0.01	-7.12e-05	2.00e-06	0.0
29973	4.29e-05	1.39e-03 -0.01	-6.91e-05	1.93e-06	0.0
3002	1.15e-04	2.79e-03 -0.03	-1.39e-04	5.66e-06	0.0
30014	1.86e-03	1.42e-03 -0.02	-8.10e-05	-3.52e-06	0.0
30031	-3.26e-04	4.09e-03 -0.02	-1.10e-04	4.43e-06	0.0
30035	-3.62e-04	4.04e-03 -0.02	-1.10e-04	5.16e-06	0.0
30046	2.58e-03	1.29e-03 -0.02	-7.87e-05	-6.34e-06	0.0
30063	-4.86e-04	5.03e-03 -0.02	-1.20e-04	4.80e-06	0.0
30067	-5.36e-04	4.96e-03 -0.02	-1.20e-04	5.84e-06	0.0
30070	8.36e-05	2.02e-03 -0.02	-1.00e-04	4.22e-06	0.0
30072	7.49e-05	1.80e-03 -0.02	-8.95e-05	3.63e-06	0.0
30073	7.28e-05	1.75e-03 -0.02	-8.68e-05	3.49e-06	0.0
3012	1.85e-04	3.17e-03 -0.03	-1.57e-04	9.44e-06	0.0
30114	1.88e-03	1.61e-03 -0.02	-9.04e-05	-5.52e-06	0.0
30131	-2.51e-04	4.53e-03 -0.03	-1.32e-04	9.94e-06	0.0
30135	-2.89e-04	4.48e-03 -0.03	-1.32e-04	1.10e-05	0.0
30146	2.58e-03	1.47e-03 -0.02	-8.72e-05	-1.00e-05	0.0
30163	-3.97e-04	5.55e-03 -0.03	-1.45e-04	1.16e-05	0.0
30167	-4.50e-04	5.48e-03 -0.03	-1.45e-04	1.32e-05	0.0
30170	1.36e-04	2.30e-03 -0.02	-1.14e-04	7.03e-06	0.0
30172	1.19e-04	2.04e-03 -0.02	-1.01e-04	6.00e-06	0.0
30173	1.14e-04	1.98e-03 -0.02	-9.81e-05	5.74e-06	0.0
3022	2.30e-04	3.25e-03 -0.04	-1.61e-04	1.19e-05	0.0
30213	1.87e-03	2.56e-03 -0.03	-1.06e-04	-4.68e-06	0.0
30231	-1.86e-04	4.65e-03 -0.03	-1.37e-04	1.39e-05	0.0
30235	-2.23e-04	4.60e-03 -0.03	-1.37e-04	1.53e-05	0.0
30245	2.57e-03	2.77e-03 -0.03	-1.09e-04	-9.44e-06	0.0
30263	-3.16e-04	5.71e-03 -0.03	-1.52e-04	1.66e-05	0.0
30267	-3.69e-04	5.64e-03 -0.03	-1.52e-04	1.85e-05	0.0
30270	1.69e-04	2.36e-03 -0.03	-1.16e-04	8.85e-06	0.0
30272	1.47e-04	2.08e-03 -0.03	-1.03e-04	7.51e-06	0.0
30273	1.41e-04	2.02e-03 -0.03	-1.00e-04	7.18e-06	0.0
3032	6.17e-04	-3.43e-03 -0.04	1.68e-04	3.22e-05	0.0
3036	2.22e-03	-2.54e-03 -0.03	1.10e-04	1.40e-05	0.0
30332	2.88e-05	-4.84e-03 -0.03	1.46e-04	2.83e-05	0.0
30336	7.61e-05	-4.85e-03 -0.03	1.46e-04	2.75e-05	0.0
30338	2.95e-03	-2.71e-03 -0.03	1.12e-04	1.17e-05	0.0
30364	-1.12e-04	-5.94e-03 -0.03	1.63e-04	3.17e-05	0.0
30368	-4.51e-05	-5.94e-03 -0.03	1.63e-04	3.06e-05	0.0
30370	4.59e-04	-2.49e-03 -0.03	1.22e-04	2.41e-05	0.0
30372	3.96e-04	-2.20e-03 -0.03	1.08e-04	2.06e-05	0.0
30373	3.80e-04	-2.12e-03 -0.03	1.04e-04	1.97e-05	0.0
3042	3.91e-04	-3.24e-03 -0.03	1.59e-04	2.07e-05	0.0
3045	2.08e-03	-1.53e-03 -0.02	8.89e-05	6.75e-06	0.0
30432	-2.01e-04	-4.54e-03 -0.02	1.32e-04	1.39e-05	0.0
30436	-1.58e-04	-4.55e-03 -0.02	1.32e-04	1.33e-05	0.0
30437	2.82e-03	-1.33e-03 -0.02	8.48e-05	4.34e-06	0.0
30464	-3.79e-04	-5.55e-03 -0.02	1.46e-04	1.44e-05	0.0
30468	-3.18e-04	-5.57e-03 -0.02	1.45e-04	1.36e-05	0.0
30470	2.90e-04	-2.36e-03 -0.02	1.15e-04	1.54e-05	0.0



EGP CODE

GRE.EEC.R.73.IT.W.15235.12.024.01

PAGE

127 di/of 527

30472	2.53e-04	-2.09e-03	-0.02	1.02e-04	1.33e-05	0.0
30473	2.44e-04	-2.02e-03	-0.02	9.93e-05	1.28e-05	0.0
3052	2.23e-04	-2.71e-03	-0.02	1.33e-04	1.13e-05	0.0
3055	2.00e-03	-1.25e-03	-0.02	7.58e-05	4.73e-06	0.0
3058	-1.72e-03	-2.13e-03	-0.02	9.11e-05	9.47e-06	0.0
30536	-2.85e-04	-3.96e-03	-0.02	1.03e-04	5.41e-06	0.0
30537	2.75e-03	-1.08e-03	-0.02	7.27e-05	3.77e-06	0.0
30540	-2.46e-03	-2.31e-03	-0.02	9.41e-05	1.04e-05	0.0
30568	-4.56e-04	-4.86e-03	-0.02	1.11e-04	4.73e-06	0.0
30570	1.65e-04	-1.96e-03	-0.02	9.65e-05	8.48e-06	0.0
30572	1.46e-04	-1.74e-03	-0.02	8.60e-05	7.37e-06	0.0
30573	1.42e-04	-1.69e-03	-0.02	8.34e-05	7.10e-06	0.0
3062	1.19e-04	-2.04e-03	-0.02	1.00e-04	5.79e-06	0.0
3065	1.92e-03	-8.82e-04	-0.01	5.92e-05	2.68e-06	0.0
30631	-5.19e-04	7.02e-04	-0.01	5.61e-05	5.96e-06	0.0
30636	-3.70e-04	-3.30e-03	-0.01	7.13e-05	2.04e-06	0.0
30637	2.66e-03	-7.24e-04	-0.01	5.76e-05	2.29e-06	0.0
30663	-7.58e-04	1.50e-03	-0.01	5.33e-05	6.88e-06	0.0
30668	-5.49e-04	-4.11e-03	-0.01	7.45e-05	1.38e-06	0.0
30670	8.69e-05	-1.48e-03	-0.01	7.27e-05	4.33e-06	0.0
30672	7.88e-05	-1.32e-03	-0.01	6.51e-05	3.80e-06	0.0
30673	7.68e-05	-1.28e-03	-0.01	6.32e-05	3.67e-06	0.0
3071	5.84e-05	-1.18e-03	-0.01	5.81e-05	2.48e-06	0.0
3072	6.32e-05	-1.37e-03	-0.01	6.75e-05	2.95e-06	0.0
3075	1.86e-03	-4.88e-04	-0.01	4.18e-05	1.44e-06	0.0
30731	-5.32e-04	9.52e-04	-0.01	4.40e-05	3.20e-06	0.0
30736	-4.26e-04	-2.72e-03	-0.01	4.17e-05	0.0	0.0
30737	2.58e-03	-3.39e-04	-0.01	4.14e-05	1.25e-06	0.0
30763	-7.62e-04	1.68e-03	-0.01	4.45e-05	3.73e-06	0.0
30768	-6.12e-04	-3.47e-03-9.78e-03		4.14e-05	0.0	0.0
30769	4.20e-05	-8.64e-04	-0.01	4.26e-05	1.90e-06	0.0
30770	4.52e-05	-9.96e-04	-0.01	4.89e-05	2.21e-06	0.0
30771	4.20e-05	-8.64e-04	-0.01	4.26e-05	1.90e-06	0.0
30772	4.27e-05	-8.91e-04	-0.01	4.38e-05	1.96e-06	0.0
30773	4.20e-05	-8.64e-04	-0.01	4.26e-05	1.90e-06	0.0
3081	3.62e-05	-6.47e-04	-0.01	3.18e-05	1.39e-06	0.0
3082	3.61e-05	-7.54e-04	-0.01	3.69e-05	1.62e-06	0.0
3085	1.80e-03	-2.49e-04-8.94e-03		2.37e-05	0.0	0.0
30831	-5.26e-04	1.28e-03-9.41e-03		2.86e-05	1.72e-06	0.0
30836	-4.64e-04	-2.23e-03-8.54e-03		1.83e-05	0.0	0.0
30837	2.52e-03	-1.58e-04-8.93e-03		2.39e-05	0.0	0.0
30863	-7.46e-04	1.99e-03-9.59e-03		3.07e-05	1.99e-06	0.0
30868	-6.60e-04	-2.94e-03-8.37e-03		1.63e-05	0.0	0.0
30869	2.50e-05	-4.75e-04-8.95e-03		2.33e-05	1.06e-06	0.0
30870	2.50e-05	-5.46e-04-8.67e-03		2.67e-05	1.21e-06	0.0
30871	2.50e-05	-4.75e-04-8.95e-03		2.33e-05	1.06e-06	0.0
30872	2.50e-05	-4.89e-04-8.89e-03		2.40e-05	1.09e-06	0.0
30873	2.50e-05	-4.75e-04-8.95e-03		2.33e-05	1.06e-06	0.0
3091	2.81e-05	-1.52e-04	-0.01	7.26e-06	1.00e-06	0.0
3092	2.63e-05	-1.77e-04	-0.01	8.41e-06	1.15e-06	0.0
3095	1.76e-03	1.03e-04-8.19e-03		6.41e-06	0.0	0.0
30931	-5.07e-04	1.60e-03-8.37e-03		1.25e-05	0.0	0.0
30936	-4.94e-04	-1.83e-03-8.15e-03		-1.77e-06	0.0	0.0
30937	2.46e-03	1.89e-04-8.17e-03		6.84e-06	0.0	0.0
30963	-7.18e-04	2.29e-03-8.43e-03		1.53e-05	1.04e-06	0.0
30968	-6.99e-04	-2.52e-03-8.12e-03		-4.61e-06	0.0	0.0
30969	1.89e-05	-1.12e-04-8.24e-03		5.32e-06	0.0	0.0
30970	1.76e-05	-1.28e-04-7.86e-03		6.09e-06	0.0	0.0
30971	1.89e-05	-1.12e-04-8.24e-03		5.32e-06	0.0	0.0
30972	1.86e-05	-1.15e-04-8.17e-03		5.47e-06	0.0	0.0
30973	1.89e-05	-1.12e-04-8.24e-03		5.32e-06	0.0	0.0
3101	3.05e-05	3.34e-04	-0.01	-1.68e-05	1.12e-06	0.0
3102	2.92e-05	3.89e-04	-0.01	-1.95e-05	1.29e-06	0.0
31014	1.77e-03	2.75e-05-8.39e-03		-1.33e-05	0.0	0.0
31031	-4.81e-04	1.97e-03-8.18e-03		-5.74e-06	0.0	0.0
31036	-5.16e-04	-1.48e-03-8.69e-03		-1.90e-05	1.20e-06	0.0
31046	2.47e-03	-5.99e-05-8.38e-03		-1.36e-05	0.0	0.0
31063	-6.82e-04	2.66e-03-8.09e-03		-3.10e-06	0.0	0.0
31068	-7.31e-04	-2.17e-03-8.80e-03		-2.17e-05	1.33e-06	0.0
31069	2.07e-05	2.45e-04-8.42e-03		-1.23e-05	0.0	0.0
31070	1.98e-05	2.81e-04-8.06e-03		-1.41e-05	0.0	0.0
31071	2.07e-05	2.45e-04-8.42e-03		-1.23e-05	0.0	0.0
31072	2.05e-05	2.52e-04-8.34e-03		-1.27e-05	0.0	0.0
31073	2.07e-05	2.45e-04-8.42e-03		-1.23e-05	0.0	0.0
3111	4.46e-05	8.41e-04	-0.01	-4.20e-05	1.81e-06	0.0
3112	4.65e-05	9.80e-04	-0.01	-4.87e-05	2.14e-06	0.0



EGP CODE

GRE.EEC.R.73.IT.W.15235.12.024.01

PAGE

128 di/of 527

31114	1.82e-03	3.83e-04-9.47e-03	-3.07e-05	1.07e-06	0.0
31131	-4.48e-04	2.41e-03-8.97e-03	-2.72e-05	0.0	0.0
31136	-5.30e-04	-1.17e-03 -0.01	-3.46e-05	2.21e-06	0.0
31146	2.53e-03	2.89e-04-9.47e-03	-3.07e-05	0.0	0.0
31163	-6.39e-04	3.13e-03-8.77e-03	-2.58e-05	0.0	0.0
31168	-7.55e-04	-1.89e-03 -0.01	-3.61e-05	2.53e-06	0.0
31169	3.15e-05	6.17e-04-9.48e-03	-3.08e-05	1.38e-06	0.0
31170	3.27e-05	7.10e-04-9.27e-03	-3.53e-05	1.60e-06	0.0
31171	3.15e-05	6.17e-04-9.48e-03	-3.08e-05	1.38e-06	0.0
31172	3.17e-05	6.36e-04-9.44e-03	-3.17e-05	1.43e-06	0.0
31173	3.15e-05	6.17e-04-9.48e-03	-3.08e-05	1.38e-06	0.0
3122	8.56e-05	1.62e-03 -0.02	-8.04e-05	4.07e-06	0.0
31214	1.88e-03	6.36e-04 -0.01	-4.86e-05	1.97e-06	0.0
31231	-4.02e-04	2.93e-03 -0.01	-5.35e-05	1.52e-06	0.0
31236	-5.28e-04	-8.54e-04 -0.01	-4.84e-05	4.09e-06	0.0
31246	2.61e-03	4.84e-04 -0.01	-4.77e-05	1.72e-06	0.0
31263	-5.86e-04	3.70e-03 -0.01	-5.47e-05	1.10e-06	0.0
31268	-7.62e-04	-1.61e-03 -0.01	-4.75e-05	4.69e-06	0.0
31270	6.19e-05	1.18e-03 -0.01	-5.82e-05	3.05e-06	0.0
31272	5.71e-05	1.05e-03 -0.01	-5.22e-05	2.68e-06	0.0
31273	5.59e-05	1.02e-03 -0.01	-5.06e-05	2.59e-06	0.0
3132	1.62e-04	2.30e-03 -0.02	-1.14e-04	7.92e-06	0.0
31314	1.95e-03	1.03e-03 -0.01	-6.62e-05	3.65e-06	0.0
31331	-3.36e-04	3.55e-03 -0.01	-8.37e-05	3.39e-06	0.0
31336	-5.00e-04	-6.28e-04 -0.01	-6.05e-05	7.40e-06	0.0
31346	2.70e-03	8.67e-04 -0.01	-6.41e-05	3.11e-06	0.0
31363	-5.12e-04	4.39e-03 -0.01	-8.86e-05	2.75e-06	0.0
31368	-7.42e-04	-1.46e-03 -0.02	-5.61e-05	8.37e-06	0.0
31370	1.19e-04	1.67e-03 -0.02	-8.24e-05	5.92e-06	0.0
31372	1.06e-04	1.48e-03 -0.01	-7.36e-05	5.17e-06	0.0
31373	1.03e-04	1.44e-03 -0.01	-7.14e-05	4.98e-06	0.0
3142	2.97e-04	2.94e-03 -0.03	-1.45e-04	1.49e-05	0.0
31414	2.04e-03	1.37e-03 -0.02	-8.14e-05	6.01e-06	0.0
31431	-2.34e-04	4.21e-03 -0.02	-1.16e-04	8.38e-06	0.0
31435	-2.74e-04	4.20e-03 -0.02	-1.16e-04	8.75e-06	0.0
31446	2.79e-03	1.18e-03 -0.02	-7.77e-05	4.69e-06	0.0
31463	-4.02e-04	5.16e-03 -0.02	-1.26e-04	8.02e-06	0.0
31467	-4.58e-04	5.14e-03 -0.02	-1.27e-04	8.54e-06	0.0
31470	2.20e-04	2.13e-03 -0.02	-1.05e-04	1.11e-05	0.0
31472	1.93e-04	1.89e-03 -0.02	-9.35e-05	9.65e-06	0.0
31473	1.87e-04	1.83e-03 -0.02	-9.07e-05	9.28e-06	0.0
3152	4.88e-04	3.38e-03 -0.03	-1.66e-04	2.54e-05	0.0
31514	2.14e-03	1.59e-03 -0.02	-9.21e-05	8.12e-06	0.0
31531	-6.74e-05	4.73e-03 -0.03	-1.41e-04	1.94e-05	0.0
31535	-1.10e-04	4.71e-03 -0.03	-1.41e-04	2.01e-05	0.0
31546	2.87e-03	1.39e-03 -0.02	-8.75e-05	5.10e-06	0.0
31563	-2.16e-04	5.78e-03 -0.03	-1.56e-04	2.09e-05	0.0
31567	-2.75e-04	5.76e-03 -0.03	-1.56e-04	2.19e-05	0.0
31570	3.63e-04	2.45e-03 -0.03	-1.21e-04	1.90e-05	0.0
31572	3.15e-04	2.17e-03 -0.02	-1.07e-04	1.63e-05	0.0
31573	3.03e-04	2.10e-03 -0.02	-1.04e-04	1.57e-05	0.0
3162	6.19e-04	3.45e-03 -0.04	-1.70e-04	3.24e-05	0.0
31613	2.23e-03	2.58e-03 -0.03	-1.10e-04	1.39e-05	0.0
31631	7.42e-05	4.88e-03 -0.03	-1.48e-04	2.77e-05	0.0
31635	2.80e-05	4.87e-03 -0.03	-1.48e-04	2.85e-05	0.0
31645	2.97e-03	2.75e-03 -0.03	-1.12e-04	1.15e-05	0.0
31663	-4.83e-05	5.98e-03 -0.03	-1.65e-04	3.08e-05	0.0
31667	-1.13e-04	5.96e-03 -0.03	-1.66e-04	3.20e-05	0.0
31670	4.61e-04	2.51e-03 -0.03	-1.23e-04	2.42e-05	0.0
31672	3.97e-04	2.21e-03 -0.03	-1.09e-04	2.07e-05	0.0
31673	3.81e-04	2.14e-03 -0.03	-1.05e-04	1.98e-05	0.0
3172	7.02e-04	-3.99e-03 -0.04	1.92e-04	3.66e-05	0.0
3176	2.39e-03	-3.06e-03 -0.03	1.26e-04	2.44e-05	0.0
31730	1.19e-03	-5.45e-03 -0.03	1.70e-04	2.96e-05	0.0
31732	6.60e-05	-5.40e-03 -0.03	1.71e-04	2.94e-05	0.0
31738	3.17e-03	-3.30e-03 -0.03	1.30e-04	2.52e-05	0.0
31762	1.49e-03	-6.65e-03 -0.03	1.90e-04	3.24e-05	0.0
31764	-8.09e-05	-6.59e-03 -0.03	1.92e-04	3.21e-05	0.0
31770	5.23e-04	-2.91e-03 -0.03	1.40e-04	2.74e-05	0.0
31772	4.51e-04	-2.54e-03 -0.03	1.23e-04	2.35e-05	0.0
31773	4.33e-04	-2.45e-03 -0.03	1.18e-04	2.25e-05	0.0
3182	2.42e-04	-3.75e-03 -0.03	1.80e-04	1.68e-05	0.0
3185	2.21e-03	-1.75e-03 -0.02	9.78e-05	1.62e-05	0.0
31832	-5.38e-04	-5.01e-03 -0.02	1.53e-04	5.82e-06	0.0
31836	-4.75e-04	-5.01e-03 -0.02	1.52e-04	6.30e-06	0.0
31837	3.03e-03	-1.52e-03 -0.02	9.21e-05	1.84e-05	0.0



EGP CODE

GRE.EEC.R.73.IT.W.15235.12.024.01

PAGE

129 di/of 527

31864	-8.17e-04	-6.08e-03	-0.02	1.69e-04	3.88e-06	0.0
31868	-7.28e-04	-6.09e-03	-0.02	1.68e-04	4.56e-06	0.0
31870	1.79e-04	-2.73e-03	-0.02	1.31e-04	1.26e-05	0.0
31872	1.64e-04	-2.40e-03	-0.02	1.16e-04	1.10e-05	0.0
31873	1.60e-04	-2.32e-03	-0.02	1.12e-04	1.07e-05	0.0
3192	2.16e-04	-2.89e-03	-0.02	1.41e-04	1.13e-05	0.0
3195	2.11e-03	-1.37e-03	-0.02	8.08e-05	1.03e-05	0.0
3198	-1.83e-03	-2.24e-03	-0.02	9.64e-05	3.92e-06	0.0
31936	-3.21e-04	-4.05e-03	-0.02	1.08e-04	4.34e-06	0.0
31937	2.90e-03	-1.20e-03	-0.02	7.76e-05	1.16e-05	0.0
31940	-2.62e-03	-2.42e-03	-0.02	9.95e-05	2.63e-06	0.0
31968	-5.05e-04	-4.95e-03	-0.02	1.15e-04	3.22e-06	0.0
31970	1.60e-04	-2.10e-03	-0.02	1.03e-04	8.49e-06	0.0
31972	1.42e-04	-1.87e-03	-0.02	9.14e-05	7.40e-06	0.0
31973	1.38e-04	-1.81e-03	-0.02	8.86e-05	7.13e-06	0.0
3202	1.21e-04	-2.13e-03	-0.02	1.05e-04	5.94e-06	0.0
3205	1.97e-03	-9.53e-04	-0.01	6.21e-05	5.58e-06	0.0
32031	-5.25e-04	6.27e-04	-0.01	5.96e-05	4.83e-06	0.0
32036	-3.88e-04	-3.33e-03	-0.01	7.29e-05	1.92e-06	0.0
32037	2.73e-03	-8.00e-04	-0.01	6.06e-05	6.32e-06	0.0
32063	-7.67e-04	1.41e-03	-0.01	5.72e-05	5.26e-06	0.0
32068	-5.74e-04	-4.13e-03	-0.01	7.58e-05	1.18e-06	0.0
32070	8.84e-05	-1.55e-03	-0.01	7.59e-05	4.45e-06	0.0
32072	7.98e-05	-1.38e-03	-0.01	6.78e-05	3.89e-06	0.0
32073	7.77e-05	-1.34e-03	-0.01	6.58e-05	3.75e-06	0.0
3211	5.94e-05	-1.21e-03	-0.01	5.97e-05	2.60e-06	0.0
3212	6.54e-05	-1.42e-03	-0.01	6.96e-05	3.12e-06	0.0
3215	1.88e-03	-5.30e-04	-0.01	4.31e-05	2.87e-06	0.0
32131	-5.33e-04	9.11e-04	-0.01	4.56e-05	2.64e-06	0.0
32136	-4.34e-04	-2.73e-03	-0.01	4.26e-05	0.0	0.0
32137	2.61e-03	-3.86e-04	-0.01	4.28e-05	3.22e-06	0.0
32163	-7.63e-04	1.63e-03	-0.01	4.63e-05	2.89e-06	0.0
32168	-6.24e-04	-3.47e-03-9.81e-03		4.22e-05	0.0	0.0
32169	4.31e-05	-8.92e-04	-0.01	4.39e-05	1.99e-06	0.0
32170	4.71e-05	-1.03e-03	-0.01	5.04e-05	2.34e-06	0.0
32171	4.31e-05	-8.92e-04	-0.01	4.39e-05	1.99e-06	0.0
32172	4.39e-05	-9.20e-04	-0.01	4.52e-05	2.06e-06	0.0
32173	4.31e-05	-8.92e-04	-0.01	4.39e-05	1.99e-06	0.0
3221	3.72e-05	-6.63e-04	-0.01	3.25e-05	1.51e-06	0.0
3222	3.82e-05	-7.74e-04	-0.01	3.78e-05	1.79e-06	0.0
3225	1.81e-03	-2.45e-04-9.00e-03		2.44e-05	1.55e-06	0.0
32231	-5.25e-04	1.25e-03-9.49e-03		2.95e-05	1.48e-06	0.0
32236	-4.67e-04	-2.23e-03-8.57e-03		1.84e-05	0.0	0.0
32237	2.53e-03	-1.48e-04-9.00e-03		2.46e-05	1.71e-06	0.0
32263	-7.45e-04	1.95e-03-9.68e-03		3.18e-05	1.61e-06	0.0
32268	-6.64e-04	-2.93e-03-8.40e-03		1.62e-05	0.0	0.0
32269	2.61e-05	-4.87e-04-9.01e-03		2.39e-05	1.16e-06	0.0
32270	2.68e-05	-5.61e-04-8.74e-03		2.74e-05	1.34e-06	0.0
32271	2.61e-05	-4.87e-04-9.01e-03		2.39e-05	1.16e-06	0.0
32272	2.62e-05	-5.02e-04-8.95e-03		2.46e-05	1.19e-06	0.0
32273	2.61e-05	-4.87e-04-9.01e-03		2.39e-05	1.16e-06	0.0
3231	2.89e-05	-1.55e-04	-0.01	7.40e-06	1.11e-06	0.0
3232	2.82e-05	-1.81e-04	-0.01	8.57e-06	1.31e-06	0.0
3235	1.77e-03	1.17e-04-8.24e-03		6.58e-06	1.01e-06	0.0
32331	-5.07e-04	1.59e-03-8.42e-03		1.29e-05	0.0	0.0
32336	-4.94e-04	-1.81e-03-8.19e-03		-1.97e-06	0.0	0.0
32337	2.47e-03	2.10e-04-8.22e-03		7.05e-06	1.08e-06	0.0
32363	-7.18e-04	2.27e-03-8.48e-03		1.59e-05	0.0	0.0
32368	-7.00e-04	-2.50e-03-8.15e-03		-4.93e-06	0.0	0.0
32369	1.98e-05	-1.14e-04-8.29e-03		5.42e-06	0.0	0.0
32370	1.93e-05	-1.31e-04-7.91e-03		6.21e-06	0.0	0.0
32371	1.98e-05	-1.14e-04-8.29e-03		5.42e-06	0.0	0.0
32372	1.97e-05	-1.17e-04-8.21e-03		5.58e-06	0.0	0.0
32373	1.98e-05	-1.14e-04-8.29e-03		5.42e-06	0.0	0.0
3241	3.12e-05	3.42e-04	-0.01	-1.72e-05	1.23e-06	0.0
3242	3.09e-05	3.99e-04	-0.01	-2.00e-05	1.45e-06	0.0
32414	1.78e-03	1.77e-05-8.44e-03		-1.36e-05	1.15e-06	0.0
32431	-4.83e-04	1.96e-03-8.22e-03		-5.73e-06	0.0	0.0
32436	-5.16e-04	-1.46e-03-8.75e-03		-1.96e-05	1.10e-06	0.0
32446	2.48e-03	-7.62e-05-8.43e-03		-1.40e-05	1.23e-06	0.0
32463	-6.84e-04	2.65e-03-8.12e-03		-2.97e-06	0.0	0.0
32468	-7.30e-04	-2.14e-03-8.86e-03		-2.24e-05	1.17e-06	0.0
32469	2.15e-05	2.51e-04-8.46e-03		-1.26e-05	0.0	0.0
32470	2.13e-05	2.89e-04-8.11e-03		-1.45e-05	1.09e-06	0.0
32471	2.15e-05	2.51e-04-8.46e-03		-1.26e-05	0.0	0.0
32472	2.15e-05	2.59e-04-8.39e-03		-1.30e-05	0.0	0.0



EGP CODE

GRE.EEC.R.73.IT.W.15235.12.024.01

PAGE

130 di/of 527

32473	2.15e-05	2.51e-04	-8.46e-03	-1.26e-05	0.0	0.0
3251	4.50e-05	8.64e-04	-0.01	-4.31e-05	1.91e-06	0.0
3252	4.79e-05	1.01e-03	-0.01	-5.01e-05	2.28e-06	0.0
32514	1.83e-03	3.86e-04	-9.55e-03	-3.17e-05	1.94e-06	0.0
32531	-4.53e-04	2.41e-03	-9.02e-03	-2.77e-05	0.0	0.0
32536	-5.29e-04	-1.13e-03	-0.01	-3.58e-05	1.89e-06	0.0
32546	2.55e-03	2.85e-04	-9.55e-03	-3.17e-05	2.14e-06	0.0
32563	-6.47e-04	3.12e-03	-8.81e-03	-2.61e-05	0.0	0.0
32568	-7.54e-04	-1.84e-03	-0.01	-3.75e-05	2.06e-06	0.0
32569	3.21e-05	6.35e-04	-9.55e-03	-3.16e-05	1.46e-06	0.0
32570	3.40e-05	7.32e-04	-9.36e-03	-3.63e-05	1.71e-06	0.0
32571	3.21e-05	6.35e-04	-9.55e-03	-3.16e-05	1.46e-06	0.0
32572	3.25e-05	6.55e-04	-9.51e-03	-3.25e-05	1.51e-06	0.0
32573	3.21e-05	6.35e-04	-9.55e-03	-3.16e-05	1.46e-06	0.0
3262	8.66e-05	1.68e-03	-0.02	-8.32e-05	4.21e-06	0.0
32614	1.91e-03	6.88e-04	-0.01	-5.05e-05	3.72e-06	0.0
32631	-4.14e-04	2.95e-03	-0.01	-5.48e-05	1.50e-06	0.0
32636	-5.31e-04	-8.02e-04	-0.01	-5.07e-05	3.40e-06	0.0
32646	2.65e-03	5.41e-04	-0.01	-4.98e-05	4.15e-06	0.0
32663	-6.02e-04	3.71e-03	-0.01	-5.57e-05	1.04e-06	0.0
32668	-7.66e-04	-1.55e-03	-0.01	-5.00e-05	3.69e-06	0.0
32670	6.29e-05	1.22e-03	-0.01	-6.03e-05	3.15e-06	0.0
32672	5.76e-05	1.09e-03	-0.01	-5.40e-05	2.76e-06	0.0
32673	5.63e-05	1.06e-03	-0.01	-5.24e-05	2.66e-06	0.0
3272	1.64e-04	2.42e-03	-0.02	-1.19e-04	8.14e-06	0.0
32714	2.02e-03	1.12e-03	-0.01	-6.98e-05	7.24e-06	0.0
32731	-3.56e-04	3.60e-03	-0.01	-8.64e-05	3.07e-06	0.0
32736	-5.10e-04	-5.35e-04	-0.02	-6.48e-05	6.24e-06	0.0
32746	2.78e-03	9.57e-04	-0.01	-6.78e-05	8.09e-06	0.0
32763	-5.40e-04	4.43e-03	-0.01	-9.09e-05	2.26e-06	0.0
32768	-7.56e-04	-1.36e-03	-0.02	-6.07e-05	6.70e-06	0.0
32770	1.20e-04	1.76e-03	-0.02	-8.66e-05	6.09e-06	0.0
32772	1.08e-04	1.56e-03	-0.01	-7.73e-05	5.31e-06	0.0
32773	1.04e-04	1.51e-03	-0.01	-7.49e-05	5.11e-06	0.0
3282	3.01e-04	3.17e-03	-0.03	-1.55e-04	1.57e-05	0.0
32814	2.19e-03	1.50e-03	-0.02	-8.75e-05	1.37e-05	0.0
32831	-2.67e-04	4.34e-03	-0.02	-1.23e-04	7.23e-06	0.0
32835	-3.20e-04	4.33e-03	-0.02	-1.23e-04	6.88e-06	0.0
32846	2.99e-03	1.32e-03	-0.02	-8.36e-05	1.52e-05	0.0
32863	-4.50e-04	5.29e-03	-0.02	-1.33e-04	6.21e-06	0.0
32867	-5.25e-04	5.28e-03	-0.02	-1.34e-04	5.71e-06	0.0
32870	2.24e-04	2.30e-03	-0.02	-1.13e-04	1.17e-05	0.0
32872	1.97e-04	2.04e-03	-0.02	-1.00e-04	1.02e-05	0.0
32873	1.91e-04	1.97e-03	-0.02	-9.72e-05	9.79e-06	0.0
3292	4.21e-04	3.97e-03	-0.04	-1.90e-04	2.49e-05	0.0
32914	2.31e-03	1.82e-03	-0.02	-1.01e-04	2.01e-05	0.0
32931	-1.77e-04	5.34e-03	-0.03	-1.66e-04	1.40e-05	0.0
32935	-2.38e-04	5.33e-03	-0.03	-1.67e-04	1.36e-05	0.0
32946	3.13e-03	1.57e-03	-0.02	-9.46e-05	2.18e-05	0.0
32963	-3.55e-04	6.49e-03	-0.03	-1.86e-04	1.34e-05	0.0
32967	-4.41e-04	6.49e-03	-0.03	-1.87e-04	1.28e-05	0.0
32970	3.13e-04	2.90e-03	-0.03	-1.39e-04	1.87e-05	0.0
32972	2.77e-04	2.54e-03	-0.02	-1.22e-04	1.62e-05	0.0
32973	2.69e-04	2.45e-03	-0.02	-1.18e-04	1.56e-05	0.0
3302	7.02e-04	4.01e-03	-0.04	-1.94e-04	3.69e-05	0.0
33013	2.42e-03	2.97e-03	-0.03	-1.26e-04	2.45e-05	0.0
33031	1.06e-04	5.47e-03	-0.03	-1.72e-04	2.91e-05	0.0
33035	4.88e-05	5.46e-03	-0.03	-1.73e-04	2.92e-05	0.0
33045	3.21e-03	3.18e-03	-0.03	-1.29e-04	2.52e-05	0.0
33063	-2.43e-05	6.68e-03	-0.03	-1.93e-04	3.17e-05	0.0
33067	-1.05e-04	6.67e-03	-0.03	-1.94e-04	3.18e-05	0.0
33070	5.23e-04	2.93e-03	-0.03	-1.41e-04	2.76e-05	0.0
33072	4.52e-04	2.56e-03	-0.03	-1.24e-04	2.36e-05	0.0
33073	4.34e-04	2.46e-03	-0.03	-1.19e-04	2.26e-05	0.0
3312	1.19e-03	-3.45e-03	-0.05	1.68e-04	6.37e-05	0.0
33110	2.65e-03	-2.41e-03	-0.03	1.04e-04	3.97e-05	0.0
33124	3.83e-04	-5.14e-03	-0.04	1.58e-04	5.74e-05	0.0
33142	3.41e-03	-2.52e-03	-0.03	1.04e-04	3.99e-05	0.0
33156	2.44e-04	-6.35e-03	-0.04	1.80e-04	6.47e-05	0.0
33170	8.92e-04	-2.51e-03	-0.04	1.22e-04	4.78e-05	0.0
33172	7.63e-04	-2.20e-03	-0.03	1.08e-04	4.09e-05	0.0
33173	7.31e-04	-2.13e-03	-0.03	1.04e-04	3.92e-05	0.0
3322	7.74e-05	-3.74e-03	-0.03	1.86e-04	2.82e-06	0.0
3325	2.40e-03	-1.92e-03	-0.02	1.09e-04	1.76e-05	0.0
33230	8.37e-04	-4.81e-03	-0.02	1.50e-04	7.98e-06	0.0
33232	-5.27e-04	-4.79e-03	-0.02	1.50e-04	-1.76e-06	0.0





EGP CODE

GRE.EEC.R.73.IT.W.15235.12.024.01

PAGE

131 di/of 527

33237	3.34e-03	-1.75e-03	-0.02	1.06e-04	2.40e-05	0.0
33262	1.15e-03	-5.81e-03	-0.02	1.65e-04	1.05e-05	0.0
33264	-7.57e-04	-5.78e-03	-0.02	1.64e-04	-3.13e-06	0.0
33270	5.59e-05	-2.73e-03	-0.02	1.35e-04	2.10e-06	0.0
33272	4.84e-05	-2.41e-03	-0.02	1.19e-04	1.74e-06	0.0
33273	4.66e-05	-2.32e-03	-0.02	1.15e-04	1.65e-06	0.0
3332	4.83e-05	-3.00e-03	-0.02	1.47e-04	2.05e-06	0.0
3335	2.06e-03	-1.52e-03	-0.02	8.86e-05	7.52e-06	0.0
33324	-7.72e-04	-3.17e-03	-0.02	1.05e-04	0.0	0.0
33330	7.00e-04	-4.09e-03	-0.02	1.11e-04	3.69e-06	0.0
33337	2.87e-03	-1.38e-03	-0.02	8.72e-05	1.00e-05	0.0
33356	-1.09e-03	-3.69e-03	-0.02	1.10e-04	-1.09e-06	0.0
33362	9.69e-04	-4.98e-03	-0.02	1.18e-04	4.68e-06	0.0
33370	3.44e-05	-2.19e-03	-0.02	1.07e-04	1.53e-06	0.0
33372	3.09e-05	-1.94e-03	-0.02	9.52e-05	1.28e-06	0.0
33373	3.00e-05	-1.87e-03	-0.02	9.22e-05	1.22e-06	0.0
3342	3.51e-05	-2.19e-03	-0.02	1.08e-04	1.65e-06	0.0
3345	1.95e-03	-1.07e-03	-0.01	6.62e-05	4.33e-06	0.0
33430	6.44e-04	-3.34e-03	-0.01	7.40e-05	2.32e-06	0.0
33431	-5.99e-04	5.96e-04	-0.01	6.12e-05	0.0	0.0
33437	2.71e-03	-9.48e-04	-0.01	6.57e-05	5.68e-06	0.0
33462	8.93e-04	-4.13e-03	-0.01	7.65e-05	2.86e-06	0.0
33463	-8.48e-04	1.39e-03	-0.01	5.86e-05	0.0	0.0
33470	2.46e-05	-1.59e-03	-0.01	7.81e-05	1.23e-06	0.0
33472	2.29e-05	-1.42e-03	-0.01	6.97e-05	1.04e-06	0.0
33473	2.25e-05	-1.37e-03	-0.01	6.76e-05	0.0	0.0
3351	2.56e-05	-1.24e-03	-0.01	6.09e-05	1.03e-06	0.0
3352	2.64e-05	-1.45e-03	-0.01	7.10e-05	1.29e-06	0.0
3355	1.86e-03	-6.38e-04	-0.01	4.51e-05	2.31e-06	0.0
33530	6.02e-04	-2.73e-03	-0.01	4.32e-05	1.47e-06	0.0
33531	-5.66e-04	9.06e-04	-0.01	4.64e-05	0.0	0.0
33537	2.60e-03	-5.28e-04	-0.01	4.52e-05	2.92e-06	0.0
33562	8.35e-04	-3.46e-03-9.81e-03		4.25e-05	1.74e-06	0.0
33563	-8.00e-04	1.63e-03	-0.01	4.70e-05	0.0	0.0
33569	1.76e-05	-9.11e-04	-0.01	4.48e-05	0.0	0.0
33570	1.81e-05	-1.05e-03	-0.01	5.15e-05	0.0	0.0
33571	1.76e-05	-9.11e-04	-0.01	4.48e-05	0.0	0.0
33572	1.77e-05	-9.39e-04	-0.01	4.61e-05	0.0	0.0
33573	1.76e-05	-9.11e-04	-0.01	4.48e-05	0.0	0.0
3361	2.17e-05	-6.74e-04	-0.01	3.31e-05	0.0	0.0
3362	2.10e-05	-7.87e-04	-0.01	3.84e-05	1.05e-06	0.0
3365	1.80e-03	-2.40e-04-9.09e-03		2.53e-05	1.35e-06	0.0
33630	5.68e-04	-2.22e-03-8.58e-03		1.86e-05	1.01e-06	0.0
33635	-5.24e-04	1.20e-03-9.54e-03		3.00e-05	0.0	0.0
33637	2.52e-03	-1.38e-04-9.11e-03		2.57e-05	1.63e-06	0.0
33662	7.90e-04	-2.91e-03-8.39e-03		1.63e-05	1.15e-06	0.0
33667	-7.40e-04	1.88e-03-9.74e-03		3.22e-05	0.0	0.0
33669	1.46e-05	-4.95e-04-9.06e-03		2.43e-05	0.0	0.0
33670	1.41e-05	-5.71e-04-8.80e-03		2.79e-05	0.0	0.0
33671	1.46e-05	-4.95e-04-9.06e-03		2.43e-05	0.0	0.0
33672	1.45e-05	-5.10e-04-9.01e-03		2.50e-05	0.0	0.0
33673	1.46e-05	-4.95e-04-9.06e-03		2.43e-05	0.0	0.0
3371	1.99e-05	-1.57e-04	-0.01	7.50e-06	0.0	0.0
3372	1.86e-05	-1.83e-04	-0.01	8.71e-06	0.0	0.0
3375	1.76e-03	1.32e-04-8.30e-03		6.88e-06	0.0	0.0
33730	5.41e-04	-1.80e-03-8.20e-03		-2.04e-06	0.0	0.0
33735	-5.10e-04	1.54e-03-8.46e-03		1.30e-05	0.0	0.0
33737	2.46e-03	2.32e-04-8.29e-03		7.43e-06	1.14e-06	0.0
33762	7.52e-04	-2.48e-03-8.14e-03		-5.06e-06	0.0	0.0
33767	-7.19e-04	2.21e-03-8.52e-03		1.61e-05	0.0	0.0
33769	1.32e-05	-1.15e-04-8.33e-03		5.50e-06	0.0	0.0
33770	1.23e-05	-1.33e-04-7.96e-03		6.31e-06	0.0	0.0
33771	1.32e-05	-1.15e-04-8.33e-03		5.50e-06	0.0	0.0
33772	1.30e-05	-1.19e-04-8.26e-03		5.66e-06	0.0	0.0
33773	1.32e-05	-1.15e-04-8.33e-03		5.50e-06	0.0	0.0
3381	2.01e-05	3.48e-04	-0.01	-1.75e-05	0.0	0.0
3382	1.88e-05	4.06e-04	-0.01	-2.03e-05	0.0	0.0
33814	1.77e-03	6.75e-06-8.50e-03		-1.41e-05	1.09e-06	0.0
33833	5.50e-04	1.95e-03-8.23e-03		-5.78e-06	0.0	0.0
33836	-5.24e-04	-1.44e-03-8.79e-03		-1.99e-05	0.0	0.0
33846	2.47e-03	-9.33e-05-8.50e-03		-1.46e-05	1.29e-06	0.0
33865	7.66e-04	2.63e-03-8.11e-03		-2.95e-06	0.0	0.0
33868	-7.39e-04	-2.12e-03-8.91e-03		-2.27e-05	0.0	0.0
33869	1.33e-05	2.56e-04-8.51e-03		-1.28e-05	0.0	0.0
33870	1.24e-05	2.95e-04-8.17e-03		-1.47e-05	0.0	0.0
33871	1.33e-05	2.56e-04-8.51e-03		-1.28e-05	0.0	0.0



EGP CODE

GRE.EEC.R.73.IT.W.15235.12.024.01

PAGE

132 di/of 527

33872	1.31e-05	2.64e-04-8.44e-03	-1.32e-05	0.0	0.0
33873	1.33e-05	2.56e-04-8.51e-03	-1.28e-05	0.0	0.0
3391	2.21e-05	8.81e-04 -0.01	-4.39e-05	0.0	0.0
3392	2.15e-05	1.03e-03 -0.01	-5.10e-05	1.09e-06	0.0
33914	1.82e-03	3.87e-04-9.67e-03	-3.29e-05	1.52e-06	0.0
33933	5.79e-04	2.40e-03-9.03e-03	-2.80e-05	1.09e-06	0.0
33936	-5.49e-04	-1.11e-03 -0.01	-3.64e-05	0.0	0.0
33946	2.54e-03	2.82e-04-9.68e-03	-3.32e-05	1.86e-06	0.0
33965	8.05e-04	3.11e-03-8.80e-03	-2.63e-05	1.25e-06	0.0
33968	-7.75e-04	-1.81e-03 -0.01	-3.81e-05	0.0	0.0
33969	1.48e-05	6.48e-04-9.62e-03	-3.22e-05	0.0	0.0
33970	1.45e-05	7.47e-04-9.44e-03	-3.70e-05	0.0	0.0
33971	1.48e-05	6.48e-04-9.62e-03	-3.22e-05	0.0	0.0
33972	1.48e-05	6.67e-04-9.58e-03	-3.32e-05	0.0	0.0
33973	1.48e-05	6.48e-04-9.62e-03	-3.22e-05	0.0	0.0
3402	2.69e-05	1.72e-03 -0.02	-8.52e-05	1.34e-06	0.0
34014	1.88e-03	7.99e-04 -0.01	-5.32e-05	2.69e-06	0.0
34033	6.14e-04	2.95e-03 -0.01	-5.55e-05	1.58e-06	0.0
34036	-5.78e-04	-7.88e-04 -0.01	-5.18e-05	0.0	0.0
34046	2.62e-03	6.85e-04 -0.01	-5.30e-05	3.44e-06	0.0
34065	8.52e-04	3.70e-03 -0.01	-5.63e-05	1.88e-06	0.0
34068	-8.16e-04	-1.54e-03 -0.01	-5.10e-05	0.0	0.0
34070	1.85e-05	1.25e-03 -0.01	-6.18e-05	1.01e-06	0.0
34072	1.80e-05	1.12e-03 -0.01	-5.53e-05	0.0	0.0
34073	1.78e-05	1.08e-03 -0.01	-5.37e-05	0.0	0.0
3412	3.51e-05	2.50e-03 -0.02	-1.23e-04	1.68e-06	0.0
34114	1.98e-03	1.24e-03 -0.02	-7.53e-05	5.28e-06	0.0
34133	6.58e-04	3.62e-03 -0.01	-8.79e-05	2.61e-06	0.0
34136	-6.13e-04	-4.89e-04 -0.02	-6.68e-05	0.0	0.0
34146	2.76e-03	1.12e-03 -0.02	-7.44e-05	7.00e-06	0.0
34165	9.13e-04	4.44e-03 -0.01	-9.21e-05	3.25e-06	0.0
34168	-8.68e-04	-1.31e-03 -0.02	-6.26e-05	-1.23e-06	0.0
34170	2.46e-05	1.82e-03 -0.02	-8.96e-05	1.26e-06	0.0
34172	2.29e-05	1.61e-03 -0.02	-7.98e-05	1.06e-06	0.0
34173	2.24e-05	1.56e-03 -0.02	-7.74e-05	1.01e-06	0.0
3422	4.62e-05	3.31e-03 -0.03	-1.63e-04	2.00e-06	0.0
34214	2.09e-03	1.69e-03 -0.02	-9.73e-05	8.16e-06	0.0
34233	7.13e-04	4.40e-03 -0.02	-1.27e-04	3.96e-06	0.0
34235	-4.82e-04	4.37e-03 -0.02	-1.27e-04	0.0	0.0
34246	2.91e-03	1.54e-03 -0.02	-9.55e-05	1.10e-05	0.0
34265	9.87e-04	5.34e-03 -0.02	-1.37e-04	5.07e-06	0.0
34267	-6.87e-04	5.30e-03 -0.02	-1.37e-04	0.0	0.0
34270	3.28e-05	2.41e-03 -0.02	-1.19e-04	1.50e-06	0.0
34272	2.95e-05	2.13e-03 -0.02	-1.05e-04	1.25e-06	0.0
34273	2.87e-05	2.06e-03 -0.02	-1.02e-04	1.18e-06	0.0
3432	5.94e-05	3.99e-03 -0.04	-2.00e-04	2.37e-06	0.0
34314	2.57e-03	2.02e-03 -0.02	-1.15e-04	2.60e-05	0.0
34333	8.80e-04	5.17e-03 -0.03	-1.72e-04	1.05e-05	0.0
34335	-5.95e-04	5.14e-03 -0.03	-1.72e-04	-4.46e-06	0.0
34346	3.59e-03	1.84e-03 -0.02	-1.11e-04	3.59e-05	0.0
34365	1.22e-03	6.25e-03 -0.03	-1.92e-04	1.41e-05	0.0
34367	-8.48e-04	6.22e-03 -0.03	-1.91e-04	-6.81e-06	0.0
34370	4.24e-05	2.91e-03 -0.03	-1.46e-04	1.76e-06	0.0
34372	3.73e-05	2.56e-03 -0.03	-1.28e-04	1.46e-06	0.0
34373	3.61e-05	2.47e-03 -0.03	-1.24e-04	1.38e-06	0.0
3442	8.09e-04	-3.73e-03 -0.05	1.83e-04	4.56e-05	0.0
34410	3.04e-03	-2.88e-03 -0.03	1.20e-04	5.17e-05	0.0
34424	-1.54e-04	-5.39e-03 -0.04	1.75e-04	3.10e-05	0.0
34426	1.17e-03	-5.45e-03 -0.04	1.73e-04	4.18e-05	0.0
34442	4.06e-03	-3.12e-03 -0.03	1.23e-04	6.11e-05	0.0
34456	-4.16e-04	-6.63e-03 -0.05	2.00e-04	3.22e-05	0.0
34458	1.43e-03	-6.71e-03 -0.04	1.97e-04	4.72e-05	0.0
34470	6.09e-04	-2.72e-03 -0.04	1.33e-04	3.42e-05	0.0
34472	5.20e-04	-2.37e-03 -0.04	1.17e-04	2.94e-05	0.0
34473	4.98e-04	-2.29e-03 -0.03	1.13e-04	2.81e-05	0.0
3452	8.45e-05	-3.90e-03 -0.05	1.91e-04	5.83e-06	0.0
3459	2.69e-03	-1.63e-03 -0.03	1.05e-04	2.93e-05	0.0
34524	-9.31e-04	-5.63e-03 -0.04	1.81e-04	-7.14e-06	0.0
34541	3.74e-03	-1.33e-03 -0.03	9.94e-05	3.94e-05	0.0
34556	-1.33e-03	-6.92e-03 -0.05	2.07e-04	-1.17e-05	0.0
34570	6.91e-05	-2.85e-03 -0.04	1.39e-04	4.51e-06	0.0
34572	6.55e-05	-2.48e-03 -0.04	1.22e-04	4.22e-06	0.0
34573	6.46e-05	-2.39e-03 -0.04	1.17e-04	4.15e-06	0.0
3462	-3.88e-04	-3.81e-03 -0.05	1.86e-04	-1.82e-05	0.0
34612	-2.31e-03	-3.04e-03 -0.04	1.24e-04	-1.66e-05	0.0
34624	-1.12e-03	-5.52e-03 -0.04	1.71e-04	-2.11e-05	0.0



EGP CODE

GRE.EEC.R.73.IT.W.15235.12.024.01

PAGE

133 di/of 527

34628	-1.03e-03	-5.41e-03	-0.04	1.72e-04	-2.08e-05	0.0
34644	-3.15e-03	-3.31e-03	-0.04	1.27e-04	-1.90e-05	0.0
34656	-1.48e-03	-6.79e-03	-0.04	1.94e-04	-2.52e-05	0.0
34660	-1.35e-03	-6.64e-03	-0.04	1.95e-04	-2.48e-05	0.0
34670	-2.85e-04	-2.78e-03	-0.04	1.36e-04	-1.35e-05	0.0
34672	-2.42e-04	-2.43e-03	-0.04	1.19e-04	-1.13e-05	0.0
34673	-2.32e-04	-2.35e-03	-0.04	1.15e-04	-1.08e-05	0.0
3472	-2.25e-04	-3.64e-03	-0.05	1.78e-04	-9.70e-06	0.0
34712	-2.02e-03	-2.92e-03	-0.04	1.19e-04	-1.90e-06	0.0
34726	1.21e-04	-5.26e-03	-0.04	1.60e-04	-1.21e-05	0.0
34728	-8.03e-04	-5.13e-03	-0.04	1.59e-04	-1.05e-05	0.0
34744	-2.78e-03	-3.18e-03	-0.04	1.22e-04	0.0	0.0
34758	2.22e-04	-6.47e-03	-0.04	1.80e-04	-1.47e-05	0.0
34760	-1.07e-03	-6.29e-03	-0.04	1.79e-04	-1.24e-05	0.0
34770	-1.62e-04	-2.65e-03	-0.04	1.30e-04	-7.10e-06	0.0
34772	-1.39e-04	-2.33e-03	-0.04	1.15e-04	-5.92e-06	0.0
34773	-1.34e-04	-2.25e-03	-0.03	1.11e-04	-5.62e-06	0.0
3482	7.58e-05	-3.63e-03	-0.05	1.78e-04	5.72e-06	0.0
3484	7.90e-05	-2.74e-03	-0.04	1.34e-04	4.99e-06	0.0
34810	1.96e-03	-2.48e-03	-0.04	1.18e-04	0.0	0.0
34824	-5.69e-04	-5.29e-03	-0.04	1.60e-04	8.62e-06	0.0
34826	4.38e-04	-5.29e-03	-0.04	1.59e-04	6.54e-06	0.0
34842	2.72e-03	-2.57e-03	-0.04	1.20e-04	-1.31e-06	0.0
34856	-8.16e-04	-6.50e-03	-0.04	1.80e-04	1.06e-05	0.0
34858	5.93e-04	-6.51e-03	-0.04	1.79e-04	7.67e-06	0.0
34870	6.29e-05	-2.65e-03	-0.04	1.30e-04	4.44e-06	0.0
34872	5.14e-05	-2.32e-03	-0.04	1.14e-04	3.88e-06	0.0
34873	4.85e-05	-2.24e-03	-0.03	1.10e-04	3.74e-06	0.0
3492	9.72e-05	-3.59e-03	-0.05	1.79e-04	6.57e-06	0.0
3494	9.79e-05	-2.72e-03	-0.04	1.35e-04	5.66e-06	0.0
34910	2.34e-03	-2.89e-03	-0.04	1.23e-04	1.62e-05	0.0
34924	-6.63e-04	-5.18e-03	-0.04	1.64e-04	3.73e-06	0.0
34926	5.25e-04	-5.35e-03	-0.04	1.66e-04	9.57e-06	0.0
34942	3.26e-03	-3.16e-03	-0.04	1.28e-04	2.10e-05	0.0
34956	-9.51e-04	-6.37e-03	-0.04	1.86e-04	3.60e-06	0.0
34958	7.14e-04	-6.61e-03	-0.04	1.88e-04	1.18e-05	0.0
34970	7.75e-05	-2.62e-03	-0.04	1.31e-04	5.02e-06	0.0
34972	5.84e-05	-2.30e-03	-0.04	1.15e-04	4.23e-06	0.0
34973	5.36e-05	-2.22e-03	-0.03	1.11e-04	4.04e-06	0.0
3502	1.94e-03	-3.17e-03	-0.05	1.53e-04	1.04e-04	0.0
35010	4.77e-03	-3.11e-03	-0.04	1.18e-04	1.33e-04	0.0
35022	2.48e-03	-5.48e-03	-0.04	1.62e-04	1.05e-04	0.0
35026	2.22e-03	-5.58e-03	-0.04	1.63e-04	9.93e-05	0.0
35042	6.17e-03	-3.54e-03	-0.04	1.27e-04	1.60e-04	0.0
35054	2.97e-03	-6.89e-03	-0.05	1.89e-04	1.20e-04	0.0
35058	2.61e-03	-7.02e-03	-0.05	1.90e-04	1.12e-04	0.0
35070	1.44e-03	-2.34e-03	-0.04	1.13e-04	7.70e-05	0.0
35072	1.29e-03	-2.05e-03	-0.04	9.89e-05	6.90e-05	0.0
35073	1.25e-03	-1.97e-03	-0.04	9.54e-05	6.71e-05	0.0
3512	-1.25e-03	-3.46e-03	-0.05	1.71e-04	-6.21e-05	0.0
35112	-3.25e-03	-3.03e-03	-0.03	1.12e-04	-5.81e-05	0.0
35122	-4.65e-04	-5.02e-03	-0.04	1.60e-04	-4.54e-05	0.0
35124	-1.88e-03	-5.27e-03	-0.04	1.58e-04	-5.60e-05	0.0
35144	-4.25e-03	-3.39e-03	-0.03	1.15e-04	-6.62e-05	0.0
35154	-3.45e-04	-6.17e-03	-0.04	1.81e-04	-4.84e-05	0.0
35156	-2.32e-03	-6.53e-03	-0.04	1.79e-04	-6.31e-05	0.0
35170	-9.27e-04	-2.52e-03	-0.04	1.25e-04	-4.64e-05	0.0
35172	-7.97e-04	-2.21e-03	-0.03	1.10e-04	-3.97e-05	0.0
35173	-7.64e-04	-2.14e-03	-0.03	1.06e-04	-3.81e-05	0.0
3522	-1.42e-03	-3.14e-03	-0.05	1.53e-04	-7.14e-05	0.0
35212	-2.88e-03	-2.06e-03	-0.03	9.59e-05	-4.42e-05	0.0
35222	-7.13e-04	-4.91e-03	-0.04	1.40e-04	-5.95e-05	0.0
35226	-8.12e-04	-4.94e-03	-0.04	1.40e-04	-5.91e-05	0.0
35244	-3.68e-03	-2.11e-03	-0.03	9.59e-05	-4.44e-05	0.0
35254	-6.50e-04	-6.10e-03	-0.04	1.58e-04	-6.59e-05	0.0
35258	-7.90e-04	-6.14e-03	-0.04	1.58e-04	-6.53e-05	0.0
35270	-1.06e-03	-2.29e-03	-0.03	1.12e-04	-5.35e-05	0.0
35272	-9.06e-04	-2.02e-03	-0.03	9.89e-05	-4.56e-05	0.0
35273	-8.69e-04	-1.95e-03	-0.03	9.57e-05	-4.37e-05	0.0
3532	-9.92e-04	-2.69e-03	-0.04	1.33e-04	-4.94e-05	0.0
35312	-2.48e-03	-1.73e-03	-0.03	8.26e-05	-2.32e-05	0.0
35322	-3.65e-04	-4.45e-03	-0.03	1.18e-04	-4.19e-05	0.0
35326	-4.51e-04	-4.48e-03	-0.03	1.18e-04	-4.07e-05	0.0
35344	-3.23e-03	-1.75e-03	-0.03	8.24e-05	-2.07e-05	0.0
35354	-2.70e-04	-5.55e-03	-0.04	1.33e-04	-4.67e-05	0.0
35358	-3.92e-04	-5.60e-03	-0.03	1.32e-04	-4.50e-05	0.0



EGP CODE

GRE.EEC.R.73.IT.W.15235.12.024.01

PAGE

134 di/of 527

35370	-7.41e-04	-1.95e-03	-0.03	9.66e-05	-3.71e-05	0.0
35372	-6.29e-04	-1.73e-03	-0.03	8.59e-05	-3.12e-05	0.0
35373	-6.01e-04	-1.68e-03	-0.03	8.33e-05	-2.98e-05	0.0
3542	-2.95e-04	-2.41e-03	-0.04	1.20e-04	-1.31e-05	0.0
35412	-2.05e-03	-2.34e-03	-0.03	7.60e-05	0.0	0.0
35422	2.26e-04	-3.97e-03	-0.03	1.07e-04	-6.31e-06	0.0
35426	1.39e-04	-4.25e-03	-0.03	1.07e-04	-5.02e-06	0.0
35444	-2.81e-03	-2.66e-03	-0.03	7.63e-05	2.72e-06	0.0
35454	3.82e-04	-4.96e-03	-0.03	1.19e-04	-6.05e-06	0.0
35458	2.59e-04	-5.35e-03	-0.03	1.20e-04	-4.23e-06	0.0
35470	-2.23e-04	-1.75e-03	-0.03	8.71e-05	-1.01e-05	0.0
35472	-1.74e-04	-1.56e-03	-0.03	7.78e-05	-7.58e-06	0.0
35473	-1.62e-04	-1.51e-03	-0.03	7.55e-05	-6.94e-06	0.0
3552	5.06e-04	-2.34e-03	-0.04	1.17e-04	2.87e-05	0.0
35510	2.37e-03	-1.38e-03	-0.03	8.24e-05	1.75e-05	0.0
35526	7.77e-04	-4.27e-03	-0.03	1.06e-04	2.71e-05	0.0
35542	3.18e-03	-1.34e-03	-0.03	8.58e-05	1.69e-05	0.0
35558	9.50e-04	-5.39e-03	-0.03	1.19e-04	3.03e-05	0.0
35570	3.73e-04	-1.70e-03	-0.03	8.47e-05	2.09e-05	0.0
35572	3.50e-04	-1.52e-03	-0.03	7.57e-05	1.96e-05	0.0
35573	3.44e-04	-1.47e-03	-0.03	7.34e-05	1.93e-05	0.0
3562	1.28e-03	-2.48e-03	-0.04	1.22e-04	6.91e-05	0.0
35610	3.12e-03	-1.42e-03	-0.03	8.84e-05	5.92e-05	0.0
35626	1.53e-03	-4.53e-03	-0.03	1.17e-04	6.51e-05	0.0
35642	4.04e-03	-1.36e-03	-0.03	9.26e-05	6.48e-05	0.0
35658	1.81e-03	-5.72e-03	-0.04	1.33e-04	7.32e-05	0.0
35670	9.48e-04	-1.81e-03	-0.03	8.95e-05	5.10e-05	0.0
35672	8.56e-04	-1.61e-03	-0.03	7.96e-05	4.61e-05	0.0
35673	8.33e-04	-1.56e-03	-0.03	7.71e-05	4.48e-05	0.0
3572	-5.33e-04	-4.18e-03	-0.04	2.00e-04	-2.76e-05	0.0
3578	-2.42e-03	-3.15e-03	-0.03	1.34e-04	-2.81e-05	0.0
35730	3.25e-04	-5.65e-03	-0.03	1.83e-04	-1.91e-05	0.0
35736	-8.08e-04	-5.67e-03	-0.03	1.82e-04	-2.40e-05	0.0
35740	-3.26e-03	-3.39e-03	-0.03	1.38e-04	-3.25e-05	0.0
35762	5.87e-04	-6.90e-03	-0.03	2.07e-04	-1.99e-05	0.0
35768	-9.99e-04	-6.93e-03	-0.03	2.06e-04	-2.67e-05	0.0
35770	-4.00e-04	-3.05e-03	-0.03	1.46e-04	-2.06e-05	0.0
35772	-3.44e-04	-2.65e-03	-0.03	1.28e-04	-1.78e-05	0.0
35773	-3.29e-04	-2.56e-03	-0.03	1.23e-04	-1.71e-05	0.0
3582	2.31e-05	-3.87e-03	-0.03	1.87e-04	-5.12e-06	0.0
3586	2.17e-03	-3.02e-03	-0.02	1.29e-04	7.97e-06	0.0
35830	8.87e-04	-5.09e-03	-0.02	1.57e-04	5.36e-06	0.0
35838	3.04e-03	-3.27e-03	-0.02	1.34e-04	1.26e-05	0.0
35862	1.24e-03	-6.17e-03	-0.02	1.74e-04	8.98e-06	0.0
35870	1.49e-05	-2.82e-03	-0.02	1.36e-04	-3.87e-06	0.0
35872	3.78e-06	-2.48e-03	-0.02	1.20e-04	-3.71e-06	0.0
35873	1.01e-06	-2.39e-03	-0.02	1.16e-04	-3.67e-06	0.0
3592	-7.04e-05	-2.96e-03	-0.02	1.45e-04	-4.53e-06	0.0
3597	-2.05e-03	-1.37e-03	-0.02	8.40e-05	-8.21e-06	0.0
35922	7.46e-04	-3.19e-03	-0.02	1.04e-04	0.0	0.0
35930	6.51e-04	-4.06e-03	-0.02	1.10e-04	0.0	0.0
35939	-2.85e-03	-1.19e-03	-0.02	8.13e-05	-1.03e-05	0.0
35954	1.06e-03	-3.72e-03	-0.02	1.10e-04	0.0	0.0
35962	9.30e-04	-4.95e-03	-0.02	1.18e-04	2.40e-06	0.0
35970	-5.45e-05	-2.15e-03	-0.02	1.05e-04	-3.40e-06	0.0
35972	-4.82e-05	-1.91e-03	-0.02	9.37e-05	-3.07e-06	0.0
35973	-4.66e-05	-1.85e-03	-0.02	9.08e-05	-2.98e-06	0.0
3602	-2.71e-05	-2.17e-03	-0.02	1.07e-04	-1.49e-06	0.0
3607	-1.92e-03	-9.54e-04	-0.01	6.38e-05	-4.07e-06	0.0
36029	4.55e-04	5.81e-04	-0.01	6.08e-05	-1.84e-06	0.0
36030	6.22e-04	-3.34e-03	-0.01	7.44e-05	1.47e-06	0.0
36039	-2.68e-03	-7.91e-04	-0.01	6.25e-05	-5.29e-06	0.0
36061	6.44e-04	1.36e-03	-0.01	5.82e-05	-2.17e-06	0.0
36062	8.78e-04	-4.13e-03	-0.01	7.73e-05	2.46e-06	0.0
36070	-2.20e-05	-1.58e-03	-0.01	7.75e-05	-1.12e-06	0.0
36072	-1.84e-05	-1.40e-03	-0.01	6.91e-05	-1.03e-06	0.0
36073	-1.76e-05	-1.36e-03	-0.01	6.71e-05	-1.01e-06	0.0
3611	0.0	-1.23e-03	-0.01	6.07e-05	0.0	0.0
3612	-3.06e-06	-1.44e-03	-0.01	7.08e-05	0.0	0.0
3614	-7.55e-06	-1.06e-03	-0.01	5.20e-05	0.0	0.0
3618	-1.84e-03	-1.18e-03	-0.01	4.35e-05	-1.27e-06	0.0
36129	4.86e-04	8.83e-04	-0.01	4.62e-05	0.0	0.0
36130	5.90e-04	-2.72e-03	-0.01	4.35e-05	1.11e-06	0.0
36140	-2.57e-03	-1.29e-03	-0.01	4.30e-05	-1.74e-06	0.0
36161	6.81e-04	1.60e-03	-0.01	4.69e-05	0.0	0.0
36162	8.27e-04	-3.45e-03	-9.88e-03	4.31e-05	1.61e-06	0.0



EGP CODE

GRE.EEC.R.73.IT.W.15235.12.024.01

PAGE

135 di/of 527

36169	-1.51e-06	-9.06e-04	-0.01	4.46e-05	0.0	0.0
36170	-3.89e-06	-1.05e-03	-0.01	5.13e-05	0.0	0.0
36171	-1.51e-06	-9.06e-04	-0.01	4.46e-05	0.0	0.0
36172	-1.99e-06	-9.34e-04	-0.01	4.59e-05	0.0	0.0
36173	-1.51e-06	-9.06e-04	-0.01	4.46e-05	0.0	0.0
3621	8.94e-06	-6.71e-04	-0.01	3.30e-05	0.0	0.0
3622	6.36e-06	-7.85e-04	-0.01	3.84e-05	0.0	0.0
3625	1.79e-03	-2.31e-04-9.14e-03		2.56e-05	0.0	0.0
36230	5.61e-04	-2.21e-03-8.61e-03		1.88e-05	0.0	0.0
36235	-5.37e-04	1.22e-03-9.55e-03		2.97e-05	0.0	0.0
36237	2.50e-03	-1.26e-04-9.16e-03		2.61e-05	1.01e-06	0.0
36262	7.84e-04	-2.90e-03-8.43e-03		1.66e-05	1.04e-06	0.0
36267	-7.54e-04	1.91e-03-9.73e-03		3.19e-05	0.0	0.0
36269	4.94e-06	-4.94e-04-9.08e-03		2.42e-05	0.0	0.0
36270	3.22e-06	-5.69e-04-8.82e-03		2.78e-05	0.0	0.0
36271	4.94e-06	-4.94e-04-9.08e-03		2.42e-05	0.0	0.0
36272	4.60e-06	-5.09e-04-9.03e-03		2.50e-05	0.0	0.0
36273	4.94e-06	-4.94e-04-9.08e-03		2.42e-05	0.0	0.0
3631	1.13e-05	-1.56e-04	-0.01	7.51e-06	0.0	0.0
3632	8.82e-06	-1.83e-04	-0.01	8.72e-06	0.0	0.0
3635	1.75e-03	1.43e-04-8.33e-03		6.99e-06	0.0	0.0
36330	5.34e-04	-1.79e-03-8.22e-03		-1.90e-06	0.0	0.0
36335	-5.17e-04	1.54e-03-8.47e-03		1.29e-05	0.0	0.0
36337	2.45e-03	2.47e-04-8.33e-03		7.58e-06	0.0	0.0
36362	7.46e-04	-2.47e-03-8.17e-03		-4.87e-06	0.0	0.0
36367	-7.26e-04	2.21e-03-8.52e-03		1.59e-05	0.0	0.0
36369	6.73e-06	-1.15e-04-8.35e-03		5.51e-06	0.0	0.0
36370	5.09e-06	-1.32e-04-7.98e-03		6.31e-06	0.0	0.0
36371	6.73e-06	-1.15e-04-8.35e-03		5.51e-06	0.0	0.0
36372	6.40e-06	-1.18e-04-8.27e-03		5.67e-06	0.0	0.0
36373	6.73e-06	-1.15e-04-8.35e-03		5.51e-06	0.0	0.0
3641	1.01e-05	3.47e-04	-0.01	-1.75e-05	0.0	0.0
3642	7.39e-06	4.06e-04	-0.01	-2.03e-05	0.0	0.0
36414	1.76e-03	-3.33e-06-8.54e-03		-1.42e-05	0.0	0.0
36432	-5.26e-04	-1.41e-03-8.80e-03		-1.98e-05	0.0	0.0
36433	5.43e-04	1.94e-03-8.25e-03		-5.90e-06	0.0	0.0
36446	2.46e-03	-1.07e-04-8.55e-03		-1.48e-05	0.0	0.0
36464	-7.39e-04	-2.08e-03-8.91e-03		-2.25e-05	0.0	0.0
36465	7.58e-04	2.62e-03-8.14e-03		-3.13e-06	0.0	0.0
36469	5.81e-06	2.55e-04-8.53e-03		-1.28e-05	0.0	0.0
36470	4.01e-06	2.94e-04-8.19e-03		-1.47e-05	0.0	0.0
36471	5.81e-06	2.55e-04-8.53e-03		-1.28e-05	0.0	0.0
36472	5.45e-06	2.63e-04-8.46e-03		-1.32e-05	0.0	0.0
36473	5.81e-06	2.55e-04-8.53e-03		-1.28e-05	0.0	0.0
3651	4.46e-06	8.77e-04	-0.01	-4.37e-05	0.0	0.0
3652	0.0	1.03e-03	-0.01	-5.09e-05	0.0	0.0
3654	-4.52e-06	7.55e-04-9.35e-03		-3.73e-05	0.0	0.0
36514	1.80e-03	3.79e-04-9.71e-03		-3.32e-05	0.0	0.0
36532	-5.50e-04	-1.10e-03	-0.01	-3.61e-05	0.0	0.0
36533	5.68e-04	2.40e-03-9.07e-03		-2.82e-05	0.0	0.0
36546	2.52e-03	2.72e-04-9.74e-03		-3.37e-05	1.01e-06	0.0
36564	-7.71e-04	-1.80e-03	-0.01	-3.77e-05	0.0	0.0
36565	7.95e-04	3.10e-03-8.84e-03		-2.66e-05	1.01e-06	0.0
36569	1.50e-06	6.45e-04-9.63e-03		-3.21e-05	0.0	0.0
36570	0.0	7.44e-04-9.46e-03		-3.69e-05	0.0	0.0
36571	1.50e-06	6.45e-04-9.63e-03		-3.21e-05	0.0	0.0
36572	1.03e-06	6.65e-04-9.60e-03		-3.31e-05	0.0	0.0
36573	1.50e-06	6.45e-04-9.63e-03		-3.21e-05	0.0	0.0
3662	-1.63e-05	1.71e-03	-0.02	-8.48e-05	0.0	0.0
3664	-1.82e-05	1.27e-03	-0.01	-6.23e-05	0.0	0.0
36615	-1.86e-03	1.36e-03	-0.01	-5.29e-05	-1.97e-06	0.0
36633	5.94e-04	2.95e-03	-0.01	-5.57e-05	0.0	0.0
36634	4.73e-04	-7.67e-04	-0.01	-5.16e-05	0.0	0.0
36647	-2.60e-03	1.47e-03	-0.01	-5.28e-05	-2.56e-06	0.0
36665	8.36e-04	3.70e-03	-0.01	-5.67e-05	1.48e-06	0.0
36666	6.66e-04	-1.51e-03	-0.01	-5.09e-05	-1.12e-06	0.0
36670	-1.38e-05	1.24e-03	-0.01	-6.15e-05	0.0	0.0
36672	-1.06e-05	1.11e-03	-0.01	-5.50e-05	0.0	0.0
36673	-9.86e-06	1.08e-03	-0.01	-5.34e-05	0.0	0.0
3672	-5.68e-05	2.47e-03	-0.02	-1.22e-04	-2.93e-06	0.0
36716	-1.96e-03	1.11e-03	-0.01	-7.20e-05	-5.59e-06	0.0
36733	6.19e-04	3.61e-03	-0.01	-8.81e-05	0.0	0.0
36734	4.32e-04	-4.77e-04	-0.02	-6.62e-05	-2.78e-06	0.0
36748	-2.74e-03	9.37e-04	-0.01	-7.02e-05	-7.06e-06	0.0
36765	8.81e-04	4.44e-03	-0.01	-9.28e-05	2.10e-06	0.0
36766	6.20e-04	-1.29e-03	-0.02	-6.20e-05	-3.13e-06	0.0





EGP CODE

GRE.EEC.R.73.IT.W.15235.12.024.01

PAGE

136 di/of 527

36770	-4.43e-05	1.80e-03	-0.02	-8.86e-05	-2.20e-06	0.0
36772	-3.78e-05	1.60e-03	-0.02	-7.89e-05	-1.97e-06	0.0
36773	-3.62e-05	1.55e-03	-0.01	-7.65e-05	-1.92e-06	0.0
3682	-1.36e-04	3.26e-03	-0.03	-1.60e-04	-7.72e-06	0.0
36816	-2.12e-03	1.52e-03	-0.02	-9.15e-05	-1.13e-05	0.0
36833	6.22e-04	4.38e-03	-0.02	-1.26e-04	0.0	0.0
36848	-2.94e-03	1.31e-03	-0.02	-8.81e-05	-1.39e-05	0.0
36865	9.07e-04	5.32e-03	-0.02	-1.36e-04	0.0	0.0
36870	-1.04e-04	2.37e-03	-0.02	-1.17e-04	-5.79e-06	0.0
36872	-9.06e-05	2.10e-03	-0.02	-1.03e-04	-5.13e-06	0.0
36873	-8.74e-05	2.03e-03	-0.02	-1.00e-04	-4.96e-06	0.0
3692	-1.32e-04	4.16e-03	-0.04	-1.99e-04	-1.22e-05	0.0
36916	-2.31e-03	1.85e-03	-0.02	-1.07e-04	-2.10e-05	0.0
36933	7.67e-04	5.53e-03	-0.03	-1.76e-04	0.0	0.0
36948	-3.19e-03	1.56e-03	-0.02	-1.00e-04	-2.62e-05	0.0
36965	1.11e-03	6.72e-03	-0.03	-1.97e-04	2.88e-06	0.0
36970	-1.01e-04	3.04e-03	-0.03	-1.45e-04	-9.18e-06	0.0
36972	-9.53e-05	2.66e-03	-0.03	-1.28e-04	-8.26e-06	0.0
36973	-9.39e-05	2.56e-03	-0.03	-1.23e-04	-8.04e-06	0.0
3702	-5.23e-04	4.20e-03	-0.04	-2.02e-04	-2.74e-05	0.0
37015	-2.46e-03	3.11e-03	-0.03	-1.34e-04	-2.84e-05	0.0
37033	3.39e-04	5.70e-03	-0.03	-1.84e-04	-1.82e-05	0.0
37047	-3.31e-03	3.33e-03	-0.03	-1.38e-04	-3.30e-05	0.0
37065	6.05e-04	6.96e-03	-0.03	-2.08e-04	-1.86e-05	0.0
37070	-3.93e-04	3.07e-03	-0.03	-1.47e-04	-2.05e-05	0.0
37072	-3.38e-04	2.67e-03	-0.03	-1.29e-04	-1.77e-05	0.0
37073	-3.24e-04	2.57e-03	-0.03	-1.24e-04	-1.70e-05	0.0
3712	-5.92e-04	-3.56e-03	-0.04	1.74e-04	-3.07e-05	0.0
3718	-2.26e-03	-2.66e-03	-0.03	1.13e-04	-1.86e-05	0.0
37130	2.22e-04	-4.93e-03	-0.03	1.53e-04	-2.50e-05	0.0
37140	-3.02e-03	-2.84e-03	-0.03	1.16e-04	-1.84e-05	0.0
37162	4.58e-04	-6.03e-03	-0.03	1.71e-04	-2.73e-05	0.0
37170	-4.45e-04	-2.59e-03	-0.03	1.27e-04	-2.30e-05	0.0
37172	-3.82e-04	-2.28e-03	-0.03	1.12e-04	-1.98e-05	0.0
37173	-3.66e-04	-2.20e-03	-0.03	1.08e-04	-1.90e-05	0.0
3722	-3.34e-04	-3.37e-03	-0.03	1.65e-04	-1.82e-05	0.0
3728	-2.09e-03	-2.47e-03	-0.02	1.05e-04	-9.37e-06	0.0
37230	4.44e-04	-4.62e-03	-0.02	1.38e-04	-1.07e-05	0.0
37240	-2.85e-03	-2.62e-03	-0.02	1.06e-04	-8.54e-06	0.0
37262	7.06e-04	-5.64e-03	-0.02	1.52e-04	-1.04e-05	0.0
37270	-2.52e-04	-2.45e-03	-0.02	1.20e-04	-1.36e-05	0.0
37272	-2.18e-04	-2.16e-03	-0.02	1.06e-04	-1.19e-05	0.0
37273	-2.10e-04	-2.09e-03	-0.02	1.03e-04	-1.14e-05	0.0
3732	-1.57e-04	-2.79e-03	-0.02	1.38e-04	-8.44e-06	0.0
3736	1.79e-03	-2.24e-03	-0.02	9.46e-05	-4.69e-06	0.0
3737	-1.99e-03	-1.25e-03	-0.02	7.79e-05	-6.13e-06	0.0
37330	5.82e-04	-3.99e-03	-0.02	1.07e-04	-2.31e-06	0.0
37338	2.54e-03	-2.44e-03	-0.02	9.79e-05	-4.41e-06	0.0
37339	-2.75e-03	-1.05e-03	-0.02	7.46e-05	-6.41e-06	0.0
37362	8.55e-04	-4.89e-03	-0.02	1.16e-04	-1.06e-06	0.0
37370	-1.19e-04	-2.03e-03	-0.02	1.00e-04	-6.33e-06	0.0
37372	-1.04e-04	-1.80e-03	-0.02	8.90e-05	-5.60e-06	0.0
37373	-1.00e-04	-1.74e-03	-0.02	8.63e-05	-5.41e-06	0.0
3742	-6.22e-05	-2.10e-03	-0.02	1.04e-04	-3.17e-06	0.0
3747	-1.89e-03	-8.95e-04	-0.01	6.06e-05	-2.88e-06	0.0
37429	4.06e-04	6.35e-04	-0.01	5.80e-05	-4.10e-06	0.0
37430	5.95e-04	-3.30e-03	-0.01	7.37e-05	0.0	0.0
37439	-2.63e-03	-7.26e-04	-0.01	5.89e-05	-3.19e-06	0.0
37461	5.85e-04	1.42e-03	-0.01	5.52e-05	-4.90e-06	0.0
37462	8.49e-04	-4.10e-03	-0.01	7.72e-05	1.06e-06	0.0
37470	-4.81e-05	-1.52e-03	-0.01	7.51e-05	-2.38e-06	0.0
37472	-4.16e-05	-1.36e-03	-0.01	6.71e-05	-2.15e-06	0.0
37473	-3.99e-05	-1.32e-03	-0.01	6.51e-05	-2.09e-06	0.0
3751	-1.29e-05	-1.20e-03	-0.01	5.96e-05	0.0	0.0
3752	-1.84e-05	-1.41e-03	-0.01	6.95e-05	0.0	0.0
3754	-1.93e-05	-1.04e-03	-0.01	5.10e-05	0.0	0.0
3757	-1.82e-03	-5.17e-04	-0.01	4.26e-05	-1.11e-06	0.0
37529	4.62e-04	9.05e-04	-0.01	4.51e-05	-1.62e-06	0.0
37530	5.79e-04	-2.70e-03	-0.01	4.33e-05	0.0	0.0
37539	-2.55e-03	-3.69e-04	-0.01	4.21e-05	-1.33e-06	0.0
37561	6.51e-04	1.62e-03	-0.01	4.57e-05	-2.04e-06	0.0
37562	8.15e-04	-3.43e-03	-9.95e-03	4.31e-05	1.14e-06	0.0
37569	-1.16e-05	-8.85e-04	-0.01	4.38e-05	0.0	0.0
37570	-1.53e-05	-1.02e-03	-0.01	5.04e-05	0.0	0.0
37571	-1.16e-05	-8.85e-04	-0.01	4.38e-05	0.0	0.0
37572	-1.23e-05	-9.13e-04	-0.01	4.51e-05	0.0	0.0



EGP CODE

GRE.EEC.R.73.IT.W.15235.12.024.01

PAGE

137 di/of 527

37573	-1.16e-05	-8.85e-04	-0.01	4.38e-05	0.0	0.0
3761	2.64e-06	-6.61e-04	-0.01	3.26e-05	0.0	0.0
3762	0.0	-7.73e-04	-0.01	3.80e-05	0.0	0.0
3764	-5.10e-06	-5.67e-04	-8.71e-03	2.78e-05	0.0	0.0
3765	1.77e-03	-2.12e-04	-9.15e-03	2.55e-05	0.0	0.0
37630	5.56e-04	-2.20e-03	-8.64e-03	1.90e-05	0.0	0.0
37635	-5.42e-04	1.23e-03	-9.52e-03	2.90e-05	0.0	0.0
37637	2.48e-03	-1.02e-04	-9.17e-03	2.61e-05	0.0	0.0
37662	7.78e-04	-2.89e-03	-8.47e-03	1.70e-05	0.0	0.0
37667	-7.59e-04	1.91e-03	-9.70e-03	3.10e-05	0.0	0.0
37669	0.0	-4.86e-04	-9.08e-03	2.39e-05	0.0	0.0
37670	-1.80e-06	-5.60e-04	-8.83e-03	2.75e-05	0.0	0.0
37671	0.0	-4.86e-04	-9.08e-03	2.39e-05	0.0	0.0
37672	0.0	-5.01e-04	-9.03e-03	2.47e-05	0.0	0.0
37673	0.0	-4.86e-04	-9.08e-03	2.39e-05	0.0	0.0
3771	7.39e-06	-1.54e-04	-0.01	7.46e-06	0.0	0.0
3772	4.83e-06	-1.80e-04	-0.01	8.66e-06	0.0	0.0
3775	1.74e-03	1.58e-04	-8.36e-03	7.01e-06	0.0	0.0
37730	5.30e-04	-1.78e-03	-8.25e-03	-1.66e-06	0.0	0.0
37735	-5.18e-04	1.54e-03	-8.47e-03	1.26e-05	0.0	0.0
37737	2.43e-03	2.67e-04	-8.36e-03	7.62e-06	0.0	0.0
37762	7.41e-04	-2.45e-03	-8.20e-03	-4.52e-06	0.0	0.0
37767	-7.27e-04	2.21e-03	-8.52e-03	1.55e-05	0.0	0.0
37769	3.92e-06	-1.13e-04	-8.36e-03	5.47e-06	0.0	0.0
37770	2.21e-06	-1.31e-04	-8.00e-03	6.27e-06	0.0	0.0
37771	3.92e-06	-1.13e-04	-8.36e-03	5.47e-06	0.0	0.0
37772	3.58e-06	-1.17e-04	-8.29e-03	5.63e-06	0.0	0.0
37773	3.92e-06	-1.13e-04	-8.36e-03	5.47e-06	0.0	0.0
3781	5.47e-06	3.43e-04	-0.01	-1.72e-05	0.0	0.0
3782	2.53e-06	4.00e-04	-0.01	-2.00e-05	0.0	0.0
37814	1.75e-03	-1.95e-05	-8.56e-03	-1.42e-05	0.0	0.0
37832	-5.28e-04	-1.43e-03	-8.80e-03	-1.93e-05	0.0	0.0
37833	5.38e-04	1.93e-03	-8.27e-03	-6.04e-06	0.0	0.0
37846	2.44e-03	-1.28e-04	-8.57e-03	-1.48e-05	0.0	0.0
37864	-7.40e-04	-2.10e-03	-8.91e-03	-2.20e-05	0.0	0.0
37865	7.52e-04	2.61e-03	-8.17e-03	-3.40e-06	0.0	0.0
37869	2.45e-06	2.52e-04	-8.54e-03	-1.26e-05	0.0	0.0
37870	0.0	2.90e-04	-8.20e-03	-1.45e-05	0.0	0.0
37871	2.45e-06	2.52e-04	-8.54e-03	-1.26e-05	0.0	0.0
37872	2.06e-06	2.59e-04	-8.47e-03	-1.30e-05	0.0	0.0
37873	2.45e-06	2.52e-04	-8.54e-03	-1.26e-05	0.0	0.0
3791	-4.34e-06	8.62e-04	-0.01	-4.31e-05	0.0	0.0
3792	-8.91e-06	1.01e-03	-0.01	-5.01e-05	0.0	0.0
3794	-1.19e-05	7.41e-04	-9.34e-03	-3.67e-05	0.0	0.0
37915	-1.79e-03	9.10e-04	-9.51e-03	-3.02e-05	0.0	0.0
37933	5.60e-04	2.38e-03	-9.09e-03	-2.82e-05	0.0	0.0
37934	4.82e-04	-1.09e-03	-0.01	-3.55e-05	0.0	0.0
37947	-2.50e-03	1.02e-03	-9.47e-03	-2.96e-05	0.0	0.0
37965	7.87e-04	3.08e-03	-8.88e-03	-2.69e-05	0.0	0.0
37966	6.76e-04	-1.79e-03	-0.01	-3.70e-05	0.0	0.0
37969	-5.06e-06	6.34e-04	-9.62e-03	-3.16e-05	0.0	0.0
37970	-8.10e-06	7.31e-04	-9.45e-03	-3.63e-05	0.0	0.0
37971	-5.06e-06	6.34e-04	-9.62e-03	-3.16e-05	0.0	0.0
37972	-5.67e-06	6.53e-04	-9.59e-03	-3.25e-05	0.0	0.0
37973	-5.06e-06	6.34e-04	-9.62e-03	-3.16e-05	0.0	0.0
3802	-3.80e-05	1.67e-03	-0.02	-8.28e-05	-1.75e-06	0.0
38016	-1.84e-03	6.59e-04	-0.01	-4.96e-05	-1.77e-06	0.0
38033	5.78e-04	2.92e-03	-0.01	-5.53e-05	0.0	0.0
38034	4.42e-04	-7.99e-04	-0.01	-4.99e-05	-2.37e-06	0.0
38048	-2.57e-03	5.04e-04	-0.01	-4.87e-05	-2.01e-06	0.0
38065	8.19e-04	3.68e-03	-0.01	-5.66e-05	0.0	0.0
38066	6.28e-04	-1.54e-03	-0.01	-4.91e-05	-2.86e-06	0.0
38070	-2.99e-05	1.21e-03	-0.01	-6.00e-05	-1.31e-06	0.0
38072	-2.51e-05	1.08e-03	-0.01	-5.37e-05	-1.19e-06	0.0
38073	-2.39e-05	1.05e-03	-0.01	-5.21e-05	-1.16e-06	0.0
3812	-1.03e-04	2.38e-03	-0.02	-1.18e-04	-5.08e-06	0.0
38116	-1.93e-03	1.03e-03	-0.01	-6.79e-05	-4.15e-06	0.0
38133	5.81e-04	3.57e-03	-0.01	-8.68e-05	0.0	0.0
38134	3.74e-04	-5.49e-04	-0.02	-6.26e-05	-5.52e-06	0.0
38148	-2.68e-03	8.51e-04	-0.01	-6.56e-05	-4.50e-06	0.0
38165	8.40e-04	4.40e-03	-0.01	-9.20e-05	0.0	0.0
38166	5.49e-04	-1.36e-03	-0.02	-5.81e-05	-6.42e-06	0.0
38170	-7.85e-05	1.72e-03	-0.02	-8.53e-05	-3.81e-06	0.0
38172	-6.80e-05	1.53e-03	-0.01	-7.60e-05	-3.39e-06	0.0
38173	-6.54e-05	1.48e-03	-0.01	-7.37e-05	-3.29e-06	0.0
3822	-2.33e-04	3.05e-03	-0.03	-1.50e-04	-1.19e-05	0.0



EGP CODE

GRE.EEC.R.73.IT.W.15235.12.024.01

PAGE

138 di/of 527

38216	-2.04e-03	1.36e-03	-0.02	-8.38e-05	-7.94e-06	0.0
38233	5.30e-04	4.27e-03	-0.02	-1.21e-04	-4.86e-06	0.0
38248	-2.80e-03	1.14e-03	-0.02	-7.97e-05	-8.11e-06	0.0
38265	8.01e-04	5.23e-03	-0.02	-1.32e-04	-3.76e-06	0.0
38270	-1.76e-04	2.21e-03	-0.02	-1.09e-04	-8.95e-06	0.0
38272	-1.53e-04	1.96e-03	-0.02	-9.70e-05	-7.86e-06	0.0
38273	-1.47e-04	1.90e-03	-0.02	-9.40e-05	-7.59e-06	0.0
3832	-4.39e-04	3.52e-03	-0.04	-1.73e-04	-2.32e-05	0.0
38315	-2.16e-03	2.57e-03	-0.02	-1.11e-04	-1.30e-05	0.0
38333	3.40e-04	4.83e-03	-0.03	-1.48e-04	-1.69e-05	0.0
38347	-2.92e-03	2.72e-03	-0.02	-1.12e-04	-1.24e-05	0.0
38365	5.86e-04	5.89e-03	-0.03	-1.64e-04	-1.79e-05	0.0
38370	-3.30e-04	2.56e-03	-0.03	-1.26e-04	-1.74e-05	0.0
38372	-2.85e-04	2.26e-03	-0.02	-1.11e-04	-1.51e-05	0.0
38373	-2.74e-04	2.18e-03	-0.02	-1.08e-04	-1.45e-05	0.0
3842	-5.90e-04	3.60e-03	-0.04	-1.76e-04	-3.08e-05	0.0
38415	-2.28e-03	2.65e-03	-0.03	-1.14e-04	-1.86e-05	0.0
38433	2.27e-04	4.99e-03	-0.03	-1.55e-04	-2.49e-05	0.0
38447	-3.05e-03	2.82e-03	-0.03	-1.16e-04	-1.84e-05	0.0
38465	4.65e-04	6.09e-03	-0.03	-1.73e-04	-2.73e-05	0.0
38470	-4.44e-04	2.62e-03	-0.03	-1.28e-04	-2.30e-05	0.0
38472	-3.81e-04	2.30e-03	-0.03	-1.13e-04	-1.99e-05	0.0
38473	-3.65e-04	2.22e-03	-0.03	-1.09e-04	-1.91e-05	0.0
3852	-2.72e-04	-3.32e-03	-0.04	1.64e-04	-1.40e-05	0.0
3858	-1.91e-03	-2.50e-03	-0.03	1.07e-04	-1.47e-06	0.0
38530	3.73e-04	-4.67e-03	-0.03	1.41e-04	-1.45e-05	0.0
38540	-2.61e-03	-2.68e-03	-0.03	1.10e-04	1.46e-06	0.0
38562	5.90e-04	-5.72e-03	-0.03	1.57e-04	-1.68e-05	0.0
38570	-2.05e-04	-2.41e-03	-0.03	1.19e-04	-1.05e-05	0.0
38572	-1.77e-04	-2.13e-03	-0.03	1.05e-04	-9.12e-06	0.0
38573	-1.70e-04	-2.06e-03	-0.03	1.02e-04	-8.78e-06	0.0
3862	-1.60e-04	-3.15e-03	-0.03	1.56e-04	-8.46e-06	0.0
3868	-1.88e-03	-2.36e-03	-0.02	1.01e-04	1.41e-06	0.0
38630	5.01e-04	-4.41e-03	-0.02	1.29e-04	-7.95e-06	0.0
38640	-2.59e-03	-2.52e-03	-0.02	1.02e-04	4.14e-06	0.0
38662	7.43e-04	-5.39e-03	-0.02	1.42e-04	-8.97e-06	0.0
38670	-1.22e-04	-2.28e-03	-0.02	1.13e-04	-6.35e-06	0.0
38672	-1.06e-04	-2.02e-03	-0.02	1.00e-04	-5.59e-06	0.0
38673	-1.02e-04	-1.96e-03	-0.02	9.70e-05	-5.40e-06	0.0
3872	-7.19e-05	-2.67e-03	-0.02	1.32e-04	-3.83e-06	0.0
3878	-1.85e-03	-2.02e-03	-0.02	8.40e-05	1.58e-06	0.0
38730	5.73e-04	-3.88e-03	-0.02	1.03e-04	-2.28e-06	0.0
38740	-2.56e-03	-2.16e-03	-0.02	8.46e-05	3.22e-06	0.0
38762	8.22e-04	-4.77e-03	-0.02	1.11e-04	-2.19e-06	0.0
38770	-5.54e-05	-1.93e-03	-0.02	9.56e-05	-2.88e-06	0.0
38772	-4.84e-05	-1.72e-03	-0.02	8.52e-05	-2.59e-06	0.0
38773	-4.66e-05	-1.66e-03	-0.02	8.26e-05	-2.52e-06	0.0
3882	-2.18e-05	-2.04e-03	-0.02	1.01e-04	-1.10e-06	0.0
3888	-1.82e-03	-1.59e-03	-0.01	6.32e-05	1.29e-06	0.0
38829	4.31e-04	6.87e-04	-0.01	5.51e-05	-2.57e-06	0.0
38830	5.91e-04	-3.26e-03	-0.01	7.26e-05	0.0	0.0
38840	-2.54e-03	-1.72e-03	-0.01	6.32e-05	2.12e-06	0.0
38861	6.09e-04	1.47e-03	-0.01	5.18e-05	-3.28e-06	0.0
38862	8.33e-04	-4.06e-03	-0.01	7.63e-05	0.0	0.0
38870	-1.78e-05	-1.48e-03	-0.01	7.30e-05	0.0	0.0
38872	-1.51e-05	-1.31e-03	-0.01	6.52e-05	0.0	0.0
38873	-1.45e-05	-1.27e-03	-0.01	6.32e-05	0.0	0.0
3891	2.45e-06	-1.18e-03	-0.01	5.86e-05	0.0	0.0
3892	0.0	-1.38e-03	-0.01	6.83e-05	0.0	0.0
3894	-3.68e-06	-1.02e-03	-0.01	5.00e-05	0.0	0.0
3895	1.79e-03	-5.66e-04	-0.01	4.38e-05	0.0	0.0
38929	4.73e-04	9.29e-04	-0.01	4.24e-05	0.0	0.0
38930	5.77e-04	-2.68e-03	-0.01	4.43e-05	0.0	0.0
38937	2.50e-03	-4.46e-04	-0.01	4.41e-05	-1.28e-06	0.0
38961	6.62e-04	1.65e-03	-0.01	4.22e-05	-1.27e-06	0.0
38962	8.08e-04	-3.41e-03	-9.99e-03	4.48e-05	0.0	0.0
38969	0.0	-8.67e-04	-0.01	4.30e-05	0.0	0.0
38970	0.0	-1.00e-03	-0.01	4.95e-05	0.0	0.0
38971	0.0	-8.67e-04	-0.01	4.30e-05	0.0	0.0
38972	0.0	-8.94e-04	-0.01	4.43e-05	0.0	0.0
38973	0.0	-8.67e-04	-0.01	4.30e-05	0.0	0.0
3901	9.86e-06	-6.52e-04	-0.01	3.23e-05	0.0	0.0
3902	8.63e-06	-7.62e-04	-0.01	3.75e-05	0.0	0.0
3905	1.76e-03	-1.90e-04	-9.15e-03	2.51e-05	0.0	0.0
39030	5.55e-04	-2.19e-03	-8.67e-03	1.90e-05	0.0	0.0
39035	-5.31e-04	1.23e-03	-9.51e-03	2.84e-05	0.0	0.0



EGP CODE

GRE.EEC.R.73.IT.W.15235.12.024.01

PAGE

139 di/of 527

39037	2.47e-03	-7.37e-05-9.17e-03	2.56e-05	0.0	0.0
39062	7.74e-04	-2.87e-03-8.50e-03	1.72e-05	0.0	0.0
39067	-7.46e-04	1.91e-03-9.68e-03	3.02e-05	0.0	0.0
39069	5.98e-06	-4.79e-04-9.09e-03	2.37e-05	0.0	0.0
39070	5.15e-06	-5.52e-04-8.84e-03	2.72e-05	0.0	0.0
39071	5.98e-06	-4.79e-04-9.09e-03	2.37e-05	0.0	0.0
39072	5.81e-06	-4.93e-04-9.04e-03	2.44e-05	0.0	0.0
39073	5.98e-06	-4.79e-04-9.09e-03	2.37e-05	0.0	0.0
3911	1.18e-05	-1.53e-04 -0.01	7.41e-06	0.0	0.0
3912	1.06e-05	-1.78e-04 -0.01	8.61e-06	0.0	0.0
3915	1.74e-03	1.73e-04-8.37e-03	6.92e-06	0.0	0.0
39130	5.31e-04	-1.77e-03-8.27e-03	-1.48e-06	0.0	0.0
39135	-5.12e-04	1.55e-03-8.48e-03	1.24e-05	0.0	0.0
39137	2.43e-03	2.87e-04-8.38e-03	7.52e-06	0.0	0.0
39162	7.40e-04	-2.44e-03-8.22e-03	-4.25e-06	0.0	0.0
39167	-7.20e-04	2.22e-03-8.53e-03	1.52e-05	0.0	0.0
39169	7.46e-06	-1.12e-04-8.37e-03	5.43e-06	0.0	0.0
39170	6.63e-06	-1.29e-04-8.02e-03	6.24e-06	0.0	0.0
39171	7.46e-06	-1.12e-04-8.37e-03	5.43e-06	0.0	0.0
39172	7.29e-06	-1.15e-04-8.30e-03	5.59e-06	0.0	0.0
39173	7.46e-06	-1.12e-04-8.37e-03	5.43e-06	0.0	0.0
3921	1.07e-05	3.39e-04 -0.01	-1.70e-05	0.0	0.0
3922	9.29e-06	3.96e-04 -0.01	-1.98e-05	0.0	0.0
39214	1.74e-03	-3.67e-05-8.58e-03	-1.39e-05	0.0	0.0
39232	-5.20e-04	-1.42e-03-8.80e-03	-1.89e-05	0.0	0.0
39233	5.38e-04	1.92e-03-8.29e-03	-6.12e-06	0.0	0.0
39246	2.44e-03	-1.51e-04-8.59e-03	-1.45e-05	0.0	0.0
39264	-7.31e-04	-2.09e-03-8.91e-03	-2.15e-05	0.0	0.0
39265	7.50e-04	2.59e-03-8.19e-03	-3.57e-06	0.0	0.0
39269	6.63e-06	2.49e-04-8.55e-03	-1.25e-05	0.0	0.0
39270	5.67e-06	2.87e-04-8.22e-03	-1.43e-05	0.0	0.0
39271	6.63e-06	2.49e-04-8.55e-03	-1.25e-05	0.0	0.0
39272	6.44e-06	2.56e-04-8.48e-03	-1.29e-05	0.0	0.0
39273	6.63e-06	2.49e-04-8.55e-03	-1.25e-05	0.0	0.0
3931	5.93e-06	8.49e-04 -0.01	-4.24e-05	0.0	0.0
3932	3.96e-06	9.93e-04 -0.01	-4.94e-05	0.0	0.0
39314	1.77e-03	3.31e-04-9.72e-03	-3.23e-05	0.0	0.0
39333	5.60e-04	2.37e-03-9.11e-03	-2.81e-05	0.0	0.0
39334	4.89e-04	-1.10e-03 -0.01	-3.45e-05	0.0	0.0
39346	2.47e-03	2.14e-04-9.77e-03	-3.28e-05	0.0	0.0
39365	7.83e-04	3.07e-03-8.91e-03	-2.69e-05	0.0	0.0
39366	6.83e-04	-1.80e-03 -0.01	-3.59e-05	0.0	0.0
39369	2.96e-06	6.23e-04-9.62e-03	-3.11e-05	0.0	0.0
39370	1.65e-06	7.19e-04-9.45e-03	-3.58e-05	0.0	0.0
39371	2.96e-06	6.23e-04-9.62e-03	-3.11e-05	0.0	0.0
39372	2.70e-06	6.42e-04-9.59e-03	-3.20e-05	0.0	0.0
39373	2.96e-06	6.23e-04-9.62e-03	-3.11e-05	0.0	0.0
3942	-1.03e-05	1.63e-03 -0.02	-8.11e-05	0.0	0.0
3944	-1.24e-05	1.20e-03 -0.01	-5.94e-05	0.0	0.0
39415	-1.80e-03	1.33e-03 -0.01	-5.04e-05	0.0	0.0
39433	5.78e-04	2.90e-03 -0.01	-5.48e-05	0.0	0.0
39434	4.58e-04	-8.32e-04 -0.01	-4.80e-05	-1.38e-06	0.0
39447	-2.51e-03	1.45e-03 -0.01	-5.02e-05	1.34e-06	0.0
39465	8.12e-04	3.65e-03 -0.01	-5.63e-05	0.0	0.0
39466	6.43e-04	-1.58e-03 -0.01	-4.68e-05	-1.81e-06	0.0
39470	-9.09e-06	1.18e-03 -0.01	-5.87e-05	0.0	0.0
39472	-7.09e-06	1.05e-03 -0.01	-5.25e-05	0.0	0.0
39473	-6.59e-06	1.02e-03 -0.01	-5.10e-05	0.0	0.0
3952	-4.34e-05	2.29e-03 -0.02	-1.14e-04	-2.04e-06	0.0
39515	-1.83e-03	1.76e-03 -0.01	-7.17e-05	1.18e-06	0.0
39533	5.82e-04	3.51e-03 -0.01	-8.49e-05	0.0	0.0
39534	4.10e-04	-6.14e-04 -0.01	-5.90e-05	-3.43e-06	0.0
39547	-2.55e-03	1.89e-03 -0.01	-7.19e-05	2.20e-06	0.0
39565	8.26e-04	4.34e-03 -0.01	-9.04e-05	0.0	0.0
39566	5.86e-04	-1.43e-03 -0.02	-5.41e-05	-4.25e-06	0.0
39570	-3.40e-05	1.66e-03 -0.02	-8.24e-05	-1.53e-06	0.0
39572	-2.93e-05	1.48e-03 -0.01	-7.35e-05	-1.41e-06	0.0
39573	-2.81e-05	1.43e-03 -0.01	-7.13e-05	-1.38e-06	0.0
3962	-1.09e-04	2.89e-03 -0.03	-1.43e-04	-5.44e-06	0.0
39615	-1.86e-03	2.16e-03 -0.02	-9.16e-05	1.44e-06	0.0
39633	5.46e-04	4.12e-03 -0.02	-1.15e-04	-3.65e-06	0.0
39647	-2.58e-03	2.31e-03 -0.02	-9.24e-05	3.42e-06	0.0
39665	7.92e-04	5.05e-03 -0.02	-1.25e-04	-3.70e-06	0.0
39670	-8.31e-05	2.09e-03 -0.02	-1.04e-04	-4.08e-06	0.0
39672	-7.23e-05	1.86e-03 -0.02	-9.24e-05	-3.64e-06	0.0
39673	-6.96e-05	1.80e-03 -0.02	-8.95e-05	-3.53e-06	0.0



EGP CODE

GRE.EEC.R.73.IT.W.15235.12.024.01

PAGE

140 di/of 527

3972	-2.09e-04	3.28e-03	-0.03	-1.62e-04	-1.07e-05	0.0
39715	-1.90e-03	2.44e-03	-0.02	-1.05e-04	0.0	0.0
39733	4.52e-04	4.58e-03	-0.03	-1.37e-04	-1.01e-05	0.0
39747	-2.61e-03	2.60e-03	-0.02	-1.07e-04	2.33e-06	0.0
39765	6.86e-04	5.60e-03	-0.03	-1.52e-04	-1.15e-05	0.0
39770	-1.58e-04	2.38e-03	-0.03	-1.18e-04	-8.02e-06	0.0
39772	-1.37e-04	2.10e-03	-0.02	-1.04e-04	-7.02e-06	0.0
39773	-1.32e-04	2.04e-03	-0.02	-1.01e-04	-6.77e-06	0.0
3982	-2.75e-04	3.35e-03	-0.04	-1.66e-04	-1.41e-05	0.0
39815	-1.92e-03	2.50e-03	-0.03	-1.08e-04	-1.13e-06	0.0
39833	3.70e-04	4.71e-03	-0.03	-1.43e-04	-1.48e-05	0.0
39847	-2.62e-03	2.67e-03	-0.03	-1.10e-04	1.96e-06	0.0
39865	5.87e-04	5.77e-03	-0.03	-1.60e-04	-1.72e-05	0.0
39870	-2.08e-04	2.44e-03	-0.03	-1.20e-04	-1.05e-05	0.0
39872	-1.79e-04	2.15e-03	-0.03	-1.07e-04	-9.17e-06	0.0
39873	-1.72e-04	2.08e-03	-0.03	-1.03e-04	-8.83e-06	0.0
3992	2.08e-04	-3.29e-03	-0.04	1.63e-04	1.06e-05	0.0
3995	1.83e-03	-1.57e-03	-0.03	9.43e-05	-4.83e-06	0.0
39934	7.25e-04	-4.60e-03	-0.03	1.39e-04	6.47e-06	0.0
39937	2.51e-03	-1.38e-03	-0.03	9.16e-05	-9.28e-06	0.0
39966	9.66e-04	-5.62e-03	-0.03	1.54e-04	6.56e-06	0.0
39970	1.53e-04	-2.39e-03	-0.03	1.18e-04	7.91e-06	0.0
39972	1.30e-04	-2.11e-03	-0.03	1.04e-04	6.60e-06	0.0
39973	1.24e-04	-2.04e-03	-0.03	1.01e-04	6.27e-06	0.0
4002	1.48e-04	-3.12e-03	-0.03	1.54e-04	7.48e-06	0.0
4005	1.84e-03	-1.50e-03	-0.02	9.07e-05	-3.12e-06	0.0
40030	6.89e-04	-4.35e-03	-0.02	1.27e-04	2.97e-06	0.0
40037	2.54e-03	-1.32e-03	-0.02	8.85e-05	-6.16e-06	0.0
40062	9.30e-04	-5.32e-03	-0.02	1.39e-04	2.37e-06	0.0
40070	1.09e-04	-2.26e-03	-0.02	1.12e-04	5.58e-06	0.0
40072	9.28e-05	-2.00e-03	-0.02	9.93e-05	4.68e-06	0.0
40073	8.88e-05	-1.94e-03	-0.02	9.62e-05	4.45e-06	0.0
4012	9.60e-05	-2.65e-03	-0.02	1.31e-04	4.83e-06	0.0
4015	1.84e-03	-1.25e-03	-0.02	7.85e-05	-1.49e-06	0.0
40130	6.43e-04	-3.84e-03	-0.02	1.02e-04	1.33e-06	0.0
40137	2.55e-03	-1.09e-03	-0.02	7.71e-05	-3.26e-06	0.0
40162	8.76e-04	-4.72e-03	-0.02	1.10e-04	0.0	0.0
40170	7.04e-05	-1.92e-03	-0.02	9.50e-05	3.61e-06	0.0
40172	6.08e-05	-1.71e-03	-0.02	8.46e-05	3.04e-06	0.0
40173	5.84e-05	-1.65e-03	-0.02	8.20e-05	2.90e-06	0.0
4022	5.93e-05	-2.03e-03	-0.02	1.01e-04	3.00e-06	0.0
4025	1.82e-03	-9.12e-04	-0.01	6.15e-05	0.0	0.0
40229	5.05e-04	6.95e-04	-0.01	5.41e-05	1.53e-06	0.0
40230	6.09e-04	-3.24e-03	-0.01	7.22e-05	0.0	0.0
40237	2.54e-03	-7.68e-04	-0.01	6.08e-05	-1.28e-06	0.0
40261	6.93e-04	1.48e-03	-0.01	5.06e-05	1.41e-06	0.0
40262	8.38e-04	-4.03e-03	-0.01	7.58e-05	0.0	0.0
40270	4.31e-05	-1.47e-03	-0.01	7.28e-05	2.24e-06	0.0
40272	3.80e-05	-1.31e-03	-0.01	6.50e-05	1.90e-06	0.0
40273	3.67e-05	-1.27e-03	-0.01	6.30e-05	1.81e-06	0.0
4032	3.67e-05	-1.38e-03	-0.01	6.83e-05	1.91e-06	0.0
4035	1.80e-03	-5.42e-04	-0.01	4.29e-05	0.0	0.0
40330	5.82e-04	-2.67e-03	-0.01	4.41e-05	0.0	0.0
40335	-5.18e-04	9.34e-04	-0.01	4.18e-05	1.71e-06	0.0
40337	2.51e-03	-4.11e-04	-0.01	4.29e-05	0.0	0.0
40362	8.05e-04	-3.39e-03	-0.01	4.45e-05	0.0	0.0
40367	-7.34e-04	1.66e-03	-0.01	4.14e-05	1.92e-06	0.0
40370	2.62e-05	-1.00e-03	-0.01	4.95e-05	1.43e-06	0.0
40372	2.39e-05	-8.93e-04	-0.01	4.43e-05	1.22e-06	0.0
40373	2.33e-05	-8.66e-04	-0.01	4.30e-05	1.17e-06	0.0
4041	2.29e-05	-6.52e-04	-0.01	3.23e-05	1.08e-06	0.0
4042	2.45e-05	-7.63e-04	-0.01	3.76e-05	1.34e-06	0.0
4045	1.77e-03	-1.74e-04-9.18e-03		2.48e-05	0.0	0.0
40430	5.56e-04	-2.17e-03-8.70e-03		1.90e-05	0.0	0.0
40435	-5.13e-04	1.22e-03-9.54e-03		2.84e-05	1.09e-06	0.0
40437	2.47e-03	-5.16e-05-9.20e-03		2.52e-05	0.0	0.0
40462	7.73e-04	-2.85e-03-8.54e-03		1.71e-05	0.0	0.0
40467	-7.25e-04	1.89e-03-9.71e-03		3.03e-05	1.19e-06	0.0
40469	1.61e-05	-4.79e-04-9.12e-03		2.37e-05	0.0	0.0
40470	1.72e-05	-5.52e-04-8.87e-03		2.72e-05	1.01e-06	0.0
40471	1.61e-05	-4.79e-04-9.12e-03		2.37e-05	0.0	0.0
40472	1.63e-05	-4.93e-04-9.07e-03		2.44e-05	0.0	0.0
40473	1.61e-05	-4.79e-04-9.12e-03		2.37e-05	0.0	0.0
4051	1.91e-05	-1.53e-04	-0.01	7.43e-06	0.0	0.0
4052	1.95e-05	-1.78e-04	-0.01	8.65e-06	1.12e-06	0.0
4055	1.74e-03	2.08e-04-8.40e-03		6.88e-06	0.0	0.0





EGP CODE

GRE.EEC.R.73.IT.W.15235.12.024.01

PAGE

141 di/of 527

40532	-4.97e-04	-1.76e-03-8.31e-03	-1.59e-06	0.0	0.0
40535	-5.04e-04	1.54e-03-8.51e-03	1.24e-05	0.0	0.0
40537	2.43e-03	3.36e-04-8.40e-03	7.45e-06	0.0	0.0
40564	-7.01e-04	-2.42e-03-8.27e-03	-4.41e-06	0.0	0.0
40567	-7.11e-04	2.20e-03-8.55e-03	1.52e-05	0.0	0.0
40569	1.32e-05	-1.12e-04-8.40e-03	5.45e-06	0.0	0.0
40570	1.35e-05	-1.29e-04-8.05e-03	6.26e-06	0.0	0.0
40571	1.32e-05	-1.12e-04-8.40e-03	5.45e-06	0.0	0.0
40572	1.32e-05	-1.15e-04-8.33e-03	5.61e-06	0.0	0.0
40573	1.32e-05	-1.12e-04-8.40e-03	5.45e-06	0.0	0.0
4061	1.97e-05	3.39e-04 -0.01	-1.70e-05	0.0	0.0
4062	2.03e-05	3.97e-04 -0.01	-1.98e-05	1.17e-06	0.0
40614	1.74e-03	-4.99e-05-8.60e-03	-1.38e-05	0.0	0.0
40632	-5.10e-04	-1.41e-03-8.83e-03	-1.89e-05	0.0	0.0
40633	5.41e-04	1.91e-03-8.32e-03	-6.11e-06	0.0	0.0
40646	2.44e-03	-1.70e-04-8.61e-03	-1.44e-05	0.0	0.0
40664	-7.19e-04	-2.08e-03-8.94e-03	-2.14e-05	0.0	0.0
40665	7.52e-04	2.58e-03-8.21e-03	-3.56e-06	0.0	0.0
40669	1.37e-05	2.49e-04-8.58e-03	-1.25e-05	0.0	0.0
40670	1.40e-05	2.87e-04-8.25e-03	-1.43e-05	0.0	0.0
40671	1.37e-05	2.49e-04-8.58e-03	-1.25e-05	0.0	0.0
40672	1.37e-05	2.57e-04-8.51e-03	-1.29e-05	0.0	0.0
40673	1.37e-05	2.49e-04-8.58e-03	-1.25e-05	0.0	0.0
4071	2.50e-05	8.49e-04 -0.01	-4.24e-05	1.20e-06	0.0
4072	2.72e-05	9.94e-04 -0.01	-4.94e-05	1.50e-06	0.0
40714	1.78e-03	3.13e-04-9.72e-03	-3.19e-05	0.0	0.0
40732	-5.18e-04	-1.11e-03 -0.01	-3.42e-05	1.28e-06	0.0
40733	5.64e-04	2.35e-03-9.14e-03	-2.81e-05	0.0	0.0
40746	2.48e-03	1.88e-04-9.76e-03	-3.22e-05	0.0	0.0
40764	-7.32e-04	-1.80e-03 -0.01	-3.54e-05	1.42e-06	0.0
40765	7.83e-04	3.05e-03-8.93e-03	-2.69e-05	0.0	0.0
40769	1.77e-05	6.24e-04-9.65e-03	-3.11e-05	0.0	0.0
40770	1.92e-05	7.20e-04-9.48e-03	-3.58e-05	1.13e-06	0.0
40771	1.77e-05	6.24e-04-9.65e-03	-3.11e-05	0.0	0.0
40772	1.80e-05	6.43e-04-9.62e-03	-3.20e-05	0.0	0.0
40773	1.77e-05	6.24e-04-9.65e-03	-3.11e-05	0.0	0.0
4082	4.24e-05	1.63e-03 -0.02	-8.10e-05	2.24e-06	0.0
40814	1.81e-03	6.86e-04 -0.01	-5.03e-05	0.0	0.0
40832	-5.19e-04	-8.42e-04 -0.01	-4.71e-05	2.01e-06	0.0
40833	5.90e-04	2.89e-03 -0.01	-5.46e-05	0.0	0.0
40846	2.52e-03	5.51e-04 -0.01	-5.01e-05	0.0	0.0
40864	-7.38e-04	-1.59e-03 -0.01	-4.56e-05	2.27e-06	0.0
40865	8.15e-04	3.63e-03 -0.01	-5.61e-05	0.0	0.0
40870	3.05e-05	1.18e-03 -0.01	-5.87e-05	1.68e-06	0.0
40872	2.75e-05	1.05e-03 -0.01	-5.24e-05	1.43e-06	0.0
40873	2.67e-05	1.02e-03 -0.01	-5.09e-05	1.37e-06	0.0
4092	6.95e-05	2.28e-03 -0.02	-1.13e-04	3.61e-06	0.0
40914	1.83e-03	1.05e-03 -0.01	-6.87e-05	0.0	0.0
40933	6.19e-04	3.48e-03 -0.01	-8.43e-05	0.0	0.0
40934	5.04e-04	-6.25e-04 -0.01	-5.79e-05	1.66e-06	0.0
40946	2.54e-03	9.03e-04 -0.01	-6.77e-05	-1.79e-06	0.0
40965	8.49e-04	4.31e-03 -0.01	-8.97e-05	0.0	0.0
40966	6.89e-04	-1.45e-03 -0.01	-5.27e-05	1.46e-06	0.0
40970	5.06e-05	1.65e-03 -0.02	-8.21e-05	2.70e-06	0.0
40972	4.44e-05	1.47e-03 -0.01	-7.32e-05	2.28e-06	0.0
40973	4.28e-05	1.43e-03 -0.01	-7.10e-05	2.18e-06	0.0
4102	1.12e-04	2.87e-03 -0.03	-1.42e-04	5.80e-06	0.0
41014	1.84e-03	1.37e-03 -0.02	-8.45e-05	-2.21e-06	0.0
41033	6.56e-04	4.07e-03 -0.02	-1.13e-04	1.69e-06	0.0
41046	2.55e-03	1.20e-03 -0.02	-8.28e-05	-4.49e-06	0.0
41065	8.91e-04	4.99e-03 -0.02	-1.23e-04	0.0	0.0
41070	8.21e-05	2.08e-03 -0.02	-1.03e-04	4.32e-06	0.0
41072	7.06e-05	1.84e-03 -0.02	-9.17e-05	3.64e-06	0.0
41073	6.78e-05	1.78e-03 -0.02	-8.89e-05	3.46e-06	0.0
4112	1.67e-04	3.24e-03 -0.03	-1.61e-04	8.68e-06	0.0
41114	1.84e-03	1.56e-03 -0.02	-9.41e-05	-3.89e-06	0.0
41133	7.07e-04	4.51e-03 -0.03	-1.35e-04	3.85e-06	0.0
41146	2.54e-03	1.38e-03 -0.02	-9.16e-05	-7.52e-06	0.0
41165	9.50e-04	5.51e-03 -0.03	-1.49e-04	3.32e-06	0.0
41170	1.23e-04	2.35e-03 -0.03	-1.17e-04	6.47e-06	0.0
41172	1.05e-04	2.08e-03 -0.02	-1.03e-04	5.41e-06	0.0
41173	1.00e-04	2.01e-03 -0.02	-1.00e-04	5.15e-06	0.0
4122	2.03e-04	3.32e-03 -0.04	-1.64e-04	1.05e-05	0.0
41214	1.83e-03	1.59e-03 -0.03	-9.54e-05	-5.25e-06	0.0
41233	7.42e-04	4.63e-03 -0.03	-1.41e-04	5.28e-06	0.0
41246	2.51e-03	1.40e-03 -0.03	-9.26e-05	-9.84e-06	0.0



EGP CODE

GRE.EEC.R.73.IT.W.15235.12.024.01

PAGE

142 di/of 527

41265	9.91e-04	5.66e-03	-0.03	-1.56e-04	4.91e-06	0.0
41270	1.50e-04	2.41e-03	-0.03	-1.19e-04	7.84e-06	0.0
41272	1.27e-04	2.12e-03	-0.03	-1.06e-04	6.54e-06	0.0
41273	1.21e-04	2.05e-03	-0.03	-1.02e-04	6.21e-06	0.0
4132	6.25e-04	-3.46e-03	-0.04	1.70e-04	3.21e-05	0.0
4136	2.15e-03	-2.62e-03	-0.03	1.12e-04	1.51e-05	0.0
41332	9.56e-05	-4.79e-03	-0.03	1.49e-04	2.74e-05	0.0
41338	2.86e-03	-2.81e-03	-0.03	1.14e-04	1.34e-05	0.0
41364	-1.78e-05	-5.85e-03	-0.03	1.66e-04	3.06e-05	0.0
41370	4.66e-04	-2.51e-03	-0.03	1.24e-04	2.40e-05	0.0
41372	3.97e-04	-2.21e-03	-0.03	1.09e-04	2.03e-05	0.0
41373	3.79e-04	-2.14e-03	-0.03	1.06e-04	1.94e-05	0.0
4142	4.03e-04	-3.27e-03	-0.03	1.61e-04	2.08e-05	0.0
4145	2.05e-03	-1.52e-03	-0.02	9.12e-05	8.15e-06	0.0
41432	-1.80e-04	-4.48e-03	-0.02	1.34e-04	1.35e-05	0.0
41437	2.78e-03	-1.32e-03	-0.02	8.76e-05	6.34e-06	0.0
41464	-3.52e-04	-5.47e-03	-0.02	1.48e-04	1.38e-05	0.0
41470	3.00e-04	-2.38e-03	-0.02	1.17e-04	1.55e-05	0.0
41472	2.58e-04	-2.10e-03	-0.02	1.04e-04	1.32e-05	0.0
41473	2.47e-04	-2.03e-03	-0.02	1.00e-04	1.27e-05	0.0
4152	2.23e-04	-2.76e-03	-0.02	1.36e-04	1.14e-05	0.0
4155	1.96e-03	-1.26e-03	-0.02	7.88e-05	5.28e-06	0.0
41532	-3.47e-04	-3.92e-03	-0.02	1.06e-04	5.75e-06	0.0
41537	2.69e-03	-1.08e-03	-0.02	7.63e-05	4.57e-06	0.0
41564	-5.42e-04	-4.80e-03	-0.02	1.14e-04	5.24e-06	0.0
41570	1.66e-04	-2.00e-03	-0.02	9.88e-05	8.54e-06	0.0
41572	1.44e-04	-1.77e-03	-0.02	8.78e-05	7.34e-06	0.0
41573	1.38e-04	-1.72e-03	-0.02	8.51e-05	7.04e-06	0.0
4162	1.13e-04	-2.09e-03	-0.02	1.03e-04	5.73e-06	0.0
4165	1.89e-03	-9.17e-04	-0.01	6.18e-05	3.23e-06	0.0
41631	-4.85e-04	6.36e-04	-0.01	5.65e-05	5.69e-06	0.0
41632	-4.29e-04	-3.26e-03	-0.01	7.38e-05	1.87e-06	0.0
41637	2.61e-03	-7.60e-04	-0.01	6.06e-05	3.10e-06	0.0
41663	-7.08e-04	1.42e-03	-0.01	5.32e-05	6.53e-06	0.0
41664	-6.29e-04	-4.05e-03	-0.01	7.73e-05	1.19e-06	0.0
41670	8.34e-05	-1.52e-03	-0.01	7.50e-05	4.29e-06	0.0
41672	7.35e-05	-1.35e-03	-0.01	6.68e-05	3.71e-06	0.0
41673	7.10e-05	-1.31e-03	-0.01	6.48e-05	3.56e-06	0.0
4172	5.58e-05	-1.42e-03	-0.01	6.98e-05	2.88e-06	0.0
4175	1.82e-03	-5.38e-04	-0.01	4.32e-05	1.97e-06	0.0
41734	5.66e-04	-2.67e-03	-0.01	4.47e-05	0.0	0.0
41735	-4.95e-04	8.94e-04	-0.01	4.29e-05	2.95e-06	0.0
41737	2.54e-03	-3.99e-04	-0.01	4.29e-05	2.03e-06	0.0
41766	7.79e-04	-3.38e-03	-0.01	4.51e-05	0.0	0.0
41767	-7.07e-04	1.61e-03	-0.01	4.26e-05	3.41e-06	0.0
41770	4.07e-05	-1.03e-03	-0.01	5.05e-05	2.16e-06	0.0
41772	3.68e-05	-9.14e-04	-0.01	4.52e-05	1.88e-06	0.0
41773	3.58e-05	-8.86e-04	-0.01	4.38e-05	1.81e-06	0.0
4181	2.70e-05	-6.63e-04	-0.01	3.28e-05	1.32e-06	0.0
4182	2.92e-05	-7.77e-04	-0.01	3.82e-05	1.61e-06	0.0
4185	1.77e-03	-1.60e-04-9.23e-03		2.50e-05	1.29e-06	0.0
41834	5.44e-04	-2.16e-03-8.73e-03		1.89e-05	0.0	0.0
41835	-5.05e-04	1.19e-03-9.61e-03		2.92e-05	1.50e-06	0.0
41837	2.48e-03	-2.85e-05-9.25e-03		2.54e-05	1.39e-06	0.0
41864	-6.87e-04	-2.84e-03-8.58e-03		1.69e-05	0.0	0.0
41867	-7.15e-04	1.86e-03-9.78e-03		3.12e-05	1.69e-06	0.0
41869	1.94e-05	-4.87e-04-9.17e-03		2.41e-05	1.02e-06	0.0
41870	2.08e-05	-5.63e-04-8.94e-03		2.77e-05	1.21e-06	0.0
41871	1.94e-05	-4.87e-04-9.17e-03		2.41e-05	1.02e-06	0.0
41872	1.97e-05	-5.03e-04-9.12e-03		2.48e-05	1.06e-06	0.0
41873	1.94e-05	-4.87e-04-9.17e-03		2.41e-05	1.02e-06	0.0
4191	1.94e-05	-1.55e-04	-0.01	7.52e-06	0.0	0.0
4192	1.97e-05	-1.81e-04	-0.01	8.77e-06	1.17e-06	0.0
4195	1.74e-03	2.06e-04-8.44e-03		6.98e-06	0.0	0.0
41932	-4.98e-04	-1.75e-03-8.34e-03		-1.73e-06	0.0	0.0
41935	-5.02e-04	1.52e-03-8.55e-03		1.28e-05	0.0	0.0
41937	2.43e-03	3.34e-04-8.44e-03		7.56e-06	1.03e-06	0.0
41964	-7.03e-04	-2.40e-03-8.30e-03		-4.63e-06	0.0	0.0
41967	-7.09e-04	2.17e-03-8.60e-03		1.57e-05	0.0	0.0
41969	1.35e-05	-1.14e-04-8.44e-03		5.52e-06	0.0	0.0
41970	1.38e-05	-1.31e-04-8.10e-03		6.35e-06	0.0	0.0
41971	1.35e-05	-1.14e-04-8.44e-03		5.52e-06	0.0	0.0
41972	1.36e-05	-1.17e-04-8.37e-03		5.69e-06	0.0	0.0
41973	1.35e-05	-1.14e-04-8.44e-03		5.52e-06	0.0	0.0
4201	2.12e-05	3.45e-04	-0.01	-1.73e-05	1.06e-06	0.0
4202	2.20e-05	4.04e-04	-0.01	-2.01e-05	1.28e-06	0.0



EGP CODE

GRE.EEC.R.73.IT.W.15235.12.024.01

PAGE

143 di/of 527

42014	1.75e-03	-5.59e-05-8.65e-03	-1.40e-05	1.09e-06	0.0
42029	5.36e-04	1.90e-03-8.35e-03	-5.94e-06	0.0	0.0
42032	-5.06e-04	-1.39e-03-8.89e-03	-1.94e-05	1.02e-06	0.0
42046	2.44e-03	-1.80e-04-8.66e-03	-1.46e-05	1.19e-06	0.0
42061	7.45e-04	2.56e-03-8.24e-03	-3.25e-06	0.0	0.0
42064	-7.15e-04	-2.05e-03-8.99e-03	-2.21e-05	1.10e-06	0.0
42069	1.49e-05	2.53e-04-8.62e-03	-1.27e-05	0.0	0.0
42070	1.54e-05	2.93e-04-8.30e-03	-1.46e-05	0.0	0.0
42071	1.49e-05	2.53e-04-8.62e-03	-1.27e-05	0.0	0.0
42072	1.50e-05	2.61e-04-8.55e-03	-1.30e-05	0.0	0.0
42073	1.49e-05	2.53e-04-8.62e-03	-1.27e-05	0.0	0.0
4211	3.36e-05	8.66e-04 -0.01	-4.31e-05	1.65e-06	0.0
4212	3.73e-05	1.02e-03 -0.01	-5.03e-05	2.01e-06	0.0
42114	1.79e-03	3.02e-04-9.79e-03	-3.22e-05	1.59e-06	0.0
42129	5.54e-04	2.35e-03-9.17e-03	-2.82e-05	0.0	0.0
42132	-5.05e-04	-1.07e-03 -0.01	-3.51e-05	1.94e-06	0.0
42146	2.49e-03	1.68e-04-9.82e-03	-3.24e-05	1.72e-06	0.0
42161	7.66e-04	3.03e-03-8.95e-03	-2.68e-05	0.0	0.0
42164	-7.17e-04	-1.76e-03 -0.01	-3.65e-05	2.21e-06	0.0
42169	2.44e-05	6.36e-04-9.71e-03	-3.16e-05	1.27e-06	0.0
42170	2.69e-05	7.36e-04-9.55e-03	-3.64e-05	1.51e-06	0.0
42171	2.44e-05	6.36e-04-9.71e-03	-3.16e-05	1.27e-06	0.0
42172	2.49e-05	6.56e-04-9.68e-03	-3.26e-05	1.32e-06	0.0
42173	2.44e-05	6.36e-04-9.71e-03	-3.16e-05	1.27e-06	0.0
4222	7.42e-05	1.67e-03 -0.02	-8.29e-05	3.81e-06	0.0
42214	1.84e-03	6.85e-04 -0.01	-5.07e-05	2.53e-06	0.0
42232	-4.87e-04	-7.94e-04 -0.01	-4.89e-05	3.82e-06	0.0
42235	-4.52e-04	2.89e-03 -0.01	-5.54e-05	1.04e-06	0.0
42246	2.56e-03	5.40e-04 -0.01	-5.01e-05	2.59e-06	0.0
42264	-7.01e-04	-1.53e-03 -0.01	-4.77e-05	4.39e-06	0.0
42267	-6.52e-04	3.63e-03 -0.01	-5.67e-05	0.0	0.0
42270	5.44e-05	1.21e-03 -0.01	-6.01e-05	2.85e-06	0.0
42272	4.86e-05	1.08e-03 -0.01	-5.37e-05	2.47e-06	0.0
42273	4.72e-05	1.05e-03 -0.01	-5.20e-05	2.38e-06	0.0
4232	1.49e-04	2.36e-03 -0.02	-1.17e-04	7.59e-06	0.0
42314	1.91e-03	1.06e-03 -0.01	-6.90e-05	4.15e-06	0.0
42335	-4.04e-04	3.52e-03 -0.01	-8.67e-05	2.91e-06	0.0
42336	-4.66e-04	-5.60e-04 -0.02	-6.06e-05	7.07e-06	0.0
42346	2.64e-03	8.90e-04 -0.01	-6.73e-05	3.92e-06	0.0
42367	-6.03e-04	4.34e-03 -0.01	-9.21e-05	2.19e-06	0.0
42368	-6.90e-04	-1.38e-03 -0.02	-5.56e-05	8.02e-06	0.0
42370	1.11e-04	1.71e-03 -0.02	-8.48e-05	5.68e-06	0.0
42372	9.68e-05	1.52e-03 -0.02	-7.56e-05	4.90e-06	0.0
42373	9.34e-05	1.47e-03 -0.01	-7.32e-05	4.71e-06	0.0
4242	2.85e-04	2.99e-03 -0.03	-1.48e-04	1.47e-05	0.0
42414	2.00e-03	1.38e-03 -0.02	-8.47e-05	6.56e-06	0.0
42435	-2.96e-04	4.17e-03 -0.02	-1.19e-04	8.37e-06	0.0
42446	2.73e-03	1.18e-03 -0.02	-8.16e-05	5.58e-06	0.0
42467	-4.86e-04	5.10e-03 -0.02	-1.30e-04	8.12e-06	0.0
42470	2.12e-04	2.17e-03 -0.02	-1.08e-04	1.10e-05	0.0
42472	1.84e-04	1.92e-03 -0.02	-9.55e-05	9.40e-06	0.0
42473	1.76e-04	1.86e-03 -0.02	-9.25e-05	9.01e-06	0.0
4252	4.87e-04	3.41e-03 -0.04	-1.68e-04	2.52e-05	0.0
42514	2.10e-03	1.58e-03 -0.02	-9.43e-05	9.49e-06	0.0
42535	-9.17e-05	4.67e-03 -0.03	-1.43e-04	1.89e-05	0.0
42546	2.82e-03	1.36e-03 -0.02	-9.01e-05	7.15e-06	0.0
42567	-2.47e-04	5.69e-03 -0.03	-1.59e-04	2.03e-05	0.0
42570	3.63e-04	2.47e-03 -0.03	-1.22e-04	1.88e-05	0.0
42572	3.10e-04	2.18e-03 -0.02	-1.08e-04	1.60e-05	0.0
42573	2.97e-04	2.11e-03 -0.02	-1.05e-04	1.53e-05	0.0
4262	6.17e-04	3.49e-03 -0.04	-1.72e-04	3.19e-05	0.0
42613	2.15e-03	2.63e-03 -0.03	-1.13e-04	1.47e-05	0.0
42635	8.52e-05	4.82e-03 -0.03	-1.50e-04	2.75e-05	0.0
42645	2.87e-03	2.82e-03 -0.03	-1.15e-04	1.29e-05	0.0
42667	-3.07e-05	5.89e-03 -0.03	-1.68e-04	3.07e-05	0.0
42670	4.60e-04	2.54e-03 -0.03	-1.25e-04	2.39e-05	0.0
42672	3.92e-04	2.23e-03 -0.03	-1.10e-04	2.02e-05	0.0
42673	3.75e-04	2.15e-03 -0.03	-1.07e-04	1.93e-05	0.0
4272	7.41e-04	-3.82e-03 -0.04	1.86e-04	3.84e-05	0.0
4276	2.41e-03	-2.86e-03 -0.03	1.22e-04	2.85e-05	0.0
42732	1.33e-04	-5.11e-03 -0.03	1.64e-04	2.92e-05	0.0
42738	3.19e-03	-3.07e-03 -0.03	1.24e-04	3.06e-05	0.0
42764	5.57e-06	-6.22e-03 -0.03	1.84e-04	3.16e-05	0.0
42770	5.52e-04	-2.78e-03 -0.03	1.36e-04	2.87e-05	0.0
42772	4.71e-04	-2.43e-03 -0.03	1.19e-04	2.44e-05	0.0
42773	4.50e-04	-2.35e-03 -0.03	1.15e-04	2.33e-05	0.0



EGP CODE

GRE.EEC.R.73.IT.W.15235.12.024.01

PAGE

144 di/of 527

4282	4.09e-04	-3.59e-03	-0.03	1.76e-04	2.19e-05	0.0
4285	2.21e-03	-1.67e-03	-0.02	9.81e-05	1.70e-05	0.0
42832	-2.49e-04	-4.77e-03	-0.02	1.47e-04	1.13e-05	0.0
42837	2.99e-03	-1.45e-03	-0.02	9.38e-05	1.84e-05	0.0
42864	-4.50e-04	-5.79e-03	-0.03	1.63e-04	1.04e-05	0.0
42870	3.05e-04	-2.61e-03	-0.02	1.28e-04	1.64e-05	0.0
42872	2.64e-04	-2.30e-03	-0.02	1.13e-04	1.41e-05	0.0
42873	2.53e-04	-2.22e-03	-0.02	1.09e-04	1.35e-05	0.0
4292	1.88e-04	-2.95e-03	-0.03	1.45e-04	9.94e-06	0.0
4295	2.05e-03	-1.36e-03	-0.02	8.34e-05	1.02e-05	0.0
42924	-6.81e-04	-3.28e-03	-0.02	1.05e-04	2.83e-06	0.0
42932	-4.19e-04	-4.02e-03	-0.02	1.11e-04	1.42e-06	0.0
42937	2.82e-03	-1.17e-03	-0.02	8.06e-05	1.17e-05	0.0
42956	-1.00e-03	-3.86e-03	-0.02	1.11e-04	1.48e-06	0.0
42964	-6.34e-04	-4.90e-03	-0.02	1.20e-04	0.0	0.0
42970	1.40e-04	-2.14e-03	-0.02	1.05e-04	7.44e-06	0.0
42972	1.23e-04	-1.89e-03	-0.02	9.33e-05	6.44e-06	0.0
42973	1.18e-04	-1.83e-03	-0.02	9.03e-05	6.19e-06	0.0
4302	7.92e-05	-2.19e-03	-0.02	1.08e-04	4.12e-06	0.0
4305	1.91e-03	-9.70e-04	-0.01	6.46e-05	5.18e-06	0.0
43032	-4.70e-04	-3.29e-03	-0.01	7.52e-05	0.0	0.0
43035	-4.85e-04	5.48e-04	-0.01	6.01e-05	4.54e-06	0.0
43037	2.66e-03	-8.11e-04	-0.01	6.34e-05	6.21e-06	0.0
43064	-6.79e-04	-4.06e-03	-0.01	7.83e-05	-1.57e-06	0.0
43067	-6.99e-04	1.32e-03	-0.01	5.71e-05	5.32e-06	0.0
43070	5.83e-05	-1.59e-03	-0.01	7.81e-05	3.09e-06	0.0
43072	5.22e-05	-1.41e-03	-0.01	6.95e-05	2.70e-06	0.0
43073	5.07e-05	-1.37e-03	-0.01	6.74e-05	2.60e-06	0.0
4312	2.96e-05	-1.46e-03	-0.01	7.16e-05	1.66e-06	0.0
4315	1.83e-03	-5.61e-04	-0.01	4.51e-05	2.63e-06	0.0
43134	5.53e-04	-2.67e-03	-0.01	4.37e-05	0.0	0.0
43135	-5.13e-04	8.40e-04	-0.01	4.63e-05	2.03e-06	0.0
43137	2.55e-03	-4.20e-04	-0.01	4.51e-05	3.26e-06	0.0
43166	7.66e-04	-3.37e-03	-0.01	4.32e-05	0.0	0.0
43167	-7.27e-04	1.54e-03	-0.01	4.68e-05	2.41e-06	0.0
43170	2.12e-05	-1.06e-03	-0.01	5.19e-05	1.25e-06	0.0
43172	2.01e-05	-9.43e-04	-0.01	4.64e-05	1.10e-06	0.0
43173	1.98e-05	-9.14e-04	-0.01	4.50e-05	1.07e-06	0.0
4321	1.07e-05	-6.78e-04	-0.01	3.34e-05	0.0	0.0
4322	9.13e-06	-7.95e-04	-0.01	3.89e-05	0.0	0.0
4325	1.77e-03	-1.67e-04-9.31e-03		2.57e-05	1.39e-06	0.0
43234	5.33e-04	-2.15e-03-8.75e-03		1.90e-05	0.0	0.0
43235	-5.19e-04	1.16e-03-9.67e-03		3.00e-05	0.0	0.0
43237	2.48e-03	-3.42e-05-9.35e-03		2.61e-05	1.76e-06	0.0
43266	7.44e-04	-2.82e-03-8.57e-03		1.68e-05	0.0	0.0
43267	-7.30e-04	1.82e-03-9.86e-03		3.22e-05	0.0	0.0
43269	7.00e-06	-4.99e-04-9.21e-03		2.45e-05	0.0	0.0
43270	5.94e-06	-5.77e-04-8.99e-03		2.82e-05	0.0	0.0
43271	7.00e-06	-4.99e-04-9.21e-03		2.45e-05	0.0	0.0
43272	6.79e-06	-5.14e-04-9.17e-03		2.52e-05	0.0	0.0
43273	7.00e-06	-4.99e-04-9.21e-03		2.45e-05	0.0	0.0
4331	5.43e-06	-1.57e-04 -0.01		7.63e-06	0.0	0.0
4332	2.64e-06	-1.84e-04 -0.01		8.89e-06	0.0	0.0
4335	1.73e-03	2.07e-04-8.50e-03		7.22e-06	0.0	0.0
43334	5.20e-04	-1.73e-03-8.36e-03		-2.00e-06	0.0	0.0
43335	-5.14e-04	1.50e-03-8.58e-03		1.32e-05	0.0	0.0
43337	2.42e-03	3.37e-04-8.50e-03		7.86e-06	1.09e-06	0.0
43366	7.27e-04	-2.37e-03-8.32e-03		-5.04e-06	0.0	0.0
43367	-7.21e-04	2.14e-03-8.63e-03		1.62e-05	0.0	0.0
43369	2.95e-06	-1.16e-04-8.47e-03		5.60e-06	0.0	0.0
43370	1.09e-06	-1.34e-04-8.13e-03		6.44e-06	0.0	0.0
43371	2.95e-06	-1.16e-04-8.47e-03		5.60e-06	0.0	0.0
43372	2.57e-06	-1.19e-04-8.40e-03		5.77e-06	0.0	0.0
43373	2.95e-06	-1.16e-04-8.47e-03		5.60e-06	0.0	0.0
4341	6.87e-06	3.52e-04 -0.01		-1.76e-05	0.0	0.0
4342	4.41e-06	4.13e-04 -0.01		-2.05e-05	0.0	0.0
43414	1.74e-03	-5.63e-05-8.71e-03		-1.44e-05	1.03e-06	0.0
43429	5.26e-04	1.88e-03-8.38e-03		-5.91e-06	0.0	0.0
43432	-5.18e-04	-1.36e-03-8.93e-03		-1.99e-05	0.0	0.0
43446	2.43e-03	-1.83e-04-8.73e-03		-1.50e-05	1.30e-06	0.0
43461	7.35e-04	2.53e-03-8.26e-03		-3.12e-06	0.0	0.0
43464	-7.27e-04	-2.01e-03-9.04e-03		-2.27e-05	0.0	0.0
43469	4.05e-06	2.59e-04-8.65e-03		-1.29e-05	0.0	0.0
43470	2.41e-06	2.99e-04-8.34e-03		-1.48e-05	0.0	0.0
43471	4.05e-06	2.59e-04-8.65e-03		-1.29e-05	0.0	0.0
43472	3.72e-06	2.67e-04-8.59e-03		-1.33e-05	0.0	0.0



EGP CODE

GRE.EEC.R.73.IT.W.15235.12.024.01

PAGE

145 di/of 527

43473	4.05e-06	2.59e-04	-8.65e-03	-1.29e-05	0.0	0.0
4351	1.63e-05	8.87e-04	-0.01	-4.40e-05	0.0	0.0
4352	1.60e-05	1.04e-03	-0.01	-5.14e-05	1.05e-06	0.0
43514	1.79e-03	3.26e-04	-9.88e-03	-3.32e-05	1.80e-06	0.0
43529	5.43e-04	2.34e-03	-9.20e-03	-2.84e-05	0.0	0.0
43530	5.04e-04	-1.03e-03	-0.01	-3.64e-05	1.58e-06	0.0
43546	2.50e-03	1.95e-04	-9.93e-03	-3.35e-05	2.25e-06	0.0
43561	7.56e-04	3.02e-03	-8.97e-03	-2.68e-05	0.0	0.0
43562	7.00e-04	-1.70e-03	-0.01	-3.80e-05	1.94e-06	0.0
43569	1.13e-05	6.53e-04	-9.76e-03	-3.23e-05	0.0	0.0
43570	1.10e-05	7.56e-04	-9.62e-03	-3.73e-05	0.0	0.0
43571	1.13e-05	6.53e-04	-9.76e-03	-3.23e-05	0.0	0.0
43572	1.12e-05	6.73e-04	-9.74e-03	-3.33e-05	0.0	0.0
43573	1.13e-05	6.53e-04	-9.76e-03	-3.23e-05	0.0	0.0
4362	4.67e-05	1.74e-03	-0.02	-8.55e-05	2.50e-06	0.0
43614	1.85e-03	7.18e-04	-0.01	-5.26e-05	3.48e-06	0.0
43632	-5.07e-04	-7.27e-04	-0.01	-5.14e-05	2.81e-06	0.0
43635	-4.79e-04	2.90e-03	-0.01	-5.61e-05	0.0	0.0
43646	2.58e-03	5.70e-04	-0.01	-5.22e-05	4.24e-06	0.0
43664	-7.22e-04	-1.45e-03	-0.01	-5.05e-05	3.30e-06	0.0
43667	-6.83e-04	3.62e-03	-0.01	-5.70e-05	-1.21e-06	0.0
43670	3.40e-05	1.26e-03	-0.01	-6.20e-05	1.87e-06	0.0
43672	3.12e-05	1.12e-03	-0.01	-5.53e-05	1.64e-06	0.0
43673	3.04e-05	1.09e-03	-0.01	-5.37e-05	1.59e-06	0.0
4372	1.18e-04	2.49e-03	-0.02	-1.23e-04	6.01e-06	0.0
43714	1.96e-03	1.13e-03	-0.02	-7.25e-05	6.85e-06	0.0
43735	-4.51e-04	3.57e-03	-0.01	-8.91e-05	0.0	0.0
43736	-4.94e-04	-4.52e-04	-0.02	-6.52e-05	5.83e-06	0.0
43746	2.71e-03	9.55e-04	-0.02	-7.08e-05	8.08e-06	0.0
43767	-6.61e-04	4.38e-03	-0.01	-9.41e-05	-1.23e-06	0.0
43768	-7.22e-04	-1.26e-03	-0.02	-6.05e-05	6.66e-06	0.0
43770	8.69e-05	1.81e-03	-0.02	-8.90e-05	4.50e-06	0.0
43772	7.69e-05	1.60e-03	-0.02	-7.91e-05	3.92e-06	0.0
43773	7.44e-05	1.55e-03	-0.02	-7.67e-05	3.77e-06	0.0
4382	2.66e-04	3.23e-03	-0.03	-1.59e-04	1.39e-05	0.0
43814	2.12e-03	1.49e-03	-0.02	-8.99e-05	1.31e-05	0.0
43835	-3.75e-04	4.34e-03	-0.02	-1.27e-04	3.79e-06	0.0
43846	2.90e-03	1.28e-03	-0.02	-8.64e-05	1.48e-05	0.0
43867	-5.91e-04	5.28e-03	-0.02	-1.38e-04	1.85e-06	0.0
43870	1.98e-04	2.35e-03	-0.02	-1.16e-04	1.04e-05	0.0
43872	1.72e-04	2.07e-03	-0.02	-1.02e-04	8.96e-06	0.0
43873	1.66e-04	2.00e-03	-0.02	-9.89e-05	8.61e-06	0.0
4392	5.27e-04	3.75e-03	-0.04	-1.84e-04	2.83e-05	0.0
43914	2.28e-03	1.74e-03	-0.02	-1.02e-04	1.96e-05	0.0
43935	-1.22e-04	4.99e-03	-0.03	-1.58e-04	1.81e-05	0.0
43946	3.06e-03	1.51e-03	-0.02	-9.70e-05	2.05e-05	0.0
43967	-3.01e-04	6.06e-03	-0.03	-1.76e-04	1.84e-05	0.0
43970	3.93e-04	2.73e-03	-0.03	-1.34e-04	2.11e-05	0.0
43972	3.38e-04	2.40e-03	-0.03	-1.18e-04	1.81e-05	0.0
43973	3.24e-04	2.32e-03	-0.03	-1.14e-04	1.73e-05	0.0
4402	7.24e-04	3.84e-03	-0.04	-1.88e-04	3.81e-05	0.0
44013	2.42e-03	2.86e-03	-0.03	-1.22e-04	2.82e-05	0.0
44035	9.34e-05	5.15e-03	-0.03	-1.66e-04	2.86e-05	0.0
44045	3.22e-03	3.07e-03	-0.03	-1.25e-04	3.03e-05	0.0
44067	-4.55e-05	6.26e-03	-0.03	-1.86e-04	3.07e-05	0.0
44070	5.40e-04	2.80e-03	-0.03	-1.37e-04	2.85e-05	0.0
44072	4.60e-04	2.45e-03	-0.03	-1.20e-04	2.42e-05	0.0
44073	4.41e-04	2.36e-03	-0.03	-1.16e-04	2.32e-05	0.0
4412	2.93e-04	-4.59e-03	-0.04	2.18e-04	1.57e-05	0.0
4416	2.43e-03	-3.56e-03	-0.03	1.51e-04	3.36e-05	0.0
44130	1.02e-03	-6.21e-03	-0.03	2.12e-04	2.00e-05	0.0
44134	9.50e-04	-6.21e-03	-0.03	2.12e-04	1.76e-05	0.0
44138	3.33e-03	-3.87e-03	-0.03	1.58e-04	4.33e-05	0.0
44162	1.36e-03	-7.58e-03	-0.04	2.43e-04	2.42e-05	0.0
44166	1.26e-03	-7.58e-03	-0.04	2.43e-04	2.09e-05	0.0
44170	2.17e-04	-3.36e-03	-0.03	1.60e-04	1.17e-05	0.0
44172	1.85e-04	-2.90e-03	-0.03	1.38e-04	9.92e-06	0.0
44173	1.77e-04	-2.78e-03	-0.03	1.33e-04	9.47e-06	0.0
4422	-2.99e-04	-4.06e-03	-0.03	1.96e-04	-8.62e-06	0.0
4428	-2.47e-03	-3.07e-03	-0.02	1.31e-04	-2.32e-05	0.0
44230	3.64e-04	-5.09e-03	-0.02	1.62e-04	-7.31e-06	0.0
44232	-9.50e-04	-5.12e-03	-0.02	1.63e-04	-1.74e-05	0.0
44240	-3.39e-03	-3.30e-03	-0.02	1.35e-04	-3.05e-05	0.0
44262	5.79e-04	-6.13e-03	-0.03	1.78e-04	-8.26e-06	0.0
44264	-1.26e-03	-6.16e-03	-0.03	1.79e-04	-2.23e-05	0.0
44270	-2.24e-04	-2.97e-03	-0.03	1.43e-04	-6.43e-06	0.0





EGP CODE

GRE.EEC.R.73.IT.W.15235.12.024.01

PAGE

146 di/of 527

44272	-1.82e-04	-2.59e-03	-0.02	1.25e-04	-5.23e-06	0.0
44273	-1.72e-04	-2.50e-03	-0.02	1.21e-04	-4.93e-06	0.0
4432	-6.00e-05	-3.11e-03	-0.03	1.51e-04	-2.23e-06	0.0
4438	-2.04e-03	-2.34e-03	-0.02	9.71e-05	-8.89e-06	0.0
44329	4.92e-04	1.98e-04	-0.02	7.63e-05	2.72e-06	0.0
44334	5.54e-04	-4.07e-03	-0.02	1.12e-04	-1.82e-06	0.0
44340	-2.84e-03	-2.51e-03	-0.02	9.84e-05	-1.19e-05	0.0
44361	7.03e-04	1.05e-03	-0.02	6.92e-05	4.34e-06	0.0
44366	7.90e-04	-4.93e-03	-0.02	1.19e-04	-2.03e-06	0.0
44370	-4.57e-05	-2.26e-03	-0.02	1.10e-04	-1.67e-06	0.0
44372	-3.72e-05	-1.99e-03	-0.02	9.72e-05	-1.40e-06	0.0
44373	-3.51e-05	-1.93e-03	-0.02	9.40e-05	-1.33e-06	0.0
4442	-4.88e-05	-2.25e-03	-0.02	1.10e-04	-2.03e-06	0.0
4448	-1.93e-03	-1.77e-03	-0.01	6.93e-05	-5.81e-06	0.0
44429	4.83e-04	4.80e-04	-0.01	6.25e-05	1.29e-06	0.0
44434	5.33e-04	-3.30e-03	-0.01	7.53e-05	-1.66e-06	0.0
44440	-2.68e-03	-1.92e-03	-0.01	6.95e-05	-7.64e-06	0.0
44461	6.88e-04	1.23e-03	-0.01	6.01e-05	2.31e-06	0.0
44466	7.58e-04	-4.06e-03	-0.01	7.79e-05	-1.83e-06	0.0
44470	-3.73e-05	-1.64e-03	-0.01	7.96e-05	-1.52e-06	0.0
44472	-3.08e-05	-1.45e-03	-0.01	7.09e-05	-1.30e-06	0.0
44473	-2.91e-05	-1.40e-03	-0.01	6.87e-05	-1.24e-06	0.0
4452	-4.17e-05	-1.48e-03	-0.01	7.23e-05	-1.64e-06	0.0
4458	-1.84e-03	-1.26e-03	-0.01	4.42e-05	-3.37e-06	0.0
44529	4.72e-04	7.94e-04	-0.01	4.74e-05	0.0	0.0
44534	5.26e-04	-2.66e-03	-0.01	4.38e-05	-1.05e-06	0.0
44540	-2.57e-03	-1.40e-03	-0.01	4.37e-05	-4.31e-06	0.0
44561	6.71e-04	1.48e-03	-0.01	4.82e-05	0.0	0.0
44566	7.46e-04	-3.35e-03	-0.01	4.31e-05	-1.06e-06	0.0
44570	-3.20e-05	-1.07e-03	-0.01	5.24e-05	-1.23e-06	0.0
44572	-2.63e-05	-9.56e-04	-0.01	4.68e-05	-1.05e-06	0.0
44573	-2.48e-05	-9.26e-04	-0.01	4.54e-05	-1.01e-06	0.0
4461	-2.48e-05	-6.83e-04	-0.01	3.35e-05	0.0	0.0
4462	-3.41e-05	-8.01e-04	-0.01	3.91e-05	-1.21e-06	0.0
4468	-1.78e-03	-8.25e-04-9.06e-03		2.28e-05	-2.04e-06	0.0
44629	4.80e-04	1.13e-03-9.70e-03		3.07e-05	0.0	0.0
44634	5.14e-04	-2.14e-03-8.75e-03		1.88e-05	0.0	0.0
44640	-2.49e-03	-9.55e-04-9.00e-03		2.21e-05	-2.56e-06	0.0
44661	6.80e-04	1.78e-03-9.90e-03		3.31e-05	0.0	0.0
44666	7.28e-04	-2.79e-03-8.56e-03		1.65e-05	0.0	0.0
44669	-2.01e-05	-5.02e-04-9.21e-03		2.46e-05	0.0	0.0
44670	-2.63e-05	-5.81e-04-8.98e-03		2.83e-05	0.0	0.0
44671	-2.01e-05	-5.02e-04-9.21e-03		2.46e-05	0.0	0.0
44672	-2.13e-05	-5.18e-04-9.16e-03		2.53e-05	0.0	0.0
44673	-2.01e-05	-5.02e-04-9.21e-03		2.46e-05	0.0	0.0
4471	-2.13e-05	-1.58e-04	-0.01	7.63e-06	0.0	0.0
4472	-2.98e-05	-1.85e-04	-0.01	8.89e-06	0.0	0.0
4478	-1.74e-03	-4.45e-04-8.41e-03		3.73e-06	-1.38e-06	0.0
44729	4.93e-04	1.48e-03-8.59e-03		1.35e-05	0.0	0.0
44734	5.01e-04	-1.71e-03-8.36e-03		-2.03e-06	0.0	0.0
44740	-2.44e-03	-5.77e-04-8.39e-03		2.98e-06	-1.69e-06	0.0
44761	6.98e-04	2.11e-03-8.64e-03		1.66e-05	0.0	0.0
44766	7.09e-04	-2.35e-03-8.32e-03		-5.09e-06	0.0	0.0
44769	-1.74e-05	-1.16e-04-8.47e-03		5.60e-06	0.0	0.0
44770	-2.31e-05	-1.34e-04-8.13e-03		6.44e-06	0.0	0.0
44771	-1.74e-05	-1.16e-04-8.47e-03		5.60e-06	0.0	0.0
44772	-1.85e-05	-1.20e-04-8.40e-03		5.77e-06	0.0	0.0
44773	-1.74e-05	-1.16e-04-8.47e-03		5.60e-06	0.0	0.0
4481	-2.20e-05	3.54e-04	-0.01	-1.76e-05	0.0	0.0
4482	-3.06e-05	4.15e-04	-0.01	-2.05e-05	-1.02e-06	0.0
44815	-1.75e-03	5.80e-04-8.55e-03		-1.10e-05	-1.54e-06	0.0
44829	5.08e-04	1.86e-03-8.38e-03		-5.75e-06	0.0	0.0
44834	4.87e-04	-1.34e-03-8.94e-03		-2.04e-05	0.0	0.0
44847	-2.45e-03	7.08e-04-8.51e-03		-1.03e-05	-1.91e-06	0.0
44861	7.19e-04	2.51e-03-8.27e-03		-2.87e-06	0.0	0.0
44866	6.88e-04	-1.98e-03-9.06e-03		-2.33e-05	0.0	0.0
44869	-1.79e-05	2.60e-04-8.65e-03		-1.29e-05	0.0	0.0
44870	-2.37e-05	3.01e-04-8.33e-03		-1.49e-05	0.0	0.0
44871	-1.79e-05	2.60e-04-8.65e-03		-1.29e-05	0.0	0.0
44872	-1.91e-05	2.68e-04-8.58e-03		-1.33e-05	0.0	0.0
44873	-1.79e-05	2.60e-04-8.65e-03		-1.29e-05	0.0	0.0
4491	-2.63e-05	8.95e-04	-0.01	-4.43e-05	-1.07e-06	0.0
4492	-3.59e-05	1.05e-03	-0.01	-5.17e-05	-1.32e-06	0.0
44915	-1.80e-03	9.85e-04-9.58e-03		-3.09e-05	-2.39e-06	0.0
44929	5.21e-04	2.32e-03-9.19e-03		-2.82e-05	0.0	0.0
44934	4.75e-04	-9.99e-04	-0.01	-3.72e-05	0.0	0.0



EGP CODE

GRE.EEC.R.73.IT.W.15235.12.024.01

PAGE

147 di/of 527

44947	-2.51e-03	1.12e-03-9.50e-03	-3.03e-05	-3.02e-06	0.0
44961	7.38e-04	2.99e-03-8.95e-03	-2.65e-05	0.0	0.0
44966	6.73e-04	-1.66e-03 -0.01	-3.91e-05	0.0	0.0
44969	-2.12e-05	6.59e-04-9.77e-03	-3.25e-05	0.0	0.0
44970	-2.77e-05	7.63e-04-9.62e-03	-3.75e-05	0.0	0.0
44971	-2.12e-05	6.59e-04-9.77e-03	-3.25e-05	0.0	0.0
44972	-2.25e-05	6.80e-04-9.74e-03	-3.35e-05	0.0	0.0
44973	-2.12e-05	6.59e-04-9.77e-03	-3.25e-05	0.0	0.0
4502	-4.25e-05	1.77e-03 -0.02	-8.67e-05	-1.72e-06	0.0
45015	-1.86e-03	1.45e-03 -0.01	-5.39e-05	-3.94e-06	0.0
45029	5.34e-04	2.89e-03 -0.01	-5.62e-05	-1.13e-06	0.0
45034	4.71e-04	-6.71e-04 -0.01	-5.30e-05	0.0	0.0
45047	-2.60e-03	1.59e-03 -0.01	-5.38e-05	-5.10e-06	0.0
45061	7.57e-04	3.61e-03 -0.01	-5.69e-05	-1.15e-06	0.0
45066	6.70e-04	-1.38e-03 -0.01	-5.25e-05	0.0	0.0
45070	-3.26e-05	1.28e-03 -0.01	-6.29e-05	-1.28e-06	0.0
45072	-2.68e-05	1.14e-03 -0.01	-5.61e-05	-1.10e-06	0.0
45073	-2.54e-05	1.10e-03 -0.01	-5.44e-05	-1.06e-06	0.0
4512	-4.40e-05	2.57e-03 -0.02	-1.26e-04	-1.84e-06	0.0
45115	-1.95e-03	1.99e-03 -0.02	-8.02e-05	-6.74e-06	0.0
45129	5.42e-04	3.59e-03 -0.01	-8.95e-05	-1.77e-06	0.0
45134	4.94e-04	-3.70e-04 -0.02	-6.83e-05	2.12e-06	0.0
45147	-2.73e-03	2.14e-03 -0.01	-8.08e-05	-8.99e-06	0.0
45161	7.69e-04	4.38e-03 -0.01	-9.38e-05	-2.03e-06	0.0
45166	7.03e-04	-1.16e-03 -0.02	-6.42e-05	3.43e-06	0.0
45170	-3.37e-05	1.87e-03 -0.02	-9.14e-05	-1.37e-06	0.0
45172	-2.76e-05	1.66e-03 -0.02	-8.12e-05	-1.17e-06	0.0
45173	-2.61e-05	1.60e-03 -0.02	-7.87e-05	-1.12e-06	0.0
4522	-4.01e-05	3.45e-03 -0.03	-1.68e-04	-1.21e-06	0.0
45215	-2.07e-03	2.57e-03 -0.02	-1.09e-04	-9.54e-06	0.0
45225	3.29e-04	3.68e-03 -0.02	-1.22e-04	0.0	0.0
45229	5.84e-04	4.42e-03 -0.02	-1.29e-04	0.0	0.0
45247	-2.88e-03	2.75e-03 -0.02	-1.10e-04	-1.31e-05	0.0
45257	4.71e-04	4.30e-03 -0.02	-1.29e-04	1.09e-06	0.0
45261	8.26e-04	5.33e-03 -0.02	-1.39e-04	0.0	0.0
45270	-3.09e-05	2.51e-03 -0.02	-1.22e-04	0.0	0.0
45272	-2.42e-05	2.21e-03 -0.02	-1.08e-04	0.0	0.0
45273	-2.26e-05	2.14e-03 -0.02	-1.04e-04	0.0	0.0
4532	-2.63e-04	4.43e-03 -0.04	-2.13e-04	-5.52e-06	0.0
45315	-2.57e-03	3.40e-03 -0.03	-1.45e-04	-2.67e-05	0.0
45333	4.06e-04	5.64e-03 -0.03	-1.87e-04	-3.96e-06	0.0
45335	-9.79e-04	5.69e-03 -0.03	-1.89e-04	-1.73e-05	0.0
45347	-3.54e-03	3.67e-03 -0.03	-1.51e-04	-3.62e-05	0.0
45365	6.28e-04	6.81e-03 -0.03	-2.10e-04	-4.35e-06	0.0
45367	-1.31e-03	6.89e-03 -0.03	-2.12e-04	-2.30e-05	0.0
45370	-1.98e-04	3.24e-03 -0.03	-1.55e-04	-4.13e-06	0.0
45372	-1.58e-04	2.82e-03 -0.03	-1.36e-04	-3.21e-06	0.0
45373	-1.47e-04	2.72e-03 -0.03	-1.31e-04	-2.98e-06	0.0
4542	2.64e-04	4.57e-03 -0.04	-2.18e-04	1.48e-05	0.0
45414	2.45e-03	2.16e-03 -0.03	-1.20e-04	3.25e-05	0.0
45429	9.11e-04	6.17e-03 -0.03	-2.11e-04	1.63e-05	0.0
45433	9.86e-04	6.17e-03 -0.03	-2.10e-04	1.88e-05	0.0
45446	3.37e-03	1.91e-03 -0.03	-1.14e-04	4.20e-05	0.0
45461	1.21e-03	7.53e-03 -0.04	-2.42e-04	1.93e-05	0.0
45465	1.32e-03	7.53e-03 -0.04	-2.42e-04	2.27e-05	0.0
45470	1.95e-04	3.34e-03 -0.03	-1.59e-04	1.10e-05	0.0
45472	1.67e-04	2.88e-03 -0.03	-1.38e-04	9.37e-06	0.0
45473	1.60e-04	2.77e-03 -0.03	-1.33e-04	8.95e-06	0.0
4552	-2.84e-04	-3.95e-03 -0.03	1.92e-04	-1.22e-05	0.0
4558	-2.50e-03	-2.90e-03 -0.02	1.24e-04	-2.54e-05	0.0
45530	5.35e-04	-4.96e-03 -0.02	1.56e-04	-5.09e-06	0.0
45534	4.56e-04	-4.97e-03 -0.02	1.56e-04	-6.86e-06	0.0
45540	-3.43e-03	-3.09e-03 -0.02	1.26e-04	-3.26e-05	0.0
45562	8.20e-04	-5.98e-03 -0.03	1.71e-04	-4.11e-06	0.0
45566	7.08e-04	-5.98e-03 -0.03	1.71e-04	-6.61e-06	0.0
45570	-2.13e-04	-2.88e-03 -0.03	1.40e-04	-9.14e-06	0.0
45572	-1.82e-04	-2.53e-03 -0.02	1.23e-04	-7.85e-06	0.0
45573	-1.74e-04	-2.44e-03 -0.02	1.19e-04	-7.53e-06	0.0
4562	-1.54e-04	-3.11e-03 -0.03	1.51e-04	-7.14e-06	0.0
4568	-2.10e-03	-2.33e-03 -0.02	9.55e-05	-1.26e-05	0.0
4569	1.83e-03	-1.33e-03 -0.02	9.05e-05	3.75e-06	0.0
45634	5.17e-04	-4.09e-03 -0.02	1.13e-04	-3.59e-06	0.0
45640	-2.91e-03	-2.49e-03 -0.02	9.62e-05	-1.59e-05	0.0
45641	2.59e-03	-1.08e-03 -0.02	8.92e-05	7.03e-06	0.0
45666	7.62e-04	-4.96e-03 -0.02	1.21e-04	-3.25e-06	0.0
45670	-1.16e-04	-2.26e-03 -0.02	1.09e-04	-5.35e-06	0.0



EGP CODE

GRE.EEC.R.73.IT.W.15235.12.024.01

PAGE

148 di/of 527

45672	-9.91e-05	-2.00e-03	-0.02	9.70e-05	-4.62e-06	0.0
45673	-9.49e-05	-1.93e-03	-0.02	9.38e-05	-4.44e-06	0.0
4572	-1.08e-04	-2.25e-03	-0.02	1.09e-04	-4.85e-06	0.0
4578	-1.96e-03	-1.75e-03	-0.01	6.80e-05	-7.52e-06	0.0
45729	4.27e-04	4.60e-04	-0.01	6.31e-05	-1.34e-06	0.0
45734	5.16e-04	-3.28e-03	-0.01	7.48e-05	-2.52e-06	0.0
45740	-2.72e-03	-1.90e-03	-0.01	6.77e-05	-9.33e-06	0.0
45761	6.24e-04	1.21e-03	-0.01	6.10e-05	0.0	0.0
45766	7.49e-04	-4.04e-03	-0.01	7.73e-05	-2.32e-06	0.0
45770	-8.17e-05	-1.63e-03	-0.01	7.94e-05	-3.63e-06	0.0
45772	-6.94e-05	-1.45e-03	-0.01	7.06e-05	-3.14e-06	0.0
45773	-6.63e-05	-1.40e-03	-0.01	6.85e-05	-3.02e-06	0.0
4582	-7.56e-05	-1.47e-03	-0.01	7.19e-05	-3.19e-06	0.0
4588	-1.86e-03	-1.25e-03	-0.01	4.34e-05	-4.37e-06	0.0
45829	4.42e-04	7.86e-04	-0.01	4.74e-05	-1.23e-06	0.0
45834	5.14e-04	-2.65e-03	-0.01	4.36e-05	-1.61e-06	0.0
45840	-2.59e-03	-1.39e-03	-0.01	4.27e-05	-5.32e-06	0.0
45861	6.37e-04	1.47e-03	-0.01	4.83e-05	0.0	0.0
45866	7.38e-04	-3.34e-03	-9.98e-03	4.30e-05	-1.45e-06	0.0
45870	-5.74e-05	-1.07e-03	-0.01	5.22e-05	-2.39e-06	0.0
45872	-4.84e-05	-9.52e-04	-0.01	4.66e-05	-2.07e-06	0.0
45873	-4.61e-05	-9.23e-04	-0.01	4.52e-05	-1.99e-06	0.0
4591	-4.20e-05	-6.80e-04	-0.01	3.33e-05	-1.74e-06	0.0
4592	-5.51e-05	-7.97e-04	-0.01	3.88e-05	-2.14e-06	0.0
4598	-1.80e-03	-8.22e-04	-9.01e-03	2.24e-05	-2.62e-06	0.0
45929	4.62e-04	1.12e-03	-9.69e-03	3.07e-05	-1.04e-06	0.0
45934	5.06e-04	-2.13e-03	-8.73e-03	1.87e-05	0.0	0.0
45940	-2.50e-03	-9.52e-04	-8.94e-03	2.16e-05	-3.13e-06	0.0
45961	6.60e-04	1.77e-03	-9.89e-03	3.32e-05	0.0	0.0
45966	7.21e-04	-2.78e-03	-8.55e-03	1.64e-05	0.0	0.0
45969	-3.33e-05	-5.00e-04	-9.19e-03	2.45e-05	-1.33e-06	0.0
45970	-4.19e-05	-5.78e-04	-8.96e-03	2.81e-05	-1.60e-06	0.0
45971	-3.33e-05	-5.00e-04	-9.19e-03	2.45e-05	-1.33e-06	0.0
45972	-3.50e-05	-5.15e-04	-9.14e-03	2.52e-05	-1.39e-06	0.0
45973	-3.33e-05	-5.00e-04	-9.19e-03	2.45e-05	-1.33e-06	0.0
4601	-3.46e-05	-1.57e-04	-0.01	7.59e-06	-1.37e-06	0.0
4602	-4.59e-05	-1.84e-04	-0.01	8.84e-06	-1.68e-06	0.0
4608	-1.75e-03	-4.47e-04	-8.38e-03	3.59e-06	-1.82e-06	0.0
46029	4.82e-04	1.47e-03	-8.58e-03	1.34e-05	0.0	0.0
46034	4.91e-04	-1.70e-03	-8.35e-03	-2.05e-06	0.0	0.0
46040	-2.44e-03	-5.80e-04	-8.35e-03	2.80e-06	-2.13e-06	0.0
46061	6.86e-04	2.10e-03	-8.63e-03	1.66e-05	0.0	0.0
46066	6.99e-04	-2.34e-03	-8.31e-03	-5.10e-06	0.0	0.0
46069	-2.75e-05	-1.16e-04	-8.45e-03	5.57e-06	-1.05e-06	0.0
46070	-3.51e-05	-1.34e-04	-8.11e-03	6.40e-06	-1.25e-06	0.0
46071	-2.75e-05	-1.16e-04	-8.45e-03	5.57e-06	-1.05e-06	0.0
46072	-2.91e-05	-1.19e-04	-8.38e-03	5.73e-06	-1.09e-06	0.0
46073	-2.75e-05	-1.16e-04	-8.45e-03	5.57e-06	-1.05e-06	0.0
4611	-3.62e-05	3.52e-04	-0.01	-1.75e-05	-1.45e-06	0.0
4612	-4.79e-05	4.13e-04	-0.01	-2.04e-05	-1.79e-06	0.0
46115	-1.76e-03	5.80e-04	-8.51e-03	-1.08e-05	-1.92e-06	0.0
46129	4.99e-04	1.85e-03	-8.36e-03	-5.69e-06	0.0	0.0
46134	4.73e-04	-1.33e-03	-8.93e-03	-2.03e-05	0.0	0.0
46147	-2.46e-03	7.09e-04	-8.47e-03	-1.00e-05	-2.25e-06	0.0
46161	7.10e-04	2.49e-03	-8.26e-03	-2.82e-06	0.0	0.0
46166	6.74e-04	-1.97e-03	-9.05e-03	-2.33e-05	0.0	0.0
46169	-2.88e-05	2.59e-04	-8.63e-03	-1.29e-05	-1.11e-06	0.0
46170	-3.66e-05	2.99e-04	-8.31e-03	-1.48e-05	-1.33e-06	0.0
46171	-2.88e-05	2.59e-04	-8.63e-03	-1.29e-05	-1.11e-06	0.0
46172	-3.04e-05	2.67e-04	-8.57e-03	-1.32e-05	-1.16e-06	0.0
46173	-2.88e-05	2.59e-04	-8.63e-03	-1.29e-05	-1.11e-06	0.0
4621	-4.70e-05	8.92e-04	-0.01	-4.41e-05	-2.01e-06	0.0
4622	-6.11e-05	1.05e-03	-0.01	-5.15e-05	-2.47e-06	0.0
46215	-1.81e-03	9.80e-04	-9.52e-03	-3.04e-05	-3.10e-06	0.0
46229	5.11e-04	2.31e-03	-9.17e-03	-2.81e-05	-1.12e-06	0.0
46234	4.52e-04	-9.91e-04	-0.01	-3.72e-05	-1.20e-06	0.0
46247	-2.52e-03	1.11e-03	-9.44e-03	-2.96e-05	-3.73e-06	0.0
46261	7.31e-04	2.98e-03	-8.94e-03	-2.63e-05	0.0	0.0
46266	6.48e-04	-1.65e-03	-0.01	-3.92e-05	-1.06e-06	0.0
46269	-3.71e-05	6.56e-04	-9.74e-03	-3.24e-05	-1.54e-06	0.0
46270	-4.65e-05	7.60e-04	-9.59e-03	-3.73e-05	-1.84e-06	0.0
46271	-3.71e-05	6.56e-04	-9.74e-03	-3.24e-05	-1.54e-06	0.0
46272	-3.90e-05	6.77e-04	-9.71e-03	-3.34e-05	-1.60e-06	0.0
46273	-3.71e-05	6.56e-04	-9.74e-03	-3.24e-05	-1.54e-06	0.0
4632	-8.58e-05	1.76e-03	-0.02	-8.63e-05	-3.73e-06	0.0
46315	-1.89e-03	1.44e-03	-0.01	-5.30e-05	-5.21e-06	0.0



EGP CODE

GRE.EEC.R.73.IT.W.15235.12.024.01

PAGE

149 di/of 527

46329	5.18e-04	2.88e-03	-0.01	-5.60e-05	-1.88e-06	0.0
46334	4.33e-04	-6.63e-04	-0.01	-5.31e-05	-1.38e-06	0.0
46347	-2.62e-03	1.57e-03	-0.01	-5.26e-05	-6.37e-06	0.0
46361	7.46e-04	3.60e-03	-0.01	-5.68e-05	-1.71e-06	0.0
46366	6.27e-04	-1.37e-03	-0.01	-5.27e-05	-1.00e-06	0.0
46370	-6.50e-05	1.28e-03	-0.01	-6.26e-05	-2.79e-06	0.0
46372	-5.50e-05	1.14e-03	-0.01	-5.58e-05	-2.42e-06	0.0
46373	-5.25e-05	1.10e-03	-0.01	-5.42e-05	-2.33e-06	0.0
4642	-1.22e-04	2.57e-03	-0.02	-1.26e-04	-5.59e-06	0.0
46415	-2.00e-03	1.97e-03	-0.01	-7.86e-05	-9.13e-06	0.0
46429	5.20e-04	3.57e-03	-0.01	-8.89e-05	-2.86e-06	0.0
46434	4.21e-04	-3.44e-04	-0.02	-6.92e-05	-1.36e-06	0.0
46447	-2.78e-03	2.11e-03	-0.01	-7.86e-05	-1.14e-05	0.0
46461	7.58e-04	4.36e-03	-0.01	-9.31e-05	-2.61e-06	0.0
46466	6.20e-04	-1.12e-03	-0.02	-6.54e-05	0.0	0.0
46470	-9.19e-05	1.87e-03	-0.02	-9.12e-05	-4.18e-06	0.0
46472	-7.83e-05	1.66e-03	-0.02	-8.10e-05	-3.62e-06	0.0
46473	-7.49e-05	1.60e-03	-0.02	-7.85e-05	-3.48e-06	0.0
4652	-1.68e-04	3.46e-03	-0.03	-1.68e-04	-7.96e-06	0.0
46515	-2.15e-03	2.57e-03	-0.02	-1.07e-04	-1.41e-05	0.0
46525	2.51e-04	3.73e-03	-0.02	-1.23e-04	-3.20e-06	0.0
46529	5.17e-04	4.46e-03	-0.02	-1.31e-04	-4.17e-06	0.0
46547	-2.96e-03	2.74e-03	-0.02	-1.08e-04	-1.78e-05	0.0
46557	3.94e-04	4.36e-03	-0.02	-1.30e-04	-2.49e-06	0.0
46561	7.65e-04	5.39e-03	-0.02	-1.41e-04	-3.86e-06	0.0
46570	-1.27e-04	2.52e-03	-0.02	-1.22e-04	-5.97e-06	0.0
46572	-1.09e-04	2.22e-03	-0.02	-1.08e-04	-5.16e-06	0.0
46573	-1.04e-04	2.14e-03	-0.02	-1.04e-04	-4.96e-06	0.0
4662	-2.92e-04	4.25e-03	-0.04	-2.08e-04	-1.27e-05	0.0
46615	-2.69e-03	3.14e-03	-0.03	-1.37e-04	-3.43e-05	0.0
46629	4.99e-04	5.43e-03	-0.03	-1.82e-04	-5.44e-06	0.0
46633	5.95e-04	5.43e-03	-0.03	-1.82e-04	-2.81e-06	0.0
46647	-3.70e-03	3.35e-03	-0.03	-1.40e-04	-4.48e-05	0.0
46661	7.70e-04	6.56e-03	-0.03	-2.04e-04	-4.46e-06	0.0
46665	9.05e-04	6.55e-03	-0.03	-2.04e-04	0.0	0.0
46670	-2.20e-04	3.11e-03	-0.03	-1.52e-04	-9.55e-06	0.0
46672	-1.88e-04	2.71e-03	-0.03	-1.33e-04	-8.24e-06	0.0
46673	-1.80e-04	2.61e-03	-0.03	-1.28e-04	-7.91e-06	0.0
4672	-8.92e-04	-4.51e-03	-0.04	2.13e-04	-4.56e-05	0.0
4678	-2.71e-03	-3.46e-03	-0.03	1.42e-04	-4.66e-05	0.0
46730	4.21e-05	-6.01e-03	-0.03	2.02e-04	-3.12e-05	0.0
46734	-1.94e-05	-6.04e-03	-0.03	2.02e-04	-3.29e-05	0.0
46740	-3.57e-03	-3.75e-03	-0.03	1.46e-04	-5.41e-05	0.0
46762	2.79e-04	-7.33e-03	-0.04	2.31e-04	-3.24e-05	0.0
46766	1.93e-04	-7.37e-03	-0.04	2.31e-04	-3.49e-05	0.0
46770	-6.68e-04	-3.30e-03	-0.03	1.56e-04	-3.41e-05	0.0
46772	-5.73e-04	-2.85e-03	-0.03	1.35e-04	-2.93e-05	0.0
46773	-5.50e-04	-2.74e-03	-0.03	1.30e-04	-2.81e-05	0.0
4682	-2.45e-04	-4.02e-03	-0.03	1.92e-04	-1.68e-05	0.0
46811	-2.36e-03	-1.54e-03	-0.02	9.94e-05	-2.64e-05	0.0
46830	7.33e-04	-5.13e-03	-0.02	1.63e-04	-2.29e-06	0.0
46843	-3.24e-03	-1.17e-03	-0.02	9.16e-05	-3.27e-05	0.0
46862	1.09e-03	-6.19e-03	-0.03	1.80e-04	1.14e-06	0.0
46870	-1.85e-04	-2.93e-03	-0.02	1.40e-04	-1.26e-05	0.0
46872	-1.68e-04	-2.57e-03	-0.02	1.23e-04	-1.12e-05	0.0
46873	-1.64e-04	-2.47e-03	-0.02	1.19e-04	-1.09e-05	0.0
4692	-2.98e-04	-3.04e-03	-0.02	1.47e-04	-1.44e-05	0.0
4698	-2.16e-03	-2.25e-03	-0.02	9.07e-05	-1.53e-05	0.0
4699	1.70e-03	-1.34e-03	-0.02	9.16e-05	-2.90e-06	0.0
46930	4.94e-04	-4.02e-03	-0.02	1.11e-04	-5.97e-06	0.0
46940	-2.96e-03	-2.39e-03	-0.02	9.02e-05	-1.79e-05	0.0
46941	2.45e-03	-1.11e-03	-0.02	9.14e-05	0.0	0.0
46962	7.66e-04	-4.88e-03	-0.02	1.19e-04	-4.74e-06	0.0
46970	-2.24e-04	-2.21e-03	-0.02	1.07e-04	-1.08e-05	0.0
46972	-1.94e-04	-1.95e-03	-0.02	9.50e-05	-9.40e-06	0.0
46973	-1.86e-04	-1.89e-03	-0.02	9.19e-05	-9.05e-06	0.0
4702	-1.94e-04	-2.20e-03	-0.02	1.07e-04	-8.92e-06	0.0
4708	-2.00e-03	-1.71e-03	-0.01	6.52e-05	-9.28e-06	0.0
47029	3.39e-04	4.71e-04	-0.01	6.22e-05	-5.52e-06	0.0
47030	5.17e-04	-3.25e-03	-0.01	7.42e-05	-3.36e-06	0.0
47040	-2.75e-03	-1.84e-03	-0.01	6.44e-05	-1.08e-05	0.0
47061	5.23e-04	1.21e-03	-0.01	6.02e-05	-5.49e-06	0.0
47062	7.73e-04	-4.00e-03	-0.01	7.70e-05	-2.46e-06	0.0
47070	-1.46e-04	-1.60e-03	-0.01	7.78e-05	-6.68e-06	0.0
47072	-1.26e-04	-1.42e-03	-0.01	6.93e-05	-5.81e-06	0.0
47073	-1.21e-04	-1.37e-03	-0.01	6.72e-05	-5.59e-06	0.0



EGP CODE

GRE.EEC.R.73.IT.W.15235.12.024.01

PAGE

150 di/of 527

4712	-1.24e-04	-1.45e-03	-0.01	7.07e-05	-5.38e-06	0.0
4718	-1.88e-03	-1.23e-03	-0.01	4.19e-05	-5.22e-06	0.0
47129	3.94e-04	7.86e-04	-0.01	4.69e-05	-3.50e-06	0.0
47130	5.16e-04	-2.62e-03	-0.01	4.33e-05	-2.08e-06	0.0
47140	-2.61e-03	-1.36e-03	-0.01	4.08e-05	-5.97e-06	0.0
47161	5.82e-04	1.46e-03	-0.01	4.79e-05	-3.54e-06	0.0
47162	7.53e-04	-3.31e-03	-9.97e-03	4.28e-05	-1.56e-06	0.0
47170	-9.34e-05	-1.05e-03	-0.01	5.12e-05	-4.03e-06	0.0
47172	-7.98e-05	-9.35e-04	-0.01	4.58e-05	-3.51e-06	0.0
47173	-7.64e-05	-9.06e-04	-0.01	4.44e-05	-3.37e-06	0.0
4721	-6.58e-05	-6.69e-04	-0.01	3.28e-05	-2.79e-06	0.0
4722	-8.38e-05	-7.84e-04	-0.01	3.82e-05	-3.41e-06	0.0
4728	-1.81e-03	-8.13e-04	-8.93e-03	2.16e-05	-3.10e-06	0.0
47229	4.35e-04	1.11e-03	-8.64e-03	3.03e-05	-2.24e-06	0.0
47234	4.93e-04	-2.11e-03	-8.70e-03	1.84e-05	-1.50e-06	0.0
47240	-2.51e-03	-9.43e-04	-8.84e-03	2.07e-05	-3.48e-06	0.0
47261	6.29e-04	1.76e-03	-9.84e-03	3.28e-05	-2.28e-06	0.0
47266	7.11e-04	-2.76e-03	-8.52e-03	1.62e-05	-1.25e-06	0.0
47269	-5.14e-05	-4.91e-04	-9.14e-03	2.40e-05	-2.14e-06	0.0
47270	-6.34e-05	-5.68e-04	-8.90e-03	2.77e-05	-2.55e-06	0.0
47271	-5.14e-05	-4.91e-04	-9.14e-03	2.40e-05	-2.14e-06	0.0
47272	-5.38e-05	-5.07e-04	-9.09e-03	2.48e-05	-2.22e-06	0.0
47273	-5.14e-05	-4.91e-04	-9.14e-03	2.40e-05	-2.14e-06	0.0
4731	-5.24e-05	-1.55e-04	-0.01	7.47e-06	-2.14e-06	0.0
4732	-6.74e-05	-1.81e-04	-0.01	8.70e-06	-2.61e-06	0.0
4738	-1.76e-03	-4.39e-04	-8.32e-03	3.37e-06	-2.24e-06	0.0
47329	4.65e-04	1.46e-03	-8.55e-03	1.33e-05	-1.54e-06	0.0
47334	4.78e-04	-1.69e-03	-8.32e-03	-2.00e-06	-1.37e-06	0.0
47340	-2.45e-03	-5.70e-04	-8.28e-03	2.53e-06	-2.48e-06	0.0
47361	6.68e-04	2.09e-03	-8.60e-03	1.64e-05	-1.50e-06	0.0
47366	6.86e-04	-2.32e-03	-8.28e-03	-5.00e-06	-1.27e-06	0.0
47369	-4.11e-05	-1.14e-04	-8.41e-03	5.48e-06	-1.63e-06	0.0
47370	-5.11e-05	-1.31e-04	-8.06e-03	6.30e-06	-1.95e-06	0.0
47371	-4.11e-05	-1.14e-04	-8.41e-03	5.48e-06	-1.63e-06	0.0
47372	-4.31e-05	-1.17e-04	-8.34e-03	5.64e-06	-1.70e-06	0.0
47373	-4.11e-05	-1.14e-04	-8.41e-03	5.48e-06	-1.63e-06	0.0
4741	-5.56e-05	3.46e-04	-0.01	-1.73e-05	-2.30e-06	0.0
4742	-7.13e-05	4.06e-04	-0.01	-2.01e-05	-2.81e-06	0.0
47415	-1.77e-03	5.78e-04	-8.45e-03	-1.04e-05	-2.42e-06	0.0
47429	4.87e-04	1.84e-03	-8.33e-03	-5.62e-06	-1.35e-06	0.0
47434	4.53e-04	-1.32e-03	-8.89e-03	-2.01e-05	-1.78e-06	0.0
47447	-2.46e-03	7.07e-04	-8.39e-03	-9.51e-06	-2.68e-06	0.0
47461	6.99e-04	2.48e-03	-8.23e-03	-2.81e-06	-1.18e-06	0.0
47466	6.52e-04	-1.96e-03	-9.01e-03	-2.30e-05	-1.79e-06	0.0
47469	-4.35e-05	2.54e-04	-8.59e-03	-1.27e-05	-1.76e-06	0.0
47470	-5.40e-05	2.94e-04	-8.26e-03	-1.45e-05	-2.10e-06	0.0
47471	-4.35e-05	2.54e-04	-8.59e-03	-1.27e-05	-1.76e-06	0.0
47472	-4.56e-05	2.62e-04	-8.52e-03	-1.30e-05	-1.83e-06	0.0
47473	-4.35e-05	2.54e-04	-8.59e-03	-1.27e-05	-1.76e-06	0.0
4751	-7.60e-05	8.77e-04	-0.01	-4.34e-05	-3.31e-06	0.0
4752	-9.63e-05	1.03e-03	-0.01	-5.06e-05	-4.05e-06	0.0
47515	-1.83e-03	9.66e-04	-9.42e-03	-2.94e-05	-3.70e-06	0.0
47529	4.97e-04	2.29e-03	-9.13e-03	-2.77e-05	-1.73e-06	0.0
47534	4.19e-04	-9.89e-04	-0.01	-3.68e-05	-2.71e-06	0.0
47547	-2.54e-03	1.09e-03	-9.32e-03	-2.84e-05	-4.16e-06	0.0
47561	7.20e-04	2.95e-03	-8.90e-03	-2.60e-05	-1.40e-06	0.0
47566	6.10e-04	-1.64e-03	-0.01	-3.87e-05	-2.78e-06	0.0
47569	-5.92e-05	6.45e-04	-9.68e-03	-3.18e-05	-2.54e-06	0.0
47570	-7.28e-05	7.46e-04	-9.52e-03	-3.67e-05	-3.03e-06	0.0
47571	-5.92e-05	6.45e-04	-9.68e-03	-3.18e-05	-2.54e-06	0.0
47572	-6.19e-05	6.65e-04	-9.65e-03	-3.28e-05	-2.64e-06	0.0
47573	-5.92e-05	6.45e-04	-9.68e-03	-3.18e-05	-2.54e-06	0.0
4762	-1.48e-04	1.73e-03	-0.02	-8.48e-05	-6.62e-06	0.0
47615	-1.92e-03	1.41e-03	-0.01	-5.11e-05	-6.44e-06	0.0
47633	5.15e-04	2.85e-03	-0.01	-5.55e-05	-2.61e-06	0.0
47634	3.73e-04	-6.64e-04	-0.01	-5.25e-05	-4.24e-06	0.0
47647	-2.65e-03	1.54e-03	-0.01	-5.02e-05	-7.36e-06	0.0
47665	7.57e-04	3.56e-03	-0.01	-5.64e-05	-1.99e-06	0.0
47666	5.59e-04	-1.36e-03	-0.01	-5.22e-05	-4.28e-06	0.0
47670	-1.11e-04	1.25e-03	-0.01	-6.15e-05	-4.95e-06	0.0
47672	-9.54e-05	1.12e-03	-0.01	-5.48e-05	-4.31e-06	0.0
47673	-9.14e-05	1.08e-03	-0.01	-5.32e-05	-4.15e-06	0.0
4772	-2.36e-04	2.52e-03	-0.02	-1.23e-04	-1.11e-05	0.0
47715	-2.05e-03	1.91e-03	-0.01	-7.52e-05	-1.14e-05	0.0
47733	5.10e-04	3.54e-03	-0.01	-8.83e-05	-4.23e-06	0.0
47734	3.08e-04	-3.62e-04	-0.02	-6.80e-05	-6.83e-06	0.0





EGP CODE

GRE.EEC.R.73.IT.W.15235.12.024.01

PAGE

151 di/of 527

47747	-2.81e-03	2.04e-03	-0.01	-7.45e-05	-1.32e-05	0.0
47765	7.73e-04	4.33e-03	-0.01	-9.28e-05	-3.15e-06	0.0
47766	4.90e-04	-1.14e-03	-0.02	-6.44e-05	-6.79e-06	0.0
47770	-1.78e-04	1.83e-03	-0.02	-8.93e-05	-8.29e-06	0.0
47772	-1.53e-04	1.62e-03	-0.02	-7.94e-05	-7.20e-06	0.0
47773	-1.47e-04	1.57e-03	-0.02	-7.69e-05	-6.93e-06	0.0
4782	-3.71e-04	3.38e-03	-0.03	-1.64e-04	-1.82e-05	0.0
47813	1.65e-03	2.65e-03	-0.02	-1.12e-04	-3.41e-06	0.0
47815	-2.25e-03	2.47e-03	-0.02	-1.02e-04	-1.90e-05	0.0
47833	4.63e-04	4.37e-03	-0.02	-1.28e-04	-8.23e-06	0.0
47845	2.41e-03	2.88e-03	-0.02	-1.17e-04	0.0	0.0
47847	-3.06e-03	2.62e-03	-0.02	-1.02e-04	-2.20e-05	0.0
47865	7.41e-04	5.29e-03	-0.02	-1.38e-04	-6.96e-06	0.0
47870	-2.79e-04	2.46e-03	-0.02	-1.19e-04	-1.37e-05	0.0
47872	-2.41e-04	2.16e-03	-0.02	-1.05e-04	-1.19e-05	0.0
47873	-2.32e-04	2.09e-03	-0.02	-1.02e-04	-1.14e-05	0.0
4792	-3.72e-04	4.38e-03	-0.04	-2.08e-04	-2.42e-05	0.0
47920	-2.51e-03	1.61e-03	-0.02	-1.03e-04	-3.39e-05	0.0
47933	6.72e-04	5.67e-03	-0.03	-1.87e-04	-7.14e-06	0.0
47952	-3.42e-03	1.19e-03	-0.02	-9.31e-05	-4.14e-05	0.0
47965	1.04e-03	6.86e-03	-0.03	-2.10e-04	-3.83e-06	0.0
47970	-2.80e-04	3.20e-03	-0.03	-1.52e-04	-1.81e-05	0.0
47972	-2.51e-04	2.78e-03	-0.03	-1.33e-04	-1.59e-05	0.0
47973	-2.44e-04	2.68e-03	-0.03	-1.28e-04	-1.54e-05	0.0
4802	-8.72e-04	4.47e-03	-0.04	-2.13e-04	-4.50e-05	0.0
48015	-2.73e-03	3.34e-03	-0.03	-1.41e-04	-4.67e-05	0.0
48029	6.47e-06	6.00e-03	-0.03	-2.01e-04	-3.16e-05	0.0
48033	6.93e-05	6.00e-03	-0.03	-2.01e-04	-2.98e-05	0.0
48047	-3.61e-03	3.59e-03	-0.03	-1.45e-04	-5.42e-05	0.0
48061	2.24e-04	7.32e-03	-0.04	-2.30e-04	-3.32e-05	0.0
48065	3.13e-04	7.31e-03	-0.04	-2.30e-04	-3.06e-05	0.0
48070	-6.53e-04	3.27e-03	-0.03	-1.55e-04	-3.37e-05	0.0
48072	-5.61e-04	2.83e-03	-0.03	-1.35e-04	-2.89e-05	0.0
48073	-5.38e-04	2.72e-03	-0.03	-1.30e-04	-2.78e-05	0.0
4812	-1.23e-03	-3.59e-03	-0.04	1.75e-04	-6.27e-05	0.0
4818	-2.67e-03	-2.68e-03	-0.03	1.11e-04	-4.18e-05	0.0
48130	-2.72e-04	-4.88e-03	-0.03	1.56e-04	-4.95e-05	0.0
48140	-3.43e-03	-2.87e-03	-0.03	1.12e-04	-4.31e-05	0.0
48162	-8.07e-05	-5.95e-03	-0.03	1.75e-04	-5.40e-05	0.0
48170	-9.17e-04	-2.61e-03	-0.03	1.27e-04	-4.69e-05	0.0
48172	-7.84e-04	-2.29e-03	-0.03	1.12e-04	-4.01e-05	0.0
48173	-7.51e-04	-2.21e-03	-0.03	1.08e-04	-3.84e-05	0.0
4822	-8.12e-04	-3.38e-03	-0.03	1.65e-04	-4.10e-05	0.0
4828	-2.37e-03	-2.48e-03	-0.02	1.02e-04	-2.66e-05	0.0
48230	1.53e-04	-4.55e-03	-0.02	1.39e-04	-2.66e-05	0.0
48240	-3.12e-03	-2.64e-03	-0.02	1.02e-04	-2.71e-05	0.0
48262	4.15e-04	-5.53e-03	-0.02	1.54e-04	-2.71e-05	0.0
48270	-6.09e-04	-2.45e-03	-0.02	1.20e-04	-3.07e-05	0.0
48272	-5.24e-04	-2.16e-03	-0.02	1.06e-04	-2.64e-05	0.0
48273	-5.03e-04	-2.09e-03	-0.02	1.02e-04	-2.54e-05	0.0
4832	-4.94e-04	-2.77e-03	-0.02	1.36e-04	-2.39e-05	0.0
4836	1.55e-03	-2.28e-03	-0.02	9.57e-05	-1.29e-05	0.0
4837	-2.17e-03	-1.16e-03	-0.02	7.37e-05	-1.70e-05	0.0
48330	3.91e-04	-3.84e-03	-0.02	1.06e-04	-1.17e-05	0.0
48338	2.30e-03	-2.51e-03	-0.02	1.00e-04	-1.21e-05	0.0
48339	-2.91e-03	-9.33e-04	-0.02	6.93e-05	-1.78e-05	0.0
48362	6.71e-04	-4.70e-03	-0.02	1.14e-04	-1.03e-05	0.0
48370	-3.71e-04	-2.01e-03	-0.02	9.84e-05	-1.79e-05	0.0
48372	-3.20e-04	-1.78e-03	-0.02	8.74e-05	-1.55e-05	0.0
48373	-3.07e-04	-1.72e-03	-0.02	8.47e-05	-1.49e-05	0.0
4842	-2.94e-04	-2.06e-03	-0.02	1.01e-04	-1.36e-05	0.0
4847	-2.00e-03	-8.09e-04	-0.01	5.67e-05	-1.00e-05	0.0
48429	2.30e-04	5.34e-04	-0.01	5.81e-05	-1.06e-05	0.0
48430	4.65e-04	-3.15e-03	-0.01	7.12e-05	-5.85e-06	0.0
48439	-2.73e-03	-6.19e-04	-0.01	5.42e-05	-1.06e-05	0.0
48461	3.96e-04	1.26e-03	-0.01	5.60e-05	-1.14e-05	0.0
48462	7.25e-04	-3.89e-03	-0.01	7.44e-05	-4.77e-06	0.0
48470	-2.21e-04	-1.49e-03	-0.01	7.30e-05	-1.02e-05	0.0
48472	-1.91e-04	-1.32e-03	-0.01	6.51e-05	-8.87e-06	0.0
48473	-1.83e-04	-1.28e-03	-0.01	6.32e-05	-8.54e-06	0.0
4851	-1.42e-04	-1.17e-03	-0.01	5.75e-05	-6.37e-06	0.0
4852	-1.77e-04	-1.37e-03	-0.01	6.71e-05	-7.77e-06	0.0
4858	-1.88e-03	-1.18e-03	-0.01	3.88e-05	-5.20e-06	0.0
48529	3.32e-04	8.15e-04	-0.01	4.44e-05	-6.28e-06	0.0
48530	4.92e-04	-2.55e-03	-0.01	4.17e-05	-3.15e-06	0.0
48540	-2.59e-03	-1.31e-03	-0.01	3.75e-05	-5.32e-06	0.0



EGP CODE

GRE.EEC.R.73.IT.W.15235.12.024.01

PAGE

152 di/of 527

48561	5.09e-04	1.48e-03	-0.01	4.53e-05	-6.84e-06	0.0
48562	7.33e-04	-3.24e-03	-9.87e-03	4.16e-05	-2.45e-06	0.0
48569	-1.10e-04	-8.56e-04	-0.01	4.21e-05	-4.88e-06	0.0
48570	-1.33e-04	-9.90e-04	-0.01	4.85e-05	-5.81e-06	0.0
48571	-1.10e-04	-8.56e-04	-0.01	4.21e-05	-4.88e-06	0.0
48572	-1.15e-04	-8.83e-04	-0.01	4.34e-05	-5.07e-06	0.0
48573	-1.10e-04	-8.56e-04	-0.01	4.21e-05	-4.88e-06	0.0
4861	-9.06e-05	-6.37e-04	-0.01	3.13e-05	-3.84e-06	0.0
4862	-1.14e-04	-7.45e-04	-0.01	3.64e-05	-4.67e-06	0.0
4868	-1.81e-03	-7.92e-04	-8.77e-03	2.02e-05	-3.05e-06	0.0
48629	4.00e-04	1.12e-03	-9.49e-03	2.88e-05	-3.72e-06	0.0
48634	4.80e-04	-2.07e-03	-8.61e-03	1.79e-05	-2.04e-06	0.0
48640	-2.50e-03	-9.23e-04	-8.67e-03	1.90e-05	-3.09e-06	0.0
48661	5.89e-04	1.76e-03	-9.68e-03	3.12e-05	-4.03e-06	0.0
48666	7.00e-04	-2.71e-03	-8.45e-03	1.59e-05	-1.68e-06	0.0
48669	-7.03e-05	-4.67e-04	-9.01e-03	2.29e-05	-2.95e-06	0.0
48670	-8.57e-05	-5.39e-04	-8.74e-03	2.63e-05	-3.50e-06	0.0
48671	-7.03e-05	-4.67e-04	-9.01e-03	2.29e-05	-2.95e-06	0.0
48672	-7.34e-05	-4.82e-04	-8.96e-03	2.36e-05	-3.06e-06	0.0
48673	-7.03e-05	-4.67e-04	-9.01e-03	2.29e-05	-2.95e-06	0.0
4871	-7.00e-05	-1.48e-04	-0.01	7.16e-06	-2.85e-06	0.0
4872	-8.85e-05	-1.73e-04	-0.01	8.32e-06	-3.46e-06	0.0
4878	-1.76e-03	-4.42e-04	-8.20e-03	3.06e-06	-2.26e-06	0.0
48729	4.46e-04	1.45e-03	-8.45e-03	1.26e-05	-2.34e-06	0.0
48734	4.64e-04	-1.67e-03	-8.24e-03	-1.74e-06	-1.96e-06	0.0
48740	-2.45e-03	-5.75e-04	-8.15e-03	2.19e-06	-2.29e-06	0.0
48761	6.46e-04	2.07e-03	-8.50e-03	1.55e-05	-2.41e-06	0.0
48766	6.71e-04	-2.29e-03	-8.20e-03	-4.54e-06	-1.87e-06	0.0
48769	-5.45e-05	-1.09e-04	-8.32e-03	5.24e-06	-2.18e-06	0.0
48770	-6.68e-05	-1.25e-04	-7.95e-03	6.01e-06	-2.59e-06	0.0
48771	-5.45e-05	-1.09e-04	-8.32e-03	5.24e-06	-2.18e-06	0.0
48772	-5.69e-05	-1.12e-04	-8.24e-03	5.40e-06	-2.26e-06	0.0
48773	-5.45e-05	-1.09e-04	-8.32e-03	5.24e-06	-2.18e-06	0.0
4881	-7.50e-05	3.30e-04	-0.01	-1.65e-05	-3.10e-06	0.0
4882	-9.46e-05	3.85e-04	-0.01	-1.92e-05	-3.77e-06	0.0
48815	-1.77e-03	5.71e-04	-8.32e-03	-9.69e-06	-2.44e-06	0.0
48829	4.73e-04	1.81e-03	-8.25e-03	-5.56e-06	-1.90e-06	0.0
48834	4.29e-04	-1.32e-03	-8.77e-03	-1.91e-05	-2.78e-06	0.0
48847	-2.46e-03	7.04e-04	-8.26e-03	-8.73e-06	-2.46e-06	0.0
48861	6.86e-04	2.44e-03	-8.16e-03	-2.95e-06	-1.71e-06	0.0
48866	6.25e-04	-1.95e-03	-8.89e-03	-2.19e-05	-2.94e-06	0.0
48869	-5.83e-05	2.42e-04	-8.48e-03	-1.21e-05	-2.38e-06	0.0
48870	-7.13e-05	2.79e-04	-8.14e-03	-1.39e-05	-2.82e-06	0.0
48871	-5.83e-05	2.42e-04	-8.48e-03	-1.21e-05	-2.38e-06	0.0
48872	-6.09e-05	2.49e-04	-8.41e-03	-1.24e-05	-2.46e-06	0.0
48873	-5.83e-05	2.42e-04	-8.48e-03	-1.21e-05	-2.38e-06	0.0
4891	-1.07e-04	8.33e-04	-0.01	-4.14e-05	-4.68e-06	0.0
4892	-1.34e-04	9.75e-04	-0.01	-4.82e-05	-5.70e-06	0.0
48915	-1.83e-03	9.33e-04	-9.23e-03	-2.74e-05	-3.72e-06	0.0
48929	4.82e-04	2.24e-03	-9.02e-03	-2.68e-05	-2.40e-06	0.0
48934	3.76e-04	-1.00e-03	-0.01	-3.49e-05	-4.60e-06	0.0
48947	-2.53e-03	1.06e-03	-9.11e-03	-2.62e-05	-3.78e-06	0.0
48961	7.08e-04	2.90e-03	-8.82e-03	-2.53e-05	-1.93e-06	0.0
48966	5.59e-04	-1.65e-03	-0.01	-3.67e-05	-5.01e-06	0.0
48969	-8.29e-05	6.11e-04	-9.53e-03	-3.03e-05	-3.59e-06	0.0
48970	-1.01e-04	7.05e-04	-9.34e-03	-3.48e-05	-4.26e-06	0.0
48971	-8.29e-05	6.11e-04	-9.53e-03	-3.03e-05	-3.59e-06	0.0
48972	-8.65e-05	6.30e-04	-9.49e-03	-3.12e-05	-3.72e-06	0.0
48973	-8.29e-05	6.11e-04	-9.53e-03	-3.03e-05	-3.59e-06	0.0
4902	-2.17e-04	1.63e-03	-0.02	-8.01e-05	-9.79e-06	0.0
49015	-1.92e-03	1.34e-03	-0.01	-4.72e-05	-6.55e-06	0.0
49033	4.83e-04	2.77e-03	-0.01	-5.32e-05	-4.10e-06	0.0
49034	2.96e-04	-7.05e-04	-0.01	-4.96e-05	-7.78e-06	0.0
49047	-2.63e-03	1.46e-03	-0.01	-4.59e-05	-6.71e-06	0.0
49065	7.30e-04	3.48e-03	-0.01	-5.44e-05	-3.28e-06	0.0
49066	4.68e-04	-1.39e-03	-0.01	-4.93e-05	-8.43e-06	0.0
49070	-1.63e-04	1.18e-03	-0.01	-5.80e-05	-7.33e-06	0.0
49072	-1.40e-04	1.05e-03	-0.01	-5.18e-05	-6.38e-06	0.0
49073	-1.35e-04	1.02e-03	-0.01	-5.03e-05	-6.15e-06	0.0
4912	-3.64e-04	2.33e-03	-0.02	-1.15e-04	-1.72e-05	0.0
49116	-2.06e-03	9.45e-04	-0.01	-6.38e-05	-1.24e-05	0.0
49118	1.51e-03	9.72e-04	-0.02	-7.44e-05	-1.03e-05	0.0
49133	4.37e-04	3.41e-03	-0.01	-8.44e-05	-7.80e-06	0.0
49148	-2.79e-03	7.40e-04	-0.01	-6.06e-05	-1.31e-05	0.0
49150	2.21e-03	7.78e-04	-0.02	-7.54e-05	-1.01e-05	0.0
49165	7.03e-04	4.20e-03	-0.01	-8.94e-05	-6.62e-06	0.0



EGP CODE

GRE.EEC.R.73.IT.W.15235.12.024.01

PAGE

153 di/of 527

49170	-2.73e-04	1.69e-03	-0.02	-8.32e-05	-1.29e-05	0.0
49172	-2.36e-04	1.50e-03	-0.01	-7.41e-05	-1.12e-05	0.0
49173	-2.27e-04	1.46e-03	-0.01	-7.19e-05	-1.08e-05	0.0
4922	-6.10e-04	3.03e-03	-0.03	-1.49e-04	-2.99e-05	0.0
49215	-2.25e-03	2.22e-03	-0.02	-9.01e-05	-1.97e-05	0.0
49217	1.48e-03	2.68e-03	-0.02	-1.08e-04	-1.64e-05	0.0
49233	3.19e-04	4.15e-03	-0.02	-1.20e-04	-1.60e-05	0.0
49247	-3.00e-03	2.35e-03	-0.02	-8.91e-05	-2.02e-05	0.0
49249	2.22e-03	3.01e-03	-0.02	-1.14e-04	-1.55e-05	0.0
49265	5.98e-04	5.05e-03	-0.02	-1.31e-04	-1.49e-05	0.0
49270	-4.57e-04	2.20e-03	-0.02	-1.08e-04	-2.24e-05	0.0
49272	-3.94e-04	1.94e-03	-0.02	-9.58e-05	-1.94e-05	0.0
49273	-3.79e-04	1.88e-03	-0.02	-9.28e-05	-1.86e-05	0.0
4932	-9.66e-04	3.53e-03	-0.04	-1.73e-04	-4.94e-05	0.0
49315	-2.48e-03	2.59e-03	-0.02	-1.08e-04	-3.14e-05	0.0
49333	6.08e-06	4.74e-03	-0.03	-1.49e-04	-3.52e-05	0.0
49347	-3.23e-03	2.76e-03	-0.02	-1.08e-04	-3.17e-05	0.0
49365	2.47e-04	5.77e-03	-0.03	-1.66e-04	-3.71e-05	0.0
49370	-7.23e-04	2.57e-03	-0.03	-1.26e-04	-3.70e-05	0.0
49372	-6.22e-04	2.25e-03	-0.02	-1.11e-04	-3.18e-05	0.0
49373	-5.96e-04	2.18e-03	-0.02	-1.07e-04	-3.05e-05	0.0
4942	-1.21e-03	3.61e-03	-0.04	-1.77e-04	-6.25e-05	0.0
49415	-2.67e-03	2.67e-03	-0.03	-1.11e-04	-4.16e-05	0.0
49433	-2.40e-04	4.90e-03	-0.03	-1.57e-04	-4.90e-05	0.0
49447	-3.45e-03	2.85e-03	-0.03	-1.12e-04	-4.29e-05	0.0
49465	-3.96e-05	5.98e-03	-0.03	-1.77e-04	-5.33e-05	0.0
49470	-9.05e-04	2.63e-03	-0.03	-1.28e-04	-4.67e-05	0.0
49472	-7.74e-04	2.30e-03	-0.03	-1.13e-04	-4.00e-05	0.0
49473	-7.42e-04	2.22e-03	-0.03	-1.09e-04	-3.83e-05	0.0
4952	-1.05e-03	-3.11e-03	-0.04	1.54e-04	-5.33e-05	0.0
4958	-2.36e-03	-2.36e-03	-0.02	9.67e-05	-2.68e-05	0.0
49530	-2.20e-04	-4.36e-03	-0.03	1.34e-04	-4.62e-05	0.0
49540	-3.05e-03	-2.53e-03	-0.02	9.73e-05	-2.45e-05	0.0
49562	-4.95e-05	-5.34e-03	-0.03	1.49e-04	-5.17e-05	0.0
49570	-7.88e-04	-2.25e-03	-0.03	1.11e-04	-3.99e-05	0.0
49572	-6.74e-04	-1.99e-03	-0.03	9.85e-05	-3.41e-05	0.0
49573	-6.45e-04	-1.92e-03	-0.03	9.53e-05	-3.26e-05	0.0
4962	-7.39e-04	-2.94e-03	-0.03	1.46e-04	-3.67e-05	0.0
4968	-2.18e-03	-2.22e-03	-0.02	9.03e-05	-1.74e-05	0.0
49630	1.29e-04	-4.10e-03	-0.02	1.21e-04	-2.72e-05	0.0
49640	-2.87e-03	-2.38e-03	-0.02	9.02e-05	-1.53e-05	0.0
49662	3.62e-04	-5.01e-03	-0.02	1.33e-04	-2.91e-05	0.0
49670	-5.53e-04	-2.13e-03	-0.02	1.05e-04	-2.75e-05	0.0
49672	-4.75e-04	-1.89e-03	-0.02	9.36e-05	-2.36e-05	0.0
49673	-4.56e-04	-1.83e-03	-0.02	9.07e-05	-2.26e-05	0.0
4972	-4.70e-04	-2.48e-03	-0.02	1.23e-04	-2.26e-05	0.0
4978	-2.03e-03	-1.90e-03	-0.02	7.44e-05	-9.78e-06	0.0
49710	1.43e-03	-2.24e-03	-0.02	8.77e-05	-1.76e-05	0.0
49730	3.45e-04	-3.59e-03	-0.02	9.58e-05	-1.39e-05	0.0
49740	-2.73e-03	-2.04e-03	-0.02	7.36e-05	-8.05e-06	0.0
49742	2.12e-03	-2.52e-03	-0.02	9.22e-05	-1.90e-05	0.0
49762	6.00e-04	-4.42e-03	-0.02	1.03e-04	-1.39e-05	0.0
49770	-3.53e-04	-1.79e-03	-0.02	8.86e-05	-1.69e-05	0.0
49772	-3.04e-04	-1.59e-03	-0.02	7.90e-05	-1.47e-05	0.0
49773	-2.92e-04	-1.54e-03	-0.02	7.66e-05	-1.41e-05	0.0
4982	-2.84e-04	-1.88e-03	-0.02	9.30e-05	-1.30e-05	0.0
4988	-1.92e-03	-1.51e-03	-0.01	5.53e-05	-5.58e-06	0.0
4989	1.49e-03	-7.00e-04	-0.01	6.07e-05	-1.10e-05	0.0
49830	4.55e-04	-3.01e-03	-0.01	6.68e-05	-6.62e-06	0.0
49840	-2.62e-03	-1.65e-03	-0.01	5.41e-05	-4.53e-06	0.0
49841	2.15e-03	-5.10e-04	-0.01	6.17e-05	-1.22e-05	0.0
49862	7.08e-04	-3.75e-03	-0.01	7.02e-05	-6.00e-06	0.0
49870	-2.13e-04	-1.36e-03	-0.01	6.71e-05	-9.76e-06	0.0
49872	-1.84e-04	-1.21e-03	-0.01	6.00e-05	-8.49e-06	0.0
49873	-1.77e-04	-1.17e-03	-0.01	5.83e-05	-8.17e-06	0.0
4991	-1.37e-04	-1.09e-03	-0.01	5.39e-05	-6.01e-06	0.0
4992	-1.70e-04	-1.27e-03	-0.01	6.27e-05	-7.32e-06	0.0
4998	-1.84e-03	-1.13e-03	-1.00e-02	3.62e-05	-3.04e-06	0.0
49929	3.18e-04	8.60e-04	-0.01	4.11e-05	-6.70e-06	0.0
49930	4.91e-04	-2.48e-03	-9.92e-03	3.95e-05	-3.29e-06	0.0
49940	-2.53e-03	-1.26e-03	-9.85e-03	3.49e-05	-2.41e-06	0.0
49961	4.88e-04	1.52e-03	-0.01	4.18e-05	-7.54e-06	0.0
49962	7.29e-04	-3.15e-03	-9.74e-03	3.96e-05	-2.77e-06	0.0
49969	-1.06e-04	-7.95e-04	-0.01	3.94e-05	-4.61e-06	0.0
49970	-1.28e-04	-9.17e-04	-0.01	4.52e-05	-5.48e-06	0.0
49971	-1.06e-04	-7.95e-04	-0.01	3.94e-05	-4.61e-06	0.0



EGP CODE

GRE.EEC.R.73.IT.W.15235.12.024.01

PAGE

154 di/of 527

49972	-1.10e-04	-8.20e-04	-0.01	4.06e-05	-4.79e-06	0.0
49973	-1.06e-04	-7.95e-04	-0.01	3.94e-05	-4.61e-06	0.0
5001	-8.62e-05	-5.99e-04	-0.01	2.96e-05	-3.53e-06	0.0
5002	-1.08e-04	-6.97e-04	-0.01	3.43e-05	-4.28e-06	0.0
5008	-1.78e-03	-7.74e-04-8.64e-03		1.90e-05	-1.73e-06	0.0
50029	3.93e-04	1.14e-03-9.29e-03		2.67e-05	-3.90e-06	0.0
50034	4.83e-04	-2.02e-03-8.51e-03		1.73e-05	-1.93e-06	0.0
50040	-2.47e-03	-9.08e-04-8.55e-03		1.80e-05	-1.34e-06	0.0
50061	5.77e-04	1.77e-03-9.47e-03		2.88e-05	-4.38e-06	0.0
50066	7.02e-04	-2.66e-03-8.36e-03		1.55e-05	-1.62e-06	0.0
50069	-6.68e-05	-4.38e-04-8.86e-03		2.16e-05	-2.71e-06	0.0
50070	-8.11e-05	-5.03e-04-8.57e-03		2.48e-05	-3.21e-06	0.0
50071	-6.68e-05	-4.38e-04-8.86e-03		2.16e-05	-2.71e-06	0.0
50072	-6.96e-05	-4.51e-04-8.80e-03		2.23e-05	-2.81e-06	0.0
50073	-6.68e-05	-4.38e-04-8.86e-03		2.16e-05	-2.71e-06	0.0
5011	-6.59e-05	-1.40e-04 -0.01		6.80e-06	-2.56e-06	0.0
5012	-8.29e-05	-1.63e-04 -0.01		7.88e-06	-3.09e-06	0.0
5018	-1.74e-03	-4.45e-04-8.10e-03		2.92e-06	-1.34e-06	0.0
50129	4.44e-04	1.44e-03-8.33e-03		1.16e-05	-2.35e-06	0.0
50134	4.63e-04	-1.65e-03-8.14e-03		-1.36e-06	-1.90e-06	0.0
50140	-2.42e-03	-5.82e-04-8.06e-03		2.10e-06	-1.09e-06	0.0
50161	6.42e-04	2.05e-03-8.38e-03		1.43e-05	-2.51e-06	0.0
50166	6.69e-04	-2.27e-03-8.11e-03		-3.89e-06	-1.87e-06	0.0
50169	-5.12e-05	-1.03e-04-8.21e-03		4.96e-06	-1.96e-06	0.0
50170	-6.25e-05	-1.18e-04-7.82e-03		5.69e-06	-2.31e-06	0.0
50171	-5.12e-05	-1.03e-04-8.21e-03		4.96e-06	-1.96e-06	0.0
50172	-5.34e-05	-1.06e-04-8.13e-03		5.11e-06	-2.03e-06	0.0
50173	-5.12e-05	-1.03e-04-8.21e-03		4.96e-06	-1.96e-06	0.0
5021	-7.08e-05	3.10e-04 -0.01		-1.56e-05	-2.81e-06	0.0
5022	-8.88e-05	3.61e-04 -0.01		-1.81e-05	-3.40e-06	0.0
50215	-1.75e-03	5.66e-04-8.22e-03		-9.14e-06	-1.43e-06	0.0
50229	4.74e-04	1.78e-03-8.16e-03		-5.54e-06	-1.82e-06	0.0
50234	4.25e-04	-1.32e-03-8.63e-03		-1.77e-05	-2.84e-06	0.0
50247	-2.43e-03	7.02e-04-8.16e-03		-8.24e-06	-1.15e-06	0.0
50261	6.86e-04	2.40e-03-8.07e-03		-3.20e-06	-1.68e-06	0.0
50266	6.18e-04	-1.94e-03-8.74e-03		-2.02e-05	-3.11e-06	0.0
50269	-5.49e-05	2.26e-04-8.37e-03		-1.14e-05	-2.15e-06	0.0
50270	-6.69e-05	2.60e-04-8.00e-03		-1.30e-05	-2.54e-06	0.0
50271	-5.49e-05	2.26e-04-8.37e-03		-1.14e-05	-2.15e-06	0.0
50272	-5.73e-05	2.33e-04-8.29e-03		-1.17e-05	-2.23e-06	0.0
50273	-5.49e-05	2.26e-04-8.37e-03		-1.14e-05	-2.15e-06	0.0
5031	-1.02e-04	7.79e-04 -0.01		-3.90e-05	-4.35e-06	0.0
5032	-1.27e-04	9.09e-04 -0.01		-4.52e-05	-5.29e-06	0.0
50315	-1.80e-03	9.04e-04-9.07e-03		-2.57e-05	-2.20e-06	0.0
50329	4.85e-04	2.19e-03-8.90e-03		-2.56e-05	-2.30e-06	0.0
50334	3.67e-04	-1.03e-03-9.88e-03		-3.23e-05	-4.84e-06	0.0
50347	-2.49e-03	1.04e-03-8.96e-03		-2.46e-05	-1.75e-06	0.0
50361	7.11e-04	2.84e-03-8.73e-03		-2.45e-05	-1.89e-06	0.0
50366	5.45e-04	-1.67e-03 -0.01		-3.38e-05	-5.45e-06	0.0
50369	-7.89e-05	5.70e-04-9.35e-03		-2.85e-05	-3.34e-06	0.0
50370	-9.56e-05	6.56e-04-9.12e-03		-3.26e-05	-3.96e-06	0.0
50371	-7.89e-05	5.70e-04-9.35e-03		-2.85e-05	-3.34e-06	0.0
50372	-8.23e-05	5.87e-04-9.30e-03		-2.93e-05	-3.46e-06	0.0
50373	-7.89e-05	5.70e-04-9.35e-03		-2.85e-05	-3.34e-06	0.0
5042	-2.08e-04	1.50e-03 -0.01		-7.45e-05	-9.28e-06	0.0
50415	-1.87e-03	1.27e-03 -0.01		-4.39e-05	-4.00e-06	0.0
50433	4.80e-04	2.67e-03 -0.01		-5.03e-05	-4.35e-06	0.0
50434	2.81e-04	-7.65e-04 -0.01		-4.54e-05	-8.22e-06	0.0
50447	-2.56e-03	1.40e-03 -0.01		-4.27e-05	-3.26e-06	0.0
50465	7.24e-04	3.37e-03 -0.01		-5.17e-05	-3.76e-06	0.0
50466	4.45e-04	-1.45e-03 -0.01		-4.48e-05	-9.18e-06	0.0
50470	-1.56e-04	1.08e-03 -0.01		-5.38e-05	-6.95e-06	0.0
50472	-1.35e-04	9.68e-04 -0.01		-4.82e-05	-6.06e-06	0.0
50473	-1.29e-04	9.39e-04 -0.01		-4.68e-05	-5.83e-06	0.0
5052	-3.48e-04	2.12e-03 -0.02		-1.05e-04	-1.64e-05	0.0
50515	-1.96e-03	1.66e-03 -0.01		-6.31e-05	-7.17e-06	0.0
50518	1.44e-03	8.38e-04 -0.01		-6.78e-05	-1.35e-05	0.0
50533	4.21e-04	3.24e-03 -0.01		-7.84e-05	-8.93e-06	0.0
50547	-2.66e-03	1.80e-03 -0.01		-6.20e-05	-5.94e-06	0.0
50550	2.10e-03	6.44e-04 -0.01		-6.85e-05	-1.48e-05	0.0
50565	6.77e-04	4.01e-03 -0.01		-8.34e-05	-8.42e-06	0.0
50570	-2.61e-04	1.53e-03 -0.01		-7.60e-05	-1.22e-05	0.0
50572	-2.25e-04	1.36e-03 -0.01		-6.79e-05	-1.06e-05	0.0
50573	-2.16e-04	1.32e-03 -0.01		-6.59e-05	-1.02e-05	0.0
5062	-5.66e-04	2.69e-03 -0.03		-1.34e-04	-2.77e-05	0.0
50615	-2.09e-03	2.03e-03 -0.02		-8.16e-05	-1.20e-05	0.0



EGP CODE

GRE.EEC.R.73.IT.W.15235.12.024.01

PAGE

155 di/of 527

50617	1.36e-03	2.41e-03	-0.02	-9.63e-05	-2.17e-05	0.0
50633	2.74e-04	3.82e-03	-0.02	-1.07e-04	-1.81e-05	0.0
50647	-2.78e-03	2.18e-03	-0.02	-8.09e-05	-9.92e-06	0.0
50649	2.05e-03	2.71e-03	-0.02	-1.02e-04	-2.36e-05	0.0
50665	5.24e-04	4.68e-03	-0.02	-1.17e-04	-1.85e-05	0.0
50670	-4.24e-04	1.94e-03	-0.02	-9.65e-05	-2.07e-05	0.0
50672	-3.65e-04	1.73e-03	-0.02	-8.60e-05	-1.79e-05	0.0
50673	-3.51e-04	1.67e-03	-0.02	-8.33e-05	-1.72e-05	0.0
5072	-8.58e-04	3.06e-03	-0.03	-1.52e-04	-4.32e-05	0.0
50715	-2.25e-03	2.30e-03	-0.02	-9.46e-05	-2.08e-05	0.0
50733	1.77e-05	4.26e-03	-0.02	-1.29e-04	-3.41e-05	0.0
50747	-2.94e-03	2.46e-03	-0.02	-9.46e-05	-1.85e-05	0.0
50765	2.36e-04	5.20e-03	-0.03	-1.43e-04	-3.71e-05	0.0
50770	-6.43e-04	2.22e-03	-0.02	-1.10e-04	-3.23e-05	0.0
50772	-5.51e-04	1.96e-03	-0.02	-9.75e-05	-2.77e-05	0.0
50773	-5.28e-04	1.90e-03	-0.02	-9.45e-05	-2.66e-05	0.0
5082	-1.04e-03	3.13e-03	-0.04	-1.55e-04	-5.32e-05	0.0
50815	-2.36e-03	2.36e-03	-0.02	-9.74e-05	-2.64e-05	0.0
50833	-2.11e-04	4.38e-03	-0.03	-1.35e-04	-4.63e-05	0.0
50847	-3.04e-03	2.53e-03	-0.02	-9.79e-05	-2.40e-05	0.0
50865	-3.94e-05	5.37e-03	-0.03	-1.51e-04	-5.18e-05	0.0
50870	-7.82e-04	2.27e-03	-0.03	-1.12e-04	-3.98e-05	0.0
50872	-6.68e-04	2.00e-03	-0.03	-9.95e-05	-3.40e-05	0.0
50873	-6.40e-04	1.93e-03	-0.03	-9.62e-05	-3.26e-05	0.0
5092	-5.83e-04	-2.81e-03	-0.04	1.40e-04	-2.90e-05	0.0
5098	-1.96e-03	-2.19e-03	-0.02	8.94e-05	-7.33e-06	0.0
50930	4.95e-05	-3.98e-03	-0.03	1.17e-04	-2.86e-05	0.0
50940	-2.60e-03	-2.37e-03	-0.02	9.04e-05	-3.12e-06	0.0
50962	2.13e-04	-4.88e-03	-0.03	1.29e-04	-3.29e-05	0.0
50970	-4.37e-04	-2.03e-03	-0.03	1.01e-04	-2.17e-05	0.0
50972	-3.74e-04	-1.80e-03	-0.02	8.98e-05	-1.86e-05	0.0
50973	-3.58e-04	-1.74e-03	-0.02	8.70e-05	-1.78e-05	0.0
5102	-4.18e-04	-2.67e-03	-0.03	1.33e-04	-2.02e-05	0.0
5108	-1.90e-03	-2.09e-03	-0.02	8.45e-05	-3.99e-06	0.0
51030	3.13e-04	-3.79e-03	-0.02	1.08e-04	-1.78e-05	0.0
51040	-2.56e-03	-2.26e-03	-0.02	8.50e-05	0.0	0.0
51062	5.41e-04	-4.65e-03	-0.02	1.18e-04	-2.00e-05	0.0
51070	-3.13e-04	-1.93e-03	-0.02	9.60e-05	-1.51e-05	0.0
51072	-2.69e-04	-1.72e-03	-0.02	8.57e-05	-1.30e-05	0.0
51073	-2.58e-04	-1.66e-03	-0.02	8.31e-05	-1.25e-05	0.0
5112	-2.74e-04	-2.27e-03	-0.02	1.13e-04	-1.27e-05	0.0
5118	-1.85e-03	-1.82e-03	-0.02	7.08e-05	0.0	0.0
51110	1.48e-03	-2.06e-03	-0.02	7.90e-05	-1.47e-05	0.0
51130	4.33e-04	-3.38e-03	-0.02	8.73e-05	-9.72e-06	0.0
51140	-2.52e-03	-1.98e-03	-0.02	7.07e-05	2.10e-06	0.0
51142	2.15e-03	-2.31e-03	-0.02	8.23e-05	-1.74e-05	0.0
51162	6.75e-04	-4.17e-03	-0.02	9.39e-05	-1.04e-05	0.0
51170	-2.06e-04	-1.64e-03	-0.02	8.16e-05	-9.51e-06	0.0
51172	-1.77e-04	-1.46e-03	-0.02	7.30e-05	-8.24e-06	0.0
51173	-1.70e-04	-1.42e-03	-0.02	7.09e-05	-7.93e-06	0.0
5122	-1.69e-04	-1.75e-03	-0.02	8.69e-05	-7.29e-06	0.0
5128	-1.80e-03	-1.46e-03	-0.01	5.33e-05	0.0	0.0
5129	1.51e-03	-6.01e-04	-0.01	5.53e-05	-9.40e-06	0.0
51234	4.89e-04	-2.89e-03	-0.01	6.22e-05	-4.27e-06	0.0
51240	-2.48e-03	-1.61e-03	-0.01	5.27e-05	1.96e-06	0.0
51241	2.16e-03	-4.04e-04	-0.01	5.56e-05	-1.13e-05	0.0
51266	7.27e-04	-3.60e-03	-0.01	6.53e-05	-4.14e-06	0.0
51270	-1.27e-04	-1.26e-03	-0.01	6.26e-05	-5.46e-06	0.0
51272	-1.09e-04	-1.13e-03	-0.01	5.61e-05	-4.76e-06	0.0
51273	-1.05e-04	-1.09e-03	-0.01	5.45e-05	-4.59e-06	0.0
5131	-8.16e-05	-1.03e-03	-0.01	5.11e-05	-3.26e-06	0.0
5132	-1.02e-04	-1.19e-03	-0.01	5.92e-05	-3.95e-06	0.0
5138	-1.77e-03	-1.11e-03-9.92e-03		3.55e-05	0.0	0.0
51329	3.57e-04	8.91e-04	-0.01	3.71e-05	-4.48e-06	0.0
51334	5.10e-04	-2.40e-03-9.76e-03		3.84e-05	-1.90e-06	0.0
51340	-2.45e-03	-1.25e-03-9.82e-03		3.47e-05	1.61e-06	0.0
51361	5.25e-04	1.55e-03	-0.01	3.70e-05	-5.27e-06	0.0
51366	7.39e-04	-3.07e-03-9.59e-03		3.88e-05	-1.66e-06	0.0
51369	-6.31e-05	-7.48e-04	-0.01	3.72e-05	-2.50e-06	0.0
51370	-7.64e-05	-8.59e-04	-0.01	4.26e-05	-2.96e-06	0.0
51371	-6.31e-05	-7.48e-04	-0.01	3.72e-05	-2.50e-06	0.0
51372	-6.58e-05	-7.70e-04	-0.01	3.83e-05	-2.59e-06	0.0
51373	-6.31e-05	-7.48e-04	-0.01	3.72e-05	-2.50e-06	0.0
5141	-5.12e-05	-5.68e-04	-0.01	2.83e-05	-1.79e-06	0.0
5142	-6.44e-05	-6.60e-04	-0.01	3.27e-05	-2.15e-06	0.0
5148	-1.74e-03	-7.67e-04-8.60e-03		1.86e-05	0.0	0.0





EGP CODE

GRE.EEC.R.73.IT.W.15235.12.024.01

PAGE

156 di/of 527

51429	4.17e-04	1.14e-03-9.13e-03	2.49e-05	-2.57e-06	0.0
51434	5.03e-04	-1.98e-03-8.43e-03	1.68e-05	-1.04e-06	0.0
51440	-2.41e-03	-9.09e-04-8.53e-03	1.78e-05	1.17e-06	0.0
51461	6.00e-04	1.77e-03-9.27e-03	2.66e-05	-3.04e-06	0.0
51466	7.20e-04	-2.61e-03-8.30e-03	1.53e-05	0.0	0.0
51469	-3.98e-05	-4.14e-04-8.76e-03	2.06e-05	-1.37e-06	0.0
51470	-4.85e-05	-4.75e-04-8.44e-03	2.35e-05	-1.61e-06	0.0
51471	-3.98e-05	-4.14e-04-8.76e-03	2.06e-05	-1.37e-06	0.0
51472	-4.15e-05	-4.27e-04-8.69e-03	2.12e-05	-1.42e-06	0.0
51473	-3.98e-05	-4.14e-04-8.76e-03	2.06e-05	-1.37e-06	0.0
5151	-3.88e-05	-1.34e-04 -0.01	6.52e-06	-1.21e-06	0.0
5152	-4.93e-05	-1.56e-04-9.91e-03	7.54e-06	-1.45e-06	0.0
5158	-1.71e-03	-4.63e-04-8.07e-03	3.00e-06	0.0	0.0
51529	4.61e-04	1.43e-03-8.23e-03	1.07e-05	-1.43e-06	0.0
51534	4.80e-04	-1.62e-03-8.06e-03	0.0	-1.08e-06	0.0
51540	-2.38e-03	-6.09e-04-8.05e-03	2.31e-06	0.0	0.0
51561	6.58e-04	2.04e-03-8.27e-03	1.31e-05	-1.63e-06	0.0
51566	6.85e-04	-2.24e-03-8.03e-03	-3.30e-06	-1.14e-06	0.0
51569	-3.03e-05	-9.78e-05-8.14e-03	4.75e-06	0.0	0.0
51570	-3.72e-05	-1.12e-04-7.73e-03	5.43e-06	-1.08e-06	0.0
51571	-3.03e-05	-9.78e-05-8.14e-03	4.75e-06	0.0	0.0
51572	-3.16e-05	-1.01e-04-8.05e-03	4.88e-06	0.0	0.0
51573	-3.03e-05	-9.78e-05-8.14e-03	4.75e-06	0.0	0.0
5161	-4.15e-05	2.94e-04 -0.01	-1.49e-05	-1.36e-06	0.0
5162	-5.26e-05	3.41e-04 -0.01	-1.72e-05	-1.63e-06	0.0
51615	-1.71e-03	5.65e-04-8.18e-03	-9.00e-06	0.0	0.0
51629	4.92e-04	1.75e-03-8.09e-03	-5.58e-06	0.0	0.0
51634	4.45e-04	-1.32e-03-8.51e-03	-1.64e-05	-1.79e-06	0.0
51647	-2.39e-03	7.06e-04-8.14e-03	-8.25e-06	0.0	0.0
51661	7.02e-04	2.37e-03-8.01e-03	-3.47e-06	0.0	0.0
51666	6.36e-04	-1.93e-03-8.60e-03	-1.87e-05	-2.09e-06	0.0
51669	-3.23e-05	2.14e-04-8.28e-03	-1.08e-05	-1.04e-06	0.0
51670	-3.97e-05	2.46e-04-7.90e-03	-1.24e-05	-1.22e-06	0.0
51671	-3.23e-05	2.14e-04-8.28e-03	-1.08e-05	-1.04e-06	0.0
51672	-3.38e-05	2.21e-04-8.21e-03	-1.12e-05	-1.08e-06	0.0
51673	-3.23e-05	2.14e-04-8.28e-03	-1.08e-05	-1.04e-06	0.0
5171	-6.01e-05	7.37e-04 -0.01	-3.71e-05	-2.28e-06	0.0
5172	-7.51e-05	8.56e-04 -0.01	-4.29e-05	-2.75e-06	0.0
51715	-1.74e-03	8.92e-04-9.01e-03	-2.50e-05	0.0	0.0
51729	5.10e-04	2.13e-03-8.81e-03	-2.47e-05	-1.28e-06	0.0
51734	3.95e-04	-1.05e-03-9.67e-03	-3.00e-05	-3.21e-06	0.0
51747	-2.42e-03	1.03e-03-8.93e-03	-2.43e-05	1.21e-06	0.0
51761	7.33e-04	2.77e-03-8.65e-03	-2.38e-05	-1.09e-06	0.0
51766	5.72e-04	-1.68e-03-9.85e-03	-3.12e-05	-3.80e-06	0.0
51769	-4.66e-05	5.37e-04-9.21e-03	-2.70e-05	-1.74e-06	0.0
51770	-5.66e-05	6.17e-04-8.97e-03	-3.09e-05	-2.06e-06	0.0
51771	-4.66e-05	5.37e-04-9.21e-03	-2.70e-05	-1.74e-06	0.0
51772	-4.86e-05	5.53e-04-9.16e-03	-2.78e-05	-1.81e-06	0.0
51773	-4.66e-05	5.37e-04-9.21e-03	-2.70e-05	-1.74e-06	0.0
5182	-1.23e-04	1.40e-03 -0.01	-7.02e-05	-5.10e-06	0.0
51815	-1.78e-03	1.24e-03 -0.01	-4.25e-05	0.0	0.0
51829	5.08e-04	2.58e-03 -0.01	-4.74e-05	-2.63e-06	0.0
51834	3.30e-04	-8.07e-04 -0.01	-4.19e-05	-5.43e-06	0.0
51847	-2.46e-03	1.39e-03 -0.01	-4.18e-05	1.57e-06	0.0
51861	7.42e-04	3.27e-03 -0.01	-4.87e-05	-2.39e-06	0.0
51866	4.92e-04	-1.48e-03 -0.01	-4.11e-05	-6.31e-06	0.0
51870	-9.21e-05	1.01e-03 -0.01	-5.05e-05	-3.82e-06	0.0
51872	-7.95e-05	9.05e-04 -0.01	-4.54e-05	-3.34e-06	0.0
51873	-7.64e-05	8.78e-04 -0.01	-4.41e-05	-3.22e-06	0.0
5192	-2.03e-04	1.96e-03 -0.02	-9.80e-05	-9.20e-06	0.0
51915	-1.82e-03	1.60e-03 -0.01	-6.05e-05	0.0	0.0
51918	1.48e-03	7.19e-04 -0.01	-6.15e-05	-1.13e-05	0.0
51933	4.80e-04	3.08e-03 -0.01	-7.27e-05	-6.37e-06	0.0
51947	-2.49e-03	1.76e-03 -0.01	-6.02e-05	1.86e-06	0.0
51950	2.12e-03	5.17e-04 -0.01	-6.16e-05	-1.35e-05	0.0
51965	7.23e-04	3.83e-03 -0.01	-7.73e-05	-6.61e-06	0.0
51970	-1.53e-04	1.41e-03 -0.01	-7.06e-05	-6.89e-06	0.0
51972	-1.32e-04	1.26e-03 -0.01	-6.32e-05	-6.00e-06	0.0
51973	-1.27e-04	1.22e-03 -0.01	-6.14e-05	-5.77e-06	0.0
5202	-3.24e-04	2.45e-03 -0.02	-1.23e-04	-1.55e-05	0.0
52015	-1.87e-03	1.94e-03 -0.02	-7.72e-05	-2.32e-06	0.0
52033	3.94e-04	3.57e-03 -0.02	-9.69e-05	-1.27e-05	0.0
52047	-2.53e-03	2.10e-03 -0.02	-7.74e-05	0.0	0.0
52065	6.32e-04	4.38e-03 -0.02	-1.05e-04	-1.39e-05	0.0
52070	-2.43e-04	1.77e-03 -0.02	-8.85e-05	-1.16e-05	0.0
52072	-2.09e-04	1.58e-03 -0.02	-7.91e-05	-1.00e-05	0.0



EGP CODE

GRE.EEC.R.73.IT.W.15235.12.024.01

PAGE

157 di/of 527

52073	-2.01e-04	1.53e-03	-0.02	-7.68e-05	-9.62e-06	0.0
5212	-4.78e-04	2.77e-03	-0.03	-1.39e-04	-2.36e-05	0.0
52115	-1.93e-03	2.16e-03	-0.02	-8.84e-05	-5.13e-06	0.0
52133	2.54e-04	3.91e-03	-0.02	-1.14e-04	-2.19e-05	0.0
52147	-2.58e-03	2.33e-03	-0.02	-8.91e-05	-1.33e-06	0.0
52165	4.74e-04	4.79e-03	-0.02	-1.25e-04	-2.48e-05	0.0
52170	-3.58e-04	2.00e-03	-0.02	-1.00e-04	-1.77e-05	0.0
52172	-3.08e-04	1.78e-03	-0.02	-8.92e-05	-1.52e-05	0.0
52173	-2.95e-04	1.72e-03	-0.02	-8.65e-05	-1.46e-05	0.0
5222	-5.76e-04	2.83e-03	-0.04	-1.41e-04	-2.89e-05	0.0
52215	-1.96e-03	2.20e-03	-0.02	-9.04e-05	-6.97e-06	0.0
52233	5.34e-05	4.00e-03	-0.03	-1.19e-04	-2.86e-05	0.0
52247	-2.60e-03	2.37e-03	-0.02	-9.13e-05	-2.64e-06	0.0
52265	2.17e-04	4.90e-03	-0.03	-1.31e-04	-3.29e-05	0.0
52270	-4.32e-04	2.04e-03	-0.03	-1.02e-04	-2.16e-05	0.0
52272	-3.70e-04	1.81e-03	-0.02	-9.08e-05	-1.85e-05	0.0
52273	-3.54e-04	1.75e-03	-0.02	-8.80e-05	-1.78e-05	0.0
5232	1.10e-05	-2.71e-03	-0.03	1.35e-04	1.60e-06	0.0
52313	1.56e-03	-1.20e-03	-0.02	7.89e-05	-1.00e-05	0.0
52330	5.99e-04	-3.81e-03	-0.03	1.11e-04	-5.47e-06	0.0
52334	6.00e-04	-3.82e-03	-0.03	1.11e-04	-4.18e-06	0.0
52345	2.18e-03	-1.00e-03	-0.02	7.68e-05	-1.43e-05	0.0
52362	8.38e-04	-4.67e-03	-0.03	1.21e-04	-7.99e-06	0.0
52366	8.39e-04	-4.67e-03	-0.03	1.21e-04	-6.17e-06	0.0
52370	7.45e-06	-1.95e-03	-0.03	9.74e-05	1.17e-06	0.0
52372	4.57e-06	-1.74e-03	-0.02	8.68e-05	0.0	0.0
52373	3.85e-06	-1.68e-03	-0.02	8.42e-05	0.0	0.0
5242	1.01e-05	-2.58e-03	-0.03	1.29e-04	1.63e-06	0.0
5245	1.62e-03	-1.13e-03	-0.02	7.66e-05	-1.04e-05	0.0
52430	6.06e-04	-3.65e-03	-0.02	1.02e-04	-3.29e-06	0.0
52434	6.03e-04	-3.65e-03	-0.02	1.02e-04	-2.27e-06	0.0
52437	2.26e-03	-9.44e-04	-0.02	7.50e-05	-1.49e-05	0.0
52462	8.48e-04	-4.47e-03	-0.02	1.11e-04	-4.95e-06	0.0
52466	8.42e-04	-4.47e-03	-0.02	1.11e-04	-3.52e-06	0.0
52470	6.94e-06	-1.86e-03	-0.02	9.28e-05	1.20e-06	0.0
52472	4.71e-06	-1.66e-03	-0.02	8.30e-05	0.0	0.0
52473	4.15e-06	-1.61e-03	-0.02	8.06e-05	0.0	0.0
5252	7.86e-06	-2.20e-03	-0.02	1.10e-04	1.54e-06	0.0
5255	1.66e-03	-9.32e-04	-0.02	6.64e-05	-7.08e-06	0.0
52530	6.02e-04	-3.27e-03	-0.02	8.34e-05	-1.15e-06	0.0
52534	5.95e-04	-3.28e-03	-0.02	8.34e-05	0.0	0.0
52537	2.32e-03	-7.54e-04	-0.02	6.54e-05	-1.03e-05	0.0
52562	8.41e-04	-4.03e-03	-0.02	8.93e-05	-1.96e-06	0.0
52566	8.32e-04	-4.04e-03	-0.02	8.92e-05	0.0	0.0
52570	5.42e-06	-1.59e-03	-0.02	7.92e-05	1.14e-06	0.0
52572	4.01e-06	-1.42e-03	-0.02	7.09e-05	0.0	0.0
52573	3.66e-06	-1.38e-03	-0.02	6.89e-05	0.0	0.0
5262	5.23e-06	-1.70e-03	-0.02	8.48e-05	1.37e-06	0.0
5265	1.68e-03	-6.52e-04	-0.01	5.23e-05	-4.42e-06	0.0
52629	3.97e-04	6.77e-04	-0.01	4.66e-05	0.0	0.0
52634	5.81e-04	-2.81e-03	-0.01	6.02e-05	0.0	0.0
52637	2.36e-03	-4.87e-04	-0.01	5.19e-05	-6.51e-06	0.0
52661	5.55e-04	1.37e-03	-0.01	4.39e-05	-1.66e-06	0.0
52666	8.13e-04	-3.52e-03	-0.01	6.30e-05	0.0	0.0
52670	3.56e-06	-1.22e-03	-0.01	6.10e-05	1.02e-06	0.0
52672	2.93e-06	-1.10e-03	-0.01	5.48e-05	0.0	0.0
52673	2.78e-06	-1.06e-03	-0.01	5.32e-05	0.0	0.0
5271	2.91e-06	-1.00e-03	-0.01	5.01e-05	0.0	0.0
5272	2.94e-06	-1.17e-03	-0.01	5.80e-05	1.17e-06	0.0
5275	1.69e-03	-3.46e-04	-0.01	3.68e-05	-2.71e-06	0.0
52729	4.30e-04	8.87e-04	-0.01	3.58e-05	0.0	0.0
52734	5.61e-04	-2.36e-03	-9.73e-03	3.74e-05	0.0	0.0
52737	2.37e-03	-1.92e-04	-0.01	3.69e-05	-4.08e-06	0.0
52761	6.01e-04	1.53e-03	-0.01	3.55e-05	-1.08e-06	0.0
52766	7.84e-04	-3.01e-03	-9.56e-03	3.78e-05	0.0	0.0
52769	1.91e-06	-7.31e-04	-0.01	3.65e-05	0.0	0.0
52770	1.92e-06	-8.39e-04	-0.01	4.18e-05	0.0	0.0
52771	1.91e-06	-7.31e-04	-0.01	3.65e-05	0.0	0.0
52772	1.91e-06	-7.52e-04	-0.01	3.75e-05	0.0	0.0
52773	1.91e-06	-7.31e-04	-0.01	3.65e-05	0.0	0.0
5281	2.20e-06	-5.58e-04	-0.01	2.78e-05	0.0	0.0
5282	1.53e-06	-6.47e-04	-0.01	3.21e-05	1.03e-06	0.0
5285	1.69e-03	-4.08e-05	-8.80e-03	2.13e-05	-1.21e-06	0.0
52834	5.36e-04	-1.95e-03	-8.41e-03	1.66e-05	0.0	0.0
52835	-5.33e-04	1.14e-03	-9.06e-03	2.38e-05	0.0	0.0
52837	2.37e-03	1.06e-04	-8.83e-03	2.18e-05	-1.95e-06	0.0



EGP CODE

GRE.EEC.R.73.IT.W.15235.12.024.01

PAGE

158 di/of 527

52866	7.50e-04	-2.57e-03-8.28e-03	1.52e-05	0.0	0.0
52867	-7.47e-04	1.75e-03-9.19e-03	2.52e-05	0.0	0.0
52869	1.36e-06	-4.06e-04-8.74e-03	2.02e-05	0.0	0.0
52870	0.0	-4.66e-04-8.42e-03	2.31e-05	0.0	0.0
52871	1.36e-06	-4.06e-04-8.74e-03	2.02e-05	0.0	0.0
52872	1.27e-06	-4.18e-04-8.67e-03	2.08e-05	0.0	0.0
52873	1.36e-06	-4.06e-04-8.74e-03	2.02e-05	0.0	0.0
5291	2.12e-06	-1.32e-04 -0.01	6.42e-06	0.0	0.0
5292	1.23e-06	-1.53e-04-9.90e-03	7.42e-06	0.0	0.0
5295	1.67e-03	2.81e-04-8.13e-03	6.07e-06	0.0	0.0
52934	5.09e-04	-1.60e-03-8.04e-03	0.0	0.0	0.0
52935	-5.06e-04	1.41e-03-8.21e-03	1.01e-05	0.0	0.0
52937	2.34e-03	4.32e-04-8.13e-03	6.62e-06	-1.23e-06	0.0
52966	7.12e-04	-2.20e-03-8.01e-03	-2.96e-06	0.0	0.0
52967	-7.09e-04	2.01e-03-8.24e-03	1.23e-05	1.03e-06	0.0
52969	1.30e-06	-9.62e-05-8.13e-03	4.67e-06	0.0	0.0
52970	0.0	-1.10e-04-7.72e-03	5.34e-06	0.0	0.0
52971	1.30e-06	-9.62e-05-8.13e-03	4.67e-06	0.0	0.0
52972	1.18e-06	-9.91e-05-8.05e-03	4.81e-06	0.0	0.0
52973	1.30e-06	-9.62e-05-8.13e-03	4.67e-06	0.0	0.0
5301	2.74e-06	2.88e-04 -0.01	-1.47e-05	0.0	0.0
5302	2.09e-06	3.34e-04 -0.01	-1.69e-05	0.0	0.0
53014	1.68e-03	-1.70e-04-8.31e-03	-1.20e-05	0.0	0.0
53029	5.22e-04	1.72e-03-8.07e-03	-5.67e-06	0.0	0.0
53032	-5.18e-04	-1.30e-03-8.48e-03	-1.57e-05	0.0	0.0
53046	2.35e-03	-3.23e-04-8.32e-03	-1.26e-05	-1.58e-06	0.0
53061	7.30e-04	2.33e-03-7.99e-03	-3.67e-06	0.0	0.0
53064	-7.26e-04	-1.91e-03-8.56e-03	-1.77e-05	0.0	0.0
53069	1.78e-06	2.10e-04-8.27e-03	-1.07e-05	0.0	0.0
53070	1.35e-06	2.40e-04-7.89e-03	-1.22e-05	0.0	0.0
53071	1.78e-06	2.10e-04-8.27e-03	-1.07e-05	0.0	0.0
53072	1.69e-06	2.16e-04-8.20e-03	-1.10e-05	0.0	0.0
53073	1.78e-06	2.10e-04-8.27e-03	-1.07e-05	0.0	0.0
5311	4.01e-06	7.21e-04 -0.01	-3.64e-05	0.0	0.0
5312	4.07e-06	8.37e-04 -0.01	-4.21e-05	1.07e-06	0.0
53114	1.69e-03	1.54e-04-9.27e-03	-2.74e-05	-1.82e-06	0.0
53129	5.49e-04	2.09e-03-8.79e-03	-2.43e-05	0.0	0.0
53132	-5.44e-04	-1.04e-03-9.58e-03	-2.87e-05	0.0	0.0
53146	2.37e-03	5.26e-06-9.30e-03	-2.77e-05	-2.81e-06	0.0
53161	7.68e-04	2.72e-03-8.63e-03	-2.34e-05	0.0	0.0
53164	-7.62e-04	-1.67e-03-9.74e-03	-2.96e-05	0.0	0.0
53169	2.75e-06	5.25e-04-9.19e-03	-2.65e-05	0.0	0.0
53170	2.79e-06	6.03e-04-8.93e-03	-3.03e-05	0.0	0.0
53171	2.75e-06	5.25e-04-9.19e-03	-2.65e-05	0.0	0.0
53172	2.76e-06	5.41e-04-9.13e-03	-2.72e-05	0.0	0.0
53173	2.75e-06	5.25e-04-9.19e-03	-2.65e-05	0.0	0.0
5321	5.75e-06	1.18e-03 -0.01	-5.92e-05	0.0	0.0
5322	6.95e-06	1.37e-03 -0.01	-6.86e-05	1.23e-06	0.0
53214	1.69e-03	4.62e-04 -0.01	-4.30e-05	-3.21e-06	0.0
53229	5.73e-04	2.53e-03 -0.01	-4.62e-05	0.0	0.0
53234	4.18e-04	-8.06e-04 -0.01	-4.04e-05	0.0	0.0
53246	2.37e-03	3.04e-04 -0.01	-4.29e-05	-4.78e-06	0.0
53261	8.01e-04	3.20e-03 -0.01	-4.74e-05	0.0	0.0
53266	5.84e-04	-1.47e-03 -0.01	-3.93e-05	-1.27e-06	0.0
53269	4.09e-06	8.56e-04 -0.01	-4.31e-05	0.0	0.0
53270	4.89e-06	9.84e-04 -0.01	-4.94e-05	0.0	0.0
53271	4.09e-06	8.56e-04 -0.01	-4.31e-05	0.0	0.0
53272	4.25e-06	8.82e-04 -0.01	-4.44e-05	0.0	0.0
53273	4.09e-06	8.56e-04 -0.01	-4.31e-05	0.0	0.0
5332	1.03e-05	1.90e-03 -0.02	-9.54e-05	1.41e-06	0.0
53314	1.68e-03	7.64e-04 -0.01	-5.82e-05	-5.27e-06	0.0
53329	5.93e-04	3.00e-03 -0.01	-6.98e-05	0.0	0.0
53334	3.86e-04	-6.11e-04 -0.01	-5.02e-05	-1.08e-06	0.0
53346	2.35e-03	5.94e-04 -0.01	-5.76e-05	-7.70e-06	0.0
53361	8.28e-04	3.73e-03 -0.01	-7.39e-05	0.0	0.0
53366	5.38e-04	-1.33e-03 -0.01	-4.64e-05	-1.84e-06	0.0
53370	7.33e-06	1.37e-03 -0.01	-6.87e-05	1.04e-06	0.0
53372	5.88e-06	1.22e-03 -0.01	-6.16e-05	0.0	0.0
53373	5.52e-06	1.19e-03 -0.01	-5.98e-05	0.0	0.0
5342	1.37e-05	2.37e-03 -0.02	-1.19e-04	1.56e-06	0.0
53414	1.65e-03	1.02e-03 -0.02	-7.13e-05	-8.38e-06	0.0
53429	6.05e-04	3.45e-03 -0.02	-9.23e-05	-1.45e-06	0.0
53433	6.09e-04	3.44e-03 -0.02	-9.23e-05	-2.31e-06	0.0
53446	2.30e-03	8.40e-04 -0.02	-7.00e-05	-1.21e-05	0.0
53461	8.44e-04	4.23e-03 -0.02	-9.94e-05	-2.37e-06	0.0
53465	8.49e-04	4.23e-03 -0.02	-9.95e-05	-3.58e-06	0.0



EGP CODE

GRE.EEC.R.73.IT.W.15235.12.024.01

PAGE

159 di/of 527

53470	9.69e-06	1.71e-03	-0.02	-8.58e-05	1.15e-06	0.0
53472	7.33e-06	1.53e-03	-0.02	-7.68e-05	0.0	0.0
53473	6.74e-06	1.48e-03	-0.02	-7.45e-05	0.0	0.0
5352	1.64e-05	2.68e-03	-0.03	-1.34e-04	1.65e-06	0.0
53514	1.60e-03	1.18e-03	-0.02	-7.92e-05	-1.21e-05	0.0
53529	6.10e-04	3.76e-03	-0.02	-1.08e-04	-3.01e-06	0.0
53533	6.10e-04	3.76e-03	-0.02	-1.08e-04	-4.15e-06	0.0
53546	2.24e-03	9.85e-04	-0.02	-7.73e-05	-1.73e-05	0.0
53561	8.51e-04	4.60e-03	-0.02	-1.18e-04	-4.56e-06	0.0
53565	8.51e-04	4.60e-03	-0.02	-1.18e-04	-6.16e-06	0.0
53570	1.16e-05	1.93e-03	-0.02	-9.68e-05	1.21e-06	0.0
53572	8.32e-06	1.72e-03	-0.02	-8.64e-05	0.0	0.0
53573	7.50e-06	1.67e-03	-0.02	-8.38e-05	0.0	0.0
5362	1.75e-05	2.73e-03	-0.03	-1.37e-04	1.67e-06	0.0
5366	1.57e-03	1.20e-03	-0.02	-7.97e-05	-1.03e-05	0.0
53629	6.07e-04	3.84e-03	-0.03	-1.12e-04	-4.23e-06	0.0
53633	6.05e-04	3.83e-03	-0.03	-1.12e-04	-5.55e-06	0.0
53638	2.20e-03	1.01e-03	-0.02	-7.75e-05	-1.47e-05	0.0
53661	8.47e-04	4.69e-03	-0.03	-1.23e-04	-6.25e-06	0.0
53665	8.44e-04	4.69e-03	-0.03	-1.23e-04	-8.11e-06	0.0
53670	1.23e-05	1.97e-03	-0.03	-9.86e-05	1.23e-06	0.0
53672	8.58e-06	1.75e-03	-0.02	-8.78e-05	0.0	0.0
53673	7.65e-06	1.69e-03	-0.02	-8.51e-05	0.0	0.0
5372	6.06e-04	-2.81e-03	-0.04	1.40e-04	3.22e-05	0.0
53710	1.96e-03	-2.35e-03	-0.02	9.33e-05	8.71e-06	0.0
53732	1.67e-04	-3.87e-03	-0.03	1.14e-04	2.71e-05	0.0
53742	2.60e-03	-2.59e-03	-0.02	9.59e-05	4.40e-06	0.0
53764	8.74e-05	-4.73e-03	-0.03	1.25e-04	3.02e-05	0.0
53770	4.52e-04	-2.03e-03	-0.03	1.01e-04	2.40e-05	0.0
53772	3.83e-04	-1.80e-03	-0.02	8.97e-05	2.04e-05	0.0
53773	3.66e-04	-1.74e-03	-0.02	8.69e-05	1.94e-05	0.0
5382	4.37e-04	-2.68e-03	-0.03	1.33e-04	2.35e-05	0.0
5385	1.89e-03	-1.11e-03	-0.02	7.57e-05	3.96e-06	0.0
53832	-2.77e-05	-3.70e-03	-0.02	1.06e-04	1.86e-05	0.0
53837	2.55e-03	-8.92e-04	-0.02	7.27e-05	0.0	0.0
53864	-1.45e-04	-4.51e-03	-0.02	1.15e-04	2.03e-05	0.0
53870	3.27e-04	-1.93e-03	-0.02	9.60e-05	1.76e-05	0.0
53872	2.78e-04	-1.72e-03	-0.02	8.57e-05	1.49e-05	0.0
53873	2.66e-04	-1.66e-03	-0.02	8.31e-05	1.43e-05	0.0
5392	2.88e-04	-2.28e-03	-0.02	1.14e-04	1.58e-05	0.0
5395	1.85e-03	-9.09e-04	-0.02	6.55e-05	2.74e-06	0.0
53932	-1.86e-04	-3.30e-03	-0.02	8.60e-05	1.10e-05	0.0
53937	2.52e-03	-7.03e-04	-0.02	6.33e-05	0.0	0.0
53964	-3.31e-04	-4.06e-03	-0.02	9.20e-05	1.16e-05	0.0
53970	2.15e-04	-1.64e-03	-0.02	8.18e-05	1.18e-05	0.0
53972	1.84e-04	-1.47e-03	-0.02	7.32e-05	1.01e-05	0.0
53973	1.77e-04	-1.42e-03	-0.02	7.10e-05	9.63e-06	0.0
5402	1.77e-04	-1.75e-03	-0.02	8.73e-05	9.93e-06	0.0
5405	1.81e-03	-6.27e-04	-0.01	5.15e-05	1.99e-06	0.0
54031	-4.69e-04	6.11e-04	-0.01	4.83e-05	8.19e-06	0.0
54032	-3.00e-04	-2.82e-03	-0.01	6.20e-05	6.65e-06	0.0
54037	2.49e-03	-4.39e-04	-0.01	5.02e-05	0.0	0.0
54063	-7.00e-04	1.30e-03	-0.01	4.58e-05	9.02e-06	0.0
54064	-4.64e-04	-3.51e-03	-0.01	6.49e-05	6.87e-06	0.0
54070	1.32e-04	-1.26e-03	-0.01	6.29e-05	7.42e-06	0.0
54072	1.14e-04	-1.13e-03	-0.01	5.64e-05	6.37e-06	0.0
54073	1.09e-04	-1.10e-03	-0.01	5.47e-05	6.11e-06	0.0
5411	8.56e-05	-1.03e-03	-0.01	5.14e-05	4.97e-06	0.0
5412	1.05e-04	-1.20e-03	-0.01	5.96e-05	6.16e-06	0.0
5415	1.77e-03	-3.21e-04	-0.01	3.62e-05	1.50e-06	0.0
54131	-4.91e-04	8.31e-04	-0.01	3.69e-05	5.25e-06	0.0
54132	-3.77e-04	-2.35e-03	-9.87e-03	3.85e-05	3.97e-06	0.0
54137	2.45e-03	-1.49e-04	-0.01	3.57e-05	0.0	0.0
54163	-7.14e-04	1.47e-03	-0.01	3.67e-05	5.83e-06	0.0
54164	-5.53e-04	-2.99e-03	-9.72e-03	3.89e-05	4.03e-06	0.0
54169	6.55e-05	-7.51e-04	-0.01	3.74e-05	3.82e-06	0.0
54170	7.84e-05	-8.64e-04	-0.01	4.29e-05	4.61e-06	0.0
54171	6.55e-05	-7.51e-04	-0.01	3.74e-05	3.82e-06	0.0
54172	6.80e-05	-7.73e-04	-0.01	3.85e-05	3.97e-06	0.0
54173	6.55e-05	-7.51e-04	-0.01	3.74e-05	3.82e-06	0.0
5421	5.37e-05	-5.71e-04	-0.01	2.84e-05	3.30e-06	0.0
5422	6.50e-05	-6.64e-04	-0.01	3.29e-05	4.06e-06	0.0
5425	1.74e-03	-1.45e-05	-8.81e-03	2.10e-05	1.19e-06	0.0
54231	-4.93e-04	1.08e-03	-9.17e-03	2.46e-05	3.37e-06	0.0
54232	-4.27e-04	-1.93e-03	-8.52e-03	1.71e-05	2.64e-06	0.0
54237	2.41e-03	1.47e-04	-8.80e-03	2.12e-05	0.0	0.0



EGP CODE

GRE.EEC.R.73.IT.W.15235.12.024.01

PAGE

160 di/of 527

54263	-7.07e-04	1.69e-03-9.31e-03	2.61e-05	3.71e-06	0.0
54264	-6.15e-04	-2.53e-03-8.40e-03	1.57e-05	2.69e-06	0.0
54269	4.10e-05	-4.17e-04-8.82e-03	2.07e-05	2.53e-06	0.0
54270	4.85e-05	-4.79e-04-8.52e-03	2.37e-05	3.04e-06	0.0
54271	4.10e-05	-4.17e-04-8.82e-03	2.07e-05	2.53e-06	0.0
54272	4.25e-05	-4.29e-04-8.76e-03	2.13e-05	2.64e-06	0.0
54273	4.10e-05	-4.17e-04-8.82e-03	2.07e-05	2.53e-06	0.0
5431	4.13e-05	-1.35e-04 -0.01	6.55e-06	2.64e-06	0.0
5432	4.95e-05	-1.57e-04 -0.01	7.59e-06	3.23e-06	0.0
5435	1.71e-03	2.90e-04-8.14e-03	5.91e-06	1.03e-06	0.0
54331	-4.77e-04	1.37e-03-8.30e-03	1.03e-05	2.44e-06	0.0
54332	-4.62e-04	-1.57e-03-8.14e-03	0.0	2.24e-06	0.0
54337	2.38e-03	4.46e-04-8.12e-03	6.36e-06	0.0	0.0
54363	-6.81e-04	1.96e-03-8.34e-03	1.26e-05	2.61e-06	0.0
54364	-6.60e-04	-2.16e-03-8.11e-03	-2.85e-06	2.32e-06	0.0
54369	3.15e-05	-9.87e-05-8.19e-03	4.77e-06	2.02e-06	0.0
54370	3.69e-05	-1.13e-04-7.80e-03	5.46e-06	2.42e-06	0.0
54371	3.15e-05	-9.87e-05-8.19e-03	4.77e-06	2.02e-06	0.0
54372	3.26e-05	-1.02e-04-8.12e-03	4.91e-06	2.10e-06	0.0
54373	3.15e-05	-9.87e-05-8.19e-03	4.77e-06	2.02e-06	0.0
5441	4.53e-05	2.94e-04 -0.01	-1.50e-05	2.81e-06	0.0
5442	5.45e-05	3.42e-04 -0.01	-1.73e-05	3.45e-06	0.0
54414	1.71e-03	-1.79e-04-8.32e-03	-1.19e-05	1.12e-06	0.0
54435	-4.47e-04	1.70e-03-8.17e-03	-5.92e-06	2.36e-06	0.0
54436	-4.84e-04	-1.26e-03-8.56e-03	-1.61e-05	2.65e-06	0.0
54446	2.39e-03	-3.37e-04-8.31e-03	-1.23e-05	0.0	0.0
54467	-6.40e-04	2.29e-03-8.10e-03	-3.93e-06	2.44e-06	0.0
54468	-6.92e-04	-1.85e-03-8.65e-03	-1.81e-05	2.85e-06	0.0
54469	3.45e-05	2.15e-04-8.34e-03	-1.09e-05	2.16e-06	0.0
54470	4.07e-05	2.46e-04-7.98e-03	-1.25e-05	2.58e-06	0.0
54471	3.45e-05	2.15e-04-8.34e-03	-1.09e-05	2.16e-06	0.0
54472	3.58e-05	2.21e-04-8.27e-03	-1.12e-05	2.24e-06	0.0
54473	3.45e-05	2.15e-04-8.34e-03	-1.09e-05	2.16e-06	0.0
5451	6.64e-05	7.39e-04 -0.01	-3.73e-05	3.87e-06	0.0
5452	8.11e-05	8.60e-04 -0.01	-4.32e-05	4.77e-06	0.0
54514	1.75e-03	1.25e-04-9.28e-03	-2.71e-05	1.40e-06	0.0
54535	-4.06e-04	2.08e-03-8.91e-03	-2.50e-05	3.09e-06	0.0
54536	-4.93e-04	-9.89e-04-9.71e-03	-2.97e-05	3.95e-06	0.0
54546	2.42e-03	-4.06e-05-9.28e-03	-2.70e-05	0.0	0.0
54567	-5.89e-04	2.70e-03-8.76e-03	-2.41e-05	3.14e-06	0.0
54568	-7.11e-04	-1.60e-03-9.88e-03	-3.07e-05	4.34e-06	0.0
54569	5.08e-05	5.39e-04-9.28e-03	-2.71e-05	2.97e-06	0.0
54570	6.05e-05	6.19e-04-9.04e-03	-3.11e-05	3.57e-06	0.0
54571	5.08e-05	5.39e-04-9.28e-03	-2.71e-05	2.97e-06	0.0
54572	5.27e-05	5.55e-04-9.23e-03	-2.79e-05	3.09e-06	0.0
54573	5.08e-05	5.39e-04-9.28e-03	-2.71e-05	2.97e-06	0.0
5462	1.34e-04	1.41e-03 -0.01	-7.05e-05	7.46e-06	0.0
54614	1.78e-03	4.33e-04 -0.01	-4.23e-05	1.82e-06	0.0
54635	-3.45e-04	2.53e-03 -0.01	-4.74e-05	4.84e-06	0.0
54636	-4.82e-04	-7.46e-04 -0.01	-4.18e-05	6.25e-06	0.0
54646	2.46e-03	2.53e-04 -0.01	-4.16e-05	0.0	0.0
54667	-5.17e-04	3.18e-03 -0.01	-4.87e-05	4.93e-06	0.0
54668	-7.09e-04	-1.40e-03 -0.01	-4.08e-05	6.91e-06	0.0
54670	1.00e-04	1.01e-03 -0.01	-5.08e-05	5.58e-06	0.0
54672	8.68e-05	9.07e-04 -0.01	-4.56e-05	4.81e-06	0.0
54673	8.34e-05	8.80e-04 -0.01	-4.42e-05	4.61e-06	0.0
5472	2.23e-04	1.96e-03 -0.02	-9.83e-05	1.20e-05	0.0
54714	1.83e-03	7.33e-04 -0.01	-5.73e-05	2.40e-06	0.0
54720	-1.53e-03	7.31e-04 -0.01	-6.03e-05	1.27e-05	0.0
54735	-2.55e-04	3.02e-03 -0.01	-7.19e-05	8.14e-06	0.0
54746	2.50e-03	5.36e-04 -0.01	-5.56e-05	0.0	0.0
54752	-2.19e-03	5.33e-04 -0.01	-5.97e-05	1.48e-05	0.0
54767	-4.12e-04	3.73e-03 -0.01	-7.61e-05	8.45e-06	0.0
54770	1.66e-04	1.41e-03 -0.01	-7.08e-05	8.94e-06	0.0
54772	1.43e-04	1.26e-03 -0.01	-6.34e-05	7.67e-06	0.0
54773	1.37e-04	1.23e-03 -0.01	-6.16e-05	7.35e-06	0.0
5482	3.51e-04	2.46e-03 -0.02	-1.23e-04	1.86e-05	0.0
54814	1.87e-03	9.93e-04 -0.02	-7.03e-05	3.19e-06	0.0
54835	-1.23e-04	3.48e-03 -0.02	-9.53e-05	1.44e-05	0.0
54846	2.53e-03	7.77e-04 -0.02	-6.76e-05	0.0	0.0
54867	-2.58e-04	4.27e-03 -0.02	-1.03e-04	1.56e-05	0.0
54870	2.62e-04	1.77e-03 -0.02	-8.87e-05	1.39e-05	0.0
54872	2.24e-04	1.58e-03 -0.02	-7.92e-05	1.18e-05	0.0
54873	2.14e-04	1.53e-03 -0.02	-7.69e-05	1.13e-05	0.0
5492	5.11e-04	2.78e-03 -0.03	-1.39e-04	2.70e-05	0.0
54917	1.93e-03	2.31e-03 -0.02	-9.20e-05	6.65e-06	0.0





EGP CODE

GRE.EEC.R.73.IT.W.15235.12.024.01

PAGE

161 di/of 527

54935	5.12e-05	3.82e-03	-0.02	-1.12e-04	2.19e-05	0.0
54949	2.57e-03	2.54e-03	-0.02	-9.42e-05	2.76e-06	0.0
54967	-5.24e-05	4.66e-03	-0.02	-1.22e-04	2.41e-05	0.0
54970	3.82e-04	2.00e-03	-0.02	-1.00e-04	2.01e-05	0.0
54972	3.25e-04	1.78e-03	-0.02	-8.93e-05	1.71e-05	0.0
54973	3.10e-04	1.73e-03	-0.02	-8.65e-05	1.64e-05	0.0
5502	6.12e-04	2.83e-03	-0.04	-1.42e-04	3.23e-05	0.0
5509	1.97e-03	2.37e-03	-0.02	-9.49e-05	1.24e-05	0.0
55035	1.70e-04	3.90e-03	-0.03	-1.16e-04	2.73e-05	0.0
55041	2.61e-03	2.62e-03	-0.02	-9.77e-05	9.56e-06	0.0
55067	9.05e-05	4.76e-03	-0.03	-1.27e-04	3.04e-05	0.0
55070	4.57e-04	2.04e-03	-0.03	-1.02e-04	2.41e-05	0.0
55072	3.88e-04	1.81e-03	-0.02	-9.08e-05	2.04e-05	0.0
55073	3.70e-04	1.75e-03	-0.02	-8.80e-05	1.95e-05	0.0
5512	1.08e-03	-3.11e-03	-0.04	1.53e-04	5.66e-05	0.0
55110	2.36e-03	-2.52e-03	-0.03	1.01e-04	2.89e-05	0.0
55132	5.20e-04	-4.15e-03	-0.03	1.28e-04	4.49e-05	0.0
55142	3.04e-03	-2.77e-03	-0.03	1.03e-04	2.67e-05	0.0
55164	4.67e-04	-5.04e-03	-0.03	1.41e-04	4.91e-05	0.0
55170	8.05e-04	-2.25e-03	-0.03	1.11e-04	4.23e-05	0.0
55172	6.84e-04	-1.98e-03	-0.03	9.81e-05	3.59e-05	0.0
55173	6.54e-04	-1.92e-03	-0.03	9.49e-05	3.43e-05	0.0
5522	7.54e-04	-2.95e-03	-0.03	1.46e-04	4.00e-05	0.0
55210	2.16e-03	-2.38e-03	-0.02	9.42e-05	1.92e-05	0.0
55232	1.64e-04	-3.92e-03	-0.02	1.17e-04	2.85e-05	0.0
55242	2.84e-03	-2.60e-03	-0.02	9.56e-05	1.71e-05	0.0
55264	4.53e-05	-4.75e-03	-0.02	1.28e-04	3.01e-05	0.0
55270	5.63e-04	-2.13e-03	-0.02	1.05e-04	2.99e-05	0.0
55272	4.81e-04	-1.89e-03	-0.02	9.36e-05	2.55e-05	0.0
55273	4.61e-04	-1.83e-03	-0.02	9.06e-05	2.44e-05	0.0
5532	4.77e-04	-2.49e-03	-0.02	1.23e-04	2.55e-05	0.0
5535	2.03e-03	-9.76e-04	-0.02	6.85e-05	1.20e-05	0.0
5538	-1.44e-03	-2.12e-03	-0.02	8.54e-05	1.93e-05	0.0
55332	-9.51e-05	-3.44e-03	-0.02	9.39e-05	1.56e-05	0.0
55337	2.72e-03	-7.46e-04	-0.02	6.52e-05	1.06e-05	0.0
55340	-2.14e-03	-2.35e-03	-0.02	8.88e-05	2.08e-05	0.0
55364	-2.51e-04	-4.20e-03	-0.02	1.01e-04	1.55e-05	0.0
55370	3.57e-04	-1.80e-03	-0.02	8.92e-05	1.91e-05	0.0
55372	3.07e-04	-1.60e-03	-0.02	7.94e-05	1.63e-05	0.0
55373	2.94e-04	-1.55e-03	-0.02	7.70e-05	1.57e-05	0.0
5542	2.84e-04	-1.90e-03	-0.02	9.39e-05	1.53e-05	0.0
5545	1.92e-03	-6.73e-04	-0.01	5.37e-05	7.94e-06	0.0
55411	-1.54e-03	-7.32e-04	-0.01	5.98e-05	1.20e-05	0.0
55432	-2.58e-04	-2.89e-03	-0.01	6.65e-05	8.31e-06	0.0
55437	2.62e-03	-4.69e-04	-0.01	5.17e-05	7.34e-06	0.0
55443	-2.22e-03	-5.52e-04	-0.01	6.02e-05	1.31e-05	0.0
55464	-4.32e-04	-3.57e-03	-0.01	6.95e-05	7.85e-06	0.0
55470	2.12e-04	-1.37e-03	-0.01	6.78e-05	1.14e-05	0.0
55472	1.83e-04	-1.22e-03	-0.01	6.05e-05	9.84e-06	0.0
55473	1.76e-04	-1.18e-03	-0.01	5.87e-05	9.45e-06	0.0
5551	1.34e-04	-1.10e-03	-0.01	5.44e-05	7.35e-06	0.0
5552	1.65e-04	-1.28e-03	-0.01	6.34e-05	9.05e-06	0.0
5555	1.84e-03	-3.49e-04	-0.01	3.76e-05	5.05e-06	0.0
55531	-4.56e-04	7.40e-04	-0.01	3.96e-05	7.28e-06	0.0
55532	-3.53e-04	-2.37e-03	-0.01	4.11e-05	4.67e-06	0.0
55537	2.53e-03	-1.67e-04	-0.01	3.67e-05	4.82e-06	0.0
55563	-6.80e-04	1.36e-03	-0.01	3.96e-05	7.93e-06	0.0
55564	-5.36e-04	-2.99e-03-9.93e-03		4.16e-05	4.28e-06	0.0
55569	1.03e-04	-8.02e-04	-0.01	3.98e-05	5.64e-06	0.0
55570	1.23e-04	-9.26e-04	-0.01	4.58e-05	6.78e-06	0.0
55571	1.03e-04	-8.02e-04	-0.01	3.98e-05	5.64e-06	0.0
55572	1.07e-04	-8.27e-04	-0.01	4.10e-05	5.87e-06	0.0
55573	1.03e-04	-8.02e-04	-0.01	3.98e-05	5.64e-06	0.0
5561	8.27e-05	-6.04e-04	-0.01	2.99e-05	4.69e-06	0.0
5562	1.01e-04	-7.06e-04	-0.01	3.48e-05	5.73e-06	0.0
5565	1.77e-03	-2.59e-05-8.93e-03		2.18e-05	3.30e-06	0.0
55631	-4.73e-04	1.02e-03-9.37e-03		2.63e-05	4.49e-06	0.0
55632	-4.13e-04	-1.92e-03-8.67e-03		1.80e-05	3.07e-06	0.0
55637	2.46e-03	1.41e-04-8.90e-03		2.18e-05	3.19e-06	0.0
55663	-6.88e-04	1.61e-03-9.53e-03		2.81e-05	4.84e-06	0.0
55664	-6.03e-04	-2.51e-03-8.55e-03		1.65e-05	2.86e-06	0.0
55669	6.34e-05	-4.42e-04-8.98e-03		2.18e-05	3.59e-06	0.0
55670	7.53e-05	-5.10e-04-8.71e-03		2.51e-05	4.29e-06	0.0
55671	6.34e-05	-4.42e-04-8.98e-03		2.18e-05	3.59e-06	0.0
55672	6.58e-05	-4.56e-04-8.92e-03		2.25e-05	3.73e-06	0.0
55673	6.34e-05	-4.42e-04-8.98e-03		2.18e-05	3.59e-06	0.0



EGP CODE

GRE.EEC.R.73.IT.W.15235.12.024.01

PAGE

162 di/of 527

5571	6.26e-05	-1.43e-04	-0.01	6.86e-06	3.65e-06	0.0
5572	7.58e-05	-1.67e-04	-0.01	7.97e-06	4.44e-06	0.0
5575	1.73e-03	2.93e-04	-8.23e-03	6.10e-06	2.50e-06	0.0
55711	-1.63e-03	3.10e-04	-8.45e-03	7.22e-06	3.23e-06	0.0
55732	-4.49e-04	-1.54e-03	-8.26e-03	0.0	2.72e-06	0.0
55737	2.41e-03	4.53e-04	-8.20e-03	6.54e-06	2.38e-06	0.0
55743	-2.31e-03	4.76e-04	-8.50e-03	8.11e-06	3.40e-06	0.0
55764	-6.48e-04	-2.12e-03	-8.24e-03	-3.01e-06	2.69e-06	0.0
55769	4.80e-05	-1.04e-04	-8.32e-03	5.01e-06	2.80e-06	0.0
55770	5.68e-05	-1.20e-04	-7.95e-03	5.75e-06	3.33e-06	0.0
55771	4.80e-05	-1.04e-04	-8.32e-03	5.01e-06	2.80e-06	0.0
55772	4.98e-05	-1.08e-04	-8.24e-03	5.15e-06	2.90e-06	0.0
55773	4.80e-05	-1.04e-04	-8.32e-03	5.01e-06	2.80e-06	0.0
5581	6.88e-05	3.11e-04	-0.01	-1.58e-05	3.93e-06	0.0
5582	8.35e-05	3.63e-04	-0.01	-1.83e-05	4.80e-06	0.0
55814	1.74e-03	-1.78e-04	-8.42e-03	-1.24e-05	2.74e-06	0.0
55835	-4.34e-04	1.68e-03	-8.30e-03	-6.26e-06	2.85e-06	0.0
55836	-4.68e-04	-1.21e-03	-8.72e-03	-1.71e-05	3.44e-06	0.0
55846	2.42e-03	-3.40e-04	-8.40e-03	-1.27e-05	2.64e-06	0.0
55867	-6.29e-04	2.26e-03	-8.23e-03	-4.16e-06	2.78e-06	0.0
55868	-6.77e-04	-1.79e-03	-8.82e-03	-1.94e-05	3.61e-06	0.0
55869	5.27e-05	2.27e-04	-8.48e-03	-1.15e-05	3.02e-06	0.0
55870	6.25e-05	2.62e-04	-8.14e-03	-1.32e-05	3.59e-06	0.0
55871	5.27e-05	2.27e-04	-8.48e-03	-1.15e-05	3.02e-06	0.0
55872	5.47e-05	2.34e-04	-8.41e-03	-1.19e-05	3.13e-06	0.0
55873	5.27e-05	2.27e-04	-8.48e-03	-1.15e-05	3.02e-06	0.0
5591	1.03e-04	7.84e-04	-0.01	-3.93e-05	5.61e-06	0.0
5592	1.26e-04	9.16e-04	-0.01	-4.58e-05	6.89e-06	0.0
55914	1.79e-03	1.42e-04	-9.42e-03	-2.82e-05	3.96e-06	0.0
55935	-3.87e-04	2.08e-03	-9.09e-03	-2.63e-05	3.68e-06	0.0
55936	-4.67e-04	-9.15e-04	-9.95e-03	-3.20e-05	5.36e-06	0.0
55946	2.48e-03	-3.10e-05	-9.40e-03	-2.79e-05	3.82e-06	0.0
55967	-5.74e-04	2.68e-03	-8.93e-03	-2.53e-05	3.43e-06	0.0
55968	-6.86e-04	-1.51e-03	-0.01	-3.32e-05	5.78e-06	0.0
55969	7.87e-05	5.73e-04	-9.47e-03	-2.87e-05	4.31e-06	0.0
55970	9.40e-05	6.61e-04	-9.27e-03	-3.30e-05	5.16e-06	0.0
55971	7.87e-05	5.73e-04	-9.47e-03	-2.87e-05	4.31e-06	0.0
55972	8.18e-05	5.91e-04	-9.43e-03	-2.96e-05	4.48e-06	0.0
55973	7.87e-05	5.73e-04	-9.47e-03	-2.87e-05	4.31e-06	0.0
5602	2.12e-04	1.51e-03	-0.02	-7.53e-05	1.13e-05	0.0
56014	1.87e-03	4.66e-04	-0.01	-4.41e-05	6.21e-06	0.0
56035	-3.13e-04	2.56e-03	-0.01	-5.03e-05	5.96e-06	0.0
56036	-4.36e-04	-6.43e-04	-0.01	-4.54e-05	8.83e-06	0.0
56046	2.56e-03	2.75e-04	-0.01	-4.29e-05	5.90e-06	0.0
56067	-4.92e-04	3.21e-03	-0.01	-5.16e-05	5.54e-06	0.0
56068	-6.64e-04	-1.28e-03	-0.01	-4.47e-05	9.56e-06	0.0
56070	1.59e-04	1.09e-03	-0.01	-5.44e-05	8.43e-06	0.0
56072	1.37e-04	9.73e-04	-0.01	-4.86e-05	7.28e-06	0.0
56073	1.32e-04	9.44e-04	-0.01	-4.72e-05	7.00e-06	0.0
5612	3.61e-04	2.13e-03	-0.02	-1.06e-04	1.89e-05	0.0
56114	1.97e-03	7.84e-04	-0.01	-5.98e-05	9.63e-06	0.0
56120	-1.49e-03	8.71e-04	-0.01	-6.68e-05	1.46e-05	0.0
56135	-1.94e-04	3.11e-03	-0.01	-7.75e-05	1.07e-05	0.0
56146	2.66e-03	5.67e-04	-0.01	-5.72e-05	8.82e-06	0.0
56152	-2.17e-03	6.88e-04	-0.01	-6.71e-05	1.58e-05	0.0
56167	-3.61e-04	3.82e-03	-0.01	-8.20e-05	1.04e-05	0.0
56170	2.70e-04	1.54e-03	-0.01	-7.66e-05	1.41e-05	0.0
56172	2.33e-04	1.37e-03	-0.01	-6.83e-05	1.21e-05	0.0
56173	2.23e-04	1.33e-03	-0.01	-6.63e-05	1.17e-05	0.0
5622	5.89e-04	2.70e-03	-0.03	-1.34e-04	3.07e-05	0.0
56214	2.08e-03	1.06e-03	-0.02	-7.35e-05	1.41e-05	0.0
56219	-1.26e-03	2.35e-03	-0.02	-9.39e-05	2.31e-05	0.0
56235	4.18e-06	3.66e-03	-0.02	-1.05e-04	1.93e-05	0.0
56246	2.77e-03	8.18e-04	-0.02	-6.95e-05	1.22e-05	0.0
56251	-1.91e-03	2.62e-03	-0.02	-9.81e-05	2.48e-05	0.0
56267	-1.39e-04	4.46e-03	-0.02	-1.13e-04	1.95e-05	0.0
56270	4.41e-04	1.95e-03	-0.02	-9.70e-05	2.30e-05	0.0
56272	3.77e-04	1.73e-03	-0.02	-8.62e-05	1.97e-05	0.0
56273	3.62e-04	1.67e-03	-0.02	-8.35e-05	1.89e-05	0.0
5632	8.91e-04	3.07e-03	-0.03	-1.52e-04	4.66e-05	0.0
56317	2.25e-03	2.46e-03	-0.02	-9.86e-05	2.29e-05	0.0
56335	3.01e-04	4.07e-03	-0.02	-1.25e-04	3.45e-05	0.0
56349	2.93e-03	2.68e-03	-0.02	-1.00e-04	2.07e-05	0.0
56367	2.04e-04	4.94e-03	-0.03	-1.37e-04	3.70e-05	0.0
56370	6.66e-04	2.22e-03	-0.02	-1.10e-04	3.48e-05	0.0
56372	5.67e-04	1.96e-03	-0.02	-9.76e-05	2.97e-05	0.0



EGP CODE

GRE.EEC.R.73.IT.W.15235.12.024.01

PAGE

163 di/of 527

56373	5.43e-04	1.90e-03	-0.02	-9.45e-05	2.84e-05	0.0
5642	1.08e-03	3.14e-03	-0.04	-1.55e-04	5.67e-05	0.0
56417	2.37e-03	2.52e-03	-0.03	-1.02e-04	2.87e-05	0.0
56435	5.24e-04	4.18e-03	-0.03	-1.30e-04	4.52e-05	0.0
56449	3.05e-03	2.76e-03	-0.03	-1.04e-04	2.64e-05	0.0
56467	4.71e-04	5.09e-03	-0.03	-1.43e-04	4.95e-05	0.0
56470	8.09e-04	2.27e-03	-0.03	-1.12e-04	4.24e-05	0.0
56472	6.88e-04	2.00e-03	-0.03	-9.94e-05	3.60e-05	0.0
56473	6.57e-04	1.94e-03	-0.03	-9.62e-05	3.44e-05	0.0
5652	1.25e-03	-3.59e-03	-0.04	1.75e-04	6.60e-05	0.0
56510	2.64e-03	-2.86e-03	-0.03	1.15e-04	4.34e-05	0.0
56532	6.00e-04	-4.57e-03	-0.03	1.48e-04	4.92e-05	0.0
56542	3.40e-03	-3.12e-03	-0.03	1.18e-04	4.47e-05	0.0
56564	5.36e-04	-5.51e-03	-0.03	1.64e-04	5.28e-05	0.0
56570	9.34e-04	-2.61e-03	-0.03	1.27e-04	4.93e-05	0.0
56572	7.94e-04	-2.28e-03	-0.03	1.12e-04	4.19e-05	0.0
56573	7.59e-04	-2.20e-03	-0.03	1.08e-04	4.01e-05	0.0
5662	8.08e-04	-3.39e-03	-0.03	1.66e-04	4.40e-05	0.0
5665	2.33e-03	-1.40e-03	-0.02	8.85e-05	2.66e-05	0.0
56624	-2.60e-04	-4.15e-03	-0.02	1.34e-04	2.89e-05	0.0
56632	1.42e-04	-4.27e-03	-0.02	1.34e-04	2.85e-05	0.0
56637	3.07e-03	-1.12e-03	-0.02	8.28e-05	2.65e-05	0.0
56656	-5.63e-04	-4.97e-03	-0.02	1.46e-04	2.97e-05	0.0
56664	0.0	-5.14e-03	-0.02	1.47e-04	2.91e-05	0.0
56670	6.05e-04	-2.46e-03	-0.02	1.20e-04	3.29e-05	0.0
56672	5.18e-04	-2.16e-03	-0.02	1.06e-04	2.82e-05	0.0
56673	4.97e-04	-2.09e-03	-0.02	1.03e-04	2.70e-05	0.0
5672	4.81e-04	-2.79e-03	-0.02	1.37e-04	2.61e-05	0.0
5675	2.15e-03	-1.11e-03	-0.02	7.52e-05	1.83e-05	0.0
56712	-1.51e-03	-2.39e-03	-0.02	9.58e-05	1.38e-05	0.0
56732	-3.26e-04	-3.64e-03	-0.02	1.04e-04	1.30e-05	0.0
56737	2.89e-03	-8.64e-04	-0.02	7.11e-05	1.92e-05	0.0
56744	-2.23e-03	-2.65e-03	-0.02	1.00e-04	1.29e-05	0.0
56764	-5.76e-04	-4.40e-03	-0.02	1.12e-04	1.18e-05	0.0
56770	3.60e-04	-2.03e-03	-0.02	9.96e-05	1.95e-05	0.0
56772	3.11e-04	-1.79e-03	-0.02	8.83e-05	1.68e-05	0.0
56773	2.98e-04	-1.73e-03	-0.02	8.54e-05	1.61e-05	0.0
5682	2.74e-04	-2.08e-03	-0.02	1.02e-04	1.48e-05	0.0
5685	1.98e-03	-7.70e-04	-0.01	5.85e-05	1.13e-05	0.0
56831	-2.83e-04	3.39e-04	-0.01	5.87e-05	1.11e-05	0.0
56832	-4.28e-04	-2.97e-03	-0.01	7.13e-05	6.58e-06	0.0
56837	2.71e-03	-5.60e-04	-0.01	5.63e-05	1.21e-05	0.0
56863	-4.65e-04	9.94e-04	-0.01	5.66e-05	1.18e-05	0.0
56864	-6.68e-04	-3.64e-03	-0.01	7.42e-05	5.52e-06	0.0
56870	2.05e-04	-1.51e-03	-0.01	7.41e-05	1.11e-05	0.0
56872	1.78e-04	-1.34e-03	-0.01	6.60e-05	9.59e-06	0.0
56873	1.71e-04	-1.30e-03	-0.01	6.39e-05	9.21e-06	0.0
5692	1.55e-04	-1.39e-03	-0.01	6.82e-05	8.52e-06	0.0
5695	1.87e-03	-4.06e-04	-0.01	4.09e-05	6.78e-06	0.0
56931	-4.76e-04	6.35e-04	-0.01	4.44e-05	6.47e-06	0.0
56932	-3.67e-04	-2.39e-03	-0.01	4.22e-05	3.65e-06	0.0
56937	2.57e-03	-2.21e-04	-0.01	4.01e-05	7.36e-06	0.0
56963	-7.05e-04	1.24e-03	-0.01	4.51e-05	6.93e-06	0.0
56964	-5.52e-04	-3.00e-03	-0.01	4.20e-05	2.97e-06	0.0
56970	1.16e-04	-1.01e-03	-0.01	4.93e-05	6.38e-06	0.0
56972	1.01e-04	-8.94e-04	-0.01	4.40e-05	5.54e-06	0.0
56973	9.71e-05	-8.66e-04	-0.01	4.27e-05	5.33e-06	0.0
5701	7.58e-05	-6.45e-04	-0.01	3.17e-05	4.34e-06	0.0
5702	9.22e-05	-7.57e-04	-0.01	3.70e-05	5.28e-06	0.0
5705	1.79e-03	-5.10e-05-9.12e-03		2.34e-05	4.23e-06	0.0
57031	-4.87e-04	9.51e-04-9.59e-03		2.83e-05	3.89e-06	0.0
57032	-4.21e-04	-1.91e-03-8.81e-03		1.89e-05	2.41e-06	0.0
57037	2.48e-03	1.18e-04-9.11e-03		2.35e-05	4.59e-06	0.0
57063	-7.05e-04	1.52e-03-9.76e-03		3.03e-05	4.11e-06	0.0
57064	-6.13e-04	-2.49e-03-8.67e-03		1.71e-05	2.05e-06	0.0
57069	5.82e-05	-4.73e-04-9.16e-03		2.32e-05	3.33e-06	0.0
57070	6.91e-05	-5.48e-04-8.92e-03		2.68e-05	3.96e-06	0.0
57071	5.82e-05	-4.73e-04-9.16e-03		2.32e-05	3.33e-06	0.0
57072	6.04e-05	-4.88e-04-9.11e-03		2.39e-05	3.45e-06	0.0
57073	5.82e-05	-4.73e-04-9.16e-03		2.32e-05	3.33e-06	0.0
5711	5.64e-05	-1.52e-04	-0.01	7.22e-06	3.34e-06	0.0
5712	6.83e-05	-1.78e-04	-0.01	8.41e-06	4.05e-06	0.0
5715	1.74e-03	2.92e-04-8.38e-03		6.57e-06	3.07e-06	0.0
57111	-1.65e-03	2.93e-04-8.59e-03		7.67e-06	2.19e-06	0.0
57132	-4.72e-04	-1.51e-03-8.39e-03		0.0	2.23e-06	0.0
57137	2.42e-03	4.54e-04-8.35e-03		7.09e-06	3.27e-06	0.0



EGP CODE

GRE.EEC.R.73.IT.W.15235.12.024.01

PAGE

164 di/of 527

57143	-2.33e-03	4.55e-04-8.64e-03	8.62e-06	2.04e-06	0.0
57164	-6.79e-04	-2.08e-03-8.36e-03	-3.39e-06	2.10e-06	0.0
57169	4.33e-05	-1.11e-04-8.46e-03	5.28e-06	2.56e-06	0.0
57170	5.13e-05	-1.29e-04-8.12e-03	6.08e-06	3.03e-06	0.0
57171	4.33e-05	-1.11e-04-8.46e-03	5.28e-06	2.56e-06	0.0
57172	4.49e-05	-1.15e-04-8.39e-03	5.44e-06	2.65e-06	0.0
57173	4.33e-05	-1.11e-04-8.46e-03	5.28e-06	2.56e-06	0.0
5721	6.25e-05	3.32e-04 -0.01	-1.67e-05	3.63e-06	0.0
5722	7.60e-05	3.88e-04 -0.01	-1.95e-05	4.41e-06	0.0
57214	1.75e-03	-1.68e-04-8.58e-03	-1.33e-05	3.39e-06	0.0
57235	-4.42e-04	1.65e-03-8.44e-03	-6.52e-06	2.35e-06	0.0
57236	-4.79e-04	-1.16e-03-8.89e-03	-1.84e-05	2.94e-06	0.0
57246	2.44e-03	-3.33e-04-8.56e-03	-1.37e-05	3.63e-06	0.0
57267	-6.38e-04	2.22e-03-8.36e-03	-4.22e-06	2.17e-06	0.0
57268	-6.89e-04	-1.72e-03-8.99e-03	-2.08e-05	3.01e-06	0.0
57269	4.81e-05	2.43e-04-8.63e-03	-1.23e-05	2.78e-06	0.0
57270	5.70e-05	2.81e-04-8.31e-03	-1.41e-05	3.30e-06	0.0
57271	4.81e-05	2.43e-04-8.63e-03	-1.23e-05	2.78e-06	0.0
57272	4.99e-05	2.51e-04-8.56e-03	-1.26e-05	2.89e-06	0.0
57273	4.81e-05	2.43e-04-8.63e-03	-1.23e-05	2.78e-06	0.0
5731	9.60e-05	8.39e-04 -0.01	-4.19e-05	5.29e-06	0.0
5732	1.17e-04	9.85e-04 -0.01	-4.90e-05	6.47e-06	0.0
57314	1.81e-03	1.78e-04-9.66e-03	-3.03e-05	5.10e-06	0.0
57335	-3.96e-04	2.08e-03-9.26e-03	-2.77e-05	3.00e-06	0.0
57336	-4.83e-04	-8.33e-04 -0.01	-3.46e-05	4.72e-06	0.0
57346	2.51e-03	2.43e-06-9.65e-03	-3.01e-05	5.51e-06	0.0
57367	-5.84e-04	2.67e-03-9.09e-03	-2.65e-05	2.58e-06	0.0
57368	-7.05e-04	-1.41e-03 -0.01	-3.61e-05	4.99e-06	0.0
57369	7.37e-05	6.16e-04-9.69e-03	-3.07e-05	4.06e-06	0.0
57370	8.80e-05	7.13e-04-9.53e-03	-3.54e-05	4.85e-06	0.0
57371	7.37e-05	6.16e-04-9.69e-03	-3.07e-05	4.06e-06	0.0
57372	7.66e-05	6.35e-04-9.66e-03	-3.17e-05	4.22e-06	0.0
57373	7.37e-05	6.16e-04-9.69e-03	-3.07e-05	4.06e-06	0.0
5742	2.05e-04	1.64e-03 -0.02	-8.14e-05	1.09e-05	0.0
57414	1.91e-03	5.38e-04 -0.01	-4.79e-05	8.40e-06	0.0
57435	-3.27e-04	2.60e-03 -0.01	-5.36e-05	4.92e-06	0.0
57436	-4.57e-04	-5.21e-04 -0.01	-4.98e-05	8.02e-06	0.0
57446	2.62e-03	3.43e-04 -0.01	-4.66e-05	9.05e-06	0.0
57467	-5.09e-04	3.23e-03 -0.01	-5.46e-05	4.18e-06	0.0
57468	-6.91e-04	-1.14e-03 -0.01	-4.94e-05	8.52e-06	0.0
57470	1.53e-04	1.19e-03 -0.01	-5.89e-05	8.14e-06	0.0
57472	1.33e-04	1.06e-03 -0.01	-5.25e-05	7.06e-06	0.0
57473	1.28e-04	1.02e-03 -0.01	-5.09e-05	6.78e-06	0.0
5752	3.61e-04	2.36e-03 -0.02	-1.16e-04	1.89e-05	0.0
57514	2.05e-03	8.98e-04 -0.01	-6.55e-05	1.40e-05	0.0
57520	-1.56e-03	1.03e-03 -0.02	-7.39e-05	1.09e-05	0.0
57535	-2.20e-04	3.22e-03 -0.01	-8.38e-05	8.99e-06	0.0
57546	2.78e-03	6.71e-04 -0.01	-6.26e-05	1.49e-05	0.0
57552	-2.28e-03	8.51e-04 -0.02	-7.43e-05	1.06e-05	0.0
57567	-3.98e-04	3.92e-03 -0.01	-8.83e-05	7.89e-06	0.0
57570	2.70e-04	1.71e-03 -0.02	-8.44e-05	1.42e-05	0.0
57572	2.33e-04	1.51e-03 -0.01	-7.50e-05	1.22e-05	0.0
57573	2.24e-04	1.46e-03 -0.01	-7.26e-05	1.17e-05	0.0
5762	6.22e-04	3.05e-03 -0.03	-1.50e-04	3.27e-05	0.0
57614	2.24e-03	1.21e-03 -0.02	-8.06e-05	2.20e-05	0.0
57615	-1.47e-03	2.57e-03 -0.02	-1.06e-04	1.82e-05	0.0
57635	-3.37e-05	3.92e-03 -0.02	-1.18e-04	1.77e-05	0.0
57646	2.98e-03	9.38e-04 -0.02	-7.56e-05	2.28e-05	0.0
57647	-2.21e-03	2.84e-03 -0.02	-1.11e-04	1.74e-05	0.0
57667	-2.01e-04	4.73e-03 -0.02	-1.27e-04	1.67e-05	0.0
57670	4.65e-04	2.21e-03 -0.02	-1.09e-04	2.44e-05	0.0
57672	4.00e-04	1.95e-03 -0.02	-9.65e-05	2.10e-05	0.0
57673	3.83e-04	1.89e-03 -0.02	-9.33e-05	2.01e-05	0.0
5772	9.90e-04	3.55e-03 -0.04	-1.74e-04	5.29e-05	0.0
57717	2.45e-03	2.76e-03 -0.02	-1.12e-04	3.33e-05	0.0
57735	3.22e-04	4.47e-03 -0.03	-1.43e-04	3.64e-05	0.0
57749	3.18e-03	3.00e-03 -0.02	-1.14e-04	3.38e-05	0.0
57767	2.09e-04	5.38e-03 -0.03	-1.58e-04	3.80e-05	0.0
57770	7.40e-04	2.58e-03 -0.03	-1.26e-04	3.95e-05	0.0
57772	6.33e-04	2.26e-03 -0.02	-1.11e-04	3.37e-05	0.0
57773	6.06e-04	2.18e-03 -0.02	-1.07e-04	3.23e-05	0.0
5782	1.25e-03	3.62e-03 -0.04	-1.77e-04	6.61e-05	0.0
57817	2.66e-03	2.85e-03 -0.03	-1.16e-04	4.35e-05	0.0
57835	5.86e-04	4.62e-03 -0.03	-1.51e-04	4.91e-05	0.0
57849	3.42e-03	3.10e-03 -0.03	-1.18e-04	4.48e-05	0.0
57867	5.17e-04	5.58e-03 -0.03	-1.67e-04	5.27e-05	0.0



EGP CODE

GRE.EEC.R.73.IT.W.15235.12.024.01

PAGE

165 di/of 527

57870	9.33e-04	2.64e-03	-0.03	-1.29e-04	4.94e-05	0.0
57872	7.93e-04	2.30e-03	-0.03	-1.13e-04	4.20e-05	0.0
57873	7.59e-04	2.22e-03	-0.03	-1.09e-04	4.02e-05	0.0
5792	9.13e-04	-4.48e-03	-0.04	2.13e-04	4.86e-05	0.0
57910	2.63e-03	-3.59e-03	-0.03	1.46e-04	4.47e-05	0.0
57924	1.40e-04	-5.42e-03	-0.03	1.88e-04	3.39e-05	0.0
57930	1.50e-03	-5.49e-03	-0.03	1.87e-04	4.08e-05	0.0
57942	3.46e-03	-3.95e-03	-0.03	1.53e-04	5.08e-05	0.0
57956	-2.69e-05	-6.51e-03	-0.03	2.12e-04	3.56e-05	0.0
57962	1.88e-03	-6.61e-03	-0.03	2.10e-04	4.53e-05	0.0
57970	6.83e-04	-3.27e-03	-0.03	1.56e-04	3.63e-05	0.0
57972	5.82e-04	-2.82e-03	-0.03	1.35e-04	3.09e-05	0.0
57973	5.56e-04	-2.71e-03	-0.03	1.30e-04	2.96e-05	0.0
5802	1.28e-04	-4.15e-03	-0.03	1.98e-04	1.63e-05	0.0
5805	2.27e-03	-1.74e-03	-0.02	1.05e-04	2.52e-05	0.0
58024	-9.17e-04	-4.83e-03	-0.02	1.61e-04	1.81e-06	0.0
58032	-6.12e-04	-4.87e-03	-0.02	1.61e-04	1.54e-06	0.0
58037	3.14e-03	-1.42e-03	-0.02	9.80e-05	3.11e-05	0.0
58056	-1.32e-03	-5.75e-03	-0.03	1.77e-04	-1.67e-06	0.0
58064	-8.94e-04	-5.80e-03	-0.03	1.77e-04	-2.04e-06	0.0
58070	9.67e-05	-3.03e-03	-0.03	1.44e-04	1.22e-05	0.0
58072	9.43e-05	-2.64e-03	-0.02	1.26e-04	1.08e-05	0.0
58073	9.36e-05	-2.54e-03	-0.02	1.22e-04	1.05e-05	0.0
5812	2.33e-04	-3.09e-03	-0.03	1.50e-04	1.41e-05	0.0
5815	2.11e-03	-1.32e-03	-0.02	8.51e-05	1.64e-05	0.0
58111	-1.78e-03	-1.42e-03	-0.02	9.21e-05	2.36e-06	0.0
58132	-3.08e-04	-3.76e-03	-0.02	1.10e-04	4.80e-06	0.0
58137	2.90e-03	-1.08e-03	-0.02	8.18e-05	1.94e-05	0.0
58143	-2.55e-03	-1.23e-03	-0.02	9.16e-05	0.0	0.0
58164	-4.91e-04	-4.50e-03	-0.02	1.17e-04	3.20e-06	0.0
58170	1.75e-04	-2.25e-03	-0.02	1.09e-04	1.06e-05	0.0
58172	1.53e-04	-1.98e-03	-0.02	9.66e-05	9.15e-06	0.0
58173	1.47e-04	-1.91e-03	-0.02	9.34e-05	8.79e-06	0.0
5822	1.38e-04	-2.24e-03	-0.02	1.09e-04	8.05e-06	0.0
5825	1.95e-03	-8.83e-04	-0.01	6.44e-05	9.99e-06	0.0
58231	-5.48e-04	2.08e-04	-0.01	6.33e-05	5.22e-06	0.0
58232	-3.65e-04	-3.02e-03	-0.01	7.44e-05	2.21e-06	0.0
58237	2.70e-03	-6.79e-04	-0.01	6.29e-05	1.20e-05	0.0
58263	-8.03e-04	8.49e-04	-0.01	6.14e-05	5.29e-06	0.0
58264	-5.47e-04	-3.67e-03	-0.01	7.68e-05	1.08e-06	0.0
58270	1.04e-04	-1.63e-03	-0.01	7.93e-05	6.02e-06	0.0
58272	9.03e-05	-1.44e-03	-0.01	7.04e-05	5.23e-06	0.0
58273	8.69e-05	-1.39e-03	-0.01	6.82e-05	5.03e-06	0.0
5832	7.45e-05	-1.47e-03	-0.01	7.18e-05	4.57e-06	0.0
5835	1.84e-03	-4.65e-04	-0.01	4.42e-05	5.76e-06	0.0
58331	-5.49e-04	5.48e-04	-0.01	4.70e-05	2.94e-06	0.0
58332	-4.11e-04	-2.40e-03	-0.01	4.37e-05	1.30e-06	0.0
58337	2.56e-03	-2.83e-04	-0.01	4.38e-05	6.92e-06	0.0
58363	-7.88e-04	1.14e-03	-0.01	4.77e-05	2.96e-06	0.0
58364	-5.94e-04	-2.99e-03	-0.01	4.32e-05	0.0	0.0
58370	5.60e-05	-1.07e-03	-0.01	5.21e-05	3.42e-06	0.0
58372	4.89e-05	-9.48e-04	-0.01	4.64e-05	2.98e-06	0.0
58373	4.71e-05	-9.18e-04	-0.01	4.50e-05	2.87e-06	0.0
5841	3.39e-05	-6.77e-04	-0.01	3.31e-05	2.32e-06	0.0
5842	4.10e-05	-7.97e-04	-0.01	3.87e-05	2.80e-06	0.0
5845	1.77e-03	-7.65e-05-9.32e-03		2.51e-05	3.50e-06	0.0
58431	-5.31e-04	8.91e-04-9.74e-03		2.96e-05	1.73e-06	0.0
58432	-4.50e-04	-1.90e-03-8.90e-03		1.93e-05	0.0	0.0
58437	2.47e-03	9.25e-05-9.34e-03		2.54e-05	4.19e-06	0.0
58463	-7.55e-04	1.45e-03-9.91e-03		3.18e-05	1.71e-06	0.0
58464	-6.41e-04	-2.46e-03-8.74e-03		1.73e-05	0.0	0.0
58469	2.62e-05	-4.98e-04-9.29e-03		2.43e-05	1.78e-06	0.0
58470	3.10e-05	-5.78e-04-9.08e-03		2.80e-05	2.10e-06	0.0
58471	2.62e-05	-4.98e-04-9.29e-03		2.43e-05	1.78e-06	0.0
58472	2.72e-05	-5.14e-04-9.25e-03		2.50e-05	1.84e-06	0.0
58473	2.62e-05	-4.98e-04-9.29e-03		2.43e-05	1.78e-06	0.0
5851	2.36e-05	-1.59e-04	-0.01	7.48e-06	1.78e-06	0.0
5852	2.85e-05	-1.86e-04	-0.01	8.73e-06	2.15e-06	0.0
5855	1.73e-03	2.91e-04-8.52e-03		7.14e-06	2.46e-06	0.0
58531	-5.02e-04	1.24e-03-8.68e-03		1.23e-05	1.17e-06	0.0
58532	-4.83e-04	-1.48e-03-8.47e-03		-1.12e-06	0.0	0.0
58537	2.41e-03	4.54e-04-8.51e-03		7.80e-06	2.90e-06	0.0
58563	-7.10e-04	1.79e-03-8.73e-03		1.50e-05	1.09e-06	0.0
58564	-6.84e-04	-2.03e-03-8.44e-03		-3.77e-06	0.0	0.0
58569	1.84e-05	-1.17e-04-8.56e-03		5.48e-06	1.37e-06	0.0
58570	2.16e-05	-1.35e-04-8.24e-03		6.32e-06	1.61e-06	0.0





EGP CODE

GRE.EEC.R.73.IT.W.15235.12.024.01

PAGE

166 di/of 527

58571	1.84e-05	-1.17e-04-8.56e-03	5.48e-06	1.37e-06	0.0
58572	1.90e-05	-1.20e-04-8.49e-03	5.65e-06	1.41e-06	0.0
58573	1.84e-05	-1.17e-04-8.56e-03	5.48e-06	1.37e-06	0.0
5861	2.73e-05	3.47e-04 -0.01	-1.75e-05	1.95e-06	0.0
5862	3.31e-05	4.08e-04 -0.01	-2.05e-05	2.36e-06	0.0
58614	1.74e-03	-1.58e-04-8.74e-03	-1.43e-05	2.72e-06	0.0
58635	-4.68e-04	1.63e-03-8.52e-03	-6.65e-06	1.01e-06	0.0
58636	-5.13e-04	-1.11e-03-8.99e-03	-1.93e-05	1.31e-06	0.0
58646	2.42e-03	-3.23e-04-8.74e-03	-1.49e-05	3.22e-06	0.0
58667	-6.63e-04	2.18e-03-8.44e-03	-4.17e-06	0.0	0.0
58668	-7.26e-04	-1.66e-03-9.10e-03	-2.18e-05	1.23e-06	0.0
58669	2.12e-05	2.55e-04-8.74e-03	-1.28e-05	1.50e-06	0.0
58670	2.50e-05	2.96e-04-8.44e-03	-1.48e-05	1.77e-06	0.0
58671	2.12e-05	2.55e-04-8.74e-03	-1.28e-05	1.50e-06	0.0
58672	2.19e-05	2.63e-04-8.68e-03	-1.32e-05	1.55e-06	0.0
58673	2.12e-05	2.55e-04-8.74e-03	-1.28e-05	1.50e-06	0.0
5871	4.60e-05	8.83e-04 -0.01	-4.39e-05	2.89e-06	0.0
5872	5.62e-05	1.04e-03 -0.01	-5.15e-05	3.51e-06	0.0
58714	1.79e-03	2.15e-04-9.90e-03	-3.26e-05	4.20e-06	0.0
58735	-4.30e-04	2.08e-03-9.37e-03	-2.86e-05	1.24e-06	0.0
58736	-5.37e-04	-7.64e-04 -0.01	-3.64e-05	2.15e-06	0.0
58746	2.49e-03	4.13e-05-9.92e-03	-3.27e-05	4.99e-06	0.0
58767	-6.16e-04	2.65e-03-9.18e-03	-2.71e-05	0.0	0.0
58768	-7.66e-04	-1.33e-03 -0.01	-3.81e-05	2.12e-06	0.0
58769	3.55e-05	6.50e-04-9.85e-03	-3.23e-05	2.21e-06	0.0
58770	4.23e-05	7.54e-04-9.73e-03	-3.73e-05	2.63e-06	0.0
58771	3.55e-05	6.50e-04-9.85e-03	-3.23e-05	2.21e-06	0.0
58772	3.68e-05	6.71e-04-9.83e-03	-3.33e-05	2.30e-06	0.0
58773	3.55e-05	6.50e-04-9.85e-03	-3.23e-05	2.21e-06	0.0
5882	1.05e-04	1.75e-03 -0.02	-8.63e-05	6.02e-06	0.0
58814	1.88e-03	6.16e-04 -0.01	-5.21e-05	7.13e-06	0.0
58835	-3.83e-04	2.62e-03 -0.01	-5.59e-05	2.01e-06	0.0
58836	-5.46e-04	-4.21e-04 -0.01	-5.29e-05	3.74e-06	0.0
58846	2.60e-03	4.25e-04 -0.01	-5.13e-05	8.48e-06	0.0
58867	-5.63e-04	3.24e-03 -0.01	-5.66e-05	1.30e-06	0.0
58868	-7.92e-04	-1.03e-03 -0.01	-5.25e-05	3.73e-06	0.0
58870	7.90e-05	1.27e-03 -0.01	-6.26e-05	4.50e-06	0.0
58872	6.85e-05	1.13e-03 -0.01	-5.57e-05	3.91e-06	0.0
58873	6.59e-05	1.09e-03 -0.01	-5.40e-05	3.77e-06	0.0
5892	1.95e-04	2.55e-03 -0.02	-1.25e-04	1.08e-05	0.0
58914	2.01e-03	1.04e-03 -0.02	-7.27e-05	1.24e-05	0.0
58935	-3.25e-04	3.29e-03 -0.01	-8.82e-05	3.56e-06	0.0
58936	-5.31e-04	-8.79e-05 -0.02	-6.97e-05	6.75e-06	0.0
58946	2.77e-03	8.19e-04 -0.02	-7.06e-05	1.48e-05	0.0
58967	-5.04e-04	3.97e-03 -0.01	-9.22e-05	2.30e-06	0.0
58968	-7.92e-04	-7.58e-04 -0.02	-6.63e-05	6.76e-06	0.0
58970	1.46e-04	1.85e-03 -0.02	-9.11e-05	8.06e-06	0.0
58972	1.27e-04	1.64e-03 -0.02	-8.07e-05	6.98e-06	0.0
58973	1.22e-04	1.58e-03 -0.02	-7.81e-05	6.71e-06	0.0
5902	3.40e-04	3.41e-03 -0.03	-1.67e-04	1.93e-05	0.0
59014	2.21e-03	1.46e-03 -0.02	-9.27e-05	2.07e-05	0.0
59015	-1.79e-03	2.76e-03 -0.02	-1.14e-04	3.13e-06	0.0
59035	-2.35e-04	4.08e-03 -0.02	-1.27e-04	7.93e-06	0.0
59046	3.01e-03	1.20e-03 -0.02	-8.84e-05	2.43e-05	0.0
59047	-2.59e-03	3.02e-03 -0.02	-1.18e-04	0.0	0.0
59067	-4.14e-04	4.88e-03 -0.02	-1.36e-04	6.33e-06	0.0
59070	2.54e-04	2.49e-03 -0.02	-1.21e-04	1.44e-05	0.0
59072	2.20e-04	2.18e-03 -0.02	-1.07e-04	1.24e-05	0.0
59073	2.12e-04	2.11e-03 -0.02	-1.03e-04	1.19e-05	0.0
5912	3.51e-04	4.50e-03 -0.04	-2.13e-04	2.66e-05	0.0
59114	2.43e-03	1.82e-03 -0.02	-1.09e-04	3.26e-05	0.0
59127	-7.60e-04	5.31e-03 -0.03	-1.82e-04	9.95e-06	0.0
59135	-5.02e-04	5.35e-03 -0.03	-1.82e-04	9.33e-06	0.0
59146	3.31e-03	1.45e-03 -0.02	-1.00e-04	3.90e-05	0.0
59159	-1.16e-03	6.35e-03 -0.03	-2.03e-04	7.24e-06	0.0
59167	-7.95e-04	6.40e-03 -0.03	-2.02e-04	6.38e-06	0.0
59170	2.63e-04	3.29e-03 -0.03	-1.56e-04	1.99e-05	0.0
59172	2.36e-04	2.85e-03 -0.03	-1.36e-04	1.74e-05	0.0
59173	2.29e-04	2.74e-03 -0.03	-1.31e-04	1.67e-05	0.0
5922	9.03e-04	4.49e-03 -0.04	-2.14e-04	4.84e-05	0.0
59217	2.66e-03	3.54e-03 -0.03	-1.46e-04	4.51e-05	0.0
59227	1.30e-04	5.47e-03 -0.03	-1.89e-04	3.28e-05	0.0
59231	3.25e-04	5.51e-03 -0.03	-1.89e-04	3.33e-05	0.0
59249	3.51e-03	3.87e-03 -0.03	-1.52e-04	5.14e-05	0.0
59259	-3.89e-05	6.57e-03 -0.03	-2.13e-04	3.41e-05	0.0
59263	2.34e-04	6.62e-03 -0.03	-2.12e-04	3.48e-05	0.0



EGP CODE

GRE.EEC.R.73.IT.W.15235.12.024.01

PAGE

167 di/of 527

59270	6.75e-04	3.28e-03	-0.03	-1.56e-04	3.62e-05	0.0
59272	5.76e-04	2.83e-03	-0.03	-1.36e-04	3.08e-05	0.0
59273	5.51e-04	2.72e-03	-0.03	-1.30e-04	2.95e-05	0.0
5932	-3.93e-05	-4.00e-03	-0.03	1.98e-04	0.0	0.0
5938	-2.34e-03	-3.10e-03	-0.02	1.32e-04	-1.95e-05	0.0
59326	3.30e-04	-4.56e-03	-0.02	1.55e-04	3.52e-06	0.0
59328	-8.62e-04	-4.55e-03	-0.02	1.55e-04	-4.17e-06	0.0
59340	-3.26e-03	-3.35e-03	-0.02	1.36e-04	-2.74e-05	0.0
59356	-1.30e-03	-5.40e-03	-0.03	1.68e-04	-8.75e-06	0.0
59360	-1.20e-03	-5.39e-03	-0.03	1.68e-04	-5.91e-06	0.0
59370	-2.89e-05	-2.92e-03	-0.03	1.44e-04	0.0	0.0
59372	-2.41e-05	-2.55e-03	-0.02	1.26e-04	0.0	0.0
59373	-2.29e-05	-2.46e-03	-0.02	1.22e-04	0.0	0.0
5942	-2.43e-05	-3.17e-03	-0.03	1.54e-04	0.0	0.0
5948	-2.00e-03	-2.52e-03	-0.02	1.01e-04	-8.84e-06	0.0
59424	-7.86e-04	-3.79e-03	-0.02	1.13e-04	-2.84e-06	0.0
59431	-7.48e-04	-1.55e-04	-0.02	7.96e-05	-2.40e-06	0.0
59440	-2.80e-03	-2.74e-03	-0.02	1.03e-04	-1.25e-05	0.0
59456	-1.10e-03	-4.52e-03	-0.02	1.19e-04	-4.04e-06	0.0
59463	-1.04e-03	5.69e-04	-0.02	7.31e-05	-3.43e-06	0.0
59470	-1.78e-05	-2.31e-03	-0.02	1.12e-04	0.0	0.0
59472	-1.49e-05	-2.03e-03	-0.02	9.92e-05	0.0	0.0
59473	-1.42e-05	-1.96e-03	-0.02	9.59e-05	0.0	0.0
5952	-2.04e-05	-2.29e-03	-0.02	1.11e-04	0.0	0.0
5958	-1.89e-03	-1.91e-03	-0.01	7.12e-05	-5.40e-06	0.0
59526	3.61e-04	-3.02e-03	-0.01	7.47e-05	0.0	0.0
59531	-6.85e-04	1.58e-04	-0.01	6.43e-05	-1.43e-06	0.0
59540	-2.64e-03	-2.10e-03	-0.01	7.18e-05	-7.59e-06	0.0
59558	5.10e-04	-3.66e-03	-0.01	7.68e-05	0.0	0.0
59563	-9.54e-04	7.91e-04	-0.01	6.22e-05	-2.03e-06	0.0
59570	-1.49e-05	-1.66e-03	-0.01	8.08e-05	0.0	0.0
59572	-1.26e-05	-1.47e-03	-0.01	7.17e-05	0.0	0.0
59573	-1.20e-05	-1.42e-03	-0.01	6.94e-05	0.0	0.0
5962	-1.87e-05	-1.50e-03	-0.01	7.29e-05	0.0	0.0
5968	-1.81e-03	-1.38e-03	-0.01	4.52e-05	-3.10e-06	0.0
59623	-4.36e-04	5.18e-04	-0.01	4.73e-05	0.0	0.0
59626	3.95e-04	-2.39e-03	-0.01	4.39e-05	0.0	0.0
59640	-2.53e-03	-1.56e-03	-0.01	4.50e-05	-4.35e-06	0.0
59655	-6.06e-04	1.10e-03	-0.01	4.80e-05	0.0	0.0
59658	5.58e-04	-2.98e-03	-0.01	4.32e-05	0.0	0.0
59670	-1.37e-05	-1.09e-03	-0.01	5.28e-05	0.0	0.0
59672	-1.17e-05	-9.65e-04	-0.01	4.70e-05	0.0	0.0
59673	-1.12e-05	-9.34e-04	-0.01	4.56e-05	0.0	0.0
5971	-1.46e-05	-6.87e-04	-0.01	3.35e-05	0.0	0.0
5972	-1.82e-05	-8.09e-04	-0.01	3.92e-05	0.0	0.0
5978	-1.76e-03	-9.26e-04-9.22e-03		2.31e-05	-1.87e-06	0.0
59723	-4.69e-04	8.67e-04-9.76e-03		2.99e-05	0.0	0.0
59726	4.37e-04	-1.88e-03-8.89e-03		1.93e-05	0.0	0.0
59740	-2.45e-03	-1.09e-03-9.17e-03		2.25e-05	-2.61e-06	0.0
59755	-6.52e-04	1.42e-03-9.93e-03		3.20e-05	0.0	0.0
59758	6.16e-04	-2.44e-03-8.72e-03		1.72e-05	0.0	0.0
59769	-1.09e-05	-5.06e-04-9.33e-03		2.46e-05	0.0	0.0
59770	-1.32e-05	-5.87e-04-9.12e-03		2.84e-05	0.0	0.0
59771	-1.09e-05	-5.06e-04-9.33e-03		2.46e-05	0.0	0.0
59772	-1.13e-05	-5.22e-04-9.29e-03		2.53e-05	0.0	0.0
59773	-1.09e-05	-5.06e-04-9.33e-03		2.46e-05	0.0	0.0
5981	-1.43e-05	-1.61e-04	-0.01	7.55e-06	0.0	0.0
5982	-1.77e-05	-1.89e-04	-0.01	8.81e-06	0.0	0.0
5988	-1.72e-03	-5.29e-04-8.57e-03		3.59e-06	-1.25e-06	0.0
59823	-5.07e-04	1.22e-03-8.70e-03		1.24e-05	0.0	0.0
59826	4.83e-04	-1.46e-03-8.47e-03		-1.30e-06	0.0	0.0
59840	-2.40e-03	-6.93e-04-8.56e-03		2.80e-06	-1.75e-06	0.0
59855	-7.06e-04	1.76e-03-8.74e-03		1.51e-05	0.0	0.0
59858	6.80e-04	-2.00e-03-8.43e-03		-4.03e-06	0.0	0.0
59869	-1.06e-05	-1.18e-04-8.59e-03		5.54e-06	0.0	0.0
59870	-1.29e-05	-1.37e-04-8.27e-03		6.38e-06	0.0	0.0
59871	-1.06e-05	-1.18e-04-8.59e-03		5.54e-06	0.0	0.0
59872	-1.11e-05	-1.22e-04-8.52e-03		5.71e-06	0.0	0.0
59873	-1.06e-05	-1.18e-04-8.59e-03		5.54e-06	0.0	0.0
5991	-1.38e-05	3.52e-04	-0.01	-1.77e-05	0.0	0.0
5992	-1.70e-05	4.14e-04	-0.01	-2.07e-05	0.0	0.0
59915	-1.73e-03	6.73e-04-8.71e-03		-1.10e-05	-1.36e-06	0.0
59927	-5.53e-04	1.61e-03-8.53e-03		-6.57e-06	0.0	0.0
59928	-4.92e-04	-1.09e-03-9.01e-03		-1.94e-05	0.0	0.0
59947	-2.41e-03	8.39e-04-8.69e-03		-1.02e-05	-1.91e-06	0.0
59959	-7.70e-04	2.15e-03-8.44e-03		-3.99e-06	0.0	0.0



EGP CODE

GRE.EEC.R.73.IT.W.15235.12.024.01

PAGE

168 di/of 527

59960	-6.85e-04	-1.63e-03-9.11e-03	-2.20e-05	0.0	0.0
59969	-1.02e-05	2.59e-04-8.77e-03	-1.30e-05	0.0	0.0
59970	-1.23e-05	3.00e-04-8.48e-03	-1.50e-05	0.0	0.0
59971	-1.02e-05	2.59e-04-8.77e-03	-1.30e-05	0.0	0.0
59972	-1.06e-05	2.67e-04-8.71e-03	-1.34e-05	0.0	0.0
59973	-1.02e-05	2.59e-04-8.77e-03	-1.30e-05	0.0	0.0
6001	-1.30e-05	8.96e-04 -0.01	-4.45e-05	0.0	0.0
6002	-1.60e-05	1.06e-03 -0.01	-5.22e-05	0.0	0.0
60015	-1.77e-03	1.09e-03-9.76e-03	-3.16e-05	-2.10e-06	0.0
60027	-6.05e-04	2.06e-03-9.38e-03	-2.87e-05	0.0	0.0
60028	-4.55e-04	-7.39e-04 -0.01	-3.68e-05	0.0	0.0
60047	-2.47e-03	1.26e-03-9.70e-03	-3.12e-05	-2.96e-06	0.0
60059	-8.43e-04	2.63e-03-9.18e-03	-2.71e-05	-1.26e-06	0.0
60060	-6.33e-04	-1.30e-03 -0.01	-3.84e-05	0.0	0.0
60069	-9.58e-06	6.60e-04-9.90e-03	-3.27e-05	0.0	0.0
60070	-1.16e-05	7.66e-04-9.78e-03	-3.78e-05	0.0	0.0
60071	-9.58e-06	6.60e-04-9.90e-03	-3.27e-05	0.0	0.0
60072	-9.98e-06	6.81e-04-9.87e-03	-3.37e-05	0.0	0.0
60073	-9.58e-06	6.60e-04-9.90e-03	-3.27e-05	0.0	0.0
6012	-1.48e-05	1.78e-03 -0.02	-8.78e-05	0.0	0.0
60115	-1.82e-03	1.57e-03 -0.01	-5.54e-05	-3.53e-06	0.0
60127	-6.61e-04	2.62e-03 -0.01	-5.62e-05	-1.34e-06	0.0
60128	-4.23e-04	-3.88e-04 -0.01	-5.36e-05	0.0	0.0
60147	-2.55e-03	1.75e-03 -0.01	-5.56e-05	-4.99e-06	0.0
60159	-9.22e-04	3.22e-03 -0.01	-5.67e-05	-1.92e-06	0.0
60160	-5.89e-04	-9.89e-04 -0.01	-5.31e-05	0.0	0.0
60170	-1.07e-05	1.29e-03 -0.01	-6.37e-05	0.0	0.0
60172	-9.20e-06	1.15e-03 -0.01	-5.66e-05	0.0	0.0
60173	-8.82e-06	1.11e-03 -0.01	-5.49e-05	0.0	0.0
6022	-1.40e-05	2.61e-03 -0.02	-1.28e-04	0.0	0.0
60215	-1.91e-03	2.13e-03 -0.02	-8.27e-05	-6.37e-06	0.0
60227	-7.26e-04	3.29e-03 -0.02	-8.90e-05	-2.04e-06	0.0
60236	-7.04e-04	-3.28e-05 -0.02	-7.10e-05	-1.65e-06	0.0
60247	-2.68e-03	2.33e-03 -0.02	-8.38e-05	-9.00e-06	0.0
60259	-1.01e-03	3.96e-03 -0.01	-9.26e-05	-2.93e-06	0.0
60268	-9.83e-04	-6.96e-04 -0.02	-6.74e-05	-2.39e-06	0.0
60270	-1.02e-05	1.90e-03 -0.02	-9.32e-05	0.0	0.0
60272	-8.66e-06	1.68e-03 -0.02	-8.25e-05	0.0	0.0
60273	-8.28e-06	1.62e-03 -0.02	-7.98e-05	0.0	0.0
6032	-1.36e-05	3.51e-03 -0.03	-1.72e-04	0.0	0.0
60315	-2.02e-03	2.76e-03 -0.02	-1.14e-04	-9.57e-06	0.0
60327	-8.00e-04	4.11e-03 -0.02	-1.30e-04	-2.78e-06	0.0
60335	-4.24e-04	4.10e-03 -0.02	-1.29e-04	-2.70e-06	0.0
60347	-2.83e-03	3.00e-03 -0.02	-1.17e-04	-1.36e-05	0.0
60359	-1.12e-03	4.89e-03 -0.02	-1.39e-04	-4.05e-06	0.0
60367	-5.91e-04	4.87e-03 -0.02	-1.38e-04	-3.94e-06	0.0
60370	-9.90e-06	2.56e-03 -0.02	-1.25e-04	0.0	0.0
60372	-8.38e-06	2.24e-03 -0.02	-1.10e-04	0.0	0.0
60373	-8.01e-06	2.17e-03 -0.02	-1.07e-04	0.0	0.0
6042	-5.09e-06	4.27e-03 -0.04	-2.14e-04	1.32e-06	0.0
60415	-2.50e-03	3.32e-03 -0.03	-1.46e-04	-2.75e-05	0.0
60421	3.83e-04	4.93e-03 -0.03	-1.78e-04	7.01e-06	0.0
60423	-8.85e-04	4.92e-03 -0.03	-1.78e-04	-4.25e-06	0.0
60447	-3.50e-03	3.60e-03 -0.03	-1.51e-04	-3.89e-05	0.0
60455	-1.24e-03	5.85e-03 -0.03	-1.97e-04	-6.26e-06	0.0
60459	-1.37e-03	5.86e-03 -0.03	-1.97e-04	-1.04e-05	0.0
60470	-3.35e-06	3.12e-03 -0.03	-1.56e-04	0.0	0.0
60472	-3.14e-06	2.72e-03 -0.03	-1.36e-04	0.0	0.0
60473	-3.09e-06	2.62e-03 -0.03	-1.31e-04	0.0	0.0
6052	1.85e-03	-2.81e-03 -0.05	1.37e-04	9.92e-05	0.0
60510	3.91e-03	-2.87e-03 -0.04	1.02e-04	9.85e-05	0.0
60526	2.07e-03	-5.09e-03 -0.04	1.40e-04	9.35e-05	0.0
60542	5.00e-03	-3.31e-03 -0.04	1.08e-04	1.12e-04	0.0
60558	2.42e-03	-6.43e-03 -0.04	1.62e-04	1.05e-04	0.0
60570	1.37e-03	-2.07e-03 -0.04	1.01e-04	7.35e-05	0.0
60572	1.23e-03	-1.82e-03 -0.03	8.88e-05	6.58e-05	0.0
60573	1.19e-03	-1.76e-03 -0.03	8.59e-05	6.39e-05	0.0
6062	9.33e-04	-3.72e-03 -0.05	1.86e-04	4.90e-05	0.0
60610	2.96e-03	-3.18e-03 -0.04	1.29e-04	5.41e-05	0.0
60624	6.25e-05	-4.76e-03 -0.04	1.69e-04	3.47e-05	0.0
60630	1.77e-03	-4.90e-03 -0.04	1.68e-04	4.66e-05	0.0
60642	3.92e-03	-3.54e-03 -0.04	1.36e-04	6.40e-05	0.0
60656	-1.34e-04	-5.76e-03 -0.04	1.91e-04	3.68e-05	0.0
60662	2.25e-03	-5.95e-03 -0.04	1.91e-04	5.35e-05	0.0
60670	6.95e-04	-2.71e-03 -0.04	1.35e-04	3.65e-05	0.0
60672	5.82e-04	-2.35e-03 -0.04	1.18e-04	3.08e-05	0.0



EGP CODE

GRE.EEC.R.73.IT.W.15235.12.024.01

PAGE

169 di/of 527

60673	5.54e-04	-2.26e-03	-0.04	1.13e-04	2.94e-05	0.0
6072	1.51e-03	3.78e-03	-0.05	-1.79e-04	8.02e-05	0.0
60713	4.17e-03	4.17e-03	-0.05	-1.51e-04	1.16e-04	0.0
60717	4.25e-03	3.67e-03	-0.04	-1.42e-04	1.15e-04	0.0
60721	1.75e-03	6.28e-03	-0.04	-1.86e-04	7.33e-05	0.0
60745	5.45e-03	4.90e-03	-0.05	-1.67e-04	1.41e-04	0.0
60749	5.56e-03	4.18e-03	-0.05	-1.54e-04	1.40e-04	0.0
60753	2.06e-03	7.85e-03	-0.05	-2.16e-04	8.17e-05	0.0
60770	1.11e-03	2.80e-03	-0.04	-1.32e-04	5.92e-05	0.0
60772	1.01e-03	2.43e-03	-0.04	-1.16e-04	5.35e-05	0.0
60773	9.82e-04	2.34e-03	-0.04	-1.11e-04	5.21e-05	0.0
6082	1.49e-03	-3.68e-03	-0.05	1.76e-04	7.96e-05	0.0
6086	4.09e-03	-4.13e-03	-0.05	1.47e-04	1.14e-04	0.0
60810	4.20e-03	-3.64e-03	-0.04	1.38e-04	1.14e-04	0.0
60826	1.65e-03	-6.15e-03	-0.04	1.82e-04	7.11e-05	0.0
60838	5.34e-03	-4.86e-03	-0.05	1.62e-04	1.40e-04	0.0
60842	5.49e-03	-4.16e-03	-0.05	1.49e-04	1.38e-04	0.0
60858	1.91e-03	-7.69e-03	-0.05	2.11e-04	7.89e-05	0.0
60870	1.10e-03	-2.73e-03	-0.04	1.30e-04	5.86e-05	0.0
60872	9.99e-04	-2.37e-03	-0.04	1.14e-04	5.31e-05	0.0
60873	9.73e-04	-2.29e-03	-0.04	1.10e-04	5.18e-05	0.0
6092	1.53e-03	-3.61e-03	-0.04	1.72e-04	7.58e-05	0.0
6096	3.97e-03	-3.86e-03	-0.04	1.50e-04	1.04e-04	0.0
60910	4.01e-03	-3.41e-03	-0.04	1.42e-04	1.03e-04	0.0
60926	1.81e-03	-5.85e-03	-0.03	1.70e-04	6.65e-05	0.0
60938	5.16e-03	-4.49e-03	-0.04	1.67e-04	1.25e-04	0.0
60942	5.22e-03	-3.85e-03	-0.04	1.56e-04	1.24e-04	0.0
60958	2.14e-03	-7.28e-03	-0.03	1.95e-04	7.35e-05	0.0
60970	1.12e-03	-2.68e-03	-0.03	1.27e-04	5.55e-05	0.0
60972	1.01e-03	-2.34e-03	-0.03	1.12e-04	5.04e-05	0.0
60973	9.86e-04	-2.26e-03	-0.03	1.08e-04	4.92e-05	0.0
6102	1.14e-03	-2.84e-03	-0.04	1.38e-04	5.89e-05	0.0
6106	3.41e-03	-3.09e-03	-0.03	1.24e-04	7.80e-05	0.0
6109	3.52e-03	-1.88e-03	-0.03	1.12e-04	7.96e-05	0.0
61026	1.27e-03	-4.70e-03	-0.03	1.19e-04	4.33e-05	0.0
61038	4.47e-03	-3.60e-03	-0.03	1.39e-04	9.37e-05	0.0
61041	4.63e-03	-1.91e-03	-0.03	1.22e-04	9.59e-05	0.0
61058	1.48e-03	-5.86e-03	-0.03	1.32e-04	4.51e-05	0.0
61070	8.24e-04	-2.11e-03	-0.03	1.02e-04	4.25e-05	0.0
61072	7.63e-04	-1.86e-03	-0.02	9.03e-05	3.96e-05	0.0
61073	7.48e-04	-1.80e-03	-0.02	8.74e-05	3.89e-05	0.0
6112	9.42e-04	-2.11e-03	-0.03	1.02e-04	4.95e-05	0.0
6115	3.02e-03	-1.11e-03	-0.02	8.69e-05	6.14e-05	0.0
6119	3.04e-03	-1.43e-03	-0.02	8.81e-05	6.08e-05	0.0
61126	1.08e-03	-3.87e-03	-0.02	7.92e-05	3.36e-05	0.0
61137	3.98e-03	-1.01e-03	-0.03	9.57e-05	7.29e-05	0.0
61141	4.01e-03	-1.46e-03	-0.03	9.73e-05	7.19e-05	0.0
61158	1.26e-03	-4.89e-03	-0.02	8.48e-05	3.39e-05	0.0
61170	6.72e-04	-1.56e-03	-0.02	7.58e-05	3.51e-05	0.0
61172	6.35e-04	-1.38e-03	-0.02	6.73e-05	3.33e-05	0.0
61173	6.25e-04	-1.34e-03	-0.02	6.52e-05	3.29e-05	0.0
6122	8.26e-04	-1.40e-03	-0.02	6.81e-05	4.36e-05	0.0
6125	2.71e-03	-7.23e-04	-0.02	6.26e-05	4.88e-05	0.0
6129	2.72e-03	-1.01e-03	-0.02	6.24e-05	4.82e-05	0.0
61226	1.01e-03	-3.18e-03	-0.02	4.47e-05	2.92e-05	0.0
61237	3.58e-03	-6.50e-04	-0.02	7.02e-05	5.67e-05	0.0
61241	3.59e-03	-1.05e-03	-0.02	6.99e-05	5.59e-05	0.0
61258	1.19e-03	-4.10e-03	-0.02	4.51e-05	2.92e-05	0.0
61270	5.80e-04	-1.04e-03	-0.02	5.05e-05	3.05e-05	0.0
61272	5.57e-04	-9.22e-04	-0.02	4.50e-05	2.94e-05	0.0
61273	5.51e-04	-8.93e-04	-0.02	4.36e-05	2.91e-05	0.0
6131	7.34e-04	-6.44e-04	-0.02	3.16e-05	3.91e-05	0.0
6132	7.63e-04	-7.60e-04	-0.02	3.71e-05	4.05e-05	0.0
6135	2.51e-03	-3.79e-04	-0.02	3.82e-05	4.08e-05	0.0
6139	2.52e-03	-6.46e-04	-0.02	3.71e-05	4.05e-05	0.0
61326	1.00e-03	-2.63e-03	-0.02	1.81e-05	2.77e-05	0.0
61337	3.31e-03	-3.32e-04	-0.02	4.39e-05	4.64e-05	0.0
61341	3.32e-03	-7.10e-04	-0.02	4.25e-05	4.59e-05	0.0
61358	1.20e-03	-3.49e-03	-0.02	1.58e-05	2.80e-05	0.0
61369	5.10e-04	-4.85e-04	-0.02	2.38e-05	2.70e-05	0.0
61370	5.29e-04	-5.63e-04	-0.02	2.74e-05	2.79e-05	0.0
61371	5.10e-04	-4.85e-04	-0.02	2.38e-05	2.70e-05	0.0
61372	5.14e-04	-5.01e-04	-0.02	2.45e-05	2.72e-05	0.0
61373	5.10e-04	-4.85e-04	-0.02	2.38e-05	2.70e-05	0.0
6141	7.15e-04	-1.46e-04	-0.02	7.21e-06	3.81e-05	0.0
6142	7.37e-04	-1.72e-04	-0.02	8.47e-06	3.92e-05	0.0



EGP CODE

GRE.EEC.R.73.IT.W.15235.12.024.01

PAGE

170 di/of 527

6145	2.39e-03	9.87e-04	-0.02	1.50e-05	3.66e-05	0.0
6149	2.39e-03	7.27e-04	-0.02	1.37e-05	3.65e-05	0.0
61426	1.04e-03	-2.18e-03	-0.02	-3.07e-06	2.85e-05	0.0
61437	3.15e-03	1.42e-03	-0.02	1.89e-05	4.07e-05	0.0
61441	3.15e-03	1.06e-03	-0.02	1.69e-05	4.06e-05	0.0
61458	1.26e-03	-3.01e-03	-0.02	-6.49e-06	2.94e-05	0.0
61469	4.93e-04	-1.10e-04	-0.02	5.43e-06	2.62e-05	0.0
61470	5.08e-04	-1.27e-04	-0.02	6.27e-06	2.69e-05	0.0
61471	4.93e-04	-1.10e-04	-0.02	5.43e-06	2.62e-05	0.0
61472	4.96e-04	-1.13e-04	-0.02	5.60e-06	2.64e-05	0.0
61473	4.93e-04	-1.10e-04	-0.02	5.43e-06	2.62e-05	0.0
6151	7.18e-04	3.42e-04	-0.02	-1.66e-05	3.84e-05	0.0
6152	7.42e-04	4.04e-04	-0.02	-1.95e-05	3.95e-05	0.0
61514	2.42e-03	-8.29e-04	-0.02	-2.38e-05	3.77e-05	0.0
61518	2.42e-03	-5.67e-04	-0.02	-2.25e-05	3.75e-05	0.0
61521	1.01e-03	2.35e-03	-0.02	-4.47e-06	2.80e-05	0.0
61546	3.19e-03	-1.26e-03	-0.02	-2.83e-05	4.22e-05	0.0
61550	3.20e-03	-8.90e-04	-0.02	-2.65e-05	4.19e-05	0.0
61553	1.22e-03	3.18e-03	-0.02	-1.24e-06	2.86e-05	0.0
61569	4.96e-04	2.58e-04	-0.02	-1.25e-05	2.64e-05	0.0
61570	5.12e-04	2.99e-04	-0.02	-1.44e-05	2.72e-05	0.0
61571	4.96e-04	2.58e-04	-0.02	-1.25e-05	2.64e-05	0.0
61572	5.00e-04	2.66e-04	-0.02	-1.29e-05	2.66e-05	0.0
61573	4.96e-04	2.58e-04	-0.02	-1.25e-05	2.64e-05	0.0
6162	7.79e-04	1.01e-03	-0.02	-4.89e-05	4.14e-05	0.0
61614	2.57e-03	5.18e-04	-0.02	-4.74e-05	4.31e-05	0.0
61618	2.58e-03	7.90e-04	-0.02	-4.66e-05	4.27e-05	0.0
61621	9.91e-04	2.83e-03	-0.02	-2.79e-05	2.79e-05	0.0
61646	3.39e-03	4.62e-04	-0.02	-5.39e-05	4.93e-05	0.0
61650	3.40e-03	8.48e-04	-0.02	-5.27e-05	4.87e-05	0.0
61653	1.18e-03	3.71e-03	-0.02	-2.65e-05	2.80e-05	0.0
61670	5.42e-04	7.48e-04	-0.02	-3.62e-05	2.87e-05	0.0
61672	5.25e-04	6.65e-04	-0.02	-3.23e-05	2.79e-05	0.0
61673	5.20e-04	6.44e-04	-0.02	-3.13e-05	2.77e-05	0.0
6172	8.57e-04	1.68e-03	-0.03	-8.13e-05	4.54e-05	0.0
61714	2.81e-03	8.79e-04	-0.02	-7.17e-05	5.26e-05	0.0
61718	2.82e-03	1.17e-03	-0.02	-7.21e-05	5.20e-05	0.0
61721	1.02e-03	3.44e-03	-0.02	-5.90e-05	3.03e-05	0.0
61746	3.70e-03	7.96e-04	-0.02	-7.96e-05	6.15e-05	0.0
61750	3.72e-03	1.21e-03	-0.02	-8.02e-05	6.06e-05	0.0
61753	1.20e-03	4.39e-03	-0.02	-6.18e-05	3.03e-05	0.0
61770	6.05e-04	1.24e-03	-0.02	-6.02e-05	3.19e-05	0.0
61772	5.78e-04	1.10e-03	-0.02	-5.36e-05	3.06e-05	0.0
61773	5.71e-04	1.07e-03	-0.02	-5.20e-05	3.03e-05	0.0
6182	9.92e-04	2.40e-03	-0.03	-1.16e-04	5.24e-05	0.0
61814	3.16e-03	1.28e-03	-0.03	-9.66e-05	6.71e-05	0.0
61818	3.18e-03	1.61e-03	-0.03	-9.86e-05	6.64e-05	0.0
61821	1.11e-03	4.18e-03	-0.02	-9.46e-05	3.60e-05	0.0
61846	4.16e-03	1.17e-03	-0.03	-1.06e-04	8.01e-05	0.0
61850	4.18e-03	1.64e-03	-0.03	-1.08e-04	7.90e-05	0.0
61853	1.30e-03	5.25e-03	-0.02	-1.03e-04	3.66e-05	0.0
61870	7.11e-04	1.78e-03	-0.02	-8.62e-05	3.74e-05	0.0
61872	6.68e-04	1.57e-03	-0.02	-7.65e-05	3.53e-05	0.0
61873	6.58e-04	1.52e-03	-0.02	-7.41e-05	3.47e-05	0.0
6192	-1.08e-03	-4.24e-03	-0.04	2.03e-04	-5.57e-05	0.0
6198	-2.61e-03	-3.38e-03	-0.03	1.36e-04	-4.13e-05	0.0
61922	-4.85e-04	-5.22e-03	-0.03	1.75e-04	-4.07e-05	0.0
61924	-1.59e-03	-5.23e-03	-0.03	1.73e-04	-4.36e-05	0.0
61940	-3.39e-03	-3.71e-03	-0.03	1.41e-04	-4.42e-05	0.0
61954	-4.15e-04	-6.28e-03	-0.03	1.96e-04	-4.34e-05	0.0
61956	-1.96e-03	-6.29e-03	-0.03	1.93e-04	-4.75e-05	0.0
61970	-8.08e-04	-3.09e-03	-0.03	1.48e-04	-4.16e-05	0.0
61972	-6.89e-04	-2.68e-03	-0.03	1.29e-04	-3.55e-05	0.0
61973	-6.59e-04	-2.57e-03	-0.03	1.24e-04	-3.39e-05	0.0
6202	-4.34e-04	-4.02e-03	-0.03	1.91e-04	-2.76e-05	0.0
62011	-2.30e-03	-1.65e-03	-0.02	9.95e-05	-2.66e-05	0.0
62022	4.18e-04	-4.83e-03	-0.02	1.57e-04	-1.13e-05	0.0
62043	-3.12e-03	-1.33e-03	-0.02	9.23e-05	-3.03e-05	0.0
62054	6.97e-04	-5.78e-03	-0.02	1.73e-04	-8.88e-06	0.0
62070	-3.24e-04	-2.93e-03	-0.02	1.39e-04	-2.07e-05	0.0
62072	-2.87e-04	-2.56e-03	-0.02	1.22e-04	-1.79e-05	0.0
62073	-2.77e-04	-2.46e-03	-0.02	1.18e-04	-1.73e-05	0.0
6212	-3.93e-04	-3.01e-03	-0.03	1.46e-04	-1.96e-05	0.0
6219	1.55e-03	-1.41e-03	-0.02	9.08e-05	-7.33e-06	0.0
62111	-2.17e-03	-1.25e-03	-0.02	8.14e-05	-1.84e-05	0.0
62122	1.87e-04	-3.76e-03	-0.02	1.09e-04	-8.11e-06	0.0





EGP CODE

GRE.EEC.R.73.IT.W.15235.12.024.01

PAGE

171 di/of 527

62141	2.27e-03	-1.23e-03	-0.02	9.08e-05	-5.39e-06	0.0
62143	-2.94e-03	-1.01e-03	-0.02	7.75e-05	-2.09e-05	0.0
62154	3.60e-04	-4.52e-03	-0.02	1.16e-04	-6.48e-06	0.0
62170	-2.94e-04	-2.19e-03	-0.02	1.06e-04	-1.47e-05	0.0
62172	-2.55e-04	-1.93e-03	-0.02	9.40e-05	-1.27e-05	0.0
62173	-2.45e-04	-1.87e-03	-0.02	9.09e-05	-1.22e-05	0.0
6222	-2.43e-04	-2.20e-03	-0.02	1.07e-04	-1.11e-05	0.0
62211	-1.99e-03	-8.55e-04	-0.01	6.23e-05	-1.10e-05	0.0
62221	4.92e-04	2.63e-04	-0.01	6.19e-05	-7.54e-06	0.0
62222	2.82e-04	-3.03e-03	-0.01	7.34e-05	-4.21e-06	0.0
62243	-2.73e-03	-6.49e-04	-0.01	6.05e-05	-1.27e-05	0.0
62253	7.50e-04	9.17e-04	-0.01	6.00e-05	-7.78e-06	0.0
62254	4.55e-04	-3.69e-03	-0.01	7.61e-05	-3.11e-06	0.0
62270	-1.81e-04	-1.60e-03	-0.01	7.77e-05	-8.33e-06	0.0
62272	-1.57e-04	-1.41e-03	-0.01	6.90e-05	-7.21e-06	0.0
62273	-1.51e-04	-1.37e-03	-0.01	6.68e-05	-6.93e-06	0.0
6232	-1.49e-04	-1.45e-03	-0.01	7.07e-05	-6.33e-06	0.0
62311	-1.87e-03	-4.56e-04	-0.01	4.31e-05	-6.44e-06	0.0
62321	5.10e-04	5.88e-04	-0.01	4.61e-05	-4.24e-06	0.0
62322	3.53e-04	-2.41e-03	-0.01	4.33e-05	-2.40e-06	0.0
62343	-2.59e-03	-2.76e-04	-0.01	4.26e-05	-7.44e-06	0.0
62353	7.51e-04	1.19e-03	-0.01	4.68e-05	-4.36e-06	0.0
62354	5.31e-04	-3.02e-03	-0.01	4.30e-05	-1.77e-06	0.0
62370	-1.11e-04	-1.05e-03	-0.01	5.12e-05	-4.73e-06	0.0
62372	-9.62e-05	-9.35e-04	-0.01	4.56e-05	-4.10e-06	0.0
62373	-9.26e-05	-9.05e-04	-0.01	4.42e-05	-3.95e-06	0.0
6241	-8.11e-05	-6.70e-04	-0.01	3.26e-05	-3.16e-06	0.0
6242	-9.89e-05	-7.88e-04	-0.01	3.82e-05	-3.87e-06	0.0
62411	-1.80e-03	-8.00e-05-9.29e-03		2.46e-05	-3.92e-06	0.0
62421	5.00e-04	9.22e-04-9.69e-03		2.93e-05	-2.47e-06	0.0
62422	4.07e-04	-1.91e-03-8.85e-03		1.90e-05	-1.60e-06	0.0
62443	-2.49e-03	8.53e-05-9.31e-03		2.49e-05	-4.52e-06	0.0
62453	7.25e-04	1.49e-03-9.87e-03		3.15e-05	-2.49e-06	0.0
62454	5.94e-04	-2.48e-03-8.69e-03		1.71e-05	-1.27e-06	0.0
62469	-6.16e-05	-4.92e-04-9.25e-03		2.39e-05	-2.42e-06	0.0
62470	-7.35e-05	-5.71e-04-9.03e-03		2.76e-05	-2.90e-06	0.0
62471	-6.16e-05	-4.92e-04-9.25e-03		2.39e-05	-2.42e-06	0.0
62472	-6.40e-05	-5.08e-04-9.20e-03		2.47e-05	-2.52e-06	0.0
62473	-6.16e-05	-4.92e-04-9.25e-03		2.39e-05	-2.42e-06	0.0
6251	-6.53e-05	-1.58e-04	-0.01	7.38e-06	-2.40e-06	0.0
6252	-7.94e-05	-1.85e-04	-0.01	8.61e-06	-2.94e-06	0.0
62511	-1.75e-03	2.80e-04-8.51e-03		7.07e-06	-2.78e-06	0.0
62521	4.72e-04	1.27e-03-8.65e-03		1.22e-05	-1.67e-06	0.0
62526	4.45e-04	-1.50e-03-8.43e-03		-1.32e-06	-1.49e-06	0.0
62543	-2.43e-03	4.39e-04-8.50e-03		7.74e-06	-3.16e-06	0.0
62553	6.80e-04	1.82e-03-8.70e-03		1.50e-05	-1.61e-06	0.0
62558	6.43e-04	-2.06e-03-8.40e-03		-4.02e-06	-1.35e-06	0.0
62569	-4.95e-05	-1.16e-04-8.53e-03		5.41e-06	-1.84e-06	0.0
62570	-5.89e-05	-1.34e-04-8.20e-03		6.23e-06	-2.20e-06	0.0
62571	-4.95e-05	-1.16e-04-8.53e-03		5.41e-06	-1.84e-06	0.0
62572	-5.14e-05	-1.20e-04-8.46e-03		5.57e-06	-1.91e-06	0.0
62573	-4.95e-05	-1.16e-04-8.53e-03		5.41e-06	-1.84e-06	0.0
6261	-6.95e-05	3.43e-04	-0.01	-1.73e-05	-2.61e-06	0.0
6262	-8.46e-05	4.02e-04	-0.01	-2.02e-05	-3.21e-06	0.0
62620	-1.76e-03	-1.48e-04-8.72e-03		-1.41e-05	-3.07e-06	0.0
62621	4.30e-04	1.65e-03-8.48e-03		-6.39e-06	-1.56e-06	0.0
62626	4.81e-04	-1.14e-03-8.96e-03		-1.92e-05	-1.90e-06	0.0
62652	-2.45e-03	-3.08e-04-8.72e-03		-1.46e-05	-3.50e-06	0.0
62653	6.23e-04	2.20e-03-8.39e-03		-3.87e-06	-1.39e-06	0.0
62658	6.95e-04	-1.70e-03-9.06e-03		-2.17e-05	-1.86e-06	0.0
62669	-5.27e-05	2.52e-04-8.70e-03		-1.27e-05	-2.00e-06	0.0
62670	-6.28e-05	2.91e-04-8.40e-03		-1.46e-05	-2.40e-06	0.0
62671	-5.27e-05	2.52e-04-8.70e-03		-1.27e-05	-2.00e-06	0.0
62672	-5.47e-05	2.59e-04-8.64e-03		-1.31e-05	-2.08e-06	0.0
62673	-5.27e-05	2.52e-04-8.70e-03		-1.27e-05	-2.00e-06	0.0
6271	-9.50e-05	8.71e-04	-0.01	-4.34e-05	-3.88e-06	0.0
6272	-1.16e-04	1.02e-03	-0.01	-5.07e-05	-4.77e-06	0.0
62720	-1.82e-03	2.17e-04-9.85e-03		-3.19e-05	-4.70e-06	0.0
62725	3.85e-04	2.09e-03-9.32e-03		-2.83e-05	-1.99e-06	0.0
62726	5.03e-04	-8.00e-04	-0.01	-3.60e-05	-3.08e-06	0.0
62752	-2.52e-03	4.70e-05-9.88e-03		-3.20e-05	-5.39e-06	0.0
62757	5.69e-04	2.67e-03-9.12e-03		-2.68e-05	-1.60e-06	0.0
62758	7.33e-04	-1.38e-03	-0.01	-3.76e-05	-3.12e-06	0.0
62769	-7.23e-05	6.40e-04-9.80e-03		-3.18e-05	-2.97e-06	0.0
62770	-8.64e-05	7.43e-04-9.67e-03		-3.67e-05	-3.57e-06	0.0
62771	-7.23e-05	6.40e-04-9.80e-03		-3.18e-05	-2.97e-06	0.0



EGP CODE

GRE.EEC.R.73.IT.W.15235.12.024.01

PAGE

172 di/of 527

62772	-7.51e-05	6.61e-04-9.77e-03	-3.28e-05	-3.09e-06	0.0
62773	-7.23e-05	6.40e-04-9.80e-03	-3.18e-05	-2.97e-06	0.0
6282	-1.84e-04	1.72e-03 -0.02	-8.48e-05	-8.17e-06	0.0
62820	-1.91e-03	6.02e-04 -0.01	-5.06e-05	-7.96e-06	0.0
62825	3.23e-04	2.63e-03 -0.01	-5.51e-05	-3.29e-06	0.0
62826	5.02e-04	-4.68e-04 -0.01	-5.21e-05	-5.41e-06	0.0
62852	-2.63e-03	4.14e-04 -0.01	-4.97e-05	-9.12e-06	0.0
62857	4.98e-04	3.26e-03 -0.01	-5.59e-05	-2.57e-06	0.0
62858	7.49e-04	-1.09e-03 -0.01	-5.18e-05	-5.54e-06	0.0
62870	-1.37e-04	1.25e-03 -0.01	-6.15e-05	-6.11e-06	0.0
62872	-1.19e-04	1.11e-03 -0.01	-5.47e-05	-5.29e-06	0.0
62873	-1.15e-04	1.07e-03 -0.01	-5.30e-05	-5.08e-06	0.0
6292	-3.10e-04	2.49e-03 -0.02	-1.23e-04	-1.46e-05	0.0
62920	-2.06e-03	1.00e-03 -0.01	-7.01e-05	-1.37e-05	0.0
62925	2.35e-04	3.29e-03 -0.01	-8.71e-05	-6.01e-06	0.0
62926	4.65e-04	-1.56e-04 -0.02	-6.78e-05	-9.64e-06	0.0
62952	-2.80e-03	7.80e-04 -0.01	-6.76e-05	-1.56e-05	0.0
62957	4.06e-04	3.99e-03 -0.01	-9.13e-05	-4.79e-06	0.0
62958	7.29e-04	-8.39e-04 -0.02	-6.44e-05	-9.88e-06	0.0
62970	-2.31e-04	1.81e-03 -0.02	-8.90e-05	-1.09e-05	0.0
62972	-2.00e-04	1.60e-03 -0.02	-7.89e-05	-9.42e-06	0.0
62973	-1.92e-04	1.55e-03 -0.02	-7.64e-05	-9.05e-06	0.0
6302	-5.17e-04	3.30e-03 -0.03	-1.61e-04	-2.59e-05	0.0
63017	1.64e-03	2.71e-03 -0.02	-1.12e-04	-8.90e-06	0.0
63020	-2.28e-03	1.37e-03 -0.02	-8.79e-05	-2.32e-05	0.0
63025	1.03e-04	4.07e-03 -0.02	-1.24e-04	-1.20e-05	0.0
63049	2.42e-03	2.97e-03 -0.02	-1.17e-04	-6.04e-06	0.0
63052	-3.06e-03	1.11e-03 -0.02	-8.31e-05	-2.60e-05	0.0
63057	2.72e-04	4.88e-03 -0.02	-1.34e-04	-1.05e-05	0.0
63070	-3.86e-04	2.40e-03 -0.02	-1.17e-04	-1.94e-05	0.0
63072	-3.34e-04	2.11e-03 -0.02	-1.03e-04	-1.67e-05	0.0
63073	-3.20e-04	2.04e-03 -0.02	-1.00e-04	-1.60e-05	0.0
6312	-6.83e-04	4.27e-03 -0.04	-2.02e-04	-3.91e-05	0.0
63120	-2.43e-03	1.71e-03 -0.02	-1.03e-04	-3.20e-05	0.0
63125	-2.01e-05	5.18e-03 -0.03	-1.72e-04	-2.05e-05	0.0
63152	-3.23e-03	1.35e-03 -0.02	-9.42e-05	-3.52e-05	0.0
63157	1.43e-04	6.21e-03 -0.03	-1.92e-04	-1.91e-05	0.0
63170	-5.11e-04	3.12e-03 -0.03	-1.47e-04	-2.92e-05	0.0
63172	-4.44e-04	2.71e-03 -0.03	-1.29e-04	-2.52e-05	0.0
63173	-4.27e-04	2.60e-03 -0.03	-1.24e-04	-2.42e-05	0.0
6322	-1.08e-03	4.26e-03 -0.04	-2.04e-04	-5.60e-05	0.0
63215	-2.63e-03	3.34e-03 -0.03	-1.36e-04	-4.14e-05	0.0
63225	-4.61e-04	5.27e-03 -0.03	-1.77e-04	-4.05e-05	0.0
63247	-3.42e-03	3.64e-03 -0.03	-1.40e-04	-4.43e-05	0.0
63257	-3.81e-04	6.34e-03 -0.03	-1.98e-04	-4.30e-05	0.0
63270	-8.06e-04	3.11e-03 -0.03	-1.49e-04	-4.19e-05	0.0
63272	-6.88e-04	2.69e-03 -0.03	-1.29e-04	-3.57e-05	0.0
63273	-6.58e-04	2.59e-03 -0.03	-1.25e-04	-3.41e-05	0.0
6332	-1.20e-03	-3.44e-03 -0.04	1.68e-04	-6.20e-05	0.0
6338	-2.55e-03	-2.77e-03 -0.03	1.10e-04	-3.75e-05	0.0
63322	-5.93e-04	-4.48e-03 -0.03	1.43e-04	-4.71e-05	0.0
63340	-3.28e-03	-3.03e-03 -0.03	1.13e-04	-3.74e-05	0.0
63354	-5.37e-04	-5.43e-03 -0.03	1.59e-04	-5.09e-05	0.0
63370	-8.99e-04	-2.50e-03 -0.03	1.22e-04	-4.64e-05	0.0
63372	-7.65e-04	-2.19e-03 -0.03	1.07e-04	-3.94e-05	0.0
63373	-7.32e-04	-2.11e-03 -0.03	1.03e-04	-3.77e-05	0.0
6342	-8.21e-04	-3.26e-03 -0.03	1.59e-04	-4.22e-05	0.0
63411	-2.28e-03	-1.34e-03 -0.02	8.48e-05	-2.29e-05	0.0
63422	-1.89e-04	-4.20e-03 -0.02	1.30e-04	-2.80e-05	0.0
63443	-2.98e-03	-1.07e-03 -0.02	7.93e-05	-2.17e-05	0.0
63454	-6.30e-05	-5.08e-03 -0.02	1.42e-04	-2.89e-05	0.0
63470	-6.13e-04	-2.36e-03 -0.02	1.16e-04	-3.15e-05	0.0
63472	-5.26e-04	-2.08e-03 -0.02	1.02e-04	-2.70e-05	0.0
63473	-5.04e-04	-2.01e-03 -0.02	9.87e-05	-2.59e-05	0.0
6352	-5.22e-04	-2.70e-03 -0.02	1.33e-04	-2.56e-05	0.0
63510	1.48e-03	-2.29e-03 -0.02	9.27e-05	-1.56e-05	0.0
63511	-2.12e-03	-1.07e-03 -0.02	7.24e-05	-1.61e-05	0.0
63522	8.19e-05	-3.62e-03 -0.02	1.02e-04	-1.35e-05	0.0
63542	2.20e-03	-2.53e-03 -0.02	9.68e-05	-1.55e-05	0.0
63543	-2.84e-03	-8.23e-04 -0.02	6.83e-05	-1.62e-05	0.0
63554	2.44e-04	-4.39e-03 -0.02	1.09e-04	-1.26e-05	0.0
63570	-3.89e-04	-1.96e-03 -0.02	9.61e-05	-1.92e-05	0.0
63572	-3.36e-04	-1.73e-03 -0.02	8.52e-05	-1.65e-05	0.0
63573	-3.22e-04	-1.68e-03 -0.02	8.25e-05	-1.58e-05	0.0
6362	-3.18e-04	-2.03e-03 -0.02	9.94e-05	-1.48e-05	0.0
63611	-1.98e-03	-7.45e-04 -0.01	5.66e-05	-1.02e-05	0.0



EGP CODE

GRE.EEC.R.73.IT.W.15235.12.024.01

PAGE

173 di/of 527

63621	4.11e-04	4.10e-04	-0.01	5.66e-05	-1.14e-05	0.0
63622	2.33e-04	-2.97e-03	-0.01	6.98e-05	-6.87e-06	0.0
63643	-2.70e-03	-5.38e-04	-0.01	5.44e-05	-1.06e-05	0.0
63653	6.54e-04	1.08e-03	-0.01	5.43e-05	-1.23e-05	0.0
63654	4.05e-04	-3.66e-03	-0.01	7.29e-05	-5.92e-06	0.0
63670	-2.37e-04	-1.47e-03	-0.01	7.19e-05	-1.11e-05	0.0
63672	-2.05e-04	-1.30e-03	-0.01	6.41e-05	-9.59e-06	0.0
63673	-1.97e-04	-1.26e-03	-0.01	6.21e-05	-9.22e-06	0.0
6371	-1.60e-04	-1.16e-03	-0.01	5.69e-05	-7.01e-06	0.0
6372	-1.96e-04	-1.36e-03	-0.01	6.65e-05	-8.62e-06	0.0
63711	-1.87e-03	-3.98e-04	-0.01	3.98e-05	-6.24e-06	0.0
63721	4.59e-04	6.85e-04	-0.01	4.31e-05	-6.68e-06	0.0
63722	3.25e-04	-2.40e-03	-0.01	4.15e-05	-3.88e-06	0.0
63743	-2.57e-03	-2.17e-04	-0.01	3.91e-05	-6.58e-06	0.0
63753	6.91e-04	1.30e-03	-0.01	4.37e-05	-7.20e-06	0.0
63754	5.04e-04	-3.03e-03	-0.01	4.14e-05	-3.28e-06	0.0
63769	-1.22e-04	-8.48e-04	-0.01	4.17e-05	-5.38e-06	0.0
63770	-1.46e-04	-9.84e-04	-0.01	4.81e-05	-6.45e-06	0.0
63771	-1.22e-04	-8.48e-04	-0.01	4.17e-05	-5.38e-06	0.0
63772	-1.27e-04	-8.75e-04	-0.01	4.29e-05	-5.59e-06	0.0
63773	-1.22e-04	-8.48e-04	-0.01	4.17e-05	-5.38e-06	0.0
6381	-1.07e-04	-6.35e-04	-0.01	3.11e-05	-4.37e-06	0.0
6382	-1.30e-04	-7.45e-04	-0.01	3.62e-05	-5.36e-06	0.0
63811	-1.80e-03	-5.54e-05-9.09e-03		2.29e-05	-3.93e-06	0.0
63821	4.68e-04	9.88e-04-9.52e-03		2.77e-05	-3.98e-06	0.0
63822	3.88e-04	-1.93e-03-8.74e-03		1.84e-05	-2.56e-06	0.0
63843	-2.49e-03	1.09e-04-9.08e-03		2.30e-05	-4.16e-06	0.0
63853	6.88e-04	1.57e-03-9.70e-03		2.97e-05	-4.23e-06	0.0
63854	5.76e-04	-2.52e-03-8.60e-03		1.67e-05	-2.25e-06	0.0
63869	-8.12e-05	-4.66e-04-9.10e-03		2.27e-05	-3.35e-06	0.0
63870	-9.67e-05	-5.39e-04-8.85e-03		2.62e-05	-4.01e-06	0.0
63871	-8.12e-05	-4.66e-04-9.10e-03		2.27e-05	-3.35e-06	0.0
63872	-8.43e-05	-4.80e-04-9.05e-03		2.34e-05	-3.49e-06	0.0
63873	-8.12e-05	-4.66e-04-9.10e-03		2.27e-05	-3.35e-06	0.0
6391	-8.61e-05	-1.51e-04 -0.01		7.07e-06	-3.36e-06	0.0
6392	-1.04e-04	-1.77e-04 -0.01		8.23e-06	-4.11e-06	0.0
63911	-1.76e-03	2.79e-04-8.36e-03		6.52e-06	-2.88e-06	0.0
63921	4.50e-04	1.31e-03-8.53e-03		1.17e-05	-2.68e-06	0.0
63922	4.30e-04	-1.53e-03-8.33e-03		-1.11e-06	-2.33e-06	0.0
63943	-2.43e-03	4.35e-04-8.34e-03		7.07e-06	-3.00e-06	0.0
63953	6.57e-04	1.88e-03-8.58e-03		1.43e-05	-2.73e-06	0.0
63954	6.29e-04	-2.11e-03-8.30e-03		-3.62e-06	-2.23e-06	0.0
63969	-6.53e-05	-1.10e-04-8.41e-03		5.17e-06	-2.58e-06	0.0
63970	-7.75e-05	-1.28e-04-8.06e-03		5.94e-06	-3.08e-06	0.0
63971	-6.53e-05	-1.10e-04-8.41e-03		5.17e-06	-2.58e-06	0.0
63972	-6.77e-05	-1.14e-04-8.34e-03		5.33e-06	-2.68e-06	0.0
63973	-6.53e-05	-1.10e-04-8.41e-03		5.17e-06	-2.58e-06	0.0
6401	-9.19e-05	3.24e-04 -0.01		-1.64e-05	-3.65e-06	0.0
6402	-1.12e-04	3.79e-04 -0.01		-1.92e-05	-4.48e-06	0.0
64020	-1.77e-03	-1.57e-04-8.55e-03		-1.31e-05	-3.18e-06	0.0
64025	4.15e-04	1.67e-03-8.38e-03		-6.23e-06	-2.43e-06	0.0
64026	4.57e-04	-1.19e-03-8.83e-03		-1.82e-05	-3.03e-06	0.0
64052	-2.44e-03	-3.16e-04-8.54e-03		-1.35e-05	-3.33e-06	0.0
64057	6.08e-04	2.25e-03-8.30e-03		-3.91e-06	-2.28e-06	0.0
64058	6.68e-04	-1.76e-03-8.93e-03		-2.06e-05	-3.13e-06	0.0
64069	-6.98e-05	2.37e-04-8.58e-03		-1.20e-05	-2.80e-06	0.0
64070	-8.29e-05	2.74e-04-8.25e-03		-1.38e-05	-3.35e-06	0.0
64071	-6.98e-05	2.37e-04-8.58e-03		-1.20e-05	-2.80e-06	0.0
64072	-7.24e-05	2.45e-04-8.51e-03		-1.24e-05	-2.91e-06	0.0
64073	-6.98e-05	2.37e-04-8.58e-03		-1.20e-05	-2.80e-06	0.0
6411	-1.26e-04	8.21e-04 -0.01		-4.11e-05	-5.35e-06	0.0
6412	-1.54e-04	9.63e-04 -0.01		-4.79e-05	-6.57e-06	0.0
64120	-1.82e-03	1.79e-04-9.61e-03		-2.96e-05	-4.75e-06	0.0
64125	3.63e-04	2.09e-03-9.18e-03		-2.71e-05	-3.16e-06	0.0
64126	4.64e-04	-8.78e-04 -0.01		-3.38e-05	-4.87e-06	0.0
64152	-2.51e-03	9.02e-06-9.60e-03		-2.94e-05	-5.00e-06	0.0
64157	5.47e-04	2.69e-03-9.01e-03		-2.60e-05	-2.79e-06	0.0
64158	6.88e-04	-1.47e-03 -0.01		-3.53e-05	-5.18e-06	0.0
64169	-9.60e-05	6.02e-04-9.61e-03		-3.01e-05	-4.10e-06	0.0
64170	-1.15e-04	6.96e-04-9.44e-03		-3.46e-05	-4.92e-06	0.0
64171	-9.60e-05	6.02e-04-9.61e-03		-3.01e-05	-4.10e-06	0.0
64172	-9.97e-05	6.21e-04-9.58e-03		-3.10e-05	-4.26e-06	0.0
64173	-9.60e-05	6.02e-04-9.61e-03		-3.01e-05	-4.10e-06	0.0
6422	-2.43e-04	1.60e-03 -0.02		-7.93e-05	-1.10e-05	0.0
64220	-1.91e-03	5.24e-04 -0.01		-4.64e-05	-7.73e-06	0.0
64225	2.87e-04	2.60e-03 -0.01		-5.25e-05	-5.20e-06	0.0



EGP CODE

GRE.EEC.R.73.IT.W.15235.12.024.01

PAGE

174 di/of 527

64226	4.40e-04	-5.82e-04	-0.01	-4.84e-05	-8.30e-06	0.0
64252	-2.61e-03	3.34e-04	-0.01	-4.52e-05	-8.09e-06	0.0
64257	4.62e-04	3.25e-03	-0.01	-5.36e-05	-4.54e-06	0.0
64258	6.77e-04	-1.22e-03	-0.01	-4.79e-05	-8.88e-06	0.0
64270	-1.81e-04	1.16e-03	-0.01	-5.74e-05	-8.23e-06	0.0
64272	-1.57e-04	1.03e-03	-0.01	-5.12e-05	-7.12e-06	0.0
64273	-1.51e-04	9.98e-04	-0.01	-4.96e-05	-6.84e-06	0.0
6432	-3.99e-04	2.28e-03	-0.02	-1.13e-04	-1.90e-05	0.0
64314	1.51e-03	9.62e-04	-0.02	-7.15e-05	-1.22e-05	0.0
64320	-2.04e-03	8.65e-04	-0.01	-6.32e-05	-1.26e-05	0.0
64325	1.71e-04	3.21e-03	-0.01	-8.20e-05	-9.42e-06	0.0
64346	2.22e-03	7.80e-04	-0.02	-7.20e-05	-1.24e-05	0.0
64352	-2.75e-03	6.44e-04	-0.01	-6.03e-05	-1.30e-05	0.0
64357	3.38e-04	3.92e-03	-0.01	-8.66e-05	-8.50e-06	0.0
64370	-2.98e-04	1.65e-03	-0.02	-8.16e-05	-1.42e-05	0.0
64372	-2.58e-04	1.47e-03	-0.01	-7.26e-05	-1.22e-05	0.0
64373	-2.47e-04	1.42e-03	-0.01	-7.04e-05	-1.17e-05	0.0
6442	-6.50e-04	2.93e-03	-0.03	-1.45e-04	-3.20e-05	0.0
64413	1.29e-03	2.53e-03	-0.02	-1.03e-04	-2.00e-05	0.0
64420	-2.19e-03	1.16e-03	-0.02	-7.75e-05	-1.92e-05	0.0
64425	-2.51e-05	3.87e-03	-0.02	-1.14e-04	-1.82e-05	0.0
64445	1.96e-03	2.81e-03	-0.02	-1.08e-04	-2.01e-05	0.0
64452	-2.91e-03	8.94e-04	-0.02	-7.26e-05	-1.89e-05	0.0
64457	1.25e-04	4.69e-03	-0.02	-1.24e-04	-1.77e-05	0.0
64470	-4.85e-04	2.13e-03	-0.02	-1.05e-04	-2.39e-05	0.0
64472	-4.17e-04	1.88e-03	-0.02	-9.28e-05	-2.05e-05	0.0
64473	-4.00e-04	1.82e-03	-0.02	-8.98e-05	-1.97e-05	0.0
6452	-9.84e-04	3.39e-03	-0.03	-1.67e-04	-5.04e-05	0.0
64515	-2.38e-03	2.67e-03	-0.02	-1.07e-04	-2.90e-05	0.0
64525	-3.52e-04	4.38e-03	-0.03	-1.38e-04	-3.55e-05	0.0
64547	-3.10e-03	2.91e-03	-0.02	-1.09e-04	-2.83e-05	0.0
64557	-2.52e-04	5.29e-03	-0.03	-1.52e-04	-3.73e-05	0.0
64570	-7.35e-04	2.46e-03	-0.03	-1.21e-04	-3.77e-05	0.0
64572	-6.28e-04	2.16e-03	-0.02	-1.06e-04	-3.22e-05	0.0
64573	-6.02e-04	2.09e-03	-0.02	-1.03e-04	-3.08e-05	0.0
6462	-1.20e-03	3.46e-03	-0.04	-1.70e-04	-6.23e-05	0.0
64615	-2.56e-03	2.75e-03	-0.03	-1.11e-04	-3.76e-05	0.0
64625	-5.88e-04	4.52e-03	-0.03	-1.45e-04	-4.74e-05	0.0
64647	-3.30e-03	3.01e-03	-0.03	-1.13e-04	-3.75e-05	0.0
64657	-5.31e-04	5.48e-03	-0.03	-1.62e-04	-5.13e-05	0.0
64670	-8.99e-04	2.51e-03	-0.03	-1.23e-04	-4.66e-05	0.0
64672	-7.66e-04	2.20e-03	-0.03	-1.08e-04	-3.96e-05	0.0
64673	-7.33e-04	2.12e-03	-0.03	-1.05e-04	-3.79e-05	0.0
6472	-8.98e-04	-3.02e-03	-0.04	1.49e-04	-4.57e-05	0.0
6478	-2.22e-03	-2.49e-03	-0.02	9.84e-05	-2.05e-05	0.0
64722	-4.00e-04	-4.11e-03	-0.03	1.25e-04	-3.68e-05	0.0
64740	-2.89e-03	-2.73e-03	-0.02	1.01e-04	-1.77e-05	0.0
64754	-3.42e-04	-5.01e-03	-0.03	1.38e-04	-4.05e-05	0.0
64770	-6.71e-04	-2.19e-03	-0.03	1.08e-04	-3.41e-05	0.0
64772	-5.71e-04	-1.93e-03	-0.03	9.55e-05	-2.90e-05	0.0
64773	-5.46e-04	-1.87e-03	-0.02	9.24e-05	-2.77e-05	0.0
6482	-6.44e-04	-2.87e-03	-0.03	1.42e-04	-3.23e-05	0.0
6488	-2.07e-03	-2.36e-03	-0.02	9.23e-05	-1.34e-05	0.0
64822	-1.14e-04	-3.90e-03	-0.02	1.15e-04	-2.36e-05	0.0
64840	-2.74e-03	-2.59e-03	-0.02	9.39e-05	-1.09e-05	0.0
64854	-1.39e-06	-4.74e-03	-0.02	1.25e-04	-2.51e-05	0.0
64870	-4.81e-04	-2.08e-03	-0.02	1.03e-04	-2.42e-05	0.0
64872	-4.11e-04	-1.84e-03	-0.02	9.12e-05	-2.06e-05	0.0
64873	-3.94e-04	-1.78e-03	-0.02	8.83e-05	-1.97e-05	0.0
6492	-4.25e-04	-2.43e-03	-0.02	1.20e-04	-2.07e-05	0.0
64910	1.44e-03	-2.06e-03	-0.02	8.29e-05	-1.72e-05	0.0
64911	-1.97e-03	-9.63e-04	-0.02	6.73e-05	-8.20e-06	0.0
64922	1.01e-04	-3.44e-03	-0.02	9.23e-05	-1.29e-05	0.0
64942	2.13e-03	-2.28e-03	-0.02	8.60e-05	-1.90e-05	0.0
64943	-2.65e-03	-7.43e-04	-0.02	6.41e-05	-6.39e-06	0.0
64954	2.46e-04	-4.21e-03	-0.02	9.92e-05	-1.29e-05	0.0
64970	-3.17e-04	-1.76e-03	-0.02	8.69e-05	-1.55e-05	0.0
64972	-2.73e-04	-1.56e-03	-0.02	7.75e-05	-1.33e-05	0.0
64973	-2.62e-04	-1.51e-03	-0.02	7.51e-05	-1.27e-05	0.0
6502	-2.68e-04	-1.86e-03	-0.02	9.19e-05	-1.24e-05	0.0
65011	-1.89e-03	-6.69e-04	-0.01	5.28e-05	-5.49e-06	0.0
65021	4.27e-04	5.54e-04	-0.01	5.11e-05	-1.01e-05	0.0
65022	2.43e-04	-2.90e-03	-0.01	6.55e-05	-6.89e-06	0.0
65043	-2.58e-03	-4.73e-04	-0.01	5.09e-05	-4.61e-06	0.0
65053	6.65e-04	1.24e-03	-0.01	4.85e-05	-1.11e-05	0.0
65054	4.07e-04	-3.60e-03	-0.01	6.87e-05	-6.58e-06	0.0



EGP CODE

GRE.EEC.R.73.IT.W.15235.12.024.01

PAGE

175 di/of 527

65070	-2.00e-04	-1.34e-03	-0.01	6.63e-05	-9.29e-06	0.0
65072	-1.73e-04	-1.20e-03	-0.01	5.92e-05	-8.01e-06	0.0
65073	-1.66e-04	-1.16e-03	-0.01	5.75e-05	-7.69e-06	0.0
6511	-1.39e-04	-1.08e-03	-0.01	5.34e-05	-5.99e-06	0.0
6512	-1.70e-04	-1.26e-03	-0.01	6.22e-05	-7.38e-06	0.0
65111	-1.82e-03	-3.53e-04	-0.01	3.70e-05	-3.58e-06	0.0
65121	4.64e-04	7.88e-04	-0.01	3.90e-05	-6.20e-06	0.0
65122	3.32e-04	-2.38e-03	-0.01	4.01e-05	-3.88e-06	0.0
65143	-2.51e-03	-1.78e-04	-0.01	3.63e-05	-3.18e-06	0.0
65153	6.92e-04	1.42e-03	-0.01	3.89e-05	-6.84e-06	0.0
65154	5.07e-04	-3.02e-03-9.83e-03		4.06e-05	-3.60e-06	0.0
65169	-1.06e-04	-7.90e-04	-0.01	3.90e-05	-4.60e-06	0.0
65170	-1.26e-04	-9.12e-04	-0.01	4.49e-05	-5.52e-06	0.0
65171	-1.06e-04	-7.90e-04	-0.01	3.90e-05	-4.60e-06	0.0
65172	-1.10e-04	-8.14e-04	-0.01	4.02e-05	-4.78e-06	0.0
65173	-1.06e-04	-7.90e-04	-0.01	3.90e-05	-4.60e-06	0.0
6521	-9.52e-05	-5.98e-04	-0.01	2.94e-05	-3.81e-06	0.0
6522	-1.15e-04	-6.99e-04	-0.01	3.42e-05	-4.67e-06	0.0
65211	-1.77e-03	-3.72e-05-8.92e-03		2.16e-05	-2.40e-06	0.0
65221	4.70e-04	1.06e-03-9.32e-03		2.59e-05	-3.76e-06	0.0
65222	3.92e-04	-1.94e-03-8.61e-03		1.76e-05	-2.57e-06	0.0
65243	-2.45e-03	1.23e-04-8.91e-03		2.17e-05	-2.19e-06	0.0
65253	6.87e-04	1.66e-03-9.48e-03		2.76e-05	-4.10e-06	0.0
65254	5.78e-04	-2.54e-03-8.47e-03		1.61e-05	-2.42e-06	0.0
65269	-7.22e-05	-4.37e-04-8.93e-03		2.15e-05	-2.92e-06	0.0
65270	-8.56e-05	-5.04e-04-8.65e-03		2.46e-05	-3.50e-06	0.0
65271	-7.22e-05	-4.37e-04-8.93e-03		2.15e-05	-2.92e-06	0.0
65272	-7.49e-05	-4.51e-04-8.88e-03		2.21e-05	-3.04e-06	0.0
65273	-7.22e-05	-4.37e-04-8.93e-03		2.15e-05	-2.92e-06	0.0
6531	-7.80e-05	-1.43e-04	-0.01	6.74e-06	-2.96e-06	0.0
6532	-9.40e-05	-1.67e-04	-0.01	7.83e-06	-3.62e-06	0.0
65311	-1.74e-03	2.78e-04-8.23e-03		6.14e-06	-1.85e-06	0.0
65321	4.52e-04	1.35e-03-8.40e-03		1.10e-05	-2.57e-06	0.0
65322	4.33e-04	-1.57e-03-8.22e-03		0.0	-2.27e-06	0.0
65343	-2.41e-03	4.31e-04-8.21e-03		6.63e-06	-1.68e-06	0.0
65353	6.57e-04	1.94e-03-8.44e-03		1.34e-05	-2.69e-06	0.0
65354	6.30e-04	-2.15e-03-8.19e-03		-3.31e-06	-2.27e-06	0.0
65369	-5.89e-05	-1.05e-04-8.28e-03		4.92e-06	-2.27e-06	0.0
65370	-6.96e-05	-1.21e-04-7.91e-03		5.65e-06	-2.71e-06	0.0
65371	-5.89e-05	-1.05e-04-8.28e-03		4.92e-06	-2.27e-06	0.0
65372	-6.11e-05	-1.08e-04-8.21e-03		5.07e-06	-2.36e-06	0.0
65373	-5.89e-05	-1.05e-04-8.28e-03		4.92e-06	-2.27e-06	0.0
6541	-8.29e-05	3.04e-04	-0.01	-1.55e-05	-3.21e-06	0.0
6542	-1.00e-04	3.55e-04	-0.01	-1.80e-05	-3.93e-06	0.0
65420	-1.74e-03	-1.64e-04-8.41e-03		-1.23e-05	-2.04e-06	0.0
65425	4.18e-04	1.69e-03-8.26e-03		-5.95e-06	-2.37e-06	0.0
65426	4.59e-04	-1.25e-03-8.68e-03		-1.70e-05	-2.88e-06	0.0
65452	-2.42e-03	-3.19e-04-8.40e-03		-1.27e-05	-1.87e-06	0.0
65457	6.10e-04	2.29e-03-8.18e-03		-3.79e-06	-2.34e-06	0.0
65458	6.68e-04	-1.83e-03-8.77e-03		-1.93e-05	-3.05e-06	0.0
65469	-6.27e-05	2.22e-04-8.44e-03		-1.13e-05	-2.46e-06	0.0
65470	-7.42e-05	2.56e-04-8.09e-03		-1.30e-05	-2.94e-06	0.0
65471	-6.27e-05	2.22e-04-8.44e-03		-1.13e-05	-2.46e-06	0.0
65472	-6.50e-05	2.29e-04-8.37e-03		-1.17e-05	-2.56e-06	0.0
65473	-6.27e-05	2.22e-04-8.44e-03		-1.13e-05	-2.46e-06	0.0
6551	-1.11e-04	7.69e-04	-0.01	-3.87e-05	-4.61e-06	0.0
6552	-1.35e-04	8.98e-04	-0.01	-4.50e-05	-5.67e-06	0.0
65520	-1.79e-03	1.50e-04-9.40e-03		-2.78e-05	-2.90e-06	0.0
65525	3.68e-04	2.09e-03-9.02e-03		-2.58e-05	-3.11e-06	0.0
65526	4.68e-04	-9.59e-04-9.88e-03		-3.13e-05	-4.54e-06	0.0
65552	-2.47e-03	-1.49e-05-9.40e-03		-2.77e-05	-2.64e-06	0.0
65557	5.50e-04	2.71e-03-8.86e-03		-2.48e-05	-2.94e-06	0.0
65558	6.89e-04	-1.57e-03	-0.01	-3.26e-05	-4.94e-06	0.0
65569	-8.44e-05	5.62e-04-9.41e-03		-2.82e-05	-3.53e-06	0.0
65570	-1.00e-04	6.48e-04-9.20e-03		-3.24e-05	-4.24e-06	0.0
65571	-8.44e-05	5.62e-04-9.41e-03		-2.82e-05	-3.53e-06	0.0
65572	-8.76e-05	5.79e-04-9.37e-03		-2.91e-05	-3.68e-06	0.0
65573	-8.44e-05	5.62e-04-9.41e-03		-2.82e-05	-3.53e-06	0.0
6562	-2.08e-04	1.48e-03	-0.01	-7.38e-05	-9.28e-06	0.0
65620	-1.85e-03	4.67e-04	-0.01	-4.34e-05	-4.44e-06	0.0
65625	2.97e-04	2.57e-03	-0.01	-4.95e-05	-5.05e-06	0.0
65626	4.50e-04	-7.01e-04	-0.01	-4.42e-05	-7.54e-06	0.0
65652	-2.53e-03	2.84e-04	-0.01	-4.23e-05	-3.91e-06	0.0
65657	4.67e-04	3.23e-03	-0.01	-5.08e-05	-4.76e-06	0.0
65658	6.81e-04	-1.35e-03	-0.01	-4.34e-05	-8.26e-06	0.0
65670	-1.54e-04	1.07e-03	-0.01	-5.32e-05	-6.94e-06	0.0





EGP CODE

GRE.EEC.R.73.IT.W.15235.12.024.01

PAGE

176 di/of 527

65672	-1.34e-04	9.52e-04	-0.01	-4.76e-05	-5.99e-06	0.0
65673	-1.29e-04	9.23e-04	-0.01	-4.62e-05	-5.76e-06	0.0
6572	-3.30e-04	2.08e-03	-0.02	-1.04e-04	-1.55e-05	0.0
65714	1.49e-03	8.09e-04	-0.01	-6.47e-05	-1.33e-05	0.0
65720	-1.92e-03	7.76e-04	-0.01	-5.88e-05	-6.69e-06	0.0
65725	1.88e-04	3.11e-03	-0.01	-7.62e-05	-9.04e-06	0.0
65746	2.17e-03	6.15e-04	-0.01	-6.47e-05	-1.48e-05	0.0
65752	-2.61e-03	5.68e-04	-0.01	-5.64e-05	-5.53e-06	0.0
65757	3.45e-04	3.83e-03	-0.01	-8.07e-05	-8.84e-06	0.0
65770	-2.46e-04	1.50e-03	-0.01	-7.47e-05	-1.16e-05	0.0
65772	-2.12e-04	1.34e-03	-0.01	-6.67e-05	-9.96e-06	0.0
65773	-2.04e-04	1.29e-03	-0.01	-6.47e-05	-9.56e-06	0.0
6582	-5.13e-04	2.62e-03	-0.03	-1.31e-04	-2.50e-05	0.0
65820	-2.01e-03	1.05e-03	-0.02	-7.21e-05	-9.63e-06	0.0
65825	1.89e-05	3.64e-03	-0.02	-1.02e-04	-1.61e-05	0.0
65852	-2.68e-03	8.15e-04	-0.02	-6.85e-05	-7.33e-06	0.0
65857	1.52e-04	4.44e-03	-0.02	-1.11e-04	-1.64e-05	0.0
65870	-3.83e-04	1.89e-03	-0.02	-9.43e-05	-1.87e-05	0.0
65872	-3.29e-04	1.68e-03	-0.02	-8.39e-05	-1.60e-05	0.0
65873	-3.15e-04	1.63e-03	-0.02	-8.13e-05	-1.54e-05	0.0
6592	-7.51e-04	2.98e-03	-0.03	-1.48e-04	-3.77e-05	0.0
65915	-2.14e-03	2.43e-03	-0.02	-9.65e-05	-1.61e-05	0.0
65925	-2.24e-04	4.03e-03	-0.02	-1.22e-04	-2.86e-05	0.0
65947	-2.81e-03	2.66e-03	-0.02	-9.83e-05	-1.34e-05	0.0
65957	-1.30e-04	4.91e-03	-0.02	-1.34e-04	-3.08e-05	0.0
65970	-5.60e-04	2.15e-03	-0.02	-1.07e-04	-2.82e-05	0.0
65972	-4.78e-04	1.90e-03	-0.02	-9.49e-05	-2.40e-05	0.0
65973	-4.58e-04	1.84e-03	-0.02	-9.19e-05	-2.30e-05	0.0
6602	-9.01e-04	3.04e-03	-0.04	-1.51e-04	-4.58e-05	0.0
66015	-2.22e-03	2.48e-03	-0.02	-9.90e-05	-2.03e-05	0.0
66025	-4.03e-04	4.13e-03	-0.03	-1.27e-04	-3.72e-05	0.0
66047	-2.89e-03	2.72e-03	-0.02	-1.01e-04	-1.72e-05	0.0
66057	-3.46e-04	5.04e-03	-0.03	-1.40e-04	-4.09e-05	0.0
66070	-6.73e-04	2.20e-03	-0.03	-1.09e-04	-3.42e-05	0.0
66072	-5.73e-04	1.94e-03	-0.03	-9.67e-05	-2.91e-05	0.0
66073	-5.48e-04	1.88e-03	-0.02	-9.35e-05	-2.78e-05	0.0
6612	-3.64e-04	-2.81e-03	-0.04	1.39e-04	-1.80e-05	0.0
6618	-1.81e-03	-2.37e-03	-0.02	9.37e-05	0.0	0.0
66122	7.94e-06	-3.92e-03	-0.03	1.15e-04	-1.66e-05	0.0
66140	-2.44e-03	-2.63e-03	-0.02	9.66e-05	4.60e-06	0.0
66154	9.92e-05	-4.80e-03	-0.03	1.27e-04	-1.89e-05	0.0
66170	-2.71e-04	-2.03e-03	-0.03	1.01e-04	-1.34e-05	0.0
66172	-2.30e-04	-1.80e-03	-0.02	8.94e-05	-1.13e-05	0.0
66173	-2.20e-04	-1.74e-03	-0.02	8.66e-05	-1.08e-05	0.0
6622	-2.70e-04	-2.67e-03	-0.03	1.33e-04	-1.30e-05	0.0
66211	-1.79e-03	-1.13e-03	-0.02	7.59e-05	2.06e-06	0.0
66222	1.29e-04	-3.74e-03	-0.02	1.06e-04	-1.17e-05	0.0
66243	-2.44e-03	-9.23e-04	-0.02	7.31e-05	6.06e-06	0.0
66254	2.46e-04	-4.58e-03	-0.02	1.16e-04	-1.32e-05	0.0
66270	-2.01e-04	-1.93e-03	-0.02	9.58e-05	-9.72e-06	0.0
66272	-1.72e-04	-1.72e-03	-0.02	8.55e-05	-8.26e-06	0.0
66273	-1.65e-04	-1.66e-03	-0.02	8.29e-05	-7.90e-06	0.0
6632	-1.88e-04	-2.28e-03	-0.02	1.13e-04	-8.65e-06	0.0
66311	-1.78e-03	-9.32e-04	-0.02	6.59e-05	1.49e-06	0.0
66322	2.30e-04	-3.35e-03	-0.02	8.66e-05	-6.65e-06	0.0
66343	-2.45e-03	-7.36e-04	-0.02	6.39e-05	4.21e-06	0.0
66354	3.69e-04	-4.12e-03	-0.02	9.29e-05	-7.20e-06	0.0
66370	-1.39e-04	-1.64e-03	-0.02	8.16e-05	-6.46e-06	0.0
66372	-1.20e-04	-1.47e-03	-0.02	7.30e-05	-5.52e-06	0.0
66373	-1.15e-04	-1.42e-03	-0.02	7.08e-05	-5.28e-06	0.0
6642	-1.26e-04	-1.76e-03	-0.02	8.72e-05	-5.41e-06	0.0
66411	-1.77e-03	-6.51e-04	-0.01	5.19e-05	0.0	0.0
66421	5.19e-04	6.56e-04	-0.01	4.75e-05	-5.16e-06	0.0
66422	3.10e-04	-2.86e-03	-0.01	6.22e-05	-4.10e-06	0.0
66443	-2.44e-03	-4.72e-04	-0.01	5.08e-05	2.46e-06	0.0
66453	7.58e-04	1.36e-03	-0.01	4.47e-05	-5.89e-06	0.0
66454	4.65e-04	-3.56e-03	-0.01	6.53e-05	-4.40e-06	0.0
66470	-9.33e-05	-1.27e-03	-0.01	6.28e-05	-4.05e-06	0.0
66472	-8.10e-05	-1.13e-03	-0.01	5.62e-05	-3.47e-06	0.0
66473	-7.79e-05	-1.10e-03	-0.01	5.46e-05	-3.33e-06	0.0
6651	-7.11e-05	-1.03e-03	-0.01	5.13e-05	-2.70e-06	0.0
6652	-8.59e-05	-1.20e-03	-0.01	5.95e-05	-3.35e-06	0.0
66511	-1.75e-03	-3.44e-04	-0.01	3.65e-05	0.0	0.0
66521	5.18e-04	8.68e-04	-0.01	3.67e-05	-3.23e-06	0.0
66522	3.69e-04	-2.38e-03	-9.84e-03	3.83e-05	-2.47e-06	0.0
66543	-2.42e-03	-1.80e-04	-0.01	3.62e-05	1.18e-06	0.0



EGP CODE

GRE.EEC.R.73.IT.W.15235.12.024.01

PAGE

177 di/of 527

66553	7.47e-04	1.52e-03	-0.01	3.65e-05	-3.70e-06	0.0
66554	5.39e-04	-3.03e-03	-9.67e-03	3.87e-05	-2.63e-06	0.0
66569	-5.35e-05	-7.53e-04	-0.01	3.74e-05	-2.07e-06	0.0
66570	-6.34e-05	-8.67e-04	-0.01	4.29e-05	-2.51e-06	0.0
66571	-5.35e-05	-7.53e-04	-0.01	3.74e-05	-2.07e-06	0.0
66572	-5.55e-05	-7.76e-04	-0.01	3.85e-05	-2.16e-06	0.0
66573	-5.35e-05	-7.53e-04	-0.01	3.74e-05	-2.07e-06	0.0
6661	-5.31e-05	-5.74e-04	-0.01	2.84e-05	-1.79e-06	0.0
6662	-6.34e-05	-6.69e-04	-0.01	3.29e-05	-2.21e-06	0.0
66611	-1.73e-03	-3.47e-05	-8.85e-03	2.13e-05	0.0	0.0
66621	5.03e-04	1.11e-03	-9.18e-03	2.45e-05	-2.04e-06	0.0
66626	4.10e-04	-1.96e-03	-8.49e-03	1.69e-05	-1.49e-06	0.0
66643	-2.40e-03	1.19e-04	-8.86e-03	2.15e-05	0.0	0.0
66653	7.21e-04	1.73e-03	-9.32e-03	2.61e-05	-2.30e-06	0.0
66658	5.90e-04	-2.57e-03	-8.36e-03	1.54e-05	-1.54e-06	0.0
66669	-3.98e-05	-4.19e-04	-8.82e-03	2.07e-05	-1.38e-06	0.0
66670	-4.66e-05	-4.82e-04	-8.52e-03	2.37e-05	-1.65e-06	0.0
66671	-3.98e-05	-4.19e-04	-8.82e-03	2.07e-05	-1.38e-06	0.0
66672	-4.11e-05	-4.32e-04	-8.76e-03	2.13e-05	-1.43e-06	0.0
66673	-3.98e-05	-4.19e-04	-8.82e-03	2.07e-05	-1.38e-06	0.0
6671	-4.59e-05	-1.38e-04	-0.01	6.53e-06	-1.44e-06	0.0
6672	-5.44e-05	-1.61e-04	-0.01	7.57e-06	-1.76e-06	0.0
66711	-1.70e-03	2.62e-04	-8.18e-03	6.04e-06	0.0	0.0
66721	4.75e-04	1.40e-03	-8.30e-03	1.05e-05	-1.45e-06	0.0
66726	4.51e-04	-1.60e-03	-8.12e-03	0.0	-1.31e-06	0.0
66743	-2.37e-03	4.07e-04	-8.17e-03	6.55e-06	0.0	0.0
66753	6.79e-04	2.00e-03	-8.34e-03	1.28e-05	-1.58e-06	0.0
66758	6.46e-04	-2.20e-03	-8.09e-03	-3.26e-06	-1.39e-06	0.0
66769	-3.42e-05	-1.01e-04	-8.20e-03	4.76e-06	-1.10e-06	0.0
66770	-3.99e-05	-1.16e-04	-7.80e-03	5.45e-06	-1.32e-06	0.0
66771	-3.42e-05	-1.01e-04	-8.20e-03	4.76e-06	-1.10e-06	0.0
66772	-3.54e-05	-1.04e-04	-8.12e-03	4.90e-06	-1.15e-06	0.0
66773	-3.42e-05	-1.01e-04	-8.20e-03	4.76e-06	-1.10e-06	0.0
6681	-4.80e-05	2.92e-04	-0.01	-1.50e-05	-1.54e-06	0.0
6682	-5.70e-05	3.39e-04	-0.01	-1.73e-05	-1.89e-06	0.0
66820	-1.71e-03	-1.52e-04	-8.35e-03	-1.20e-05	0.0	0.0
66821	4.38e-04	1.72e-03	-8.16e-03	-5.63e-06	-1.35e-06	0.0
66826	4.85e-04	-1.29e-03	-8.56e-03	-1.62e-05	-1.60e-06	0.0
66852	-2.38e-03	-2.99e-04	-8.36e-03	-1.25e-05	0.0	0.0
66853	6.28e-04	2.32e-03	-8.08e-03	-3.52e-06	-1.42e-06	0.0
66858	6.94e-04	-1.90e-03	-8.65e-03	-1.84e-05	-1.77e-06	0.0
66869	-3.58e-05	2.13e-04	-8.35e-03	-1.09e-05	-1.18e-06	0.0
66870	-4.18e-05	2.44e-04	-7.98e-03	-1.25e-05	-1.42e-06	0.0
66871	-3.58e-05	2.13e-04	-8.35e-03	-1.09e-05	-1.18e-06	0.0
66872	-3.70e-05	2.19e-04	-8.27e-03	-1.12e-05	-1.23e-06	0.0
66873	-3.58e-05	2.13e-04	-8.35e-03	-1.09e-05	-1.18e-06	0.0
6691	-5.97e-05	7.36e-04	-0.01	-3.72e-05	-2.12e-06	0.0
6692	-7.17e-05	8.56e-04	-0.01	-4.31e-05	-2.62e-06	0.0
66920	-1.73e-03	1.45e-04	-9.32e-03	-2.73e-05	0.0	0.0
66921	3.93e-04	2.10e-03	-8.88e-03	-2.47e-05	-1.76e-06	0.0
66926	5.08e-04	-1.02e-03	-9.71e-03	-2.96e-05	-2.40e-06	0.0
66952	-2.41e-03	-1.22e-05	-9.34e-03	-2.74e-05	0.0	0.0
66953	5.68e-04	2.73e-03	-8.73e-03	-2.38e-05	-1.81e-06	0.0
66958	7.30e-04	-1.65e-03	-9.88e-03	-3.06e-05	-2.71e-06	0.0
66969	-4.48e-05	5.37e-04	-9.28e-03	-2.71e-05	-1.63e-06	0.0
66970	-5.28e-05	6.17e-04	-9.04e-03	-3.10e-05	-1.96e-06	0.0
66971	-4.48e-05	5.37e-04	-9.28e-03	-2.71e-05	-1.63e-06	0.0
66972	-4.64e-05	5.53e-04	-9.23e-03	-2.79e-05	-1.70e-06	0.0
66973	-4.48e-05	5.37e-04	-9.28e-03	-2.71e-05	-1.63e-06	0.0
6702	-1.01e-04	1.40e-03	-0.01	-7.03e-05	-4.11e-06	0.0
67020	-1.75e-03	4.55e-04	-0.01	-4.26e-05	0.0	0.0
67025	3.46e-04	2.55e-03	-0.01	-4.73e-05	-3.05e-06	0.0
67026	5.18e-04	-7.90e-04	-0.01	-4.13e-05	-3.86e-06	0.0
67052	-2.43e-03	2.86e-04	-0.01	-4.20e-05	1.41e-06	0.0
67057	5.10e-04	3.22e-03	-0.01	-4.86e-05	-3.26e-06	0.0
67058	7.51e-04	-1.46e-03	-0.01	-4.02e-05	-4.40e-06	0.0
67070	-7.50e-05	1.01e-03	-0.01	-5.06e-05	-3.07e-06	0.0
67072	-6.54e-05	9.04e-04	-0.01	-4.54e-05	-2.65e-06	0.0
67073	-6.30e-05	8.77e-04	-0.01	-4.41e-05	-2.54e-06	0.0
6712	-1.50e-04	1.96e-03	-0.02	-9.80e-05	-6.60e-06	0.0
67114	1.57e-03	6.91e-04	-0.01	-5.93e-05	-9.25e-06	0.0
67120	-1.77e-03	7.56e-04	-0.01	-5.77e-05	0.0	0.0
67125	2.79e-04	3.05e-03	-0.01	-7.21e-05	-5.01e-06	0.0
67146	2.24e-03	4.79e-04	-0.01	-5.84e-05	-1.13e-05	0.0
67152	-2.44e-03	5.70e-04	-0.01	-5.62e-05	2.88e-06	0.0
67157	4.28e-04	3.78e-03	-0.01	-7.64e-05	-5.40e-06	0.0



EGP CODE

GRE.EEC.R.73.IT.W.15235.12.024.01

PAGE

178 di/of 527

67170	-1.11e-04	1.41e-03	-0.01	-7.06e-05	-4.94e-06	0.0
67172	-9.63e-05	1.26e-03	-0.01	-6.32e-05	-4.23e-06	0.0
67173	-9.26e-05	1.22e-03	-0.01	-6.13e-05	-4.05e-06	0.0
6722	-2.21e-04	2.45e-03	-0.02	-1.23e-04	-1.03e-05	0.0
67220	-1.79e-03	1.02e-03	-0.02	-7.07e-05	1.70e-06	0.0
67225	1.91e-04	3.52e-03	-0.02	-9.57e-05	-9.25e-06	0.0
67252	-2.45e-03	8.12e-04	-0.02	-6.83e-05	4.90e-06	0.0
67257	3.22e-04	4.32e-03	-0.02	-1.03e-04	-1.04e-05	0.0
67270	-1.64e-04	1.76e-03	-0.02	-8.84e-05	-7.69e-06	0.0
67272	-1.41e-04	1.57e-03	-0.02	-7.89e-05	-6.55e-06	0.0
67273	-1.35e-04	1.52e-03	-0.02	-7.66e-05	-6.27e-06	0.0
6732	-3.09e-04	2.77e-03	-0.03	-1.38e-04	-1.50e-05	0.0
67315	-1.80e-03	2.33e-03	-0.02	-9.25e-05	0.0	0.0
67325	8.16e-05	3.85e-03	-0.02	-1.13e-04	-1.37e-05	0.0
67347	-2.44e-03	2.58e-03	-0.02	-9.50e-05	4.71e-06	0.0
67357	1.89e-04	4.71e-03	-0.02	-1.23e-04	-1.55e-05	0.0
67370	-2.30e-04	1.99e-03	-0.02	-9.98e-05	-1.12e-05	0.0
67372	-1.96e-04	1.77e-03	-0.02	-8.89e-05	-9.51e-06	0.0
67373	-1.88e-04	1.72e-03	-0.02	-8.62e-05	-9.08e-06	0.0
6742	-3.65e-04	2.82e-03	-0.04	-1.41e-04	-1.80e-05	0.0
67415	-1.81e-03	2.38e-03	-0.02	-9.47e-05	0.0	0.0
67425	7.91e-06	3.94e-03	-0.03	-1.17e-04	-1.68e-05	0.0
67447	-2.44e-03	2.63e-03	-0.02	-9.75e-05	5.17e-06	0.0
67457	9.95e-05	4.82e-03	-0.03	-1.28e-04	-1.92e-05	0.0
67470	-2.72e-04	2.03e-03	-0.03	-1.02e-04	-1.35e-05	0.0
67472	-2.31e-04	1.80e-03	-0.02	-9.04e-05	-1.14e-05	0.0
67473	-2.21e-04	1.75e-03	-0.02	-8.76e-05	-1.09e-05	0.0
6752	2.39e-04	-2.79e-03	-0.03	1.39e-04	1.32e-05	0.0
67510	1.74e-03	-2.22e-03	-0.02	9.15e-05	-2.21e-06	0.0
67524	-4.32e-04	-3.96e-03	-0.03	1.16e-04	1.63e-05	0.0
67542	2.37e-03	-2.42e-03	-0.02	9.35e-05	-6.34e-06	0.0
67556	-6.64e-04	-4.86e-03	-0.03	1.27e-04	1.96e-05	0.0
67570	1.80e-04	-2.02e-03	-0.03	1.00e-04	9.85e-06	0.0
67572	1.53e-04	-1.79e-03	-0.02	8.91e-05	8.46e-06	0.0
67573	1.47e-04	-1.73e-03	-0.02	8.63e-05	8.11e-06	0.0
6762	1.64e-04	-2.66e-03	-0.03	1.32e-04	9.24e-06	0.0
67610	1.74e-03	-2.12e-03	-0.02	8.66e-05	-2.65e-06	0.0
67624	-5.11e-04	-3.78e-03	-0.02	1.07e-04	1.03e-05	0.0
67642	2.39e-03	-2.31e-03	-0.02	8.82e-05	-6.01e-06	0.0
67656	-7.56e-04	-4.64e-03	-0.02	1.16e-04	1.22e-05	0.0
67670	1.24e-04	-1.92e-03	-0.02	9.54e-05	6.92e-06	0.0
67672	1.06e-04	-1.71e-03	-0.02	8.52e-05	5.97e-06	0.0
67673	1.01e-04	-1.66e-03	-0.02	8.26e-05	5.74e-06	0.0
6772	9.85e-05	-2.27e-03	-0.02	1.13e-04	5.81e-06	0.0
67710	1.73e-03	-1.85e-03	-0.02	7.28e-05	-3.35e-06	0.0
67724	-5.61e-04	-3.38e-03	-0.02	8.68e-05	5.41e-06	0.0
67742	2.39e-03	-2.02e-03	-0.02	7.37e-05	-6.14e-06	0.0
67756	-8.10e-04	-4.17e-03	-0.02	9.33e-05	6.12e-06	0.0
67770	7.47e-05	-1.64e-03	-0.02	8.13e-05	4.35e-06	0.0
67772	6.38e-05	-1.46e-03	-0.02	7.27e-05	3.78e-06	0.0
67773	6.11e-05	-1.42e-03	-0.02	7.06e-05	3.63e-06	0.0
6782	5.06e-05	-1.75e-03	-0.02	8.69e-05	3.32e-06	0.0
67810	1.72e-03	-1.49e-03	-0.01	5.50e-05	-2.42e-06	0.0
67823	-3.41e-04	6.91e-04	-0.01	4.72e-05	4.05e-06	0.0
67824	-5.81e-04	-2.89e-03	-0.01	6.23e-05	2.78e-06	0.0
67842	2.39e-03	-1.65e-03	-0.01	5.52e-05	-4.22e-06	0.0
67855	-4.90e-04	1.41e-03	-0.01	4.43e-05	4.83e-06	0.0
67856	-8.26e-04	-3.61e-03	-0.01	6.55e-05	3.06e-06	0.0
67870	3.88e-05	-1.26e-03	-0.01	6.25e-05	2.49e-06	0.0
67872	3.29e-05	-1.13e-03	-0.01	5.60e-05	2.17e-06	0.0
67873	3.15e-05	-1.09e-03	-0.01	5.44e-05	2.09e-06	0.0
6791	1.48e-05	-1.03e-03	-0.01	5.11e-05	1.48e-06	0.0
6792	2.03e-05	-1.20e-03	-0.01	5.93e-05	1.79e-06	0.0
67910	1.70e-03	-1.12e-03	-0.01	3.67e-05	-1.67e-06	0.0
67923	-3.97e-04	8.98e-04	-0.01	3.67e-05	2.63e-06	0.0
67924	-5.73e-04	-2.41e-03	-9.80e-03	3.83e-05	1.22e-06	0.0
67942	2.38e-03	-1.27e-03	-0.01	3.64e-05	-2.79e-06	0.0
67955	-5.61e-04	1.56e-03	-0.01	3.64e-05	3.24e-06	0.0
67956	-8.08e-04	-3.07e-03	-9.63e-03	3.87e-05	1.26e-06	0.0
67969	1.25e-05	-7.50e-04	-0.01	3.72e-05	1.13e-06	0.0
67970	1.62e-05	-8.64e-04	-0.01	4.27e-05	1.34e-06	0.0
67971	1.25e-05	-7.50e-04	-0.01	3.72e-05	1.13e-06	0.0
67972	1.32e-05	-7.73e-04	-0.01	3.83e-05	1.17e-06	0.0
67973	1.25e-05	-7.50e-04	-0.01	3.72e-05	1.13e-06	0.0
6801	1.20e-06	-5.73e-04	-0.01	2.83e-05	0.0	0.0
6802	3.73e-06	-6.66e-04	-0.01	3.27e-05	0.0	0.0



EGP CODE

GRE.EEC.R.73.IT.W.15235.12.024.01

PAGE

179 di/of 527

6804	6.05e-06	-4.82e-04-8.36e-03	2.36e-05	0.0	0.0
68010	1.69e-03	-7.72e-04-8.70e-03	1.92e-05	-1.05e-06	0.0
68023	-4.47e-04	1.14e-03-9.16e-03	2.46e-05	1.54e-06	0.0
68024	-5.48e-04	-1.98e-03-8.46e-03	1.69e-05	0.0	0.0
68042	2.36e-03	-9.15e-04-8.66e-03	1.87e-05	-1.71e-06	0.0
68055	-6.26e-04	1.77e-03-9.30e-03	2.62e-05	1.90e-06	0.0
68056	-7.69e-04	-2.61e-03-8.33e-03	1.54e-05	0.0	0.0
68069	2.05e-06	-4.18e-04-8.80e-03	2.06e-05	0.0	0.0
68070	3.74e-06	-4.80e-04-8.49e-03	2.36e-05	0.0	0.0
68071	2.05e-06	-4.18e-04-8.80e-03	2.06e-05	0.0	0.0
68072	2.39e-06	-4.30e-04-8.74e-03	2.12e-05	0.0	0.0
68073	2.05e-06	-4.18e-04-8.80e-03	2.06e-05	0.0	0.0
6811	-4.20e-06	-1.38e-04 -0.01	6.51e-06	0.0	0.0
6812	-2.79e-06	-1.61e-04-9.98e-03	7.54e-06	0.0	0.0
68111	-1.67e-03	2.49e-04-8.21e-03	6.31e-06	1.44e-06	0.0
68123	-4.89e-04	1.42e-03-8.27e-03	1.07e-05	0.0	0.0
68124	-5.13e-04	-1.63e-03-8.09e-03	-1.04e-06	0.0	0.0
68143	-2.34e-03	3.89e-04-8.22e-03	6.93e-06	1.85e-06	0.0
68155	-6.83e-04	2.03e-03-8.31e-03	1.31e-05	0.0	0.0
68156	-7.18e-04	-2.24e-03-8.06e-03	-3.36e-06	0.0	0.0
68169	-2.09e-06	-1.01e-04-8.18e-03	4.74e-06	0.0	0.0
68170	-1.15e-06	-1.16e-04-7.78e-03	5.43e-06	0.0	0.0
68171	-2.09e-06	-1.01e-04-8.18e-03	4.74e-06	0.0	0.0
68172	-1.90e-06	-1.04e-04-8.10e-03	4.88e-06	0.0	0.0
68173	-2.09e-06	-1.01e-04-8.18e-03	4.74e-06	0.0	0.0
6821	-2.73e-06	2.91e-04 -0.01	-1.49e-05	0.0	0.0
6822	0.0	3.38e-04 -0.01	-1.73e-05	0.0	0.0
68220	-1.67e-03	-1.38e-04-8.39e-03	-1.24e-05	1.65e-06	0.0
68227	-5.25e-04	1.75e-03-8.13e-03	-5.56e-06	0.0	0.0
68228	-4.73e-04	-1.32e-03-8.54e-03	-1.64e-05	1.03e-06	0.0
68252	-2.34e-03	-2.78e-04-8.41e-03	-1.30e-05	2.12e-06	0.0
68259	-7.35e-04	2.36e-03-8.04e-03	-3.44e-06	0.0	0.0
68260	-6.62e-04	-1.93e-03-8.63e-03	-1.86e-05	1.26e-06	0.0
68269	0.0	2.12e-04-8.33e-03	-1.09e-05	0.0	0.0
68270	0.0	2.43e-04-7.95e-03	-1.24e-05	0.0	0.0
68271	0.0	2.12e-04-8.33e-03	-1.09e-05	0.0	0.0
68272	0.0	2.18e-04-8.25e-03	-1.12e-05	0.0	0.0
68273	0.0	2.12e-04-8.33e-03	-1.09e-05	0.0	0.0
6831	5.99e-06	7.34e-04 -0.01	-3.71e-05	1.05e-06	0.0
6832	9.60e-06	8.53e-04 -0.01	-4.29e-05	1.27e-06	0.0
6834	1.08e-05	6.16e-04-8.88e-03	-3.09e-05	1.02e-06	0.0
68317	1.69e-03	8.94e-04-9.13e-03	-2.58e-05	-1.15e-06	0.0
68327	-5.57e-04	2.13e-03-8.85e-03	-2.47e-05	0.0	0.0
68328	-4.28e-04	-1.05e-03-9.69e-03	-2.97e-05	1.89e-06	0.0
68349	2.36e-03	1.04e-03-9.08e-03	-2.54e-05	-1.93e-06	0.0
68359	-7.82e-04	2.77e-03-8.69e-03	-2.38e-05	0.0	0.0
68360	-6.02e-04	-1.69e-03-9.86e-03	-3.07e-05	2.32e-06	0.0
68369	5.73e-06	5.35e-04-9.26e-03	-2.70e-05	0.0	0.0
68370	8.14e-06	6.14e-04-9.02e-03	-3.09e-05	0.0	0.0
68371	5.73e-06	5.35e-04-9.26e-03	-2.70e-05	0.0	0.0
68372	6.21e-06	5.51e-04-9.21e-03	-2.78e-05	0.0	0.0
68373	5.73e-06	5.35e-04-9.26e-03	-2.70e-05	0.0	0.0
6842	3.16e-05	1.40e-03 -0.01	-7.01e-05	2.36e-06	0.0
68417	1.71e-03	1.25e-03 -0.01	-4.38e-05	-1.77e-06	0.0
68427	-5.75e-04	2.58e-03 -0.01	-4.73e-05	1.74e-06	0.0
68428	-3.76e-04	-8.22e-04 -0.01	-4.12e-05	3.12e-06	0.0
68449	2.38e-03	1.40e-03 -0.01	-4.37e-05	-3.08e-06	0.0
68459	-8.13e-04	3.27e-03 -0.01	-4.87e-05	1.84e-06	0.0
68460	-5.34e-04	-1.50e-03 -0.01	-4.00e-05	3.78e-06	0.0
68470	2.46e-05	1.01e-03 -0.01	-5.04e-05	1.77e-06	0.0
68472	2.06e-05	9.00e-04 -0.01	-4.53e-05	1.55e-06	0.0
68473	1.96e-05	8.74e-04 -0.01	-4.40e-05	1.49e-06	0.0
6852	6.89e-05	1.95e-03 -0.02	-9.76e-05	4.25e-06	0.0
68516	-1.55e-03	6.85e-04 -0.01	-5.92e-05	7.92e-06	0.0
68517	1.72e-03	1.62e-03 -0.01	-6.23e-05	-2.59e-06	0.0
68527	-5.73e-04	3.08e-03 -0.01	-7.22e-05	3.79e-06	0.0
68548	-2.18e-03	4.73e-04 -0.01	-5.84e-05	1.00e-05	0.0
68549	2.39e-03	1.79e-03 -0.01	-6.27e-05	-4.70e-06	0.0
68559	-8.20e-04	3.83e-03 -0.01	-7.66e-05	4.24e-06	0.0
68570	5.25e-05	1.40e-03 -0.01	-7.03e-05	3.18e-06	0.0
68572	4.47e-05	1.25e-03 -0.01	-6.30e-05	2.77e-06	0.0
68573	4.28e-05	1.22e-03 -0.01	-6.11e-05	2.67e-06	0.0
6862	1.24e-04	2.44e-03 -0.02	-1.22e-04	7.10e-06	0.0
68617	1.73e-03	1.96e-03 -0.02	-7.92e-05	-3.67e-06	0.0
68627	-5.41e-04	3.55e-03 -0.02	-9.60e-05	7.48e-06	0.0
68649	2.39e-03	2.14e-03 -0.02	-8.03e-05	-6.92e-06	0.0



EGP CODE

GRE.EEC.R.73.IT.W.15235.12.024.01

PAGE

180 di/of 527

68659	-7.89e-04	4.37e-03	-0.02	-1.04e-04	8.71e-06	0.0
68670	9.39e-05	1.76e-03	-0.02	-8.80e-05	5.32e-06	0.0
68672	8.03e-05	1.57e-03	-0.02	-7.87e-05	4.61e-06	0.0
68673	7.69e-05	1.52e-03	-0.02	-7.63e-05	4.43e-06	0.0
6872	1.95e-04	2.75e-03	-0.03	-1.38e-04	1.08e-05	0.0
68717	1.74e-03	2.19e-03	-0.02	-9.04e-05	-2.67e-06	0.0
68727	-4.79e-04	3.89e-03	-0.02	-1.13e-04	1.27e-05	0.0
68749	2.38e-03	2.38e-03	-0.02	-9.22e-05	-6.43e-06	0.0
68759	-7.19e-04	4.77e-03	-0.02	-1.24e-04	1.51e-05	0.0
68770	1.47e-04	1.99e-03	-0.02	-9.94e-05	8.10e-06	0.0
68772	1.25e-04	1.77e-03	-0.02	-8.86e-05	6.98e-06	0.0
68773	1.20e-04	1.71e-03	-0.02	-8.59e-05	6.70e-06	0.0
6882	2.39e-04	2.81e-03	-0.04	-1.40e-04	1.32e-05	0.0
68817	1.73e-03	2.23e-03	-0.02	-9.24e-05	-2.61e-06	0.0
68827	-4.30e-04	3.98e-03	-0.03	-1.17e-04	1.65e-05	0.0
68849	2.37e-03	2.42e-03	-0.02	-9.44e-05	-6.92e-06	0.0
68859	-6.60e-04	4.88e-03	-0.03	-1.29e-04	1.98e-05	0.0
68870	1.80e-04	2.03e-03	-0.03	-1.01e-04	9.89e-06	0.0
68872	1.53e-04	1.80e-03	-0.02	-9.01e-05	8.49e-06	0.0
68873	1.47e-04	1.74e-03	-0.02	-8.73e-05	8.14e-06	0.0
6892	7.80e-04	-2.99e-03	-0.04	1.48e-04	4.12e-05	0.0
68910	2.14e-03	-2.31e-03	-0.02	9.51e-05	1.76e-05	0.0
68924	5.20e-05	-4.23e-03	-0.03	1.27e-04	3.72e-05	0.0
68942	2.81e-03	-2.49e-03	-0.02	9.65e-05	1.46e-05	0.0
68956	-1.18e-04	-5.19e-03	-0.03	1.41e-04	4.21e-05	0.0
68970	5.85e-04	-2.16e-03	-0.03	1.07e-04	3.08e-05	0.0
68972	4.98e-04	-1.91e-03	-0.03	9.46e-05	2.63e-05	0.0
68973	4.76e-04	-1.85e-03	-0.02	9.16e-05	2.52e-05	0.0
6902	5.45e-04	-2.84e-03	-0.03	1.41e-04	2.89e-05	0.0
69010	2.02e-03	-2.19e-03	-0.02	8.95e-05	1.13e-05	0.0
69024	-2.71e-04	-4.01e-03	-0.02	1.16e-04	2.27e-05	0.0
69042	2.70e-03	-2.36e-03	-0.02	9.03e-05	8.75e-06	0.0
69056	-5.13e-04	-4.91e-03	-0.02	1.27e-04	2.47e-05	0.0
69070	4.08e-04	-2.05e-03	-0.02	1.01e-04	2.16e-05	0.0
69072	3.49e-04	-1.82e-03	-0.02	9.03e-05	1.85e-05	0.0
69073	3.35e-04	-1.76e-03	-0.02	8.75e-05	1.78e-05	0.0
6912	3.42e-04	-2.41e-03	-0.02	1.19e-04	1.81e-05	0.0
6918	-1.48e-03	-2.17e-03	-0.02	8.33e-05	1.60e-05	0.0
69110	1.91e-03	-1.88e-03	-0.02	7.44e-05	5.92e-06	0.0
69124	-4.35e-04	-3.54e-03	-0.02	9.29e-05	1.19e-05	0.0
69140	-2.16e-03	-2.44e-03	-0.02	8.69e-05	1.79e-05	0.0
69142	2.60e-03	-2.04e-03	-0.02	7.43e-05	3.78e-06	0.0
69156	-6.94e-04	-4.36e-03	-0.02	1.00e-04	1.22e-05	0.0
69170	2.57e-04	-1.74e-03	-0.02	8.60e-05	1.36e-05	0.0
69172	2.21e-04	-1.55e-03	-0.02	7.67e-05	1.17e-05	0.0
69173	2.11e-04	-1.50e-03	-0.02	7.44e-05	1.13e-05	0.0
6922	1.98e-04	-1.84e-03	-0.02	9.09e-05	1.06e-05	0.0
69210	1.84e-03	-1.50e-03	-0.01	5.56e-05	3.35e-06	0.0
69223	-2.41e-04	6.63e-04	-0.01	5.01e-05	9.36e-06	0.0
69224	-5.17e-04	-2.99e-03	-0.01	6.56e-05	5.62e-06	0.0
69242	2.52e-03	-1.64e-03	-0.01	5.51e-05	2.04e-06	0.0
69255	-3.86e-04	1.39e-03	-0.01	4.74e-05	1.05e-05	0.0
69256	-7.73e-04	-3.73e-03	-0.01	6.90e-05	5.22e-06	0.0
69270	1.49e-04	-1.33e-03	-0.01	6.56e-05	7.92e-06	0.0
69272	1.28e-04	-1.18e-03	-0.01	5.87e-05	6.87e-06	0.0
69273	1.23e-04	-1.15e-03	-0.01	5.69e-05	6.61e-06	0.0
6931	8.55e-05	-1.07e-03	-0.01	5.30e-05	4.92e-06	0.0
6932	1.08e-04	-1.25e-03	-0.01	6.16e-05	6.01e-06	0.0
69310	1.78e-03	-1.12e-03	-0.01	3.69e-05	1.89e-06	0.0
69323	-3.37e-04	8.83e-04	-0.01	3.87e-05	5.83e-06	0.0
69324	-5.37e-04	-2.47e-03-9.90e-03		3.99e-05	2.70e-06	0.0
69342	2.46e-03	-1.26e-03-9.98e-03		3.62e-05	1.13e-06	0.0
69355	-4.99e-04	1.55e-03	-0.01	3.87e-05	6.66e-06	0.0
69356	-7.79e-04	-3.15e-03-9.72e-03		4.04e-05	2.27e-06	0.0
69369	6.69e-05	-7.82e-04	-0.01	3.87e-05	3.77e-06	0.0
69370	8.17e-05	-9.02e-04	-0.01	4.44e-05	4.50e-06	0.0
69371	6.69e-05	-7.82e-04	-0.01	3.87e-05	3.77e-06	0.0
69372	6.99e-05	-8.06e-04	-0.01	3.98e-05	3.92e-06	0.0
69373	6.69e-05	-7.82e-04	-0.01	3.87e-05	3.77e-06	0.0
6941	4.56e-05	-5.93e-04	-0.01	2.92e-05	2.94e-06	0.0
6942	5.87e-05	-6.91e-04	-0.01	3.39e-05	3.58e-06	0.0
69410	1.73e-03	-7.65e-04-8.71e-03		1.92e-05	1.19e-06	0.0
69423	-4.11e-04	1.14e-03-9.29e-03		2.60e-05	3.42e-06	0.0
69424	-5.24e-04	-2.02e-03-8.52e-03		1.73e-05	1.62e-06	0.0
69442	2.41e-03	-8.99e-04-8.65e-03		1.84e-05	0.0	0.0
69455	-5.89e-04	1.77e-03-9.45e-03		2.79e-05	3.89e-06	0.0





EGP CODE

GRE.EEC.R.73.IT.W.15235.12.024.01

PAGE

181 di/of 527

69456	-7.48e-04	-2.66e-03-8.38e-03	1.56e-05	1.37e-06	0.0
69469	3.63e-05	-4.33e-04-8.88e-03	2.13e-05	2.25e-06	0.0
69470	4.50e-05	-4.99e-04-8.58e-03	2.44e-05	2.67e-06	0.0
69471	3.63e-05	-4.33e-04-8.88e-03	2.13e-05	2.25e-06	0.0
69472	3.80e-05	-4.46e-04-8.82e-03	2.19e-05	2.33e-06	0.0
69473	3.63e-05	-4.33e-04-8.88e-03	2.13e-05	2.25e-06	0.0
6951	2.98e-05	-1.42e-04 -0.01	6.69e-06	2.17e-06	0.0
6952	3.94e-05	-1.66e-04 -0.01	7.76e-06	2.64e-06	0.0
69510	1.70e-03	-4.37e-04-8.17e-03	3.04e-06	1.05e-06	0.0
69523	-4.64e-04	1.43e-03-8.35e-03	1.14e-05	2.06e-06	0.0
69524	-4.91e-04	-1.65e-03-8.15e-03	-1.31e-06	1.60e-06	0.0
69542	2.37e-03	-5.70e-04-8.14e-03	2.30e-06	0.0	0.0
69555	-6.59e-04	2.05e-03-8.39e-03	1.40e-05	2.22e-06	0.0
69556	-6.97e-04	-2.27e-03-8.12e-03	-3.80e-06	1.58e-06	0.0
69569	2.41e-05	-1.04e-04-8.23e-03	4.88e-06	1.66e-06	0.0
69570	3.05e-05	-1.20e-04-7.85e-03	5.59e-06	1.97e-06	0.0
69571	2.41e-05	-1.04e-04-8.23e-03	4.88e-06	1.66e-06	0.0
69572	2.54e-05	-1.07e-04-8.16e-03	5.02e-06	1.72e-06	0.0
69573	2.41e-05	-1.04e-04-8.23e-03	4.88e-06	1.66e-06	0.0
6961	3.42e-05	3.02e-04 -0.01	-1.54e-05	2.39e-06	0.0
6962	4.48e-05	3.51e-04 -0.01	-1.79e-05	2.91e-06	0.0
69617	1.71e-03	5.52e-04-8.29e-03	-9.32e-06	1.11e-06	0.0
69627	-5.02e-04	1.78e-03-8.18e-03	-5.57e-06	1.60e-06	0.0
69628	-4.45e-04	-1.33e-03-8.63e-03	-1.73e-05	2.44e-06	0.0
69649	2.38e-03	6.85e-04-8.25e-03	-8.56e-06	0.0	0.0
69659	-7.15e-04	2.40e-03-8.10e-03	-3.30e-06	1.51e-06	0.0
69660	-6.33e-04	-1.95e-03-8.73e-03	-1.98e-05	2.69e-06	0.0
69669	2.75e-05	2.20e-04-8.39e-03	-1.12e-05	1.83e-06	0.0
69670	3.46e-05	2.53e-04-8.03e-03	-1.29e-05	2.18e-06	0.0
69671	2.75e-05	2.20e-04-8.39e-03	-1.12e-05	1.83e-06	0.0
69672	2.89e-05	2.27e-04-8.32e-03	-1.16e-05	1.90e-06	0.0
69673	2.75e-05	2.20e-04-8.39e-03	-1.12e-05	1.83e-06	0.0
6971	5.99e-05	7.62e-04 -0.01	-3.84e-05	3.66e-06	0.0
6972	7.64e-05	8.88e-04 -0.01	-4.45e-05	4.48e-06	0.0
69717	1.75e-03	8.89e-04-9.15e-03	-2.60e-05	1.54e-06	0.0
69727	-5.27e-04	2.18e-03-8.93e-03	-2.55e-05	2.07e-06	0.0
69728	-3.84e-04	-1.05e-03-9.85e-03	-3.14e-05	4.21e-06	0.0
69749	2.43e-03	1.02e-03-9.07e-03	-2.52e-05	1.04e-06	0.0
69759	-7.57e-04	2.83e-03-8.75e-03	-2.45e-05	1.77e-06	0.0
69760	-5.56e-04	-1.69e-03 -0.01	-3.27e-05	4.77e-06	0.0
69769	4.72e-05	5.56e-04-9.35e-03	-2.80e-05	2.81e-06	0.0
69770	5.82e-05	6.41e-04-9.13e-03	-3.21e-05	3.35e-06	0.0
69771	4.72e-05	5.56e-04-9.35e-03	-2.80e-05	2.81e-06	0.0
69772	4.94e-05	5.73e-04-9.31e-03	-2.88e-05	2.91e-06	0.0
69773	4.72e-05	5.56e-04-9.35e-03	-2.80e-05	2.81e-06	0.0
6982	1.42e-04	1.46e-03 -0.01	-7.31e-05	7.74e-06	0.0
69817	1.80e-03	1.25e-03 -0.01	-4.41e-05	2.61e-06	0.0
69827	-5.27e-04	2.66e-03 -0.01	-4.94e-05	3.80e-06	0.0
69828	-3.02e-04	-8.00e-04 -0.01	-4.37e-05	7.06e-06	0.0
69849	2.48e-03	1.39e-03 -0.01	-4.35e-05	1.72e-06	0.0
69859	-7.74e-04	3.36e-03 -0.01	-5.08e-05	3.39e-06	0.0
69860	-4.57e-04	-1.49e-03 -0.01	-4.28e-05	7.96e-06	0.0
69870	1.07e-04	1.06e-03 -0.01	-5.27e-05	5.79e-06	0.0
69872	9.18e-05	9.43e-04 -0.01	-4.72e-05	5.03e-06	0.0
69873	8.80e-05	9.14e-04 -0.01	-4.58e-05	4.84e-06	0.0
6992	2.54e-04	2.05e-03 -0.02	-1.02e-04	1.34e-05	0.0
69916	-1.46e-03	7.76e-04 -0.01	-6.41e-05	1.23e-05	0.0
69917	1.87e-03	1.64e-03 -0.01	-6.31e-05	4.50e-06	0.0
69927	-4.85e-04	3.20e-03 -0.01	-7.64e-05	7.83e-06	0.0
69948	-2.11e-03	5.74e-04 -0.01	-6.41e-05	1.39e-05	0.0
69949	2.55e-03	1.78e-03 -0.01	-6.27e-05	2.97e-06	0.0
69959	-7.42e-04	3.97e-03 -0.01	-8.14e-05	7.63e-06	0.0
69970	1.91e-04	1.48e-03 -0.01	-7.39e-05	1.00e-05	0.0
69972	1.64e-04	1.32e-03 -0.01	-6.61e-05	8.68e-06	0.0
69973	1.57e-04	1.28e-03 -0.01	-6.41e-05	8.34e-06	0.0
7002	4.23e-04	2.59e-03 -0.02	-1.29e-04	2.22e-05	0.0
70017	1.96e-03	2.00e-03 -0.02	-8.11e-05	7.46e-06	0.0
70027	-3.71e-04	3.74e-03 -0.02	-1.03e-04	1.58e-05	0.0
70049	2.64e-03	2.16e-03 -0.02	-8.13e-05	4.96e-06	0.0
70059	-6.25e-04	4.60e-03 -0.02	-1.12e-04	1.67e-05	0.0
70070	3.17e-04	1.87e-03 -0.02	-9.33e-05	1.66e-05	0.0
70072	2.72e-04	1.66e-03 -0.02	-8.31e-05	1.43e-05	0.0
70073	2.61e-04	1.61e-03 -0.02	-8.06e-05	1.37e-05	0.0
7012	6.42e-04	2.94e-03 -0.03	-1.47e-04	3.39e-05	0.0
70117	2.07e-03	2.25e-03 -0.02	-9.34e-05	1.37e-05	0.0
70127	-1.78e-04	4.15e-03 -0.02	-1.23e-04	2.82e-05	0.0



EGP CODE

GRE.EEC.R.73.IT.W.15235.12.024.01

PAGE

182 di/of 527

70149	2.75e-03	2.43e-03	-0.02	-9.44e-05	1.09e-05	0.0
70159	-4.07e-04	5.08e-03	-0.03	-1.36e-04	3.12e-05	0.0
70170	4.82e-04	2.13e-03	-0.02	-1.06e-04	2.53e-05	0.0
70172	4.11e-04	1.88e-03	-0.02	-9.40e-05	2.17e-05	0.0
70173	3.94e-04	1.82e-03	-0.02	-9.11e-05	2.08e-05	0.0
7022	7.82e-04	3.00e-03	-0.04	-1.49e-04	4.14e-05	0.0
70217	2.14e-03	2.30e-03	-0.02	-9.57e-05	1.73e-05	0.0
70227	5.00e-05	4.26e-03	-0.03	-1.28e-04	3.76e-05	0.0
70249	2.81e-03	2.48e-03	-0.02	-9.70e-05	1.41e-05	0.0
70259	-1.21e-04	5.22e-03	-0.03	-1.43e-04	4.26e-05	0.0
70270	5.86e-04	2.17e-03	-0.03	-1.08e-04	3.09e-05	0.0
70272	4.99e-04	1.92e-03	-0.03	-9.57e-05	2.64e-05	0.0
70273	4.77e-04	1.86e-03	-0.02	-9.26e-05	2.53e-05	0.0
7032	1.10e-03	-3.38e-03	-0.04	1.65e-04	5.85e-05	0.0
70310	2.49e-03	-2.56e-03	-0.03	1.06e-04	3.46e-05	0.0
70324	2.09e-04	-4.69e-03	-0.03	1.46e-04	4.79e-05	0.0
70342	3.22e-03	-2.75e-03	-0.03	1.07e-04	3.41e-05	0.0
70356	2.33e-05	-5.74e-03	-0.03	1.64e-04	5.27e-05	0.0
70370	8.27e-04	-2.45e-03	-0.03	1.20e-04	4.38e-05	0.0
70372	7.05e-04	-2.15e-03	-0.03	1.06e-04	3.74e-05	0.0
70373	6.74e-04	-2.08e-03	-0.03	1.02e-04	3.58e-05	0.0
7042	7.39e-04	-3.20e-03	-0.03	1.57e-04	3.96e-05	0.0
70410	2.24e-03	-2.39e-03	-0.02	9.81e-05	2.22e-05	0.0
70424	-1.98e-04	-4.39e-03	-0.02	1.32e-04	2.71e-05	0.0
70442	2.95e-03	-2.55e-03	-0.02	9.85e-05	2.13e-05	0.0
70456	-4.60e-04	-5.36e-03	-0.02	1.45e-04	2.82e-05	0.0
70470	5.54e-04	-2.32e-03	-0.02	1.14e-04	2.96e-05	0.0
70472	4.75e-04	-2.05e-03	-0.02	1.01e-04	2.54e-05	0.0
70473	4.55e-04	-1.98e-03	-0.02	9.73e-05	2.44e-05	0.0
7052	4.53e-04	-2.66e-03	-0.02	1.31e-04	2.39e-05	0.0
7055	2.07e-03	-9.20e-04	-0.02	7.01e-05	1.47e-05	0.0
70512	-1.51e-03	-2.20e-03	-0.02	9.09e-05	1.51e-05	0.0
70524	-4.24e-04	-3.78e-03	-0.02	1.02e-04	1.25e-05	0.0
70537	2.79e-03	-6.26e-04	-0.02	6.55e-05	1.47e-05	0.0
70544	-2.23e-03	-2.42e-03	-0.02	9.47e-05	1.53e-05	0.0
70556	-7.06e-04	-4.64e-03	-0.02	1.11e-04	1.16e-05	0.0
70570	3.40e-04	-1.93e-03	-0.02	9.46e-05	1.78e-05	0.0
70572	2.92e-04	-1.71e-03	-0.02	8.40e-05	1.54e-05	0.0
70573	2.81e-04	-1.65e-03	-0.02	8.14e-05	1.48e-05	0.0
7062	2.58e-04	-2.00e-03	-0.02	9.80e-05	1.36e-05	0.0
7065	1.94e-03	-6.13e-04	-0.01	5.51e-05	9.17e-06	0.0
70623	-2.10e-04	5.87e-04	-0.01	5.52e-05	1.12e-05	0.0
70624	-5.08e-04	-3.12e-03	-0.01	6.99e-05	5.77e-06	0.0
70637	2.65e-03	-3.60e-04	-0.01	5.26e-05	9.45e-06	0.0
70655	-3.58e-04	1.32e-03	-0.01	5.27e-05	1.23e-05	0.0
70656	-7.76e-04	-3.87e-03	-0.01	7.33e-05	4.69e-06	0.0
70670	1.94e-04	-1.44e-03	-0.01	7.09e-05	1.01e-05	0.0
70672	1.67e-04	-1.28e-03	-0.01	6.32e-05	8.80e-06	0.0
70673	1.60e-04	-1.24e-03	-0.01	6.13e-05	8.47e-06	0.0
7071	1.13e-04	-1.14e-03	-0.01	5.62e-05	6.25e-06	0.0
7072	1.42e-04	-1.34e-03	-0.01	6.56e-05	7.65e-06	0.0
7079	1.83e-03	-4.23e-04	-0.01	3.89e-05	5.17e-06	0.0
70723	-3.25e-04	8.41e-04	-0.01	4.28e-05	6.63e-06	0.0
70724	-5.28e-04	-2.54e-03	-0.01	4.10e-05	2.89e-06	0.0
70741	2.53e-03	-2.56e-04	-0.01	3.80e-05	5.32e-06	0.0
70755	-4.90e-04	1.51e-03	-0.01	4.34e-05	7.37e-06	0.0
70756	-7.75e-04	-3.23e-03-9.83e-03		4.10e-05	2.12e-06	0.0
70769	8.80e-05	-8.37e-04	-0.01	4.12e-05	4.79e-06	0.0
70770	1.07e-04	-9.69e-04	-0.01	4.74e-05	5.72e-06	0.0
70771	8.80e-05	-8.37e-04	-0.01	4.12e-05	4.79e-06	0.0
70772	9.18e-05	-8.63e-04	-0.01	4.24e-05	4.97e-06	0.0
70773	8.80e-05	-8.37e-04	-0.01	4.12e-05	4.79e-06	0.0
7081	6.20e-05	-6.27e-04	-0.01	3.07e-05	3.73e-06	0.0
7082	7.94e-05	-7.34e-04	-0.01	3.57e-05	4.55e-06	0.0
7089	1.77e-03	-8.15e-05-8.99e-03		2.20e-05	3.11e-06	0.0
70823	-4.04e-04	1.13e-03-9.48e-03		2.80e-05	3.85e-06	0.0
70824	-5.17e-04	-2.07e-03-8.61e-03		1.78e-05	1.80e-06	0.0
70841	2.45e-03	6.99e-05-8.98e-03		2.18e-05	3.21e-06	0.0
70855	-5.85e-04	1.77e-03-9.66e-03		3.03e-05	4.24e-06	0.0
70856	-7.43e-04	-2.71e-03-8.45e-03		1.59e-05	1.38e-06	0.0
70869	4.89e-05	-4.60e-04-9.01e-03		2.25e-05	2.85e-06	0.0
70870	6.05e-05	-5.31e-04-8.74e-03		2.58e-05	3.40e-06	0.0
70871	4.89e-05	-4.60e-04-9.01e-03		2.25e-05	2.85e-06	0.0
70872	5.12e-05	-4.74e-04-8.96e-03		2.31e-05	2.96e-06	0.0
70873	4.89e-05	-4.60e-04-9.01e-03		2.25e-05	2.85e-06	0.0
7091	4.19e-05	-1.49e-04	-0.01	7.00e-06	2.76e-06	0.0



EGP CODE

GRE.EEC.R.73.IT.W.15235.12.024.01

PAGE

183 di/of 527

7092	5.49e-05	-1.74e-04	-0.01	8.13e-06	3.37e-06	0.0
70910	1.72e-03	-4.27e-04	-8.26e-03	3.09e-06	2.17e-06	0.0
70923	-4.58e-04	1.44e-03	-8.46e-03	1.24e-05	2.33e-06	0.0
70924	-4.85e-04	-1.67e-03	-8.24e-03	-1.74e-06	1.82e-06	0.0
70942	2.40e-03	-5.54e-04	-8.23e-03	2.29e-06	2.19e-06	0.0
70955	-6.55e-04	2.07e-03	-8.51e-03	1.53e-05	2.42e-06	0.0
70956	-6.93e-04	-2.30e-03	-8.20e-03	-4.48e-06	1.71e-06	0.0
70969	3.36e-05	-1.09e-04	-8.33e-03	5.11e-06	2.11e-06	0.0
70970	4.22e-05	-1.26e-04	-7.97e-03	5.87e-06	2.51e-06	0.0
70971	3.36e-05	-1.09e-04	-8.33e-03	5.11e-06	2.11e-06	0.0
70972	3.53e-05	-1.12e-04	-8.26e-03	5.27e-06	2.19e-06	0.0
70973	3.36e-05	-1.09e-04	-8.33e-03	5.11e-06	2.11e-06	0.0
7101	4.74e-05	3.20e-04	-0.01	-1.63e-05	3.04e-06	0.0
7102	6.16e-05	3.73e-04	-0.01	-1.89e-05	3.71e-06	0.0
71018	1.73e-03	-1.30e-04	-8.48e-03	-1.23e-05	2.49e-06	0.0
71027	-4.97e-04	1.81e-03	-8.27e-03	-5.57e-06	1.82e-06	0.0
71028	-4.39e-04	-1.33e-03	-8.77e-03	-1.87e-05	2.77e-06	0.0
71050	2.41e-03	-2.76e-04	-8.47e-03	-1.24e-05	2.55e-06	0.0
71059	-7.11e-04	2.44e-03	-8.18e-03	-3.04e-06	1.62e-06	0.0
71060	-6.29e-04	-1.95e-03	-8.87e-03	-2.15e-05	2.95e-06	0.0
71069	3.78e-05	2.34e-04	-8.50e-03	-1.19e-05	2.33e-06	0.0
71070	4.72e-05	2.70e-04	-8.16e-03	-1.36e-05	2.78e-06	0.0
71071	3.78e-05	2.34e-04	-8.50e-03	-1.19e-05	2.33e-06	0.0
71072	3.97e-05	2.41e-04	-8.43e-03	-1.22e-05	2.42e-06	0.0
71073	3.78e-05	2.34e-04	-8.50e-03	-1.19e-05	2.33e-06	0.0
7111	8.00e-05	8.10e-04	-0.01	-4.06e-05	4.66e-06	0.0
7112	1.02e-04	9.48e-04	-0.01	-4.73e-05	5.70e-06	0.0
71118	1.79e-03	2.03e-04	-9.49e-03	-2.86e-05	3.84e-06	0.0
71127	-5.19e-04	2.23e-03	-9.04e-03	-2.65e-05	2.30e-06	0.0
71128	-3.75e-04	-1.02e-03	-0.01	-3.39e-05	4.78e-06	0.0
71150	2.48e-03	4.65e-05	-9.48e-03	-2.82e-05	3.95e-06	0.0
71159	-7.52e-04	2.89e-03	-8.85e-03	-2.53e-05	1.79e-06	0.0
71160	-5.50e-04	-1.67e-03	-0.01	-3.56e-05	5.26e-06	0.0
71169	6.28e-05	5.94e-04	-9.52e-03	-2.97e-05	3.57e-06	0.0
71170	7.72e-05	6.85e-04	-9.33e-03	-3.41e-05	4.26e-06	0.0
71171	6.28e-05	5.94e-04	-9.52e-03	-2.97e-05	3.57e-06	0.0
71172	6.57e-05	6.12e-04	-9.48e-03	-3.06e-05	3.71e-06	0.0
71173	6.28e-05	5.94e-04	-9.52e-03	-2.97e-05	3.57e-06	0.0
7122	1.86e-04	1.58e-03	-0.02	-7.82e-05	9.92e-06	0.0
71218	1.87e-03	5.48e-04	-0.01	-4.55e-05	6.57e-06	0.0
71227	-5.16e-04	2.75e-03	-0.01	-5.21e-05	4.14e-06	0.0
71228	-2.83e-04	-7.44e-04	-0.01	-4.77e-05	8.20e-06	0.0
71250	2.57e-03	3.74e-04	-0.01	-4.41e-05	6.73e-06	0.0
71259	-7.69e-04	3.46e-03	-0.01	-5.34e-05	3.32e-06	0.0
71260	-4.43e-04	-1.44e-03	-0.01	-4.71e-05	9.00e-06	0.0
71270	1.41e-04	1.14e-03	-0.01	-5.65e-05	7.42e-06	0.0
71272	1.20e-04	1.02e-03	-0.01	-5.05e-05	6.44e-06	0.0
71273	1.15e-04	9.84e-04	-0.01	-4.90e-05	6.19e-06	0.0
7132	3.35e-04	2.25e-03	-0.02	-1.11e-04	1.75e-05	0.0
71314	1.99e-03	7.27e-04	-0.01	-6.14e-05	1.14e-05	0.0
71316	-1.48e-03	9.07e-04	-0.01	-7.06e-05	1.19e-05	0.0
71327	-4.70e-04	3.36e-03	-0.01	-8.23e-05	8.35e-06	0.0
71346	2.70e-03	4.57e-04	-0.01	-5.82e-05	1.16e-05	0.0
71348	-2.15e-03	7.09e-04	-0.02	-7.11e-05	1.23e-05	0.0
71359	-7.42e-04	4.15e-03	-0.01	-8.74e-05	7.34e-06	0.0
71370	2.52e-04	1.63e-03	-0.01	-8.04e-05	1.31e-05	0.0
71372	2.17e-04	1.44e-03	-0.01	-7.16e-05	1.13e-05	0.0
71373	2.08e-04	1.40e-03	-0.01	-6.94e-05	1.09e-05	0.0
7142	5.74e-04	2.88e-03	-0.03	-1.42e-04	2.99e-05	0.0
71415	-1.43e-03	2.57e-03	-0.02	-1.02e-04	1.94e-05	0.0
71417	2.14e-03	2.14e-03	-0.02	-8.74e-05	1.67e-05	0.0
71427	-3.34e-04	4.04e-03	-0.02	-1.15e-04	1.76e-05	0.0
71447	-2.14e-03	2.89e-03	-0.02	-1.08e-04	1.98e-05	0.0
71449	2.86e-03	2.27e-03	-0.02	-8.69e-05	1.60e-05	0.0
71459	-6.09e-04	4.95e-03	-0.02	-1.26e-04	1.72e-05	0.0
71470	4.31e-04	2.09e-03	-0.02	-1.03e-04	2.24e-05	0.0
71472	3.70e-04	1.85e-03	-0.02	-9.15e-05	1.93e-05	0.0
71473	3.55e-04	1.79e-03	-0.02	-8.86e-05	1.85e-05	0.0
7152	8.94e-04	3.33e-03	-0.03	-1.64e-04	4.74e-05	0.0
71517	2.34e-03	2.47e-03	-0.02	-1.03e-04	2.67e-05	0.0
71527	-5.04e-05	4.57e-03	-0.03	-1.41e-04	3.53e-05	0.0
71549	3.05e-03	2.64e-03	-0.02	-1.03e-04	2.58e-05	0.0
71559	-2.90e-04	5.58e-03	-0.03	-1.56e-04	3.77e-05	0.0
71570	6.69e-04	2.42e-03	-0.03	-1.19e-04	3.55e-05	0.0
71572	5.73e-04	2.13e-03	-0.02	-1.05e-04	3.04e-05	0.0
71573	5.48e-04	2.06e-03	-0.02	-1.01e-04	2.91e-05	0.0



EGP CODE

GRE.EEC.R.73.IT.W.15235.12.024.01

PAGE

184 di/of 527

7162	1.10e-03	3.40e-03	-0.04	-1.67e-04	5.88e-05	0.0
71617	2.50e-03	2.55e-03	-0.03	-1.06e-04	3.47e-05	0.0
71627	2.04e-04	4.73e-03	-0.03	-1.48e-04	4.82e-05	0.0
71649	3.23e-03	2.73e-03	-0.03	-1.08e-04	3.41e-05	0.0
71659	1.59e-05	5.78e-03	-0.03	-1.66e-04	5.31e-05	0.0
71670	8.27e-04	2.47e-03	-0.03	-1.21e-04	4.40e-05	0.0
71672	7.05e-04	2.17e-03	-0.03	-1.07e-04	3.75e-05	0.0
71673	6.74e-04	2.09e-03	-0.03	-1.03e-04	3.59e-05	0.0
7172	1.02e-03	-4.15e-03	-0.04	1.99e-04	5.42e-05	0.0
71710	2.57e-03	-3.10e-03	-0.03	1.30e-04	3.93e-05	0.0
71724	1.15e-04	-5.54e-03	-0.03	1.80e-04	4.21e-05	0.0
71728	1.62e-04	-5.54e-03	-0.03	1.80e-04	4.26e-05	0.0
71742	3.35e-03	-3.33e-03	-0.03	1.33e-04	4.17e-05	0.0
71756	-8.86e-05	-6.74e-03	-0.03	2.03e-04	4.56e-05	0.0
71760	-2.30e-05	-6.75e-03	-0.03	2.04e-04	4.63e-05	0.0
71770	7.64e-04	-3.03e-03	-0.03	1.45e-04	4.06e-05	0.0
71772	6.52e-04	-2.63e-03	-0.03	1.26e-04	3.46e-05	0.0
71773	6.24e-04	-2.53e-03	-0.03	1.22e-04	3.32e-05	0.0
7182	4.00e-04	-3.93e-03	-0.03	1.87e-04	2.72e-05	0.0
7185	2.27e-03	-1.46e-03	-0.02	9.54e-05	2.58e-05	0.0
71824	-6.12e-04	-5.09e-03	-0.02	1.60e-04	1.12e-05	0.0
71837	3.08e-03	-1.08e-03	-0.02	8.75e-05	2.93e-05	0.0
71856	-9.59e-04	-6.17e-03	-0.02	1.78e-04	8.79e-06	0.0
71870	3.01e-04	-2.86e-03	-0.02	1.36e-04	2.04e-05	0.0
71872	2.65e-04	-2.50e-03	-0.02	1.19e-04	1.77e-05	0.0
71873	2.56e-04	-2.41e-03	-0.02	1.15e-04	1.71e-05	0.0
7192	3.50e-04	-2.96e-03	-0.02	1.44e-04	1.91e-05	0.0
7199	2.14e-03	-1.30e-03	-0.02	8.06e-05	1.73e-05	0.0
71911	-1.59e-03	-1.50e-03	-0.02	9.09e-05	7.49e-06	0.0
71924	-5.21e-04	-3.99e-03	-0.02	1.10e-04	7.66e-06	0.0
71941	2.91e-03	-1.09e-03	-0.02	7.70e-05	1.95e-05	0.0
71943	-2.31e-03	-1.37e-03	-0.02	9.14e-05	5.72e-06	0.0
71956	-8.17e-04	-4.86e-03	-0.02	1.18e-04	5.96e-06	0.0
71970	2.63e-04	-2.15e-03	-0.02	1.04e-04	1.43e-05	0.0
71972	2.27e-04	-1.90e-03	-0.02	9.25e-05	1.24e-05	0.0
71973	2.18e-04	-1.83e-03	-0.02	8.96e-05	1.19e-05	0.0
7202	2.01e-04	-2.16e-03	-0.02	1.05e-04	1.07e-05	0.0
7209	1.97e-03	-8.93e-04	-0.01	6.11e-05	1.01e-05	0.0
72023	-2.82e-04	5.01e-04	-0.01	6.04e-05	7.97e-06	0.0
72024	-5.47e-04	-3.23e-03	-0.01	7.34e-05	3.60e-06	0.0
72041	2.70e-03	-7.12e-04	-0.01	5.92e-05	1.15e-05	0.0
72055	-4.45e-04	1.24e-03	-0.01	5.82e-05	8.48e-06	0.0
72056	-8.16e-04	-3.99e-03	-0.01	7.64e-05	2.36e-06	0.0
72070	1.52e-04	-1.57e-03	-0.01	7.64e-05	8.03e-06	0.0
72072	1.30e-04	-1.39e-03	-0.01	6.80e-05	6.97e-06	0.0
72073	1.25e-04	-1.35e-03	-0.01	6.59e-05	6.71e-06	0.0
7212	1.07e-04	-1.43e-03	-0.01	6.96e-05	5.96e-06	0.0
72110	1.85e-03	-1.20e-03	-0.01	4.13e-05	5.29e-06	0.0
72123	-3.71e-04	8.00e-04	-0.01	4.58e-05	4.57e-06	0.0
72124	-5.47e-04	-2.61e-03	-0.01	4.27e-05	1.81e-06	0.0
72142	2.56e-03	-1.32e-03	-0.01	4.03e-05	5.92e-06	0.0
72155	-5.46e-04	1.48e-03	-0.01	4.67e-05	4.91e-06	0.0
72156	-7.92e-04	-3.30e-03-9.91e-03	-0.01	4.24e-05	1.05e-06	0.0
72170	8.14e-05	-1.04e-03	-0.01	5.04e-05	4.45e-06	0.0
72172	6.90e-05	-9.21e-04	-0.01	4.50e-05	3.87e-06	0.0
72173	6.59e-05	-8.92e-04	-0.01	4.37e-05	3.72e-06	0.0
7221	4.31e-05	-6.61e-04	-0.01	3.23e-05	2.85e-06	0.0
7222	5.70e-05	-7.76e-04	-0.01	3.76e-05	3.49e-06	0.0
72210	1.77e-03	-7.88e-04-8.98e-03	-0.01	2.14e-05	3.12e-06	0.0
72223	-4.32e-04	1.12e-03-9.65e-03	-0.01	2.99e-05	2.59e-06	0.0
72224	-5.29e-04	-2.11e-03-8.69e-03	-0.01	1.82e-05	1.14e-06	0.0
72242	2.47e-03	-9.09e-04-8.91e-03	-0.01	2.05e-05	3.50e-06	0.0
72255	-6.19e-04	1.76e-03-9.85e-03	-0.01	3.23e-05	2.76e-06	0.0
72256	-7.55e-04	-2.76e-03-8.50e-03	-0.01	1.60e-05	0.0	0.0
72269	3.46e-05	-4.86e-04-9.14e-03	-0.01	2.37e-05	2.18e-06	0.0
72270	4.39e-05	-5.62e-04-8.90e-03	-0.01	2.72e-05	2.61e-06	0.0
72271	3.46e-05	-4.86e-04-9.14e-03	-0.01	2.37e-05	2.18e-06	0.0
72272	3.65e-05	-5.01e-04-9.09e-03	-0.01	2.44e-05	2.26e-06	0.0
72273	3.46e-05	-4.86e-04-9.14e-03	-0.01	2.37e-05	2.18e-06	0.0
7231	2.70e-05	-1.56e-04	-0.01	7.30e-06	2.07e-06	0.0
7232	3.73e-05	-1.83e-04	-0.01	8.50e-06	2.55e-06	0.0
72310	1.72e-03	-4.18e-04-8.38e-03	-0.01	3.34e-06	2.27e-06	0.0
72323	-4.76e-04	1.45e-03-8.56e-03	-0.01	1.32e-05	1.54e-06	0.0
72324	-4.98e-04	-1.70e-03-8.32e-03	-0.01	-2.15e-06	1.20e-06	0.0
72342	2.41e-03	-5.40e-04-8.35e-03	-0.01	2.54e-06	2.55e-06	0.0
72355	-6.75e-04	2.08e-03-8.61e-03	-0.01	1.63e-05	1.53e-06	0.0



EGP CODE

GRE.EEC.R.73.IT.W.15235.12.024.01

PAGE

185 di/of 527

72356	-7.06e-04	-2.33e-03-8.27e-03	-5.16e-06	1.04e-06	0.0
72369	2.23e-05	-1.14e-04-8.43e-03	5.35e-06	1.58e-06	0.0
72370	2.91e-05	-1.32e-04-8.08e-03	6.15e-06	1.90e-06	0.0
72371	2.23e-05	-1.14e-04-8.43e-03	5.35e-06	1.58e-06	0.0
72372	2.37e-05	-1.18e-04-8.36e-03	5.51e-06	1.65e-06	0.0
72373	2.23e-05	-1.14e-04-8.43e-03	5.35e-06	1.58e-06	0.0
7241	3.11e-05	3.38e-04 -0.01	-1.71e-05	2.29e-06	0.0
7242	4.23e-05	3.96e-04 -0.01	-1.99e-05	2.81e-06	0.0
72417	1.73e-03	5.51e-04-8.51e-03	-1.04e-05	2.47e-06	0.0
72427	-5.10e-04	1.84e-03-8.35e-03	-5.55e-06	1.17e-06	0.0
72428	-4.59e-04	-1.33e-03-8.89e-03	-2.00e-05	1.87e-06	0.0
72449	2.42e-03	6.72e-04-8.48e-03	-9.59e-06	2.75e-06	0.0
72459	-7.24e-04	2.48e-03-8.25e-03	-2.76e-06	0.0	0.0
72460	-6.52e-04	-1.96e-03-9.00e-03	-2.29e-05	1.92e-06	0.0
72469	2.54e-05	2.48e-04-8.61e-03	-1.25e-05	1.75e-06	0.0
72470	3.29e-05	2.86e-04-8.28e-03	-1.44e-05	2.10e-06	0.0
72471	2.54e-05	2.48e-04-8.61e-03	-1.25e-05	1.75e-06	0.0
72472	2.69e-05	2.56e-04-8.54e-03	-1.29e-05	1.82e-06	0.0
72473	2.54e-05	2.48e-04-8.61e-03	-1.25e-05	1.75e-06	0.0
7251	5.68e-05	8.59e-04 -0.01	-4.28e-05	3.57e-06	0.0
7252	7.39e-05	1.01e-03 -0.01	-5.00e-05	4.38e-06	0.0
72517	1.79e-03	9.35e-04-9.48e-03	-2.92e-05	3.80e-06	0.0
72527	-5.35e-04	2.28e-03-9.14e-03	-2.75e-05	1.47e-06	0.0
72528	-4.09e-04	-1.00e-03 -0.01	-3.62e-05	3.28e-06	0.0
72549	2.49e-03	1.06e-03-9.40e-03	-2.83e-05	4.22e-06	0.0
72559	-7.67e-04	2.95e-03-8.92e-03	-2.59e-05	0.0	0.0
72560	-5.90e-04	-1.65e-03 -0.01	-3.81e-05	3.50e-06	0.0
72569	4.52e-05	6.31e-04-9.69e-03	-3.14e-05	2.73e-06	0.0
72570	5.65e-05	7.30e-04-9.53e-03	-3.62e-05	3.27e-06	0.0
72571	4.52e-05	6.31e-04-9.69e-03	-3.14e-05	2.73e-06	0.0
72572	4.74e-05	6.51e-04-9.66e-03	-3.24e-05	2.84e-06	0.0
72573	4.52e-05	6.31e-04-9.69e-03	-3.14e-05	2.73e-06	0.0
7262	1.42e-04	1.69e-03 -0.02	-8.36e-05	7.78e-06	0.0
72617	1.88e-03	1.37e-03 -0.01	-5.04e-05	6.70e-06	0.0
72627	-5.43e-04	2.83e-03 -0.01	-5.47e-05	2.69e-06	0.0
72628	-3.37e-04	-6.89e-04 -0.01	-5.15e-05	5.78e-06	0.0
72649	2.60e-03	1.49e-03 -0.01	-4.96e-05	7.44e-06	0.0
72659	-7.96e-04	3.55e-03 -0.01	-5.56e-05	1.82e-06	0.0
72660	-5.08e-04	-1.39e-03 -0.01	-5.11e-05	6.15e-06	0.0
72670	1.07e-04	1.23e-03 -0.01	-6.05e-05	5.82e-06	0.0
72672	9.15e-05	1.09e-03 -0.01	-5.40e-05	5.04e-06	0.0
72673	8.75e-05	1.06e-03 -0.01	-5.23e-05	4.85e-06	0.0
7272	2.66e-04	2.45e-03 -0.02	-1.21e-04	1.41e-05	0.0
72718	2.03e-03	1.04e-03 -0.01	-6.91e-05	1.27e-05	0.0
72727	-5.25e-04	3.51e-03 -0.01	-8.74e-05	5.44e-06	0.0
72728	-2.32e-04	-4.07e-04 -0.02	-6.56e-05	1.00e-05	0.0
72750	2.77e-03	8.46e-04 -0.01	-6.65e-05	1.43e-05	0.0
72759	-8.02e-04	4.30e-03 -0.01	-9.22e-05	4.10e-06	0.0
72760	-3.91e-04	-1.18e-03 -0.02	-6.17e-05	1.05e-05	0.0
72770	2.00e-04	1.78e-03 -0.02	-8.75e-05	1.06e-05	0.0
72772	1.72e-04	1.58e-03 -0.02	-7.77e-05	9.15e-06	0.0
72773	1.65e-04	1.52e-03 -0.01	-7.53e-05	8.79e-06	0.0
7282	4.70e-04	3.24e-03 -0.03	-1.59e-04	2.53e-05	0.0
72815	-1.65e-03	2.80e-03 -0.02	-1.12e-04	9.13e-06	0.0
72818	2.24e-03	1.43e-03 -0.02	-8.75e-05	2.20e-05	0.0
72827	-4.59e-04	4.31e-03 -0.02	-1.26e-04	1.18e-05	0.0
72847	-2.43e-03	3.12e-03 -0.02	-1.17e-04	6.51e-06	0.0
72850	3.02e-03	1.20e-03 -0.02	-8.32e-05	2.45e-05	0.0
72859	-7.60e-04	5.23e-03 -0.02	-1.37e-04	1.02e-05	0.0
72870	3.53e-04	2.36e-03 -0.02	-1.15e-04	1.89e-05	0.0
72872	3.04e-04	2.08e-03 -0.02	-1.02e-04	1.63e-05	0.0
72873	2.91e-04	2.01e-03 -0.02	-9.85e-05	1.57e-05	0.0
7292	6.39e-04	4.17e-03 -0.04	-1.98e-04	3.82e-05	0.0
72918	2.40e-03	1.80e-03 -0.02	-1.04e-04	3.05e-05	0.0
72927	-3.98e-04	5.46e-03 -0.03	-1.76e-04	2.22e-05	0.0
72950	3.20e-03	1.50e-03 -0.02	-9.67e-05	3.32e-05	0.0
72959	-7.17e-04	6.63e-03 -0.03	-1.98e-04	2.15e-05	0.0
72970	4.79e-04	3.04e-03 -0.03	-1.44e-04	2.86e-05	0.0
72972	4.16e-04	2.65e-03 -0.03	-1.26e-04	2.47e-05	0.0
72973	4.00e-04	2.55e-03 -0.02	-1.22e-04	2.37e-05	0.0
7302	1.02e-03	4.17e-03 -0.04	-2.00e-04	5.46e-05	0.0
73017	2.59e-03	3.08e-03 -0.03	-1.29e-04	3.94e-05	0.0
73023	1.49e-04	5.58e-03 -0.03	-1.82e-04	4.23e-05	0.0
73027	1.02e-04	5.58e-03 -0.03	-1.82e-04	4.18e-05	0.0
73049	3.38e-03	3.30e-03 -0.03	-1.32e-04	4.18e-05	0.0
73055	-3.99e-05	6.80e-03 -0.03	-2.05e-04	4.59e-05	0.0





EGP CODE

GRE.EEC.R.73.IT.W.15235.12.024.01

PAGE

186 di/of 527

73059	-1.06e-04	6.80e-03	-0.03	-2.05e-04	4.52e-05	0.0
73070	7.62e-04	3.05e-03	-0.03	-1.46e-04	4.08e-05	0.0
73072	6.51e-04	2.64e-03	-0.03	-1.27e-04	3.49e-05	0.0
73073	6.23e-04	2.54e-03	-0.03	-1.23e-04	3.34e-05	0.0
7312	1.20e-03	3.12e-03	-0.04	-1.51e-04	6.26e-05	0.0
73113	3.59e-03	3.34e-03	-0.03	-1.36e-04	8.62e-05	0.0
73117	3.70e-03	2.96e-03	-0.03	-1.31e-04	8.67e-05	0.0
73121	1.36e-03	5.06e-03	-0.03	-1.37e-04	4.73e-05	0.0
73145	4.72e-03	3.88e-03	-0.04	-1.52e-04	1.04e-04	0.0
73149	4.87e-03	3.34e-03	-0.04	-1.46e-04	1.05e-04	0.0
73153	1.58e-03	6.30e-03	-0.03	-1.53e-04	4.97e-05	0.0
73170	8.75e-04	2.32e-03	-0.03	-1.12e-04	4.55e-05	0.0
73172	8.07e-04	2.04e-03	-0.03	-9.88e-05	4.21e-05	0.0
73173	7.89e-04	1.97e-03	-0.03	-9.55e-05	4.12e-05	0.0
7322	6.16e-05	-3.92e-03	-0.03	1.94e-04	2.49e-06	0.0
73210	2.36e-03	-2.87e-03	-0.02	1.26e-04	2.04e-05	0.0
73224	-7.45e-04	-4.88e-03	-0.02	1.58e-04	-3.53e-06	0.0
73242	3.29e-03	-3.05e-03	-0.02	1.29e-04	2.79e-05	0.0
73256	-1.06e-03	-5.87e-03	-0.03	1.73e-04	-5.56e-06	0.0
73270	4.75e-05	-2.86e-03	-0.03	1.41e-04	1.87e-06	0.0
73272	3.82e-05	-2.51e-03	-0.02	1.24e-04	1.60e-06	0.0
73273	3.59e-05	-2.42e-03	-0.02	1.20e-04	1.54e-06	0.0
7332	2.37e-05	-3.12e-03	-0.03	1.52e-04	1.49e-06	0.0
7334	2.49e-05	-2.34e-03	-0.02	1.14e-04	1.22e-06	0.0
73310	2.01e-03	-2.33e-03	-0.02	9.78e-05	9.18e-06	0.0
73324	-6.65e-04	-4.09e-03	-0.02	1.14e-04	-1.35e-06	0.0
73331	-7.84e-04	-5.37e-04	-0.02	8.21e-05	-1.82e-06	0.0
73342	2.81e-03	-2.49e-03	-0.02	9.90e-05	1.25e-05	0.0
73356	-9.36e-04	-4.96e-03	-0.02	1.22e-04	-2.25e-06	0.0
73363	-1.10e-03	2.30e-05	-0.02	7.71e-05	-2.92e-06	0.0
73370	1.92e-05	-2.27e-03	-0.02	1.11e-04	1.12e-06	0.0
73372	1.43e-05	-2.00e-03	-0.02	9.78e-05	0.0	0.0
73373	1.30e-05	-1.93e-03	-0.02	9.47e-05	0.0	0.0
7342	7.08e-06	-2.25e-03	-0.02	1.10e-04	0.0	0.0
7344	1.12e-05	-1.68e-03	-0.01	8.14e-05	0.0	0.0
73410	1.89e-03	-1.74e-03	-0.01	6.94e-05	5.46e-06	0.0
73423	-4.69e-04	4.73e-04	-0.01	6.29e-05	0.0	0.0
73424	-6.27e-04	-3.30e-03	-0.01	7.50e-05	0.0	0.0
73442	2.65e-03	-1.88e-03	-0.01	6.96e-05	7.41e-06	0.0
73455	-6.58e-04	1.23e-03	-0.01	6.06e-05	-1.56e-06	0.0
73456	-8.79e-04	-4.06e-03	-0.01	7.75e-05	-1.27e-06	0.0
73470	6.75e-06	-1.64e-03	-0.01	7.98e-05	0.0	0.0
73472	3.61e-06	-1.45e-03	-0.01	7.09e-05	0.0	0.0
73473	2.83e-06	-1.40e-03	-0.01	6.87e-05	0.0	0.0
7351	-7.35e-06	-1.25e-03	-0.01	6.15e-05	0.0	0.0
7352	-3.67e-06	-1.48e-03	-0.01	7.20e-05	0.0	0.0
73511	-1.81e-03	-6.13e-04	-0.01	4.61e-05	-2.36e-06	0.0
73523	-4.79e-04	7.93e-04	-0.01	4.73e-05	0.0	0.0
73524	-5.90e-04	-2.66e-03	-0.01	4.34e-05	0.0	0.0
73543	-2.53e-03	-4.88e-04	-0.01	4.65e-05	-3.44e-06	0.0
73555	-6.69e-04	1.48e-03	-0.01	4.82e-05	0.0	0.0
73556	-8.25e-04	-3.35e-03-9.93e-03		4.27e-05	0.0	0.0
73569	-3.81e-06	-9.24e-04	-0.01	4.52e-05	0.0	0.0
73570	-1.36e-06	-1.07e-03	-0.01	5.22e-05	0.0	0.0
73571	-3.81e-06	-9.24e-04	-0.01	4.52e-05	0.0	0.0
73572	-3.32e-06	-9.54e-04	-0.01	4.66e-05	0.0	0.0
73573	-3.81e-06	-9.24e-04	-0.01	4.52e-05	0.0	0.0
7361	-1.25e-05	-6.81e-04	-0.01	3.32e-05	0.0	0.0
7362	-1.01e-05	-7.99e-04	-0.01	3.88e-05	0.0	0.0
73611	-1.76e-03	-2.05e-04-9.29e-03		2.59e-05	-1.40e-06	0.0
73624	-5.58e-04	-2.14e-03-8.71e-03		1.83e-05	0.0	0.0
73625	5.30e-04	1.13e-03-9.73e-03		3.05e-05	0.0	0.0
73643	-2.46e-03	-8.71e-05-9.32e-03		2.65e-05	-2.02e-06	0.0
73656	-7.79e-04	-2.80e-03-8.51e-03		1.59e-05	0.0	0.0
73657	7.45e-04	1.78e-03-9.93e-03		3.30e-05	0.0	0.0
73669	-7.81e-06	-5.01e-04-9.22e-03		2.44e-05	0.0	0.0
73670	-6.23e-06	-5.80e-04-8.99e-03		2.81e-05	0.0	0.0
73671	-7.81e-06	-5.01e-04-9.22e-03		2.44e-05	0.0	0.0
73672	-7.49e-06	-5.16e-04-9.17e-03		2.51e-05	0.0	0.0
73673	-7.81e-06	-5.01e-04-9.22e-03		2.44e-05	0.0	0.0
7371	-1.50e-05	-1.59e-04	-0.01	7.50e-06	0.0	0.0
7372	-1.32e-05	-1.87e-04	-0.01	8.74e-06	0.0	0.0
73711	-1.72e-03	1.73e-04-8.48e-03		7.25e-06	0.0	0.0
73724	-5.28e-04	-1.72e-03-8.35e-03		-2.42e-06	0.0	0.0
73725	5.04e-04	1.47e-03-8.62e-03		1.34e-05	0.0	0.0
73743	-2.40e-03	2.89e-04-8.48e-03		7.95e-06	-1.33e-06	0.0



EGP CODE

GRE.EEC.R.73.IT.W.15235.12.024.01

PAGE

187 di/of 527

73756	-7.35e-04	-2.36e-03-8.29e-03	-5.59e-06	0.0	0.0
73757	7.10e-04	2.11e-03-8.67e-03	1.66e-05	0.0	0.0
73769	-9.73e-06	-1.17e-04-8.48e-03	5.50e-06	0.0	0.0
73770	-8.57e-06	-1.36e-04-8.14e-03	6.32e-06	0.0	0.0
73771	-9.73e-06	-1.17e-04-8.48e-03	5.50e-06	0.0	0.0
73772	-9.50e-06	-1.21e-04-8.41e-03	5.66e-06	0.0	0.0
73773	-9.73e-06	-1.17e-04-8.48e-03	5.50e-06	0.0	0.0
7381	-1.51e-05	3.49e-04 -0.01	-1.76e-05	0.0	0.0
7382	-1.34e-05	4.09e-04 -0.01	-2.05e-05	0.0	0.0
73820	-1.73e-03	-3.52e-05-8.69e-03	-1.46e-05	-1.03e-06	0.0
73822	5.16e-04	-1.34e-03-8.95e-03	-2.04e-05	0.0	0.0
73827	-5.40e-04	1.87e-03-8.38e-03	-5.48e-06	0.0	0.0
73852	-2.41e-03	-1.52e-04-8.71e-03	-1.53e-05	-1.47e-06	0.0
73854	7.26e-04	-1.98e-03-9.07e-03	-2.34e-05	0.0	0.0
73859	-7.53e-04	2.52e-03-8.26e-03	-2.51e-06	0.0	0.0
73869	-9.80e-06	2.56e-04-8.66e-03	-1.29e-05	0.0	0.0
73870	-8.67e-06	2.96e-04-8.35e-03	-1.49e-05	0.0	0.0
73871	-9.80e-06	2.56e-04-8.66e-03	-1.29e-05	0.0	0.0
73872	-9.58e-06	2.64e-04-8.60e-03	-1.33e-05	0.0	0.0
73873	-9.80e-06	2.56e-04-8.66e-03	-1.29e-05	0.0	0.0
7391	-1.28e-05	8.87e-04 -0.01	-4.42e-05	0.0	0.0
7392	-1.06e-05	1.04e-03 -0.01	-5.17e-05	0.0	0.0
73920	-1.77e-03	3.52e-04-9.87e-03	-3.38e-05	-1.63e-06	0.0
73922	5.42e-04	-1.02e-03 -0.01	-3.71e-05	0.0	0.0
73927	-5.72e-04	2.33e-03-9.17e-03	-2.79e-05	0.0	0.0
73952	-2.48e-03	2.31e-04-9.91e-03	-3.43e-05	-2.35e-06	0.0
73954	7.63e-04	-1.69e-03 -0.01	-3.89e-05	0.0	0.0
73959	-7.98e-04	3.00e-03-8.92e-03	-2.60e-05	0.0	0.0
73969	-8.05e-06	6.53e-04-9.78e-03	-3.24e-05	0.0	0.0
73970	-6.58e-06	7.57e-04-9.64e-03	-3.74e-05	0.0	0.0
73971	-8.05e-06	6.53e-04-9.78e-03	-3.24e-05	0.0	0.0
73972	-7.76e-06	6.74e-04-9.75e-03	-3.34e-05	0.0	0.0
73973	-8.05e-06	6.53e-04-9.78e-03	-3.24e-05	0.0	0.0
7401	-8.13e-06	1.49e-03 -0.02	-7.39e-05	0.0	0.0
7402	-4.81e-06	1.76e-03 -0.02	-8.67e-05	0.0	0.0
74020	-1.83e-03	7.76e-04 -0.01	-5.45e-05	-2.80e-06	0.0
74027	-6.06e-04	2.89e-03 -0.01	-5.59e-05	0.0	0.0
74028	-4.72e-04	-6.74e-04 -0.01	-5.32e-05	0.0	0.0
74052	-2.56e-03	6.47e-04 -0.01	-5.46e-05	-4.07e-06	0.0
74059	-8.48e-04	3.61e-03 -0.01	-5.65e-05	0.0	0.0
74060	-6.59e-04	-1.38e-03 -0.01	-5.28e-05	0.0	0.0
74069	-4.37e-06	1.10e-03 -0.01	-5.43e-05	0.0	0.0
74070	-2.16e-06	1.28e-03 -0.01	-6.29e-05	0.0	0.0
74071	-4.37e-06	1.10e-03 -0.01	-5.43e-05	0.0	0.0
74072	-3.93e-06	1.13e-03 -0.01	-5.61e-05	0.0	0.0
74073	-4.37e-06	1.10e-03 -0.01	-5.43e-05	0.0	0.0
7412	4.68e-06	2.57e-03 -0.02	-1.26e-04	1.00e-06	0.0
7414	9.28e-06	1.92e-03 -0.02	-9.39e-05	0.0	0.0
74117	1.92e-03	1.96e-03 -0.02	-8.03e-05	6.53e-06	0.0
74127	-6.49e-04	3.58e-03 -0.01	-8.96e-05	-1.08e-06	0.0
74128	-4.66e-04	-3.64e-04 -0.02	-6.88e-05	-1.22e-06	0.0
74149	2.69e-03	2.10e-03 -0.02	-8.09e-05	8.90e-06	0.0
74159	-9.09e-04	4.38e-03 -0.01	-9.39e-05	-1.76e-06	0.0
74160	-6.54e-04	-1.15e-03 -0.02	-6.47e-05	-1.95e-06	0.0
74170	5.02e-06	1.87e-03 -0.02	-9.19e-05	0.0	0.0
74172	2.26e-06	1.65e-03 -0.02	-8.15e-05	0.0	0.0
74173	1.56e-06	1.60e-03 -0.02	-7.89e-05	0.0	0.0
7422	1.83e-05	3.45e-03 -0.03	-1.69e-04	1.40e-06	0.0
7424	2.05e-05	2.59e-03 -0.02	-1.27e-04	1.15e-06	0.0
74217	2.04e-03	2.56e-03 -0.02	-1.10e-04	1.01e-05	0.0
74227	-6.85e-04	4.43e-03 -0.02	-1.32e-04	-1.67e-06	0.0
74235	-3.45e-04	3.63e-03 -0.02	-1.23e-04	-1.53e-06	0.0
74249	2.85e-03	2.73e-03 -0.02	-1.11e-04	1.37e-05	0.0
74259	-9.64e-04	5.35e-03 -0.02	-1.42e-04	-2.69e-06	0.0
74267	-4.88e-04	4.23e-03 -0.02	-1.30e-04	-2.50e-06	0.0
74270	1.52e-05	2.51e-03 -0.02	-1.23e-04	1.05e-06	0.0
74272	1.11e-05	2.21e-03 -0.02	-1.09e-04	0.0	0.0
74273	1.00e-05	2.13e-03 -0.02	-1.05e-04	0.0	0.0
7432	3.59e-05	4.18e-03 -0.04	-2.10e-04	1.92e-06	0.0
74317	2.54e-03	3.07e-03 -0.03	-1.38e-04	2.90e-05	0.0
74323	-7.36e-04	5.28e-03 -0.03	-1.83e-04	-3.80e-06	0.0
74327	-8.41e-04	5.28e-03 -0.03	-1.83e-04	-6.60e-06	0.0
74349	3.54e-03	3.28e-03 -0.03	-1.42e-04	4.01e-05	0.0
74355	-1.04e-03	6.37e-03 -0.03	-2.05e-04	-5.80e-06	0.0
74359	-1.19e-03	6.37e-03 -0.03	-2.05e-04	-9.74e-06	0.0
74370	2.83e-05	3.05e-03 -0.03	-1.53e-04	1.44e-06	0.0



EGP CODE

GRE.EEC.R.73.IT.W.15235.12.024.01

PAGE

188 di/of 527

74372	2.26e-05	2.67e-03	-0.03	-1.34e-04	1.26e-06	0.0
74373	2.12e-05	2.57e-03	-0.03	-1.29e-04	1.22e-06	0.0
7442	1.53e-03	3.80e-03	-0.05	-1.79e-04	7.71e-05	0.0
74413	4.10e-03	4.08e-03	-0.04	-1.56e-04	1.10e-04	0.0
74417	4.15e-03	3.60e-03	-0.04	-1.47e-04	1.09e-04	0.0
74421	1.82e-03	6.21e-03	-0.04	-1.85e-04	6.89e-05	0.0
74445	5.35e-03	4.76e-03	-0.04	-1.74e-04	1.34e-04	0.0
74449	5.42e-03	4.07e-03	-0.04	-1.61e-04	1.33e-04	0.0
74453	2.15e-03	7.75e-03	-0.04	-2.15e-04	7.64e-05	0.0
74470	1.13e-03	2.82e-03	-0.03	-1.33e-04	5.66e-05	0.0
74472	1.02e-03	2.46e-03	-0.03	-1.16e-04	5.13e-05	0.0
74473	9.89e-04	2.37e-03	-0.03	-1.12e-04	5.00e-05	0.0
7452	1.41e-03	3.55e-03	-0.06	-1.67e-04	8.19e-05	0.0
74513	4.42e-03	4.06e-03	-0.05	-1.46e-04	1.29e-04	0.0
74517	4.54e-03	3.56e-03	-0.05	-1.36e-04	1.27e-04	0.0
74521	1.67e-03	6.15e-03	-0.05	-1.85e-04	8.30e-05	0.0
74545	5.82e-03	4.80e-03	-0.06	-1.62e-04	1.59e-04	0.0
74549	5.99e-03	4.08e-03	-0.06	-1.48e-04	1.56e-04	0.0
74553	1.96e-03	7.73e-03	-0.06	-2.18e-04	9.49e-05	0.0
74570	1.04e-03	2.63e-03	-0.04	-1.23e-04	6.05e-05	0.0
74572	9.49e-04	2.29e-03	-0.04	-1.08e-04	5.47e-05	0.0
74573	9.26e-04	2.20e-03	-0.04	-1.04e-04	5.32e-05	0.0
7462	1.44e-03	-3.47e-03	-0.06	1.64e-04	8.18e-05	0.0
7466	4.47e-03	-2.42e-03	-0.05	1.43e-04	1.27e-04	0.0
74610	4.56e-03	-1.93e-03	-0.05	1.33e-04	1.25e-04	0.0
74626	1.78e-03	-6.03e-03	-0.05	1.82e-04	8.19e-05	0.0
74638	5.88e-03	-2.54e-03	-0.06	1.58e-04	1.56e-04	0.0
74642	6.01e-03	-1.84e-03	-0.06	1.44e-04	1.54e-04	0.0
74658	2.11e-03	-7.59e-03	-0.06	2.14e-04	9.33e-05	0.0
74670	1.07e-03	-2.57e-03	-0.04	1.22e-04	6.05e-05	0.0
74672	9.70e-04	-2.23e-03	-0.04	1.06e-04	5.47e-05	0.0
74673	9.45e-04	-2.15e-03	-0.04	1.03e-04	5.32e-05	0.0
7472	-9.36e-04	-3.53e-03	-0.05	1.67e-04	-4.99e-05	0.0
7478	-3.99e-03	-3.61e-03	-0.04	1.37e-04	-9.70e-05	0.0
74712	-3.85e-03	-4.02e-03	-0.04	1.44e-04	-9.74e-05	0.0
74736	-1.25e-03	-5.88e-03	-0.04	1.72e-04	-5.04e-05	0.0
74740	-5.33e-03	-4.15e-03	-0.05	1.49e-04	-1.22e-04	0.0
74744	-5.14e-03	-4.73e-03	-0.05	1.60e-04	-1.23e-04	0.0
74768	-1.50e-03	-7.35e-03	-0.04	1.99e-04	-5.71e-05	0.0
74770	-6.87e-04	-2.62e-03	-0.04	1.24e-04	-3.64e-05	0.0
74772	-6.41e-04	-2.30e-03	-0.03	1.09e-04	-3.42e-05	0.0
74773	-6.30e-04	-2.22e-03	-0.03	1.05e-04	-3.36e-05	0.0
7482	-9.43e-04	3.63e-03	-0.05	-1.70e-04	-5.03e-05	0.0
74815	-4.06e-03	3.66e-03	-0.04	-1.42e-04	-9.90e-05	0.0
74819	-3.94e-03	4.07e-03	-0.04	-1.49e-04	-9.95e-05	0.0
74831	-1.29e-03	6.03e-03	-0.04	-1.77e-04	-5.24e-05	0.0
74847	-5.43e-03	4.19e-03	-0.05	-1.55e-04	-1.25e-04	0.0
74851	-5.26e-03	4.78e-03	-0.05	-1.66e-04	-1.26e-04	0.0
74863	-1.56e-03	7.53e-03	-0.04	-2.05e-04	-5.98e-05	0.0
74870	-6.93e-04	2.69e-03	-0.04	-1.26e-04	-3.67e-05	0.0
74872	-6.46e-04	2.36e-03	-0.03	-1.11e-04	-3.44e-05	0.0
74873	-6.34e-04	2.28e-03	-0.03	-1.07e-04	-3.38e-05	0.0
7492	-1.10e-03	-3.40e-03	-0.04	1.62e-04	-5.15e-05	0.0
7498	-3.89e-03	-3.36e-03	-0.04	1.41e-04	-8.99e-05	0.0
74912	-3.86e-03	-3.72e-03	-0.04	1.48e-04	-9.06e-05	0.0
74936	-1.63e-03	-5.56e-03	-0.03	1.61e-04	-5.09e-05	0.0
74940	-5.16e-03	-3.81e-03	-0.04	1.57e-04	-1.12e-04	0.0
74944	-5.12e-03	-4.34e-03	-0.04	1.66e-04	-1.13e-04	0.0
74968	-1.99e-03	-6.93e-03	-0.03	1.84e-04	-5.76e-05	0.0
74970	-8.06e-04	-2.53e-03	-0.03	1.20e-04	-3.73e-05	0.0
74972	-7.40e-04	-2.23e-03	-0.03	1.07e-04	-3.49e-05	0.0
74973	-7.23e-04	-2.15e-03	-0.03	1.03e-04	-3.43e-05	0.0
7502	-7.75e-04	-2.65e-03	-0.03	1.30e-04	-3.87e-05	0.0
7508	-3.42e-03	-2.69e-03	-0.03	1.21e-04	-6.73e-05	0.0
75012	-3.31e-03	-2.98e-03	-0.03	1.24e-04	-6.70e-05	0.0
75036	-1.10e-03	-4.48e-03	-0.02	1.14e-04	-3.15e-05	0.0
75040	-4.57e-03	-3.07e-03	-0.03	1.35e-04	-8.37e-05	0.0
75044	-4.43e-03	-3.49e-03	-0.03	1.40e-04	-8.33e-05	0.0
75068	-1.32e-03	-5.59e-03	-0.03	1.26e-04	-3.36e-05	0.0
75070	-5.54e-04	-1.97e-03	-0.02	9.61e-05	-2.74e-05	0.0
75072	-5.30e-04	-1.75e-03	-0.02	8.57e-05	-2.66e-05	0.0
75073	-5.24e-04	-1.70e-03	-0.02	8.31e-05	-2.64e-05	0.0
7512	-6.50e-04	-1.96e-03	-0.03	9.64e-05	-3.33e-05	0.0
7517	-2.97e-03	-1.36e-03	-0.02	8.87e-05	-5.17e-05	0.0
75111	-2.94e-03	-1.11e-03	-0.02	8.74e-05	-5.22e-05	0.0
75136	-9.41e-04	-3.71e-03	-0.02	7.67e-05	-2.45e-05	0.0



EGP CODE

GRE.EEC.R.73.IT.W.15235.12.024.01

PAGE

189 di/of 527

75139	-3.98e-03	-1.40e-03	-0.03	9.94e-05	-6.33e-05	0.0
75143	-3.95e-03	-1.04e-03	-0.03	9.76e-05	-6.39e-05	0.0
75168	-1.14e-03	-4.69e-03	-0.02	8.26e-05	-2.52e-05	0.0
75170	-4.53e-04	-1.46e-03	-0.02	7.14e-05	-2.30e-05	0.0
75172	-4.45e-04	-1.30e-03	-0.02	6.39e-05	-2.29e-05	0.0
75173	-4.43e-04	-1.26e-03	-0.02	6.20e-05	-2.29e-05	0.0
7521	-5.91e-04	-1.12e-03	-0.02	5.51e-05	-3.11e-05	0.0
7522	-5.91e-04	-1.31e-03	-0.02	6.42e-05	-3.07e-05	0.0
7527	-2.68e-03	-9.70e-04	-0.02	6.30e-05	-4.09e-05	0.0
75211	-2.66e-03	-7.43e-04	-0.02	6.30e-05	-4.12e-05	0.0
75236	-8.96e-04	-3.06e-03	-0.02	4.33e-05	-2.18e-05	0.0
75239	-3.58e-03	-1.02e-03	-0.02	7.16e-05	-4.89e-05	0.0
75243	-3.57e-03	-6.98e-04	-0.02	7.17e-05	-4.94e-05	0.0
75268	-1.09e-03	-3.94e-03	-0.02	4.41e-05	-2.21e-05	0.0
75269	-4.03e-04	-8.42e-04	-0.02	4.15e-05	-2.10e-05	0.0
75270	-4.03e-04	-9.68e-04	-0.02	4.75e-05	-2.07e-05	0.0
75271	-4.03e-04	-8.42e-04	-0.02	4.15e-05	-2.10e-05	0.0
75272	-4.03e-04	-8.68e-04	-0.02	4.27e-05	-2.10e-05	0.0
75273	-4.03e-04	-8.42e-04	-0.02	4.15e-05	-2.10e-05	0.0
7531	-5.73e-04	-6.09e-04	-0.02	3.00e-05	-3.02e-05	0.0
7532	-5.65e-04	-7.10e-04	-0.02	3.49e-05	-2.95e-05	0.0
7537	-2.48e-03	-6.37e-04	-0.02	3.78e-05	-3.42e-05	0.0
75311	-2.47e-03	-4.25e-04	-0.02	3.86e-05	-3.44e-05	0.0
75336	-9.06e-04	-2.53e-03	-0.02	1.78e-05	-2.14e-05	0.0
75339	-3.32e-03	-7.11e-04	-0.02	4.39e-05	-3.99e-05	0.0
75343	-3.31e-03	-4.08e-04	-0.02	4.50e-05	-4.02e-05	0.0
75368	-1.11e-03	-3.36e-03	-0.02	1.58e-05	-2.19e-05	0.0
75369	-3.86e-04	-4.58e-04	-0.02	2.26e-05	-2.02e-05	0.0
75370	-3.80e-04	-5.26e-04	-0.02	2.58e-05	-1.97e-05	0.0
75371	-3.86e-04	-4.58e-04	-0.02	2.26e-05	-2.02e-05	0.0
75372	-3.85e-04	-4.72e-04	-0.02	2.32e-05	-2.01e-05	0.0
75373	-3.86e-04	-4.58e-04	-0.02	2.26e-05	-2.02e-05	0.0
7541	-5.67e-04	-1.38e-04	-0.02	6.87e-06	-3.00e-05	0.0
7542	-5.56e-04	-1.61e-04	-0.02	7.98e-06	-2.91e-05	0.0
7547	-2.36e-03	8.14e-04	-0.02	1.44e-05	-3.07e-05	0.0
75411	-2.36e-03	1.02e-03	-0.02	1.55e-05	-3.07e-05	0.0
75436	-9.49e-04	-2.10e-03	-0.01	-2.56e-06	-2.24e-05	0.0
75439	-3.15e-03	1.17e-03	-0.02	1.81e-05	-3.50e-05	0.0
75443	-3.15e-03	1.47e-03	-0.02	1.96e-05	-3.50e-05	0.0
75468	-1.18e-03	-2.90e-03	-0.02	-5.66e-06	-2.35e-05	0.0
75469	-3.79e-04	-1.04e-04	-0.01	5.17e-06	-1.99e-05	0.0
75470	-3.72e-04	-1.19e-04	-0.01	5.91e-06	-1.94e-05	0.0
75471	-3.79e-04	-1.04e-04	-0.01	5.17e-06	-1.99e-05	0.0
75472	-3.78e-04	-1.07e-04	-0.01	5.32e-06	-1.98e-05	0.0
75473	-3.79e-04	-1.04e-04	-0.01	5.17e-06	-1.99e-05	0.0
7551	-5.67e-04	3.22e-04	-0.02	-1.58e-05	-3.00e-05	0.0
7552	-5.56e-04	3.75e-04	-0.02	-1.83e-05	-2.92e-05	0.0
75516	-2.39e-03	6.60e-04	-0.02	-2.32e-05	-3.15e-05	0.0
75520	-2.39e-03	-8.67e-04	-0.02	-2.42e-05	-3.17e-05	0.0
75531	-9.24e-04	2.26e-03	-0.01	-4.60e-06	-2.18e-05	0.0
75548	-3.20e-03	-1.01e-03	-0.02	-2.77e-05	-3.62e-05	0.0
75552	-3.19e-03	-1.31e-03	-0.02	-2.91e-05	-3.64e-05	0.0
75563	-1.14e-03	3.07e-03	-0.01	-1.67e-06	-2.25e-05	0.0
75569	-3.80e-04	2.42e-04	-0.01	-1.19e-05	-2.00e-05	0.0
75570	-3.73e-04	2.78e-04	-0.01	-1.36e-05	-1.94e-05	0.0
75571	-3.80e-04	2.42e-04	-0.01	-1.19e-05	-2.00e-05	0.0
75572	-3.78e-04	2.50e-04	-0.01	-1.22e-05	-1.99e-05	0.0
75573	-3.80e-04	2.42e-04	-0.01	-1.19e-05	-2.00e-05	0.0
7561	-5.74e-04	8.06e-04	-0.02	-3.96e-05	-3.04e-05	0.0
7562	-5.67e-04	9.41e-04	-0.02	-4.60e-05	-2.97e-05	0.0
75616	-2.53e-03	7.69e-04	-0.02	-4.72e-05	-3.60e-05	0.0
75620	-2.53e-03	5.52e-04	-0.02	-4.79e-05	-3.64e-05	0.0
75631	-8.88e-04	2.72e-03	-0.02	-2.72e-05	-2.11e-05	0.0
75648	-3.39e-03	8.36e-04	-0.02	-5.42e-05	-4.23e-05	0.0
75652	-3.38e-03	5.26e-04	-0.02	-5.51e-05	-4.28e-05	0.0
75663	-1.09e-03	3.57e-03	-0.02	-2.61e-05	-2.14e-05	0.0
75669	-3.88e-04	6.07e-04	-0.02	-2.98e-05	-2.04e-05	0.0
75670	-3.83e-04	6.97e-04	-0.02	-3.41e-05	-1.99e-05	0.0
75671	-3.88e-04	6.07e-04	-0.02	-2.98e-05	-2.04e-05	0.0
75672	-3.87e-04	6.25e-04	-0.02	-3.07e-05	-2.03e-05	0.0
75673	-3.88e-04	6.07e-04	-0.02	-2.98e-05	-2.04e-05	0.0
7572	-8.17e-04	-4.39e-03	-0.04	2.09e-04	-4.17e-05	0.0
7578	-2.56e-03	-3.70e-03	-0.03	1.50e-04	-3.92e-05	0.0
75722	-2.04e-04	-5.87e-03	-0.03	1.94e-04	-2.98e-05	0.0
75724	-1.39e-03	-5.91e-03	-0.03	1.95e-04	-3.67e-05	0.0
75740	-3.39e-03	-4.11e-03	-0.03	1.58e-04	-4.48e-05	0.0



EGP CODE

GRE.EEC.R.73.IT.W.15235.12.024.01

PAGE

190 di/of 527

75754	-8.49e-05	-7.16e-03	-0.04	2.20e-04	-3.16e-05	0.0
75756	-1.74e-03	-7.21e-03	-0.03	2.22e-04	-4.12e-05	0.0
75770	-6.09e-04	-3.21e-03	-0.03	1.53e-04	-3.11e-05	0.0
75772	-5.22e-04	-2.77e-03	-0.03	1.33e-04	-2.66e-05	0.0
75773	-5.00e-04	-2.66e-03	-0.03	1.28e-04	-2.54e-05	0.0
7581	-9.90e-05	-3.37e-03	-0.03	1.62e-04	-1.04e-05	0.0
7582	-9.32e-05	-4.08e-03	-0.03	1.95e-04	-1.23e-05	0.0
75811	-2.24e-03	-1.89e-03	-0.02	1.07e-04	-2.13e-05	0.0
75822	6.32e-04	-5.22e-03	-0.02	1.66e-04	1.43e-06	0.0
75843	-3.11e-03	-1.65e-03	-0.02	1.01e-04	-2.67e-05	0.0
75854	9.15e-04	-6.31e-03	-0.03	1.84e-04	5.20e-06	0.0
75869	-7.28e-05	-2.50e-03	-0.02	1.20e-04	-7.97e-06	0.0
75870	-6.90e-05	-2.98e-03	-0.03	1.42e-04	-9.19e-06	0.0
75871	-7.28e-05	-2.50e-03	-0.02	1.20e-04	-7.97e-06	0.0
75872	-7.21e-05	-2.60e-03	-0.02	1.25e-04	-8.21e-06	0.0
75873	-7.28e-05	-2.50e-03	-0.02	1.20e-04	-7.97e-06	0.0
7592	-2.07e-04	-3.05e-03	-0.03	1.49e-04	-1.10e-05	0.0
7599	1.70e-03	-1.51e-03	-0.02	9.17e-05	-1.08e-06	0.0
75911	-2.11e-03	-1.45e-03	-0.02	8.62e-05	-1.35e-05	0.0
75926	3.48e-04	-4.06e-03	-0.02	1.12e-04	-3.38e-06	0.0
75941	2.44e-03	-1.35e-03	-0.02	9.13e-05	1.24e-06	0.0
75943	-2.90e-03	-1.28e-03	-0.02	8.37e-05	-1.61e-05	0.0
75958	5.40e-04	-4.93e-03	-0.02	1.20e-04	-1.99e-06	0.0
75970	-1.53e-04	-2.22e-03	-0.02	1.08e-04	-8.20e-06	0.0
75972	-1.36e-04	-1.96e-03	-0.02	9.58e-05	-7.13e-06	0.0
75973	-1.32e-04	-1.89e-03	-0.02	9.27e-05	-6.86e-06	0.0
7602	-1.32e-04	-2.22e-03	-0.02	1.09e-04	-6.03e-06	0.0
76011	-1.96e-03	-1.00e-03	-0.01	6.51e-05	-7.95e-06	0.0
76021	5.00e-04	5.22e-04	-0.01	6.18e-05	-4.46e-06	0.0
76026	3.89e-04	-3.30e-03	-0.01	7.45e-05	-1.24e-06	0.0
76043	-2.71e-03	-8.48e-04	-0.01	6.40e-05	-9.62e-06	0.0
76053	7.33e-04	1.29e-03	-0.01	5.93e-05	-4.73e-06	0.0
76058	5.78e-04	-4.07e-03	-0.01	7.72e-05	0.0	0.0
76070	-9.75e-05	-1.61e-03	-0.01	7.87e-05	-4.52e-06	0.0
76072	-8.70e-05	-1.43e-03	-0.01	7.00e-05	-3.94e-06	0.0
76073	-8.44e-05	-1.38e-03	-0.01	6.78e-05	-3.79e-06	0.0
7612	-8.41e-05	-1.46e-03	-0.01	7.14e-05	-3.37e-06	0.0
76111	-1.85e-03	-6.01e-04	-0.01	4.47e-05	-4.45e-06	0.0
76125	4.85e-04	8.26e-04	-0.01	4.66e-05	-2.71e-06	0.0
76126	4.18e-04	-2.67e-03	-0.01	4.32e-05	0.0	0.0
76143	-2.57e-03	-4.76e-04	-0.01	4.46e-05	-5.38e-06	0.0
76157	7.01e-04	1.52e-03	-0.01	4.73e-05	-2.94e-06	0.0
76158	6.06e-04	-3.37e-03-9.94e-03		4.26e-05	0.0	0.0
76170	-6.15e-05	-1.06e-03	-0.01	5.18e-05	-2.53e-06	0.0
76172	-5.57e-05	-9.43e-04	-0.01	4.62e-05	-2.22e-06	0.0
76173	-5.43e-05	-9.14e-04	-0.01	4.48e-05	-2.14e-06	0.0
7621	-5.39e-05	-6.75e-04	-0.01	3.30e-05	-1.76e-06	0.0
7622	-6.04e-05	-7.92e-04	-0.01	3.85e-05	-2.11e-06	0.0
76211	-1.79e-03	-2.06e-04-9.21e-03		2.51e-05	-2.68e-06	0.0
76225	4.85e-04	1.15e-03-9.71e-03		3.03e-05	-1.59e-06	0.0
76226	4.44e-04	-2.16e-03-8.72e-03		1.82e-05	0.0	0.0
76243	-2.49e-03	-8.98e-05-9.22e-03		2.55e-05	-3.21e-06	0.0
76257	6.95e-04	1.81e-03-9.91e-03		3.28e-05	-1.68e-06	0.0
76258	6.38e-04	-2.82e-03-8.53e-03		1.58e-05	0.0	0.0
76269	-3.94e-05	-4.96e-04-9.19e-03		2.42e-05	-1.36e-06	0.0
76270	-4.38e-05	-5.74e-04-8.96e-03		2.79e-05	-1.59e-06	0.0
76271	-3.94e-05	-4.96e-04-9.19e-03		2.42e-05	-1.36e-06	0.0
76272	-4.03e-05	-5.12e-04-9.15e-03		2.50e-05	-1.40e-06	0.0
76273	-3.94e-05	-4.96e-04-9.19e-03		2.42e-05	-1.36e-06	0.0
7631	-4.72e-05	-1.58e-04	-0.01	7.47e-06	-1.41e-06	0.0
7632	-5.23e-05	-1.85e-04	-0.01	8.71e-06	-1.67e-06	0.0
76311	-1.74e-03	1.65e-04-8.42e-03		6.73e-06	-1.90e-06	0.0
76324	-5.49e-04	-1.74e-03-8.32e-03		-2.46e-06	-1.18e-06	0.0
76325	4.76e-04	1.49e-03-8.60e-03		1.34e-05	-1.01e-06	0.0
76343	-2.42e-03	2.77e-04-8.40e-03		7.23e-06	-2.23e-06	0.0
76356	-7.55e-04	-2.39e-03-8.26e-03		-5.64e-06	-1.22e-06	0.0
76357	6.81e-04	2.13e-03-8.66e-03		1.66e-05	0.0	0.0
76369	-3.43e-05	-1.16e-04-8.46e-03		5.48e-06	-1.08e-06	0.0
76370	-3.77e-05	-1.34e-04-8.12e-03		6.30e-06	-1.26e-06	0.0
76371	-3.43e-05	-1.16e-04-8.46e-03		5.48e-06	-1.08e-06	0.0
76372	-3.50e-05	-1.20e-04-8.39e-03		5.64e-06	-1.12e-06	0.0
76373	-3.43e-05	-1.16e-04-8.46e-03		5.48e-06	-1.08e-06	0.0
7641	-5.01e-05	3.46e-04	-0.01	-1.75e-05	-1.53e-06	0.0
7642	-5.58e-05	4.06e-04	-0.01	-2.04e-05	-1.83e-06	0.0
76420	-1.75e-03	-2.95e-05-8.63e-03		-1.40e-05	-2.10e-06	0.0
76421	4.56e-04	1.89e-03-8.38e-03		-5.44e-06	0.0	0.0





EGP CODE

GRE.EEC.R.73.IT.W.15235.12.024.01

PAGE

191 di/of 527

76422	4.84e-04	-1.36e-03-8.94e-03	-2.03e-05	-1.14e-06	0.0
76452	-2.44e-03	-1.44e-04-8.63e-03	-1.44e-05	-2.47e-06	0.0
76453	6.54e-04	2.54e-03-8.28e-03	-2.48e-06	0.0	0.0
76454	6.92e-04	-2.01e-03-9.06e-03	-2.33e-05	-1.13e-06	0.0
76469	-3.65e-05	2.54e-04-8.64e-03	-1.28e-05	-1.18e-06	0.0
76470	-4.03e-05	2.94e-04-8.33e-03	-1.47e-05	-1.38e-06	0.0
76471	-3.65e-05	2.54e-04-8.64e-03	-1.28e-05	-1.18e-06	0.0
76472	-3.72e-05	2.62e-04-8.58e-03	-1.32e-05	-1.22e-06	0.0
76473	-3.65e-05	2.54e-04-8.64e-03	-1.28e-05	-1.18e-06	0.0
7651	-6.36e-05	8.80e-04 -0.01	-4.38e-05	-2.19e-06	0.0
7652	-7.25e-05	1.03e-03 -0.01	-5.12e-05	-2.65e-06	0.0
76520	-1.81e-03	3.49e-04-9.79e-03	-3.28e-05	-3.23e-06	0.0
76521	4.29e-04	2.34e-03-9.17e-03	-2.77e-05	0.0	0.0
76522	4.88e-04	-1.03e-03 -0.01	-3.68e-05	-1.95e-06	0.0
76552	-2.51e-03	2.29e-04-9.81e-03	-3.30e-05	-3.84e-06	0.0
76553	6.19e-04	3.02e-03-8.94e-03	-2.59e-05	0.0	0.0
76554	7.02e-04	-1.70e-03 -0.01	-3.86e-05	-2.06e-06	0.0
76569	-4.68e-05	6.47e-04-9.75e-03	-3.22e-05	-1.69e-06	0.0
76570	-5.28e-05	7.49e-04-9.60e-03	-3.71e-05	-1.99e-06	0.0
76571	-4.68e-05	6.47e-04-9.75e-03	-3.22e-05	-1.69e-06	0.0
76572	-4.80e-05	6.67e-04-9.72e-03	-3.32e-05	-1.75e-06	0.0
76573	-4.68e-05	6.47e-04-9.75e-03	-3.22e-05	-1.69e-06	0.0
7662	-1.09e-04	1.74e-03 -0.02	-8.58e-05	-4.52e-06	0.0
76620	-1.89e-03	7.20e-04 -0.01	-5.26e-05	-5.57e-06	0.0
76621	3.96e-04	2.90e-03 -0.01	-5.54e-05	-1.28e-06	0.0
76626	5.05e-04	-7.13e-04 -0.01	-5.24e-05	-3.18e-06	0.0
76652	-2.62e-03	5.74e-04 -0.01	-5.21e-05	-6.67e-06	0.0
76653	5.82e-04	3.62e-03 -0.01	-5.60e-05	0.0	0.0
76658	7.35e-04	-1.43e-03 -0.01	-5.18e-05	-3.31e-06	0.0
76670	-8.04e-05	1.26e-03 -0.01	-6.22e-05	-3.39e-06	0.0
76672	-7.19e-05	1.12e-03 -0.01	-5.54e-05	-2.95e-06	0.0
76673	-6.97e-05	1.08e-03 -0.01	-5.37e-05	-2.85e-06	0.0
7672	-1.81e-04	2.53e-03 -0.02	-1.24e-04	-8.31e-06	0.0
76720	-2.01e-03	1.17e-03 -0.02	-7.36e-05	-1.01e-05	0.0
76721	3.56e-04	3.58e-03 -0.01	-8.88e-05	-2.37e-06	0.0
76726	4.83e-04	-4.20e-04 -0.02	-6.74e-05	-5.77e-06	0.0
76752	-2.77e-03	1.01e-03 -0.02	-7.20e-05	-1.20e-05	0.0
76753	5.44e-04	4.39e-03 -0.01	-9.32e-05	-1.25e-06	0.0
76758	7.22e-04	-1.22e-03 -0.02	-6.32e-05	-6.00e-06	0.0
76770	-1.34e-04	1.84e-03 -0.02	-9.03e-05	-6.22e-06	0.0
76772	-1.18e-04	1.63e-03 -0.02	-8.02e-05	-5.40e-06	0.0
76773	-1.14e-04	1.57e-03 -0.02	-7.77e-05	-5.19e-06	0.0
7682	-3.02e-04	3.37e-03 -0.03	-1.65e-04	-1.55e-05	0.0
76820	-2.20e-03	1.60e-03 -0.02	-9.41e-05	-1.74e-05	0.0
76825	3.31e-04	4.40e-03 -0.02	-1.29e-04	-5.59e-06	0.0
76852	-3.01e-03	1.41e-03 -0.02	-9.07e-05	-2.05e-05	0.0
76857	5.39e-04	5.33e-03 -0.02	-1.40e-04	-3.98e-06	0.0
76870	-2.24e-04	2.45e-03 -0.02	-1.20e-04	-1.16e-05	0.0
76872	-1.97e-04	2.16e-03 -0.02	-1.06e-04	-1.00e-05	0.0
76873	-1.90e-04	2.09e-03 -0.02	-1.02e-04	-9.62e-06	0.0
7692	-3.00e-04	4.41e-03 -0.04	-2.10e-04	-2.16e-05	0.0
76920	-2.40e-03	1.98e-03 -0.02	-1.11e-04	-2.83e-05	0.0
76925	4.57e-04	5.73e-03 -0.03	-1.87e-04	-6.28e-06	0.0
76952	-3.28e-03	1.70e-03 -0.02	-1.04e-04	-3.42e-05	0.0
76957	7.19e-04	6.95e-03 -0.03	-2.11e-04	-3.32e-06	0.0
76970	-2.23e-04	3.22e-03 -0.03	-1.53e-04	-1.62e-05	0.0
76972	-2.03e-04	2.80e-03 -0.03	-1.34e-04	-1.42e-05	0.0
76973	-1.98e-04	2.69e-03 -0.03	-1.29e-04	-1.37e-05	0.0
7702	-8.08e-04	4.40e-03 -0.04	-2.11e-04	-4.15e-05	0.0
77019	-2.60e-03	3.31e-03 -0.03	-1.38e-04	-3.90e-05	0.0
77023	-1.30e-03	5.93e-03 -0.03	-1.95e-04	-3.47e-05	0.0
77025	-1.57e-04	5.92e-03 -0.03	-1.96e-04	-2.86e-05	0.0
77051	-3.44e-03	3.57e-03 -0.03	-1.42e-04	-4.45e-05	0.0
77055	-1.63e-03	7.23e-03 -0.03	-2.21e-04	-3.85e-05	0.0
77057	-2.21e-05	7.21e-03 -0.04	-2.23e-04	-2.99e-05	0.0
77070	-6.02e-04	3.22e-03 -0.03	-1.54e-04	-3.10e-05	0.0
77072	-5.16e-04	2.78e-03 -0.03	-1.33e-04	-2.65e-05	0.0
77073	-4.95e-04	2.67e-03 -0.03	-1.28e-04	-2.53e-05	0.0
7712	-1.09e-03	-3.58e-03 -0.04	1.75e-04	-5.57e-05	0.0
7718	-2.53e-03	-3.02e-03 -0.03	1.18e-04	-3.52e-05	0.0
77122	-4.46e-04	-4.96e-03 -0.03	1.55e-04	-4.39e-05	0.0
77126	-4.88e-04	-4.96e-03 -0.03	1.54e-04	-4.37e-05	0.0
77140	-3.28e-03	-3.34e-03 -0.03	1.22e-04	-3.58e-05	0.0
77154	-3.59e-04	-6.06e-03 -0.03	1.74e-04	-4.80e-05	0.0
77158	-4.19e-04	-6.07e-03 -0.03	1.73e-04	-4.77e-05	0.0
77170	-8.11e-04	-2.61e-03 -0.03	1.27e-04	-4.16e-05	0.0



EGP CODE

GRE.EEC.R.73.IT.W.15235.12.024.01

PAGE

192 di/of 527

77172	-6.92e-04	-2.28e-03	-0.03	1.12e-04	-3.54e-05	0.0
77173	-6.63e-04	-2.20e-03	-0.03	1.08e-04	-3.39e-05	0.0
7722	-7.00e-04	-3.39e-03	-0.03	1.66e-04	-3.66e-05	0.0
77211	-2.29e-03	-1.59e-03	-0.02	9.17e-05	-2.09e-05	0.0
77222	-5.04e-06	-4.63e-03	-0.02	1.39e-04	-2.36e-05	0.0
77226	-4.53e-05	-4.63e-03	-0.02	1.39e-04	-2.35e-05	0.0
77243	-3.03e-03	-1.38e-03	-0.02	8.71e-05	-2.02e-05	0.0
77254	1.66e-04	-5.65e-03	-0.02	1.54e-04	-2.40e-05	0.0
77258	1.09e-04	-5.65e-03	-0.02	1.53e-04	-2.39e-05	0.0
77270	-5.22e-04	-2.46e-03	-0.02	1.20e-04	-2.73e-05	0.0
77272	-4.50e-04	-2.17e-03	-0.02	1.06e-04	-2.34e-05	0.0
77273	-4.32e-04	-2.09e-03	-0.02	1.03e-04	-2.24e-05	0.0
7732	-4.18e-04	-2.80e-03	-0.02	1.38e-04	-2.11e-05	0.0
77310	1.60e-03	-2.19e-03	-0.02	9.40e-05	-1.20e-05	0.0
77311	-2.12e-03	-1.28e-03	-0.02	7.77e-05	-1.41e-05	0.0
77326	2.20e-04	-3.96e-03	-0.02	1.07e-04	-9.84e-06	0.0
77342	2.35e-03	-2.37e-03	-0.02	9.73e-05	-1.16e-05	0.0
77343	-2.87e-03	-1.10e-03	-0.02	7.44e-05	-1.45e-05	0.0
77358	4.12e-04	-4.85e-03	-0.02	1.15e-04	-8.56e-06	0.0
77370	-3.11e-04	-2.03e-03	-0.02	9.99e-05	-1.58e-05	0.0
77372	-2.71e-04	-1.80e-03	-0.02	8.86e-05	-1.36e-05	0.0
77373	-2.61e-04	-1.74e-03	-0.02	8.58e-05	-1.30e-05	0.0
7742	-2.45e-04	-2.09e-03	-0.02	1.03e-04	-1.16e-05	0.0
77411	-1.97e-03	-9.17e-04	-0.01	6.03e-05	-8.40e-06	0.0
77421	3.92e-04	6.34e-04	-0.01	5.77e-05	-9.70e-06	0.0
77426	3.28e-04	-3.26e-03	-0.01	7.22e-05	-4.52e-06	0.0
77443	-2.70e-03	-7.63e-04	-0.01	5.86e-05	-8.86e-06	0.0
77453	6.11e-04	1.41e-03	-0.01	5.50e-05	-1.07e-05	0.0
77458	5.20e-04	-4.05e-03	-0.01	7.54e-05	-3.42e-06	0.0
77470	-1.82e-04	-1.51e-03	-0.01	7.45e-05	-8.71e-06	0.0
77472	-1.60e-04	-1.35e-03	-0.01	6.64e-05	-7.55e-06	0.0
77473	-1.54e-04	-1.30e-03	-0.01	6.44e-05	-7.26e-06	0.0
7751	-1.27e-04	-1.19e-03	-0.01	5.87e-05	-5.40e-06	0.0
7752	-1.50e-04	-1.40e-03	-0.01	6.86e-05	-6.60e-06	0.0
77511	-1.87e-03	-5.18e-04	-0.01	4.21e-05	-4.93e-06	0.0
77521	4.42e-04	8.98e-04	-0.01	4.45e-05	-5.66e-06	0.0
77526	3.87e-04	-2.66e-03	-0.01	4.22e-05	-2.43e-06	0.0
77543	-2.58e-03	-3.77e-04	-0.01	4.18e-05	-5.24e-06	0.0
77553	6.58e-04	1.61e-03	-0.01	4.50e-05	-6.27e-06	0.0
77558	5.79e-04	-3.38e-03-9.89e-03		4.19e-05	-1.73e-06	0.0
77569	-9.51e-05	-8.73e-04	-0.01	4.30e-05	-4.15e-06	0.0
77570	-1.10e-04	-1.01e-03	-0.01	4.97e-05	-4.94e-06	0.0
77571	-9.51e-05	-8.73e-04	-0.01	4.30e-05	-4.15e-06	0.0
77572	-9.82e-05	-9.00e-04	-0.01	4.44e-05	-4.31e-06	0.0
77573	-9.51e-05	-8.73e-04	-0.01	4.30e-05	-4.15e-06	0.0
7761	-8.79e-05	-6.51e-04	-0.01	3.20e-05	-3.39e-06	0.0
7762	-1.02e-04	-7.62e-04	-0.01	3.73e-05	-4.11e-06	0.0
77611	-1.80e-03	-1.98e-04-9.06e-03		2.39e-05	-3.06e-06	0.0
77621	4.59e-04	1.21e-03-9.58e-03		2.91e-05	-3.38e-06	0.0
77626	4.24e-04	-2.17e-03-8.66e-03		1.81e-05	-1.70e-06	0.0
77643	-2.49e-03	-8.53e-05-9.05e-03		2.41e-05	-3.24e-06	0.0
77653	6.69e-04	1.89e-03-9.77e-03		3.13e-05	-3.69e-06	0.0
77658	6.19e-04	-2.85e-03-8.49e-03		1.59e-05	-1.34e-06	0.0
77669	-6.53e-05	-4.77e-04-9.09e-03		2.34e-05	-2.61e-06	0.0
77670	-7.46e-05	-5.52e-04-8.84e-03		2.70e-05	-3.09e-06	0.0
77671	-6.53e-05	-4.77e-04-9.09e-03		2.34e-05	-2.61e-06	0.0
77672	-6.72e-05	-4.92e-04-9.04e-03		2.42e-05	-2.70e-06	0.0
77673	-6.53e-05	-4.77e-04-9.09e-03		2.34e-05	-2.61e-06	0.0
7771	-7.36e-05	-1.53e-04	-0.01	7.29e-06	-2.65e-06	0.0
7772	-8.43e-05	-1.79e-04	-0.01	8.48e-06	-3.20e-06	0.0
77711	-1.75e-03	1.56e-04-8.31e-03		6.50e-06	-2.26e-06	0.0
77721	4.55e-04	1.54e-03-8.52e-03		1.28e-05	-2.21e-06	0.0
77726	4.47e-04	-1.76e-03-8.29e-03		-2.08e-06	-1.77e-06	0.0
77743	-2.43e-03	2.64e-04-8.28e-03		6.96e-06	-2.34e-06	0.0
77753	6.59e-04	2.20e-03-8.58e-03		1.58e-05	-2.28e-06	0.0
77758	6.48e-04	-2.43e-03-8.25e-03		-5.05e-06	-1.67e-06	0.0
77769	-5.44e-05	-1.12e-04-8.38e-03		5.34e-06	-2.04e-06	0.0
77770	-6.15e-05	-1.30e-04-8.02e-03		6.14e-06	-2.41e-06	0.0
77771	-5.44e-05	-1.12e-04-8.38e-03		5.34e-06	-2.04e-06	0.0
77772	-5.58e-05	-1.16e-04-8.31e-03		5.50e-06	-2.11e-06	0.0
77773	-5.44e-05	-1.12e-04-8.38e-03		5.34e-06	-2.04e-06	0.0
7781	-7.86e-05	3.35e-04	-0.01	-1.69e-05	-2.88e-06	0.0
7782	-9.05e-05	3.91e-04	-0.01	-1.97e-05	-3.48e-06	0.0
77820	-1.76e-03	-2.70e-05-8.51e-03		-1.34e-05	-2.48e-06	0.0
77821	4.36e-04	1.91e-03-8.31e-03		-5.45e-06	-1.82e-06	0.0
77822	4.55e-04	-1.39e-03-8.84e-03		-1.94e-05	-2.52e-06	0.0



EGP CODE

GRE.EEC.R.73.IT.W.15235.12.024.01

PAGE

193 di/of 527

77852	-2.45e-03	-1.36e-04-8.49e-03	-1.38e-05	-2.59e-06	0.0
77853	6.33e-04	2.57e-03-8.22e-03	-2.67e-06	-1.66e-06	0.0
77854	6.61e-04	-2.05e-03-8.96e-03	-2.22e-05	-2.64e-06	0.0
77869	-5.82e-05	2.45e-04-8.55e-03	-1.24e-05	-2.21e-06	0.0
77870	-6.61e-05	2.83e-04-8.22e-03	-1.42e-05	-2.61e-06	0.0
77871	-5.82e-05	2.45e-04-8.55e-03	-1.24e-05	-2.21e-06	0.0
77872	-5.97e-05	2.53e-04-8.49e-03	-1.27e-05	-2.29e-06	0.0
77873	-5.82e-05	2.45e-04-8.55e-03	-1.24e-05	-2.21e-06	0.0
7791	-1.04e-04	8.46e-04 -0.01	-4.23e-05	-4.15e-06	0.0
7792	-1.22e-04	9.92e-04 -0.01	-4.93e-05	-5.05e-06	0.0
77920	-1.82e-03	2.75e-04-9.61e-03	-3.10e-05	-3.71e-06	0.0
77921	4.04e-04	2.35e-03-9.09e-03	-2.71e-05	-2.12e-06	0.0
77926	4.56e-04	-1.08e-03 -0.01	-3.51e-05	-4.10e-06	0.0
77952	-2.52e-03	1.37e-04-9.60e-03	-3.11e-05	-3.92e-06	0.0
77953	5.96e-04	3.04e-03-8.88e-03	-2.56e-05	-1.70e-06	0.0
77958	6.69e-04	-1.77e-03 -0.01	-3.68e-05	-4.47e-06	0.0
77969	-7.79e-05	6.21e-04-9.62e-03	-3.10e-05	-3.18e-06	0.0
77970	-9.00e-05	7.18e-04-9.45e-03	-3.57e-05	-3.79e-06	0.0
77971	-7.79e-05	6.21e-04-9.62e-03	-3.10e-05	-3.18e-06	0.0
77972	-8.03e-05	6.40e-04-9.59e-03	-3.19e-05	-3.31e-06	0.0
77973	-7.79e-05	6.21e-04-9.62e-03	-3.10e-05	-3.18e-06	0.0
7802	-1.91e-04	1.65e-03 -0.02	-8.19e-05	-8.51e-06	0.0
78020	-1.91e-03	6.70e-04 -0.01	-4.92e-05	-6.20e-06	0.0
78021	3.55e-04	2.88e-03 -0.01	-5.38e-05	-3.41e-06	0.0
78026	4.26e-04	-7.97e-04 -0.01	-4.96e-05	-7.00e-06	0.0
78052	-2.62e-03	5.25e-04 -0.01	-4.83e-05	-6.54e-06	0.0
78053	5.45e-04	3.62e-03 -0.01	-5.47e-05	-2.64e-06	0.0
78058	6.45e-04	-1.53e-03 -0.01	-4.89e-05	-7.67e-06	0.0
78070	-1.42e-04	1.20e-03 -0.01	-5.93e-05	-6.37e-06	0.0
78072	-1.25e-04	1.06e-03 -0.01	-5.29e-05	-5.53e-06	0.0
78073	-1.21e-04	1.03e-03 -0.01	-5.13e-05	-5.33e-06	0.0
7812	-3.20e-04	2.36e-03 -0.02	-1.17e-04	-1.51e-05	0.0
78120	-2.03e-03	1.06e-03 -0.01	-6.76e-05	-1.06e-05	0.0
78121	2.74e-04	3.52e-03 -0.01	-8.53e-05	-6.52e-06	0.0
78126	3.59e-04	-5.53e-04 -0.02	-6.22e-05	-1.19e-05	0.0
78152	-2.77e-03	8.94e-04 -0.01	-6.54e-05	-1.11e-05	0.0
78153	4.63e-04	4.35e-03 -0.01	-9.03e-05	-5.38e-06	0.0
78158	5.82e-04	-1.36e-03 -0.02	-5.79e-05	-1.29e-05	0.0
78170	-2.37e-04	1.71e-03 -0.02	-8.47e-05	-1.13e-05	0.0
78172	-2.07e-04	1.52e-03 -0.01	-7.54e-05	-9.76e-06	0.0
78173	-2.00e-04	1.47e-03 -0.01	-7.31e-05	-9.38e-06	0.0
7822	-5.41e-04	3.05e-03 -0.03	-1.51e-04	-2.67e-05	0.0
78220	-2.20e-03	1.39e-03 -0.02	-8.35e-05	-1.73e-05	0.0
78225	1.54e-04	4.25e-03 -0.02	-1.22e-04	-1.40e-05	0.0
78252	-2.95e-03	1.19e-03 -0.02	-7.94e-05	-1.76e-05	0.0
78257	3.49e-04	5.20e-03 -0.02	-1.33e-04	-1.31e-05	0.0
78270	-4.03e-04	2.22e-03 -0.02	-1.09e-04	-2.00e-05	0.0
78272	-3.49e-04	1.96e-03 -0.02	-9.68e-05	-1.72e-05	0.0
78273	-3.35e-04	1.89e-03 -0.02	-9.37e-05	-1.65e-05	0.0
7832	-8.62e-04	3.54e-03 -0.04	-1.74e-04	-4.43e-05	0.0
78319	-2.38e-03	2.62e-03 -0.02	-1.10e-04	-2.64e-05	0.0
78325	-1.81e-04	4.84e-03 -0.03	-1.49e-04	-3.14e-05	0.0
78351	-3.12e-03	2.80e-03 -0.02	-1.11e-04	-2.61e-05	0.0
78357	-4.19e-05	5.90e-03 -0.03	-1.66e-04	-3.31e-05	0.0
78370	-6.42e-04	2.58e-03 -0.03	-1.26e-04	-3.31e-05	0.0
78372	-5.52e-04	2.26e-03 -0.02	-1.11e-04	-2.83e-05	0.0
78373	-5.29e-04	2.18e-03 -0.02	-1.08e-04	-2.71e-05	0.0
7842	-1.09e-03	3.62e-03 -0.04	-1.77e-04	-5.58e-05	0.0
78415	-2.55e-03	3.02e-03 -0.03	-1.19e-04	-3.53e-05	0.0
78425	-4.34e-04	5.01e-03 -0.03	-1.57e-04	-4.39e-05	0.0
78447	-3.31e-03	3.33e-03 -0.03	-1.22e-04	-3.59e-05	0.0
78457	-3.42e-04	6.13e-03 -0.03	-1.77e-04	-4.79e-05	0.0
78470	-8.11e-04	2.63e-03 -0.03	-1.29e-04	-4.17e-05	0.0
78472	-6.93e-04	2.31e-03 -0.03	-1.13e-04	-3.55e-05	0.0
78473	-6.63e-04	2.22e-03 -0.03	-1.09e-04	-3.39e-05	0.0
7852	-8.72e-04	-3.17e-03 -0.04	1.57e-04	-4.40e-05	0.0
7858	-2.22e-03	-2.72e-03 -0.03	1.06e-04	-1.90e-05	0.0
78522	-3.34e-04	-4.56e-03 -0.03	1.36e-04	-3.79e-05	0.0
78526	-3.61e-04	-4.56e-03 -0.03	1.35e-04	-3.68e-05	0.0
78540	-2.90e-03	-3.03e-03 -0.03	1.10e-04	-1.59e-05	0.0
78554	-2.56e-04	-5.60e-03 -0.03	1.51e-04	-4.23e-05	0.0
78558	-2.94e-04	-5.61e-03 -0.03	1.51e-04	-4.08e-05	0.0
78570	-6.49e-04	-2.30e-03 -0.03	1.14e-04	-3.29e-05	0.0
78572	-5.53e-04	-2.03e-03 -0.03	1.00e-04	-2.79e-05	0.0
78573	-5.29e-04	-1.96e-03 -0.03	9.72e-05	-2.67e-05	0.0
7862	-6.11e-04	-3.01e-03 -0.03	1.49e-04	-3.08e-05	0.0



EGP CODE

GRE.EEC.R.73.IT.W.15235.12.024.01

PAGE

194 di/of 527

78611	-2.10e-03	-1.41e-03	-0.02	8.44e-05	-1.06e-05	0.0
78622	-1.30e-05	-4.30e-03	-0.02	1.24e-04	-2.27e-05	0.0
78626	-4.18e-05	-4.30e-03	-0.02	1.23e-04	-2.20e-05	0.0
78643	-2.79e-03	-1.23e-03	-0.02	8.11e-05	-7.30e-06	0.0
78654	1.31e-04	-5.27e-03	-0.02	1.36e-04	-2.43e-05	0.0
78658	9.10e-05	-5.28e-03	-0.02	1.35e-04	-2.32e-05	0.0
78670	-4.54e-04	-2.18e-03	-0.02	1.08e-04	-2.30e-05	0.0
78672	-3.90e-04	-1.93e-03	-0.02	9.57e-05	-1.96e-05	0.0
78673	-3.74e-04	-1.87e-03	-0.02	9.27e-05	-1.88e-05	0.0
7872	-3.90e-04	-2.55e-03	-0.02	1.26e-04	-1.93e-05	0.0
78711	-1.99e-03	-1.17e-03	-0.02	7.26e-05	-7.12e-06	0.0
78722	2.08e-04	-3.79e-03	-0.02	9.85e-05	-1.19e-05	0.0
78726	1.80e-04	-3.79e-03	-0.02	9.81e-05	-1.15e-05	0.0
78743	-2.69e-03	-1.00e-03	-0.02	7.02e-05	-5.22e-06	0.0
78754	3.88e-04	-4.67e-03	-0.02	1.06e-04	-1.20e-05	0.0
78758	3.49e-04	-4.68e-03	-0.02	1.06e-04	-1.13e-05	0.0
78770	-2.89e-04	-1.84e-03	-0.02	9.12e-05	-1.44e-05	0.0
78772	-2.51e-04	-1.64e-03	-0.02	8.13e-05	-1.24e-05	0.0
78773	-2.41e-04	-1.59e-03	-0.02	7.88e-05	-1.18e-05	0.0
7882	-2.39e-04	-1.94e-03	-0.02	9.61e-05	-1.13e-05	0.0
78811	-1.91e-03	-8.30e-04	-0.01	5.68e-05	-4.59e-06	0.0
78821	3.87e-04	7.53e-04	-0.01	5.26e-05	-9.84e-06	0.0
78826	3.09e-04	-3.20e-03	-0.01	6.86e-05	-5.58e-06	0.0
78843	-2.61e-03	-6.78e-04	-0.01	5.54e-05	-3.62e-06	0.0
78853	6.02e-04	1.54e-03	-0.01	4.95e-05	-1.10e-05	0.0
78858	4.93e-04	-4.00e-03	-0.01	7.20e-05	-5.00e-06	0.0
78870	-1.77e-04	-1.40e-03	-0.01	6.95e-05	-8.46e-06	0.0
78872	-1.55e-04	-1.25e-03	-0.01	6.21e-05	-7.30e-06	0.0
78873	-1.49e-04	-1.21e-03	-0.01	6.02e-05	-7.01e-06	0.0
7891	-1.27e-04	-1.12e-03	-0.01	5.58e-05	-5.43e-06	0.0
7892	-1.51e-04	-1.31e-03	-0.01	6.50e-05	-6.67e-06	0.0
78911	-1.84e-03	-4.63e-04	-0.01	3.96e-05	-2.93e-06	0.0
78921	4.34e-04	9.77e-04	-0.01	4.04e-05	-6.09e-06	0.0
78926	3.77e-04	-2.65e-03-9.99e-03		4.16e-05	-3.03e-06	0.0
78943	-2.53e-03	-3.19e-04	-0.01	3.92e-05	-2.44e-06	0.0
78953	6.46e-04	1.70e-03	-0.01	4.03e-05	-6.86e-06	0.0
78958	5.67e-04	-3.38e-03-9.78e-03		4.20e-05	-2.57e-06	0.0
78969	-9.52e-05	-8.23e-04	-0.01	4.08e-05	-4.16e-06	0.0
78970	-1.11e-04	-9.50e-04	-0.01	4.70e-05	-4.99e-06	0.0
78971	-9.52e-05	-8.23e-04	-0.01	4.08e-05	-4.16e-06	0.0
78972	-9.83e-05	-8.49e-04	-0.01	4.20e-05	-4.33e-06	0.0
78973	-9.52e-05	-8.23e-04	-0.01	4.08e-05	-4.16e-06	0.0
7901	-9.01e-05	-6.20e-04	-0.01	3.07e-05	-3.51e-06	0.0
7902	-1.05e-04	-7.24e-04	-0.01	3.56e-05	-4.28e-06	0.0
79011	-1.78e-03	-1.91e-04-8.93e-03		2.29e-05	-2.00e-06	0.0
79021	4.52e-04	1.27e-03-9.39e-03		2.74e-05	-3.75e-06	0.0
79026	4.18e-04	-2.18e-03-8.56e-03		1.77e-05	-2.11e-06	0.0
79043	-2.47e-03	-8.49e-05-8.92e-03		2.31e-05	-1.72e-06	0.0
79053	6.60e-04	1.96e-03-9.57e-03		2.93e-05	-4.17e-06	0.0
79058	6.12e-04	-2.87e-03-8.40e-03		1.58e-05	-1.87e-06	0.0
79069	-6.68e-05	-4.54e-04-8.95e-03		2.24e-05	-2.69e-06	0.0
79070	-7.65e-05	-5.23e-04-8.67e-03		2.57e-05	-3.21e-06	0.0
79071	-6.68e-05	-4.54e-04-8.95e-03		2.24e-05	-2.69e-06	0.0
79072	-6.88e-05	-4.68e-04-8.89e-03		2.31e-05	-2.80e-06	0.0
79073	-6.68e-05	-4.54e-04-8.95e-03		2.24e-05	-2.69e-06	0.0
7911	-7.64e-05	-1.46e-04	-0.01	7.04e-06	-2.78e-06	0.0
7912	-8.76e-05	-1.71e-04	-0.01	8.17e-06	-3.38e-06	0.0
79111	-1.74e-03	1.45e-04-8.21e-03		6.21e-06	-1.60e-06	0.0
79121	4.49e-04	1.58e-03-8.40e-03		1.21e-05	-2.52e-06	0.0
79124	-5.62e-04	-1.79e-03-8.14e-03		-1.80e-06	-1.75e-06	0.0
79143	-2.42e-03	2.47e-04-8.18e-03		6.64e-06	-1.38e-06	0.0
79153	6.52e-04	2.25e-03-8.45e-03		1.49e-05	-2.68e-06	0.0
79156	-7.64e-04	-2.47e-03-8.09e-03		-4.58e-06	-1.60e-06	0.0
79169	-5.63e-05	-1.07e-04-8.27e-03		5.15e-06	-2.14e-06	0.0
79170	-6.38e-05	-1.23e-04-7.89e-03		5.90e-06	-2.53e-06	0.0
79171	-5.63e-05	-1.07e-04-8.27e-03		5.15e-06	-2.14e-06	0.0
79172	-5.78e-05	-1.10e-04-8.19e-03		5.30e-06	-2.22e-06	0.0
79173	-5.63e-05	-1.07e-04-8.27e-03		5.15e-06	-2.14e-06	0.0
7921	-8.11e-05	3.20e-04	-0.01	-1.62e-05	-2.99e-06	0.0
7922	-9.34e-05	3.73e-04	-0.01	-1.88e-05	-3.64e-06	0.0
79220	-1.75e-03	-2.24e-05-8.40e-03		-1.28e-05	-1.74e-06	0.0
79221	4.30e-04	1.93e-03-8.21e-03		-5.45e-06	-2.13e-06	0.0
79222	4.50e-04	-1.43e-03-8.70e-03		-1.83e-05	-2.80e-06	0.0
79252	-2.43e-03	-1.25e-04-8.38e-03		-1.32e-05	-1.52e-06	0.0
79253	6.26e-04	2.61e-03-8.12e-03		-2.90e-06	-2.06e-06	0.0
79254	6.54e-04	-2.10e-03-8.81e-03		-2.09e-05	-3.00e-06	0.0



EGP CODE

GRE.EEC.R.73.IT.W.15235.12.024.01

PAGE

195 di/of 527

79269	-5.99e-05	2.34e-04-8.43e-03	-1.18e-05	-2.30e-06	0.0
79270	-6.81e-05	2.69e-04-8.08e-03	-1.36e-05	-2.73e-06	0.0
79271	-5.99e-05	2.34e-04-8.43e-03	-1.18e-05	-2.30e-06	0.0
79272	-6.16e-05	2.41e-04-8.36e-03	-1.22e-05	-2.38e-06	0.0
79273	-5.99e-05	2.34e-04-8.43e-03	-1.18e-05	-2.30e-06	0.0
7931	-1.05e-04	8.04e-04 -0.01	-4.03e-05	-4.19e-06	0.0
7932	-1.24e-04	9.39e-04 -0.01	-4.69e-05	-5.13e-06	0.0
79320	-1.80e-03	3.16e-04-9.44e-03	-2.96e-05	-2.40e-06	0.0
79321	3.97e-04	2.35e-03-8.97e-03	-2.63e-05	-2.51e-06	0.0
79326	4.49e-04	-1.17e-03-9.98e-03	-3.29e-05	-4.47e-06	0.0
79352	-2.49e-03	2.07e-04-9.44e-03	-2.97e-05	-2.08e-06	0.0
79353	5.88e-04	3.05e-03-8.78e-03	-2.50e-05	-2.22e-06	0.0
79358	6.60e-04	-1.87e-03 -0.01	-3.43e-05	-4.97e-06	0.0
79369	-7.86e-05	5.89e-04-9.45e-03	-2.95e-05	-3.22e-06	0.0
79370	-9.09e-05	6.79e-04-9.25e-03	-3.39e-05	-3.84e-06	0.0
79371	-7.86e-05	5.89e-04-9.45e-03	-2.95e-05	-3.22e-06	0.0
79372	-8.11e-05	6.07e-04-9.41e-03	-3.04e-05	-3.34e-06	0.0
79373	-7.86e-05	5.89e-04-9.45e-03	-2.95e-05	-3.22e-06	0.0
7942	-1.88e-04	1.55e-03 -0.02	-7.71e-05	-8.34e-06	0.0
79420	-1.86e-03	6.03e-04 -0.01	-4.66e-05	-3.68e-06	0.0
79421	3.45e-04	2.85e-03 -0.01	-5.15e-05	-3.95e-06	0.0
79426	4.19e-04	-8.90e-04 -0.01	-4.58e-05	-7.35e-06	0.0
79452	-2.56e-03	4.57e-04 -0.01	-4.58e-05	-3.07e-06	0.0
79453	5.31e-04	3.61e-03 -0.01	-5.28e-05	-3.46e-06	0.0
79458	6.35e-04	-1.64e-03 -0.01	-4.48e-05	-8.22e-06	0.0
79470	-1.39e-04	1.12e-03 -0.01	-5.57e-05	-6.24e-06	0.0
79472	-1.22e-04	9.99e-04 -0.01	-4.99e-05	-5.40e-06	0.0
79473	-1.18e-04	9.69e-04 -0.01	-4.84e-05	-5.19e-06	0.0
7952	-3.01e-04	2.18e-03 -0.02	-1.09e-04	-1.41e-05	0.0
79514	1.52e-03	7.70e-04 -0.01	-6.65e-05	-1.26e-05	0.0
79520	-1.94e-03	9.66e-04 -0.01	-6.33e-05	-5.70e-06	0.0
79521	2.56e-04	3.43e-03 -0.01	-8.04e-05	-7.47e-06	0.0
79546	2.20e-03	5.32e-04 -0.01	-6.59e-05	-1.42e-05	0.0
79552	-2.64e-03	8.08e-04 -0.01	-6.15e-05	-4.49e-06	0.0
79553	4.34e-04	4.26e-03 -0.01	-8.55e-05	-6.96e-06	0.0
79570	-2.24e-04	1.58e-03 -0.01	-7.85e-05	-1.06e-05	0.0
79572	-1.95e-04	1.40e-03 -0.01	-7.00e-05	-9.09e-06	0.0
79573	-1.87e-04	1.36e-03 -0.01	-6.79e-05	-8.72e-06	0.0
7962	-4.81e-04	2.76e-03 -0.03	-1.37e-04	-2.34e-05	0.0
79620	-2.04e-03	1.28e-03 -0.02	-7.80e-05	-8.80e-06	0.0
79621	9.40e-05	4.02e-03 -0.02	-1.10e-04	-1.49e-05	0.0
79625	1.21e-04	4.02e-03 -0.02	-1.10e-04	-1.55e-05	0.0
79652	-2.73e-03	1.10e-03 -0.02	-7.50e-05	-6.56e-06	0.0
79653	2.50e-04	4.95e-03 -0.02	-1.19e-04	-1.51e-05	0.0
79657	2.87e-04	4.94e-03 -0.02	-1.20e-04	-1.59e-05	0.0
79670	-3.58e-04	2.00e-03 -0.02	-9.92e-05	-1.75e-05	0.0
79672	-3.09e-04	1.77e-03 -0.02	-8.82e-05	-1.50e-05	0.0
79673	-2.96e-04	1.71e-03 -0.02	-8.55e-05	-1.44e-05	0.0
7972	-7.24e-04	3.13e-03 -0.03	-1.56e-04	-3.61e-05	0.0
79719	-2.15e-03	2.37e-03 -0.02	-9.99e-05	-1.45e-05	0.0
79721	-1.65e-04	4.47e-03 -0.03	-1.32e-04	-2.74e-05	0.0
79725	-1.38e-04	4.46e-03 -0.03	-1.32e-04	-2.83e-05	0.0
79751	-2.84e-03	2.54e-03 -0.02	-1.01e-04	-1.15e-05	0.0
79753	-5.39e-05	5.48e-03 -0.03	-1.45e-04	-2.96e-05	0.0
79757	-1.60e-05	5.48e-03 -0.03	-1.46e-04	-3.09e-05	0.0
79770	-5.39e-04	2.27e-03 -0.02	-1.13e-04	-2.70e-05	0.0
79772	-4.61e-04	2.01e-03 -0.02	-9.98e-05	-2.30e-05	0.0
79773	-4.42e-04	1.94e-03 -0.02	-9.67e-05	-2.20e-05	0.0
7982	-8.78e-04	3.20e-03 -0.04	-1.59e-04	-4.42e-05	0.0
79815	-2.23e-03	2.74e-03 -0.03	-1.07e-04	-1.87e-05	0.0
79821	-3.67e-04	4.60e-03 -0.03	-1.37e-04	-3.71e-05	0.0
79825	-3.41e-04	4.59e-03 -0.03	-1.38e-04	-3.82e-05	0.0
79847	-2.91e-03	3.04e-03 -0.03	-1.10e-04	-1.55e-05	0.0
79853	-3.00e-04	5.65e-03 -0.03	-1.53e-04	-4.12e-05	0.0
79857	-2.64e-04	5.64e-03 -0.03	-1.54e-04	-4.28e-05	0.0
79870	-6.54e-04	2.32e-03 -0.03	-1.15e-04	-3.30e-05	0.0
79872	-5.58e-04	2.05e-03 -0.03	-1.02e-04	-2.80e-05	0.0
79873	-5.33e-04	1.98e-03 -0.03	-9.84e-05	-2.68e-05	0.0
7992	-3.78e-04	-2.96e-03 -0.04	1.47e-04	-1.86e-05	0.0
79912	-1.83e-03	-2.33e-03 -0.03	9.81e-05	1.59e-06	0.0
79924	-8.69e-04	-4.35e-03 -0.03	1.25e-04	-1.03e-05	0.0
79928	-8.47e-04	-4.34e-03 -0.03	1.25e-04	-1.18e-05	0.0
79944	-2.47e-03	-2.53e-03 -0.03	1.01e-04	6.68e-06	0.0
79956	-1.13e-03	-5.35e-03 -0.03	1.38e-04	-1.00e-05	0.0
79960	-1.09e-03	-5.34e-03 -0.03	1.38e-04	-1.21e-05	0.0
79970	-2.80e-04	-2.14e-03 -0.03	1.06e-04	-1.38e-05	0.0





EGP CODE

GRE.EEC.R.73.IT.W.15235.12.024.01

PAGE

196 di/of 527

79972	-2.37e-04	-1.90e-03	-0.03	9.44e-05	-1.16e-05	0.0
79973	-2.27e-04	-1.84e-03	-0.02	9.14e-05	-1.11e-05	0.0
8002	-2.80e-04	-2.81e-03	-0.03	1.40e-04	-1.36e-05	0.0
80011	-1.83e-03	-1.40e-03	-0.02	8.30e-05	3.27e-06	0.0
80024	-7.67e-04	-4.14e-03	-0.02	1.14e-04	-6.13e-06	0.0
80028	-7.42e-04	-4.13e-03	-0.02	1.15e-04	-7.24e-06	0.0
80043	-2.49e-03	-1.26e-03	-0.02	8.13e-05	7.86e-06	0.0
80056	-1.01e-03	-5.09e-03	-0.02	1.25e-04	-5.31e-06	0.0
80060	-9.72e-04	-5.09e-03	-0.02	1.25e-04	-6.87e-06	0.0
80070	-2.07e-04	-2.03e-03	-0.02	1.01e-04	-1.01e-05	0.0
80072	-1.77e-04	-1.81e-03	-0.02	9.00e-05	-8.57e-06	0.0
80073	-1.70e-04	-1.75e-03	-0.02	8.73e-05	-8.17e-06	0.0
8012	-1.93e-04	-2.39e-03	-0.02	1.19e-04	-9.17e-06	0.0
80111	-1.81e-03	-1.18e-03	-0.02	7.17e-05	1.94e-06	0.0
80124	-6.85e-04	-3.69e-03	-0.02	9.24e-05	-2.96e-06	0.0
80143	-2.49e-03	-1.05e-03	-0.02	7.06e-05	4.94e-06	0.0
80156	-9.11e-04	-4.58e-03	-0.02	9.95e-05	-1.92e-06	0.0
80170	-1.42e-04	-1.73e-03	-0.02	8.60e-05	-6.84e-06	0.0
80172	-1.23e-04	-1.54e-03	-0.02	7.68e-05	-5.80e-06	0.0
80173	-1.18e-04	-1.50e-03	-0.02	7.46e-05	-5.54e-06	0.0
8022	-1.30e-04	-1.84e-03	-0.02	9.16e-05	-5.85e-06	0.0
80211	-1.80e-03	-8.67e-04	-0.01	5.62e-05	1.21e-06	0.0
80224	-6.29e-04	-3.16e-03	-0.01	6.58e-05	-1.39e-06	0.0
80225	4.46e-04	8.23e-04	-0.01	4.90e-05	-5.26e-06	0.0
80243	-2.48e-03	-7.52e-04	-0.01	5.56e-05	3.13e-06	0.0
80256	-8.49e-04	-3.97e-03	-0.01	6.92e-05	0.0	0.0
80257	6.57e-04	1.61e-03	-0.01	4.57e-05	-5.94e-06	0.0
80270	-9.51e-05	-1.33e-03	-0.01	6.61e-05	-4.37e-06	0.0
80272	-8.37e-05	-1.19e-03	-0.01	5.92e-05	-3.73e-06	0.0
80273	-8.08e-05	-1.15e-03	-0.01	5.74e-05	-3.57e-06	0.0
8031	-7.81e-05	-1.08e-03	-0.01	5.37e-05	-3.02e-06	0.0
8032	-9.08e-05	-1.26e-03	-0.01	6.24e-05	-3.76e-06	0.0
80311	-1.77e-03	-5.32e-04	-0.01	3.93e-05	0.0	0.0
80324	-5.93e-04	-2.64e-03	-9.83e-03	4.02e-05	0.0	0.0
80325	4.61e-04	1.03e-03	-0.01	3.83e-05	-3.56e-06	0.0
80343	-2.46e-03	-4.29e-04	-0.01	3.93e-05	1.50e-06	0.0
80356	-8.08e-04	-3.39e-03	-9.63e-03	4.06e-05	0.0	0.0
80357	6.69e-04	1.76e-03	-0.01	3.80e-05	-4.06e-06	0.0
80369	-5.74e-05	-7.89e-04	-0.01	3.93e-05	-2.31e-06	0.0
80370	-6.58e-05	-9.09e-04	-0.01	4.51e-05	-2.81e-06	0.0
80371	-5.74e-05	-7.89e-04	-0.01	3.93e-05	-2.31e-06	0.0
80372	-5.91e-05	-8.13e-04	-0.01	4.04e-05	-2.41e-06	0.0
80373	-5.74e-05	-7.89e-04	-0.01	3.93e-05	-2.31e-06	0.0
8041	-6.18e-05	-5.99e-04	-0.01	2.97e-05	-2.13e-06	0.0
8042	-6.99e-05	-6.97e-04	-0.01	3.44e-05	-2.62e-06	0.0
80411	-1.75e-03	-1.98e-04	-8.87e-03	2.27e-05	0.0	0.0
80424	-5.66e-04	-2.19e-03	-8.44e-03	1.74e-05	0.0	0.0
80425	4.66e-04	1.28e-03	-9.23e-03	2.60e-05	-2.41e-06	0.0
80443	-2.43e-03	-1.02e-04	-8.88e-03	2.31e-05	0.0	0.0
80456	-7.75e-04	-2.90e-03	-8.28e-03	1.57e-05	0.0	0.0
80457	6.70e-04	1.97e-03	-9.39e-03	2.78e-05	-2.72e-06	0.0
80469	-4.49e-05	-4.38e-04	-8.83e-03	2.17e-05	-1.63e-06	0.0
80470	-5.03e-05	-5.03e-04	-8.54e-03	2.49e-05	-1.96e-06	0.0
80471	-4.49e-05	-4.38e-04	-8.83e-03	2.17e-05	-1.63e-06	0.0
80472	-4.59e-05	-4.51e-04	-8.77e-03	2.23e-05	-1.70e-06	0.0
80473	-4.49e-05	-4.38e-04	-8.83e-03	2.17e-05	-1.63e-06	0.0
8051	-5.58e-05	-1.41e-04	-0.01	6.85e-06	-1.79e-06	0.0
8052	-6.22e-05	-1.65e-04	-9.98e-03	7.94e-06	-2.18e-06	0.0
80511	-1.72e-03	1.29e-04	-8.15e-03	6.30e-06	0.0	0.0
80524	-5.45e-04	-1.82e-03	-8.07e-03	-1.47e-06	0.0	0.0
80525	4.60e-04	1.57e-03	-8.28e-03	1.15e-05	-1.80e-06	0.0
80543	-2.39e-03	2.23e-04	-8.14e-03	6.83e-06	0.0	0.0
80556	-7.46e-04	-2.50e-03	-8.03e-03	-4.06e-06	0.0	0.0
80557	6.61e-04	2.24e-03	-8.33e-03	1.41e-05	-1.97e-06	0.0
80569	-4.03e-05	-1.03e-04	-8.18e-03	5.00e-06	-1.37e-06	0.0
80570	-4.46e-05	-1.19e-04	-7.78e-03	5.73e-06	-1.64e-06	0.0
80571	-4.03e-05	-1.03e-04	-8.18e-03	5.00e-06	-1.37e-06	0.0
80572	-4.11e-05	-1.07e-04	-8.10e-03	5.15e-06	-1.42e-06	0.0
80573	-4.03e-05	-1.03e-04	-8.18e-03	5.00e-06	-1.37e-06	0.0
8061	-5.83e-05	3.09e-04	-0.01	-1.57e-05	-1.88e-06	0.0
8062	-6.54e-05	3.59e-04	-0.01	-1.81e-05	-2.31e-06	0.0
80620	-1.72e-03	-8.98e-06	-8.34e-03	-1.27e-05	0.0	0.0
80622	4.68e-04	-1.46e-03	-8.58e-03	-1.74e-05	-1.95e-06	0.0
80627	-5.56e-04	1.95e-03	-8.09e-03	-5.51e-06	0.0	0.0
80652	-2.40e-03	-1.03e-04	-8.34e-03	-1.32e-05	0.0	0.0
80654	6.72e-04	-2.14e-03	-8.68e-03	-1.98e-05	-2.15e-06	0.0



EGP CODE

GRE.EEC.R.73.IT.W.15235.12.024.01

PAGE

197 di/of 527

80659	-7.62e-04	2.64e-03-7.99e-03	-3.14e-06	0.0	0.0
80669	-4.22e-05	2.26e-04-8.33e-03	-1.14e-05	-1.45e-06	0.0
80670	-4.70e-05	2.59e-04-7.96e-03	-1.31e-05	-1.73e-06	0.0
80671	-4.22e-05	2.26e-04-8.33e-03	-1.14e-05	-1.45e-06	0.0
80672	-4.31e-05	2.33e-04-8.26e-03	-1.18e-05	-1.50e-06	0.0
80673	-4.22e-05	2.26e-04-8.33e-03	-1.14e-05	-1.45e-06	0.0
8071	-6.97e-05	7.75e-04 -0.01	-3.90e-05	-2.44e-06	0.0
8072	-8.00e-05	9.03e-04 -0.01	-4.52e-05	-3.02e-06	0.0
80720	-1.76e-03	3.21e-04-9.37e-03	-2.93e-05	0.0	0.0
80722	4.69e-04	-1.19e-03-9.80e-03	-3.12e-05	-2.77e-06	0.0
80727	-5.82e-04	2.36e-03-8.84e-03	-2.58e-05	0.0	0.0
80752	-2.44e-03	2.22e-04-9.39e-03	-2.96e-05	0.0	0.0
80754	6.77e-04	-1.89e-03-9.99e-03	-3.23e-05	-3.13e-06	0.0
80759	-7.95e-04	3.07e-03-8.65e-03	-2.47e-05	0.0	0.0
80769	-5.09e-05	5.67e-04-9.31e-03	-2.85e-05	-1.87e-06	0.0
80770	-5.78e-05	6.52e-04-9.09e-03	-3.26e-05	-2.26e-06	0.0
80771	-5.09e-05	5.67e-04-9.31e-03	-2.85e-05	-1.87e-06	0.0
80772	-5.23e-05	5.84e-04-9.27e-03	-2.93e-05	-1.95e-06	0.0
80773	-5.09e-05	5.67e-04-9.31e-03	-2.85e-05	-1.87e-06	0.0
8082	-1.10e-04	1.48e-03 -0.01	-7.39e-05	-4.49e-06	0.0
80820	-1.78e-03	6.57e-04 -0.01	-4.60e-05	0.0	0.0
80822	4.59e-04	-9.50e-04 -0.01	-4.29e-05	-4.16e-06	0.0
80827	-6.13e-04	2.84e-03 -0.01	-4.99e-05	-1.03e-06	0.0
80852	-2.47e-03	5.49e-04 -0.01	-4.59e-05	1.82e-06	0.0
80854	6.71e-04	-1.70e-03 -0.01	-4.15e-05	-4.71e-06	0.0
80859	-8.31e-04	3.60e-03 -0.01	-5.13e-05	0.0	0.0
80870	-7.98e-05	1.07e-03 -0.01	-5.33e-05	-3.36e-06	0.0
80872	-7.08e-05	9.55e-04 -0.01	-4.78e-05	-2.88e-06	0.0
80873	-6.86e-05	9.26e-04 -0.01	-4.64e-05	-2.76e-06	0.0
8092	-1.59e-04	2.06e-03 -0.02	-1.03e-04	-7.01e-06	0.0
80920	-1.81e-03	9.87e-04 -0.01	-6.27e-05	1.42e-06	0.0
80922	4.39e-04	-7.61e-04 -0.01	-5.25e-05	-6.06e-06	0.0
80927	-6.57e-04	3.37e-03 -0.01	-7.67e-05	-1.89e-06	0.0
80952	-2.49e-03	8.66e-04 -0.01	-6.19e-05	3.70e-06	0.0
80954	6.55e-04	-1.58e-03 -0.01	-4.76e-05	-6.78e-06	0.0
80959	-8.80e-04	4.21e-03 -0.01	-8.15e-05	0.0	0.0
80970	-1.17e-04	1.49e-03 -0.01	-7.44e-05	-5.23e-06	0.0
80972	-1.02e-04	1.33e-03 -0.01	-6.66e-05	-4.46e-06	0.0
80973	-9.82e-05	1.29e-03 -0.01	-6.46e-05	-4.26e-06	0.0
8102	-2.33e-04	2.59e-03 -0.02	-1.29e-04	-1.08e-05	0.0
81020	-1.83e-03	1.27e-03 -0.02	-7.72e-05	2.66e-06	0.0
81027	-7.23e-04	3.89e-03 -0.02	-1.03e-04	-3.59e-06	0.0
81052	-2.50e-03	1.14e-03 -0.02	-7.58e-05	6.33e-06	0.0
81059	-9.56e-04	4.81e-03 -0.02	-1.11e-04	-2.42e-06	0.0
81070	-1.72e-04	1.87e-03 -0.02	-9.32e-05	-8.05e-06	0.0
81072	-1.48e-04	1.66e-03 -0.02	-8.32e-05	-6.82e-06	0.0
81073	-1.42e-04	1.61e-03 -0.02	-8.07e-05	-6.51e-06	0.0
8112	-3.27e-04	2.92e-03 -0.03	-1.46e-04	-1.56e-05	0.0
81120	-1.84e-03	1.45e-03 -0.02	-8.60e-05	3.89e-06	0.0
81123	-7.93e-04	4.24e-03 -0.02	-1.22e-04	-8.87e-06	0.0
81127	-8.15e-04	4.27e-03 -0.02	-1.21e-04	-7.61e-06	0.0
81152	-2.49e-03	1.30e-03 -0.02	-8.40e-05	9.20e-06	0.0
81155	-1.03e-03	5.21e-03 -0.02	-1.34e-04	-8.69e-06	0.0
81159	-1.06e-03	5.25e-03 -0.02	-1.34e-04	-6.91e-06	0.0
81170	-2.42e-04	2.11e-03 -0.02	-1.05e-04	-1.17e-05	0.0
81172	-2.06e-04	1.88e-03 -0.02	-9.38e-05	-9.82e-06	0.0
81173	-1.97e-04	1.82e-03 -0.02	-9.09e-05	-9.36e-06	0.0
8122	-3.86e-04	2.98e-03 -0.04	-1.49e-04	-1.87e-05	0.0
81219	-1.83e-03	2.34e-03 -0.03	-9.93e-05	1.91e-06	0.0
81223	-8.57e-04	4.34e-03 -0.03	-1.26e-04	-1.18e-05	0.0
81227	-8.77e-04	4.37e-03 -0.03	-1.26e-04	-1.03e-05	0.0
81251	-2.48e-03	2.53e-03 -0.03	-1.02e-04	7.15e-06	0.0
81255	-1.11e-03	5.34e-03 -0.03	-1.40e-04	-1.20e-05	0.0
81259	-1.14e-03	5.38e-03 -0.03	-1.40e-04	-9.90e-06	0.0
81270	-2.86e-04	2.16e-03 -0.03	-1.08e-04	-1.39e-05	0.0
81272	-2.43e-04	1.91e-03 -0.03	-9.55e-05	-1.17e-05	0.0
81273	-2.32e-04	1.85e-03 -0.02	-9.25e-05	-1.11e-05	0.0
8132	2.07e-04	-2.95e-03 -0.04	1.46e-04	1.15e-05	0.0
81310	1.74e-03	-2.13e-03 -0.02	9.34e-05	-6.00e-06	0.0
81324	-3.96e-04	-4.37e-03 -0.03	1.25e-04	1.51e-05	0.0
81342	2.38e-03	-2.25e-03 -0.02	9.43e-05	-1.14e-05	0.0
81356	-6.08e-04	-5.39e-03 -0.03	1.39e-04	1.83e-05	0.0
81370	1.59e-04	-2.13e-03 -0.03	1.06e-04	8.69e-06	0.0
81372	1.37e-04	-1.89e-03 -0.03	9.42e-05	7.62e-06	0.0
81373	1.31e-04	-1.83e-03 -0.02	9.12e-05	7.36e-06	0.0
8142	1.33e-04	-2.80e-03 -0.03	1.39e-04	7.49e-06	0.0



EGP CODE

GRE.EEC.R.73.IT.W.15235.12.024.01

PAGE

198 di/of 527

81410	1.74e-03	-2.03e-03	-0.02	8.83e-05	-5.69e-06	0.0
81424	-4.79e-04	-4.17e-03	-0.02	1.15e-04	9.49e-06	0.0
81442	2.41e-03	-2.14e-03	-0.02	8.88e-05	-9.92e-06	0.0
81456	-7.04e-04	-5.14e-03	-0.02	1.26e-04	1.13e-05	0.0
81470	1.02e-04	-2.02e-03	-0.02	1.01e-04	5.65e-06	0.0
81472	8.83e-05	-1.80e-03	-0.02	8.98e-05	5.00e-06	0.0
81473	8.48e-05	-1.75e-03	-0.02	8.71e-05	4.84e-06	0.0
8152	6.94e-05	-2.38e-03	-0.02	1.19e-04	4.14e-06	0.0
8158	-1.61e-03	-2.27e-03	-0.02	8.29e-05	1.06e-05	0.0
81510	1.74e-03	-1.74e-03	-0.02	7.42e-05	-5.52e-06	0.0
81524	-5.32e-04	-3.72e-03	-0.02	9.29e-05	4.56e-06	0.0
81540	-2.28e-03	-2.58e-03	-0.02	8.64e-05	1.37e-05	0.0
81542	2.42e-03	-1.85e-03	-0.02	7.41e-05	-8.82e-06	0.0
81556	-7.62e-04	-4.62e-03	-0.02	1.00e-04	5.30e-06	0.0
81570	5.47e-05	-1.72e-03	-0.02	8.56e-05	3.13e-06	0.0
81572	4.67e-05	-1.54e-03	-0.02	7.65e-05	2.81e-06	0.0
81573	4.46e-05	-1.49e-03	-0.02	7.43e-05	2.73e-06	0.0
8162	2.56e-05	-1.83e-03	-0.02	9.10e-05	1.92e-06	0.0
8164	2.80e-05	-1.33e-03	-0.01	6.60e-05	1.54e-06	0.0
81610	1.73e-03	-1.38e-03	-0.01	5.60e-05	-3.98e-06	0.0
81623	-4.11e-04	8.27e-04	-0.01	4.98e-05	3.47e-06	0.0
81624	-5.54e-04	-3.19e-03	-0.01	6.62e-05	2.22e-06	0.0
81642	2.42e-03	-1.47e-03	-0.01	5.56e-05	-6.10e-06	0.0
81655	-5.82e-04	1.62e-03	-0.01	4.68e-05	4.35e-06	0.0
81656	-7.83e-04	-4.01e-03	-0.01	6.98e-05	2.60e-06	0.0
81670	2.17e-05	-1.32e-03	-0.01	6.57e-05	1.46e-06	0.0
81672	1.74e-05	-1.18e-03	-0.01	5.89e-05	1.33e-06	0.0
81673	1.63e-05	-1.15e-03	-0.01	5.72e-05	1.30e-06	0.0
8171	-4.81e-06	-1.07e-03	-0.01	5.35e-05	0.0	0.0
8172	0.0	-1.25e-03	-0.01	6.21e-05	0.0	0.0
8174	6.89e-06	-9.10e-04	-0.01	4.49e-05	0.0	0.0
81711	-1.72e-03	-5.70e-04	-0.01	4.07e-05	3.73e-06	0.0
81723	-4.55e-04	1.04e-03	-0.01	3.88e-05	1.88e-06	0.0
81724	-5.54e-04	-2.67e-03-9.84e-03		4.05e-05	0.0	0.0
81743	-2.40e-03	-4.83e-04	-0.01	4.13e-05	5.04e-06	0.0
81755	-6.36e-04	1.77e-03	-0.01	3.87e-05	2.44e-06	0.0
81756	-7.75e-04	-3.42e-03-9.65e-03		4.11e-05	1.14e-06	0.0
81769	0.0	-7.86e-04	-0.01	3.91e-05	0.0	0.0
81770	1.86e-06	-9.04e-04	-0.01	4.48e-05	0.0	0.0
81771	0.0	-7.86e-04	-0.01	3.91e-05	0.0	0.0
81772	0.0	-8.09e-04	-0.01	4.02e-05	0.0	0.0
81773	0.0	-7.86e-04	-0.01	3.91e-05	0.0	0.0
8181	-1.69e-05	-5.96e-04	-0.01	2.96e-05	0.0	0.0
8182	-1.47e-05	-6.93e-04	-0.01	3.43e-05	0.0	0.0
81811	-1.71e-03	-2.26e-04-8.92e-03		2.34e-05	2.06e-06	0.0
81823	-4.87e-04	1.29e-03-9.19e-03		2.63e-05	0.0	0.0
81824	-5.40e-04	-2.22e-03-8.43e-03		1.76e-05	0.0	0.0
81843	-2.39e-03	-1.42e-04-8.97e-03		2.42e-05	2.87e-06	0.0
81855	-6.78e-04	1.99e-03-9.35e-03		2.82e-05	1.19e-06	0.0
81856	-7.52e-04	-2.93e-03-8.28e-03		1.60e-05	0.0	0.0
81869	-1.02e-05	-4.36e-04-8.79e-03		2.16e-05	0.0	0.0
81870	-8.74e-06	-5.00e-04-8.48e-03		2.47e-05	0.0	0.0
81871	-1.02e-05	-4.36e-04-8.79e-03		2.16e-05	0.0	0.0
81872	-9.91e-06	-4.49e-04-8.73e-03		2.22e-05	0.0	0.0
81873	-1.02e-05	-4.36e-04-8.79e-03		2.16e-05	0.0	0.0
8191	-2.20e-05	-1.41e-04	-0.01	6.83e-06	0.0	0.0
8192	-2.06e-05	-1.63e-04-9.92e-03		7.90e-06	0.0	0.0
81911	-1.69e-03	1.07e-04-8.17e-03		6.57e-06	1.25e-06	0.0
81923	-5.10e-04	1.59e-03-8.24e-03		1.16e-05	0.0	0.0
81924	-5.20e-04	-1.84e-03-8.05e-03		-1.34e-06	0.0	0.0
81943	-2.36e-03	1.91e-04-8.19e-03		7.20e-06	1.79e-06	0.0
81955	-7.08e-04	2.26e-03-8.28e-03		1.43e-05	0.0	0.0
81956	-7.22e-04	-2.54e-03-8.02e-03		-3.87e-06	0.0	0.0
81969	-1.41e-05	-1.03e-04-8.14e-03		4.98e-06	0.0	0.0
81970	-1.32e-05	-1.18e-04-7.74e-03		5.70e-06	0.0	0.0
81971	-1.41e-05	-1.03e-04-8.14e-03		4.98e-06	0.0	0.0
81972	-1.39e-05	-1.06e-04-8.06e-03		5.13e-06	0.0	0.0
81973	-1.41e-05	-1.03e-04-8.14e-03		4.98e-06	0.0	0.0
8201	-2.15e-05	3.08e-04	-0.01	-1.56e-05	0.0	0.0
8202	-2.01e-05	3.58e-04	-0.01	-1.80e-05	0.0	0.0
82020	-1.69e-03	1.60e-05-8.37e-03		-1.31e-05	1.43e-06	0.0
82027	-5.31e-04	1.97e-03-8.07e-03		-5.65e-06	0.0	0.0
82028	-4.98e-04	-1.47e-03-8.54e-03		-1.76e-05	0.0	0.0
82052	-2.37e-03	-6.80e-05-8.40e-03		-1.38e-05	2.03e-06	0.0
82059	-7.39e-04	2.67e-03-7.98e-03		-3.36e-06	0.0	0.0
82060	-6.92e-04	-2.15e-03-8.64e-03		-2.01e-05	0.0	0.0



EGP CODE

GRE.EEC.R.73.IT.W.15235.12.024.01

PAGE

199 di/of 527

82069	-1.37e-05	2.25e-04-8.29e-03	-1.14e-05	0.0	0.0
82070	-1.28e-05	2.59e-04-7.92e-03	-1.30e-05	0.0	0.0
82071	-1.37e-05	2.25e-04-8.29e-03	-1.14e-05	0.0	0.0
82072	-1.35e-05	2.32e-04-8.22e-03	-1.17e-05	0.0	0.0
82073	-1.37e-05	2.25e-04-8.29e-03	-1.14e-05	0.0	0.0
8211	-1.49e-05	7.73e-04 -0.01	-3.88e-05	0.0	0.0
8212	-1.27e-05	8.99e-04 -0.01	-4.50e-05	0.0	0.0
82120	-1.71e-03	3.53e-04-9.43e-03	-3.02e-05	2.51e-06	0.0
82127	-5.50e-04	2.38e-03-8.83e-03	-2.60e-05	0.0	0.0
82128	-4.73e-04	-1.20e-03-9.77e-03	-3.15e-05	1.19e-06	0.0
82152	-2.39e-03	2.68e-04-9.50e-03	-3.09e-05	3.44e-06	0.0
82159	-7.67e-04	3.11e-03-8.65e-03	-2.51e-05	0.0	0.0
82160	-6.58e-04	-1.90e-03-9.96e-03	-3.28e-05	1.59e-06	0.0
82169	-8.67e-06	5.65e-04-9.27e-03	-2.83e-05	0.0	0.0
82170	-7.17e-06	6.49e-04-9.03e-03	-3.24e-05	0.0	0.0
82171	-8.67e-06	5.65e-04-9.27e-03	-2.83e-05	0.0	0.0
82172	-8.37e-06	5.82e-04-9.22e-03	-2.92e-05	0.0	0.0
82173	-8.67e-06	5.65e-04-9.27e-03	-2.83e-05	0.0	0.0
8222	4.37e-06	1.47e-03 -0.01	-7.35e-05	1.09e-06	0.0
8224	1.09e-05	1.07e-03 -0.01	-5.32e-05	0.0	0.0
82217	1.72e-03	1.14e-03 -0.01	-4.48e-05	-3.06e-06	0.0
82227	-5.61e-04	2.86e-03 -0.01	-5.03e-05	1.31e-06	0.0
82228	-4.37e-04	-9.57e-04 -0.01	-4.35e-05	2.40e-06	0.0
82249	2.40e-03	1.23e-03 -0.01	-4.42e-05	-4.58e-06	0.0
82259	-7.87e-04	3.64e-03 -0.01	-5.19e-05	1.54e-06	0.0
82260	-6.13e-04	-1.71e-03 -0.01	-4.24e-05	3.06e-06	0.0
82270	5.73e-06	1.06e-03 -0.01	-5.30e-05	0.0	0.0
82272	3.30e-06	9.51e-04 -0.01	-4.76e-05	0.0	0.0
82273	2.69e-06	9.23e-04 -0.01	-4.62e-05	0.0	0.0
8232	3.59e-05	2.05e-03 -0.02	-1.03e-04	2.69e-06	0.0
8234	3.63e-05	1.50e-03 -0.01	-7.45e-05	2.17e-06	0.0
82317	1.73e-03	1.52e-03 -0.01	-6.36e-05	-4.39e-06	0.0
82320	-1.68e-03	1.05e-03 -0.01	-6.51e-05	7.98e-06	0.0
82327	-5.55e-04	3.40e-03 -0.01	-7.72e-05	3.03e-06	0.0
82349	2.41e-03	1.62e-03 -0.01	-6.33e-05	-6.87e-06	0.0
82352	-2.37e-03	9.51e-04 -0.01	-6.54e-05	1.05e-05	0.0
82359	-7.86e-04	4.25e-03 -0.01	-8.23e-05	3.52e-06	0.0
82370	2.95e-05	1.48e-03 -0.01	-7.40e-05	2.04e-06	0.0
82372	2.46e-05	1.32e-03 -0.01	-6.63e-05	1.84e-06	0.0
82373	2.33e-05	1.29e-03 -0.01	-6.44e-05	1.79e-06	0.0
8242	8.65e-05	2.57e-03 -0.02	-1.29e-04	5.35e-06	0.0
82417	1.74e-03	1.87e-03 -0.02	-8.09e-05	-6.14e-06	0.0
82427	-5.21e-04	3.92e-03 -0.02	-1.03e-04	6.81e-06	0.0
82449	2.41e-03	1.98e-03 -0.02	-8.10e-05	-1.00e-05	0.0
82459	-7.52e-04	4.85e-03 -0.02	-1.12e-04	8.14e-06	0.0
82470	6.77e-05	1.86e-03 -0.02	-9.28e-05	4.04e-06	0.0
82472	5.82e-05	1.66e-03 -0.02	-8.29e-05	3.60e-06	0.0
82473	5.58e-05	1.61e-03 -0.02	-8.05e-05	3.49e-06	0.0
8252	1.55e-04	2.91e-03 -0.03	-1.45e-04	9.02e-06	0.0
82517	1.74e-03	2.10e-03 -0.02	-9.24e-05	-6.03e-06	0.0
82527	-4.57e-04	4.30e-03 -0.02	-1.22e-04	1.15e-05	0.0
82549	2.40e-03	2.22e-03 -0.02	-9.31e-05	-1.08e-05	0.0
82559	-6.79e-04	5.29e-03 -0.02	-1.35e-04	1.38e-05	0.0
82570	1.19e-04	2.10e-03 -0.02	-1.05e-04	6.80e-06	0.0
82572	1.03e-04	1.87e-03 -0.02	-9.35e-05	6.00e-06	0.0
82573	9.89e-05	1.81e-03 -0.02	-9.07e-05	5.80e-06	0.0
8262	1.99e-04	2.97e-03 -0.04	-1.48e-04	1.14e-05	0.0
82617	1.73e-03	2.14e-03 -0.02	-9.45e-05	-6.46e-06	0.0
82627	-4.05e-04	4.40e-03 -0.03	-1.27e-04	1.51e-05	0.0
82649	2.37e-03	2.26e-03 -0.02	-9.54e-05	-1.20e-05	0.0
82659	-6.18e-04	5.42e-03 -0.03	-1.41e-04	1.82e-05	0.0
82670	1.52e-04	2.15e-03 -0.03	-1.07e-04	8.61e-06	0.0
82672	1.31e-04	1.90e-03 -0.03	-9.52e-05	7.55e-06	0.0
82673	1.26e-04	1.84e-03 -0.02	-9.23e-05	7.29e-06	0.0
8272	7.34e-04	-3.14e-03 -0.04	1.55e-04	3.87e-05	0.0
82710	2.15e-03	-2.21e-03 -0.02	9.69e-05	1.43e-05	0.0
82724	7.06e-06	-4.64e-03 -0.03	1.37e-04	3.54e-05	0.0
82742	2.83e-03	-2.31e-03 -0.02	9.69e-05	1.04e-05	0.0
82756	-1.72e-04	-5.71e-03 -0.03	1.53e-04	4.00e-05	0.0
82770	5.53e-04	-2.28e-03 -0.03	1.13e-04	2.90e-05	0.0
82772	4.74e-04	-2.02e-03 -0.03	9.99e-05	2.50e-05	0.0
82773	4.54e-04	-1.95e-03 -0.03	9.67e-05	2.40e-05	0.0
8282	4.97e-04	-2.98e-03 -0.03	1.47e-04	2.61e-05	0.0
82810	2.03e-03	-2.08e-03 -0.02	9.07e-05	8.37e-06	0.0
82824	-2.58e-04	-4.38e-03 -0.02	1.24e-04	2.09e-05	0.0
82842	2.73e-03	-2.17e-03 -0.02	9.01e-05	5.17e-06	0.0



EGP CODE

GRE.EEC.R.73.IT.W.15235.12.024.01

PAGE

200 di/of 527

82856	-4.85e-04	-5.39e-03	-0.02	1.37e-04	2.27e-05	0.0
82870	3.75e-04	-2.16e-03	-0.02	1.07e-04	1.96e-05	0.0
82872	3.23e-04	-1.91e-03	-0.02	9.50e-05	1.70e-05	0.0
82873	3.10e-04	-1.85e-03	-0.02	9.21e-05	1.64e-05	0.0
8292	2.97e-04	-2.51e-03	-0.02	1.24e-04	1.57e-05	0.0
8298	-1.53e-03	-2.42e-03	-0.02	8.98e-05	1.52e-05	0.0
82910	1.93e-03	-1.76e-03	-0.02	7.51e-05	3.82e-06	0.0
82924	-4.22e-04	-3.86e-03	-0.02	9.85e-05	1.02e-05	0.0
82940	-2.22e-03	-2.76e-03	-0.02	9.46e-05	1.74e-05	0.0
82942	2.63e-03	-1.84e-03	-0.02	7.39e-05	1.39e-06	0.0
82956	-6.65e-04	-4.78e-03	-0.02	1.07e-04	1.03e-05	0.0
82970	2.25e-04	-1.82e-03	-0.02	9.00e-05	1.18e-05	0.0
82972	1.94e-04	-1.62e-03	-0.02	8.04e-05	1.03e-05	0.0
82973	1.86e-04	-1.57e-03	-0.02	7.80e-05	9.89e-06	0.0
8302	1.61e-04	-1.91e-03	-0.02	9.47e-05	8.72e-06	0.0
8307	-1.57e-03	-7.48e-04	-0.01	6.20e-05	9.56e-06	0.0
8309	1.85e-03	-7.08e-04	-0.01	5.31e-05	2.31e-06	0.0
83024	-5.00e-04	-3.27e-03	-0.01	6.89e-05	4.86e-06	0.0
83039	-2.24e-03	-5.68e-04	-0.01	6.29e-05	1.12e-05	0.0
83041	2.56e-03	-5.12e-04	-0.01	5.05e-05	1.01e-06	0.0
83056	-7.41e-04	-4.10e-03	-0.01	7.27e-05	4.59e-06	0.0
83070	1.24e-04	-1.38e-03	-0.01	6.84e-05	6.55e-06	0.0
83072	1.06e-04	-1.24e-03	-0.01	6.13e-05	5.74e-06	0.0
83073	1.01e-04	-1.20e-03	-0.01	5.95e-05	5.54e-06	0.0
8311	6.07e-05	-1.11e-03	-0.01	5.52e-05	3.89e-06	0.0
8312	8.03e-05	-1.30e-03	-0.01	6.41e-05	4.69e-06	0.0
8319	1.79e-03	-3.75e-04	-0.01	3.68e-05	1.05e-06	0.0
83123	-3.99e-04	1.01e-03	-0.01	4.06e-05	4.80e-06	0.0
83124	-5.21e-04	-2.72e-03-9.92e-03		4.20e-05	2.48e-06	0.0
83141	2.48e-03	-2.00e-04	-0.01	3.54e-05	0.0	0.0
83155	-5.79e-04	1.74e-03	-0.01	4.07e-05	5.53e-06	0.0
83156	-7.50e-04	-3.48e-03-9.74e-03		4.27e-05	2.27e-06	0.0
83169	4.98e-05	-8.14e-04	-0.01	4.03e-05	3.00e-06	0.0
83170	6.28e-05	-9.37e-04	-0.01	4.63e-05	3.53e-06	0.0
83171	4.98e-05	-8.14e-04	-0.01	4.03e-05	3.00e-06	0.0
83172	5.24e-05	-8.39e-04	-0.01	4.15e-05	3.10e-06	0.0
83173	4.98e-05	-8.14e-04	-0.01	4.03e-05	3.00e-06	0.0
8321	2.47e-05	-6.13e-04	-0.01	3.04e-05	2.15e-06	0.0
8322	3.69e-05	-7.14e-04	-0.01	3.52e-05	2.60e-06	0.0
8324	3.83e-05	-5.20e-04-8.40e-03		2.55e-05	2.12e-06	0.0
83210	1.73e-03	-6.28e-04-8.62e-03		1.96e-05	0.0	0.0
83223	-4.52e-04	1.29e-03-9.28e-03		2.75e-05	2.67e-06	0.0
83224	-5.17e-04	-2.25e-03-8.48e-03		1.81e-05	1.49e-06	0.0
83242	2.42e-03	-7.00e-04-8.54e-03		1.86e-05	0.0	0.0
83255	-6.42e-04	1.98e-03-9.46e-03		2.96e-05	3.08e-06	0.0
83256	-7.34e-04	-2.97e-03-8.33e-03		1.64e-05	1.43e-06	0.0
83269	2.21e-05	-4.49e-04-8.83e-03		2.22e-05	1.66e-06	0.0
83270	3.02e-05	-5.16e-04-8.54e-03		2.54e-05	1.96e-06	0.0
83271	2.21e-05	-4.49e-04-8.83e-03		2.22e-05	1.66e-06	0.0
83272	2.37e-05	-4.62e-04-8.77e-03		2.28e-05	1.72e-06	0.0
83273	2.21e-05	-4.49e-04-8.83e-03		2.22e-05	1.66e-06	0.0
8331	1.03e-05	-1.44e-04	-0.01	6.99e-06	1.47e-06	0.0
8332	1.95e-05	-1.67e-04-9.96e-03		8.10e-06	1.79e-06	0.0
8334	2.43e-05	-1.22e-04-7.63e-03		5.87e-06	1.47e-06	0.0
83310	1.69e-03	-2.91e-04-8.07e-03		3.23e-06	0.0	0.0
83323	-4.85e-04	1.59e-03-8.28e-03		1.21e-05	1.59e-06	0.0
83324	-4.98e-04	-1.86e-03-8.09e-03		-1.40e-06	1.33e-06	0.0
83342	2.37e-03	-3.65e-04-8.03e-03		2.47e-06	0.0	0.0
83355	-6.84e-04	2.27e-03-8.33e-03		1.49e-05	1.76e-06	0.0
83356	-7.02e-04	-2.56e-03-8.06e-03		-4.01e-06	1.40e-06	0.0
83369	1.10e-05	-1.05e-04-8.16e-03		5.11e-06	1.14e-06	0.0
83370	1.72e-05	-1.21e-04-7.77e-03		5.85e-06	1.36e-06	0.0
83371	1.10e-05	-1.05e-04-8.16e-03		5.11e-06	1.14e-06	0.0
83372	1.22e-05	-1.09e-04-8.08e-03		5.26e-06	1.18e-06	0.0
83373	1.10e-05	-1.05e-04-8.16e-03		5.11e-06	1.14e-06	0.0
8341	1.33e-05	3.18e-04	-0.01	-1.60e-05	1.65e-06	0.0
8342	2.32e-05	3.69e-04	-0.01	-1.85e-05	2.00e-06	0.0
8344	2.72e-05	2.69e-04-7.81e-03		-1.34e-05	1.64e-06	0.0
83418	1.70e-03	-1.56e-04-8.27e-03		-1.15e-05	0.0	0.0
83427	-5.09e-04	2.00e-03-8.11e-03		-5.79e-06	1.31e-06	0.0
83428	-4.70e-04	-1.47e-03-8.60e-03		-1.83e-05	1.91e-06	0.0
83450	2.38e-03	-3.10e-04-8.24e-03		-1.15e-05	0.0	0.0
83459	-7.19e-04	2.71e-03-8.02e-03		-3.43e-06	1.33e-06	0.0
83460	-6.64e-04	-2.16e-03-8.71e-03		-2.09e-05	2.16e-06	0.0
83469	1.34e-05	2.32e-04-8.32e-03		-1.17e-05	1.27e-06	0.0
83470	1.99e-05	2.67e-04-7.95e-03		-1.34e-05	1.51e-06	0.0





EGP CODE

GRE.EEC.R.73.IT.W.15235.12.024.01

PAGE

201 di/of 527

83471	1.34e-05	2.32e-04-8.32e-03	-1.17e-05	1.27e-06	0.0
83472	1.47e-05	2.39e-04-8.25e-03	-1.20e-05	1.32e-06	0.0
83473	1.34e-05	2.32e-04-8.32e-03	-1.17e-05	1.27e-06	0.0
8351	3.50e-05	7.98e-04 -0.01	-3.99e-05	2.72e-06	0.0
8352	4.92e-05	9.29e-04 -0.01	-4.63e-05	3.29e-06	0.0
83518	1.75e-03	1.69e-04-9.22e-03	-2.74e-05	0.0	0.0
83527	-5.24e-04	2.42e-03-8.89e-03	-2.67e-05	1.79e-06	0.0
83528	-4.31e-04	-1.18e-03-9.88e-03	-3.30e-05	3.36e-06	0.0
83550	2.44e-03	3.56e-06-9.18e-03	-2.66e-05	0.0	0.0
83559	-7.45e-04	3.16e-03-8.71e-03	-2.57e-05	1.67e-06	0.0
83560	-6.15e-04	-1.89e-03 -0.01	-3.45e-05	3.86e-06	0.0
83569	3.00e-05	5.84e-04-9.33e-03	-2.92e-05	2.10e-06	0.0
83570	3.94e-05	6.72e-04-9.10e-03	-3.34e-05	2.48e-06	0.0
83571	3.00e-05	5.84e-04-9.33e-03	-2.92e-05	2.10e-06	0.0
83572	3.19e-05	6.01e-04-9.28e-03	-3.00e-05	2.17e-06	0.0
83573	3.00e-05	5.84e-04-9.33e-03	-2.92e-05	2.10e-06	0.0
8362	1.05e-04	1.53e-03 -0.01	-7.60e-05	6.06e-06	0.0
83618	1.81e-03	5.01e-04 -0.01	-4.34e-05	1.59e-06	0.0
83627	-5.20e-04	2.92e-03 -0.01	-5.20e-05	3.24e-06	0.0
83628	-3.69e-04	-9.20e-04 -0.01	-4.60e-05	5.99e-06	0.0
83650	2.50e-03	3.18e-04 -0.01	-4.16e-05	0.0	0.0
83659	-7.54e-04	3.71e-03 -0.01	-5.36e-05	2.99e-06	0.0
83660	-5.43e-04	-1.67e-03 -0.01	-4.53e-05	6.84e-06	0.0
83670	8.15e-05	1.11e-03 -0.01	-5.49e-05	4.56e-06	0.0
83672	6.88e-05	9.89e-04 -0.01	-4.93e-05	4.01e-06	0.0
83673	6.56e-05	9.60e-04 -0.01	-4.79e-05	3.87e-06	0.0
8372	2.05e-04	2.15e-03 -0.02	-1.07e-04	1.11e-05	0.0
83716	-1.54e-03	8.86e-04 -0.01	-6.91e-05	1.17e-05	0.0
83718	1.88e-03	8.29e-04 -0.01	-5.94e-05	3.17e-06	0.0
83727	-4.81e-04	3.50e-03 -0.01	-8.08e-05	6.54e-06	0.0
83748	-2.21e-03	7.00e-04 -0.01	-6.98e-05	1.36e-05	0.0
83750	2.58e-03	6.22e-04 -0.01	-5.63e-05	1.62e-06	0.0
83759	-7.25e-04	4.37e-03 -0.01	-8.63e-05	6.34e-06	0.0
83770	1.56e-04	1.56e-03 -0.01	-7.74e-05	8.34e-06	0.0
83772	1.34e-04	1.39e-03 -0.01	-6.92e-05	7.30e-06	0.0
83773	1.29e-04	1.35e-03 -0.01	-6.72e-05	7.04e-06	0.0
8382	3.65e-04	2.72e-03 -0.03	-1.35e-04	1.94e-05	0.0
83815	-1.48e-03	2.59e-03 -0.02	-9.85e-05	1.87e-05	0.0
83817	1.97e-03	1.89e-03 -0.02	-8.21e-05	5.00e-06	0.0
83827	-3.73e-04	4.09e-03 -0.02	-1.10e-04	1.33e-05	0.0
83847	-2.16e-03	2.95e-03 -0.02	-1.04e-04	2.14e-05	0.0
83849	2.67e-03	1.97e-03 -0.02	-8.11e-05	2.11e-06	0.0
83859	-6.14e-04	5.05e-03 -0.02	-1.20e-04	1.37e-05	0.0
83870	2.76e-04	1.97e-03 -0.02	-9.79e-05	1.46e-05	0.0
83872	2.38e-04	1.75e-03 -0.02	-8.73e-05	1.27e-05	0.0
83873	2.28e-04	1.70e-03 -0.02	-8.47e-05	1.22e-05	0.0
8392	5.84e-04	3.10e-03 -0.03	-1.54e-04	3.10e-05	0.0
83917	2.08e-03	2.15e-03 -0.02	-9.49e-05	1.05e-05	0.0
83927	-1.75e-04	4.53e-03 -0.03	-1.32e-04	2.60e-05	0.0
83949	2.77e-03	2.25e-03 -0.02	-9.45e-05	6.89e-06	0.0
83959	-3.91e-04	5.58e-03 -0.03	-1.46e-04	2.87e-05	0.0
83970	4.40e-04	2.24e-03 -0.02	-1.11e-04	2.33e-05	0.0
83972	3.78e-04	1.99e-03 -0.02	-9.90e-05	2.01e-05	0.0
83973	3.63e-04	1.93e-03 -0.02	-9.59e-05	1.93e-05	0.0
8402	7.23e-04	3.16e-03 -0.04	-1.57e-04	3.85e-05	0.0
84017	2.14e-03	2.21e-03 -0.02	-9.76e-05	1.38e-05	0.0
84027	-5.45e-06	4.66e-03 -0.03	-1.38e-04	3.55e-05	0.0
84049	2.82e-03	2.31e-03 -0.02	-9.76e-05	9.79e-06	0.0
84059	-1.87e-04	5.74e-03 -0.03	-1.54e-04	4.01e-05	0.0
84070	5.45e-04	2.30e-03 -0.03	-1.14e-04	2.89e-05	0.0
84072	4.67e-04	2.03e-03 -0.03	-1.01e-04	2.49e-05	0.0
84073	4.48e-04	1.96e-03 -0.03	-9.77e-05	2.39e-05	0.0
8412	1.02e-03	-3.55e-03 -0.04	1.73e-04	5.40e-05	0.0
84110	2.53e-03	-2.46e-03 -0.03	1.07e-04	3.27e-05	0.0
84124	1.55e-04	-5.06e-03 -0.03	1.55e-04	4.38e-05	0.0
84142	3.28e-03	-2.56e-03 -0.03	1.07e-04	3.25e-05	0.0
84156	-3.62e-05	-6.21e-03 -0.03	1.74e-04	4.80e-05	0.0
84170	7.71e-04	-2.58e-03 -0.03	1.26e-04	4.05e-05	0.0
84172	6.61e-04	-2.27e-03 -0.03	1.11e-04	3.48e-05	0.0
84173	6.33e-04	-2.19e-03 -0.03	1.07e-04	3.34e-05	0.0
8422	6.70e-04	-3.33e-03 -0.03	1.63e-04	3.54e-05	0.0
84210	2.29e-03	-2.26e-03 -0.02	9.92e-05	2.05e-05	0.0
84224	-2.10e-04	-4.74e-03 -0.02	1.39e-04	2.44e-05	0.0
84242	3.04e-03	-2.34e-03 -0.02	9.82e-05	1.98e-05	0.0
84256	-4.62e-04	-5.81e-03 -0.02	1.54e-04	2.53e-05	0.0
84270	5.05e-04	-2.42e-03 -0.02	1.19e-04	2.66e-05	0.0



EGP CODE

GRE.EEC.R.73.IT.W.15235.12.024.01

PAGE

202 di/of 527

84272	4.35e-04	-2.14e-03	-0.02	1.05e-04	2.30e-05	0.0
84273	4.18e-04	-2.07e-03	-0.02	1.02e-04	2.21e-05	0.0
8432	3.95e-04	-2.75e-03	-0.02	1.35e-04	2.07e-05	0.0
8439	2.11e-03	-1.12e-03	-0.02	7.29e-05	1.29e-05	0.0
84312	-1.62e-03	-2.31e-03	-0.02	9.62e-05	1.32e-05	0.0
84324	-4.20e-04	-4.07e-03	-0.02	1.06e-04	1.06e-05	0.0
84341	2.86e-03	-8.77e-04	-0.02	6.82e-05	1.28e-05	0.0
84344	-2.36e-03	-2.55e-03	-0.02	1.01e-04	1.33e-05	0.0
84356	-6.87e-04	-5.01e-03	-0.02	1.15e-04	9.61e-06	0.0
84370	2.99e-04	-1.99e-03	-0.02	9.79e-05	1.56e-05	0.0
84372	2.58e-04	-1.77e-03	-0.02	8.72e-05	1.36e-05	0.0
84373	2.47e-04	-1.71e-03	-0.02	8.45e-05	1.31e-05	0.0
8442	2.22e-04	-2.05e-03	-0.02	1.01e-04	1.18e-05	0.0
8447	-1.60e-03	-8.63e-04	-0.01	6.69e-05	8.54e-06	0.0
8449	1.96e-03	-7.68e-04	-0.01	5.61e-05	7.34e-06	0.0
84424	-4.84e-04	-3.38e-03	-0.01	7.25e-05	5.62e-06	0.0
84439	-2.30e-03	-6.93e-04	-0.01	6.84e-05	8.96e-06	0.0
84441	2.69e-03	-5.61e-04	-0.01	5.32e-05	7.28e-06	0.0
84456	-7.33e-04	-4.22e-03	-0.01	7.61e-05	4.87e-06	0.0
84470	1.70e-04	-1.49e-03	-0.01	7.31e-05	8.91e-06	0.0
84472	1.45e-04	-1.33e-03	-0.01	6.53e-05	7.78e-06	0.0
84473	1.39e-04	-1.29e-03	-0.01	6.34e-05	7.49e-06	0.0
8451	9.28e-05	-1.17e-03	-0.01	5.80e-05	5.57e-06	0.0
8452	1.21e-04	-1.37e-03	-0.01	6.75e-05	6.80e-06	0.0
8459	1.85e-03	-4.05e-04	-0.01	3.92e-05	3.99e-06	0.0
84523	-3.84e-04	9.64e-04	-0.01	4.46e-05	5.70e-06	0.0
84524	-5.07e-04	-2.78e-03	-0.01	4.26e-05	3.21e-06	0.0
84541	2.56e-03	-2.23e-04	-0.01	3.78e-05	3.86e-06	0.0
84555	-5.68e-04	1.70e-03	-0.01	4.55e-05	6.26e-06	0.0
84556	-7.41e-04	-3.55e-03-9.87e-03		4.27e-05	2.77e-06	0.0
84569	7.47e-05	-8.62e-04	-0.01	4.25e-05	4.30e-06	0.0
84570	9.34e-05	-9.95e-04	-0.01	4.88e-05	5.12e-06	0.0
84571	7.47e-05	-8.62e-04	-0.01	4.25e-05	4.30e-06	0.0
84572	7.85e-05	-8.89e-04	-0.01	4.38e-05	4.46e-06	0.0
84573	7.47e-05	-8.62e-04	-0.01	4.25e-05	4.30e-06	0.0
8461	4.73e-05	-6.44e-04	-0.01	3.17e-05	3.35e-06	0.0
8462	6.57e-05	-7.51e-04	-0.01	3.68e-05	4.11e-06	0.0
84610	1.77e-03	-6.25e-04-8.68e-03		2.03e-05	1.94e-06	0.0
84623	-4.39e-04	1.26e-03-9.43e-03		2.91e-05	3.41e-06	0.0
84624	-5.06e-04	-2.29e-03-8.57e-03		1.87e-05	2.11e-06	0.0
84642	2.46e-03	-6.86e-04-8.58e-03		1.92e-05	1.68e-06	0.0
84655	-6.31e-04	1.96e-03-9.63e-03		3.14e-05	3.74e-06	0.0
84656	-7.24e-04	-3.02e-03-8.42e-03		1.68e-05	1.91e-06	0.0
84669	3.98e-05	-4.72e-04-8.94e-03		2.32e-05	2.60e-06	0.0
84670	5.21e-05	-5.44e-04-8.66e-03		2.66e-05	3.10e-06	0.0
84671	3.98e-05	-4.72e-04-8.94e-03		2.32e-05	2.60e-06	0.0
84672	4.23e-05	-4.86e-04-8.89e-03		2.39e-05	2.70e-06	0.0
84673	3.98e-05	-4.72e-04-8.94e-03		2.32e-05	2.60e-06	0.0
8471	2.89e-05	-1.50e-04	-0.01	7.27e-06	2.47e-06	0.0
8472	4.35e-05	-1.75e-04	-0.01	8.44e-06	3.05e-06	0.0
8474	4.48e-05	-1.28e-04-7.73e-03		6.15e-06	2.52e-06	0.0
8477	-1.66e-03	2.93e-04-8.39e-03		8.41e-06	2.49e-06	0.0
84710	1.72e-03	-2.71e-04-8.11e-03		3.27e-06	1.36e-06	0.0
84724	-4.87e-04	-1.88e-03-8.17e-03		-1.58e-06	1.93e-06	0.0
84739	-2.33e-03	4.55e-04-8.45e-03		9.64e-06	2.72e-06	0.0
84742	2.40e-03	-3.36e-04-8.05e-03		2.45e-06	1.14e-06	0.0
84756	-6.92e-04	-2.59e-03-8.14e-03		-4.35e-06	1.93e-06	0.0
84769	2.57e-05	-1.10e-04-8.24e-03		5.33e-06	1.92e-06	0.0
84770	3.54e-05	-1.27e-04-7.86e-03		6.10e-06	2.31e-06	0.0
84771	2.57e-05	-1.10e-04-8.24e-03		5.33e-06	1.92e-06	0.0
84772	2.77e-05	-1.13e-04-8.16e-03		5.48e-06	2.00e-06	0.0
84773	2.57e-05	-1.10e-04-8.24e-03		5.33e-06	1.92e-06	0.0
8481	3.31e-05	3.34e-04	-0.01	-1.67e-05	2.70e-06	0.0
8482	4.85e-05	3.89e-04	-0.01	-1.94e-05	3.32e-06	0.0
8484	4.88e-05	2.84e-04-7.93e-03		-1.41e-05	2.74e-06	0.0
84818	1.73e-03	-1.59e-04-8.32e-03		-1.20e-05	1.62e-06	0.0
84827	-4.98e-04	2.03e-03-8.19e-03		-5.93e-06	1.93e-06	0.0
84828	-4.58e-04	-1.46e-03-8.71e-03		-1.93e-05	2.58e-06	0.0
84850	2.41e-03	-3.19e-04-8.28e-03		-1.19e-05	1.43e-06	0.0
84859	-7.09e-04	2.74e-03-8.10e-03		-3.41e-06	1.86e-06	0.0
84860	-6.53e-04	-2.15e-03-8.83e-03		-2.22e-05	2.77e-06	0.0
84869	2.89e-05	2.45e-04-8.41e-03		-1.22e-05	2.09e-06	0.0
84870	3.92e-05	2.81e-04-8.05e-03		-1.40e-05	2.51e-06	0.0
84871	2.89e-05	2.45e-04-8.41e-03		-1.22e-05	2.09e-06	0.0
84872	3.10e-05	2.52e-04-8.34e-03		-1.26e-05	2.18e-06	0.0
84873	2.89e-05	2.45e-04-8.41e-03		-1.22e-05	2.09e-06	0.0



EGP CODE

GRE.EEC.R.73.IT.W.15235.12.024.01

PAGE

203 di/of 527

8491	6.10e-05	8.40e-04	-0.01	-4.18e-05	4.08e-06	0.0
8492	8.22e-05	9.81e-04	-0.01	-4.85e-05	5.00e-06	0.0
84918	1.79e-03	1.84e-04-9.31e-03		-2.86e-05	2.76e-06	0.0
84927	-5.11e-04	2.47e-03-9.00e-03		-2.77e-05	2.48e-06	0.0
84928	-4.17e-04	-1.15e-03	-0.01	-3.51e-05	4.16e-06	0.0
84950	2.49e-03	1.18e-05-9.25e-03		-2.77e-05	2.60e-06	0.0
84959	-7.35e-04	3.21e-03-8.81e-03		-2.66e-05	2.20e-06	0.0
84960	-6.04e-04	-1.86e-03	-0.01	-3.69e-05	4.57e-06	0.0
84969	5.04e-05	6.17e-04-9.46e-03		-3.06e-05	3.16e-06	0.0
84970	6.45e-05	7.10e-04-9.26e-03		-3.51e-05	3.77e-06	0.0
84971	5.04e-05	6.17e-04-9.46e-03		-3.06e-05	3.16e-06	0.0
84972	5.32e-05	6.35e-04-9.42e-03		-3.15e-05	3.28e-06	0.0
84973	5.04e-05	6.17e-04-9.46e-03		-3.06e-05	3.16e-06	0.0
8502	1.54e-04	1.63e-03	-0.02	-8.04e-05	8.54e-06	0.0
85018	1.88e-03	5.42e-04	-0.01	-4.57e-05	5.12e-06	0.0
85027	-5.03e-04	3.00e-03	-0.01	-5.43e-05	4.08e-06	0.0
85028	-3.52e-04	-8.58e-04	-0.01	-4.96e-05	7.03e-06	0.0
85050	2.59e-03	3.51e-04	-0.01	-4.37e-05	5.01e-06	0.0
85059	-7.42e-04	3.80e-03	-0.01	-5.57e-05	3.55e-06	0.0
85060	-5.31e-04	-1.61e-03	-0.01	-4.92e-05	7.68e-06	0.0
85070	1.18e-04	1.18e-03	-0.01	-5.83e-05	6.42e-06	0.0
85072	1.00e-04	1.05e-03	-0.01	-5.22e-05	5.61e-06	0.0
85073	9.56e-05	1.02e-03	-0.01	-5.06e-05	5.40e-06	0.0
8512	2.81e-04	2.33e-03	-0.02	-1.15e-04	1.49e-05	0.0
85116	-1.57e-03	1.02e-03	-0.02	-7.51e-05	1.05e-05	0.0
85118	2.01e-03	9.04e-04	-0.01	-6.31e-05	9.29e-06	0.0
85127	-4.63e-04	3.64e-03	-0.01	-8.56e-05	7.32e-06	0.0
85148	-2.27e-03	8.50e-04	-0.02	-7.64e-05	1.10e-05	0.0
85150	2.74e-03	6.84e-04	-0.01	-5.95e-05	9.23e-06	0.0
85159	-7.19e-04	4.52e-03	-0.01	-9.10e-05	6.48e-06	0.0
85170	2.13e-04	1.69e-03	-0.02	-8.31e-05	1.12e-05	0.0
85172	1.83e-04	1.50e-03	-0.01	-7.42e-05	9.78e-06	0.0
85173	1.76e-04	1.45e-03	-0.01	-7.20e-05	9.42e-06	0.0
8522	4.92e-04	3.00e-03	-0.03	-1.48e-04	2.58e-05	0.0
85215	-1.54e-03	2.84e-03	-0.02	-1.09e-04	1.63e-05	0.0
85218	2.18e-03	1.23e-03	-0.02	-7.87e-05	1.59e-05	0.0
85227	-3.61e-04	4.36e-03	-0.02	-1.21e-04	1.43e-05	0.0
85247	-2.28e-03	3.23e-03	-0.02	-1.16e-04	1.63e-05	0.0
85250	2.93e-03	9.71e-04	-0.02	-7.32e-05	1.57e-05	0.0
85259	-6.28e-04	5.35e-03	-0.02	-1.32e-04	1.35e-05	0.0
85270	3.72e-04	2.18e-03	-0.02	-1.07e-04	1.94e-05	0.0
85272	3.21e-04	1.93e-03	-0.02	-9.54e-05	1.69e-05	0.0
85273	3.08e-04	1.87e-03	-0.02	-9.24e-05	1.62e-05	0.0
8532	8.00e-04	3.48e-03	-0.03	-1.71e-04	4.26e-05	0.0
85317	2.37e-03	2.37e-03	-0.02	-1.05e-04	2.45e-05	0.0
85327	-8.61e-05	4.93e-03	-0.03	-1.49e-04	3.14e-05	0.0
85349	3.12e-03	2.45e-03	-0.02	-1.04e-04	2.37e-05	0.0
85359	-3.20e-04	6.05e-03	-0.03	-1.66e-04	3.33e-05	0.0
85370	6.02e-04	2.53e-03	-0.03	-1.24e-04	3.20e-05	0.0
85372	5.18e-04	2.23e-03	-0.02	-1.10e-04	2.76e-05	0.0
85373	4.97e-04	2.16e-03	-0.02	-1.06e-04	2.65e-05	0.0
8542	1.01e-03	3.56e-03	-0.04	-1.75e-04	5.38e-05	0.0
85417	2.53e-03	2.44e-03	-0.03	-1.08e-04	3.25e-05	0.0
85427	1.23e-04	5.09e-03	-0.03	-1.56e-04	4.33e-05	0.0
85449	3.30e-03	2.54e-03	-0.03	-1.08e-04	3.22e-05	0.0
85459	-7.75e-05	6.25e-03	-0.03	-1.76e-04	4.73e-05	0.0
85470	7.58e-04	2.59e-03	-0.03	-1.27e-04	4.04e-05	0.0
85472	6.51e-04	2.28e-03	-0.03	-1.12e-04	3.47e-05	0.0
85473	6.24e-04	2.20e-03	-0.03	-1.08e-04	3.33e-05	0.0
8552	8.78e-04	-4.38e-03	-0.04	2.08e-04	4.66e-05	0.0
85510	2.70e-03	-3.10e-03	-0.03	1.35e-04	4.42e-05	0.0
85524	-2.89e-05	-6.09e-03	-0.03	1.96e-04	3.27e-05	0.0
85542	3.56e-03	-3.26e-03	-0.03	1.38e-04	5.03e-05	0.0
85556	-2.59e-04	-7.46e-03	-0.04	2.24e-04	3.42e-05	0.0
85570	6.61e-04	-3.20e-03	-0.03	1.52e-04	3.50e-05	0.0
85572	5.68e-04	-2.78e-03	-0.03	1.32e-04	3.01e-05	0.0
85573	5.44e-04	-2.68e-03	-0.03	1.27e-04	2.89e-05	0.0
8562	3.07e-04	-3.89e-03	-0.03	1.87e-04	2.08e-05	0.0
8569	2.41e-03	-1.67e-03	-0.02	1.00e-04	2.59e-05	0.0
85624	-6.52e-04	-5.26e-03	-0.02	1.60e-04	5.91e-06	0.0
85641	3.29e-03	-1.38e-03	-0.02	9.36e-05	3.09e-05	0.0
85656	-9.94e-04	-6.40e-03	-0.03	1.77e-04	2.92e-06	0.0
85670	2.34e-04	-2.84e-03	-0.02	1.37e-04	1.56e-05	0.0
85672	2.08e-04	-2.49e-03	-0.02	1.20e-04	1.38e-05	0.0
85673	2.02e-04	-2.41e-03	-0.02	1.16e-04	1.34e-05	0.0
8572	3.06e-04	-2.99e-03	-0.02	1.46e-04	1.66e-05	0.0



EGP CODE

GRE.EEC.R.73.IT.W.15235.12.024.01

PAGE

204 di/of 527

85710	2.18e-03	-2.02e-03	-0.02	8.82e-05	1.49e-05	0.0
85712	-1.66e-03	-2.46e-03	-0.02	1.01e-04	5.69e-06	0.0
85724	-4.67e-04	-4.23e-03	-0.02	1.12e-04	7.96e-06	0.0
85742	2.97e-03	-2.07e-03	-0.02	8.69e-05	1.67e-05	0.0
85744	-2.41e-03	-2.69e-03	-0.02	1.05e-04	3.77e-06	0.0
85756	-7.31e-04	-5.17e-03	-0.02	1.20e-04	6.96e-06	0.0
85770	2.33e-04	-2.18e-03	-0.02	1.06e-04	1.25e-05	0.0
85772	2.00e-04	-1.93e-03	-0.02	9.42e-05	1.09e-05	0.0
85773	1.91e-04	-1.87e-03	-0.02	9.12e-05	1.05e-05	0.0
8582	1.90e-04	-2.19e-03	-0.02	1.07e-04	1.05e-05	0.0
85810	2.00e-03	-1.51e-03	-0.01	6.40e-05	8.97e-06	0.0
85823	-3.57e-04	6.19e-04	-0.01	6.18e-05	6.89e-06	0.0
85824	-5.05e-04	-3.48e-03	-0.01	7.55e-05	4.86e-06	0.0
85842	2.75e-03	-1.56e-03	-0.01	6.27e-05	9.91e-06	0.0
85855	-5.47e-04	1.42e-03	-0.01	5.96e-05	7.00e-06	0.0
85856	-7.54e-04	-4.32e-03	-0.01	7.88e-05	4.16e-06	0.0
85870	1.46e-04	-1.59e-03	-0.01	7.77e-05	7.92e-06	0.0
85872	1.24e-04	-1.41e-03	-0.01	6.93e-05	6.88e-06	0.0
85873	1.18e-04	-1.37e-03	-0.01	6.73e-05	6.62e-06	0.0
8592	1.11e-04	-1.45e-03	-0.01	7.10e-05	6.53e-06	0.0
85910	1.87e-03	-1.04e-03	-0.01	4.13e-05	4.94e-06	0.0
85923	-4.11e-04	9.22e-04	-0.01	4.71e-05	4.50e-06	0.0
85924	-5.14e-04	-2.84e-03	-0.01	4.43e-05	3.12e-06	0.0
85942	2.59e-03	-1.09e-03	-0.01	3.99e-05	5.29e-06	0.0
85955	-6.02e-04	1.66e-03	-0.01	4.80e-05	4.66e-06	0.0
85956	-7.46e-04	-3.62e-03	-0.01	4.41e-05	2.73e-06	0.0
85970	8.62e-05	-1.05e-03	-0.01	5.15e-05	4.92e-06	0.0
85972	7.15e-05	-9.39e-04	-0.01	4.61e-05	4.26e-06	0.0
85973	6.78e-05	-9.11e-04	-0.01	4.47e-05	4.10e-06	0.0
8601	4.51e-05	-6.75e-04	-0.01	3.32e-05	3.40e-06	0.0
8602	6.46e-05	-7.88e-04	-0.01	3.86e-05	4.24e-06	0.0
86010	1.79e-03	-6.28e-04-8.81e-03		2.16e-05	2.86e-06	0.0
86023	-4.50e-04	1.24e-03-9.60e-03		3.06e-05	2.98e-06	0.0
86024	-5.08e-04	-2.33e-03-8.67e-03		1.93e-05	2.14e-06	0.0
86042	2.48e-03	-6.81e-04-8.70e-03		2.05e-05	2.94e-06	0.0
86055	-6.45e-04	1.94e-03-9.81e-03		3.30e-05	3.12e-06	0.0
86056	-7.27e-04	-3.06e-03-8.51e-03		1.73e-05	1.94e-06	0.0
86069	3.87e-05	-4.96e-04-9.08e-03		2.43e-05	2.65e-06	0.0
86070	5.16e-05	-5.72e-04-8.83e-03		2.79e-05	3.21e-06	0.0
86071	3.87e-05	-4.96e-04-9.08e-03		2.43e-05	2.65e-06	0.0
86072	4.13e-05	-5.11e-04-9.03e-03		2.51e-05	2.76e-06	0.0
86073	3.87e-05	-4.96e-04-9.08e-03		2.43e-05	2.65e-06	0.0
8611	2.93e-05	-1.57e-04 -0.01		7.58e-06	2.62e-06	0.0
8612	4.53e-05	-1.83e-04 -0.01		8.81e-06	3.30e-06	0.0
8614	4.77e-05	-1.34e-04-7.87e-03		6.44e-06	2.77e-06	0.0
8617	-1.67e-03	2.72e-04-8.50e-03		8.70e-06	2.13e-06	0.0
86110	1.73e-03	-2.53e-04-8.19e-03		3.52e-06	1.99e-06	0.0
86124	-4.89e-04	-1.90e-03-8.27e-03		-1.76e-06	1.95e-06	0.0
86139	-2.35e-03	4.27e-04-8.57e-03		9.95e-06	2.15e-06	0.0
86142	2.41e-03	-3.09e-04-8.14e-03		2.70e-06	1.97e-06	0.0
86156	-6.95e-04	-2.61e-03-8.24e-03		-4.69e-06	1.91e-06	0.0
86169	2.65e-05	-1.15e-04-8.34e-03		5.57e-06	2.05e-06	0.0
86170	3.72e-05	-1.33e-04-7.98e-03		6.38e-06	2.50e-06	0.0
86171	2.65e-05	-1.15e-04-8.34e-03		5.57e-06	2.05e-06	0.0
86172	2.86e-05	-1.19e-04-8.27e-03		5.73e-06	2.14e-06	0.0
86173	2.65e-05	-1.15e-04-8.34e-03		5.57e-06	2.05e-06	0.0
8621	3.29e-05	3.50e-04 -0.01		-1.75e-05	2.82e-06	0.0
8622	4.97e-05	4.09e-04 -0.01		-2.03e-05	3.54e-06	0.0
8624	5.12e-05	3.01e-04-8.07e-03		-1.48e-05	2.96e-06	0.0
86218	1.74e-03	-1.60e-04-8.42e-03		-1.27e-05	2.33e-06	0.0
86227	-5.00e-04	2.05e-03-8.29e-03		-6.08e-06	1.96e-06	0.0
86228	-4.64e-04	-1.45e-03-8.84e-03		-2.03e-05	2.39e-06	0.0
86250	2.43e-03	-3.26e-04-8.37e-03		-1.27e-05	2.38e-06	0.0
86259	-7.11e-04	2.77e-03-8.20e-03		-3.39e-06	1.86e-06	0.0
86260	-6.61e-04	-2.14e-03-8.96e-03		-2.32e-05	2.47e-06	0.0
86269	2.92e-05	2.57e-04-8.52e-03		-1.28e-05	2.20e-06	0.0
86270	4.05e-05	2.97e-04-8.19e-03		-1.47e-05	2.68e-06	0.0
86271	2.92e-05	2.57e-04-8.52e-03		-1.28e-05	2.20e-06	0.0
86272	3.15e-05	2.65e-04-8.45e-03		-1.32e-05	2.30e-06	0.0
86273	2.92e-05	2.57e-04-8.52e-03		-1.28e-05	2.20e-06	0.0
8631	5.66e-05	8.83e-04 -0.01		-4.38e-05	4.02e-06	0.0
8632	7.85e-05	1.03e-03 -0.01		-5.09e-05	4.99e-06	0.0
86317	1.81e-03	7.80e-04-9.30e-03		-2.92e-05	3.48e-06	0.0
86327	-5.14e-04	2.51e-03-9.12e-03		-2.87e-05	2.47e-06	0.0
86328	-4.32e-04	-1.12e-03 -0.01		-3.70e-05	3.51e-06	0.0
86349	2.51e-03	8.32e-04-9.17e-03		-2.81e-05	3.62e-06	0.0



EGP CODE

GRE.EEC.R.73.IT.W.15235.12.024.01

PAGE

205 di/of 527

86359	-7.39e-04	3.26e-03	-8.92e-03	-2.73e-05	2.21e-06	0.0
86360	-6.24e-04	-1.83e-03	-0.01	-3.89e-05	3.66e-06	0.0
86369	4.75e-05	6.50e-04	-9.63e-03	-3.22e-05	3.12e-06	0.0
86370	6.21e-05	7.50e-04	-9.45e-03	-3.69e-05	3.77e-06	0.0
86371	4.75e-05	6.50e-04	-9.63e-03	-3.22e-05	3.12e-06	0.0
86372	5.04e-05	6.70e-04	-9.59e-03	-3.31e-05	3.25e-06	0.0
86373	4.75e-05	6.50e-04	-9.63e-03	-3.22e-05	3.12e-06	0.0
8642	1.37e-04	1.73e-03	-0.02	-8.49e-05	7.92e-06	0.0
86417	1.91e-03	1.21e-03	-0.01	-5.04e-05	6.17e-06	0.0
86427	-5.12e-04	3.08e-03	-0.01	-5.66e-05	3.83e-06	0.0
86428	-3.88e-04	-8.04e-04	-0.01	-5.25e-05	5.34e-06	0.0
86449	2.64e-03	1.27e-03	-0.01	-4.92e-05	6.65e-06	0.0
86459	-7.51e-04	3.88e-03	-0.01	-5.78e-05	3.37e-06	0.0
86460	-5.77e-04	-1.56e-03	-0.01	-5.22e-05	5.49e-06	0.0
86470	1.06e-04	1.25e-03	-0.01	-6.16e-05	5.97e-06	0.0
86472	8.86e-05	1.12e-03	-0.01	-5.51e-05	5.18e-06	0.0
86473	8.43e-05	1.08e-03	-0.01	-5.35e-05	4.98e-06	0.0
8652	2.34e-04	2.50e-03	-0.02	-1.22e-04	1.28e-05	0.0
86516	-1.68e-03	1.13e-03	-0.02	-7.89e-05	5.30e-06	0.0
86517	2.05e-03	1.70e-03	-0.01	-7.36e-05	1.11e-05	0.0
86527	-4.96e-04	3.76e-03	-0.01	-8.94e-05	5.95e-06	0.0
86548	-2.41e-03	9.51e-04	-0.02	-7.97e-05	4.18e-06	0.0
86549	2.82e-03	1.75e-03	-0.01	-7.23e-05	1.23e-05	0.0
86559	-7.53e-04	4.64e-03	-0.01	-9.45e-05	5.10e-06	0.0
86570	1.79e-04	1.81e-03	-0.02	-8.88e-05	9.66e-06	0.0
86572	1.52e-04	1.61e-03	-0.02	-7.92e-05	8.39e-06	0.0
86573	1.45e-04	1.56e-03	-0.01	-7.68e-05	8.07e-06	0.0
8662	3.78e-04	3.31e-03	-0.03	-1.61e-04	2.04e-05	0.0
86615	-1.74e-03	3.02e-03	-0.02	-1.15e-04	6.87e-06	0.0
86617	2.26e-03	2.22e-03	-0.02	-9.83e-05	1.84e-05	0.0
86627	-4.36e-04	4.56e-03	-0.02	-1.28e-04	1.01e-05	0.0
86647	-2.54e-03	3.41e-03	-0.02	-1.21e-04	4.47e-06	0.0
86649	3.07e-03	2.28e-03	-0.02	-9.73e-05	2.05e-05	0.0
86659	-7.06e-04	5.57e-03	-0.02	-1.39e-04	9.05e-06	0.0
86670	2.87e-04	2.41e-03	-0.02	-1.17e-04	1.54e-05	0.0
86672	2.47e-04	2.13e-03	-0.02	-1.04e-04	1.34e-05	0.0
86673	2.37e-04	2.06e-03	-0.02	-1.01e-04	1.29e-05	0.0
8672	4.26e-04	4.22e-03	-0.04	-2.02e-04	2.77e-05	0.0
86718	2.56e-03	1.77e-03	-0.02	-1.05e-04	3.32e-05	0.0
86727	-5.95e-04	5.75e-03	-0.03	-1.82e-04	1.03e-05	0.0
86750	3.48e-03	1.44e-03	-0.02	-9.70e-05	3.94e-05	0.0
86759	-9.44e-04	7.02e-03	-0.03	-2.04e-04	7.35e-06	0.0
86770	3.23e-04	3.08e-03	-0.03	-1.47e-04	2.08e-05	0.0
86772	2.86e-04	2.69e-03	-0.03	-1.29e-04	1.83e-05	0.0
86773	2.77e-04	2.59e-03	-0.03	-1.25e-04	1.77e-05	0.0
8682	8.61e-04	4.35e-03	-0.04	-2.07e-04	4.62e-05	0.0
86817	2.72e-03	3.04e-03	-0.03	-1.34e-04	4.43e-05	0.0
86827	-1.18e-04	6.07e-03	-0.03	-1.96e-04	3.15e-05	0.0
86849	3.60e-03	3.19e-03	-0.03	-1.37e-04	5.05e-05	0.0
86859	-3.80e-04	7.43e-03	-0.04	-2.23e-04	3.27e-05	0.0
86870	6.48e-04	3.18e-03	-0.03	-1.51e-04	3.46e-05	0.0
86872	5.57e-04	2.76e-03	-0.03	-1.32e-04	2.99e-05	0.0
86873	5.34e-04	2.66e-03	-0.03	-1.27e-04	2.87e-05	0.0
8692	3.91e-04	-3.87e-03	-0.03	1.89e-04	1.95e-05	0.0
86910	2.58e-03	-2.63e-03	-0.02	1.20e-04	2.81e-05	0.0
86924	-4.58e-04	-5.14e-03	-0.02	1.55e-04	1.08e-05	0.0
86942	3.52e-03	-2.72e-03	-0.02	1.21e-04	3.45e-05	0.0
86956	-7.38e-04	-6.23e-03	-0.03	1.70e-04	1.02e-05	0.0
86970	2.97e-04	-2.82e-03	-0.03	1.38e-04	1.47e-05	0.0
86972	2.52e-04	-2.48e-03	-0.02	1.21e-04	1.27e-05	0.0
86973	2.41e-04	-2.40e-03	-0.02	1.17e-04	1.22e-05	0.0
8702	2.23e-04	-3.07e-03	-0.03	1.50e-04	1.24e-05	0.0
87010	2.16e-03	-2.09e-03	-0.02	9.31e-05	1.44e-05	0.0
87012	-1.75e-03	-2.49e-03	-0.02	1.01e-04	1.53e-06	0.0
87024	-5.10e-04	-4.31e-03	-0.02	1.14e-04	6.66e-06	0.0
87042	2.97e-03	-2.16e-03	-0.02	9.30e-05	1.71e-05	0.0
87044	-2.51e-03	-2.71e-03	-0.02	1.05e-04	0.0	0.0
87056	-7.69e-04	-5.27e-03	-0.02	1.23e-04	6.22e-06	0.0
87070	1.71e-04	-2.24e-03	-0.02	1.09e-04	9.36e-06	0.0
87072	1.44e-04	-1.98e-03	-0.02	9.66e-05	8.09e-06	0.0
87073	1.38e-04	-1.92e-03	-0.02	9.36e-05	7.77e-06	0.0
8712	1.43e-04	-2.25e-03	-0.02	1.10e-04	8.39e-06	0.0
87110	1.99e-03	-1.54e-03	-0.01	6.70e-05	8.59e-06	0.0
87123	-4.12e-04	5.92e-04	-0.01	6.31e-05	4.05e-06	0.0
87124	-5.21e-04	-3.52e-03	-0.01	7.68e-05	4.50e-06	0.0
87142	2.75e-03	-1.60e-03	-0.01	6.62e-05	9.93e-06	0.0





EGP CODE

GRE.EEC.R.73.IT.W.15235.12.024.01

PAGE

206 di/of 527

87155	-6.13e-04	1.39e-03	-0.01	6.08e-05	3.57e-06	0.0
87156	-7.65e-04	-4.36e-03	-0.01	7.99e-05	4.20e-06	0.0
87170	1.11e-04	-1.63e-03	-0.01	7.97e-05	6.33e-06	0.0
87172	9.26e-05	-1.45e-03	-0.01	7.11e-05	5.46e-06	0.0
87173	8.80e-05	-1.41e-03	-0.01	6.89e-05	5.25e-06	0.0
8722	8.66e-05	-1.49e-03	-0.01	7.26e-05	5.50e-06	0.0
87210	1.87e-03	-1.06e-03	-0.01	4.30e-05	4.81e-06	0.0
87223	-4.37e-04	9.07e-04	-0.01	4.80e-05	3.20e-06	0.0
87224	-5.25e-04	-2.88e-03	-0.01	4.51e-05	2.78e-06	0.0
87242	2.59e-03	-1.11e-03	-0.01	4.18e-05	5.36e-06	0.0
87255	-6.34e-04	1.64e-03	-0.01	4.89e-05	3.11e-06	0.0
87256	-7.56e-04	-3.65e-03	-0.01	4.48e-05	2.52e-06	0.0
87270	6.84e-05	-1.08e-03	-0.01	5.27e-05	4.16e-06	0.0
87272	5.55e-05	-9.62e-04	-0.01	4.72e-05	3.58e-06	0.0
87273	5.23e-05	-9.33e-04	-0.01	4.58e-05	3.43e-06	0.0
8731	3.34e-05	-6.89e-04	-0.01	3.39e-05	2.93e-06	0.0
8732	5.12e-05	-8.07e-04	-0.01	3.94e-05	3.71e-06	0.0
8734	5.33e-05	-5.95e-04-8.82e-03		2.89e-05	3.13e-06	0.0
87310	1.78e-03	-6.29e-04-8.89e-03		2.24e-05	2.82e-06	0.0
87323	-4.64e-04	1.24e-03-9.68e-03		3.11e-05	2.34e-06	0.0
87324	-5.16e-04	-2.35e-03-8.73e-03		1.96e-05	1.90e-06	0.0
87342	2.49e-03	-6.77e-04-8.79e-03		2.14e-05	3.03e-06	0.0
87355	-6.62e-04	1.93e-03-9.89e-03		3.36e-05	2.36e-06	0.0
87356	-7.34e-04	-3.08e-03-8.57e-03		1.75e-05	1.74e-06	0.0
87369	2.99e-05	-5.07e-04-9.15e-03		2.49e-05	2.29e-06	0.0
87370	4.18e-05	-5.86e-04-8.91e-03		2.86e-05	2.82e-06	0.0
87371	2.99e-05	-5.07e-04-9.15e-03		2.49e-05	2.29e-06	0.0
87372	3.23e-05	-5.23e-04-9.10e-03		2.56e-05	2.40e-06	0.0
87373	2.99e-05	-5.07e-04-9.15e-03		2.49e-05	2.29e-06	0.0
8741	2.06e-05	-1.60e-04	-0.01	7.74e-06	2.29e-06	0.0
8742	3.56e-05	-1.87e-04	-0.01	9.00e-06	2.94e-06	0.0
8744	4.07e-05	-1.37e-04-7.94e-03		6.60e-06	2.51e-06	0.0
8747	-1.68e-03	2.60e-04-8.56e-03		8.75e-06	1.62e-06	0.0
87410	1.73e-03	-2.43e-04-8.25e-03		3.73e-06	1.99e-06	0.0
87424	-4.96e-04	-1.91e-03-8.32e-03		-1.81e-06	1.67e-06	0.0
87439	-2.36e-03	4.12e-04-8.62e-03		9.98e-06	1.54e-06	0.0
87442	2.41e-03	-2.93e-04-8.20e-03		2.95e-06	2.07e-06	0.0
87456	-7.02e-04	-2.63e-03-8.29e-03		-4.82e-06	1.62e-06	0.0
87469	2.01e-05	-1.18e-04-8.40e-03		5.69e-06	1.80e-06	0.0
87470	3.01e-05	-1.35e-04-8.05e-03		6.53e-06	2.23e-06	0.0
87471	2.01e-05	-1.18e-04-8.40e-03		5.69e-06	1.80e-06	0.0
87472	2.21e-05	-1.21e-04-8.33e-03		5.85e-06	1.89e-06	0.0
87473	2.01e-05	-1.18e-04-8.40e-03		5.69e-06	1.80e-06	0.0
8751	2.34e-05	3.58e-04	-0.01	-1.78e-05	2.45e-06	0.0
8752	3.91e-05	4.19e-04	-0.01	-2.07e-05	3.13e-06	0.0
8754	4.35e-05	3.09e-04-8.15e-03		-1.52e-05	2.66e-06	0.0
87517	1.74e-03	3.86e-04-8.40e-03		-1.09e-05	2.19e-06	0.0
87527	-5.07e-04	2.07e-03-8.34e-03		-6.18e-06	1.72e-06	0.0
87528	-4.74e-04	-1.45e-03-8.90e-03		-2.06e-05	1.96e-06	0.0
87549	2.43e-03	4.35e-04-8.32e-03		-1.01e-05	2.29e-06	0.0
87559	-7.18e-04	2.79e-03-8.25e-03		-3.41e-06	1.63e-06	0.0
87560	-6.72e-04	-2.14e-03-9.03e-03		-2.37e-05	1.97e-06	0.0
87569	2.23e-05	2.63e-04-8.58e-03		-1.31e-05	1.93e-06	0.0
87570	3.28e-05	3.04e-04-8.26e-03		-1.50e-05	2.38e-06	0.0
87571	2.23e-05	2.63e-04-8.58e-03		-1.31e-05	1.93e-06	0.0
87572	2.44e-05	2.72e-04-8.52e-03		-1.35e-05	2.02e-06	0.0
87573	2.23e-05	2.63e-04-8.58e-03		-1.31e-05	1.93e-06	0.0
8761	4.21e-05	9.04e-04	-0.01	-4.47e-05	3.41e-06	0.0
8762	6.18e-05	1.06e-03	-0.01	-5.21e-05	4.30e-06	0.0
8764	6.19e-05	7.82e-04-9.47e-03		-3.83e-05	3.61e-06	0.0
87617	1.81e-03	7.86e-04-9.41e-03		-3.03e-05	3.40e-06	0.0
87627	-5.23e-04	2.54e-03-9.19e-03		-2.92e-05	2.19e-06	0.0
87628	-4.50e-04	-1.11e-03	-0.01	-3.77e-05	2.66e-06	0.0
87649	2.52e-03	8.35e-04-9.29e-03		-2.93e-05	3.69e-06	0.0
87659	-7.47e-04	3.29e-03-8.98e-03		-2.78e-05	2.00e-06	0.0
87660	-6.45e-04	-1.82e-03	-0.01	-3.96e-05	2.65e-06	0.0
87669	3.66e-05	6.65e-04-9.71e-03		-3.29e-05	2.67e-06	0.0
87670	4.98e-05	7.69e-04-9.56e-03		-3.78e-05	3.26e-06	0.0
87671	3.66e-05	6.65e-04-9.71e-03		-3.29e-05	2.67e-06	0.0
87672	3.93e-05	6.86e-04-9.68e-03		-3.39e-05	2.78e-06	0.0
87673	3.66e-05	6.65e-04-9.71e-03		-3.29e-05	2.67e-06	0.0
8772	1.05e-04	1.77e-03	-0.02	-8.69e-05	6.50e-06	0.0
87717	1.90e-03	1.24e-03	-0.01	-5.25e-05	5.85e-06	0.0
87727	-5.27e-04	3.11e-03	-0.01	-5.77e-05	3.34e-06	0.0
87728	-4.23e-04	-7.87e-04	-0.01	-5.35e-05	3.64e-06	0.0
87749	2.64e-03	1.29e-03	-0.01	-5.16e-05	6.57e-06	0.0



EGP CODE

GRE.EEC.R.73.IT.W.15235.12.024.01

PAGE

207 di/of 527

87759	-7.64e-04	3.92e-03	-0.01	-5.89e-05	3.06e-06	0.0
87760	-6.18e-04	-1.55e-03	-0.01	-5.30e-05	3.47e-06	0.0
87770	8.19e-05	1.29e-03	-0.01	-6.31e-05	4.91e-06	0.0
87772	6.73e-05	1.15e-03	-0.01	-5.64e-05	4.23e-06	0.0
87773	6.36e-05	1.11e-03	-0.01	-5.47e-05	4.06e-06	0.0
8782	1.68e-04	2.56e-03	-0.02	-1.25e-04	9.77e-06	0.0
87816	-1.76e-03	1.15e-03	-0.02	-7.92e-05	1.74e-06	0.0
87817	2.04e-03	1.75e-03	-0.01	-7.72e-05	1.05e-05	0.0
87827	-5.21e-04	3.80e-03	-0.01	-9.09e-05	5.26e-06	0.0
87848	-2.50e-03	9.73e-04	-0.02	-7.94e-05	0.0	0.0
87849	2.82e-03	1.81e-03	-0.01	-7.65e-05	1.23e-05	0.0
87859	-7.72e-04	4.69e-03	-0.01	-9.57e-05	4.92e-06	0.0
87870	1.30e-04	1.87e-03	-0.02	-9.12e-05	7.37e-06	0.0
87872	1.09e-04	1.66e-03	-0.02	-8.12e-05	6.37e-06	0.0
87873	1.04e-04	1.60e-03	-0.02	-7.87e-05	6.11e-06	0.0
8792	2.51e-04	3.41e-03	-0.03	-1.66e-04	1.41e-05	0.0
87917	2.21e-03	2.31e-03	-0.02	-1.04e-04	1.63e-05	0.0
87919	-1.76e-03	2.72e-03	-0.02	-1.13e-04	1.89e-06	0.0
87927	-5.02e-04	4.66e-03	-0.02	-1.31e-04	7.87e-06	0.0
87949	3.03e-03	2.39e-03	-0.02	-1.04e-04	1.93e-05	0.0
87951	-2.52e-03	2.96e-03	-0.02	-1.17e-04	0.0	0.0
87959	-7.65e-04	5.68e-03	-0.02	-1.42e-04	7.49e-06	0.0
87970	1.92e-04	2.48e-03	-0.02	-1.21e-04	1.06e-05	0.0
87972	1.63e-04	2.19e-03	-0.02	-1.07e-04	9.16e-06	0.0
87973	1.56e-04	2.12e-03	-0.02	-1.04e-04	8.80e-06	0.0
8802	4.17e-04	4.14e-03	-0.04	-2.03e-04	2.11e-05	0.0
88017	2.79e-03	2.84e-03	-0.03	-1.31e-04	3.75e-05	0.0
88027	-4.99e-04	5.56e-03	-0.03	-1.79e-04	9.51e-06	0.0
88049	3.80e-03	2.95e-03	-0.03	-1.33e-04	4.72e-05	0.0
88059	-8.03e-04	6.76e-03	-0.03	-2.00e-04	8.05e-06	0.0
88070	3.17e-04	3.03e-03	-0.03	-1.48e-04	1.59e-05	0.0
88072	2.70e-04	2.65e-03	-0.03	-1.30e-04	1.37e-05	0.0
88073	2.58e-04	2.56e-03	-0.03	-1.26e-04	1.32e-05	0.0
8812	-3.01e-05	-4.44e-03	-0.04	2.13e-04	0.0	0.0
88111	-2.31e-03	-2.39e-03	-0.03	1.21e-04	-2.12e-05	0.0
88124	-8.13e-04	-6.25e-03	-0.03	2.05e-04	-8.67e-06	0.0
88143	-3.22e-03	-2.26e-03	-0.03	1.17e-04	-2.98e-05	0.0
88156	-1.13e-03	-7.66e-03	-0.04	2.35e-04	-1.22e-05	0.0
88170	-1.76e-05	-3.25e-03	-0.03	1.55e-04	0.0	0.0
88172	-1.65e-05	-2.82e-03	-0.03	1.35e-04	0.0	0.0
88173	-1.63e-05	-2.71e-03	-0.03	1.30e-04	0.0	0.0
8822	4.18e-04	-3.98e-03	-0.03	1.92e-04	1.75e-05	0.0
88210	2.55e-03	-2.76e-03	-0.02	1.26e-04	2.70e-05	0.0
88224	-2.87e-04	-5.27e-03	-0.03	1.61e-04	1.32e-05	0.0
88242	3.47e-03	-2.87e-03	-0.02	1.28e-04	3.37e-05	0.0
88256	-5.01e-04	-6.39e-03	-0.03	1.78e-04	1.43e-05	0.0
88270	3.16e-04	-2.91e-03	-0.03	1.40e-04	1.32e-05	0.0
88272	2.61e-04	-2.55e-03	-0.02	1.24e-04	1.11e-05	0.0
88273	2.48e-04	-2.46e-03	-0.02	1.20e-04	1.06e-05	0.0
8832	1.64e-04	-3.09e-03	-0.03	1.51e-04	9.36e-06	0.0
88310	2.12e-03	-2.11e-03	-0.02	9.56e-05	1.21e-05	0.0
88312	-1.79e-03	-2.48e-03	-0.02	1.00e-04	0.0	0.0
88324	-5.35e-04	-4.30e-03	-0.02	1.14e-04	5.73e-06	0.0
88342	2.93e-03	-2.18e-03	-0.02	9.60e-05	1.46e-05	0.0
88344	-2.54e-03	-2.70e-03	-0.02	1.03e-04	-2.03e-06	0.0
88356	-7.90e-04	-5.25e-03	-0.02	1.22e-04	5.71e-06	0.0
88370	1.27e-04	-2.25e-03	-0.02	1.10e-04	7.06e-06	0.0
88372	1.05e-04	-1.99e-03	-0.02	9.75e-05	6.05e-06	0.0
88373	9.99e-05	-1.93e-03	-0.02	9.44e-05	5.79e-06	0.0
8842	1.07e-04	-2.26e-03	-0.02	1.11e-04	6.72e-06	0.0
88410	1.97e-03	-1.56e-03	-0.01	6.87e-05	7.73e-06	0.0
88423	-4.47e-04	5.97e-04	-0.01	6.30e-05	2.33e-06	0.0
88424	-5.35e-04	-3.54e-03	-0.01	7.77e-05	4.00e-06	0.0
88442	2.73e-03	-1.62e-03	-0.01	6.83e-05	9.16e-06	0.0
88455	-6.52e-04	1.40e-03	-0.01	6.03e-05	1.59e-06	0.0
88456	-7.75e-04	-4.39e-03	-0.01	8.09e-05	3.93e-06	0.0
88470	8.40e-05	-1.65e-03	-0.01	8.05e-05	5.08e-06	0.0
88472	6.87e-05	-1.46e-03	-0.01	7.18e-05	4.35e-06	0.0
88473	6.49e-05	-1.42e-03	-0.01	6.96e-05	4.17e-06	0.0
8852	6.62e-05	-1.50e-03	-0.01	7.35e-05	4.60e-06	0.0
88510	1.86e-03	-1.06e-03	-0.01	4.39e-05	4.49e-06	0.0
88523	-4.56e-04	9.02e-04	-0.01	4.84e-05	2.25e-06	0.0
88524	-5.35e-04	-2.89e-03	-0.01	4.55e-05	2.52e-06	0.0
88542	2.59e-03	-1.11e-03	-0.01	4.30e-05	5.15e-06	0.0
88555	-6.54e-04	1.64e-03	-0.01	4.92e-05	2.00e-06	0.0
88556	-7.65e-04	-3.67e-03	-0.01	4.52e-05	2.39e-06	0.0



EGP CODE

GRE.EEC.R.73.IT.W.15235.12.024.01

PAGE

208 di/of 527

88570	5.32e-05	-1.09e-03	-0.01	5.33e-05	3.49e-06	0.0
88572	4.21e-05	-9.72e-04	-0.01	4.77e-05	2.98e-06	0.0
88573	3.93e-05	-9.42e-04	-0.01	4.63e-05	2.85e-06	0.0
8861	2.23e-05	-6.97e-04	-0.01	3.43e-05	2.45e-06	0.0
8862	3.83e-05	-8.16e-04	-0.01	3.99e-05	3.16e-06	0.0
8864	4.34e-05	-6.02e-04-8.87e-03		2.93e-05	2.71e-06	0.0
88610	1.78e-03	-6.28e-04-8.95e-03		2.29e-05	2.57e-06	0.0
88623	-4.75e-04	1.23e-03-9.72e-03		3.14e-05	1.85e-06	0.0
88624	-5.23e-04	-2.36e-03-8.77e-03		1.98e-05	1.61e-06	0.0
88642	2.48e-03	-6.73e-04-8.85e-03		2.21e-05	2.83e-06	0.0
88655	-6.74e-04	1.93e-03-9.93e-03		3.38e-05	1.81e-06	0.0
88656	-7.41e-04	-3.10e-03-8.60e-03		1.77e-05	1.48e-06	0.0
88669	2.17e-05	-5.13e-04-9.19e-03		2.52e-05	1.94e-06	0.0
88670	3.23e-05	-5.92e-04-8.97e-03		2.89e-05	2.41e-06	0.0
88671	2.17e-05	-5.13e-04-9.19e-03		2.52e-05	1.94e-06	0.0
88672	2.38e-05	-5.29e-04-9.15e-03		2.59e-05	2.03e-06	0.0
88673	2.17e-05	-5.13e-04-9.19e-03		2.52e-05	1.94e-06	0.0
8871	1.18e-05	-1.61e-04	-0.01	7.83e-06	1.92e-06	0.0
8872	2.55e-05	-1.89e-04	-0.01	9.10e-06	2.51e-06	0.0
8874	3.31e-05	-1.39e-04-7.99e-03		6.68e-06	2.19e-06	0.0
8877	-1.69e-03	2.52e-04-8.58e-03		8.75e-06	1.25e-06	0.0
88710	1.72e-03	-2.35e-04-8.29e-03		3.88e-06	1.80e-06	0.0
88724	-5.03e-04	-1.92e-03-8.35e-03		-1.83e-06	1.39e-06	0.0
88739	-2.37e-03	4.02e-04-8.65e-03		9.94e-06	1.14e-06	0.0
88742	2.41e-03	-2.82e-04-8.24e-03		3.14e-06	1.91e-06	0.0
88756	-7.09e-04	-2.64e-03-8.32e-03		-4.87e-06	1.34e-06	0.0
88769	1.36e-05	-1.19e-04-8.43e-03		5.75e-06	1.53e-06	0.0
88770	2.27e-05	-1.37e-04-8.09e-03		6.61e-06	1.92e-06	0.0
88771	1.36e-05	-1.19e-04-8.43e-03		5.75e-06	1.53e-06	0.0
88772	1.54e-05	-1.22e-04-8.36e-03		5.92e-06	1.61e-06	0.0
88773	1.36e-05	-1.19e-04-8.43e-03		5.75e-06	1.53e-06	0.0
8881	1.41e-05	3.62e-04	-0.01	-1.80e-05	2.05e-06	0.0
8882	2.83e-05	4.24e-04	-0.01	-2.10e-05	2.67e-06	0.0
8884	3.54e-05	3.13e-04-8.20e-03		-1.54e-05	2.32e-06	0.0
88817	1.74e-03	3.81e-04-8.44e-03		-1.12e-05	1.98e-06	0.0
88827	-5.13e-04	2.08e-03-8.37e-03		-6.25e-06	1.44e-06	0.0
88828	-4.82e-04	-1.45e-03-8.93e-03		-2.08e-05	1.59e-06	0.0
88849	2.43e-03	4.27e-04-8.37e-03		-1.04e-05	2.12e-06	0.0
88859	-7.25e-04	2.80e-03-8.28e-03		-3.44e-06	1.36e-06	0.0
88860	-6.81e-04	-2.14e-03-9.06e-03		-2.38e-05	1.57e-06	0.0
88869	1.54e-05	2.67e-04-8.61e-03		-1.33e-05	1.63e-06	0.0
88870	2.48e-05	3.08e-04-8.30e-03		-1.52e-05	2.04e-06	0.0
88871	1.54e-05	2.67e-04-8.61e-03		-1.33e-05	1.63e-06	0.0
88872	1.73e-05	2.75e-04-8.55e-03		-1.36e-05	1.71e-06	0.0
88873	1.54e-05	2.67e-04-8.61e-03		-1.33e-05	1.63e-06	0.0
8891	2.91e-05	9.13e-04	-0.01	-4.52e-05	2.84e-06	0.0
8892	4.65e-05	1.07e-03	-0.01	-5.27e-05	3.63e-06	0.0
8894	5.01e-05	7.91e-04-9.53e-03		-3.88e-05	3.09e-06	0.0
88917	1.80e-03	7.88e-04-9.48e-03		-3.10e-05	3.25e-06	0.0
88927	-5.31e-04	2.55e-03-9.23e-03		-2.95e-05	1.85e-06	0.0
88928	-4.63e-04	-1.11e-03	-0.01	-3.80e-05	2.07e-06	0.0
88949	2.51e-03	8.35e-04-9.36e-03		-3.01e-05	3.65e-06	0.0
88959	-7.54e-04	3.31e-03-9.02e-03		-2.80e-05	1.69e-06	0.0
88960	-6.60e-04	-1.82e-03	-0.01	-3.99e-05	2.01e-06	0.0
88969	2.69e-05	6.73e-04-9.76e-03		-3.33e-05	2.24e-06	0.0
88970	3.85e-05	7.78e-04-9.62e-03		-3.82e-05	2.76e-06	0.0
88971	2.69e-05	6.73e-04-9.76e-03		-3.33e-05	2.24e-06	0.0
88972	2.92e-05	6.94e-04-9.73e-03		-3.43e-05	2.34e-06	0.0
88973	2.69e-05	6.73e-04-9.76e-03		-3.33e-05	2.24e-06	0.0
8902	7.85e-05	1.79e-03	-0.02	-8.78e-05	5.32e-06	0.0
89017	1.89e-03	1.25e-03	-0.01	-5.37e-05	5.41e-06	0.0
89027	-5.40e-04	3.13e-03	-0.01	-5.82e-05	2.96e-06	0.0
89028	-4.46e-04	-7.82e-04	-0.01	-5.38e-05	2.44e-06	0.0
89049	2.63e-03	1.30e-03	-0.01	-5.30e-05	6.26e-06	0.0
89059	-7.75e-04	3.94e-03	-0.01	-5.94e-05	2.82e-06	0.0
89060	-6.43e-04	-1.54e-03	-0.01	-5.32e-05	2.10e-06	0.0
89070	6.25e-05	1.30e-03	-0.01	-6.38e-05	4.03e-06	0.0
89072	5.02e-05	1.16e-03	-0.01	-5.70e-05	3.45e-06	0.0
89073	4.71e-05	1.12e-03	-0.01	-5.53e-05	3.30e-06	0.0
8912	1.20e-04	2.58e-03	-0.02	-1.27e-04	7.48e-06	0.0
89116	-1.80e-03	1.15e-03	-0.02	-7.85e-05	0.0	0.0
89117	2.01e-03	1.77e-03	-0.01	-7.92e-05	9.18e-06	0.0
89127	-5.37e-04	3.83e-03	-0.02	-9.18e-05	4.68e-06	0.0
89148	-2.54e-03	9.63e-04	-0.02	-7.82e-05	-1.86e-06	0.0
89149	2.79e-03	1.84e-03	-0.01	-7.91e-05	1.10e-05	0.0
89159	-7.82e-04	4.72e-03	-0.01	-9.68e-05	4.70e-06	0.0



EGP CODE

GRE.EEC.R.73.IT.W.15235.12.024.01

PAGE

209 di/of 527

89170	9.34e-05	1.88e-03	-0.02	-9.20e-05	5.65e-06	0.0
89172	7.69e-05	1.67e-03	-0.02	-8.19e-05	4.85e-06	0.0
89173	7.28e-05	1.61e-03	-0.02	-7.94e-05	4.65e-06	0.0
8922	1.68e-04	3.42e-03	-0.03	-1.67e-04	9.63e-06	0.0
89217	2.16e-03	2.33e-03	-0.02	-1.06e-04	1.35e-05	0.0
89227	-5.50e-04	4.64e-03	-0.02	-1.31e-04	5.69e-06	0.0
89249	2.99e-03	2.41e-03	-0.02	-1.07e-04	1.65e-05	0.0
89259	-8.11e-04	5.65e-03	-0.02	-1.41e-04	5.59e-06	0.0
89270	1.30e-04	2.49e-03	-0.02	-1.22e-04	7.27e-06	0.0
89272	1.07e-04	2.20e-03	-0.02	-1.08e-04	6.22e-06	0.0
89273	1.02e-04	2.13e-03	-0.02	-1.04e-04	5.96e-06	0.0
8932	4.04e-04	4.31e-03	-0.04	-2.08e-04	1.60e-05	0.0
89317	2.67e-03	3.03e-03	-0.03	-1.38e-04	3.15e-05	0.0
89321	9.72e-04	5.77e-03	-0.03	-1.84e-04	2.13e-05	0.0
89327	-3.16e-04	5.77e-03	-0.03	-1.84e-04	1.11e-05	0.0
89349	3.64e-03	3.18e-03	-0.03	-1.42e-04	4.03e-05	0.0
89353	1.27e-03	7.03e-03	-0.03	-2.06e-04	2.60e-05	0.0
89359	-5.38e-04	7.01e-03	-0.03	-2.07e-04	1.17e-05	0.0
89370	3.07e-04	3.15e-03	-0.03	-1.52e-04	1.20e-05	0.0
89372	2.51e-04	2.75e-03	-0.03	-1.33e-04	1.01e-05	0.0
89373	2.37e-04	2.66e-03	-0.03	-1.29e-04	9.58e-06	0.0
8941	-9.78e-06	3.63e-03	-0.04	-1.76e-04	0.0	0.0
8942	-5.68e-06	4.43e-03	-0.04	-2.13e-04	0.0	0.0
89420	-2.33e-03	2.36e-03	-0.03	-1.21e-04	-2.23e-05	0.0
89427	-7.85e-04	6.22e-03	-0.03	-2.04e-04	-4.30e-06	0.0
89452	-3.26e-03	2.22e-03	-0.03	-1.17e-04	-3.15e-05	0.0
89459	-1.10e-03	7.63e-03	-0.04	-2.34e-04	-6.27e-06	0.0
89469	-1.89e-06	2.71e-03	-0.03	-1.31e-04	0.0	0.0
89470	0.0	3.24e-03	-0.03	-1.56e-04	0.0	0.0
89471	-1.89e-06	2.71e-03	-0.03	-1.31e-04	0.0	0.0
89472	-1.35e-06	2.81e-03	-0.03	-1.36e-04	0.0	0.0
89473	-1.89e-06	2.71e-03	-0.03	-1.31e-04	0.0	0.0
8952	-3.13e-04	-3.90e-03	-0.04	1.90e-04	-1.44e-05	0.0
89512	-2.22e-03	-3.07e-03	-0.03	1.26e-04	-1.25e-05	0.0
89524	-9.38e-04	-5.41e-03	-0.03	1.67e-04	-1.35e-05	0.0
89528	-8.57e-04	-5.31e-03	-0.03	1.67e-04	-1.33e-05	0.0
89544	-3.03e-03	-3.33e-03	-0.03	1.29e-04	-1.41e-05	0.0
89556	-1.24e-03	-6.62e-03	-0.03	1.87e-04	-1.54e-05	0.0
89560	-1.12e-03	-6.47e-03	-0.03	1.87e-04	-1.51e-05	0.0
89570	-2.29e-04	-2.84e-03	-0.03	1.39e-04	-1.06e-05	0.0
89572	-1.97e-04	-2.49e-03	-0.03	1.22e-04	-9.01e-06	0.0
89573	-1.89e-04	-2.41e-03	-0.03	1.18e-04	-8.60e-06	0.0
8962	-1.20e-04	-3.67e-03	-0.03	1.80e-04	-5.18e-06	0.0
89611	-2.08e-03	-2.01e-03	-0.02	1.04e-04	-6.46e-06	0.0
89624	-7.08e-04	-5.05e-03	-0.03	1.50e-04	-2.24e-06	0.0
89626	3.74e-04	-5.05e-03	-0.03	1.51e-04	0.0	0.0
89643	-2.88e-03	-1.90e-03	-0.02	1.01e-04	-7.78e-06	0.0
89656	-9.61e-04	-6.16e-03	-0.03	1.66e-04	-1.87e-06	0.0
89658	5.53e-04	-6.17e-03	-0.03	1.66e-04	0.0	0.0
89670	-8.55e-05	-2.67e-03	-0.03	1.31e-04	-3.79e-06	0.0
89672	-7.77e-05	-2.36e-03	-0.02	1.16e-04	-3.29e-06	0.0
89673	-7.58e-05	-2.28e-03	-0.02	1.12e-04	-3.16e-06	0.0
8971	-2.24e-05	-2.56e-03	-0.02	1.26e-04	0.0	0.0
8972	-1.55e-05	-3.03e-03	-0.03	1.49e-04	0.0	0.0
89711	-1.98e-03	-1.69e-03	-0.02	8.89e-05	-3.26e-06	0.0
89726	4.53e-04	-4.31e-03	-0.02	1.15e-04	3.97e-06	0.0
89732	-3.57e-04	-3.18e-03	-0.02	1.07e-04	1.24e-06	0.0
89743	-2.77e-03	-1.61e-03	-0.02	8.72e-05	-4.72e-06	0.0
89758	6.38e-04	-5.28e-03	-0.02	1.24e-04	5.41e-06	0.0
89764	-4.96e-04	-3.70e-03	-0.02	1.12e-04	1.59e-06	0.0
89769	-1.19e-05	-1.89e-03	-0.02	9.33e-05	0.0	0.0
89770	-7.29e-06	-2.21e-03	-0.02	1.08e-04	0.0	0.0
89771	-1.19e-05	-1.89e-03	-0.02	9.33e-05	0.0	0.0
89772	-1.10e-05	-1.96e-03	-0.02	9.64e-05	0.0	0.0
89773	-1.19e-05	-1.89e-03	-0.02	9.33e-05	0.0	0.0
8982	1.21e-05	-2.27e-03	-0.02	1.11e-04	2.19e-06	0.0
8984	2.39e-05	-1.69e-03	-0.01	8.26e-05	1.99e-06	0.0
89810	1.89e-03	-1.57e-03	-0.01	7.10e-05	3.67e-06	0.0
89823	-5.03e-04	6.20e-04	-0.01	6.19e-05	0.0	0.0
89824	-5.87e-04	-3.57e-03	-0.01	7.87e-05	2.11e-06	0.0
89842	2.65e-03	-1.62e-03	-0.01	7.14e-05	4.61e-06	0.0
89855	-7.06e-04	1.44e-03	-0.01	5.86e-05	-1.53e-06	0.0
89856	-8.24e-04	-4.43e-03	-0.01	8.22e-05	2.42e-06	0.0
89870	1.32e-05	-1.65e-03	-0.01	8.10e-05	1.70e-06	0.0
89872	6.77e-06	-1.47e-03	-0.01	7.23e-05	1.39e-06	0.0
89873	5.16e-06	-1.42e-03	-0.01	7.01e-05	1.32e-06	0.0



EGP CODE

GRE.EEC.R.73.IT.W.15235.12.024.01

PAGE

210 di/of 527

8992	1.02e-05	-1.52e-03	-0.01	7.45e-05	2.02e-06	0.0
8994	2.21e-05	-1.13e-03	-0.01	5.50e-05	1.84e-06	0.0
89910	1.82e-03	-1.06e-03	-0.01	4.55e-05	2.63e-06	0.0
89923	-4.94e-04	9.06e-04	-0.01	4.85e-05	0.0	0.0
89924	-5.67e-04	-2.92e-03	-0.01	4.61e-05	1.35e-06	0.0
89942	2.55e-03	-1.11e-03	-0.01	4.49e-05	3.20e-06	0.0
89955	-6.93e-04	1.65e-03	-0.01	4.91e-05	0.0	0.0
89956	-7.95e-04	-3.71e-03	-0.01	4.57e-05	1.41e-06	0.0
89970	1.16e-05	-1.10e-03	-0.01	5.41e-05	1.57e-06	0.0
89972	5.34e-06	-9.83e-04	-0.01	4.84e-05	1.28e-06	0.0
89973	3.77e-06	-9.53e-04	-0.01	4.70e-05	1.20e-06	0.0
9001	-8.50e-06	-7.07e-04	-0.01	3.48e-05	1.08e-06	0.0
9002	1.95e-06	-8.29e-04	-0.01	4.06e-05	1.55e-06	0.0
9004	1.54e-05	-6.13e-04-8.98e-03		2.99e-05	1.45e-06	0.0
90011	-1.76e-03	-4.25e-04-9.47e-03		2.73e-05	0.0	0.0
90023	-5.00e-04	1.23e-03-9.78e-03		3.15e-05	0.0	0.0
90024	-5.45e-04	-2.38e-03-8.83e-03		2.02e-05	0.0	0.0
90043	-2.47e-03	-3.86e-04-9.55e-03		2.80e-05	0.0	0.0
90055	-7.00e-04	1.94e-03-9.98e-03		3.39e-05	0.0	0.0
90056	-7.63e-04	-3.13e-03-8.66e-03		1.81e-05	0.0	0.0
90069	-1.56e-06	-5.21e-04-9.26e-03		2.56e-05	0.0	0.0
90070	5.41e-06	-6.02e-04-9.06e-03		2.95e-05	1.21e-06	0.0
90071	-1.56e-06	-5.21e-04-9.26e-03		2.56e-05	0.0	0.0
90072	0.0	-5.38e-04-9.22e-03		2.64e-05	0.0	0.0
90073	-1.56e-06	-5.21e-04-9.26e-03		2.56e-05	0.0	0.0
9011	-1.27e-05	-1.64e-04 -0.01		7.97e-06	0.0	0.0
9012	-3.08e-06	-1.92e-04 -0.01		9.27e-06	1.28e-06	0.0
90111	-1.72e-03	-2.61e-05-8.61e-03		7.48e-06	0.0	0.0
90123	-5.12e-04	1.59e-03-8.64e-03		1.38e-05	0.0	0.0
90124	-5.21e-04	-1.94e-03-8.40e-03		-1.80e-06	0.0	0.0
90143	-2.40e-03	1.20e-05-8.66e-03		8.12e-06	0.0	0.0
90155	-7.15e-04	2.28e-03-8.69e-03		1.69e-05	0.0	0.0
90156	-7.28e-04	-2.66e-03-8.37e-03		-4.87e-06	0.0	0.0
90169	-4.81e-06	-1.21e-04-8.49e-03		5.86e-06	0.0	0.0
90170	1.63e-06	-1.39e-04-8.17e-03		6.73e-06	1.01e-06	0.0
90171	-4.81e-06	-1.21e-04-8.49e-03		5.86e-06	0.0	0.0
90172	-3.52e-06	-1.24e-04-8.42e-03		6.03e-06	0.0	0.0
90173	-4.81e-06	-1.21e-04-8.49e-03		5.86e-06	0.0	0.0
9021	-1.18e-05	3.69e-04 -0.01		-1.84e-05	0.0	0.0
9022	-1.95e-06	4.32e-04 -0.01		-2.14e-05	1.36e-06	0.0
9024	1.23e-05	3.19e-04-8.29e-03		-1.57e-05	1.30e-06	0.0
90220	-1.73e-03	1.77e-04-8.83e-03		-1.52e-05	0.0	0.0
90227	-5.33e-04	2.10e-03-8.43e-03		-6.41e-06	0.0	0.0
90228	-5.03e-04	-1.45e-03-8.99e-03		-2.09e-05	0.0	0.0
90252	-2.42e-03	1.40e-04-8.89e-03		-1.59e-05	0.0	0.0
90259	-7.44e-04	2.83e-03-8.33e-03		-3.57e-06	0.0	0.0
90260	-7.03e-04	-2.14e-03-9.11e-03		-2.39e-05	0.0	0.0
90269	-4.08e-06	2.72e-04-8.68e-03		-1.35e-05	0.0	0.0
90270	2.48e-06	3.14e-04-8.38e-03		-1.55e-05	1.07e-06	0.0
90271	-4.08e-06	2.72e-04-8.68e-03		-1.35e-05	0.0	0.0
90272	-2.77e-06	2.80e-04-8.62e-03		-1.39e-05	0.0	0.0
90273	-4.08e-06	2.72e-04-8.68e-03		-1.35e-05	0.0	0.0
9031	-6.37e-06	9.27e-04 -0.01		-4.59e-05	1.24e-06	0.0
9032	4.54e-06	1.09e-03 -0.01		-5.36e-05	1.74e-06	0.0
9034	1.75e-05	8.04e-04-9.65e-03		-3.95e-05	1.61e-06	0.0
90317	1.78e-03	7.83e-04-9.60e-03		-3.22e-05	2.01e-06	0.0
90327	-5.56e-04	2.58e-03-9.30e-03		-3.01e-05	1.07e-06	0.0
90328	-4.93e-04	-1.11e-03 -0.01		-3.81e-05	0.0	0.0
90349	2.49e-03	8.24e-04-9.51e-03		-3.16e-05	2.40e-06	0.0
90359	-7.79e-04	3.34e-03-9.09e-03		-2.86e-05	1.09e-06	0.0
90360	-6.91e-04	-1.82e-03 -0.01		-3.99e-05	0.0	0.0
90369	0.0	6.83e-04-9.84e-03		-3.38e-05	1.02e-06	0.0
90370	7.38e-06	7.90e-04-9.72e-03		-3.89e-05	1.36e-06	0.0
90371	0.0	6.83e-04-9.84e-03		-3.38e-05	1.02e-06	0.0
90372	1.57e-06	7.05e-04-9.82e-03		-3.48e-05	1.09e-06	0.0
90373	0.0	6.83e-04-9.84e-03		-3.38e-05	1.02e-06	0.0
9042	1.10e-05	1.80e-03 -0.02		-8.88e-05	2.16e-06	0.0
9044	2.29e-05	1.34e-03 -0.01		-6.56e-05	1.95e-06	0.0
90417	1.84e-03	1.25e-03 -0.01		-5.55e-05	3.07e-06	0.0
90427	-5.77e-04	3.17e-03 -0.01		-5.91e-05	1.60e-06	0.0
90428	-4.92e-04	-7.91e-04 -0.01		-5.35e-05	0.0	0.0
90449	2.58e-03	1.30e-03 -0.01		-5.54e-05	3.78e-06	0.0
90459	-8.10e-04	3.98e-03 -0.01		-6.03e-05	1.73e-06	0.0
90460	-6.91e-04	-1.56e-03 -0.01		-5.25e-05	0.0	0.0
90470	1.23e-05	1.31e-03 -0.01		-6.45e-05	1.67e-06	0.0
90472	5.96e-06	1.17e-03 -0.01		-5.77e-05	1.37e-06	0.0





EGP CODE

GRE.EEC.R.73.IT.W.15235.12.024.01

PAGE

211 di/of 527

90473	4.37e-06	1.13e-03	-0.01	-5.59e-05	1.29e-06	0.0
9052	3.09e-06	2.57e-03	-0.02	-1.27e-04	1.85e-06	0.0
9054	1.69e-05	1.92e-03	-0.02	-9.41e-05	1.72e-06	0.0
90520	-1.91e-03	1.45e-03	-0.02	-7.75e-05	-1.76e-06	0.0
90527	-6.01e-04	3.86e-03	-0.02	-9.28e-05	2.27e-06	0.0
90528	-5.13e-04	-5.31e-04	-0.02	-6.66e-05	-1.56e-06	0.0
90552	-2.68e-03	1.38e-03	-0.02	-7.67e-05	-2.91e-06	0.0
90559	-8.41e-04	4.76e-03	-0.02	-9.81e-05	2.74e-06	0.0
90560	-7.18e-04	-1.39e-03	-0.02	-6.14e-05	-2.63e-06	0.0
90570	6.56e-06	1.87e-03	-0.02	-9.21e-05	1.45e-06	0.0
90572	1.00e-06	1.66e-03	-0.02	-8.20e-05	1.18e-06	0.0
90573	0.0	1.61e-03	-0.02	-7.95e-05	1.11e-06	0.0
9061	-5.08e-05	2.79e-03	-0.03	-1.38e-04	0.0	0.0
9062	-5.06e-05	3.32e-03	-0.03	-1.63e-04	-1.04e-06	0.0
90620	-2.03e-03	1.83e-03	-0.02	-9.59e-05	-4.86e-06	0.0
90621	4.33e-04	4.63e-03	-0.02	-1.31e-04	3.29e-06	0.0
90627	-6.53e-04	4.62e-03	-0.02	-1.30e-04	1.51e-06	0.0
90652	-2.83e-03	1.74e-03	-0.02	-9.35e-05	-6.54e-06	0.0
90653	6.20e-04	5.66e-03	-0.02	-1.42e-04	4.87e-06	0.0
90659	-9.02e-04	5.65e-03	-0.02	-1.42e-04	2.38e-06	0.0
90669	-3.35e-05	2.07e-03	-0.02	-1.02e-04	0.0	0.0
90670	-3.34e-05	2.42e-03	-0.02	-1.19e-04	0.0	0.0
90671	-3.35e-05	2.07e-03	-0.02	-1.02e-04	0.0	0.0
90672	-3.35e-05	2.14e-03	-0.02	-1.05e-04	0.0	0.0
90673	-3.35e-05	2.07e-03	-0.02	-1.02e-04	0.0	0.0
9072	-1.86e-04	3.84e-03	-0.04	-1.88e-04	-8.63e-06	0.0
90720	-2.13e-03	2.09e-03	-0.03	-1.08e-04	-8.16e-06	0.0
90721	3.05e-04	5.27e-03	-0.03	-1.61e-04	-3.65e-06	0.0
90723	-7.04e-04	5.17e-03	-0.03	-1.61e-04	-4.73e-06	0.0
90752	-2.94e-03	1.98e-03	-0.03	-1.05e-04	-9.33e-06	0.0
90753	4.73e-04	6.43e-03	-0.03	-1.79e-04	-3.02e-06	0.0
90755	-9.40e-04	6.28e-03	-0.03	-1.79e-04	-4.53e-06	0.0
90770	-1.34e-04	2.80e-03	-0.03	-1.37e-04	-6.36e-06	0.0
90772	-1.19e-04	2.46e-03	-0.03	-1.21e-04	-5.46e-06	0.0
90773	-1.15e-04	2.38e-03	-0.03	-1.17e-04	-5.23e-06	0.0
9082	-3.01e-04	3.93e-03	-0.04	-1.92e-04	-1.41e-05	0.0
90819	-2.23e-03	3.08e-03	-0.03	-1.27e-04	-1.23e-05	0.0
90823	-8.40e-04	5.34e-03	-0.03	-1.69e-04	-1.28e-05	0.0
90827	-9.22e-04	5.44e-03	-0.03	-1.69e-04	-1.30e-05	0.0
90851	-3.06e-03	3.34e-03	-0.03	-1.31e-04	-1.38e-05	0.0
90855	-1.10e-03	6.50e-03	-0.04	-1.89e-04	-1.45e-05	0.0
90859	-1.22e-03	6.65e-03	-0.04	-1.89e-04	-1.48e-05	0.0
90870	-2.20e-04	2.87e-03	-0.03	-1.40e-04	-1.04e-05	0.0
90872	-1.90e-04	2.51e-03	-0.03	-1.23e-04	-8.84e-06	0.0
90873	-1.83e-04	2.43e-03	-0.03	-1.19e-04	-8.44e-06	0.0
9092	-1.90e-04	-3.72e-03	-0.04	1.83e-04	-7.70e-06	0.0
90912	-2.02e-03	-2.97e-03	-0.03	1.21e-04	-1.21e-06	0.0
90924	-8.09e-04	-5.27e-03	-0.03	1.60e-04	-6.48e-06	0.0
90926	2.09e-04	-5.27e-03	-0.03	1.60e-04	-8.41e-06	0.0
90944	-2.78e-03	-3.23e-03	-0.03	1.24e-04	0.0	0.0
90956	-1.09e-03	-6.46e-03	-0.03	1.79e-04	-7.28e-06	0.0
90958	3.38e-04	-6.46e-03	-0.03	1.79e-04	-9.98e-06	0.0
90970	-1.37e-04	-2.71e-03	-0.03	1.33e-04	-5.63e-06	0.0
90972	-1.19e-04	-2.39e-03	-0.03	1.17e-04	-4.72e-06	0.0
90973	-1.14e-04	-2.31e-03	-0.03	1.14e-04	-4.49e-06	0.0
9102	-1.20e-04	-3.52e-03	-0.03	1.73e-04	-4.20e-06	0.0
91011	-1.98e-03	-1.97e-03	-0.02	1.01e-04	0.0	0.0
91024	-7.15e-04	-4.93e-03	-0.03	1.44e-04	-1.17e-06	0.0
91026	3.15e-04	-4.93e-03	-0.02	1.45e-04	-2.35e-06	0.0
91043	-2.74e-03	-1.88e-03	-0.02	9.83e-05	1.19e-06	0.0
91056	-9.73e-04	-6.03e-03	-0.03	1.59e-04	0.0	0.0
91058	4.70e-04	-6.03e-03	-0.03	1.59e-04	-2.30e-06	0.0
91070	-8.49e-05	-2.56e-03	-0.03	1.26e-04	-3.04e-06	0.0
91072	-7.59e-05	-2.26e-03	-0.02	1.12e-04	-2.59e-06	0.0
91073	-7.37e-05	-2.19e-03	-0.02	1.08e-04	-2.48e-06	0.0
9112	-6.82e-05	-2.97e-03	-0.03	1.46e-04	-1.68e-06	0.0
91111	-1.94e-03	-1.68e-03	-0.02	8.79e-05	0.0	0.0
91124	-6.64e-04	-4.30e-03	-0.02	1.14e-04	0.0	0.0
91132	-3.68e-04	-3.16e-03	-0.02	1.05e-04	0.0	0.0
91143	-2.70e-03	-1.61e-03	-0.02	8.64e-05	0.0	0.0
91156	-9.12e-04	-5.28e-03	-0.02	1.23e-04	0.0	0.0
91164	-5.00e-04	-3.67e-03	-0.02	1.11e-04	0.0	0.0
91170	-4.64e-05	-2.16e-03	-0.02	1.06e-04	-1.18e-06	0.0
91172	-4.39e-05	-1.91e-03	-0.02	9.45e-05	-1.05e-06	0.0
91173	-4.33e-05	-1.85e-03	-0.02	9.16e-05	-1.01e-06	0.0
9121	-4.54e-05	-1.91e-03	-0.02	9.45e-05	0.0	0.0



EGP CODE

GRE.EEC.R.73.IT.W.15235.12.024.01

PAGE

212 di/of 527

9122	-4.42e-05	-2.25e-03	-0.02	1.11e-04	0.0	0.0
91211	-1.89e-03	-1.29e-03	-0.01	6.84e-05	-1.21e-06	0.0
91223	-5.15e-04	6.48e-04	-0.01	6.05e-05	-1.19e-06	0.0
91224	-6.30e-04	-3.59e-03	-0.01	7.92e-05	0.0	0.0
91243	-2.64e-03	-1.24e-03	-0.01	6.79e-05	-1.55e-06	0.0
91255	-7.10e-04	1.47e-03	-0.01	5.69e-05	-1.52e-06	0.0
91256	-8.71e-04	-4.46e-03	-0.01	8.30e-05	0.0	0.0
91269	-2.95e-05	-1.41e-03	-0.01	6.97e-05	0.0	0.0
91270	-2.87e-05	-1.64e-03	-0.01	8.06e-05	0.0	0.0
91271	-2.95e-05	-1.41e-03	-0.01	6.97e-05	0.0	0.0
91272	-2.94e-05	-1.46e-03	-0.01	7.19e-05	0.0	0.0
91273	-2.95e-05	-1.41e-03	-0.01	6.97e-05	0.0	0.0
9131	-4.01e-05	-1.29e-03	-0.01	6.39e-05	0.0	0.0
9132	-3.66e-05	-1.52e-03	-0.01	7.46e-05	0.0	0.0
91311	-1.84e-03	-8.61e-04	-0.01	4.81e-05	-1.10e-06	0.0
91323	-5.15e-04	9.16e-04	-0.01	4.83e-05	0.0	0.0
91324	-6.00e-04	-2.94e-03	-0.01	4.61e-05	0.0	0.0
91343	-2.56e-03	-8.25e-04	-0.01	4.85e-05	-1.46e-06	0.0
91355	-7.12e-04	1.67e-03	-0.01	4.88e-05	-1.10e-06	0.0
91356	-8.30e-04	-3.74e-03	-0.01	4.58e-05	0.0	0.0
91369	-2.55e-05	-9.53e-04	-0.01	4.70e-05	0.0	0.0
91370	-2.31e-05	-1.10e-03	-0.01	5.42e-05	0.0	0.0
91371	-2.55e-05	-9.53e-04	-0.01	4.70e-05	0.0	0.0
91372	-2.50e-05	-9.83e-04	-0.01	4.85e-05	0.0	0.0
91373	-2.55e-05	-9.53e-04	-0.01	4.70e-05	0.0	0.0
9141	-3.95e-05	-7.10e-04	-0.01	3.50e-05	0.0	0.0
9142	-3.52e-05	-8.31e-04	-0.01	4.08e-05	0.0	0.0
91411	-1.78e-03	-4.47e-04-9.46e-03		2.70e-05	0.0	0.0
91423	-5.22e-04	1.24e-03-9.78e-03		3.14e-05	0.0	0.0
91424	-5.70e-04	-2.40e-03-8.84e-03		2.04e-05	0.0	0.0
91443	-2.49e-03	-4.16e-04-9.53e-03		2.75e-05	0.0	0.0
91455	-7.21e-04	1.94e-03-9.98e-03		3.36e-05	0.0	0.0
91456	-7.88e-04	-3.16e-03-8.67e-03		1.83e-05	0.0	0.0
91469	-2.51e-05	-5.23e-04-9.28e-03		2.58e-05	0.0	0.0
91470	-2.23e-05	-6.04e-04-9.09e-03		2.96e-05	0.0	0.0
91471	-2.51e-05	-5.23e-04-9.28e-03		2.58e-05	0.0	0.0
91472	-2.45e-05	-5.39e-04-9.24e-03		2.65e-05	0.0	0.0
91473	-2.51e-05	-5.23e-04-9.28e-03		2.58e-05	0.0	0.0
9151	-3.99e-05	-1.64e-04	-0.01	8.00e-06	0.0	0.0
9152	-3.53e-05	-1.92e-04	-0.01	9.31e-06	0.0	0.0
91511	-1.73e-03	-4.94e-05-8.61e-03		7.27e-06	0.0	0.0
91523	-5.32e-04	1.59e-03-8.64e-03		1.37e-05	0.0	0.0
91524	-5.41e-04	-1.95e-03-8.41e-03		-1.76e-06	0.0	0.0
91543	-2.42e-03	-2.05e-05-8.65e-03		7.81e-06	0.0	0.0
91555	-7.35e-04	2.28e-03-8.70e-03		1.68e-05	0.0	0.0
91556	-7.48e-04	-2.69e-03-8.37e-03		-4.82e-06	0.0	0.0
91569	-2.54e-05	-1.21e-04-8.50e-03		5.89e-06	0.0	0.0
91570	-2.24e-05	-1.40e-04-8.19e-03		6.76e-06	0.0	0.0
91571	-2.54e-05	-1.21e-04-8.50e-03		5.89e-06	0.0	0.0
91572	-2.48e-05	-1.25e-04-8.44e-03		6.06e-06	0.0	0.0
91573	-2.54e-05	-1.21e-04-8.50e-03		5.89e-06	0.0	0.0
9161	-3.97e-05	3.71e-04	-0.01	-1.85e-05	0.0	0.0
9162	-3.52e-05	4.34e-04	-0.01	-2.15e-05	0.0	0.0
91620	-1.75e-03	2.01e-04-8.82e-03		-1.50e-05	0.0	0.0
91627	-5.54e-04	2.12e-03-8.44e-03		-6.52e-06	0.0	0.0
91628	-5.23e-04	-1.45e-03-8.99e-03		-2.09e-05	0.0	0.0
91652	-2.44e-03	1.71e-04-8.88e-03		-1.55e-05	0.0	0.0
91659	-7.65e-04	2.86e-03-8.34e-03		-3.68e-06	0.0	0.0
91660	-7.23e-04	-2.14e-03-9.11e-03		-2.38e-05	0.0	0.0
91669	-2.52e-05	2.73e-04-8.69e-03		-1.36e-05	0.0	0.0
91670	-2.22e-05	3.15e-04-8.41e-03		-1.56e-05	0.0	0.0
91671	-2.52e-05	2.73e-04-8.69e-03		-1.36e-05	0.0	0.0
91672	-2.46e-05	2.82e-04-8.63e-03		-1.40e-05	0.0	0.0
91673	-2.52e-05	2.73e-04-8.69e-03		-1.36e-05	0.0	0.0
9171	-3.93e-05	9.29e-04	-0.01	-4.61e-05	0.0	0.0
9172	-3.50e-05	1.09e-03	-0.01	-5.38e-05	0.0	0.0
91720	-1.80e-03	6.04e-04	-0.01	-3.50e-05	0.0	0.0
91727	-5.82e-04	2.60e-03-9.33e-03		-3.03e-05	0.0	0.0
91728	-5.15e-04	-1.11e-03	-0.01	-3.79e-05	0.0	0.0
91752	-2.51e-03	5.72e-04	-0.01	-3.54e-05	-1.15e-06	0.0
91759	-8.06e-04	3.37e-03-9.11e-03		-2.88e-05	0.0	0.0
91760	-7.11e-04	-1.83e-03	-0.01	-3.95e-05	0.0	0.0
91769	-2.49e-05	6.85e-04-9.86e-03		-3.40e-05	0.0	0.0
91770	-2.20e-05	7.92e-04-9.75e-03		-3.91e-05	0.0	0.0
91771	-2.49e-05	6.85e-04-9.86e-03		-3.40e-05	0.0	0.0
91772	-2.43e-05	7.07e-04-9.84e-03		-3.50e-05	0.0	0.0



EGP CODE

GRE.EEC.R.73.IT.W.15235.12.024.01

PAGE

213 di/of 527

91773	-2.49e-05	6.85e-04	-9.86e-03	-3.40e-05	0.0	0.0
9181	-4.08e-05	1.53e-03	-0.02	-7.59e-05	0.0	0.0
9182	-3.75e-05	1.80e-03	-0.02	-8.87e-05	0.0	0.0
91820	-1.86e-03	1.03e-03	-0.01	-5.57e-05	-1.22e-06	0.0
91827	-6.12e-04	3.19e-03	-0.01	-5.94e-05	0.0	0.0
91828	-5.12e-04	-8.06e-04	-0.01	-5.28e-05	0.0	0.0
91852	-2.59e-03	9.86e-04	-0.01	-5.56e-05	-1.65e-06	0.0
91859	-8.47e-04	4.01e-03	-0.01	-6.08e-05	0.0	0.0
91860	-7.06e-04	-1.58e-03	-0.01	-5.16e-05	-1.28e-06	0.0
91869	-2.59e-05	1.13e-03	-0.01	-5.59e-05	0.0	0.0
91870	-2.38e-05	1.31e-03	-0.01	-6.45e-05	0.0	0.0
91871	-2.59e-05	1.13e-03	-0.01	-5.59e-05	0.0	0.0
91872	-2.55e-05	1.16e-03	-0.01	-5.76e-05	0.0	0.0
91873	-2.59e-05	1.13e-03	-0.01	-5.59e-05	0.0	0.0
9191	-4.95e-05	2.15e-03	-0.02	-1.07e-04	0.0	0.0
9192	-4.95e-05	2.54e-03	-0.02	-1.25e-04	0.0	0.0
91920	-1.91e-03	1.45e-03	-0.02	-7.66e-05	-1.24e-06	0.0
91927	-6.41e-04	3.87e-03	-0.02	-9.30e-05	0.0	0.0
91928	-5.16e-04	-5.68e-04	-0.02	-6.48e-05	-1.38e-06	0.0
91952	-2.66e-03	1.39e-03	-0.02	-7.57e-05	-1.56e-06	0.0
91959	-8.85e-04	4.79e-03	-0.02	-9.87e-05	0.0	0.0
91960	-7.10e-04	-1.43e-03	-0.02	-5.92e-05	-1.74e-06	0.0
91969	-3.25e-05	1.59e-03	-0.02	-7.87e-05	0.0	0.0
91970	-3.25e-05	1.85e-03	-0.02	-9.12e-05	0.0	0.0
91971	-3.25e-05	1.59e-03	-0.02	-7.87e-05	0.0	0.0
91972	-3.25e-05	1.64e-03	-0.02	-8.12e-05	0.0	0.0
91973	-3.25e-05	1.59e-03	-0.02	-7.87e-05	0.0	0.0
9202	-8.28e-05	3.22e-03	-0.03	-1.59e-04	-2.40e-06	0.0
92020	-1.96e-03	1.82e-03	-0.02	-9.46e-05	0.0	0.0
92021	3.61e-04	4.58e-03	-0.02	-1.27e-04	-1.11e-06	0.0
92027	-6.79e-04	4.58e-03	-0.02	-1.28e-04	0.0	0.0
92052	-2.72e-03	1.74e-03	-0.02	-9.27e-05	0.0	0.0
92053	5.25e-04	5.61e-03	-0.02	-1.39e-04	0.0	0.0
92059	-9.30e-04	5.61e-03	-0.02	-1.39e-04	0.0	0.0
92070	-5.71e-05	2.35e-03	-0.02	-1.16e-04	-1.71e-06	0.0
92072	-5.30e-05	2.08e-03	-0.02	-1.03e-04	-1.49e-06	0.0
92073	-5.19e-05	2.01e-03	-0.02	-9.94e-05	-1.43e-06	0.0
9212	-1.45e-04	3.67e-03	-0.04	-1.81e-04	-5.47e-06	0.0
92120	-2.00e-03	2.04e-03	-0.02	-1.05e-04	0.0	0.0
92121	2.87e-04	5.13e-03	-0.03	-1.54e-04	-5.23e-06	0.0
92127	-7.44e-04	5.13e-03	-0.03	-1.54e-04	-3.73e-06	0.0
92152	-2.77e-03	1.94e-03	-0.02	-1.01e-04	1.77e-06	0.0
92153	4.37e-04	6.28e-03	-0.03	-1.71e-04	-6.04e-06	0.0
92159	-1.01e-03	6.28e-03	-0.03	-1.71e-04	-3.94e-06	0.0
92170	-1.03e-04	2.67e-03	-0.03	-1.32e-04	-3.98e-06	0.0
92172	-9.10e-05	2.36e-03	-0.03	-1.16e-04	-3.36e-06	0.0
92173	-8.80e-05	2.28e-03	-0.03	-1.13e-04	-3.21e-06	0.0
9222	-1.87e-04	3.76e-03	-0.04	-1.85e-04	-7.51e-06	0.0
92219	-2.02e-03	3.00e-03	-0.03	-1.24e-04	0.0	0.0
92227	-8.05e-04	5.31e-03	-0.03	-1.62e-04	-6.39e-06	0.0
92251	-2.78e-03	3.27e-03	-0.03	-1.27e-04	0.0	0.0
92259	-1.08e-03	6.50e-03	-0.03	-1.81e-04	-7.20e-06	0.0
92270	-1.34e-04	2.74e-03	-0.03	-1.35e-04	-5.49e-06	0.0
92272	-1.16e-04	2.41e-03	-0.03	-1.19e-04	-4.60e-06	0.0
92273	-1.12e-04	2.33e-03	-0.03	-1.15e-04	-4.37e-06	0.0
9232	3.85e-05	-3.73e-03	-0.04	1.83e-04	4.43e-06	0.0
9234	4.74e-05	-2.81e-03	-0.03	1.37e-04	3.87e-06	0.0
92310	1.96e-03	-2.53e-03	-0.03	1.20e-04	0.0	0.0
92324	-6.44e-04	-5.28e-03	-0.03	1.60e-04	5.96e-06	0.0
92326	3.86e-04	-5.28e-03	-0.03	1.59e-04	4.49e-06	0.0
92342	2.73e-03	-2.62e-03	-0.03	1.23e-04	-2.32e-06	0.0
92356	-9.13e-04	-6.47e-03	-0.03	1.79e-04	7.16e-06	0.0
92358	5.30e-04	-6.47e-03	-0.03	1.78e-04	5.12e-06	0.0
92370	3.47e-05	-2.72e-03	-0.03	1.33e-04	3.45e-06	0.0
92372	2.78e-05	-2.39e-03	-0.03	1.18e-04	3.05e-06	0.0
92373	2.60e-05	-2.31e-03	-0.03	1.14e-04	2.95e-06	0.0
9242	-3.40e-05	-3.54e-03	-0.03	1.74e-04	1.02e-06	0.0
92412	-1.94e-03	-2.88e-03	-0.02	1.17e-04	2.55e-06	0.0
92424	-7.09e-04	-4.96e-03	-0.02	1.45e-04	0.0	0.0
92444	-2.70e-03	-3.14e-03	-0.02	1.21e-04	3.24e-06	0.0
92456	-9.86e-04	-6.07e-03	-0.03	1.59e-04	-1.22e-06	0.0
92470	-2.02e-05	-2.58e-03	-0.03	1.27e-04	0.0	0.0
92472	-1.91e-05	-2.28e-03	-0.02	1.12e-04	0.0	0.0
92473	-1.88e-05	-2.20e-03	-0.02	1.09e-04	0.0	0.0
9252	-7.00e-05	-2.97e-03	-0.03	1.46e-04	-1.52e-06	0.0
92512	-1.95e-03	-2.48e-03	-0.02	9.77e-05	-1.07e-06	0.0



EGP CODE

GRE.EEC.R.73.IT.W.15235.12.024.01

PAGE

214 di/of 527

92524	-7.19e-04	-4.32e-03	-0.02	1.14e-04	-2.86e-06	0.0
92532	-8.25e-04	-3.17e-03	-0.02	1.06e-04	-1.96e-06	0.0
92544	-2.72e-03	-2.73e-03	-0.02	1.00e-04	-1.16e-06	0.0
92556	-9.90e-04	-5.31e-03	-0.02	1.23e-04	-3.67e-06	0.0
92564	-1.14e-03	-3.69e-03	-0.02	1.11e-04	-2.40e-06	0.0
92570	-4.76e-05	-2.16e-03	-0.02	1.06e-04	-1.06e-06	0.0
92572	-4.41e-05	-1.92e-03	-0.02	9.46e-05	0.0	0.0
92573	-4.32e-05	-1.86e-03	-0.02	9.17e-05	0.0	0.0
9262	-8.00e-05	-2.25e-03	-0.02	1.11e-04	-2.28e-06	0.0
92612	-1.92e-03	-1.97e-03	-0.01	7.23e-05	-2.41e-06	0.0
92623	-5.14e-04	6.40e-04	-0.01	6.09e-05	0.0	0.0
92624	-6.78e-04	-3.60e-03	-0.01	7.88e-05	-2.69e-06	0.0
92644	-2.67e-03	-2.19e-03	-0.01	7.34e-05	-2.80e-06	0.0
92655	-7.00e-04	1.46e-03	-0.01	5.75e-05	0.0	0.0
92656	-9.29e-04	-4.48e-03	-0.01	8.25e-05	-3.20e-06	0.0
92670	-5.55e-05	-1.63e-03	-0.01	8.04e-05	-1.65e-06	0.0
92672	-5.22e-05	-1.45e-03	-0.01	7.18e-05	-1.47e-06	0.0
92673	-5.13e-05	-1.41e-03	-0.01	6.96e-05	-1.42e-06	0.0
9272	-7.61e-05	-1.51e-03	-0.01	7.44e-05	-2.12e-06	0.0
92711	-1.86e-03	-8.83e-04	-0.01	4.77e-05	-1.93e-06	0.0
92723	-5.32e-04	9.17e-04	-0.01	4.80e-05	-1.16e-06	0.0
92724	-6.32e-04	-2.96e-03	-0.01	4.60e-05	-2.01e-06	0.0
92743	-2.59e-03	-8.56e-04	-0.01	4.79e-05	-2.15e-06	0.0
92755	-7.25e-04	1.67e-03	-0.01	4.85e-05	-1.07e-06	0.0
92756	-8.65e-04	-3.76e-03	-0.01	4.57e-05	-2.26e-06	0.0
92770	-5.28e-05	-1.10e-03	-0.01	5.40e-05	-1.55e-06	0.0
92772	-5.07e-05	-9.81e-04	-0.01	4.84e-05	-1.42e-06	0.0
92773	-5.02e-05	-9.51e-04	-0.01	4.70e-05	-1.39e-06	0.0
9281	-6.81e-05	-7.08e-04	-0.01	3.49e-05	-1.67e-06	0.0
9282	-7.01e-05	-8.28e-04	-0.01	4.06e-05	-1.80e-06	0.0
92811	-1.80e-03	-4.68e-04-9.40e-03		2.67e-05	-1.44e-06	0.0
92824	-5.93e-04	-2.42e-03-8.81e-03		2.03e-05	-1.55e-06	0.0
92827	-5.20e-04	1.37e-03-9.73e-03		3.12e-05	-1.06e-06	0.0
92843	-2.50e-03	-4.46e-04-9.47e-03		2.70e-05	-1.53e-06	0.0
92856	-8.11e-04	-3.18e-03-8.63e-03		1.81e-05	-1.68e-06	0.0
92859	-7.09e-04	2.13e-03-9.93e-03		3.34e-05	0.0	0.0
92869	-4.71e-05	-5.22e-04-9.24e-03		2.57e-05	-1.23e-06	0.0
92870	-4.85e-05	-6.02e-04-9.05e-03		2.95e-05	-1.32e-06	0.0
92871	-4.71e-05	-5.22e-04-9.24e-03		2.57e-05	-1.23e-06	0.0
92872	-4.74e-05	-5.38e-04-9.20e-03		2.65e-05	-1.25e-06	0.0
92873	-4.71e-05	-5.22e-04-9.24e-03		2.57e-05	-1.23e-06	0.0
9291	-6.57e-05	-1.64e-04	-0.01	7.97e-06	-1.54e-06	0.0
9292	-6.68e-05	-1.91e-04	-0.01	9.26e-06	-1.61e-06	0.0
92911	-1.75e-03	-7.31e-05-8.57e-03		7.20e-06	-1.01e-06	0.0
92924	-5.60e-04	-1.97e-03-8.37e-03		-1.71e-06	-1.15e-06	0.0
92927	-5.45e-04	1.73e-03-8.61e-03		1.35e-05	-1.02e-06	0.0
92943	-2.43e-03	-5.40e-05-8.61e-03		7.72e-06	0.0	0.0
92956	-7.66e-04	-2.71e-03-8.34e-03		-4.75e-06	-1.16e-06	0.0
92959	-7.45e-04	2.47e-03-8.67e-03		1.66e-05	0.0	0.0
92969	-4.53e-05	-1.21e-04-8.47e-03		5.86e-06	-1.13e-06	0.0
92970	-4.61e-05	-1.39e-04-8.16e-03		6.72e-06	-1.17e-06	0.0
92971	-4.53e-05	-1.21e-04-8.47e-03		5.86e-06	-1.13e-06	0.0
92972	-4.55e-05	-1.24e-04-8.40e-03		6.03e-06	-1.14e-06	0.0
92973	-4.53e-05	-1.21e-04-8.47e-03		5.86e-06	-1.13e-06	0.0
9301	-6.61e-05	3.70e-04	-0.01	-1.85e-05	-1.54e-06	0.0
9302	-6.74e-05	4.33e-04	-0.01	-2.15e-05	-1.61e-06	0.0
93020	-1.76e-03	2.24e-04-8.78e-03		-1.48e-05	-1.06e-06	0.0
93024	-5.33e-04	-1.59e-03-8.95e-03		-2.07e-05	-1.22e-06	0.0
93027	-5.74e-04	2.13e-03-8.41e-03		-6.56e-06	0.0	0.0
93052	-2.45e-03	2.04e-04-8.83e-03		-1.53e-05	-1.04e-06	0.0
93053	6.36e-04	2.88e-03-8.24e-03		-3.61e-06	0.0	0.0
93056	-7.27e-04	-2.33e-03-9.07e-03		-2.36e-05	-1.26e-06	0.0
93069	-4.57e-05	2.73e-04-8.66e-03		-1.36e-05	-1.13e-06	0.0
93070	-4.65e-05	3.15e-04-8.38e-03		-1.56e-05	-1.18e-06	0.0
93071	-4.57e-05	2.73e-04-8.66e-03		-1.36e-05	-1.13e-06	0.0
93072	-4.58e-05	2.81e-04-8.60e-03		-1.40e-05	-1.14e-06	0.0
93073	-4.57e-05	2.73e-04-8.66e-03		-1.36e-05	-1.13e-06	0.0
9311	-6.88e-05	9.28e-04	-0.01	-4.61e-05	-1.66e-06	0.0
9312	-7.13e-05	1.09e-03	-0.01	-5.37e-05	-1.79e-06	0.0
93120	-1.82e-03	6.25e-04	-0.01	-3.46e-05	-1.73e-06	0.0
93124	-5.09e-04	-1.25e-03	-0.01	-3.77e-05	-1.01e-06	0.0
93127	-6.08e-04	2.61e-03-9.29e-03		-3.02e-05	-1.63e-06	0.0
93152	-2.53e-03	6.01e-04	-0.01	-3.49e-05	-1.93e-06	0.0
93156	-6.94e-04	-2.02e-03	-0.01	-3.93e-05	0.0	0.0
93159	-8.33e-04	3.39e-03-9.08e-03		-2.87e-05	-1.79e-06	0.0
93169	-4.77e-05	6.84e-04-9.83e-03		-3.39e-05	-1.22e-06	0.0



EGP CODE

GRE.EEC.R.73.IT.W.15235.12.024.01

PAGE

215 di/of 527

93170	-4.93e-05	7.90e-04-9.72e-03	-3.90e-05	-1.31e-06	0.0
93171	-4.77e-05	6.84e-04-9.83e-03	-3.39e-05	-1.22e-06	0.0
93172	-4.80e-05	7.05e-04-9.81e-03	-3.49e-05	-1.23e-06	0.0
93173	-4.77e-05	6.84e-04-9.83e-03	-3.39e-05	-1.22e-06	0.0
9322	-7.55e-05	1.79e-03 -0.02	-8.86e-05	-2.00e-06	0.0
93220	-1.88e-03	1.05e-03 -0.01	-5.54e-05	-1.97e-06	0.0
93227	-6.47e-04	3.20e-03 -0.01	-5.91e-05	-1.96e-06	0.0
93228	-5.24e-04	-8.04e-04 -0.01	-5.28e-05	-1.11e-06	0.0
93252	-2.61e-03	1.02e-03 -0.01	-5.52e-05	-2.25e-06	0.0
93259	-8.87e-04	4.02e-03 -0.01	-6.04e-05	-2.22e-06	0.0
93260	-7.14e-04	-1.58e-03 -0.01	-5.16e-05	-1.04e-06	0.0
93270	-5.23e-05	1.30e-03 -0.01	-6.44e-05	-1.45e-06	0.0
93272	-5.01e-05	1.16e-03 -0.01	-5.75e-05	-1.33e-06	0.0
93273	-4.95e-05	1.13e-03 -0.01	-5.58e-05	-1.30e-06	0.0
9332	-7.27e-05	2.54e-03 -0.02	-1.25e-04	-1.83e-06	0.0
93319	-1.93e-03	2.17e-03 -0.02	-8.25e-05	-2.12e-06	0.0
93327	-6.89e-04	3.88e-03 -0.02	-9.26e-05	-2.52e-06	0.0
93328	-5.00e-04	-5.55e-04 -0.02	-6.55e-05	0.0	0.0
93351	-2.69e-03	2.40e-03 -0.02	-8.40e-05	-2.52e-06	0.0
93359	-9.47e-04	4.80e-03 -0.02	-9.82e-05	-3.08e-06	0.0
93360	-6.82e-04	-1.42e-03 -0.02	-6.02e-05	0.0	0.0
93370	-4.99e-05	1.85e-03 -0.02	-9.10e-05	-1.31e-06	0.0
93372	-4.70e-05	1.64e-03 -0.02	-8.12e-05	-1.15e-06	0.0
93373	-4.63e-05	1.59e-03 -0.02	-7.87e-05	-1.11e-06	0.0
9342	-4.79e-05	3.23e-03 -0.03	-1.59e-04	0.0	0.0
93419	-1.95e-03	2.67e-03 -0.02	-1.07e-04	0.0	0.0
93427	-7.12e-04	4.61e-03 -0.02	-1.28e-04	-2.18e-06	0.0
93451	-2.72e-03	2.93e-03 -0.02	-1.10e-04	0.0	0.0
93459	-9.86e-04	5.65e-03 -0.02	-1.39e-04	-3.00e-06	0.0
93470	-3.09e-05	2.35e-03 -0.02	-1.16e-04	0.0	0.0
93472	-2.93e-05	2.08e-03 -0.02	-1.03e-04	0.0	0.0
93473	-2.90e-05	2.01e-03 -0.02	-9.96e-05	0.0	0.0
9352	0.0	3.69e-03 -0.04	-1.81e-04	2.62e-06	0.0
9354	1.48e-05	2.78e-03 -0.03	-1.36e-04	2.34e-06	0.0
93518	1.92e-03	1.60e-03 -0.02	-1.04e-04	0.0	0.0
93527	-6.79e-04	5.16e-03 -0.03	-1.55e-04	0.0	0.0
93550	2.69e-03	1.32e-03 -0.02	-9.97e-05	-1.67e-06	0.0
93559	-9.51e-04	6.31e-03 -0.03	-1.71e-04	0.0	0.0
93570	5.32e-06	2.69e-03 -0.03	-1.32e-04	2.08e-06	0.0
93572	2.80e-06	2.37e-03 -0.03	-1.17e-04	1.88e-06	0.0
93573	2.17e-06	2.29e-03 -0.03	-1.13e-04	1.83e-06	0.0
9362	3.76e-05	3.77e-03 -0.04	-1.85e-04	4.60e-06	0.0
9364	4.67e-05	2.85e-03 -0.03	-1.39e-04	4.01e-06	0.0
93617	1.97e-03	2.55e-03 -0.03	-1.22e-04	0.0	0.0
93621	3.91e-04	5.33e-03 -0.03	-1.61e-04	4.82e-06	0.0
93627	-6.48e-04	5.33e-03 -0.03	-1.62e-04	6.34e-06	0.0
93649	2.75e-03	2.63e-03 -0.03	-1.24e-04	-2.41e-06	0.0
93653	5.37e-04	6.52e-03 -0.03	-1.80e-04	5.52e-06	0.0
93659	-9.18e-04	6.52e-03 -0.03	-1.81e-04	7.65e-06	0.0
93670	3.40e-05	2.75e-03 -0.03	-1.35e-04	3.58e-06	0.0
93672	2.71e-05	2.42e-03 -0.03	-1.19e-04	3.16e-06	0.0
93673	2.53e-05	2.34e-03 -0.03	-1.15e-04	3.05e-06	0.0
9372	7.38e-05	-4.01e-03 -0.04	1.95e-04	6.12e-06	0.0
9374	7.66e-05	-3.06e-03 -0.03	1.48e-04	5.24e-06	0.0
93710	2.06e-03	-3.20e-03 -0.03	1.31e-04	6.61e-06	0.0
93724	-6.30e-04	-5.45e-03 -0.03	1.71e-04	5.32e-06	0.0
93726	4.39e-04	-5.62e-03 -0.03	1.72e-04	6.50e-06	0.0
93742	2.87e-03	-3.48e-03 -0.03	1.36e-04	7.66e-06	0.0
93756	-9.01e-04	-6.64e-03 -0.03	1.92e-04	5.87e-06	0.0
93758	5.96e-04	-6.88e-03 -0.03	1.93e-04	7.52e-06	0.0
93770	6.11e-05	-2.93e-03 -0.03	1.43e-04	4.70e-06	0.0
93772	4.96e-05	-2.56e-03 -0.03	1.25e-04	4.09e-06	0.0
93773	4.68e-05	-2.47e-03 -0.03	1.21e-04	3.93e-06	0.0
9382	-2.41e-04	-3.87e-03 -0.03	1.87e-04	-5.88e-06	0.0
93812	-2.24e-03	-3.18e-03 -0.02	1.28e-04	-1.06e-05	0.0
93824	-9.97e-04	-5.29e-03 -0.02	1.57e-04	-1.10e-05	0.0
93844	-3.09e-03	-3.49e-03 -0.02	1.32e-04	-1.35e-05	0.0
93856	-1.34e-03	-6.44e-03 -0.03	1.74e-04	-1.40e-05	0.0
93870	-1.75e-04	-2.83e-03 -0.03	1.36e-04	-4.32e-06	0.0
93872	-1.48e-04	-2.49e-03 -0.02	1.21e-04	-3.49e-06	0.0
93873	-1.41e-04	-2.40e-03 -0.02	1.17e-04	-3.28e-06	0.0
9392	-1.46e-04	-3.03e-03 -0.03	1.49e-04	-4.93e-06	0.0
93912	-2.09e-03	-2.54e-03 -0.02	9.87e-05	-7.27e-06	0.0
93924	-8.10e-04	-4.33e-03 -0.02	1.14e-04	-7.13e-06	0.0
93936	-8.28e-04	-3.03e-03 -0.02	1.06e-04	-5.38e-06	0.0
93944	-2.89e-03	-2.79e-03 -0.02	1.01e-04	-9.00e-06	0.0





EGP CODE

GRE.EEC.R.73.IT.W.15235.12.024.01

PAGE

216 di/of 527

93956	-1.10e-03	-5.31e-03	-0.02	1.22e-04	-8.80e-06	0.0
93968	-1.12e-03	-3.48e-03	-0.02	1.11e-04	-6.34e-06	0.0
93970	-1.05e-04	-2.21e-03	-0.02	1.08e-04	-3.64e-06	0.0
93972	-9.32e-05	-1.96e-03	-0.02	9.63e-05	-3.10e-06	0.0
93973	-9.02e-05	-1.90e-03	-0.02	9.33e-05	-2.96e-06	0.0
9402	-1.38e-04	-2.25e-03	-0.02	1.11e-04	-5.09e-06	0.0
94012	-1.98e-03	-1.99e-03	-0.01	7.16e-05	-5.48e-06	0.0
94026	3.24e-04	-3.59e-03	-0.01	7.73e-05	-4.20e-06	0.0
94027	-4.99e-04	7.66e-04	-0.01	6.21e-05	-2.17e-06	0.0
94044	-2.74e-03	-2.22e-03	-0.01	7.23e-05	-6.40e-06	0.0
94056	-9.85e-04	-4.47e-03	-0.01	8.05e-05	-5.93e-06	0.0
94059	-6.63e-04	1.64e-03	-0.01	5.90e-05	-1.76e-06	0.0
94070	-9.94e-05	-1.64e-03	-0.01	8.04e-05	-3.80e-06	0.0
94072	-8.99e-05	-1.46e-03	-0.01	7.18e-05	-3.30e-06	0.0
94073	-8.75e-05	-1.41e-03	-0.01	6.97e-05	-3.18e-06	0.0
9412	-1.20e-04	-1.50e-03	-0.01	7.38e-05	-4.21e-06	0.0
94111	-1.89e-03	-9.00e-04	-0.01	4.66e-05	-3.43e-06	0.0
94126	3.67e-04	-2.96e-03	-0.01	4.56e-05	-3.05e-06	0.0
94127	-5.22e-04	1.06e-03	-0.01	4.77e-05	-2.36e-06	0.0
94143	-2.62e-03	-8.82e-04	-0.01	4.66e-05	-3.73e-06	0.0
94158	5.45e-04	-3.76e-03	-0.01	4.52e-05	-3.19e-06	0.0
94159	-7.00e-04	1.87e-03	-0.01	4.81e-05	-2.22e-06	0.0
94170	-8.62e-05	-1.09e-03	-0.01	5.36e-05	-3.15e-06	0.0
94172	-7.93e-05	-9.75e-04	-0.01	4.80e-05	-2.80e-06	0.0
94173	-7.76e-05	-9.46e-04	-0.01	4.66e-05	-2.71e-06	0.0
9421	-9.37e-05	-7.01e-04	-0.01	3.46e-05	-2.84e-06	0.0
9422	-1.03e-04	-8.19e-04	-0.01	4.02e-05	-3.30e-06	0.0
94211	-1.82e-03	-4.86e-04	-9.31e-03	2.58e-05	-2.04e-06	0.0
94226	4.04e-04	-2.43e-03	-8.66e-03	2.00e-05	-2.51e-06	0.0
94227	-5.39e-04	1.39e-03	-9.65e-03	3.09e-05	-1.85e-06	0.0
94243	-2.52e-03	-4.73e-04	-9.38e-03	2.59e-05	-1.99e-06	0.0
94258	5.92e-04	-3.19e-03	-8.47e-03	1.78e-05	-2.64e-06	0.0
94259	-7.28e-04	2.16e-03	-9.85e-03	3.30e-05	-1.71e-06	0.0
94269	-6.76e-05	-5.17e-04	-9.16e-03	2.54e-05	-2.18e-06	0.0
94270	-7.35e-05	-5.95e-04	-8.96e-03	2.92e-05	-2.48e-06	0.0
94271	-6.76e-05	-5.17e-04	-9.16e-03	2.54e-05	-2.18e-06	0.0
94272	-6.87e-05	-5.32e-04	-9.12e-03	2.62e-05	-2.24e-06	0.0
94273	-6.76e-05	-5.17e-04	-9.16e-03	2.54e-05	-2.18e-06	0.0
9431	-8.69e-05	-1.62e-04	-0.01	7.86e-06	-2.47e-06	0.0
9432	-9.39e-05	-1.88e-04	-0.01	9.11e-06	-2.83e-06	0.0
94311	-1.76e-03	-9.69e-05	-8.51e-03	6.57e-06	-1.53e-06	0.0
94326	4.35e-04	-1.98e-03	-8.24e-03	-1.68e-06	-2.08e-06	0.0
94327	-5.60e-04	1.75e-03	-8.54e-03	1.32e-05	-1.71e-06	0.0
94343	-2.44e-03	-8.81e-05	-8.55e-03	6.89e-06	-1.39e-06	0.0
94358	6.35e-04	-2.73e-03	-8.18e-03	-4.66e-06	-2.15e-06	0.0
94359	-7.59e-04	2.49e-03	-8.60e-03	1.62e-05	-1.64e-06	0.0
94369	-6.24e-05	-1.19e-04	-8.39e-03	5.78e-06	-1.89e-06	0.0
94370	-6.71e-05	-1.37e-04	-8.08e-03	6.62e-06	-2.13e-06	0.0
94371	-6.24e-05	-1.19e-04	-8.39e-03	5.78e-06	-1.89e-06	0.0
94372	-6.33e-05	-1.23e-04	-8.33e-03	5.94e-06	-1.94e-06	0.0
94373	-6.24e-05	-1.19e-04	-8.39e-03	5.78e-06	-1.89e-06	0.0
9441	-8.86e-05	3.67e-04	-0.01	-1.83e-05	-2.54e-06	0.0
9442	-9.60e-05	4.28e-04	-0.01	-2.13e-05	-2.91e-06	0.0
94420	-1.78e-03	2.45e-04	-8.71e-03	-1.41e-05	-1.68e-06	0.0
94421	4.21e-04	2.15e-03	-8.28e-03	-6.53e-06	-1.93e-06	0.0
94424	-5.48e-04	-1.61e-03	-8.87e-03	-2.04e-05	-1.96e-06	0.0
94452	-2.46e-03	2.35e-04	-8.77e-03	-1.44e-05	-1.57e-06	0.0
94453	6.15e-04	2.90e-03	-8.16e-03	-3.75e-06	-1.92e-06	0.0
94456	-7.42e-04	-2.36e-03	-8.99e-03	-2.32e-05	-1.97e-06	0.0
94469	-6.37e-05	2.70e-04	-8.58e-03	-1.35e-05	-1.94e-06	0.0
94470	-6.87e-05	3.11e-04	-8.29e-03	-1.54e-05	-2.19e-06	0.0
94471	-6.37e-05	2.70e-04	-8.58e-03	-1.35e-05	-1.94e-06	0.0
94472	-6.47e-05	2.78e-04	-8.52e-03	-1.39e-05	-1.99e-06	0.0
94473	-6.37e-05	2.70e-04	-8.58e-03	-1.35e-05	-1.94e-06	0.0
9451	-9.81e-05	9.21e-04	-0.01	-4.57e-05	-3.01e-06	0.0
9452	-1.08e-04	1.08e-03	-0.01	-5.32e-05	-3.52e-06	0.0
94520	-1.84e-03	6.42e-04	-9.90e-03	-3.37e-05	-2.68e-06	0.0
94521	3.88e-04	2.62e-03	-9.15e-03	-2.98e-05	-2.67e-06	0.0
94524	-5.30e-04	-1.26e-03	-0.01	-3.75e-05	-1.93e-06	0.0
94552	-2.55e-03	6.27e-04	-9.97e-03	-3.38e-05	-2.84e-06	0.0
94553	5.72e-04	3.40e-03	-8.92e-03	-2.83e-05	-2.82e-06	0.0
94556	-7.13e-04	-2.04e-03	-0.01	-3.90e-05	-1.78e-06	0.0
94569	-7.09e-05	6.79e-04	-9.74e-03	-3.37e-05	-2.30e-06	0.0
94570	-7.77e-05	7.83e-04	-9.62e-03	-3.86e-05	-2.64e-06	0.0
94571	-7.09e-05	6.79e-04	-9.74e-03	-3.37e-05	-2.30e-06	0.0
94572	-7.23e-05	7.00e-04	-9.72e-03	-3.47e-05	-2.37e-06	0.0



EGP CODE

GRE.EEC.R.73.IT.W.15235.12.024.01

PAGE

217 di/of 527

94573	-7.09e-05	6.79e-04	-9.74e-03	-3.37e-05	-2.30e-06	0.0
9462	-1.25e-04	1.79e-03	-0.02	-8.82e-05	-4.39e-06	0.0
94620	-1.92e-03	1.07e-03	-0.01	-5.46e-05	-3.83e-06	0.0
94621	3.51e-04	3.20e-03	-0.01	-5.83e-05	-3.21e-06	0.0
94624	-5.12e-04	-9.46e-04	-0.01	-5.30e-05	-2.38e-06	0.0
94652	-2.66e-03	1.05e-03	-0.01	-5.42e-05	-4.24e-06	0.0
94653	5.23e-04	4.03e-03	-0.01	-5.94e-05	-3.38e-06	0.0
94656	-6.85e-04	-1.78e-03	-0.01	-5.20e-05	-2.22e-06	0.0
94670	-9.03e-05	1.30e-03	-0.01	-6.41e-05	-3.28e-06	0.0
94672	-8.27e-05	1.16e-03	-0.01	-5.74e-05	-2.90e-06	0.0
94673	-8.08e-05	1.12e-03	-0.01	-5.57e-05	-2.80e-06	0.0
9472	-1.35e-04	2.55e-03	-0.02	-1.26e-04	-4.80e-06	0.0
94719	-2.01e-03	2.20e-03	-0.02	-8.22e-05	-5.81e-06	0.0
94724	-4.81e-04	-6.67e-04	-0.02	-6.73e-05	-1.65e-06	0.0
94727	-7.50e-04	3.88e-03	-0.02	-9.15e-05	-5.47e-06	0.0
94751	-2.78e-03	2.44e-03	-0.02	-8.34e-05	-6.95e-06	0.0
94756	-6.39e-04	-1.58e-03	-0.02	-6.25e-05	-1.12e-06	0.0
94759	-1.02e-03	4.79e-03	-0.01	-9.65e-05	-6.48e-06	0.0
94770	-9.67e-05	1.86e-03	-0.02	-9.16e-05	-3.56e-06	0.0
94772	-8.73e-05	1.65e-03	-0.02	-8.17e-05	-3.09e-06	0.0
94773	-8.49e-05	1.60e-03	-0.02	-7.92e-05	-2.97e-06	0.0
9482	-1.13e-04	3.32e-03	-0.03	-1.63e-04	-3.14e-06	0.0
94819	-2.11e-03	2.75e-03	-0.02	-1.09e-04	-7.14e-06	0.0
94827	-8.15e-04	4.64e-03	-0.02	-1.29e-04	-6.61e-06	0.0
94851	-2.92e-03	3.02e-03	-0.02	-1.12e-04	-9.27e-06	0.0
94859	-1.11e-03	5.67e-03	-0.02	-1.40e-04	-8.52e-06	0.0
94870	-7.99e-05	2.42e-03	-0.02	-1.19e-04	-2.30e-06	0.0
94872	-7.11e-05	2.14e-03	-0.02	-1.05e-04	-1.92e-06	0.0
94873	-6.89e-05	2.07e-03	-0.02	-1.02e-04	-1.82e-06	0.0
9492	-1.24e-04	4.08e-03	-0.04	-1.96e-04	0.0	0.0
94919	-2.17e-03	3.36e-03	-0.03	-1.35e-04	-6.65e-06	0.0
94927	-8.94e-04	5.59e-03	-0.03	-1.71e-04	-6.14e-06	0.0
94951	-3.02e-03	3.69e-03	-0.03	-1.41e-04	-9.26e-06	0.0
94959	-1.22e-03	6.82e-03	-0.03	-1.90e-04	-8.54e-06	0.0
94970	-8.77e-05	2.98e-03	-0.03	-1.43e-04	0.0	0.0
94972	-7.34e-05	2.62e-03	-0.03	-1.26e-04	0.0	0.0
94973	-6.98e-05	2.53e-03	-0.03	-1.22e-04	0.0	0.0
9502	6.58e-05	4.07e-03	-0.04	-1.98e-04	6.24e-06	0.0
9504	7.01e-05	3.10e-03	-0.03	-1.50e-04	5.34e-06	0.0
95017	2.09e-03	2.72e-03	-0.03	-1.29e-04	6.65e-06	0.0
95021	4.31e-04	5.68e-03	-0.03	-1.73e-04	6.70e-06	0.0
95027	-6.56e-04	5.67e-03	-0.03	-1.75e-04	5.54e-06	0.0
95049	2.91e-03	2.80e-03	-0.03	-1.32e-04	7.69e-06	0.0
95053	5.86e-04	6.94e-03	-0.03	-1.94e-04	7.78e-06	0.0
95059	-9.36e-04	6.93e-03	-0.03	-1.95e-04	6.15e-06	0.0
95070	5.51e-05	2.97e-03	-0.03	-1.44e-04	4.80e-06	0.0
95072	4.45e-05	2.60e-03	-0.03	-1.27e-04	4.17e-06	0.0
95073	4.18e-05	2.51e-03	-0.03	-1.22e-04	4.01e-06	0.0
9512	-5.99e-04	1.56e-03	-0.02	-7.66e-05	-3.12e-05	0.0
95116	-2.76e-03	1.12e-03	-0.02	-7.28e-05	-4.40e-05	0.0
95120	-2.74e-03	8.89e-04	-0.02	-7.22e-05	-4.45e-05	0.0
95131	-8.91e-04	3.30e-03	-0.02	-5.72e-05	-2.20e-05	0.0
95148	-3.69e-03	1.17e-03	-0.02	-8.22e-05	-5.30e-05	0.0
95152	-3.68e-03	8.36e-04	-0.02	-8.13e-05	-5.37e-05	0.0
95163	-1.08e-03	4.22e-03	-0.02	-6.03e-05	-2.23e-05	0.0
95170	-4.11e-04	1.16e-03	-0.02	-5.67e-05	-2.12e-05	0.0
95172	-4.10e-04	1.04e-03	-0.02	-5.09e-05	-2.14e-05	0.0
95173	-4.10e-04	1.01e-03	-0.02	-4.94e-05	-2.14e-05	0.0
9522	-5.23e-04	-3.72e-03	-0.03	1.84e-04	-2.41e-05	0.0
95212	-2.72e-03	-2.45e-03	-0.02	1.18e-04	-3.19e-05	0.0
95222	2.23e-04	-4.99e-03	-0.02	1.50e-04	-1.33e-05	0.0
95226	1.03e-04	-5.01e-03	-0.02	1.50e-04	-1.49e-05	0.0
95244	-3.67e-03	-2.51e-03	-0.02	1.19e-04	-3.87e-05	0.0
95254	4.43e-04	-6.06e-03	-0.02	1.64e-04	-1.26e-05	0.0
95258	2.74e-04	-6.08e-03	-0.02	1.64e-04	-1.49e-05	0.0
95270	-3.87e-04	-2.72e-03	-0.02	1.35e-04	-1.80e-05	0.0
95272	-3.40e-04	-2.40e-03	-0.02	1.19e-04	-1.56e-05	0.0
95273	-3.28e-04	-2.32e-03	-0.02	1.15e-04	-1.50e-05	0.0
9532	-3.49e-04	-3.00e-03	-0.02	1.47e-04	-1.58e-05	0.0
95311	-2.26e-03	-1.79e-03	-0.02	8.62e-05	-1.55e-05	0.0
95326	1.99e-04	-4.30e-03	-0.02	1.11e-04	-9.74e-06	0.0
95330	5.96e-04	-2.99e-03	-0.02	1.05e-04	-8.96e-06	0.0
95343	-3.08e-03	-1.75e-03	-0.02	8.37e-05	-1.77e-05	0.0
95358	3.66e-04	-5.27e-03	-0.02	1.19e-04	-9.69e-06	0.0
95362	9.21e-04	-3.43e-03	-0.02	1.09e-04	-8.60e-06	0.0
95370	-2.58e-04	-2.19e-03	-0.02	1.07e-04	-1.19e-05	0.0



EGP CODE

GRE.EEC.R.73.IT.W.15235.12.024.01

PAGE

218 di/of 527

95372	-2.27e-04	-1.94e-03	-0.02	9.54e-05	-1.02e-05	0.0
95373	-2.19e-04	-1.88e-03	-0.02	9.25e-05	-9.85e-06	0.0
9542	-2.46e-04	-2.20e-03	-0.02	1.08e-04	-1.05e-05	0.0
95411	-2.07e-03	-1.33e-03	-0.01	6.44e-05	-9.15e-06	0.0
95421	4.69e-04	7.83e-04	-0.01	6.23e-05	-5.48e-06	0.0
95426	2.77e-04	-3.56e-03	-0.01	7.51e-05	-6.42e-06	0.0
95443	-2.83e-03	-1.31e-03	-0.01	6.29e-05	-1.02e-05	0.0
95453	7.20e-04	1.65e-03	-0.01	6.00e-05	-5.05e-06	0.0
95458	4.50e-04	-4.44e-03	-0.01	7.79e-05	-6.36e-06	0.0
95470	-1.82e-04	-1.60e-03	-0.01	7.84e-05	-7.91e-06	0.0
95472	-1.61e-04	-1.43e-03	-0.01	7.02e-05	-6.85e-06	0.0
95473	-1.56e-04	-1.38e-03	-0.01	6.81e-05	-6.58e-06	0.0
9552	-1.73e-04	-1.45e-03	-0.01	7.14e-05	-6.70e-06	0.0
95511	-1.92e-03	-8.93e-04	-0.01	4.38e-05	-4.99e-06	0.0
95526	3.40e-04	-2.94e-03	-0.01	4.42e-05	-3.78e-06	0.0
95527	-5.62e-04	1.11e-03	-0.01	4.62e-05	-4.74e-06	0.0
95543	-2.65e-03	-8.83e-04	-0.01	4.32e-05	-5.29e-06	0.0
95558	5.21e-04	-3.75e-03-9.79e-03		4.38e-05	-3.59e-06	0.0
95559	-7.42e-04	1.92e-03	-0.01	4.66e-05	-4.93e-06	0.0
95570	-1.28e-04	-1.06e-03	-0.01	5.19e-05	-5.12e-06	0.0
95572	-1.14e-04	-9.46e-04	-0.01	4.66e-05	-4.43e-06	0.0
95573	-1.11e-04	-9.18e-04	-0.01	4.52e-05	-4.26e-06	0.0
9561	-1.10e-04	-6.78e-04	-0.01	3.34e-05	-3.49e-06	0.0
9562	-1.26e-04	-7.90e-04	-0.01	3.87e-05	-4.33e-06	0.0
95611	-1.83e-03	-4.96e-04-9.17e-03		2.42e-05	-2.44e-06	0.0
95626	3.90e-04	-2.43e-03-8.51e-03		1.93e-05	-2.68e-06	0.0
95627	-5.54e-04	1.43e-03-9.50e-03		2.98e-05	-2.92e-06	0.0
95643	-2.52e-03	-4.94e-04-9.24e-03		2.40e-05	-2.29e-06	0.0
95658	5.79e-04	-3.20e-03-8.31e-03		1.72e-05	-2.64e-06	0.0
95659	-7.43e-04	2.20e-03-9.69e-03		3.19e-05	-2.97e-06	0.0
95669	-8.22e-05	-4.99e-04-9.00e-03		2.46e-05	-2.80e-06	0.0
95670	-9.34e-05	-5.73e-04-8.78e-03		2.81e-05	-3.36e-06	0.0
95671	-8.22e-05	-4.99e-04-9.00e-03		2.46e-05	-2.80e-06	0.0
95672	-8.44e-05	-5.14e-04-8.96e-03		2.53e-05	-2.91e-06	0.0
95673	-8.22e-05	-4.99e-04-9.00e-03		2.46e-05	-2.80e-06	0.0
9571	-9.35e-05	-1.56e-04	-0.01	7.58e-06	-2.65e-06	0.0
9572	-1.07e-04	-1.81e-04	-0.01	8.77e-06	-3.29e-06	0.0
95711	-1.76e-03	-1.24e-04-8.41e-03		6.05e-06	-1.35e-06	0.0
95715	-1.73e-03	7.08e-04-8.44e-03		7.32e-06	-1.29e-06	0.0
95726	4.26e-04	-2.00e-03-8.10e-03		-1.64e-06	-2.35e-06	0.0
95743	-2.44e-03	-1.28e-04-8.47e-03		6.23e-06	-1.03e-06	0.0
95747	-2.40e-03	1.04e-03-8.51e-03		8.04e-06	0.0	0.0
95758	6.24e-04	-2.76e-03-8.04e-03		-4.53e-06	-2.42e-06	0.0
95769	-6.99e-05	-1.15e-04-8.26e-03		5.56e-06	-2.16e-06	0.0
95770	-7.87e-05	-1.32e-04-7.93e-03		6.36e-06	-2.60e-06	0.0
95771	-6.99e-05	-1.15e-04-8.26e-03		5.56e-06	-2.16e-06	0.0
95772	-7.17e-05	-1.18e-04-8.19e-03		5.72e-06	-2.25e-06	0.0
95773	-6.99e-05	-1.15e-04-8.26e-03		5.56e-06	-2.16e-06	0.0
9581	-9.80e-05	3.55e-04	-0.01	-1.77e-05	-2.86e-06	0.0
9582	-1.12e-04	4.13e-04	-0.01	-2.05e-05	-3.55e-06	0.0
95820	-1.78e-03	2.66e-04-8.61e-03		-1.33e-05	-1.61e-06	0.0
95821	4.09e-04	2.16e-03-8.14e-03		-6.30e-06	-2.38e-06	0.0
95824	-5.56e-04	-1.64e-03-8.75e-03		-1.97e-05	-2.27e-06	0.0
95852	-2.46e-03	2.68e-04-8.67e-03		-1.33e-05	-1.32e-06	0.0
95853	6.02e-04	2.92e-03-8.02e-03		-3.60e-06	-2.40e-06	0.0
95856	-7.49e-04	-2.40e-03-8.87e-03		-2.24e-05	-2.25e-06	0.0
95869	-7.34e-05	2.61e-04-8.44e-03		-1.30e-05	-2.32e-06	0.0
95870	-8.28e-05	3.00e-04-8.14e-03		-1.49e-05	-2.79e-06	0.0
95871	-7.34e-05	2.61e-04-8.44e-03		-1.30e-05	-2.32e-06	0.0
95872	-7.53e-05	2.69e-04-8.38e-03		-1.34e-05	-2.41e-06	0.0
95873	-7.34e-05	2.61e-04-8.44e-03		-1.30e-05	-2.32e-06	0.0
9591	-1.24e-04	8.92e-04	-0.01	-4.43e-05	-4.13e-06	0.0
9592	-1.44e-04	1.04e-03	-0.01	-5.14e-05	-5.11e-06	0.0
95920	-1.85e-03	6.45e-04-9.74e-03		-3.18e-05	-3.08e-06	0.0
95921	3.67e-04	2.62e-03-8.98e-03		-2.88e-05	-3.07e-06	0.0
95924	-5.53e-04	-1.30e-03	-0.01	-3.63e-05	-3.50e-06	0.0
95952	-2.56e-03	6.41e-04-9.80e-03		-3.15e-05	-3.01e-06	0.0
95953	5.51e-04	3.40e-03-8.75e-03		-2.73e-05	-2.99e-06	0.0
95956	-7.36e-04	-2.09e-03	-0.01	-3.78e-05	-3.58e-06	0.0
95969	-9.28e-05	6.57e-04-9.57e-03		-3.26e-05	-3.29e-06	0.0
95970	-1.06e-04	7.56e-04-9.42e-03		-3.73e-05	-3.94e-06	0.0
95971	-9.28e-05	6.57e-04-9.57e-03		-3.26e-05	-3.29e-06	0.0
95972	-9.54e-05	6.77e-04-9.54e-03		-3.35e-05	-3.42e-06	0.0
95973	-9.28e-05	6.57e-04-9.57e-03		-3.26e-05	-3.29e-06	0.0
9602	-2.02e-04	1.74e-03	-0.02	-8.57e-05	-8.05e-06	0.0
96020	-1.97e-03	1.06e-03	-0.01	-5.16e-05	-6.24e-06	0.0



EGP CODE

GRE.EEC.R.73.IT.W.15235.12.024.01

PAGE

219 di/of 527

96021	3.11e-04	3.17e-03	-0.01	-5.66e-05	-4.63e-06	0.0
96024	-5.68e-04	-9.85e-04	-0.01	-5.18e-05	-5.55e-06	0.0
96052	-2.70e-03	1.04e-03	-0.01	-5.05e-05	-6.69e-06	0.0
96053	4.87e-04	4.01e-03	-0.01	-5.75e-05	-4.45e-06	0.0
96056	-7.44e-04	-1.82e-03	-0.01	-5.08e-05	-5.73e-06	0.0
96070	-1.49e-04	1.26e-03	-0.01	-6.22e-05	-6.12e-06	0.0
96072	-1.33e-04	1.13e-03	-0.01	-5.58e-05	-5.30e-06	0.0
96073	-1.29e-04	1.09e-03	-0.01	-5.42e-05	-5.09e-06	0.0
9612	-2.87e-04	2.51e-03	-0.02	-1.24e-04	-1.24e-05	0.0
96120	-2.13e-03	1.51e-03	-0.01	-7.32e-05	-1.13e-05	0.0
96121	2.41e-04	3.84e-03	-0.01	-8.90e-05	-7.66e-06	0.0
96126	4.71e-04	-6.70e-04	-0.02	-6.81e-05	-6.12e-06	0.0
96152	-2.91e-03	1.48e-03	-0.01	-7.14e-05	-1.27e-05	0.0
96153	4.09e-04	4.74e-03	-0.01	-9.34e-05	-7.61e-06	0.0
96158	7.32e-04	-1.57e-03	-0.02	-6.42e-05	-5.46e-06	0.0
96170	-2.12e-04	1.82e-03	-0.02	-8.99e-05	-9.36e-06	0.0
96172	-1.87e-04	1.63e-03	-0.02	-8.03e-05	-8.09e-06	0.0
96173	-1.81e-04	1.58e-03	-0.02	-7.79e-05	-7.78e-06	0.0
9622	-4.02e-04	3.31e-03	-0.03	-1.63e-04	-1.83e-05	0.0
96219	-2.33e-03	2.18e-03	-0.02	-1.03e-04	-1.85e-05	0.0
96221	1.55e-04	4.61e-03	-0.02	-1.27e-04	-1.16e-05	0.0
96225	2.37e-04	4.59e-03	-0.02	-1.27e-04	-1.09e-05	0.0
96251	-3.16e-03	2.23e-03	-0.02	-1.04e-04	-2.13e-05	0.0
96253	3.17e-04	5.62e-03	-0.02	-1.37e-04	-1.17e-05	0.0
96257	4.33e-04	5.59e-03	-0.02	-1.37e-04	-1.08e-05	0.0
96270	-2.97e-04	2.41e-03	-0.02	-1.19e-04	-1.37e-05	0.0
96272	-2.61e-04	2.14e-03	-0.02	-1.06e-04	-1.19e-05	0.0
96273	-2.52e-04	2.07e-03	-0.02	-1.02e-04	-1.14e-05	0.0
9632	-6.02e-04	3.96e-03	-0.04	-1.98e-04	-2.75e-05	0.0
96319	-2.97e-03	2.62e-03	-0.03	-1.28e-04	-4.32e-05	0.0
96321	5.81e-05	5.35e-03	-0.03	-1.70e-04	-1.64e-05	0.0
96325	1.99e-04	5.32e-03	-0.03	-1.70e-04	-1.40e-05	0.0
96351	-4.01e-03	2.69e-03	-0.03	-1.30e-04	-5.36e-05	0.0
96353	2.31e-04	6.50e-03	-0.03	-1.89e-04	-1.62e-05	0.0
96357	4.30e-04	6.47e-03	-0.03	-1.89e-04	-1.27e-05	0.0
96370	-4.46e-04	2.89e-03	-0.03	-1.45e-04	-2.05e-05	0.0
96372	-3.91e-04	2.55e-03	-0.03	-1.28e-04	-1.77e-05	0.0
96373	-3.77e-04	2.46e-03	-0.03	-1.23e-04	-1.70e-05	0.0
9642	-6.68e-04	2.24e-03	-0.03	-1.10e-04	-3.44e-05	0.0
96416	-3.08e-03	1.54e-03	-0.03	-9.91e-05	-5.65e-05	0.0
96420	-3.06e-03	1.27e-03	-0.03	-9.72e-05	-5.71e-05	0.0
96431	-9.54e-04	4.00e-03	-0.02	-9.12e-05	-2.56e-05	0.0
96448	-4.14e-03	1.58e-03	-0.03	-1.11e-04	-6.97e-05	0.0
96452	-4.11e-03	1.20e-03	-0.03	-1.08e-04	-7.05e-05	0.0
96463	-1.15e-03	5.03e-03	-0.02	-9.95e-05	-2.64e-05	0.0
96470	-4.69e-04	1.66e-03	-0.02	-8.12e-05	-2.40e-05	0.0
96472	-4.59e-04	1.48e-03	-0.02	-7.26e-05	-2.37e-05	0.0
96473	-4.56e-04	1.44e-03	-0.02	-7.04e-05	-2.36e-05	0.0
9652	-7.98e-04	2.92e-03	-0.04	-1.42e-04	-4.02e-05	0.0
96515	-3.58e-03	2.92e-03	-0.03	-1.31e-04	-7.45e-05	0.0
96519	-3.48e-03	3.23e-03	-0.03	-1.35e-04	-7.42e-05	0.0
96531	-1.14e-03	4.82e-03	-0.03	-1.30e-04	-3.36e-05	0.0
96547	-4.80e-03	3.32e-03	-0.03	-1.47e-04	-9.34e-05	0.0
96551	-4.65e-03	3.77e-03	-0.04	-1.53e-04	-9.29e-05	0.0
96563	-1.38e-03	6.01e-03	-0.03	-1.46e-04	-3.61e-05	0.0
96570	-5.74e-04	2.16e-03	-0.03	-1.05e-04	-2.86e-05	0.0
96572	-5.47e-04	1.92e-03	-0.03	-9.37e-05	-2.76e-05	0.0
96573	-5.40e-04	1.86e-03	-0.03	-9.08e-05	-2.74e-05	0.0
9662	-1.06e-03	3.61e-03	-0.04	-1.70e-04	-5.07e-05	0.0
96615	-4.02e-03	3.57e-03	-0.04	-1.47e-04	-9.58e-05	0.0
96619	-3.98e-03	3.97e-03	-0.04	-1.55e-04	-9.62e-05	0.0
96631	-1.59e-03	5.94e-03	-0.04	-1.76e-04	-5.13e-05	0.0
96647	-5.35e-03	4.06e-03	-0.04	-1.63e-04	-1.21e-04	0.0
96651	-5.30e-03	4.63e-03	-0.04	-1.73e-04	-1.21e-04	0.0
96663	-1.94e-03	7.41e-03	-0.04	-2.03e-04	-5.83e-05	0.0
96670	-7.75e-04	2.68e-03	-0.03	-1.26e-04	-3.69e-05	0.0
96672	-7.12e-04	2.35e-03	-0.03	-1.11e-04	-3.44e-05	0.0
96673	-6.97e-04	2.27e-03	-0.03	-1.08e-04	-3.38e-05	0.0
9672	-7.40e-04	3.43e-03	-0.06	-1.60e-04	-4.91e-05	0.0
96715	-4.25e-03	3.57e-03	-0.05	-1.35e-04	-1.08e-04	0.0
96719	-4.08e-03	3.98e-03	-0.05	-1.44e-04	-1.09e-04	0.0
96731	-1.15e-03	5.91e-03	-0.05	-1.75e-04	-5.78e-05	0.0
96747	-5.75e-03	4.11e-03	-0.06	-1.49e-04	-1.38e-04	0.0
96751	-5.52e-03	4.70e-03	-0.06	-1.61e-04	-1.39e-04	0.0
96763	-1.40e-03	7.42e-03	-0.05	-2.05e-04	-6.77e-05	0.0
96770	-5.42e-04	2.55e-03	-0.04	-1.19e-04	-3.59e-05	0.0



EGP CODE

GRE.EEC.R.73.IT.W.15235.12.024.01

PAGE

220 di/of 527

96772	-5.19e-04	2.23e-03	-0.04	-1.04e-04	-3.37e-05	0.0
96773	-5.13e-04	2.15e-03	-0.04	-1.01e-04	-3.32e-05	0.0
9682	-7.61e-04	-3.34e-03	-0.06	1.57e-04	-4.90e-05	0.0
9688	-4.25e-03	-3.53e-03	-0.05	1.31e-04	-1.05e-04	0.0
96812	-4.07e-03	-2.93e-03	-0.05	1.40e-04	-1.06e-04	0.0
96836	-1.15e-03	-5.77e-03	-0.05	1.71e-04	-5.65e-05	0.0
96840	-5.73e-03	-4.08e-03	-0.05	1.44e-04	-1.34e-04	0.0
96844	-5.50e-03	-4.66e-03	-0.06	1.56e-04	-1.36e-04	0.0
96868	-1.41e-03	-7.24e-03	-0.05	2.00e-04	-6.59e-05	0.0
96870	-5.58e-04	-2.48e-03	-0.04	1.17e-04	-3.58e-05	0.0
96872	-5.33e-04	-2.17e-03	-0.04	1.03e-04	-3.36e-05	0.0
96873	-5.27e-04	-2.10e-03	-0.04	9.92e-05	-3.31e-05	0.0
9692	1.89e-03	3.71e-03	-0.05	-1.75e-04	9.96e-05	0.0
96917	4.35e-03	3.53e-03	-0.04	-1.36e-04	1.22e-04	0.0
96921	2.05e-03	6.18e-03	-0.04	-1.86e-04	9.00e-05	0.0
96925	2.25e-03	6.09e-03	-0.04	-1.84e-04	9.50e-05	0.0
96949	5.60e-03	4.00e-03	-0.04	-1.46e-04	1.46e-04	0.0
96953	2.38e-03	7.74e-03	-0.04	-2.16e-04	1.00e-04	0.0
96957	2.66e-03	7.61e-03	-0.04	-2.15e-04	1.07e-04	0.0
96970	1.40e-03	2.75e-03	-0.03	-1.29e-04	7.35e-05	0.0
96972	1.26e-03	2.39e-03	-0.03	-1.13e-04	6.63e-05	0.0
96973	1.23e-03	2.30e-03	-0.03	-1.09e-04	6.45e-05	0.0
9702	1.89e-03	-3.71e-03	-0.05	1.74e-04	9.96e-05	0.0
97010	4.28e-03	-3.52e-03	-0.04	1.36e-04	1.21e-04	0.0
97022	2.24e-03	-6.09e-03	-0.04	1.84e-04	9.45e-05	0.0
97026	2.04e-03	-6.19e-03	-0.04	1.86e-04	8.97e-05	0.0
97042	5.51e-03	-3.99e-03	-0.04	1.46e-04	1.43e-04	0.0
97054	2.65e-03	-7.60e-03	-0.04	2.15e-04	1.07e-04	0.0
97058	2.37e-03	-7.74e-03	-0.04	2.16e-04	9.97e-05	0.0
97070	1.40e-03	-2.75e-03	-0.03	1.29e-04	7.35e-05	0.0
97072	1.26e-03	-2.39e-03	-0.03	1.13e-04	6.63e-05	0.0
97073	1.23e-03	-2.30e-03	-0.03	1.09e-04	6.45e-05	0.0
9712	1.47e-03	-3.25e-03	-0.04	1.56e-04	7.83e-05	0.0
9716	3.89e-03	-3.54e-03	-0.03	1.23e-04	9.97e-05	0.0
9719	4.02e-03	-2.18e-03	-0.03	1.03e-04	1.00e-04	0.0
97126	1.51e-03	-5.24e-03	-0.03	1.46e-04	5.91e-05	0.0
97138	5.06e-03	-4.14e-03	-0.03	1.33e-04	1.19e-04	0.0
97141	5.25e-03	-2.24e-03	-0.03	1.05e-04	1.20e-04	0.0
97158	1.73e-03	-6.52e-03	-0.03	1.64e-04	6.21e-05	0.0
97170	1.08e-03	-2.40e-03	-0.03	1.15e-04	5.72e-05	0.0
97172	9.89e-04	-2.11e-03	-0.03	1.02e-04	5.26e-05	0.0
97173	9.67e-04	-2.04e-03	-0.03	9.86e-05	5.14e-05	0.0
9722	1.32e-03	-2.59e-03	-0.03	1.26e-04	6.84e-05	0.0
9726	3.36e-03	-2.90e-03	-0.02	1.01e-04	7.68e-05	0.0
97210	3.46e-03	-2.55e-03	-0.02	9.78e-05	7.70e-05	0.0
97226	1.41e-03	-4.39e-03	-0.02	1.05e-04	4.99e-05	0.0
97238	4.36e-03	-3.40e-03	-0.03	1.09e-04	8.95e-05	0.0
97242	4.49e-03	-2.90e-03	-0.03	1.05e-04	8.98e-05	0.0
97258	1.62e-03	-5.49e-03	-0.02	1.15e-04	5.19e-05	0.0
97270	9.56e-04	-1.91e-03	-0.02	9.29e-05	4.93e-05	0.0
97272	8.87e-04	-1.70e-03	-0.02	8.26e-05	4.59e-05	0.0
97273	8.69e-04	-1.64e-03	-0.02	8.00e-05	4.50e-05	0.0
9732	1.14e-03	-1.93e-03	-0.02	9.40e-05	5.92e-05	0.0
9735	3.07e-03	-1.02e-03	-0.02	7.07e-05	6.37e-05	0.0
9739	3.09e-03	-1.33e-03	-0.02	7.18e-05	6.33e-05	0.0
97326	1.24e-03	-3.69e-03	-0.02	7.14e-05	4.14e-05	0.0
97337	3.99e-03	-9.28e-04	-0.02	7.50e-05	7.35e-05	0.0
97341	4.03e-03	-1.38e-03	-0.02	7.66e-05	7.30e-05	0.0
97358	1.44e-03	-4.67e-03	-0.02	7.59e-05	4.22e-05	0.0
97370	8.15e-04	-1.42e-03	-0.02	6.92e-05	4.20e-05	0.0
97372	7.67e-04	-1.26e-03	-0.02	6.18e-05	3.97e-05	0.0
97373	7.55e-04	-1.23e-03	-0.02	5.99e-05	3.92e-05	0.0
9742	1.02e-03	-1.29e-03	-0.02	6.29e-05	5.30e-05	0.0
9745	2.79e-03	-6.62e-04	-0.02	5.16e-05	5.26e-05	0.0
9749	2.81e-03	-9.52e-04	-0.02	5.15e-05	5.23e-05	0.0
97426	1.16e-03	-3.08e-03	-0.01	4.09e-05	3.64e-05	0.0
97437	3.64e-03	-5.93e-04	-0.02	5.61e-05	5.95e-05	0.0
97441	3.66e-03	-1.00e-03	-0.02	5.61e-05	5.91e-05	0.0
97458	1.35e-03	-3.98e-03	-0.01	4.11e-05	3.69e-05	0.0
97470	7.17e-04	-9.49e-04	-0.02	4.63e-05	3.71e-05	0.0
97472	6.84e-04	-8.47e-04	-0.02	4.15e-05	3.56e-05	0.0
97473	6.76e-04	-8.21e-04	-0.02	4.03e-05	3.52e-05	0.0
9751	9.01e-04	-6.00e-04	-0.02	2.95e-05	4.72e-05	0.0
9752	9.47e-04	-7.03e-04	-0.02	3.44e-05	4.94e-05	0.0
9755	2.60e-03	6.13e-04	-0.01	3.14e-05	4.55e-05	0.0
9759	2.61e-03	3.37e-04	-0.01	3.06e-05	4.53e-05	0.0





EGP CODE

GRE.EEC.R.73.IT.W.15235.12.024.01

PAGE

221 di/of 527

97526	1.13e-03	-2.58e-03	-0.01	1.71e-05	3.42e-05	0.0
97537	3.39e-03	1.03e-03	-0.02	3.52e-05	5.05e-05	0.0
97541	3.41e-03	6.44e-04	-0.02	3.40e-05	5.03e-05	0.0
97558	1.34e-03	-3.43e-03	-0.01	1.52e-05	3.48e-05	0.0
97569	6.29e-04	-4.49e-04	-0.01	2.20e-05	3.28e-05	0.0
97570	6.59e-04	-5.17e-04	-0.01	2.53e-05	3.43e-05	0.0
97571	6.29e-04	-4.49e-04	-0.01	2.20e-05	3.28e-05	0.0
97572	6.35e-04	-4.62e-04	-0.01	2.27e-05	3.31e-05	0.0
97573	6.29e-04	-4.49e-04	-0.01	2.20e-05	3.28e-05	0.0
9761	8.77e-04	-1.36e-04	-0.02	6.74e-06	4.61e-05	0.0
9762	9.16e-04	-1.59e-04	-0.02	7.86e-06	4.79e-05	0.0
9765	2.49e-03	9.77e-04	-0.01	1.19e-05	4.17e-05	0.0
9769	2.49e-03	7.08e-04	-0.01	1.07e-05	4.16e-05	0.0
97626	1.15e-03	-2.17e-03	-0.01	-2.27e-06	3.42e-05	0.0
97637	3.25e-03	1.41e-03	-0.01	1.46e-05	4.56e-05	0.0
97641	3.25e-03	1.03e-03	-0.01	1.30e-05	4.55e-05	0.0
97658	1.37e-03	-3.00e-03	-0.01	-5.20e-06	3.51e-05	0.0
97669	6.09e-04	-1.02e-04	-0.01	5.04e-06	3.19e-05	0.0
97670	6.35e-04	-1.17e-04	-0.01	5.78e-06	3.31e-05	0.0
97671	6.09e-04	-1.02e-04	-0.01	5.04e-06	3.19e-05	0.0
97672	6.14e-04	-1.05e-04	-0.01	5.19e-06	3.21e-05	0.0
97673	6.09e-04	-1.02e-04	-0.01	5.04e-06	3.19e-05	0.0
9772	-1.16e-03	-4.08e-03	-0.04	1.95e-04	-5.80e-05	0.0
97712	-2.87e-03	-3.37e-03	-0.03	1.26e-04	-4.67e-05	0.0
97722	-3.75e-04	-5.56e-03	-0.03	1.77e-04	-4.20e-05	0.0
97726	-4.80e-04	-5.78e-03	-0.03	1.77e-04	-4.28e-05	0.0
97744	-3.73e-03	-3.71e-03	-0.03	1.29e-04	-5.11e-05	0.0
97754	-2.37e-04	-6.79e-03	-0.03	1.99e-04	-4.45e-05	0.0
97758	-3.84e-04	-7.10e-03	-0.03	1.99e-04	-4.57e-05	0.0
97770	-8.65e-04	-2.99e-03	-0.03	1.42e-04	-4.34e-05	0.0
97772	-7.49e-04	-2.61e-03	-0.03	1.25e-04	-3.73e-05	0.0
97773	-7.20e-04	-2.51e-03	-0.03	1.20e-04	-3.58e-05	0.0
9782	-5.17e-04	-3.72e-03	-0.03	1.79e-04	-2.97e-05	0.0
97811	-2.53e-03	-1.64e-03	-0.02	9.71e-05	-2.90e-05	0.0
97822	3.71e-04	-5.11e-03	-0.02	1.51e-04	-1.35e-05	0.0
97826	2.71e-04	-5.16e-03	-0.02	1.51e-04	-1.44e-05	0.0
97843	-3.40e-03	-1.37e-03	-0.02	9.11e-05	-3.32e-05	0.0
97854	6.54e-04	-6.23e-03	-0.02	1.67e-04	-1.15e-05	0.0
97858	5.12e-04	-6.31e-03	-0.02	1.66e-04	-1.27e-05	0.0
97870	-3.84e-04	-2.72e-03	-0.02	1.31e-04	-2.23e-05	0.0
97872	-3.45e-04	-2.39e-03	-0.02	1.16e-04	-1.95e-05	0.0
97873	-3.35e-04	-2.31e-03	-0.02	1.12e-04	-1.88e-05	0.0
9792	-4.53e-04	-2.86e-03	-0.02	1.40e-04	-2.16e-05	0.0
97910	1.72e-03	-2.41e-03	-0.02	9.73e-05	-9.43e-06	0.0
97911	-2.29e-03	-1.18e-03	-0.02	7.89e-05	-1.76e-05	0.0
97926	1.50e-04	-4.21e-03	-0.02	1.06e-04	-1.20e-05	0.0
97942	2.52e-03	-2.65e-03	-0.02	1.01e-04	-7.80e-06	0.0
97943	-3.09e-03	-9.35e-04	-0.02	7.52e-05	-1.92e-05	0.0
97958	3.24e-04	-5.18e-03	-0.02	1.14e-04	-1.14e-05	0.0
97970	-3.38e-04	-2.08e-03	-0.02	1.02e-04	-1.63e-05	0.0
97972	-2.97e-04	-1.85e-03	-0.02	9.08e-05	-1.41e-05	0.0
97973	-2.86e-04	-1.79e-03	-0.02	8.81e-05	-1.35e-05	0.0
9802	-2.93e-04	-2.10e-03	-0.02	1.03e-04	-1.28e-05	0.0
98011	-2.07e-03	-7.34e-04	-0.01	5.96e-05	-9.79e-06	0.0
98021	4.19e-04	6.86e-04	-0.01	6.01e-05	-8.66e-06	0.0
98026	2.57e-04	-3.51e-03	-0.01	7.24e-05	-6.68e-06	0.0
98043	-2.83e-03	-5.03e-04	-0.01	5.74e-05	-1.05e-05	0.0
98053	6.61e-04	1.49e-03	-0.01	5.80e-05	-8.91e-06	0.0
98058	4.35e-04	-4.39e-03	-0.01	7.53e-05	-6.14e-06	0.0
98070	-2.19e-04	-1.52e-03	-0.01	7.49e-05	-9.78e-06	0.0
98072	-1.92e-04	-1.36e-03	-0.01	6.71e-05	-8.38e-06	0.0
98073	-1.85e-04	-1.32e-03	-0.01	6.51e-05	-8.03e-06	0.0
9811	-1.52e-04	-1.19e-03	-0.01	5.90e-05	-5.54e-06	0.0
9812	-1.84e-04	-1.39e-03	-0.01	6.84e-05	-7.15e-06	0.0
98111	-1.92e-03	-8.69e-04	-0.01	4.09e-05	-4.44e-06	0.0
98126	3.37e-04	-2.92e-03	-9.90e-03	4.27e-05	-3.79e-06	0.0
98127	-5.70e-04	1.16e-03	-0.01	4.41e-05	-5.22e-06	0.0
98143	-2.64e-03	-8.65e-04	-0.01	4.00e-05	-4.42e-06	0.0
98158	5.18e-04	-3.74e-03	-9.64e-03	4.24e-05	-3.50e-06	0.0
98159	-7.52e-04	1.98e-03	-0.01	4.43e-05	-5.50e-06	0.0
98169	-1.17e-04	-8.79e-04	-0.01	4.34e-05	-4.50e-06	0.0
98170	-1.38e-04	-1.01e-03	-0.01	4.97e-05	-5.57e-06	0.0
98171	-1.17e-04	-8.79e-04	-0.01	4.34e-05	-4.50e-06	0.0
98172	-1.21e-04	-9.05e-04	-0.01	4.46e-05	-4.72e-06	0.0
98173	-1.17e-04	-8.79e-04	-0.01	4.34e-05	-4.50e-06	0.0
9821	-9.93e-05	-6.51e-04	-0.01	3.21e-05	-2.87e-06	0.0



EGP CODE

GRE.EEC.R.73.IT.W.15235.12.024.01

PAGE

222 di/of 527

9822	-1.20e-04	-7.56e-04	-0.01	3.71e-05	-3.89e-06	0.0
98211	-1.81e-03	-4.94e-04	-9.08e-03	2.27e-05	-1.73e-06	0.0
98226	3.95e-04	-2.43e-03	-8.40e-03	1.86e-05	-2.24e-06	0.0
98227	-5.49e-04	1.47e-03	-9.38e-03	2.86e-05	-2.71e-06	0.0
98243	-2.51e-03	-5.00e-04	-9.16e-03	2.24e-05	-1.43e-06	0.0
98258	5.83e-04	-3.21e-03	-8.21e-03	1.66e-05	-2.15e-06	0.0
98259	-7.37e-04	2.25e-03	-9.57e-03	3.06e-05	-2.81e-06	0.0
98269	-7.70e-05	-4.78e-04	-8.89e-03	2.36e-05	-2.48e-06	0.0
98270	-9.07e-05	-5.48e-04	-8.64e-03	2.69e-05	-3.16e-06	0.0
98271	-7.70e-05	-4.78e-04	-8.89e-03	2.36e-05	-2.48e-06	0.0
98272	-7.98e-05	-4.92e-04	-8.84e-03	2.42e-05	-2.61e-06	0.0
98273	-7.70e-05	-4.78e-04	-8.89e-03	2.36e-05	-2.48e-06	0.0
9831	-7.77e-05	-1.50e-04	-0.01	7.29e-06	-1.76e-06	0.0
9832	-9.36e-05	-1.74e-04	-0.01	8.42e-06	-2.55e-06	0.0
98311	-1.74e-03	-1.42e-04	-8.37e-03	5.63e-06	0.0	0.0
98315	-1.72e-03	7.42e-04	-8.40e-03	6.96e-06	0.0	0.0
98326	4.33e-04	-2.02e-03	-8.01e-03	-1.58e-06	-1.87e-06	0.0
98343	-2.42e-03	-1.55e-04	-8.45e-03	5.74e-06	0.0	0.0
98347	-2.38e-03	1.08e-03	-8.49e-03	7.62e-06	0.0	0.0
98358	6.31e-04	-2.78e-03	-7.95e-03	-4.35e-06	-1.96e-06	0.0
98369	-6.07e-05	-1.10e-04	-8.18e-03	5.35e-06	-1.64e-06	0.0
98370	-7.13e-05	-1.26e-04	-7.83e-03	6.10e-06	-2.16e-06	0.0
98371	-6.07e-05	-1.10e-04	-8.18e-03	5.35e-06	-1.64e-06	0.0
98372	-6.28e-05	-1.13e-04	-8.11e-03	5.50e-06	-1.74e-06	0.0
98373	-6.07e-05	-1.10e-04	-8.18e-03	5.35e-06	-1.64e-06	0.0
9841	-8.39e-05	3.40e-04	-0.01	-1.70e-05	-2.05e-06	0.0
9842	-1.01e-04	3.95e-04	-0.01	-1.97e-05	-2.90e-06	0.0
98420	-1.76e-03	2.77e-04	-8.56e-03	-1.25e-05	0.0	0.0
98421	4.16e-04	2.17e-03	-8.05e-03	-6.04e-06	-1.94e-06	0.0
98424	-5.47e-04	-1.67e-03	-8.66e-03	-1.89e-05	-1.78e-06	0.0
98452	-2.44e-03	2.88e-04	-8.64e-03	-1.24e-05	0.0	0.0
98453	6.08e-04	2.94e-03	-7.93e-03	-3.46e-06	-1.97e-06	0.0
98456	-7.39e-04	-2.44e-03	-8.78e-03	-2.15e-05	-1.75e-06	0.0
98469	-6.54e-05	2.50e-04	-8.36e-03	-1.25e-05	-1.86e-06	0.0
98470	-7.69e-05	2.87e-04	-8.03e-03	-1.43e-05	-2.42e-06	0.0
98471	-6.54e-05	2.50e-04	-8.36e-03	-1.25e-05	-1.86e-06	0.0
98472	-6.77e-05	2.57e-04	-8.29e-03	-1.28e-05	-1.97e-06	0.0
98473	-6.54e-05	2.50e-04	-8.36e-03	-1.25e-05	-1.86e-06	0.0
9851	-1.19e-04	8.56e-04	-0.01	-4.26e-05	-3.79e-06	0.0
9852	-1.44e-04	9.95e-04	-0.01	-4.93e-05	-5.02e-06	0.0
98520	-1.84e-03	6.36e-04	-9.62e-03	-2.98e-05	-2.60e-06	0.0
98521	3.68e-04	2.61e-03	-8.86e-03	-2.78e-05	-2.82e-06	0.0
98524	-5.52e-04	-1.35e-03	-0.01	-3.47e-05	-3.54e-06	0.0
98552	-2.55e-03	6.38e-04	-9.69e-03	-2.93e-05	-2.37e-06	0.0
98553	5.52e-04	3.40e-03	-8.63e-03	-2.64e-05	-2.67e-06	0.0
98556	-7.36e-04	-2.14e-03	-0.01	-3.61e-05	-3.68e-06	0.0
98569	-9.20e-05	6.29e-04	-9.43e-03	-3.13e-05	-3.18e-06	0.0
98570	-1.09e-04	7.22e-04	-9.26e-03	-3.57e-05	-4.00e-06	0.0
98571	-9.20e-05	6.29e-04	-9.43e-03	-3.13e-05	-3.18e-06	0.0
98572	-9.53e-05	6.48e-04	-9.40e-03	-3.21e-05	-3.34e-06	0.0
98573	-9.20e-05	6.29e-04	-9.43e-03	-3.13e-05	-3.18e-06	0.0
9862	-2.28e-04	1.66e-03	-0.02	-8.20e-05	-9.25e-06	0.0
98620	-1.97e-03	1.02e-03	-0.01	-4.81e-05	-6.33e-06	0.0
98621	2.99e-04	3.14e-03	-0.01	-5.45e-05	-5.06e-06	0.0
98624	-5.88e-04	-1.05e-03	-0.01	-4.93e-05	-6.55e-06	0.0
98652	-2.70e-03	1.01e-03	-0.01	-4.66e-05	-6.53e-06	0.0
98653	4.76e-04	3.98e-03	-0.01	-5.56e-05	-4.76e-06	0.0
98656	-7.65e-04	-1.89e-03	-0.01	-4.82e-05	-6.85e-06	0.0
98670	-1.71e-04	1.21e-03	-0.01	-5.95e-05	-7.14e-06	0.0
98672	-1.50e-04	1.08e-03	-0.01	-5.34e-05	-6.07e-06	0.0
98673	-1.44e-04	1.05e-03	-0.01	-5.19e-05	-5.81e-06	0.0
9872	-3.66e-04	2.39e-03	-0.02	-1.18e-04	-1.63e-05	0.0
98720	-2.15e-03	9.10e-04	-0.01	-6.75e-05	-1.26e-05	0.0
98721	2.04e-04	3.78e-03	-0.01	-8.56e-05	-8.84e-06	0.0
98726	3.94e-04	-5.83e-04	-0.02	-6.56e-05	-1.05e-05	0.0
98752	-2.92e-03	6.76e-04	-0.01	-6.47e-05	-1.36e-05	0.0
98753	3.78e-04	4.69e-03	-0.01	-9.02e-05	-8.30e-06	0.0
98758	6.44e-04	-1.42e-03	-0.02	-6.21e-05	-1.06e-05	0.0
98770	-2.74e-04	1.74e-03	-0.02	-8.56e-05	-1.24e-05	0.0
98772	-2.39e-04	1.55e-03	-0.01	-7.66e-05	-1.06e-05	0.0
98773	-2.31e-04	1.50e-03	-0.01	-7.43e-05	-1.02e-05	0.0
9882	-5.71e-04	3.15e-03	-0.03	-1.54e-04	-2.74e-05	0.0
98813	1.59e-03	2.96e-03	-0.02	-1.10e-04	-1.19e-05	0.0
98820	-2.41e-03	1.34e-03	-0.02	-8.61e-05	-2.25e-05	0.0
98821	6.54e-05	4.51e-03	-0.02	-1.21e-04	-1.56e-05	0.0
98845	2.38e-03	3.35e-03	-0.02	-1.16e-04	-9.77e-06	0.0



EGP CODE

GRE.EEC.R.73.IT.W.15235.12.024.01

PAGE

223 di/of 527

98852	-3.23e-03	1.09e-03	-0.02	-8.18e-05	-2.47e-05	0.0
98853	2.35e-04	5.53e-03	-0.02	-1.31e-04	-1.51e-05	0.0
98870	-4.26e-04	2.29e-03	-0.02	-1.12e-04	-2.06e-05	0.0
98872	-3.72e-04	2.04e-03	-0.02	-1.00e-04	-1.78e-05	0.0
98873	-3.59e-04	1.97e-03	-0.02	-9.70e-05	-1.71e-05	0.0
9892	-7.22e-04	4.01e-03	-0.04	-1.92e-04	-3.94e-05	0.0
98920	-2.71e-03	1.76e-03	-0.02	-1.01e-04	-3.68e-05	0.0
98921	7.17e-06	5.57e-03	-0.03	-1.68e-04	-2.15e-05	0.0
98925	1.14e-04	5.51e-03	-0.03	-1.69e-04	-2.04e-05	0.0
98952	-3.60e-03	1.48e-03	-0.02	-9.43e-05	-4.17e-05	0.0
98953	1.94e-04	6.81e-03	-0.03	-1.88e-04	-2.02e-05	0.0
98957	3.44e-04	6.73e-03	-0.03	-1.88e-04	-1.87e-05	0.0
98970	-5.37e-04	2.93e-03	-0.03	-1.40e-04	-2.95e-05	0.0
98972	-4.76e-04	2.57e-03	-0.02	-1.23e-04	-2.57e-05	0.0
98973	-4.61e-04	2.48e-03	-0.02	-1.19e-04	-2.47e-05	0.0
9902	-1.17e-03	4.08e-03	-0.04	-1.95e-04	-5.81e-05	0.0
99019	-2.92e-03	3.34e-03	-0.03	-1.25e-04	-4.73e-05	0.0
99021	-4.58e-04	5.80e-03	-0.03	-1.77e-04	-4.23e-05	0.0
99025	-3.51e-04	5.58e-03	-0.03	-1.77e-04	-4.14e-05	0.0
99051	-3.80e-03	3.66e-03	-0.03	-1.27e-04	-5.19e-05	0.0
99053	-3.52e-04	7.12e-03	-0.03	-2.00e-04	-4.48e-05	0.0
99057	-2.02e-04	6.82e-03	-0.03	-2.00e-04	-4.36e-05	0.0
99070	-8.68e-04	2.99e-03	-0.03	-1.43e-04	-4.34e-05	0.0
99072	-7.53e-04	2.61e-03	-0.03	-1.25e-04	-3.74e-05	0.0
99073	-7.24e-04	2.51e-03	-0.03	-1.21e-04	-3.59e-05	0.0
9912	-1.21e-03	-3.25e-03	-0.04	1.59e-04	-6.05e-05	0.0
99112	-2.73e-03	-2.12e-03	-0.03	9.92e-05	-3.66e-05	0.0
99122	-4.46e-04	-4.89e-03	-0.03	1.40e-04	-4.65e-05	0.0
99126	-5.35e-04	-4.92e-03	-0.03	1.40e-04	-4.61e-05	0.0
99144	-3.52e-03	-2.17e-03	-0.02	9.92e-05	-3.65e-05	0.0
99154	-3.27e-04	-6.03e-03	-0.03	1.56e-04	-5.02e-05	0.0
99158	-4.51e-04	-6.08e-03	-0.03	1.56e-04	-4.97e-05	0.0
99170	-9.04e-04	-2.37e-03	-0.03	1.16e-04	-4.53e-05	0.0
99172	-7.77e-04	-2.09e-03	-0.03	1.03e-04	-3.87e-05	0.0
99173	-7.46e-04	-2.02e-03	-0.03	9.94e-05	-3.71e-05	0.0
9922	-8.08e-04	-3.08e-03	-0.03	1.51e-04	-4.00e-05	0.0
99211	-2.43e-03	-1.23e-03	-0.02	8.20e-05	-2.15e-05	0.0
99222	-6.23e-05	-4.60e-03	-0.02	1.27e-04	-2.68e-05	0.0
99226	-1.38e-04	-4.64e-03	-0.02	1.26e-04	-2.65e-05	0.0
99243	-3.20e-03	-9.54e-04	-0.02	7.69e-05	-2.02e-05	0.0
99254	1.13e-04	-5.67e-03	-0.02	1.40e-04	-2.77e-05	0.0
99258	6.70e-06	-5.73e-03	-0.02	1.39e-04	-2.73e-05	0.0
99270	-6.05e-04	-2.24e-03	-0.02	1.10e-04	-3.01e-05	0.0
99272	-5.22e-04	-1.99e-03	-0.02	9.80e-05	-2.57e-05	0.0
99273	-5.01e-04	-1.93e-03	-0.02	9.50e-05	-2.46e-05	0.0
9932	-4.88e-04	-2.56e-03	-0.02	1.26e-04	-2.29e-05	0.0
99310	1.60e-03	-2.25e-03	-0.02	9.02e-05	-1.47e-05	0.0
99311	-2.21e-03	-9.67e-04	-0.02	6.90e-05	-1.36e-05	0.0
99326	1.18e-04	-4.05e-03	-0.02	9.86e-05	-1.25e-05	0.0
99342	2.36e-03	-2.50e-03	-0.02	9.44e-05	-1.49e-05	0.0
99343	-2.97e-03	-7.16e-04	-0.02	6.48e-05	-1.34e-05	0.0
99358	2.86e-04	-5.03e-03	-0.02	1.06e-04	-1.18e-05	0.0
99370	-3.67e-04	-1.86e-03	-0.02	9.17e-05	-1.75e-05	0.0
99372	-3.16e-04	-1.66e-03	-0.02	8.20e-05	-1.48e-05	0.0
99373	-3.04e-04	-1.61e-03	-0.02	7.96e-05	-1.42e-05	0.0
9942	-2.72e-04	-1.92e-03	-0.02	9.49e-05	-1.16e-05	0.0
99411	-2.01e-03	-5.98e-04	-0.01	5.33e-05	-6.60e-06	0.0
99421	4.19e-04	8.02e-04	-0.01	5.49e-05	-9.20e-06	0.0
99426	2.66e-04	-3.43e-03	-0.01	6.79e-05	-5.60e-06	0.0
99443	-2.75e-03	-3.57e-04	-0.01	5.06e-05	-6.38e-06	0.0
99453	6.55e-04	1.61e-03	-0.01	5.29e-05	-1.00e-05	0.0
99458	4.40e-04	-4.32e-03	-0.01	7.11e-05	-4.98e-06	0.0
99470	-2.07e-04	-1.39e-03	-0.01	6.88e-05	-9.10e-06	0.0
99472	-1.77e-04	-1.25e-03	-0.01	6.18e-05	-7.55e-06	0.0
99473	-1.69e-04	-1.21e-03	-0.01	6.00e-05	-7.16e-06	0.0
9951	-1.05e-04	-1.11e-03	-0.01	5.50e-05	-3.12e-06	0.0
9952	-1.39e-04	-1.29e-03	-0.01	6.36e-05	-4.81e-06	0.0
99511	-1.87e-03	-8.29e-04	-0.01	3.72e-05	-1.98e-06	0.0
99526	3.64e-04	-2.88e-03-9.74e-03		4.01e-05	-2.00e-06	0.0
99527	-5.37e-04	1.25e-03	-0.01	4.05e-05	-3.81e-06	0.0
99543	-2.58e-03	-8.35e-04	-0.01	3.59e-05	-1.61e-06	0.0
99558	5.45e-04	-3.71e-03-9.50e-03		4.01e-05	-1.64e-06	0.0
99559	-7.17e-04	2.08e-03	-0.01	4.06e-05	-4.18e-06	0.0
99569	-8.61e-05	-8.14e-04	-0.01	4.03e-05	-2.91e-06	0.0
99570	-1.08e-04	-9.32e-04	-0.01	4.61e-05	-4.03e-06	0.0
99571	-8.61e-05	-8.14e-04	-0.01	4.03e-05	-2.91e-06	0.0



EGP CODE

GRE.EEC.R.73.IT.W.15235.12.024.01

PAGE

224 di/of 527

99572	-9.06e-05	-8.37e-04	-0.01	4.15e-05	-3.13e-06	0.0	
99573	-8.61e-05	-8.14e-04	-0.01	4.03e-05	-2.91e-06	0.0	
9961	-4.32e-05	-6.07e-04	-0.01	3.01e-05	0.0	0.0	
9962	-6.37e-05	-7.02e-04	-0.01	3.47e-05	-1.02e-06	0.0	
9964	-6.78e-05	-5.12e-04-8.37e-03		2.52e-05	-2.29e-06	0.0	
99611	-1.76e-03	-4.88e-04-9.05e-03		2.08e-05	0.0	0.0	
99626	4.30e-04	-2.42e-03-8.33e-03		1.76e-05	0.0	0.0	
99627	-5.09e-04	1.53e-03-9.28e-03		2.65e-05	0.0	0.0	
99643	-2.45e-03	-5.06e-04-9.14e-03		2.03e-05	1.19e-06	0.0	
99658	6.18e-04	-3.21e-03-8.14e-03		1.58e-05	0.0	0.0	
99659	-6.97e-04	2.32e-03-9.47e-03		2.83e-05	0.0	0.0	
99669	-3.94e-05	-4.45e-04-8.80e-03		2.20e-05	0.0	0.0	
99670	-5.30e-05	-5.09e-04-8.52e-03		2.51e-05	-1.23e-06	0.0	
99671	-3.94e-05	-4.45e-04-8.80e-03		2.20e-05	0.0	0.0	
99672	-4.21e-05	-4.58e-04-8.75e-03		2.27e-05	0.0	0.0	
99673	-3.94e-05	-4.45e-04-8.80e-03		2.20e-05	0.0	0.0	
9971	-1.82e-05	-1.40e-04 -0.01		6.86e-06	1.28e-06	0.0	
9972	-3.36e-05	-1.62e-04-9.97e-03		7.89e-06	0.0	0.0	
9974	-4.45e-05	-1.18e-04-7.61e-03		5.73e-06	-1.10e-06	0.0	
99711	-1.70e-03	-1.64e-04-8.40e-03		5.13e-06	1.85e-06	0.0	
99715	-1.67e-03	7.89e-04-8.42e-03		6.45e-06	1.83e-06	0.0	
99726	4.71e-04	-2.04e-03-7.96e-03		-1.46e-06	0.0	0.0	
99743	-2.37e-03	-1.89e-04-8.50e-03		5.16e-06	2.42e-06	0.0	
99747	-2.33e-03	1.15e-03-8.54e-03		7.04e-06	2.39e-06	0.0	
99758	6.68e-04	-2.81e-03-7.89e-03		-4.05e-06	0.0	0.0	
99769	-2.06e-05	-1.03e-04-8.14e-03		5.02e-06	0.0	0.0	
99770	-3.08e-05	-1.17e-04-7.76e-03		5.71e-06	0.0	0.0	
99771	-2.06e-05	-1.03e-04-8.14e-03		5.02e-06	0.0	0.0	
99772	-2.26e-05	-1.05e-04-8.06e-03		5.16e-06	0.0	0.0	
99773	-2.06e-05	-1.03e-04-8.14e-03		5.02e-06	0.0	0.0	
9981	-2.55e-05	3.18e-04 -0.01		-1.59e-05	0.0	0.0	
9982	-4.25e-05	3.68e-04 -0.01		-1.83e-05	0.0	0.0	
9984	-5.14e-05	2.68e-04-7.80e-03		-1.33e-05	-1.42e-06	0.0	
9988	-1.67e-03	-6.66e-04-8.62e-03		-1.29e-05	1.51e-06	0.0	
99820	-1.72e-03	2.89e-04-8.57e-03		-1.14e-05	1.55e-06	0.0	
99821	4.54e-04	2.18e-03-7.99e-03		-5.67e-06	0.0	0.0	
99840	-2.33e-03	-1.02e-03-8.75e-03		-1.34e-05	2.05e-06	0.0	
99852	-2.39e-03	3.12e-04-8.67e-03		-1.13e-05	2.10e-06	0.0	
99853	6.46e-04	2.96e-03-7.87e-03		-3.27e-06	0.0	0.0	
99869	-2.61e-05	2.33e-04-8.30e-03		-1.17e-05	0.0	0.0	
99870	-3.74e-05	2.67e-04-7.94e-03		-1.33e-05	0.0	0.0	
99871	-2.61e-05	2.33e-04-8.30e-03		-1.17e-05	0.0	0.0	
99872	-2.83e-05	2.40e-04-8.23e-03		-1.20e-05	0.0	0.0	
99873	-2.61e-05	2.33e-04-8.30e-03		-1.17e-05	0.0	0.0	
9991	-6.64e-05	7.97e-04 -0.01		-3.97e-05	-1.06e-06	0.0	
9992	-9.19e-05	9.23e-04 -0.01		-4.59e-05	-2.33e-06	0.0	
99920	-1.80e-03	6.18e-04-9.53e-03		-2.72e-05	0.0	0.0	
99921	4.02e-04	2.59e-03-8.75e-03		-2.62e-05	0.0	0.0	
99924	-5.15e-04	-1.42e-03-9.86e-03		-3.21e-05	-1.79e-06	0.0	
99952	-2.49e-03	6.31e-04-9.62e-03		-2.65e-05	0.0	0.0	
99953	5.85e-04	3.40e-03-8.53e-03		-2.50e-05	0.0	0.0	
99956	-6.99e-04	-2.23e-03 -0.01		-3.33e-05	-1.96e-06	0.0	
99969	-5.69e-05	5.85e-04-9.30e-03		-2.91e-05	-1.36e-06	0.0	
99970	-7.39e-05	6.69e-04-9.09e-03		-3.32e-05	-2.20e-06	0.0	
99971	-5.69e-05	5.85e-04-9.30e-03		-2.91e-05	-1.36e-06	0.0	
99972	-6.03e-05	6.02e-04-9.26e-03		-2.99e-05	-1.53e-06	0.0	
99973	-5.69e-05	5.85e-04-9.30e-03		-2.91e-05	-1.36e-06	0.0	
1000	2	-1.92e-041.53e-03		-0.01	-7.58e-05	-7.29e-06	0.0
1000	20	-1.92e-039.67e-04		-0.01	-4.35e-05	-3.63e-06	0.0
1000	21	3.22e-043.09e-03		-0.01	-5.11e-05	-3.44e-06	0.0
1000	24	-5.60e-04-1.15e-03		-0.01	-4.49e-05	-5.46e-06	0.0
1000	52	-2.64e-039.66e-04		-0.01	-4.16e-05	-3.30e-06	0.0
1000	53	4.98e-043.94e-03		-0.01	-5.24e-05	-3.03e-06	0.0
1000	56	-7.36e-04-2.00e-03		-0.01	-4.37e-05	-5.87e-06	0.0
1000	70	-1.48e-041.11e-03		-0.01	-5.49e-05	-5.88e-06	0.0
1000	72	-1.25e-049.95e-04		-0.01	-4.94e-05	-4.73e-06	0.0
1000	73	-1.19e-049.66e-04		-0.01	-4.80e-05	-4.45e-06	0.0
1001	2	-3.59e-042.17e-03		-0.02	-1.08e-04	-1.58e-05	0.0
1001	14	1.60e-031.00e-03		-0.01	-7.11e-05	-1.09e-05	0.0
1001	20	-2.09e-037.51e-04		-0.01	-5.99e-05	-9.26e-06	0.0
1001	21	2.04e-043.67e-03		-0.01	-7.99e-05	-8.18e-06	0.0
1001	46	2.34e-038.55e-04		-0.01	-7.23e-05	-1.14e-05	0.0
1001	52	-2.84e-035.08e-04		-0.01	-5.66e-05	-9.09e-06	0.0
1001	53	3.75e-044.59e-03		-0.01	-8.46e-05	-7.57e-06	0.0
1001	70	-2.72e-041.58e-03		-0.01	-7.81e-05	-1.22e-05	0.0
1001	72	-2.33e-041.41e-03		-0.01	-7.00e-05	-1.02e-05	0.0



EGP CODE

GRE.EEC.R.73.IT.W.15235.12.024.01

PAGE

225 di/of 527

1001	73	-2.23e-041.37e-03	-0.01	-6.80e-05	-9.71e-06	0.0
1002	2	-6.21e-042.79e-03	-0.03	-1.38e-04	-2.92e-05	0.0
1002	13	1.44e-032.76e-03	-0.02	-1.02e-04	-1.87e-05	0.0
1002	20	-2.31e-031.10e-03	-0.02	-7.43e-05	-1.74e-05	0.0
1002	21	1.99e-054.31e-03	-0.02	-1.11e-04	-1.71e-05	0.0
1002	45	2.17e-033.16e-03	-0.02	-1.08e-04	-1.90e-05	0.0
1002	52	-3.08e-038.41e-04	-0.02	-6.94e-05	-1.72e-05	0.0
1002	53	1.82e-045.34e-03	-0.02	-1.21e-04	-1.67e-05	0.0
1002	70	-4.66e-042.03e-03	-0.02	-1.00e-04	-2.22e-05	0.0
1002	72	-4.02e-041.81e-03	-0.02	-8.94e-05	-1.89e-05	0.0
1002	73	-3.86e-041.75e-03	-0.02	-8.67e-05	-1.80e-05	0.0
1003	2	-9.78e-043.22e-03	-0.03	-1.58e-04	-4.82e-05	0.0
1003	19	-2.55e-032.12e-03	-0.02	-9.67e-05	-2.79e-05	0.0
1003	21	-2.97e-044.81e-03	-0.02	-1.35e-04	-3.41e-05	0.0
1003	25	-2.18e-044.77e-03	-0.03	-1.35e-04	-3.45e-05	0.0
1003	51	-3.33e-032.17e-03	-0.02	-9.58e-05	-2.72e-05	0.0
1003	53	-1.74e-045.94e-03	-0.03	-1.49e-04	-3.59e-05	0.0
1003	57	-6.31e-055.88e-03	-0.03	-1.50e-04	-3.65e-05	0.0
1003	70	-7.31e-042.34e-03	-0.02	-1.15e-04	-3.63e-05	0.0
1003	72	-6.30e-042.07e-03	-0.02	-1.02e-04	-3.10e-05	0.0
1003	73	-6.05e-042.01e-03	-0.02	-9.90e-05	-2.97e-05	0.0
1004	2	-1.22e-033.28e-03	-0.04	-1.61e-04	-6.06e-05	0.0
1004	19	-2.75e-032.16e-03	-0.03	-9.95e-05	-3.67e-05	0.0
1004	21	-5.30e-044.95e-03	-0.03	-1.41e-04	-4.62e-05	0.0
1004	25	-4.41e-044.91e-03	-0.03	-1.42e-04	-4.65e-05	0.0
1004	51	-3.55e-032.21e-03	-0.02	-9.91e-05	-3.66e-05	0.0
1004	53	-4.43e-046.12e-03	-0.03	-1.58e-04	-4.98e-05	0.0
1004	57	-3.18e-046.06e-03	-0.03	-1.58e-04	-5.03e-05	0.0
1004	70	-9.08e-042.39e-03	-0.03	-1.17e-04	-4.54e-05	0.0
1004	72	-7.81e-042.11e-03	-0.03	-1.04e-04	-3.88e-05	0.0
1004	73	-7.49e-042.04e-03	-0.03	-1.00e-04	-3.72e-05	0.0
1005	2	-8.38e-04-2.81e-03	-0.04	1.39e-04	-4.09e-05	0.0
1005	12	-2.37e-03-1.81e-03	-0.02	8.68e-05	-1.84e-05	0.0
1005	22	-1.97e-04-4.50e-03	-0.03	1.22e-04	-3.30e-05	0.0
1005	26	-2.74e-04-4.54e-03	-0.03	1.21e-04	-3.20e-05	0.0
1005	44	-3.12e-03-1.83e-03	-0.02	8.65e-05	-1.60e-05	0.0
1005	54	-7.19e-05-5.60e-03	-0.03	1.35e-04	-3.63e-05	0.0
1005	58	-1.81e-04-5.65e-03	-0.03	1.35e-04	-3.49e-05	0.0
1005	70	-6.28e-04-2.04e-03	-0.03	1.01e-04	-3.08e-05	0.0
1005	72	-5.32e-04-1.82e-03	-0.02	9.02e-05	-2.59e-05	0.0
1005	73	-5.08e-04-1.76e-03	-0.02	8.75e-05	-2.46e-05	0.0
1006	2	-5.51e-04-2.69e-03	-0.03	1.33e-04	-2.62e-05	0.0
1006	11	-2.19e-03-9.58e-04	-0.02	7.31e-05	-9.00e-06	0.0
1006	22	8.02e-05-4.29e-03	-0.02	1.12e-04	-1.88e-05	0.0
1006	26	1.09e-05-4.33e-03	-0.02	1.11e-04	-1.81e-05	0.0
1006	43	-2.93e-03-6.71e-04	-0.02	6.88e-05	-6.33e-06	0.0
1006	54	2.46e-04-5.33e-03	-0.02	1.23e-04	-2.00e-05	0.0
1006	58	1.48e-04-5.38e-03	-0.02	1.22e-04	-1.90e-05	0.0
1006	70	-4.16e-04-1.95e-03	-0.02	9.67e-05	-2.00e-05	0.0
1006	72	-3.50e-04-1.74e-03	-0.02	8.66e-05	-1.66e-05	0.0
1006	73	-3.33e-04-1.69e-03	-0.02	8.40e-05	-1.57e-05	0.0
1007	2	-3.02e-04-2.28e-03	-0.02	1.13e-04	-1.33e-05	0.0
1007	6	1.57e-03-2.46e-03	-0.02	8.27e-05	-1.16e-05	0.0
1007	11	-2.02e-03-7.50e-04	-0.02	6.26e-05	-4.09e-06	0.0
1007	26	2.18e-04-3.88e-03	-0.02	8.95e-05	-7.57e-06	0.0
1007	38	2.27e-03-2.87e-03	-0.02	8.72e-05	-1.31e-05	0.0
1007	43	-2.76e-03-4.80e-04	-0.02	5.90e-05	-2.58e-06	0.0
1007	58	3.77e-04-4.86e-03	-0.02	9.67e-05	-7.45e-06	0.0
1007	70	-2.33e-04-1.65e-03	-0.02	8.21e-05	-1.05e-05	0.0
1007	72	-1.92e-04-1.48e-03	-0.02	7.37e-05	-8.40e-06	0.0
1007	73	-1.81e-04-1.44e-03	-0.02	7.16e-05	-7.87e-06	0.0
1008	2	-1.22e-04-1.74e-03	-0.02	8.66e-05	-4.11e-06	0.0
1008	4	-1.30e-04-1.27e-03	-0.01	6.29e-05	-5.55e-06	0.0
1008	11	-1.88e-03-4.43e-04	-0.01	4.86e-05	0.0	0.0
1008	21	5.11e-049.15e-04	-0.01	4.92e-05	-4.42e-06	0.0
1008	26	3.56e-04-3.35e-03	-0.01	6.32e-05	-1.23e-06	0.0
1008	43	-2.61e-03-1.85e-04	-0.01	4.61e-05	0.0	0.0
1008	53	7.44e-041.72e-03	-0.01	4.69e-05	-5.31e-06	0.0
1008	58	5.26e-04-4.25e-03	-0.01	6.65e-05	0.0	0.0
1008	70	-1.00e-04-1.26e-03	-0.01	6.26e-05	-3.73e-06	0.0
1008	72	-7.66e-05-1.13e-03	-0.01	5.64e-05	-2.50e-06	0.0
1008	73	-7.07e-05-1.10e-03	-0.01	5.49e-05	-2.19e-06	0.0
1009	1	1.74e-05-1.02e-03	-0.01	5.09e-05	3.04e-06	0.0
1009	2	-7.47e-06-1.18e-03	-0.01	5.87e-05	1.75e-06	0.0
1009	4	-4.11e-05-8.58e-04	-9.96e-03	4.25e-05	-1.03e-06	0.0
1009	10	1.77e-03-7.00e-04	-0.01	4.09e-05	0.0	0.0





EGP CODE

GRE.EEC.R.73.IT.W.15235.12.024.01

PAGE

226 di/of 527

1009	26	4.47e-04-2.85e-03	-9.72e-03	3.87e-05	2.10e-06	0.0
1009	27	-4.46e-041.35e-03	-0.01	3.58e-05	0.0	0.0
1009	42	2.48e-03-6.81e-04	-1.00e-02	4.24e-05	0.0	0.0
1009	58	6.26e-04-3.69e-03	-9.50e-03	3.93e-05	2.37e-06	0.0
1009	59	-6.25e-042.19e-03	-0.01	3.53e-05	0.0	0.0
1009	69	0.0 -7.48e-04	-0.01	3.73e-05	1.43e-06	0.0
1009	70	-1.61e-05-8.54e-04	-0.01	4.24e-05	0.0	0.0
1009	71	0.0 -7.48e-04	-0.01	3.73e-05	1.43e-06	0.0
1009	72	-2.78e-06-7.69e-04	-0.01	3.83e-05	1.26e-06	0.0
1009	73	0.0 -7.48e-04	-0.01	3.73e-05	1.43e-06	0.0
1010	1	7.14e-05-5.63e-04	-0.01	2.80e-05	5.77e-06	0.0
1010	2	5.74e-05-6.49e-04	-0.01	3.22e-05	5.03e-06	0.0
1010	10	1.76e-03-3.38e-04	-8.55e-03	2.19e-05	2.19e-06	0.0
1010	26	5.09e-04-2.42e-03	-8.40e-03	1.66e-05	3.68e-06	0.0
1010	27	-4.28e-041.60e-03	-9.32e-03	2.45e-05	3.27e-06	0.0
1010	42	2.45e-03-3.08e-04	-8.43e-03	2.24e-05	1.68e-06	0.0
1010	58	6.97e-04-3.22e-03	-8.21e-03	1.50e-05	3.76e-06	0.0
1010	59	-6.15e-042.40e-03	-9.51e-03	2.60e-05	3.18e-06	0.0
1010	69	4.08e-05-4.12e-04	-8.86e-03	2.05e-05	3.47e-06	0.0
1010	70	3.15e-05-4.70e-04	-8.54e-03	2.33e-05	2.98e-06	0.0
1010	71	4.08e-05-4.12e-04	-8.86e-03	2.05e-05	3.47e-06	0.0
1010	72	3.89e-05-4.24e-04	-8.80e-03	2.11e-05	3.37e-06	0.0
1010	73	4.08e-05-4.12e-04	-8.86e-03	2.05e-05	3.47e-06	0.0
1011	1	9.32e-05-1.30e-04	-0.01	6.42e-06	6.88e-06	0.0
1011	2	8.34e-05-1.50e-04	-0.01	7.37e-06	6.36e-06	0.0
1011	10	1.74e-03-2.48e-06	-7.91e-03	4.68e-06	3.02e-06	0.0
1011	15	-1.60e-038.39e-04	-8.60e-03	5.97e-06	5.54e-06	0.0
1011	26	5.49e-04-2.06e-03	-8.05e-03	-1.34e-06	4.06e-06	0.0
1011	42	2.41e-033.52e-05	-7.78e-03	4.68e-06	2.51e-06	0.0
1011	47	-2.26e-031.21e-03	-8.74e-03	6.50e-06	6.04e-06	0.0
1011	58	7.46e-04-2.85e-03	-7.97e-03	-3.76e-06	3.97e-06	0.0
1011	69	5.70e-05-9.53e-05	-8.24e-03	4.70e-06	4.30e-06	0.0
1011	70	5.05e-05-1.08e-04	-7.84e-03	5.33e-06	3.95e-06	0.0
1011	71	5.70e-05-9.53e-05	-8.24e-03	4.70e-06	4.30e-06	0.0
1011	72	5.57e-05-9.79e-05	-8.16e-03	4.82e-06	4.23e-06	0.0
1011	73	5.70e-05-9.53e-05	-8.24e-03	4.70e-06	4.30e-06	0.0
1012	1	8.67e-052.96e-04	-0.01	-1.48e-05	6.58e-06	0.0
1012	2	7.56e-053.41e-04	-0.01	-1.70e-05	6.01e-06	0.0
1012	8	-1.59e-03-7.25e-04	-8.78e-03	-1.19e-05	5.29e-06	0.0
1012	17	1.74e-031.29e-04	-8.06e-03	-1.12e-05	2.83e-06	0.0
1012	21	5.32e-042.19e-03	-8.07e-03	-5.30e-06	3.96e-06	0.0
1012	40	-2.25e-03-1.10e-03	-8.94e-03	-1.23e-05	5.78e-06	0.0
1012	49	2.42e-039.34e-05	-7.92e-03	-1.14e-05	2.33e-06	0.0
1012	53	7.24e-042.98e-03	-7.95e-03	-3.08e-06	3.91e-06	0.0
1012	69	5.22e-052.16e-04	-8.39e-03	-1.09e-05	4.08e-06	0.0
1012	70	4.48e-052.47e-04	-8.01e-03	-1.23e-05	3.70e-06	0.0
1012	71	5.22e-052.16e-04	-8.39e-03	-1.09e-05	4.08e-06	0.0
1012	72	5.07e-052.23e-04	-8.32e-03	-1.11e-05	4.00e-06	0.0
1012	73	5.22e-052.16e-04	-8.39e-03	-1.09e-05	4.08e-06	0.0
1013	1	5.10e-057.38e-04	-0.01	-3.69e-05	4.84e-06	0.0
1013	2	3.26e-058.52e-04	-0.01	-4.24e-05	3.91e-06	0.0
1013	17	1.76e-034.74e-04	-9.03e-03	-2.90e-05	1.48e-06	0.0
1013	21	4.82e-042.58e-03	-8.79e-03	-2.45e-05	3.09e-06	0.0
1013	24	-4.31e-04-1.50e-03	-9.86e-03	-2.95e-05	2.46e-06	0.0
1013	49	2.46e-034.48e-04	-8.92e-03	-2.98e-05	0.0	0.0
1013	53	6.65e-043.39e-03	-8.57e-03	-2.36e-05	3.22e-06	0.0
1013	56	-6.14e-04-2.31e-03	-0.01	-3.04e-05	2.34e-06	0.0
1013	69	2.55e-055.40e-04	-9.32e-03	-2.70e-05	2.78e-06	0.0
1013	70	1.33e-056.16e-04	-9.07e-03	-3.07e-05	2.16e-06	0.0
1013	71	2.55e-055.40e-04	-9.32e-03	-2.70e-05	2.78e-06	0.0
1013	72	2.31e-055.56e-04	-9.27e-03	-2.77e-05	2.65e-06	0.0
1013	73	2.55e-055.40e-04	-9.32e-03	-2.70e-05	2.78e-06	0.0
1014	1	-2.02e-051.21e-03	-0.01	-6.04e-05	1.32e-06	0.0
1014	2	-5.32e-051.40e-03	-0.01	-6.96e-05	0.0	0.0
1014	4	-7.64e-051.02e-03	-0.01	-5.05e-05	-2.64e-06	0.0
1014	20	-1.81e-039.21e-04	-0.01	-3.97e-05	1.78e-06	0.0
1014	21	4.09e-043.04e-03	-0.01	-4.78e-05	0.0	0.0
1014	24	-4.64e-04-1.27e-03	-0.01	-4.06e-05	0.0	0.0
1014	52	-2.53e-039.35e-04	-0.01	-3.79e-05	2.43e-06	0.0
1014	53	5.84e-043.90e-03	-0.01	-4.92e-05	1.19e-06	0.0
1014	56	-6.39e-04-2.13e-03	-0.01	-3.92e-05	0.0	0.0
1014	69	-2.77e-058.85e-04	-0.01	-4.42e-05	0.0	0.0
1014	70	-4.97e-051.01e-03	-0.01	-5.04e-05	0.0	0.0
1014	71	-2.77e-058.85e-04	-0.01	-4.42e-05	0.0	0.0
1014	72	-3.21e-059.11e-04	-0.01	-4.54e-05	0.0	0.0
1014	73	-2.77e-058.85e-04	-0.01	-4.42e-05	0.0	0.0



EGP CODE

GRE.EEC.R.73.IT.W.15235.12.024.01

PAGE

227 di/of 527

1015	2	-1.95e-041.96e-03	-0.02	-9.77e-05	-7.41e-06	0.0
1015	20	-1.94e-035.73e-04	-0.01	-5.44e-05	-1.64e-06	0.0
1015	21	3.01e-043.56e-03	-0.01	-7.38e-05	-3.41e-06	0.0
1015	26	4.79e-048.49e-04	-0.01	-5.29e-05	-6.46e-06	0.0
1015	52	-2.67e-033.13e-04	-0.01	-5.14e-05	0.0	0.0
1015	53	4.67e-044.49e-03	-0.01	-7.86e-05	-3.08e-06	0.0
1015	58	7.17e-041.69e-03	-0.01	-4.93e-05	-7.35e-06	0.0
1015	70	-1.54e-041.42e-03	-0.01	-7.07e-05	-6.16e-06	0.0
1015	72	-1.23e-041.28e-03	-0.01	-6.36e-05	-4.61e-06	0.0
1015	73	-1.15e-041.24e-03	-0.01	-6.18e-05	-4.23e-06	0.0
1016	2	-4.04e-042.47e-03	-0.02	-1.23e-04	-1.81e-05	0.0
1016	20	-2.09e-038.56e-04	-0.02	-6.73e-05	-6.48e-06	0.0
1016	21	1.37e-044.08e-03	-0.02	-9.97e-05	-1.11e-05	0.0
1016	25	1.99e-044.04e-03	-0.02	-1.00e-04	-1.16e-05	0.0
1016	52	-2.83e-035.83e-04	-0.02	-6.32e-05	-4.76e-06	0.0
1016	53	2.90e-045.09e-03	-0.02	-1.09e-04	-1.12e-05	0.0
1016	57	3.77e-045.04e-03	-0.02	-1.09e-04	-1.20e-05	0.0
1016	70	-3.08e-041.79e-03	-0.02	-8.91e-05	-1.40e-05	0.0
1016	72	-2.57e-041.60e-03	-0.02	-7.99e-05	-1.14e-05	0.0
1016	73	-2.44e-041.56e-03	-0.02	-7.76e-05	-1.08e-05	0.0
1017	2	-6.74e-042.79e-03	-0.03	-1.39e-04	-3.20e-05	0.0
1017	19	-2.28e-031.81e-03	-0.02	-8.52e-05	-1.35e-05	0.0
1017	21	-1.00e-044.47e-03	-0.02	-1.19e-04	-2.33e-05	0.0
1017	25	-2.90e-054.43e-03	-0.02	-1.19e-04	-2.42e-05	0.0
1017	51	-3.03e-031.83e-03	-0.02	-8.44e-05	-1.12e-05	0.0
1017	53	2.25e-055.55e-03	-0.02	-1.31e-04	-2.49e-05	0.0
1017	57	1.23e-045.50e-03	-0.02	-1.31e-04	-2.61e-05	0.0
1017	70	-5.07e-042.03e-03	-0.02	-1.01e-04	-2.43e-05	0.0
1017	72	-4.29e-041.81e-03	-0.02	-9.00e-05	-2.03e-05	0.0
1017	73	-4.09e-041.75e-03	-0.02	-8.73e-05	-1.93e-05	0.0
1018	2	-8.46e-042.84e-03	-0.04	-1.41e-04	-4.10e-05	0.0
1018	19	-2.39e-031.84e-03	-0.02	-8.72e-05	-1.82e-05	0.0
1018	21	-2.80e-044.57e-03	-0.03	-1.23e-04	-3.23e-05	0.0
1018	25	-2.04e-044.53e-03	-0.03	-1.23e-04	-3.33e-05	0.0
1018	51	-3.14e-031.86e-03	-0.02	-8.66e-05	-1.56e-05	0.0
1018	53	-1.88e-045.68e-03	-0.03	-1.37e-04	-3.53e-05	0.0
1018	57	-8.05e-055.63e-03	-0.03	-1.37e-04	-3.68e-05	0.0
1018	70	-6.34e-042.06e-03	-0.03	-1.02e-04	-3.09e-05	0.0
1018	72	-5.37e-041.83e-03	-0.02	-9.12e-05	-2.59e-05	0.0
1018	73	-5.13e-041.78e-03	-0.02	-8.84e-05	-2.47e-05	0.0
1019	2	-2.17e-042.56e-03	-0.03	1.28e-04	-8.96e-06	0.0
1019	11	-1.99e-031.63e-03	-0.02	7.07e-05	3.81e-06	0.0
1019	22	2.98e-044.05e-03	-0.03	1.11e-04	-4.36e-06	0.0
1019	26	2.19e-044.33e-03	-0.03	1.11e-04	-3.29e-06	0.0
1019	43	-2.75e-031.63e-03	-0.02	6.68e-05	7.08e-06	0.0
1019	54	4.64e-045.03e-03	-0.03	1.23e-04	-4.31e-06	0.0
1019	58	3.53e-045.42e-03	-0.03	1.23e-04	-2.80e-06	0.0
1019	70	-1.67e-041.86e-03	-0.02	9.26e-05	-7.16e-06	0.0
1019	72	-1.26e-041.66e-03	-0.02	8.28e-05	-5.01e-06	0.0
1019	73	-1.15e-041.61e-03	-0.02	8.04e-05	-4.47e-06	0.0
1020	2	-7.72e-052.46e-03	-0.03	1.23e-04	-1.92e-06	0.0
1020	4	-1.01e-041.80e-03	-0.02	8.95e-05	-4.22e-06	0.0
1020	11	-1.91e-037.67e-04	-0.02	6.86e-05	4.24e-06	0.0
1020	22	4.12e-044.13e-03	-0.02	1.03e-04	0.0	0.0
1020	26	3.41e-044.17e-03	-0.02	1.03e-04	0.0	0.0
1020	43	-2.66e-034.61e-04	-0.02	6.51e-05	6.03e-06	0.0
1020	54	5.90e-045.17e-03	-0.02	1.13e-04	0.0	0.0
1020	58	4.89e-045.21e-03	-0.02	1.13e-04	0.0	0.0
1020	70	-6.66e-051.78e-03	-0.02	8.88e-05	-2.10e-06	0.0
1020	72	-3.81e-051.60e-03	-0.02	7.98e-05	0.0	0.0
1020	73	-3.09e-051.55e-03	-0.02	7.75e-05	0.0	0.0
1021	1	7.93e-051.81e-03	-0.02	9.08e-05	6.05e-06	0.0
1021	2	4.72e-052.10e-03	-0.02	1.05e-04	4.33e-06	0.0
1021	10	1.90e-031.29e-03	-0.02	7.37e-05	0.0	0.0
1021	22	5.06e-043.51e-03	-0.02	8.35e-05	3.29e-06	0.0
1021	26	4.44e-043.78e-03	-0.02	8.35e-05	3.69e-06	0.0
1021	42	2.64e-031.27e-03	-0.02	7.65e-05	0.0	0.0
1021	54	6.91e-044.39e-03	-0.02	9.04e-05	3.19e-06	0.0
1021	58	6.04e-044.76e-03	-0.02	9.03e-05	3.75e-06	0.0
1021	69	4.41e-051.33e-03	-0.02	6.65e-05	3.53e-06	0.0
1021	70	2.27e-051.52e-03	-0.02	7.59e-05	2.38e-06	0.0
1021	71	4.41e-051.33e-03	-0.02	6.65e-05	3.53e-06	0.0
1021	72	3.99e-051.37e-03	-0.02	6.84e-05	3.30e-06	0.0
1021	73	4.41e-051.33e-03	-0.02	6.65e-05	3.53e-06	0.0
1022	1	1.58e-041.40e-03	-0.02	7.01e-05	1.00e-05	0.0
1022	2	1.42e-041.62e-03	-0.02	8.07e-05	9.11e-06	0.0



EGP CODE

GRE.EEC.R.73.IT.W.15235.12.024.01

PAGE

228 di/of 527

1022	10	1.93e-03-9.63e-04	-0.01	5.64e-05	4.80e-06	0.0
1022	26	5.25e-04-3.30e-03	-0.01	5.97e-05	6.72e-06	0.0
1022	27	-3.22e-041.25e-03	-0.01	4.29e-05	6.14e-06	0.0
1022	42	2.66e-03-9.37e-04	-0.01	5.85e-05	4.15e-06	0.0
1022	58	6.94e-04-4.21e-03	-0.01	6.31e-05	6.85e-06	0.0
1022	59	-4.91e-042.16e-03	-0.01	3.95e-05	6.02e-06	0.0
1022	69	1.02e-04-1.03e-03	-0.01	5.13e-05	6.43e-06	0.0
1022	70	9.04e-05-1.17e-03	-0.01	5.84e-05	5.81e-06	0.0
1022	71	1.02e-04-1.03e-03	-0.01	5.13e-05	6.43e-06	0.0
1022	72	9.93e-05-1.05e-03	-0.01	5.27e-05	6.31e-06	0.0
1022	73	1.02e-04-1.03e-03	-0.01	5.13e-05	6.43e-06	0.0
1023	1	2.12e-04-9.60e-04	-0.01	4.80e-05	1.27e-05	0.0
1023	2	2.05e-04-1.11e-03	-0.01	5.51e-05	1.23e-05	0.0
1023	10	1.93e-03-6.15e-04	-0.01	3.82e-05	7.71e-06	0.0
1023	26	5.86e-04-2.83e-03	-9.97e-03	3.66e-05	8.66e-06	0.0
1023	27	-3.06e-041.43e-03	-0.01	3.36e-05	8.11e-06	0.0
1023	42	2.64e-03-5.80e-04	-0.01	3.94e-05	7.44e-06	0.0
1023	58	7.64e-04-3.69e-03	-9.76e-03	3.72e-05	8.77e-06	0.0
1023	59	-4.84e-042.28e-03	-0.01	3.30e-05	8.00e-06	0.0
1023	69	1.40e-04-7.02e-04	-0.01	3.51e-05	8.38e-06	0.0
1023	70	1.36e-04-8.00e-04	-0.01	3.99e-05	8.10e-06	0.0
1023	71	1.40e-04-7.02e-04	-0.01	3.51e-05	8.38e-06	0.0
1023	72	1.39e-04-7.22e-04	-0.01	3.60e-05	8.33e-06	0.0
1023	73	1.40e-04-7.02e-04	-0.01	3.51e-05	8.38e-06	0.0
1024	1	2.43e-04-5.31e-04	-0.01	2.65e-05	1.43e-05	0.0
1024	2	2.42e-04-6.11e-04	-0.01	3.04e-05	1.42e-05	0.0
1024	10	1.90e-03-2.81e-04	-8.81e-03	2.06e-05	9.19e-06	0.0
1024	26	6.33e-04-2.43e-03	-8.71e-03	1.58e-05	9.66e-06	0.0
1024	27	-3.08e-041.65e-03	-9.63e-03	2.31e-05	9.38e-06	0.0
1024	42	2.60e-03-2.37e-04	-8.67e-03	2.11e-05	9.06e-06	0.0
1024	58	8.21e-04-3.24e-03	-8.53e-03	1.43e-05	9.72e-06	0.0
1024	59	-4.96e-042.47e-03	-9.81e-03	2.45e-05	9.33e-06	0.0
1024	69	1.62e-04-3.89e-04	-9.17e-03	1.94e-05	9.52e-06	0.0
1024	70	1.62e-04-4.42e-04	-8.84e-03	2.20e-05	9.42e-06	0.0
1024	71	1.62e-04-3.89e-04	-9.17e-03	1.94e-05	9.52e-06	0.0
1024	72	1.62e-04-3.99e-04	-9.10e-03	1.99e-05	9.50e-06	0.0
1024	73	1.62e-04-3.89e-04	-9.17e-03	1.94e-05	9.52e-06	0.0
1025	1	2.56e-04-1.23e-04	-0.01	6.10e-06	1.50e-05	0.0
1025	2	2.57e-04-1.41e-04	-0.01	6.99e-06	1.50e-05	0.0
1025	10	1.87e-033.45e-05	-8.21e-03	4.50e-06	9.67e-06	0.0
1025	15	-1.50e-038.87e-04	-8.98e-03	5.60e-06	1.03e-05	0.0
1025	26	6.68e-04-2.09e-03	-8.38e-03	-1.31e-06	9.96e-06	0.0
1025	42	2.55e-038.50e-05	-8.06e-03	4.53e-06	9.54e-06	0.0
1025	47	-2.17e-031.28e-03	-9.14e-03	6.07e-06	1.05e-05	0.0
1025	58	8.67e-04-2.88e-03	-8.30e-03	-3.62e-06	9.95e-06	0.0
1025	69	1.71e-04-8.99e-05	-8.58e-03	4.46e-06	9.99e-06	0.0
1025	70	1.72e-04-1.02e-04	-8.17e-03	5.05e-06	9.97e-06	0.0
1025	71	1.71e-04-8.99e-05	-8.58e-03	4.46e-06	9.99e-06	0.0
1025	72	1.72e-04-9.23e-05	-8.50e-03	4.58e-06	9.99e-06	0.0
1025	73	1.71e-04-8.99e-05	-8.58e-03	4.46e-06	9.99e-06	0.0
1026	1	2.52e-042.80e-04	-0.01	-1.40e-05	1.48e-05	0.0
1026	2	2.52e-043.22e-04	-0.01	-1.61e-05	1.48e-05	0.0
1026	8	-1.49e-03-7.78e-04	-9.16e-03	-1.12e-05	1.02e-05	0.0
1026	17	1.88e-038.41e-05	-8.35e-03	-1.07e-05	9.59e-06	0.0
1026	21	6.52e-042.21e-03	-8.40e-03	-4.99e-06	9.87e-06	0.0
1026	40	-2.16e-03-1.17e-03	-9.33e-03	-1.16e-05	1.04e-05	0.0
1026	49	2.56e-033.53e-05	-8.20e-03	-1.08e-05	9.48e-06	0.0
1026	53	8.45e-043.01e-03	-8.27e-03	-2.87e-06	9.87e-06	0.0
1026	69	1.68e-042.05e-04	-8.73e-03	-1.03e-05	9.87e-06	0.0
1026	70	1.68e-042.33e-04	-8.34e-03	-1.16e-05	9.83e-06	0.0
1026	71	1.68e-042.05e-04	-8.73e-03	-1.03e-05	9.87e-06	0.0
1026	72	1.68e-042.10e-04	-8.65e-03	-1.05e-05	9.86e-06	0.0
1026	73	1.68e-042.05e-04	-8.73e-03	-1.03e-05	9.87e-06	0.0
1027	1	2.31e-046.96e-04	-0.01	-3.49e-05	1.38e-05	0.0
1027	2	2.27e-048.01e-04	-0.01	-4.00e-05	1.36e-05	0.0
1027	17	1.91e-034.07e-04	-9.27e-03	-2.73e-05	8.80e-06	0.0
1027	21	6.11e-042.58e-03	-9.08e-03	-2.33e-05	9.29e-06	0.0
1027	24	-3.05e-04-1.56e-03	-0.01	-2.76e-05	8.99e-06	0.0
1027	49	2.61e-033.66e-04	-9.13e-03	-2.80e-05	8.67e-06	0.0
1027	53	7.94e-043.41e-03	-8.86e-03	-2.25e-05	9.35e-06	0.0
1027	56	-4.88e-04-2.39e-03	-0.01	-2.85e-05	8.93e-06	0.0
1027	69	1.53e-045.09e-04	-9.60e-03	-2.55e-05	9.14e-06	0.0
1027	70	1.51e-045.79e-04	-9.33e-03	-2.89e-05	8.98e-06	0.0
1027	71	1.53e-045.09e-04	-9.60e-03	-2.55e-05	9.14e-06	0.0
1027	72	1.53e-045.23e-04	-9.55e-03	-2.62e-05	9.11e-06	0.0
1027	73	1.53e-045.09e-04	-9.60e-03	-2.55e-05	9.14e-06	0.0



EGP CODE

GRE.EEC.R.73.IT.W.15235.12.024.01

PAGE

229 di/of 527

1028	1	1.89e-041.13e-03	-0.01	-5.68e-05	1.18e-05	0.0
1028	2	1.78e-041.31e-03	-0.01	-6.53e-05	1.12e-05	0.0
1028	17	1.93e-037.51e-04	-0.01	-4.54e-05	6.86e-06	0.0
1028	21	5.59e-043.01e-03	-0.01	-4.54e-05	7.96e-06	0.0
1028	24	-3.12e-04-1.35e-03	-0.01	-3.76e-05	7.43e-06	0.0
1028	49	2.65e-037.19e-04	-0.01	-4.69e-05	6.54e-06	0.0
1028	53	7.33e-043.89e-03	-0.01	-4.70e-05	8.07e-06	0.0
1028	56	-4.86e-04-2.23e-03	-0.01	-3.61e-05	7.32e-06	0.0
1028	69	1.24e-048.30e-04	-0.01	-4.15e-05	7.70e-06	0.0
1028	70	1.16e-049.46e-04	-0.01	-4.72e-05	7.29e-06	0.0
1028	71	1.24e-048.30e-04	-0.01	-4.15e-05	7.70e-06	0.0
1028	72	1.22e-048.53e-04	-0.01	-4.27e-05	7.62e-06	0.0
1028	73	1.24e-048.30e-04	-0.01	-4.15e-05	7.70e-06	0.0
1029	1	1.25e-041.57e-03	-0.02	-7.88e-05	8.61e-06	0.0
1029	2	1.01e-041.82e-03	-0.02	-9.09e-05	7.39e-06	0.0
1029	17	1.92e-031.10e-03	-0.01	-6.38e-05	3.40e-06	0.0
1029	21	4.91e-043.49e-03	-0.01	-6.95e-05	5.67e-06	0.0
1029	24	-3.37e-04-1.19e-03	-0.01	-4.58e-05	5.11e-06	0.0
1029	49	2.65e-031.08e-03	-0.01	-6.62e-05	2.61e-06	0.0
1029	53	6.56e-044.43e-03	-0.01	-7.43e-05	5.79e-06	0.0
1029	56	-5.02e-04-2.13e-03	-0.01	-4.11e-05	4.99e-06	0.0
1029	69	7.68e-051.15e-03	-0.01	-5.77e-05	5.39e-06	0.0
1029	70	6.12e-051.32e-03	-0.01	-6.57e-05	4.58e-06	0.0
1029	71	7.68e-051.15e-03	-0.01	-5.77e-05	5.39e-06	0.0
1029	72	7.37e-051.19e-03	-0.01	-5.93e-05	5.23e-06	0.0
1029	73	7.68e-051.15e-03	-0.01	-5.77e-05	5.39e-06	0.0
1030	2	-7.16e-062.27e-03	-0.02	-1.14e-04	2.01e-06	0.0
1030	4	-5.01e-051.66e-03	-0.02	-8.26e-05	-1.34e-06	0.0
1030	17	1.88e-032.19e-03	-0.02	-8.00e-05	-1.39e-06	0.0
1030	21	4.01e-043.96e-03	-0.02	-9.27e-05	2.41e-06	0.0
1030	25	4.65e-043.92e-03	-0.02	-9.27e-05	1.90e-06	0.0
1030	49	2.63e-032.49e-03	-0.02	-8.33e-05	-2.79e-06	0.0
1030	53	5.57e-044.97e-03	-0.02	-1.01e-04	2.52e-06	0.0
1030	57	6.47e-044.92e-03	-0.02	-1.01e-04	1.81e-06	0.0
1030	70	-1.65e-051.64e-03	-0.02	-8.21e-05	0.0	0.0
1030	71	1.12e-051.43e-03	-0.02	-7.18e-05	2.13e-06	0.0
1030	72	5.68e-061.48e-03	-0.02	-7.39e-05	1.85e-06	0.0
1030	73	1.12e-051.43e-03	-0.02	-7.18e-05	2.13e-06	0.0
1031	2	-1.42e-042.55e-03	-0.03	-1.27e-04	-4.73e-06	0.0
1031	4	-1.49e-041.87e-03	-0.02	-9.32e-05	-6.29e-06	0.0
1031	20	-1.95e-038.12e-04	-0.02	-7.07e-05	4.85e-06	0.0
1031	21	2.89e-044.28e-03	-0.02	-1.09e-04	-1.16e-06	0.0
1031	25	3.63e-044.25e-03	-0.02	-1.09e-04	-2.01e-06	0.0
1031	52	-2.71e-035.01e-04	-0.02	-6.69e-05	7.53e-06	0.0
1031	53	4.33e-045.35e-03	-0.02	-1.20e-04	0.0	0.0
1031	57	5.36e-045.31e-03	-0.02	-1.20e-04	-2.04e-06	0.0
1031	70	-1.13e-041.85e-03	-0.02	-9.23e-05	-4.12e-06	0.0
1031	72	-7.84e-051.65e-03	-0.02	-8.28e-05	-2.37e-06	0.0
1031	73	-6.98e-051.61e-03	-0.02	-8.04e-05	-1.93e-06	0.0
1032	2	-2.26e-042.58e-03	-0.03	-1.29e-04	-9.03e-06	0.0
1032	19	-2.01e-031.61e-03	-0.02	-8.09e-05	1.78e-06	0.0
1032	21	2.16e-044.36e-03	-0.03	-1.13e-04	-3.09e-06	0.0
1032	25	2.93e-044.32e-03	-0.03	-1.12e-04	-4.20e-06	0.0
1032	51	-2.76e-031.61e-03	-0.02	-8.08e-05	4.29e-06	0.0
1032	53	3.51e-045.45e-03	-0.03	-1.25e-04	-2.51e-06	0.0
1032	57	4.59e-045.41e-03	-0.03	-1.25e-04	-4.07e-06	0.0
1032	70	-1.74e-041.88e-03	-0.02	-9.36e-05	-7.21e-06	0.0
1032	72	-1.31e-041.67e-03	-0.02	-8.37e-05	-5.05e-06	0.0
1032	73	-1.21e-041.62e-03	-0.02	-8.12e-05	-4.51e-06	0.0
1033	2	5.03e-04-2.49e-03	-0.03	1.24e-04	2.80e-05	0.0
1033	10	2.34e-03-1.49e-03	-0.02	8.78e-05	1.76e-05	0.0
1033	26	7.86e-04-4.35e-03	-0.03	1.11e-04	2.58e-05	0.0
1033	42	3.15e-03-1.46e-03	-0.02	9.14e-05	1.72e-05	0.0
1033	58	9.64e-04-5.46e-03	-0.03	1.24e-04	2.86e-05	0.0
1033	70	3.67e-04-1.81e-03	-0.03	9.04e-05	2.03e-05	0.0
1033	72	3.46e-04-1.62e-03	-0.02	8.09e-05	1.92e-05	0.0
1033	73	3.41e-04-1.57e-03	-0.02	7.85e-05	1.89e-05	0.0
1034	2	4.89e-04-2.40e-03	-0.03	1.20e-04	2.69e-05	0.0
1034	10	2.32e-03-1.44e-03	-0.02	8.42e-05	2.01e-05	0.0
1034	22	8.41e-04-3.87e-03	-0.02	1.02e-04	2.14e-05	0.0
1034	26	7.58e-04-4.18e-03	-0.02	1.02e-04	2.14e-05	0.0
1034	42	3.11e-03-1.41e-03	-0.02	8.74e-05	2.07e-05	0.0
1034	54	1.04e-03-4.82e-03	-0.02	1.12e-04	2.27e-05	0.0
1034	58	9.28e-04-5.25e-03	-0.02	1.13e-04	2.27e-05	0.0
1034	70	3.52e-04-1.74e-03	-0.02	8.69e-05	1.92e-05	0.0
1034	72	3.35e-04-1.56e-03	-0.02	7.81e-05	1.83e-05	0.0



EGP CODE

GRE.EEC.R.73.IT.W.15235.12.024.01

PAGE

230 di/of 527

1034	73	3.31e-04-1.52e-03	-0.02	7.58e-05	1.81e-05	0.0
1035	2	4.78e-04-2.05e-03	-0.02	1.02e-04	2.60e-05	0.0
1035	10	2.27e-03-1.21e-03	-0.02	7.14e-05	1.91e-05	0.0
1035	22	8.13e-04-3.49e-03	-0.02	8.25e-05	1.87e-05	0.0
1035	26	7.41e-04-3.79e-03	-0.02	8.26e-05	1.86e-05	0.0
1035	42	3.05e-03-1.17e-03	-0.02	7.39e-05	1.96e-05	0.0
1035	54	1.01e-03-4.37e-03	-0.02	8.95e-05	1.92e-05	0.0
1035	58	9.08e-04-4.78e-03	-0.02	8.97e-05	1.91e-05	0.0
1035	70	3.38e-04-1.49e-03	-0.02	7.42e-05	1.83e-05	0.0
1035	72	3.25e-04-1.34e-03	-0.02	6.69e-05	1.77e-05	0.0
1035	73	3.22e-04-1.30e-03	-0.02	6.50e-05	1.75e-05	0.0
1036	2	4.72e-04-1.58e-03	-0.02	7.89e-05	2.56e-05	0.0
1036	10	2.22e-03-8.97e-04	-0.01	5.46e-05	1.90e-05	0.0
1036	26	7.44e-04-3.31e-03	-0.01	5.88e-05	1.73e-05	0.0
1036	27	-1.12e-041.30e-03	-0.01	4.16e-05	1.70e-05	0.0
1036	42	2.98e-03-8.54e-04	-0.01	5.64e-05	1.97e-05	0.0
1036	58	9.15e-04-4.24e-03	-0.01	6.23e-05	1.73e-05	0.0
1036	59	-2.83e-042.23e-03	-0.01	3.81e-05	1.70e-05	0.0
1036	70	3.29e-04-1.15e-03	-0.01	5.71e-05	1.77e-05	0.0
1036	72	3.19e-04-1.03e-03	-0.01	5.16e-05	1.73e-05	0.0
1036	73	3.16e-04-1.00e-03	-0.01	5.02e-05	1.72e-05	0.0
1037	1	4.53e-04-9.38e-04	-0.01	4.69e-05	2.48e-05	0.0
1037	2	4.70e-04-1.08e-03	-0.01	5.39e-05	2.55e-05	0.0
1037	10	2.16e-03-5.65e-04	-0.01	3.72e-05	1.89e-05	0.0
1037	26	7.62e-04-2.85e-03	-0.01	3.59e-05	1.70e-05	0.0
1037	27	-1.35e-041.47e-03	-0.01	3.29e-05	1.71e-05	0.0
1037	42	2.90e-03-5.15e-04	-0.01	3.84e-05	1.97e-05	0.0
1037	58	9.42e-04-3.72e-03	-0.01	3.65e-05	1.69e-05	0.0
1037	59	-3.15e-042.34e-03	-0.01	3.23e-05	1.71e-05	0.0
1037	69	3.14e-04-6.89e-04	-0.01	3.44e-05	1.70e-05	0.0
1037	70	3.25e-04-7.84e-04	-0.01	3.90e-05	1.75e-05	0.0
1037	71	3.14e-04-6.89e-04	-0.01	3.44e-05	1.70e-05	0.0
1037	72	3.16e-04-7.08e-04	-0.01	3.53e-05	1.71e-05	0.0
1037	73	3.14e-04-6.89e-04	-0.01	3.44e-05	1.70e-05	0.0
1038	1	4.55e-04-5.20e-04	-0.01	2.59e-05	2.49e-05	0.0
1038	2	4.70e-04-5.98e-04	-0.01	2.98e-05	2.55e-05	0.0
1038	10	2.10e-03-2.42e-04	-9.49e-03	2.03e-05	1.87e-05	0.0
1038	26	7.88e-04-2.45e-03	-9.37e-03	1.53e-05	1.70e-05	0.0
1038	27	-1.63e-041.69e-03	-0.01	2.27e-05	1.69e-05	0.0
1038	42	2.81e-03-1.85e-04	-9.36e-03	2.09e-05	1.94e-05	0.0
1038	58	9.78e-04-3.28e-03	-9.19e-03	1.39e-05	1.71e-05	0.0
1038	59	-3.53e-042.51e-03	-0.01	2.42e-05	1.69e-05	0.0
1038	69	3.12e-04-3.81e-04	-9.82e-03	1.90e-05	1.70e-05	0.0
1038	70	3.22e-04-4.33e-04	-9.50e-03	2.16e-05	1.74e-05	0.0
1038	71	3.12e-04-3.81e-04	-9.82e-03	1.90e-05	1.70e-05	0.0
1038	72	3.14e-04-3.92e-04	-9.76e-03	1.95e-05	1.71e-05	0.0
1038	73	3.12e-04-3.81e-04	-9.82e-03	1.90e-05	1.70e-05	0.0
1039	1	4.55e-04-1.20e-04	-0.01	5.97e-06	2.49e-05	0.0
1039	2	4.69e-04-1.38e-04	-0.01	6.85e-06	2.55e-05	0.0
1039	10	2.04e-036.61e-05	-8.90e-03	4.61e-06	1.85e-05	0.0
1039	15	-1.39e-039.30e-04	-9.63e-03	5.34e-06	1.56e-05	0.0
1039	26	8.18e-04-2.11e-03	-9.06e-03	-1.40e-06	1.73e-05	0.0
1039	42	2.74e-031.28e-04	-8.76e-03	4.71e-06	1.91e-05	0.0
1039	47	-2.07e-031.34e-03	-9.78e-03	5.75e-06	1.50e-05	0.0
1039	58	1.02e-03-2.92e-03	-8.98e-03	-3.71e-06	1.74e-05	0.0
1039	69	3.12e-04-8.80e-05	-9.25e-03	4.38e-06	1.70e-05	0.0
1039	70	3.21e-04-9.99e-05	-8.85e-03	4.96e-06	1.74e-05	0.0
1039	71	3.12e-04-8.80e-05	-9.25e-03	4.38e-06	1.70e-05	0.0
1039	72	3.14e-04-9.04e-05	-9.17e-03	4.49e-06	1.70e-05	0.0
1039	73	3.12e-04-8.80e-05	-9.25e-03	4.38e-06	1.70e-05	0.0
1040	1	4.54e-042.74e-04	-0.01	-1.37e-05	2.49e-05	0.0
1040	2	4.68e-043.16e-04	-0.01	-1.57e-05	2.55e-05	0.0
1040	8	-1.38e-03-8.22e-04	-9.80e-03	-1.09e-05	1.56e-05	0.0
1040	18	2.06e-03-5.28e-04	-9.10e-03	-1.24e-05	1.87e-05	0.0
1040	21	8.02e-042.23e-03	-9.07e-03	-4.76e-06	1.72e-05	0.0
1040	40	-2.06e-03-1.23e-03	-9.97e-03	-1.12e-05	1.50e-05	0.0
1040	50	2.76e-03-8.14e-04	-8.99e-03	-1.33e-05	1.94e-05	0.0
1040	53	9.99e-043.05e-03	-8.94e-03	-2.64e-06	1.73e-05	0.0
1040	69	3.11e-042.01e-04	-9.39e-03	-1.01e-05	1.70e-05	0.0
1040	70	3.21e-042.29e-04	-9.01e-03	-1.14e-05	1.74e-05	0.0
1040	71	3.11e-042.01e-04	-9.39e-03	-1.01e-05	1.70e-05	0.0
1040	72	3.13e-042.07e-04	-9.31e-03	-1.03e-05	1.71e-05	0.0
1040	73	3.11e-042.01e-04	-9.39e-03	-1.01e-05	1.70e-05	0.0
1041	1	4.52e-046.81e-04	-0.01	-3.41e-05	2.48e-05	0.0
1041	2	4.67e-047.85e-04	-0.01	-3.91e-05	2.55e-05	0.0
1041	18	2.12e-03-2.33e-04	-0.01	-2.76e-05	1.91e-05	0.0





EGP CODE

GRE.EEC.R.73.IT.W.15235.12.024.01

PAGE

231 di/of 527

1041	21	7.74e-042.60e-03	-9.72e-03	-2.28e-05	1.70e-05	0.0
1041	24	-1.51e-04-1.60e-03	-0.01	-2.71e-05	1.69e-05	0.0
1041	50	2.84e-03-5.20e-04	-0.01	-2.87e-05	2.00e-05	0.0
1041	53	9.59e-043.44e-03	-9.51e-03	-2.20e-05	1.71e-05	0.0
1041	56	-3.36e-04-2.44e-03	-0.01	-2.80e-05	1.69e-05	0.0
1041	69	3.11e-045.00e-04	-0.01	-2.50e-05	1.70e-05	0.0
1041	70	3.21e-045.69e-04	-9.98e-03	-2.83e-05	1.74e-05	0.0
1041	71	3.11e-045.00e-04	-0.01	-2.50e-05	1.70e-05	0.0
1041	72	3.13e-045.14e-04	-0.01	-2.56e-05	1.71e-05	0.0
1041	73	3.11e-045.00e-04	-0.01	-2.50e-05	1.70e-05	0.0
1042	1	4.49e-041.11e-03	-0.02	-5.54e-05	2.47e-05	0.0
1042	2	4.66e-041.28e-03	-0.02	-6.38e-05	2.55e-05	0.0
1042	17	2.18e-036.95e-04	-0.01	-4.41e-05	1.91e-05	0.0
1042	21	7.50e-043.03e-03	-0.01	-4.47e-05	1.70e-05	0.0
1042	24	-1.27e-04-1.40e-03	-0.01	-3.66e-05	1.71e-05	0.0
1042	49	2.92e-036.47e-04	-0.01	-4.55e-05	2.00e-05	0.0
1042	53	9.26e-043.92e-03	-0.01	-4.63e-05	1.70e-05	0.0
1042	56	-3.03e-04-2.29e-03	-0.01	-3.50e-05	1.71e-05	0.0
1042	69	3.12e-048.14e-04	-0.01	-4.06e-05	1.71e-05	0.0
1042	70	3.23e-049.28e-04	-0.01	-4.62e-05	1.76e-05	0.0
1042	71	3.12e-048.14e-04	-0.01	-4.06e-05	1.71e-05	0.0
1042	72	3.14e-048.37e-04	-0.01	-4.18e-05	1.72e-05	0.0
1042	73	3.12e-048.14e-04	-0.01	-4.06e-05	1.71e-05	0.0
1043	2	4.68e-041.78e-03	-0.02	-8.88e-05	2.57e-05	0.0
1043	17	2.24e-031.03e-03	-0.01	-6.17e-05	1.92e-05	0.0
1043	21	7.38e-043.51e-03	-0.01	-6.87e-05	1.72e-05	0.0
1043	24	-1.09e-04-1.25e-03	-0.01	-4.42e-05	1.73e-05	0.0
1043	49	3.01e-039.84e-04	-0.01	-6.37e-05	1.99e-05	0.0
1043	53	9.07e-044.46e-03	-0.01	-7.36e-05	1.72e-05	0.0
1043	56	-2.78e-04-2.20e-03	-0.01	-3.93e-05	1.73e-05	0.0
1043	70	3.28e-041.29e-03	-0.01	-6.43e-05	1.79e-05	0.0
1043	72	3.17e-041.16e-03	-0.01	-5.80e-05	1.74e-05	0.0
1043	73	3.14e-041.13e-03	-0.01	-5.64e-05	1.73e-05	0.0
1044	2	4.75e-042.22e-03	-0.02	-1.11e-04	2.63e-05	0.0
1044	17	2.29e-031.32e-03	-0.02	-7.75e-05	1.94e-05	0.0
1044	21	7.43e-043.97e-03	-0.02	-9.19e-05	1.98e-05	0.0
1044	25	8.18e-043.67e-03	-0.02	-9.16e-05	1.98e-05	0.0
1044	49	3.08e-031.28e-03	-0.02	-8.04e-05	1.99e-05	0.0
1044	53	9.12e-045.00e-03	-0.02	-1.01e-04	2.06e-05	0.0
1044	57	1.02e-034.58e-03	-0.02	-1.00e-04	2.06e-05	0.0
1044	70	3.38e-041.61e-03	-0.02	-8.04e-05	1.86e-05	0.0
1044	72	3.24e-041.45e-03	-0.02	-7.23e-05	1.79e-05	0.0
1044	73	3.21e-041.40e-03	-0.02	-7.03e-05	1.77e-05	0.0
1045	2	4.87e-042.49e-03	-0.03	-1.24e-04	2.73e-05	0.0
1045	17	2.33e-031.49e-03	-0.02	-8.76e-05	2.10e-05	0.0
1045	21	7.70e-044.30e-03	-0.02	-1.08e-04	2.32e-05	0.0
1045	25	8.54e-043.99e-03	-0.02	-1.08e-04	2.32e-05	0.0
1045	49	3.13e-031.46e-03	-0.02	-9.11e-05	2.19e-05	0.0
1045	53	9.45e-045.39e-03	-0.02	-1.20e-04	2.51e-05	0.0
1045	57	1.06e-034.95e-03	-0.02	-1.20e-04	2.51e-05	0.0
1045	70	3.52e-041.81e-03	-0.02	-9.03e-05	1.96e-05	0.0
1045	72	3.34e-041.62e-03	-0.02	-8.09e-05	1.87e-05	0.0
1045	73	3.30e-041.57e-03	-0.02	-7.86e-05	1.84e-05	0.0
1046	2	4.94e-042.52e-03	-0.03	-1.26e-04	2.80e-05	0.0
1046	17	2.35e-031.51e-03	-0.02	-8.88e-05	1.75e-05	0.0
1046	21	7.89e-044.37e-03	-0.03	-1.12e-04	2.60e-05	0.0
1046	49	3.15e-031.47e-03	-0.03	-9.24e-05	1.71e-05	0.0
1046	53	9.71e-045.49e-03	-0.03	-1.25e-04	2.89e-05	0.0
1046	70	3.61e-041.83e-03	-0.03	-9.14e-05	2.02e-05	0.0
1046	72	3.40e-041.64e-03	-0.02	-8.17e-05	1.91e-05	0.0
1046	73	3.35e-041.59e-03	-0.02	-7.93e-05	1.89e-05	0.0
1047	2	1.20e-03-2.62e-03	-0.04	1.30e-04	6.39e-05	0.0
1047	10	3.03e-03-1.54e-03	-0.03	9.33e-05	5.45e-05	0.0
1047	26	1.42e-03-4.60e-03	-0.03	1.21e-04	5.60e-05	0.0
1047	42	3.93e-03-1.49e-03	-0.03	9.76e-05	5.95e-05	0.0
1047	58	1.67e-03-5.79e-03	-0.03	1.36e-04	6.17e-05	0.0
1047	70	8.87e-04-1.92e-03	-0.03	9.49e-05	4.69e-05	0.0
1047	72	8.05e-04-1.70e-03	-0.03	8.45e-05	4.27e-05	0.0
1047	73	7.85e-04-1.65e-03	-0.03	8.20e-05	4.16e-05	0.0
1048	2	1.04e-03-2.52e-03	-0.03	1.25e-04	5.49e-05	0.0
1048	10	2.88e-03-1.47e-03	-0.02	8.85e-05	4.69e-05	0.0
1048	22	1.27e-03-4.03e-03	-0.02	1.09e-04	4.32e-05	0.0
1048	26	1.17e-03-4.38e-03	-0.02	1.10e-04	4.24e-05	0.0
1048	42	3.75e-03-1.43e-03	-0.02	9.21e-05	5.12e-05	0.0
1048	54	1.51e-03-5.01e-03	-0.02	1.21e-04	4.60e-05	0.0
1048	58	1.36e-03-5.49e-03	-0.02	1.22e-04	4.50e-05	0.0



EGP CODE

GRE.EEC.R.73.IT.W.15235.12.024.01

PAGE

232 di/of 527

1048	70	7.60e-04-1.83e-03	-0.02	9.09e-05	3.98e-05	0.0
1048	72	7.00e-04-1.64e-03	-0.02	8.14e-05	3.68e-05	0.0
1048	73	6.85e-04-1.59e-03	-0.02	7.90e-05	3.60e-05	0.0
1049	2	9.02e-04-2.14e-03	-0.02	1.06e-04	4.73e-05	0.0
1049	10	2.71e-03-1.23e-03	-0.02	7.44e-05	4.09e-05	0.0
1049	22	1.13e-03-3.59e-03	-0.02	8.68e-05	3.49e-05	0.0
1049	26	1.04e-03-3.92e-03	-0.02	8.71e-05	3.41e-05	0.0
1049	42	3.56e-03-1.18e-03	-0.02	7.71e-05	4.48e-05	0.0
1049	54	1.35e-03-4.49e-03	-0.02	9.46e-05	3.64e-05	0.0
1049	58	1.22e-03-4.95e-03	-0.02	9.50e-05	3.52e-05	0.0
1049	70	6.48e-04-1.56e-03	-0.02	7.72e-05	3.38e-05	0.0
1049	72	6.06e-04-1.40e-03	-0.02	6.93e-05	3.18e-05	0.0
1049	73	5.95e-04-1.36e-03	-0.02	6.74e-05	3.12e-05	0.0
1050	2	8.02e-04-1.64e-03	-0.02	8.11e-05	4.20e-05	0.0
1050	9	2.56e-03-2.26e-04	-0.01	5.40e-05	3.65e-05	0.0
1050	21	1.21e-031.29e-03	-0.01	4.47e-05	3.17e-05	0.0
1050	26	9.72e-04-3.39e-03	-0.01	6.08e-05	2.83e-05	0.0
1050	41	3.37e-039.29e-05	-0.01	5.50e-05	4.00e-05	0.0
1050	53	1.48e-032.22e-03	-0.01	4.19e-05	3.33e-05	0.0
1050	58	1.15e-03-4.33e-03	-0.01	6.45e-05	2.84e-05	0.0
1050	70	5.68e-04-1.19e-03	-0.01	5.90e-05	2.96e-05	0.0
1050	72	5.38e-04-1.07e-03	-0.01	5.31e-05	2.82e-05	0.0
1050	73	5.31e-04-1.04e-03	-0.01	5.17e-05	2.79e-05	0.0
1051	1	6.99e-04-9.61e-04	-0.02	4.78e-05	3.70e-05	0.0
1051	2	7.39e-04-1.11e-03	-0.02	5.51e-05	3.88e-05	0.0
1051	9	2.42e-036.68e-05	-0.01	3.84e-05	3.28e-05	0.0
1051	26	9.48e-04-2.90e-03	-0.01	3.68e-05	2.60e-05	0.0
1051	27	3.13e-051.48e-03	-0.01	3.36e-05	2.56e-05	0.0
1051	41	3.20e-033.71e-04	-0.01	3.97e-05	3.56e-05	0.0
1051	58	1.13e-03-3.78e-03	-0.01	3.74e-05	2.61e-05	0.0
1051	59	-1.52e-042.36e-03	-0.01	3.30e-05	2.55e-05	0.0
1051	69	4.90e-04-7.09e-04	-0.01	3.52e-05	2.58e-05	0.0
1051	70	5.16e-04-8.10e-04	-0.01	4.01e-05	2.70e-05	0.0
1051	71	4.90e-04-7.09e-04	-0.01	3.52e-05	2.58e-05	0.0
1051	72	4.95e-04-7.29e-04	-0.01	3.62e-05	2.60e-05	0.0
1051	73	4.90e-04-7.09e-04	-0.01	3.52e-05	2.58e-05	0.0
1052	1	6.72e-04-5.31e-04	-0.01	2.64e-05	3.57e-05	0.0
1052	2	7.03e-04-6.13e-04	-0.01	3.04e-05	3.71e-05	0.0
1052	9	2.32e-033.69e-04	-0.01	2.29e-05	3.01e-05	0.0
1052	26	9.52e-04-2.48e-03	-0.01	1.55e-05	2.51e-05	0.0
1052	27	-1.91e-051.70e-03	-0.01	2.34e-05	2.42e-05	0.0
1052	41	3.06e-036.67e-04	-0.01	2.43e-05	3.22e-05	0.0
1052	58	1.15e-03-3.32e-03	-0.01	1.39e-05	2.53e-05	0.0
1052	59	-2.13e-042.54e-03	-0.01	2.50e-05	2.40e-05	0.0
1052	69	4.66e-04-3.91e-04	-0.01	1.94e-05	2.46e-05	0.0
1052	70	4.87e-04-4.46e-04	-0.01	2.21e-05	2.56e-05	0.0
1052	71	4.66e-04-3.91e-04	-0.01	1.94e-05	2.46e-05	0.0
1052	72	4.70e-04-4.02e-04	-0.01	2.00e-05	2.48e-05	0.0
1052	73	4.66e-04-3.91e-04	-0.01	1.94e-05	2.46e-05	0.0
1053	1	6.60e-04-1.22e-04	-0.01	6.06e-06	3.52e-05	0.0
1053	2	6.88e-04-1.41e-04	-0.01	6.97e-06	3.64e-05	0.0
1053	10	2.24e-038.87e-05	-0.01	5.19e-06	2.84e-05	0.0
1053	15	-1.29e-039.64e-04	-0.01	5.13e-06	2.02e-05	0.0
1053	26	9.75e-04-2.13e-03	-0.01	-1.60e-06	2.52e-05	0.0
1053	42	2.95e-031.61e-04	-9.99e-03	5.49e-06	3.01e-05	0.0
1053	47	-1.99e-031.38e-03	-0.01	5.42e-06	1.87e-05	0.0
1053	58	1.18e-03-2.95e-03	-0.01	-4.03e-06	2.56e-05	0.0
1053	69	4.56e-04-8.99e-05	-0.01	4.46e-06	2.42e-05	0.0
1053	70	4.75e-04-1.02e-04	-9.91e-03	5.07e-06	2.50e-05	0.0
1053	71	4.56e-04-8.99e-05	-0.01	4.46e-06	2.42e-05	0.0
1053	72	4.60e-04-9.23e-05	-0.01	4.59e-06	2.43e-05	0.0
1053	73	4.56e-04-8.99e-05	-0.01	4.46e-06	2.42e-05	0.0
1054	1	6.62e-042.81e-04	-0.01	-1.39e-05	3.53e-05	0.0
1054	2	6.90e-043.24e-04	-0.01	-1.60e-05	3.65e-05	0.0
1054	18	2.26e-03-5.57e-04	-0.01	-1.34e-05	2.89e-05	0.0
1054	21	9.61e-042.26e-03	-0.01	-4.68e-06	2.51e-05	0.0
1054	24	-4.44e-05-1.85e-03	-0.01	-1.59e-05	2.35e-05	0.0
1054	50	2.98e-03-8.57e-04	-0.01	-1.46e-05	3.08e-05	0.0
1054	53	1.16e-033.09e-03	-0.01	-2.43e-06	2.54e-05	0.0
1054	56	-2.46e-04-2.67e-03	-0.01	-1.81e-05	2.32e-05	0.0
1054	69	4.58e-042.07e-04	-0.01	-1.03e-05	2.43e-05	0.0
1054	70	4.77e-042.36e-04	-0.01	-1.17e-05	2.51e-05	0.0
1054	71	4.58e-042.07e-04	-0.01	-1.03e-05	2.43e-05	0.0
1054	72	4.62e-042.13e-04	-0.01	-1.05e-05	2.45e-05	0.0
1054	73	4.58e-042.07e-04	-0.01	-1.03e-05	2.43e-05	0.0
1055	1	6.78e-046.97e-04	-0.02	-3.47e-05	3.61e-05	0.0



EGP CODE

GRE.EEC.R.73.IT.W.15235.12.024.01

PAGE

233 di/of 527

1055	2	7.12e-048.07e-04	-0.01	-3.99e-05	3.76e-05	0.0
1055	18	2.35e-03-2.52e-04	-0.01	-2.92e-05	3.10e-05	0.0
1055	21	9.44e-042.64e-03	-0.01	-2.32e-05	2.54e-05	0.0
1055	24	0.0 -1.61e-03	-0.01	-2.79e-05	2.47e-05	0.0
1055	50	3.10e-03-5.53e-04	-0.01	-3.06e-05	3.33e-05	0.0
1055	53	1.13e-033.49e-03	-0.01	-2.22e-05	2.55e-05	0.0
1055	56	-1.89e-04-2.46e-03	-0.01	-2.89e-05	2.45e-05	0.0
1055	69	4.72e-045.14e-04	-0.01	-2.55e-05	2.50e-05	0.0
1055	70	4.94e-045.87e-04	-0.01	-2.90e-05	2.60e-05	0.0
1055	71	4.72e-045.14e-04	-0.01	-2.55e-05	2.50e-05	0.0
1055	72	4.77e-045.29e-04	-0.01	-2.62e-05	2.52e-05	0.0
1055	73	4.72e-045.14e-04	-0.01	-2.55e-05	2.50e-05	0.0
1056	1	7.12e-041.14e-03	-0.02	-5.66e-05	3.78e-05	0.0
1056	2	7.56e-041.32e-03	-0.02	-6.54e-05	3.99e-05	0.0
1056	18	2.47e-034.93e-05	-0.01	-4.49e-05	3.42e-05	0.0
1056	21	9.51e-043.09e-03	-0.01	-4.59e-05	2.67e-05	0.0
1056	26	1.15e-03-1.39e-03	-0.01	-3.96e-05	3.01e-05	0.0
1056	50	3.26e-03-2.60e-04	-0.01	-4.62e-05	3.72e-05	0.0
1056	53	1.13e-033.99e-03	-0.01	-4.76e-05	2.68e-05	0.0
1056	58	1.41e-03-2.28e-03	-0.01	-3.87e-05	3.15e-05	0.0
1056	69	5.01e-048.40e-04	-0.01	-4.17e-05	2.65e-05	0.0
1056	70	5.31e-049.61e-04	-0.01	-4.76e-05	2.79e-05	0.0
1056	71	5.01e-048.40e-04	-0.01	-4.17e-05	2.65e-05	0.0
1056	72	5.07e-048.64e-04	-0.01	-4.29e-05	2.68e-05	0.0
1056	73	5.01e-048.40e-04	-0.01	-4.17e-05	2.65e-05	0.0
1056	73	5.01e-048.40e-04	-0.01	-4.17e-05	2.65e-05	0.0
1057	2	8.32e-041.85e-03	-0.02	-9.15e-05	4.38e-05	0.0
1057	14	2.59e-035.90e-06	-0.02	-5.86e-05	3.85e-05	0.0
1057	18	2.62e-033.33e-04	-0.02	-6.02e-05	3.83e-05	0.0
1057	21	9.91e-043.60e-03	-0.02	-7.14e-05	2.96e-05	0.0
1057	46	3.40e-03-4.57e-04	-0.02	-5.87e-05	4.23e-05	0.0
1057	50	3.45e-034.77e-06	-0.02	-6.10e-05	4.20e-05	0.0
1057	53	1.17e-034.58e-03	-0.02	-7.67e-05	2.98e-05	0.0
1057	70	5.92e-041.35e-03	-0.02	-6.66e-05	3.11e-05	0.0
1057	72	5.59e-041.21e-03	-0.02	-5.99e-05	2.94e-05	0.0
1057	73	5.50e-041.17e-03	-0.02	-5.82e-05	2.90e-05	0.0
1058	2	9.47e-042.32e-03	-0.03	-1.15e-04	5.00e-05	0.0
1058	17	2.78e-031.34e-03	-0.02	-8.10e-05	4.32e-05	0.0
1058	21	1.09e-034.13e-03	-0.02	-9.74e-05	3.71e-05	0.0
1058	25	1.18e-033.79e-03	-0.02	-9.71e-05	3.80e-05	0.0
1058	49	3.64e-031.29e-03	-0.02	-8.40e-05	4.73e-05	0.0
1058	53	1.27e-035.19e-03	-0.02	-1.07e-04	3.88e-05	0.0
1058	57	1.40e-034.73e-03	-0.02	-1.07e-04	4.00e-05	0.0
1058	70	6.84e-041.69e-03	-0.02	-8.38e-05	3.60e-05	0.0
1058	72	6.36e-041.51e-03	-0.02	-7.51e-05	3.36e-05	0.0
1058	73	6.24e-041.47e-03	-0.02	-7.30e-05	3.30e-05	0.0
1059	2	1.10e-032.61e-03	-0.03	-1.30e-04	5.84e-05	0.0
1059	17	2.95e-031.53e-03	-0.02	-9.23e-05	4.98e-05	0.0
1059	21	1.22e-034.52e-03	-0.03	-1.17e-04	4.75e-05	0.0
1059	25	1.33e-034.17e-03	-0.03	-1.16e-04	4.82e-05	0.0
1059	49	3.84e-031.48e-03	-0.02	-9.62e-05	5.44e-05	0.0
1059	53	1.42e-035.67e-03	-0.03	-1.31e-04	5.12e-05	0.0
1059	57	1.57e-035.18e-03	-0.03	-1.30e-04	5.21e-05	0.0
1059	70	8.05e-041.91e-03	-0.02	-9.45e-05	4.26e-05	0.0
1059	72	7.37e-041.70e-03	-0.02	-8.44e-05	3.91e-05	0.0
1059	73	7.20e-041.65e-03	-0.02	-8.19e-05	3.83e-05	0.0
1060	2	1.19e-032.65e-03	-0.04	-1.31e-04	6.38e-05	0.0
1060	17	3.04e-031.55e-03	-0.03	-9.43e-05	5.43e-05	0.0
1060	21	1.41e-034.63e-03	-0.03	-1.22e-04	5.63e-05	0.0
1060	49	3.94e-031.50e-03	-0.03	-9.86e-05	5.93e-05	0.0
1060	53	1.67e-035.81e-03	-0.03	-1.38e-04	6.22e-05	0.0
1060	70	8.80e-041.94e-03	-0.03	-9.59e-05	4.69e-05	0.0
1060	72	7.99e-041.72e-03	-0.03	-8.54e-05	4.27e-05	0.0
1060	73	7.79e-041.67e-03	-0.03	-8.28e-05	4.16e-05	0.0
1061	2	1.73e-03-2.95e-03	-0.04	1.44e-04	9.12e-05	0.0
1061	10	3.76e-03-2.90e-03	-0.03	1.06e-04	9.03e-05	0.0
1061	22	2.02e-03-4.99e-03	-0.03	1.38e-04	8.18e-05	0.0
1061	26	1.87e-03-5.04e-03	-0.03	1.39e-04	7.96e-05	0.0
1061	42	4.81e-03-3.31e-03	-0.03	1.11e-04	1.03e-04	0.0
1061	54	2.38e-03-6.25e-03	-0.03	1.57e-04	9.10e-05	0.0
1061	58	2.17e-03-6.32e-03	-0.03	1.58e-04	8.79e-05	0.0
1061	70	1.28e-03-2.17e-03	-0.03	1.06e-04	6.72e-05	0.0
1061	72	1.15e-03-1.91e-03	-0.03	9.36e-05	6.07e-05	0.0
1061	73	1.12e-03-1.85e-03	-0.03	9.05e-05	5.90e-05	0.0
1062	2	1.45e-03-2.80e-03	-0.03	1.37e-04	7.59e-05	0.0
1062	10	3.45e-03-2.77e-03	-0.02	9.96e-05	7.49e-05	0.0
1062	22	1.63e-03-4.70e-03	-0.03	1.24e-04	6.10e-05	0.0



EGP CODE

GRE.EEC.R.73.IT.W.15235.12.024.01

PAGE

234 di/of 527

1062	26	1.49e-03-4.75e-03	-0.03	1.25e-04	5.88e-05	0.0
1062	42	4.45e-03-3.15e-03	-0.03	1.05e-04	8.51e-05	0.0
1062	54	1.90e-03-5.88e-03	-0.03	1.39e-04	6.57e-05	0.0
1062	58	1.71e-03-5.94e-03	-0.03	1.40e-04	6.25e-05	0.0
1062	70	1.06e-03-2.05e-03	-0.02	1.01e-04	5.53e-05	0.0
1062	72	9.73e-04-1.82e-03	-0.02	8.94e-05	5.07e-05	0.0
1062	73	9.51e-04-1.76e-03	-0.02	8.66e-05	4.96e-05	0.0
1063	2	1.22e-03-2.34e-03	-0.03	1.15e-04	6.31e-05	0.0
1063	6	3.07e-03-1.69e-03	-0.02	8.55e-05	6.25e-05	0.0
1063	9	3.17e-03-5.68e-04	-0.02	7.60e-05	6.34e-05	0.0
1063	26	1.27e-03-4.14e-03	-0.02	9.53e-05	4.42e-05	0.0
1063	38	3.98e-03-1.79e-03	-0.02	9.04e-05	7.09e-05	0.0
1063	41	4.12e-03-2.13e-04	-0.02	7.73e-05	7.21e-05	0.0
1063	58	1.46e-03-5.20e-03	-0.02	1.04e-04	4.53e-05	0.0
1063	70	8.79e-04-1.71e-03	-0.02	8.41e-05	4.54e-05	0.0
1063	72	8.16e-04-1.53e-03	-0.02	7.51e-05	4.23e-05	0.0
1063	73	8.01e-04-1.48e-03	-0.02	7.29e-05	4.15e-05	0.0
1064	2	-1.01e-03-3.07e-03	-0.05	1.51e-04	-5.16e-05	0.0
1064	8	-2.29e-03-2.66e-03	-0.03	1.02e-04	-2.33e-05	0.0
1064	22	-5.29e-04-4.52e-03	-0.04	1.34e-04	-4.74e-05	0.0
1064	26	-5.55e-04-4.53e-03	-0.04	1.34e-04	-4.61e-05	0.0
1064	40	-2.97e-03-2.97e-03	-0.03	1.06e-04	-2.02e-05	0.0
1064	54	-4.96e-04-5.58e-03	-0.04	1.50e-04	-5.40e-05	0.0
1064	58	-5.33e-04-5.58e-03	-0.04	1.50e-04	-5.22e-05	0.0
1064	70	-7.52e-04-2.23e-03	-0.03	1.10e-04	-3.85e-05	0.0
1064	72	-6.39e-04-1.96e-03	-0.03	9.70e-05	-3.26e-05	0.0
1064	73	-6.11e-04-1.90e-03	-0.03	9.38e-05	-3.11e-05	0.0
1065	1	8.91e-04-1.02e-03	-0.02	5.03e-05	4.66e-05	0.0
1065	2	9.48e-04-1.19e-03	-0.02	5.84e-05	4.93e-05	0.0
1065	9	2.67e-033.35e-05	-0.01	4.39e-05	4.52e-05	0.0
1065	21	1.30e-031.43e-03	-0.01	4.01e-05	3.81e-05	0.0
1065	26	1.10e-03-2.98e-03	-0.01	3.76e-05	3.35e-05	0.0
1065	41	3.48e-033.43e-04	-0.01	4.65e-05	5.02e-05	0.0
1065	53	1.56e-032.31e-03	-0.01	4.13e-05	4.03e-05	0.0
1065	58	1.29e-03-3.87e-03	-0.01	3.77e-05	3.38e-05	0.0
1065	69	6.27e-04-7.58e-04	-0.01	3.73e-05	3.27e-05	0.0
1065	70	6.65e-04-8.70e-04	-0.01	4.28e-05	3.44e-05	0.0
1065	71	6.27e-04-7.58e-04	-0.01	3.73e-05	3.27e-05	0.0
1065	72	6.35e-04-7.80e-04	-0.01	3.84e-05	3.30e-05	0.0
1065	73	6.27e-04-7.58e-04	-0.01	3.73e-05	3.27e-05	0.0
1066	1	8.44e-04-5.60e-04	-0.02	2.76e-05	4.43e-05	0.0
1066	2	8.86e-04-6.51e-04	-0.02	3.20e-05	4.63e-05	0.0
1066	9	2.51e-033.64e-04	-0.01	2.60e-05	4.00e-05	0.0
1066	21	1.20e-031.68e-03	-0.01	2.70e-05	3.46e-05	0.0
1066	26	1.09e-03-2.53e-03	-0.01	1.61e-05	3.17e-05	0.0
1066	41	3.28e-036.70e-04	-0.01	2.81e-05	4.37e-05	0.0
1066	53	1.44e-032.51e-03	-0.01	2.96e-05	3.61e-05	0.0
1066	58	1.28e-03-3.37e-03	-0.01	1.44e-05	3.21e-05	0.0
1066	69	5.88e-04-4.16e-04	-0.01	2.05e-05	3.07e-05	0.0
1066	70	6.16e-04-4.77e-04	-0.01	2.34e-05	3.20e-05	0.0
1066	71	5.88e-04-4.16e-04	-0.01	2.05e-05	3.07e-05	0.0
1066	72	5.93e-04-4.28e-04	-0.01	2.11e-05	3.10e-05	0.0
1066	73	5.88e-04-4.16e-04	-0.01	2.05e-05	3.07e-05	0.0
1067	1	8.23e-04-1.28e-04	-0.02	6.34e-06	4.33e-05	0.0
1067	2	8.60e-04-1.49e-04	-0.02	7.34e-06	4.50e-05	0.0
1067	10	2.41e-031.01e-04	-0.01	6.36e-06	3.71e-05	0.0
1067	21	1.13e-031.96e-03	-0.01	1.27e-05	3.24e-05	0.0
1067	26	1.10e-03-2.15e-03	-0.01	-1.88e-06	3.17e-05	0.0
1067	42	3.15e-031.80e-04	-0.01	7.04e-06	4.01e-05	0.0
1067	53	1.35e-032.78e-03	-0.01	1.59e-05	3.34e-05	0.0
1067	58	1.32e-03-2.98e-03	-0.01	-4.52e-06	3.24e-05	0.0
1067	69	5.71e-04-9.50e-05	-0.01	4.70e-06	2.99e-05	0.0
1067	70	5.95e-04-1.09e-04	-0.01	5.37e-06	3.10e-05	0.0
1067	71	5.71e-04-9.50e-05	-0.01	4.70e-06	2.99e-05	0.0
1067	72	5.76e-04-9.77e-05	-0.01	4.84e-06	3.01e-05	0.0
1067	73	5.71e-04-9.50e-05	-0.01	4.70e-06	2.99e-05	0.0
1068	1	8.27e-042.96e-04	-0.02	-1.46e-05	4.36e-05	0.0
1068	2	8.65e-043.45e-04	-0.02	-1.69e-05	4.53e-05	0.0
1068	18	2.44e-03-5.69e-04	-0.01	-1.54e-05	3.80e-05	0.0
1068	21	1.09e-032.29e-03	-0.01	-4.71e-06	3.16e-05	0.0
1068	26	1.15e-03-1.84e-03	-0.01	-1.85e-05	3.30e-05	0.0
1068	50	3.18e-03-8.78e-04	-0.01	-1.72e-05	4.11e-05	0.0
1068	53	1.30e-033.12e-03	-0.01	-2.25e-06	3.21e-05	0.0
1068	58	1.39e-03-2.67e-03	-0.01	-2.16e-05	3.42e-05	0.0
1068	69	5.74e-042.20e-04	-0.01	-1.08e-05	3.01e-05	0.0
1068	70	6.00e-042.52e-04	-0.01	-1.24e-05	3.13e-05	0.0



EGP CODE

GRE.EEC.R.73.IT.W.15235.12.024.01

PAGE

235 di/of 527

1068	71	5.74e-042.20e-04	-0.01	-1.08e-05	3.01e-05	0.0
1068	72	5.79e-042.27e-04	-0.01	-1.11e-05	3.03e-05	0.0
1068	73	5.74e-042.20e-04	-0.01	-1.08e-05	3.01e-05	0.0
1069	1	8.57e-047.38e-04	-0.02	-3.64e-05	4.51e-05	0.0
1069	2	9.03e-048.60e-04	-0.02	-4.22e-05	4.72e-05	0.0
1069	18	2.56e-03-2.37e-04	-0.01	-3.30e-05	4.16e-05	0.0
1069	21	1.08e-032.70e-03	-0.01	-2.43e-05	3.22e-05	0.0
1069	26	1.23e-03-1.58e-03	-0.01	-3.22e-05	3.57e-05	0.0
1069	50	3.34e-03-5.44e-04	-0.01	-3.53e-05	4.57e-05	0.0
1069	53	1.28e-033.56e-03	-0.01	-2.33e-05	3.26e-05	0.0
1069	58	1.49e-03-2.43e-03	-0.01	-3.43e-05	3.75e-05	0.0
1069	69	5.99e-045.48e-04	-0.01	-2.70e-05	3.14e-05	0.0
1069	70	6.30e-046.30e-04	-0.01	-3.09e-05	3.28e-05	0.0
1069	71	5.99e-045.48e-04	-0.01	-2.70e-05	3.14e-05	0.0
1069	72	6.05e-045.65e-04	-0.01	-2.78e-05	3.16e-05	0.0
1069	73	5.99e-045.48e-04	-0.01	-2.70e-05	3.14e-05	0.0
1070	2	9.80e-041.42e-03	-0.02	-6.95e-05	5.11e-05	0.0
1070	14	2.72e-03-2.06e-04	-0.02	-5.02e-05	4.80e-05	0.0
1070	18	2.74e-039.52e-05	-0.02	-5.06e-05	4.77e-05	0.0
1070	21	1.11e-033.19e-03	-0.01	-4.90e-05	3.47e-05	0.0
1070	46	3.55e-03-6.46e-04	-0.02	-5.25e-05	5.36e-05	0.0
1070	50	3.57e-03-2.19e-04	-0.02	-5.31e-05	5.33e-05	0.0
1070	53	1.30e-034.10e-03	-0.01	-5.08e-05	3.50e-05	0.0
1070	70	6.91e-041.04e-03	-0.01	-5.09e-05	3.59e-05	0.0
1070	72	6.57e-049.28e-04	-0.01	-4.57e-05	3.43e-05	0.0
1070	73	6.48e-049.01e-04	-0.01	-4.44e-05	3.38e-05	0.0
1071	2	1.11e-032.00e-03	-0.02	-9.82e-05	5.76e-05	0.0
1071	14	2.95e-031.08e-03	-0.02	-6.58e-05	5.69e-05	0.0
1071	18	2.98e-031.41e-03	-0.02	-6.75e-05	5.66e-05	0.0
1071	21	1.20e-033.76e-03	-0.02	-7.70e-05	3.96e-05	0.0
1071	46	3.84e-039.94e-04	-0.02	-6.70e-05	6.45e-05	0.0
1071	50	3.88e-031.46e-03	-0.02	-6.95e-05	6.40e-05	0.0
1071	53	1.38e-034.76e-03	-0.02	-8.29e-05	4.02e-05	0.0
1071	70	7.91e-041.47e-03	-0.02	-7.19e-05	4.10e-05	0.0
1071	72	7.42e-041.31e-03	-0.02	-6.44e-05	3.86e-05	0.0
1071	73	7.29e-041.27e-03	-0.02	-6.25e-05	3.80e-05	0.0
1072	2	1.30e-032.55e-03	-0.03	-1.25e-04	6.76e-05	0.0
1072	13	3.19e-031.84e-03	-0.02	-9.38e-05	6.85e-05	0.0
1072	17	3.29e-031.47e-03	-0.02	-9.01e-05	6.81e-05	0.0
1072	21	1.35e-034.40e-03	-0.02	-1.08e-04	5.12e-05	0.0
1072	45	4.12e-031.93e-03	-0.02	-9.95e-05	7.82e-05	0.0
1072	49	4.26e-031.41e-03	-0.02	-9.43e-05	7.76e-05	0.0
1072	53	1.55e-035.52e-03	-0.02	-1.20e-04	5.39e-05	0.0
1072	70	9.42e-041.87e-03	-0.02	-9.17e-05	4.89e-05	0.0
1072	72	8.69e-041.66e-03	-0.02	-8.18e-05	4.53e-05	0.0
1072	73	8.51e-041.61e-03	-0.02	-7.93e-05	4.44e-05	0.0
1073	2	1.56e-032.92e-03	-0.04	-1.43e-04	8.19e-05	0.0
1073	17	3.57e-032.87e-03	-0.03	-1.04e-04	8.05e-05	0.0
1073	21	1.58e-034.93e-03	-0.03	-1.33e-04	6.68e-05	0.0
1073	25	1.72e-034.88e-03	-0.03	-1.33e-04	6.89e-05	0.0
1073	49	4.59e-033.27e-03	-0.03	-1.10e-04	9.14e-05	0.0
1073	53	1.80e-036.16e-03	-0.03	-1.51e-04	7.22e-05	0.0
1073	57	2.00e-036.10e-03	-0.03	-1.50e-04	7.52e-05	0.0
1073	70	1.14e-032.14e-03	-0.03	-1.05e-04	6.00e-05	0.0
1073	72	1.04e-031.90e-03	-0.03	-9.30e-05	5.46e-05	0.0
1073	73	1.01e-031.84e-03	-0.03	-9.01e-05	5.33e-05	0.0
1074	2	1.72e-032.98e-03	-0.04	-1.45e-04	9.11e-05	0.0
1074	17	3.78e-032.94e-03	-0.03	-1.06e-04	9.07e-05	0.0
1074	21	1.86e-035.06e-03	-0.03	-1.40e-04	7.98e-05	0.0
1074	25	2.01e-035.02e-03	-0.03	-1.39e-04	8.20e-05	0.0
1074	49	4.85e-033.35e-03	-0.03	-1.12e-04	1.03e-04	0.0
1074	53	2.16e-036.34e-03	-0.03	-1.60e-04	8.81e-05	0.0
1074	57	2.37e-036.29e-03	-0.03	-1.58e-04	9.12e-05	0.0
1074	70	1.27e-032.19e-03	-0.03	-1.07e-04	6.72e-05	0.0
1074	72	1.15e-031.93e-03	-0.03	-9.44e-05	6.06e-05	0.0
1074	73	1.12e-031.87e-03	-0.03	-9.14e-05	5.90e-05	0.0
1075	2	5.21e-041.90e-04	-0.34	0.0	5.14e-05	0.0
1075	6	0.21 -0.06	-0.20	-4.11e-05	3.40e-04	1.66e-04
1075	19	-0.21 0.02	-0.22	4.71e-06	-2.67e-04	1.42e-04
1075	33	0.06 0.16	-0.21	1.04e-04	1.33e-04	-8.48e-05
1075	38	0.29 -0.08	-0.20	-5.68e-05	4.60e-04	2.32e-04
1075	51	-0.29 0.02	-0.22	6.80e-06	-3.87e-04	1.99e-04
1075	65	0.08 0.22	-0.21	1.46e-04	1.71e-04	-1.18e-04
1075	70	4.26e-041.41e-04	-0.25	0.0	3.98e-05	0.0
1075	72	3.67e-041.23e-04	-0.22	0.0	3.72e-05	0.0
1075	73	3.53e-041.19e-04	-0.21	0.0	3.66e-05	0.0





EGP CODE

GRE.EEC.R.73.IT.W.15235.12.024.01

PAGE

236 di/of 527

1076	2	-1.16e-03-3.53e-03	-0.05	1.76e-04	-6.08e-05	0.0
1076	8	-2.95e-03-3.05e-03	-0.03	1.23e-04	-5.50e-05	0.0
1076	22	-6.33e-04-4.69e-03	-0.04	1.61e-04	-4.48e-05	0.0
1076	24	-1.88e-03-4.77e-03	-0.04	1.61e-04	-5.35e-05	0.0
1076	40	-3.85e-03-3.41e-03	-0.04	1.29e-04	-6.23e-05	0.0
1076	54	-6.06e-04-5.71e-03	-0.04	1.82e-04	-4.81e-05	0.0
1076	56	-2.36e-03-5.82e-03	-0.04	1.82e-04	-6.03e-05	0.0
1076	70	-8.68e-04-2.57e-03	-0.04	1.28e-04	-4.54e-05	0.0
1076	72	-7.34e-04-2.23e-03	-0.04	1.12e-04	-3.84e-05	0.0
1076	73	-7.00e-04-2.15e-03	-0.03	1.08e-04	-3.67e-05	0.0
1077	2	-1.41e-03-3.33e-03	-0.05	1.63e-04	-7.27e-05	0.0
1077	8	-2.68e-03-2.71e-03	-0.03	1.07e-04	-4.48e-05	0.0
1077	22	-8.94e-04-4.49e-03	-0.04	1.43e-04	-6.05e-05	0.0
1077	40	-3.42e-03-2.98e-03	-0.03	1.10e-04	-4.52e-05	0.0
1077	54	-9.11e-04-5.48e-03	-0.04	1.60e-04	-6.71e-05	0.0
1077	70	-1.05e-03-2.42e-03	-0.04	1.18e-04	-5.43e-05	0.0
1077	72	-8.91e-04-2.11e-03	-0.03	1.04e-04	-4.61e-05	0.0
1077	73	-8.52e-04-2.04e-03	-0.03	1.00e-04	-4.40e-05	0.0
1078	2	-1.03e-03-2.91e-03	-0.04	1.43e-04	-5.33e-05	0.0
1078	8	-2.29e-03-2.41e-03	-0.03	9.45e-05	-2.49e-05	0.0
1078	22	-5.79e-04-4.07e-03	-0.03	1.23e-04	-4.50e-05	0.0
1078	40	-2.95e-03-2.66e-03	-0.03	9.68e-05	-2.19e-05	0.0
1078	54	-5.61e-04-4.98e-03	-0.04	1.36e-04	-5.02e-05	0.0
1078	70	-7.72e-04-2.11e-03	-0.03	1.04e-04	-3.98e-05	0.0
1078	72	-6.56e-04-1.86e-03	-0.03	9.18e-05	-3.38e-05	0.0
1078	73	-6.27e-04-1.80e-03	-0.03	8.88e-05	-3.22e-05	0.0
1079	2	-4.14e-04-2.68e-03	-0.04	1.33e-04	-2.08e-05	0.0
1079	8	-1.81e-03-2.30e-03	-0.03	8.97e-05	0.0	0.0
1079	22	-7.66e-05-3.86e-03	-0.03	1.12e-04	-1.97e-05	0.0
1079	40	-2.44e-03-2.55e-03	-0.03	9.26e-05	4.68e-06	0.0
1079	54	-7.41e-06-4.74e-03	-0.03	1.24e-04	-2.26e-05	0.0
1079	70	-3.08e-04-1.93e-03	-0.03	9.58e-05	-1.55e-05	0.0
1079	72	-2.62e-04-1.71e-03	-0.03	8.51e-05	-1.31e-05	0.0
1079	73	-2.50e-04-1.66e-03	-0.03	8.25e-05	-1.25e-05	0.0
1080	2	2.78e-04-2.67e-03	-0.04	1.32e-04	1.54e-05	0.0
1080	10	1.73e-03-2.14e-03	-0.03	8.74e-05	-1.89e-06	0.0
1080	24	-4.00e-04-3.90e-03	-0.03	1.12e-04	2.00e-05	0.0
1080	42	2.36e-03-2.34e-03	-0.03	8.95e-05	-6.45e-06	0.0
1080	56	-6.29e-04-4.80e-03	-0.03	1.24e-04	2.42e-05	0.0
1080	70	2.09e-04-1.93e-03	-0.03	9.54e-05	1.16e-05	0.0
1080	72	1.78e-04-1.71e-03	-0.03	8.48e-05	9.89e-06	0.0
1080	73	1.71e-04-1.65e-03	-0.03	8.22e-05	9.48e-06	0.0
1081	2	9.05e-04-2.88e-03	-0.04	1.42e-04	4.83e-05	0.0
1081	10	2.20e-03-2.23e-03	-0.03	9.12e-05	2.14e-05	0.0
1081	24	1.50e-04-4.19e-03	-0.03	1.24e-04	4.63e-05	0.0
1081	42	2.86e-03-2.42e-03	-0.03	9.25e-05	1.82e-05	0.0
1081	56	-1.12e-05-5.16e-03	-0.04	1.39e-04	5.31e-05	0.0
1081	70	6.78e-04-2.08e-03	-0.03	1.03e-04	3.61e-05	0.0
1081	72	5.77e-04-1.84e-03	-0.03	9.08e-05	3.08e-05	0.0
1081	73	5.52e-04-1.78e-03	-0.03	8.79e-05	2.94e-05	0.0
1082	1	8.82e-043.18e-04	-0.02	-1.55e-05	4.64e-05	0.0
1082	2	9.22e-043.72e-04	-0.02	-1.81e-05	4.82e-05	0.0
1082	14	2.52e-03-8.36e-04	-0.01	-1.94e-05	4.26e-05	0.0
1082	18	2.53e-03-5.65e-04	-0.01	-1.84e-05	4.25e-05	0.0
1082	21	1.14e-032.32e-03	-0.01	-4.76e-06	3.40e-05	0.0
1082	46	3.29e-03-1.26e-03	-0.01	-2.26e-05	4.69e-05	0.0
1082	50	3.29e-03-8.80e-04	-0.01	-2.10e-05	4.67e-05	0.0
1082	53	1.35e-033.15e-03	-0.01	-2.01e-06	3.48e-05	0.0
1082	69	6.13e-042.38e-04	-0.01	-1.16e-05	3.21e-05	0.0
1082	70	6.40e-042.74e-04	-0.01	-1.33e-05	3.33e-05	0.0
1082	71	6.13e-042.38e-04	-0.01	-1.16e-05	3.21e-05	0.0
1082	72	6.18e-042.45e-04	-0.01	-1.20e-05	3.23e-05	0.0
1082	73	6.13e-042.38e-04	-0.01	-1.16e-05	3.21e-05	0.0
1083	1	9.16e-047.93e-04	-0.02	-3.88e-05	4.81e-05	0.0
1083	2	9.67e-049.30e-04	-0.02	-4.53e-05	5.05e-05	0.0
1083	14	2.66e-03-4.74e-04	-0.02	-3.93e-05	4.76e-05	0.0
1083	18	2.67e-03-1.94e-04	-0.02	-3.87e-05	4.73e-05	0.0
1083	21	1.13e-032.76e-03	-0.01	-2.60e-05	3.48e-05	0.0
1083	46	3.47e-03-8.98e-04	-0.02	-4.34e-05	5.32e-05	0.0
1083	50	3.48e-03-5.01e-04	-0.02	-4.25e-05	5.29e-05	0.0
1083	53	1.33e-033.63e-03	-0.01	-2.48e-05	3.53e-05	0.0
1083	69	6.42e-045.93e-04	-0.01	-2.90e-05	3.36e-05	0.0
1083	70	6.75e-046.85e-04	-0.01	-3.34e-05	3.52e-05	0.0
1083	71	6.42e-045.93e-04	-0.01	-2.90e-05	3.36e-05	0.0
1083	72	6.48e-046.12e-04	-0.01	-2.99e-05	3.39e-05	0.0
1083	73	6.42e-045.93e-04	-0.01	-2.90e-05	3.36e-05	0.0



EGP CODE

GRE.EEC.R.73.IT.W.15235.12.024.01

PAGE

237 di/of 527

1084	2	1.06e-031.54e-03	-0.02	-7.50e-05	5.51e-05	0.0
1084	14	2.88e-038.03e-04	-0.02	-5.91e-05	5.60e-05	0.0
1084	18	2.89e-031.10e-03	-0.02	-5.95e-05	5.57e-05	0.0
1084	21	1.18e-033.30e-03	-0.02	-5.35e-05	3.79e-05	0.0
1084	46	3.75e-037.27e-04	-0.02	-6.36e-05	6.39e-05	0.0
1084	50	3.77e-031.15e-03	-0.02	-6.42e-05	6.34e-05	0.0
1084	53	1.37e-034.23e-03	-0.02	-5.57e-05	3.85e-05	0.0
1084	70	7.47e-041.13e-03	-0.02	-5.52e-05	3.88e-05	0.0
1084	72	7.09e-041.01e-03	-0.02	-4.94e-05	3.70e-05	0.0
1084	73	7.00e-049.80e-04	-0.02	-4.79e-05	3.65e-05	0.0
1085	2	1.20e-032.20e-03	-0.03	-1.07e-04	6.25e-05	0.0
1085	14	3.19e-031.17e-03	-0.02	-7.82e-05	6.88e-05	0.0
1085	18	3.22e-031.50e-03	-0.02	-8.00e-05	6.84e-05	0.0
1085	21	1.29e-033.96e-03	-0.02	-8.48e-05	4.40e-05	0.0
1085	46	4.15e-031.07e-03	-0.02	-8.23e-05	7.98e-05	0.0
1085	50	4.19e-031.54e-03	-0.02	-8.49e-05	7.92e-05	0.0
1085	53	1.48e-034.99e-03	-0.02	-9.14e-05	4.51e-05	0.0
1085	70	8.61e-041.62e-03	-0.02	-7.88e-05	4.46e-05	0.0
1085	72	8.06e-041.44e-03	-0.02	-7.02e-05	4.19e-05	0.0
1085	73	7.92e-041.39e-03	-0.02	-6.80e-05	4.12e-05	0.0
1086	2	1.40e-032.85e-03	-0.03	-1.38e-04	7.31e-05	0.0
1086	13	3.52e-033.13e-03	-0.03	-1.11e-04	8.46e-05	0.0
1086	17	3.61e-032.75e-03	-0.03	-1.07e-04	8.42e-05	0.0
1086	21	1.49e-034.70e-03	-0.02	-1.20e-04	5.77e-05	0.0
1086	45	4.56e-033.65e-03	-0.03	-1.20e-04	9.93e-05	0.0
1086	49	4.69e-033.12e-03	-0.03	-1.15e-04	9.87e-05	0.0
1086	53	1.72e-035.86e-03	-0.03	-1.33e-04	6.15e-05	0.0
1086	70	1.02e-032.11e-03	-0.02	-1.02e-04	5.30e-05	0.0
1086	72	9.42e-041.86e-03	-0.02	-9.05e-05	4.90e-05	0.0
1086	73	9.22e-041.80e-03	-0.02	-8.76e-05	4.80e-05	0.0
1087	2	1.57e-033.49e-03	-0.04	-1.67e-04	8.46e-05	0.0
1087	13	4.12e-032.47e-03	-0.03	-1.33e-04	1.12e-04	0.0
1087	17	4.25e-032.01e-03	-0.03	-1.25e-04	1.11e-04	0.0
1087	21	1.64e-035.68e-03	-0.03	-1.65e-04	7.07e-05	0.0
1087	45	5.36e-032.59e-03	-0.03	-1.43e-04	1.34e-04	0.0
1087	49	5.54e-031.95e-03	-0.03	-1.32e-04	1.33e-04	0.0
1087	53	1.88e-037.09e-03	-0.03	-1.89e-04	7.68e-05	0.0
1087	70	1.15e-032.58e-03	-0.03	-1.23e-04	6.21e-05	0.0
1087	72	1.06e-032.26e-03	-0.03	-1.08e-04	5.68e-05	0.0
1087	73	1.03e-032.18e-03	-0.03	-1.05e-04	5.54e-05	0.0
1088	2	1.30e-03-3.27e-03	-0.05	1.60e-04	6.87e-05	0.0
1088	10	2.60e-03-2.50e-03	-0.03	1.03e-04	4.11e-05	0.0
1088	24	4.52e-04-4.71e-03	-0.04	1.46e-04	6.24e-05	0.0
1088	42	3.33e-03-2.70e-03	-0.03	1.04e-04	4.08e-05	0.0
1088	56	3.17e-04-5.80e-03	-0.04	1.66e-04	7.06e-05	0.0
1088	70	9.71e-04-2.37e-03	-0.03	1.16e-04	5.14e-05	0.0
1088	72	8.25e-04-2.08e-03	-0.03	1.02e-04	4.37e-05	0.0
1088	73	7.89e-04-2.01e-03	-0.03	9.86e-05	4.18e-05	0.0
1089	2	1.59e-03-3.32e-03	-0.04	1.61e-04	8.13e-05	0.0
1089	6	4.13e-03-3.53e-03	-0.03	1.34e-04	1.09e-04	0.0
1089	10	4.22e-03-3.12e-03	-0.03	1.28e-04	1.08e-04	0.0
1089	26	1.74e-03-5.30e-03	-0.03	1.50e-04	6.93e-05	0.0
1089	38	5.37e-03-4.09e-03	-0.03	1.47e-04	1.31e-04	0.0
1089	42	5.49e-03-3.51e-03	-0.03	1.39e-04	1.30e-04	0.0
1089	58	2.02e-03-6.59e-03	-0.03	1.69e-04	7.57e-05	0.0
1089	70	1.17e-03-2.46e-03	-0.03	1.19e-04	5.96e-05	0.0
1089	72	1.06e-03-2.16e-03	-0.03	1.05e-04	5.44e-05	0.0
1089	73	1.04e-03-2.09e-03	-0.03	1.02e-04	5.31e-05	0.0
1090	2	1.31e-03-2.71e-03	-0.03	1.31e-04	6.73e-05	0.0
1090	6	3.43e-03-2.99e-03	-0.03	1.11e-04	8.01e-05	0.0
1090	10	3.53e-03-2.63e-03	-0.03	1.07e-04	8.03e-05	0.0
1090	26	1.41e-03-4.56e-03	-0.02	1.12e-04	4.98e-05	0.0
1090	38	4.46e-03-3.50e-03	-0.03	1.21e-04	9.44e-05	0.0
1090	42	4.59e-03-2.98e-03	-0.03	1.17e-04	9.48e-05	0.0
1090	58	1.63e-03-5.70e-03	-0.02	1.24e-04	5.19e-05	0.0
1090	70	9.47e-04-2.01e-03	-0.02	9.72e-05	4.86e-05	0.0
1090	72	8.75e-04-1.77e-03	-0.02	8.62e-05	4.51e-05	0.0
1090	73	8.57e-04-1.72e-03	-0.02	8.34e-05	4.43e-05	0.0
1091	2	1.11e-03-2.01e-03	-0.03	9.78e-05	5.75e-05	0.0
1091	5	3.09e-03-1.05e-03	-0.02	7.82e-05	6.50e-05	0.0
1091	9	3.12e-03-1.37e-03	-0.02	7.93e-05	6.46e-05	0.0
1091	26	1.22e-03-3.77e-03	-0.02	7.48e-05	4.05e-05	0.0
1091	37	4.04e-03-9.52e-04	-0.02	8.45e-05	7.58e-05	0.0
1091	41	4.07e-03-1.40e-03	-0.02	8.60e-05	7.52e-05	0.0
1091	58	1.42e-03-4.76e-03	-0.02	7.97e-05	4.14e-05	0.0
1091	70	7.91e-04-1.49e-03	-0.02	7.23e-05	4.09e-05	0.0



EGP CODE

GRE.EEC.R.73.IT.W.15235.12.024.01

PAGE

238 di/of 527

1091	72	7.44e-04-1.32e-03	-0.02	6.43e-05	3.86e-05	0.0
1091	73	7.32e-04-1.28e-03	-0.02	6.24e-05	3.80e-05	0.0
1092	2	9.80e-04-1.34e-03	-0.02	6.53e-05	5.11e-05	0.0
1092	5	2.79e-03-6.82e-04	-0.02	5.65e-05	5.29e-05	0.0
1092	9	2.81e-03-9.70e-04	-0.02	5.64e-05	5.25e-05	0.0
1092	26	1.13e-03-3.12e-03	-0.02	4.26e-05	3.51e-05	0.0
1092	37	3.65e-03-6.08e-04	-0.02	6.23e-05	6.05e-05	0.0
1092	41	3.67e-03-1.02e-03	-0.02	6.22e-05	5.99e-05	0.0
1092	58	1.32e-03-4.03e-03	-0.02	4.30e-05	3.56e-05	0.0
1092	70	6.90e-04-9.90e-04	-0.02	4.82e-05	3.58e-05	0.0
1092	72	6.58e-04-8.81e-04	-0.02	4.31e-05	3.43e-05	0.0
1092	73	6.50e-04-8.54e-04	-0.02	4.18e-05	3.39e-05	0.0
1093	1	8.61e-04-6.20e-04	-0.02	3.04e-05	4.53e-05	0.0
1093	2	9.04e-04-7.29e-04	-0.02	3.56e-05	4.73e-05	0.0
1093	5	2.60e-035.88e-04	-0.02	3.45e-05	4.51e-05	0.0
1093	9	2.60e-033.16e-04	-0.02	3.36e-05	4.49e-05	0.0
1093	26	1.11e-03-2.60e-03	-0.01	1.76e-05	3.29e-05	0.0
1093	37	3.39e-031.01e-03	-0.02	3.91e-05	5.06e-05	0.0
1093	41	3.41e-036.21e-04	-0.02	3.78e-05	5.03e-05	0.0
1093	58	1.31e-03-3.45e-03	-0.01	1.55e-05	3.35e-05	0.0
1093	69	6.01e-04-4.66e-04	-0.01	2.28e-05	3.15e-05	0.0
1093	70	6.30e-04-5.38e-04	-0.01	2.63e-05	3.29e-05	0.0
1093	71	6.01e-04-4.66e-04	-0.01	2.28e-05	3.15e-05	0.0
1093	72	6.07e-04-4.80e-04	-0.01	2.35e-05	3.18e-05	0.0
1093	73	6.01e-04-4.66e-04	-0.01	2.28e-05	3.15e-05	0.0
1094	1	8.36e-04-1.41e-04	-0.02	6.96e-06	4.41e-05	0.0
1094	2	8.72e-04-1.65e-04	-0.02	8.13e-06	4.58e-05	0.0
1094	5	2.48e-039.74e-04	-0.01	1.33e-05	4.10e-05	0.0
1094	9	2.48e-037.08e-04	-0.01	1.21e-05	4.09e-05	0.0
1094	26	1.13e-03-2.17e-03	-0.01	-2.61e-06	3.30e-05	0.0
1094	37	3.24e-031.40e-03	-0.02	1.65e-05	4.52e-05	0.0
1094	41	3.24e-031.03e-03	-0.02	1.48e-05	4.51e-05	0.0
1094	58	1.35e-03-3.00e-03	-0.01	-5.76e-06	3.40e-05	0.0
1094	69	5.81e-04-1.06e-04	-0.01	5.22e-06	3.05e-05	0.0
1094	70	6.05e-04-1.22e-04	-0.01	6.00e-06	3.16e-05	0.0
1094	71	5.81e-04-1.06e-04	-0.01	5.22e-06	3.05e-05	0.0
1094	72	5.85e-04-1.09e-04	-0.01	5.38e-06	3.07e-05	0.0
1094	73	5.81e-04-1.06e-04	-0.01	5.22e-06	3.05e-05	0.0
1095	1	8.41e-043.29e-04	-0.02	-1.60e-05	4.44e-05	0.0
1095	2	8.79e-043.87e-04	-0.02	-1.87e-05	4.61e-05	0.0
1095	14	2.51e-03-8.25e-04	-0.02	-2.14e-05	4.20e-05	0.0
1095	18	2.51e-03-5.57e-04	-0.02	-2.02e-05	4.19e-05	0.0
1095	21	1.11e-032.33e-03	-0.01	-4.65e-06	3.27e-05	0.0
1095	46	3.28e-03-1.25e-03	-0.02	-2.51e-05	4.66e-05	0.0
1095	50	3.28e-03-8.72e-04	-0.02	-2.35e-05	4.64e-05	0.0
1095	53	1.32e-033.16e-03	-0.01	-1.68e-06	3.35e-05	0.0
1095	69	5.85e-042.47e-04	-0.01	-1.20e-05	3.07e-05	0.0
1095	70	6.10e-042.85e-04	-0.01	-1.38e-05	3.19e-05	0.0
1095	71	5.85e-042.47e-04	-0.01	-1.20e-05	3.07e-05	0.0
1095	72	5.90e-042.55e-04	-0.01	-1.24e-05	3.10e-05	0.0
1095	73	5.85e-042.47e-04	-0.01	-1.20e-05	3.07e-05	0.0
1096	1	8.77e-048.21e-04	-0.02	-4.01e-05	4.62e-05	0.0
1096	2	9.25e-049.67e-04	-0.02	-4.70e-05	4.85e-05	0.0
1096	14	2.65e-034.83e-04	-0.02	-4.29e-05	4.74e-05	0.0
1096	18	2.66e-037.61e-04	-0.02	-4.23e-05	4.71e-05	0.0
1096	21	1.10e-032.79e-03	-0.01	-2.69e-05	3.34e-05	0.0
1096	46	3.47e-034.25e-04	-0.02	-4.81e-05	5.35e-05	0.0
1096	50	3.48e-038.18e-04	-0.02	-4.71e-05	5.31e-05	0.0
1096	53	1.30e-033.66e-03	-0.01	-2.56e-05	3.39e-05	0.0
1096	69	6.14e-046.17e-04	-0.02	-3.01e-05	3.23e-05	0.0
1096	70	6.46e-047.14e-04	-0.02	-3.47e-05	3.38e-05	0.0
1096	71	6.14e-046.17e-04	-0.02	-3.01e-05	3.23e-05	0.0
1096	72	6.21e-046.36e-04	-0.02	-3.10e-05	3.26e-05	0.0
1096	73	6.14e-046.17e-04	-0.02	-3.01e-05	3.23e-05	0.0
1097	2	1.02e-031.60e-03	-0.02	-7.79e-05	5.32e-05	0.0
1097	14	2.88e-038.29e-04	-0.02	-6.48e-05	5.66e-05	0.0
1097	18	2.90e-031.13e-03	-0.02	-6.51e-05	5.61e-05	0.0
1097	21	1.15e-033.36e-03	-0.02	-5.60e-05	3.66e-05	0.0
1097	46	3.77e-037.46e-04	-0.02	-7.08e-05	6.51e-05	0.0
1097	50	3.79e-031.17e-03	-0.02	-7.13e-05	6.45e-05	0.0
1097	53	1.34e-034.30e-03	-0.02	-5.84e-05	3.71e-05	0.0
1097	70	7.19e-041.18e-03	-0.02	-5.75e-05	3.75e-05	0.0
1097	72	6.83e-041.05e-03	-0.02	-5.13e-05	3.57e-05	0.0
1097	73	6.74e-041.02e-03	-0.02	-4.98e-05	3.53e-05	0.0
1098	2	1.16e-032.29e-03	-0.03	-1.11e-04	6.07e-05	0.0
1098	14	3.22e-031.21e-03	-0.02	-8.66e-05	7.05e-05	0.0



EGP CODE

GRE.EEC.R.73.IT.W.15235.12.024.01

PAGE

239 di/of 527

1098	18	3.25e-031.54e-03	-0.02	-8.85e-05	7.01e-05	0.0
1098	21	1.27e-034.06e-03	-0.02	-8.91e-05	4.33e-05	0.0
1098	46	4.21e-031.10e-03	-0.02	-9.30e-05	8.28e-05	0.0
1098	50	4.25e-031.57e-03	-0.02	-9.56e-05	8.21e-05	0.0
1098	53	1.47e-035.10e-03	-0.02	-9.64e-05	4.45e-05	0.0
1098	70	8.36e-041.70e-03	-0.02	-8.22e-05	4.34e-05	0.0
1098	72	7.82e-041.50e-03	-0.02	-7.31e-05	4.08e-05	0.0
1098	73	7.68e-041.45e-03	-0.02	-7.09e-05	4.01e-05	0.0
1099	2	1.38e-032.99e-03	-0.04	-1.44e-04	7.17e-05	0.0
1099	13	3.59e-033.23e-03	-0.03	-1.22e-04	8.79e-05	0.0
1099	17	3.68e-032.85e-03	-0.03	-1.17e-04	8.74e-05	0.0
1099	21	1.48e-034.89e-03	-0.03	-1.28e-04	5.75e-05	0.0
1099	45	4.66e-033.76e-03	-0.03	-1.34e-04	1.04e-04	0.0
1099	49	4.79e-033.22e-03	-0.03	-1.28e-04	1.04e-04	0.0
1099	53	1.71e-036.10e-03	-0.03	-1.43e-04	6.16e-05	0.0
1099	70	1.01e-032.21e-03	-0.03	-1.07e-04	5.21e-05	0.0
1099	72	9.26e-041.95e-03	-0.02	-9.45e-05	4.80e-05	0.0
1099	73	9.06e-041.88e-03	-0.02	-9.15e-05	4.70e-05	0.0
1100	2	1.68e-033.53e-03	-0.04	-1.71e-04	8.67e-05	0.0
1100	13	4.46e-033.76e-03	-0.04	-1.44e-04	1.24e-04	0.0
1100	17	4.53e-033.32e-03	-0.03	-1.36e-04	1.23e-04	0.0
1100	21	1.94e-035.67e-03	-0.03	-1.70e-04	7.85e-05	0.0
1100	45	5.82e-034.38e-03	-0.04	-1.58e-04	1.51e-04	0.0
1100	49	5.90e-033.75e-03	-0.04	-1.47e-04	1.49e-04	0.0
1100	53	2.28e-037.06e-03	-0.03	-1.95e-04	8.74e-05	0.0
1100	70	1.25e-032.62e-03	-0.03	-1.27e-04	6.38e-05	0.0
1100	72	1.13e-032.29e-03	-0.03	-1.12e-04	5.79e-05	0.0
1100	73	1.10e-032.21e-03	-0.03	-1.08e-04	5.64e-05	0.0
1101	2	-9.43e-043.17e-03	-0.05	-1.55e-04	-5.67e-05	0.0
1101	15	-4.35e-033.27e-03	-0.05	-1.24e-04	-1.06e-04	0.0
1101	31	-1.30e-035.44e-03	-0.05	-1.64e-04	-6.05e-05	0.0
1101	35	-1.58e-035.36e-03	-0.05	-1.63e-04	-6.66e-05	0.0
1101	47	-5.84e-033.76e-03	-0.05	-1.34e-04	-1.33e-04	0.0
1101	63	-1.56e-036.82e-03	-0.05	-1.90e-04	-6.95e-05	0.0
1101	67	-1.96e-036.71e-03	-0.05	-1.88e-04	-7.81e-05	0.0
1101	70	-6.91e-042.34e-03	-0.04	-1.15e-04	-4.15e-05	0.0
1101	72	-6.50e-042.06e-03	-0.04	-1.01e-04	-3.87e-05	0.0
1101	73	-6.40e-041.99e-03	-0.04	-9.79e-05	-3.81e-05	0.0
1102	2	1.17e-043.63e-03	-0.05	-1.79e-04	5.39e-06	0.0
1102	14	2.88e-032.21e-03	-0.03	-9.95e-05	2.56e-05	0.0
1102	31	-3.87e-045.27e-03	-0.04	-1.61e-04	-3.34e-06	0.0
1102	33	1.05e-035.27e-03	-0.04	-1.59e-04	7.75e-06	0.0
1102	46	4.01e-032.20e-03	-0.03	-9.49e-05	3.46e-05	0.0
1102	63	-5.68e-046.49e-03	-0.04	-1.82e-04	-5.80e-06	0.0
1102	65	1.45e-036.48e-03	-0.04	-1.79e-04	9.72e-06	0.0
1102	70	8.46e-052.66e-03	-0.04	-1.31e-04	4.07e-06	0.0
1102	72	7.07e-052.33e-03	-0.03	-1.15e-04	3.10e-06	0.0
1102	73	6.72e-052.25e-03	-0.03	-1.12e-04	2.86e-06	0.0
1103	2	-5.97e-053.66e-03	-0.05	-1.85e-04	-3.56e-06	0.0
1103	4	-6.19e-052.77e-03	-0.04	-1.40e-04	-3.07e-06	0.0
1103	15	-2.63e-032.54e-03	-0.04	-1.23e-04	-2.01e-05	0.0
1103	33	8.60e-045.13e-03	-0.04	-1.67e-04	0.0	0.0
1103	47	-3.67e-032.65e-03	-0.04	-1.27e-04	-2.73e-05	0.0
1103	65	1.22e-036.28e-03	-0.04	-1.89e-04	2.21e-06	0.0
1103	70	-4.92e-052.67e-03	-0.04	-1.35e-04	-2.76e-06	0.0
1103	72	-3.95e-052.34e-03	-0.04	-1.19e-04	-2.42e-06	0.0
1103	73	-3.71e-052.26e-03	-0.03	-1.15e-04	-2.33e-06	0.0
1104	2	-4.68e-053.73e-03	-0.05	-1.89e-04	0.0	0.0
1104	15	-2.58e-032.84e-03	-0.04	-1.29e-04	-2.07e-05	0.0
1104	31	-5.47e-045.18e-03	-0.04	-1.74e-04	-5.34e-06	0.0
1104	35	-6.65e-045.17e-03	-0.04	-1.74e-04	-7.38e-06	0.0
1104	47	-3.61e-033.05e-03	-0.04	-1.35e-04	-2.90e-05	0.0
1104	63	-7.56e-046.34e-03	-0.04	-1.97e-04	-7.45e-06	0.0
1104	67	-9.21e-046.33e-03	-0.04	-1.98e-04	-1.03e-05	0.0
1104	70	-3.68e-052.72e-03	-0.04	-1.38e-04	0.0	0.0
1104	72	-2.74e-052.38e-03	-0.04	-1.21e-04	0.0	0.0
1104	73	-2.51e-052.30e-03	-0.03	-1.16e-04	0.0	0.0
1105	2	-1.80e-044.02e-03	-0.05	-1.98e-04	-1.05e-05	0.0
1105	15	-2.71e-033.00e-03	-0.04	-1.31e-04	-3.07e-05	0.0
1105	29	7.07e-045.42e-03	-0.04	-1.82e-04	-2.73e-06	0.0
1105	33	8.12e-045.42e-03	-0.04	-1.82e-04	0.0	0.0
1105	47	-3.75e-033.22e-03	-0.04	-1.35e-04	-4.03e-05	0.0
1105	61	1.04e-036.61e-03	-0.05	-2.06e-04	-1.13e-06	0.0
1105	65	1.19e-036.61e-03	-0.05	-2.06e-04	2.25e-06	0.0
1105	70	-1.36e-042.93e-03	-0.04	-1.44e-04	-7.89e-06	0.0
1105	72	-1.22e-042.55e-03	-0.04	-1.26e-04	-6.98e-06	0.0



EGP CODE

GRE.EEC.R.73.IT.W.15235.12.024.01

PAGE

240 di/of 527

1105	73	-1.18e-042.45e-03	-0.04	-1.21e-04	-6.76e-06	0.0
1106	2	1.30e-043.95e-03	-0.06	-2.00e-04	4.80e-06	0.0
1106	17	2.57e-033.19e-03	-0.04	-1.40e-04	2.73e-05	0.0
1106	23	-8.33e-044.90e-03	-0.04	-1.79e-04	0.0	0.0
1106	25	5.16e-044.92e-03	-0.04	-1.79e-04	1.15e-05	0.0
1106	49	3.58e-033.50e-03	-0.04	-1.48e-04	3.72e-05	0.0
1106	55	-1.20e-035.90e-03	-0.05	-2.01e-04	-1.84e-06	0.0
1106	57	6.93e-045.92e-03	-0.05	-2.02e-04	1.50e-05	0.0
1106	70	9.70e-052.88e-03	-0.04	-1.46e-04	3.58e-06	0.0
1106	72	7.87e-052.50e-03	-0.04	-1.27e-04	2.96e-06	0.0
1106	73	7.41e-052.41e-03	-0.04	-1.22e-04	2.81e-06	0.0
1107	2	-9.72e-053.88e-03	-0.05	-1.97e-04	-1.19e-06	0.0
1107	20	-2.58e-031.86e-03	-0.03	-1.10e-04	-2.33e-05	0.0
1107	23	-9.19e-045.30e-03	-0.04	-1.86e-04	-6.25e-06	0.0
1107	27	-1.03e-035.30e-03	-0.04	-1.86e-04	-8.59e-06	0.0
1107	52	-3.59e-031.65e-03	-0.03	-1.06e-04	-3.24e-05	0.0
1107	55	-1.26e-036.47e-03	-0.05	-2.12e-04	-8.51e-06	0.0
1107	59	-1.41e-036.48e-03	-0.05	-2.12e-04	-1.18e-05	0.0
1107	70	-7.08e-052.83e-03	-0.04	-1.43e-04	0.0	0.0
1107	72	-5.86e-052.46e-03	-0.04	-1.25e-04	0.0	0.0
1107	73	-5.55e-052.37e-03	-0.04	-1.20e-04	0.0	0.0
1108	2	3.25e-043.94e-03	-0.05	-1.94e-04	2.05e-05	0.0
1108	17	2.84e-032.73e-03	-0.04	-1.26e-04	3.46e-05	0.0
1108	27	-6.79e-045.56e-03	-0.04	-1.79e-04	9.26e-06	0.0
1108	49	3.89e-032.85e-03	-0.04	-1.29e-04	4.32e-05	0.0
1108	59	-1.03e-036.82e-03	-0.05	-2.03e-04	7.76e-06	0.0
1108	70	2.48e-042.88e-03	-0.04	-1.42e-04	1.55e-05	0.0
1108	72	2.16e-042.51e-03	-0.04	-1.24e-04	1.35e-05	0.0
1108	73	2.08e-042.42e-03	-0.04	-1.20e-04	1.30e-05	0.0
1109	2	-6.27e-043.70e-03	-0.05	-1.86e-04	-3.05e-05	0.0
1109	19	-3.03e-033.06e-03	-0.04	-1.22e-04	-4.06e-05	0.0
1109	21	-2.94e-055.34e-03	-0.04	-1.70e-04	-2.03e-05	0.0
1109	25	1.31e-045.14e-03	-0.04	-1.70e-04	-1.83e-05	0.0
1109	51	-4.08e-033.37e-03	-0.04	-1.25e-04	-4.93e-05	0.0
1109	53	1.14e-046.56e-03	-0.04	-1.92e-04	-2.08e-05	0.0
1109	57	3.40e-046.29e-03	-0.04	-1.92e-04	-1.80e-05	0.0
1109	70	-4.65e-042.70e-03	-0.04	-1.36e-04	-2.28e-05	0.0
1109	72	-4.05e-042.37e-03	-0.04	-1.19e-04	-1.96e-05	0.0
1109	73	-3.90e-042.29e-03	-0.03	-1.15e-04	-1.88e-05	0.0
1110	2	1.64e-033.34e-03	-0.06	-1.62e-04	9.21e-05	0.0
1110	17	4.67e-033.29e-03	-0.04	-1.26e-04	1.27e-04	0.0
1110	21	1.92e-035.75e-03	-0.05	-1.72e-04	8.80e-05	0.0
1110	25	2.18e-035.67e-03	-0.05	-1.70e-04	9.39e-05	0.0
1110	49	6.11e-033.75e-03	-0.05	-1.35e-04	1.54e-04	0.0
1110	53	2.25e-037.21e-03	-0.05	-2.00e-04	9.93e-05	0.0
1110	57	2.63e-037.10e-03	-0.05	-1.98e-04	1.08e-04	0.0
1110	70	1.22e-032.48e-03	-0.04	-1.20e-04	6.81e-05	0.0
1110	72	1.10e-032.16e-03	-0.04	-1.05e-04	6.14e-05	0.0
1110	73	1.07e-032.08e-03	-0.04	-1.01e-04	5.97e-05	0.0
1111	2	-1.27e-033.02e-03	-0.05	-1.47e-04	-6.74e-05	0.0
1111	15	-4.23e-033.03e-03	-0.04	-1.18e-04	-1.02e-04	0.0
1111	31	-1.75e-035.25e-03	-0.04	-1.53e-04	-7.03e-05	0.0
1111	35	-1.99e-035.14e-03	-0.04	-1.52e-04	-7.49e-05	0.0
1111	47	-5.58e-033.46e-03	-0.04	-1.28e-04	-1.26e-04	0.0
1111	63	-2.12e-036.60e-03	-0.05	-1.77e-04	-8.05e-05	0.0
1111	67	-2.45e-036.43e-03	-0.05	-1.76e-04	-8.70e-05	0.0
1111	70	-9.36e-042.23e-03	-0.04	-1.09e-04	-4.96e-05	0.0
1111	72	-8.62e-041.97e-03	-0.03	-9.61e-05	-4.58e-05	0.0
1111	73	-8.44e-041.90e-03	-0.03	-9.30e-05	-4.49e-05	0.0
1112	2	-8.56e-042.83e-03	-0.05	-1.39e-04	-4.65e-05	0.0
1112	15	-3.28e-032.92e-03	-0.04	-1.04e-04	-5.92e-05	0.0
1112	31	-1.36e-034.92e-03	-0.04	-1.37e-04	-5.04e-05	0.0
1112	35	-1.52e-034.88e-03	-0.04	-1.36e-04	-5.18e-05	0.0
1112	47	-4.37e-033.37e-03	-0.04	-1.10e-04	-7.02e-05	0.0
1112	63	-1.67e-036.18e-03	-0.04	-1.56e-04	-5.79e-05	0.0
1112	67	-1.90e-036.11e-03	-0.04	-1.55e-04	-5.99e-05	0.0
1112	70	-6.31e-042.08e-03	-0.03	-1.02e-04	-3.41e-05	0.0
1112	72	-5.92e-041.84e-03	-0.03	-9.05e-05	-3.21e-05	0.0
1112	73	-5.83e-041.78e-03	-0.03	-8.76e-05	-3.16e-05	0.0
1113	1	-2.47e-042.35e-03	-0.04	-1.16e-04	-1.48e-05	0.0
1113	2	-2.17e-042.78e-03	-0.05	-1.37e-04	-1.30e-05	0.0
1113	15	-2.57e-031.65e-03	-0.03	-9.95e-05	-2.29e-05	0.0
1113	31	-5.94e-044.69e-03	-0.04	-1.29e-04	-1.89e-05	0.0
1113	47	-3.53e-031.60e-03	-0.03	-1.04e-04	-2.78e-05	0.0
1113	63	-7.61e-045.88e-03	-0.04	-1.46e-04	-2.23e-05	0.0
1113	69	-1.75e-041.75e-03	-0.03	-8.66e-05	-1.03e-05	0.0





EGP CODE

GRE.EEC.R.73.IT.W.15235.12.024.01

PAGE

241 di/of 527

1113	70	-1.55e-042.03e-03	-0.03	-1.00e-04	-9.14e-06	0.0
1113	71	-1.75e-041.75e-03	-0.03	-8.66e-05	-1.03e-05	0.0
1113	72	-1.71e-041.80e-03	-0.03	-8.93e-05	-1.01e-05	0.0
1113	73	-1.75e-041.75e-03	-0.03	-8.66e-05	-1.03e-05	0.0
1114	2	4.12e-042.94e-03	-0.05	-1.45e-04	2.01e-05	0.0
1114	13	2.50e-031.81e-03	-0.03	-9.21e-05	1.75e-05	0.0
1114	31	-7.84e-054.76e-03	-0.04	-1.33e-04	1.29e-05	0.0
1114	45	3.41e-031.79e-03	-0.03	-9.24e-05	2.01e-05	0.0
1114	63	-2.00e-045.94e-03	-0.04	-1.50e-04	1.37e-05	0.0
1114	70	3.12e-042.15e-03	-0.03	-1.06e-04	1.54e-05	0.0
1114	72	2.44e-041.90e-03	-0.03	-9.42e-05	1.17e-05	0.0
1114	73	2.27e-041.84e-03	-0.03	-9.13e-05	1.08e-05	0.0
1115	2	7.75e-043.28e-03	-0.05	-1.61e-04	3.94e-05	0.0
1115	13	2.82e-033.02e-03	-0.03	-1.03e-04	3.41e-05	0.0
1115	31	2.28e-045.09e-03	-0.04	-1.49e-04	2.94e-05	0.0
1115	45	3.77e-033.40e-03	-0.03	-1.04e-04	3.84e-05	0.0
1115	63	1.35e-046.31e-03	-0.04	-1.69e-04	3.19e-05	0.0
1115	70	5.80e-042.40e-03	-0.04	-1.17e-04	2.97e-05	0.0
1115	72	4.86e-042.11e-03	-0.03	-1.04e-04	2.45e-05	0.0
1115	73	4.62e-042.04e-03	-0.03	-1.00e-04	2.32e-05	0.0
1116	2	4.43e-043.49e-03	-0.05	-1.72e-04	2.31e-05	0.0
1116	13	3.05e-033.19e-03	-0.03	-1.13e-04	4.03e-05	0.0
1116	31	-1.01e-045.24e-03	-0.04	-1.61e-04	1.26e-05	0.0
1116	33	1.32e-035.25e-03	-0.04	-1.59e-04	2.55e-05	0.0
1116	45	4.17e-033.59e-03	-0.03	-1.15e-04	5.10e-05	0.0
1116	63	-2.46e-046.47e-03	-0.04	-1.83e-04	1.23e-05	0.0
1116	65	1.75e-036.49e-03	-0.04	-1.79e-04	3.03e-05	0.0
1116	70	3.27e-042.55e-03	-0.04	-1.26e-04	1.73e-05	0.0
1116	72	2.76e-042.24e-03	-0.03	-1.11e-04	1.43e-05	0.0
1116	73	2.63e-042.17e-03	-0.03	-1.07e-04	1.36e-05	0.0
1117	2	-1.86e-043.54e-03	-0.05	-1.75e-04	-1.16e-05	0.0
1117	15	-2.84e-032.31e-03	-0.03	-1.14e-04	-3.14e-05	0.0
1117	31	-5.89e-045.26e-03	-0.04	-1.60e-04	-1.72e-05	0.0
1117	33	8.11e-045.23e-03	-0.04	-1.63e-04	-5.57e-06	0.0
1117	47	-3.93e-032.35e-03	-0.03	-1.16e-04	-4.09e-05	0.0
1117	63	-7.78e-046.49e-03	-0.04	-1.81e-04	-2.11e-05	0.0
1117	65	1.18e-036.45e-03	-0.04	-1.84e-04	-4.80e-06	0.0
1117	70	-1.42e-042.59e-03	-0.04	-1.28e-04	-8.64e-06	0.0
1117	72	-1.22e-042.27e-03	-0.03	-1.12e-04	-7.71e-06	0.0
1117	73	-1.17e-042.19e-03	-0.03	-1.09e-04	-7.47e-06	0.0
1118	2	-5.40e-043.45e-03	-0.05	-1.69e-04	-2.90e-05	0.0
1118	15	-2.41e-032.19e-03	-0.03	-1.07e-04	-1.67e-05	0.0
1118	33	1.12e-045.13e-03	-0.04	-1.54e-04	-2.87e-05	0.0
1118	47	-3.25e-032.20e-03	-0.03	-1.07e-04	-1.60e-05	0.0
1118	65	2.92e-046.32e-03	-0.04	-1.74e-04	-3.29e-05	0.0
1118	70	-4.11e-042.52e-03	-0.04	-1.24e-04	-2.19e-05	0.0
1118	72	-3.52e-042.22e-03	-0.03	-1.09e-04	-1.90e-05	0.0
1118	73	-3.37e-042.15e-03	-0.03	-1.06e-04	-1.82e-05	0.0
1119	2	-2.62e-043.26e-03	-0.05	-1.61e-04	-1.42e-05	0.0
1119	15	-2.00e-032.09e-03	-0.03	-1.03e-04	3.55e-06	0.0
1119	33	4.71e-044.83e-03	-0.04	-1.41e-04	-1.89e-05	0.0
1119	47	-2.74e-032.12e-03	-0.03	-1.03e-04	8.66e-06	0.0
1119	65	7.26e-045.95e-03	-0.04	-1.58e-04	-2.28e-05	0.0
1119	70	-2.03e-042.37e-03	-0.04	-1.17e-04	-1.08e-05	0.0
1119	72	-1.72e-042.10e-03	-0.03	-1.04e-04	-9.41e-06	0.0
1119	73	-1.65e-042.03e-03	-0.03	-1.01e-04	-9.07e-06	0.0
1120	2	2.13e-043.24e-03	-0.05	-1.60e-04	1.09e-05	0.0
1120	13	1.92e-032.77e-03	-0.03	-1.09e-04	-7.49e-06	0.0
1120	33	8.10e-044.78e-03	-0.04	-1.39e-04	6.20e-06	0.0
1120	45	2.64e-033.07e-03	-0.03	-1.12e-04	-1.31e-05	0.0
1120	65	1.08e-035.88e-03	-0.04	-1.55e-04	6.12e-06	0.0
1120	70	1.53e-042.36e-03	-0.04	-1.16e-04	7.96e-06	0.0
1120	72	1.34e-042.08e-03	-0.03	-1.03e-04	6.72e-06	0.0
1120	73	1.29e-042.02e-03	-0.03	-9.99e-05	6.40e-06	0.0
1121	2	6.06e-043.42e-03	-0.05	-1.68e-04	3.13e-05	0.0
1121	13	2.29e-032.84e-03	-0.03	-1.11e-04	1.21e-05	0.0
1121	31	1.78e-045.00e-03	-0.04	-1.49e-04	3.00e-05	0.0
1121	35	9.92e-054.84e-03	-0.04	-1.49e-04	3.10e-05	0.0
1121	45	3.06e-033.13e-03	-0.03	-1.13e-04	9.34e-06	0.0
1121	63	1.02e-046.15e-03	-0.04	-1.67e-04	3.44e-05	0.0
1121	67	-9.61e-065.94e-03	-0.04	-1.67e-04	3.58e-05	0.0
1121	70	4.48e-042.49e-03	-0.04	-1.22e-04	2.32e-05	0.0
1121	72	3.87e-042.20e-03	-0.03	-1.08e-04	1.98e-05	0.0
1121	73	3.71e-042.12e-03	-0.03	-1.04e-04	1.90e-05	0.0
1122	2	5.84e-043.54e-03	-0.05	-1.76e-04	2.90e-05	0.0
1122	13	2.72e-033.02e-03	-0.03	-1.21e-04	3.06e-05	0.0



EGP CODE

GRE.EEC.R.73.IT.W.15235.12.024.01

PAGE

242 di/of 527

1122	33	1.32e-035.18e-03	-0.04	-1.61e-04	2.88e-05	0.0
1122	35	-3.26e-054.98e-03	-0.04	-1.60e-04	2.20e-05	0.0
1122	45	3.66e-033.35e-03	-0.04	-1.25e-04	3.59e-05	0.0
1122	65	1.70e-036.38e-03	-0.04	-1.82e-04	3.33e-05	0.0
1122	67	-1.87e-046.10e-03	-0.04	-1.81e-04	2.38e-05	0.0
1122	70	4.30e-042.58e-03	-0.04	-1.28e-04	2.16e-05	0.0
1122	72	3.68e-042.27e-03	-0.03	-1.13e-04	1.84e-05	0.0
1122	73	3.53e-042.19e-03	-0.03	-1.09e-04	1.76e-05	0.0
1123	2	-4.29e-04-2.83e-03	-0.04	1.41e-04	-2.14e-05	0.0
1123	12	-1.82e-03-2.25e-03	-0.03	9.42e-05	1.41e-06	0.0
1123	24	-9.28e-04-4.29e-03	-0.03	1.22e-04	-1.30e-05	0.0
1123	28	-9.07e-04-4.28e-03	-0.03	1.22e-04	-1.47e-05	0.0
1123	44	-2.45e-03-2.45e-03	-0.03	9.69e-05	7.09e-06	0.0
1123	56	-1.20e-03-5.30e-03	-0.04	1.35e-04	-1.31e-05	0.0
1123	60	-1.17e-03-5.30e-03	-0.04	1.36e-04	-1.55e-05	0.0
1123	70	-3.17e-04-2.05e-03	-0.03	1.02e-04	-1.59e-05	0.0
1123	72	-2.69e-04-1.82e-03	-0.03	9.02e-05	-1.34e-05	0.0
1123	73	-2.57e-04-1.76e-03	-0.03	8.74e-05	-1.27e-05	0.0
1124	2	-7.21e-043.51e-03	-0.05	-1.74e-04	-3.67e-05	0.0
1124	15	-2.78e-032.79e-03	-0.03	-1.17e-04	-3.60e-05	0.0
1124	31	-1.17e-035.11e-03	-0.04	-1.59e-04	-3.30e-05	0.0
1124	33	5.93e-055.02e-03	-0.04	-1.60e-04	-2.71e-05	0.0
1124	47	-3.72e-033.03e-03	-0.03	-1.20e-04	-4.13e-05	0.0
1124	63	-1.46e-036.29e-03	-0.04	-1.80e-04	-3.71e-05	0.0
1124	65	2.59e-046.16e-03	-0.04	-1.81e-04	-2.89e-05	0.0
1124	70	-5.43e-042.56e-03	-0.04	-1.27e-04	-2.75e-05	0.0
1124	72	-4.59e-042.25e-03	-0.03	-1.12e-04	-2.36e-05	0.0
1124	73	-4.38e-042.17e-03	-0.03	-1.08e-04	-2.26e-05	0.0
1125	2	-7.31e-043.35e-03	-0.05	-1.64e-04	-3.81e-05	0.0
1125	15	-2.32e-032.35e-03	-0.03	-1.06e-04	-1.72e-05	0.0
1125	33	-6.13e-054.91e-03	-0.04	-1.47e-04	-3.59e-05	0.0
1125	47	-3.07e-032.46e-03	-0.03	-1.07e-04	-1.46e-05	0.0
1125	65	9.42e-056.05e-03	-0.04	-1.65e-04	-4.08e-05	0.0
1125	70	-5.51e-042.44e-03	-0.04	-1.20e-04	-2.86e-05	0.0
1125	72	-4.70e-042.15e-03	-0.03	-1.06e-04	-2.46e-05	0.0
1125	73	-4.49e-042.08e-03	-0.03	-1.02e-04	-2.36e-05	0.0
1126	2	-2.97e-043.14e-03	-0.05	-1.55e-04	-1.56e-05	0.0
1126	15	-1.91e-032.25e-03	-0.03	-1.01e-04	3.78e-06	0.0
1126	33	3.84e-044.63e-03	-0.04	-1.35e-04	-1.92e-05	0.0
1126	47	-2.60e-032.37e-03	-0.03	-1.03e-04	9.21e-06	0.0
1126	65	6.11e-045.71e-03	-0.04	-1.51e-04	-2.30e-05	0.0
1126	70	-2.26e-042.28e-03	-0.03	-1.12e-04	-1.17e-05	0.0
1126	72	-1.92e-042.02e-03	-0.03	-9.97e-05	-1.01e-05	0.0
1126	73	-1.83e-041.95e-03	-0.03	-9.65e-05	-9.71e-06	0.0
1127	2	2.70e-043.13e-03	-0.05	-1.55e-04	1.42e-05	0.0
1127	13	1.87e-032.49e-03	-0.03	-1.03e-04	-4.89e-06	0.0
1127	31	-1.19e-044.61e-03	-0.04	-1.35e-04	1.77e-05	0.0
1127	35	-1.58e-044.56e-03	-0.04	-1.35e-04	1.93e-05	0.0
1127	45	2.55e-032.71e-03	-0.03	-1.05e-04	-1.03e-05	0.0
1127	63	-2.32e-045.68e-03	-0.04	-1.51e-04	2.14e-05	0.0
1127	67	-2.88e-045.61e-03	-0.04	-1.51e-04	2.36e-05	0.0
1127	70	1.99e-042.28e-03	-0.03	-1.12e-04	1.06e-05	0.0
1127	72	1.71e-042.01e-03	-0.03	-9.95e-05	8.96e-06	0.0
1127	73	1.64e-041.94e-03	-0.03	-9.63e-05	8.55e-06	0.0
1128	2	7.36e-043.34e-03	-0.05	-1.64e-04	3.86e-05	0.0
1128	13	2.27e-032.52e-03	-0.03	-1.06e-04	1.66e-05	0.0
1128	31	2.71e-044.89e-03	-0.04	-1.47e-04	3.73e-05	0.0
1128	35	2.24e-044.87e-03	-0.04	-1.48e-04	3.83e-05	0.0
1128	45	3.00e-032.70e-03	-0.03	-1.08e-04	1.38e-05	0.0
1128	63	1.99e-046.02e-03	-0.04	-1.66e-04	4.28e-05	0.0
1128	67	1.34e-046.00e-03	-0.04	-1.66e-04	4.43e-05	0.0
1128	70	5.48e-042.43e-03	-0.04	-1.19e-04	2.88e-05	0.0
1128	72	4.70e-042.14e-03	-0.03	-1.05e-04	2.45e-05	0.0
1128	73	4.50e-042.07e-03	-0.03	-1.02e-04	2.35e-05	0.0
1129	2	8.02e-043.51e-03	-0.05	-1.74e-04	4.13e-05	0.0
1129	13	2.72e-032.83e-03	-0.03	-1.17e-04	3.73e-05	0.0
1129	33	1.45e-035.13e-03	-0.04	-1.62e-04	3.92e-05	0.0
1129	35	1.72e-045.05e-03	-0.04	-1.63e-04	3.32e-05	0.0
1129	45	3.62e-033.10e-03	-0.03	-1.21e-04	4.22e-05	0.0
1129	65	1.83e-036.32e-03	-0.04	-1.83e-04	4.48e-05	0.0
1129	67	4.63e-056.20e-03	-0.04	-1.85e-04	3.64e-05	0.0
1129	70	5.97e-042.55e-03	-0.04	-1.27e-04	3.09e-05	0.0
1129	72	5.09e-042.24e-03	-0.03	-1.11e-04	2.63e-05	0.0
1129	73	4.87e-042.16e-03	-0.03	-1.08e-04	2.51e-05	0.0
1130	2	1.11e-03-3.48e-03	-0.05	1.74e-04	5.95e-05	0.0
1130	10	2.91e-03-2.83e-03	-0.03	1.17e-04	5.29e-05	0.0



EGP CODE

GRE.EEC.R.73.IT.W.15235.12.024.01

PAGE

243 di/of 527

1130	22	1.45e-03-5.08e-03	-0.04	1.66e-04	5.53e-05	0.0
1130	24	1.87e-04-5.00e-03	-0.04	1.67e-04	4.69e-05	0.0
1130	42	3.81e-03-3.11e-03	-0.03	1.21e-04	5.96e-05	0.0
1130	54	1.76e-03-6.26e-03	-0.04	1.90e-04	6.29e-05	0.0
1130	56	-6.21e-06-6.15e-03	-0.04	1.91e-04	5.13e-05	0.0
1130	70	8.32e-04-2.53e-03	-0.04	1.26e-04	4.45e-05	0.0
1130	72	7.03e-04-2.21e-03	-0.03	1.11e-04	3.78e-05	0.0
1130	73	6.71e-04-2.12e-03	-0.03	1.07e-04	3.61e-05	0.0
1131	2	-5.85e-043.66e-03	-0.05	-1.81e-04	-2.85e-05	0.0
1131	15	-2.76e-032.87e-03	-0.03	-1.22e-04	-3.77e-05	0.0
1131	33	1.78e-045.19e-03	-0.04	-1.70e-04	-1.95e-05	0.0
1131	35	-1.20e-035.24e-03	-0.04	-1.69e-04	-3.06e-05	0.0
1131	47	-3.73e-033.11e-03	-0.04	-1.26e-04	-4.58e-05	0.0
1131	65	3.90e-046.38e-03	-0.04	-1.93e-04	-2.03e-05	0.0
1131	67	-1.54e-036.44e-03	-0.04	-1.93e-04	-3.59e-05	0.0
1131	70	-4.38e-042.66e-03	-0.04	-1.32e-04	-2.13e-05	0.0
1131	72	-3.68e-042.33e-03	-0.04	-1.16e-04	-1.82e-05	0.0
1131	73	-3.51e-042.24e-03	-0.03	-1.12e-04	-1.74e-05	0.0
1132	2	-7.18e-043.49e-03	-0.05	-1.71e-04	-3.71e-05	0.0
1132	15	-2.35e-032.59e-03	-0.03	-1.11e-04	-2.29e-05	0.0
1132	33	-3.68e-055.03e-03	-0.04	-1.56e-04	-3.45e-05	0.0
1132	47	-3.12e-032.76e-03	-0.03	-1.13e-04	-2.30e-05	0.0
1132	65	1.25e-046.18e-03	-0.04	-1.76e-04	-3.92e-05	0.0
1132	70	-5.39e-042.54e-03	-0.04	-1.24e-04	-2.78e-05	0.0
1132	72	-4.60e-042.23e-03	-0.03	-1.10e-04	-2.38e-05	0.0
1132	73	-4.41e-042.15e-03	-0.03	-1.06e-04	-2.28e-05	0.0
1133	2	-3.29e-043.25e-03	-0.05	-1.60e-04	-1.72e-05	0.0
1133	15	-1.93e-032.43e-03	-0.03	-1.04e-04	-2.21e-06	0.0
1133	33	3.21e-044.68e-03	-0.04	-1.42e-04	-1.94e-05	0.0
1133	47	-2.62e-032.59e-03	-0.03	-1.06e-04	1.22e-06	0.0
1133	65	5.32e-045.75e-03	-0.04	-1.59e-04	-2.29e-05	0.0
1133	70	-2.48e-042.36e-03	-0.04	-1.16e-04	-1.29e-05	0.0
1133	72	-2.14e-042.08e-03	-0.03	-1.03e-04	-1.12e-05	0.0
1133	73	-2.05e-042.01e-03	-0.03	-9.95e-05	-1.08e-05	0.0
1134	2	2.35e-043.20e-03	-0.05	-1.59e-04	1.23e-05	0.0
1134	13	1.82e-032.49e-03	-0.03	-1.07e-04	-2.92e-06	0.0
1134	33	7.81e-044.59e-03	-0.04	-1.39e-04	6.77e-06	0.0
1134	45	2.49e-032.69e-03	-0.03	-1.11e-04	-6.99e-06	0.0
1134	61	1.01e-035.63e-03	-0.04	-1.55e-04	8.36e-06	0.0
1134	65	1.04e-035.63e-03	-0.04	-1.55e-04	6.58e-06	0.0
1134	70	1.74e-042.33e-03	-0.04	-1.15e-04	9.15e-06	0.0
1134	72	1.47e-042.05e-03	-0.03	-1.02e-04	7.62e-06	0.0
1134	73	1.40e-041.98e-03	-0.03	-9.84e-05	7.23e-06	0.0
1135	2	7.29e-043.39e-03	-0.05	-1.67e-04	3.82e-05	0.0
1135	17	2.21e-032.85e-03	-0.03	-1.13e-04	1.86e-05	0.0
1135	35	2.57e-044.80e-03	-0.04	-1.49e-04	3.60e-05	0.0
1135	49	2.92e-033.15e-03	-0.03	-1.17e-04	1.69e-05	0.0
1135	67	1.84e-045.88e-03	-0.04	-1.67e-04	4.11e-05	0.0
1135	70	5.44e-042.47e-03	-0.04	-1.22e-04	2.86e-05	0.0
1135	72	4.62e-042.17e-03	-0.03	-1.07e-04	2.41e-05	0.0
1135	73	4.41e-042.09e-03	-0.03	-1.04e-04	2.30e-05	0.0
1136	2	8.71e-043.75e-03	-0.05	-1.83e-04	4.58e-05	0.0
1136	17	2.57e-033.14e-03	-0.04	-1.26e-04	3.63e-05	0.0
1136	35	3.60e-045.26e-03	-0.04	-1.71e-04	4.00e-05	0.0
1136	49	3.38e-033.47e-03	-0.04	-1.31e-04	3.99e-05	0.0
1136	67	2.94e-046.45e-03	-0.04	-1.94e-04	4.49e-05	0.0
1136	70	6.50e-042.74e-03	-0.04	-1.34e-04	3.42e-05	0.0
1136	72	5.51e-042.39e-03	-0.04	-1.17e-04	2.89e-05	0.0
1136	73	5.26e-042.30e-03	-0.03	-1.13e-04	2.76e-05	0.0
1137	2	1.44e-043.92e-03	-0.05	-1.92e-04	8.86e-06	0.0
1137	13	2.63e-033.07e-03	-0.04	-1.29e-04	3.25e-05	0.0
1137	29	1.04e-035.43e-03	-0.04	-1.84e-04	1.59e-05	0.0
1137	33	1.14e-035.43e-03	-0.04	-1.83e-04	1.86e-05	0.0
1137	45	3.66e-033.35e-03	-0.04	-1.34e-04	4.35e-05	0.0
1137	61	1.42e-036.65e-03	-0.05	-2.10e-04	2.04e-05	0.0
1137	65	1.56e-036.65e-03	-0.05	-2.09e-04	2.41e-05	0.0
1137	70	1.05e-042.86e-03	-0.04	-1.40e-04	6.55e-06	0.0
1137	72	8.05e-052.48e-03	-0.04	-1.22e-04	5.22e-06	0.0
1137	73	7.44e-052.39e-03	-0.04	-1.18e-04	4.88e-06	0.0
1138	2	-7.24e-043.75e-03	-0.05	-1.86e-04	-4.09e-05	0.0
1138	15	-2.96e-032.97e-03	-0.04	-1.23e-04	-5.16e-05	0.0
1138	33	2.38e-045.25e-03	-0.04	-1.79e-04	-2.70e-05	0.0
1138	35	-1.20e-035.29e-03	-0.04	-1.77e-04	-4.17e-05	0.0
1138	47	-3.97e-033.24e-03	-0.04	-1.27e-04	-6.22e-05	0.0
1138	65	5.11e-046.43e-03	-0.05	-2.05e-04	-2.78e-05	0.0
1138	67	-1.50e-036.49e-03	-0.04	-2.02e-04	-4.84e-05	0.0



EGP CODE

GRE.EEC.R.73.IT.W.15235.12.024.01

PAGE

244 di/of 527

1138	70	-5.41e-042.73e-03	-0.04	-1.35e-04	-3.06e-05	0.0
1138	72	-4.62e-042.38e-03	-0.04	-1.18e-04	-2.62e-05	0.0
1138	73	-4.42e-042.29e-03	-0.03	-1.14e-04	-2.50e-05	0.0
1139	2	-1.40e-033.52e-03	-0.05	-1.72e-04	-7.36e-05	0.0
1139	15	-2.82e-032.63e-03	-0.03	-1.09e-04	-5.04e-05	0.0
1139	33	-5.12e-045.00e-03	-0.04	-1.61e-04	-6.48e-05	0.0
1139	47	-3.60e-032.82e-03	-0.03	-1.10e-04	-5.26e-05	0.0
1139	65	-3.73e-046.14e-03	-0.04	-1.83e-04	-7.27e-05	0.0
1139	70	-1.05e-032.56e-03	-0.04	-1.25e-04	-5.50e-05	0.0
1139	72	-8.96e-042.24e-03	-0.03	-1.10e-04	-4.69e-05	0.0
1139	73	-8.57e-042.16e-03	-0.03	-1.06e-04	-4.49e-05	0.0
1140	2	-1.21e-033.03e-03	-0.04	-1.50e-04	-6.28e-05	0.0
1140	15	-2.45e-032.28e-03	-0.03	-9.36e-05	-3.21e-05	0.0
1140	33	-3.88e-044.36e-03	-0.04	-1.34e-04	-5.83e-05	0.0
1140	47	-3.13e-032.44e-03	-0.03	-9.39e-05	-2.97e-05	0.0
1140	65	-2.48e-045.36e-03	-0.04	-1.50e-04	-6.64e-05	0.0
1140	70	-9.04e-042.20e-03	-0.03	-1.09e-04	-4.69e-05	0.0
1140	72	-7.72e-041.94e-03	-0.03	-9.61e-05	-4.00e-05	0.0
1140	73	-7.39e-041.87e-03	-0.03	-9.30e-05	-3.83e-05	0.0
1141	2	-6.64e-042.71e-03	-0.04	-1.35e-04	-3.40e-05	0.0
1141	7	-1.99e-032.12e-03	-0.03	-8.74e-05	-1.34e-05	0.0
1141	33	0.0 3.94e-03	-0.03	-1.16e-04	-3.54e-05	0.0
1141	39	-2.62e-032.30e-03	-0.03	-8.88e-05	-1.04e-05	0.0
1141	65	1.62e-044.85e-03	-0.03	-1.28e-04	-4.12e-05	0.0
1141	70	-4.97e-041.95e-03	-0.03	-9.76e-05	-2.55e-05	0.0
1141	72	-4.25e-041.73e-03	-0.03	-8.67e-05	-2.18e-05	0.0
1141	73	-4.07e-041.68e-03	-0.03	-8.40e-05	-2.08e-05	0.0
1142	2	1.77e-052.60e-03	-0.04	-1.30e-04	1.69e-06	0.0
1142	6	1.55e-031.12e-03	-0.03	-7.54e-05	-1.23e-05	0.0
1142	29	6.16e-043.77e-03	-0.03	-1.08e-04	-5.47e-06	0.0
1142	33	6.10e-043.76e-03	-0.03	-1.08e-04	-6.96e-06	0.0
1142	38	2.16e-039.21e-04	-0.03	-7.31e-05	-1.75e-05	0.0
1142	61	8.59e-044.63e-03	-0.03	-1.19e-04	-7.98e-06	0.0
1142	65	8.50e-044.63e-03	-0.03	-1.19e-04	-1.01e-05	0.0
1142	70	1.24e-051.87e-03	-0.03	-9.38e-05	1.24e-06	0.0
1142	72	8.36e-061.66e-03	-0.03	-8.35e-05	0.0	0.0
1142	73	7.36e-061.61e-03	-0.03	-8.09e-05	0.0	0.0
1143	2	7.01e-042.71e-03	-0.04	-1.35e-04	3.74e-05	0.0
1143	9	2.01e-032.30e-03	-0.03	-9.09e-05	1.48e-05	0.0
1143	35	2.92e-043.84e-03	-0.03	-1.13e-04	3.28e-05	0.0
1143	41	2.65e-032.55e-03	-0.03	-9.37e-05	1.16e-05	0.0
1143	67	2.40e-044.71e-03	-0.03	-1.25e-04	3.69e-05	0.0
1143	70	5.23e-041.96e-03	-0.03	-9.76e-05	2.80e-05	0.0
1143	72	4.43e-041.73e-03	-0.03	-8.67e-05	2.37e-05	0.0
1143	73	4.23e-041.68e-03	-0.03	-8.40e-05	2.26e-05	0.0
1144	2	1.25e-033.04e-03	-0.05	-1.50e-04	6.63e-05	0.0
1144	17	2.47e-032.45e-03	-0.03	-9.78e-05	3.46e-05	0.0
1144	35	7.36e-044.15e-03	-0.03	-1.28e-04	5.56e-05	0.0
1144	49	3.15e-032.68e-03	-0.03	-9.98e-05	3.24e-05	0.0
1144	67	7.28e-045.07e-03	-0.04	-1.42e-04	6.17e-05	0.0
1144	70	9.35e-042.20e-03	-0.03	-1.09e-04	4.96e-05	0.0
1144	72	7.94e-041.94e-03	-0.03	-9.61e-05	4.20e-05	0.0
1144	73	7.58e-041.87e-03	-0.03	-9.29e-05	4.01e-05	0.0
1145	2	1.47e-033.53e-03	-0.05	-1.73e-04	7.76e-05	0.0
1145	17	2.83e-032.81e-03	-0.03	-1.13e-04	5.24e-05	0.0
1145	35	9.13e-044.67e-03	-0.04	-1.52e-04	6.32e-05	0.0
1145	49	3.60e-033.08e-03	-0.03	-1.16e-04	5.46e-05	0.0
1145	67	9.22e-045.68e-03	-0.04	-1.71e-04	6.98e-05	0.0
1145	70	1.10e-032.57e-03	-0.04	-1.25e-04	5.80e-05	0.0
1145	72	9.32e-042.24e-03	-0.03	-1.10e-04	4.91e-05	0.0
1145	73	8.90e-042.16e-03	-0.03	-1.06e-04	4.69e-05	0.0
1146	2	9.21e-043.75e-03	-0.05	-1.87e-04	4.85e-05	0.0
1146	17	2.96e-033.15e-03	-0.04	-1.30e-04	5.45e-05	0.0
1146	27	4.95e-054.80e-03	-0.04	-1.70e-04	3.41e-05	0.0
1146	33	1.76e-034.91e-03	-0.04	-1.70e-04	4.64e-05	0.0
1146	49	3.93e-033.50e-03	-0.04	-1.36e-04	6.46e-05	0.0
1146	59	-1.50e-045.81e-03	-0.04	-1.93e-04	3.61e-05	0.0
1146	65	2.24e-035.97e-03	-0.04	-1.92e-04	5.34e-05	0.0
1146	70	6.86e-042.73e-03	-0.04	-1.36e-04	3.62e-05	0.0
1146	72	5.75e-042.37e-03	-0.04	-1.18e-04	3.05e-05	0.0
1146	73	5.47e-042.28e-03	-0.04	-1.14e-04	2.91e-05	0.0
1147	2	1.91e-033.18e-03	-0.05	-1.54e-04	1.04e-04	0.0
1147	17	4.75e-033.12e-03	-0.04	-1.19e-04	1.34e-04	0.0
1147	21	2.20e-035.58e-03	-0.04	-1.64e-04	9.93e-05	0.0
1147	25	2.45e-035.49e-03	-0.05	-1.63e-04	1.05e-04	0.0
1147	49	6.15e-033.56e-03	-0.04	-1.27e-04	1.61e-04	0.0



EGP CODE

GRE.EEC.R.73.IT.W.15235.12.024.01

PAGE

245 di/of 527

1147	53	2.58e-037.03e-03	-0.05	-1.92e-04	1.12e-04	0.0
1147	57	2.93e-036.90e-03	-0.05	-1.90e-04	1.20e-04	0.0
1147	70	1.42e-032.35e-03	-0.04	-1.13e-04	7.67e-05	0.0
1147	72	1.27e-032.05e-03	-0.04	-9.94e-05	6.88e-05	0.0
1147	73	1.24e-031.98e-03	-0.04	-9.59e-05	6.68e-05	0.0
1148	2	-1.15e-033.55e-03	-0.05	-1.78e-04	-6.06e-05	0.0
1148	15	-2.95e-033.01e-03	-0.04	-1.23e-04	-5.55e-05	0.0
1148	25	-6.19e-044.73e-03	-0.04	-1.63e-04	-4.46e-05	0.0
1148	27	-1.87e-034.77e-03	-0.04	-1.61e-04	-5.36e-05	0.0
1148	47	-3.86e-033.35e-03	-0.04	-1.28e-04	-6.31e-05	0.0
1148	57	-5.89e-045.76e-03	-0.04	-1.84e-04	-4.78e-05	0.0
1148	59	-2.35e-035.82e-03	-0.04	-1.82e-04	-6.05e-05	0.0
1148	70	-8.59e-042.58e-03	-0.04	-1.29e-04	-4.52e-05	0.0
1148	72	-7.26e-042.25e-03	-0.04	-1.13e-04	-3.84e-05	0.0
1148	73	-6.93e-042.16e-03	-0.03	-1.09e-04	-3.66e-05	0.0
1149	2	-1.40e-033.35e-03	-0.05	-1.64e-04	-7.31e-05	0.0
1149	15	-2.69e-032.69e-03	-0.03	-1.08e-04	-4.47e-05	0.0
1149	25	-8.85e-044.54e-03	-0.04	-1.45e-04	-6.09e-05	0.0
1149	47	-3.43e-032.95e-03	-0.03	-1.10e-04	-4.49e-05	0.0
1149	57	-8.98e-045.53e-03	-0.04	-1.62e-04	-6.75e-05	0.0
1149	70	-1.05e-032.44e-03	-0.04	-1.19e-04	-5.46e-05	0.0
1149	72	-8.90e-042.13e-03	-0.03	-1.05e-04	-4.63e-05	0.0
1149	73	-8.51e-042.05e-03	-0.03	-1.01e-04	-4.42e-05	0.0
1150	2	-1.03e-032.93e-03	-0.04	-1.45e-04	-5.36e-05	0.0
1150	15	-2.29e-032.41e-03	-0.03	-9.51e-05	-2.45e-05	0.0
1150	25	-5.76e-044.09e-03	-0.03	-1.24e-04	-4.55e-05	0.0
1150	47	-2.96e-032.65e-03	-0.03	-9.73e-05	-2.13e-05	0.0
1150	57	-5.56e-045.01e-03	-0.04	-1.38e-04	-5.08e-05	0.0
1150	70	-7.72e-042.12e-03	-0.03	-1.05e-04	-4.01e-05	0.0
1150	72	-6.56e-041.87e-03	-0.03	-9.29e-05	-3.40e-05	0.0
1150	73	-6.27e-041.81e-03	-0.03	-8.99e-05	-3.24e-05	0.0
1151	2	-4.14e-042.69e-03	-0.04	-1.34e-04	-2.09e-05	0.0
1151	15	-1.81e-032.30e-03	-0.03	-9.06e-05	0.0	0.0
1151	25	-7.57e-053.87e-03	-0.03	-1.13e-04	-2.00e-05	0.0
1151	47	-2.44e-032.55e-03	-0.03	-9.35e-05	5.50e-06	0.0
1151	57	-5.98e-064.76e-03	-0.03	-1.25e-04	-2.30e-05	0.0
1151	70	-3.09e-041.94e-03	-0.03	-9.70e-05	-1.56e-05	0.0
1151	72	-2.62e-041.72e-03	-0.03	-8.62e-05	-1.32e-05	0.0
1151	73	-2.50e-041.67e-03	-0.03	-8.35e-05	-1.26e-05	0.0
1152	2	2.78e-042.68e-03	-0.04	-1.34e-04	1.55e-05	0.0
1152	17	1.73e-032.15e-03	-0.03	-8.83e-05	-2.48e-06	0.0
1152	27	-3.99e-043.92e-03	-0.03	-1.14e-04	2.04e-05	0.0
1152	49	2.36e-032.34e-03	-0.03	-9.03e-05	-7.29e-06	0.0
1152	59	-6.26e-044.82e-03	-0.03	-1.26e-04	2.47e-05	0.0
1152	70	2.09e-041.93e-03	-0.03	-9.66e-05	1.16e-05	0.0
1152	72	1.78e-041.71e-03	-0.03	-8.58e-05	9.95e-06	0.0
1152	73	1.70e-041.66e-03	-0.03	-8.32e-05	9.53e-06	0.0
1153	2	9.04e-042.89e-03	-0.04	-1.44e-04	4.86e-05	0.0
1153	17	2.20e-032.22e-03	-0.03	-9.17e-05	2.10e-05	0.0
1153	27	1.46e-044.22e-03	-0.03	-1.26e-04	4.68e-05	0.0
1153	49	2.87e-032.40e-03	-0.03	-9.29e-05	1.75e-05	0.0
1153	59	-1.67e-055.19e-03	-0.04	-1.41e-04	5.37e-05	0.0
1153	70	6.77e-042.09e-03	-0.03	-1.04e-04	3.63e-05	0.0
1153	72	5.77e-041.85e-03	-0.03	-9.19e-05	3.09e-05	0.0
1153	73	5.51e-041.79e-03	-0.03	-8.89e-05	2.96e-05	0.0
1154	2	1.29e-033.29e-03	-0.05	-1.62e-04	6.91e-05	0.0
1154	17	2.61e-032.48e-03	-0.03	-1.03e-04	4.10e-05	0.0
1154	27	4.43e-044.75e-03	-0.04	-1.48e-04	6.28e-05	0.0
1154	49	3.34e-032.66e-03	-0.03	-1.04e-04	4.06e-05	0.0
1154	59	3.05e-045.85e-03	-0.04	-1.68e-04	7.12e-05	0.0
1154	70	9.69e-042.39e-03	-0.03	-1.17e-04	5.17e-05	0.0
1154	72	8.24e-042.10e-03	-0.03	-1.03e-04	4.40e-05	0.0
1154	73	7.87e-042.02e-03	-0.03	-9.96e-05	4.20e-05	0.0
1155	2	1.10e-033.50e-03	-0.05	-1.75e-04	5.94e-05	0.0
1155	17	2.91e-032.79e-03	-0.03	-1.17e-04	5.34e-05	0.0
1155	25	1.44e-035.08e-03	-0.04	-1.67e-04	5.54e-05	0.0
1155	27	1.74e-045.04e-03	-0.04	-1.68e-04	4.67e-05	0.0
1155	49	3.81e-033.06e-03	-0.03	-1.21e-04	6.03e-05	0.0
1155	57	1.75e-036.26e-03	-0.04	-1.91e-04	6.31e-05	0.0
1155	59	-2.21e-056.20e-03	-0.04	-1.92e-04	5.10e-05	0.0
1155	70	8.22e-042.54e-03	-0.04	-1.27e-04	4.43e-05	0.0
1155	72	6.95e-042.22e-03	-0.03	-1.11e-04	3.77e-05	0.0
1155	73	6.64e-042.14e-03	-0.03	-1.07e-04	3.61e-05	0.0
1156	2	-8.40e-04-3.68e-03	-0.05	1.83e-04	-4.19e-05	0.0
1156	8	-2.90e-03-3.31e-03	-0.04	1.33e-04	-4.84e-05	0.0
1156	22	-3.12e-04-5.24e-03	-0.04	1.76e-04	-3.12e-05	0.0





EGP CODE

GRE.EEC.R.73.IT.W.15235.12.024.01

PAGE

246 di/of 527

1156	24	-1.66e-03-5.33e-03	-0.04	1.77e-04	-4.30e-05	0.0
1156	40	-3.86e-03-3.74e-03	-0.04	1.41e-04	-5.77e-05	0.0
1156	54	-2.37e-04-6.43e-03	-0.05	2.01e-04	-3.36e-05	0.0
1156	56	-2.13e-03-6.57e-03	-0.04	2.03e-04	-5.01e-05	0.0
1156	70	-6.24e-04-2.68e-03	-0.04	1.34e-04	-3.13e-05	0.0
1156	72	-5.25e-04-2.33e-03	-0.04	1.17e-04	-2.64e-05	0.0
1156	73	-5.00e-04-2.24e-03	-0.03	1.12e-04	-2.52e-05	0.0
1157	2	-8.30e-043.71e-03	-0.05	-1.85e-04	-4.15e-05	0.0
1157	15	-2.90e-033.29e-03	-0.04	-1.34e-04	-4.88e-05	0.0
1157	25	-3.01e-045.28e-03	-0.04	-1.77e-04	-3.06e-05	0.0
1157	27	-1.66e-035.35e-03	-0.04	-1.78e-04	-4.28e-05	0.0
1157	47	-3.87e-033.70e-03	-0.04	-1.43e-04	-5.83e-05	0.0
1157	57	-2.23e-046.49e-03	-0.05	-2.03e-04	-3.29e-05	0.0
1157	59	-2.12e-036.58e-03	-0.04	-2.04e-04	-5.00e-05	0.0
1157	70	-6.17e-042.70e-03	-0.04	-1.35e-04	-3.09e-05	0.0
1157	72	-5.19e-042.35e-03	-0.04	-1.18e-04	-2.61e-05	0.0
1157	73	-4.95e-042.26e-03	-0.04	-1.13e-04	-2.49e-05	0.0
1158	2	-1.28e-033.52e-03	-0.05	-1.72e-04	-6.57e-05	0.0
1158	15	-2.70e-032.98e-03	-0.03	-1.16e-04	-4.30e-05	0.0
1158	25	-7.53e-045.08e-03	-0.04	-1.60e-04	-5.81e-05	0.0
1158	47	-3.47e-033.31e-03	-0.03	-1.20e-04	-4.43e-05	0.0
1158	57	-7.44e-046.25e-03	-0.04	-1.81e-04	-6.54e-05	0.0
1158	70	-9.57e-042.56e-03	-0.04	-1.25e-04	-4.91e-05	0.0
1158	72	-8.14e-042.24e-03	-0.03	-1.10e-04	-4.16e-05	0.0
1158	73	-7.78e-042.16e-03	-0.03	-1.06e-04	-3.98e-05	0.0
1159	2	-1.01e-033.10e-03	-0.05	-1.53e-04	-5.19e-05	0.0
1159	15	-2.31e-032.67e-03	-0.03	-1.03e-04	-2.31e-05	0.0
1159	21	-5.51e-044.57e-03	-0.04	-1.36e-04	-4.65e-05	0.0
1159	25	-5.26e-044.56e-03	-0.04	-1.36e-04	-4.78e-05	0.0
1159	47	-2.98e-032.97e-03	-0.03	-1.06e-04	-1.97e-05	0.0
1159	53	-5.27e-045.63e-03	-0.04	-1.52e-04	-5.26e-05	0.0
1159	57	-4.91e-045.62e-03	-0.04	-1.53e-04	-5.45e-05	0.0
1159	70	-7.55e-042.25e-03	-0.03	-1.11e-04	-3.87e-05	0.0
1159	72	-6.42e-041.98e-03	-0.03	-9.82e-05	-3.28e-05	0.0
1159	73	-6.14e-041.91e-03	-0.03	-9.50e-05	-3.13e-05	0.0
1160	2	-4.37e-042.86e-03	-0.04	-1.42e-04	-2.16e-05	0.0
1160	19	-1.83e-032.26e-03	-0.03	-9.55e-05	1.84e-06	0.0
1160	23	-9.17e-044.28e-03	-0.03	-1.23e-04	-1.48e-05	0.0
1160	27	-9.37e-044.31e-03	-0.03	-1.23e-04	-1.30e-05	0.0
1160	51	-2.46e-032.46e-03	-0.03	-9.83e-05	7.74e-06	0.0
1160	55	-1.18e-035.29e-03	-0.04	-1.37e-04	-1.55e-05	0.0
1160	59	-1.21e-035.33e-03	-0.04	-1.37e-04	-1.31e-05	0.0
1160	70	-3.23e-042.07e-03	-0.03	-1.03e-04	-1.61e-05	0.0
1160	72	-2.74e-041.83e-03	-0.03	-9.14e-05	-1.35e-05	0.0
1160	73	-2.62e-041.77e-03	-0.03	-8.85e-05	-1.29e-05	0.0
1161	2	2.38e-042.84e-03	-0.04	-1.42e-04	1.38e-05	0.0
1161	17	1.73e-032.06e-03	-0.03	-9.04e-05	-6.82e-06	0.0
1161	27	-3.63e-044.34e-03	-0.03	-1.24e-04	1.87e-05	0.0
1161	49	2.36e-032.18e-03	-0.03	-9.14e-05	-1.31e-05	0.0
1161	59	-5.69e-045.37e-03	-0.04	-1.38e-04	2.27e-05	0.0
1161	70	1.81e-042.06e-03	-0.03	-1.02e-04	1.04e-05	0.0
1161	72	1.57e-041.82e-03	-0.03	-9.10e-05	9.06e-06	0.0
1161	73	1.51e-041.76e-03	-0.03	-8.82e-05	8.74e-06	0.0
1162	2	8.44e-043.06e-03	-0.05	-1.51e-04	4.57e-05	0.0
1162	17	2.20e-032.13e-03	-0.03	-9.35e-05	1.74e-05	0.0
1162	27	1.35e-044.63e-03	-0.04	-1.36e-04	4.48e-05	0.0
1162	49	2.88e-032.22e-03	-0.03	-9.33e-05	1.30e-05	0.0
1162	59	-2.05e-055.72e-03	-0.04	-1.53e-04	5.14e-05	0.0
1162	70	6.36e-042.22e-03	-0.03	-1.10e-04	3.43e-05	0.0
1162	72	5.45e-041.96e-03	-0.03	-9.72e-05	2.95e-05	0.0
1162	73	5.22e-041.89e-03	-0.03	-9.41e-05	2.83e-05	0.0
1163	2	1.17e-033.46e-03	-0.05	-1.70e-04	6.34e-05	0.0
1163	17	2.65e-032.39e-03	-0.03	-1.05e-04	3.94e-05	0.0
1163	27	3.63e-045.16e-03	-0.04	-1.59e-04	5.69e-05	0.0
1163	49	3.42e-032.49e-03	-0.03	-1.05e-04	3.96e-05	0.0
1163	59	2.18e-046.38e-03	-0.04	-1.81e-04	6.41e-05	0.0
1163	70	8.82e-042.52e-03	-0.04	-1.23e-04	4.76e-05	0.0
1163	72	7.55e-042.21e-03	-0.03	-1.09e-04	4.08e-05	0.0
1163	73	7.23e-042.13e-03	-0.03	-1.05e-04	3.91e-05	0.0
1164	2	7.83e-043.71e-03	-0.05	-1.83e-04	4.48e-05	0.0
1164	17	3.01e-032.68e-03	-0.03	-1.19e-04	5.10e-05	0.0
1164	21	1.15e-035.42e-03	-0.04	-1.73e-04	4.10e-05	0.0
1164	27	-1.69e-045.42e-03	-0.04	-1.76e-04	3.04e-05	0.0
1164	49	4.02e-032.84e-03	-0.03	-1.22e-04	6.04e-05	0.0
1164	53	1.41e-036.68e-03	-0.04	-1.97e-04	4.63e-05	0.0
1164	59	-4.30e-046.67e-03	-0.05	-2.01e-04	3.14e-05	0.0



EGP CODE

GRE.EEC.R.73.IT.W.15235.12.024.01

PAGE

247 di/of 527

1164	70	5.89e-042.71e-03	-0.04	-1.34e-04	3.36e-05	0.0
1164	72	5.04e-042.36e-03	-0.04	-1.17e-04	2.89e-05	0.0
1164	73	4.82e-042.28e-03	-0.03	-1.13e-04	2.77e-05	0.0
1165	2	7.48e-053.90e-03	-0.05	-1.92e-04	6.00e-06	0.0
1165	18	2.66e-031.65e-03	-0.03	-1.05e-04	2.90e-05	0.0
1165	27	-9.34e-045.62e-03	-0.04	-1.82e-04	-6.83e-06	0.0
1165	50	3.70e-031.35e-03	-0.03	-1.00e-04	3.89e-05	0.0
1165	59	-1.33e-036.91e-03	-0.05	-2.07e-04	-1.13e-05	0.0
1165	70	6.20e-052.85e-03	-0.04	-1.40e-04	4.63e-06	0.0
1165	72	5.93e-052.49e-03	-0.04	-1.22e-04	4.32e-06	0.0
1165	73	5.86e-052.39e-03	-0.04	-1.18e-04	4.24e-06	0.0
1166	2	-3.82e-043.84e-03	-0.05	-1.87e-04	-1.78e-05	0.0
1166	19	-2.32e-033.04e-03	-0.04	-1.25e-04	-1.63e-05	0.0
1166	23	-1.02e-035.43e-03	-0.04	-1.73e-04	-2.02e-05	0.0
1166	27	-1.11e-035.54e-03	-0.04	-1.73e-04	-2.05e-05	0.0
1166	51	-3.16e-033.32e-03	-0.04	-1.28e-04	-1.86e-05	0.0
1166	55	-1.34e-036.66e-03	-0.04	-1.96e-04	-2.41e-05	0.0
1166	59	-1.47e-036.81e-03	-0.04	-1.95e-04	-2.44e-05	0.0
1166	70	-2.80e-042.80e-03	-0.04	-1.37e-04	-1.32e-05	0.0
1166	72	-2.39e-042.45e-03	-0.04	-1.20e-04	-1.10e-05	0.0
1166	73	-2.28e-042.36e-03	-0.04	-1.16e-04	-1.05e-05	0.0
1167	2	-2.22e-043.67e-03	-0.05	-1.80e-04	-9.36e-06	0.0
1167	19	-2.04e-032.95e-03	-0.04	-1.20e-04	-1.19e-06	0.0
1167	21	1.35e-045.30e-03	-0.04	-1.62e-04	-1.19e-05	0.0
1167	23	-8.00e-045.17e-03	-0.04	-1.61e-04	-1.01e-05	0.0
1167	51	-2.80e-033.21e-03	-0.04	-1.24e-04	0.0	0.0
1167	53	2.41e-046.51e-03	-0.04	-1.82e-04	-1.45e-05	0.0
1167	55	-1.07e-036.33e-03	-0.04	-1.81e-04	-1.20e-05	0.0
1167	70	-1.60e-042.68e-03	-0.04	-1.31e-04	-6.86e-06	0.0
1167	72	-1.38e-042.35e-03	-0.04	-1.16e-04	-5.71e-06	0.0
1167	73	-1.32e-042.27e-03	-0.03	-1.12e-04	-5.42e-06	0.0
1168	2	7.18e-053.67e-03	-0.05	-1.80e-04	5.97e-06	0.0
1168	4	7.60e-052.78e-03	-0.04	-1.36e-04	5.19e-06	0.0
1168	17	1.97e-032.49e-03	-0.04	-1.19e-04	0.0	0.0
1168	27	-5.77e-045.34e-03	-0.04	-1.62e-04	9.20e-06	0.0
1168	49	2.74e-032.57e-03	-0.04	-1.21e-04	-1.72e-06	0.0
1168	59	-8.26e-046.57e-03	-0.04	-1.82e-04	1.13e-05	0.0
1168	70	6.00e-052.68e-03	-0.04	-1.31e-04	4.63e-06	0.0
1168	72	4.88e-052.35e-03	-0.04	-1.16e-04	4.04e-06	0.0
1168	73	4.60e-052.27e-03	-0.03	-1.12e-04	3.89e-06	0.0
1169	2	8.90e-053.65e-03	-0.05	-1.81e-04	6.44e-06	0.0
1169	4	9.09e-052.76e-03	-0.04	-1.37e-04	5.54e-06	0.0
1169	17	2.36e-032.94e-03	-0.04	-1.24e-04	1.66e-05	0.0
1169	21	5.28e-045.40e-03	-0.04	-1.68e-04	9.78e-06	0.0
1169	27	-6.72e-045.23e-03	-0.04	-1.66e-04	3.67e-06	0.0
1169	49	3.28e-033.21e-03	-0.04	-1.29e-04	2.17e-05	0.0
1169	53	7.19e-046.66e-03	-0.04	-1.90e-04	1.21e-05	0.0
1169	59	-9.61e-046.43e-03	-0.04	-1.88e-04	3.55e-06	0.0
1169	70	7.14e-052.66e-03	-0.04	-1.32e-04	4.92e-06	0.0
1169	72	5.34e-052.33e-03	-0.04	-1.16e-04	4.17e-06	0.0
1169	73	4.89e-052.25e-03	-0.03	-1.12e-04	3.98e-06	0.0
1170	2	-1.28e-03-3.49e-03	-0.05	1.70e-04	-6.56e-05	0.0
1170	8	-2.68e-03-2.99e-03	-0.03	1.16e-04	-4.29e-05	0.0
1170	22	-7.66e-04-5.02e-03	-0.04	1.58e-04	-5.80e-05	0.0
1170	26	-8.08e-04-5.02e-03	-0.04	1.57e-04	-5.78e-05	0.0
1170	40	-3.45e-03-3.33e-03	-0.03	1.20e-04	-4.43e-05	0.0
1170	54	-7.61e-04-6.18e-03	-0.04	1.79e-04	-6.54e-05	0.0
1170	58	-8.20e-04-6.18e-03	-0.04	1.78e-04	-6.50e-05	0.0
1170	70	-9.58e-04-2.54e-03	-0.04	1.24e-04	-4.90e-05	0.0
1170	72	-8.14e-04-2.22e-03	-0.03	1.09e-04	-4.15e-05	0.0
1170	73	-7.78e-04-2.14e-03	-0.03	1.05e-04	-3.96e-05	0.0
1171	2	-1.24e-033.47e-03	-0.05	-1.72e-04	-6.18e-05	0.0
1171	19	-3.26e-033.01e-03	-0.03	-1.12e-04	-5.86e-05	0.0
1171	25	-4.59e-045.04e-03	-0.04	-1.61e-04	-4.51e-05	0.0
1171	27	-1.88e-035.28e-03	-0.04	-1.58e-04	-5.60e-05	0.0
1171	51	-4.26e-033.35e-03	-0.03	-1.14e-04	-6.69e-05	0.0
1171	57	-3.37e-046.20e-03	-0.04	-1.82e-04	-4.80e-05	0.0
1171	59	-2.33e-036.53e-03	-0.04	-1.79e-04	-6.33e-05	0.0
1171	70	-9.23e-042.53e-03	-0.04	-1.25e-04	-4.61e-05	0.0
1171	72	-7.94e-042.22e-03	-0.03	-1.10e-04	-3.96e-05	0.0
1171	73	-7.62e-042.14e-03	-0.03	-1.07e-04	-3.79e-05	0.0
1172	2	-1.42e-033.16e-03	-0.05	-1.55e-04	-7.16e-05	0.0
1172	19	-2.90e-032.10e-03	-0.03	-9.60e-05	-4.42e-05	0.0
1172	21	-8.09e-044.98e-03	-0.04	-1.42e-04	-5.93e-05	0.0
1172	25	-7.09e-044.94e-03	-0.04	-1.42e-04	-5.97e-05	0.0
1172	51	-3.72e-032.16e-03	-0.03	-9.57e-05	-4.44e-05	0.0



EGP CODE

GRE.EEC.R.73.IT.W.15235.12.024.01

PAGE

248 di/of 527

1172	53	-7.84e-046.19e-03	-0.04	-1.60e-04	-6.55e-05	0.0
1172	57	-6.44e-046.13e-03	-0.04	-1.60e-04	-6.61e-05	0.0
1172	70	-1.06e-032.31e-03	-0.03	-1.13e-04	-5.36e-05	0.0
1172	72	-9.11e-042.03e-03	-0.03	-9.98e-05	-4.57e-05	0.0
1172	73	-8.73e-041.96e-03	-0.03	-9.65e-05	-4.38e-05	0.0
1173	2	-1.00e-032.71e-03	-0.04	-1.34e-04	-4.96e-05	0.0
1173	19	-2.50e-031.76e-03	-0.03	-8.29e-05	-2.29e-05	0.0
1173	21	-4.51e-044.51e-03	-0.03	-1.20e-04	-4.10e-05	0.0
1173	25	-3.66e-044.47e-03	-0.03	-1.20e-04	-4.22e-05	0.0
1173	51	-3.25e-031.79e-03	-0.03	-8.24e-05	-2.02e-05	0.0
1173	53	-3.90e-045.64e-03	-0.04	-1.34e-04	-4.54e-05	0.0
1173	57	-2.69e-045.58e-03	-0.04	-1.35e-04	-4.72e-05	0.0
1173	70	-7.47e-041.97e-03	-0.03	-9.76e-05	-3.73e-05	0.0
1173	72	-6.35e-041.75e-03	-0.03	-8.69e-05	-3.13e-05	0.0
1173	73	-6.06e-041.70e-03	-0.03	-8.42e-05	-2.99e-05	0.0
1174	2	-3.05e-042.44e-03	-0.04	-1.21e-04	-1.32e-05	0.0
1174	19	-2.07e-032.35e-03	-0.03	-7.67e-05	0.0	0.0
1174	21	1.36e-044.28e-03	-0.03	-1.08e-04	-4.85e-06	0.0
1174	25	2.23e-044.00e-03	-0.03	-1.08e-04	-6.20e-06	0.0
1174	51	-2.83e-032.67e-03	-0.03	-7.68e-05	3.27e-06	0.0
1174	53	2.58e-045.38e-03	-0.03	-1.21e-04	-3.96e-06	0.0
1174	57	3.79e-044.99e-03	-0.03	-1.21e-04	-5.86e-06	0.0
1174	70	-2.30e-041.77e-03	-0.03	-8.81e-05	-1.02e-05	0.0
1174	72	-1.81e-041.58e-03	-0.03	-7.87e-05	-7.66e-06	0.0
1174	73	-1.68e-041.53e-03	-0.03	-7.63e-05	-7.02e-06	0.0
1175	2	4.96e-042.36e-03	-0.04	-1.18e-04	2.86e-05	0.0
1175	17	2.37e-031.39e-03	-0.03	-8.33e-05	1.73e-05	0.0
1175	21	7.83e-044.29e-03	-0.03	-1.08e-04	2.74e-05	0.0
1175	49	3.19e-031.35e-03	-0.03	-8.67e-05	1.66e-05	0.0
1175	53	9.61e-045.41e-03	-0.03	-1.21e-04	3.07e-05	0.0
1175	70	3.66e-041.72e-03	-0.03	-8.57e-05	2.09e-05	0.0
1175	72	3.43e-041.53e-03	-0.03	-7.65e-05	1.96e-05	0.0
1175	73	3.37e-041.49e-03	-0.03	-7.42e-05	1.93e-05	0.0
1176	2	1.27e-032.50e-03	-0.04	-1.24e-04	6.90e-05	0.0
1176	17	3.14e-031.42e-03	-0.03	-8.93e-05	5.91e-05	0.0
1176	21	1.53e-034.55e-03	-0.03	-1.18e-04	6.52e-05	0.0
1176	49	4.06e-031.36e-03	-0.03	-9.36e-05	6.46e-05	0.0
1176	53	1.81e-035.75e-03	-0.04	-1.34e-04	7.34e-05	0.0
1176	70	9.40e-041.83e-03	-0.03	-9.05e-05	5.10e-05	0.0
1176	72	8.49e-041.62e-03	-0.03	-8.04e-05	4.60e-05	0.0
1176	73	8.26e-041.57e-03	-0.03	-7.79e-05	4.48e-05	0.0
1177	2	1.84e-032.84e-03	-0.05	-1.38e-04	9.92e-05	0.0
1177	17	3.93e-031.63e-03	-0.04	-1.03e-04	9.91e-05	0.0
1177	21	2.07e-035.11e-03	-0.04	-1.41e-04	9.39e-05	0.0
1177	49	5.03e-031.57e-03	-0.04	-1.08e-04	1.13e-04	0.0
1177	53	2.42e-036.45e-03	-0.04	-1.63e-04	1.06e-04	0.0
1177	70	1.36e-032.09e-03	-0.04	-1.01e-04	7.34e-05	0.0
1177	72	1.22e-031.84e-03	-0.03	-8.96e-05	6.58e-05	0.0
1177	73	1.19e-031.77e-03	-0.03	-8.66e-05	6.39e-05	0.0
1178	2	1.47e-033.50e-03	-0.05	1.71e-04	7.74e-05	0.0
1178	10	2.81e-032.83e-03	-0.03	1.13e-04	5.23e-05	0.0
1178	32	9.28e-044.62e-03	-0.04	1.50e-04	6.32e-05	0.0
1178	42	3.58e-033.10e-03	-0.03	1.16e-04	5.45e-05	0.0
1178	64	9.42e-045.61e-03	-0.04	1.69e-04	6.97e-05	0.0
1178	70	1.10e-032.54e-03	-0.04	1.24e-04	5.78e-05	0.0
1178	72	9.33e-042.22e-03	-0.03	1.09e-04	4.90e-05	0.0
1178	73	8.91e-042.14e-03	-0.03	1.05e-04	4.68e-05	0.0
1179	2	-9.59e-043.12e-03	-0.05	1.53e-04	-5.65e-05	0.0
1179	8	-4.34e-033.23e-03	-0.04	1.22e-04	-1.04e-04	0.0
1179	32	-1.58e-035.30e-03	-0.05	1.60e-04	-6.56e-05	0.0
1179	36	-1.30e-035.38e-03	-0.05	1.61e-04	-5.96e-05	0.0
1179	40	-5.82e-033.71e-03	-0.05	1.32e-04	-1.31e-04	0.0
1179	64	-1.95e-036.63e-03	-0.05	1.85e-04	-7.66e-05	0.0
1179	68	-1.56e-036.74e-03	-0.05	1.87e-04	-6.82e-05	0.0
1179	70	-7.03e-042.31e-03	-0.04	1.14e-04	-4.14e-05	0.0
1179	72	-6.61e-042.03e-03	-0.04	1.00e-04	-3.86e-05	0.0
1179	73	-6.50e-041.96e-03	-0.04	9.68e-05	-3.80e-05	0.0
1180	2	1.12e-043.64e-03	-0.05	1.79e-04	5.43e-06	0.0
1180	5	2.90e-032.21e-03	-0.03	9.88e-05	2.64e-05	0.0
1180	30	1.06e-035.29e-03	-0.04	1.59e-04	8.12e-06	0.0
1180	36	-3.93e-045.30e-03	-0.04	1.62e-04	-3.41e-06	0.0
1180	37	4.04e-032.20e-03	-0.03	9.41e-05	3.58e-05	0.0
1180	62	1.45e-036.51e-03	-0.04	1.79e-04	1.02e-05	0.0
1180	68	-5.75e-046.51e-03	-0.04	1.82e-04	-5.91e-06	0.0
1180	70	8.06e-052.66e-03	-0.04	1.31e-04	4.09e-06	0.0
1180	72	6.73e-052.34e-03	-0.03	1.15e-04	3.12e-06	0.0



EGP CODE

GRE.EEC.R.73.IT.W.15235.12.024.01

PAGE

249 di/of 527

1180	73	6.40e-05-2.25e-03	-0.03	1.11e-04	2.88e-06	0.0
1181	2	-6.57e-05-3.63e-03	-0.05	1.84e-04	-3.49e-06	0.0
1181	4	-6.66e-05-2.75e-03	-0.04	1.39e-04	-3.01e-06	0.0
1181	8	-2.62e-03-2.52e-03	-0.04	1.22e-04	-1.96e-05	0.0
1181	30	8.50e-04-5.11e-03	-0.04	1.66e-04	0.0	0.0
1181	40	-3.65e-03-2.63e-03	-0.04	1.26e-04	-2.65e-05	0.0
1181	62	1.21e-03-6.26e-03	-0.04	1.87e-04	2.09e-06	0.0
1181	70	-5.36e-05-2.65e-03	-0.04	1.34e-04	-2.70e-06	0.0
1181	72	-4.34e-05-2.33e-03	-0.04	1.18e-04	-2.37e-06	0.0
1181	73	-4.08e-05-2.25e-03	-0.03	1.14e-04	-2.29e-06	0.0
1182	2	-4.79e-05-3.71e-03	-0.05	1.87e-04	0.0	0.0
1182	8	-2.57e-03-2.82e-03	-0.04	1.28e-04	-2.02e-05	0.0
1182	32	-6.63e-04-5.15e-03	-0.04	1.73e-04	-7.19e-06	0.0
1182	36	-5.44e-04-5.16e-03	-0.04	1.73e-04	-5.19e-06	0.0
1182	40	-3.59e-03-3.04e-03	-0.04	1.34e-04	-2.83e-05	0.0
1182	64	-9.18e-04-6.30e-03	-0.04	1.96e-04	-1.00e-05	0.0
1182	68	-7.51e-04-6.31e-03	-0.04	1.96e-04	-7.22e-06	0.0
1182	70	-3.75e-05-2.70e-03	-0.04	1.36e-04	0.0	0.0
1182	72	-2.82e-05-2.37e-03	-0.04	1.19e-04	0.0	0.0
1182	73	-2.58e-05-2.28e-03	-0.03	1.15e-04	0.0	0.0
1183	2	-1.93e-04-4.03e-03	-0.05	1.97e-04	-1.08e-05	0.0
1183	8	-2.74e-03-3.02e-03	-0.04	1.31e-04	-3.17e-05	0.0
1183	30	8.09e-04-5.46e-03	-0.04	1.82e-04	0.0	0.0
1183	34	6.98e-04-5.46e-03	-0.04	1.83e-04	-2.72e-06	0.0
1183	40	-3.79e-03-3.24e-03	-0.04	1.35e-04	-4.16e-05	0.0
1183	62	1.18e-03-6.66e-03	-0.05	2.07e-04	2.47e-06	0.0
1183	66	1.03e-03-6.66e-03	-0.05	2.07e-04	-1.05e-06	0.0
1183	70	-1.46e-04-2.95e-03	-0.04	1.44e-04	-8.09e-06	0.0
1183	72	-1.30e-04-2.56e-03	-0.04	1.25e-04	-7.15e-06	0.0
1183	73	-1.26e-04-2.46e-03	-0.04	1.21e-04	-6.91e-06	0.0
1184	2	1.29e-04-3.92e-03	-0.06	1.99e-04	4.87e-06	0.0
1184	10	2.56e-03-3.18e-03	-0.04	1.39e-04	2.68e-05	0.0
1184	22	5.10e-04-4.90e-03	-0.04	1.78e-04	1.14e-05	0.0
1184	26	4.17e-04-4.89e-03	-0.04	1.78e-04	9.00e-06	0.0
1184	42	3.56e-03-3.49e-03	-0.04	1.47e-04	3.63e-05	0.0
1184	54	6.85e-04-5.90e-03	-0.05	2.01e-04	1.49e-05	0.0
1184	58	5.54e-04-5.90e-03	-0.05	2.01e-04	1.14e-05	0.0
1184	70	9.62e-05-2.86e-03	-0.04	1.45e-04	3.64e-06	0.0
1184	72	7.81e-05-2.49e-03	-0.04	1.26e-04	3.01e-06	0.0
1184	73	7.36e-05-2.39e-03	-0.04	1.21e-04	2.85e-06	0.0
1185	2	-9.51e-05-3.85e-03	-0.05	1.95e-04	-1.29e-06	0.0
1185	11	-2.57e-03-1.85e-03	-0.03	1.09e-04	-2.27e-05	0.0
1185	24	-1.02e-03-5.28e-03	-0.04	1.84e-04	-8.57e-06	0.0
1185	28	-9.14e-04-5.28e-03	-0.04	1.85e-04	-6.29e-06	0.0
1185	43	-3.57e-03-1.64e-03	-0.03	1.05e-04	-3.15e-05	0.0
1185	56	-1.41e-03-6.46e-03	-0.05	2.10e-04	-1.17e-05	0.0
1185	60	-1.26e-03-6.45e-03	-0.05	2.11e-04	-8.53e-06	0.0
1185	70	-6.92e-05-2.81e-03	-0.04	1.42e-04	0.0	0.0
1185	72	-5.73e-05-2.44e-03	-0.04	1.24e-04	0.0	0.0
1185	73	-5.43e-05-2.35e-03	-0.04	1.19e-04	0.0	0.0
1186	2	3.43e-04-3.95e-03	-0.05	1.94e-04	2.08e-05	0.0
1186	10	2.87e-03-2.73e-03	-0.04	1.26e-04	3.56e-05	0.0
1186	24	-6.70e-04-5.59e-03	-0.04	1.79e-04	9.08e-06	0.0
1186	42	3.93e-03-2.86e-03	-0.04	1.29e-04	4.46e-05	0.0
1186	56	-1.03e-03-6.86e-03	-0.05	2.03e-04	7.45e-06	0.0
1186	70	2.62e-04-2.89e-03	-0.04	1.41e-04	1.57e-05	0.0
1186	72	2.27e-04-2.52e-03	-0.04	1.24e-04	1.36e-05	0.0
1186	73	2.19e-04-2.42e-03	-0.04	1.19e-04	1.31e-05	0.0
1187	2	-6.22e-04-3.67e-03	-0.05	1.85e-04	-3.03e-05	0.0
1187	12	-3.01e-03-3.05e-03	-0.04	1.21e-04	-3.99e-05	0.0
1187	22	1.31e-04-5.12e-03	-0.04	1.69e-04	-1.82e-05	0.0
1187	26	-3.08e-05-5.31e-03	-0.04	1.69e-04	-2.01e-05	0.0
1187	44	-4.06e-03-3.36e-03	-0.04	1.24e-04	-4.84e-05	0.0
1187	54	3.38e-04-6.26e-03	-0.04	1.91e-04	-1.80e-05	0.0
1187	58	1.11e-04-6.53e-03	-0.04	1.91e-04	-2.07e-05	0.0
1187	70	-4.61e-04-2.68e-03	-0.04	1.35e-04	-2.26e-05	0.0
1187	72	-4.02e-04-2.35e-03	-0.04	1.18e-04	-1.95e-05	0.0
1187	73	-3.87e-04-2.27e-03	-0.03	1.14e-04	-1.87e-05	0.0
1188	2	1.67e-03-3.31e-03	-0.06	1.60e-04	9.21e-05	0.0
1188	10	4.69e-03-3.27e-03	-0.04	1.24e-04	1.26e-04	0.0
1188	22	2.22e-03-5.64e-03	-0.05	1.69e-04	9.34e-05	0.0
1188	26	1.95e-03-5.72e-03	-0.05	1.70e-04	8.75e-05	0.0
1188	42	6.13e-03-3.73e-03	-0.05	1.34e-04	1.53e-04	0.0
1188	54	2.67e-03-7.07e-03	-0.05	1.97e-04	1.07e-04	0.0
1188	58	2.29e-03-7.18e-03	-0.05	1.98e-04	9.86e-05	0.0
1188	70	1.24e-03-2.45e-03	-0.04	1.19e-04	6.81e-05	0.0



EGP CODE

GRE.EEC.R.73.IT.W.15235.12.024.01

PAGE

250 di/of 527

1188	72	1.12e-03-2.14e-03	-0.04	1.04e-04	6.14e-05	0.0
1188	73	1.09e-03-2.06e-03	-0.04	1.00e-04	5.97e-05	0.0
1189	2	-1.28e-03-3.00e-03	-0.05	1.46e-04	-6.76e-05	0.0
1189	8	-4.22e-03-3.00e-03	-0.04	1.18e-04	-1.01e-04	0.0
1189	32	-2.01e-03-5.11e-03	-0.04	1.51e-04	-7.44e-05	0.0
1189	36	-1.77e-03-5.24e-03	-0.04	1.52e-04	-6.98e-05	0.0
1189	40	-5.56e-03-3.43e-03	-0.04	1.28e-04	-1.24e-04	0.0
1189	64	-2.47e-03-6.41e-03	-0.05	1.74e-04	-8.61e-05	0.0
1189	68	-2.13e-03-6.58e-03	-0.04	1.75e-04	-7.97e-05	0.0
1189	70	-9.49e-04-2.22e-03	-0.04	1.08e-04	-4.98e-05	0.0
1189	72	-8.73e-04-1.96e-03	-0.03	9.54e-05	-4.60e-05	0.0
1189	73	-8.54e-04-1.89e-03	-0.03	9.23e-05	-4.50e-05	0.0
1190	2	-8.62e-04-2.80e-03	-0.05	1.37e-04	-4.65e-05	0.0
1190	8	-3.26e-03-2.88e-03	-0.04	1.03e-04	-5.88e-05	0.0
1190	32	-1.53e-03-4.84e-03	-0.04	1.34e-04	-5.14e-05	0.0
1190	36	-1.36e-03-4.89e-03	-0.04	1.35e-04	-5.00e-05	0.0
1190	40	-4.34e-03-3.31e-03	-0.04	1.09e-04	-6.95e-05	0.0
1190	64	-1.91e-03-6.07e-03	-0.04	1.53e-04	-5.94e-05	0.0
1190	68	-1.67e-03-6.15e-03	-0.04	1.55e-04	-5.73e-05	0.0
1190	70	-6.35e-04-2.06e-03	-0.03	1.01e-04	-3.40e-05	0.0
1190	72	-5.96e-04-1.82e-03	-0.03	8.96e-05	-3.21e-05	0.0
1190	73	-5.87e-04-1.77e-03	-0.03	8.68e-05	-3.16e-05	0.0
1191	1	-2.52e-04-2.32e-03	-0.04	1.15e-04	-1.47e-05	0.0
1191	2	-2.22e-04-2.75e-03	-0.05	1.36e-04	-1.29e-05	0.0
1191	8	-2.56e-03-1.64e-03	-0.03	9.86e-05	-2.28e-05	0.0
1191	32	-7.17e-04-4.30e-03	-0.04	1.27e-04	-1.90e-05	0.0
1191	36	-5.80e-04-4.67e-03	-0.04	1.27e-04	-1.87e-05	0.0
1191	40	-3.51e-03-1.60e-03	-0.03	1.04e-04	-2.77e-05	0.0
1191	68	-7.40e-04-5.85e-03	-0.04	1.44e-04	-2.21e-05	0.0
1191	69	-1.78e-04-1.73e-03	-0.03	8.57e-05	-1.03e-05	0.0
1191	70	-1.59e-04-2.01e-03	-0.03	9.94e-05	-9.10e-06	0.0
1191	71	-1.78e-04-1.73e-03	-0.03	8.57e-05	-1.03e-05	0.0
1191	72	-1.75e-04-1.79e-03	-0.03	8.84e-05	-1.00e-05	0.0
1191	73	-1.78e-04-1.73e-03	-0.03	8.57e-05	-1.03e-05	0.0
1192	2	4.10e-04-2.91e-03	-0.05	1.44e-04	2.02e-05	0.0
1192	6	2.48e-03-2.80e-03	-0.03	9.13e-05	1.76e-05	0.0
1192	36	-6.39e-05-4.74e-03	-0.04	1.32e-04	1.32e-05	0.0
1192	38	3.39e-03-3.18e-03	-0.03	9.16e-05	2.03e-05	0.0
1192	68	-1.79e-04-5.91e-03	-0.04	1.49e-04	1.42e-05	0.0
1192	70	3.11e-04-2.13e-03	-0.03	1.05e-04	1.55e-05	0.0
1192	72	2.42e-04-1.89e-03	-0.03	9.34e-05	1.18e-05	0.0
1192	73	2.25e-04-1.83e-03	-0.03	9.04e-05	1.08e-05	0.0
1193	2	7.74e-04-3.26e-03	-0.05	1.60e-04	3.96e-05	0.0
1193	6	2.81e-03-3.02e-03	-0.03	1.02e-04	3.41e-05	0.0
1193	36	2.40e-04-5.07e-03	-0.04	1.48e-04	2.99e-05	0.0
1193	38	3.75e-03-3.40e-03	-0.03	1.04e-04	3.84e-05	0.0
1193	68	1.52e-04-6.29e-03	-0.04	1.68e-04	3.25e-05	0.0
1193	70	5.79e-04-2.38e-03	-0.04	1.17e-04	2.99e-05	0.0
1193	72	4.85e-04-2.10e-03	-0.03	1.03e-04	2.47e-05	0.0
1193	73	4.61e-04-2.03e-03	-0.03	9.98e-05	2.34e-05	0.0
1194	2	4.45e-04-3.50e-03	-0.05	1.72e-04	2.36e-05	0.0
1194	6	3.07e-03-3.21e-03	-0.03	1.12e-04	4.08e-05	0.0
1194	30	1.33e-03-5.27e-03	-0.04	1.58e-04	2.61e-05	0.0
1194	36	-1.01e-04-5.25e-03	-0.04	1.61e-04	1.31e-05	0.0
1194	38	4.19e-03-3.62e-03	-0.03	1.15e-04	5.16e-05	0.0
1194	62	1.75e-03-6.52e-03	-0.04	1.79e-04	3.10e-05	0.0
1194	68	-2.46e-04-6.49e-03	-0.04	1.82e-04	1.28e-05	0.0
1194	70	3.29e-04-2.56e-03	-0.04	1.25e-04	1.76e-05	0.0
1194	72	2.77e-04-2.24e-03	-0.03	1.10e-04	1.46e-05	0.0
1194	73	2.64e-04-2.17e-03	-0.03	1.07e-04	1.38e-05	0.0
1195	2	-2.00e-04-3.54e-03	-0.05	1.74e-04	-1.19e-05	0.0
1195	8	-2.87e-03-3.07e-03	-0.03	1.13e-04	-3.18e-05	0.0
1195	30	8.09e-04-5.01e-03	-0.04	1.62e-04	-5.81e-06	0.0
1195	36	-5.97e-04-5.27e-03	-0.04	1.60e-04	-1.75e-05	0.0
1195	40	-3.96e-03-3.41e-03	-0.03	1.16e-04	-4.14e-05	0.0
1195	62	1.18e-03-6.14e-03	-0.04	1.84e-04	-5.05e-06	0.0
1195	68	-7.86e-04-6.50e-03	-0.04	1.81e-04	-2.15e-05	0.0
1195	70	-1.52e-04-2.59e-03	-0.04	1.27e-04	-8.93e-06	0.0
1195	72	-1.30e-04-2.27e-03	-0.03	1.12e-04	-7.94e-06	0.0
1195	73	-1.24e-04-2.19e-03	-0.03	1.08e-04	-7.69e-06	0.0
1196	2	-5.57e-04-3.43e-03	-0.05	1.68e-04	-2.93e-05	0.0
1196	8	-2.41e-03-2.19e-03	-0.03	1.06e-04	-1.69e-05	0.0
1196	30	9.06e-05-5.11e-03	-0.04	1.53e-04	-2.91e-05	0.0
1196	40	-3.24e-03-2.21e-03	-0.03	1.06e-04	-1.63e-05	0.0
1196	62	2.66e-04-6.30e-03	-0.04	1.73e-04	-3.34e-05	0.0
1196	70	-4.23e-04-2.50e-03	-0.04	1.23e-04	-2.21e-05	0.0





EGP CODE

GRE.EEC.R.73.IT.W.15235.12.024.01

PAGE

251 di/of 527

1196	72	-3.62e-04-2.21e-03	-0.03	1.08e-04	-1.92e-05	0.0
1196	73	-3.47e-04-2.13e-03	-0.03	1.05e-04	-1.84e-05	0.0
1197	2	-2.77e-04-3.23e-03	-0.05	1.59e-04	-1.44e-05	0.0
1197	8	-2.00e-03-2.08e-03	-0.03	1.01e-04	2.88e-06	0.0
1197	30	4.57e-04-4.80e-03	-0.04	1.40e-04	-1.90e-05	0.0
1197	40	-2.73e-03-2.11e-03	-0.03	1.02e-04	7.77e-06	0.0
1197	62	7.10e-04-5.92e-03	-0.04	1.56e-04	-2.30e-05	0.0
1197	70	-2.14e-04-2.35e-03	-0.04	1.16e-04	-1.10e-05	0.0
1197	72	-1.82e-04-2.08e-03	-0.03	1.03e-04	-9.54e-06	0.0
1197	73	-1.74e-04-2.01e-03	-0.03	9.95e-05	-9.19e-06	0.0
1198	2	2.03e-04-3.21e-03	-0.05	1.58e-04	1.06e-05	0.0
1198	6	1.91e-03-2.76e-03	-0.03	1.08e-04	-6.97e-06	0.0
1198	30	7.94e-04-4.75e-03	-0.04	1.37e-04	6.24e-06	0.0
1198	38	2.62e-03-3.06e-03	-0.03	1.11e-04	-1.23e-05	0.0
1198	62	1.06e-03-5.85e-03	-0.04	1.53e-04	6.22e-06	0.0
1198	70	1.45e-04-2.34e-03	-0.03	1.15e-04	7.80e-06	0.0
1198	72	1.27e-04-2.07e-03	-0.03	1.02e-04	6.58e-06	0.0
1198	73	1.23e-04-2.00e-03	-0.03	9.88e-05	6.27e-06	0.0
1199	2	6.00e-04-3.38e-03	-0.05	1.66e-04	3.11e-05	0.0
1199	6	2.27e-03-2.84e-03	-0.03	1.10e-04	1.23e-05	0.0
1199	30	1.18e-03-4.96e-03	-0.04	1.46e-04	2.54e-05	0.0
1199	32	9.81e-05-4.80e-03	-0.04	1.47e-04	3.07e-05	0.0
1199	38	3.03e-03-3.14e-03	-0.03	1.13e-04	9.72e-06	0.0
1199	62	1.50e-03-6.10e-03	-0.04	1.63e-04	2.80e-05	0.0
1199	64	-9.56e-06-5.88e-03	-0.04	1.64e-04	3.55e-05	0.0
1199	70	4.43e-04-2.47e-03	-0.04	1.21e-04	2.31e-05	0.0
1199	72	3.83e-04-2.17e-03	-0.03	1.07e-04	1.97e-05	0.0
1199	73	3.67e-04-2.10e-03	-0.03	1.03e-04	1.89e-05	0.0
1200	2	5.85e-04-3.51e-03	-0.05	1.75e-04	2.93e-05	0.0
1200	6	2.70e-03-3.04e-03	-0.03	1.21e-04	3.03e-05	0.0
1200	30	1.31e-03-5.16e-03	-0.04	1.60e-04	2.88e-05	0.0
1200	32	-3.10e-05-4.94e-03	-0.04	1.59e-04	2.24e-05	0.0
1200	38	3.64e-03-3.39e-03	-0.04	1.26e-04	3.53e-05	0.0
1200	62	1.69e-03-6.36e-03	-0.04	1.81e-04	3.32e-05	0.0
1200	64	-1.85e-04-6.05e-03	-0.04	1.79e-04	2.42e-05	0.0
1200	70	4.31e-04-2.56e-03	-0.04	1.27e-04	2.18e-05	0.0
1200	72	3.69e-04-2.25e-03	-0.03	1.12e-04	1.85e-05	0.0
1200	73	3.53e-04-2.17e-03	-0.03	1.08e-04	1.77e-05	0.0
1201	2	8.57e-04-3.04e-03	-0.05	1.50e-04	4.59e-05	0.0
1201	10	2.20e-03-2.13e-03	-0.03	9.28e-05	1.80e-05	0.0
1201	24	1.55e-04-4.60e-03	-0.04	1.35e-04	4.49e-05	0.0
1201	42	2.87e-03-2.23e-03	-0.03	9.27e-05	1.38e-05	0.0
1201	56	5.31e-06-5.69e-03	-0.04	1.51e-04	5.16e-05	0.0
1201	70	6.45e-04-2.20e-03	-0.03	1.09e-04	3.44e-05	0.0
1201	72	5.52e-04-1.95e-03	-0.03	9.63e-05	2.96e-05	0.0
1201	73	5.29e-04-1.88e-03	-0.03	9.32e-05	2.83e-05	0.0
1202	2	-7.35e-04-3.49e-03	-0.05	1.73e-04	-3.69e-05	0.0
1202	8	-2.78e-03-2.77e-03	-0.03	1.16e-04	-3.56e-05	0.0
1202	30	4.43e-05-4.99e-03	-0.04	1.58e-04	-2.73e-05	0.0
1202	36	-1.17e-03-5.09e-03	-0.04	1.58e-04	-3.30e-05	0.0
1202	40	-3.71e-03-3.01e-03	-0.03	1.20e-04	-4.08e-05	0.0
1202	62	2.41e-04-6.13e-03	-0.04	1.79e-04	-2.92e-05	0.0
1202	68	-1.47e-03-6.26e-03	-0.04	1.78e-04	-3.71e-05	0.0
1202	70	-5.53e-04-2.54e-03	-0.04	1.26e-04	-2.77e-05	0.0
1202	72	-4.68e-04-2.23e-03	-0.03	1.11e-04	-2.37e-05	0.0
1202	73	-4.46e-04-2.15e-03	-0.03	1.07e-04	-2.27e-05	0.0
1203	2	-7.37e-04-3.32e-03	-0.05	1.63e-04	-3.80e-05	0.0
1203	8	-2.31e-03-2.36e-03	-0.03	1.05e-04	-1.74e-05	0.0
1203	30	-7.43e-05-4.87e-03	-0.04	1.45e-04	-3.56e-05	0.0
1203	40	-3.05e-03-2.48e-03	-0.03	1.07e-04	-1.50e-05	0.0
1203	62	7.76e-05-6.00e-03	-0.04	1.63e-04	-4.05e-05	0.0
1203	70	-5.56e-04-2.42e-03	-0.04	1.18e-04	-2.85e-05	0.0
1203	72	-4.74e-04-2.13e-03	-0.03	1.05e-04	-2.44e-05	0.0
1203	73	-4.53e-04-2.06e-03	-0.03	1.01e-04	-2.34e-05	0.0
1204	2	-3.01e-04-3.11e-03	-0.05	1.53e-04	-1.54e-05	0.0
1204	8	-1.90e-03-2.24e-03	-0.03	1.00e-04	3.10e-06	0.0
1204	30	3.78e-04-4.60e-03	-0.04	1.34e-04	-1.89e-05	0.0
1204	40	-2.59e-03-2.37e-03	-0.03	1.03e-04	8.22e-06	0.0
1204	62	6.03e-04-5.67e-03	-0.04	1.49e-04	-2.26e-05	0.0
1204	70	-2.29e-04-2.26e-03	-0.03	1.11e-04	-1.16e-05	0.0
1204	72	-1.94e-04-2.00e-03	-0.03	9.85e-05	-1.00e-05	0.0
1204	73	-1.86e-04-1.93e-03	-0.03	9.54e-05	-9.64e-06	0.0
1205	2	2.68e-04-3.11e-03	-0.05	1.53e-04	1.42e-05	0.0
1205	6	1.86e-03-2.48e-03	-0.03	1.02e-04	-4.13e-06	0.0
1205	32	-1.58e-04-4.53e-03	-0.04	1.33e-04	1.90e-05	0.0
1205	36	-1.18e-04-4.59e-03	-0.04	1.33e-04	1.75e-05	0.0



EGP CODE

GRE.EEC.R.73.IT.W.15235.12.024.01

PAGE

252 di/of 527

1205	38	2.54e-03-2.70e-03	-0.03	1.04e-04	-9.21e-06	0.0
1205	64	-2.87e-04-5.58e-03	-0.04	1.49e-04	2.32e-05	0.0
1205	68	-2.30e-04-5.65e-03	-0.04	1.49e-04	2.11e-05	0.0
1205	70	1.97e-04-2.26e-03	-0.03	1.11e-04	1.05e-05	0.0
1205	72	1.70e-04-2.00e-03	-0.03	9.83e-05	8.91e-06	0.0
1205	73	1.63e-04-1.93e-03	-0.03	9.52e-05	8.50e-06	0.0
1206	2	7.36e-04-3.31e-03	-0.05	1.62e-04	3.84e-05	0.0
1206	6	2.26e-03-2.49e-03	-0.03	1.06e-04	1.70e-05	0.0
1206	32	2.29e-04-4.85e-03	-0.04	1.46e-04	3.80e-05	0.0
1206	36	2.76e-04-4.85e-03	-0.04	1.46e-04	3.70e-05	0.0
1206	38	2.98e-03-2.67e-03	-0.03	1.08e-04	1.45e-05	0.0
1206	64	1.41e-04-5.97e-03	-0.04	1.64e-04	4.39e-05	0.0
1206	68	2.07e-04-5.97e-03	-0.04	1.64e-04	4.25e-05	0.0
1206	70	5.48e-04-2.41e-03	-0.04	1.18e-04	2.87e-05	0.0
1206	72	4.70e-04-2.12e-03	-0.03	1.04e-04	2.44e-05	0.0
1206	73	4.50e-04-2.05e-03	-0.03	1.01e-04	2.34e-05	0.0
1207	2	8.09e-04-3.49e-03	-0.05	1.73e-04	4.15e-05	0.0
1207	6	2.71e-03-2.86e-03	-0.03	1.18e-04	3.70e-05	0.0
1207	30	1.45e-03-5.12e-03	-0.04	1.61e-04	3.91e-05	0.0
1207	32	1.81e-04-5.01e-03	-0.04	1.61e-04	3.34e-05	0.0
1207	38	3.61e-03-3.14e-03	-0.03	1.23e-04	4.17e-05	0.0
1207	62	1.83e-03-6.32e-03	-0.04	1.83e-04	4.46e-05	0.0
1207	64	5.62e-05-6.16e-03	-0.04	1.82e-04	3.66e-05	0.0
1207	70	6.02e-04-2.54e-03	-0.04	1.26e-04	3.10e-05	0.0
1207	72	5.13e-04-2.22e-03	-0.03	1.11e-04	2.64e-05	0.0
1207	73	4.91e-04-2.15e-03	-0.03	1.07e-04	2.52e-05	0.0
1208	1	-2.13e-031.29e-04	-0.31	0.0	-1.00e-04	0.0
1208	2	-2.05e-031.56e-04	-0.39	0.0	-1.04e-04	0.0
1208	8	-0.23 -0.08	-0.23	-5.66e-05	-4.36e-04	-1.65e-04
1208	17	0.22 -2.03e-03	-0.24	-5.57e-06	2.81e-04	-1.44e-04
1208	21	0.07 0.18	-0.24	1.18e-04	2.52e-05	9.02e-05
1208	40	-0.32 -0.11	-0.23	-7.90e-05	-5.79e-04	-2.31e-04
1208	49	0.31 -3.00e-03	-0.25	-7.89e-06	4.24e-04	-2.01e-04
1208	53	0.10 0.25	-0.24	1.65e-04	6.62e-05	1.26e-04
1208	69	-1.65e-039.76e-05	-0.24	0.0	-7.74e-05	0.0
1208	70	-1.60e-031.16e-04	-0.29	0.0	-8.03e-05	0.0
1208	71	-1.65e-039.76e-05	-0.24	0.0	-7.74e-05	0.0
1208	72	-1.64e-031.01e-04	-0.25	0.0	-7.80e-05	0.0
1208	73	-1.65e-039.76e-05	-0.24	0.0	-7.74e-05	0.0
1209	2	-5.95e-04-3.63e-03	-0.05	1.80e-04	-2.89e-05	0.0
1209	8	-2.76e-03-2.89e-03	-0.03	1.23e-04	-3.73e-05	0.0
1209	30	1.66e-04-5.15e-03	-0.04	1.68e-04	-2.00e-05	0.0
1209	32	-1.20e-03-5.22e-03	-0.04	1.69e-04	-3.07e-05	0.0
1209	40	-3.72e-03-3.15e-03	-0.04	1.29e-04	-4.52e-05	0.0
1209	62	3.76e-04-6.32e-03	-0.04	1.91e-04	-2.10e-05	0.0
1209	64	-1.54e-03-6.42e-03	-0.04	1.92e-04	-3.60e-05	0.0
1209	70	-4.46e-04-2.64e-03	-0.04	1.31e-04	-2.16e-05	0.0
1209	72	-3.74e-04-2.31e-03	-0.04	1.15e-04	-1.84e-05	0.0
1209	73	-3.56e-04-2.23e-03	-0.03	1.11e-04	-1.76e-05	0.0
1210	2	-7.21e-04-3.46e-03	-0.05	1.69e-04	-3.70e-05	0.0
1210	8	-2.34e-03-2.60e-03	-0.03	1.10e-04	-2.30e-05	0.0
1210	30	-5.05e-05-4.97e-03	-0.04	1.54e-04	-3.45e-05	0.0
1210	40	-3.10e-03-2.79e-03	-0.03	1.13e-04	-2.31e-05	0.0
1210	62	1.06e-04-6.11e-03	-0.04	1.74e-04	-3.92e-05	0.0
1210	70	-5.41e-04-2.52e-03	-0.04	1.23e-04	-2.77e-05	0.0
1210	72	-4.62e-04-2.21e-03	-0.03	1.08e-04	-2.38e-05	0.0
1210	73	-4.42e-04-2.13e-03	-0.03	1.05e-04	-2.28e-05	0.0
1211	2	-3.28e-04-3.21e-03	-0.05	1.58e-04	-1.70e-05	0.0
1211	8	-1.92e-03-2.43e-03	-0.03	1.04e-04	-2.62e-06	0.0
1211	30	3.19e-04-4.63e-03	-0.04	1.40e-04	-1.90e-05	0.0
1211	40	-2.60e-03-2.60e-03	-0.03	1.06e-04	0.0	0.0
1211	62	5.28e-04-5.69e-03	-0.04	1.56e-04	-2.24e-05	0.0
1211	70	-2.47e-04-2.34e-03	-0.04	1.15e-04	-1.28e-05	0.0
1211	72	-2.13e-04-2.06e-03	-0.03	1.02e-04	-1.11e-05	0.0
1211	73	-2.04e-04-1.99e-03	-0.03	9.83e-05	-1.06e-05	0.0
1212	2	2.41e-04-3.18e-03	-0.05	1.57e-04	1.25e-05	0.0
1212	6	1.81e-03-2.47e-03	-0.03	1.04e-04	-2.23e-06	0.0
1212	34	7.66e-04-4.56e-03	-0.04	1.37e-04	8.28e-06	0.0
1212	38	2.48e-03-2.67e-03	-0.03	1.07e-04	-6.06e-06	0.0
1212	66	1.02e-03-5.59e-03	-0.04	1.53e-04	8.66e-06	0.0
1212	70	1.79e-04-2.31e-03	-0.03	1.14e-04	9.28e-06	0.0
1212	72	1.50e-04-2.03e-03	-0.03	1.01e-04	7.72e-06	0.0
1212	73	1.43e-04-1.96e-03	-0.03	9.73e-05	7.33e-06	0.0
1213	2	7.40e-04-3.37e-03	-0.05	1.66e-04	3.84e-05	0.0
1213	10	2.21e-03-2.84e-03	-0.03	1.12e-04	1.92e-05	0.0
1213	32	2.79e-04-4.76e-03	-0.04	1.48e-04	3.62e-05	0.0



EGP CODE

GRE.EEC.R.73.IT.W.15235.12.024.01

PAGE

253 di/of 527

1213	42	2.92e-03-3.14e-03	-0.03	1.16e-04	1.77e-05	0.0
1213	64	2.11e-04-5.84e-03	-0.04	1.66e-04	4.15e-05	0.0
1213	70	5.51e-04-2.45e-03	-0.04	1.20e-04	2.87e-05	0.0
1213	72	4.68e-04-2.15e-03	-0.03	1.06e-04	2.43e-05	0.0
1213	73	4.47e-04-2.08e-03	-0.03	1.03e-04	2.32e-05	0.0
1214	2	8.82e-04-3.73e-03	-0.05	1.82e-04	4.62e-05	0.0
1214	10	2.56e-03-3.14e-03	-0.04	1.25e-04	3.66e-05	0.0
1214	32	3.83e-04-5.24e-03	-0.04	1.70e-04	4.07e-05	0.0
1214	42	3.37e-03-3.48e-03	-0.04	1.30e-04	4.01e-05	0.0
1214	64	3.23e-04-6.42e-03	-0.04	1.93e-04	4.58e-05	0.0
1214	70	6.58e-04-2.72e-03	-0.04	1.33e-04	3.45e-05	0.0
1214	72	5.58e-04-2.38e-03	-0.03	1.16e-04	2.92e-05	0.0
1214	73	5.33e-04-2.29e-03	-0.03	1.12e-04	2.78e-05	0.0
1215	2	1.41e-04-3.92e-03	-0.05	1.92e-04	9.12e-06	0.0
1215	6	2.65e-03-3.09e-03	-0.04	1.32e-04	3.29e-05	0.0
1215	30	1.14e-03-5.45e-03	-0.04	1.84e-04	1.90e-05	0.0
1215	34	1.04e-03-5.45e-03	-0.04	1.84e-04	1.63e-05	0.0
1215	38	3.68e-03-3.37e-03	-0.04	1.38e-04	4.41e-05	0.0
1215	62	1.57e-03-6.68e-03	-0.05	2.10e-04	2.46e-05	0.0
1215	66	1.42e-03-6.67e-03	-0.05	2.10e-04	2.08e-05	0.0
1215	70	1.03e-04-2.86e-03	-0.04	1.40e-04	6.75e-06	0.0
1215	72	7.88e-05-2.48e-03	-0.04	1.22e-04	5.37e-06	0.0
1215	73	7.28e-05-2.39e-03	-0.04	1.17e-04	5.03e-06	0.0
1216	2	-7.48e-04-3.77e-03	-0.05	1.85e-04	-4.18e-05	0.0
1216	8	-2.99e-03-3.00e-03	-0.04	1.24e-04	-5.22e-05	0.0
1216	30	2.25e-04-5.27e-03	-0.04	1.79e-04	-2.78e-05	0.0
1216	32	-1.22e-03-5.33e-03	-0.04	1.77e-04	-4.26e-05	0.0
1216	40	-4.01e-03-3.29e-03	-0.04	1.28e-04	-6.29e-05	0.0
1216	62	4.98e-04-6.46e-03	-0.05	2.05e-04	-2.87e-05	0.0
1216	64	-1.52e-03-6.54e-03	-0.04	2.03e-04	-4.94e-05	0.0
1216	70	-5.60e-04-2.75e-03	-0.04	1.35e-04	-3.13e-05	0.0
1216	72	-4.77e-04-2.39e-03	-0.04	1.18e-04	-2.67e-05	0.0
1216	73	-4.57e-04-2.30e-03	-0.03	1.14e-04	-2.56e-05	0.0
1217	2	-1.41e-03-3.51e-03	-0.05	1.71e-04	-7.39e-05	0.0
1217	8	-2.82e-03-2.65e-03	-0.03	1.08e-04	-5.06e-05	0.0
1217	30	-5.31e-04-4.98e-03	-0.04	1.60e-04	-6.52e-05	0.0
1217	40	-3.60e-03-2.85e-03	-0.03	1.09e-04	-5.27e-05	0.0
1217	62	-3.98e-04-6.12e-03	-0.04	1.82e-04	-7.33e-05	0.0
1217	70	-1.06e-03-2.55e-03	-0.04	1.24e-04	-5.53e-05	0.0
1217	72	-9.03e-04-2.23e-03	-0.03	1.09e-04	-4.71e-05	0.0
1217	73	-8.64e-04-2.15e-03	-0.03	1.05e-04	-4.50e-05	0.0
1218	2	-1.22e-03-3.01e-03	-0.04	1.49e-04	-6.29e-05	0.0
1218	8	-2.45e-03-2.29e-03	-0.03	9.30e-05	-3.26e-05	0.0
1218	30	-4.06e-04-4.34e-03	-0.04	1.32e-04	-5.85e-05	0.0
1218	40	-3.13e-03-2.46e-03	-0.03	9.34e-05	-3.03e-05	0.0
1218	62	-2.70e-04-5.33e-03	-0.04	1.48e-04	-6.66e-05	0.0
1218	70	-9.12e-04-2.18e-03	-0.03	1.08e-04	-4.70e-05	0.0
1218	72	-7.78e-04-1.92e-03	-0.03	9.52e-05	-4.01e-05	0.0
1218	73	-7.45e-04-1.86e-03	-0.03	9.21e-05	-3.84e-05	0.0
1219	2	-6.72e-04-2.69e-03	-0.04	1.34e-04	-3.41e-05	0.0
1219	16	-1.99e-03-2.11e-03	-0.03	8.65e-05	-1.38e-05	0.0
1219	30	-8.01e-06-3.93e-03	-0.03	1.14e-04	-3.53e-05	0.0
1219	48	-2.62e-03-2.29e-03	-0.03	8.79e-05	-1.09e-05	0.0
1219	62	1.54e-04-4.83e-03	-0.03	1.27e-04	-4.11e-05	0.0
1219	70	-5.04e-04-1.94e-03	-0.03	9.65e-05	-2.55e-05	0.0
1219	72	-4.31e-04-1.72e-03	-0.03	8.58e-05	-2.18e-05	0.0
1219	73	-4.12e-04-1.67e-03	-0.03	8.31e-05	-2.09e-05	0.0
1220	2	1.00e-05-2.58e-03	-0.04	1.28e-04	1.55e-06	0.0
1220	13	1.53e-03-1.11e-03	-0.03	7.46e-05	-1.19e-05	0.0
1220	30	6.02e-04-3.74e-03	-0.03	1.07e-04	-6.91e-06	0.0
1220	34	6.07e-04-3.75e-03	-0.03	1.07e-04	-5.45e-06	0.0
1220	45	2.15e-03-9.16e-04	-0.03	7.24e-05	-1.70e-05	0.0
1220	62	8.42e-04-4.60e-03	-0.03	1.18e-04	-9.98e-06	0.0
1220	66	8.49e-04-4.61e-03	-0.03	1.18e-04	-7.93e-06	0.0
1220	70	6.65e-06-1.86e-03	-0.03	9.26e-05	1.13e-06	0.0
1220	72	3.64e-06-1.65e-03	-0.03	8.25e-05	0.0	0.0
1220	73	2.89e-06-1.60e-03	-0.03	8.00e-05	0.0	0.0
1221	2	6.94e-04-2.69e-03	-0.04	1.33e-04	3.72e-05	0.0
1221	18	2.00e-03-2.29e-03	-0.03	9.00e-05	1.50e-05	0.0
1221	32	2.90e-04-3.81e-03	-0.03	1.11e-04	3.24e-05	0.0
1221	50	2.63e-03-2.54e-03	-0.03	9.28e-05	1.20e-05	0.0
1221	64	2.39e-04-4.68e-03	-0.03	1.23e-04	3.64e-05	0.0
1221	70	5.18e-04-1.94e-03	-0.03	9.63e-05	2.78e-05	0.0
1221	72	4.39e-04-1.72e-03	-0.03	8.56e-05	2.35e-05	0.0
1221	73	4.19e-04-1.66e-03	-0.03	8.29e-05	2.24e-05	0.0
1222	2	1.25e-03-3.01e-03	-0.05	1.48e-04	6.60e-05	0.0

1222	10	2.46e-03-2.45e-03	-0.03	9.72e-05	3.48e-05	0.0
1222	32	7.42e-04-4.11e-03	-0.03	1.26e-04	5.51e-05	0.0
1222	42	3.14e-03-2.69e-03	-0.03	9.94e-05	3.28e-05	0.0
1222	64	7.36e-04-5.02e-03	-0.04	1.40e-04	6.12e-05	0.0
1222	70	9.33e-04-2.18e-03	-0.03	1.07e-04	4.93e-05	0.0
1222	72	7.92e-04-1.92e-03	-0.03	9.48e-05	4.18e-05	0.0
1222	73	7.56e-04-1.85e-03	-0.03	9.17e-05	3.99e-05	0.0

Nodo	Traslazione X			Traslazione Y			Traslazione Z			Rotazione X			Rotazione Y			Rotazione Z		
	-0.32	-0.42	-0.39	-2.41e-03	-5.79e-04	-2.45e-04												
	0.31	0.42	-7.61e-03	2.41e-03	4.60e-04	2.50e-04												

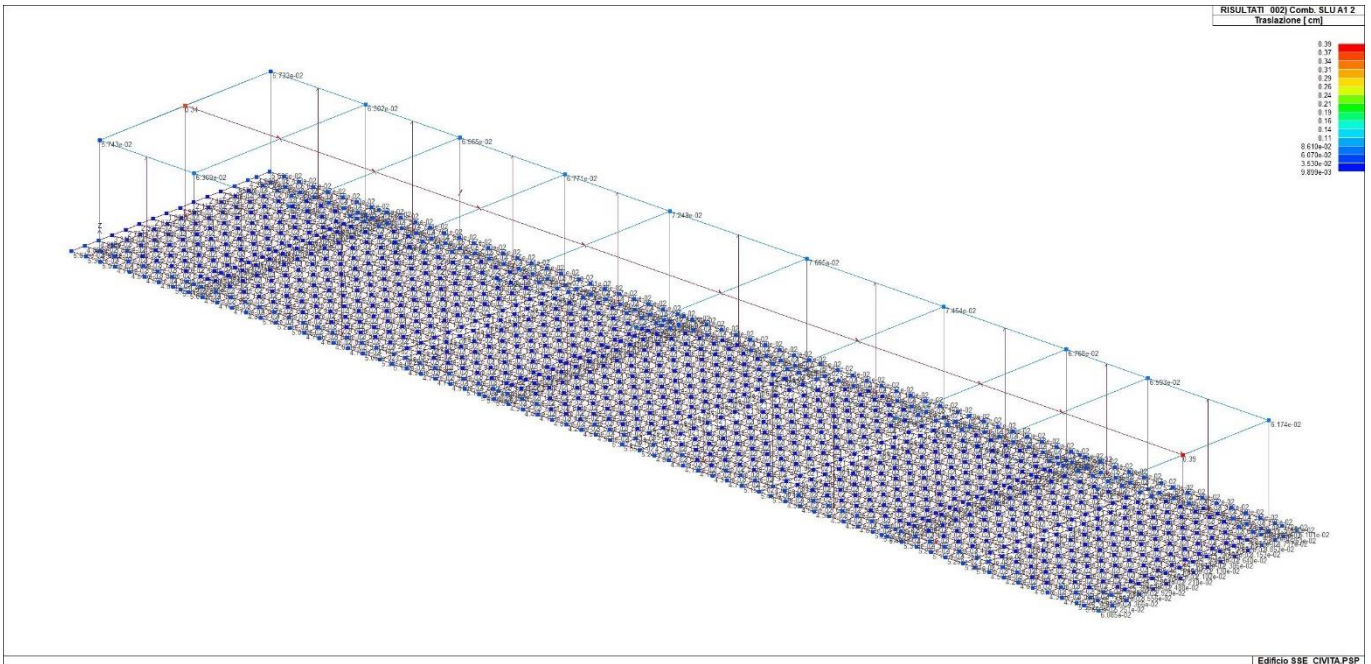

41\_RIS\_SPOSTAMENTI\_002\_Comb. SLU A1 2

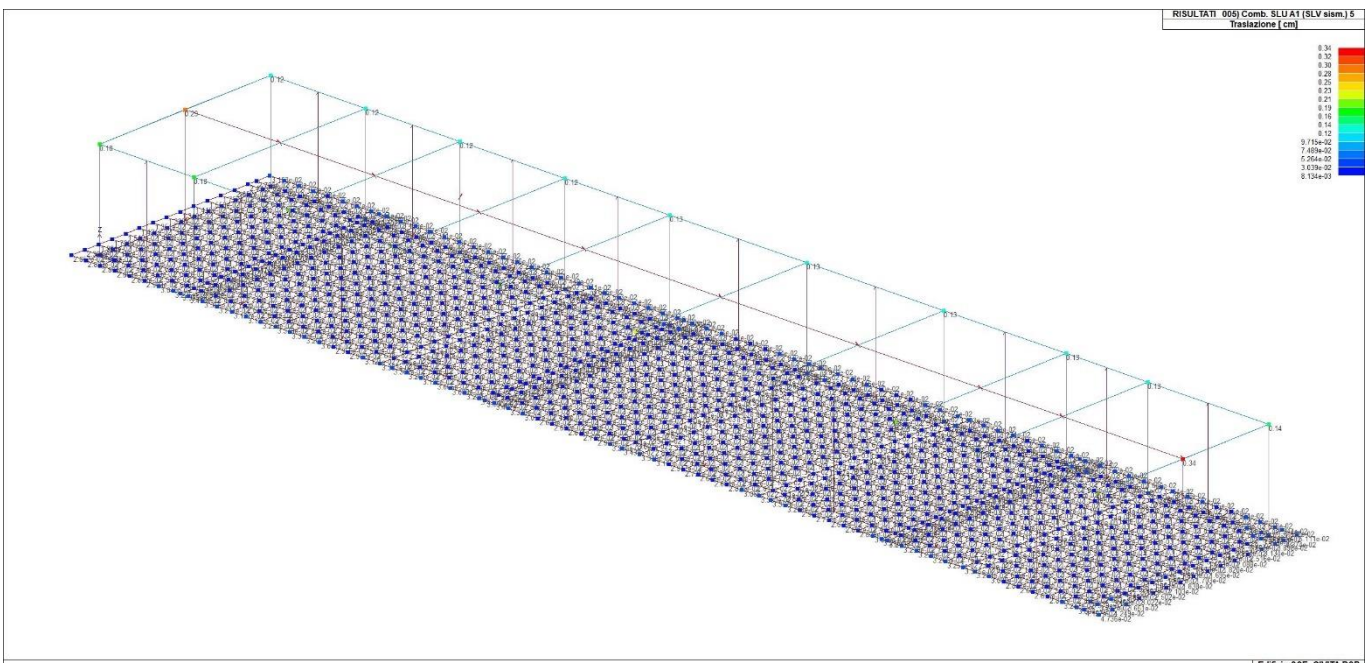

41\_RIS\_SPOSTAMENTI\_005\_Comb. SLU A1 (SLV sism.) 5



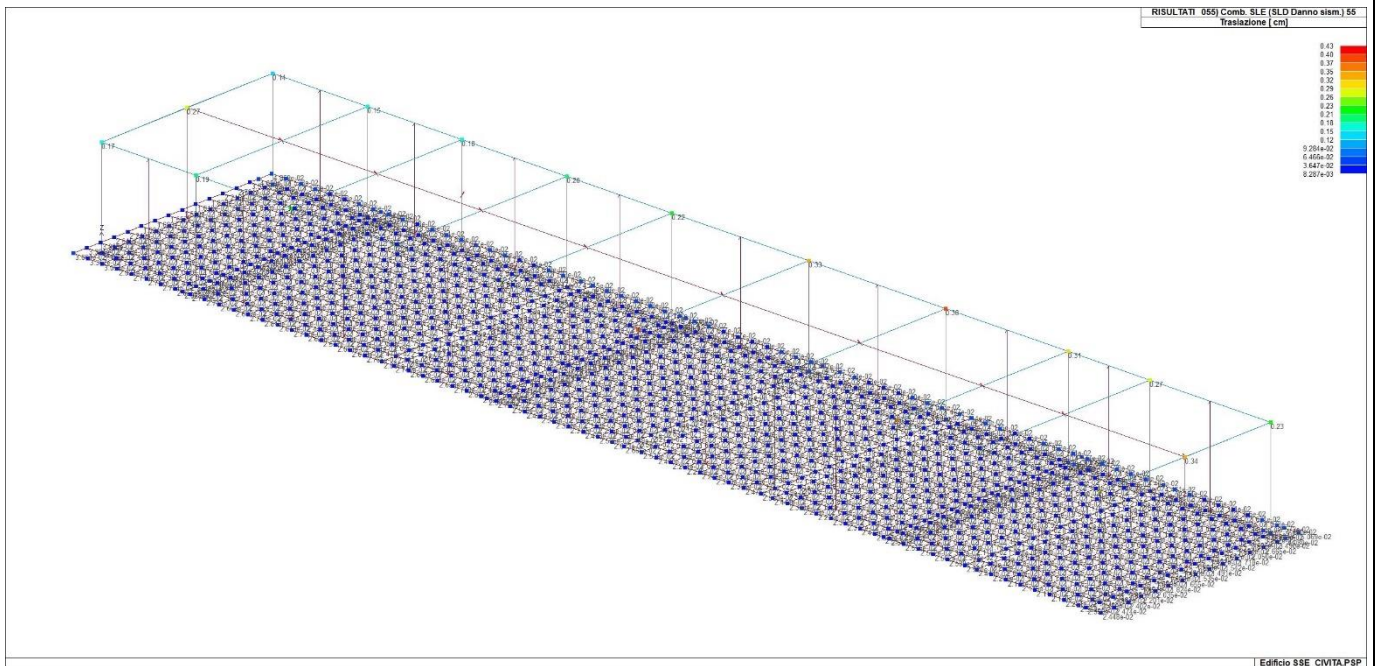

41\_RIS\_SPOSTAMENTI\_055\_Comb. SLE (SLD Danno sism.) 55

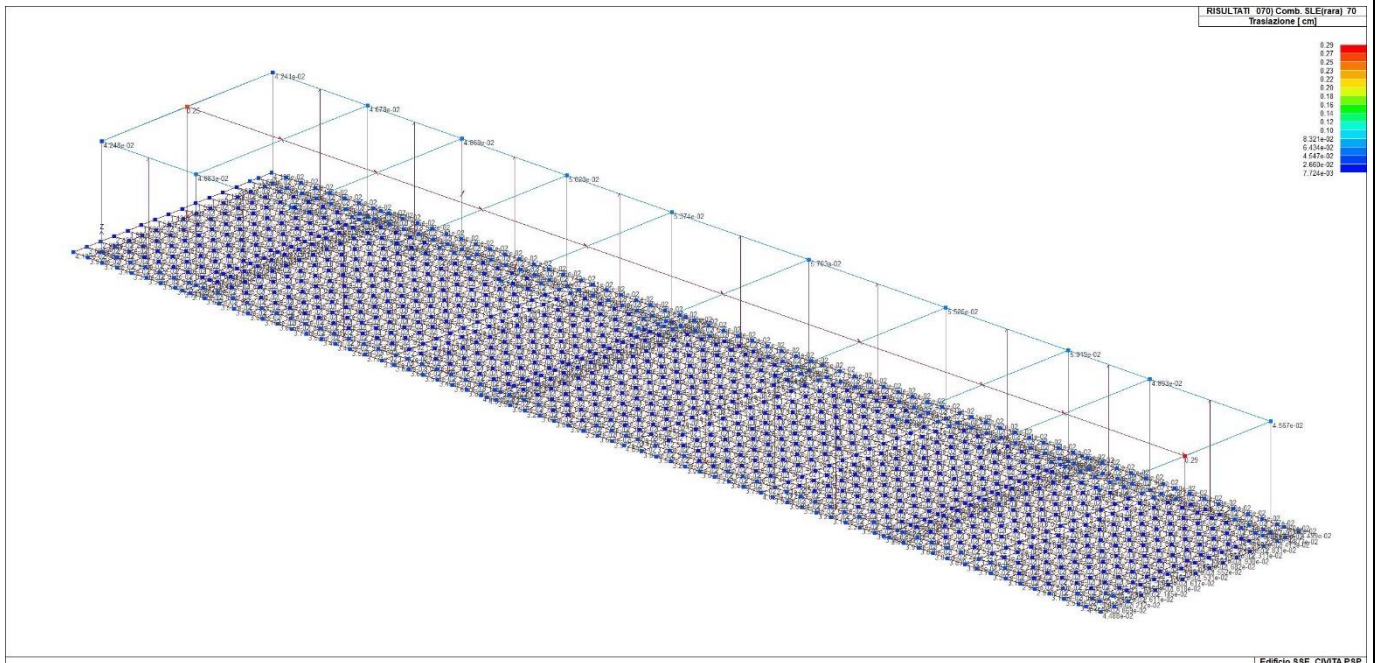

41\_RIS\_SPOSTAMENTI\_070\_Comb. SLE(rara) 70



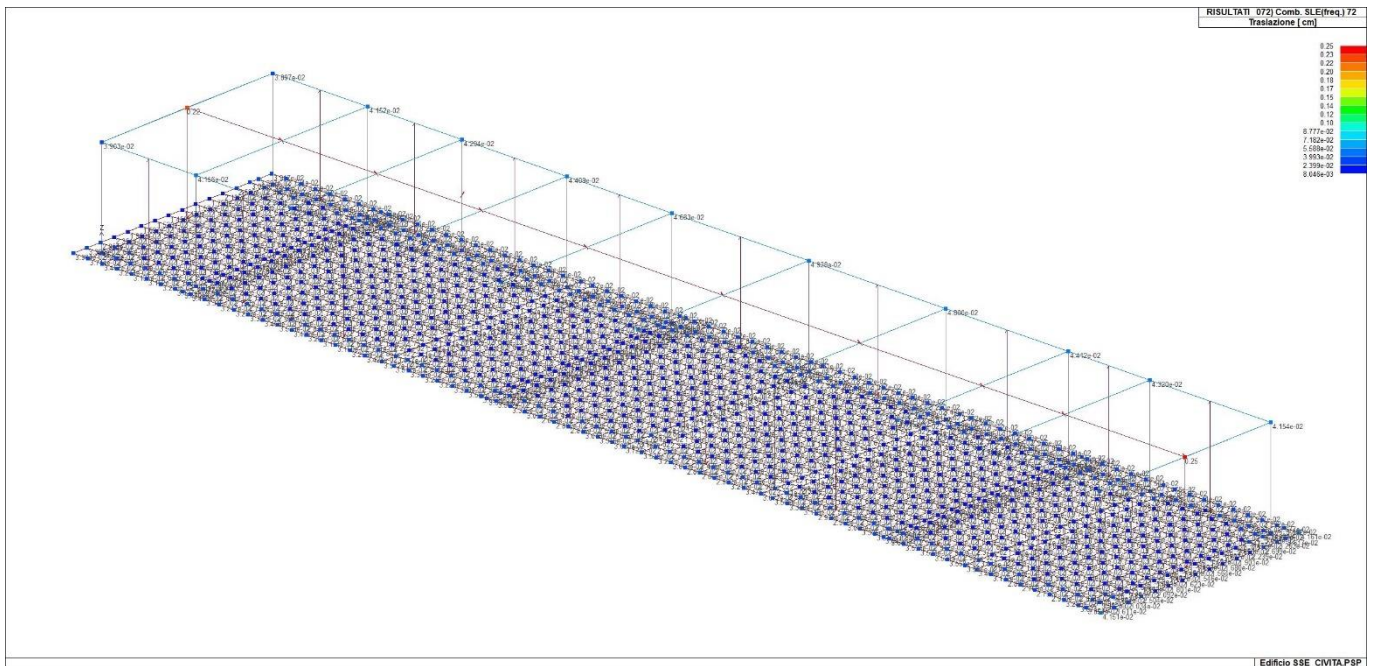

41\_RIS\_SPOSTAMENTI\_072\_Comb. SLE(freq.) 72

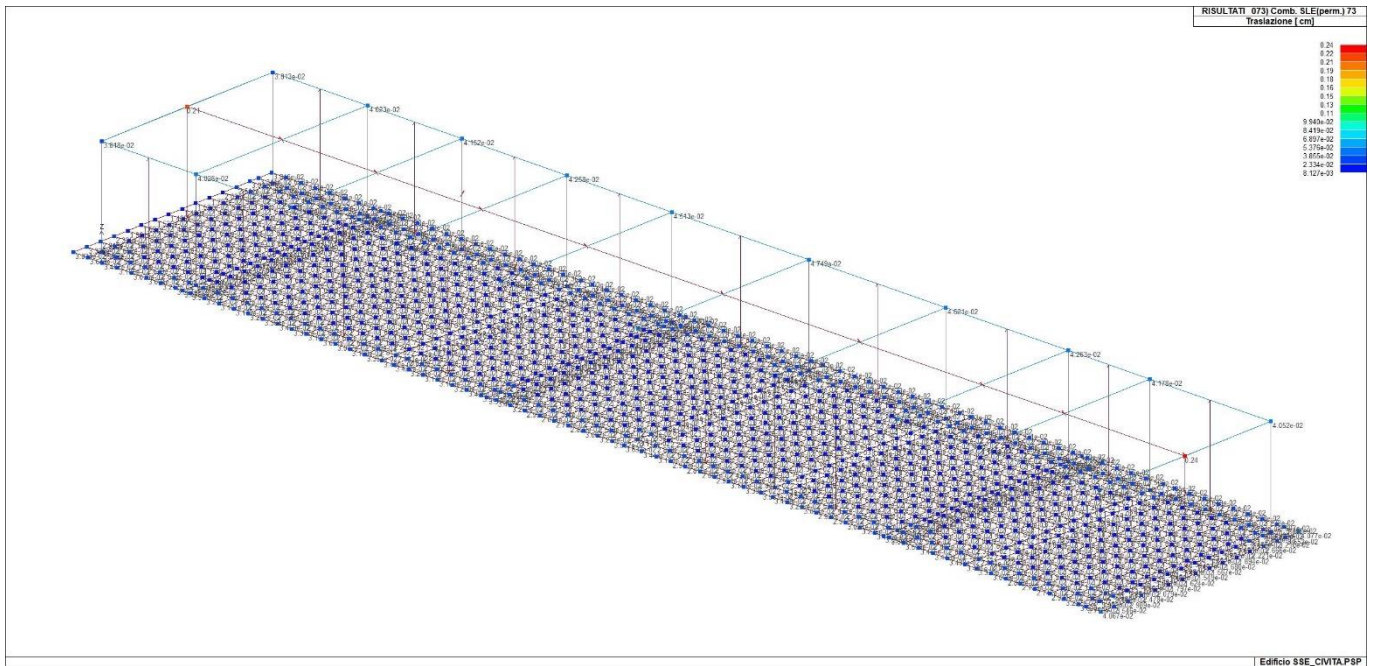

41\_RIS\_SPOSTAMENTI\_073\_Comb. SLE(perm.) 73

Nodo	Cmb daN	Azione X daN	Azione Y daN	Azione Z daN cm	Azione RX daN cm	Azione RY daN cm	Azione RZ
Nodo	Azione X	Azione Y	Azione Z	Azione RX	Azione RY	Azione RZ	
Nodo	Cmb daN	Azione X daN	Azione Y daN	Azione Z daN cm	Azione RX daN cm	Azione RY daN cm	Azione RZ

## 15. RISULTATI OPERE DI FONDAZIONE

### 15.1. LEGENDA RISULTATI OPERE DI FONDAZIONE

Il controllo dei risultati delle analisi condotte, per quanto concerne le opere di fondazione, è possibile in relazione alle tabelle sotto riportate.

La prima tabella è riferita alle fondazioni tipo palo e plinto su pali.

Per questo tipo di fondazione vengono riportate le sei componenti di sollecitazione (espresse nel riferimento globale della struttura) per ogni palo componente l'opera.

In particolare viene riportato:

<b>Nodo</b>	numero del nodo a cui è applicato il plinto
<b>Tipo</b>	codice corrispondente al nome assegnato al tipo di plinto di fondazione: 3) palo singolo ( <i>PALO</i> ) 4) plinto su palo 5) plinto su due pali ( <i>PL.2P</i> ) 6) plinto su tre pali ( <i>PL.3P</i> ) 7) plinto su quattro pali ( <i>PL.4P</i> ) 8) plinto rettangolare su cinque pali ( <i>PL.5P.R</i> ) 9) plinto pentagonale su cinque pali ( <i>PL.5P</i> ) 10) plinto su sei pali ( <i>PL.6P</i> )
<b>Palo</b>	numero del palo
<b>Comb.</b>	combinazione di carico in cui si verificano le sei componenti di sollecitazione.
<b>Quota</b>	quota assoluta della sezione del palo per cui si riportano le sei componenti di sollecitazione.

L'azione  $F_z$  ( corrispondente allo sforzo normale nel palo) è costante poiché il peso del palo stesso non è considerato nella modellazione.

La seconda tabella è riferita alle fondazioni tipo plinto su suolo elastico.

Per questo tipo di fondazione vengono riportate le pressioni nei quattro vertici dell'impronta sul terreno.

In particolare viene riportato:

<b>Nodo</b>	numero del nodo a cui è applicato il plinto
<b>Tipo</b>	Codice identificativo del nome assegnato al plinto
<b>area</b>	area dell'impronta del plinto
<b>Wink O</b> <b>Wink V</b>	coefficienti di Winkler (orizzontale e verticale) adottati
<b>Comb</b>	Combinazione di carico in cui si verificano i valori riportati
<b>Pt (P1 P2 P3 P4)</b>	valori di pressione nei vertici

La terza tabella è riferita alle fondazioni tipo platea su suolo elastico.

Per questo tipo di fondazione vengono riportate le pressioni in ogni vertice (nodo) degli elementi costituenti la platea.

La quarta tabella è riferita alle fondazioni tipo trave su suolo elastico.

Per questo tipo di fondazione vengono riportate le pressioni alle estremità dell'elemento e la massima (in valore assoluto) pressione lungo lo sviluppo dell'elemento.

Vengono inoltre riportati, con funzione statistica, i valori massimo e minimo delle pressioni che compaiono nella tabella.

Con riferimento al **Documento di Affidabilità** "Test di validazione del software di calcolo PRO\_SAP e dei moduli aggiuntivi PRO\_SAP Modulo Geotecnico, PRO\_CAD nodi acciaio e PRO\_MST" - versione Settembre 2014, disponibile per il download sul sito [www.2si.it](http://www.2si.it), si segnalano i seguenti esempi applicativi:

Test N°	Titolo
105	PLINTO SUPERFICIALE
106	PLINTO SUPERFICIALE
107	PLINTO SUPERFICIALE
108	PLINTO SUPERFICIALE
109	PLINTO SUPERFICIALE
110	PLINTO SUPERFICIALE
111	PLINTO SUPERFICIALE
112	PLINTO SUPERFICIALE
113	PLINTO SUPERFICIALE
114	PLINTO SUPERFICIALE
115	PLINTO SUPERFICIALE
116	PLINTO SUPERFICIALE
117	PLINTO SUPERFICIALE
118	PLINTO SUPERFICIALE
119	PLINTO SUPERFICIALE
120	PLINTO SUPERFICIALE
121	PLINTO SUPERFICIALE
122	PLINTO SUPERFICIALE
123	PLINTO SUPERFICIALE
124	FONDAZIONE NASTRIFORME
125	CALCOLO DEI K DI WINKLER

Nodo (G)	Pt 1/12 daN/cm2	Pt 2/13 daN/cm2	Pt 3... daN/cm2	Pt 4... daN/cm2	daN/cm2	daN/cm2	daN/cm2	daN/cm2	daN/cm2	daN/cm2
1	-0.47	-0.40	-0.43	-0.34	-0.32	-0.32				
3	-0.47	-0.40	-0.43	-0.35	-0.32	-0.32				
5	-0.43	-0.33	-0.35	-0.32	-0.30	-0.29				
7	-0.44	-0.33	-0.35	-0.33	-0.30	-0.30				
9	-0.45	-0.34	-0.35	-0.33	-0.30	-0.30				
11	-0.46	-0.35	-0.37	-0.34	-0.31	-0.31				
13	-0.47	-0.35	-0.36	-0.35	-0.32	-0.31				
15	-0.46	-0.35	-0.37	-0.34	-0.31	-0.31				
17	-0.45	-0.35	-0.37	-0.34	-0.31	-0.30				
19	-0.44	-0.34	-0.35	-0.33	-0.30	-0.30				
21	-0.49	-0.40	-0.43	-0.36	-0.34	-0.33				
23	-0.43	-0.33	-0.35	-0.32	-0.30	-0.29				
25	-0.44	-0.33	-0.35	-0.33	-0.30	-0.29				
27	-0.44	-0.34	-0.35	-0.33	-0.30	-0.30				
29	-0.46	-0.35	-0.37	-0.34	-0.31	-0.30				
31	-0.47	-0.35	-0.36	-0.35	-0.32	-0.31				
33	-0.46	-0.35	-0.37	-0.34	-0.31	-0.31				
35	-0.45	-0.35	-0.37	-0.33	-0.31	-0.30				
37	-0.44	-0.34	-0.35	-0.33	-0.30	-0.30				
39	-0.49	-0.40	-0.42	-0.36	-0.34	-0.33				
41	-0.43	-0.34	-0.36	-0.32	-0.30	-0.29				
42	-0.35	-0.28	-0.29	-0.26	-0.25	-0.24				
43	-0.38	-0.32	-0.35	-0.28	-0.27	-0.26				
44	-0.28	-0.23	-0.24	-0.21	-0.20	-0.20				
45	-0.31	-0.26	-0.28	-0.23	-0.22	-0.22				
46	-0.23	-0.19	-0.19	-0.17	-0.17	-0.17				
47	-0.25	-0.21	-0.23	-0.19	-0.18	-0.18				
48	-0.20	-0.16	-0.16	-0.14	-0.14	-0.14				
49	-0.22	-0.18	-0.19	-0.16	-0.16	-0.16				
50	-0.17	-0.14	-0.14	-0.13	-0.13	-0.13				
51	-0.20	-0.16	-0.16	-0.14	-0.14	-0.14				
52	-0.17	-0.13	-0.13	-0.12	-0.12	-0.12				



EGP CODE

GRE.EEC.R.73.IT.W.15235.12.024.01

PAGE

259 di/of 527

53	-0.19	-0.15	-0.15	-0.14	-0.14	-0.14
54	-0.17	-0.13	-0.13	-0.12	-0.12	-0.12
55	-0.19	-0.15	-0.15	-0.14	-0.14	-0.14
56	-0.18	-0.14	-0.15	-0.13	-0.13	-0.13
57	-0.20	-0.17	-0.17	-0.15	-0.15	-0.15
58	-0.21	-0.17	-0.17	-0.15	-0.15	-0.15
59	-0.23	-0.19	-0.20	-0.17	-0.17	-0.17
60	-0.25	-0.20	-0.21	-0.19	-0.18	-0.18
61	-0.27	-0.23	-0.25	-0.20	-0.20	-0.20
62	-0.31	-0.25	-0.26	-0.23	-0.22	-0.22
63	-0.34	-0.28	-0.30	-0.25	-0.24	-0.24
64	-0.38	-0.30	-0.32	-0.28	-0.27	-0.26
65	-0.41	-0.35	-0.38	-0.30	-0.29	-0.29
66	-0.43	-0.35	-0.37	-0.32	-0.30	-0.29
67	-0.40	-0.32	-0.33	-0.29	-0.28	-0.27
68	-0.33	-0.25	-0.26	-0.24	-0.23	-0.23
69	-0.26	-0.20	-0.21	-0.19	-0.19	-0.19
70	-0.21	-0.16	-0.17	-0.16	-0.16	-0.15
71	-0.18	-0.14	-0.14	-0.13	-0.13	-0.13
72	-0.16	-0.12	-0.12	-0.12	-0.12	-0.12
73	-0.15	-0.11	-0.11	-0.11	-0.11	-0.11
74	-0.15	-0.11	-0.12	-0.11	-0.11	-0.11
75	-0.16	-0.13	-0.13	-0.12	-0.12	-0.12
76	-0.19	-0.15	-0.15	-0.14	-0.14	-0.14
77	-0.23	-0.18	-0.18	-0.17	-0.17	-0.17
78	-0.29	-0.22	-0.22	-0.21	-0.20	-0.20
79	-0.36	-0.28	-0.29	-0.26	-0.25	-0.25
80	-0.40	-0.32	-0.33	-0.29	-0.28	-0.27
81	-0.38	-0.30	-0.32	-0.28	-0.27	-0.26
82	-0.31	-0.24	-0.24	-0.23	-0.22	-0.22
83	-0.25	-0.18	-0.19	-0.18	-0.18	-0.18
84	-0.20	-0.15	-0.15	-0.15	-0.14	-0.14
85	-0.16	-0.13	-0.13	-0.12	-0.12	-0.12
86	-0.14	-0.11	-0.11	-0.11	-0.11	-0.11
87	-0.13	-0.10	-0.10	-0.10	-0.10	-0.10
88	-0.13	-0.10	-0.11	-0.10	-0.10	-0.10
89	-0.15	-0.12	-0.12	-0.11	-0.11	-0.11
90	-0.17	-0.13	-0.14	-0.13	-0.13	-0.13
91	-0.22	-0.16	-0.16	-0.16	-0.16	-0.16
92	-0.27	-0.20	-0.21	-0.20	-0.19	-0.19
93	-0.34	-0.26	-0.27	-0.25	-0.24	-0.24
94	-0.38	-0.30	-0.32	-0.28	-0.27	-0.26
95	-0.38	-0.30	-0.31	-0.28	-0.27	-0.26
96	-0.31	-0.23	-0.24	-0.23	-0.22	-0.22
97	-0.24	-0.18	-0.18	-0.18	-0.17	-0.17
98	-0.19	-0.14	-0.14	-0.14	-0.14	-0.14
99	-0.15	-0.12	-0.12	-0.11	-0.11	-0.11
100	-0.13	-0.10	-0.11	-0.10	-0.10	-0.10
101	-0.12	-0.10	-0.10	-0.09	-0.09	-0.09
102	-0.12	-0.10	-0.10	-0.09	-0.09	-0.09
103	-0.14	-0.11	-0.11	-0.10	-0.10	-0.10
104	-0.16	-0.13	-0.13	-0.12	-0.12	-0.12
105	-0.21	-0.15	-0.15	-0.16	-0.15	-0.15
106	-0.27	-0.20	-0.20	-0.20	-0.19	-0.19
107	-0.34	-0.26	-0.27	-0.25	-0.24	-0.23
108	-0.39	-0.30	-0.31	-0.28	-0.27	-0.26
109	-0.40	-0.31	-0.32	-0.29	-0.28	-0.27
110	-0.32	-0.23	-0.24	-0.23	-0.22	-0.22
111	-0.24	-0.18	-0.18	-0.18	-0.17	-0.17
112	-0.19	-0.14	-0.14	-0.14	-0.14	-0.14
113	-0.14	-0.12	-0.12	-0.11	-0.11	-0.11
114	-0.12	-0.10	-0.10	-0.09	-0.09	-0.09
115	-0.11	-0.09	-0.09	-0.09	-0.09	-0.09
116	-0.12	-0.09	-0.10	-0.09	-0.09	-0.09
117	-0.13	-0.11	-0.11	-0.10	-0.10	-0.10
118	-0.16	-0.13	-0.13	-0.12	-0.12	-0.12
119	-0.21	-0.15	-0.15	-0.15	-0.15	-0.15
120	-0.27	-0.20	-0.20	-0.20	-0.19	-0.19
121	-0.35	-0.26	-0.27	-0.26	-0.24	-0.24
122	-0.40	-0.31	-0.32	-0.30	-0.28	-0.27
123	-0.42	-0.32	-0.33	-0.31	-0.29	-0.28
124	-0.32	-0.24	-0.24	-0.24	-0.23	-0.22
125	-0.24	-0.18	-0.18	-0.18	-0.18	-0.17
126	-0.18	-0.14	-0.14	-0.14	-0.14	-0.13
127	-0.14	-0.11	-0.12	-0.11	-0.11	-0.11
128	-0.12	-0.10	-0.10	-0.09	-0.09	-0.09



EGP CODE

GRE.EEC.R.73.IT.W.15235.12.024.01

PAGE

260 di/of 527

129	-0.11	-0.09	-0.09	-0.08	-0.08	-0.08
130	-0.11	-0.09	-0.09	-0.09	-0.09	-0.09
131	-0.13	-0.10	-0.11	-0.10	-0.10	-0.10
132	-0.16	-0.12	-0.13	-0.12	-0.12	-0.12
133	-0.21	-0.15	-0.16	-0.15	-0.15	-0.15
134	-0.27	-0.20	-0.20	-0.20	-0.19	-0.19
135	-0.36	-0.27	-0.28	-0.27	-0.25	-0.25
136	-0.42	-0.32	-0.33	-0.31	-0.29	-0.28
137	-0.33	-0.24	-0.25	-0.24	-0.23	-0.22
138	-0.24	-0.18	-0.18	-0.18	-0.18	-0.17
139	-0.18	-0.14	-0.14	-0.14	-0.14	-0.13
140	-0.14	-0.11	-0.12	-0.11	-0.11	-0.11
141	-0.12	-0.10	-0.10	-0.09	-0.09	-0.09
142	-0.11	-0.09	-0.09	-0.08	-0.08	-0.08
143	-0.11	-0.09	-0.09	-0.09	-0.09	-0.09
144	-0.13	-0.10	-0.11	-0.10	-0.10	-0.10
145	-0.16	-0.12	-0.13	-0.12	-0.12	-0.12
146	-0.21	-0.15	-0.16	-0.15	-0.15	-0.15
147	-0.27	-0.20	-0.20	-0.20	-0.19	-0.19
148	-0.36	-0.27	-0.28	-0.27	-0.25	-0.25
149	-0.42	-0.32	-0.34	-0.31	-0.29	-0.28
150	-0.33	-0.24	-0.25	-0.24	-0.23	-0.22
151	-0.24	-0.18	-0.18	-0.18	-0.18	-0.17
152	-0.18	-0.14	-0.14	-0.14	-0.13	-0.13
153	-0.14	-0.11	-0.12	-0.11	-0.11	-0.11
154	-0.12	-0.10	-0.10	-0.09	-0.09	-0.09
155	-0.11	-0.09	-0.09	-0.08	-0.08	-0.08
156	-0.11	-0.09	-0.09	-0.08	-0.08	-0.08
157	-0.12	-0.10	-0.10	-0.10	-0.10	-0.10
158	-0.15	-0.12	-0.13	-0.12	-0.12	-0.12
159	-0.21	-0.15	-0.16	-0.15	-0.15	-0.15
160	-0.27	-0.20	-0.20	-0.20	-0.19	-0.19
161	-0.36	-0.27	-0.28	-0.27	-0.25	-0.25
162	-0.42	-0.32	-0.34	-0.31	-0.29	-0.28
163	-0.41	-0.31	-0.33	-0.30	-0.28	-0.27
164	-0.32	-0.24	-0.25	-0.24	-0.22	-0.22
165	-0.24	-0.18	-0.18	-0.18	-0.17	-0.17
166	-0.18	-0.14	-0.14	-0.14	-0.13	-0.13
167	-0.14	-0.11	-0.12	-0.11	-0.11	-0.11
168	-0.12	-0.09	-0.10	-0.09	-0.09	-0.09
169	-0.11	-0.09	-0.09	-0.08	-0.08	-0.08
170	-0.11	-0.09	-0.09	-0.08	-0.08	-0.08
171	-0.12	-0.10	-0.10	-0.09	-0.09	-0.09
172	-0.15	-0.12	-0.13	-0.12	-0.12	-0.12
173	-0.20	-0.15	-0.16	-0.15	-0.15	-0.15
174	-0.27	-0.20	-0.20	-0.20	-0.19	-0.19
175	-0.35	-0.27	-0.28	-0.26	-0.25	-0.24
176	-0.41	-0.31	-0.33	-0.30	-0.28	-0.27
177	-0.39	-0.30	-0.32	-0.29	-0.27	-0.27
178	-0.31	-0.23	-0.24	-0.23	-0.22	-0.22
179	-0.24	-0.18	-0.18	-0.18	-0.17	-0.17
180	-0.18	-0.14	-0.14	-0.14	-0.13	-0.13
181	-0.14	-0.11	-0.11	-0.11	-0.11	-0.11
182	-0.12	-0.09	-0.10	-0.09	-0.09	-0.09
183	-0.11	-0.08	-0.09	-0.08	-0.08	-0.08
184	-0.11	-0.09	-0.09	-0.08	-0.08	-0.08
185	-0.12	-0.10	-0.10	-0.09	-0.09	-0.09
186	-0.15	-0.12	-0.12	-0.12	-0.12	-0.12
187	-0.20	-0.15	-0.15	-0.15	-0.15	-0.15
188	-0.27	-0.20	-0.20	-0.20	-0.19	-0.19
189	-0.34	-0.26	-0.27	-0.26	-0.24	-0.24
190	-0.39	-0.30	-0.32	-0.29	-0.27	-0.27
191	-0.39	-0.30	-0.31	-0.29	-0.27	-0.27
192	-0.31	-0.23	-0.24	-0.23	-0.22	-0.22
193	-0.24	-0.17	-0.18	-0.18	-0.17	-0.17
194	-0.18	-0.14	-0.14	-0.14	-0.13	-0.13
195	-0.14	-0.11	-0.11	-0.11	-0.11	-0.11
196	-0.12	-0.09	-0.10	-0.09	-0.09	-0.09
197	-0.11	-0.08	-0.09	-0.08	-0.08	-0.08
198	-0.11	-0.09	-0.09	-0.08	-0.08	-0.08
199	-0.12	-0.10	-0.10	-0.09	-0.09	-0.09
200	-0.15	-0.12	-0.12	-0.12	-0.12	-0.12
201	-0.20	-0.15	-0.15	-0.15	-0.15	-0.15
202	-0.27	-0.20	-0.20	-0.20	-0.19	-0.19
203	-0.34	-0.26	-0.27	-0.25	-0.24	-0.24
204	-0.39	-0.30	-0.31	-0.29	-0.27	-0.27





EGP CODE

GRE.EEC.R.73.IT.W.15235.12.024.01

PAGE

261 di/of 527

205	-0.40	-0.31	-0.32	-0.30	-0.28	-0.27
206	-0.32	-0.23	-0.24	-0.24	-0.22	-0.22
207	-0.24	-0.17	-0.18	-0.18	-0.17	-0.17
208	-0.18	-0.14	-0.14	-0.14	-0.13	-0.13
209	-0.14	-0.11	-0.11	-0.11	-0.11	-0.11
210	-0.12	-0.09	-0.10	-0.09	-0.09	-0.09
211	-0.11	-0.08	-0.08	-0.08	-0.08	-0.08
212	-0.11	-0.09	-0.09	-0.08	-0.08	-0.08
213	-0.12	-0.10	-0.10	-0.10	-0.10	-0.10
214	-0.15	-0.12	-0.12	-0.12	-0.12	-0.12
215	-0.20	-0.15	-0.15	-0.15	-0.15	-0.15
216	-0.27	-0.20	-0.20	-0.20	-0.19	-0.19
217	-0.35	-0.26	-0.27	-0.26	-0.24	-0.24
218	-0.40	-0.31	-0.32	-0.30	-0.28	-0.27
219	-0.42	-0.32	-0.33	-0.31	-0.29	-0.28
220	-0.33	-0.24	-0.25	-0.24	-0.23	-0.22
221	-0.25	-0.18	-0.18	-0.18	-0.18	-0.17
222	-0.18	-0.14	-0.14	-0.14	-0.14	-0.13
223	-0.14	-0.11	-0.12	-0.11	-0.11	-0.11
224	-0.12	-0.09	-0.10	-0.09	-0.09	-0.09
225	-0.11	-0.08	-0.08	-0.08	-0.08	-0.08
226	-0.11	-0.09	-0.09	-0.08	-0.08	-0.08
227	-0.12	-0.10	-0.10	-0.10	-0.10	-0.10
228	-0.16	-0.12	-0.13	-0.12	-0.12	-0.12
229	-0.21	-0.15	-0.15	-0.16	-0.15	-0.15
230	-0.28	-0.20	-0.20	-0.21	-0.20	-0.19
231	-0.36	-0.27	-0.28	-0.27	-0.25	-0.25
232	-0.42	-0.32	-0.34	-0.31	-0.29	-0.28
233	-0.43	-0.34	-0.36	-0.32	-0.30	-0.29
234	-0.33	-0.24	-0.25	-0.25	-0.23	-0.23
235	-0.25	-0.18	-0.18	-0.19	-0.18	-0.17
236	-0.18	-0.14	-0.14	-0.14	-0.14	-0.13
237	-0.14	-0.11	-0.12	-0.11	-0.11	-0.11
238	-0.12	-0.09	-0.10	-0.09	-0.09	-0.09
239	-0.11	-0.08	-0.08	-0.08	-0.08	-0.08
240	-0.11	-0.09	-0.09	-0.08	-0.08	-0.08
241	-0.12	-0.10	-0.10	-0.10	-0.10	-0.10
242	-0.16	-0.12	-0.13	-0.12	-0.12	-0.12
243	-0.21	-0.15	-0.16	-0.16	-0.15	-0.15
244	-0.28	-0.20	-0.20	-0.21	-0.20	-0.19
245	-0.37	-0.27	-0.28	-0.28	-0.26	-0.25
246	-0.22	-0.17	-0.17	-0.16	-0.16	-0.16
247	-0.42	-0.32	-0.33	-0.31	-0.29	-0.28
248	-0.32	-0.24	-0.25	-0.24	-0.23	-0.22
249	-0.24	-0.18	-0.18	-0.18	-0.17	-0.17
250	-0.18	-0.14	-0.14	-0.14	-0.13	-0.13
251	-0.14	-0.11	-0.12	-0.11	-0.11	-0.11
252	-0.12	-0.09	-0.10	-0.09	-0.09	-0.09
253	-0.11	-0.08	-0.08	-0.08	-0.08	-0.08
254	-0.11	-0.09	-0.09	-0.08	-0.08	-0.08
255	-0.12	-0.10	-0.10	-0.10	-0.10	-0.10
256	-0.15	-0.12	-0.12	-0.12	-0.12	-0.12
257	-0.20	-0.15	-0.15	-0.15	-0.15	-0.15
258	-0.27	-0.20	-0.20	-0.20	-0.19	-0.19
259	-0.36	-0.27	-0.28	-0.27	-0.25	-0.25
260	-0.42	-0.32	-0.34	-0.31	-0.29	-0.28
261	-0.40	-0.30	-0.32	-0.29	-0.27	-0.27
262	-0.31	-0.23	-0.24	-0.23	-0.22	-0.22
263	-0.24	-0.17	-0.18	-0.18	-0.17	-0.17
264	-0.18	-0.14	-0.14	-0.14	-0.13	-0.13
265	-0.14	-0.11	-0.11	-0.11	-0.11	-0.11
266	-0.12	-0.09	-0.10	-0.09	-0.09	-0.09
267	-0.11	-0.08	-0.08	-0.08	-0.08	-0.08
268	-0.11	-0.09	-0.09	-0.08	-0.08	-0.08
269	-0.12	-0.10	-0.10	-0.09	-0.09	-0.09
270	-0.15	-0.12	-0.12	-0.12	-0.12	-0.11
271	-0.20	-0.15	-0.15	-0.15	-0.15	-0.15
272	-0.27	-0.19	-0.20	-0.20	-0.19	-0.19
273	-0.35	-0.26	-0.27	-0.26	-0.24	-0.24
274	-0.40	-0.30	-0.32	-0.29	-0.27	-0.27
275	-0.38	-0.29	-0.31	-0.28	-0.26	-0.26
276	-0.30	-0.23	-0.23	-0.23	-0.21	-0.21
277	-0.23	-0.17	-0.17	-0.17	-0.17	-0.17
278	-0.18	-0.13	-0.14	-0.13	-0.13	-0.13
279	-0.14	-0.11	-0.11	-0.11	-0.11	-0.11
280	-0.12	-0.09	-0.09	-0.09	-0.09	-0.09



EGP CODE

GRE.EEC.R.73.IT.W.15235.12.024.01

PAGE

262 di/of 527

281	-0.11	-0.08	-0.08	-0.08	-0.08	-0.08
282	-0.11	-0.09	-0.09	-0.08	-0.08	-0.08
283	-0.12	-0.10	-0.10	-0.09	-0.09	-0.09
284	-0.15	-0.12	-0.12	-0.11	-0.11	-0.11
285	-0.20	-0.15	-0.15	-0.15	-0.14	-0.14
286	-0.26	-0.19	-0.19	-0.19	-0.18	-0.18
287	-0.34	-0.25	-0.26	-0.25	-0.23	-0.23
288	-0.38	-0.29	-0.31	-0.28	-0.26	-0.26
289	-0.38	-0.29	-0.31	-0.28	-0.26	-0.26
290	-0.30	-0.23	-0.23	-0.23	-0.21	-0.21
291	-0.23	-0.17	-0.17	-0.17	-0.17	-0.17
292	-0.18	-0.13	-0.14	-0.13	-0.13	-0.13
293	-0.14	-0.11	-0.11	-0.11	-0.11	-0.11
294	-0.12	-0.09	-0.10	-0.09	-0.09	-0.09
295	-0.11	-0.08	-0.08	-0.08	-0.08	-0.08
296	-0.11	-0.09	-0.09	-0.08	-0.08	-0.08
297	-0.12	-0.10	-0.10	-0.09	-0.09	-0.09
298	-0.15	-0.12	-0.12	-0.11	-0.11	-0.11
299	-0.20	-0.15	-0.15	-0.15	-0.14	-0.14
300	-0.26	-0.19	-0.19	-0.19	-0.18	-0.18
301	-0.34	-0.25	-0.26	-0.25	-0.23	-0.23
302	-0.38	-0.29	-0.31	-0.28	-0.26	-0.26
303	-0.40	-0.30	-0.32	-0.29	-0.27	-0.27
304	-0.31	-0.23	-0.24	-0.23	-0.22	-0.22
305	-0.24	-0.17	-0.18	-0.18	-0.17	-0.17
306	-0.18	-0.14	-0.14	-0.14	-0.13	-0.13
307	-0.14	-0.11	-0.11	-0.11	-0.11	-0.11
308	-0.12	-0.09	-0.10	-0.09	-0.09	-0.09
309	-0.11	-0.08	-0.08	-0.08	-0.08	-0.08
310	-0.11	-0.09	-0.09	-0.08	-0.08	-0.08
311	-0.12	-0.10	-0.10	-0.09	-0.09	-0.09
312	-0.15	-0.12	-0.12	-0.12	-0.12	-0.11
313	-0.20	-0.15	-0.15	-0.15	-0.15	-0.15
314	-0.27	-0.19	-0.20	-0.20	-0.19	-0.19
315	-0.34	-0.26	-0.27	-0.26	-0.24	-0.24
316	-0.40	-0.30	-0.32	-0.29	-0.27	-0.27
317	-0.42	-0.32	-0.34	-0.31	-0.29	-0.28
318	-0.32	-0.24	-0.25	-0.24	-0.23	-0.22
319	-0.24	-0.18	-0.18	-0.18	-0.17	-0.17
320	-0.18	-0.14	-0.14	-0.14	-0.13	-0.13
321	-0.14	-0.11	-0.12	-0.11	-0.11	-0.11
322	-0.12	-0.09	-0.10	-0.09	-0.09	-0.09
323	-0.11	-0.08	-0.08	-0.08	-0.08	-0.08
324	-0.11	-0.09	-0.09	-0.08	-0.08	-0.08
325	-0.12	-0.10	-0.10	-0.10	-0.10	-0.10
326	-0.15	-0.12	-0.13	-0.12	-0.12	-0.12
327	-0.20	-0.15	-0.15	-0.15	-0.15	-0.15
328	-0.27	-0.20	-0.20	-0.20	-0.19	-0.19
329	-0.36	-0.27	-0.28	-0.27	-0.25	-0.25
330	-0.42	-0.32	-0.34	-0.31	-0.29	-0.28
331	-0.49	-0.39	-0.42	-0.36	-0.33	-0.32
332	-0.33	-0.24	-0.25	-0.25	-0.23	-0.23
333	-0.25	-0.18	-0.18	-0.19	-0.18	-0.18
334	-0.19	-0.14	-0.14	-0.14	-0.14	-0.14
335	-0.14	-0.11	-0.12	-0.11	-0.11	-0.11
336	-0.12	-0.10	-0.10	-0.09	-0.09	-0.09
337	-0.11	-0.08	-0.09	-0.08	-0.08	-0.08
338	-0.11	-0.09	-0.09	-0.09	-0.09	-0.09
339	-0.13	-0.10	-0.10	-0.10	-0.10	-0.10
340	-0.16	-0.12	-0.13	-0.12	-0.12	-0.12
341	-0.21	-0.15	-0.16	-0.16	-0.15	-0.15
342	-0.28	-0.20	-0.20	-0.21	-0.20	-0.20
343	-0.37	-0.28	-0.28	-0.28	-0.26	-0.25
344	-0.52	-0.42	-0.45	-0.39	-0.35	-0.35
345	-0.54	-0.43	-0.46	-0.40	-0.36	-0.36
346	-0.53	-0.42	-0.45	-0.39	-0.36	-0.35
347	-0.52	-0.41	-0.43	-0.38	-0.35	-0.34
348	-0.52	-0.41	-0.43	-0.38	-0.35	-0.34
349	-0.53	-0.42	-0.44	-0.39	-0.36	-0.35
350	-0.53	-0.45	-0.48	-0.39	-0.37	-0.36
351	-0.50	-0.40	-0.43	-0.37	-0.34	-0.33
352	-0.46	-0.36	-0.39	-0.34	-0.31	-0.31
353	-0.42	-0.33	-0.35	-0.31	-0.29	-0.28
354	-0.40	-0.32	-0.33	-0.29	-0.28	-0.27
355	-0.40	-0.32	-0.34	-0.30	-0.28	-0.27
356	-0.43	-0.35	-0.37	-0.32	-0.30	-0.29



EGP CODE

GRE.EEC.R.73.IT.W.15235.12.024.01

PAGE

263 di/of 527

357	-0.43	-0.33	-0.34	-0.32	-0.29	-0.29
358	-0.33	-0.24	-0.25	-0.25	-0.23	-0.23
359	-0.25	-0.18	-0.18	-0.19	-0.18	-0.18
360	-0.19	-0.14	-0.14	-0.14	-0.14	-0.14
361	-0.14	-0.11	-0.12	-0.11	-0.11	-0.11
362	-0.12	-0.10	-0.10	-0.09	-0.09	-0.09
363	-0.11	-0.08	-0.09	-0.08	-0.08	-0.08
364	-0.11	-0.09	-0.09	-0.09	-0.09	-0.09
365	-0.13	-0.10	-0.10	-0.10	-0.10	-0.10
366	-0.16	-0.12	-0.13	-0.12	-0.12	-0.12
367	-0.21	-0.15	-0.16	-0.16	-0.15	-0.15
368	-0.28	-0.20	-0.20	-0.21	-0.20	-0.19
369	-0.37	-0.27	-0.28	-0.27	-0.25	-0.25
370	-0.43	-0.33	-0.34	-0.32	-0.29	-0.29
371	-0.41	-0.31	-0.33	-0.30	-0.28	-0.27
372	-0.32	-0.24	-0.25	-0.24	-0.22	-0.22
373	-0.24	-0.18	-0.18	-0.18	-0.17	-0.17
374	-0.18	-0.14	-0.14	-0.14	-0.14	-0.13
375	-0.14	-0.11	-0.12	-0.11	-0.11	-0.11
376	-0.12	-0.10	-0.10	-0.09	-0.09	-0.09
377	-0.11	-0.08	-0.09	-0.08	-0.08	-0.08
378	-0.11	-0.09	-0.09	-0.09	-0.09	-0.09
379	-0.13	-0.10	-0.10	-0.10	-0.10	-0.10
380	-0.16	-0.12	-0.13	-0.12	-0.12	-0.12
381	-0.21	-0.15	-0.15	-0.15	-0.15	-0.15
382	-0.27	-0.20	-0.20	-0.20	-0.19	-0.19
383	-0.36	-0.27	-0.28	-0.26	-0.25	-0.24
384	-0.41	-0.31	-0.33	-0.30	-0.28	-0.28
385	-0.40	-0.30	-0.32	-0.29	-0.27	-0.27
386	-0.31	-0.23	-0.24	-0.23	-0.22	-0.22
387	-0.24	-0.18	-0.18	-0.18	-0.17	-0.17
388	-0.18	-0.14	-0.14	-0.14	-0.13	-0.13
389	-0.14	-0.11	-0.12	-0.11	-0.11	-0.11
390	-0.12	-0.10	-0.10	-0.09	-0.09	-0.09
391	-0.11	-0.08	-0.09	-0.08	-0.08	-0.08
392	-0.11	-0.09	-0.09	-0.09	-0.09	-0.09
393	-0.13	-0.10	-0.10	-0.10	-0.10	-0.10
394	-0.15	-0.12	-0.12	-0.12	-0.12	-0.12
395	-0.20	-0.15	-0.15	-0.15	-0.15	-0.15
396	-0.27	-0.20	-0.20	-0.20	-0.19	-0.19
397	-0.35	-0.26	-0.27	-0.26	-0.24	-0.24
398	-0.40	-0.30	-0.32	-0.29	-0.27	-0.27
399	-0.39	-0.30	-0.31	-0.29	-0.27	-0.27
400	-0.31	-0.23	-0.24	-0.23	-0.22	-0.22
401	-0.24	-0.17	-0.18	-0.18	-0.17	-0.17
402	-0.18	-0.14	-0.14	-0.14	-0.13	-0.13
403	-0.14	-0.11	-0.12	-0.11	-0.11	-0.11
404	-0.12	-0.10	-0.10	-0.09	-0.09	-0.09
405	-0.11	-0.09	-0.09	-0.08	-0.08	-0.08
406	-0.11	-0.09	-0.09	-0.09	-0.09	-0.09
407	-0.13	-0.10	-0.10	-0.10	-0.10	-0.10
408	-0.16	-0.12	-0.12	-0.12	-0.12	-0.12
409	-0.20	-0.15	-0.15	-0.15	-0.15	-0.15
410	-0.27	-0.20	-0.20	-0.20	-0.19	-0.19
411	-0.34	-0.26	-0.27	-0.26	-0.24	-0.24
412	-0.39	-0.30	-0.31	-0.29	-0.27	-0.27
413	-0.41	-0.31	-0.32	-0.30	-0.28	-0.27
414	-0.32	-0.24	-0.24	-0.24	-0.22	-0.22
415	-0.25	-0.18	-0.18	-0.18	-0.18	-0.17
416	-0.19	-0.14	-0.14	-0.14	-0.14	-0.14
417	-0.14	-0.11	-0.12	-0.11	-0.11	-0.11
418	-0.12	-0.10	-0.10	-0.09	-0.09	-0.09
419	-0.11	-0.09	-0.09	-0.08	-0.08	-0.08
420	-0.11	-0.09	-0.09	-0.09	-0.09	-0.09
421	-0.13	-0.10	-0.10	-0.10	-0.10	-0.10
422	-0.16	-0.12	-0.13	-0.12	-0.12	-0.12
423	-0.21	-0.15	-0.15	-0.16	-0.15	-0.15
424	-0.27	-0.20	-0.20	-0.20	-0.19	-0.19
425	-0.35	-0.27	-0.28	-0.26	-0.25	-0.24
426	-0.41	-0.31	-0.33	-0.30	-0.28	-0.27
427	-0.43	-0.33	-0.34	-0.32	-0.29	-0.29
428	-0.33	-0.25	-0.25	-0.25	-0.23	-0.23
429	-0.25	-0.18	-0.18	-0.19	-0.18	-0.18
430	-0.19	-0.14	-0.14	-0.14	-0.14	-0.14
431	-0.14	-0.12	-0.12	-0.11	-0.11	-0.11
432	-0.12	-0.10	-0.10	-0.09	-0.09	-0.09



EGP CODE

GRE.EEC.R.73.IT.W.15235.12.024.01

PAGE

264 di/of 527

433	-0.11	-0.09	-0.09	-0.08	-0.08	-0.08
434	-0.11	-0.09	-0.09	-0.09	-0.09	-0.09
435	-0.13	-0.10	-0.11	-0.10	-0.10	-0.10
436	-0.16	-0.13	-0.13	-0.12	-0.12	-0.12
437	-0.21	-0.16	-0.16	-0.16	-0.15	-0.15
438	-0.28	-0.20	-0.21	-0.21	-0.20	-0.20
439	-0.37	-0.28	-0.29	-0.27	-0.26	-0.25
440	-0.43	-0.33	-0.34	-0.32	-0.29	-0.29
441	-0.45	-0.34	-0.36	-0.33	-0.30	-0.30
442	-0.34	-0.25	-0.25	-0.25	-0.24	-0.23
443	-0.25	-0.18	-0.18	-0.19	-0.18	-0.18
444	-0.19	-0.14	-0.15	-0.14	-0.14	-0.14
445	-0.14	-0.12	-0.12	-0.11	-0.11	-0.11
446	-0.12	-0.10	-0.10	-0.09	-0.09	-0.09
447	-0.11	-0.09	-0.09	-0.08	-0.08	-0.08
448	-0.11	-0.09	-0.09	-0.09	-0.09	-0.09
449	-0.13	-0.10	-0.11	-0.10	-0.10	-0.10
450	-0.16	-0.13	-0.13	-0.12	-0.12	-0.12
451	-0.21	-0.16	-0.16	-0.16	-0.15	-0.15
452	-0.29	-0.20	-0.21	-0.21	-0.20	-0.20
453	-0.38	-0.28	-0.29	-0.28	-0.26	-0.26
454	-0.45	-0.34	-0.36	-0.33	-0.30	-0.30
455	-0.34	-0.25	-0.25	-0.25	-0.24	-0.23
456	-0.25	-0.18	-0.18	-0.19	-0.18	-0.18
457	-0.19	-0.14	-0.15	-0.14	-0.14	-0.14
458	-0.14	-0.12	-0.12	-0.11	-0.11	-0.11
459	-0.12	-0.10	-0.10	-0.09	-0.09	-0.09
460	-0.11	-0.09	-0.09	-0.08	-0.08	-0.08
461	-0.11	-0.09	-0.09	-0.09	-0.09	-0.09
462	-0.13	-0.10	-0.11	-0.10	-0.10	-0.10
463	-0.16	-0.13	-0.13	-0.12	-0.12	-0.12
464	-0.21	-0.16	-0.16	-0.16	-0.15	-0.15
465	-0.29	-0.20	-0.21	-0.21	-0.20	-0.20
466	-0.38	-0.28	-0.29	-0.28	-0.26	-0.26
467	-0.44	-0.34	-0.35	-0.32	-0.30	-0.29
468	-0.33	-0.24	-0.25	-0.25	-0.23	-0.23
469	-0.25	-0.18	-0.19	-0.19	-0.18	-0.18
470	-0.19	-0.14	-0.15	-0.14	-0.14	-0.14
471	-0.14	-0.12	-0.12	-0.11	-0.11	-0.11
472	-0.12	-0.10	-0.10	-0.09	-0.09	-0.09
473	-0.11	-0.09	-0.09	-0.08	-0.08	-0.08
474	-0.11	-0.09	-0.09	-0.09	-0.09	-0.09
475	-0.13	-0.10	-0.11	-0.10	-0.10	-0.10
476	-0.16	-0.13	-0.13	-0.12	-0.12	-0.12
477	-0.21	-0.16	-0.16	-0.16	-0.15	-0.15
478	-0.28	-0.20	-0.21	-0.21	-0.20	-0.20
479	-0.37	-0.28	-0.29	-0.28	-0.26	-0.25
480	-0.44	-0.34	-0.35	-0.32	-0.30	-0.29
481	-0.40	-0.31	-0.33	-0.30	-0.28	-0.27
482	-0.32	-0.24	-0.24	-0.23	-0.22	-0.22
483	-0.24	-0.18	-0.18	-0.18	-0.17	-0.17
484	-0.18	-0.14	-0.14	-0.14	-0.13	-0.13
485	-0.14	-0.11	-0.12	-0.11	-0.11	-0.11
486	-0.12	-0.09	-0.10	-0.09	-0.09	-0.09
487	-0.11	-0.08	-0.09	-0.08	-0.08	-0.08
488	-0.11	-0.09	-0.09	-0.08	-0.08	-0.08
489	-0.12	-0.10	-0.10	-0.10	-0.10	-0.10
490	-0.15	-0.12	-0.13	-0.12	-0.12	-0.12
491	-0.20	-0.15	-0.16	-0.15	-0.15	-0.15
492	-0.27	-0.20	-0.20	-0.20	-0.19	-0.19
493	-0.35	-0.26	-0.28	-0.26	-0.24	-0.24
494	-0.40	-0.31	-0.33	-0.30	-0.28	-0.27
495	-0.37	-0.29	-0.30	-0.27	-0.26	-0.25
496	-0.30	-0.22	-0.23	-0.22	-0.21	-0.20
497	-0.23	-0.17	-0.17	-0.17	-0.16	-0.16
498	-0.17	-0.13	-0.14	-0.13	-0.13	-0.13
499	-0.14	-0.11	-0.11	-0.10	-0.10	-0.10
500	-0.12	-0.09	-0.09	-0.09	-0.09	-0.09
501	-0.11	-0.08	-0.08	-0.08	-0.08	-0.08
502	-0.11	-0.09	-0.09	-0.08	-0.08	-0.08
503	-0.12	-0.10	-0.10	-0.09	-0.09	-0.09
504	-0.15	-0.12	-0.12	-0.11	-0.11	-0.11
505	-0.19	-0.15	-0.15	-0.14	-0.14	-0.14
506	-0.25	-0.19	-0.19	-0.19	-0.18	-0.18
507	-0.33	-0.25	-0.26	-0.24	-0.23	-0.22
508	-0.37	-0.29	-0.30	-0.27	-0.26	-0.25



EGP CODE

GRE.EEC.R.73.IT.W.15235.12.024.01

PAGE

265 di/of 527

509	-0.35	-0.27	-0.28	-0.26	-0.24	-0.24
510	-0.28	-0.21	-0.22	-0.21	-0.20	-0.19
511	-0.22	-0.16	-0.16	-0.16	-0.16	-0.16
512	-0.17	-0.13	-0.13	-0.13	-0.13	-0.12
513	-0.13	-0.11	-0.11	-0.10	-0.10	-0.10
514	-0.11	-0.09	-0.09	-0.09	-0.09	-0.09
515	-0.11	-0.08	-0.08	-0.08	-0.08	-0.08
516	-0.11	-0.09	-0.09	-0.08	-0.08	-0.08
517	-0.12	-0.10	-0.10	-0.09	-0.09	-0.09
518	-0.14	-0.11	-0.12	-0.11	-0.11	-0.11
519	-0.19	-0.14	-0.14	-0.14	-0.14	-0.14
520	-0.24	-0.18	-0.18	-0.18	-0.17	-0.17
521	-0.31	-0.23	-0.24	-0.23	-0.22	-0.21
522	-0.35	-0.27	-0.28	-0.26	-0.24	-0.24
523	-0.34	-0.26	-0.27	-0.25	-0.24	-0.23
524	-0.28	-0.20	-0.21	-0.20	-0.19	-0.19
525	-0.21	-0.16	-0.16	-0.16	-0.16	-0.15
526	-0.17	-0.13	-0.13	-0.13	-0.12	-0.12
527	-0.13	-0.11	-0.11	-0.10	-0.10	-0.10
528	-0.11	-0.09	-0.09	-0.09	-0.09	-0.09
529	-0.11	-0.08	-0.08	-0.08	-0.08	-0.08
530	-0.11	-0.08	-0.09	-0.08	-0.08	-0.08
531	-0.12	-0.10	-0.10	-0.09	-0.09	-0.09
532	-0.14	-0.11	-0.11	-0.11	-0.11	-0.11
533	-0.18	-0.14	-0.14	-0.14	-0.14	-0.13
534	-0.24	-0.17	-0.18	-0.18	-0.17	-0.17
535	-0.30	-0.23	-0.23	-0.22	-0.21	-0.21
536	-0.34	-0.26	-0.27	-0.25	-0.24	-0.23
537	-0.35	-0.26	-0.28	-0.26	-0.24	-0.24
538	-0.28	-0.21	-0.21	-0.21	-0.20	-0.20
539	-0.22	-0.16	-0.16	-0.16	-0.16	-0.16
540	-0.17	-0.13	-0.13	-0.13	-0.13	-0.13
541	-0.13	-0.11	-0.11	-0.10	-0.10	-0.10
542	-0.11	-0.09	-0.09	-0.09	-0.09	-0.09
543	-0.11	-0.08	-0.08	-0.08	-0.08	-0.08
544	-0.11	-0.09	-0.09	-0.08	-0.08	-0.08
545	-0.12	-0.10	-0.10	-0.09	-0.09	-0.09
546	-0.15	-0.11	-0.12	-0.11	-0.11	-0.11
547	-0.19	-0.14	-0.14	-0.14	-0.14	-0.14
548	-0.24	-0.18	-0.18	-0.18	-0.17	-0.17
549	-0.31	-0.23	-0.24	-0.23	-0.22	-0.21
550	-0.35	-0.27	-0.28	-0.26	-0.24	-0.24
551	-0.38	-0.28	-0.30	-0.28	-0.26	-0.25
552	-0.30	-0.22	-0.23	-0.22	-0.21	-0.21
553	-0.23	-0.17	-0.17	-0.17	-0.17	-0.16
554	-0.18	-0.13	-0.14	-0.13	-0.13	-0.13
555	-0.14	-0.11	-0.11	-0.10	-0.10	-0.10
556	-0.12	-0.09	-0.10	-0.09	-0.09	-0.09
557	-0.11	-0.08	-0.09	-0.08	-0.08	-0.08
558	-0.11	-0.09	-0.09	-0.08	-0.08	-0.08
559	-0.12	-0.10	-0.10	-0.09	-0.09	-0.09
560	-0.15	-0.12	-0.12	-0.11	-0.11	-0.11
561	-0.20	-0.15	-0.15	-0.15	-0.14	-0.14
562	-0.26	-0.19	-0.19	-0.19	-0.18	-0.18
563	-0.33	-0.25	-0.25	-0.24	-0.23	-0.22
564	-0.38	-0.28	-0.30	-0.28	-0.26	-0.25
565	-0.41	-0.31	-0.32	-0.30	-0.28	-0.27
566	-0.32	-0.24	-0.24	-0.24	-0.22	-0.22
567	-0.24	-0.18	-0.18	-0.18	-0.17	-0.17
568	-0.18	-0.14	-0.14	-0.14	-0.14	-0.13
569	-0.14	-0.11	-0.12	-0.11	-0.11	-0.11
570	-0.12	-0.10	-0.10	-0.09	-0.09	-0.09
571	-0.11	-0.09	-0.09	-0.08	-0.08	-0.08
572	-0.11	-0.09	-0.09	-0.09	-0.09	-0.09
573	-0.13	-0.10	-0.10	-0.10	-0.10	-0.10
574	-0.16	-0.12	-0.13	-0.12	-0.12	-0.12
575	-0.21	-0.15	-0.16	-0.15	-0.15	-0.15
576	-0.27	-0.20	-0.20	-0.20	-0.19	-0.19
577	-0.36	-0.26	-0.27	-0.26	-0.25	-0.24
578	-0.41	-0.31	-0.32	-0.30	-0.28	-0.27
579	-0.44	-0.33	-0.35	-0.33	-0.30	-0.29
580	-0.34	-0.25	-0.25	-0.25	-0.24	-0.23
581	-0.26	-0.18	-0.19	-0.19	-0.18	-0.18
582	-0.19	-0.14	-0.15	-0.14	-0.14	-0.14
583	-0.14	-0.12	-0.12	-0.11	-0.11	-0.11
584	-0.12	-0.10	-0.10	-0.09	-0.09	-0.09





EGP CODE

GRE.EEC.R.73.IT.W.15235.12.024.01

PAGE

266 di/of 527

585	-0.11	-0.09	-0.09	-0.09	-0.09	-0.09
586	-0.11	-0.09	-0.09	-0.09	-0.09	-0.09
587	-0.13	-0.10	-0.11	-0.10	-0.10	-0.10
588	-0.16	-0.13	-0.13	-0.12	-0.12	-0.12
589	-0.21	-0.16	-0.16	-0.16	-0.15	-0.15
590	-0.29	-0.20	-0.21	-0.21	-0.20	-0.20
591	-0.38	-0.28	-0.29	-0.28	-0.26	-0.26
592	-0.44	-0.33	-0.35	-0.33	-0.30	-0.30
593	-0.35	-0.25	-0.25	-0.26	-0.24	-0.24
594	-0.26	-0.18	-0.18	-0.19	-0.18	-0.18
595	-0.19	-0.15	-0.15	-0.14	-0.14	-0.14
596	-0.15	-0.12	-0.12	-0.11	-0.11	-0.11
597	-0.12	-0.10	-0.10	-0.09	-0.09	-0.09
598	-0.11	-0.09	-0.09	-0.09	-0.09	-0.09
599	-0.11	-0.09	-0.09	-0.09	-0.09	-0.09
600	-0.13	-0.10	-0.11	-0.10	-0.10	-0.10
601	-0.16	-0.13	-0.13	-0.12	-0.12	-0.12
602	-0.22	-0.16	-0.16	-0.16	-0.16	-0.15
603	-0.29	-0.21	-0.21	-0.22	-0.20	-0.20
604	-0.39	-0.28	-0.29	-0.29	-0.27	-0.26
605	-0.48	-0.39	-0.42	-0.35	-0.33	-0.32
606	-0.54	-0.42	-0.45	-0.40	-0.36	-0.35
607	-0.52	-0.46	-0.50	-0.39	-0.36	-0.35
608	-0.52	-0.45	-0.49	-0.39	-0.36	-0.35
609	-0.43	-0.38	-0.41	-0.32	-0.30	-0.30
610	-0.35	-0.30	-0.32	-0.26	-0.25	-0.25
611	-0.29	-0.25	-0.26	-0.21	-0.21	-0.21
612	-0.25	-0.21	-0.22	-0.18	-0.18	-0.18
613	-0.22	-0.18	-0.19	-0.16	-0.16	-0.16
614	-0.21	-0.17	-0.17	-0.15	-0.15	-0.15
615	-0.22	-0.17	-0.18	-0.16	-0.16	-0.16
616	-0.23	-0.19	-0.20	-0.17	-0.17	-0.17
617	-0.26	-0.22	-0.24	-0.19	-0.19	-0.19
618	-0.31	-0.27	-0.29	-0.23	-0.22	-0.22
619	-0.43	-0.33	-0.34	-0.32	-0.29	-0.29
620	-0.33	-0.24	-0.25	-0.25	-0.23	-0.23
621	-0.25	-0.18	-0.18	-0.19	-0.18	-0.18
622	-0.19	-0.14	-0.15	-0.14	-0.14	-0.14
623	-0.14	-0.12	-0.12	-0.11	-0.11	-0.11
624	-0.12	-0.10	-0.10	-0.09	-0.09	-0.09
625	-0.11	-0.09	-0.09	-0.09	-0.09	-0.09
626	-0.11	-0.09	-0.09	-0.09	-0.09	-0.09
627	-0.13	-0.10	-0.11	-0.10	-0.10	-0.10
628	-0.16	-0.13	-0.13	-0.12	-0.12	-0.12
629	-0.21	-0.16	-0.16	-0.16	-0.15	-0.15
630	-0.28	-0.20	-0.21	-0.21	-0.20	-0.20
631	-0.37	-0.28	-0.28	-0.28	-0.26	-0.25
632	-0.43	-0.33	-0.34	-0.32	-0.29	-0.29
633	-0.40	-0.30	-0.32	-0.29	-0.27	-0.27
634	-0.31	-0.23	-0.24	-0.23	-0.22	-0.21
635	-0.24	-0.18	-0.18	-0.18	-0.17	-0.17
636	-0.18	-0.14	-0.14	-0.14	-0.13	-0.13
637	-0.14	-0.11	-0.12	-0.11	-0.11	-0.11
638	-0.12	-0.10	-0.10	-0.09	-0.09	-0.09
639	-0.11	-0.09	-0.09	-0.08	-0.08	-0.08
640	-0.11	-0.09	-0.09	-0.09	-0.09	-0.09
641	-0.13	-0.10	-0.10	-0.10	-0.10	-0.10
642	-0.15	-0.12	-0.12	-0.12	-0.12	-0.12
643	-0.20	-0.15	-0.15	-0.15	-0.15	-0.15
644	-0.27	-0.19	-0.20	-0.20	-0.19	-0.19
645	-0.35	-0.26	-0.27	-0.26	-0.24	-0.24
646	-0.40	-0.30	-0.32	-0.29	-0.27	-0.27
647	-0.37	-0.28	-0.29	-0.27	-0.25	-0.25
648	-0.29	-0.22	-0.22	-0.22	-0.21	-0.20
649	-0.23	-0.17	-0.17	-0.17	-0.16	-0.16
650	-0.17	-0.13	-0.13	-0.13	-0.13	-0.13
651	-0.14	-0.11	-0.11	-0.10	-0.10	-0.10
652	-0.12	-0.09	-0.09	-0.09	-0.09	-0.09
653	-0.11	-0.08	-0.08	-0.08	-0.08	-0.08
654	-0.11	-0.09	-0.09	-0.08	-0.08	-0.08
655	-0.12	-0.10	-0.10	-0.09	-0.09	-0.09
656	-0.15	-0.12	-0.12	-0.11	-0.11	-0.11
657	-0.19	-0.14	-0.15	-0.14	-0.14	-0.14
658	-0.25	-0.18	-0.19	-0.19	-0.18	-0.18
659	-0.32	-0.24	-0.25	-0.24	-0.22	-0.22
660	-0.37	-0.28	-0.29	-0.27	-0.25	-0.25



EGP CODE

GRE.EEC.R.73.IT.W.15235.12.024.01

PAGE

267 di/of 527

661	-0.35	-0.27	-0.28	-0.26	-0.24	-0.24
662	-0.28	-0.21	-0.21	-0.21	-0.20	-0.20
663	-0.22	-0.16	-0.16	-0.16	-0.16	-0.16
664	-0.17	-0.13	-0.13	-0.13	-0.13	-0.13
665	-0.13	-0.11	-0.11	-0.10	-0.10	-0.10
666	-0.11	-0.09	-0.09	-0.09	-0.09	-0.09
667	-0.11	-0.08	-0.08	-0.08	-0.08	-0.08
668	-0.11	-0.09	-0.09	-0.08	-0.08	-0.08
669	-0.12	-0.10	-0.10	-0.09	-0.09	-0.09
670	-0.15	-0.11	-0.12	-0.11	-0.11	-0.11
671	-0.19	-0.14	-0.14	-0.14	-0.14	-0.14
672	-0.24	-0.18	-0.18	-0.18	-0.17	-0.17
673	-0.31	-0.23	-0.24	-0.23	-0.22	-0.21
674	-0.35	-0.27	-0.28	-0.26	-0.24	-0.24
675	-0.35	-0.27	-0.28	-0.26	-0.24	-0.24
676	-0.28	-0.21	-0.21	-0.21	-0.20	-0.19
677	-0.22	-0.16	-0.16	-0.16	-0.16	-0.16
678	-0.17	-0.13	-0.13	-0.13	-0.13	-0.12
679	-0.13	-0.11	-0.11	-0.10	-0.10	-0.10
680	-0.11	-0.09	-0.09	-0.09	-0.09	-0.09
681	-0.11	-0.08	-0.08	-0.08	-0.08	-0.08
682	-0.11	-0.09	-0.09	-0.08	-0.08	-0.08
683	-0.12	-0.10	-0.10	-0.09	-0.09	-0.09
684	-0.14	-0.11	-0.12	-0.11	-0.11	-0.11
685	-0.19	-0.14	-0.14	-0.14	-0.14	-0.14
686	-0.24	-0.18	-0.18	-0.18	-0.17	-0.17
687	-0.31	-0.23	-0.24	-0.23	-0.21	-0.21
688	-0.35	-0.27	-0.28	-0.26	-0.24	-0.24
689	-0.36	-0.28	-0.29	-0.27	-0.25	-0.25
690	-0.29	-0.22	-0.22	-0.22	-0.20	-0.20
691	-0.22	-0.17	-0.17	-0.17	-0.16	-0.16
692	-0.17	-0.13	-0.13	-0.13	-0.13	-0.13
693	-0.14	-0.11	-0.11	-0.10	-0.10	-0.10
694	-0.12	-0.09	-0.09	-0.09	-0.09	-0.09
695	-0.11	-0.08	-0.08	-0.08	-0.08	-0.08
696	-0.11	-0.09	-0.09	-0.08	-0.08	-0.08
697	-0.12	-0.10	-0.10	-0.09	-0.09	-0.09
698	-0.15	-0.12	-0.12	-0.11	-0.11	-0.11
699	-0.19	-0.14	-0.14	-0.14	-0.14	-0.14
700	-0.25	-0.18	-0.19	-0.19	-0.18	-0.18
701	-0.32	-0.24	-0.25	-0.24	-0.22	-0.22
702	-0.36	-0.28	-0.29	-0.27	-0.25	-0.25
703	-0.39	-0.30	-0.32	-0.29	-0.27	-0.26
704	-0.31	-0.23	-0.24	-0.23	-0.22	-0.21
705	-0.24	-0.17	-0.18	-0.18	-0.17	-0.17
706	-0.18	-0.14	-0.14	-0.13	-0.13	-0.13
707	-0.14	-0.11	-0.12	-0.11	-0.11	-0.11
708	-0.12	-0.09	-0.10	-0.09	-0.09	-0.09
709	-0.11	-0.08	-0.09	-0.08	-0.08	-0.08
710	-0.11	-0.09	-0.09	-0.08	-0.08	-0.08
711	-0.12	-0.10	-0.10	-0.10	-0.10	-0.10
712	-0.15	-0.12	-0.12	-0.12	-0.11	-0.11
713	-0.20	-0.15	-0.15	-0.15	-0.15	-0.14
714	-0.26	-0.19	-0.20	-0.20	-0.19	-0.18
715	-0.34	-0.26	-0.27	-0.25	-0.24	-0.23
716	-0.39	-0.30	-0.32	-0.29	-0.27	-0.26
717	-0.42	-0.33	-0.34	-0.31	-0.29	-0.28
718	-0.33	-0.24	-0.25	-0.24	-0.23	-0.23
719	-0.25	-0.18	-0.18	-0.19	-0.18	-0.17
720	-0.19	-0.14	-0.14	-0.14	-0.14	-0.14
721	-0.14	-0.12	-0.12	-0.11	-0.11	-0.11
722	-0.12	-0.10	-0.10	-0.09	-0.09	-0.09
723	-0.11	-0.09	-0.09	-0.08	-0.08	-0.08
724	-0.11	-0.09	-0.09	-0.09	-0.09	-0.09
725	-0.13	-0.10	-0.11	-0.10	-0.10	-0.10
726	-0.16	-0.13	-0.13	-0.12	-0.12	-0.12
727	-0.21	-0.15	-0.16	-0.16	-0.15	-0.15
728	-0.28	-0.20	-0.20	-0.21	-0.20	-0.19
729	-0.37	-0.27	-0.29	-0.27	-0.25	-0.25
730	-0.43	-0.33	-0.35	-0.31	-0.29	-0.28
731	-0.38	-0.33	-0.35	-0.28	-0.27	-0.27
732	-0.34	-0.25	-0.25	-0.26	-0.24	-0.23
733	-0.25	-0.18	-0.18	-0.19	-0.18	-0.18
734	-0.19	-0.14	-0.15	-0.14	-0.14	-0.14
735	-0.14	-0.12	-0.12	-0.11	-0.11	-0.11
736	-0.12	-0.10	-0.10	-0.09	-0.09	-0.09



EGP CODE

GRE.EEC.R.73.IT.W.15235.12.024.01

PAGE

268 di/of 527

737	-0.11	-0.09	-0.09	-0.08	-0.08	-0.08
738	-0.11	-0.09	-0.09	-0.09	-0.09	-0.09
739	-0.13	-0.10	-0.11	-0.10	-0.10	-0.10
740	-0.16	-0.13	-0.13	-0.12	-0.12	-0.12
741	-0.21	-0.16	-0.16	-0.16	-0.15	-0.15
742	-0.29	-0.20	-0.21	-0.21	-0.20	-0.20
743	-0.39	-0.28	-0.29	-0.29	-0.27	-0.26
744	-0.47	-0.41	-0.44	-0.35	-0.33	-0.32
745	-0.61	-0.53	-0.58	-0.45	-0.42	-0.41
746	-0.61	-0.52	-0.57	-0.45	-0.41	-0.41
747	-0.49	-0.44	-0.49	-0.36	-0.34	-0.33
748	-0.49	-0.45	-0.49	-0.36	-0.34	-0.33
749	-0.41	-0.37	-0.40	-0.30	-0.28	-0.28
750	-0.33	-0.30	-0.32	-0.24	-0.23	-0.23
751	-0.27	-0.24	-0.26	-0.20	-0.20	-0.20
752	-0.23	-0.20	-0.22	-0.17	-0.17	-0.17
753	-0.21	-0.18	-0.18	-0.15	-0.15	-0.15
754	-0.20	-0.16	-0.17	-0.15	-0.15	-0.15
755	-0.20	-0.17	-0.17	-0.15	-0.15	-0.15
756	-0.22	-0.18	-0.19	-0.16	-0.16	-0.16
757	-0.44	-0.33	-0.35	-0.32	-0.30	-0.29
758	-0.34	-0.25	-0.25	-0.25	-0.23	-0.23
759	-0.25	-0.18	-0.18	-0.19	-0.18	-0.18
760	-0.19	-0.14	-0.15	-0.14	-0.14	-0.14
761	-0.14	-0.12	-0.12	-0.11	-0.11	-0.11
762	-0.12	-0.10	-0.10	-0.09	-0.09	-0.09
763	-0.11	-0.09	-0.09	-0.08	-0.08	-0.08
764	-0.11	-0.09	-0.09	-0.09	-0.09	-0.09
765	-0.13	-0.10	-0.11	-0.10	-0.10	-0.10
766	-0.16	-0.13	-0.13	-0.12	-0.12	-0.12
767	-0.21	-0.16	-0.16	-0.16	-0.15	-0.15
768	-0.28	-0.20	-0.20	-0.21	-0.20	-0.20
769	-0.38	-0.28	-0.29	-0.28	-0.26	-0.25
770	-0.44	-0.34	-0.35	-0.32	-0.30	-0.29
771	-0.41	-0.31	-0.33	-0.30	-0.28	-0.27
772	-0.32	-0.24	-0.24	-0.24	-0.22	-0.22
773	-0.24	-0.18	-0.18	-0.18	-0.17	-0.17
774	-0.18	-0.14	-0.14	-0.14	-0.13	-0.13
775	-0.14	-0.11	-0.12	-0.11	-0.11	-0.11
776	-0.12	-0.10	-0.10	-0.09	-0.09	-0.09
777	-0.11	-0.09	-0.09	-0.08	-0.08	-0.08
778	-0.11	-0.09	-0.09	-0.09	-0.09	-0.09
779	-0.13	-0.10	-0.10	-0.10	-0.10	-0.10
780	-0.16	-0.12	-0.13	-0.12	-0.12	-0.12
781	-0.20	-0.15	-0.15	-0.15	-0.15	-0.15
782	-0.27	-0.20	-0.20	-0.20	-0.19	-0.19
783	-0.36	-0.27	-0.28	-0.26	-0.25	-0.24
784	-0.41	-0.31	-0.33	-0.30	-0.28	-0.27
785	-0.38	-0.29	-0.31	-0.28	-0.26	-0.26
786	-0.30	-0.23	-0.23	-0.22	-0.21	-0.21
787	-0.23	-0.17	-0.17	-0.17	-0.17	-0.17
788	-0.18	-0.13	-0.14	-0.13	-0.13	-0.13
789	-0.14	-0.11	-0.11	-0.11	-0.11	-0.11
790	-0.12	-0.09	-0.10	-0.09	-0.09	-0.09
791	-0.11	-0.08	-0.08	-0.08	-0.08	-0.08
792	-0.11	-0.09	-0.09	-0.08	-0.08	-0.08
793	-0.12	-0.10	-0.10	-0.09	-0.09	-0.09
794	-0.15	-0.12	-0.12	-0.11	-0.11	-0.11
795	-0.20	-0.15	-0.15	-0.15	-0.14	-0.14
796	-0.26	-0.19	-0.19	-0.19	-0.18	-0.18
797	-0.33	-0.25	-0.26	-0.25	-0.23	-0.23
798	-0.38	-0.29	-0.31	-0.28	-0.26	-0.26
799	-0.36	-0.28	-0.29	-0.27	-0.25	-0.25
800	-0.29	-0.22	-0.22	-0.22	-0.20	-0.20
801	-0.22	-0.16	-0.17	-0.17	-0.16	-0.16
802	-0.17	-0.13	-0.13	-0.13	-0.13	-0.13
803	-0.14	-0.11	-0.11	-0.10	-0.10	-0.10
804	-0.11	-0.09	-0.09	-0.09	-0.09	-0.09
805	-0.11	-0.08	-0.08	-0.08	-0.08	-0.08
806	-0.11	-0.09	-0.09	-0.08	-0.08	-0.08
807	-0.12	-0.10	-0.10	-0.09	-0.09	-0.09
808	-0.15	-0.12	-0.12	-0.11	-0.11	-0.11
809	-0.19	-0.14	-0.14	-0.14	-0.14	-0.14
810	-0.25	-0.18	-0.19	-0.19	-0.18	-0.18
811	-0.32	-0.24	-0.25	-0.24	-0.22	-0.22
812	-0.36	-0.28	-0.29	-0.27	-0.25	-0.25



EGP CODE

GRE.EEC.R.73.IT.W.15235.12.024.01

PAGE

269 di/of 527

813	-0.36	-0.28	-0.29	-0.27	-0.25	-0.25
814	-0.29	-0.22	-0.22	-0.21	-0.20	-0.20
815	-0.22	-0.16	-0.17	-0.17	-0.16	-0.16
816	-0.17	-0.13	-0.13	-0.13	-0.13	-0.13
817	-0.13	-0.11	-0.11	-0.10	-0.10	-0.10
818	-0.11	-0.09	-0.09	-0.09	-0.09	-0.09
819	-0.11	-0.08	-0.08	-0.08	-0.08	-0.08
820	-0.11	-0.09	-0.09	-0.08	-0.08	-0.08
821	-0.12	-0.10	-0.10	-0.09	-0.09	-0.09
822	-0.15	-0.12	-0.12	-0.11	-0.11	-0.11
823	-0.19	-0.14	-0.14	-0.14	-0.14	-0.14
824	-0.25	-0.18	-0.19	-0.18	-0.18	-0.17
825	-0.32	-0.24	-0.25	-0.23	-0.22	-0.22
826	-0.36	-0.28	-0.29	-0.27	-0.25	-0.25
827	-0.38	-0.29	-0.31	-0.28	-0.26	-0.25
828	-0.30	-0.22	-0.23	-0.22	-0.21	-0.21
829	-0.23	-0.17	-0.18	-0.17	-0.16	-0.16
830	-0.17	-0.13	-0.14	-0.13	-0.13	-0.13
831	-0.14	-0.11	-0.11	-0.10	-0.10	-0.10
832	-0.11	-0.09	-0.09	-0.09	-0.09	-0.09
833	-0.11	-0.08	-0.08	-0.08	-0.08	-0.08
834	-0.11	-0.09	-0.09	-0.08	-0.08	-0.08
835	-0.12	-0.10	-0.10	-0.09	-0.09	-0.09
836	-0.15	-0.12	-0.12	-0.11	-0.11	-0.11
837	-0.19	-0.15	-0.15	-0.15	-0.14	-0.14
838	-0.25	-0.19	-0.19	-0.19	-0.18	-0.18
839	-0.33	-0.25	-0.26	-0.24	-0.23	-0.23
840	-0.38	-0.29	-0.31	-0.28	-0.26	-0.25
841	-0.40	-0.31	-0.33	-0.30	-0.28	-0.27
842	-0.31	-0.24	-0.24	-0.23	-0.22	-0.22
843	-0.24	-0.18	-0.18	-0.18	-0.17	-0.17
844	-0.18	-0.14	-0.14	-0.14	-0.13	-0.13
845	-0.14	-0.11	-0.12	-0.11	-0.11	-0.11
846	-0.12	-0.09	-0.10	-0.09	-0.09	-0.09
847	-0.11	-0.08	-0.08	-0.08	-0.08	-0.08
848	-0.11	-0.09	-0.09	-0.08	-0.08	-0.08
849	-0.12	-0.10	-0.10	-0.09	-0.09	-0.09
850	-0.15	-0.12	-0.12	-0.12	-0.11	-0.11
851	-0.20	-0.15	-0.16	-0.15	-0.15	-0.15
852	-0.27	-0.20	-0.21	-0.20	-0.19	-0.19
853	-0.35	-0.27	-0.28	-0.26	-0.24	-0.24
854	-0.40	-0.31	-0.33	-0.30	-0.28	-0.27
855	-0.43	-0.33	-0.35	-0.32	-0.29	-0.29
856	-0.33	-0.25	-0.25	-0.25	-0.23	-0.23
857	-0.25	-0.18	-0.19	-0.19	-0.18	-0.18
858	-0.19	-0.14	-0.15	-0.14	-0.14	-0.14
859	-0.14	-0.12	-0.12	-0.11	-0.11	-0.11
860	-0.12	-0.10	-0.10	-0.09	-0.09	-0.09
861	-0.11	-0.09	-0.09	-0.08	-0.08	-0.08
862	-0.11	-0.09	-0.09	-0.09	-0.09	-0.09
863	-0.13	-0.10	-0.11	-0.10	-0.10	-0.10
864	-0.16	-0.13	-0.13	-0.12	-0.12	-0.12
865	-0.21	-0.16	-0.16	-0.16	-0.15	-0.15
866	-0.28	-0.21	-0.21	-0.21	-0.20	-0.19
867	-0.37	-0.28	-0.29	-0.27	-0.26	-0.25
868	-0.43	-0.33	-0.35	-0.32	-0.30	-0.29
869	-0.34	-0.25	-0.26	-0.25	-0.24	-0.23
870	-0.25	-0.19	-0.19	-0.19	-0.18	-0.18
871	-0.19	-0.14	-0.15	-0.14	-0.14	-0.14
872	-0.14	-0.12	-0.12	-0.11	-0.11	-0.11
873	-0.12	-0.10	-0.10	-0.09	-0.09	-0.09
874	-0.11	-0.09	-0.09	-0.08	-0.08	-0.08
875	-0.11	-0.09	-0.09	-0.09	-0.09	-0.09
876	-0.13	-0.10	-0.11	-0.10	-0.10	-0.10
877	-0.16	-0.13	-0.13	-0.12	-0.12	-0.12
878	-0.21	-0.16	-0.16	-0.16	-0.15	-0.15
879	-0.28	-0.21	-0.21	-0.21	-0.20	-0.20
880	-0.38	-0.28	-0.29	-0.28	-0.26	-0.26
881	-0.45	-0.34	-0.36	-0.33	-0.30	-0.30
882	-0.34	-0.25	-0.26	-0.25	-0.24	-0.23
883	-0.26	-0.19	-0.19	-0.19	-0.18	-0.18
884	-0.19	-0.15	-0.15	-0.14	-0.14	-0.14
885	-0.14	-0.12	-0.12	-0.11	-0.11	-0.11
886	-0.12	-0.10	-0.10	-0.09	-0.09	-0.09
887	-0.11	-0.09	-0.09	-0.08	-0.08	-0.08
888	-0.11	-0.09	-0.09	-0.09	-0.09	-0.09



EGP CODE

GRE.EEC.R.73.IT.W.15235.12.024.01

PAGE

270 di/of 527

889	-0.13	-0.10	-0.11	-0.10	-0.10	-0.10
890	-0.16	-0.13	-0.13	-0.12	-0.12	-0.12
891	-0.21	-0.16	-0.16	-0.16	-0.15	-0.15
892	-0.29	-0.21	-0.21	-0.21	-0.20	-0.20
893	-0.38	-0.28	-0.29	-0.28	-0.26	-0.26
894	-0.45	-0.34	-0.36	-0.33	-0.30	-0.30
895	-0.44	-0.33	-0.35	-0.32	-0.30	-0.29
896	-0.34	-0.25	-0.26	-0.25	-0.24	-0.23
897	-0.26	-0.19	-0.19	-0.19	-0.18	-0.18
898	-0.19	-0.15	-0.15	-0.14	-0.14	-0.14
899	-0.15	-0.12	-0.12	-0.11	-0.11	-0.11
900	-0.12	-0.10	-0.10	-0.09	-0.09	-0.09
901	-0.11	-0.09	-0.09	-0.08	-0.08	-0.08
902	-0.11	-0.09	-0.09	-0.09	-0.09	-0.09
903	-0.13	-0.10	-0.11	-0.10	-0.10	-0.10
904	-0.16	-0.13	-0.13	-0.12	-0.12	-0.12
905	-0.22	-0.16	-0.16	-0.16	-0.16	-0.15
906	-0.29	-0.21	-0.21	-0.22	-0.20	-0.20
907	-0.38	-0.28	-0.29	-0.28	-0.26	-0.26
908	-0.44	-0.33	-0.35	-0.32	-0.30	-0.29
909	-0.43	-0.33	-0.34	-0.32	-0.29	-0.29
910	-0.34	-0.25	-0.26	-0.25	-0.24	-0.23
911	-0.26	-0.19	-0.19	-0.19	-0.18	-0.18
912	-0.19	-0.14	-0.15	-0.15	-0.14	-0.14
913	-0.15	-0.12	-0.12	-0.11	-0.11	-0.11
914	-0.12	-0.10	-0.10	-0.09	-0.09	-0.09
915	-0.11	-0.09	-0.09	-0.09	-0.09	-0.09
916	-0.11	-0.09	-0.09	-0.09	-0.09	-0.09
917	-0.13	-0.10	-0.11	-0.10	-0.10	-0.10
918	-0.16	-0.13	-0.13	-0.12	-0.12	-0.12
919	-0.22	-0.16	-0.16	-0.16	-0.16	-0.15
920	-0.29	-0.21	-0.21	-0.21	-0.20	-0.20
921	-0.37	-0.28	-0.29	-0.28	-0.26	-0.25
922	-0.43	-0.33	-0.34	-0.32	-0.29	-0.29
923	-0.43	-0.33	-0.34	-0.32	-0.29	-0.29
924	-0.34	-0.25	-0.26	-0.25	-0.23	-0.23
925	-0.26	-0.18	-0.19	-0.19	-0.18	-0.18
926	-0.19	-0.14	-0.15	-0.14	-0.14	-0.14
927	-0.15	-0.12	-0.12	-0.11	-0.11	-0.11
928	-0.12	-0.10	-0.10	-0.09	-0.09	-0.09
929	-0.11	-0.09	-0.09	-0.08	-0.08	-0.08
930	-0.11	-0.09	-0.09	-0.09	-0.09	-0.09
931	-0.13	-0.10	-0.11	-0.10	-0.10	-0.10
932	-0.16	-0.13	-0.13	-0.12	-0.12	-0.12
933	-0.21	-0.16	-0.16	-0.16	-0.16	-0.15
934	-0.29	-0.21	-0.21	-0.21	-0.20	-0.20
935	-0.37	-0.28	-0.29	-0.28	-0.26	-0.25
936	-0.43	-0.33	-0.34	-0.32	-0.29	-0.29
937	-0.43	-0.33	-0.35	-0.32	-0.30	-0.29
938	-0.34	-0.25	-0.26	-0.25	-0.24	-0.23
939	-0.25	-0.18	-0.18	-0.19	-0.18	-0.18
940	-0.19	-0.14	-0.15	-0.14	-0.14	-0.14
941	-0.14	-0.12	-0.12	-0.11	-0.11	-0.11
942	-0.12	-0.10	-0.10	-0.09	-0.09	-0.09
943	-0.11	-0.09	-0.09	-0.08	-0.08	-0.08
944	-0.11	-0.09	-0.09	-0.09	-0.09	-0.09
945	-0.13	-0.10	-0.11	-0.10	-0.10	-0.10
946	-0.16	-0.13	-0.13	-0.12	-0.12	-0.12
947	-0.21	-0.16	-0.16	-0.16	-0.15	-0.15
948	-0.29	-0.21	-0.21	-0.21	-0.20	-0.20
949	-0.38	-0.28	-0.29	-0.28	-0.26	-0.26
950	-0.44	-0.33	-0.35	-0.32	-0.30	-0.29
951	-0.25	-0.22	-0.23	-0.18	-0.18	-0.18
952	-0.33	-0.24	-0.25	-0.25	-0.23	-0.23
953	-0.25	-0.18	-0.18	-0.19	-0.18	-0.18
954	-0.19	-0.14	-0.14	-0.14	-0.14	-0.14
955	-0.14	-0.11	-0.12	-0.11	-0.11	-0.11
956	-0.12	-0.09	-0.10	-0.09	-0.09	-0.09
957	-0.11	-0.08	-0.09	-0.08	-0.08	-0.08
958	-0.11	-0.09	-0.09	-0.08	-0.08	-0.08
959	-0.12	-0.10	-0.10	-0.10	-0.10	-0.10
960	-0.16	-0.12	-0.13	-0.12	-0.12	-0.12
961	-0.21	-0.15	-0.16	-0.16	-0.15	-0.15
962	-0.28	-0.20	-0.20	-0.21	-0.20	-0.20
963	-0.37	-0.28	-0.29	-0.28	-0.26	-0.25
964	-0.29	-0.26	-0.28	-0.21	-0.21	-0.21





EGP CODE

GRE.EEC.R.73.IT.W.15235.12.024.01

PAGE

271 di/of 527

965	-0.36	-0.32	-0.35	-0.26	-0.25	-0.25
966	-0.44	-0.40	-0.44	-0.32	-0.31	-0.30
967	-0.57	-0.52	-0.57	-0.42	-0.39	-0.38
968	-0.57	-0.51	-0.56	-0.42	-0.39	-0.38
969	-0.46	-0.37	-0.39	-0.34	-0.32	-0.31
970	-0.46	-0.37	-0.39	-0.34	-0.32	-0.31
971	-0.38	-0.30	-0.31	-0.28	-0.26	-0.26
972	-0.30	-0.24	-0.25	-0.22	-0.22	-0.21
973	-0.25	-0.20	-0.21	-0.18	-0.18	-0.18
974	-0.21	-0.17	-0.17	-0.16	-0.15	-0.15
975	-0.19	-0.15	-0.15	-0.14	-0.14	-0.14
976	-0.18	-0.14	-0.14	-0.13	-0.13	-0.13
977	-0.41	-0.32	-0.33	-0.31	-0.28	-0.28
978	-0.32	-0.24	-0.24	-0.24	-0.22	-0.22
979	-0.24	-0.18	-0.18	-0.18	-0.17	-0.17
980	-0.18	-0.14	-0.14	-0.14	-0.13	-0.13
981	-0.14	-0.11	-0.11	-0.11	-0.11	-0.11
982	-0.12	-0.09	-0.10	-0.09	-0.09	-0.09
983	-0.11	-0.08	-0.08	-0.08	-0.08	-0.08
984	-0.11	-0.09	-0.09	-0.08	-0.08	-0.08
985	-0.12	-0.10	-0.10	-0.09	-0.09	-0.09
986	-0.15	-0.12	-0.12	-0.12	-0.12	-0.11
987	-0.20	-0.15	-0.15	-0.15	-0.15	-0.15
988	-0.27	-0.20	-0.20	-0.20	-0.19	-0.19
989	-0.36	-0.27	-0.28	-0.27	-0.25	-0.24
990	-0.41	-0.32	-0.33	-0.31	-0.28	-0.28
991	-0.38	-0.29	-0.31	-0.28	-0.26	-0.26
992	-0.30	-0.22	-0.23	-0.22	-0.21	-0.21
993	-0.23	-0.17	-0.17	-0.17	-0.17	-0.16
994	-0.17	-0.13	-0.14	-0.13	-0.13	-0.13
995	-0.14	-0.11	-0.11	-0.10	-0.10	-0.10
996	-0.11	-0.09	-0.09	-0.09	-0.09	-0.09
997	-0.11	-0.08	-0.09	-0.08	-0.08	-0.08
998	-0.11	-0.09	-0.09	-0.08	-0.08	-0.08
999	-0.12	-0.10	-0.10	-0.09	-0.09	-0.09
1000	-0.15	-0.12	-0.12	-0.11	-0.11	-0.11
1001	-0.19	-0.14	-0.15	-0.15	-0.14	-0.14
1002	-0.26	-0.19	-0.19	-0.19	-0.18	-0.18
1003	-0.33	-0.25	-0.26	-0.25	-0.23	-0.23
1004	-0.38	-0.29	-0.31	-0.28	-0.26	-0.26
1005	-0.35	-0.27	-0.28	-0.26	-0.24	-0.24
1006	-0.28	-0.21	-0.22	-0.21	-0.20	-0.20
1007	-0.22	-0.16	-0.16	-0.16	-0.16	-0.16
1008	-0.17	-0.13	-0.13	-0.13	-0.13	-0.13
1009	-0.14	-0.11	-0.11	-0.10	-0.10	-0.10
1010	-0.12	-0.09	-0.10	-0.09	-0.09	-0.09
1011	-0.11	-0.09	-0.09	-0.08	-0.08	-0.08
1012	-0.11	-0.09	-0.09	-0.08	-0.08	-0.08
1013	-0.12	-0.10	-0.10	-0.09	-0.09	-0.09
1014	-0.15	-0.12	-0.12	-0.11	-0.11	-0.11
1015	-0.19	-0.14	-0.14	-0.14	-0.14	-0.14
1016	-0.24	-0.18	-0.18	-0.18	-0.17	-0.17
1017	-0.31	-0.24	-0.24	-0.23	-0.22	-0.21
1018	-0.35	-0.27	-0.28	-0.26	-0.25	-0.24
1019	-0.34	-0.26	-0.27	-0.25	-0.24	-0.23
1020	-0.27	-0.21	-0.21	-0.20	-0.19	-0.19
1021	-0.22	-0.16	-0.16	-0.16	-0.16	-0.16
1022	-0.17	-0.13	-0.13	-0.13	-0.13	-0.13
1023	-0.14	-0.11	-0.11	-0.11	-0.11	-0.11
1024	-0.12	-0.10	-0.10	-0.09	-0.09	-0.09
1025	-0.11	-0.09	-0.09	-0.09	-0.09	-0.09
1026	-0.11	-0.09	-0.09	-0.09	-0.09	-0.09
1027	-0.13	-0.10	-0.10	-0.10	-0.10	-0.10
1028	-0.15	-0.12	-0.12	-0.11	-0.11	-0.11
1029	-0.19	-0.14	-0.14	-0.14	-0.14	-0.14
1030	-0.24	-0.18	-0.18	-0.18	-0.17	-0.17
1031	-0.30	-0.23	-0.24	-0.22	-0.21	-0.21
1032	-0.34	-0.26	-0.27	-0.25	-0.24	-0.23
1033	-0.34	-0.27	-0.28	-0.25	-0.24	-0.24
1034	-0.28	-0.21	-0.22	-0.21	-0.20	-0.20
1035	-0.22	-0.17	-0.17	-0.17	-0.16	-0.16
1036	-0.18	-0.14	-0.14	-0.13	-0.13	-0.13
1037	-0.15	-0.12	-0.12	-0.11	-0.11	-0.11
1038	-0.13	-0.10	-0.10	-0.10	-0.10	-0.10
1039	-0.12	-0.10	-0.10	-0.09	-0.09	-0.09
1040	-0.12	-0.10	-0.10	-0.09	-0.09	-0.09



EGP CODE

GRE.EEC.R.73.IT.W.15235.12.024.01

PAGE

272 di/of 527

1041	-0.14	-0.11	-0.11	-0.10	-0.10	-0.10
1042	-0.16	-0.12	-0.13	-0.12	-0.12	-0.12
1043	-0.20	-0.14	-0.15	-0.15	-0.14	-0.14
1044	-0.25	-0.18	-0.19	-0.18	-0.18	-0.17
1045	-0.30	-0.23	-0.24	-0.23	-0.21	-0.21
1046	-0.34	-0.27	-0.28	-0.25	-0.24	-0.24
1047	-0.37	-0.29	-0.30	-0.27	-0.26	-0.25
1048	-0.30	-0.23	-0.23	-0.22	-0.21	-0.21
1049	-0.24	-0.18	-0.18	-0.18	-0.17	-0.17
1050	-0.20	-0.15	-0.15	-0.15	-0.14	-0.14
1051	-0.16	-0.13	-0.13	-0.12	-0.12	-0.12
1052	-0.15	-0.11	-0.11	-0.11	-0.11	-0.11
1053	-0.14	-0.11	-0.11	-0.10	-0.10	-0.10
1054	-0.14	-0.11	-0.11	-0.10	-0.10	-0.10
1055	-0.15	-0.12	-0.12	-0.11	-0.11	-0.11
1056	-0.17	-0.13	-0.14	-0.13	-0.13	-0.13
1057	-0.21	-0.16	-0.16	-0.16	-0.16	-0.15
1058	-0.26	-0.20	-0.20	-0.20	-0.19	-0.19
1059	-0.33	-0.25	-0.26	-0.24	-0.23	-0.23
1060	-0.37	-0.29	-0.30	-0.27	-0.26	-0.25
1061	-0.41	-0.32	-0.34	-0.30	-0.28	-0.28
1062	-0.33	-0.25	-0.26	-0.25	-0.24	-0.23
1063	-0.27	-0.20	-0.21	-0.20	-0.19	-0.19
1064	-0.46	-0.36	-0.38	-0.34	-0.31	-0.30
1065	-0.18	-0.14	-0.15	-0.14	-0.14	-0.14
1066	-0.17	-0.13	-0.13	-0.12	-0.12	-0.12
1067	-0.16	-0.12	-0.12	-0.12	-0.12	-0.12
1068	-0.16	-0.12	-0.12	-0.12	-0.12	-0.12
1069	-0.17	-0.13	-0.14	-0.13	-0.13	-0.13
1070	-0.20	-0.15	-0.16	-0.15	-0.15	-0.14
1071	-0.24	-0.18	-0.19	-0.18	-0.17	-0.17
1072	-0.29	-0.22	-0.23	-0.22	-0.21	-0.21
1073	-0.36	-0.28	-0.29	-0.27	-0.25	-0.25
1074	-0.41	-0.32	-0.34	-0.30	-0.28	-0.28
1076	-0.52	-0.41	-0.43	-0.39	-0.35	-0.34
1077	-0.48	-0.37	-0.40	-0.35	-0.32	-0.32
1078	-0.44	-0.34	-0.36	-0.32	-0.30	-0.29
1079	-0.42	-0.32	-0.34	-0.31	-0.29	-0.28
1080	-0.42	-0.32	-0.34	-0.31	-0.29	-0.28
1081	-0.44	-0.34	-0.36	-0.32	-0.30	-0.29
1082	-0.18	-0.14	-0.14	-0.13	-0.13	-0.13
1083	-0.20	-0.16	-0.16	-0.14	-0.14	-0.14
1084	-0.22	-0.18	-0.19	-0.17	-0.16	-0.16
1085	-0.27	-0.21	-0.22	-0.20	-0.19	-0.19
1086	-0.33	-0.26	-0.27	-0.24	-0.23	-0.23
1087	-0.41	-0.32	-0.34	-0.30	-0.28	-0.28
1088	-0.47	-0.38	-0.40	-0.35	-0.32	-0.31
1089	-0.40	-0.32	-0.34	-0.29	-0.28	-0.27
1090	-0.32	-0.26	-0.28	-0.24	-0.23	-0.23
1091	-0.27	-0.22	-0.23	-0.19	-0.19	-0.19
1092	-0.22	-0.18	-0.19	-0.16	-0.16	-0.16
1093	-0.20	-0.16	-0.17	-0.15	-0.15	-0.15
1094	-0.19	-0.15	-0.15	-0.14	-0.14	-0.14
1095	-0.19	-0.15	-0.16	-0.14	-0.14	-0.14
1096	-0.21	-0.17	-0.17	-0.15	-0.15	-0.15
1097	-0.24	-0.19	-0.20	-0.18	-0.17	-0.17
1098	-0.29	-0.23	-0.24	-0.21	-0.20	-0.20
1099	-0.35	-0.28	-0.30	-0.26	-0.25	-0.24
1100	-0.43	-0.35	-0.37	-0.32	-0.30	-0.29
1101	-0.54	-0.46	-0.50	-0.40	-0.37	-0.37
1102	-0.51	-0.41	-0.43	-0.38	-0.35	-0.34
1103	-0.52	-0.41	-0.44	-0.39	-0.35	-0.35
1104	-0.53	-0.42	-0.45	-0.39	-0.36	-0.35
1105	-0.54	-0.44	-0.47	-0.40	-0.37	-0.36
1106	-0.56	-0.43	-0.46	-0.41	-0.37	-0.36
1107	-0.55	-0.44	-0.47	-0.40	-0.37	-0.36
1108	-0.54	-0.43	-0.47	-0.40	-0.36	-0.36
1109	-0.53	-0.42	-0.45	-0.39	-0.36	-0.35
1110	-0.56	-0.48	-0.52	-0.42	-0.39	-0.38
1111	-0.50	-0.42	-0.45	-0.37	-0.35	-0.34
1112	-0.47	-0.39	-0.41	-0.35	-0.32	-0.32
1113	-0.45	-0.37	-0.39	-0.34	-0.31	-0.31
1114	-0.46	-0.37	-0.39	-0.34	-0.32	-0.31
1115	-0.48	-0.38	-0.41	-0.35	-0.33	-0.32
1116	-0.50	-0.40	-0.43	-0.37	-0.34	-0.34
1117	-0.51	-0.41	-0.43	-0.38	-0.35	-0.34



EGP CODE

GRE.EEC.R.73.IT.W.15235.12.024.01

PAGE

273 di/of 527

1118	-0.49	-0.39	-0.41	-0.36	-0.33	-0.33
1119	-0.48	-0.37	-0.40	-0.35	-0.32	-0.32
1120	-0.48	-0.37	-0.39	-0.35	-0.32	-0.32
1121	-0.49	-0.38	-0.40	-0.36	-0.33	-0.33
1122	-0.51	-0.40	-0.43	-0.38	-0.35	-0.34
1123	-0.44	-0.34	-0.36	-0.32	-0.30	-0.29
1124	-0.51	-0.40	-0.43	-0.37	-0.34	-0.34
1125	-0.48	-0.38	-0.40	-0.35	-0.33	-0.32
1126	-0.46	-0.36	-0.38	-0.34	-0.32	-0.31
1127	-0.46	-0.36	-0.38	-0.34	-0.32	-0.31
1128	-0.48	-0.38	-0.40	-0.35	-0.33	-0.32
1129	-0.51	-0.40	-0.43	-0.37	-0.34	-0.34
1130	-0.51	-0.41	-0.44	-0.38	-0.35	-0.34
1131	-0.52	-0.41	-0.44	-0.38	-0.35	-0.34
1132	-0.50	-0.39	-0.42	-0.37	-0.34	-0.33
1133	-0.48	-0.37	-0.40	-0.35	-0.32	-0.32
1134	-0.48	-0.37	-0.39	-0.35	-0.32	-0.32
1135	-0.49	-0.39	-0.41	-0.36	-0.33	-0.33
1136	-0.52	-0.41	-0.44	-0.38	-0.35	-0.34
1137	-0.54	-0.43	-0.46	-0.40	-0.36	-0.36
1138	-0.53	-0.43	-0.46	-0.39	-0.36	-0.35
1139	-0.49	-0.39	-0.42	-0.36	-0.33	-0.33
1140	-0.45	-0.35	-0.38	-0.33	-0.31	-0.30
1141	-0.42	-0.33	-0.34	-0.31	-0.29	-0.28
1142	-0.41	-0.31	-0.33	-0.30	-0.28	-0.28
1143	-0.42	-0.32	-0.34	-0.31	-0.29	-0.28
1144	-0.45	-0.35	-0.37	-0.33	-0.31	-0.30
1145	-0.50	-0.39	-0.41	-0.37	-0.34	-0.33
1146	-0.54	-0.42	-0.45	-0.40	-0.36	-0.35
1147	-0.54	-0.45	-0.49	-0.40	-0.37	-0.36
1148	-0.52	-0.41	-0.44	-0.39	-0.35	-0.34
1149	-0.48	-0.37	-0.40	-0.35	-0.33	-0.32
1150	-0.44	-0.34	-0.36	-0.33	-0.30	-0.30
1151	-0.42	-0.32	-0.34	-0.31	-0.29	-0.28
1152	-0.42	-0.32	-0.34	-0.31	-0.29	-0.28
1153	-0.44	-0.34	-0.36	-0.32	-0.30	-0.29
1154	-0.47	-0.38	-0.40	-0.35	-0.32	-0.31
1155	-0.52	-0.41	-0.44	-0.38	-0.35	-0.34
1156	-0.53	-0.42	-0.45	-0.39	-0.36	-0.35
1157	-0.53	-0.43	-0.46	-0.39	-0.36	-0.35
1158	-0.50	-0.39	-0.42	-0.37	-0.34	-0.33
1159	-0.46	-0.36	-0.38	-0.34	-0.31	-0.31
1160	-0.44	-0.34	-0.36	-0.32	-0.30	-0.29
1161	-0.43	-0.34	-0.36	-0.32	-0.30	-0.29
1162	-0.45	-0.36	-0.38	-0.33	-0.31	-0.30
1163	-0.49	-0.39	-0.42	-0.36	-0.33	-0.32
1164	-0.52	-0.42	-0.46	-0.39	-0.35	-0.35
1165	-0.54	-0.43	-0.46	-0.40	-0.36	-0.36
1166	-0.53	-0.42	-0.45	-0.39	-0.36	-0.35
1167	-0.52	-0.41	-0.44	-0.38	-0.35	-0.34
1168	-0.52	-0.41	-0.44	-0.38	-0.35	-0.34
1169	-0.53	-0.42	-0.44	-0.39	-0.36	-0.35
1170	-0.49	-0.39	-0.42	-0.36	-0.33	-0.33
1171	-0.50	-0.40	-0.43	-0.37	-0.34	-0.33
1172	-0.46	-0.36	-0.39	-0.34	-0.31	-0.31
1173	-0.42	-0.33	-0.35	-0.31	-0.29	-0.28
1174	-0.40	-0.32	-0.33	-0.30	-0.28	-0.27
1175	-0.40	-0.32	-0.34	-0.30	-0.28	-0.27
1176	-0.43	-0.35	-0.37	-0.32	-0.30	-0.29
1177	-0.48	-0.39	-0.42	-0.35	-0.33	-0.32
1178	-0.49	-0.38	-0.41	-0.36	-0.33	-0.33
1179	-0.54	-0.46	-0.50	-0.40	-0.37	-0.36
1180	-0.51	-0.41	-0.43	-0.38	-0.35	-0.34
1181	-0.52	-0.41	-0.44	-0.38	-0.35	-0.35
1182	-0.53	-0.42	-0.45	-0.39	-0.36	-0.35
1183	-0.54	-0.44	-0.47	-0.40	-0.37	-0.36
1184	-0.55	-0.43	-0.46	-0.41	-0.37	-0.36
1185	-0.54	-0.44	-0.47	-0.40	-0.37	-0.36
1186	-0.54	-0.43	-0.47	-0.40	-0.36	-0.35
1187	-0.53	-0.42	-0.44	-0.39	-0.36	-0.35
1188	-0.56	-0.48	-0.52	-0.41	-0.38	-0.38
1189	-0.50	-0.42	-0.45	-0.37	-0.35	-0.34
1190	-0.47	-0.38	-0.41	-0.35	-0.32	-0.32
1191	-0.45	-0.36	-0.39	-0.33	-0.31	-0.31
1192	-0.46	-0.36	-0.39	-0.34	-0.31	-0.31
1193	-0.48	-0.38	-0.40	-0.35	-0.33	-0.32

1194	-0.50	-0.40	-0.43	-0.37	-0.34	-0.34
1195	-0.51	-0.40	-0.43	-0.37	-0.35	-0.34
1196	-0.49	-0.39	-0.41	-0.36	-0.33	-0.33
1197	-0.47	-0.37	-0.39	-0.35	-0.32	-0.32
1198	-0.47	-0.37	-0.39	-0.35	-0.32	-0.32
1199	-0.49	-0.38	-0.40	-0.36	-0.33	-0.32
1200	-0.51	-0.40	-0.42	-0.38	-0.35	-0.34
1201	-0.45	-0.36	-0.38	-0.33	-0.31	-0.30
1202	-0.50	-0.40	-0.43	-0.37	-0.34	-0.33
1203	-0.48	-0.38	-0.40	-0.35	-0.33	-0.32
1204	-0.46	-0.36	-0.38	-0.34	-0.31	-0.31
1205	-0.46	-0.36	-0.38	-0.34	-0.31	-0.31
1206	-0.48	-0.38	-0.40	-0.35	-0.32	-0.32
1207	-0.50	-0.40	-0.43	-0.37	-0.34	-0.33
1209	-0.52	-0.41	-0.44	-0.38	-0.35	-0.34
1210	-0.49	-0.39	-0.42	-0.36	-0.33	-0.33
1211	-0.48	-0.37	-0.39	-0.35	-0.32	-0.32
1212	-0.47	-0.37	-0.39	-0.35	-0.32	-0.32
1213	-0.49	-0.38	-0.41	-0.36	-0.33	-0.32
1214	-0.52	-0.41	-0.44	-0.38	-0.35	-0.34
1215	-0.54	-0.43	-0.46	-0.40	-0.36	-0.36
1216	-0.53	-0.43	-0.46	-0.39	-0.36	-0.35
1217	-0.49	-0.39	-0.42	-0.36	-0.33	-0.32
1218	-0.45	-0.35	-0.37	-0.33	-0.30	-0.30
1219	-0.42	-0.32	-0.34	-0.31	-0.29	-0.28
1220	-0.41	-0.31	-0.33	-0.30	-0.28	-0.27
1221	-0.42	-0.32	-0.34	-0.31	-0.29	-0.28
1222	-0.45	-0.35	-0.37	-0.33	-0.31	-0.30

Nodo (G)	Pt 1/12	Pt 2/13	Pt 3...	Pt 4...
	-0.61			
	-0.08			

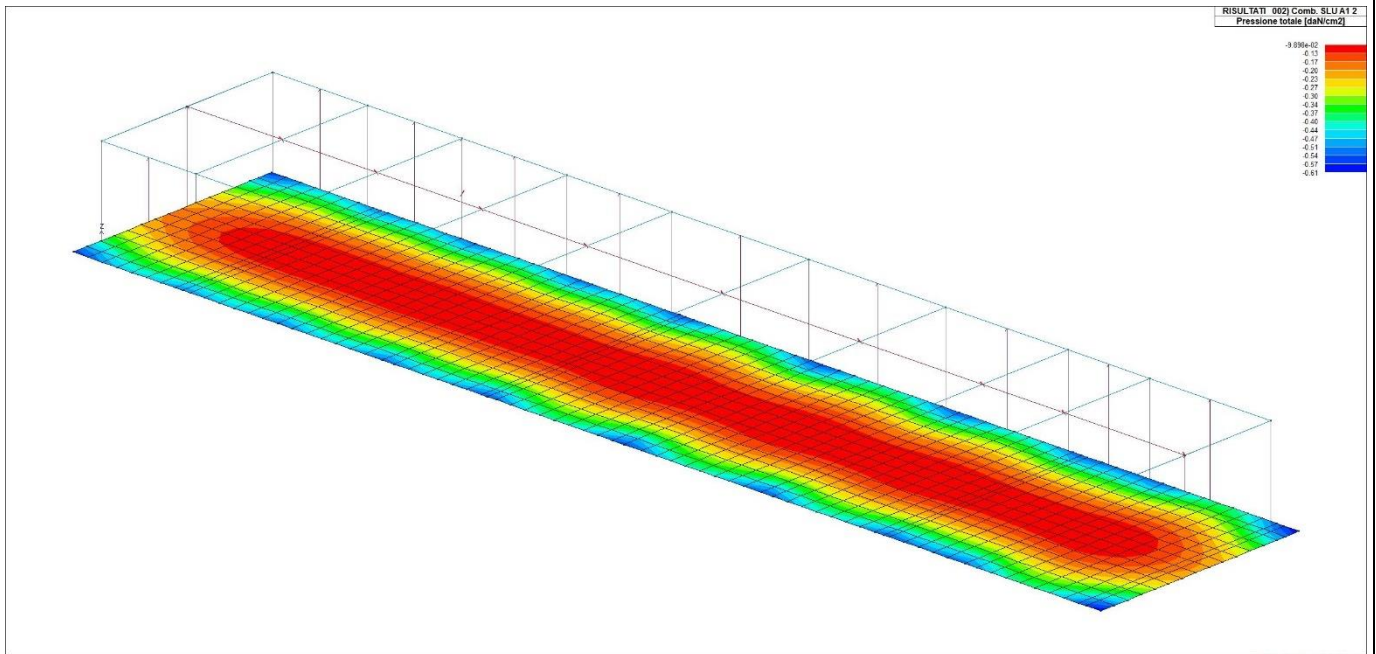

46\_RIS\_PRESSIONI\_002\_Comb. SLU A1 2

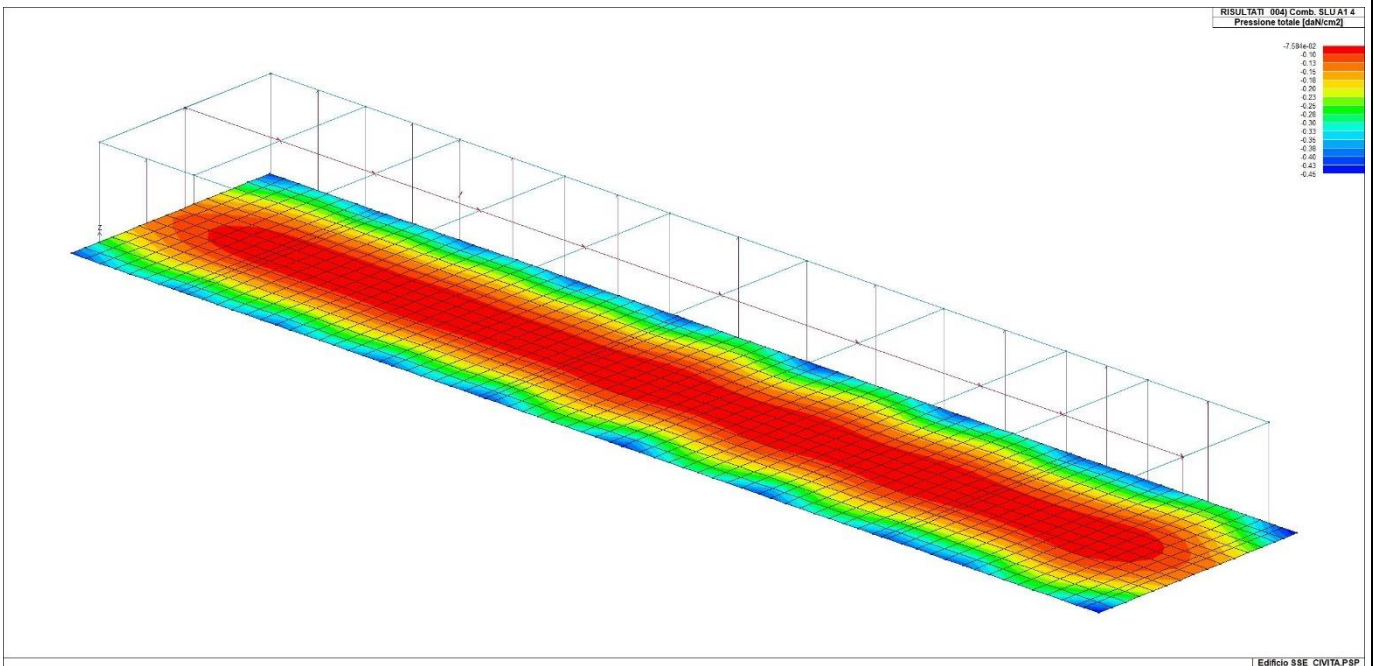

46\_RIS\_PRESSIONI\_004\_Comb. SLU A1 4

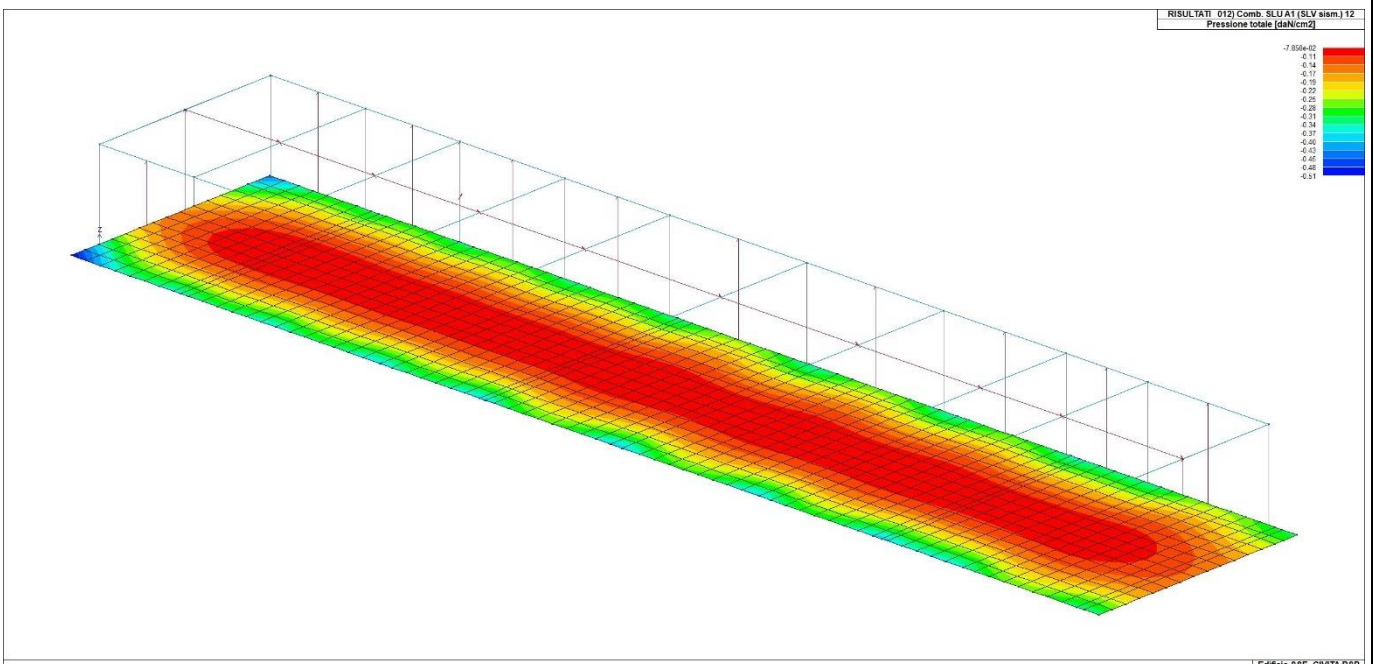

46\_RIS\_PRESSIONI\_012\_Comb. SLU A1 (SLV sism.) 12



RISULTATI 013 Comb. SLU A1 (SLV sism.) 13

Pressione totale [daN/cm<sup>2</sup>]

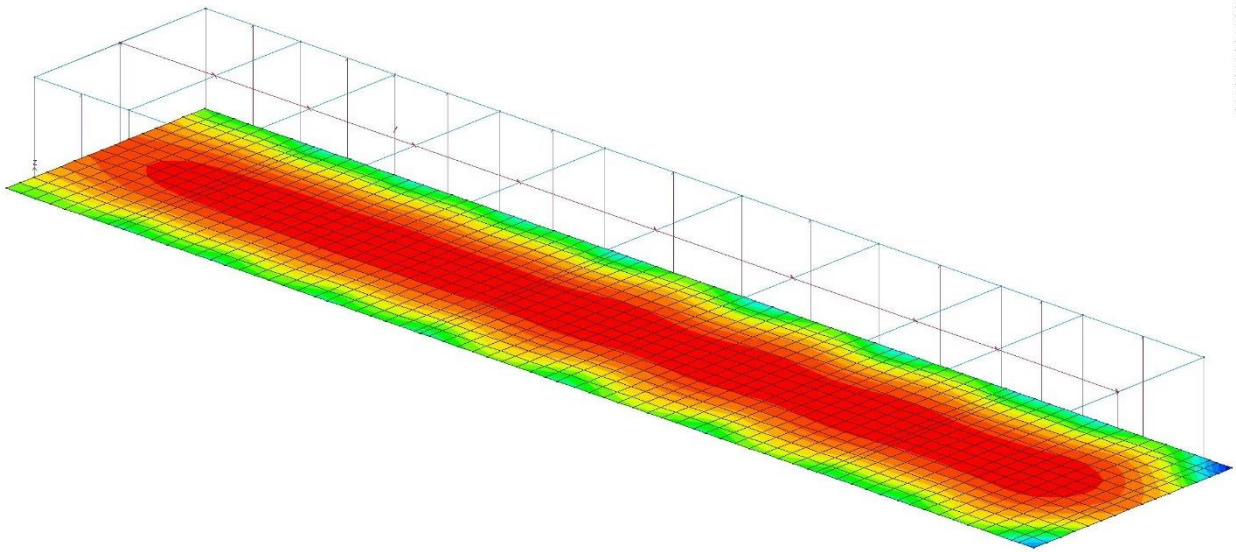
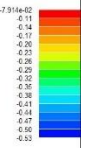

Edificio S8E CIVITA'PSP

46\_RIS\_PRESSIONI\_013\_Comb. SLU A1 (SLV sism.) 13

RISULTATI 044 Comb. SLE (SLD Danno sism.) 44

Pressione totale [daN/cm<sup>2</sup>]

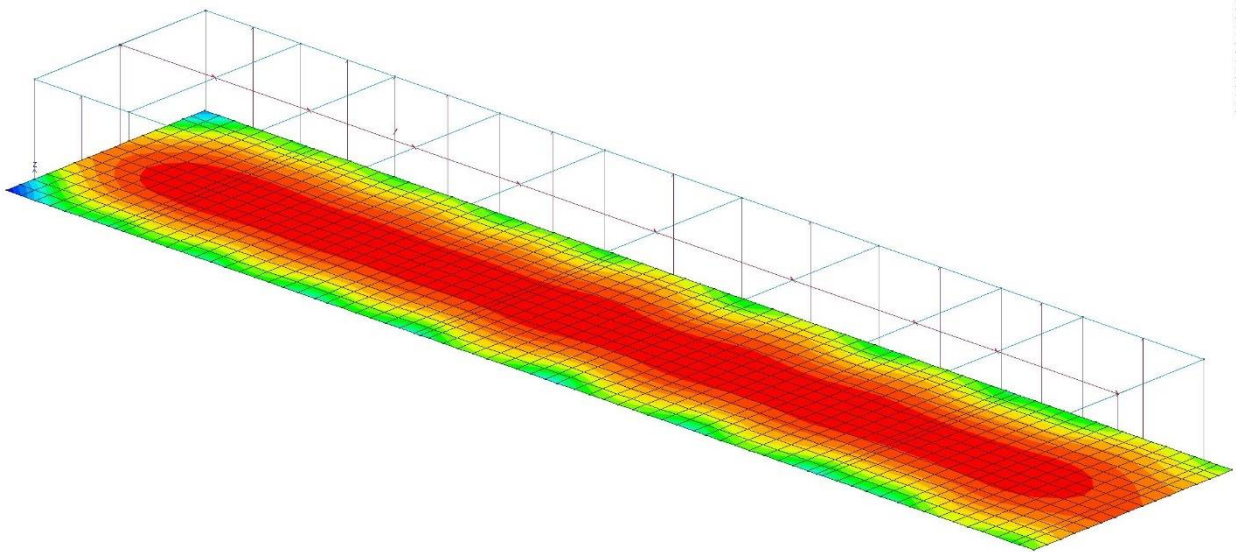
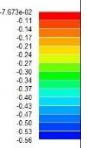

Edificio S8E CIVITA'PSP

46\_RIS\_PRESSIONI\_044\_Comb. SLE (SLD Danno sism.) 44

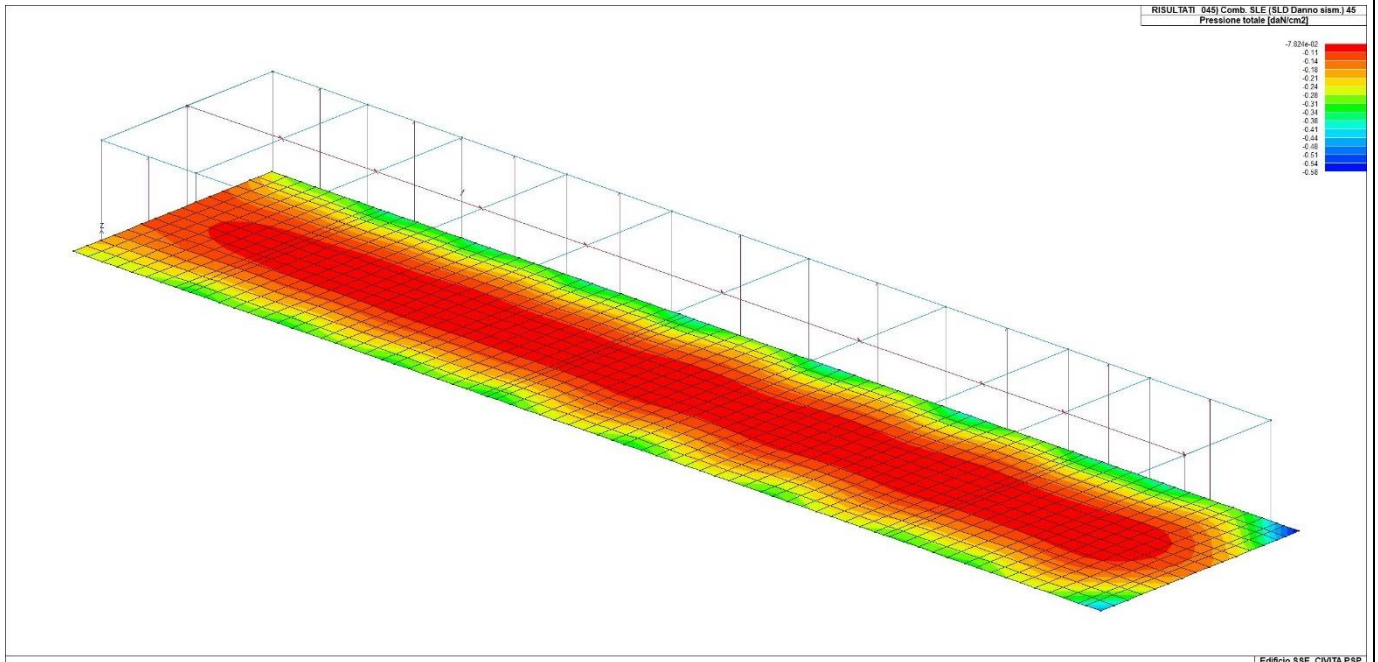

46\_RIS\_PRESSIONI\_045\_Comb. SLE (SLD Danno sism.) 45

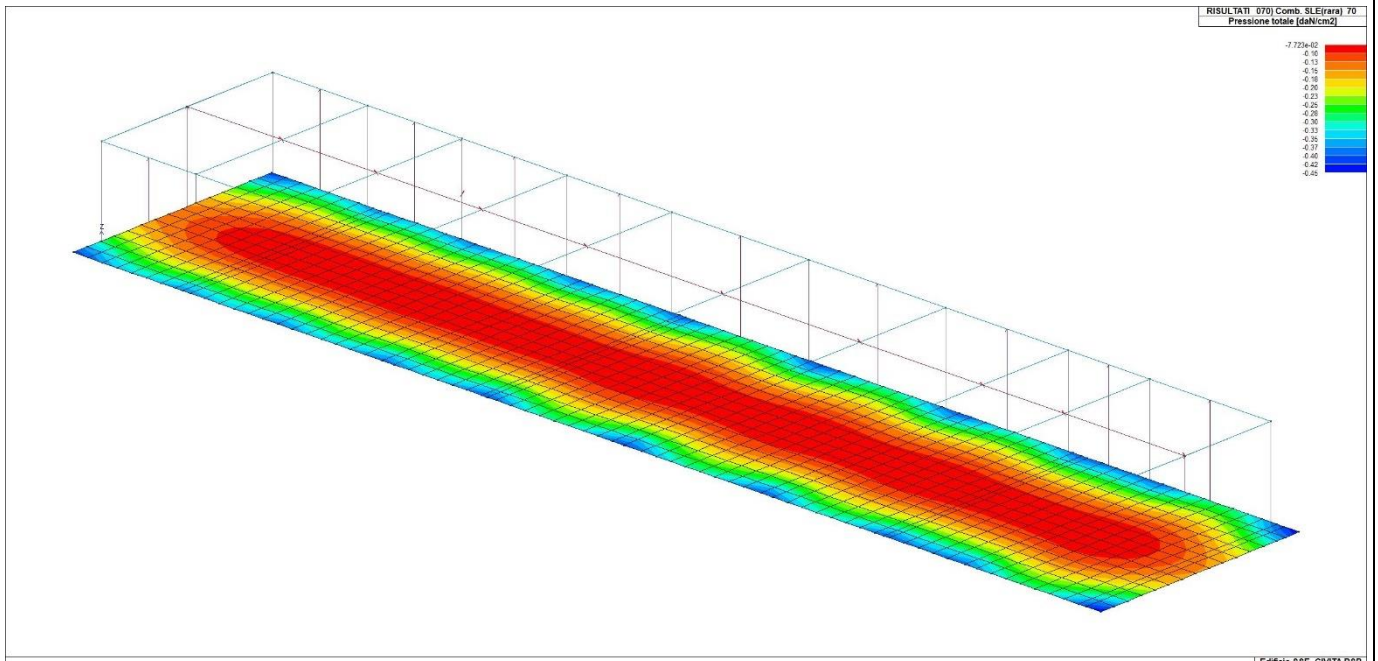

46\_RIS\_PRESSIONI\_070\_Comb. SLE(rara) 70

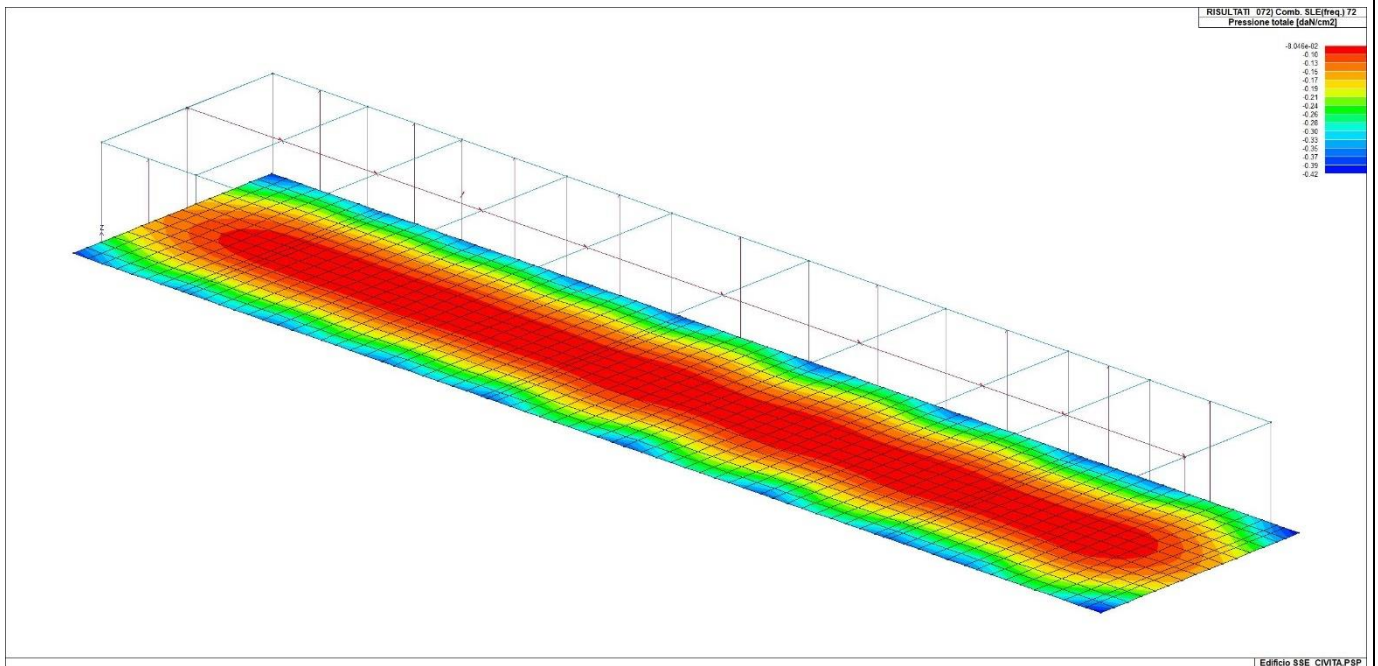

46\_RIS\_PRESSIONI\_072\_Comb. SLE(freq.) 72

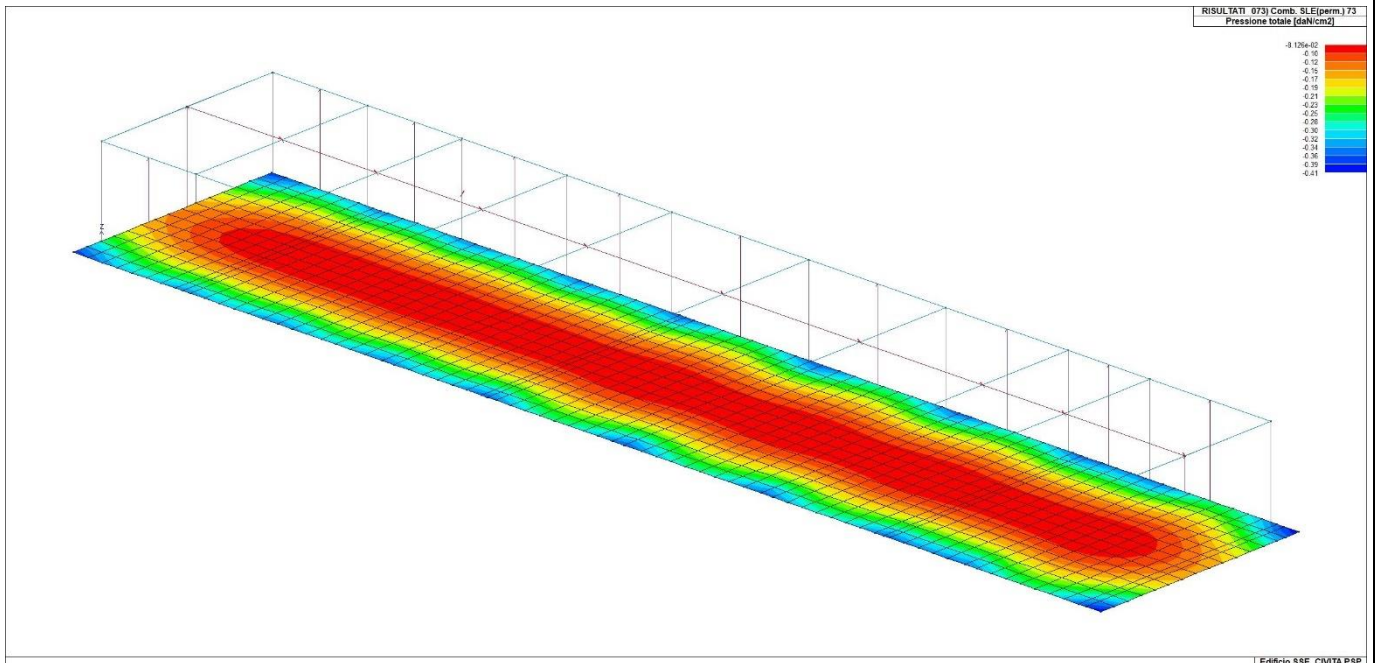

46\_RIS\_PRESSIONI\_073\_Comb. SLE(perm.) 73

## 16. RISULTATI ELEMENTI TIPO TRAVE

### 16.1. LEGENDA RISULTATI ELEMENTI TIPO TRAVE

Il controllo dei risultati delle analisi condotte, per quanto concerne gli elementi tipo trave, è possibile in relazione alle tabelle sotto riportate.

Gli elementi vengono suddivisi in relazione alle proprietà in elementi:

- tipo **pilastro**
- tipo **trave in elevazione**
- tipo **trave in fondazione**

Per ogni elemento e per ogni combinazione (o caso di carico) vengono riportati i risultati più significativi.

Per gli elementi tipo *pilastro* sono riportati in tabella i seguenti valori:

<b>Pilas.</b>	numero dell'elemento pilastro
<b>Cmb</b>	combinazione in cui si verificano i valori riportati
<b>M3 mx/mn</b>	momento flettente in campata M3 max (prima riga) / min (seconda riga)
<b>M2 mx/mn</b>	momento flettente in campata M2 max (prima riga) / min (seconda riga)
<b>D2/D3</b>	freccia massima in direzione 2 (prima riga) / direzione 3 (seconda riga)
<b>Q2/Q3</b>	carico totale in direzione 2 (prima riga) / direzione 3 (seconda riga)
<b>Pos.</b>	ascissa del punto iniziale e finale dell'elemento
<b>N, V2, ecc..</b>	sei componenti di sollecitazione al piede ed in sommità dell'elemento

Per gli elementi tipo *trave in elevazione* sono riportati, oltre al numero dell'elemento, i medesimi risultati visti per i pilastri.

Per gli elementi tipo *trave in fondazione* (trave f.) sono riportati, oltre al numero dell'elemento, i medesimi risultati visti per i pilastri e la massima pressione sul terreno.

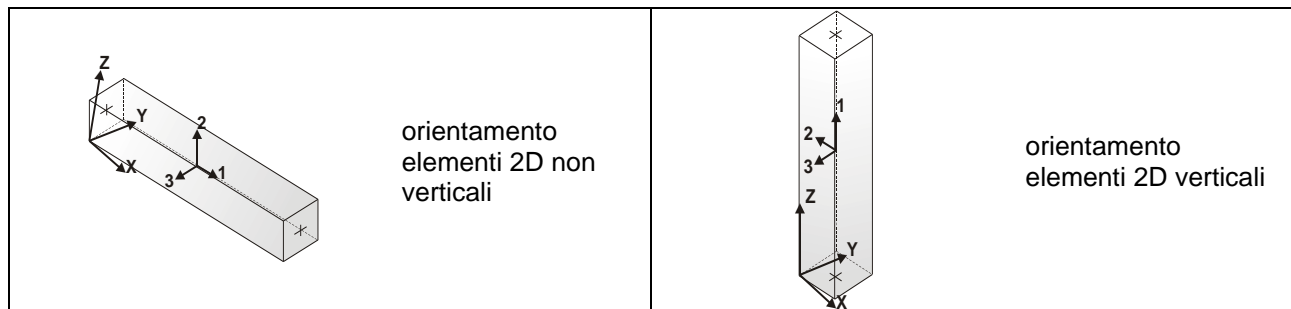















EGP CODE

GRE.EEC.R.73.IT.W.15235.12.024.01

PAGE

284 di/of 527

2.183e+05	6	33	6.158e+04	5.344e+05	-0.06	0.0	0.0	-7439.58	442.25	3038.46	1254.53	-3.772e+05	-
7.109e+04			-7.109e+04	-3.772e+05	-0.24	0.0	300.0	-6764.58	442.25	3038.46	1254.53	5.344e+05	
6.158e+04	6	35	6.386e+04	5.383e+05	0.05	0.0	0.0	-7333.74	-429.21	3067.22	2141.14	-3.819e+05	
6.386e+04			-6.490e+04	-3.819e+05	-0.24	0.0	300.0	-6658.74	-429.21	3067.22	2141.14	5.383e+05	-
6.490e+04	6	36	7.225e+04	1.829e+05	0.06	0.0	0.0	-5904.90	-481.67	-333.68	-1201.37	1.829e+05	
7.225e+04			-7.226e+04	8.278e+04	0.28	0.0	300.0	-5229.90	-481.67	-333.68	-1201.37	8.278e+04	-
7.226e+04	6	46	2.931e+05	2.369e+05	-0.25	0.0	0.0	-6664.76	2035.63	816.91	-6288.71	-8181.45	-
3.176e+05			-3.176e+05	-8181.450.11	0.0	300.0	-5989.76	2035.63	816.91	-6288.71	2.369e+05	2.931e+05	
3.188e+05	6	47	3.188e+05	3.803e+05	0.25	0.0	0.0	-6679.72	-2075.05	1887.87	6341.86	-1.861e+05	
3.188e+05			-3.038e+05	-1.861e+05	-0.09	0.0	300.0	-6004.72	-2075.05	1887.87	6341.86	3.803e+05	-
3.038e+05	6	65	8.843e+04	6.249e+05	-0.08	0.0	0.0	-7746.52	627.54	3714.32	1741.06	-4.894e+05	-
9.984e+04			-9.984e+04	-4.894e+05	-0.33	0.0	300.0	-7071.52	627.54	3714.32	1741.06	6.249e+05	
8.843e+04	6	67	8.925e+04	6.302e+05	0.07	0.0	0.0	-7598.78	-593.50	3754.12	2979.00	-4.960e+05	
8.925e+04			-8.880e+04	-4.960e+05	-0.34	0.0	300.0	-6923.78	-593.50	3754.12	2979.00	6.302e+05	-
8.880e+04	6	68	1.010e+05	2.951e+05	0.08	0.0	0.0	-5597.96	-666.96	-1009.54	-1687.91	2.951e+05	
1.010e+05			-9.910e+04	-7724.020.39	0.0	300.0	-4922.96	-666.96	-1009.54	-1687.91	-7724.02	-9.910e+04	
	6	69	576.77	3.086e+05	9.58e-04	0.0	0.0	-6672.24	-19.71	1352.39	26.58	-9.714e+04	576.77
			-5336.59	-9.714e+04	-0.04	0.0	300.0	-5997.24	-19.71	1352.39	26.58	3.086e+05	-5336.59
	6	70	180.01	4.031e+05	1.00e-03	0.0	0.0	-8109.84	-18.42	1778.30	35.67	-1.304e+05	180.01
			-5347.35	-1.304e+05	-0.05	0.0	300.0	-7434.84	-18.42	1778.30	35.67	4.031e+05	-5347.35
	6	71	576.77	3.086e+05	9.58e-04	0.0	0.0	-6672.24	-19.71	1352.39	26.58	-9.714e+04	576.77
			-5336.59	-9.714e+04	-0.04	0.0	300.0	-5997.24	-19.71	1352.39	26.58	3.086e+05	-5336.59
	6	72	497.42	3.275e+05	9.66e-04	0.0	0.0	-6959.76	-19.45	1437.57	28.39	-1.038e+05	497.42
			-5338.74	-1.038e+05	-0.04	0.0	300.0	-6284.76	-19.45	1437.57	28.39	3.275e+05	-5338.74
	6	73	576.77	3.086e+05	9.58e-04	0.0	0.0	-6672.24	-19.71	1352.39	26.58	-9.714e+04	576.77
			-5336.59	-9.714e+04	-0.04	0.0	300.0	-5997.24	-19.71	1352.39	26.58	3.086e+05	-5336.59
	7	2	636.04	5.978e+05	2.88e-04	0.0	0.0	-1.202e+04	-0.97	2652.74	84.04	-1.981e+05	636.04
			346.43	-1.981e+05	-0.07	0.0	300.0	-1.114e+04	-0.97	2652.74	84.04	5.978e+05	346.43
	7	3	398.54	3.376e+05	2.70e-04	0.0	0.0	-7350.93	-0.30	1495.21	48.72	-1.110e+05	398.54
			308.61	-1.110e+05	-0.04	0.0	300.0	-6675.93	-0.30	1495.21	48.72	3.376e+05	308.61
	7	4	495.89	4.959e+05	1.85e-04	0.0	0.0	-9791.60	-0.72	2212.15	69.89	-1.677e+05	495.89
			279.51	-1.677e+05	-0.06	0.0	300.0	-9116.60	-0.72	2212.15	69.89	4.959e+05	279.51
	7	14	2.079e+05	2.699e+05	-0.18	0.0	0.0	-7115.19	1442.60	983.09	-3794.81	-2.507e+04	-
2.248e+05			-2.248e+05	-2.507e+04	0.11	0.0	300.0	-6440.19	1442.60	983.09	-3794.81	2.699e+05	
2.079e+05	7	15	2.257e+05	4.058e+05	0.18	0.0	0.0	-7607.91	-1443.34	2000.41	3891.84	-1.943e+05	
2.257e+05			-2.073e+05	-1.943e+05	-0.09	0.0	300.0	-6932.91	-1443.34	2000.41	3891.84	4.058e+05	-
2.073e+05	7	21	3.434e+04	5.589e+05	-0.03	0.0	0.0	-8070.16	237.48	3137.76	9144.23	-3.835e+05	-
3.690e+04			-3.690e+04	-3.835e+05	-0.23	0.0	300.0	-7395.16	237.48	3137.76	9144.23	5.589e+05	
3.434e+04	7	23	5.165e+04	5.578e+05	0.04	0.0	0.0	-8088.42	-329.55	3146.14	8423.54	-3.849e+05	
5.165e+04			-4.722e+04	-3.849e+05	-0.23	0.0	300.0	-7413.42	-329.55	3146.14	8423.54	5.578e+05	-
4.722e+04	7	26	6.872e+04	1.655e+05	-0.06	0.0	0.0	-6634.49	474.08	-162.54	-9053.67	1.655e+05	-
7.351e+04			-7.351e+04	1.168e+05	0.28	0.0	300.0	-5959.49	474.08	-162.54	-9053.67	1.168e+05	
6.872e+04	7	27	7.433e+04	5.589e+05	0.06	0.0	0.0	-8088.60	-474.82	3146.03	9150.70	-3.849e+05	
7.433e+04			-6.812e+04	-3.849e+05	-0.23	0.0	300.0	-7413.60	-474.82	3146.03	9150.70	5.589e+05	-
6.812e+04	7	46	2.912e+05	2.426e+05	-0.25	0.0	0.0	-7023.31	2021.41	779.25	-5321.28	8841.12	-
3.152e+05			-3.152e+05	8841.120.14	0.0	300.0	-6348.31	2021.41	779.25	-5321.28	2.426e+05	2.912e+05	
3.160e+05	7	47	3.160e+05	4.331e+05	0.25	0.0	0.0	-7699.78	-2022.15	2204.25	5418.31	-2.282e+05	



EGP CODE

GRE.EEC.R.73.IT.W.15235.12.024.01

PAGE

285 di/of 527

2.906e+05	-2.906e+05	-2.282e+05	-0.12	0.0	300.0	-7024.78	-2022.15	2204.25	5418.31	4.331e+05	-		
7	53	4.787e+04	6.475e+05	-0.04	0.0	0.0	-8355.68	331.98	3797.72	1.278e+04	-4.933e+05	-	
5.172e+04		-5.172e+04	-4.933e+05	-0.32	0.0	300.0	-7680.68	331.98	3797.72	1.278e+04	6.475e+05	-	
4.787e+04	7	55	7.204e+04	6.460e+05	0.06	0.0	0.0	-8376.24	-460.51	3809.40	1.178e+04	-4.953e+05	-
7.204e+04			-6.612e+04	-4.953e+05	-0.32	0.0	300.0	-7701.24	-460.51	3809.40	1.178e+04	6.460e+05	-
6.612e+04	7	58	9.615e+04	2.759e+05	-0.08	0.0	0.0	-6346.06	664.31	-825.75	-1.269e+04	2.759e+05	-
1.031e+05			-1.031e+05	2.815e+04	0.38	0.0	300.0	-5671.06	664.31	-825.75	-1.269e+04	2.815e+04	-
9.615e+04	7	59	1.040e+05	6.475e+05	0.08	0.0	0.0	-8377.03	-665.05	3809.25	1.279e+04	-4.953e+05	-
1.040e+05			-9.555e+04	-4.953e+05	-0.32	0.0	300.0	-7702.03	-665.05	3809.25	1.279e+04	6.475e+05	-
9.555e+04	7	69	407.49	3.378e+05	2.80e-04	0.0	0.0	-7361.55	-0.37	1491.75	48.51	-1.097e+05	407.49
			297.45	-1.097e+05	-0.04	0.0	300.0	-6686.55	-0.37	1491.75	48.51	3.378e+05	297.45
	7	70	472.39	4.434e+05	2.23e-04	0.0	0.0	-8988.66	-0.65	1969.71	62.63	-1.475e+05	472.39
			278.05	-1.475e+05	-0.06	0.0	300.0	-8313.66	-0.65	1969.71	62.63	4.434e+05	278.05
	7	71	407.49	3.378e+05	2.80e-04	0.0	0.0	-7361.55	-0.37	1491.75	48.51	-1.097e+05	407.49
			297.45	-1.097e+05	-0.04	0.0	300.0	-6686.55	-0.37	1491.75	48.51	3.378e+05	297.45
	7	72	420.47	3.589e+05	2.68e-04	0.0	0.0	-7686.97	-0.42	1587.34	51.34	-1.173e+05	420.47
			293.57	-1.173e+05	-0.04	0.0	300.0	-7011.97	-0.42	1587.34	51.34	3.589e+05	293.57
	7	73	407.49	3.378e+05	2.80e-04	0.0	0.0	-7361.55	-0.37	1491.75	48.51	-1.097e+05	407.49
			297.45	-1.097e+05	-0.04	0.0	300.0	-6686.55	-0.37	1491.75	48.51	3.378e+05	297.45
	8	2	2218.53	5.705e+05	3.24e-04	0.0	0.0	-1.151e+04	9.60	2527.12	-60.24	-1.876e+05	-661.65
			-661.65	-1.876e+05	-0.07	0.0	300.0	-1.063e+04	9.60	2527.12	-60.24	5.705e+05	2218.53
	8	3	1362.78	3.230e+05	3.02e-04	0.0	0.0	-7056.63	5.59	1428.15	-36.24	-1.054e+05	-313.97
			-313.97	-1.054e+05	-0.04	0.0	300.0	-6381.63	5.59	1428.15	-36.24	3.230e+05	1362.78
	8	14	2.114e+05	2.571e+05	-0.18	0.0	0.0	-6796.34	1460.62	929.14	-1228.74	-2.165e+04	-
2.268e+05			-2.268e+05	-2.165e+04	0.10	0.0	300.0	-6121.34	1460.62	929.14	-1228.74	2.571e+05	-
2.114e+05	8	15	2.261e+05	3.894e+05	0.18	0.0	0.0	-7337.46	-1449.56	1919.92	1156.69	-1.866e+05	-
2.261e+05			-2.087e+05	-1.866e+05	-0.09	0.0	300.0	-6662.46	-1449.56	1919.92	1156.69	3.894e+05	-
2.087e+05	8	22	4.826e+04	2.080e+05	-0.04	0.0	0.0	-6277.10	330.33	-451.91	2112.04	2.080e+05	-
5.084e+04			-5.084e+04	7.242e+04	0.31	0.0	300.0	-5602.10	330.33	-451.91	2112.04	7.242e+04	-
4.826e+04	8	23	5.023e+04	5.741e+05	0.04	0.0	0.0	-7856.70	-319.27	3300.96	-2184.09	-4.162e+05	-
5.023e+04			-4.555e+04	-4.162e+05	-0.26	0.0	300.0	-7181.70	-319.27	3300.96	-2184.09	5.741e+05	-
4.555e+04	8	25	5.833e+04	5.742e+05	-0.05	0.0	0.0	-7831.59	400.35	3301.87	-2232.02	-4.164e+05	-
6.177e+04			-6.177e+04	-4.164e+05	-0.26	0.0	300.0	-7156.59	400.35	3301.87	-2232.02	5.742e+05	-
5.833e+04	8	46	2.957e+05	2.304e+05	-0.25	0.0	0.0	-6689.70	2044.29	729.56	-1701.83	1.157e+04	-
3.176e+05			-3.176e+05	1.157e+04	0.13	0.0	300.0	-6014.70	2044.29	729.56	-1701.83	2.304e+05	-
2.957e+05	8	47	3.170e+05	4.161e+05	0.25	0.0	0.0	-7444.10	-2033.23	2119.49	1629.78	-2.198e+05	-
3.170e+05			-2.930e+05	-2.198e+05	-0.11	0.0	300.0	-6769.10	-2033.23	2119.49	1629.78	4.161e+05	-
2.930e+05	8	54	6.692e+04	3.330e+05	-0.06	0.0	0.0	-5961.58	459.52	-1203.64	2967.31	3.330e+05	-
7.094e+04			-7.094e+04	-2.807e+04	0.42	0.0	300.0	-5286.58	459.52	-1203.64	2967.31	-2.807e+04	-
6.692e+04	8	55	7.033e+04	6.746e+05	0.06	0.0	0.0	-8172.22	-448.46	4052.69	-3039.36	-5.412e+05	-
7.033e+04			-6.421e+04	-5.412e+05	-0.36	0.0	300.0	-7497.22	-448.46	4052.69	-3039.36	6.746e+05	-
6.421e+04	8	57	8.121e+04	6.747e+05	-0.07	0.0	0.0	-8138.20	558.85	4053.95	-3106.28	-5.415e+05	-
8.645e+04			-8.645e+04	-5.415e+05	-0.36	0.0	300.0	-7463.20	558.85	4053.95	-3106.28	6.747e+05	-
8.121e+04	8	69	1354.60	3.233e+05	3.06e-04	0.0	0.0	-7066.90	5.53	1424.53	-36.02	-1.041e+05	-304.20
			-304.20	-1.041e+05	-0.04	0.0	300.0	-6391.90	5.53	1424.53	-36.02	3.233e+05	1354.60
	8	70	1665.09	4.233e+05	2.54e-04	0.0	0.0	-8607.87	7.18	1877.10	-45.11	-1.398e+05	-488.18
			-488.18	-1.398e+05	-0.05	0.0	300.0	-7932.87	7.18	1877.10	-45.11	4.233e+05	1665.09





EGP CODE

GRE.EEC.R.73.IT.W.15235.12.024.01

PAGE

286 di/of 527

8	71	1354.60	3.233e+05	3.06e-04	0.0	0.0	-7066.90	5.53	1424.53	-36.02-1.041e+05	-304.20
		-304.20	-1.041e+05	-0.04	0.0	300.0	-6391.90	5.53	1424.53	-36.02 3.233e+05	1354.60
8	72	1416.70	3.433e+05	2.95e-04	0.0	0.0	-7375.09	5.86	1515.04	-37.84-1.113e+05	-341.00
		-341.00	-1.113e+05	-0.04	0.0	300.0	-6700.09	5.86	1515.04	-37.84 3.433e+05	1416.70
8	73	1354.60	3.233e+05	3.06e-04	0.0	0.0	-7066.90	5.53	1424.53	-36.02-1.041e+05	-304.20
		-304.20	-1.041e+05	-0.04	0.0	300.0	-6391.90	5.53	1424.53	-36.02 3.233e+05	1354.60
9	1	6771.15	3.568e+05	-1.40e-03	0.0	0.0	-7521.27	17.68	1546.38	-32.38-1.071e+05	1465.78
		1465.78	-1.071e+05	-0.05	0.0	300.0	-6643.77	17.68	1546.38	-32.38 3.568e+05	6771.15
9	2	6686.38	4.792e+05	-1.60e-03	0.0	0.0	-9342.58	14.37	2095.48	-45.25-1.494e+05	2374.40
		2374.40	-1.494e+05	-0.06	0.0	300.0	-8465.08	14.37	2095.48	-45.25 4.792e+05	6686.38
9	3	5084.73	2.743e+05	-1.06e-03	0.0	0.0	-5774.90	12.90	1196.75	-25.61-8.474e+04	1216.04
		1216.04	-8.474e+04	-0.03	0.0	300.0	-5099.90	12.90	1196.75	-25.61 2.743e+05	5084.73
9	14	2.237e+05	2.194e+05	-0.18	0.0	0.0	-5291.34	1509.05	782.12	-600.50-1.524e+04	-
2.291e+05		-2.291e+05	-1.524e+04	0.09	0.0	300.0	-4616.34	1509.05	782.12	-600.50 2.194e+05	-
2.237e+05											
9	15	2.314e+05	3.294e+05	0.18	0.0	0.0	-6270.55	-1482.46	1603.20	550.07-1.516e+05	-
2.314e+05		-2.134e+05	-1.516e+05	-0.08	0.0	300.0	-5595.55	-1482.46	1603.20	550.07 3.294e+05	-
2.134e+05											
9	25	6.495e+04	4.742e+05	-0.05	0.0	0.0	-6339.54	420.35	2686.27	-6968.97-3.317e+05	-
6.116e+04		-6.116e+04	-3.317e+05	-0.21	0.0	300.0	-5664.54	420.35	2686.27	-6968.97 4.742e+05	-
6.495e+04											
9	26	7.552e+04	1.614e+05	-0.06	0.0	0.0	-5045.09	496.81	-280.27	5455.19 1.614e+05	-
7.353e+04		-7.353e+04	7.728e+04	0.25	0.0	300.0	-4370.09	496.81	-280.27	5455.19 7.728e+04	-
7.552e+04											
9	27	7.586e+04	4.715e+05	0.06	0.0	0.0	-6516.80	-470.22	2665.60	-5505.62-3.282e+05	-
7.586e+04		-6.521e+04	-3.282e+05	-0.21	0.0	300.0	-5841.80	-470.22	2665.60	-5505.62 4.715e+05	-
6.521e+04											
9	46	3.113e+05	1.973e+05	-0.25	0.0	0.0	-5095.57	2109.03	617.48	-801.37 1.210e+04	-
3.214e+05		-3.214e+05	1.210e+04	0.12	0.0	300.0	-4420.57	2109.03	617.48	-801.37 1.973e+05	-
3.113e+05											
9	47	3.237e+05	3.514e+05	0.25	0.0	0.0	-6466.32	-2082.44	1767.85	750.94-1.789e+05	-
3.237e+05		-3.010e+05	-1.789e+05	-0.10	0.0	300.0	-5791.32	-2082.44	1767.85	750.94 3.514e+05	-
3.010e+05											
9	57	8.895e+04	5.543e+05	-0.07	0.0	0.0	-6563.22	583.78	3284.85	-9739.88-4.312e+05	-
8.618e+04		-8.618e+04	-4.312e+05	-0.30	0.0	300.0	-5888.22	583.78	3284.85	-9739.88 5.543e+05	-
8.895e+04											
9	58	1.037e+05	2.595e+05	-0.08	0.0	0.0	-4750.59	690.64	-870.64	7657.95 2.595e+05	-
1.035e+05		-1.035e+05	-1713.960.34	0.0	300.0	-4075.59	690.64	-870.64	7657.95	-1713.96 1.037e+05	-
9	59	1.058e+05	5.505e+05	0.08	0.0	0.0	-6811.30	-664.04	3255.97	-7708.39-4.263e+05	-
1.058e+05		-9.341e+04	-4.263e+05	-0.29	0.0	300.0	-6136.30	-664.04	3255.97	-7708.39 5.505e+05	-
9.341e+04											
9	69	5154.73	2.744e+05	-1.07e-03	0.0	0.0	-5780.94	13.30	1192.66	-25.22-8.342e+04	1166.01
		1166.01	-8.342e+04	-0.04	0.0	300.0	-5105.94	13.30	1192.66	-25.22 2.744e+05	5154.73
9	70	5098.22	3.560e+05	-1.20e-03	0.0	0.0	-6995.15	11.09	1558.73	-33.79-1.116e+05	1771.75
		1771.75	-1.116e+05	-0.05	0.0	300.0	-6320.15	11.09	1558.73	-33.79 3.560e+05	5098.22
9	71	5154.73	2.744e+05	-1.07e-03	0.0	0.0	-5780.94	13.30	1192.66	-25.22-8.342e+04	1166.01
		1166.01	-8.342e+04	-0.04	0.0	300.0	-5105.94	13.30	1192.66	-25.22 2.744e+05	5154.73
9	72	5143.43	2.907e+05	-1.10e-03	0.0	0.0	-6023.79	12.85	1265.88	-26.93-8.906e+04	1287.16
		1287.16	-8.906e+04	-0.04	0.0	300.0	-5348.79	12.85	1265.88	-26.93 2.907e+05	5143.43
9	73	5154.73	2.744e+05	-1.07e-03	0.0	0.0	-5780.94	13.30	1192.66	-25.22-8.342e+04	1166.01
		1166.01	-8.342e+04	-0.04	0.0	300.0	-5105.94	13.30	1192.66	-25.22 2.744e+05	5154.73
10	1	-1498.66	3.398e+05	2.11e-03	0.0	0.0	-7775.93	-27.01	1472.82	16.82-1.021e+05	-1498.66
		-9601.87	-1.021e+05	-0.04	0.0	300.0	-6898.43	-27.01	1472.82	16.82 3.398e+05	-9601.87
10	2	-3412.58	4.548e+05	2.20e-03	0.0	0.0	-9580.88	-16.88	1989.42	22.32-1.420e+05	-3412.58
		-8476.19	-1.420e+05	-0.06	0.0	300.0	-8703.38	-16.88	1989.42	22.32 4.548e+05	-8476.19
10	3	-1162.04	2.613e+05	1.60e-03	0.0	0.0	-5960.88	-20.25	1140.24	12.21-8.081e+04	-1162.04
		-7237.78	-8.081e+04	-0.03	0.0	300.0	-5285.88	-20.25	1140.24	12.21 2.613e+05	-7237.78
10	17	2.166e+05	2.832e+05	-0.18	0.0	0.0	-6235.70	1500.40	1298.57	-6066.47-1.064e+05	-
2.335e+05		-2.335e+05	-1.064e+05	-0.05	0.0	300.0	-5560.70	1500.40	1298.57	-6066.47 2.832e+05	-
2.166e+05											
10	20	2.312e+05	2.394e+05	0.18	0.0	0.0	-5709.36	-1541.50	973.65	6091.71-5.265e+04	-
2.312e+05		-2.312e+05	-5.265e+04	0.05	0.0	300.0	-5034.36	-1541.50	973.65	6091.71 2.394e+05	-
2.312e+05											
10	21	3.239e+04	4.428e+05	-0.03	0.0	0.0	-6624.20	250.53	2494.69	-6050.87-2.992e+05	-





EGP CODE

GRE.EEC.R.73.IT.W.15235.12.024.01

PAGE

288 di/of 527

11	27	7.609e+04	3.563e+05	0.06	0.0	0.0	-4415.04	-401.01	2026.52	-5258.09	-2.517e+05	
7.609e+04												
		-4.423e+04	-2.517e+05	-0.17	0.0	300.0	-3740.04	-401.01	2026.52	-5258.09	3.563e+05	-
4.423e+04												
11	45	2.389e+05	2.186e+05	-0.25	0.0	0.0	-5204.65	1667.77	1002.44	1.101e+04	-8.203e+04	-
2.615e+05												
		-2.615e+05	-8.203e+04	-0.04	0.0	300.0	-4529.65	1667.77	1002.44	1.101e+04	2.186e+05	-
2.389e+05												
11	46	2.434e+05	8.993e+04	-0.25	0.0	0.0	-4740.00	1704.19	52.49	1.315e+04	7.430e+04	-
2.678e+05												
		-2.678e+05	7.430e+04	0.14	0.0	300.0	-4065.00	1704.19	52.49	1.315e+04	8.993e+04	-
2.434e+05												
11	47	2.873e+05	2.991e+05	0.25	0.0	0.0	-3375.76	-1698.61	1608.95	-1.314e+04	-1.837e+05	-
2.873e+05												
		-2.223e+05	-1.837e+05	-0.11	0.0	300.0	-2700.76	-1698.61	1608.95	-1.314e+04	2.991e+05	-
2.223e+05												
11	48	2.809e+05	1.704e+05	0.25	0.0	0.0	-2911.11	-1662.19	659.00	-1.100e+04	-2.738e+04	-
2.809e+05												
		-2.177e+05	-2.738e+04	0.05	0.0	300.0	-2236.11	-1662.19	659.00	-1.100e+04	1.704e+05	-
2.177e+05												
11	53	4.739e+04	4.211e+05	-0.04	0.0	0.0	-5050.02	269.37	2327.87	2068.67	-3.015e+05	-
3.341e+04												
		-3.341e+04	-3.015e+05	-0.24	0.0	300.0	-4375.02	269.37	2327.87	2068.67	4.211e+05	-
4.739e+04												
11	59	1.027e+05	4.210e+05	0.08	0.0	0.0	-4557.96	-562.87	2504.95	-7185.57	-3.305e+05	-
1.027e+05												
		-6.619e+04	-3.305e+05	-0.24	0.0	300.0	-3882.96	-562.87	2504.95	-7185.57	4.210e+05	-
6.619e+04												
11	69	1.058e+04	1.945e+05	-3.65e-03	0.0	0.0	-4057.88	2.79	830.72	4.09	-5.470e+04	9739.28
1.058e+04												
		9739.28	-5.470e+04	-0.03	0.0	300.0	-3382.88	2.79	830.72	4.09	1.945e+05	
1.178e+04												
11	70	1.178e+04	2.456e+05	-4.03e-03	0.0	0.0	-4777.47	-5.46	1055.70	8.30	-7.110e+04	-
1.178e+04												
		1.014e+04	-7.110e+04	-0.03	0.0	300.0	-4102.47	-5.46	1055.70	8.30	2.456e+05	-
1.014e+04												
11	71	1.058e+04	1.945e+05	-3.65e-03	0.0	0.0	-4057.88	2.79	830.72	4.09	-5.470e+04	9739.28
1.058e+04												
		9739.28	-5.470e+04	-0.03	0.0	300.0	-3382.88	2.79	830.72	4.09	1.945e+05	
1.015e+04												
11	72	1.049e+04	2.047e+05	-3.73e-03	0.0	0.0	-4201.80	1.14	875.72	4.93	-5.798e+04	-
1.015e+04												
		1.015e+04	-5.798e+04	-0.03	0.0	300.0	-3526.80	1.14	875.72	4.93	2.047e+05	-
1.049e+04												
11	73	1.058e+04	1.945e+05	-3.65e-03	0.0	0.0	-4057.88	2.79	830.72	4.09	-5.470e+04	9739.28
1.058e+04												
		9739.28	-5.470e+04	-0.03	0.0	300.0	-3382.88	2.79	830.72	4.09	1.945e+05	
12	1	2672.55	9.330e+04	6.74e-04	0.0	0.0	-7384.43	9.56	-1367.94	5.98	9.330e+04	-193.95
		-193.95	-3.171e+05	0.04	0.0	300.0	-6506.93	9.56	-1367.94	5.98	-3.171e+05	2672.55
12	2	1952.65	1.294e+05	5.63e-04	0.0	0.0	-9065.71	5.09	-1838.61	14.20	1.294e+05	425.95
		425.95	-4.222e+05	0.05	0.0	300.0	-8188.21	5.09	-1838.61	14.20	-4.222e+05	1952.65
12	3	1779.10	7.395e+04	4.43e-04	0.0	0.0	-5658.36	5.91	-1059.33	6.61	7.395e+04	6.44
		6.44	-2.438e+05	0.03	0.0	300.0	-4983.36	5.91	-1059.33	6.61	-2.438e+05	1779.10
12	5	2.238e+05	5.188e+04	-0.17	0.0	0.0	-5791.39	1512.98	-929.26	5886.61	5.188e+04	-
2.301e+05												
		-2.301e+05	-2.269e+05	-0.04	0.0	300.0	-5116.39	1512.98	-929.26	5886.61	-2.269e+05	-
2.238e+05												
12	8	2.300e+05	9.356e+04	0.17	0.0	0.0	-5550.17	-1499.53	-1181.41	-5875.66	9.356e+04	-
2.300e+05												
		-2.199e+05	-2.609e+05	0.04	0.0	300.0	-4875.17	-1499.53	-1181.41	-5875.66	-2.609e+05	-
2.199e+05												
12	30	7.079e+04	2.737e+05	-0.05	0.0	0.0	-6357.38	474.35	-2265.72	-3147.39	2.737e+05	-
7.152e+04												
		-7.152e+04	-4.060e+05	0.17	0.0	300.0	-5682.38	474.35	-2265.72	-3147.39	-4.060e+05	-
7.079e+04												
12	31	7.136e+04	-8.179e+04	0.05	0.0	0.0	-4984.18	-460.91	155.05	3158.34	-1.283e+05	-
7.136e+04												
		-6.692e+04	-1.283e+05	-0.21	0.0	300.0	-4309.18	-460.91	155.05	3158.34	-8.179e+04	-
6.692e+04												
12	36	4.211e+04	2.737e+05	0.03	0.0	0.0	-6234.68	-269.77	-2265.77	-5119.46	2.737e+05	-
4.211e+04												
		-3.882e+04	-4.060e+05	0.17	0.0	300.0	-5559.68	-269.77	-2265.77	-5119.46	-4.060e+05	-
3.882e+04												
12	37	3.127e+05	4.357e+04	-0.24	0.0	0.0	-5839.78	2117.10	-878.97	8196.00	4.357e+04	-
3.224e+05												
		-3.224e+05	-2.201e+05	-0.05	0.0	300.0	-5164.78	2117.10	-878.97	8196.00	-2.201e+05	-
3.127e+05												
12	40	3.222e+05	1.019e+05	0.24	0.0	0.0	-5501.78	-2103.65	-1231.70	-8185.06	1.019e+05	-









EGP CODE

GRE.EEC.R.73.IT.W.15235.12.024.01

PAGE

291 di/of 527

2.072e+05	-2.264e+05	-2.575e+05	-0.09	0.0	300.0	-5996.45	1445.40	-970.87	4400.15	-2.575e+05		
15	8	2.276e+05	1.604e+05	0.18	0.0	0.0	-6672.58	-1485.19	-1733.19	-4430.23	1.604e+05	
2.276e+05		-2.179e+05	-3.595e+05	0.07	0.0	300.0	-5997.58	-1485.19	-1733.19	-4430.23	-3.595e+05	-
2.179e+05	30	6.146e+04	3.773e+05	-0.06	0.0	0.0	-7441.15	441.61	-3038.80	-1262.87	3.773e+05	-
7.102e+04		-7.102e+04	-5.344e+05	0.24	0.0	300.0	-6766.15	441.61	-3038.80	-1262.87	-5.344e+05	
6.146e+04	31	7.225e+04	-8.267e+04	0.06	0.0	0.0	-5902.87	-481.39	334.74	1232.79	-1.831e+05	
7.225e+04		-7.217e+04	-1.831e+05	-0.28	0.0	300.0	-5227.87	-481.39	334.74	1232.79	-8.267e+04	-
7.217e+04	32	6.389e+04	3.819e+05	0.05	0.0	0.0	-7335.50	-428.86	-3066.56	-2090.46	3.819e+05	
6.389e+04		-6.477e+04	-5.381e+05	0.24	0.0	300.0	-6660.50	-428.86	-3066.56	-2090.46	-5.381e+05	-
6.477e+04	37	2.925e+05	8469.19-0.25	0.0	0.0	-6670.81	2033.15	-818.71	6163.41	8469.19	-3.175e+05	
2.925e+05		-3.175e+05	-2.371e+05	-0.11	0.0	300.0	-5995.81	2033.15	-818.71	6163.41	-2.371e+05	
15	40	3.187e+05	1.857e+05	0.25	0.0	0.0	-6673.22	-2072.93	-1885.35	-6193.48	1.857e+05	
3.187e+05		-3.032e+05	-3.799e+05	0.09	0.0	300.0	-5998.22	-2072.93	-1885.35	-6193.48	-3.799e+05	-
3.032e+05	62	8.826e+04	4.896e+05	-0.08	0.0	0.0	-7748.64	626.70	-3714.90	-1757.26	4.896e+05	-
9.975e+04		-9.975e+04	-6.249e+05	0.33	0.0	300.0	-7073.64	626.70	-3714.90	-1757.26	-6.249e+05	
8.826e+04	63	1.010e+05	7863.430.08	0.0	0.0	-5595.38	-666.48	1010.84	1727.19	-2.954e+05	1.010e+05	
15		-9.896e+04	-2.954e+05	-0.39	0.0	300.0	-4920.38	-666.48	1010.84	1727.19	7863.43	-
9.896e+04	64	8.927e+04	4.959e+05	0.07	0.0	0.0	-7601.12	-592.94	-3753.37	-2912.51	4.959e+05	
8.927e+04		-8.861e+04	-6.301e+05	0.34	0.0	300.0	-6926.12	-592.94	-3753.37	-2912.51	-6.301e+05	-
8.861e+04	69	613.92	9.709e+04	9.55e-04	0.0	0.0	-6672.01	-19.89	-1352.03	-15.04	9.709e+04	613.92
15		-5354.01	-3.085e+05	0.04	0.0	300.0	-5997.01	-19.89	-1352.03	-15.04	-3.085e+05	-5354.01
15	70	225.76	1.303e+05	9.97e-04	0.0	0.0	-8109.57	-18.65	-1777.86	-20.98	1.303e+05	225.76
15		-5369.11	-4.030e+05	0.05	0.0	300.0	-7434.57	-18.65	-1777.86	-20.98	-4.030e+05	-5369.11
15	71	613.92	9.709e+04	9.55e-04	0.0	0.0	-6672.01	-19.89	-1352.03	-15.04	9.709e+04	613.92
15		-5354.01	-3.085e+05	0.04	0.0	300.0	-5997.01	-19.89	-1352.03	-15.04	-3.085e+05	-5354.01
15	72	536.29	1.037e+05	9.64e-04	0.0	0.0	-6959.52	-19.64	-1437.20	-16.23	1.037e+05	536.29
15		-5357.03	-3.274e+05	0.04	0.0	300.0	-6284.52	-19.64	-1437.20	-16.23	-3.274e+05	-5357.03
15	73	613.92	9.709e+04	9.55e-04	0.0	0.0	-6672.01	-19.89	-1352.03	-15.04	9.709e+04	613.92
15		-5354.01	-3.085e+05	0.04	0.0	300.0	-5997.01	-19.89	-1352.03	-15.04	-3.085e+05	-5354.01
16	2	638.33	1.982e+05	2.88e-04	0.0	0.0	-1.202e+04	-0.96	-2652.97	-78.16	1.982e+05	638.33
16		350.40	-5.977e+05	0.07	0.0	300.0	-1.114e+04	-0.96	-2652.97	-78.16	-5.977e+05	350.40
16	3	398.82	1.110e+05	2.69e-04	0.0	0.0	-7350.89	-0.29	-1495.35	-45.33	1.110e+05	398.82
16		311.56	-3.376e+05	0.04	0.0	300.0	-6675.89	-0.29	-1495.35	-45.33	-3.376e+05	311.56
16	4	496.17	1.678e+05	1.84e-04	0.0	0.0	-9791.56	-0.71	-2212.33	-65.11	1.678e+05	496.17
16		283.53	-4.959e+05	0.06	0.0	300.0	-9116.56	-0.71	-2212.33	-65.11	-4.959e+05	283.53
16	5	2.076e+05	2.510e+04	-0.18	0.0	0.0	-7117.74	1441.73	-983.08	3711.16	2.510e+04	-
2.249e+05		-2.249e+05	-2.698e+05	-0.11	0.0	300.0	-6442.74	1441.73	-983.08	3711.16	-2.698e+05	
2.076e+05	8	2.257e+05	1.944e+05	0.18	0.0	0.0	-7605.24	-1442.45	-2000.69	-3801.34	1.944e+05	
2.257e+05		-2.070e+05	-4.058e+05	0.09	0.0	300.0	-6930.24	-1442.45	-2000.69	-3801.34	-4.058e+05	-
2.070e+05	25	4.764e+04	-1.178e+05	-0.04	0.0	0.0	-6635.79	327.90	163.02	8311.43	-1.656e+05	-
5.073e+04		-5.073e+04	-1.656e+05	-0.28	0.0	300.0	-5960.79	327.90	163.02	8311.43	-1.178e+05	-
4.764e+04	26	3.412e+04	3.837e+05	-0.03	0.0	0.0	-8067.60	236.22	-3138.44	-9157.46	3.837e+05	-
3.674e+04		-3.674e+04	-5.589e+05	0.23	0.0	300.0	-7392.60	236.22	-3138.44	-9157.46	-5.589e+05	
3.412e+04	28	5.155e+04	3.851e+05	0.04	0.0	0.0	-8087.19	-328.62	-3146.79	-8401.61	3.851e+05	
5.155e+04		-4.704e+04	-5.578e+05	0.23	0.0	300.0	-7412.19	-328.62	-3146.79	-8401.61	-5.578e+05	-
4.704e+04	37	2.907e+05	-8825.79-0.25	0.0	0.0	-7026.52	2020.18	-779.17	5202.93	-8825.79	-3.153e+05	
2.907e+05		-3.153e+05	-2.426e+05	-0.14	0.0	300.0	-6351.52	2020.18	-779.17	5202.93	-2.426e+05	
16	40	3.161e+05	2.283e+05	0.25	0.0	0.0	-7696.46	-2020.90	-2204.60	-5293.11	2.283e+05	







EGP CODE

GRE.EEC.R.73.IT.W.15235.12.024.01

PAGE

294 di/of 527

19	23	6.382e+04	-8.504e+04	0.05	0.0	0.0	-5313.81	-443.90	183.53	-6457.14	-1.401e+05	
6.382e+04		-6.933e+04	-1.401e+05	-0.22	0.0	300.0	-4638.81	-443.90	183.53	-6457.14	-8.504e+04	-
6.933e+04	19	24	7.285e+04	3.060e+05	0.06	0.0	0.0	-6560.50	-505.37	-2496.23	3819.18	3.060e+05
7.285e+04			-7.878e+04	-4.428e+05	0.19	0.0	300.0	-5885.50	-505.37	-2496.23	3819.18	-4.428e+05
7.878e+04	19	42	3.059e+05	1.170e+05	-0.25	0.0	0.0	-6341.65	2108.46	-1362.22	8332.15	1.170e+05
3.267e+05			-3.267e+05	-2.917e+05	0.05	0.0	300.0	-5666.65	2108.46	-1362.22	8332.15	-2.917e+05
3.059e+05	19	43	3.247e+05	4.219e+04	0.25	0.0	0.0	-5603.36	-2151.42	-910.24	-8312.71	4.219e+04
3.247e+05			-3.207e+05	-2.309e+05	-0.06	0.0	300.0	-4928.36	-2151.42	-910.24	-8312.71	-2.309e+05
3.207e+05	19	54	7.937e+04	3.874e+05	-0.07	0.0	0.0	-6894.60	570.55	-2985.50	9060.44	3.874e+05
9.177e+04			-9.177e+04	-5.083e+05	0.26	0.0	300.0	-6219.60	570.55	-2985.50	9060.44	-5.083e+05
7.937e+04	19	55	8.983e+04	-1.432e+04	0.07	0.0	0.0	-5050.42	-613.50	713.04	-9040.99	-2.282e+05
8.983e+04			-9.419e+04	-2.282e+05	-0.30	0.0	300.0	-4375.42	-613.50	713.04	-9040.99	-1.432e+04
9.419e+04	19	56	1.024e+05	3.968e+05	0.08	0.0	0.0	-6795.59	-699.34	-3041.13	5350.28	3.968e+05
1.024e+05			-1.074e+05	-5.156e+05	0.27	0.0	300.0	-6120.59	-699.34	-3041.13	5350.28	-5.156e+05
1.074e+05	19	69	-967.21	7.958e+04	1.60e-03	0.0	0.0	-5972.51	-21.48	-1136.23	9.72	7.958e+04
			-7411.00	-2.613e+05	0.03	0.0	300.0	-5297.51	-21.48	-1136.23	9.72	-2.613e+05
	19	70	-2204.58	1.062e+05	1.66e-03	0.0	0.0	-7175.80	-14.91	-1480.66	10.84	1.062e+05
			-6677.81	-3.380e+05	0.04	0.0	300.0	-6500.80	-14.91	-1480.66	10.84	-3.380e+05
	19	71	-967.21	7.958e+04	1.60e-03	0.0	0.0	-5972.51	-21.48	-1136.23	9.72	7.958e+04
			-7411.00	-2.613e+05	0.03	0.0	300.0	-5297.51	-21.48	-1136.23	9.72	-2.613e+05
	19	72	-1214.68	8.491e+04	1.61e-03	0.0	0.0	-6213.17	-20.17	-1205.12	9.95	8.491e+04
			-7264.36	-2.766e+05	0.04	0.0	300.0	-5538.17	-20.17	-1205.12	9.95	-2.766e+05
	19	73	-967.21	7.958e+04	1.60e-03	0.0	0.0	-5972.51	-21.48	-1136.23	9.72	7.958e+04
			-7411.00	-2.613e+05	0.03	0.0	300.0	-5297.51	-21.48	-1136.23	9.72	-2.613e+05
	20	2	1.606e+04	9.527e+04	-5.33e-03	0.0	0.0	-6357.00	-11.07	-1416.30	-68.06	9.527e+04
1.606e+04			1.274e+04	-3.296e+05	0.04	0.0	300.0	-5479.50	-11.07	-1416.30	-68.06	-3.296e+05
1.274e+04	20	3	1.114e+04	5.529e+04	-3.56e-03	0.0	0.0	-4055.04	7.79	-831.92	-43.22	5.529e+04
			8804.85	-1.943e+05	0.03	0.0	300.0	-3380.04	7.79	-831.92	-43.22	-1.943e+05
1.114e+04	20	5	1.766e+05	-3.776e+04	-0.18	0.0	0.0	-4554.19	1217.67	-272.14	-1.006e+04	-3.776e+04
1.887e+05			-1.887e+05	-1.193e+05	-0.10	0.0	300.0	-3879.19	1217.67	-272.14	-1.006e+04	-1.193e+05
1.766e+05	20	6	1.733e+05	7.401e+04	-0.17	0.0	0.0	-4868.13	1191.91	-951.01	-8277.30	7.401e+04
1.842e+05			-1.842e+05	-2.112e+05	0.04	0.0	300.0	-4193.13	1191.91	-951.01	-8277.30	-2.112e+05
1.733e+05	20	7	2.033e+05	3.552e+04	0.18	0.0	0.0	-3247.24	-1184.38	-710.49	8198.01	3.552e+04
2.033e+05			-1.520e+05	-1.777e+05	-0.04	0.0	300.0	-2572.24	-1184.38	-710.49	8198.01	-1.777e+05
1.520e+05	20	8	2.078e+05	1.473e+05	0.18	0.0	0.0	-3561.18	-1210.14	-1389.35	9976.06	1.473e+05
2.078e+05			-1.553e+05	-2.696e+05	0.08	0.0	300.0	-2886.18	-1210.14	-1389.35	9976.06	-2.696e+05
1.553e+05	20	24	7.580e+04	2.520e+05	0.06	0.0	0.0	-4384.87	-399.47	-2027.94	5661.77	2.520e+05
7.580e+04			-4.406e+04	-3.564e+05	0.17	0.0	300.0	-3709.87	-399.47	-2027.94	5661.77	-3.564e+05
4.406e+04	20	26	3.689e+04	2.311e+05	-0.03	0.0	0.0	-4735.80	194.36	-2024.50	-1188.74	2.311e+05
2.141e+04			-2.141e+04	-3.564e+05	0.17	0.0	300.0	-4060.80	194.36	-2024.50	-1188.74	-3.564e+05
3.689e+04	20	37	2.431e+05	-7.433e+04	-0.25	0.0	0.0	-4751.09	1704.52	-51.73	-1.349e+04	-7.433e+04
2.682e+05			-2.682e+05	-8.974e+04	-0.14	0.0	300.0	-4076.09	1704.52	-51.73	-1.349e+04	-8.974e+04
2.431e+05	20	38	2.386e+05	8.226e+04	-0.24	0.0	0.0	-5190.81	1668.48	-1002.84	-1.100e+04	8.226e+04
2.620e+05			-2.620e+05	-2.185e+05	0.04	0.0	300.0	-4515.81	1668.48	-1002.84	-1.100e+04	-2.185e+05







EGP CODE

GRE.EEC.R.73.IT.W.15235.12.024.01

PAGE

296 di/of 527

1.651e+05	-1.651e+05	-4.175e+04	0.02	0.0	415.1	421.54	-1161.44	327.36	1.208e+04	9.426e+04	-	
21	47	1.440e+05	4.193e+04	-0.02	-1245.23	0.0	-428.96	1330.55	-328.12	2.229e+04	4.193e+04	-
1.499e+05	-1.499e+05	-9.440e+04	0.01	0.0	415.1	-428.96	85.32	-328.12	2.229e+04	-9.440e+04	-	
1.440e+05	50	5.982e+04	9.633e+04	-7.20e-03	-1245.23	0.0	414.49	81.98	342.47	1.189e+04	-4.600e+04	-
5.893e+04	-1.655e+05	-4.600e+04	0.03	0.0	415.1	414.49	-1163.25	342.47	1.189e+04	9.633e+04	-	
1.655e+05	51	1.443e+05	4.618e+04	-0.02	-1245.23	0.0	-421.91	1332.36	-343.23	2.248e+04	4.618e+04	-
1.503e+05	-1.503e+05	-9.646e+04	-0.02	0.0	415.1	-421.91	87.13	-343.23	2.248e+04	-9.646e+04	-	
1.443e+05	69	3.765e+04	90.10-0.01	-1245.23	0.0	-3.71	707.17	-0.38	1.718e+04	90.10-4.566e+04	-	
21		-4.566e+04	-67.955.45e-03	0.0	415.1	-3.71	-538.06	-0.38	1.718e+04	-67.95-1.057e+04	-	
21	70	3.799e+04	125.54-0.01	-1245.23	0.0	4.27	706.69	-0.53	2.364e+04	125.54-4.521e+04	-	
21		-4.521e+04	-93.717.51e-03	0.0	415.1	4.27	-538.55	-0.53	2.364e+04	-93.71-1.031e+04	-	
21	71	3.765e+04	90.10-0.01	-1245.23	0.0	-3.71	707.17	-0.38	1.718e+04	90.10-4.566e+04	-	
21		-4.566e+04	-67.955.45e-03	0.0	415.1	-3.71	-538.06	-0.38	1.718e+04	-67.95-1.057e+04	-	
21	72	3.772e+04	97.19-0.01	-1245.23	0.0	-2.11	707.07	-0.41	1.847e+04	97.19-4.557e+04	-	
21		-4.557e+04	-73.105.87e-03	0.0	415.1	-2.11	-538.16	-0.41	1.847e+04	-73.10-1.052e+04	-	
21	73	3.765e+04	90.10-0.01	-1245.23	0.0	-3.71	707.17	-0.38	1.718e+04	90.10-4.566e+04	-	
22		-4.566e+04	-67.955.45e-03	0.0	415.1	-3.71	-538.06	-0.38	1.718e+04	-67.95-1.057e+04	-	
22	1	2.880e+04	139.99-4.23e-03	-1266.67	0.0	20.31	512.36	0.56	-3.128e+04	-41.62	-4672.60	-
22		-4.396e+04	-41.62-7.74e-03	0.0	324.8	20.31	-754.31	0.56	-3.128e+04	139.99-4.396e+04	-	
22	2	2.904e+04	209.92-4.98e-03	-1266.67	0.0	23.23	517.23	0.87	-4.481e+04	-72.71	-5032.84	-
22		-4.274e+04	-72.71-0.01	0.0	324.8	23.23	-749.44	0.87	-4.481e+04	209.92-4.274e+04	-	
22	3	2.201e+04	107.08-3.63e-03	-974.36	0.0	8.02	399.85	0.42	-2.386e+04	-29.64	-4433.60	-
22		-3.280e+04	-29.64-5.91e-03	0.0	324.8	8.02	-574.52	0.42	-2.386e+04	107.08-3.280e+04	-	
1.629e+05	5	1.629e+05	1.901e+04	-0.01	-974.36	0.0	261.38	-474.24	213.99	-2.872e+04	-5.073e+04	-
1.494e+05	-1.494e+05	-5.073e+04	-0.03	0.0	324.8	261.38	-1448.60	213.99	-2.872e+04	1.901e+04	-	
22	6	1.601e+05	1353.54-0.01	-974.36	0.0	327.42	-459.19	93.70	-2.410e+04	-2.926e+04	1.601e+05	-
22		-1.473e+05	-2.926e+04	-0.02	0.0	324.8	327.42	-1433.55	93.70	-2.410e+04	1353.54	-
1.473e+05	7	8.058e+04	2.920e+04	8.84e-03	-974.36	0.0	-302.78	1252.41	-92.84	-2.385e+04	2.920e+04	-
1.680e+05	-1.680e+05	-1138.707.39e-03	0.0	324.8	-302.78	278.05	-92.84	-2.385e+04	-1138.70	8.058e+04	-	
22		8.262e+04	5.067e+04	8.89e-03	-974.36	0.0	-236.74	1267.47	-213.14	-1.923e+04	5.067e+04	-
1.708e+05	-1.708e+05	-1.879e+04	0.02	0.0	324.8	-236.74	293.11	-213.14	-1.923e+04	-1.879e+04	-	
8.262e+04	13	1.111e+05	2.898e+04	-0.01	-974.36	0.0	165.10	-196.84	294.98	-2.804e+04	-6.690e+04	-
1.111e+05	-1.111e+05	-6.690e+04	0.01	0.0	324.8	165.10	-1171.20	294.98	-2.804e+04	2.898e+04	-	
1.111e+05	16	4.430e+04	6.684e+04	6.78e-03	-974.36	0.0	-140.46	990.06	-294.13	-1.991e+04	6.684e+04	-
1.190e+05	-1.190e+05	-2.877e+04	-0.02	0.0	324.8	-140.46	15.70	-294.13	-1.991e+04	-2.877e+04	-	
4.430e+04	37	2.298e+05	2.580e+04	-0.02	-974.36	0.0	329.11	-823.51	290.42	-3.056e+04	-6.885e+04	-
2.298e+05	-1.959e+05	-6.885e+04	-0.04	0.0	324.8	329.11	-1797.87	290.42	-3.056e+04	2.580e+04	-	
1.959e+05	38	2.259e+05	1181.25-0.02	-974.36	0.0	421.12	-802.59	122.82	-2.412e+04	-3.896e+04	2.259e+05	-
22		-1.930e+05	-3.896e+04	-0.02	0.0	324.8	421.12	-1776.95	122.82	-2.412e+04	1181.25	-
1.930e+05	39	1.263e+05	3.890e+04	0.01	-974.36	0.0	-396.49	1595.82	-121.97	-2.383e+04	3.890e+04	-
2.338e+05	-2.338e+05	-966.410.01	0.0	324.8	-396.49	621.45	-121.97	-2.383e+04	-966.41	1.263e+05	-	
22		1.291e+05	6.879e+04	0.01	-974.36	0.0	-304.47	1616.73	-289.57	-1.738e+04	6.879e+04	-
2.378e+05	-2.378e+05	-2.559e+04	0.02	0.0	324.8	-304.47	642.37	-289.57	-1.738e+04	-2.559e+04	-	
1.291e+05	45	1.569e+05	3.997e+04	-0.02	-974.36	0.0	166.99	-432.95	405.14	-2.957e+04	-9.172e+04	-
1.569e+05	-1.419e+05	-9.172e+04	0.02	0.0	324.8	166.99	-1407.32	405.14	-2.957e+04	3.997e+04	-	
1.419e+05	48	7.517e+04	9.165e+04	9.19e-03	-974.36	0.0	-142.35	1226.18	-404.29	-1.837e+04	9.165e+04	-
1.649e+05	-1.649e+05	-3.975e+04	-0.02	0.0	324.8	-142.35	251.82	-404.29	-1.837e+04	-3.975e+04	-	
7.517e+04	69	2.210e+04	107.42-3.42e-03	-974.36	0.0	12.32	396.61	0.43	-2.397e+04	-30.98	-3959.22	-
22		-3.337e+04	-30.98-5.93e-03	0.0	324.8	12.32	-577.75	0.43	-2.397e+04	107.42-3.337e+04	-	





EGP CODE

GRE.EEC.R.73.IT.W.15235.12.024.01

PAGE

298 di/of 527

24	8	2.839e+05	1.044e+05	-0.20	-2844.71	0.0	-1144.27	3074.00	478.15	-7849.24	-4.795e+04	-
2.303e+05		-2.303e+05	-4.795e+04	-0.05	0.0	315.0	-1144.27	229.29	478.15	-7849.24	1.044e+05	
2.839e+05	21	2.962e+05	-1541.44-0.21-2844.71	0.0	-405.31	2326.17	-94.41	1707.86	-1541.44	-4504.89		
		-4504.89	-3.567e+04	0.02	0.0	315.0	-405.31	-518.54	-94.41	1707.86	-3.567e+04	
2.818e+05	24	2.929e+05	3.558e+04	-0.19	-2844.71	0.0	-1256.94	3363.08	94.29	-1726.85	1484.82	-
3.168e+05		-3.168e+05	1484.82-0.02	0.0	315.0	-1256.94	518.37	94.29	-1726.85	3.558e+04	2.929e+05	
	24	2.964e+05	4.038e+04	-0.20	-2844.71	0.0	-1141.50	3366.88	-224.53	5055.29	4.038e+04	-
3.170e+05		-3.170e+05	-2.620e+04	0.03	0.0	315.0	-1141.50	522.16	-224.53	5055.29	-2.620e+04	
2.964e+05	24	2.960e+05	6.446e+04	-0.21	-2844.71	0.0	-395.80	2527.26	-648.33	1.044e+04	6.446e+04	-
6.362e+04		-6.362e+04	-1.421e+05	0.06	0.0	315.0	-395.80	-317.45	-648.33	1.044e+04	-1.421e+05	
2.912e+05	24	2.835e+05	1.420e+05	-0.19	-2844.71	0.0	-1266.46	3162.00	648.22	-1.046e+04	-6.451e+04	-
2.577e+05		-2.577e+05	-6.451e+04	-0.06	0.0	315.0	-1266.46	317.28	648.22	-1.046e+04	1.420e+05	
2.835e+05	24	3.070e+05	-2915.30-0.21-2844.71	0.0	-236.35	2119.47	-126.31	2260.18	-2915.30	5.795e+04		
		5.795e+04	-4.843e+04	0.02	0.0	315.0	-236.35	-725.25	-126.31	2260.18	-4.843e+04	
2.793e+05	24	2.954e+05	4.834e+04	-0.19	-2844.71	0.0	-1425.91	3569.79	126.20	-2279.16	2858.69	-
3.793e+05		-3.793e+05	2858.69-0.02	0.0	315.0	-1425.91	725.07	126.20	-2279.16	4.834e+04	2.954e+05	
	24	2.998e+05	5.576e+04	-0.19	-2844.71	0.0	-1268.60	3575.78	-307.37	6955.10	5.576e+04	-
3.796e+05		-3.796e+05	-3.567e+04	0.05	0.0	315.0	-1268.60	731.06	-307.37	6955.10	-3.567e+04	
2.998e+05	24	2.873e+05	-28.31-0.20	-2844.71	0.0	-831.13	2844.63	-0.06	-9.49	-28.31	-1.607e+05	
		-1.607e+05	-45.977.39e-05	0.0	315.0	-831.13	-0.09	-0.06	-9.49	-45.97	2.873e+05	
	24	3.605e+05	-40.66-0.25	-3563.82	0.0	-1056.28	3563.72	-0.07	-11.89	-40.66	-2.008e+05	
		-2.008e+05	-63.931.03e-04	0.0	315.0	-1056.28	-0.10	-0.07	-11.89	-63.93	3.605e+05	
	24	2.873e+05	-28.31-0.20	-2844.71	0.0	-831.13	2844.63	-0.06	-9.49	-28.31	-1.607e+05	
		-1.607e+05	-45.977.39e-05	0.0	315.0	-831.13	-0.09	-0.06	-9.49	-45.97	2.873e+05	
	24	3.020e+05	-30.78-0.21	-2988.53	0.0	-876.16	2988.45	-0.06	-9.97	-30.78	-1.687e+05	
		-1.687e+05	-49.577.98e-05	0.0	315.0	-876.16	-0.09	-0.06	-9.97	-49.57	3.020e+05	
	24	2.873e+05	-28.31-0.20	-2844.71	0.0	-831.13	2844.63	-0.06	-9.49	-28.31	-1.607e+05	
		-1.607e+05	-45.977.39e-05	0.0	315.0	-831.13	-0.09	-0.06	-9.49	-45.97	2.873e+05	
	25	2.412e+05	149.92-0.29	-4008.62	0.0	-1220.61	4008.50	0.16	8.04	99.16	-2.172e+05	
		-2.172e+05	99.16-2.45e-04	0.0	315.0	-1220.61	-0.12	0.16	8.04	149.92	4.142e+05	
	25	2.495e+05	82.55-0.17	-2427.79	0.0	-727.26	2427.72	0.11	5.39	49.27	-1.328e+05	
		-1.328e+05	49.27-1.35e-04	0.0	315.0	-727.26	-0.07	0.11	5.39	82.55	2.495e+05	
	25	2.454e+05	3.700e+04	-0.17	-2431.47	0.0	-1029.56	2588.27	-375.82	7335.00	3.700e+04	-
1.806e+05		-1.806e+05	-8.469e+04	0.03	0.0	315.0	-1029.56	156.80	-375.82	7335.00	-8.469e+04	
2.454e+05	25	2.560e+05	8.486e+04	-0.18	-2431.47	0.0	-421.92	2274.52	376.01	-7324.86	-3.689e+04	-
8.502e+04		-8.502e+04	-3.689e+04	-0.03	0.0	315.0	-421.92	-156.95	376.01	-7324.86	8.486e+04	
2.548e+05	25	2.589e+05	8.242e+04	-0.18	-2431.47	0.0	-610.77	2656.75	491.60	-1.185e+04	-7.206e+04	-
1.974e+05		-1.974e+05	-7.206e+04	-0.09	0.0	315.0	-610.77	225.27	491.60	-1.185e+04	8.242e+04	
2.589e+05	25	2.543e+05	-4829.22-0.17-2431.47	0.0	-1107.04	2885.47	-64.97	2654.04	-4829.22	-2.699e+05		
		-2.699e+05	-2.822e+04	0.01	0.0	315.0	-1107.04	454.00	-64.97	2654.04	-2.822e+04	
2.543e+05	25	2.589e+05	2.838e+04	-0.18	-2431.47	0.0	-344.45	1977.32	65.17	-2643.90	4931.14	4255.96
		4255.96	4931.14-0.01	0.0	315.0	-344.45	-454.15	65.17	-2643.90	2.838e+04	2.459e+05	
	25	2.582e+05	2.180e+04	-0.17	-2431.47	0.0	-977.33	2890.71	200.11	-3068.07	-3.865e+04	-
2.703e+05		-2.703e+05	-3.865e+04	-0.03	0.0	315.0	-977.33	459.24	200.11	-3068.07	2.180e+04	
2.582e+05	25	2.448e+05	4.936e+04	-0.17	-2431.47	0.0	-1142.26	2645.06	-507.77	9828.51	4.936e+04	-
1.987e+05		-1.987e+05	-1.151e+05	0.05	0.0	315.0	-1142.26	213.58	-507.77	9828.51	-1.151e+05	
2.448e+05	25	2.576e+05	1.153e+05	-0.18	-2431.47	0.0	-309.23	2217.74	507.97	-9818.37	-4.926e+04	-
6.696e+04		-6.696e+04	-4.926e+04	-0.05	0.0	315.0	-309.23	-213.73	507.97	-9818.37	1.153e+05	
2.553e+05	25	2.563e+05	-7410.92-0.17-2431.47	0.0	-1256.36	3066.40	-85.62	3579.51	-7410.92	-3.248e+05		



EGP CODE

GRE.EEC.R.73.IT.W.15235.12.024.01

PAGE

299 di/of 527

2.563e+05	-3.248e+05	-3.841e+04	0.02	0.0	315.0	-1256.36	634.93	-85.62	3579.51	-3.841e+04	
25	63	2.689e+05	3.858e+04	-0.19	-2431.47	0.0	-195.13	1796.39	85.82	-3569.37	7512.84
5.910e+04	5.910e+04	7512.84-0.02	0.0	315.0	-195.13	-635.08	85.82	-3569.37	3.858e+04	2.439e+05	
25	68	2.611e+05	2.956e+04	-0.17	-2431.47	0.0	-1079.81	3074.07	274.62	-4215.26	-5.339e+04
3.252e+05	-3.252e+05	-5.339e+04	-0.04	0.0	315.0	-1079.81	642.60	274.62	-4215.26	2.956e+04	
2.611e+05	69	2.501e+05	81.74-0.17	-2431.47	0.0	-725.74	2431.40	0.10	5.07	50.96-1.328e+05	
25		-1.328e+05	50.96-1.34e-04	0.0	315.0	-725.74	-0.07	0.10	5.07	81.74	2.501e+05
25	70	3.091e+05	111.38-0.22	-2994.15	0.0	-911.52	2994.07	0.13	6.24	71.78-1.625e+05	
		-1.625e+05	71.78-1.82e-04	0.0	315.0	-911.52	-0.09	0.13	6.24	111.38	3.091e+05
25	71	2.501e+05	81.74-0.17	-2431.47	0.0	-725.74	2431.40	0.10	5.07	50.96-1.328e+05	
		-1.328e+05	50.96-1.34e-04	0.0	315.0	-725.74	-0.07	0.10	5.07	81.74	2.501e+05
25	72	2.619e+05	87.67-0.18	-2544.01	0.0	-762.90	2543.93	0.10	5.31	55.12-1.388e+05	
		-1.388e+05	55.12-1.43e-04	0.0	315.0	-762.90	-0.08	0.10	5.31	87.67	2.619e+05
25	73	2.501e+05	81.74-0.17	-2431.47	0.0	-725.74	2431.40	0.10	5.07	50.96-1.328e+05	
		-1.328e+05	50.96-1.34e-04	0.0	315.0	-725.74	-0.07	0.10	5.07	81.74	2.501e+05
26	1	1.298e+04	100.10-1.68e-03	-1266.67	0.0	29.90	652.04	-0.74	-8642.25	100.10-4.148e+04	
		-4.148e+04	-139.94-2.17e-03	0.0	324.8	29.90	-614.63	-0.74	-8642.25	-139.94-3.541e+04	
26	2	1.327e+04	145.54-1.93e-03	-1266.67	0.0	28.38	650.19	-1.03	-1.240e+04	145.54-4.089e+04	
		-4.089e+04	-190.06-3.11e-03	0.0	324.8	28.38	-616.48	-1.03	-1.240e+04	-190.06-3.542e+04	
26	4	1.052e+04	122.93-1.57e-03	-974.36	0.0	12.45	496.50	-0.87	-1.034e+04	122.93-3.055e+04	
		-3.055e+04	-159.61-2.59e-03	0.0	324.8	12.45	-477.86	-0.87	-1.034e+04	-159.61-2.752e+04	
26	5	6.981e+04	1.532e+04	3.68e-03	-974.36	0.0	364.63	-147.24	-61.70	-1.036e+04	1.532e+04
6.981e+04		-1.362e+05	-4421.48-0.02	0.0	324.8	364.63	-1121.60	-61.70	-1.036e+04	-4421.48-1.362e+05	
26	6	6.801e+04	2.474e+04	3.39e-03	-974.36	0.0	469.63	-136.26	-133.81	-6174.86	2.474e+04
6.801e+04		-1.345e+05	-1.910e+04	-9.95e-03	0.0	324.8	469.63	-1110.62	-133.81	-6174.86-1.910e+04	
1.345e+05	7	7.976e+04	1.889e+04	-5.23e-03	-974.36	0.0	-431.48	1136.60	132.67	-7069.14-2.459e+04	
1.312e+05		-1.312e+05	-2.459e+04	6.63e-03	0.0	324.8	-431.48	162.24	132.67	-7069.14	1.889e+04
7.976e+04	8	8.154e+04	4204.58-5.49e-03	-974.36	0.0	-326.48	1147.58	60.56	-2880.48	-1.517e+04-1.330e+05	
		-1.330e+05	-1.517e+04	0.02	0.0	324.8	-326.48	173.22	60.56	-2880.48	4204.58
8.154e+04	29	1.479e+04	3.322e+04	-1.52e-03	-974.36	0.0	-20.42	301.40	105.78	-1.371e+04	3.322e+04
26		-5.851e+04	1.445e+04	-0.03	0.0	324.8	-20.42	-672.96	105.78	-1.371e+04	1.445e+04
5.851e+04	32	1.709e+04	-1.467e+04	-2.09e-03	-974.36	0.0	58.57	698.94	-106.92	467.52-3.307e+04	
6.258e+04		-6.258e+04	-3.307e+04	0.02	0.0	324.8	58.57	-275.42	-106.92	467.52-1.467e+04	3803.17
26	37	1.105e+05	2.112e+04	5.49e-03	-974.36	0.0	496.42	-406.86	-84.99	-1.181e+04	2.112e+04
1.105e+05		-1.799e+05	-6066.95-0.03	0.0	324.8	496.42	-1381.22	-84.99	-1.181e+04	-6066.95-1.799e+05	
26	38	1.080e+05	3.414e+04	5.12e-03	-974.36	0.0	642.91	-391.51	-184.99	-6004.72	3.414e+04
1.080e+05		-1.774e+05	-2.648e+04	-0.01	0.0	324.8	642.91	-1365.87	-184.99	-6004.72-2.648e+04	
1.774e+05	39	1.227e+05	2.626e+04	-6.96e-03	-974.36	0.0	-604.76	1391.85	183.85	-7239.29-3.399e+04	
1.711e+05		-1.711e+05	-3.399e+04	9.16e-03	0.0	324.8	-604.76	417.49	183.85	-7239.29	2.626e+04
1.227e+05	40	1.252e+05	5850.06-7.32e-03	-974.36	0.0	-458.26	1407.21	83.85	-1429.35	-2.096e+04-1.736e+05	
		-1.736e+05	-2.096e+04	0.03	0.0	324.8	-458.26	432.84	83.85	-1429.35	5850.06
1.252e+05	61	2.083e+04	4.631e+04	-1.77e-03	-974.36	0.0	-37.47	221.70	148.79	-1.655e+04	4.631e+04
1.186e+04		-7.101e+04	2.034e+04	-0.04	0.0	324.8	-37.47	-752.67	148.79	-1.655e+04	2.034e+04
7.101e+04	64	2.314e+04	-2.055e+04	-2.51e-03	-974.36	0.0	75.63	778.65	-149.93	3302.43-4.615e+04	
7.501e+04		-7.501e+04	-4.615e+04	0.03	0.0	324.8	75.63	-195.71	-149.93	3302.43-2.055e+04	
1.630e+04	69	1.009e+04	77.21-1.31e-03	-974.36	0.0	19.08	500.17	-0.57	-6622.00	77.21-3.157e+04	
		-3.157e+04	-108.45-1.66e-03	0.0	324.8	19.08	-474.19	-0.57	-6622.00	-108.45-2.736e+04	
26	70	1.029e+04	107.51-1.47e-03	-974.36	0.0	18.06	498.94	-0.77	-9124.24	107.51-3.118e+04	
		-3.118e+04	-141.86-2.29e-03	0.0	324.8	18.06	-475.43	-0.77	-9124.24	-141.86-2.736e+04	
26	71	1.009e+04	77.21-1.31e-03	-974.36	0.0	19.08	500.17	-0.57	-6622.00	77.21-3.157e+04	
		-3.157e+04	-108.45-1.66e-03	0.0	324.8	19.08	-474.19	-0.57	-6622.00	-108.45-2.736e+04	
26	72	1.013e+04	83.27-1.34e-03	-974.36	0.0	18.87	499.92	-0.61	-7122.45	83.27-3.150e+04	
		-3.150e+04	-115.13-1.79e-03	0.0	324.8	18.87	-474.44	-0.61	-7122.45	-115.13-2.736e+04	
26	73	1.009e+04	77.21-1.31e-03	-974.36	0.0	19.08	500.17	-0.57	-6622.00	77.21-3.157e+04	







EGP CODE

GRE.EEC.R.73.IT.W.15235.12.024.01

PAGE

301 di/of 527

28	35	1.982e+04	-1.904e+04	-3.46e-03	-1081.75	0.0	-287.28	656.86	-162.50	-1.214e+04	-1.904e+04	-
5.141e+04		-5.141e+04	-3.039e+04	-0.03	0.0	360.3	-287.28	-424.89	-162.50	-1.214e+04	-3.039e+04	-9768.39
28	37	1.178e+05	1.018e+04	-7.30e-03	-1081.75	0.0	648.59	-285.37	-62.91	-8037.55	1.018e+04	-
1.178e+05		-1.801e+05	-1.107e+04	-0.01	0.0	360.3	648.59	-1367.12	-62.91	-8037.55	-1.107e+04	-
1.801e+05												
28	42	1.168e+05	2.696e+04	-7.32e-03	-1081.75	0.0	825.76	-280.28	-34.66	-2305.52	2.696e+04	-
1.168e+05		-1.792e+05	-5386.048.55e-03	0.0	360.3	825.76	-1362.03	-34.66	-2305.52	-5386.04	-1.792e+05	-
28	43	1.158e+05	5353.03-7.99e-03	-1081.75	0.0	-791.15	1350.86	34.02	-6512.69	-2.676e+04	-1.759e+05	-
1.158e+05		-1.759e+05	-2.676e+04	-0.01	0.0	360.3	-791.15	269.11	34.02	-6512.69	5353.03	-
28	66	2.316e+04	4.240e+04	-3.82e-03	-1081.75	0.0	441.46	365.43	226.16	6390.20	2.684e+04	1011.40
6.236e+04		-6.236e+04	2.684e+04	0.04	0.0	360.3	441.46	-716.32	226.16	6390.20	4.240e+04	-
6.009e+04												
28	67	2.254e+04	-2.664e+04	-3.54e-03	-1081.75	0.0	-406.84	705.15	-226.81	-1.521e+04	-2.664e+04	-
6.009e+04		-6.009e+04	-4.243e+04	-0.04	0.0	360.3	-406.84	-376.60	-226.81	-1.521e+04	-4.243e+04	-1055.52
28	69	1.805e+04	99.91-3.38e-03	-1081.75	0.0	17.31	535.29	-0.32	-4409.10	99.91	-2.954e+04	-
		-3.171e+04	-16.50-1.22e-03	0.0	360.3	17.31	-546.46	-0.32	-4409.10	-16.50	-3.171e+04	-
28	70	1.799e+04	128.37-3.44e-03	-1081.75	0.0	18.82	534.86	-0.42	-6080.64	128.37	-2.953e+04	-
		-3.185e+04	-22.12-1.68e-03	0.0	360.3	18.82	-546.89	-0.42	-6080.64	-22.12	-3.185e+04	-
28	71	1.805e+04	99.91-3.38e-03	-1081.75	0.0	17.31	535.29	-0.32	-4409.10	99.91	-2.954e+04	-
		-3.171e+04	-16.50-1.22e-03	0.0	360.3	17.31	-546.46	-0.32	-4409.10	-16.50	-3.171e+04	-
28	72	1.804e+04	105.60-3.39e-03	-1081.75	0.0	17.61	535.20	-0.34	-4743.41	105.60	-2.954e+04	-
		-3.174e+04	-17.63-1.31e-03	0.0	360.3	17.61	-546.54	-0.34	-4743.41	-17.63	-3.174e+04	-
28	73	1.805e+04	99.91-3.38e-03	-1081.75	0.0	17.31	535.29	-0.32	-4409.10	99.91	-2.954e+04	-
		-3.171e+04	-16.50-1.22e-03	0.0	360.3	17.31	-546.46	-0.32	-4409.10	-16.50	-3.171e+04	-
29	1	2.351e+04	32.85-4.42e-03	-1406.44	0.0	27.26	695.92	0.42	5746.82	-118.59	-3.834e+04	-
		-4.120e+04	-118.591.60e-03	0.0	360.3	27.26	-710.52	0.42	5746.82	32.85	-4.120e+04	-
29	2	2.343e+04	44.55-4.51e-03	-1406.44	0.0	29.74	695.29	0.57	8254.33	-159.02	-3.831e+04	-
		-4.140e+04	-159.022.29e-03	0.0	360.3	29.74	-711.16	0.57	8254.33	44.55	-4.140e+04	-
29	3	1.803e+04	24.79-3.36e-03	-1081.58	0.0	13.35	535.27	0.32	4395.55	-91.93	-2.959e+04	-
		-3.171e+04	-91.931.22e-03	0.0	360.3	13.35	-546.31	0.32	4395.55	24.79	-3.171e+04	-
29	14	7.577e+04	8309.36-5.88e-03	-1081.75	0.0	464.29	-51.45	47.22	7031.06	-7680.36	7.577e+04	-
		-1.378e+05	-7680.367.78e-03	0.0	360.3	464.29	-1133.20	47.22	7031.06	8309.36	-1.378e+05	-
29	17	7.506e+04	4274.85-5.90e-03	-1081.75	0.0	596.82	-47.74	27.16	2923.28	-1.966e+04	7.506e+04	-
1.372e+05		-1.372e+05	-1.966e+04	-5.48e-03	0.0	360.3	596.82	-1129.49	27.16	2923.28	4274.85	-
29	20	7.377e+04	1.947e+04	-6.46e-03	-1081.75	0.0	-561.50	1118.34	-26.51	5896.18	1.947e+04	-
1.341e+05												
29	29	2.051e+04	-1.921e+04	-3.66e-03	-1081.75	0.0	323.26	413.43	-160.76	-3319.86	-1.921e+04	-7611.02
		-5.368e+04	-3.019e+04	-0.03	0.0	360.3	323.26	-668.32	-160.76	-3319.86	-3.019e+04	-
5.368e+04												
29	32	1.983e+04	3.024e+04	-3.46e-03	-1081.75	0.0	-287.94	657.16	161.40	1.214e+04	1.903e+04	-
5.146e+04		-5.146e+04	1.903e+04	0.03	0.0	360.3	-287.94	-424.58	161.40	1.214e+04	3.024e+04	-9714.70
29	46	1.180e+05	1.163e+04	-7.31e-03	-1081.75	0.0	643.35	-286.76	65.93	8034.64	-1.069e+04	-
1.180e+05		-1.804e+05	-1.069e+04	0.01	0.0	360.3	643.35	-1368.51	65.93	8034.64	1.163e+04	-
1.804e+05												
29	49	1.170e+05	5939.85-7.33e-03	-1081.75	0.0	828.29	-281.58	37.75	2302.31	-2.742e+04	1.170e+05	-
		-1.795e+05	-2.742e+04	-7.98e-03	0.0	360.3	828.29	-1363.33	37.75	2302.31	5939.85	-
1.795e+05												
29	52	1.161e+05	2.724e+04	-8.00e-03	-1081.75	0.0	-792.98	1352.18	-37.11	6517.15	2.724e+04	-
1.761e+05		-1.761e+05	-5889.730.01	0.0	360.3	-792.98	270.43	-37.11	6517.15	-5889.73	1.161e+05	-
29	61	2.320e+04	-2.681e+04	-3.83e-03	-1081.75	0.0	443.43	365.01	-224.65	-6395.00	-2.681e+04	1100.47
		-6.242e+04	-4.218e+04	-0.04	0.0	360.3	443.43	-716.73	-224.65	-6395.00	-4.218e+04	-
6.242e+04												
29	64	2.256e+04	4.223e+04	-3.54e-03	-1081.75	0.0	-408.11	705.58	225.30	1.521e+04	2.663e+04	-
6.017e+04		-6.017e+04	2.663e+04	0.04	0.0	360.3	-408.11	-376.16	225.30	1.521e+04	4.223e+04	-980.87
29	69	1.806e+04	25.06-3.38e-03	-1081.75	0.0	17.66	535.30	0.32	4409.73	-91.53	-2.954e+04	-
		-3.170e+04	-91.531.23e-03	0.0	360.3	17.66	-546.45	0.32	4409.73	25.06	-3.170e+04	-
29	70	1.800e+04	32.86-3.45e-03	-1081.75	0.0	19.31	534.88	0.42	6081.40	-118.49	-2.952e+04	-
		-3.183e+04	-118.491.69e-03	0.0	360.3	19.31	-546.87	0.42	6081.40	32.86	-3.183e+04	-
29	71	1.806e+04	25.06-3.38e-03	-1081.75	0.0	17.66	535.30	0.32	4409.73	-91.53	-2.954e+04	-
		-3.170e+04	-91.531.23e-03	0.0	360.3	17.66	-546.45	0.32	4409.73	25.06	-3.170e+04	-
29	72	1.805e+04	26.62-3.40e-03	-1081.75	0.0	17.99	535.21	0.34	4744.06	-96.92	-2.953e+04	-
		-3.173e+04	-96.921.32e-03	0.0	360.3	17.99	-546.53	0.34	4744.06	26.62	-3.173e+04	-
29	73	1.806e+04	25.06-3.38e-03	-1081.75	0.0	17.66	535.30	0.32	4409.73	-91.53	-2.954e+04	-
		-3.170e+04	-91.531.23e-03	0.0	360.3	17.66	-546.45	0.32	4409.73	25.06	-3.170e+04	-
30	1	1.575e+04	4.37-2.69e-03	-1405.15	0.0	28.59	663.95	0.20	-1.135e+04	-67.65	-4.057e+04	-



EGP CODE

GRE.EEC.R.73.IT.W.15235.12.024.01

PAGE

302 di/of 527

		-5.449e+04	-67.65-3.10e-03	0.0	360.3	28.59	-741.20	0.20	-1.135e+04	4.37	-5.449e+04	
30	2	1.562e+04	9.69-2.99e-03-1405.15		0.0	29.98	665.38	0.29	-1.629e+04	-96.52	-4.096e+04	
		-5.436e+04	-96.52-4.46e-03	0.0	360.3	29.98	-739.77	0.29	-1.629e+04	9.69	-5.436e+04	
30	3	1.212e+04	3.44-2.07e-03-1080.88		0.0	14.53	510.60	0.15	-8691.88	-52.31	-3.118e+04	
		-4.193e+04	-52.31-2.37e-03	0.0	360.3	14.53	-570.28	0.15	-8691.88	3.44	-4.193e+04	
30	5	7.782e+04	3924.00-4.93e-03-1080.88		0.0	539.06	-108.38	-28.45	-1.201e+04	3924.00	7.782e+04	
		-1.560e+05	-5735.86-0.01	0.0	360.3	539.06	-1189.27	-28.45	-1.201e+04	-5735.86	-1.560e+05	
30	10	7.719e+04	1.649e+04 -4.95e-03	-1080.88	0.0	683.94	-104.88	-96.24	-7763.52	1.649e+04		
7.719e+04		-1.553e+05	-1.856e+04 4.27e-03	0.0	360.3	683.94	-1185.77	-96.24	-7763.52	-1.856e+04		-
1.553e+05	30	11	7.148e+04 1.856e+04 -5.16e-03	-1080.88	0.0	-646.45	1126.23	96.55	-9663.61	-1.659e+04		-
1.396e+05		-1.396e+05	-1.659e+04 -8.36e-03	0.0	360.3	-646.45	45.35	96.55	-9663.61	1.856e+04		
7.148e+04	30	22	1.741e+04 3.310e+04 -2.38e-03	-1080.88	0.0	375.67	346.80	-149.41	1025.68	3.310e+04	-2605.73	
7.236e+04		-7.236e+04	-2.275e+04 0.02	0.0	360.3	375.67	-734.09	-149.41	1025.68	-2.275e+04		-
5.979e+04	30	23	1.569e+04 2.275e+04 -2.58e-03	-1080.88	0.0	-338.17	674.55	149.72	-1.845e+04	-3.321e+04		-
1.148e+04		-5.979e+04	-3.321e+04 -0.02	0.0	360.3	-338.17	-406.33	149.72	-1.845e+04	2.275e+04		-
30	37	1.215e+05	5473.35-6.45e-03-1080.88	0.0	748.42	-356.66	-39.71	-1.332e+04	5473.35	1.215e+05		
		-2.017e+05	-8018.40-0.02	0.0	360.3	748.42	-1437.54	-39.71	-1.332e+04	-8018.40	-2.017e+05	
1.207e+05	30	42	1.207e+05 2.306e+04 -6.47e-03	-1080.88	0.0	950.62	-351.76	-134.60	-7374.79	2.306e+04		
		-2.008e+05	-2.594e+04 6.82e-03	0.0	360.3	950.62	-1432.65	-134.60	-7374.79	-2.594e+04		-
2.008e+05	30	43	1.170e+05 2.594e+04 -6.74e-03	-1080.88	0.0	-913.12	1373.11	134.90	-1.005e+04	-2.317e+04		-
1.831e+05		-1.831e+05	-2.317e+04 -0.01	0.0	360.3	-913.12	292.23	134.90	-1.005e+04	2.594e+04		
1.170e+05	30	54	2.202e+04 4.637e+04 -2.68e-03	-1080.88	0.0	516.59	281.02	-208.99	4921.53	4.637e+04	8867.39	
8.458e+04		-8.458e+04	-3.171e+04 0.03	0.0	360.3	516.59	-799.86	-208.99	4921.53	-3.171e+04		-
7.126e+04	30	55	2.001e+04 3.172e+04 -2.92e-03	-1080.88	0.0	-479.09	740.33	209.30	-2.235e+04	-4.647e+04		-
		-7.126e+04	-4.647e+04 -0.03	0.0	360.3	-479.09	-340.56	209.30	-2.235e+04	3.172e+04	734.50	
30	69	1.212e+04	3.39-2.07e-03-1080.88	0.0	18.75	510.68	0.15	-8713.56	-52.16	-3.120e+04		
		-4.192e+04	-52.16-2.38e-03	0.0	360.3	18.75	-570.21	0.15	-8713.56	3.39	-4.192e+04	
30	70	1.203e+04	6.94-2.27e-03-1080.88	0.0	19.67	511.63	0.22	-1.201e+04	-71.41	-3.145e+04		
		-4.184e+04	-71.41-3.28e-03	0.0	360.3	19.67	-569.25	0.22	-1.201e+04	6.94	-4.184e+04	
30	71	1.212e+04	3.39-2.07e-03-1080.88	0.0	18.75	510.68	0.15	-8713.56	-52.16	-3.120e+04		
		-4.192e+04	-52.16-2.38e-03	0.0	360.3	18.75	-570.21	0.15	-8713.56	3.39	-4.192e+04	
30	72	1.210e+04	4.10-2.11e-03-1080.88	0.0	18.93	510.87	0.17	-9372.90	-56.01	-3.125e+04		
		-4.190e+04	-56.01-2.56e-03	0.0	360.3	18.93	-570.02	0.17	-9372.90	4.10	-4.190e+04	
30	73	1.212e+04	3.39-2.07e-03-1080.88	0.0	18.75	510.68	0.15	-8713.56	-52.16	-3.120e+04		
		-4.192e+04	-52.16-2.38e-03	0.0	360.3	18.75	-570.21	0.15	-8713.56	3.39	-4.192e+04	
31	1	1.575e+04	116.97-2.68e-03-1405.15	0.0	28.70	663.87	-0.49	1.135e+04	116.97	-4.057e+04		
		-5.451e+04	-60.063.17e-03	0.0	360.3	28.70	-741.28	-0.49	1.135e+04	-60.06	-5.451e+04	
31	2	1.561e+04	159.10-2.98e-03-1405.15	0.0	30.23	665.28	-0.66	1.629e+04	159.10	-4.095e+04		
		-5.439e+04	-79.814.54e-03	0.0	360.3	30.23	-739.87	-0.66	1.629e+04	-79.81	-5.439e+04	
31	3	1.212e+04	89.70-2.06e-03-1080.88	0.0	14.83	510.55	-0.38	8689.50	89.70	-3.118e+04		
		-4.195e+04	-45.482.43e-03	0.0	360.3	14.83	-570.34	-0.38	8689.50	-45.48	-4.195e+04	
31	14	7.801e+04	5963.18-4.94e-03-1080.88	0.0	531.87	-109.55	29.70	1.201e+04	-4152.01	7.801e+04		
		-1.562e+05	-4152.010.01	0.0	360.3	531.87	-1190.43	29.70	1.201e+04	5963.18	-1.562e+05	
7.738e+04	31	17	7.738e+04 1.879e+04 -4.95e-03	-1080.88	0.0	686.06	-106.05	97.51	7759.98	1.879e+04		
		-1.556e+05	-1.671e+04 -4.24e-03	0.0	360.3	686.06	-1186.94	97.51	7759.98	1.879e+04		-
1.556e+05	31	20	7.168e+04 1.689e+04 -5.16e-03	-1080.88	0.0	-648.21	1127.29	-98.26	9662.39	1.689e+04		-
1.398e+05		-1.398e+05	-1.888e+04 8.42e-03	0.0	360.3	-648.21	46.40	-98.26	9662.39	-1.888e+04		
7.168e+04	31	25	1.745e+04 2.279e+04 -2.39e-03	-1080.88	0.0	403.52	346.21	149.62	-1028.84	-3.313e+04	-2499.04	
		-7.247e+04	-3.313e+04 -0.02	0.0	360.3	403.52	-734.68	149.62	-1028.84	2.279e+04		-
7.247e+04	31	28	1.571e+04 3.331e+04 -2.56e-03	-1080.88	0.0	-365.68	675.03	-150.37	1.845e+04	3.331e+04		-
5.989e+04		-5.989e+04	-2.288e+04 0.02	0.0	360.3	-365.68	-405.86	-150.37	1.845e+04	-2.288e+04		-
1.141e+04	31	46	1.218e+05 8350.64-6.46e-03-1080.88	0.0	738.50	-358.26	41.55	1.332e+04	-5805.53	1.218e+05		
		-2.020e+05	-5805.530.02	0.0	360.3	738.50	-1439.15	41.55	1.332e+04	8350.64	-2.020e+05	
1.209e+05	31	49	1.209e+05 2.627e+04 -6.48e-03	-1080.88	0.0	953.58	-353.38	136.45	7370.03	-2.339e+04		
		-2.011e+05	-2.339e+04 -6.79e-03	0.0	360.3	953.58	-1434.27	136.45	7370.03	2.627e+04		-



EGP CODE

GRE.EEC.R.73.IT.W.15235.12.024.01

PAGE

303 di/of 527

2.011e+05	31	52	1.172e+05	2.357e+04	-6.74e-03	-1080.88	0.0	-915.73	1374.62	-137.20	1.005e+04	2.357e+04	-
1.833e+05			-1.833e+05	-2.636e+04	0.01	0.0	360.3	-915.73	293.73	-137.20	1.005e+04	-2.636e+04	
1.172e+05	31	57	2.209e+04	3.179e+04	-2.70e-03	-1080.88	0.0	554.88	280.22	209.36	-4925.29	-4.642e+04	9016.53
			-8.473e+04	-4.642e+04	-0.03	0.0	360.3	554.88	-800.67	209.36	-4925.29	3.179e+04	-
8.473e+04	31	60	2.004e+04	4.660e+04	-2.89e-03	-1080.88	0.0	-517.03	741.02	-210.12	2.235e+04	4.660e+04	-
7.140e+04			-7.140e+04	-3.188e+04	0.03	0.0	360.3	-517.03	-339.87	-210.12	2.235e+04	-3.188e+04	849.81
	31	69	1.211e+04	89.86-2.06e-03	-1080.88	0.0	18.92	510.62	-0.38	8711.18	89.86-3.119e+04		
			-4.194e+04	-45.892.43e-03	0.0	360.3	18.92	-570.27	-0.38	8711.18	-45.89-4.194e+04		
	31	70	1.203e+04	117.94-2.26e-03	-1080.88	0.0	19.94	511.55	-0.49	1.201e+04	117.94-3.145e+04		
			-4.186e+04	-59.053.35e-03	0.0	360.3	19.94	-569.33	-0.49	1.201e+04	-59.05-4.186e+04		
	31	71	1.211e+04	89.86-2.06e-03	-1080.88	0.0	18.92	510.62	-0.38	8711.18	89.86-3.119e+04		
			-4.194e+04	-45.892.43e-03	0.0	360.3	18.92	-570.27	-0.38	8711.18	-45.89-4.194e+04		
	31	72	1.210e+04	95.47-2.10e-03	-1080.88	0.0	19.13	510.80	-0.40	9370.41	95.47-3.124e+04		
			-4.192e+04	-48.522.61e-03	0.0	360.3	19.13	-570.08	-0.40	9370.41	-48.52-4.192e+04		
	31	73	1.211e+04	89.86-2.06e-03	-1080.88	0.0	18.92	510.62	-0.38	8711.18	89.86-3.119e+04		
			-4.194e+04	-45.892.43e-03	0.0	360.3	18.92	-570.27	-0.38	8711.18	-45.89-4.194e+04		
	32	1	3.999e+04	24.00-0.01	-1832.33	0.0	2.61	887.38	0.07	-8319.28	-7.21-6.095e+04		
			-7.448e+04	-7.21-3.04e-03	0.0	469.8	2.61	-944.95	0.07	-8319.28	24.00-7.448e+04		
	32	2	4.019e+04	34.65-0.01	-1832.33	0.0	5.87	887.93	0.09	-1.196e+04	-7.61-6.088e+04		
			-7.415e+04	-7.61-4.36e-03	0.0	469.8	5.87	-944.40	0.09	-1.196e+04	34.65-7.415e+04		
	32	3	3.076e+04	17.63-9.34e-03	-1409.48	0.0	-5.19	682.52	0.05	-6369.90	-4.70-4.687e+04		
			-5.731e+04	-4.70-2.33e-03	0.0	469.8	-5.19	-726.96	0.05	-6369.90	17.63-5.731e+04		
	32	5	6.351e+04	1435.42-0.01	-1409.48	0.0	373.52	243.54	-2.64	-1.003e+04	1435.42	5.363e+04	
			-1.631e+05	250.57-0.02	0.0	469.8	373.52	-1165.95	-2.64	-1.003e+04	250.57	-1.631e+05	
	32	10	6.324e+04	2.068e+04	-0.01	-1409.48	0.0	538.77	246.13	-77.80	-4459.97	2.068e+04	
5.315e+04			-1.623e+05	-1.814e+04	-3.62e-03	0.0	469.8	538.77	-1163.35	-77.80	-4459.97	-1.814e+04	-
1.623e+05	32	11	6.172e+04	1.818e+04	-0.01	-1409.48	0.0	-541.02	1119.00	77.90	-8313.23	-2.069e+04	-
1.469e+05			-1.469e+05	-2.069e+04	-3.61e-03	0.0	469.8	-541.02	-290.49	77.90	-8313.23	1.818e+04	-
4.772e+04	32	25	3.238e+04	5.524e+04	-8.73e-03	-1409.48	0.0	-135.46	579.55	229.29	-2.132e+04	-5.270e+04	-
2.333e+04			-8.215e+04	-5.270e+04	-0.08	0.0	469.8	-135.46	-829.93	229.29	-2.132e+04	5.524e+04	-
8.215e+04	32	28	3.195e+04	5.269e+04	-0.01	-1409.48	0.0	133.22	785.58	-229.19	8542.91	5.269e+04	-
7.043e+04			-7.043e+04	-5.520e+04	0.08	0.0	469.8	133.22	-623.90	-229.19	8542.91	-5.520e+04	-
3.244e+04	32	37	9.462e+04	1958.84-0.01	-1409.48	0.0	522.46	67.45	-3.49	-1.151e+04	1958.84	9.394e+04	
			-2.055e+05	398.30-0.03	0.0	469.8	522.46	-1342.04	-3.49	-1.151e+04	398.30	-2.055e+05	
	32	42	9.406e+04	2.888e+04	-0.01	-1409.48	0.0	753.28	71.08	-108.58	-3704.97	2.888e+04	
9.327e+04			-2.044e+05	-2.534e+04	-4.82e-03	0.0	469.8	753.28	-1338.40	-108.58	-3704.97	-2.534e+04	-
2.044e+05	32	43	9.206e+04	2.537e+04	-0.02	-1409.48	0.0	-755.52	1294.05	108.68	-9068.23	-2.890e+04	-
1.870e+05			-1.870e+05	-2.890e+04	-4.23e-03	0.0	469.8	-755.52	-115.43	108.68	-9068.23	2.537e+04	-
8.985e+04	32	57	3.438e+04	7.735e+04	-8.80e-03	-1409.48	0.0	-188.33	538.58	321.06	-2.730e+04	-7.377e+04	-
1.396e+04			-9.203e+04	-7.377e+04	-0.11	0.0	469.8	-188.33	-870.90	321.06	-2.730e+04	7.735e+04	-
9.203e+04	32	60	3.405e+04	7.376e+04	-0.01	-1409.48	0.0	186.09	826.55	-320.96	1.452e+04	7.376e+04	-
7.979e+04			-7.979e+04	-7.732e+04	0.11	0.0	469.8	186.09	-582.94	-320.96	1.452e+04	-7.732e+04	-
2.256e+04	32	69	3.076e+04	18.10-9.34e-03	-1409.48	0.0	-1.12	682.57	0.05	-6386.60	-5.18-4.688e+04		
			-5.730e+04	-5.18-2.33e-03	0.0	469.8	-1.12	-726.92	0.05	-6386.60	18.10-5.730e+04		
	32	70	3.090e+04	25.20-9.61e-03	-1409.48	0.0	1.05	682.93	0.07	-8812.63	-5.44-4.683e+04		
			-5.708e+04	-5.44-3.22e-03	0.0	469.8	1.05	-726.55	0.07	-8812.63	25.20-5.708e+04		
	32	71	3.076e+04	18.10-9.34e-03	-1409.48	0.0	-1.12	682.57	0.05	-6386.60	-5.18-4.688e+04		
			-5.730e+04	-5.18-2.33e-03	0.0	469.8	-1.12	-726.92	0.05	-6386.60	18.10-5.730e+04		
	32	72	3.079e+04	19.52-9.39e-03	-1409.48	0.0	-0.69	682.64	0.05	-6871.81	-5.23-4.687e+04		
			-5.725e+04	-5.23-2.51e-03	0.0	469.8	-0.69	-726.85	0.05	-6871.81	19.52-5.725e+04		
	32	73	3.076e+04	18.10-9.34e-03	-1409.48	0.0	-1.12	682.57	0.05	-6386.60	-5.18-4.688e+04		
			-5.730e+04	-5.18-2.33e-03	0.0	469.8	-1.12	-726.92	0.05	-6386.60	18.10-5.730e+04		
	33	1	3.999e+04	9.49-0.01	-1832.33	0.0	2.90	887.41	0.12	8320.15	-44.63-6.096e+04		
			-7.447e+04	-44.632.98e-03	0.0	469.8	2.90	-944.92	0.12	8320.15	9.49-7.447e+04		
	33	2	4.019e+04	7.69-0.01	-1832.33	0.0	6.35	887.97	0.14	1.196e+04	-58.07-6.089e+04		





EGP CODE

GRE.EEC.R.73.IT.W.15235.12.024.01

PAGE

305 di/of 527

34	40	9.552e+04	1.101e+04	-0.01	-1409.48	0.0	-23.46	1348.13	63.19	4644.72	-2.313e+04	-	
2.074e+05		-2.074e+05	-2.313e+04	6.36e-03	0.0	469.8	-23.46	-61.36	63.19	4644.72	1.101e+04		
9.494e+04	34	43	9.535e+04	4089.97	0.01	-1409.48	0.0	-258.85	1348.13	9.54	7863.83	-188.30	-2.075e+05
			-2.075e+05	-188.300.02	0.0	469.8	-258.85	-61.36	9.54	7863.83	4089.97	9.477e+04	
3.104e+04	34	58	3.019e+04	-1.609e+04	-8.00e-03	-1409.48	0.0	467.20	606.48	-61.29	1.054e+04	-1.609e+04	-
			-7.717e+04	-3.007e+04	0.05	0.0	469.8	467.20	-803.00	-61.29	1.054e+04	-3.007e+04	-
7.717e+04	34	59	2.923e+04	3.015e+04	-6.56e-03	-1409.48	0.0	-470.22	821.48	61.29	-3953.49	1.616e+04	-
8.294e+04			-8.294e+04	1.616e+04	-0.05	0.0	469.8	-470.22	-588.01	61.29	-3953.49	3.015e+04	-
2.813e+04	34	66	3.077e+04	6.630e+04	-7.08e-03	-1409.48	0.0	411.02	572.38	294.07	-1.523e+04	-7.257e+04	-
2.328e+04			-8.547e+04	-7.257e+04	-0.10	0.0	469.8	411.02	-837.10	294.07	-1.523e+04	6.630e+04	-
8.547e+04	34	67	3.039e+04	7.265e+04	-7.99e-03	-1409.48	0.0	-414.04	855.58	-294.07	2.181e+04	7.265e+04	-
9.070e+04			-9.070e+04	-6.622e+04	0.11	0.0	469.8	-414.04	-553.90	-294.07	2.181e+04	-6.622e+04	-
1.982e+04	34	69	2.796e+04	38.68	-7.03e-03	-1409.48	0.0	-1.51	713.98	-5.03e-04	3291.18	38.68	-5.699e+04
			-5.699e+04	38.451.18e-03	0.0	469.8	-1.51	-695.50	-5.03e-04	3291.18	38.45	-5.265e+04	
	34	70	2.806e+04	51.80	-6.97e-03	-1409.48	0.0	0.38	713.55	-1.48e-03	4538.64	51.80	-5.678e+04
			-5.678e+04	51.101.63e-03	0.0	469.8	0.38	-695.93	-1.48e-03	4538.64	51.10	-5.264e+04	
	34	71	2.796e+04	38.68	-7.03e-03	-1409.48	0.0	-1.51	713.98	-5.03e-04	3291.18	38.68	-5.699e+04
			-5.699e+04	38.451.18e-03	0.0	469.8	-1.51	-695.50	-5.03e-04	3291.18	38.45	-5.265e+04	
	34	72	2.798e+04	41.31	-7.01e-03	-1409.48	0.0	-1.13	713.90	-6.98e-04	3540.67	41.31	-5.695e+04
			-5.695e+04	40.981.27e-03	0.0	469.8	-1.13	-695.59	-6.98e-04	3540.67	40.98	-5.265e+04	
	34	73	2.796e+04	38.68	-7.03e-03	-1409.48	0.0	-1.51	713.98	-5.03e-04	3291.18	38.68	-5.699e+04
			-5.699e+04	38.451.18e-03	0.0	469.8	-1.51	-695.50	-5.03e-04	3291.18	38.45	-5.265e+04	
	35	1	3.635e+04	-42.35	-9.13e-03	-1832.33	0.0	2.39	928.18	2.94e-03	-4287.39	-43.73	-7.408e+04
			-7.408e+04	-43.73	-1.55e-03	0.0	469.8	2.39	-904.15	2.94e-03	-4287.39	-42.35	-6.844e+04
	35	2	3.651e+04	-59.36	-9.05e-03	-1832.33	0.0	5.43	927.54	5.42e-03	-6158.65	-61.90	-7.377e+04
			-7.377e+04	-61.90	-2.23e-03	0.0	469.8	5.43	-904.79	5.42e-03	-6158.65	-59.36	-6.843e+04
	35	3	2.796e+04	-32.83	-7.03e-03	-1409.48	0.0	-5.04	713.99	1.71e-03	-3282.92	-33.64	-5.699e+04
			-5.699e+04	-33.64	-1.19e-03	0.0	469.8	-5.04	-695.49	1.71e-03	-3282.92	-32.83	-5.264e+04
1.645e+05	35	15	6.201e+04	1.694e+04	-0.01	-1409.48	0.0	-25.73	1167.48	-46.75	-4222.16	1.694e+04	-
			-1.645e+05	-8254.38	-4.59e-03	0.0	469.8	-25.73	-242.01	-46.75	-4222.16	-8254.38	5.290e+04
	35	20	6.188e+04	534.88	-0.01	-1409.48	0.0	-196.60	1167.46	-8.53	-6516.78	534.88	-1.646e+05
			-1.646e+05	-3321.26	-0.01	0.0	469.8	-196.60	-242.02	-8.53	-6516.78	-3321.26	5.277e+04
3.840e+04	35	21	2.924e+04	2.162e+04	-7.69e-03	-1409.48	0.0	341.00	637.10	44.50	-8472.88	1.148e+04	-
			-7.018e+04	1.148e+04	-0.03	0.0	469.8	341.00	-772.39	44.50	-8472.88	2.162e+04	-
7.018e+04	35	24	2.865e+04	-1.154e+04	-6.63e-03	-1409.48	0.0	-343.30	790.88	-44.49	1890.00	-1.154e+04	-
7.557e+04			-7.557e+04	-2.169e+04	0.03	0.0	469.8	-343.30	-618.60	-44.49	1890.00	-2.169e+04	-
3.511e+04	35	34	3.005e+04	4.747e+04	-7.88e-03	-1409.48	0.0	-231.94	591.72	210.47	-1.651e+04	-5.193e+04	-
2.806e+04			-8.116e+04	-5.193e+04	-0.08	0.0	469.8	-231.94	-817.76	210.47	-1.651e+04	4.747e+04	-
8.116e+04	35	35	3.011e+04	5.186e+04	-6.79e-03	-1409.48	0.0	229.64	836.26	-210.46	9932.06	5.186e+04	-
8.591e+04			-8.591e+04	-4.753e+04	0.07	0.0	469.8	229.64	-573.23	-210.46	9932.06	-4.753e+04	-
2.413e+04	35	47	9.580e+04	2.365e+04	-0.01	-1409.48	0.0	-20.55	1349.37	-65.32	-4606.90	2.365e+04	-
2.076e+05			-2.076e+05	-1.150e+04	-6.31e-03	0.0	469.8	-20.55	-60.11	-65.32	-4606.90	-1.150e+04	-
9.523e+04	35	52	9.561e+04	701.10	-0.01	-1409.48	0.0	-259.27	1349.36	-11.68	-7825.43	701.10	-2.078e+05
			-2.078e+05	-4582.74	-0.02	0.0	469.8	-259.27	-60.13	-11.68	-7825.43	-4582.74	9.505e+04
	35	53	3.021e+04	3.027e+04	-8.02e-03	-1409.48	0.0	472.67	606.57	62.07	-1.054e+04	1.594e+04	-
3.103e+04			-7.713e+04	1.594e+04	-0.05	0.0	469.8	472.67	-802.91	62.07	-1.054e+04	3.027e+04	-
7.713e+04	35	56	2.921e+04	-1.601e+04	-6.55e-03	-1409.48	0.0	-474.97	821.40	-62.06	3958.87	-1.601e+04	-
8.295e+04			-8.295e+04	-3.033e+04	0.05	0.0	469.8	-474.97	-588.08	-62.06	3958.87	-3.033e+04	-
2.815e+04	35	66	3.197e+04	6.645e+04	-8.29e-03	-1409.48	0.0	-327.18	542.68	294.69	-2.181e+04	-7.272e+04	-
1.646e+04			-9.259e+04	-7.272e+04	-0.11	0.0	469.8	-327.18	-866.81	294.69	-2.181e+04	6.645e+04	-







EGP CODE

GRE.EEC.R.73.IT.W.15235.12.024.01

PAGE

307 di/of 527

37	24	2.665e+04	2.999e+04	-5.07e-03	-1260.25	0.0	-230.27	765.16	169.38	-1.860e+04	-4.140e+04	-	
7.060e+04		-7.060e+04	-4.140e+04	-0.05	0.0	420.1	-230.27	-495.09	169.38	-1.860e+04	2.999e+04	-	
1.387e+04	37	2.763e+04	2.924e+04	-5.67e-03	-1260.25	0.0	-331.92	518.54	167.05	-1.900e+04	-4.121e+04	-	
1.673e+04		-6.361e+04	-4.121e+04	-0.05	0.0	420.1	-331.92	-741.71	167.05	-1.900e+04	2.924e+04	-	
6.361e+04	37	3.089e+04	4.115e+04	-5.19e-03	-1260.25	0.0	340.66	838.29	-166.68	-4985.95	4.115e+04	-	
8.606e+04		-8.606e+04	-2.914e+04	0.05	0.0	420.1	340.66	-421.95	-166.68	-4985.95	-2.914e+04	1390.93	
	37	52	1.096e+05	3604.86	-9.86e-03	-1260.25	0.0	183.39	1376.07	-18.69	-1.550e+04	3604.86	-2.037e+05
			-2.037e+05	-3692.55	-0.03	0.0	420.1	183.39	115.82	-18.69	-1.550e+04	-3692.55	1.096e+05
	37	53	2.715e+04	5.790e+04	-5.50e-03	-1260.25	0.0	345.29	557.21	-236.72	-2732.10	5.790e+04	-
2.457e+04			-5.519e+04	-4.187e+04	0.07	0.0	420.1	345.29	-703.04	-236.72	-2732.10	-4.187e+04	-
5.519e+04	37	56	2.750e+04	4.197e+04	-5.15e-03	-1260.25	0.0	-336.55	799.62	237.09	-2.125e+04	-5.796e+04	-
7.823e+04			-7.823e+04	-5.796e+04	-0.07	0.0	420.1	-336.55	-460.62	237.09	-2.125e+04	4.197e+04	-7026.16
	37	58	3.139e+04	4.092e+04	-6.17e-03	-1260.25	0.0	-461.44	454.42	233.88	-2.180e+04	-5.769e+04	-2832.89
			-7.665e+04	-5.769e+04	-0.07	0.0	420.1	-461.44	-805.82	233.88	-2.180e+04	4.092e+04	-
7.665e+04	37	59	3.560e+04	5.763e+04	-5.47e-03	-1260.25	0.0	470.18	902.41	-233.50	-2183.45	5.763e+04	-
9.996e+04			-9.996e+04	-4.083e+04	0.07	0.0	420.1	470.18	-357.84	-233.50	-2183.45	-4.083e+04	-
1.442e+04	37	69	2.502e+04	48.64	-5.02e-03	-1260.25	0.0	4.37	678.42	0.19	-1.199e+04	-30.76	-5.140e+04
			-5.140e+04	-30.76	-3.87e-03	0.0	420.1	4.37	-581.83	0.19	-1.199e+04	48.64	-3.111e+04
	37	70	2.501e+04	69.20	-4.77e-03	-1260.25	0.0	8.04	677.22	0.27	-1.655e+04	-45.66	-5.111e+04
			-5.111e+04	-45.66	-5.34e-03	0.0	420.1	8.04	-583.02	0.27	-1.655e+04	69.20	-3.133e+04
	37	71	2.502e+04	48.64	-5.02e-03	-1260.25	0.0	4.37	678.42	0.19	-1.199e+04	-30.76	-5.140e+04
			-5.140e+04	-30.76	-3.87e-03	0.0	420.1	4.37	-581.83	0.19	-1.199e+04	48.64	-3.111e+04
	37	72	2.501e+04	52.75	-4.97e-03	-1260.25	0.0	5.10	678.18	0.21	-1.290e+04	-33.74	-5.134e+04
			-5.134e+04	-33.74	-4.16e-03	0.0	420.1	5.10	-582.07	0.21	-1.290e+04	52.75	-3.115e+04
	37	73	2.502e+04	48.64	-5.02e-03	-1260.25	0.0	4.37	678.42	0.19	-1.199e+04	-30.76	-5.140e+04
			-5.140e+04	-30.76	-3.87e-03	0.0	420.1	4.37	-581.83	0.19	-1.199e+04	48.64	-3.111e+04
	38	2	-3957.49	142.762	2.3e-03	-1091.68	0.0	29.58	486.46	0.94	9792.78	-121.45	-3.425e+04
			-5.088e+04	-121.452	0.08e-03	0.0	279.9	29.58	-605.22	0.94	9792.78	142.76	-5.088e+04
	38	3	-2675.70	79.231	4.8e-03	-839.75	0.0	13.45	376.97	0.52	5214.25	-66.59	-2.631e+04
			-3.832e+04	-66.591	1.1e-03	0.0	279.9	13.45	-462.78	0.52	5214.25	79.23	-3.832e+04
	38	6	8.906e+04	1.589e+04	-2.50e-03	-839.75	0.0	-108.65	-419.08	-62.84	973.99	1.589e+04	-
8.906e+04			-1.458e+05	-1.353e+04	-0.02	0.0	279.9	-108.65	-1258.84	-62.84	973.99	-1.353e+04	-
1.458e+05	38	10	8.901e+04	5868.33	-2.49e-03	-839.75	0.0	-123.13	-419.64	-82.59	1215.04	5868.33	8.901e+04
			-1.460e+05	-1.573e+04	-0.02	0.0	279.9	-123.13	-1259.39	-82.59	1215.04	-1.573e+04	-
1.460e+05	38	13	4.849e+04	-1.025e+04	1.51e-03	-839.75	0.0	-227.84	-137.34	-75.96	5411.22	-1.025e+04	-
4.849e+04			-1.075e+05	-1.457e+04	0.02	0.0	279.9	-227.84	-977.09	-75.96	5411.22	-1.457e+04	-
1.075e+05	38	16	3.009e+04	1.472e+04	3.53e-03	-839.75	0.0	263.42	887.80	76.98	5067.05	1.012e+04	-
1.009e+05			-1.009e+05	1.012e+04	-0.02	0.0	279.9	263.42	48.05	76.98	5067.05	1.472e+04	-
3.009e+04	38	21	9797.98	-1.678e+04	1.27e-03	-839.75	0.0	-192.86	152.51	-188.21	1.161e+04	-1.678e+04	5942.55
			-6.881e+04	-3.003e+04	0.02	0.0	279.9	-192.86	-687.25	-188.21	1.161e+04	-3.003e+04	-
6.881e+04	38	24	1185.52	3.019e+04	2.27e-03	-839.75	0.0	228.44	597.96	189.24	-1136.69	1.665e+04	-
5.832e+04			-5.832e+04	1.665e+04	-0.02	0.0	279.9	228.44	-241.80	189.24	-1136.69	3.019e+04	-8570.03
	38	38	1.353e+05	2.202e+04	-3.91e-03	-839.75	0.0	-115.71	-737.62	-85.51	-710.16	2.202e+04	-
1.353e+05			-1.888e+05	-1.847e+04	-0.03	0.0	279.9	-115.71	-1577.37	-85.51	-710.16	-1.847e+04	-
1.888e+05	38	42	1.352e+05	8043.23	-3.90e-03	-839.75	0.0	-136.14	-738.41	-113.44	-354.45	8043.23	1.352e+05
			-1.890e+05	-2.156e+04	-0.02	0.0	279.9	-136.14	-1578.16	-113.44	-354.45	-2.156e+04	-
1.890e+05	38	45	7.814e+04	-1.428e+04	-2.33e-03	-839.75	0.0	-276.85	-340.76	-105.10	5518.78	-1.428e+04	-
7.814e+04			-1.347e+05	-1.990e+04	0.03	0.0	279.9	-276.85	-1180.52	-105.10	5518.78	-1.990e+04	-
1.347e+05	38	48	5.737e+04	2.005e+04	4.47e-03	-839.75	0.0	312.42	1091.23	106.13	4959.50	1.415e+04	-
1.305e+05			-1.305e+05	1.415e+04	-0.03	0.0	279.9	312.42	251.47	106.13	4959.50	2.005e+04	-



EGP CODE

GRE.EEC.R.73.IT.W.15235.12.024.01

PAGE

308 di/of 527

5.737e+04	38	53	1.951e+04	-2.351e+04	-1.19e-03	-839.75	0.0	-263.59	63.14	-262.61	1.417e+04	-2.351e+04	
1.884e+04			-8.089e+04	-4.188e+04	0.03	0.0	279.9	-263.59	-776.61	-262.61	1.417e+04	-4.188e+04	-
8.089e+04	38	56	7371.87	4.204e+04	2.70e-03	-839.75	0.0	299.16	687.32	263.64	-3693.39	2.337e+04	-
7.122e+04			-7.122e+04	2.337e+04	-0.03	0.0	279.9	299.16	-152.44	263.64	-3693.39	4.204e+04	3512.68
	38	69	-2761.19	77.911.52e-03	-839.75	0.0	17.79	375.23	0.51	5239.14	-65.93	-2.619e+04	
			-3.869e+04	-65.931.11e-03	0.0	279.9	17.79	-464.52	0.51	5239.14	77.91	-3.869e+04	
	38	70	-2949.49	106.441.66e-03	-839.75	0.0	19.20	375.50	0.70	7210.48	-90.21	-2.641e+04	
			-3.883e+04	-90.211.53e-03	0.0	279.9	19.20	-464.26	0.70	7210.48	106.44	-3.883e+04	
	38	71	-2761.19	77.911.52e-03	-839.75	0.0	17.79	375.23	0.51	5239.14	-65.93	-2.619e+04	
			-3.869e+04	-65.931.11e-03	0.0	279.9	17.79	-464.52	0.51	5239.14	77.91	-3.869e+04	
	38	72	-2798.85	83.621.55e-03	-839.75	0.0	18.07	375.28	0.55	5633.41	-70.78	-2.623e+04	
			-3.872e+04	-70.781.20e-03	0.0	279.9	18.07	-464.47	0.55	5633.41	83.62	-3.872e+04	
	38	73	-2761.19	77.911.52e-03	-839.75	0.0	17.79	375.23	0.51	5239.14	-65.93	-2.619e+04	
			-3.869e+04	-65.931.11e-03	0.0	279.9	17.79	-464.52	0.51	5239.14	77.91	-3.869e+04	
	39	2	-3998.50	86.482.23e-03	-1091.68	0.0	29.42	486.54	-0.69	-9790.19	86.48	-3.431e+04	
			-5.090e+04	-106.79	-2.11e-03	0.0	279.9	29.42	-605.14	-0.69	-9790.19	-106.79	-5.090e+04
	39	3	-2701.08	45.451.47e-03	-839.75	0.0	13.46	377.01	-0.37	-5212.81	45.45	-2.634e+04	
			-3.834e+04	-57.88	-1.13e-03	0.0	279.9	13.46	-462.75	-0.37	-5212.81	-57.88	-3.834e+04
	39	6	5.016e+04	1.436e+04	-1.49e-03	-839.75	0.0	-229.38	-140.10	74.14	-5422.58	9878.26	
5.016e+04			-1.079e+05	9878.26	0.02	0.0	279.9	-229.38	-979.86	74.14	-5422.58	1.436e+04	-1.079e+05
	39	7	3.046e+04	-9787.703.66e-03	-839.75	0.0	264.74	890.65	-74.87	-5052.35	-9787.70	-1.026e+05	
			-1.026e+05	-1.447e+04	0.02	0.0	279.9	264.74	50.90	-74.87	-5052.35	-1.447e+04	
3.046e+04													
8.921e+04													
8.921e+04													
8.917e+04													
8.917e+04													
1.040e+04													
6.900e+04													
6.284e+04													
6.284e+04													
1.355e+05													
1.354e+05													
1.354e+05													
6.549e+04													
6.101e+04													
6.101e+04													
1.192e+04													
2.507e+04													
2.507e+04													
8.117e+04													
8.117e+04													
7.751e+04													
7.751e+04													
	39	69	-2785.99	45.281.52e-03	-839.75	0.0	17.68	375.27	-0.36	-5237.47	45.28	-2.622e+04	
			-3.871e+04	-56.25	-1.13e-03	0.0	279.9	17.68	-0.36	-5237.47	-56.25	-3.871e+04	
	39	70	-2980.52	63.801.66e-03	-839.75	0.0	19.15	375.55	-0.51	-7208.68	63.80	-2.645e+04	
			-3.886e+04	-79.78	-1.56e-03	0.0	279.9	19.15	-0.51	-7208.68	-79.78	-3.886e+04	
	39	71	-2785.99	45.281.52e-03	-839.75	0.0	17.68	375.27	-0.36	-5237.47	45.28	-2.622e+04	
			-3.871e+04	-56.25	-1.13e-03	0.0	279.9	17.68	-0.36	-5237.47	-56.25	-3.871e+04	
	39	72	-2824.90	48.981.55e-03	-839.75	0.0	17.98	375.33	-0.39	-5631.71	48.98	-2.627e+04	
			-3.874e+04	-60.95	-1.22e-03	0.0	279.9	17.98	-0.39	-5631.71	-60.95	-3.874e+04	
	39	73	-2785.99	45.281.52e-03	-839.75	0.0	17.68	375.27	-0.36	-5237.47	45.28	-2.622e+04	
			-3.871e+04	-56.25	-1.13e-03	0.0	279.9	17.68	-0.36	-5237.47	-56.25	-3.871e+04	
	40	1	4.905e+04	85.11	-0.01	-1618.80	0.0	0.22	921.33	0.52	-2.243e+04	-129.81	-5.975e+04
			-5.975e+04	-129.81	-7.16e-03	0.0	415.1	0.22	-697.47	0.52	-2.243e+04	85.11	-1.329e+04
	40	2	4.958e+04	126.77	-0.01	-1618.80	0.0	12.57	920.62	0.76	-3.211e+04	-190.41	-5.905e+04
			-5.905e+04	-190.41	-0.01	0.0	415.1	12.57	-698.18	0.76	-3.211e+04	126.77	-1.288e+04
	40	3	3.765e+04	70.68	-0.01	-1245.23	0.0	-6.77	705.13	0.42	-1.709e+04	-104.41	-4.518e+04



EGP CODE

GRE.EEC.R.73.IT.W.15235.12.024.01

PAGE

309 di/of 527

40	-4.518e+04	-104.41-5.47e-03	0.0	415.1	-6.77	-540.10	0.42-1.709e+04	70.68-1.093e+04		
2.931e+04	5 4.049e+04	3.023e+04	-7.41e-03	-1245.23	0.0	335.66	259.32	-239.31-1.348e+04	3.023e+04	
1.215e+05	-1.215e+05	-6.924e+04	-0.02	0.0	415.1	335.66	-985.91	-239.31-1.348e+04	-6.924e+04	-
40	8 1.018e+05	6.937e+04	-0.02	-1245.23	0.0	-341.36	1154.99	240.13-2.089e+04	-3.044e+04	-
1.205e+05	-1.205e+05	-3.044e+04	-0.01	0.0	415.1	-341.36	-90.24	240.13-2.089e+04	6.937e+04	
1.004e+05	9 4.060e+04	3.349e+04	-7.31e-03	-1245.23	0.0	332.77	258.10	-251.53-1.328e+04	3.349e+04	
2.953e+04	-1.218e+05	-7.103e+04	-0.02	0.0	415.1	332.77	-987.13	-251.53-1.328e+04	-7.103e+04	-
1.218e+05	12 1.020e+05	7.116e+04	-0.02	-1245.23	0.0	-338.47	1156.21	252.35-2.108e+04	-3.369e+04	-
1.208e+05	-1.208e+05	-3.369e+04	9.78e-03	0.0	415.1	-338.47	-89.02	252.35-2.108e+04	7.116e+04	
1.007e+05	14 6.827e+04	7068.41-7.22e-03	-1245.23	0.0	-274.27	39.57	-106.08-1.667e+04	7068.41 6.801e+04		
40	-1.740e+05	-3.717e+04	0.02	0.0	415.1	-274.27	-1205.66	-106.08-1.667e+04	-3.717e+04	-
1.740e+05	15 1.529e+05	3.731e+04	-0.02	-1245.23	0.0	268.57	1374.73	106.90-1.769e+04	-7272.09	-
1.593e+05	-1.593e+05	-7272.09-0.02	0.0	415.1	268.57	129.50	106.90-1.769e+04	3.731e+04 1.529e+05		
40	37 6.001e+04	4.154e+04	-7.66e-03	-1245.23	0.0	422.01	80.85	-327.88-1.207e+04	4.154e+04	
5.913e+04	-1.658e+05	-9.475e+04	-0.02	0.0	415.1	422.01	-1164.38	-327.88-1.207e+04	-9.475e+04	-
1.658e+05	40 1.447e+05	9.488e+04	-0.02	-1245.23	0.0	-427.71	1333.46	328.70-2.229e+04	-4.174e+04	-
1.504e+05	-1.504e+05	-4.174e+04	-0.01	0.0	415.1	-427.71	88.22	328.70-2.229e+04	9.488e+04	
1.447e+05	41 6.030e+04	4.604e+04	-7.26e-03	-1245.23	0.0	417.89	79.11	-344.61-1.182e+04	4.604e+04	
5.945e+04	-1.662e+05	-9.716e+04	-0.03	0.0	415.1	417.89	-1166.12	-344.61-1.182e+04	-9.716e+04	-
1.662e+05	44 1.451e+05	9.730e+04	-0.02	-1245.23	0.0	-423.58	1335.20	345.42-2.254e+04	-4.624e+04	-
1.507e+05	-1.507e+05	-4.624e+04	0.02	0.0	415.1	-423.58	89.97	345.42-2.254e+04	9.730e+04	
1.451e+05	46 1.136e+05	9316.02-8.43e-03	-1245.23	0.0	-322.01	-228.25	-142.20-1.651e+04	9316.02 1.136e+05		
40	-2.396e+05	-5.001e+04	0.02	0.0	415.1	-322.01	-1473.49	-142.20-1.651e+04	-5.001e+04	-
2.396e+05	47 2.185e+05	5.015e+04	-0.03	-1245.23	0.0	316.32	1642.56	143.02-1.786e+04	-9519.70	-
2.048e+05	-2.048e+05	-9519.70-0.03	0.0	415.1	316.32	397.33	143.02-1.786e+04	5.015e+04 2.185e+05		
40	69 3.769e+04	67.73-0.01	-1245.23	0.0	-2.85	707.15	0.41-1.718e+04	-101.84-4.562e+04		
	-4.562e+04	-101.84-5.49e-03	0.0	415.1	-2.85	-538.08	0.41-1.718e+04	67.73-1.053e+04		
40	70 3.805e+04	95.50-0.01	-1245.23	0.0	5.39	706.68	0.57-2.364e+04	-142.23-4.516e+04		
	-4.516e+04	-142.23-7.56e-03	0.0	415.1	5.39	-538.55	0.57-2.364e+04	95.50-1.026e+04		
40	71 3.769e+04	67.73-0.01	-1245.23	0.0	-2.85	707.15	0.41-1.718e+04	-101.84-4.562e+04		
	-4.562e+04	-101.84-5.49e-03	0.0	415.1	-2.85	-538.08	0.41-1.718e+04	67.73-1.053e+04		
40	72 3.776e+04	73.29-0.01	-1245.23	0.0	-1.20	707.06	0.44-1.847e+04	-109.92-4.553e+04		
	-4.553e+04	-109.92-5.91e-03	0.0	415.1	-1.20	-538.17	0.44-1.847e+04	73.29-1.048e+04		
40	73 3.769e+04	67.73-0.01	-1245.23	0.0	-2.85	707.15	0.41-1.718e+04	-101.84-4.562e+04		
	-4.562e+04	-101.84-5.49e-03	0.0	415.1	-2.85	-538.08	0.41-1.718e+04	67.73-1.053e+04		
41	2 6.513e+05	86.57-0.44-1.358e+04	0.0	0.0-1836.71	6788.59	0.06	-0.86	50.17-4.179e+05		
	-4.180e+05	50.17-1.13e-04	0.0	630.0-1836.71	-6788.94	0.06	-0.86	86.57-4.180e+05		
41	3 3.759e+05	48.77-0.25	-7821.20	0.0-1058.33	3910.50	0.04	-0.81	22.98-2.399e+05		
	-2.400e+05	22.98-6.00e-05	0.0	630.0-1058.33	-3910.71	0.04	-0.81	48.77-2.400e+05		
41	5 3.768e+05	1.211e+04	-0.26	-7835.94	0.0	-820.21	3865.19	31.15	-2035.86	-7721.97
2.237e+05	-2.569e+05	-7721.97-0.06	0.0	630.0	-820.21	-3970.75	31.15	-2035.86	1.211e+04-2.569e+05	
41	8 3.770e+05	7771.45-0.25-7835.94	0.06	0.0-1288.47	3970.53	-31.08	2034.75	7771.45-2.566e+05		
	-2.566e+05	-1.202e+04	0.06	0.0	630.0	-1288.47	-3865.40	-31.08	2034.75-1.202e+04	
2.235e+05	25 3.791e+05	4.335e+04	-0.26	-7835.94	0.0	-974.04	3615.64	-134.93	261.06 4.335e+04	
1.450e+05	-3.354e+05	-4.172e+04	0.01	0.0	630.0	-974.04	-4220.30	-134.93	261.06-4.172e+04	
3.354e+05	41 28 3.792e+05	4.181e+04	-0.25	-7835.94	0.0	-1134.64	4220.08	135.00	-262.17-4.330e+04	
3.353e+05	-3.353e+05	-4.330e+04	-0.01	0.0	630.0	-1134.64	-3615.85	135.00	-262.17 4.181e+04	
1.450e+05	41 31 3.875e+05	3.095e+04	-0.26	-7835.94	0.0	-1116.92	3405.47	-99.99	318.43 3.095e+04	
7.869e+04	-4.016e+05	-3.210e+04	0.03	0.0	630.0	-1116.92	-4430.46	-99.99	318.43-3.210e+04	



EGP CODE

GRE.EEC.R.73.IT.W.15235.12.024.01

PAGE

310 di/of 527

4.016e+05	41	33	3.874e+05	3.242e+04	-0.26	-7835.94	0.0	-978.58	3405.60	-100.62	333.06	3.242e+04	-
7.881e+04			-4.016e+05	-3.103e+04	0.03	0.0	630.0	-978.58	-4430.33	-100.62	333.06	-3.103e+04	-
4.016e+05	41	37	3.767e+05	1.689e+04	-0.26	-7835.94	0.0	-735.78	3844.18	43.61	-2843.41	-1.086e+04	-
2.171e+05			-2.636e+05	-1.086e+04	-0.09	0.0	630.0	-735.78	-3991.76	43.61	-2843.41	1.689e+04	-
2.636e+05	41	40	3.771e+05	1.091e+04	-0.25	-7835.94	0.0	-1372.89	3991.54	-43.54	2842.30	1.091e+04	-
2.631e+05			-2.631e+05	-1.680e+04	0.09	0.0	630.0	-1372.89	-3844.39	-43.54	2842.30	-1.680e+04	-
2.168e+05	41	57	3.838e+05	6.029e+04	-0.26	-7835.94	0.0	-945.09	3497.78	-187.75	367.21	6.029e+04	-
1.079e+05			-3.726e+05	-5.807e+04	0.02	0.0	630.0	-945.09	-4338.15	-187.75	367.21	-5.807e+04	-
3.726e+05	41	60	3.839e+05	5.816e+04	-0.25	-7835.94	0.0	-1163.58	4337.94	187.82	-368.32	-6.024e+04	-
3.724e+05			-3.724e+05	-6.024e+04	-0.02	0.0	630.0	-1163.58	-3498.00	187.82	-368.32	5.816e+04	-
1.078e+05	41	63	3.956e+05	4.329e+04	-0.26	-7835.94	0.0	-1139.46	3200.20	-139.87	444.26	4.329e+04	-
1.401e+04			-4.662e+05	-4.490e+04	0.04	0.0	630.0	-1139.46	-4635.73	-139.87	444.26	-4.490e+04	-
4.662e+05	41	65	3.955e+05	4.532e+04	-0.26	-7835.94	0.0	-951.25	3200.40	-140.74	464.60	4.532e+04	-
1.419e+04			-4.663e+05	-4.343e+04	0.04	0.0	630.0	-951.25	-4635.53	-140.74	464.60	-4.343e+04	-
4.663e+05	41	69	3.769e+05	46.81-0.25	-7835.94	0.0-1054.34	3917.86	0.04	-0.55	24.74	-2.401e+05		-
			-2.402e+05	24.74-5.94e-05	0.0	630.0-1054.34	-3918.08	0.04	-0.55	46.81	-2.402e+05		-
	41	70	4.838e+05	65.25-0.33-1.009e+04	0.0	0.0-1367.71	5043.20	0.05	-0.81	35.57	-3.105e+05		-
			-3.106e+05	35.57-8.35e-05	0.0	630.0-1367.71	-5043.46	0.05	-0.81	65.25	-3.106e+05		-
	41	71	3.769e+05	46.81-0.25	-7835.94	0.0-1054.34	3917.86	0.04	-0.55	24.74	-2.401e+05		-
			-2.402e+05	24.74-5.94e-05	0.0	630.0-1054.34	-3918.08	0.04	-0.55	46.81	-2.402e+05		-
	41	72	3.983e+05	50.50-0.27	-8286.08	0.0-1117.01	4142.93	0.04	-0.61	26.90	-2.542e+05		-
			-2.543e+05	26.90-6.42e-05	0.0	630.0-1117.01	-4143.15	0.04	-0.61	50.50	-2.543e+05		-
	41	73	3.769e+05	46.81-0.25	-7835.94	0.0-1054.34	3917.86	0.04	-0.55	24.74	-2.401e+05		-
			-2.402e+05	24.74-5.94e-05	0.0	630.0-1054.34	-3918.08	0.04	-0.55	46.81	-2.402e+05		-
	42	2	6.925e+05	88.74-0.47-1.419e+04	0.0	0.0-2019.98	7092.63	-0.02	2.29	88.74	-4.246e+05		-
			-4.246e+05	78.26-1.37e-04	0.0	630.0-2019.98	-7092.78	-0.02	2.29	78.26	-4.246e+05		-
	42	3	3.979e+05	49.54-0.27	-8145.43	0.0-1157.02	4072.67	-6.92e-03	1.29	49.54	-2.436e+05		-
			-2.436e+05	45.17-7.81e-05	0.0	630.0-1157.02	-4072.76	-6.92e-03	1.29	45.17	-2.436e+05		-
	42	18	3.989e+05	1.458e+04	-0.27	-8160.96	0.0	-1199.31	4256.18	-47.44	2258.67	1.458e+04	-
2.991e+05			-2.991e+05	-1.531e+04	0.06	0.0	630.0	-1199.31	-3904.79	-47.44	2258.67	-1.531e+04	-
1.884e+05	42	19	3.989e+05	1.540e+04	-0.27	-8160.96	0.0	-1106.24	3904.69	47.42	-2256.05	-1.448e+04	-
1.884e+05			-2.991e+05	-1.448e+04	-0.06	0.0	630.0	-1106.24	-4256.28	47.42	-2256.05	1.540e+04	-
2.991e+05	42	29	4.111e+05	2.693e+04	-0.28	-8160.96	0.0	-1163.02	3515.47	-85.81	-334.02	2.693e+04	-
6.575e+04			-4.217e+05	-2.713e+04	-0.01	0.0	630.0	-1163.02	-4645.49	-85.81	-334.02	-2.713e+04	-
4.217e+05	42	32	4.111e+05	2.721e+04	-0.27	-8160.96	0.0	-1142.53	4645.40	85.79	336.65	-2.683e+04	-
4.217e+05			-4.217e+05	-2.683e+04	0.01	0.0	630.0	-1142.53	-3515.57	85.79	336.65	2.721e+04	-
6.582e+04	42	33	4.110e+05	4.186e+04	-0.28	-8160.96	0.0	-1163.05	3519.76	-133.20	1072.09	4.186e+04	-
6.710e+04			-4.204e+05	-4.206e+04	0.03	0.0	630.0	-1163.05	-4641.21	-133.20	1072.09	-4.206e+04	-
4.204e+05	42	36	4.109e+05	4.214e+04	-0.27	-8160.96	0.0	-1142.51	4641.11	133.19	-1069.46	-4.176e+04	-
4.204e+05			-4.204e+05	-4.176e+04	-0.03	0.0	630.0	-1142.51	-3519.85	133.19	-1069.46	4.214e+04	-
6.717e+04	42	50	3.989e+05	2.030e+04	-0.27	-8160.96	0.0	-1215.17	4326.08	-66.07	3154.32	2.030e+04	-
3.211e+05			-3.211e+05	-2.134e+04	0.08	0.0	630.0	-1215.17	-3834.89	-66.07	3154.32	-2.134e+04	-
1.664e+05	42	51	3.989e+05	2.143e+04	-0.27	-8160.96	0.0	-1090.38	3834.79	66.06	-3151.69	-2.020e+04	-
1.664e+05			-3.211e+05	-2.020e+04	-0.08	0.0	630.0	-1090.38	-4326.17	66.06	-3151.69	2.143e+04	-
3.211e+05	42	61	4.211e+05	3.771e+04	-0.28	-8160.96	0.0	-1166.42	3289.09	-120.19	-465.89	3.771e+04	5560.84





EGP CODE

GRE.EEC.R.73.IT.W.15235.12.024.01

PAGE

311 di/of 527

4.930e+05		-4.930e+05	-3.801e+04	-0.02	0.0	630.0	-1166.42	-4871.88	-120.19	-465.89	-3.801e+04	-
42	64	4.210e+05	3.810e+04	-0.27	-8160.96	0.0	-1139.13	4871.78	120.17	468.52	-3.761e+04	-
4.930e+05		-4.930e+05	-3.761e+04	0.02	0.0	630.0	-1139.13	-3289.19	120.17	468.52	3.810e+04	5481.23
42	65	4.206e+05	5.854e+04	-0.28	-8160.96	0.0	-1166.43	3294.76	-186.33	1498.52	5.854e+04	3774.20
		-4.912e+05	-5.885e+04	0.04	0.0	630.0	-1166.43	-4866.20	-186.33	1498.52	-5.885e+04	-
4.912e+05		-4.912e+05	-5.844e+04	-0.04	0.0	630.0	-1139.12	-3294.86	186.31	-1495.90	5.893e+04	3693.09
42	68	4.206e+05	5.893e+04	-0.27	-8160.96	0.0	-1139.12	4866.10	186.31	-1495.90	-5.844e+04	-
4.912e+05		-4.912e+05	-5.844e+04	-0.04	0.0	630.0	-1139.12	-3294.86	186.31	-1495.90	5.893e+04	3693.09
42	69	3.989e+05	50.08-0.27	-8160.96	0.0-1152.78	4080.43	-8.98e-03	1.31	50.08	-2.437e+05		
		-2.438e+05	44.43-7.77e-05	0.0	630.0-1152.78	-4080.53	-8.98e-03	1.31	44.43	-2.438e+05		
42	70	5.141e+05	65.48-0.35-1.053e+04	0.0	0.0-1503.19	5267.30	-0.01	1.69	65.48	-3.154e+05		
		-3.155e+05	58.59-1.02e-04	0.0	630.0-1503.19	-5267.41	-0.01	1.69	58.59	-3.155e+05		
42	71	3.989e+05	50.08-0.27	-8160.96	0.0-1152.78	4080.43	-8.98e-03	1.31	50.08	-2.437e+05		
		-2.438e+05	44.43-7.77e-05	0.0	630.0-1152.78	-4080.53	-8.98e-03	1.31	44.43	-2.438e+05		
42	72	4.220e+05	53.16-0.29	-8635.71	0.0-1222.86	4317.81	-9.37e-03	1.39	53.16	-2.581e+05		
		-2.581e+05	47.26-8.25e-05	0.0	630.0-1222.86	-4317.91	-9.37e-03	1.39	47.26	-2.581e+05		
42	73	3.989e+05	50.08-0.27	-8160.96	0.0-1152.78	4080.43	-8.98e-03	1.31	50.08	-2.437e+05		
		-2.438e+05	44.43-7.77e-05	0.0	630.0-1152.78	-4080.53	-8.98e-03	1.31	44.43	-2.438e+05		
43	1	5.437e+05	20.65-0.37-1.105e+04	0.0	0.0-1585.06	5524.01	0.05	-1.17	-9.00	-3.263e+05		
		-3.263e+05	-9.00-1.14e-05	0.0	630.0-1585.06	-5524.12	0.05	-1.17	20.65	-3.263e+05		
43	2	7.270e+05	28.53-0.50-1.479e+04	0.0	0.0-2149.80	7396.60	0.06	-1.53	-8.57	-4.379e+05		
		-4.379e+05	-8.57-1.83e-05	0.0	630.0-2149.80	-7396.71	0.06	-1.53	28.53	-4.379e+05		
43	3	4.163e+05	15.83-0.28	-8469.65	0.0-1226.53	4234.79	0.04	-0.87	-7.25	-2.507e+05		
		-2.507e+05	-7.25-9.09e-06	0.0	630.0-1226.53	-4234.86	0.04	-0.87	15.83	-2.507e+05		
43	17	4.174e+05	3.625e+04	-0.29	-8485.99	0.0	-1214.33	4061.27	-114.81	2562.32	3.625e+04	-
1.936e+05		-3.081e+05	-3.608e+04	0.06	0.0	630.0	-1214.33	-4424.72	-114.81	2562.32	-3.608e+04	-
3.081e+05		-3.081e+05	-3.626e+04	-0.06	0.0	630.0	-1230.53	-4061.34	114.89	-2564.10	3.611e+04	-
43	20	4.174e+05	3.611e+04	-0.28	-8485.99	0.0	-1230.53	4424.65	114.89	-2564.10	-3.626e+04	-
3.081e+05		-3.081e+05	-3.626e+04	-0.06	0.0	630.0	-1230.53	-4061.34	114.89	-2564.10	3.611e+04	-
1.936e+05		-3.081e+05	-3.608e+04	0.06	0.0	630.0	-1214.33	-4424.72	-114.81	2562.32	-3.608e+04	-
43	33	4.320e+05	3.813e+04	-0.29	-8485.99	0.0	-1219.01	3607.76	-120.95	1064.43	3.813e+04	-
5.075e+04		-4.509e+05	-3.807e+04	0.03	0.0	630.0	-1219.01	-4878.23	-120.95	1064.43	-3.807e+04	-
4.509e+05		-4.509e+05	-3.807e+04	0.03	0.0	630.0	-1219.01	-4878.23	-120.95	1064.43	-3.807e+04	-
43	34	4.322e+05	2.183e+04	-0.28	-8485.99	0.0	-1221.19	4884.01	69.22	413.10	-2.178e+04	-
4.528e+05		-4.528e+05	-2.178e+04	0.01	0.0	630.0	-1221.19	-3601.98	69.22	413.10	2.183e+04	-
4.896e+04		-4.528e+05	-2.178e+04	0.01	0.0	630.0	-1221.19	-3601.98	69.22	413.10	2.183e+04	-
43	35	4.322e+05	2.177e+04	-0.29	-8485.99	0.0	-1223.67	3601.91	-69.15	-414.88	2.177e+04	-
4.890e+04		-4.528e+05	-2.180e+04	-0.01	0.0	630.0	-1223.67	-4884.08	-69.15	-414.88	-2.180e+04	-
4.528e+05		-4.528e+05	-2.180e+04	-0.01	0.0	630.0	-1223.67	-4884.08	-69.15	-414.88	-2.180e+04	-
43	36	4.320e+05	3.810e+04	-0.28	-8485.99	0.0	-1225.86	4878.16	121.02	-1066.20	-3.814e+04	-
4.509e+05		-4.509e+05	-3.814e+04	-0.03	0.0	630.0	-1225.86	-3607.83	121.02	-1066.20	3.810e+04	-
5.080e+04		-4.509e+05	-3.814e+04	-0.03	0.0	630.0	-1225.86	-3607.83	121.02	-1066.20	3.810e+04	-
43	49	4.174e+05	5.065e+04	-0.29	-8485.99	0.0	-1211.31	3988.30	-160.45	3580.23	5.065e+04	-
1.706e+05		-3.311e+05	-5.043e+04	0.09	0.0	630.0	-1211.31	-4497.69	-160.45	3580.23	-5.043e+04	-
3.311e+05		-3.311e+05	-5.043e+04	0.09	0.0	630.0	-1211.31	-4497.69	-160.45	3580.23	-5.043e+04	-
43	52	4.174e+05	5.046e+04	-0.28	-8485.99	0.0	-1233.55	4497.62	160.52	-3582.01	-5.067e+04	-
3.311e+05		-3.311e+05	-5.067e+04	-0.09	0.0	630.0	-1233.55	-3988.37	160.52	-3582.01	5.046e+04	-
1.706e+05		-3.311e+05	-5.067e+04	-0.09	0.0	630.0	-1233.55	-3988.37	160.52	-3582.01	5.046e+04	-
43	65	4.457e+05	5.335e+04	-0.29	-8485.99	0.0	-1217.73	3353.17	-169.25	1488.64	5.335e+04	-
2.945e+04		-5.311e+05	-5.327e+04	0.04	0.0	630.0	-1217.73	-5132.82	-169.25	1488.64	-5.327e+04	-
5.311e+05		-5.311e+05	-5.327e+04	0.04	0.0	630.0	-1217.73	-5132.82	-169.25	1488.64	-5.327e+04	-
43	66	4.463e+05	3.058e+04	-0.28	-8485.99	0.0	-1220.73	5140.84	96.99	576.13	-3.052e+04	-
5.337e+05		-5.337e+05	-3.052e+04	0.02	0.0	630.0	-1220.73	-3345.15	96.99	576.13	3.058e+04	-
3.193e+04		-5.337e+05	-3.052e+04	0.02	0.0	630.0	-1220.73	-3345.15	96.99	576.13	3.058e+04	-
43	67	4.464e+05	3.050e+04	-0.29	-8485.99	0.0	-1224.13	3345.08	-96.92	-577.91	3.050e+04	-
3.201e+04		-5.337e+05	-3.055e+04	-0.02	0.0	630.0	-1224.13	-5140.91	-96.92	-577.91	-3.055e+04	-
5.337e+05		-5.337e+05	-3.055e+04	-0.02	0.0	630.0	-1224.13	-5140.91	-96.92	-577.91	-3.055e+04	-
43	68	4.457e+05	5.330e+04	-0.28	-8485.99	0.0	-1227.13	5132.75	169.32	-1490.42	-5.337e+04	-
5.311e+05		-5.311e+05	-5.337e+04	-0.04	0.0	630.0	-1227.13	-3353.25	169.32	-1490.42	5.330e+04	-
2.939e+04		-5.311e+05	-5.337e+04	-0.04	0.0	630.0	-1227.13	-3353.25	169.32	-1490.42	5.330e+04	-
43	69	4.174e+05	15.86-0.28	-8485.99	0.0-1222.43	4242.96	0.04	-0.89	-7.07	-2.508e+05		



EGP CODE

GRE.EEC.R.73.IT.W.15235.12.024.01

PAGE

312 di/of 527

43	70	-2.509e+05	-7.07-8.90e-06	0.0	630.0-1222.43	-4243.03	0.04	-0.89	15.86-2.509e+05	-		
		5.396e+05	21.11-0.37-1.098e+04		0.0-1598.92	5491.35	0.04	-1.12	-6.78-3.252e+05	-		
		-3.253e+05	-6.78-1.34e-05	0.0	630.0-1598.92	-5491.42	0.04	-1.12	21.11-3.253e+05	-		
43	71	4.174e+05	15.86-0.28	-8485.99	0.0-1222.43	4242.96	0.04	-0.89	-7.07-2.508e+05	-		
		-2.509e+05	-7.07-8.90e-06	0.0	630.0-1222.43	-4243.03	0.04	-0.89	15.86-2.509e+05	-		
43	72	4.418e+05	16.91-0.30	-8985.35	0.0-1297.73	4492.64	0.04	-0.94	-7.01-2.657e+05	-		
		-2.657e+05	-7.01-9.78e-06	0.0	630.0-1297.73	-4492.71	0.04	-0.94	16.91-2.657e+05	-		
43	73	4.174e+05	15.86-0.28	-8485.99	0.0-1222.43	4242.96	0.04	-0.89	-7.07-2.508e+05	-		
		-2.509e+05	-7.07-8.90e-06	0.0	630.0-1222.43	-4243.03	0.04	-0.89	15.86-2.509e+05	-		
44	2	8.130e+05	69.50-0.55-1.667e+04		0.0-2392.44	8334.13	0.04	1.38	45.47-4.995e+05	-		
		-4.996e+05	45.47-9.39e-05	0.0	630.0-2392.44	-8334.36	0.04	1.38	69.50-4.996e+05	-		
44	3	4.622e+05	38.36-0.31	-9469.80	0.0-1355.66	4734.83	0.02	0.84	23.46-2.835e+05	-		
		-2.836e+05	23.46-5.09e-05	0.0	630.0-1355.66	-4734.96	0.02	0.84	38.36-2.836e+05	-		
44	17	4.634e+05	3.257e+04	-0.32	-9488.62	0.0	-1346.34	4547.82	-103.34	2898.95 3.257e+04		
2.219e+05										-		
		-3.457e+05	-3.253e+04	0.06	0.0	630.0	-1346.34	-4940.80	-103.34	2898.95-3.253e+04	-	
3.457e+05	44	20	4.634e+05	3.260e+04	-0.31	-9488.62	0.0	-1357.51	4940.66	103.38	-2897.27-3.253e+04	-
3.457e+05											-	
		-3.457e+05	-3.253e+04	-0.06	0.0	630.0	-1357.51	-4547.96	103.38	-2897.27 3.260e+04	-	
2.220e+05	44	28	4.701e+05	5.900e+04	-0.31	-9488.62	0.0	-1354.45	5210.56	187.19	-764.48-5.893e+04	-
4.307e+05											-	
		-4.307e+05	-5.893e+04	-0.02	0.0	630.0	-1354.45	-4278.06	187.19	-764.48 5.900e+04	-	
1.370e+05	44	29	4.799e+05	2445.77-0.32-9488.62		0.0-1348.89	4028.16	-7.67	-610.80	2445.77-5.823e+04	-	
											-	
		-5.094e+05	-2385.52-0.01	0.0	630.0-1348.89	-5460.46	-7.67	-610.80	-2385.52-5.094e+05	-		
44	35	4.799e+05	2236.55-0.32-9488.62		0.0-1351.87	4027.96	-6.99	-627.73	2236.55-5.818e+04	-		
											-	
		-5.095e+05	-2168.77-0.01	0.0	630.0-1351.87	-5460.67	-6.99	-627.73	-2168.77-5.095e+05	-		
44	49	4.634e+05	4.550e+04	-0.32	-9488.62	0.0	-1345.57	4468.78	-144.38	4049.62 4.550e+04	-	
1.970e+05											-	
		-3.706e+05	-4.546e+04	0.09	0.0	630.0	-1345.57	-5019.84	-144.38	4049.62-4.546e+04	-	
3.706e+05	44	52	4.633e+05	4.553e+04	-0.31	-9488.62	0.0	-1358.28	5019.70	144.43	-4047.95-4.545e+04	-
3.706e+05											-	
		-3.706e+05	-4.545e+04	-0.09	0.0	630.0	-1358.28	-4468.92	144.43	-4047.95 4.553e+04	-	
1.971e+05	44	60	4.774e+05	8.260e+04	-0.31	-9488.62	0.0	-1354.98	5397.71	262.13	-1069.74-8.253e+04	-
4.897e+05											-	
		-4.897e+05	-8.253e+04	-0.03	0.0	630.0	-1354.98	-4090.91	262.13	-1069.74 8.260e+04	-	
7.803e+04	44	67	4.957e+05	3111.50-0.33-9488.62		0.0-1351.46	3741.02	-9.77	-876.73	3111.50 3.220e+04	-	
											-	
		-5.999e+05	-3041.42-0.02	0.0	630.0-1351.46	-5747.60	-9.77	-876.73	-3041.42-5.999e+05	-		
44	69	4.634e+05	38.22-0.31	-9488.62	0.0-1351.93	4744.24	0.02	0.84	23.61-2.838e+05	-		
											-	
		-2.839e+05	23.61-5.07e-05	0.0	630.0-1351.93	-4744.38	0.02	0.84	38.22-2.839e+05	-		
44	70	6.030e+05	51.52-0.41-1.236e+04		0.0-1777.71	6182.38	0.03	1.03	33.36-3.707e+05	-		
											-	
		-3.707e+05	33.36-6.95e-05	0.0	630.0-1777.71	-6182.55	0.03	1.03	51.52-3.707e+05	-		
44	71	4.634e+05	38.22-0.31	-9488.62	0.0-1351.93	4744.24	0.02	0.84	23.61-2.838e+05	-		
											-	
		-2.839e+05	23.61-5.07e-05	0.0	630.0-1351.93	-4744.38	0.02	0.84	38.22-2.839e+05	-		
44	72	4.913e+05	40.88-0.33-1.006e+04		0.0-1437.08	5031.87	0.02	0.88	25.56-3.012e+05	-		
											-	
		-3.012e+05	25.56-5.45e-05	0.0	630.0-1437.08	-5032.02	0.02	0.88	40.88-3.012e+05	-		
44	73	4.634e+05	38.22-0.31	-9488.62	0.0-1351.93	4744.24	0.02	0.84	23.61-2.838e+05	-		
											-	
		-2.839e+05	23.61-5.07e-05	0.0	630.0-1351.93	-4744.38	0.02	0.84	38.22-2.839e+05	-		
45	2	8.975e+05	42.79-0.61-1.854e+04		0.0-2652.88	9271.79	-0.05	1.00	42.79-5.628e+05	-		
											-	
		-5.628e+05	14.44-4.67e-05	0.0	630.0-2652.88	-9271.89	-0.05	1.00	14.44-5.628e+05	-		
45	3	5.072e+05	24.33-0.34-1.047e+04		0.0-1495.30	5234.94	-0.03	0.49	24.33-3.173e+05	-		
											-	
		-3.173e+05	7.81-2.65e-05	0.0	630.0-1495.30	-5235.00	-0.03	0.49	7.81-3.173e+05	-		
45	17	5.085e+05	2.061e+04	-0.35-1.049e+04	0.0	-1486.95	5048.87	-65.45	3271.71	2.061e+04	-	
2.557e+05											-	
		-3.796e+05	-2.062e+04	0.06	0.0	630.0	-1486.95	-5442.39	-65.45	3271.71-2.062e+04	-	
3.796e+05	45	20	5.085e+05	2.063e+04	-0.34-1.049e+04	0.0	-1496.72	5442.31	65.39	-3270.64-2.056e+04	-	
3.796e+05											-	
		-3.796e+05	-2.056e+04	-0.06	0.0	630.0	-1496.72	-5048.94	65.39	-3270.64 2.063e+04	-	
2.557e+05	45	21	5.225e+05	3.411e+04	-0.35-1.049e+04	0.0	-1489.43	4561.54	-108.25	-1159.11 3.411e+04	-	
1.022e+05											-	
		-5.331e+05	-3.409e+04	-0.03	0.0	630.0	-1489.43	-5929.71	-108.25	-1159.11-3.409e+04	-	
5.331e+05	45	25	5.224e+05	5.261e+04	-0.35-1.049e+04	0.0	-1489.35	4564.90	-166.99	800.31 5.261e+04	-	
1.032e+05											-	
		-5.321e+05	-5.259e+04	0.02	0.0	630.0	-1489.35	-5926.35	-166.99	800.31-5.259e+04	-	
5.321e+05	45	27	5.225e+05	3.389e+04	-0.35-1.049e+04	0.0	-1492.01	4561.55	-107.53	-1177.43 3.389e+04	-	
1.022e+05											-	
		-5.331e+05	-3.385e+04	-0.03	0.0	630.0	-1492.01	-5929.70	-107.53	-1177.43-3.385e+04	-	



EGP CODE

GRE.EEC.R.73.IT.W.15235.12.024.01

PAGE

313 di/of 527

5.331e+05	49	5.085e+05	2.876e+04	-0.35	-1.049e+04	0.0	-1486.15	4969.96	-91.33	4570.88	2.876e+04	-
2.308e+05		-4.045e+05	-2.878e+04	0.09	0.0	630.0	-1486.15	-5521.29	-91.33	4570.88	-2.878e+04	-
4.045e+05	52	5.085e+05	2.879e+04	-0.34	-1.049e+04	0.0	-1497.52	5521.22	91.27	-4569.81	-2.871e+04	-
4.045e+05		-4.045e+05	-2.871e+04	-0.09	0.0	630.0	-1497.52	-4970.03	91.27	-4569.81	2.879e+04	-
2.309e+05	53	5.333e+05	4.777e+04	-0.35	-1.049e+04	0.0	-1488.82	4287.30	-151.63	-1617.37	4.777e+04	-
1.579e+04		-6.195e+05	-4.775e+04	-0.04	0.0	630.0	-1488.82	-6203.95	-151.63	-1617.37	-4.775e+04	-
6.195e+05	56	5.333e+05	4.777e+04	-0.34	-1.049e+04	0.0	-1494.85	6203.88	151.58	1618.44	-4.772e+04	-
6.195e+05		-6.195e+05	-4.772e+04	0.04	0.0	630.0	-1494.85	-4287.37	151.58	1618.44	4.777e+04	-
1.584e+04	57	5.332e+05	7.362e+04	-0.35	-1.049e+04	0.0	-1488.74	4291.99	-233.68	1120.08	7.362e+04	-
1.726e+04		-6.180e+05	-7.360e+04	0.02	0.0	630.0	-1488.74	-6199.26	-233.68	1120.08	-7.360e+04	-
6.180e+05	60	5.331e+05	7.362e+04	-0.34	-1.049e+04	0.0	-1494.93	6199.19	233.63	-1119.01	-7.357e+04	-
6.180e+05		-6.180e+05	-7.357e+04	-0.02	0.0	630.0	-1494.93	-4292.06	233.63	-1119.01	7.362e+04	-
1.732e+04	69	5.085e+05	24.51-0.34-1.049e+04			0.0-1491.83	5245.59	-0.03	0.54	24.51	-3.177e+05	-
45		-3.177e+05	7.59-2.64e-05	0.0	630.0-1491.83	-5245.66	-0.03	0.54	7.59	-3.177e+05		-
45	70	6.652e+05	31.68-0.45-1.375e+04			0.0-1969.81	6873.50	-0.03	0.71	31.68	-4.173e+05	-
45		-4.173e+05	10.79-3.47e-05	0.0	630.0-1969.81	-6873.57	-0.03	0.71	10.79	-4.173e+05		-
45	71	5.085e+05	24.51-0.34-1.049e+04			0.0-1491.83	5245.59	-0.03	0.54	24.51	-3.177e+05	-
45		-3.177e+05	7.59-2.64e-05	0.0	630.0-1491.83	-5245.66	-0.03	0.54	7.59	-3.177e+05		-
45	72	5.398e+05	25.94-0.37-1.114e+04			0.0-1587.43	5571.17	-0.03	0.57	25.94	-3.376e+05	-
45		-3.376e+05	8.23-2.81e-05	0.0	630.0-1587.43	-5571.24	-0.03	0.57	8.23	-3.376e+05		-
45	73	5.085e+05	24.51-0.34-1.049e+04			0.0-1491.83	5245.59	-0.03	0.54	24.51	-3.177e+05	-
45		-3.177e+05	7.59-2.64e-05	0.0	630.0-1491.83	-5245.66	-0.03	0.54	7.59	-3.177e+05		-
46	2	8.570e+05	-63.17-0.58-1.769e+04			0.0-2526.75	8845.95	0.02	-1.92	-73.71	-5.362e+05	-
46		-5.363e+05	-73.711.12e-04	0.0	630.0-2526.75	-8846.08	0.02	-1.92	-63.17	-5.363e+05		-
46	3	4.856e+05	-34.22-0.33-1.002e+04			0.0-1427.97	5007.82	0.01	-1.05	-40.66	-3.031e+05	-
46		-3.032e+05	-40.666.13e-05	0.0	630.0-1427.97	-5007.89	0.01	-1.05	-34.22	-3.032e+05		-
46	18	4.868e+05	4.347e+04	-0.33	-1.004e+04	0.0	-1435.31	5139.26	-137.77	3056.04	4.347e+04	-
3.417e+05		-3.417e+05	-4.332e+04	0.06	0.0	630.0	-1435.31	-4896.63	-137.77	3056.04	-4.332e+04	-
2.653e+05	19	4.869e+05	4.326e+04	-0.33	-1.004e+04	0.0	-1413.37	4896.54	137.79	-3058.23	-4.355e+04	-
2.652e+05		-3.416e+05	-4.355e+04	-0.06	0.0	630.0	-1413.37	-5139.35	137.79	-3058.23	4.326e+04	-
3.416e+05	23	5.051e+05	4446.17-0.34-1.004e+04			0.0-1420.51	4242.31	14.34	579.25	-4587.70	-5.910e+04	-
46		-5.477e+05	-4587.708.24e-03	0.0	630.0-1420.51	-5793.59	14.34	579.25	4446.17	-5.477e+05		-
46	25	5.051e+05	4282.05-0.34-1.004e+04			0.0-1426.85	4242.11	13.61	596.31	-4290.19	-5.907e+04	-
46		-5.478e+05	-4290.198.69e-03	0.0	630.0-1426.85	-5793.78	13.61	596.31	4282.05	-5.478e+05		-
4.527e+05	34	4.931e+05	5.737e+04	-0.33	-1.004e+04	0.0	-1428.60	5491.59	-182.14	825.10	5.737e+04	-
4.527e+05		-4.527e+05	-5.738e+04	0.02	0.0	630.0	-1428.60	-4544.30	-182.14	825.10	-5.738e+04	-
1.543e+05	35	4.932e+05	5.731e+04	-0.33	-1.004e+04	0.0	-1420.07	4544.21	182.16	-827.29	-5.745e+04	-
1.542e+05		-4.527e+05	-5.745e+04	-0.02	0.0	630.0	-1420.07	-5491.68	182.16	-827.29	5.731e+04	-
4.527e+05	50	4.868e+05	6.079e+04	-0.33	-1.004e+04	0.0	-1438.51	5188.35	-192.63	4269.48	6.079e+04	-
3.572e+05		-3.572e+05	-6.056e+04	0.08	0.0	630.0	-1438.51	-4847.54	-192.63	4269.48	-6.056e+04	-
2.498e+05	51	4.869e+05	6.049e+04	-0.33	-1.004e+04	0.0	-1410.17	4847.45	192.65	-4271.66	-6.088e+04	-
2.497e+05		-3.571e+05	-6.088e+04	-0.08	0.0	630.0	-1410.17	-5188.44	192.65	-4271.66	6.049e+04	-
3.571e+05	55	5.230e+05	6239.26-0.34-1.004e+04			0.0-1419.32	3931.57	20.07	809.28	-6406.88	3.879e+04	-
46		-6.456e+05	-6406.880.01	0.0	630.0-1419.32	-6104.33	20.07	809.28	6239.26	-6.456e+05		-
46	57	5.230e+05	6010.98-0.34-1.004e+04			0.0-1427.53	3931.30	19.05	832.92	-5992.46	3.883e+04	-
46		-6.457e+05	-5992.460.01	0.0	630.0-1427.53	-6104.59	19.05	832.92	6010.98	-6.457e+05		-
46	66	5.006e+05	8.034e+04	-0.33	-1.004e+04	0.0	-1429.93	5681.74	-255.02	1152.76	8.034e+04	-
5.126e+05		-5.126e+05	-8.032e+04	0.03	0.0	630.0	-1429.93	-4354.15	-255.02	1152.76	-8.032e+04	-
9.439e+04	67	5.007e+05	8.025e+04	-0.34	-1.004e+04	0.0	-1418.75	4354.06	255.04	-1154.94	-8.042e+04	-





EGP CODE

GRE.EEC.R.73.IT.W.15235.12.024.01

PAGE

315 di/of 527

		-4.373e+05	-61.308.64e-05	0.0	630.0-1987.97	-7177.62	-0.03	6.81	-61.30-4.373e+05		
48	3	3.982e+05	-21.31-0.27	-8235.94	0.0-1139.45	4117.93	-0.02	4.25	-21.31-2.503e+05		
		-2.503e+05	-34.334.69e-05	0.0	630.0-1139.45	-4118.01	-0.02	4.25	-34.33-2.503e+05		
48	6	3.994e+05	1.327e+04	-0.27	-8251.71	0.0	-1368.72	4268.08	33.20	-2114.52	-7865.46
2.952e+05											
		-2.952e+05	-7865.46-0.06	0.0	630.0-1368.72	-3983.63	33.20	-2114.52	1.327e+04-2.056e+05		
48	7	3.992e+05	7821.64-0.27	-8251.71	0.0 -901.95	3983.55	-33.24	2122.72	7821.64-2.058e+05		
		-2.955e+05	-1.333e+04	0.06	0.0 630.0	-901.95	-4268.16	-33.24	2122.72-1.333e+04		
2.955e+05											
48	21	4.118e+05	3.819e+04	-0.28	-8251.71	0.0	-1193.50	3552.02	118.32	-250.09-3.642e+04	
6.972e+04											
		-4.312e+05	-3.642e+04	-0.03	0.0 630.0	-1193.50	-4699.69	118.32	-250.09 3.819e+04		
4.312e+05											
48	24	4.117e+05	3.638e+04	-0.27	-8251.71	0.0	-1077.17	4699.60	-118.36	258.29 3.638e+04	
4.313e+05											
		-4.313e+05	-3.825e+04	0.03	0.0 630.0	-1077.17	-3552.10	-118.36	258.29-3.825e+04		
6.985e+04											
48	26	4.117e+05	3.823e+04	-0.27	-8251.71	0.0	-1215.11	4699.42	-119.02	271.97 3.823e+04	
4.312e+05											
		-4.312e+05	-3.681e+04	0.03	0.0 630.0	-1215.11	-3552.29	-119.02	271.97-3.681e+04		
6.983e+04											
48	27	4.117e+05	3.675e+04	-0.28	-8251.71	0.0	-1055.57	3552.21	118.98	-263.76-3.827e+04	
6.985e+04											
		-4.312e+05	-3.827e+04	-0.03	0.0 630.0	-1055.57	-4699.50	118.98	-263.76 3.675e+04		
4.312e+05											
48	38	3.995e+05	1.835e+04	-0.27	-8251.71	0.0	-1451.92	4325.66	46.01	-2956.22-1.092e+04	
3.133e+05											
		-3.133e+05	-1.092e+04	-0.08	0.0 630.0	-1451.92	-3926.05	46.01	-2956.22 1.835e+04		
1.874e+05											
48	39	3.991e+05	1.087e+04	-0.27	-8251.71	0.0	-818.76	3925.96	-46.05	2964.42 1.087e+04	
1.877e+05											
		-3.137e+05	-1.841e+04	0.08	0.0 630.0	-818.76	-4325.74	-46.05	2964.42-1.841e+04		
3.137e+05											
48	53	4.220e+05	5.343e+04	-0.28	-8251.71	0.0	-1214.36	3322.13	165.60	-349.61-5.098e+04	2719.02
5.036e+05											
48	56	4.219e+05	5.094e+04	-0.27	-8251.71	0.0	-1056.32	4929.49	-165.63	357.81 5.094e+04	
5.037e+05											
		-5.037e+05	-5.349e+04	0.04	0.0 630.0	-1056.32	-3322.21	-165.63	357.81-5.349e+04	2543.66	
48	58	4.220e+05	5.348e+04	-0.27	-8251.71	0.0	-1243.42	4929.23	-166.55	376.80 5.348e+04	
5.036e+05											
		-5.036e+05	-5.152e+04	0.04	0.0 630.0	-1243.42	-3322.47	-166.55	376.80-5.152e+04	2570.61	
48	59	4.219e+05	5.145e+04	-0.28	-8251.71	0.0	-1027.26	3322.39	166.51	-368.60-5.353e+04	2527.26
5.036e+05											
		-5.036e+05	-5.353e+04	-0.04	0.0 630.0	-1027.26	-4929.31	166.51	-368.60 5.145e+04		
5.036e+05											
48	69	3.993e+05	-21.91-0.27	-8251.71	0.0-1135.34	4125.81	-0.02	4.10	-21.91-2.505e+05		
		-2.505e+05	-32.974.62e-05	0.0	630.0-1135.34	-4125.89	-0.02	4.10	-32.97-2.505e+05		
48	70	5.146e+05	-29.94-0.35-1.066e+04	0.0	0.0-1479.43	5329.86	-0.03	5.19	-29.94-3.248e+05		
		-3.248e+05	-46.176.42e-05	0.0	630.0-1479.43	-5329.95	-0.03	5.19	-46.17-3.248e+05		
48	71	3.993e+05	-21.91-0.27	-8251.71	0.0-1135.34	4125.81	-0.02	4.10	-21.91-2.505e+05		
		-2.505e+05	-32.974.62e-05	0.0	630.0-1135.34	-4125.89	-0.02	4.10	-32.97-2.505e+05		
48	72	4.224e+05	-23.52-0.29	-8733.32	0.0-1204.16	4366.62	-0.02	4.32	-23.52-2.654e+05		
		-2.654e+05	-35.614.98e-05	0.0	630.0-1204.16	-4366.70	-0.02	4.32	-35.61-2.654e+05		
48	73	3.993e+05	-21.91-0.27	-8251.71	0.0-1135.34	4125.81	-0.02	4.10	-21.91-2.505e+05		
		-2.505e+05	-32.974.62e-05	0.0	630.0-1135.34	-4125.89	-0.02	4.10	-32.97-2.505e+05		
49	2	4.838e+05	-86.850.34	-4781.49	0.0-1417.01	-0.14	-0.09	-15.62	-86.85 4.838e+05		
		-2.693e+05	-116.37-1.45e-04	0.0	315.0-1417.01	-4781.63	-0.09	-15.62	-116.37-2.693e+05		
49	3	2.867e+05	-45.830.20	-2840.01	0.0 -832.30	-0.08	-0.06	-9.81	-45.83 2.867e+05		
		-1.606e+05	-65.35-7.67e-05	0.0	315.0 -832.30	-2840.09	-0.06	-9.81	-65.35-1.606e+05		
49	5	2.956e+05	8.200e+04	0.20	-2844.71	0.0	-759.95	-241.37	589.31	-1.478e+04-1.045e+05	
2.956e+05											
		-2.309e+05	-1.045e+05	-0.11	0.0 315.0	-759.95	-3086.09	589.31	-1.478e+04 8.200e+04		
2.309e+05											
49	8	2.824e+05	1.044e+05	0.20	-2844.71	0.0	-902.31	241.20	-589.43	1.477e+04 1.044e+05	
2.791e+05											
		-9.054e+04	-8.212e+04	0.11	0.0 315.0	-902.31	-2603.51	-589.43	1.477e+04-8.212e+04		
9.054e+04											
49	21	2.965e+05	4.243e+04	0.20	-2844.71	0.0	-1139.73	-522.23	241.42	-5241.77-3.567e+04	
2.965e+05											
		-3.170e+05	-3.567e+04	-0.04	0.0 315.0	-1139.73	-3366.94	241.42	-5241.77 4.243e+04		
3.170e+05											
49	26	2.962e+05	-3898.660.21-2844.71	0.0	0.0 -407.74	518.23	76.53	-1541.65	-2.620e+04 2.817e+05		
		-4628.66	-2.620e+04 -5.01e-03	0.0	0.0 315.0	-407.74	-2326.48	76.53	-1541.65 -3898.66-4628.66		
49	27	2.929e+05	2.611e+04	0.19	-2844.71	0.0	-1254.52	-518.41	-76.64	1522.67 2.611e+04	
2.929e+05											
		-3.168e+05	3771.374.86e-03	0.0	315.0-1254.52	-3363.12	-76.64	1522.67	3771.37-3.168e+05		





EGP CODE

GRE.EEC.R.73.IT.W.15235.12.024.01

PAGE

316 di/of 527

49	37	2.981e+05	1.123e+05	0.20	-2844.71	0.0	-742.28	-336.64	803.91	-2.036e+04	-1.421e+05		
2.981e+05		-2.587e+05	-1.421e+05	-0.15	0.0	315.0	-742.28	-3181.35	803.91	-2.036e+04	1.123e+05	-	
2.587e+05	49	40	2.831e+05	1.420e+05	0.20	-2844.71	0.0	-919.98	336.46	-804.02	2.034e+04	1.420e+05	
2.766e+05		-6.275e+04	-1.124e+05	0.15	0.0	315.0	-919.98	-2508.25	-804.02	2.034e+04	-1.124e+05	-	
6.275e+04	49	53	2.999e+05	5.868e+04	0.19	-2844.71	0.0	-1266.02	-731.16	331.37	-7224.70	-4.843e+04	
2.999e+05		-3.796e+05	-4.843e+04	-0.05	0.0	315.0	-1266.02	-3575.88	331.37	-7224.70	5.868e+04	-	
3.796e+05	49	58	3.077e+05	-6224.980.21-2844.71	0.0	-239.68	724.86	101.02	-2002.56	-3.567e+04	2.792e+05		
5.779e+04		5.779e+04	-3.567e+04	-6.91e-03	0.0	315.0	-239.68	-2119.85	101.02	-2002.56	-6224.98	-	
2.955e+05	49	59	2.955e+05	3.558e+04	0.19	-2844.71	0.0	-1422.57	-725.04	-101.13	1983.57	3.558e+04	
49	69	2.873e+05	-45.970.20	-2844.71	0.0	-831.13	-0.09	-0.06	-9.49	-45.97	2.873e+05		
		-1.607e+05	-63.64-7.69e-05	0.0	315.0	-831.13	-2844.80	-0.06	-9.49	-63.64	-1.607e+05	-	
	49	70	3.605e+05	-63.930.25	-3563.82	0.0-1056.28	-0.10	-0.07	-11.89	-63.93	3.605e+05		
		-2.009e+05	-87.20-1.06e-04	0.0	315.0-1056.28	-3563.92	-0.07	-0.07	-11.89	-87.20	-2.009e+05	-	
	49	71	2.873e+05	-45.970.20	-2844.71	0.0	-831.13	-0.09	-0.06	-9.49	2.873e+05		
		-1.607e+05	-63.64-7.69e-05	0.0	315.0	-831.13	-2844.80	-0.06	-9.49	-63.64	-1.607e+05	-	
	49	72	3.020e+05	-49.570.21	-2988.53	0.0	-876.16	-0.09	-0.06	-9.97	3.020e+05		
		-1.687e+05	-68.36-8.28e-05	0.0	315.0	-876.16	-2988.62	-0.06	-9.97	-68.36	-1.687e+05	-	
	49	73	2.873e+05	-45.970.20	-2844.71	0.0	-831.13	-0.09	-0.06	-9.49	2.873e+05		
		-1.607e+05	-63.64-7.69e-05	0.0	315.0	-831.13	-2844.80	-0.06	-9.49	-63.64	-1.607e+05	-	
	50	2	4.142e+05	200.670.29	-4008.62	0.0-1220.61	-0.12	0.16	8.04	149.92	4.142e+05		
		-2.172e+05	149.922.47e-04	0.0	315.0-1220.61	-4008.73	0.16	0.16	8.04	200.67	-2.172e+05	-	
	50	3	2.495e+05	115.820.17	-2427.79	0.0	-727.26	-0.07	0.11	5.39	82.55	2.495e+05	
		-1.328e+05	82.551.36e-04	0.0	315.0	-727.26	-2427.86	0.11	5.39	115.82	-1.328e+05	-	
	50	6	2.436e+05	7.399e+04	0.17	-2431.47	0.0	-859.82	172.57	494.51	-1.180e+04	-8.469e+04	
2.418e+05		-8.426e+04	-8.469e+04	-0.09	0.0	315.0	-859.82	-2258.90	494.51	-1.180e+04	7.399e+04	-	
8.426e+04	50	7	2.584e+05	8.486e+04	0.18	-2431.47	0.0	-591.66	-172.73	-494.31	1.182e+04	8.486e+04	
2.584e+05		-1.815e+05	-7.376e+04	0.09	0.0	315.0	-591.66	-2604.20	-494.31	1.182e+04	-7.376e+04	-	
1.815e+05	50	31	2.591e+05	2.838e+04	0.17	-2431.47	0.0	-984.93	-457.69	-211.71	3212.93	2.838e+04	
2.591e+05		-2.700e+05	-4.003e+04	0.03	0.0	315.0	-984.93	-2889.16	-211.71	3212.93	-4.003e+04	-	
2.700e+05	50	33	2.551e+05	-6412.170.17-2431.47	0.0-1114.14	-452.90	52.71	-2498.65	-2.164e+04	2.551e+05			
2.698e+05		-2.698e+05	-2.164e+04	4.57e-03	0.0	315.0	-1114.14	-2884.37	52.71	-2498.65	-6412.17	-	
2.451e+05	50	36	2.581e+05	2.180e+04	0.18	-2431.47	0.0	-337.34	452.75	-52.51	2508.80	2.180e+04	
		4015.08	6637.19-4.54e-03	0.0	315.0	-337.34	-1978.72	-52.51	2508.80	6637.19	4015.08		
	50	38	2.436e+05	1.014e+05	0.17	-2431.47	0.0	-905.53	237.08	674.78	-1.625e+04	-1.151e+05	
2.397e+05		-6.577e+04	-1.151e+05	-0.12	0.0	315.0	-905.53	-2194.39	674.78	-1.625e+04	1.014e+05	-	
6.577e+04	50	39	2.605e+05	1.153e+05	0.18	-2431.47	0.0	-545.95	-237.23	-674.58	1.626e+04	1.153e+05	
2.605e+05		-2.000e+05	-1.012e+05	0.12	0.0	315.0	-545.95	-2668.70	-674.58	1.626e+04	-1.012e+05	-	
2.000e+05	50	63	2.622e+05	3.858e+04	0.17	-2431.47	0.0	-1089.87	-640.41	-290.27	4427.22	3.858e+04	
2.622e+05		-3.249e+05	-5.526e+04	0.04	0.0	315.0	-1089.87	-3071.88	-290.27	4427.22	-5.526e+04	-	
3.249e+05	50	65	2.575e+05	-9574.330.17-2431.47	0.0-1265.70	-633.23	69.00	-3351.87	-2.939e+04	2.575e+05			
3.245e+05		-3.245e+05	-2.939e+04	6.34e-03	0.0	315.0	-1265.70	-3064.70	69.00	-3351.87	-9574.33	-	
2.427e+05	50	68	2.685e+05	2.956e+04	0.18	-2431.47	0.0	-185.79	633.08	-68.80	3362.01	2.956e+04	
		5.877e+04	9799.35-6.31e-03	0.0	315.0	-185.79	-1798.39	-68.80	3362.01	9799.35	5.877e+04		
	50	69	2.501e+05	112.510.17	-2431.47	0.0	-725.74	-0.08	0.10	5.07	81.74	2.501e+05	
		-1.329e+05	81.741.34e-04	0.0	315.0	-725.74	-2431.55	0.10	5.07	112.51	-1.329e+05	-	
	50	70	3.091e+05	150.990.22	-2994.15	0.0	-911.52	-0.09	0.13	6.24	111.38	3.091e+05	
		-1.625e+05	111.381.83e-04	0.0	315.0	-911.52	-2994.24	0.13	6.24	150.99	-1.625e+05	-	
	50	71	2.501e+05	112.510.17	-2431.47	0.0	-725.74	-0.08	0.10	5.07	81.74	2.501e+05	
		-1.329e+05	81.741.34e-04	0.0	315.0	-725.74	-2431.55	0.10	5.07	112.51	-1.329e+05	-	
	50	72	2.619e+05	120.210.18	-2544.01	0.0	-762.90	-0.08	0.10	5.31	87.67	2.619e+05	
		-1.388e+05	87.671.44e-04	0.0	315.0	-762.90	-2544.09	0.10	5.31	120.21	-1.388e+05	-	

50	73	2.501e+05	112.510.17	-2431.47	0.0	-725.74	-0.08	0.10	5.07	81.74	2.501e+05
		-1.329e+05	81.741.34e-04	0.0	315.0	-725.74	-2431.55	0.10	5.07	112.51	-1.329e+05

Trave	M3 mx/mn	M2 mx/mn	D 2 / D 3	Q 2 / Q 3	N	V 2	V 3	T
	-6.457e+05	-1.421e+05	-0.61	-1.854e+04	-2652.88	-9271.89	-804.02	-4.481e+04
	8.975e+05	1.420e+05	0.34	0.0	953.58	9271.79	803.91	4.480e+04

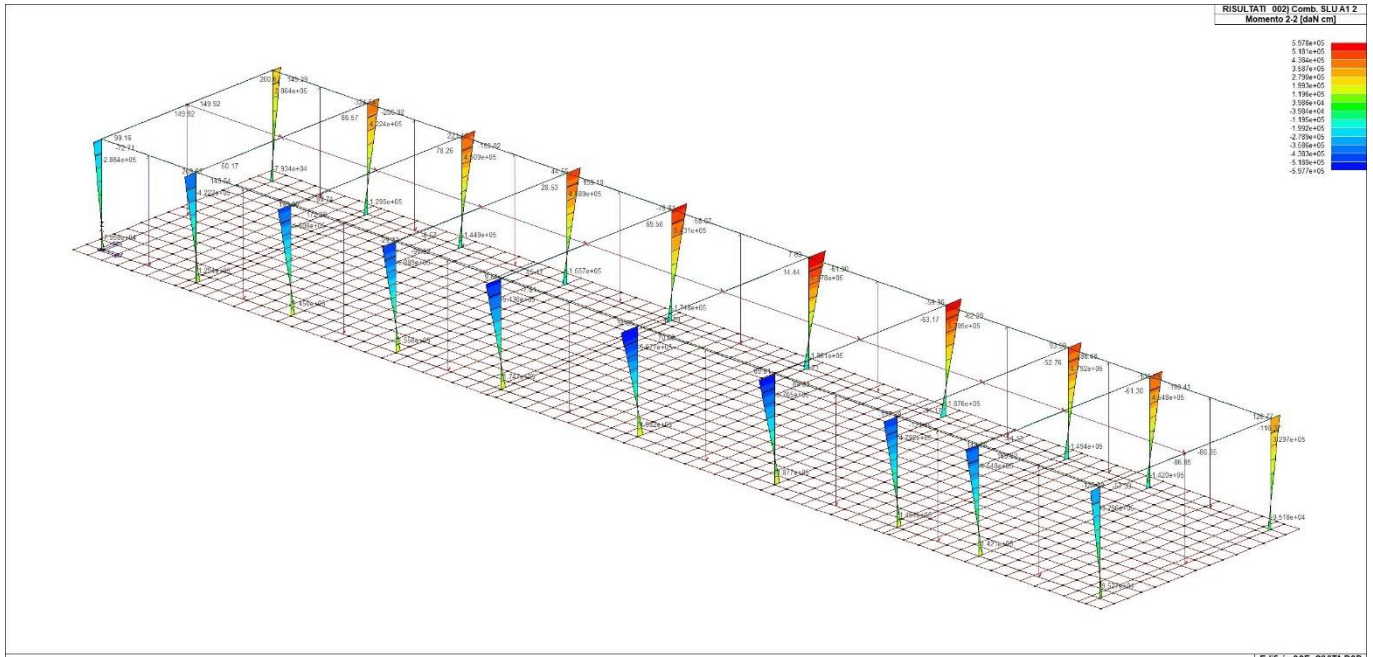

43\_RIS\_M2\_002\_Comb. SLU A1 2

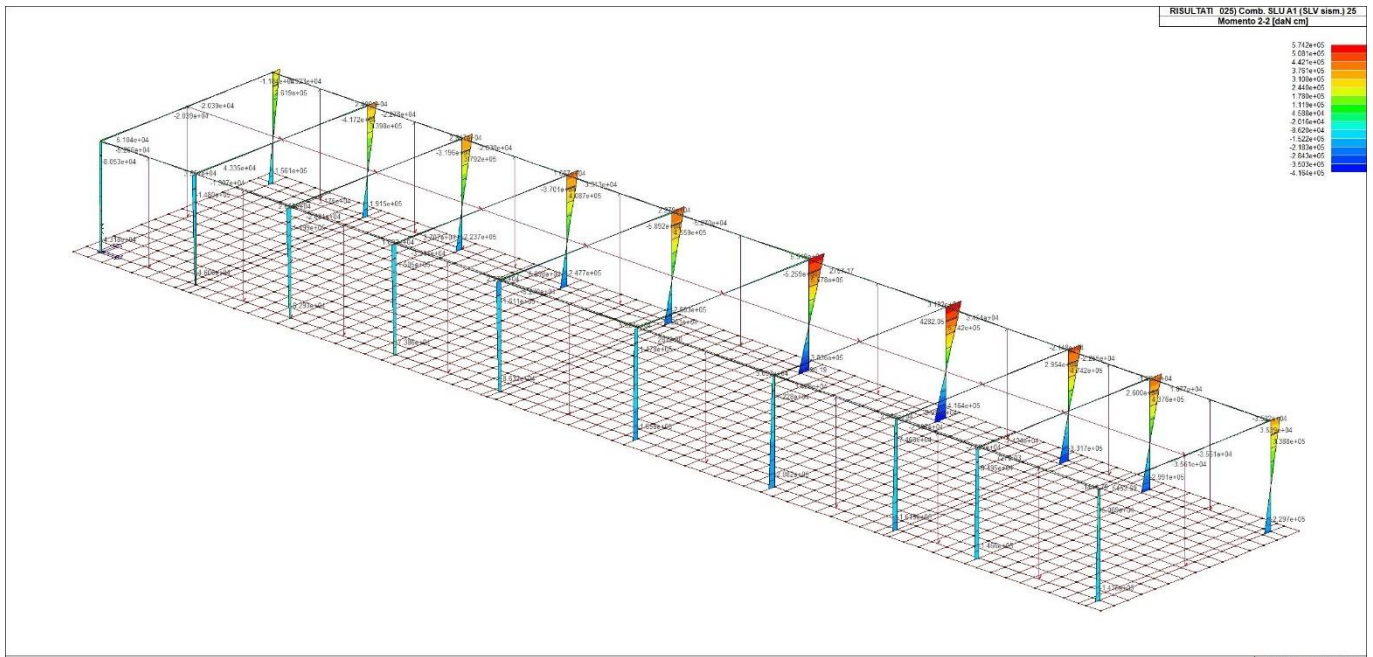

43\_RIS\_M2\_025\_Comb. SLU A1 (SLV sism.) 25

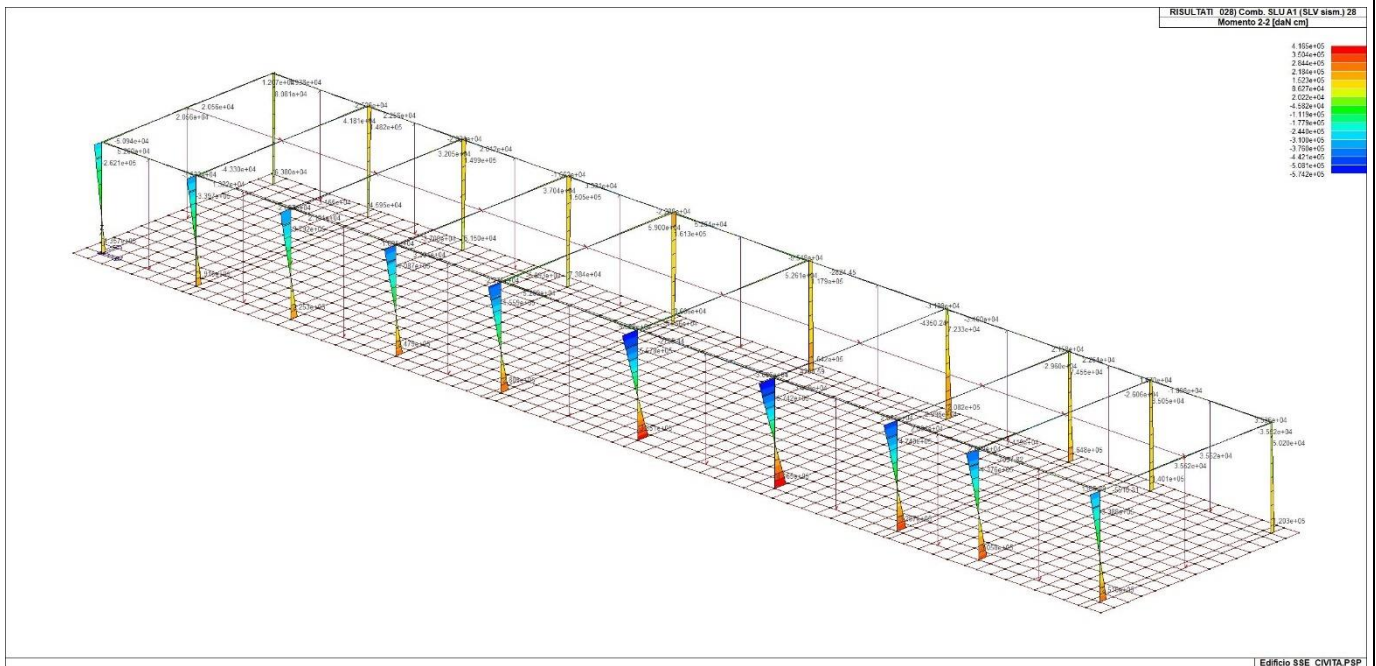

43\_RIS\_M2\_028\_Comb. SLU A1 (SLV sism.) 28

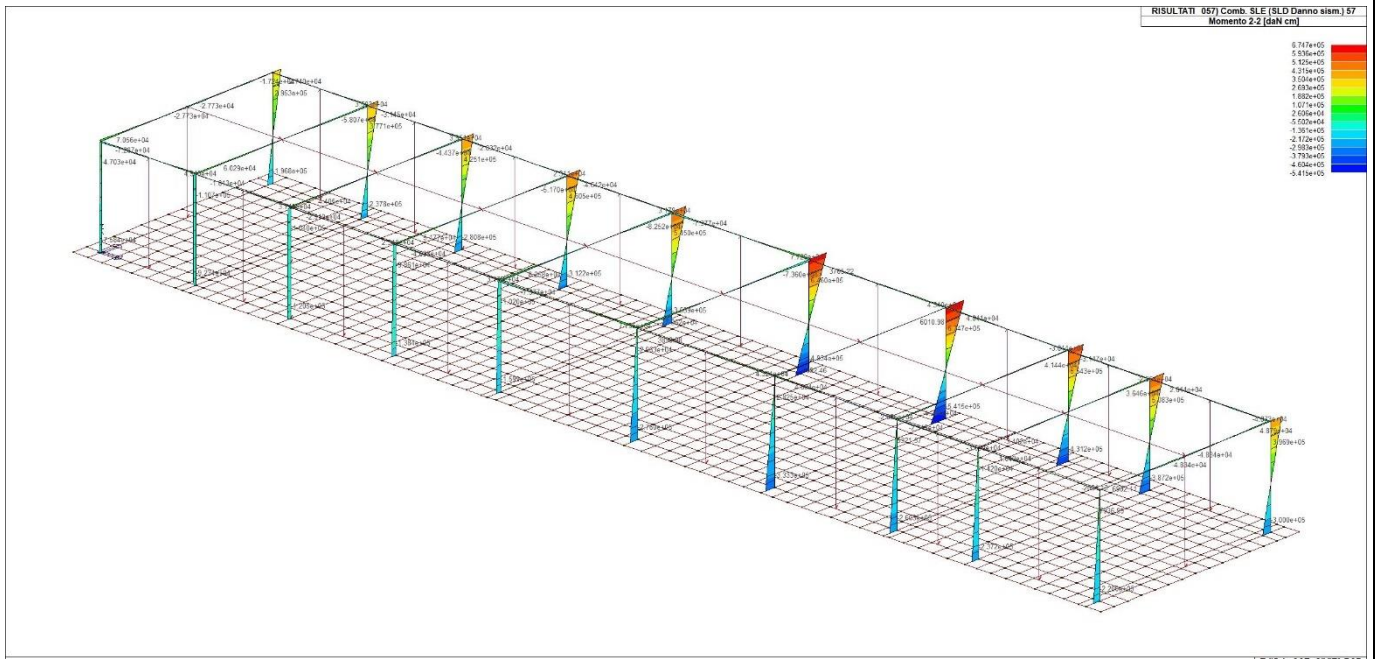

43\_RIS\_M2\_057\_Comb. SLE (SLD Danno sism.) 57



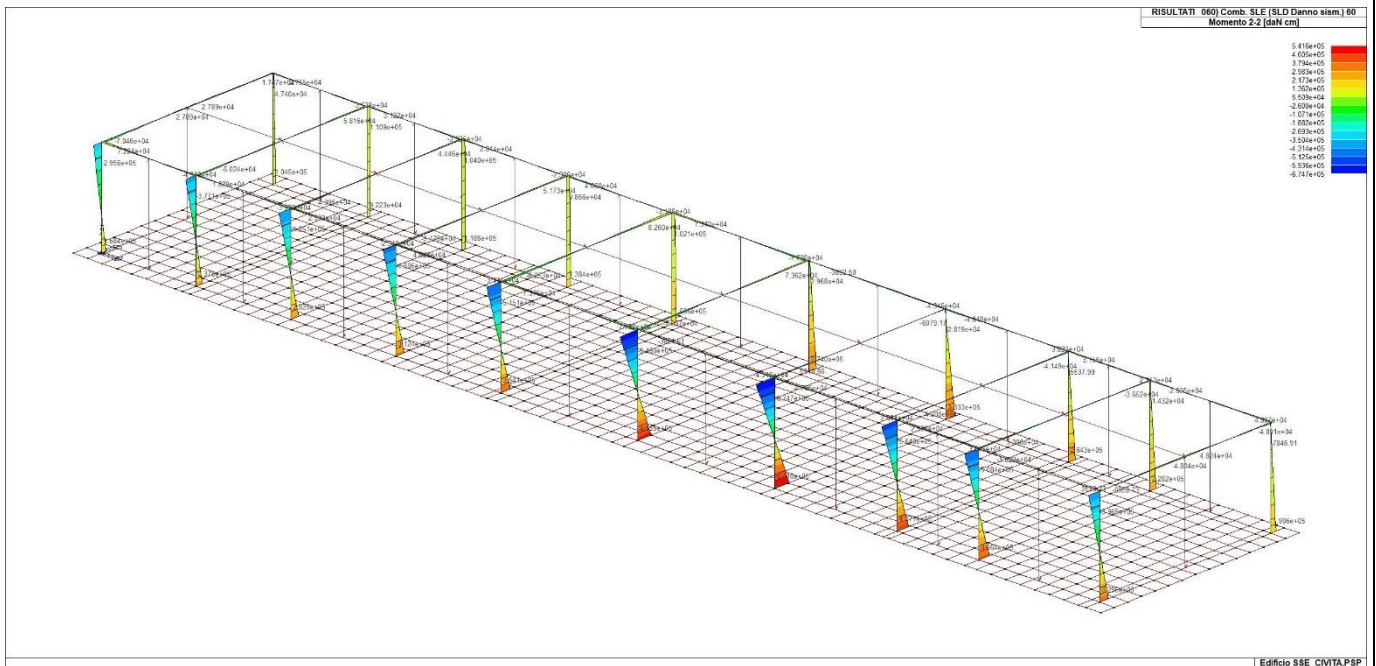

43\_RIS\_M2\_060\_Comb. SLE (SLD Danno sism.) 60

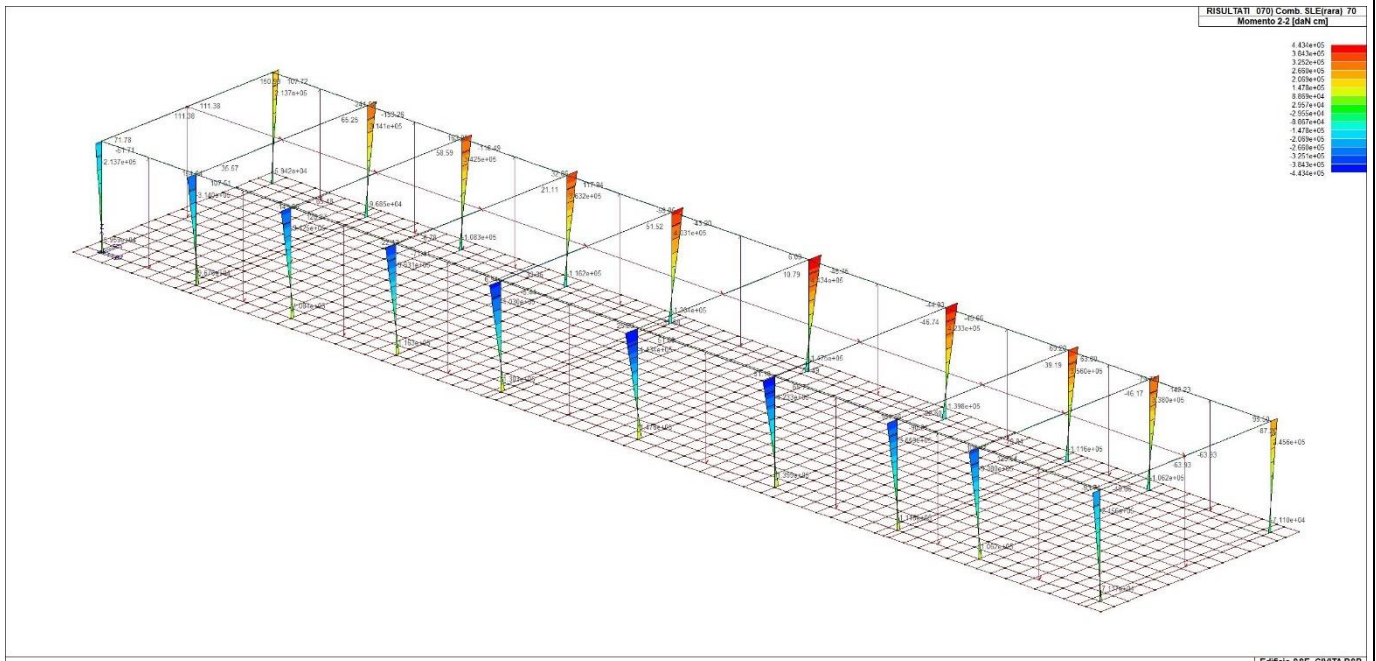

43\_RIS\_M2\_070\_Comb. SLE(rara) 70

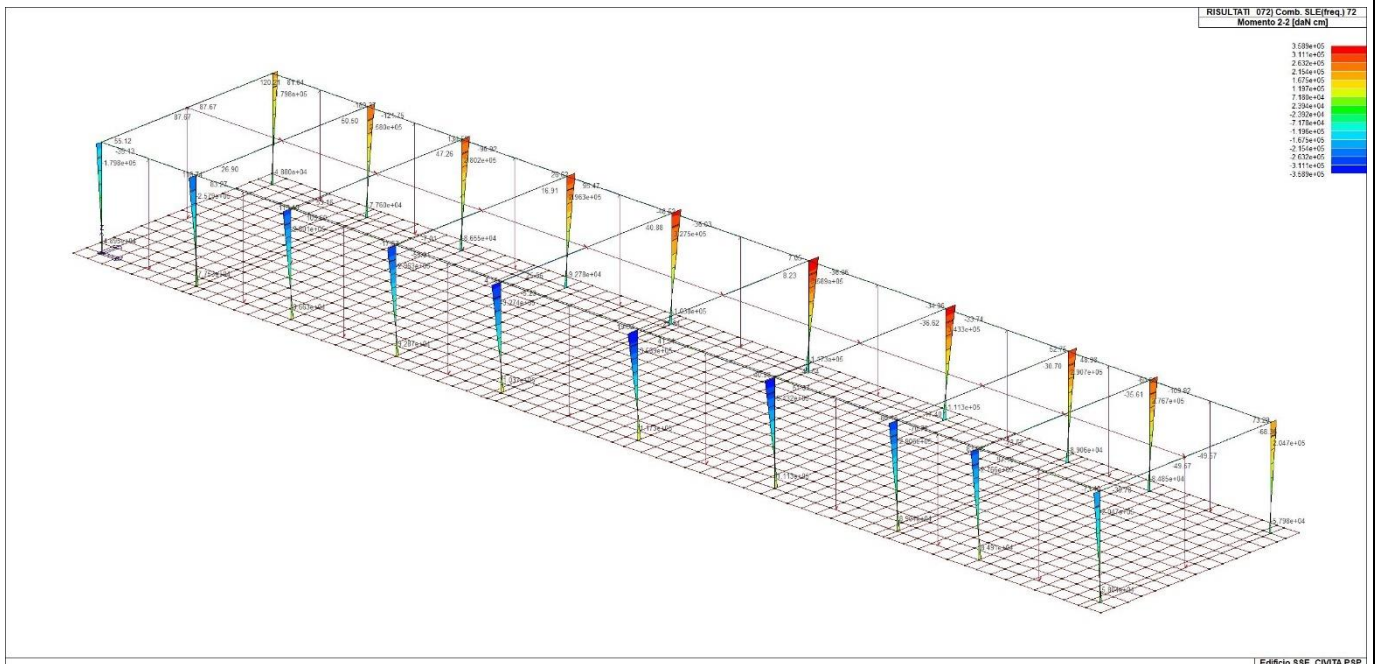

43\_RIS\_M2\_072\_Comb. SLE(freq.) 72

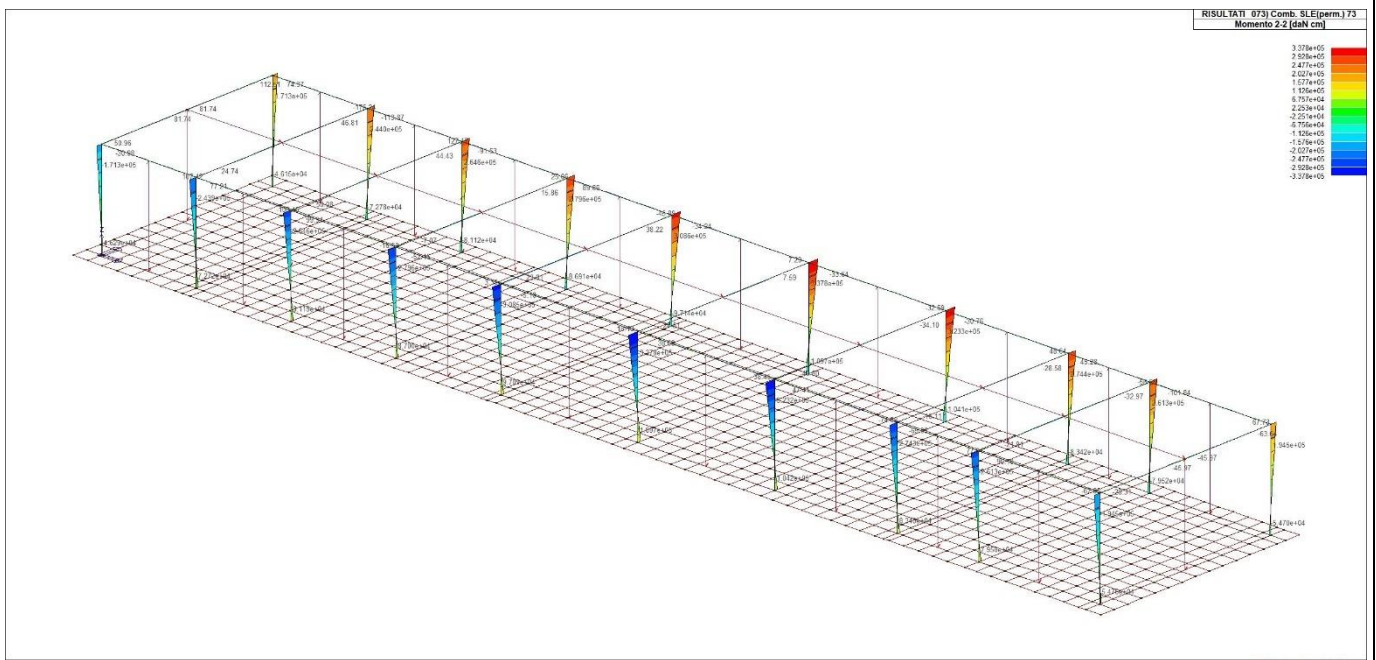

43\_RIS\_M2\_073\_Comb. SLE(perm.) 73



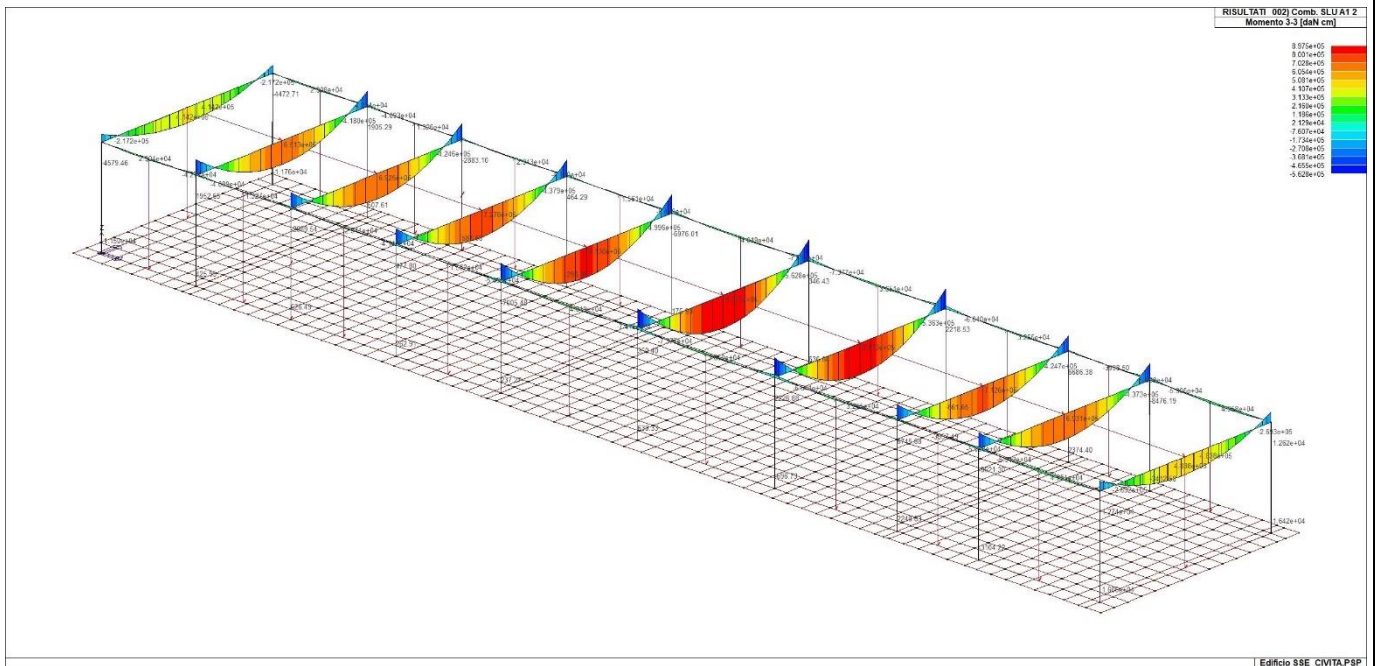

43\_RIS\_M3\_002\_Comb. SLU A1 2

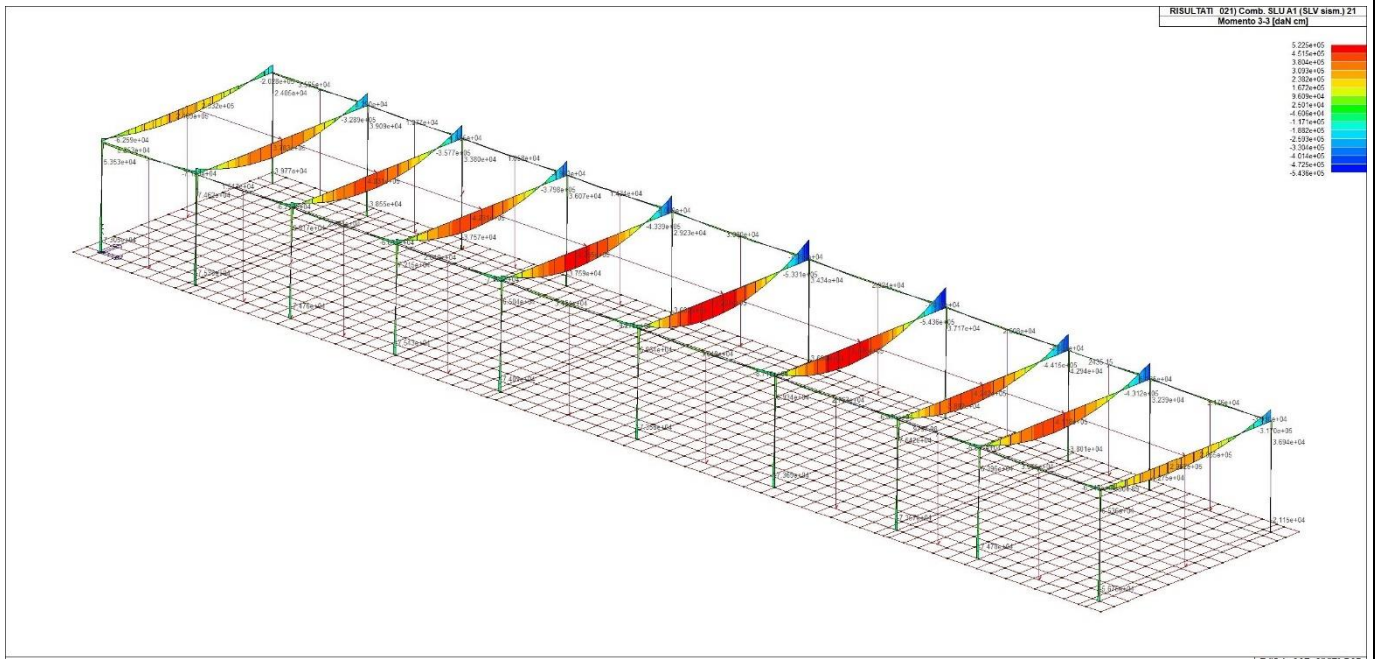

43\_RIS\_M3\_021\_Comb. SLU A1 (SLV sism.) 21

RISULTATI 025) Comb. SLU A1 (SLV sism.) 25

Momento 3-3 [daN cm]

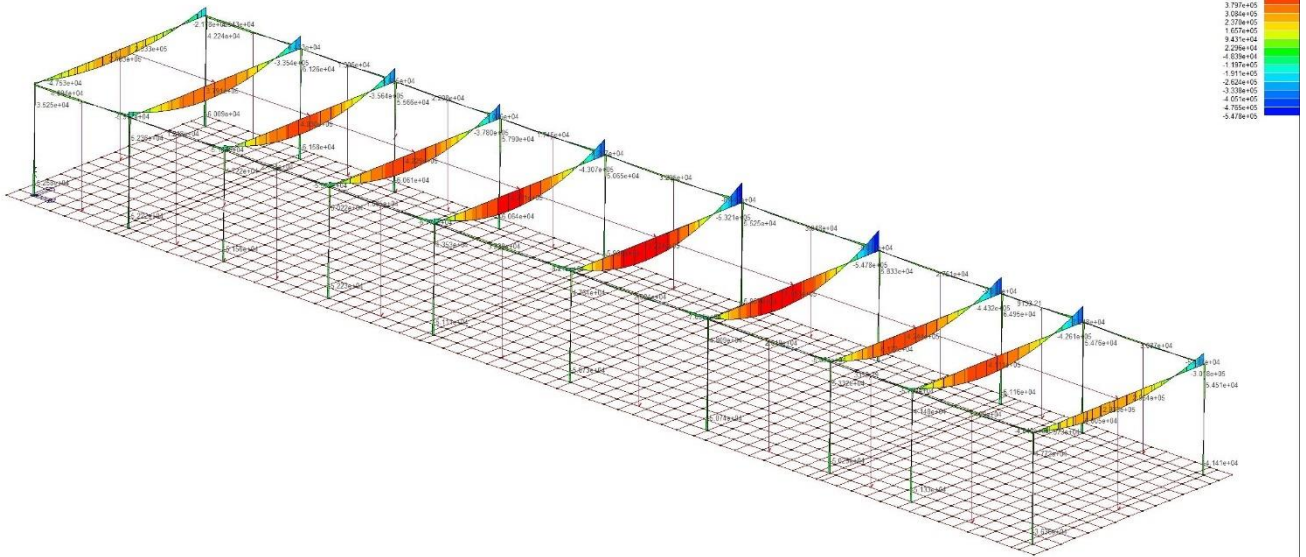

Edificio S8E CIVITA' P8P

43\_RIS\_M3\_025\_Comb. SLU A1 (SLV sism.) 25

RISULTATI 053) Comb. SLE (SLD Danno sism.) 53

Momento 3-3 [daN cm]

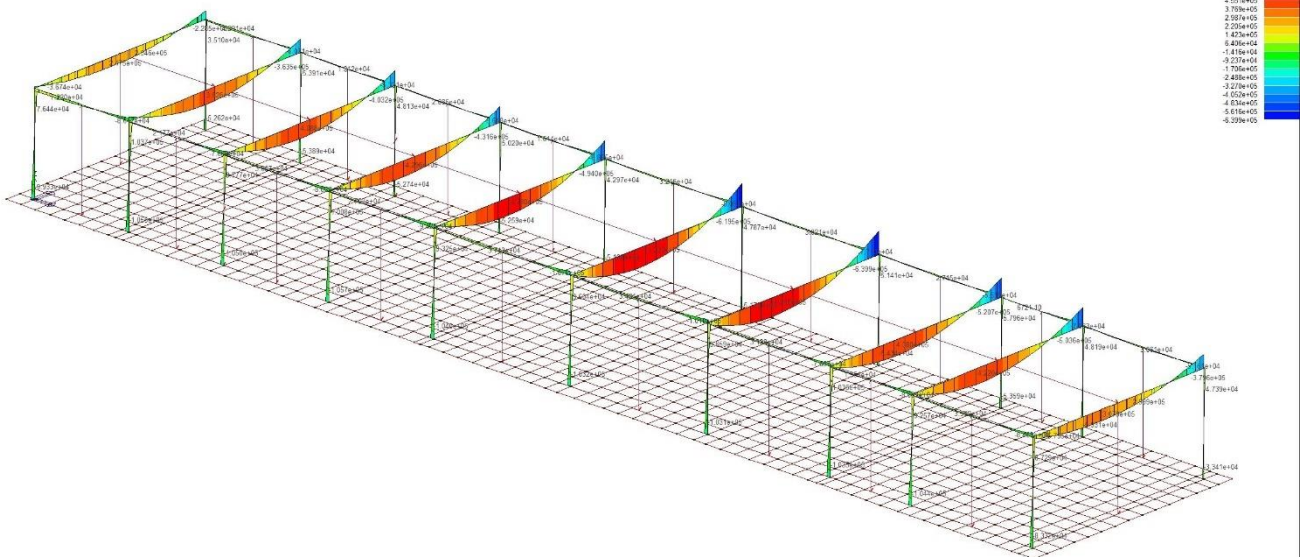

Edificio S8E CIVITA' P8P

43\_RIS\_M3\_053\_Comb. SLE (SLD Danno sism.) 53



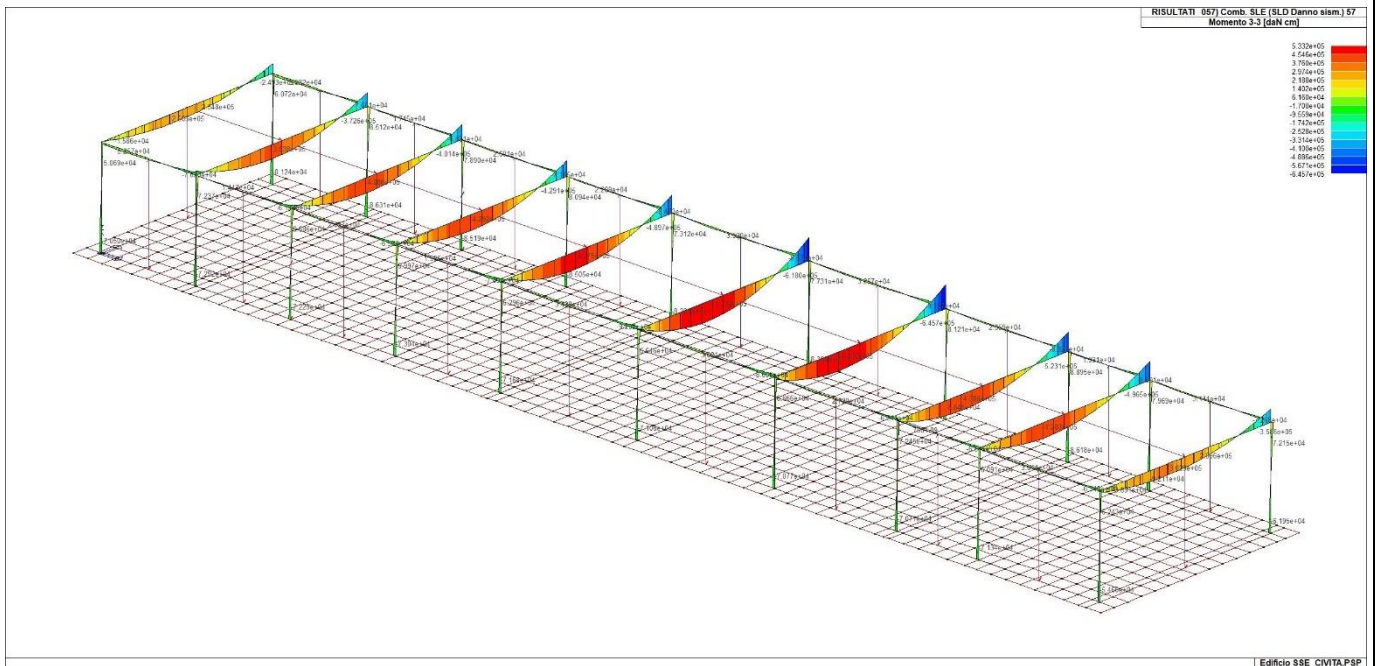

43\_RIS\_M3\_057\_Comb. SLE (SLD Danno sism.) 57

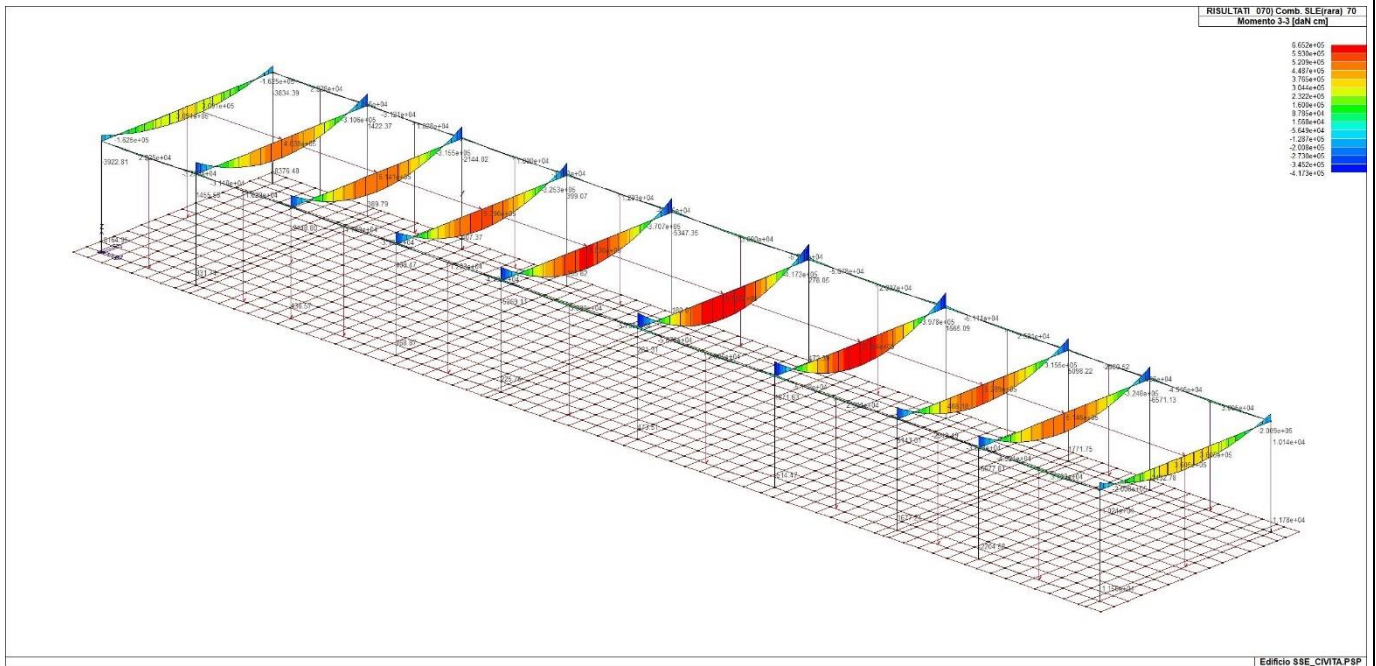

43\_RIS\_M3\_070\_Comb. SLE(rara) 70

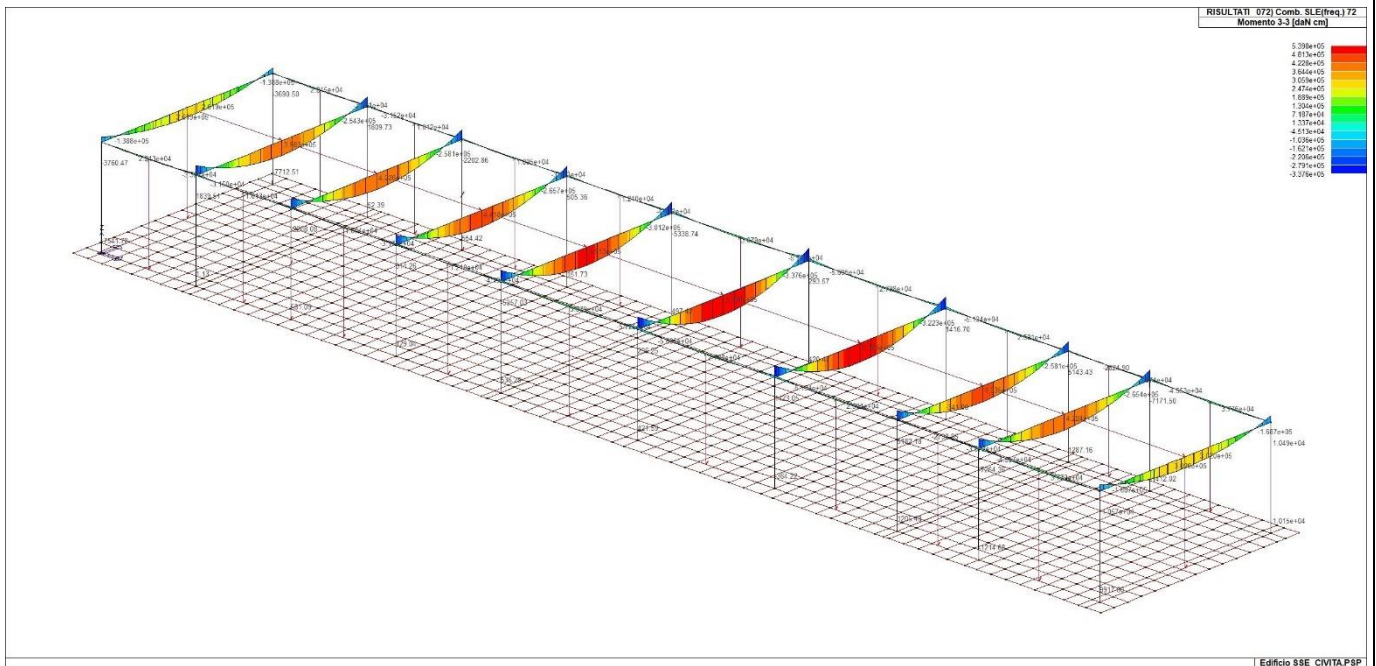

43\_RIS\_M3\_072\_Comb. SLE(freq.) 72

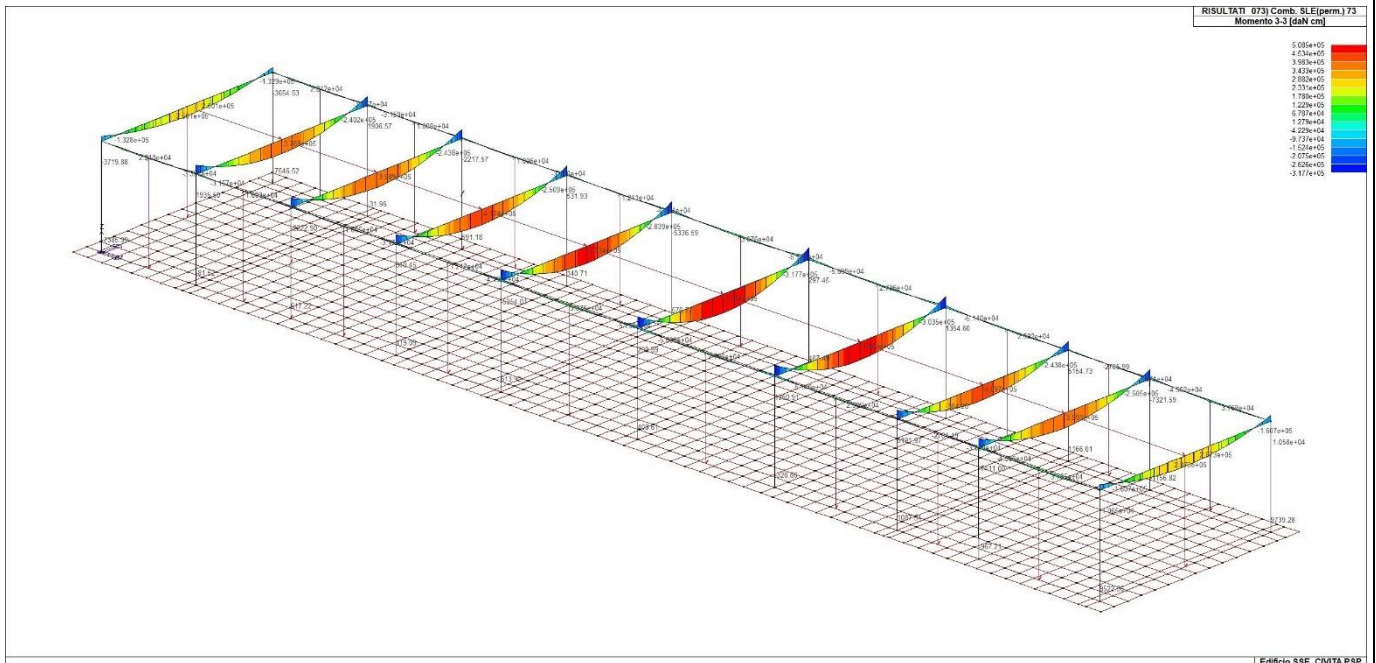

43\_RIS\_M3\_073\_Comb. SLE(perm.) 73

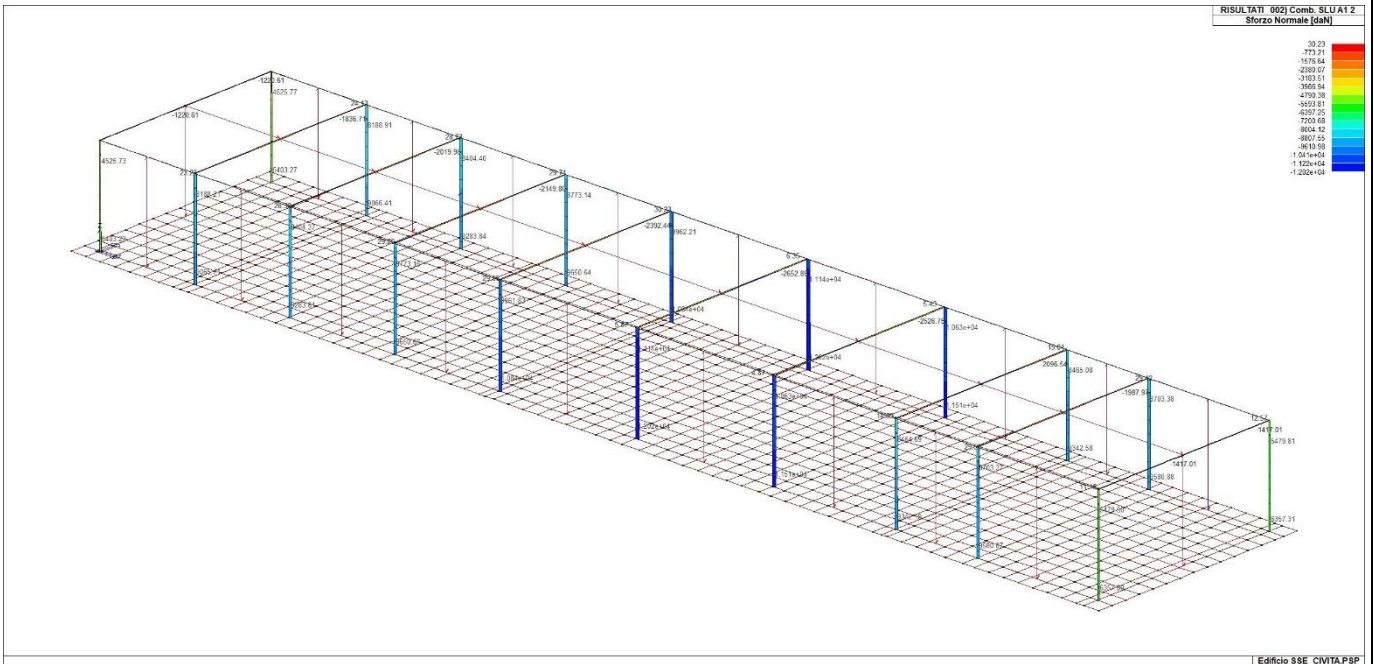

43\_RIS\_N\_002\_Comb. SLU A1 2

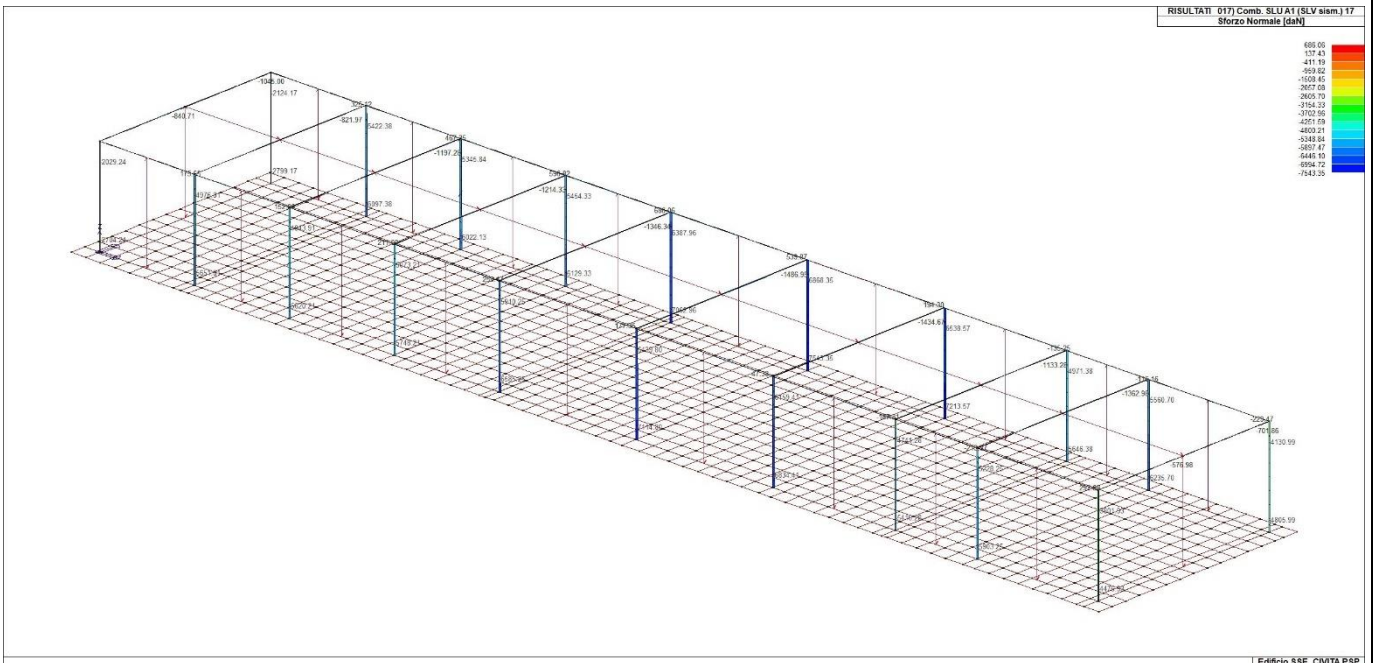

43\_RIS\_N\_017\_Comb. SLU A1 (SLV sism.) 17



RISULTATI 027) Comb. SLU A1 (SLV sism.) 27

Sforzo Normale [daN]

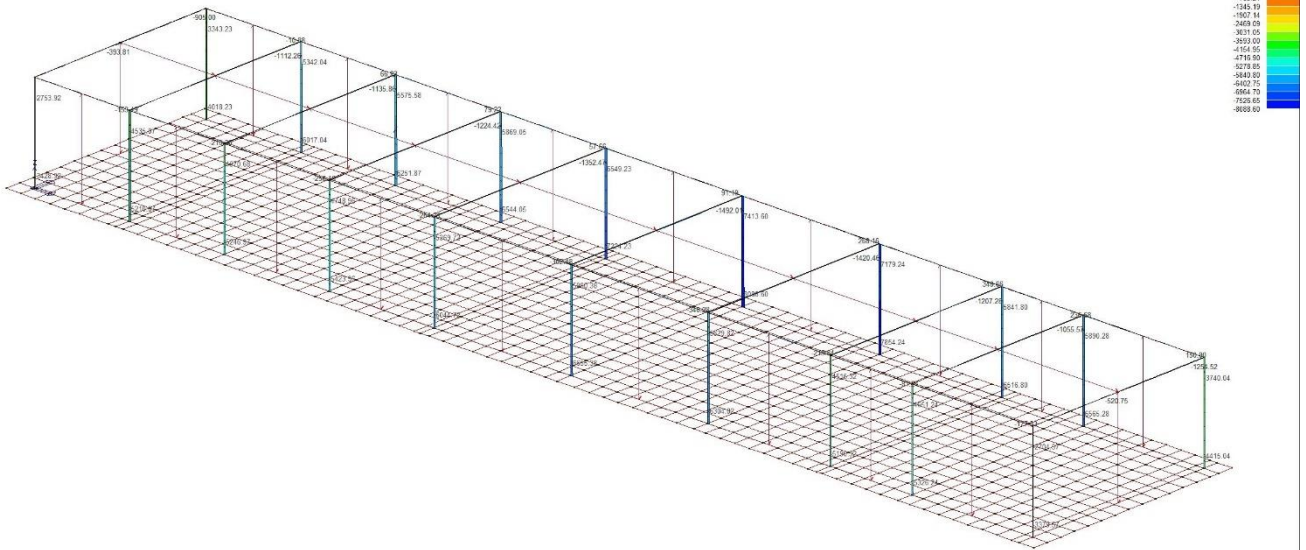

Edificio S8E CIVITA' P8P

43\_RIS\_N\_027\_Comb. SLU A1 (SLV sism.) 27

RISULTATI 049) Comb. SLE (SLD Danno sism.) 49

Sforzo Normale [daN]

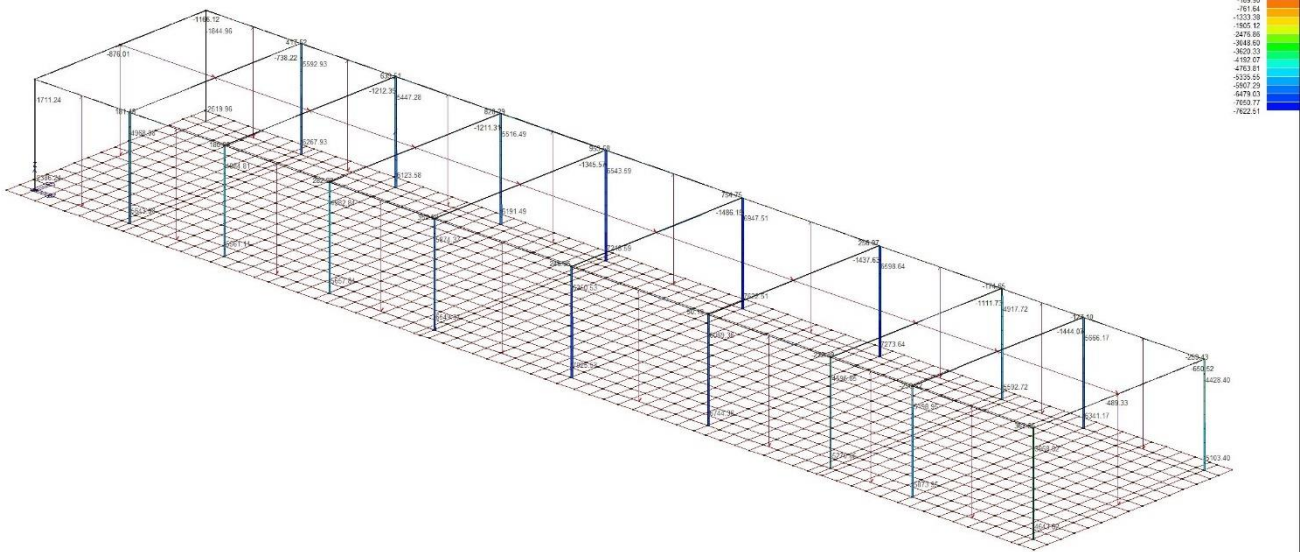

Edificio S8E CIVITA' P8P

43\_RIS\_N\_049\_Comb. SLE (SLD Danno sism.) 49

RISULTATI 059) Comb. SLE (SLD Danno sism.) 59

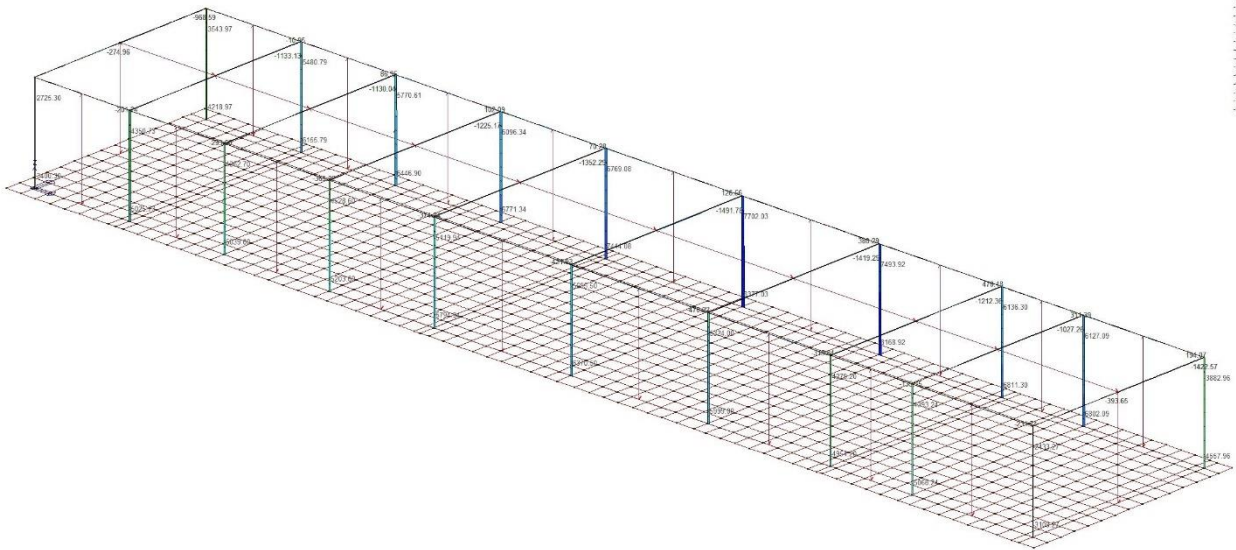
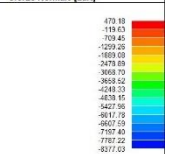

Edificio S8E CIVITA'PSP

43\_RIS\_N\_059\_Comb. SLE (SLD Danno sism.) 59

RISULTATI 070) Comb. SLE(rara) 70

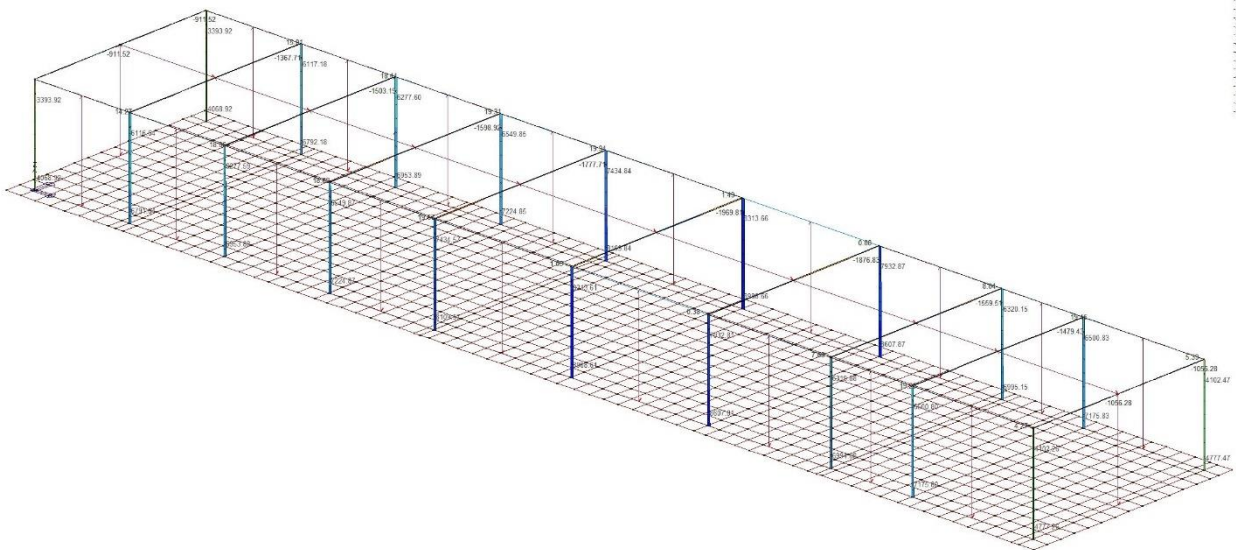
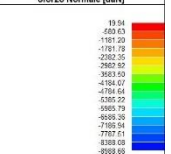

Edificio S8E CIVITA'PSP

43\_RIS\_N\_070\_Comb. SLE(rara) 70

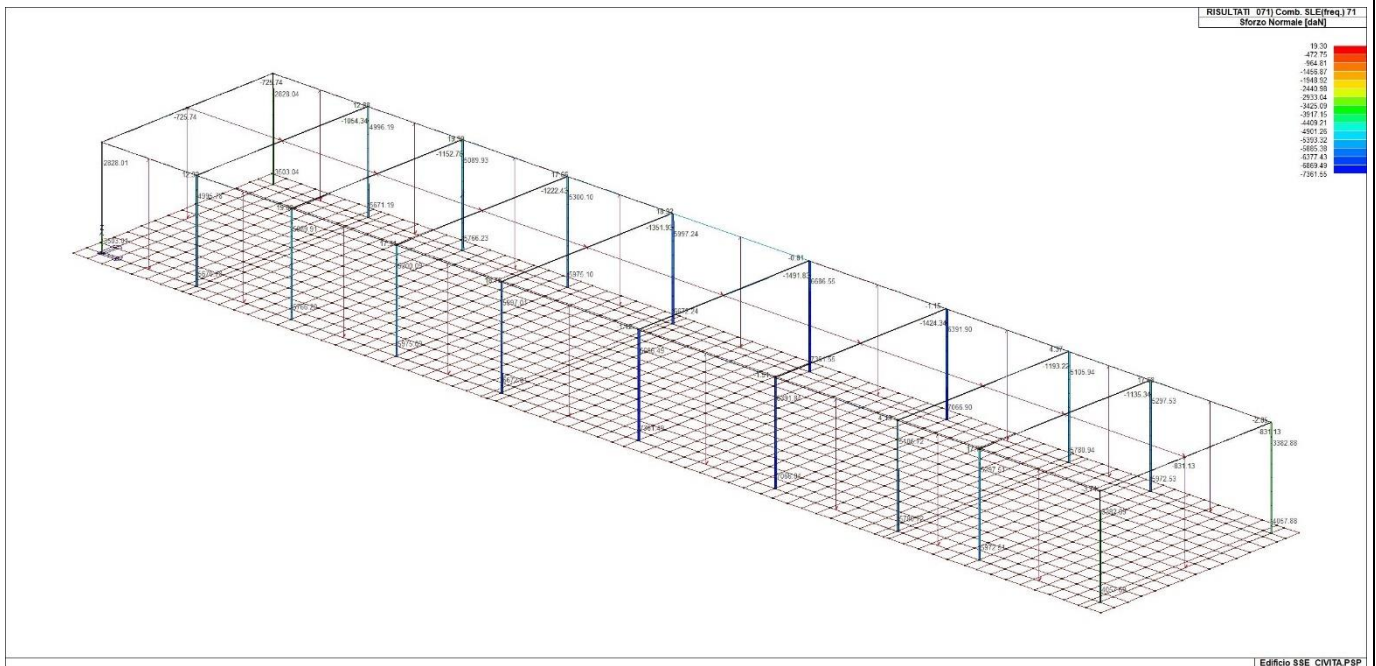

43\_RIS\_N\_071\_Comb. SLE(freq.) 71

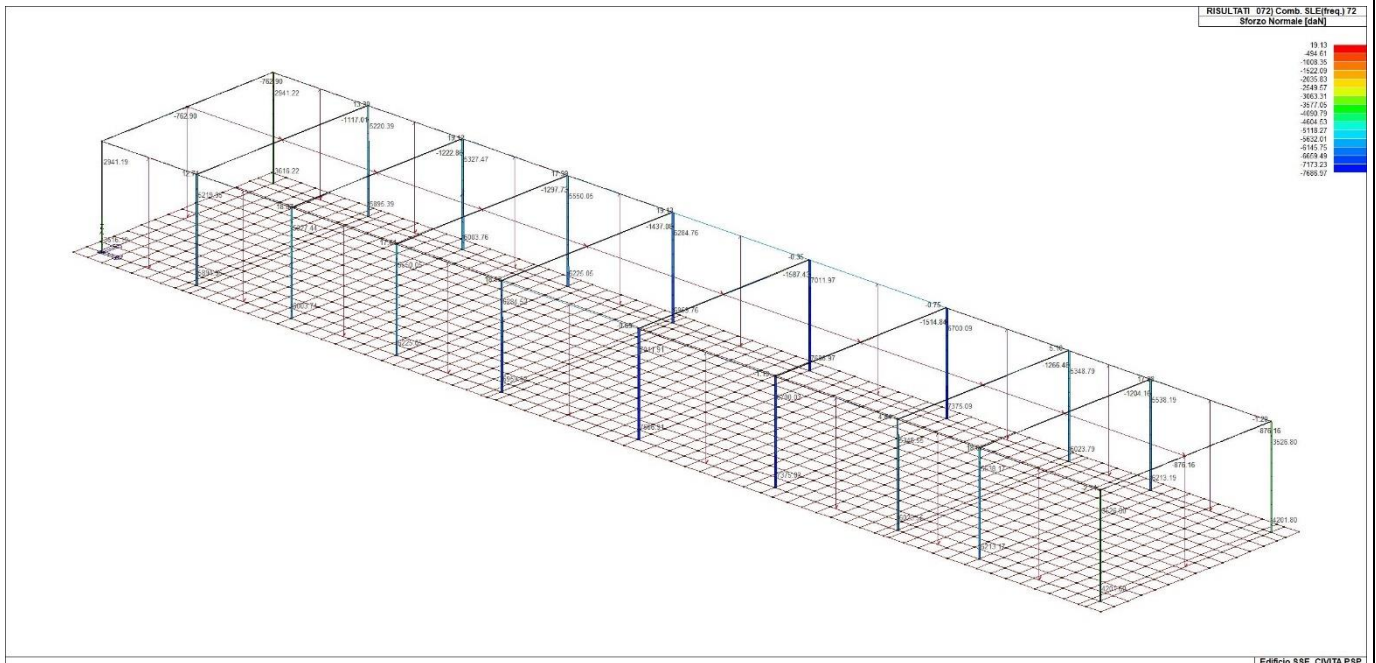

43\_RIS\_N\_072\_Comb. SLE(freq.) 72



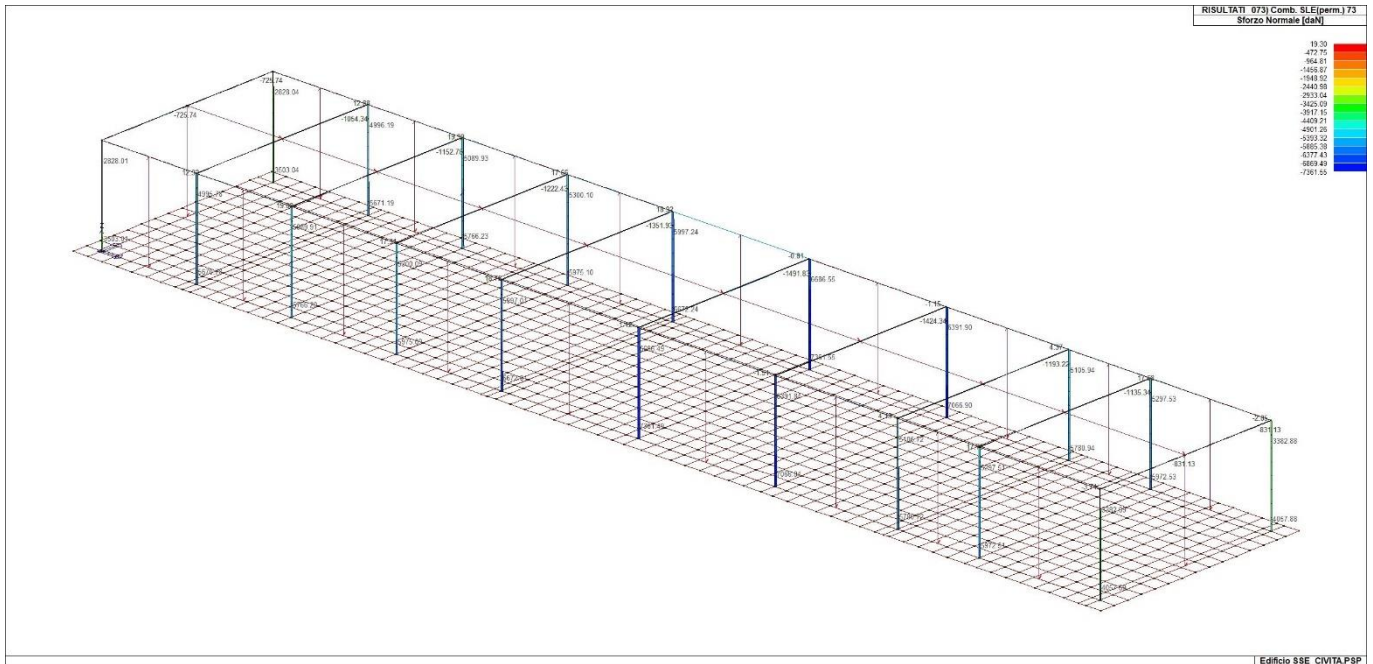

43\_RIS\_N\_073\_Comb. SLE(perm.) 73

## 17. RISULTATI ELEMENTI TIPO SHELL

### 17.1. LEGENDA RISULTATI ELEMENTI TIPO SHELL

Il controllo dei risultati delle analisi condotte, per quanto concerne gli elementi tipo shell, è possibile in relazione alle tabelle sottoriportate.

Per ogni elemento, e per ogni combinazione(o caso di carico) vengono riportati i risultati più significativi.

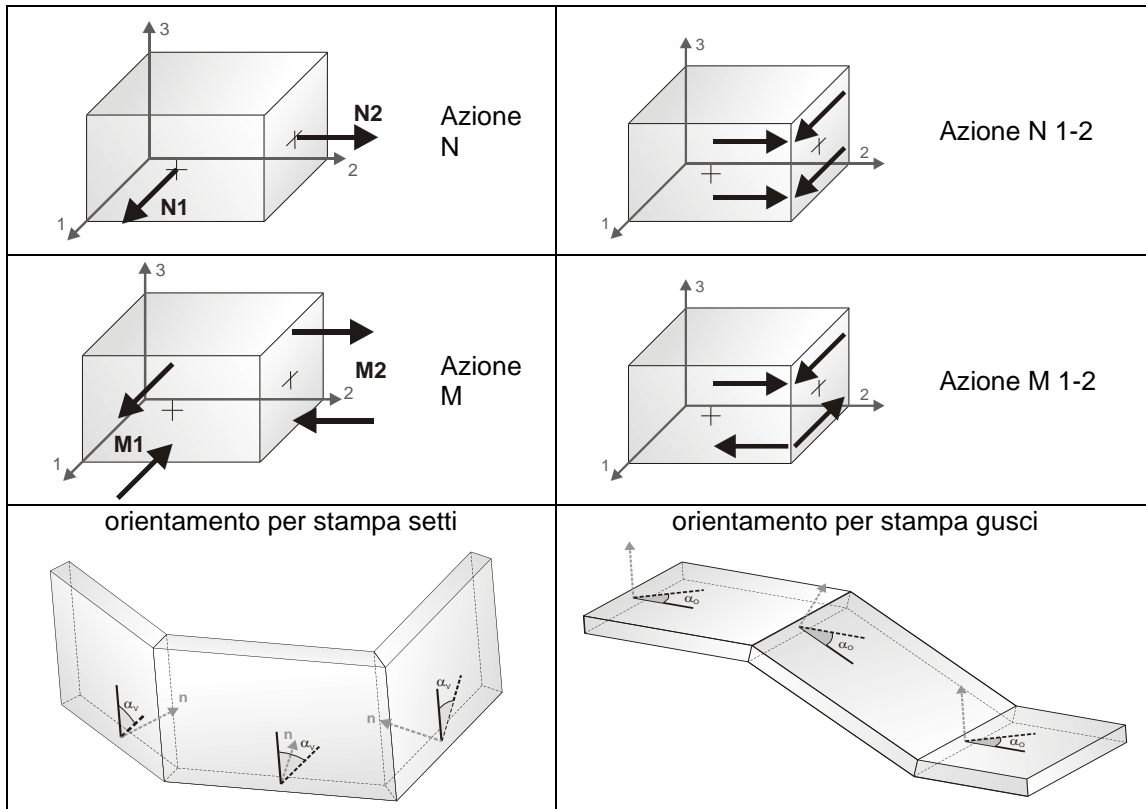

In particolare vengono riportati in ogni nodo di un elemento per ogni combinazione:

<b>tensione di Von Mises</b>	(valore riassuntivo del complessivo stato di sollecitazione)
<b>N max</b>	sforzamento membranale principale massimo
<b>N min</b>	sforzamento membranale principale minimo
<b>M max</b>	sforzamento flessionale principale massimo
<b>M min</b>	sforzamento flessionale principale minimo
<b>N1</b>	<b>N2</b>
<b>N1-2</b>	<b>M1</b>
<b>M2</b>	<b>M1-2</b>
	sforzi membranali e flessionali in direzione locale 1 e 2 dell'elemento (lo sforzo 2-1 è uguale allo sforzo 1-2 per la reciprocità delle tensioni tangenziali)

I suddetti risultati possono a scelta del progettista essere preceduti o sostituiti da valori di sollecitazione non più riferiti al sistema locale dell'elemento ma al sistema globale.

In questo caso gli elementi vengono raggruppati in gruppi (M\_S: macro gusci o macro setti, raggruppati per materiale, spessore, e posizione fisica) per la valutazione dei valori mediati ai nodi appartenenti agli elementi dei gruppi stessi.

I valori di sollecitazione sono, in questo caso, riferiti ad una terna specifica del gruppo ruotata di  $\alpha_o$  attorno all'asse Z per i gusci e ruotata di  $\alpha_v$  attorno alla normale (che per definizione è orizzontale) al piano del setto.

Per i setti, in particolare, se  $\alpha_v$  è zero, l'asse '1-1' rappresenta la verticale e l'asse '2-2' l'orizzontale contenuta nel setto.

Le azioni sui setti possono essere espresse anche con formato macro, cioè riferite all'intero macroelemento.

In particolare vengono riportati per ogni quota Z dei nodi e per ogni combinazione i seguenti valori:

<b>N memb.</b>	Azione membranale complessiva agente sulla parete in direzione Z
<b>V memb.</b>	Azione complessiva di taglio agente nel piano del macroelemento
<b>V orto</b>	Azione complessiva di taglio agente in direzione perpendicolare al macroelemento





EGP CODE

GRE.EEC.R.73.IT.W.15235.12.024.01

PAGE

331 di/of 527

<b>M memb.</b>	Azione flessionale compressiva agente nel piano del macroelemento
<b>M orto</b>	Azione flessionale compressiva agente in direzione perpendicolare al macroelemento
<b>T</b>	Azione torsionale compressiva agente nel piano orizzontale

Macro	Tipo	Angolo 1-X (gradi)
1	Guscio	0.0

M_G	Cmb	Nodo	N max daN/cm	N min daN/cm	N 1 daN/cm	N 2 daN/cm	N 1-2 daN/cm	M max daN	M min daN	M 1 daN	M 2 daN	M 1-2 daN
1	2	1	1.46-2.81	1.28	-2.63	-0.87	-793.67	-1234.63	-1107.08	-921.22	199.94	
1	2	3	1.41-3.35	1.04	-2.97	1.28	-814.21	-1253.40	-1122.83	-944.78	-200.74	
1	2	5	-3.76-12.37	-3.78	-12.34	-0.46	-1809.50	-2915.97	-2908.27	-1817.19	91.95	
1	2	7	2.18-8.33	2.18	-8.33	-4.84e-02	-1765.07	-2624.68	-2623.84	-1765.92	-26.95	
1	2	9	4.36-10.74	2.59	-8.97	4.86	-1821.01	-2777.50	-2768.17	-1830.34	-94.00	
1	2	11	-0.37-20.05	-3.85	-16.57	-7.51	-2169.14	-3876.04	-3876.04	-2169.14	2.04	
1	2	13	7.51-12.84	5.33	-10.66	-6.29	-2352.93	-3901.36	-3888.02	-2366.26	143.06	
1	2	15	6.63-12.27	4.62	-10.26	5.83	-2247.39	-3659.31	-3651.31	-2255.39	-105.96	
1	2	17	-0.55-17.20	-3.66	-14.08	6.49	-1816.05	-3106.51	-3101.03	-1821.53	83.91	
1	2	19	3.18-8.97	1.74	-7.52	3.93	-1743.74	-2868.08	-2760.01	-1851.82	-331.41	
1	2	21	4.17-8.10	-0.49	-3.45	-5.96	-827.60	-1902.31	-1534.28	-1195.63	509.98	
1	2	23	3.10e-02	-2.91	-2.71	-0.17	0.73	-1727.97	-2872.15	-2865.59	-1734.54	-86.40
1	2	25	5.00-7.00	5.00	-7.00	6.70e-02	-1706.57	-2591.06	-2590.28	-1707.35	26.24	
1	2	27	6.55-8.30	5.19	-6.94	-4.29	-1758.98	-2742.60	-2736.43	-1765.14	77.65	
1	2	29	6.05-8.66	-2.73	0.12	7.22	-2084.70	-3834.33	-3833.41	-2085.61	40.02	
1	2	31	10.26-9.89	8.59	-8.22	5.56	-2275.90	-3856.09	-3846.39	-2285.60	-123.42	
1	2	33	9.25-9.52	7.72	-7.98	-5.15	-2172.37	-3616.70	-3611.28	-2177.78	88.27	
1	2	35	4.78-7.24	-2.43	-3.28e-02	-5.89	-1743.14	-3075.48	-3064.70	-1753.91	-119.32	
1	2	37	5.43-6.69	4.30	-5.55	-3.53	-1682.37	-2820.77	-2725.69	-1777.45	314.96	
1	2	39	6.52-6.28	-0.56	0.79	6.36	-816.23	-1836.01	-1506.44	-1145.79	-476.94	
1	2	41	4.22-7.46	-2.72	-0.52	-5.74	532.80	-114.20	486.17	-67.57	167.32	
1	2	42	4.24-3.43	7.04e-03	0.80	-3.82	888.10	193.29	392.10	689.29	314.02	
1	2	43	13.58-4.71	13.47	-4.61	-1.38	822.47	-216.54	-175.85	781.79	201.53	
1	2	44	5.010.73	2.03	3.72	1.97	1093.54	367.10	411.11	1049.53	173.30	
1	2	45	9.513.16	5.74	6.93	3.12	1122.09	-39.46	-6.77	1089.40	192.11	
1	2	46	4.375.61e-02	0.83	3.59	1.66	1102.10	349.93	361.02	1091.02	90.64	
1	2	47	5.209.60e-02	0.29	5.01	0.97	1096.46	-48.73	-35.77	1083.49	121.16	
1	2	48	3.36-8.84e-02	0.19	3.08	0.94	1026.89	300.53	303.71	1023.71	47.94	
1	2	49	3.71-0.15-8.94e-02		3.65	0.47	1002.72	-64.72	-60.56	998.56	66.52	
1	2	50	2.74-5.27e-022.58e-02		2.66	0.46	939.04	260.31	261.04	938.31	22.23	
1	2	51	3.00-0.12-9.65e-02		2.98	0.24	901.67	-81.17	-80.21	900.72	30.63	
1	2	52	2.48-2.17e-02-1.62e-02		2.47	0.12	890.02	240.74	240.78	889.98	4.93	
1	2	53	2.71-9.13e-02-9.01e-02		2.71	5.74e-02	846.78	-89.98	-89.93	846.72	6.95	
1	2	54	2.51-1.65e-02-1.28e-03		2.49	-0.20	903.36	245.09	245.26	903.19	-10.49	
1	2	55	2.76-9.08e-02-8.55e-02		2.76	-0.12	861.35	-88.12	-87.92	861.16	-13.62	
1	2	56	2.83-4.19e-027.12e-02		2.72	-0.56	973.28	272.33	273.64	971.97	-30.28	
1	2	57	3.16-0.11-8.12e-02		3.13	-0.33	939.62	-76.54	-74.92	938.01	-40.45	
1	2	58	3.49-7.85e-02 0.27		3.15	-1.06	1064.74	316.18	321.27	1059.64	-61.53	
1	2	59	4.01-0.14-5.10e-02		3.92	-0.61	1046.26	-61.12	-55.06	1040.20	-81.71	
1	2	60	4.430.12	0.93	3.61	-1.68	1115.43	358.25	375.94	1097.74	-114.37	
1	2	61	5.650.15	0.44	5.36	-1.23	1114.10	-56.41	-39.22	1096.91	-140.81	
1	2	62	4.281.13	1.74	3.67	-1.25	1052.26	334.80	409.03	978.04	-218.51	
1	2	63	9.973.28	6.65	6.60	-3.34	1059.60	-83.72	-46.07	1021.95	-204.02	
1	2	64	6.55-4.32	-2.98	5.21	3.57	786.69	72.27	410.85	448.10	-356.72	
1	2	65	13.98-12.68	13.89	-12.59	1.57	620.44	-469.75	-436.15	586.84	-188.42	
1	2	66	3.86-6.86	0.58	-3.59	4.94	541.53	-117.02	502.54	-78.04	-155.42	
1	2	67	1.08-4.33	-4.24	0.98	0.71	963.05	70.13	946.41	86.77	120.75	
1	2	68	3.22-0.87	-0.61	2.95	1.01	904.83	631.95	829.93	706.84	121.77	
1	2	69	2.330.39	0.94	1.78	0.88	1030.16	668.81	682.39	1016.58	68.72	
1	2	70	2.780.17	0.95	2.00	1.19	1086.49	577.13	578.53	1085.09	26.63	
1	2	71	2.480.15	0.52	2.11	0.85	1035.51	495.17	495.34	1035.34	9.51	
1	2	72	2.210.14	0.24	2.10	0.45	958.91	439.80	439.81	958.89	2.97	
1	2	73	2.080.12	0.13	2.07	0.13	913.94	414.63	414.63	913.94	0.49	
1	2	74	2.080.14	0.15	2.07	-0.17	926.33	420.61	420.61	926.32	-1.32	
1	2	75	2.220.17	0.31	2.09	-0.50	989.75	457.52	457.57	989.70	-5.15	
1	2	76	2.510.17	0.60	2.07	-0.91	1065.82	523.91	524.35	1065.39	-15.31	
1	2	77	2.869.26e-02	0.95	2.01	-1.28	1085.62	615.19	618.57	1082.23	-39.77	
1	2	78	3.04-0.16	0.71	2.17	-1.42	975.57	701.43	736.42	940.59	-91.47	
1	2	79	1.33-0.37	-0.37	1.33	-4.76e-02	932.24	481.37	895.00	518.61	-124.11	
1	2	80	1.60-5.88	-5.80	1.52	-0.77	954.82	68.94	937.96	85.80	-121.04	



EGP CODE

GRE.EEC.R.73.IT.W.15235.12.024.01

PAGE

332 di/of 527

1	2	81	-4.37e-02	-3.50	-3.49	-4.83e-02	-0.13	1119.46	108.13	1110.12	117.47	-96.74
1	2	82	0.72-1.20	-1.19	0.71	-0.16	960.68	667.46	932.30	695.84	-86.69	
1	2	83	0.860.37	0.42	0.81	0.14	1026.44	742.71	765.87	1003.28	-77.69	
1	2	84	1.360.61	0.88	1.10	0.36	1099.91	630.26	638.08	1092.10	-60.07	
1	2	85	1.590.52	0.64	1.48	0.34	1054.95	547.52	550.47	1051.99	-38.62	
1	2	86	1.720.32	0.35	1.69	0.22	978.71	495.03	495.86	977.88	-19.97	
1	2	87	1.770.21	0.21	1.77	8.16e-02	933.18	471.66	471.70	933.14	-4.50	
1	2	88	1.760.23	0.23	1.76	-5.21e-02	945.66	477.57	477.79	945.45	10.07	
1	2	89	1.680.40	0.42	1.65	-0.18	1009.54	512.86	514.27	1008.13	26.46	
1	2	90	1.510.61	0.74	1.39	-0.31	1084.23	577.77	582.08	1079.93	46.49	
1	2	91	1.310.57	0.95	0.93	-0.37	1096.15	673.68	685.07	1084.76	68.45	
1	2	92	0.550.23	0.32	0.47	-0.14	971.00	780.11	829.11	922.00	83.38	
1	2	93	0.52-1.94	-1.93	0.50	0.21	1020.09	509.37	1004.63	524.83	87.49	
1	2	94	-0.18-3.71	-3.70	-0.19	0.12	1120.37	113.09	1111.36	122.11	94.88	
1	2	95	0.55-3.72	-3.21	3.99e-02	-1.39	1033.53	-34.51	912.15	86.87	-338.98	
1	2	96	1.64-1.99	-1.57	1.22	-1.16	1034.58	429.73	768.27	696.05	-300.26	
1	2	97	1.51-0.34	3.37e-02	1.13	-0.74	1140.80	542.41	642.45	1040.76	-223.28	
1	2	98	1.490.38	0.66	1.21	-0.48	1165.36	529.26	559.98	1134.63	-136.38	
1	2	99	1.590.41	0.48	1.53	-0.27	1095.24	495.83	505.67	1085.39	-76.17	
1	2	100	1.680.24	0.25	1.68	-8.22e-02	1005.64	466.74	469.26	1003.12	-36.76	
1	2	101	1.720.14	0.14	1.72	1.29e-02	954.68	452.15	452.28	954.56	-7.97	
1	2	102	1.730.15	0.15	1.73	8.08e-02	968.50	456.12	456.79	967.83	18.53	
1	2	103	1.700.27	0.30	1.68	0.20	1040.75	477.85	482.42	1036.18	50.54	
1	2	104	1.670.41	0.57	1.51	0.42	1132.79	511.43	526.90	1117.33	96.80	
1	2	105	1.620.24	0.76	1.10	0.67	1176.77	542.97	590.54	1129.19	167.01	
1	2	106	1.24-0.48-3.98e-03	0.76	0.76	0.77	1108.13	528.77	687.89	949.00	258.59	
1	2	107	1.59-2.51	-2.24	1.31	1.03	1020.60	316.50	827.81	509.30	313.97	
1	2	108	0.49-4.17	-3.57	-0.11	1.56	1031.74	-32.92	911.91	86.91	336.48	
1	2	109	-0.30-4.27	-3.80	-0.77	-1.29	591.95	-356.86	291.78	-56.69	-441.25	
1	2	110	7.46-3.20	-2.08	6.34	-3.26	1043.38	27.24	345.41	725.21	-471.25	
1	2	111	2.50-0.37	-0.10	2.24	-0.83	1236.96	256.76	343.37	1150.35	-278.19	
1	2	112	3.06-0.34	0.19	2.53	-1.24	1236.15	373.75	401.14	1208.75	-151.24	
1	2	113	2.42-0.13	3.13e-02	2.26	-0.61	1138.86	400.69	409.86	1129.69	-81.77	
1	2	114	2.04-6.06e-02-3.54e-02	2.02	2.02	-0.23	1034.00	399.19	401.60	1031.58	-39.07	
1	2	115	1.91-6.06e-02-6.03e-02	1.91	-2.08e-02	976.88	394.60	394.60	394.72	976.76	-8.43	
1	2	116	1.95-6.38e-02-5.41e-02	1.94	0.14	992.32	396.06	396.71	991.66	19.77		
1	2	117	2.17-8.20e-02-1.69e-02	2.11	0.38	1074.24	401.44	405.84	1069.84	54.22		
1	2	118	2.68-0.20	6.39e-02	2.42	0.83	1185.60	396.65	411.14	1171.11	105.94	
1	2	119	3.54-0.50	0.25	2.78	1.58	1259.07	348.94	391.82	1216.18	192.86	
1	2	120	3.47-0.97	-0.48	2.97	1.40	1201.88	181.84	324.17	1059.54	353.45	
1	2	121	4.90-0.63	-0.19	4.47	1.49	881.87	-53.78	377.75	450.34	466.42	
1	2	122	0.56-8.43	-7.74	-0.13	2.39	560.61	-377.39	258.15	-74.92	438.44	
1	2	123	9.38-5.92	2.93	0.53	7.56	-582.91	-938.47	-784.99	-736.39	-176.11	
1	2	124	4.60-5.56	3.39	-4.35	3.29	1087.94	-457.76	-309.57	939.75	-455.08	
1	2	125	6.98-3.39	-1.17	4.75	-4.26	1290.85	71.26	106.41	1255.70	-204.04	
1	2	126	4.56-1.16	-1.00	4.39	-0.97	1275.45	259.68	268.31	1266.82	-93.20	
1	2	127	3.08-0.49	-0.47	3.06	-0.30	1166.32	317.55	320.83	1163.04	-52.68	
1	2	128	2.35-0.28	-0.28	2.35	-7.07e-02	1053.19	329.59	330.56	1052.22	-26.51	
1	2	129	2.08-0.21	-0.21	2.08	1.54e-02	992.56	329.70	329.75	992.51	-5.95	
1	2	130	2.13-0.22	-0.22	2.13	6.88e-02	1008.99	329.89	330.16	1008.72	13.49	
1	2	131	2.53-0.30	-0.29	2.52	0.17	1096.50	327.17	328.84	1094.83	35.84	
1	2	132	3.44-0.56	-0.51	3.39	0.45	1218.23	302.20	307.05	1213.39	66.45	
1	2	133	5.16-1.36	-1.13	4.92	1.21	1303.93	208.14	220.83	1291.24	117.24	
1	2	134	7.64-3.68	-0.47	4.42	5.10	1246.72	-76.63	-22.22	1192.31	262.76	
1	2	135	6.44-8.54	-1.72	-0.38	-7.46	845.27	-819.23	-518.32	544.36	640.56	
1	2	136	11.36-2.68	9.43	-0.74	-4.84	-657.82	-893.87	-735.29	-816.40	110.83	
1	2	137	26.587.70	26.55	7.72	0.68	1139.31	-137.14	-133.77	1135.93	-65.54	
1	2	138	12.622.42e-022.57e-02	12.62	0.14	1370.59	85.67	88.25	1368.00	-57.55		
1	2	139	4.64-3.53e-02-3.45e-02	4.64	6.26e-02	1281.80	247.66	249.76	1279.70	-46.52		
1	2	140	3.05-0.43	-0.43	3.05	6.65e-02	1170.52	292.63	293.84	1169.31	-32.53	
1	2	141	2.36-0.32	-0.32	2.36	6.13e-02	1057.18	301.95	302.39	1056.73	-18.27	
1	2	142	2.08-0.24	-0.24	2.08	4.29e-02	996.25	301.38	301.41	996.23	-4.37	
1	2	143	2.14-0.24	-0.24	2.14	2.08e-02	1012.79	301.73	301.85	1012.67	9.39	
1	2	144	2.53-0.33	-0.33	2.53	4.58e-03	1100.75	299.99	300.68	1100.07	23.43	
1	2	145	3.37-0.43	-0.43	3.37	-5.19e-03	1222.47	278.34	279.86	1220.95	37.81	
1	2	146	5.290.15	0.15	5.29	-3.64e-02	1309.71	201.28	203.68	1307.30	51.57	
1	2	147	15.87-0.56	-0.55	15.87	-0.23	1350.20	-33.55	-30.80	1347.45	61.68	
1	2	148	39.24-10.97	39.20	-10.94	-1.32	883.48	-709.49	-707.36	881.35	58.25	
1	2	149	8.03-4.09	3.96	-1.63e-02	-5.72	-709.86	-803.37	-789.09	-724.14	33.64	
1	2	150	3.99-5.14	2.87	-4.02	-2.99	1018.00	-434.88	-361.59	944.71	317.98	
1	2	151	6.68-3.24	-1.03	4.47	4.13	1263.88	54.52	60.58	1257.82	85.41	
1	2	152	4.54-1.22	-1.03	4.35	1.04	1273.31	219.42	219.42	1273.31	-0.19	
1	2	153	3.09-0.54	-0.49	3.04	0.43	1170.37	270.91	271.07	1170.20	-12.26	
1	2	154	2.34-0.31	-0.29	2.33	0.19	1059.19	280.46	280.59	1059.07	-9.91	
1	2	155	2.06-0.22	-0.22	2.06	7.00e-02	999.01	279.84	279.85	999.00	-2.74	
1	2	156	2.12-0.22	-0.22	2.12	-2.94e-02	1015.35	280.32	280.36	1015.31	5.24	



EGP CODE

GRE.EEC.R.73.IT.W.15235.12.024.01

PAGE

333 di/of 527

1	2	157	2.52-0.31	-0.30	2.51	-0.16	1102.07	279.08	279.22	1101.92	10.90
1	2	158	3.43-0.57	-0.52	3.38	-0.44	1220.81	257.96	258.04	1220.73	9.06
1	2	159	5.09-1.35	-1.13	4.87	-1.18	1297.78	173.00	173.16	1297.63	-13.33
1	2	160	7.24-3.47	-0.24	4.01	-4.92	1208.47	-81.15	-67.13	1194.45	-133.75
1	2	161	5.73-8.86	-2.02	-1.11	7.28	720.65	-751.78	-561.49	530.36	-493.95
1	2	162	9.61-1.93	8.96	-1.28	2.66	-740.09	-829.68	-753.19	-816.58	31.66
1	2	163	-0.41-4.07	-3.35	-1.13	1.46	361.79	-233.20	184.17	-55.58	272.28
1	2	164	6.76-3.24	-2.51	6.03	2.59	877.07	64.91	220.09	721.89	319.30
1	2	165	2.38-0.60	-0.49	2.27	0.57	1187.67	180.40	204.67	1163.40	154.45
1	2	166	3.06-0.51	8.45e-03	2.53	1.26	1233.08	253.39	256.52	1229.95	55.34
1	2	167	2.45-0.27	-5.40e-02	2.23	0.74	1152.93	262.98	263.27	1152.64	16.26
1	2	168	2.02-0.12	-5.65e-02	1.96	0.36	1053.09	255.32	255.33	1053.08	2.99
1	2	169	1.85-6.04e-02	-5.52e-02	1.84	9.99e-02	996.85	249.16	249.16	996.85	1.08e-02
1	2	170	1.90-6.20e-02	-5.52e-02	1.89	-0.12	1012.14	251.31	251.31	1012.14	-1.12
1	2	171	2.17-0.11	-4.70e-02	2.10	-0.38	1092.27	260.19	260.26	1092.21	-7.37
1	2	172	2.69-0.24	-2.00e-03	2.45	-0.81	1195.58	265.40	266.31	1194.67	-29.01
1	2	173	3.44-0.47	0.17	2.80	-1.44	1244.34	243.33	250.68	1236.98	-85.51
1	2	174	3.20-0.92	-0.65	2.93	-1.02	1122.12	140.23	191.79	1070.56	-219.01
1	2	175	4.65-0.80	-0.65	4.50	-0.91	675.35	34.54	258.04	451.84	-305.40
1	2	176	0.93-8.31	-7.34	-4.10e-02	-2.83	331.83	-247.54	153.61	-69.32	-267.38
1	2	177	0.47-2.82	-2.66	0.31	0.71	737.53	51.19	703.53	85.19	148.93
1	2	178	1.91-2.21	-2.12	1.82	0.60	784.18	468.69	548.28	704.59	137.02
1	2	179	1.74-0.83	-0.69	1.60	0.59	1081.60	399.31	410.99	1069.92	88.52
1	2	180	1.65-1.37e-02	0.25	1.39	0.60	1178.99	323.73	325.38	1177.35	37.51
1	2	181	1.670.16	0.31	1.52	0.45	1129.55	274.65	274.83	1129.37	12.37
1	2	182	1.620.17	0.21	1.58	0.23	1042.71	243.66	243.68	1042.70	3.17
1	2	183	1.610.14	0.14	1.60	5.57e-02	990.78	229.85	229.85	990.78	0.52
1	2	184	1.650.14	0.14	1.64	-9.54e-02	1004.90	234.13	234.13	1004.90	-0.96
1	2	185	1.730.18	0.22	1.68	-0.26	1077.73	256.41	256.45	1077.69	-5.71
1	2	186	1.800.22	0.38	1.64	-0.47	1163.23	296.01	296.48	1162.76	-20.14
1	2	187	1.690.16	0.43	1.42	-0.59	1174.77	354.91	358.52	1171.16	-54.32
1	2	188	1.41-0.55	-0.45	1.30	-0.44	998.30	438.93	461.85	975.38	-110.89
1	2	189	1.85-2.37	-2.30	1.79	-0.50	715.04	416.25	614.03	517.26	-141.34
1	2	190	0.50-3.40	-3.07	0.16	-1.10	737.00	55.99	705.03	87.97	-144.06
1	2	191	1.04-3.34	-2.81	0.50	-1.43	788.85	86.40	775.56	99.69	-95.70
1	2	192	2.05-2.58	-2.54	2.01	-0.42	756.10	552.63	600.70	708.04	-86.43
1	2	193	1.63-0.81	-0.81	1.63	8.88e-02	1067.12	434.16	440.19	1061.09	-61.53
1	2	194	1.330.32	0.32	1.32	3.89e-02	1170.64	331.15	332.29	1169.50	-30.93
1	2	195	1.440.43	0.43	1.44	-1.55e-02	1125.34	267.32	267.56	1125.11	-14.07
1	2	196	1.520.31	0.31	1.52	-2.07e-02	1040.36	229.56	229.60	1040.33	-5.63
1	2	197	1.570.23	0.23	1.57	-2.44e-02	988.98	213.30	213.30	988.98	-0.64
1	2	198	1.600.22	0.22	1.60	-2.56e-02	1002.88	218.09	218.11	1002.87	3.69
1	2	199	1.620.30	0.30	1.62	-8.29e-03	1074.51	244.30	244.41	1074.40	9.63
1	2	200	1.600.42	0.42	1.60	6.19e-02	1156.87	293.75	294.22	1156.41	20.01
1	2	201	1.550.33	0.38	1.51	0.22	1163.05	373.38	375.35	1161.08	39.39
1	2	202	1.54-0.60	-0.57	1.51	0.26	982.98	492.04	502.81	972.21	71.92
1	2	203	1.95-2.51	-2.46	1.90	0.48	720.74	486.40	675.02	532.12	92.87
1	2	204	0.84-3.51	-3.04	0.37	1.35	793.83	90.89	778.77	105.94	101.77
1	2	205	1.00-6.43	-4.64	-0.78	-3.17	556.85	-134.58	417.02	5.26	-277.73
1	2	206	5.84-3.77	-3.59	5.66	-1.29	881.02	229.06	382.06	728.02	-276.30
1	2	207	2.75-0.81	-0.81	2.75	3.63e-02	1171.51	246.38	282.97	1134.92	-180.30
1	2	208	2.330.21	0.30	2.24	-0.44	1219.97	252.06	258.73	1213.30	-80.10
1	2	209	2.040.27	0.35	1.97	-0.36	1146.41	229.39	230.60	1145.19	-33.39
1	2	210	1.850.22	0.24	1.82	-0.20	1049.01	206.84	207.01	1048.84	-12.04
1	2	211	1.760.17	0.17	1.76	-7.98e-02	993.39	195.04	195.04	993.39	-1.54
1	2	212	1.780.16	0.16	1.78	2.51e-02	1008.38	198.22	198.28	1008.32	6.98
1	2	213	1.930.19	0.20	1.91	0.15	1086.82	215.60	216.11	1086.32	21.03
1	2	214	2.240.18	0.24	2.18	0.34	1185.33	241.61	244.36	1182.58	50.87
1	2	215	2.89-7.58e-02	-23.75e-02	2.77	0.57	1224.54	265.25	278.63	1211.17	112.46
1	2	216	4.60-1.34	-1.01	4.27	1.36	1111.42	256.25	322.37	1045.29	228.42
1	2	217	3.89-1.30	-1.29	3.88	-0.25	753.80	204.50	440.87	517.43	271.97
1	2	218	3.12-9.37	-8.15	1.90	3.71	544.72	-138.51	400.08	6.13	279.11
1	2	219	4.05-4.28	3.77	-4.00	1.50	29.42	-407.99	-144.39	-234.18	-214.04
1	2	220	5.28-8.40	-3.17	5.19e-02	6.65	942.99	-357.08	-168.98	754.89	-457.34
1	2	221	4.24-0.34	-0.34	4.24	-3.43e-02	1276.36	22.16	53.10	1245.42	-194.55
1	2	222	3.480.40	0.47	3.42	-0.45	1279.90	155.01	158.91	1276.00	-66.10
1	2	223	2.740.16	0.21	2.70	-0.33	1173.26	185.67	186.24	1172.69	-23.79
1	2	224	2.258.57e-02	0.10	2.24	-0.18	1060.12	184.61	184.67	1060.06	-7.42
1	2	225	2.036.48e-02	-26.70e-02	2.02	-6.58e-02	998.93	179.54	179.54	998.93	-0.73
1	2	226	2.045.96e-02	-26.00e-02	2.04	2.59e-02	1015.45	180.34	180.36	1015.43	4.26
1	2	227	2.286.61e-02	-27.33e-02	2.28	0.13	1103.18	184.40	184.62	1102.96	14.26
1	2	228	2.790.11	0.13	2.78	0.22	1222.84	175.69	177.16	1221.37	39.29
1	2	229	3.580.22	0.22	3.58	0.11	1300.78	116.80	125.42	1292.16	100.67
1	2	230	5.00-1.74	-1.36	4.62	-1.55	1215.61	-85.48	-26.41	1156.54	270.87
1	2	231	9.99-10.02	-7.94	7.91	-6.10	693.98	-505.70	-194.11	382.39	526.03
1	2	232	7.20-8.90	7.16	-8.86	0.75	-17.42	-410.44	-136.32	-291.53	180.54



EGP CODE

GRE.EEC.R.73.IT.W.15235.12.024.01

PAGE

334 di/of 527

1	2	233	-0.69-7.67	-7.67	-0.69	4.56e-02	1234.83	-65.03	1232.64	-62.84	-53.27
1	2	234	19.82-12.46	19.82	-12.46	-0.20	1122.91	-643.10	-642.86	1122.67	20.56
1	2	235	8.544.37	8.54	4.37	-1.74e-02	1390.23	-20.92	-20.66	1389.96	19.36
1	2	236	3.921.12	1.12	3.92	4.58e-02	1305.09	120.87	121.11	1304.85	16.86
1	2	237	3.050.17	0.17	3.05	4.35e-02	1182.55	169.16	169.31	1182.40	12.14
1	2	238	2.444.09e-024.12e-02		2.44	2.79e-02	1061.91	177.14	177.19	1061.86	6.91
1	2	239	2.162.49e-022.49e-02		2.16	9.41e-03	998.02	174.97	174.97	998.01	1.57
1	2	240	2.162.00e-022.00e-02		2.16	-7.82e-03	1015.28	174.73	174.74	1015.27	-3.80
1	2	241	2.442.89e-022.91e-02		2.44	-2.19e-02	1107.60	172.85	172.94	1107.51	-9.19
1	2	242	3.000.17	0.17	3.00	-3.11e-02	1237.67	148.57	148.76	1237.48	-14.38
1	2	243	3.621.22	1.22	3.62	-2.80e-02	1335.45	56.75	57.03	1335.17	-18.78
1	2	244	9.043.13	9.04	3.13	5.74e-02	1339.59	-187.17	-186.90	1339.31	-20.40
1	2	245	21.51-28.93	21.51	-28.93	0.23	799.58	-1225.89	-1225.71	799.40	-19.09
1	2	246	3.85-0.52	0.46	2.87	-1.82	1140.62	478.55	538.16	1081.01	-189.50
1	2	247	3.87-4.21	3.34	-3.68	-2.01	83.95	-445.53	-130.42	-231.16	259.91
1	2	248	5.48-8.57	-3.23	0.14	-6.82	978.93	-373.58	-152.24	757.59	500.37
1	2	249	4.48-0.26	-0.24	4.46	0.30	1288.22	25.44	70.69	1242.97	234.71
1	2	250	3.630.37	0.48	3.52	0.59	1276.82	162.70	171.52	1268.00	98.74
1	2	251	2.830.16	0.23	2.75	0.43	1164.65	193.05	195.32	1162.38	46.96
1	2	252	2.300.11	0.14	2.28	0.24	1049.30	190.67	191.16	1048.81	20.49
1	2	253	2.060.10	0.10	2.06	8.53e-02	987.41	184.79	184.81	987.40	3.72
1	2	254	2.089.10e-029.20e-02		2.08	-4.44e-02	1004.02	185.90	186.06	1003.86	-11.37
1	2	255	2.338.27e-029.66e-02		2.32	-0.18	1092.90	191.19	192.30	1091.79	-31.68
1	2	256	2.870.11	0.14	2.83	-0.30	1216.01	183.50	187.86	1211.65	-66.93
1	2	257	3.690.21	0.23	3.67	-0.22	1301.88	123.42	139.65	1285.65	-137.32
1	2	258	5.07-1.50	-1.24	4.81	1.30	1235.51	-86.38	-7.12	1156.25	-313.83
1	2	259	10.22-10.20	-8.12	8.15	6.18	744.56	-531.22	-177.81	391.14	-570.94
1	2	260	7.23-8.81	7.23	-8.81	-0.25	39.24	-443.85	-118.49	-286.11	-226.54
1	2	261	0.97-6.51	-4.94	-0.60	3.05	629.62	-160.00	458.28	11.34	325.48
1	2	262	6.09-3.80	-3.56	5.85	1.53	933.70	220.84	421.19	733.36	320.44
1	2	263	2.90-0.79	-0.77	2.89	0.21	1182.69	262.52	317.05	1128.16	217.27
1	2	264	2.550.16	0.36	2.35	0.65	1210.28	272.24	285.00	1197.52	108.67
1	2	265	2.190.29	0.43	2.05	0.50	1128.20	245.29	248.43	1125.06	52.55
1	2	266	1.940.28	0.33	1.89	0.28	1027.96	217.69	218.31	1027.34	22.43
1	2	267	1.830.25	0.26	1.82	9.92e-02	971.60	203.27	203.29	971.58	3.97
1	2	268	1.850.23	0.23	1.85	-5.11e-02	986.55	207.36	207.56	986.35	-12.35
1	2	269	2.020.23	0.26	1.99	-0.22	1066.12	228.87	230.33	1064.66	-34.90
1	2	270	2.360.19	0.28	2.27	-0.44	1169.36	260.31	266.43	1163.24	-74.32
1	2	271	3.04-9.31e-028.24e-02		2.87	-0.72	1221.63	286.07	309.32	1198.38	-145.63
1	2	272	4.77-1.37	-0.94	4.34	-1.56	1136.80	266.88	359.80	1043.88	-268.70
1	2	273	3.80-1.24	-1.24	3.80	6.92e-02	820.96	185.93	482.78	524.11	-316.84
1	2	274	3.05-9.56	-8.43	1.92	-3.60	617.89	-163.03	443.19	11.67	-325.43
1	2	275	1.03-3.62	-3.17	0.58	1.37	893.59	87.51	868.83	112.27	139.08
1	2	276	2.22-2.81	-2.74	2.15	0.59	823.55	570.94	679.94	714.55	125.11
1	2	277	1.75-0.82	-0.80	1.73	0.21	1064.22	488.52	503.38	1049.36	91.32
1	2	278	1.450.40	0.45	1.41	0.21	1148.32	372.48	375.63	1145.18	49.33
1	2	279	1.550.55	0.59	1.52	0.17	1097.09	291.37	292.07	1096.38	23.79
1	2	280	1.610.46	0.47	1.60	9.90e-02	1011.26	240.77	240.90	1011.13	10.08
1	2	281	1.650.36	0.36	1.65	4.04e-02	959.97	218.71	218.71	959.96	1.82
1	2	282	1.690.34	0.34	1.69	-9.57e-03	973.47	225.27	225.31	973.43	-5.41
1	2	283	1.720.39	0.40	1.72	-7.35e-02	1044.59	260.82	261.12	1044.29	-15.44
1	2	284	1.740.47	0.49	1.71	-0.18	1128.97	326.17	327.53	1127.61	-32.91
1	2	285	1.710.35	0.45	1.61	-0.35	1146.01	423.69	429.27	1140.43	-63.23
1	2	286	1.61-0.58	-0.50	1.53	-0.40	996.93	548.37	575.41	969.89	-106.77
1	2	287	1.94-2.65	-2.57	1.85	-0.62	824.45	483.88	762.33	546.00	-131.52
1	2	288	0.85-3.84	-3.36	0.36	-1.43	901.33	94.57	875.61	120.29	-141.74
1	2	289	0.77-3.50	-3.27	0.54	-0.96	913.64	96.29	892.95	116.98	-128.38
1	2	290	2.02-2.61	-2.60	2.01	-0.25	822.59	594.83	698.98	718.44	-113.47
1	2	291	1.73-0.69	-0.67	1.72	-0.21	1062.29	505.39	517.61	1050.07	-81.60
1	2	292	1.590.36	0.47	1.49	-0.35	1147.01	382.28	384.81	1144.47	-43.98
1	2	293	1.670.49	0.56	1.60	-0.29	1096.59	296.85	297.43	1096.01	-21.54
1	2	294	1.690.42	0.44	1.67	-0.16	1011.28	244.17	244.29	1011.17	-9.26
1	2	295	1.710.34	0.34	1.70	-4.43e-02	960.20	221.35	221.36	960.19	-1.58
1	2	296	1.740.31	0.32	1.74	5.65e-02	973.68	228.02	228.06	973.64	5.28
1	2	297	1.790.36	0.38	1.77	0.16	1044.49	264.62	264.90	1044.22	14.59
1	2	298	1.840.42	0.48	1.77	0.30	1128.07	332.69	333.83	1126.92	30.11
1	2	299	1.820.32	0.48	1.65	0.47	1143.87	435.73	440.23	1139.37	56.22
1	2	300	1.56-0.45	-0.38	1.49	0.37	993.63	569.51	591.84	971.30	94.72
1	2	301	1.68-2.50	-2.48	1.66	0.29	833.53	500.47	783.25	550.74	119.23
1	2	302	0.61-3.66	-3.39	0.34	1.05	921.71	104.65	900.38	125.98	130.30
1	2	303	0.44-6.40	-5.15	-0.81	-2.64	698.24	-131.25	539.11	27.88	-326.61
1	2	304	5.23-3.16	-3.02	5.09	-1.07	951.56	271.06	476.51	746.11	-312.41
1	2	305	3.21-0.52	-0.42	3.11	-0.59	1186.20	303.24	361.13	1128.31	-218.55
1	2	306	2.908.83e-02	0.34	2.65	-0.80	1210.20	294.53	308.33	1196.40	-111.57
1	2	307	2.440.19	0.35	2.29	-0.58	1128.74	258.02	261.47	1125.29	-54.72
1	2	308	2.120.20	0.25	2.07	-0.31	1029.02	226.10	226.79	1028.33	-23.52



EGP CODE

GRE.EEC.R.73.IT.W.15235.12.024.01

PAGE

335 di/of 527

1	2	309	1.970.18	0.19	1.97	-8.84e-02	972.86	210.12	210.14	972.84	-4.18
1	2	310	1.990.17	0.17	1.99	9.71e-02	987.83	214.37	214.59	987.61	12.98
1	2	311	2.180.16	0.20	2.14	0.30	1067.15	237.97	239.59	1065.54	36.57
1	2	312	2.570.12	0.25	2.44	0.55	1169.53	274.89	281.61	1162.82	77.23
1	2	313	3.29-0.13	0.10	3.06	0.86	1220.66	312.71	337.76	1195.61	148.70
1	2	314	4.96-1.15	-0.50	4.31	1.89	1141.12	315.17	412.05	1044.24	265.77
1	2	315	3.07-1.15	-1.09	3.01	-0.49	856.98	226.84	541.72	542.09	315.07
1	2	316	2.76-9.01	-8.13	1.89	3.08	690.85	-127.72	530.58	32.54	324.81
1	2	317	3.63-4.75	3.42	-4.55	1.28	298.38	-378.56	35.39	-115.57	-329.95
1	2	318	5.59-8.00	-3.57	1.16	6.37	1007.18	-328.37	-68.34	747.15	-528.84
1	2	319	5.340.15	0.16	5.33	0.23	1305.66	53.49	109.24	1249.91	-258.25
1	2	320	4.110.35	0.45	4.02	-0.59	1285.26	177.20	189.18	1273.27	-114.63
1	2	321	3.156.12e-02	0.12	3.09	-0.44	1170.41	203.80	206.91	1167.30	-54.75
1	2	322	2.547.93e-032.81e-02		2.52	-0.23	1053.70	200.48	201.14	1053.04	-23.74
1	2	323	2.266.61e-037.93e-03		2.26	-5.44e-02	991.24	194.36	194.38	991.22	-4.44
1	2	324	2.271.10e-034.73e-03		2.27	9.08e-02	1008.09	195.31	195.51	1007.89	12.75
1	2	325	2.56-5.22e-031.77e-02		2.54	0.24	1097.96	200.54	202.00	1096.50	36.18
1	2	326	3.154.52e-029.40e-02		3.10	0.39	1222.71	193.68	199.53	1216.86	77.38
1	2	327	4.060.27	0.29	4.04	0.29	1311.60	137.67	159.43	1289.83	158.35
1	2	328	6.06-1.51	-0.95	5.51	-1.97	1252.39	-53.80	43.29	1155.30	342.63
1	2	329	10.38-9.38	-7.99	8.99	-5.05	798.09	-452.13	-58.20	404.17	580.79
1	2	330	6.63-9.80	6.55	-9.72	1.11	258.56	-388.34	41.31	-171.09	305.52
1	2	331	4.17-6.37	-1.82	-0.38	-5.22	435.30	-272.16	268.98	-105.84	-300.00
1	2	332	21.69-12.40	21.66	-12.37	-1.05	1166.49	-667.44	-664.87	1163.92	-68.61
1	2	333	8.954.61	8.43	5.12	-1.41	1421.31	-34.62	-34.26	1420.96	-22.77
1	2	334	4.221.10	1.10	4.22	9.61e-02	1324.45	120.37	120.55	1324.27	-14.93
1	2	335	3.288.07e-029.06e-02		3.27	0.18	1195.17	174.69	174.78	1195.08	-9.53
1	2	336	2.63-4.78e-02-4.22e-02		2.62	0.12	1070.30	185.53	185.56	1070.27	-5.33
1	2	337	2.32-4.94e-02-4.76e-02		2.32	6.63e-02	1004.61	184.34	184.34	1004.61	-1.46
1	2	338	2.32-4.68e-02-4.67e-02		2.32	1.47e-02	1022.40	183.84	183.84	1022.39	2.32
1	2	339	2.64-3.77e-02-3.73e-02		2.64	-3.31e-02	1117.56	180.33	180.37	1117.52	6.10
1	2	340	3.250.12	0.12	3.25	-5.34e-02	1252.84	152.11	152.20	1252.75	10.01
1	2	341	3.991.24	1.25	3.98	0.16	1358.10	52.67	52.84	1357.93	15.06
1	2	342	9.953.24	9.00	4.19	2.34	1376.84	-206.58	-205.96	1376.22	31.38
1	2	343	24.18-30.15	24.09	-30.07	2.17	852.28	-1274.65	-1272.11	849.73	73.53
1	2	344	22.44-6.55	9.55	6.34	14.41	-241.17	-1415.23	-1415.12	-241.27	-11.00
1	2	345	21.627.92	12.35	17.18	-6.41	-31.31	-1608.79	-1608.18	-31.92	-31.08
1	2	346	3.86-5.19	1.94	-3.27	3.70	59.14	-232.37	-29.29	-143.94	134.01
1	2	347	-1.99-2.46	-2.43	-2.02	-0.11	601.25	-98.49	597.76	-95.01	49.27
1	2	348	4.90-1.22	1.66	2.02	-3.05	505.89	-84.54	492.91	-71.57	-86.56
1	2	349	12.92-13.84	8.37	-9.28	10.06	-359.98	-492.68	-444.74	-407.92	63.75
1	2	350	15.22-1.35	0.72	13.15	5.48	7.34	-562.85	-532.19	-23.32	-128.61
1	2	351	22.69-6.62	15.84	0.22	-12.40	-266.88	-1068.14	-1066.10	-268.91	40.34
1	2	352	6.20-4.27	1.59	0.34	5.20	581.00	-242.36	427.11	-88.46	320.98
1	2	353	-1.33-5.98	-5.96	-1.35	0.31	1129.61	-97.68	1097.69	-65.76	195.33
1	2	354	-0.59-7.87	-7.87	-0.59	1.48e-02	1401.60	-59.94	1395.81	-54.14	91.83
1	2	355	-0.58-8.56	-8.56	-0.58	0.12	1466.74	-54.89	1466.61	-54.76	-13.96
1	2	356	-1.60-8.66	-8.66	-1.60	0.11	1316.58	-80.23	1306.18	-69.83	-120.07
1	2	357	5.87-4.51	4.47	-3.12	-3.54	-226.41	-590.40	-420.01	-396.80	181.63
1	2	358	5.60-9.74	-3.13	-1.01	-7.60	1000.42	-479.20	-304.15	825.37	477.88
1	2	359	3.90-0.86	-0.70	3.74	0.86	1311.99	-26.71	3.56	1281.71	199.02
1	2	360	3.610.21	0.34	3.48	0.64	1305.58	144.53	148.12	1301.99	64.48
1	2	361	2.896.34e-02	0.14	2.81	0.46	1187.82	188.86	189.42	1187.26	23.61
1	2	362	2.372.49e-025.74e-02		2.34	0.27	1068.06	192.21	192.27	1068.00	7.54
1	2	363	2.133.26e-023.98e-02		2.12	0.12	1004.24	188.24	188.24	1004.24	0.62
1	2	364	2.143.58e-023.59e-02		2.14	-1.14e-02	1021.47	188.91	188.93	1021.45	-4.68
1	2	365	2.422.76e-023.69e-02		2.41	-0.15	1113.44	191.23	191.46	1113.20	-14.76
1	2	366	2.993.97e-026.48e-02		2.97	-0.27	1241.69	176.22	177.65	1240.27	-38.89
1	2	367	3.825.65e-027.07e-02		3.80	-0.23	1332.86	99.17	106.92	1325.12	-97.44
1	2	368	4.21-1.59	-1.54	4.16	0.54	1261.25	-155.30	-99.56	1205.52	-275.41
1	2	369	11.17-11.83	-8.46	7.80	8.13	725.72	-691.25	-382.90	417.37	-584.67
1	2	370	9.18-8.05	9.10	-7.97	1.17	-298.30	-569.82	-405.18	-462.93	-132.65
1	2	371	2.21-6.78	-4.24	-0.32	4.05	546.62	-223.61	332.38	-9.36	345.13
1	2	372	7.83-4.83	-4.43	7.43	2.21	944.21	132.19	331.85	744.55	349.67
1	2	373	2.96-1.45	-1.42	2.93	-0.36	1215.72	200.53	249.88	1166.37	218.31
1	2	374	2.396.15e-02	0.19	2.26	0.53	1244.74	244.17	254.00	1234.91	98.65
1	2	375	2.120.17	0.31	1.98	0.50	1158.53	233.99	235.84	1156.69	41.26
1	2	376	1.890.19	0.25	1.83	0.32	1055.06	214.19	214.45	1054.81	14.73
1	2	377	1.790.19	0.21	1.77	0.14	997.30	202.61	202.61	997.30	1.87
1	2	378	1.810.20	0.20	1.81	-3.31e-02	1012.94	205.91	206.00	1012.86	-8.34
1	2	379	1.980.19	0.22	1.96	-0.23	1095.14	222.82	223.56	1094.40	-25.43
1	2	380	2.370.12	0.22	2.27	-0.46	1202.32	244.05	248.06	1198.31	-61.89
1	2	381	3.10-0.20-4.79e-02		2.95	-0.69	1258.43	249.03	267.89	1239.57	-136.68
1	2	382	5.03-1.85	-1.65	4.84	-1.15	1168.77	189.41	276.95	1081.24	-279.40
1	2	383	5.56-1.31	-1.29	5.53	-0.43	799.99	107.24	388.78	518.45	-340.26
1	2	384	4.15-10.57	-8.71	2.29	-4.89	526.53	-238.76	304.62	-16.86	-347.25





EGP CODE

GRE.EEC.R.73.IT.W.15235.12.024.01

PAGE

336 di/of 527

1	2	385	1.75-3.68	-2.53	0.60	2.22	875.23	72.42	835.38	112.27	174.38	
1	2	386	2.55-3.03	-2.82	2.34	1.07	849.00	525.12	648.81	725.31	157.36	
1	2	387	1.81-1.21	-1.20	1.80	0.17	1091.11	457.25	477.14	1071.22	110.50	
1	2	388	1.310.11	0.12	1.30	0.11	1176.92	353.13	356.60	1173.45	53.33	
1	2	389	1.380.37	0.40	1.36	0.17	1127.16	279.34	279.85	1126.65	20.80	
1	2	390	1.460.36	0.38	1.45	0.12	1041.40	233.36	233.41	1041.34	6.53	
1	2	391	1.510.32	0.33	1.51	7.31e-02	989.96	213.37	213.37	989.96	0.51	
1	2	392	1.540.34	0.34	1.54	1.78e-02	1004.10	219.17	219.19	1004.09	-3.86	
1	2	393	1.540.40	0.40	1.54	-7.54e-02	1076.45	251.05	251.22	1076.27	-12.03	
1	2	394	1.570.40	0.45	1.52	-0.24	1161.05	310.00	311.13	1159.92	-31.03	
1	2	395	1.660.11	0.25	1.52	-0.44	1175.46	398.25	404.69	1169.02	-70.46	
1	2	396	1.79-0.95	-0.83	1.67	-0.56	1023.26	507.73	543.92	987.06	-131.72	
1	2	397	2.50-2.79	-2.53	2.25	-1.13	828.28	449.34	727.67	549.96	-167.34	
1	2	398	1.51-3.91	-2.84	0.43	-2.16	880.33	74.63	837.91	117.05	-179.94	
1	2	399	0.20-2.67	-2.67	0.19	0.10	925.15	118.66	911.96	131.85	-102.27	
1	2	400	1.21-1.97	-1.97	1.20	-6.91e-02	802.57	628.45	705.11	725.91	-86.44	
1	2	401	1.36-0.93	-0.89	1.33	-0.27	1063.92	504.74	512.48	1056.18	-65.31	
1	2	402	1.30-3.26e-027.17e-02		1.19	-0.36	1163.52	368.29	370.42	1161.40	-41.05	
1	2	403	1.390.27	0.37	1.29	-0.31	1122.95	280.83	281.43	1122.34	-22.55	
1	2	404	1.480.31	0.33	1.45	-0.18	1041.13	230.64	230.77	1040.99	-10.58	
1	2	405	1.540.28	0.28	1.54	-2.73e-02	990.93	209.72	209.73	990.93	-2.39	
1	2	406	1.580.29	0.31	1.57	0.12	1004.90	215.81	215.84	1004.87	5.00	
1	2	407	1.560.37	0.43	1.50	0.25	1075.53	249.41	249.66	1075.28	14.51	
1	2	408	1.430.44	0.55	1.32	0.31	1155.38	314.15	315.16	1154.36	29.20	
1	2	409	1.180.30	0.38	1.10	0.25	1158.59	419.46	422.97	1155.08	50.85	
1	2	410	1.05-0.59	-0.58	1.04	0.13	985.80	572.18	586.19	971.79	74.82	
1	2	411	0.82-2.06	-2.06	0.82	7.51e-02	818.74	521.68	789.18	551.24	88.92	
1	2	412	5.84e-02	-2.89	-2.89	5.67e-02	7.14e-02	926.84	127.72	914.62	139.94	98.03
1	2	413	1.42-3.26	-2.28	0.44	-1.91	801.02	-98.53	617.63	84.86	-362.40	
1	2	414	2.66-2.64	-2.26	2.29	-1.36	943.16	252.71	468.06	727.81	-319.86	
1	2	415	2.16-1.08	-0.84	1.91	-0.85	1165.51	283.23	343.07	1105.66	-221.85	
1	2	416	2.09-0.27	0.18	1.64	-0.93	1221.88	257.71	272.00	1207.58	-116.52	
1	2	417	2.18-0.15	0.20	1.84	-0.83	1152.80	227.12	230.26	1149.66	-53.86	
1	2	418	2.03-3.62e-028.07e-02		1.91	-0.48	1056.53	202.06	202.62	1055.97	-21.81	
1	2	419	1.941.82e-022.55e-02		1.94	-0.12	1001.04	189.81	189.83	1001.02	-4.08	
1	2	420	1.993.16e-025.85e-02		1.97	0.23	1016.34	193.64	193.78	1016.20	10.77	
1	2	421	2.161.40e-02	0.19	1.98	0.59	1095.38	212.86	214.07	1094.17	32.70	
1	2	422	2.37-4.88e-02	0.42	1.90	0.96	1193.95	242.80	248.61	1188.14	74.11	
1	2	423	2.25-0.13	0.52	1.60	1.06	1231.00	274.25	298.85	1206.40	151.43	
1	2	424	1.86-0.82	-0.53	1.57	0.83	1106.74	288.76	386.88	1008.62	265.77	
1	2	425	2.82-2.70	-2.38	2.50	1.29	866.03	195.12	530.80	530.35	335.46	
1	2	426	1.54-4.02	-2.79	0.31	2.31	796.65	-95.59	617.37	83.69	357.52	
1	2	427	0.71-5.04	-2.83	-1.50	-2.80	296.10	-573.14	-166.68	-110.36	-433.70	
1	2	428	9.90-4.56	-3.57	8.92	-3.65	993.10	-287.23	-57.64	763.52	-491.16	
1	2	429	2.70-0.59	-0.56	2.67	-0.34	1288.86	-56.19	-10.79	1243.46	-242.92	
1	2	430	4.14-0.74	5.63e-02	3.35	-1.80	1300.47	105.34	114.54	1291.27	-104.47	
1	2	431	3.42-0.62	-0.27	3.07	-1.14	1191.46	154.70	156.43	1189.72	-42.35	
1	2	432	2.81-0.46	-0.36	2.71	-0.57	1074.85	164.37	164.62	1074.61	-14.91	
1	2	433	2.54-0.36	-0.35	2.53	-0.15	1011.76	164.16	164.17	1011.75	-2.30	
1	2	434	2.60-0.35	-0.33	2.58	0.24	1028.94	164.69	164.75	1028.88	7.42	
1	2	435	3.01-0.42	-0.27	2.87	0.69	1119.88	163.57	164.20	1119.25	24.57	
1	2	436	3.78-0.56-9.94e-02		3.33	1.33	1244.20	144.74	148.36	1240.57	63.01	
1	2	437	4.74-0.68	0.37	3.69	2.14	1325.97	70.68	88.19	1308.46	147.21	
1	2	438	3.65-0.94	-0.82	3.52	0.75	1239.80	-144.72	-59.27	1154.35	333.18	
1	2	439	7.95-0.88	-0.59	7.66	1.56	739.70	-326.19	-28.04	441.56	478.44	
1	2	440	1.97-10.75	-8.55	-0.23	4.81	255.75	-605.07	-215.25	-134.07	428.49	
1	2	441	15.82-9.51	6.07	0.24	12.32	-1045.97	-1623.14	-1612.87	-1056.24	-76.29	
1	2	442	6.04-8.07	5.48	-7.51	2.75	1174.12	-866.64	-798.01	1105.50	-367.89	
1	2	443	9.23-4.81	-0.78	5.19	-6.35	1361.44	-221.04	-212.76	1353.15	-114.18	
1	2	444	6.43-1.89	-1.53	6.07	-1.69	1339.01	21.79	21.80	1339.00	-2.68	
1	2	445	4.44-1.03	-0.95	4.36	-0.67	1207.31	112.87	112.99	1207.19	11.46	
1	2	446	3.36-0.75	-0.74	3.35	-0.27	1077.55	141.24	141.34	1077.45	9.70	
1	2	447	2.93-0.64	-0.64	2.93	-7.22e-02	1009.37	147.48	147.49	1009.36	2.74	
1	2	448	3.01-0.63	-0.62	3.01	8.04e-02	1027.87	146.00	146.03	1027.84	-5.11	
1	2	449	3.61-0.72	-0.70	3.59	0.30	1126.88	133.30	133.41	1126.77	-10.40	
1	2	450	4.93-1.00	-0.89	4.82	0.78	1268.27	86.51	86.56	1268.22	-7.63	
1	2	451	7.24-2.01	-1.53	6.76	2.05	1377.06	-50.20	-49.97	1376.83	17.93	
1	2	452	10.56-5.67	0.36	4.54	7.84	1315.42	-407.95	-390.99	1298.46	170.13	
1	2	453	7.55-12.60-2.28e-03		-5.05	-9.75	884.36	-1307.82	-1106.10	682.64	633.65	
1	2	454	16.95-3.95	12.64	0.36	-8.46	-1196.47	-1569.90	-1569.08	-1197.28	-17.42	
1	2	455	39.959.38	39.78	9.55	-2.28	1280.30	-418.73	-410.19	1271.76	120.16	
1	2	456	18.19-0.12	0.14	17.93	-2.17	1499.08	-186.78	-184.99	1497.28	54.97	
1	2	457	6.74-0.12	-0.11	6.74	-0.21	1344.04	38.57	41.02	1341.59	56.50	
1	2	458	4.43-0.88	-0.88	4.43	-0.11	1203.03	113.92	115.27	1201.69	38.28	
1	2	459	3.38-0.79	-0.79	3.38	-5.70e-02	1071.44	140.00	140.48	1070.95	21.20	
1	2	460	2.95-0.68	-0.68	2.95	-2.41e-02	1002.59	145.91	145.94	1002.56	4.97	



EGP CODE

GRE.EEC.R.73.IT.W.15235.12.024.01

PAGE

337 di/of 527

1	2	461	3.02-0.67	-0.67	3.02	1.20e-03	1021.29	144.35	144.48	1021.15	-10.99	
1	2	462	3.62-0.76	-0.76	3.62	3.65e-02	1121.43	131.73	132.48	1120.68	-27.34	
1	2	463	4.89-0.79	-0.79	4.89	8.11e-02	1265.29	87.20	88.89	1263.59	-44.63	
1	2	464	7.650.28	0.29	7.65	0.14	1385.33	-29.23	-26.37	1382.48	-63.47	
1	2	465	22.51-0.70	-0.47	22.27	2.34	1501.82	-342.61	-340.81	1500.02	-57.54	
1	2	466	57.75-15.25	57.74	-15.23	0.92	1048.31	-1115.69	-1101.96	1034.58	-171.79	
1	2	467	11.75-4.37	8.36	-0.97	-6.58	-606.53	-1229.57	-1107.25	-728.86	247.49	
1	2	468	8.38-6.62	6.20	-4.45	-5.28	1204.54	-832.68	-634.22	1006.08	604.09	
1	2	469	10.80-4.18	-1.10	7.73	6.05	1388.00	-210.68	-157.77	1335.10	285.98	
1	2	470	6.75-1.76	-1.52	6.51	1.40	1327.65	31.12	45.07	1313.69	133.76	
1	2	471	4.52-1.07	-1.00	4.45	0.60	1189.27	118.89	124.28	1183.87	75.81	
1	2	472	3.34-0.78	-0.76	3.32	0.27	1057.75	146.89	148.46	1056.17	37.82	
1	2	473	2.87-0.65	-0.64	2.87	5.53e-02	989.23	153.11	153.19	989.15	8.22	
1	2	474	2.94-0.64	-0.63	2.94	-0.13	1007.82	151.46	151.91	1007.37	-19.62	
1	2	475	3.59-0.76	-0.73	3.56	-0.36	1107.56	138.42	141.20	1104.78	-51.83	
1	2	476	5.02-1.06	-0.97	4.93	-0.74	1251.80	91.66	99.66	1243.80	-96.02	
1	2	477	7.57-1.84	-1.55	7.29	-1.61	1369.80	-41.13	-21.02	1349.69	-167.24	
1	2	478	11.37-3.978	2.9e-02	7.31	-6.77	1357.53	-395.59	-316.65	1278.59	-363.53	
1	2	479	9.78-9.18	-0.30	0.91	9.46	922.12	-1217.69	-852.39	556.81	-805.13	
1	2	480	17.95-5.75	17.66	-5.46	2.60	-744.63	-1154.37	-1053.12	-845.88	-176.73	
1	2	481	-2.62-4.28	-4.21	-2.70	0.35	548.13	-675.74	-49.80	-77.81	611.77	
1	2	482	9.22-3.02	-1.56	7.77	3.96	1117.19	-294.83	64.00	758.36	614.75	
1	2	483	4.02-0.58	0.15	3.28	1.69	1306.93	-41.02	79.26	1186.65	384.27	
1	2	484	4.72-1.13-7.58e-02		3.66	2.25	1264.64	121.62	164.39	1221.87	216.93	
1	2	485	3.52-0.84	-0.37	3.05	1.35	1137.94	171.43	186.64	1122.73	120.31	
1	2	486	2.67-0.52	-0.37	2.52	0.68	1016.23	180.65	184.68	1012.20	57.89	
1	2	487	2.27-0.33	-0.32	2.26	0.16	952.36	179.78	179.97	952.16	12.14	
1	2	488	2.34-0.34	-0.30	2.30	-0.32	969.74	180.10	181.25	968.59	-30.07	
1	2	489	2.89-0.54	-0.30	2.66	-0.87	1062.53	179.01	186.51	1055.03	-81.04	
1	2	490	3.93-0.87	-0.24	3.30	-1.62	1195.23	159.38	183.15	1171.46	-155.10	
1	2	491	5.40-1.19	0.18	4.03	-2.68	1302.31	83.39	147.77	1237.92	-272.65	
1	2	492	5.61-1.12	0.17	4.32	-2.65	1288.11	-131.08	53.80	1103.23	-477.70	
1	2	493	4.831.18	1.37	4.64	-0.80	924.38	-357.37	88.00	479.01	-610.33	
1	2	494	-0.89-9.86	-9.48	-1.27	-1.81	511.61	-710.66	-93.32	-105.73	-611.10	
1	2	495	0.43-3.86	-3.39	-4.11e-02	1.34	1002.16	-225.92	692.51	83.73	533.29	
1	2	496	1.75-2.38	-1.88	1.25	1.36	1085.85	152.86	546.78	691.93	460.81	
1	2	497	2.10-1.21	-0.25	1.15	1.50	1181.23	264.98	419.81	1026.40	343.36	
1	2	498	2.37-0.82	0.37	1.18	1.55	1160.89	280.55	335.13	1106.30	212.31	
1	2	499	2.18-0.53	0.25	1.40	1.23	1064.33	258.53	276.45	1046.41	118.84	
1	2	500	1.72-0.15	0.18	1.40	0.71	963.00	231.18	235.62	958.55	56.88	
1	2	501	1.390.14	0.17	1.37	0.18	908.20	216.17	216.38	908.00	11.82	
1	2	502	1.460.12	0.20	1.37	-0.33	923.32	220.27	221.51	922.08	-29.49	
1	2	503	1.89-0.20	0.29	1.41	-0.88	1002.63	242.08	250.49	994.22	-79.56	
1	2	504	2.44-0.61	0.46	1.38	-1.45	1111.44	271.65	299.94	1083.15	-151.52	
1	2	505	2.67-0.95	0.66	1.06	-1.80	1189.19	286.53	367.69	1108.03	-258.20	
1	2	506	1.77-1.14-3.49e-02		0.67	-1.42	1165.49	243.01	465.98	942.51	-394.93	
1	2	507	1.58-2.63	-2.44	1.39	-0.87	1044.62	71.11	607.20	508.53	-484.25	
1	2	508	0.43-4.34	-3.74	-0.17	-1.58	999.53	-226.30	692.17	81.05	-531.32	
1	2	509	-0.31-4.15	-4.12	-0.33	0.31	1106.18	42.76	1024.74	124.20	282.79	
1	2	510	-3.12e-02	-2.14	-2.01	-0.16	0.51	999.08	495.35	822.84	671.59	240.24
1	2	511	0.46-1.02	-0.52	-4.23e-02	0.70	1034.25	540.62	626.40	948.46	187.05	
1	2	512	1.05-0.63	0.30	0.12	0.84	1052.01	439.25	465.02	1026.24	122.99	
1	2	513	1.21-0.30	0.55	0.36	0.75	994.97	342.08	349.76	987.29	70.39	
1	2	514	1.049.19e-02	0.59	0.54	0.47	918.15	276.16	277.93	916.38	33.66	
1	2	515	0.740.47	0.59	0.62	0.13	873.57	246.59	246.66	873.49	6.95	
1	2	516	0.830.40	0.63	0.60	-0.21	886.23	254.44	254.92	885.75	-17.46	
1	2	517	1.162.80e-02	0.71	0.47	-0.55	950.22	299.46	302.89	946.78	-47.15	
1	2	518	1.34-0.38	0.76	0.21	-0.82	1029.35	379.53	392.03	1016.85	-89.25	
1	2	519	1.10-0.75	0.51	-0.16	-0.86	1064.67	485.16	525.30	1024.54	-147.13	
1	2	520	0.18-1.10	-0.54	-0.38	-0.63	1019.21	563.08	702.93	879.37	-210.31	
1	2	521	-0.31-2.73	-2.67	-0.37	-0.38	1027.08	388.62	904.66	511.04	-251.34	
1	2	522	-0.36-4.28	-4.25	-0.38	-0.33	1107.36	49.46	1026.81	130.01	-280.57	
1	2	523	-0.36-4.32	-4.29	-0.38	-0.33	1122.00	131.08	1122.00	131.09	2.32	
1	2	524	-0.29-2.29	-2.25	-0.32	-0.25	907.34	663.52	907.34	663.52	-0.49	
1	2	525	-0.27-0.78	-0.78	-0.27	3.26e-02	922.98	693.04	693.11	922.91	-3.85	
1	2	526	0.29-0.28	0.20	-0.19	0.21	998.35	509.23	509.29	998.29	-5.58	
1	2	527	0.73-8.73e-02	0.66	-1.81e-02	0.23	966.08	374.96	375.00	966.04	-5.07	
1	2	528	0.820.14	0.79	0.18	0.15	901.64	291.76	291.77	901.63	-3.16	
1	2	529	0.810.29	0.81	0.29	4.97e-02	861.77	256.04	256.04	861.77	-0.74	
1	2	530	0.850.27	0.84	0.28	-4.54e-02	873.25	265.58	265.58	873.25	1.67	
1	2	531	0.900.10	0.89	0.12	-0.12	929.90	320.79	320.82	929.88	3.71	
1	2	532	0.84-0.18	0.82	-0.16	-0.14	993.10	424.39	424.43	993.06	4.92	
1	2	533	0.38-0.45	0.37	-0.44	-8.16e-02	996.55	578.91	578.96	996.50	4.78	
1	2	534	-0.57-0.81	-0.79	-0.59	6.47e-02	860.30	778.11	778.25	860.16	3.32	
1	2	535	-0.60-2.86	-2.84	-0.62	0.19	995.25	510.62	995.24	510.63	1.60	
1	2	536	-0.43-4.45	-4.44	-0.44	0.17	1125.28	138.55	1125.27	138.55	1.03	



EGP CODE

GRE.EEC.R.73.IT.W.15235.12.024.01

PAGE

338 di/of 527

1	2	537	0.29-4.21	-3.87	-4.89e-02	-1.19	1103.90	41.95	1025.64	120.21	-277.46	
1	2	538	0.69-2.88	-2.57	0.39	-1.00	997.62	488.13	822.98	662.76	-241.82	
1	2	539	0.42-1.21	-1.06	0.28	-0.47	1034.82	528.75	622.83	940.74	-196.88	
1	2	540	0.42-0.16	0.15	0.11	-0.29	1054.77	426.64	457.55	1023.87	-135.85	
1	2	541	0.788.26e-02	0.67	0.19	-0.25	999.18	330.68	340.66	989.19	-81.08	
1	2	542	0.850.30	0.79	0.36	-0.18	922.63	266.53	268.97	920.20	-39.90	
1	2	543	0.800.46	0.79	0.47	-4.84e-02	877.84	238.14	238.24	877.74	-8.23	
1	2	544	0.840.45	0.81	0.48	0.11	890.33	246.13	246.81	889.64	20.97	
1	2	545	0.970.24	0.83	0.38	0.29	954.13	290.49	295.08	949.54	55.00	
1	2	546	1.02-6.49e-02	0.75	0.20	0.47	1032.77	369.87	385.37	1017.27	100.18	
1	2	547	0.77-0.44	0.31	2.67e-02	0.59	1067.64	475.48	521.41	1021.71	158.39	
1	2	548	0.39-1.28	-0.91	2.60e-02	0.69	1023.31	554.01	702.68	874.63	218.33	
1	2	549	0.28-3.05	-2.82	4.66e-02	0.84	1031.21	383.93	907.04	508.10	254.86	
1	2	550	-6.31e-03	-4.20	-4.02	-0.19	0.86	1111.36	47.16	1029.94	128.58	282.87
1	2	551	2.31-4.78	-3.13	0.67	-2.99	994.55	-227.54	693.54	73.47	-526.55	
1	2	552	2.89-3.97	-3.56	2.48	-1.64	1075.07	137.49	543.74	668.81	-464.60	
1	2	553	1.73-1.52	-1.39	1.59	-0.66	1178.07	236.45	405.34	1009.18	-361.25	
1	2	554	1.35-0.14	0.29	0.92	-0.67	1165.33	251.48	313.34	1103.47	-229.57	
1	2	555	1.518.00e-02	0.61	0.98	-0.69	1072.28	233.55	254.21	1051.63	-129.99	
1	2	556	1.340.32	0.61	1.05	-0.46	971.41	210.60	215.72	966.29	-62.21	
1	2	557	1.140.53	0.56	1.10	-0.15	916.18	198.08	198.30	915.97	-12.47	
1	2	558	1.210.49	0.55	1.15	0.20	931.02	202.15	203.66	929.51	33.11	
1	2	559	1.530.23	0.57	1.19	0.57	1010.04	221.84	231.76	1000.13	87.84	
1	2	560	1.90-9.31e-02	0.56	1.25	0.93	1117.58	248.76	281.31	1085.03	164.98	
1	2	561	2.08-0.47	0.32	1.29	1.18	1192.34	263.44	353.59	1102.20	274.97	
1	2	562	1.95-1.41	-0.99	1.54	1.10	1166.86	224.20	460.54	930.53	408.57	
1	2	563	2.96-3.52	-3.18	2.61	1.45	1046.71	64.46	610.06	501.11	488.10	
1	2	564	1.98-4.92	-3.41	0.47	2.85	1005.35	-231.80	696.99	76.56	535.16	
1	2	565	0.56-8.07	-5.30	-2.22	-4.03	543.17	-700.25	-58.14	-98.94	-621.38	
1	2	566	9.78-5.72	-5.19	9.25	-2.81	1071.42	-314.84	50.11	706.47	-610.52	
1	2	567	3.47-1.40	-1.39	3.46	0.22	1304.05	-107.29	32.34	1164.41	-421.39	
1	2	568	3.151.41e-02	0.44	2.72	-1.07	1273.32	66.29	114.51	1225.10	-236.38	
1	2	569	2.752.03e-02	0.42	2.35	-0.97	1149.69	129.48	145.76	1133.41	-127.84	
1	2	570	2.280.10	0.28	2.10	-0.60	1027.02	147.94	152.02	1022.94	-59.74	
1	2	571	2.010.18	0.20	1.99	-0.20	962.08	151.17	151.33	961.92	-11.56	
1	2	572	2.070.16	0.18	2.05	0.20	979.27	150.72	152.00	977.99	32.49	
1	2	573	2.472.73e-02	0.19	2.31	0.61	1072.47	144.30	152.52	1064.25	86.97	
1	2	574	3.16-0.13	0.23	2.80	1.02	1204.76	115.63	142.38	1178.01	168.59	
1	2	575	4.16-0.35	8.69e-02	3.72	1.34	1306.71	31.35	105.56	1232.50	298.56	
1	2	576	6.42-1.98	-1.58	6.02	1.79	1287.18	-173.97	33.94	1079.27	510.45	
1	2	577	6.62-0.73	-0.73	6.62	-7.98e-02	907.68	-352.17	87.32	468.19	600.45	
1	2	578	3.22-13.20	-11.36	1.39	5.17	522.42	-731.26	-97.02	-111.83	626.80	
1	2	579	10.62-6.83	9.68	-5.89	3.94	-397.63	-1170.44	-994.17	-573.90	-324.27	
1	2	580	7.67-11.82	-2.28	-1.87	9.74	1070.32	-1013.04	-759.76	817.04	-680.83	
1	2	581	5.60-0.82	-0.39	5.17	-1.60	1391.39	-360.39	-296.19	1327.19	-329.14	
1	2	582	5.050.36	0.62	4.79	-1.07	1348.47	-57.02	-43.09	1334.54	-139.24	
1	2	583	3.95-2.17e-03	0.14	3.81	-0.74	1203.44	60.42	64.76	1199.10	-70.33	
1	2	584	3.17-0.12	6.05e-02	3.11	-0.43	1067.24	104.09	105.17	1066.17	-32.19	
1	2	585	2.79-0.13	-0.12	2.78	-0.16	996.44	116.45	116.49	996.40	-5.91	
1	2	586	2.83-0.15	-0.14	2.83	9.00e-02	1015.19	112.71	113.08	1014.83	18.21	
1	2	587	3.29-0.16	-0.13	3.26	0.33	1117.32	89.03	91.35	1115.01	48.75	
1	2	588	4.18-7.41e-02	2.10e-03	4.11	0.55	1265.35	21.34	28.98	1257.72	97.18	
1	2	589	5.370.20	0.26	5.31	0.56	1386.25	-146.08	-122.74	1362.91	187.68	
1	2	590	5.81-1.41	-1.41	5.80	-0.19	1348.75	-559.30	-456.98	1246.43	429.84	
1	2	591	13.66-13.41	-8.78	9.03	-10.19	751.49	-1303.44	-895.71	343.77	819.51	
1	2	592	16.28-13.23	16.26	-13.21	-0.77	-519.68	-1128.12	-974.83	-672.97	264.14	
1	2	593	30.49-16.68	30.43	-16.62	1.73	1250.88	-1197.81	-1196.16	1249.23	63.66	
1	2	594	12.986.54	12.18	7.34	2.12	1519.91	-330.60	-330.53	1519.84	10.63	
1	2	595	5.921.65	1.65	5.92	-4.79e-02	1372.04	-76.94	-76.94	1372.03	2.76	
1	2	596	4.545.74e-02	6.46e-02	4.54	-0.18	1219.41	43.88	43.88	1219.41	0.23	
1	2	597	3.58-0.21	-0.21	3.58	-0.12	1079.70	93.65	93.65	1079.70	-7.39e-02	
1	2	598	3.14-0.26	-0.26	3.14	-6.20e-02	1007.45	108.45	108.45	1007.45	0.26	
1	2	599	3.16-0.27	-0.27	3.16	-1.43e-02	1026.67	103.43	103.44	1026.67	0.81	
1	2	600	3.66-0.23	-0.23	3.66	2.52e-02	1131.20	74.06	74.07	1131.20	1.29	
1	2	601	4.606.73e-02	6.75e-02	4.60	2.81e-02	1283.74	-5.66	-5.66	1283.73	1.34	
1	2	602	5.741.83	1.85	5.72	-0.29	1412.99	-189.75	-189.75	1412.99	-0.92	
1	2	603	14.434.82	13.02	6.23	-3.40	1479.56	-578.24	-578.02	1479.34	-20.89	
1	2	604	33.91-39.49	33.77	-39.36	-3.14	894.66	-1984.82	-1983.04	892.88	-71.54	
1	2	605	-0.79-8.19	-5.54	-3.44	-3.55	789.97	-184.54	736.07	-130.64	-222.75	
1	2	606	33.70-14.90	24.08	-5.28	19.36	-435.41	-1835.25	-1831.67	-438.99	70.74	
1	2	607	5.78-0.30	-0.20	5.68	-0.78	569.80	-535.90	310.07	-276.17	468.74	
1	2	608	2.58-1.21	-1.21	2.58	-0.16	457.82	-416.68	257.64	-216.49	-367.41	
1	2	609	27.773.13	18.31	12.59	-11.98	748.27	200.13	228.37	720.03	-121.16	
1	2	610	6.51-5.22	-4.91	6.21	1.87	1154.95	-111.04	-104.59	1148.49	-90.19	
1	2	611	6.46-0.81	-0.78	6.43	0.52	1211.18	-34.13	-28.60	1205.64	-82.84	
1	2	612	5.37-0.19	-0.18	5.37	0.20	1109.87	-14.80	-12.64	1107.72	-49.14	



EGP CODE

GRE.EEC.R.73.IT.W.15235.12.024.01

PAGE

339 di/of 527

1	2	613	4.53-0.12	-0.12	4.53	8.67e-02	998.78	-5.98	-5.40	998.20	-24.15	
1	2	614	4.14-0.11	-0.11	4.14	1.84e-02	938.53	-2.39	-2.36	938.50	-5.32	
1	2	615	4.22-0.11	-0.11	4.22	-4.28e-02	954.51	-3.23	-3.08	954.36	11.94	
1	2	616	4.77-0.12	-0.12	4.77	-0.12	1040.40	-8.60	-7.59	1039.39	32.49	
1	2	617	5.75-0.20	-0.19	5.74	-0.24	1157.28	-19.40	-16.31	1154.19	60.24	
1	2	618	6.85-0.85	-0.81	6.81	-0.58	1228.31	-40.92	-33.64	1221.03	95.82	
1	2	619	8.48-8.47	8.47	-8.46	-0.43	201.97	-803.44	-378.39	-223.08	496.67	
1	2	620	6.72-9.16	-3.20	0.76	-7.69	1076.30	-792.62	-439.36	723.04	731.72	
1	2	621	7.140-67	0.68	7.13	0.11	1391.24	-234.62	-138.70	1295.31	383.09	
1	2	622	5.670-52	0.80	5.39	1.16	1332.73	1.00	27.83	1305.90	187.13	
1	2	623	4.28-1.51e-02	0.17	4.10	0.86	1190.39	92.49	101.26	1181.61	97.76	
1	2	624	3.36-0.11-4.40e-02		3.30	0.48	1057.70	125.24	127.44	1055.49	45.32	
1	2	625	2.93-0.10-9.71e-02		2.92	0.13	988.63	133.62	133.71	988.53	8.89	
1	2	626	2.95-0.12	-0.11	2.94	-0.20	1006.96	130.39	131.07	1006.28	-24.45	
1	2	627	3.43-0.16-7.66e-02		3.35	-0.53	1106.58	111.93	116.39	1102.12	-66.47	
1	2	628	4.35-6.45e-02	0.10	4.18	-0.84	1250.61	57.23	72.04	1235.80	-132.11	
1	2	629	5.620-46	0.58	5.49	-0.79	1369.42	-79.94	-36.26	1325.73	-247.80	
1	2	630	8.02-1.30	-0.74	7.46	2.21	1342.96	-404.52	-252.49	1190.92	-492.50	
1	2	631	12.24-10.36	-8.68	10.55	5.94	826.96	-958.29	-459.78	328.45	-800.91	
1	2	632	12.88-16.09	12.62	-15.82	-2.76	126.55	-811.66	-374.85	-310.26	-467.99	
1	2	633	-1.63-8.10	-6.85	-2.88	2.55	703.60	-478.17	271.58	-46.16	569.12	
1	2	634	6.03-3.68	-3.45	5.80	1.48	1082.57	-75.62	288.15	718.79	537.58	
1	2	635	3.82-0.44-4.51e-02		3.43	1.24	1280.02	68.28	218.70	1129.61	399.55	
1	2	636	3.81-8.66e-02	0.67	3.05	1.54	1242.14	165.59	218.09	1189.64	231.86	
1	2	637	3.161-42e-02	0.55	2.62	1.18	1126.39	186.44	204.23	1108.59	128.10	
1	2	638	2.540-17	0.38	2.33	0.68	1010.59	183.23	187.69	1006.14	60.52	
1	2	639	2.200-28	0.30	2.18	0.20	948.85	177.96	178.14	948.67	11.79	
1	2	640	2.240-24	0.28	2.21	-0.26	965.12	179.14	180.53	963.72	-33.06	
1	2	641	2.648-39e-02	0.32	2.41	-0.74	1053.34	184.91	193.97	1044.28	-88.22	
1	2	642	3.35-0.13	0.40	2.83	-1.24	1177.24	183.09	212.73	1147.61	-169.07	
1	2	643	4.35-0.41	0.32	3.62	-1.72	1270.92	149.59	231.28	1189.23	-291.42	
1	2	644	6.45-1.47	-0.12	5.10	-2.98	1262.72	34.69	253.78	1043.63	-470.16	
1	2	645	3.43-1.00	-0.71	3.15	1.08	973.57	-127.76	338.65	507.17	-544.18	
1	2	646	1.74-11.59	-10.87	1.02	-3.01	697.11	-482.02	257.09	-42.00	-570.29	
1	2	647	1.04-5.13	-4.42	0.33	1.98	1049.39	-92.80	861.56	95.03	423.39	
1	2	648	1.64-3.29	-3.13	1.48	0.88	1054.40	309.93	684.29	680.04	372.23	
1	2	649	1.33-0.83	-0.54	1.04	0.74	1135.57	379.58	515.59	999.55	290.39	
1	2	650	1.85-0.13	0.79	0.92	0.99	1131.95	343.70	390.12	1085.53	185.57	
1	2	651	1.930-14	0.90	1.18	0.88	1051.37	288.54	303.50	1036.41	105.77	
1	2	652	1.660-45	0.80	1.31	0.55	958.94	244.82	248.45	955.31	50.78	
1	2	653	1.410-67	0.71	1.37	0.17	907.20	224.04	224.18	907.05	9.97	
1	2	654	1.450-63	0.69	1.39	-0.22	920.82	230.01	231.12	919.70	-27.70	
1	2	655	1.750-36	0.75	1.37	-0.62	993.86	262.22	269.55	986.54	-72.85	
1	2	656	2.11-9.50e-04	0.82	1.29	-1.03	1090.52	315.42	339.89	1066.05	-135.51	
1	2	657	2.26-0.43	0.75	1.08	-1.33	1151.60	374.09	443.94	1081.75	-222.33	
1	2	658	1.45-0.98	-0.36	0.83	-1.06	1123.50	387.75	585.56	925.69	-326.20	
1	2	659	1.49-3.32	-3.21	1.38	-0.72	1049.37	231.87	762.44	518.80	-390.18	
1	2	660	0.85-5.08	-4.42	0.19	-1.86	1061.91	-90.07	868.70	103.14	-430.40	
1	2	661	-5.65e-02	-4.77	-4.71	-0.11	0.52	1115.43	102.95	1090.21	128.16	157.77
1	2	662	0.24-2.69	-2.64	0.20	0.36	946.30	603.81	877.65	672.45	137.10	
1	2	663	0.20-0.75	-0.67	0.13	0.25	985.24	628.60	666.74	947.10	110.22	
1	2	664	0.77-7.89e-03	0.61	0.16	0.32	1037.72	480.19	490.40	1027.51	74.74	
1	2	665	1.160-28	1.03	0.41	0.32	994.92	361.13	364.21	991.84	44.08	
1	2	666	1.130-58	1.03	0.68	0.21	923.30	285.73	286.46	922.57	21.55	
1	2	667	0.990-81	0.97	0.83	6.21e-02	879.84	253.19	253.22	879.81	4.30	
1	2	668	1.010-79	0.96	0.84	-9.44e-02	891.38	262.52	262.74	891.16	-11.70	
1	2	669	1.150-56	1.01	0.70	-0.25	951.81	314.07	315.52	950.35	-30.43	
1	2	670	1.210-21	1.02	0.40	-0.39	1022.96	408.89	413.92	1017.93	-55.32	
1	2	671	0.89-0.20	0.67	2.50e-02	-0.44	1040.49	544.69	560.73	1024.46	-87.70	
1	2	672	4.98e-03	-0.83	-0.63	-0.19	-0.36	956.24	679.69	753.08	882.85	-122.11
1	2	673	-0.21-3.09	-3.06	-0.24	-0.31	1009.83	477.73	967.62	519.94	-143.79	
1	2	674	-0.26-4.82	-4.78	-0.29	-0.38	1123.13	112.60	1097.12	138.61	-160.02	
1	2	675	-7.78e-02	-4.78	-4.73	-0.13	-0.49	1111.21	112.34	1095.15	128.40	-125.66
1	2	676	0.22-2.69	-2.64	0.17	-0.36	928.44	625.60	882.39	671.65	-108.74	
1	2	677	0.19-0.77	-0.69	0.11	-0.26	969.64	646.25	671.09	944.80	-86.12	
1	2	678	0.74-2.40e-02	0.58	0.13	-0.30	1030.43	487.94	493.92	1024.45	-56.65	
1	2	679	1.120-27	1.01	0.37	-0.28	990.44	365.10	366.76	988.78	-32.18	
1	2	680	1.110-56	1.03	0.63	-0.18	920.14	287.90	288.27	919.77	-15.21	
1	2	681	0.990-76	0.97	0.78	-6.26e-02	877.21	254.66	254.67	877.20	-2.91	
1	2	682	0.980-77	0.96	0.79	6.30e-02	888.63	264.15	264.26	888.52	8.31	
1	2	683	1.100-56	1.01	0.65	0.20	948.27	316.76	317.52	947.50	21.96	
1	2	684	1.150-22	1.01	0.36	0.33	1017.68	413.91	416.73	1014.87	41.14	
1	2	685	0.83-0.20	0.64	-7.19e-03	0.40	1031.23	554.78	564.49	1021.52	67.32	
1	2	686	-2.02e-02	-0.86	-0.66	-0.22	0.36	933.30	705.12	757.56	880.85	96.01
1	2	687	-0.22-3.11	-3.07	-0.26	0.33	999.49	492.16	972.38	519.27	114.10	
1	2	688	-0.27-4.83	-4.80	-0.30	0.38	1118.46	122.17	1101.96	138.67	127.16	





EGP CODE

GRE.EEC.R.73.IT.W.15235.12.024.01

PAGE

340 di/of 527

1	2	689	0.97-5.10	-4.44	0.30	-1.90	1042.82	-65.36	880.35	97.11	-391.98
1	2	690	1.57-3.28	-3.11	1.40	-0.90	1034.07	345.52	701.57	678.02	-344.07
1	2	691	1.26-0.90	-0.60	0.97	-0.74	1114.52	408.44	530.68	992.28	-267.15
1	2	692	1.72-0.17	0.72	0.83	-0.95	1116.36	361.49	401.59	1076.26	-169.30
1	2	693	1.790.12	0.87	1.05	-0.83	1040.10	298.94	311.47	1027.57	-95.55
1	2	694	1.530.44	0.81	1.16	-0.52	950.37	251.05	254.02	947.40	-45.47
1	2	695	1.270.68	0.73	1.22	-0.16	899.82	228.55	228.66	899.70	-8.84
1	2	696	1.290.66	0.72	1.23	0.19	913.17	234.93	235.84	912.26	24.84
1	2	697	1.590.38	0.75	1.22	0.56	984.49	269.73	275.80	978.41	65.62
1	2	698	1.932.00e-03	0.78	1.15	0.95	1077.88	328.09	348.86	1057.11	123.06
1	2	699	2.09-0.46	0.66	0.96	1.26	1134.01	395.26	456.44	1072.83	203.60
1	2	700	1.36-1.06	-0.46	0.76	1.04	1100.53	420.26	601.41	919.38	300.69
1	2	701	1.41-3.35	-3.23	1.28	0.75	1032.65	264.73	780.10	517.27	360.77
1	2	702	0.78-5.07	-4.45	0.16	1.80	1054.15	-62.04	887.28	104.83	398.01
1	2	703	-1.27-7.88	-6.69	-2.46	-2.53	714.80	-429.00	320.63	-34.83	-543.58
1	2	704	5.84-3.68	-3.44	5.59	-1.50	1069.56	-28.46	325.66	715.43	-513.26
1	2	705	3.61-0.55	-0.18	3.25	-1.18	1258.71	105.93	249.31	1115.33	-380.44
1	2	706	3.53-0.14	0.58	2.82	-1.45	1223.93	189.65	239.09	1174.50	-220.65
1	2	707	2.898.56e-03	0.53	2.38	-1.11	1111.78	201.63	218.21	1095.20	-121.73
1	2	708	2.300.19	0.41	2.08	-0.64	998.71	193.16	197.28	994.59	-57.43
1	2	709	1.960.32	0.35	1.94	-0.20	938.26	185.66	185.83	938.10	-11.18
1	2	710	1.990.30	0.33	1.96	0.23	954.25	187.41	188.69	952.96	31.36
1	2	711	2.380.12	0.34	2.16	0.67	1040.65	196.58	204.97	1032.26	83.77
1	2	712	3.06-0.12	0.36	2.57	1.14	1161.49	201.29	229.01	1133.78	160.77
1	2	713	4.04-0.46	0.22	3.36	1.61	1251.68	177.81	255.09	1174.40	277.51
1	2	714	6.09-1.55	-0.30	4.83	2.83	1241.04	76.32	286.45	1030.91	447.87
1	2	715	3.23-1.09	-0.89	3.03	-0.90	965.46	-82.09	377.40	505.98	519.82
1	2	716	1.86-11.20	-10.49	1.15	2.95	707.73	-432.18	306.98	-31.43	544.26
1	2	717	7.28-7.63	7.23	-7.58	0.81	229.13	-739.74	-304.06	-206.55	-481.97
1	2	718	6.49-9.08	-3.40	0.81	7.50	1067.84	-717.77	-369.77	719.85	-707.30
1	2	719	6.700.53	0.54	6.70	-0.11	1370.64	-185.91	-90.30	1275.03	-373.74
1	2	720	5.240.44	0.68	4.99	-1.06	1314.08	31.64	58.91	1286.80	-185.01
1	2	721	3.91-7.91e-03	0.16	3.74	-0.79	1175.27	112.27	121.32	1166.22	-97.69
1	2	722	3.03-5.93e-026.02e-03		2.97	-0.44	1045.19	138.74	141.05	1042.88	-45.69
1	2	723	2.62-3.11e-02-2.52e-02		2.61	-0.13	977.35	144.50	144.60	977.25	-9.05
1	2	724	2.64-4.94e-02-3.82e-02		2.63	0.17	995.42	141.99	142.70	994.71	24.60
1	2	725	3.09-0.11-3.44e-02		3.02	0.48	1093.31	127.68	132.29	1088.70	66.59
1	2	726	3.96-6.69e-027.91e-02		3.81	0.75	1234.46	81.12	96.25	1219.33	131.21
1	2	727	5.200.35	0.45	5.09	0.70	1350.05	-42.73	1.28	1306.04	243.64
1	2	728	7.55-1.36	-0.84	7.03	-2.09	1324.17	-346.09	-195.02	1173.10	479.06
1	2	729	11.86-10.32	-8.68	10.22	-5.81	830.85	-878.65	-386.27	338.47	774.14
1	2	730	11.52-14.79	11.34	-14.60	2.19	161.65	-747.48	-299.29	-286.53	454.52
1	2	731	6.53-4.10	-3.95	6.39	-1.24	1081.51	-117.98	-109.90	1073.44	98.07
1	2	732	28.36-15.94	28.32	-15.90	-1.28	1225.44	-1092.80	-1089.99	1222.63	-80.67
1	2	733	11.976.11	11.34	6.74	-1.82	1492.41	-271.77	-271.32	1491.96	-28.31
1	2	734	5.431.51	1.51	5.43	8.71e-02	1355.38	-38.58	-38.34	1355.14	-18.10
1	2	735	4.147.11e-027.89e-02		4.14	0.18	1207.62	68.64	68.75	1207.51	-11.09
1	2	736	3.25-0.15	-0.15	3.24	0.11	1071.04	110.41	110.45	1071.00	-6.03
1	2	737	2.83-0.18	-0.18	2.83	5.26e-02	1000.20	121.89	121.89	1000.19	-1.66
1	2	738	2.85-0.19	-0.19	2.85	7.57e-03	1019.09	117.79	117.80	1019.09	2.47
1	2	739	3.31-0.18	-0.18	3.31	-3.39e-02	1121.60	93.74	93.79	1121.55	6.74
1	2	740	4.186.36e-026.42e-02		4.18	-5.20e-02	1270.46	24.57	24.68	1270.35	11.49
1	2	741	5.241.66	1.67	5.23	0.21	1394.63	-142.22	-142.00	1394.42	18.15
1	2	742	13.244.51	12.09	5.66	2.96	1450.85	-504.07	-503.29	1450.07	39.07
1	2	743	31.43-37.49	31.34	-37.40	2.57	875.37	-1841.74	-1838.97	872.60	86.67
1	2	744	32.76-0.10	13.39	19.27	16.16	355.08	152.83	238.27	269.64	99.90
1	2	745	8.67-11.08	-9.66	7.25	5.11	-226.11	-473.14	-408.87	-290.37	-108.38
1	2	746	6.96-9.99	-8.08	5.06	-5.36	-250.11	-451.94	-386.00	-316.05	94.66
1	2	747	8.79-4.16	-1.41	6.04	5.30	407.68	-356.89	210.54	-159.75	334.46
1	2	748	10.52-3.81	-0.94	7.65	-5.73	516.27	-462.51	257.14	-203.37	-431.84
1	2	749	31.516.96	20.10	18.38	12.25	689.01	258.12	281.84	665.29	98.29
1	2	750	5.75-5.61	-5.35	5.49	-1.70	1067.61	-108.62	-107.80	1066.80	30.94
1	2	751	4.11-0.73	-0.67	4.05	-0.52	1133.60	-24.70	-23.28	1132.19	40.46
1	2	752	3.38-0.16	-0.15	3.37	-0.21	1041.02	-8.05	-7.69	1040.65	19.53
1	2	753	2.86-9.45e-02-9.16e-02		2.86	-9.31e-02	936.60	-0.91	-0.85	936.55	7.40
1	2	754	2.62-8.40e-02-8.38e-02		2.62	-2.07e-02	879.52	2.01	2.01	879.52	1.60
1	2	755	2.68-8.51e-02-8.44e-02		2.68	4.44e-02	894.56	1.34	1.35	894.55	-2.58
1	2	756	3.07-9.77e-02-9.33e-02		3.07	0.12	975.56	-2.94	-2.84	975.45	-10.00
1	2	757	9.29-6.30	8.48	-5.49	-3.46	-377.71	-1020.30	-862.75	-535.26	276.44
1	2	758	6.91-11.31	-2.66	-1.75	-9.10	1037.77	-887.26	-661.81	812.32	619.01
1	2	759	5.01-0.87	-0.52	4.65	1.40	1364.60	-284.23	-233.18	1313.55	285.61
1	2	760	4.600.31	0.56	4.36	0.99	1334.05	-12.44	-3.21	1324.82	111.12
1	2	761	3.602.44e-02	0.16	3.47	0.68	1196.27	87.77	90.20	1193.84	51.83
1	2	762	2.88-6.21e-02-1.06e-02		2.83	0.39	1064.25	121.82	122.34	1063.74	22.11
1	2	763	2.54-6.83e-02-6.08e-02		2.53	0.14	995.20	130.23	130.24	995.19	3.65
1	2	764	2.58-8.45e-02-8.20e-02		2.58	-8.06e-02	1013.54	127.55	127.73	1013.36	-12.79





EGP CODE

GRE.EEC.R.73.IT.W.15235.12.024.01

PAGE

341 di/of 527

1	2	765	3.00-0.11-8.06e-02	2.97	-0.30	1113.04	110.12	111.36	1111.80	-35.26		
1	2	766	3.81-5.99e-027.61e-03	3.74	-0.51	1255.90	54.96	59.64	1251.22	-74.82		
1	2	767	4.900.13	0.18	4.84	-0.52	1368.53	-91.16	-74.52	1351.89	-154.95	
1	2	768	5.27-1.56	-1.55	5.26	0.30	1318.04	-466.31	-381.43	1233.16	-379.80	
1	2	769	12.81-13.11	-8.88	8.57	9.58	722.75	-1155.45	-783.64	350.94	-748.39	
1	2	770	14.36-12.19	14.35	-12.18	0.44	-492.38	-982.11	-846.53	-627.96	-219.12	
1	2	771	0.87-8.09	-5.29	-1.93	4.15	523.06	-559.52	42.43	-78.88	537.88	
1	2	772	9.15-5.71	-5.22	8.66	2.66	1027.75	-190.91	122.46	714.38	532.63	
1	2	773	3.22-1.48	-1.46	3.20	-0.25	1276.27	-22.34	87.24	1166.68	360.97	
1	2	774	2.853.47e-02	0.39	2.50	0.93	1263.59	115.97	149.66	1229.90	193.71	
1	2	775	2.518.08e-02	0.42	2.18	0.84	1151.27	158.09	168.27	1141.09	100.05	
1	2	776	2.120.15	0.29	1.98	0.51	1034.50	164.98	167.31	1032.18	44.87	
1	2	777	1.910.20	0.22	1.89	0.17	971.80	163.57	163.66	971.72	8.25	
1	2	778	1.960.18	0.19	1.94	-0.16	988.45	164.31	165.05	987.72	-24.56	
1	2	779	2.297.36e-02	0.20	2.16	-0.52	1078.16	165.14	170.08	1073.21	-67.02	
1	2	780	2.89-7.45e-02	0.23	2.59	-0.89	1202.71	151.35	168.97	1185.10	-134.95	
1	2	781	3.81-0.35	2.98e-02	3.43	-1.20	1290.86	92.40	146.68	1236.58	-249.21	
1	2	782	5.98-2.06	-1.70	5.62	-1.66	1250.53	-73.61	95.87	1081.04	-442.38	
1	2	783	6.30-1.13	-1.13	6.30	-4.21e-02	867.31	-222.59	165.06	479.66	-521.76	
1	2	784	3.43-12.88	-10.98	1.53	-5.23	503.09	-586.55	6.23	-89.69	-542.70	
1	2	785	2.20-4.83	-3.25	0.62	2.93	957.33	-116.55	754.07	86.71	420.67	
1	2	786	2.75-3.91	-3.51	2.35	1.57	1015.70	263.50	590.28	688.92	372.85	
1	2	787	1.63-1.46	-1.37	1.54	0.53	1147.32	322.86	438.64	1031.54	286.44	
1	2	788	1.207.10e-03	0.27	0.94	0.49	1165.00	298.01	335.17	1127.84	175.61	
1	2	789	1.370.24	0.58	1.04	0.52	1087.89	257.20	268.31	1076.79	95.38	
1	2	790	1.300.40	0.55	1.14	0.34	993.44	223.18	225.70	990.92	44.02	
1	2	791	1.220.48	0.50	1.21	0.11	940.09	206.60	206.70	939.99	8.44	
1	2	792	1.270.46	0.49	1.24	-0.15	954.50	211.65	212.40	953.75	-23.55	
1	2	793	1.470.32	0.52	1.27	-0.43	1030.30	237.78	242.89	1025.19	-63.44	
1	2	794	1.737.17e-02	0.53	1.27	-0.74	1128.58	279.43	297.68	1110.34	-123.13	
1	2	795	1.88-0.33	0.29	1.26	-0.99	1182.42	322.56	379.06	1125.92	-213.05	
1	2	796	1.83-1.38	-1.03	1.48	-1.01	1122.37	327.92	498.64	951.65	-326.32	
1	2	797	2.81-3.58	-3.22	2.45	-1.47	988.88	191.64	661.50	519.02	-392.20	
1	2	798	1.88-5.00	-3.55	0.44	-2.80	967.04	-119.36	757.18	90.49	-428.90	
1	2	799	0.25-4.16	-3.86	-5.18e-02	1.11	1073.09	106.00	1046.69	132.40	157.59	
1	2	800	0.68-2.66	-2.44	0.46	0.83	918.60	606.85	833.37	692.08	138.95	
1	2	801	0.50-1.00	-0.96	0.46	0.24	1015.63	592.74	625.81	982.56	113.54	
1	2	802	0.380.16	0.16	0.38	3.36e-02	1080.29	448.13	457.64	1070.78	76.93	
1	2	803	0.600.50	0.59	0.51	2.85e-02	1037.58	338.39	341.25	1034.72	44.65	
1	2	804	0.710.63	0.65	0.70	3.12e-02	962.70	270.36	271.02	962.04	21.35	
1	2	805	0.810.62	0.62	0.81	6.85e-03	917.27	241.14	241.16	917.24	4.19	
1	2	806	0.830.63	0.64	0.82	-4.14e-02	929.95	249.30	249.49	929.76	-11.38	
1	2	807	0.820.59	0.70	0.72	-0.11	994.13	295.24	296.53	992.85	-29.93	
1	2	808	0.830.37	0.70	0.50	-0.21	1068.46	380.89	385.42	1063.93	-55.59	
1	2	809	0.63-2.48e-02	0.34	0.26	-0.32	1082.17	507.44	521.91	1067.70	-90.03	
1	2	810	0.37-1.02	-0.82	0.17	-0.50	972.64	647.55	707.81	912.38	-126.32	
1	2	811	0.28-2.94	-2.75	8.73e-02	-0.76	970.47	482.51	921.04	531.94	-147.23	
1	2	812	-2.27e-02	-4.22	-4.05	-0.19	-0.82	1078.89	112.83	1050.59	141.13	-162.91
1	2	813	-0.26-4.04	-4.04	-0.26	5.99e-02	1092.27	119.88	1073.99	138.16	-132.07	
1	2	814	9.11e-02	-2.05	-2.04	8.48e-02	-0.12	914.98	643.83	858.07	700.73	-110.42
1	2	815	0.43-0.79	-0.64	0.27	-0.40	1005.85	631.25	649.50	987.59	-80.65	
1	2	816	0.88-0.26	0.21	0.41	-0.56	1074.66	475.47	479.34	1070.79	-48.02	
1	2	817	1.055.81e-02	0.50	0.61	-0.49	1033.34	358.51	359.43	1032.41	-24.93	
1	2	818	0.980.33	0.54	0.78	-0.30	959.70	285.67	285.86	959.51	-11.19	
1	2	819	0.890.51	0.53	0.87	-8.96e-02	915.03	254.20	254.21	915.02	-2.32	
1	2	820	0.890.52	0.56	0.86	0.11	927.69	262.70	262.75	927.65	5.63	
1	2	821	0.990.39	0.64	0.74	0.30	991.12	311.43	311.82	990.73	16.12	
1	2	822	1.060.12	0.68	0.49	0.46	1064.16	402.14	403.80	1062.50	33.08	
1	2	823	0.79-0.21	0.44	0.14	0.48	1075.29	536.45	543.21	1068.53	59.96	
1	2	824	1.67e-02	-0.72	-0.58	-0.12	0.29	955.19	692.48	731.02	916.65	92.94
1	2	825	-0.24-2.65	-2.64	-0.24	8.45e-02	976.02	507.07	945.81	537.27	115.12	
1	2	826	-0.35-4.24	-4.24	-0.35	7.41e-02	1094.27	127.98	1076.90	145.35	128.38	
1	2	827	0.26-3.84	-3.54	-3.99e-02	-1.06	1020.61	-69.95	842.33	108.33	-403.29	
1	2	828	1.54-2.28	-1.92	1.18	-1.11	1043.20	346.46	670.54	719.12	-347.52	
1	2	829	1.83-1.08	-0.39	1.15	-1.23	1147.80	414.71	516.33	1046.18	-253.32	
1	2	830	2.03-0.62	0.24	1.18	-1.24	1156.48	373.05	403.52	1126.01	-151.49	
1	2	831	1.91-0.32	0.24	1.35	-0.97	1078.88	313.91	322.88	1069.91	-82.35	
1	2	832	1.571.37e-03	0.22	1.35	-0.54	986.81	266.73	268.82	984.72	-38.72	
1	2	833	1.350.21	0.23	1.33	-0.15	935.26	244.04	244.14	935.17	-8.00	
1	2	834	1.380.21	0.26	1.34	0.23	949.65	250.17	250.74	949.08	19.98	
1	2	835	1.661.57e-02	0.32	1.35	0.64	1023.87	284.17	288.22	1019.82	54.58	
1	2	836	2.04-0.32	0.43	1.30	1.10	1120.56	339.42	354.15	1105.83	106.27	
1	2	837	2.19-0.68	0.50	1.01	1.41	1175.38	398.93	446.73	1127.59	186.62	
1	2	838	1.45-1.03	-0.21	0.62	1.17	1122.49	416.56	574.18	964.88	293.98	
1	2	839	1.32-2.68	-2.52	1.16	0.78	1019.16	259.71	741.62	537.26	365.72	
1	2	840	0.19-4.34	-3.94	-0.20	1.28	1018.93	-68.09	843.18	107.65	400.19	



EGP CODE

GRE.EEC.R.73.IT.W.15235.12.024.01

PAGE

342 di/of 527

1	2	841	-1.36-4.39	-4.33	-1.42	-0.43	643.91	-439.47	226.82	-22.39	-527.17
1	2	842	8.26-2.92	-1.62	6.95	-3.59	1114.06	-60.65	273.75	779.66	-530.10
1	2	843	3.60-0.71	-0.12	3.02	-1.48	1284.90	136.64	241.04	1180.50	-330.12
1	2	844	4.05-1.00	-0.18	3.23	-1.86	1256.25	234.54	270.02	1220.77	-187.08
1	2	845	3.05-0.66	-0.29	2.67	-1.11	1143.43	243.70	255.94	1131.19	-104.20
1	2	846	2.35-0.35	-0.22	2.22	-0.57	1030.47	229.73	232.91	1027.29	-50.37
1	2	847	2.02-0.17	-0.16	2.01	-0.15	970.28	219.37	219.52	970.13	-10.60
1	2	848	2.07-0.17	-0.14	2.05	0.25	986.83	222.20	223.10	985.93	26.19
1	2	849	2.50-0.34	-0.16	2.32	0.70	1074.23	235.95	241.89	1068.29	70.31
1	2	850	3.34-0.66	-0.17	2.84	1.32	1196.56	245.80	265.07	1177.30	133.96
1	2	851	4.57-1.05	3.40e-02	3.48	2.22	1289.12	217.72	271.87	1234.97	234.69
1	2	852	4.91-1.25	-0.19	3.85	2.33	1263.95	73.97	237.61	1100.31	409.81
1	2	853	4.330.45	0.76	4.02	1.05	951.88	-123.92	313.35	514.60	528.40
1	2	854	-0.22-9.04	-8.77	-0.49	1.53	611.31	-465.64	191.22	-45.56	525.30
1	2	855	9.88-5.05	5.20	-0.36	6.93	-387.47	-913.80	-714.94	-586.34	-255.19
1	2	856	6.58-5.76	4.33	-3.52	4.76	1192.76	-549.28	-340.44	983.93	-565.85
1	2	857	9.13-3.67	-1.31	6.77	-4.96	1372.02	-35.06	25.06	1311.90	-284.58
1	2	858	5.76-1.54	-1.35	5.57	-1.16	1323.07	140.53	159.09	1304.51	-147.01
1	2	859	3.90-0.86	-0.80	3.84	-0.54	1196.56	188.24	195.76	1189.04	-86.78
1	2	860	2.94-0.57	-0.55	2.92	-0.27	1072.49	194.21	196.44	1070.26	-44.16
1	2	861	2.56-0.45	-0.44	2.56	-6.84e-02	1007.01	191.66	191.78	1006.90	-9.60
1	2	862	2.63-0.44	-0.44	2.62	0.12	1024.87	192.45	193.09	1024.23	23.14
1	2	863	3.15-0.56	-0.53	3.11	0.34	1120.05	193.53	197.44	1116.15	60.04
1	2	864	4.30-0.85	-0.77	4.21	0.66	1255.45	175.62	186.53	1244.54	108.00
1	2	865	6.40-1.61	-1.38	6.17	1.35	1361.29	92.41	118.28	1335.42	179.33
1	2	866	9.52-3.47	-0.36	6.41	5.54	1341.97	-179.97	-92.55	1254.55	354.12
1	2	867	8.50-8.18	-1.51	1.83	-8.17	957.53	-883.87	-512.88	586.54	738.58
1	2	868	14.34-4.75	13.57	-3.99	-3.74	-471.98	-862.67	-661.28	-673.37	195.25
1	2	869	32.448.21	32.14	8.51	2.66	1238.15	-207.03	-185.02	1216.14	-176.98
1	2	870	15.14-0.37	-0.12	14.89	1.96	1457.69	-25.84	-17.64	1449.49	-110.03
1	2	871	5.75-0.17	-0.16	5.75	0.13	1343.43	131.62	139.57	1335.49	-97.81
1	2	872	3.87-0.68	-0.68	3.87	-3.19e-03	1216.15	171.64	175.79	1212.00	-65.72
1	2	873	3.04-0.59	-0.59	3.04	-3.68e-02	1091.45	178.53	179.92	1090.06	-35.64
1	2	874	2.71-0.50	-0.50	2.71	-1.64e-02	1025.10	177.06	177.13	1025.02	-7.99
1	2	875	2.77-0.50	-0.50	2.77	2.96e-02	1043.13	177.65	178.06	1042.71	18.87
1	2	876	3.24-0.57	-0.57	3.24	6.18e-02	1139.24	177.38	179.67	1136.95	46.94
1	2	877	4.25-0.61	-0.61	4.24	5.12e-02	1274.40	158.85	164.25	1269.00	77.39
1	2	878	6.480.17	0.17	6.48	-4.98e-02	1379.21	87.40	96.72	1369.89	109.38
1	2	879	18.64-0.90	-0.66	18.40	-2.16	1448.53	-142.66	-134.21	1440.08	115.62
1	2	880	47.10-12.71	47.03	-12.64	-2.01	1013.09	-793.53	-767.39	986.95	215.76
1	2	881	12.78-8.39	3.95	0.45	-10.44	-871.27	-1161.94	-1159.04	-874.16	-28.87
1	2	882	3.89-6.55	3.33	-5.99	-2.34	1108.31	-563.49	-532.93	1077.75	223.96
1	2	883	7.45-3.87	-0.82	4.40	5.02	1333.16	-56.58	-56.41	1333.00	15.23
1	2	884	5.46-1.53	-1.30	5.22	1.26	1341.83	106.48	109.30	1339.00	-58.98
1	2	885	3.89-0.77	-0.73	3.86	0.40	1225.44	160.59	162.92	1223.11	-49.81
1	2	886	3.07-0.56	-0.56	3.07	9.73e-02	1102.56	171.58	172.50	1101.64	-29.27
1	2	887	2.77-0.50	-0.50	2.77	9.74e-03	1036.51	171.63	171.68	1036.46	-6.75
1	2	888	2.84-0.49	-0.49	2.84	-1.92e-02	1054.38	172.03	172.32	1054.10	15.75
1	2	889	3.30-0.55	-0.54	3.29	-0.11	1149.64	170.08	171.51	1148.21	37.34
1	2	890	4.30-0.74	-0.70	4.26	-0.45	1281.73	147.66	150.28	1279.11	54.48
1	2	891	6.08-1.58	-1.28	5.78	-1.48	1372.24	59.75	61.94	1370.06	53.54
1	2	892	8.43-4.48	0.20	3.75	-6.21	1277.84	-194.43	-192.28	1275.69	-56.23
1	2	893	5.73-11.47	-1.48	-4.26	8.48	815.88	-905.76	-777.88	688.00	-451.46
1	2	894	12.66-3.24	8.41	1.02	7.04	-932.65	-1190.98	-1128.51	-995.11	110.62
1	2	895	1.32-4.33	-2.59	-0.42	2.61	191.38	-256.52	-0.43	-64.71	221.63
1	2	896	8.60-4.35	-3.78	8.03	2.65	869.87	-51.17	45.69	773.01	282.54
1	2	897	2.74-0.84	-0.84	2.73	3.12e-02	1259.06	43.40	50.65	1251.80	93.63
1	2	898	3.61-0.36	6.25e-02	3.19	1.22	1319.81	136.12	136.18	1319.75	8.32
1	2	899	3.15-0.30	-0.17	3.02	0.66	1229.90	162.24	162.40	1229.74	-13.25
1	2	900	2.81-0.34	-0.32	2.79	0.26	1117.85	165.54	165.69	1117.70	-11.83
1	2	901	2.68-0.38	-0.38	2.68	3.71e-02	1054.97	164.23	164.24	1054.96	-2.89
1	2	902	2.75-0.38	-0.37	2.75	-0.13	1071.84	165.38	165.43	1071.78	7.16
1	2	903	3.02-0.33	-0.29	2.98	-0.36	1161.10	167.55	167.74	1160.91	13.52
1	2	904	3.49-0.25	-8.96e-02	3.33	-0.76	1276.94	160.56	160.61	1276.89	7.32
1	2	905	4.07-0.20	0.30	3.57	-1.37	1331.63	122.02	122.90	1330.75	-32.60
1	2	906	3.47-0.99	-0.98	3.46	-0.21	1181.28	1.34	23.71	1158.92	-160.90
1	2	907	7.25-1.41	-1.27	7.10	-1.11	609.89	-49.81	87.81	472.26	-268.05
1	2	908	2.71-9.35	-7.37	0.74	-4.46	156.33	-272.62	-37.61	-78.68	-213.49
1	2	909	1.02-2.14	-2.09	0.96	0.42	516.27	38.01	486.39	67.89	115.75
1	2	910	3.50-3.10	-2.99	3.39	0.85	762.68	325.20	348.10	739.78	97.45
1	2	911	2.71-1.09	-1.00	2.63	0.55	1164.62	234.10	237.15	1161.57	53.19
1	2	912	2.240.24	0.31	2.17	0.36	1282.58	192.10	192.41	1282.27	18.28
1	2	913	2.440.14	0.17	2.41	0.26	1221.88	177.15	177.16	1221.87	3.49
1	2	914	2.49-9.62e-02	-9.20e-02	2.49	0.11	1120.74	167.60	167.60	1120.74	-0.24
1	2	915	2.50-0.23	-0.23	2.50	-1.81e-02	1061.21	162.79	162.79	1061.21	0.26
1	2	916	2.56-0.23	-0.22	2.55	-0.13	1077.13	164.86	164.86	1077.12	1.52



EGP CODE

GRE.EEC.R.73.IT.W.15235.12.024.01

PAGE

343 di/of 527

1	2	917	2.66-9.65e-02-7.43e-02	2.63	-0.25	1160.37	173.67	173.67	1160.37	0.82	
1	2	918	2.710.16	0.22	2.66	-0.37	1260.12	187.82	187.86	1260.08	-6.50
1	2	919	2.520.40	0.45	2.47	-0.32	1276.59	211.63	212.46	1275.76	-29.74
1	2	920	2.59-0.66	-0.64	2.56	-0.30	1061.68	270.32	277.19	1054.81	-73.42
1	2	921	3.80-2.70	-2.61	3.70	-0.78	597.56	351.29	409.20	539.66	-104.44
1	2	922	1.02-2.65	-2.48	0.85	-0.76	514.24	44.88	488.32	70.80	-107.20
1	2	923	-0.17-5.48	-4.20	-1.45	-2.27	392.82	-5.29	379.96	7.58	-70.41
1	2	924	4.51-3.32	-3.32	4.51	0.14	756.85	293.98	312.24	738.59	-90.09
1	2	925	2.97-0.61	-0.61	2.97	8.13e-02	1183.52	210.03	212.96	1180.59	-53.38
1	2	926	2.730.19	0.21	2.71	-0.24	1283.87	190.18	190.19	1283.86	-3.03
1	2	927	2.560.14	0.16	2.55	-0.19	1219.82	178.52	178.59	1219.75	8.82
1	2	928	2.47-7.14e-02-6.69e-02	2.47	-0.11	1118.55	170.16	170.22	1118.49	7.81	
1	2	929	2.43-0.19	-0.19	2.43	-8.16e-02	1059.23	165.71	165.71	1059.22	2.72
1	2	930	2.46-0.19	-0.19	2.46	-8.09e-02	1075.16	167.16	167.16	1075.15	-2.84
1	2	931	2.57-5.89e-02-5.76e-02	2.56	-5.70e-02	1158.19	174.22	174.26	1158.15	-6.29	
1	2	932	2.740.14	0.14	2.74	3.56e-02	1257.69	185.48	185.48	1257.69	-2.85
1	2	933	3.148.49e-029.72e-02	3.13	0.19	1275.75	205.23	205.53	1275.45	18.03	
1	2	934	4.33-0.81	-0.62	4.14	0.97	1082.54	248.02	255.20	1075.36	77.05
1	2	935	3.74-1.85	-1.49	3.38	-1.38	564.02	338.88	373.01	529.89	80.74
1	2	936	2.33-7.75	-6.93	1.52	2.76	385.22	4.75	371.25	18.72	71.55
1	2	937	4.77-5.34	4.60	-5.17	-1.30	47.73	-184.94	-2.08	-135.13	-95.44
1	2	938	3.83-6.13	-2.63	0.34	4.76	829.63	-231.27	-122.31	720.68	-322.06
1	2	939	4.57-0.52	-0.43	4.49	0.66	1265.36	25.26	31.21	1259.41	-85.67
1	2	940	3.730.31	0.36	3.68	-0.41	1316.00	131.20	131.32	1315.88	11.84
1	2	941	3.06-2.88e-02-1.47e-03	3.03	-0.29	1223.17	166.72	167.47	1222.42	28.24	
1	2	942	2.63-0.19	-0.18	2.62	-0.15	1111.49	175.80	176.26	1111.04	20.60
1	2	943	2.43-0.25	-0.24	2.43	-8.65e-02	1049.22	176.64	176.68	1049.18	5.68
1	2	944	2.44-0.24	-0.24	2.44	-5.45e-02	1066.06	176.01	176.13	1065.94	-10.24
1	2	945	2.65-0.16	-0.16	2.65	9.21e-03	1154.58	172.01	172.53	1154.06	-22.65
1	2	946	3.077.72e-031.29e-02	3.07	0.13	1269.41	153.63	154.08	1268.95	-22.59	
1	2	947	3.690.29	0.29	3.69	7.47e-02	1324.43	96.49	96.64	1324.29	13.28
1	2	948	5.37-2.19	-1.38	4.56	-2.33	1171.09	-56.31	-37.11	1151.89	152.31
1	2	949	7.87-7.74	-6.61	6.74	-4.05	547.71	-297.08	-101.93	352.56	356.06
1	2	950	6.61-9.52	5.82	-8.73	3.48	16.40	-210.48	-5.81	-188.27	67.42
1	2	951	3.79-0.17	-0.15	3.78	0.23	1084.64	-11.53	-10.97	1084.08	-24.80
1	2	952	20.17-10.11	19.79	-9.74	-3.36	1136.92	-667.11	-658.73	1128.53	122.72
1	2	953	8.733.87	7.48	5.11	-2.12	1404.64	-58.66	-44.77	1390.74	141.90
1	2	954	4.140.78	0.78	4.14	-2.58e-02	1330.08	112.35	124.60	1317.82	121.56
1	2	955	3.18-0.11	-0.10	3.17	0.17	1207.82	183.18	190.25	1200.75	84.80
1	2	956	2.53-0.23	-0.22	2.53	0.12	1084.93	206.94	209.47	1082.40	47.03
1	2	957	2.23-0.23	-0.23	2.23	6.24e-03	1019.35	212.23	212.37	1019.21	10.73
1	2	958	2.25-0.24	-0.24	2.24	-0.11	1037.10	210.13	210.89	1036.34	-25.09
1	2	959	2.57-0.25	-0.23	2.56	-0.19	1131.61	197.40	201.56	1127.46	-62.16
1	2	960	3.19-0.12	-0.11	3.18	-0.17	1263.40	154.74	164.00	1254.15	-100.85
1	2	961	3.990.85	0.87	3.97	0.24	1359.11	39.04	53.46	1344.69	-137.21
1	2	962	9.822.44	7.86	4.41	3.26	1350.88	-232.22	-218.94	1337.60	-144.40
1	2	963	22.84-26.33	22.44	-25.94	4.40	803.50	-1261.24	-1255.48	797.74	-108.93
1	2	964	4.86-0.67	-0.62	4.82	0.51	1147.14	-29.00	-27.09	1145.23	-47.39
1	2	965	7.84-4.56	-4.49	7.77	0.93	999.42	-108.73	-107.85	998.54	-31.24
1	2	966	37.724.49	16.28	25.93	-15.90	387.31	183.67	277.32	293.66	-101.49
1	2	967	10.67-10.87	-10.35	10.15	-3.31	-129.44	-452.71	-421.25	-160.90	95.81
1	2	968	9.44-10.39	-9.65	8.70	3.75	-155.66	-434.74	-407.52	-182.87	-82.79
1	2	969	14.89-7.30	8.13	-0.55	-10.21	-7.08	-605.69	-136.22	-476.54	246.23
1	2	970	11.18-9.84	0.45	0.89	10.51	-5.90	-652.24	-194.95	-463.19	-294.03
1	2	971	4.45-2.26	2.94	-0.76	2.80	1074.33	-191.61	109.44	773.28	-538.96
1	2	972	7.52-1.89	7.46e-03	5.63	-3.77	1214.53	88.51	208.54	1094.49	-347.50
1	2	973	5.86-0.74	-0.15	5.27	-1.88	1176.14	166.53	216.93	1125.75	-219.86
1	2	974	4.38-0.32-9.53e-02	4.16	-0.99	1063.03	164.67	185.61	1042.08	-135.55	
1	2	975	3.61-0.12-5.04e-02	3.53	-0.52	951.89	149.20	155.40	945.69	-70.24	
1	2	976	3.28-3.92e-02-3.37e-02	3.28	-0.14	892.96	139.63	139.96	892.63	-15.71	
1	2	977	7.01-5.85	3.78	-2.63	-5.57	-26.35	-818.34	-423.61	-421.08	396.00
1	2	978	5.99-8.80	-2.19	-0.62	-7.35	1101.78	-597.71	-272.72	776.80	668.35
1	2	979	5.11-1.21	-0.80	4.69	1.57	1351.05	-56.89	51.42	1242.74	375.18
1	2	980	3.78-0.12	3.92e-02	3.61	0.78	1303.61	161.49	200.03	1265.08	206.22
1	2	981	2.80-0.19-9.45e-02	2.70	0.53	1176.21	232.95	249.15	1160.01	122.56	
1	2	982	2.18-0.16	-0.12	2.14	0.29	1052.87	253.34	258.33	1047.88	62.92
1	2	983	1.89-0.12	-0.12	1.89	6.76e-02	987.73	257.01	257.26	987.48	13.55
1	2	984	1.92-0.15	-0.14	1.91	-0.14	1005.28	255.60	257.13	1003.75	-33.78
1	2	985	2.27-0.23	-0.18	2.22	-0.34	1099.30	246.16	255.08	1090.38	-86.80
1	2	986	2.95-0.32	-0.24	2.88	-0.48	1232.80	209.51	233.46	1208.84	-154.73
1	2	987	4.02-0.38	-0.32	3.97	-0.49	1338.01	98.96	153.84	1283.14	-254.92
1	2	988	5.23-1.65	-1.62	5.20	-0.45	1318.59	-213.19	-55.78	1161.18	-465.13
1	2	989	11.01-10.17	-7.31	8.16	7.23	877.42	-857.17	-367.78	388.04	-780.63
1	2	990	11.09-9.08	10.40	-8.38	3.68	-73.72	-784.47	-389.12	-469.06	-353.12
1	2	991	0.43-6.12	-5.19	-0.50	2.29	790.25	-457.27	368.79	-35.81	590.04
1	2	992	7.72-4.25	-3.55	7.02	2.82	1146.50	-36.96	408.09	701.45	573.26



EGP CODE

GRE.EEC.R.73.IT.W.15235.12.024.01

PAGE

344 di/of 527

1	2	993	2.84-1.20	-1.16	2.80	0.42	1276.77	176.33	354.85	1098.25	405.69		
1	2	994	2.53-0.39	1.35e-02	2.13	1.00	1233.28	301.70	372.90	1162.09	247.50		
1	2	995	1.99-0.16	0.14	1.69	0.75	1116.99	335.27	363.06	1089.21	144.73		
1	2	996	1.562.07e-02	0.14	1.43	0.42	1002.87	337.81	345.76	994.91	72.30		
1	2	997	1.330.12	0.13	1.32	0.11	942.20	334.93	335.31	941.82	15.21		
1	2	998	1.387.55e-02	0.10	1.35	-0.19	958.48	335.75	338.16	956.07	-38.67		
1	2	999	1.70-0.11	4.73e-02	1.54	-0.50	1045.77	338.38	353.04	1031.12	-100.76		
1	2	1000	2.27-0.38-6.48e-02		1.95	-0.85	1169.19	329.05	371.40	1126.84	-183.81		
1	2	1001	3.21-0.80	-0.36	2.77	-1.26	1267.69	276.32	379.87	1164.14	-303.20		
1	2	1002	5.04-2.08	-1.54	4.51	-1.88	1270.66	113.44	370.53	1013.56	-481.06		
1	2	1003	4.49-0.83	-0.74	4.40	-0.68	1034.78	-112.34	450.73	471.71	-573.47		
1	2	1004	2.11-10.18	-9.43	1.36	-2.94	770.23	-477.20	341.86	-48.83	-592.33		
1	2	1005	1.08-4.60	-3.80	0.27	1.98	1176.00	-118.22	973.32	84.46	470.36		
1	2	1006	1.90-3.33	-2.93	1.50	1.39	1157.91	323.69	821.57	660.02	409.21		
1	2	1007	1.28-1.34	-1.04	0.99	0.83	1178.58	474.05	677.86	974.78	319.45		
1	2	1008	1.11-0.33	0.14	0.64	0.68	1140.40	492.81	570.85	1062.36	210.83		
1	2	1009	1.11-5.93e-03	0.40	0.70	0.54	1047.14	467.23	495.78	1018.59	125.46		
1	2	1010	0.940.24	0.43	0.76	0.31	950.97	438.53	446.37	943.13	62.87		
1	2	1011	0.800.40	0.41	0.78	7.56e-02	898.53	423.59	423.96	898.16	13.26		
1	2	1012	0.860.33	0.39	0.80	-0.16	912.69	427.84	430.15	910.37	-33.41		
1	2	1013	1.070.11	0.36	0.81	-0.42	987.75	450.39	464.81	973.34	-86.82		
1	2	1014	1.34-0.24	0.28	0.82	-0.74	1090.70	483.04	526.45	1047.29	-156.51		
1	2	1015	1.53-0.72	9.38e-03	0.80	-1.05	1169.86	502.33	614.74	1057.45	-249.80		
1	2	1016	1.33-1.55	-1.04	0.82	-1.10	1184.26	447.20	735.27	896.19	-359.64		
1	2	1017	1.82-3.49	-3.19	1.53	-1.21	1163.35	215.91	887.61	491.64	-430.37		
1	2	1018	0.83-4.82	-4.09	9.30e-02	-1.90	1181.54	-119.20	976.41	85.93	-474.07		
1	2	1019	-0.11-4.62	-4.47	-0.26	0.81	1294.46	72.77	1250.84	116.39	226.69		
1	2	1020	0.15-2.58	-2.36	-7.04e-02	0.74	1139.80	574.81	1062.33	652.28	194.34		
1	2	1021	0.13-0.92	-0.76	-2.78e-02	0.37	1060.21	739.07	875.53	923.75	158.75		
1	2	1022	0.33-6.80e-02	0.21	4.62e-02	0.18	1043.65	679.57	718.81	1004.41	112.90		
1	2	1023	0.590.22	0.56	0.25	9.88e-02	985.73	592.16	605.23	972.65	70.54		
1	2	1024	0.630.43	0.61	0.44	4.53e-02	911.93	530.46	533.94	908.45	36.26		
1	2	1025	0.590.54	0.59	0.54	3.38e-04	869.06	502.65	502.81	868.89	7.77		
1	2	1026	0.620.50	0.59	0.53	-4.93e-02	880.88	510.14	511.15	879.87	-19.24		
1	2	1027	0.660.35	0.59	0.42	-0.12	941.65	552.80	559.15	935.31	-49.26		
1	2	1028	0.656.86e-02	0.53	0.19	-0.24	1017.41	627.83	647.86	997.38	-86.02		
1	2	1029	0.43-0.37	0.15	-9.04e-02	-0.38	1059.38	718.40	778.97	998.80	-130.33		
1	2	1030	1.74e-02	-1.25	-0.97	-0.26	-0.52	1083.92	720.91	950.10	854.73	-175.13	
1	2	1031	-0.13-3.21	-3.07	-0.28	-0.65	1199.64	435.61	1140.16	495.09	-204.71		
1	2	1032	-0.25-4.72	-4.63	-0.34	-0.63	1298.67	78.04	1254.12	122.59	-228.90		
1	2	1033	-0.40-4.61	-4.60	-0.42	0.25	1321.14	119.84	1320.02	120.96	-36.66		
1	2	1034	-0.33-1.99	-1.99	-0.33	6.40e-03	1130.83	653.07	1128.80	655.10	-31.02		
1	2	1035	7.46e-02	-0.62	-0.41	-0.13	-0.31	950.54	907.58	939.01	919.11	-19.03	
1	2	1036	0.74-0.23	0.38	0.13	-0.47	994.63	776.57	776.79	994.41	-6.89		
1	2	1037	0.967.81e-02	0.62	0.41	-0.43	961.89	656.48	656.48	961.89	-0.66		
1	2	1038	0.910.36	0.64	0.63	-0.27	899.02	579.84	579.84	899.01	0.84		
1	2	1039	0.780.57	0.61	0.74	-8.53e-02	860.52	546.11	546.11	860.52	0.27		
1	2	1040	0.790.55	0.61	0.72	0.10	871.32	554.91	554.91	871.32	-0.63		
1	2	1041	0.900.33	0.65	0.58	0.28	925.55	606.29	606.29	925.55	-0.49		
1	2	1042	0.911.82e-02	0.63	0.30	0.41	986.74	700.64	700.66	986.72	2.62		
1	2	1043	0.60-0.35	0.35	-0.10	0.42	990.57	837.34	838.15	989.76	11.12		
1	2	1044	-0.30-0.80	-0.67	-0.43	0.22	1017.59	847.92	1014.13	851.38	23.98		
1	2	1045	-0.52-2.90	-2.90	-0.52	-7.36e-02	1208.38	496.59	1206.91	498.06	32.29		
1	2	1046	-0.47-4.77	-4.77	-0.47	-0.17	1323.54	125.76	1322.49	126.80	35.36		
1	2	1047	-9.67e-02	-4.01	-3.97	-0.14	-0.39	1247.62	29.34	1175.22	101.74	-288.03	
1	2	1048	1.00-1.82	-1.52	0.71	-0.86	1142.30	535.34	1011.01	666.64	-249.90		
1	2	1049	1.66-0.84	1.82e-02	0.80	-1.19	1095.51	711.00	852.89	953.62	-185.54		
1	2	1050	1.97-0.44	0.53	0.99	-1.18	1065.37	682.13	721.89	1025.60	-116.87		
1	2	1051	1.89-0.11	0.54	1.24	-0.94	994.46	609.77	621.98	982.26	-67.42		
1	2	1052	1.620.22	0.49	1.35	-0.55	915.15	551.95	555.02	912.07	-33.29		
1	2	1053	1.420.43	0.46	1.39	-0.15	870.75	524.45	524.60	870.60	-7.17		
1	2	1054	1.440.40	0.46	1.39	0.24	882.99	531.52	532.36	882.15	17.24		
1	2	1055	1.690.15	0.50	1.33	0.65	946.58	572.26	577.95	940.89	45.79		
1	2	1056	1.97-0.23	0.56	1.18	1.06	1030.09	639.51	658.92	1010.68	84.89		
1	2	1057	2.02-0.65	0.53	0.84	1.33	1086.83	708.14	771.30	1023.67	141.17		
1	2	1058	1.29-1.03-8.55e-02		0.35	1.14	1110.59	682.83	913.75	879.68	213.20		
1	2	1059	0.72-2.47	-2.34	0.60	0.62	1181.31	397.21	1079.43	499.09	263.63		
1	2	1060	-0.36-4.33	-4.28	-0.41	0.42	1248.08	31.16	1176.33	102.91	286.65		
1	2	1061	1.03-4.22	-4.20	1.02	0.32	917.86	-188.32	715.86	13.68	-427.37		
1	2	1062	7.15-1.93	-0.54	5.76	-3.26	1138.92	246.06	681.25	703.74	-446.29		
1	2	1063	3.55-0.30	0.51	2.74	-1.57	1180.19	441.53	591.77	1029.95	-297.33		
1	2	1064	-1.28-3.93	-3.79	-1.41	0.58	914.69	-106.15	882.76	-74.22	177.70		
1	2	1065	3.19-0.25	0.27	2.67	-1.24	1040.51	452.53	475.70	1017.34	-114.38		
1	2	1066	2.643.05e-02	0.22	2.45	-0.67	941.14	420.42	427.06	934.50	-58.43		
1	2	1067	2.360.19	0.21	2.34	-0.18	887.97	403.25	403.59	887.63	-12.87		
1	2	1068	2.400.16	0.20	2.36	0.30	902.36	407.52	409.39	900.49	30.35		





EGP CODE

GRE.EEC.R.73.IT.W.15235.12.024.01

PAGE

345 di/of 527

1	2	1069	2.77-4.65e-02	0.21	2.51	0.81	978.99	431.79	443.48	967.31	79.11
1	2	1070	3.41-0.39	0.24	2.79	1.41	1086.42	465.28	499.48	1052.22	141.68
1	2	1071	4.23-0.75	0.39	3.09	2.09	1171.40	478.59	563.53	1086.46	227.23
1	2	1072	4.47-0.99	0.11	3.36	2.20	1178.74	393.03	613.76	958.02	353.14
1	2	1073	4.38-3.44e-02	1.12	3.23	1.94	1073.30	135.98	735.82	473.47	449.93
1	2	1074	0.45-6.80	-6.80	0.44	-0.10	893.88	-204.30	691.20	-1.62	426.03
1	2	1076	23.24-25.51	15.86	-18.13	-17.47	-619.21	-1036.06	-1035.24	-620.04	18.51
1	2	1077	9.99-2.11	2.80	5.08	5.94	570.98	-228.45	378.40	-35.87	341.86
1	2	1078	-0.71-6.09	-6.03	-0.76	0.53	1025.63	-94.60	997.04	-66.02	176.65
1	2	1079	-0.57-8.11	-8.11	-0.57	8.51e-03	1249.18	-61.27	1246.15	-58.24	62.94
1	2	1080	-0.56-8.14	-8.14	-0.56	-1.95e-02	1253.21	-59.85	1251.25	-57.89	-50.71
1	2	1081	-0.74-6.25	-6.21	-0.79	-0.50	1041.20	-89.65	1016.86	-65.31	-164.12
1	2	1082	3.34-5.38e-02	-3.73e-02	3.32	0.24	908.70	141.90	143.61	906.98	36.21
1	2	1083	3.78-0.17	-6.93e-02	3.68	0.62	993.50	154.51	165.15	982.86	93.90
1	2	1084	4.68-0.41	-0.16	4.43	1.10	1113.57	167.36	197.09	1083.83	165.07
1	2	1085	6.33-0.91	-0.27	5.69	2.06	1206.92	151.98	219.26	1139.64	257.78
1	2	1086	7.88-1.95	0.17	5.76	4.05	1189.40	14.84	173.87	1030.36	401.87
1	2	1087	7.57-2.35	-0.49	5.71	-3.88	970.06	-443.91	12.35	513.81	661.03
1	2	1088	9.00-2.39	2.16	4.46	-5.58	591.16	-207.70	425.17	-41.71	-324.12
1	2	1089	16.572.42	15.34	3.65	3.98	964.74	-178.77	-91.64	877.61	-303.39
1	2	1090	10.302.90	3.26	9.94	-1.59	1240.22	-90.47	-4.94	1154.69	-326.35
1	2	1091	6.24-7.98e-02	22.86e-02	6.14	-0.82	1182.92	-60.97	-16.10	1138.05	-231.95
1	2	1092	4.82-0.19	-9.93e-02	4.73	-0.67	1065.56	-56.12	-36.76	1046.20	-146.09
1	2	1093	4.04-0.10	-5.97e-02	4.00	-0.41	948.60	-60.99	-55.29	942.90	-75.63
1	2	1094	3.70-4.67e-02	-4.36e-02	3.70	-0.11	886.66	-65.16	-64.86	886.36	-16.96
1	2	1095	3.76-5.60e-02	-4.56e-02	3.75	0.20	903.06	-64.20	-62.65	901.51	38.65
1	2	1096	4.23-0.13	-6.99e-02	4.18	0.49	992.01	-59.29	-49.54	982.27	100.75
1	2	1097	5.14-0.23	-0.13	5.04	0.73	1117.93	-58.02	-30.83	1090.75	176.71
1	2	1098	6.79-0.13	-4.12e-02	6.71	0.76	1211.08	-76.48	-19.09	1153.69	265.72
1	2	1099	11.283.15	3.26	11.17	0.94	1186.03	-140.57	-44.90	1090.36	343.15
1	2	1100	22.32-8.78	20.83	-7.29	-6.65	754.40	-438.06	-388.55	704.89	237.88
1	2	1101	-3.40-32.56	-29.09	-6.88	9.45	335.24	-468.72	-456.12	322.63	99.86
1	2	1102	-1.02-26.29	-1.18	-26.14	-1.98	870.47	-1185.65	-1185.64	870.47	-3.24
1	2	1103	-5.45-24.22	-24.18	-5.49	0.87	706.86	-1650.88	-1650.87	706.85	3.47
1	2	1104	-5.52-26.05	-24.70	-6.86	-5.09	741.01	-1750.67	-1749.24	739.58	-59.70
1	2	1105	8.60-36.80	6.78	-34.98	8.90	1106.25	-1786.45	-1786.45	1106.25	0.71
1	2	1106	-3.39-24.37	-22.36	-5.40	6.18	989.10	-2665.99	-2664.42	987.53	75.85
1	2	1107	-3.34-25.02	-22.86	-5.50	-6.49	936.61	-2472.26	-2470.66	934.71	-73.92
1	2	1108	1.28-34.27	-1.84	-31.15	-10.06	926.69	-1338.07	-1337.89	926.51	-20.06
1	2	1109	-4.94-20.52	-19.79	-5.68	3.30	725.26	-1739.48	-1739.48	725.26	-4.16
1	2	1110	-8.11-24.90	-19.34	-13.68	-7.90	479.43	-556.85	-549.74	472.33	-85.53
1	2	1111	6.11-3.00	-1.48	4.59	3.40	287.57	-130.89	255.19	-98.51	-111.81
1	2	1112	-0.93-6.42	-5.83	-1.52	-1.70	1049.11	-111.22	1043.61	-105.71	-79.74
1	2	1113	-1.01-8.47	-8.47	-1.01	2.49e-02	1249.68	-73.53	1248.76	-72.61	34.82
1	2	1114	-1.30-7.27	-7.25	-1.32	0.29	1045.77	-93.81	1028.04	-76.08	141.03
1	2	1115	3.75-4.95	0.48	-1.68	4.22	399.16	-217.60	291.46	-109.90	234.15
1	2	1116	21.61-2.76	7.16	11.69	-11.97	-144.47	-1358.96	-1358.87	-144.56	-10.46
1	2	1117	20.16-2.65	7.34	10.17	11.31	-163.27	-1360.45	-1356.06	-167.66	72.39
1	2	1118	3.80-4.06	1.09	-1.35	-3.73	263.74	-171.69	198.19	-106.15	-155.70
1	2	1119	-1.24-6.23	-6.22	-1.25	-0.27	829.76	-83.39	825.41	-79.04	-62.90
1	2	1120	-0.93-6.13	-6.11	-0.95	0.31	913.20	-78.61	911.16	-76.57	44.94
1	2	1121	6.16-2.49	2.79	0.88	4.22	559.27	-131.01	511.86	-83.61	174.57
1	2	1122	19.43-9.47	13.78	-3.82	-11.46	-329.65	-682.44	-681.84	-330.25	-14.54
1	2	1123	-0.71-6.85	-6.85	-0.71	4.12e-02	1206.64	-66.20	1203.40	-62.96	64.09
1	2	1124	19.29-9.52	13.51	-3.75	11.53	-328.48	-666.43	-666.37	-328.54	-4.20
1	2	1125	5.94-2.85	2.19	0.90	-4.34	612.21	-137.61	556.95	-82.35	-195.91
1	2	1126	-0.87-6.89	-6.87	-0.89	-0.30	1020.04	-77.57	1016.53	-74.05	-62.01
1	2	1127	-0.76-7.17	-7.16	-0.77	0.27	1047.00	-76.20	1044.13	-73.33	56.69
1	2	1128	5.59-2.86	0.97	1.76	4.21	700.47	-125.54	649.24	-74.31	199.23
1	2	1129	17.36-12.17	12.45	-7.26	-10.99	-356.66	-466.76	-437.27	-386.15	48.75
1	2	1130	21.93-22.60	15.14	-15.82	16.00	-564.31	-926.64	-923.95	-567.00	-31.10
1	2	1131	24.64-4.65	17.93	2.07	12.31	-262.01	-1045.72	-1044.74	-262.99	27.66
1	2	1132	8.30-3.08	5.65	-0.42	-4.81	476.19	-173.73	404.23	-101.77	-203.94
1	2	1133	-1.08-5.41	-5.37	-1.12	-0.39	982.31	-84.60	976.51	-78.79	-78.49
1	2	1134	-0.93-6.76	-6.75	-0.93	-1.79e-02	1067.25	-75.79	1065.83	-74.37	40.36
1	2	1135	-1.62-5.05	-5.00	-1.67	0.42	759.69	-113.84	732.33	-86.48	152.16
1	2	1136	8.09-5.41	5.92	-3.24	4.96	52.56	-420.49	-230.68	-137.25	231.87
1	2	1137	31.456.31	16.69	21.07	-12.38	-81.36	-2144.23	-2143.41	-82.18	-41.04
1	2	1138	29.12-15.27	10.42	3.43	21.92	-380.72	-1945.81	-1941.62	-384.91	80.90
1	2	1139	7.97-4.31	2.60	1.06	-6.09	292.55	-399.84	-23.55	-83.75	-344.88
1	2	1140	-1.05-6.98	-6.96	-1.07	-0.29	861.16	-123.74	809.42	-72.00	-219.74
1	2	1141	-0.57-8.08	-8.08	-0.57	6.87e-02	1187.73	-69.28	1177.47	-59.03	-113.08
1	2	1142	-0.42-8.11	-8.11	-0.42	2.36e-03	1283.50	-55.50	1283.50	-55.50	0.16
1	2	1143	-0.59-7.58	-7.58	-0.59	-3.88e-02	1191.25	-69.45	1180.94	-59.14	113.51
1	2	1144	-0.94-5.25	-5.20	-0.99	0.48	867.73	-123.23	815.75	-71.25	220.93
1	2	1145	13.55-2.47	9.35	1.73	7.05	315.26	-394.11	-3.37	-75.48	352.84





EGP CODE

GRE.EEC.R.73.IT.W.15235.12.024.01

PAGE

346 di/of 527

1	2	1146	35.00-16.16	24.25	-5.41	-20.85	-450.31	-1846.64	-1841.62	-455.33	-83.58
1	2	1147	15.53-7.26	-4.05	12.33	-7.92	-26.38	-555.67	-529.12	-52.93	115.53
1	2	1148	24.37-26.32	16.38	-18.34	18.47	-632.89	-1049.72	-1049.27	-633.34	-13.69
1	2	1149	10.56-2.23	3.58	4.74	-6.37	565.83	-224.42	379.11	-37.70	-335.69
1	2	1150	-0.39-7.73	-7.71	-0.41	-0.38	1032.30	-94.17	1003.30	-65.16	-178.42
1	2	1151	-0.49-9.11	-9.11	-0.49	1.81e-02	1256.79	-61.84	1253.67	-58.71	-64.14
1	2	1152	-0.49-9.11	-9.11	-0.49	-2.16e-03	1260.69	-60.36	1258.68	-58.35	51.53
1	2	1153	-0.43-7.79	-7.77	-0.45	0.35	1047.64	-89.11	1023.00	-64.47	165.55
1	2	1154	9.55-2.46	2.91	4.17	5.97	587.26	-203.59	426.56	-42.90	318.22
1	2	1155	22.86-23.56	15.44	-16.13	-17.01	-579.99	-937.37	-935.45	-581.92	26.18
1	2	1156	31.04-12.97	22.19	-4.12	-17.64	-400.34	-1652.37	-1648.58	-404.13	-68.80
1	2	1157	32.37-13.94	22.55	-4.12	18.92	-412.29	-1664.21	-1659.07	-417.44	80.07
1	2	1158	12.17-2.55	8.28	1.34	-6.49	335.73	-312.09	103.33	-79.68	-310.71
1	2	1159	-0.94-5.62	-5.57	-0.98	-0.47	915.69	-105.68	883.16	-73.15	-179.35
1	2	1160	-0.63-7.94	-7.94	-0.63	-5.95e-03	1210.28	-66.93	1206.81	-63.47	-66.45
1	2	1161	-0.62-8.39	-8.39	-0.62	-2.07e-02	1236.84	-65.31	1234.76	-63.24	51.98
1	2	1162	-1.12-7.62	-7.61	-1.12	0.23	1000.89	-99.84	974.98	-73.93	166.88
1	2	1163	5.34-4.97	0.41	-4.51e-02	5.15	432.00	-258.92	269.77	-96.68	292.87
1	2	1164	23.70-10.71	6.60	6.39	-17.21	-282.81	-1406.54	-1406.43	-282.92	-11.07
1	2	1165	24.767.86	12.56	20.05	7.58	-39.28	-1592.25	-1591.70	-39.82	29.16
1	2	1166	5.68-5.09	4.11	-3.52	-3.80	45.76	-222.14	-34.52	-141.86	-122.73
1	2	1167	-1.57-4.22	-4.22	-1.58	-5.35e-02	597.60	-97.13	594.63	-94.15	-45.36
1	2	1168	4.89-1.90	1.43	1.56	3.39	498.51	-89.89	486.74	-78.11	82.39
1	2	1169	14.19-12.93	9.65	-8.39	-10.12	-360.13	-503.06	-464.65	-398.53	-63.36
1	2	1170	10.88-2.47	6.64	1.77	6.21	349.08	-317.93	111.52	-80.37	319.40
1	2	1171	22.60-9.33	14.06	-0.79	14.13	-297.36	-1063.67	-1062.77	-298.26	-26.24
1	2	1172	7.10-3.79	3.00	0.31	-5.27	578.55	-233.53	428.36	-83.33	-315.30
1	2	1173	-0.97-6.96	-6.94	-0.98	-0.25	1130.97	-96.59	1098.84	-64.46	-195.97
1	2	1174	-0.53-8.48	-8.48	-0.53	2.16e-03	1404.54	-60.42	1398.61	-54.49	-93.03
1	2	1175	-0.54-8.94	-8.94	-0.54	-0.10	1468.65	-55.25	1468.53	-55.13	13.59
1	2	1176	-1.35-8.95	-8.94	-1.35	-0.10	1316.13	-79.34	1305.81	-69.01	119.58
1	2	1177	-0.57-7.36	-4.75	-3.18	3.31	796.12	-177.30	742.69	-123.87	221.69
1	2	1178	12.11-2.46	7.50	2.14	-6.77	328.11	-400.57	4.48	-76.94	-362.06
1	2	1179	-3.00-31.46	-27.85	-6.62	-9.48	335.50	-474.79	-461.08	321.79	-104.50
1	2	1180	-1.20-23.42	-1.39	-23.24	2.01	846.02	-1204.12	-1204.11	846.01	2.79
1	2	1181	-4.95-24.81	-24.77	-4.99	-0.90	697.44	-1651.39	-1651.39	697.44	-4.31
1	2	1182	-5.37-26.33	-25.32	-6.38	4.48	730.73	-1751.30	-1750.12	729.56	53.99
1	2	1183	7.75-32.56	6.24	-31.04	-7.68	1077.20	-1811.08	-1811.07	1077.20	-1.73
1	2	1184	-3.38-24.77	-23.40	-4.76	-5.25	977.15	-2667.41	-2666.20	975.93	-66.56
1	2	1185	-3.33-25.41	-23.85	-4.89	5.66	924.68	-2473.08	-2471.79	923.39	66.17
1	2	1186	0.81-30.72	-2.07	-27.84	9.08	900.77	-1357.53	-1357.33	900.57	21.36
1	2	1187	-4.20-21.08	-19.99	-5.28	-4.14	715.66	-1741.12	-1741.09	715.63	-8.62
1	2	1188	-6.16-24.18	-17.14	-13.20	8.79	477.48	-570.23	-562.71	469.95	88.47
1	2	1189	6.65-0.30	0.54	5.80	-2.27	285.03	-111.80	247.63	-74.39	115.94
1	2	1190	-1.11-6.62	-6.06	-1.68	1.67	1045.52	-115.16	1039.86	-109.51	80.79
1	2	1191	-1.22-7.91	-7.91	-1.22	1.46e-02	1250.23	-74.15	1249.30	-73.23	-35.01
1	2	1192	-1.65-6.84	-6.83	-1.66	-0.25	1050.01	-95.35	1031.91	-77.25	-142.84
1	2	1193	2.57-6.01	-1.64	-1.80	-4.29	404.58	-227.08	293.37	-115.87	-240.58
1	2	1194	19.75-5.23e-02	029.05	10.65	9.87	-118.57	-1366.69	-1366.67	-118.58	-3.76
1	2	1195	18.03-1.47	7.93	8.63	-9.75	-147.30	-1370.33	-1367.12	-150.50	-62.52
1	2	1196	2.62-4.80	-0.86	-1.32	3.70	272.78	-180.36	202.33	-109.91	164.20
1	2	1197	-1.57-5.20	-5.19	-1.59	0.22	832.19	-84.64	827.41	-79.86	66.05
1	2	1198	-1.20-4.59	-4.54	-1.25	-0.42	912.26	-79.06	910.33	-77.14	-43.65
1	2	1199	5.70-2.27	2.23	1.20	-3.95	565.06	-132.19	515.08	-82.21	-179.86
1	2	1200	18.71-8.97	13.57	-3.83	10.76	-321.65	-672.43	-672.16	-321.92	9.74
1	2	1201	-1.54-7.06	-7.05	-1.54	-0.20	1003.76	-102.00	977.28	-75.53	-169.04
1	2	1202	18.82-8.61	13.72	-3.51	-10.67	-315.20	-661.03	-660.72	-315.51	10.31
1	2	1203	5.47-2.73	1.60	1.14	4.09	614.58	-140.54	556.17	-82.14	201.72
1	2	1204	-1.18-5.21	-5.17	-1.22	0.38	1014.42	-78.25	1010.87	-74.70	62.15
1	2	1205	-1.04-5.47	-5.44	-1.07	-0.35	1040.48	-76.75	1037.57	-73.84	-56.90
1	2	1206	5.28-2.63	0.67	1.98	-3.90	700.39	-127.02	646.26	-72.88	-204.61
1	2	1207	16.79-11.44	12.39	-7.05	10.23	-343.39	-462.17	-430.81	-374.75	-52.36
1	2	1209	23.72-3.91	17.78	2.03	-11.35	-251.82	-1038.67	-1038.21	-252.28	-19.11
1	2	1210	7.33-2.93	4.48	-8.37e-02	4.60	485.75	-177.55	410.16	-101.95	210.78
1	2	1211	-1.35-3.91	-3.82	-1.44	0.47	982.21	-85.12	976.53	-79.44	77.63
1	2	1212	-1.02-5.59	-5.58	-1.02	5.01e-02	1066.68	-75.51	1065.13	-73.97	-41.98
1	2	1213	-1.99-4.26	-4.21	-2.05	-0.35	766.05	-115.90	737.68	-87.53	-155.62
1	2	1214	5.48-5.91	2.59	-3.02	-4.96	64.68	-430.03	-223.92	-141.43	-243.89
1	2	1215	28.026.95	17.01	17.96	10.53	-67.17	-2158.56	-2157.82	-67.91	39.41
1	2	1216	27.49-11.51	12.95	3.03	-18.86	-339.61	-1952.96	-1951.00	-341.58	-56.31
1	2	1217	6.38-5.95	-0.33	0.75	6.14	299.05	-413.28	-20.61	-93.61	354.29
1	2	1218	-1.54-6.45	-6.43	-1.56	0.26	866.20	-126.27	813.90	-73.97	221.74
1	2	1219	-0.63-7.56	-7.55	-0.64	-8.23e-02	1186.72	-69.07	1176.37	-58.72	113.52
1	2	1220	-0.44-7.51	-7.51	-0.44	-1.81e-02	1280.17	-54.91	1280.16	-54.91	1.18
1	2	1221	-0.67-6.54	-6.54	-0.67	2.28e-03	1186.76	-68.52	1176.88	-58.65	-110.89
1	2	1222	-1.29-3.57	-3.40	-1.46	-0.59	866.26	-123.67	815.12	-72.53	-219.11



EGP CODE

GRE.EEC.R.73.IT.W.15235.12.024.01

PAGE

347 di/of 527

1	32	1	4.77-10.82	-0.84	-5.21	-7.48	-207.41	-764.09	-654.21	-317.29	221.56		
1	32	3	6.38-1.70	-0.70	5.39	-2.65	-669.13	-1096.46	-686.43	-1079.16	-84.22		
1	32	5	8.04-3.96	-3.64	7.72	1.92	-1550.44	-1694.13	-1686.44	-1558.12	32.33		
1	32	7	7.73-0.98	-0.79	7.54	1.29	-1535.48	-1605.90	-1574.77	-1566.61	-34.97		
1	32	9	8.86-3.88	-3.77	8.75	1.19	-1587.02	-1687.29	-1618.87	-1655.44	-46.68		
1	32	11	11.21-6.85	-6.82	11.18	0.77	-1906.53	-2213.58	-2191.10	-1929.01	-79.99		
1	32	13	8.78-0.65	-0.45	8.58	1.35	-1998.28	-2256.27	-2251.86	-2002.69	33.43		
1	32	15	5.50-2.17	-1.32	4.65	2.40	-1749.15	-2117.27	-2109.08	-1757.34	-54.30		
1	32	17	4.44-8.06	-5.81	2.19	4.80	-1419.77	-1811.91	-1802.63	-1429.05	59.60		
1	32	19	3.00-2.01	-1.65	2.64	1.29	-1310.91	-1752.44	-1647.72	-1415.64	-187.81		
1	32	21	7.83-3.24	1.54	3.04	5.49	-854.19	-1266.23	-1069.21	-1051.22	205.82		
1	32	23	0.32-2.57	-0.54	-1.71	-1.32	-831.02	-1913.42	-1912.33	-832.11	-34.32		
1	32	25	5.51-10.69	5.45	-10.62	-1.04	-767.85	-1711.77	-1710.84	-768.78	29.65		
1	32	27	7.87-12.87	5.92	-10.92	-6.05	-744.51	-1808.49	-1802.72	-750.27	78.13		
1	32	29	6.38-3.63	4.49	-1.75	3.91	-963.38	-2696.17	-2696.17	-963.38	2.23		
1	32	31	11.49-13.05	10.64	-12.19	4.51	-1087.82	-2592.12	-2588.32	-1091.62	-75.52		
1	32	33	7.07-11.87	4.82	-9.61	-6.14	-1107.71	-2333.04	-2327.65	-1113.11	81.09		
1	32	35	3.62-7.07	-2.16	-1.28	-5.32	-937.03	-2040.73	-2038.90	-938.87	-44.92		
1	32	37	4.43-9.14	1.84	-6.55	-5.34	-877.40	-1791.09	-1729.90	-938.59	228.40		
1	32	39	7.99-6.64	2.09	-0.75	7.18	-401.19	-1320.32	-1173.45	-548.05	-336.78		
1	32	41	8.29-17.61	-10.03	0.71	-11.79	977.72	-53.01	644.19	280.52	482.22		
1	32	42	22.474.82	13.31	13.99	-8.81	1281.10	388.87	603.49	1066.49	381.35		
1	32	43	21.49-22.23	20.84	-21.58	-5.30	1457.54	106.04	226.39	1337.19	384.92		
1	32	44	6.694.12	5.50	5.31	1.28	1267.16	419.08	476.46	1209.78	213.00		
1	32	45	8.71-1.52	6.08	1.11	4.47	1320.66	54.74	127.69	1247.71	295.00		
1	32	46	5.44-0.12	1.49	3.83	2.52	1097.95	338.73	358.58	1078.10	121.15		
1	32	47	5.590.15	0.69	5.04	1.63	1160.30	31.11	55.29	1136.12	163.47		
1	32	48	3.63-0.55	0.23	2.85	1.63	934.34	268.01	274.23	928.12	64.07		
1	32	49	3.12-0.21-4.82e-02		2.96	0.71	955.03	-0.98	5.97	948.08	81.22		
1	32	50	2.11-0.52-9.68e-02		1.69	0.96	774.89	220.09	221.29	773.70	25.72		
1	32	51	1.53-0.27	-0.17	1.43	0.41	774.55	-25.47	-24.40	773.49	29.18		
1	32	52	1.05-0.50	-0.23	0.77	0.59	647.07	192.09	192.09	647.07	-0.52		
1	32	53	0.56-0.29	-0.19	0.47	0.27	637.35	-40.45	-40.42	637.32	-4.89		
1	32	54	0.30-0.51	-0.31	9.58e-02	0.35	563.89	181.70	185.73	559.86	-39.05		
1	32	55	-4.02e-02	-0.36	-0.21	-0.19	0.16	550.60	-48.58	-44.92	546.94	-46.68	
1	32	56	-0.26-0.54	-0.36	-0.44	0.13	510.34	183.75	194.06	500.03	-57.11		
1	32	57	-0.23-0.68	-0.23	-0.68	3.48e-02	497.18	-51.32	-42.38	488.24	-69.45		
1	32	58	-0.42-0.84	-0.43	-0.84	-1.61e-02	465.19	186.88	215.50	436.57	-84.55		
1	32	59	-0.28-1.14	-0.29	-1.13	-7.93e-02	445.11	-59.61	-37.64	423.14	-102.98		
1	32	60	-0.52-1.23	-0.70	-1.05	-0.31	395.67	164.02	235.23	324.45	-106.89		
1	32	61	-0.37-0.96	-0.38	-0.95	-9.70e-02	325.70	-91.19	-46.61	281.11	-128.83		
1	32	62	-1.97-7.68	-3.43	-6.22	-2.49	297.13	-47.15	221.37	28.61	-142.63		
1	32	63	8.931.74	1.82	8.85	-0.76	125.57	-153.66	-70.05	41.96	-127.89		
1	32	64	-4.87-9.83	-7.79	-6.91	-2.44	290.26	-260.16	277.51	-247.41	-82.78		
1	32	65	19.63-3.59	-3.45	19.50	1.75	-464.47	-807.96	-491.06	-781.38	-91.79		
1	32	66	8.81-5.63	-3.88	7.06	-4.71	560.24	-223.57	508.36	-171.69	194.87		
1	32	67	3.95-5.85	-5.00	3.10	2.77	1038.40	176.16	910.95	303.60	306.01		
1	32	68	4.11-2.09	-1.76	3.78	1.39	1025.08	560.61	731.21	854.49	223.91		
1	32	69	4.472.16	3.22	3.42	1.15	1113.86	593.71	616.44	1091.13	106.34		
1	32	70	4.15-0.23	1.77	2.16	2.18	1059.44	490.08	494.48	1055.03	49.90		
1	32	71	3.20-0.66	0.71	1.83	1.85	919.10	401.53	403.02	917.61	27.77		
1	32	72	2.13-0.66	0.15	1.32	1.27	771.51	343.34	343.72	771.13	12.75		
1	32	73	1.23-0.62	-0.15	0.76	0.80	649.01	311.03	311.03	649.00	1.33		
1	32	74	0.52-0.59	-0.33	0.26	0.47	565.02	301.70	303.98	562.73	-24.41		
1	32	75	-3.82e-03	-0.58	-0.45	-0.14	0.24	507.36	314.29	319.24	502.41	-30.52	
1	32	76	-0.37-0.60	-0.58	-0.40	7.09e-02	455.33	340.24	356.98	438.59	-40.57		
1	32	77	-0.49-1.09	-0.92	-0.67	-0.27	434.36	312.19	414.36	332.18	-45.20		
1	32	78	0.25-1.44	-0.91	-0.29	-0.79	492.05	196.01	488.50	199.57	-32.25		
1	32	79	4.420.83	4.05	1.20	1.09	633.27	-4.46	626.96	1.85	63.12		
1	32	80	-0.11-2.24	-1.55	-0.80	1.00	589.75	-166.79	579.99	-157.03	85.38		
1	32	81	0.39-3.30	-3.27	0.37	0.28	984.91	262.26	984.73	262.44	11.27		
1	32	82	1.27-0.96	-0.85	1.15	0.50	778.08	755.49	756.18	777.39	3.89		
1	32	83	2.20-4.48e-02	1.08	1.08	1.12	1023.72	603.42	603.98	1023.16	-15.28		
1	32	84	2.85-0.23	1.57	1.05	1.52	1035.60	496.39	496.87	1035.12	-16.06		
1	32	85	2.45-0.47	0.99	0.99	1.46	918.44	425.88	425.99	918.33	-7.56		
1	32	86	1.81-0.57	0.36	0.89	1.16	772.51	374.90	374.93	772.48	-3.49		
1	32	87	1.18-0.59-5.66e-02		0.65	0.81	650.51	344.78	344.78	650.51	1.16		
1	32	88	0.64-0.61	-0.32	0.36	0.52	565.77	336.77	336.79	565.75	-2.04		
1	32	89	0.25-0.64	-0.50	0.11	0.32	506.65	352.73	352.79	506.59	2.98		
1	32	90	-5.97e-02	-0.71	-0.68	-8.19e-02	0.12	451.70	387.61	393.28	446.03	18.20	
1	32	91	-0.18-0.78	-0.74	-0.23	-0.15	478.11	348.04	464.85	361.30	39.36		
1	32	92	0.13-0.84	-0.39	-0.31	-0.48	563.11	219.96	546.69	236.37	73.23		
1	32	93	0.81-0.94	0.29	-0.42	-0.80	614.44	23.59	598.01	40.02	97.14		
1	32	94	1.41-0.63	1.30	-0.51	-0.47	625.64	-105.29	610.76	-90.41	103.23		
1	32	95	0.76-3.81	-3.25	0.20	-1.49	859.72	130.51	754.00	236.23	-256.75		
1	32	96	1.16-2.09	-1.89	0.96	-0.78	904.81	450.88	583.55	772.14	-206.45		



EGP CODE

GRE.EEC.R.73.IT.W.15235.12.024.01

PAGE

348 di/of 527

1	32	97	0.88-2.38e-026.43e-02	0.79	0.27	1064.57	454.20	479.60	1039.17	-121.89		
1	32	98	1.930.29	1.40	0.83	0.77	1060.21	425.87	430.54	1055.55	-54.19	
1	32	99	1.71-3.21e-02	0.86	0.82	0.87	930.58	386.70	387.90	929.38	-25.52	
1	32	100	1.50-0.31	0.37	0.83	0.87	778.39	350.65	351.20	777.85	-15.25	
1	32	101	1.12-0.50-4.58e-02	0.67	0.67	0.73	655.24	324.75	324.80	655.19	-4.18	
1	32	102	0.73-0.62	-0.33	0.45	0.55	574.22	313.64	313.87	573.99	7.76	
1	32	103	0.43-0.71	-0.54	0.26	0.40	525.56	312.96	316.51	522.02	27.22	
1	32	104	0.17-0.72	-0.69	0.14	0.16	500.60	301.75	333.37	468.99	72.71	
1	32	105	-0.19-0.86	-0.86	-0.20	-5.45e-02	489.03	261.71	368.58	382.16	113.46	
1	32	106	7.61e-02	-0.78	-0.20	-0.50	-0.40	513.66	141.05	419.34	235.37	162.01
1	32	107	1.11-0.80	0.72	-0.42	-0.76	493.51	-42.12	450.41	0.98	145.70	
1	32	108	0.82-1.12	0.51	-0.82	-0.70	473.89	-160.67	444.43	-131.20	133.52	
1	32	109	3.95-2.07	1.34	0.54	-2.98	658.44	-263.91	206.77	187.76	-461.08	
1	32	110	3.69-9.69	-8.59	2.59	-3.67	978.45	24.47	187.88	815.04	-359.43	
1	32	111	2.651.05	1.11	2.59	0.31	1185.09	290.71	314.27	1161.53	-143.24	
1	32	112	1.670.79	0.84	1.62	-0.20	1108.38	342.70	346.26	1104.83	-52.06	
1	32	113	1.700.34	0.49	1.56	0.42	941.97	328.46	328.64	941.80	-10.36	
1	32	114	1.59-0.21	0.15	1.22	0.72	783.79	301.84	302.62	783.00	-19.46	
1	32	115	1.22-0.48	-0.13	0.87	0.69	660.94	279.61	279.67	660.88	-4.72	
1	32	116	0.85-0.65	-0.38	0.57	0.58	585.10	262.89	263.14	584.86	8.94	
1	32	117	0.56-0.80	-0.58	0.34	0.50	549.51	243.21	248.34	544.38	39.29	
1	32	118	0.25-0.77	-0.74	0.22	0.18	529.36	201.99	226.17	505.18	85.61	
1	32	119	0.37-0.65	-0.65	0.37	-2.66e-02	472.35	121.02	186.74	406.64	137.00	
1	32	120	-0.71-2.05	-2.01	-0.76	0.25	379.82	-50.47	105.13	224.22	206.74	
1	32	121	6.271.15	5.91	1.51	-1.31	238.46	-142.28	184.62	-88.45	132.66	
1	32	122	0.63-4.81	-1.68	-2.50	-2.69	47.47	-309.63	43.08	-305.24	39.36	
1	32	123	21.41-13.02	14.62	-6.23	13.71	-7.01	-1101.67	-840.00	-268.69	-466.87	
1	32	124	9.93-0.94	5.27	3.72	5.38	1337.08	-46.79	-8.39	1298.67	-227.31	
1	32	125	5.610.42	0.64	5.39	-1.05	1305.25	226.47	229.07	1302.66	-52.86	
1	32	126	4.12-0.19	-0.15	4.09	-0.36	1114.25	282.25	282.68	1113.82	-18.98	
1	32	127	2.91-5.33e-028.52e-02	2.77	0.63	0.63	945.45	276.34	276.34	945.45	-0.25	
1	32	128	2.03-0.40-8.16e-02	1.72	0.82	0.82	784.24	253.13	253.40	783.97	-11.91	
1	32	129	1.43-0.55	-0.21	1.09	0.75	663.05	231.09	231.13	663.01	-4.11	
1	32	130	0.94-0.65	-0.38	0.66	0.60	591.37	210.70	210.75	591.32	4.43	
1	32	131	0.56-0.74	-0.55	0.37	0.46	559.65	185.15	186.34	558.46	21.07	
1	32	132	0.16-0.68	-0.64	0.12	0.18	541.15	134.06	141.94	533.27	56.12	
1	32	133	0.54-1.04	-0.92	0.41	-0.42	466.34	18.39	30.15	454.58	71.64	
1	32	134	2.35-4.95	-1.27	-1.33	3.65	164.03	-265.16	-205.93	104.80	148.03	
1	32	135	-10.48-22.46-17.64	-15.30	-15.30	5.87	-301.15	-832.52	-627.75	-505.92	258.61	
1	32	136	20.14-2.57	14.34	3.23	9.90	-316.76	-1098.83	-605.25	-810.35	-377.35	
1	32	137	35.53-18.59	35.40	-18.46	-2.66	1744.42	423.91	427.77	1740.56	71.30	
1	32	138	9.66-1.76	-1.55	9.44	1.56	1305.36	240.32	240.48	1305.20	13.06	
1	32	139	5.640.36	0.48	5.52	0.79	1131.52	287.36	287.42	1131.45	7.45	
1	32	140	3.16-0.65	-0.36	2.87	1.01	943.52	256.38	256.43	943.47	-5.69	
1	32	141	2.22-0.58	-0.22	1.86	0.94	784.62	232.54	232.61	784.55	-6.39	
1	32	142	1.53-0.61	-0.23	1.15	0.82	662.73	209.44	209.47	662.70	-3.79	
1	32	143	1.00-0.64	-0.33	0.69	0.64	591.45	188.66	188.67	591.44	1.67	
1	32	144	0.54-0.69	-0.51	0.36	0.44	559.22	162.14	162.27	559.09	7.21	
1	32	145	0.30-0.46	-0.38	0.22	0.23	539.85	119.67	120.40	539.12	17.45	
1	32	146	-0.21-1.12	-0.32	-1.01	-0.30	445.16	3.34	4.21	444.29	19.55	
1	32	147	12.351.58	1.90	12.03	-1.85	221.90	-196.73	-196.59	221.76	-7.55	
1	32	148	37.37-0.15-3.61e-02	37.26	2.06	-768.36	-993.57	-971.24	-790.70	-67.32		
1	32	149	8.13-19.86	-9.39	-2.34	-13.55	299.28	-600.63	-194.10	-107.25	447.86	
1	32	150	23.974.02	17.51	10.48	-9.34	1395.32	64.44	111.73	1348.02	246.39	
1	32	151	5.59-1.96	-0.39	4.03	3.07	1289.05	238.97	242.99	1285.03	64.84	
1	32	152	5.53-1.09	-0.41	4.84	2.02	1099.73	255.53	255.69	1099.56	11.80	
1	32	153	3.56-0.65	-0.16	3.07	1.35	936.39	241.71	241.71	936.39	0.70	
1	32	154	2.36-0.72	-0.25	1.89	1.11	779.13	213.33	213.36	779.10	-4.05	
1	32	155	1.62-0.64	-0.20	1.18	0.90	660.68	192.06	192.10	660.64	-4.33	
1	32	156	1.04-0.63	-0.30	0.71	0.67	589.43	172.67	172.68	589.42	-1.78	
1	32	157	0.58-0.58	-0.41	0.40	0.42	554.78	150.57	150.57	554.78	-0.76	
1	32	158	0.15-0.62	-0.61	0.14	7.97e-02	525.50	108.79	108.95	525.33	-8.37	
1	32	159	0.64-0.35	-0.26	0.55	-0.29	446.41	23.38	26.08	443.71	-33.66	
1	32	160	3.21-8.63	-1.57	-3.85	-5.81	143.59	-250.28	-192.80	86.11	-139.06	
1	32	161	-6.49-11.83	-7.76	-10.56	-2.27	-197.06	-672.93	-438.58	-431.41	-237.91	
1	32	162	12.01-10.88	-6.44	7.57	-9.05	110.65	-902.13	-129.54	-661.94	430.78	
1	32	163	4.53-6.46	-4.35	2.42	4.33	676.63	-117.21	331.84	227.58	393.48	
1	32	164	6.63-5.26	-4.67	6.04	2.59	951.66	140.68	258.67	833.68	285.94	
1	32	165	4.401.28	1.52	4.16	0.83	1153.41	256.73	265.41	1144.73	87.79	
1	32	166	3.90-0.86	0.39	2.65	2.09	1079.83	254.05	254.62	1079.25	21.77	
1	32	167	3.30-0.70	0.30	2.30	1.73	925.42	223.39	223.44	925.37	5.77	
1	32	168	2.40-0.66	0.14	1.61	1.34	774.59	192.61	192.61	774.58	-1.18	
1	32	169	1.68-0.65-3.99e-02	1.06	1.06	1.03	656.45	167.58	167.63	656.40	-4.68	
1	32	170	1.09-0.55	-0.13	0.66	0.72	582.10	152.34	152.44	582.00	-6.59	
1	32	171	0.57-0.32	-0.13	0.37	0.37	540.90	143.55	143.92	540.52	-12.22	
1	32	172	0.261.70e-023.14e-02	0.24	-5.70e-02	499.01	131.27	134.14	496.14	-32.36		



EGP CODE

GRE.EEC.R.73.IT.W.15235.12.024.01

PAGE

349 di/of 527

1	32	173	0.92-0.66-1.62e-02	0.27	-0.78	411.48	92.11	112.17	391.43	-77.48		
1	32	174	0.64-1.92	-0.83	-0.45	-1.26	293.26	9.72	83.02	219.97	-124.14	
1	32	175	9.092.39	8.56	2.92	1.80	273.72	-58.19	270.42	-54.88	-32.96	
1	32	176	-1.34-6.43	-5.72	-2.05	1.76	146.68	-276.92	140.54	-270.78	50.62	
1	32	177	1.80-2.60	-2.02	1.22	1.49	662.81	183.39	614.44	231.75	144.39	
1	32	178	3.07-2.59	-2.25	2.74	1.34	799.46	395.31	431.01	763.76	114.69	
1	32	179	3.02-1.15	-0.58	2.45	1.43	1027.73	306.86	310.26	1024.34	49.35	
1	32	180	3.09-0.60	0.59	1.89	1.73	1040.81	249.83	250.02	1040.62	12.12	
1	32	181	2.81-0.71	0.62	1.48	1.70	919.09	210.01	210.01	919.09	0.15	
1	32	182	2.29-0.60	0.48	1.21	1.40	771.77	177.21	177.23	771.75	-3.97	
1	32	183	1.71-0.65	0.17	0.89	1.12	652.21	150.68	150.74	652.15	-5.60	
1	32	184	1.18-0.55	4.88e-02	0.57	0.82	574.13	139.37	139.46	574.04	-6.09	
1	32	185	0.67-0.37-1.33e-03	0.30	0.50	0.50	524.28	141.98	142.12	524.14	-7.27	
1	32	186	0.22-8.76e-027.60e-025.80e-02	0.15	0.15	0.15	471.14	160.17	160.72	470.59	-13.07	
1	32	187	0.62-0.60	0.37	-0.35	-0.49	387.26	204.29	209.55	382.01	-30.56	
1	32	188	1.24-0.86	0.89	-0.51	-0.78	314.29	220.28	297.74	236.83	-35.80	
1	32	189	1.03-0.65	0.80	-0.42	-0.58	340.66	9.64	340.38	9.92	-9.64	
1	32	190	1.01-0.87	0.96	-0.83	-0.29	360.30	-120.49	360.30	-120.49	-0.48	
1	32	191	1.66-3.03	-2.54	1.16	-1.43	625.52	197.71	600.41	222.82	-100.57	
1	32	192	2.55-2.87	-2.87	2.55	-3.68e-02	762.72	394.50	417.92	739.30	-89.87	
1	32	193	2.53-1.39	-1.01	2.15	1.16	1016.45	279.54	284.34	1011.65	-59.30	
1	32	194	2.73-0.71	0.36	1.66	1.59	1040.30	221.42	221.70	1040.03	-15.05	
1	32	195	2.66-0.30	1.04	1.31	1.48	923.05	196.47	196.48	923.03	3.11	
1	32	196	2.20-0.48	0.65	1.07	1.33	773.43	162.11	162.31	773.23	-11.06	
1	32	197	1.75-0.63	0.29	0.83	1.16	651.63	136.56	136.66	651.53	-7.18	
1	32	198	1.29-0.62	0.12	0.55	0.93	572.48	125.88	125.91	572.46	-3.38	
1	32	199	0.92-0.47	0.20	0.26	0.69	522.46	133.09	133.58	521.97	13.91	
1	32	200	0.50-0.53	8.93e-02	-0.13	0.50	473.44	148.55	152.46	469.54	35.40	
1	32	201	1.02-0.64	1.02	-0.63	9.24e-02	400.00	205.97	221.79	384.18	53.10	
1	32	202	1.19-1.11	1.00	-0.92	-0.63	319.16	211.48	290.01	240.63	47.85	
1	32	203	1.14-1.26	0.69	-0.81	-0.94	343.02	19.38	339.41	22.99	34.02	
1	32	204	0.22-1.14-2.04e-02	-0.91	-0.51	-0.51	337.12	-118.10	331.98	-112.96	48.11	
1	32	205	4.81-5.03	-1.95	1.73	-4.56	575.42	-114.14	265.23	196.05	-343.04	
1	32	206	4.06-9.06	-8.72	3.72	-2.09	890.50	47.89	161.05	777.34	-287.31	
1	32	207	4.20-0.69	-0.20	3.71	1.46	1118.72	179.91	195.24	1103.39	-118.98	
1	32	208	3.140.30	1.11	2.34	1.28	1089.52	196.35	196.73	1089.14	-18.45	
1	32	209	2.680.12	1.13	1.67	1.25	936.50	177.62	178.16	935.97	20.20	
1	32	210	2.28-0.28	0.70	1.30	1.25	777.98	148.15	149.01	777.12	23.30	
1	32	211	1.86-0.60	0.31	0.95	1.19	654.14	124.21	124.26	654.09	5.12	
1	32	212	1.43-0.67	0.12	0.64	1.02	577.88	110.15	110.38	577.64	10.56	
1	32	213	1.09-0.60	0.15	0.34	0.84	540.01	103.05	107.56	535.50	44.15	
1	32	214	0.84-0.63	0.23	-1.97e-02	0.72	505.17	93.64	107.39	491.43	73.95	
1	32	215	0.79-0.89	0.54	-0.64	0.60	425.91	78.35	113.38	390.88	104.64	
1	32	216	0.55-1.49	0.29	-1.23	0.68	316.99	27.36	116.70	227.66	133.77	
1	32	217	6.54-1.38	5.24	-7.50e-02	-2.94	188.08	-58.15	183.96	-54.03	31.58	
1	32	218	1.10e-02	-5.18	-2.85	-2.32	-2.58	111.98	-239.28	111.97	-239.26	-2.19
1	32	219	13.44-13.86	11.10	-11.53	7.64	280.48	-624.11	-342.96	-0.67	-418.66	
1	32	220	12.99-5.05	-0.38	8.33	7.90	1095.36	-183.04	-91.28	1003.60	-329.98	
1	32	221	9.581.04	2.98	7.63	3.58	1315.09	137.80	142.11	1310.78	-71.10	
1	32	222	3.841.10	1.84	3.09	1.22	1122.37	176.52	176.53	1122.36	3.08	
1	32	223	3.090.40	1.18	2.31	1.22	945.45	165.55	166.81	944.19	31.36	
1	32	224	2.47-0.31	0.49	1.66	1.26	781.58	135.13	137.90	778.81	42.21	
1	32	225	2.02-0.62	0.24	1.17	1.24	655.76	114.97	115.03	655.70	-5.46	
1	32	226	1.57-0.68	8.57e-02	0.80	1.07	584.71	95.99	97.02	583.68	22.39	
1	32	227	1.22-0.58	9.25e-02	0.55	0.87	555.11	73.98	79.45	549.63	51.04	
1	32	228	0.88-0.68	-0.23	0.43	0.71	527.98	31.52	38.94	520.56	60.25	
1	32	229	0.73-0.51-6.60e-03	0.23	0.61	0.61	447.01	-44.36	-30.12	432.77	82.43	
1	32	230	-2.07-6.59	-3.66	-5.00	2.16	175.06	-272.19	-203.62	106.49	161.14	
1	32	231	-8.03-17.03	-11.85	-13.21	4.45	-165.40	-531.20	-324.05	-372.55	181.28	
1	32	232	13.02-8.01	8.76	-3.75	8.45	-95.23	-557.34	-223.30	-429.27	-206.83	
1	32	233	-0.53-8.37	-8.37	-0.53	4.01e-02	909.35	-0.24	893.52	15.58	-118.92	
1	32	234	22.18-36.00	22.08	-35.90	-2.36	1662.47	-84.27	-78.30	1656.49	102.00	
1	32	235	6.71-3.49	6.56	-3.34	1.23	1326.10	130.95	133.35	1323.70	53.54	
1	32	236	3.771.88	2.44	3.21	0.86	1140.29	188.89	191.30	1137.88	47.78	
1	32	237	3.350.57	1.24	2.68	1.19	943.12	169.35	171.10	941.37	36.79	
1	32	238	2.77-0.38	0.48	1.92	1.40	774.82	139.12	139.18	774.76	5.93	
1	32	239	2.18-0.70	0.18	1.30	1.32	652.98	113.32	113.33	652.97	-1.52	
1	32	240	1.65-0.67	7.73e-02	0.89	1.09	582.86	93.72	93.79	582.79	-5.74	
1	32	241	1.26-0.50	7.74e-02	0.68	0.83	552.70	70.48	70.71	552.47	-10.51	
1	32	242	0.83-0.70	-0.65	0.78	0.27	529.11	7.55	7.56	529.09	2.85	
1	32	243	2.16-0.50	-0.41	2.07	-0.48	441.29	-101.23	-100.54	440.61	-19.29	
1	32	244	14.164.74	4.89	14.01	-1.18	215.81	-304.02	-298.62	210.41	-52.70	
1	32	245	24.865.43	5.68	24.61	2.19	-718.01	-1112.97	-1086.76	-744.22	-98.31	
1	32	246	3.44-0.37	0.75	2.32	-1.73	863.97	287.40	299.14	852.24	-81.41	
1	32	247	4.56-11.63	-3.72	-3.35	-8.10	619.63	-348.37	116.82	154.43	483.63	
1	32	248	21.90-0.47	7.46	13.98	-10.70	1195.70	-7.17	125.05	1063.47	376.25	



EGP CODE

GRE.EEC.R.73.IT.W.15235.12.024.01

PAGE

350 di/of 527

1	32	249	7.532.53	3.41	6.66	-1.90	1301.10	209.56	225.98	1284.68	132.87
1	32	250	3.881.90	2.14	3.63	0.65	1101.45	219.05	221.75	1098.74	48.78
1	32	251	3.530.46	1.35	2.65	1.39	927.20	190.71	191.18	926.72	18.65
1	32	252	2.94-0.49	0.59	1.86	1.59	766.63	149.67	150.01	766.29	14.52
1	32	253	2.29-0.73	0.30	1.26	1.43	645.29	121.64	121.64	645.29	0.25
1	32	254	1.65-0.67	0.13	0.85	1.10	573.39	103.38	103.57	573.20	-9.51
1	32	255	0.94-0.22	0.12	0.60	0.52	539.41	86.78	88.70	537.49	-29.43
1	32	256	0.94-0.23	0.22	0.49	-0.57	514.91	55.32	65.58	504.65	-67.89
1	32	257	1.97-1.52	0.17	0.28	-1.74	446.59	-19.20	12.79	414.61	-117.79
1	32	258	-0.75-9.20	-3.42	-6.52	-3.93	218.03	-265.26	-133.05	85.82	-215.45
1	32	259	-5.11-9.98	-6.41	-8.68	-2.16	40.91	-432.35	-94.14	-297.30	-213.72
1	32	260	8.38-6.95	-1.77	3.20	-7.25	199.64	-352.60	139.65	-292.61	171.84
1	32	261	6.40-7.56	-4.31	3.15	5.90	715.74	-42.06	440.22	233.46	364.52
1	32	262	6.78-7.37	-6.92	6.33	2.48	951.82	207.97	342.08	817.71	285.96
1	32	263	5.170.90	0.90	5.16	-0.16	1115.01	285.50	303.02	1097.49	119.28
1	32	264	3.360.96	1.39	2.93	0.93	1062.78	259.05	261.02	1060.81	39.71
1	32	265	3.430.24	1.54	2.13	1.57	910.79	216.24	217.04	909.99	23.51
1	32	266	3.00-0.46	0.99	1.55	1.71	757.35	168.74	168.98	757.10	11.96
1	32	267	2.29-0.80	0.41	1.08	1.51	636.73	132.67	132.67	636.72	-1.29
1	32	268	1.68-0.62	0.37	0.69	1.14	559.80	121.93	122.19	559.54	-10.74
1	32	269	0.750.18	0.57	0.37	0.27	517.05	125.20	127.68	514.57	-31.09
1	32	270	1.27-0.42	0.81	3.74e-02	-0.75	482.26	131.12	145.83	467.55	-70.36
1	32	271	1.68-1.37	0.90	-0.59	-1.33	421.52	117.18	169.79	368.91	-115.08
1	32	272	2.27-1.34	1.39	-0.45	-1.55	351.43	96.80	217.07	231.16	-127.12
1	32	273	7.231.76e-02	6.35	0.91	2.37	343.54	-19.40	340.84	-16.71	-31.13
1	32	274	-0.70-4.48	-3.03	-2.15	1.84	264.87	-211.73	264.39	-211.25	-15.02
1	32	275	2.40-3.98	-3.12	1.54	2.17	718.99	201.32	683.89	236.41	130.14
1	32	276	3.54-3.35	-2.97	3.16	1.57	780.11	460.38	492.61	747.88	96.25
1	32	277	3.07-1.47	-1.24	2.84	1.00	1005.82	343.88	347.39	1002.30	48.10
1	32	278	2.43-0.71	-0.43	2.15	0.90	1019.83	250.65	250.75	1019.73	9.05
1	32	279	2.230.64	1.26	1.62	0.77	902.88	222.49	222.70	902.67	-11.79
1	32	280	1.750.66	1.15	1.26	0.54	755.36	178.61	179.43	754.54	-21.77
1	32	281	1.140.35	0.58	0.90	0.36	633.70	140.44	141.93	632.22	-27.04
1	32	282	0.620.53	0.60	0.54	3.09e-02	552.82	134.49	136.61	550.71	-29.68
1	32	283	1.173.03e-02	1.03	0.17	-0.37	500.41	155.92	158.57	497.76	-30.08
1	32	284	1.63-0.39	1.51	-0.27	-0.48	448.57	199.33	202.80	445.10	-29.22
1	32	285	1.93-0.77	1.85	-0.69	-0.46	376.90	260.75	269.84	367.81	-31.20
1	32	286	1.72-0.98	1.67	-0.93	-0.39	363.29	236.70	356.97	243.02	-27.56
1	32	287	1.04-0.89	0.99	-0.83	-0.33	412.14	39.23	412.00	39.37	-7.26
1	32	288	1.35-0.88	1.34	-0.87	-0.18	436.20	-97.30	436.18	-97.28	-3.31
1	32	289	1.45-4.46	-4.28	1.27	-1.02	701.83	169.69	638.96	232.57	-171.77
1	32	290	2.76-2.98	-2.97	2.76	0.15	808.29	399.82	464.17	743.94	-148.81
1	32	291	2.51-1.41	-1.33	2.43	0.55	1015.41	309.30	319.46	1005.24	-84.11
1	32	292	2.04-0.68	-0.64	2.01	0.32	1030.88	231.30	232.31	1029.87	-28.34
1	32	293	1.811.10	1.30	1.61	-0.31	912.07	215.34	215.38	912.03	-5.35
1	32	294	1.960.51	1.20	1.26	-0.72	760.04	178.24	178.25	760.04	-1.68
1	32	295	1.58-8.24e-02	0.60	0.89	-0.82	635.13	142.21	142.29	635.05	6.24
1	32	296	1.63-0.49	0.64	0.51	-1.06	552.83	137.24	137.56	552.52	11.51
1	32	297	1.77-0.59	1.09	9.47e-02	-1.07	501.62	157.69	160.23	499.08	29.44
1	32	298	1.77-0.52	1.61	-0.36	-0.58	451.94	196.21	202.35	445.80	39.14
1	32	299	2.03-0.96	2.00	-0.93	-0.30	392.84	238.62	265.75	365.71	58.72
1	32	300	1.96-1.31	1.84	-1.19	-0.62	361.58	217.09	341.80	236.86	49.66
1	32	301	1.49-1.44	1.15	-1.10	-0.93	402.90	32.81	401.83	33.87	19.79
1	32	302	0.61-1.17	0.39	-0.95	-0.59	400.67	-101.68	400.59	-101.60	6.55
1	32	303	4.12-6.77	-4.70	2.06	-4.27	675.58	-129.01	328.78	217.79	-398.45
1	32	304	4.08-7.78	-7.42	3.72	-2.05	961.39	64.68	220.67	805.40	-339.92
1	32	305	4.410.36	0.47	4.30	0.64	1139.90	216.73	242.94	1113.69	-153.32
1	32	306	2.991.63	1.64	2.98	-0.11	1097.08	230.78	234.19	1093.67	-54.24
1	32	307	2.470.37	0.68	2.15	-0.75	934.57	184.74	185.44	933.87	-22.96
1	32	308	2.080.34	0.83	1.59	-0.79	770.54	162.02	162.05	770.50	-4.81
1	32	309	1.60-8.30e-02	0.46	1.06	-0.79	643.91	134.26	134.35	643.82	7.01
1	32	310	1.35-0.33	0.42	0.60	-0.84	564.44	123.52	124.26	563.69	18.10
1	32	311	1.42-0.18	1.07	0.18	-0.67	520.17	135.39	138.53	517.03	34.61
1	32	312	0.92-0.27	0.91	-0.26	-9.86e-02	486.13	123.94	142.17	467.90	79.18
1	32	313	1.11-0.95	1.06	-0.91	0.29	418.39	105.99	160.32	364.06	118.41
1	32	314	1.66-1.77	1.50	-1.61	0.72	336.11	71.13	196.76	210.48	132.31
1	32	315	6.62-1.97	5.18	-0.53	-3.21	255.60	-59.00	252.77	-56.17	29.72
1	32	316	0.75-5.29	-2.19	-2.35	-3.02	203.30	-227.80	203.25	-227.76	4.33
1	32	317	12.67-14.63	10.31	-12.27	7.67	483.38	-604.23	-209.21	88.36	-523.06
1	32	318	15.00-2.36	2.00	10.63	7.53	1146.68	-173.12	-29.16	1002.72	-411.43
1	32	319	10.563.08	4.63	9.01	3.03	1365.62	178.40	190.95	1353.07	-121.42
1	32	320	4.152.69	2.77	4.06	0.35	1147.82	209.93	211.36	1146.39	-36.55
1	32	321	2.900.55	0.55	2.90	5.67e-02	954.71	166.97	167.03	954.65	-6.54
1	32	322	1.990.39	0.39	1.99	2.00e-02	782.17	146.47	146.49	782.16	2.75
1	32	323	1.290.28	0.28	1.29	4.02e-02	654.23	125.88	126.22	653.89	13.44
1	32	324	0.800.12	0.15	0.77	0.16	581.51	103.63	107.32	577.83	41.80





EGP CODE

GRE.EEC.R.73.IT.W.15235.12.024.01

PAGE

351 di/of 527

1	32	325	0.730.21	0.55	0.38	0.25	545.57	92.85	98.88	539.55	51.87
1	32	326	0.66-0.44	1.00e-01	0.12	0.55	518.23	44.02	58.69	503.56	82.10
1	32	327	0.13-1.22	-0.95	-0.13	0.53	431.03	-56.24	-26.80	401.60	116.09
1	32	328	-3.52-6.53	-4.71	-5.34	1.47	178.84	-273.34	-167.77	73.27	191.29
1	32	329	-9.46-18.79	-13.67	-14.58	4.65	-94.15	-473.62	-226.44	-341.33	180.84
1	32	330	11.17-9.28	6.43	-4.54	8.63	-24.58	-444.19	-111.84	-356.93	-170.29
1	32	331	1.76-6.23	-5.72	1.25	-1.95	320.24	-345.86	-55.87	30.25	-330.26
1	32	332	26.87-38.70	26.51	-38.34	-4.86	1803.30	-51.24	-50.71	1802.77	31.34
1	32	333	6.54-3.08	6.50	-3.04	-0.63	1385.97	127.15	127.77	1385.35	27.91
1	32	334	4.172.89	3.37	3.69	0.62	1175.47	205.46	205.69	1175.24	14.97
1	32	335	3.530.64	1.15	3.01	1.10	963.44	174.72	175.17	963.00	18.69
1	32	336	2.64-0.20	0.31	2.12	1.10	786.96	143.12	143.12	786.96	5.25e-02
1	32	337	1.98-0.37	0.23	1.38	1.02	659.21	123.44	123.44	659.20	-1.45
1	32	338	1.44-0.46	0.11	0.87	0.87	584.89	100.20	100.25	584.84	-4.94
1	32	339	1.102.43e-02	0.55	0.57	0.54	550.43	83.92	84.00	550.35	-5.95
1	32	340	0.62-1.37	-1.36	0.61	0.14	522.47	-6.30	-5.90	522.08	14.48
1	32	341	1.94-1.56	-1.48	1.86	-0.53	420.89	-130.64	-130.53	420.79	-7.59
1	32	342	15.753.68	3.85	15.59	-1.39	160.18	-341.05	-339.89	159.02	-24.03
1	32	343	29.096.03	6.03	29.09	0.41	-866.77	-1184.54	-1166.72	-884.59	-73.10
1	32	344	3.13-39.62	-12.44	-24.06	20.57	-355.67	-1256.36	-1256.00	-356.03	17.86
1	32	345	20.08-2.45	17.87	-0.24	-6.70	-276.99	-1065.00	-1064.29	-277.71	-23.76
1	32	346	16.281.26	13.29	4.25	5.99	306.87	-83.90	145.16	77.81	192.46
1	32	347	2.11-0.68	1.96	-0.54	0.62	571.12	0.49	558.69	12.91	83.28
1	32	348	5.561.94	3.69	3.80	-1.81	326.21	-7.72	303.59	14.90	-83.91
1	32	349	0.26-32.77	-5.91	-26.59	12.88	-250.33	-458.81	-447.14	-262.01	47.93
1	32	350	-2.11-32.52	-19.44	-15.19	15.06	-177.55	-687.54	-661.75	-203.33	-111.74
1	32	351	18.57-12.39	15.65	-9.46	-9.06	-166.40	-664.15	-616.77	-213.77	146.07
1	32	352	14.380.13	9.24	5.27	6.84	653.93	-135.99	460.60	57.34	339.62
1	32	353	-0.28-5.01	-4.54	-0.75	1.41	912.66	-33.64	866.82	12.21	203.18
1	32	354	-0.53-8.25	-8.23	-0.55	0.38	1005.56	9.35	1003.26	11.65	47.84
1	32	355	-0.54-9.11	-9.11	-0.54	0.15	997.62	-0.19	990.30	7.14	-85.16
1	32	356	-1.33-9.21	-9.21	-1.33	-7.60e-02	838.15	-48.55	795.02	-5.42	-190.74
1	32	357	7.77-14.27	-2.60	-3.91	-11.00	544.26	-506.17	-62.26	100.34	518.89
1	32	358	25.66-0.68	9.82	15.15	-12.90	1349.03	-39.12	63.82	1246.09	363.74
1	32	359	7.862.59	4.14	6.31	-2.40	1378.55	204.95	215.19	1368.31	109.16
1	32	360	3.701.75	1.90	3.55	0.53	1146.16	204.66	206.51	1144.30	41.74
1	32	361	3.350.52	1.17	2.70	1.19	957.04	186.64	186.81	956.87	11.61
1	32	362	2.65-0.41	0.33	1.91	1.31	785.44	147.99	148.14	785.29	9.74
1	32	363	2.04-0.52	0.25	1.26	1.17	657.47	125.64	125.65	657.46	2.13
1	32	364	1.31-0.36	0.15	0.80	0.77	581.44	106.02	106.13	581.33	-7.20
1	32	365	0.76-0.12	0.12	0.52	0.39	542.87	87.33	87.99	542.20	-17.42
1	32	366	0.72-8.75e-02	0.17	0.46	-0.38	510.24	51.17	56.20	505.22	-47.76
1	32	367	1.83-1.56-7.24e-02	0.34	0.34	-1.68	429.27	-40.06	-18.88	408.10	-97.42
1	32	368	-0.39-12.34	-4.49	-8.25	-5.67	138.42	-352.15	-228.93	15.20	-212.75
1	32	369	-6.38-12.94	-8.45	-10.88	-3.05	-101.61	-593.00	-250.09	-444.52	-225.64
1	32	370	10.11-8.52	-3.16	4.76	-8.43	161.96	-593.29	7.01	-438.34	304.98
1	32	371	8.76-7.49	-2.69	3.96	7.41	753.56	-124.95	370.65	257.96	435.63
1	32	372	8.24-8.87	-8.30	7.66	3.09	1010.35	127.53	272.27	865.61	326.85
1	32	373	5.830.80	0.97	5.65	-0.93	1185.28	257.13	275.48	1166.93	129.22
1	32	374	2.97-0.40	-0.35	2.92	0.42	1110.66	212.06	213.77	1108.95	39.25
1	32	375	2.65-1.19e-02	0.55	2.09	1.09	942.22	193.03	193.25	942.01	12.69
1	32	376	2.49-0.16	0.84	1.49	1.28	779.76	166.43	166.49	779.70	6.33
1	32	377	1.88-0.54	0.34	1.01	1.16	653.04	131.84	131.86	653.03	2.80
1	32	378	1.17-0.30	0.25	0.62	0.71	571.41	118.80	118.83	571.37	-4.06
1	32	379	0.484.74e-02	0.23	0.30	0.22	523.94	115.77	117.08	522.63	-23.08
1	32	380	1.23-0.21	1.06	-3.99e-02	-0.47	478.71	128.05	137.20	469.57	-55.88
1	32	381	1.81-1.40	1.17	-0.76	-1.28	407.03	93.75	144.71	356.08	-115.62
1	32	382	2.55-1.50	1.90	-0.85	-1.49	330.61	47.30	177.13	200.78	-141.16
1	32	383	9.450.28	8.34	1.39	2.99	327.72	-56.91	326.88	-56.07	-17.93
1	32	384	-1.41-7.50	-6.15	-2.76	2.52	180.50	-259.48	179.85	-258.83	16.93
1	32	385	3.12-5.49	-4.02	1.65	3.24	692.58	186.18	624.85	253.91	172.37
1	32	386	4.06-4.07	-3.49	3.48	2.10	831.80	416.51	464.50	783.81	132.77
1	32	387	3.08-2.13	-2.02	2.97	0.76	1047.51	324.45	330.03	1041.94	63.24
1	32	388	2.20-1.37	-1.31	2.14	0.48	1055.33	235.43	235.64	1055.12	12.97
1	32	389	1.59-0.98	-0.84	1.46	0.57	930.86	180.18	180.23	930.81	-6.57
1	32	390	1.570.47	0.94	1.09	0.54	777.49	174.47	174.54	777.41	-6.82
1	32	391	1.100.17	0.52	0.75	0.45	650.09	137.45	137.69	649.85	-10.96
1	32	392	0.450.33	0.35	0.43	4.31e-02	563.46	131.80	132.19	563.06	-13.05
1	32	393	0.99-4.93e-03	0.89	9.10e-02	-0.29	505.46	148.14	148.81	504.79	-15.46
1	32	394	2.10-0.36	2.06	-0.32	-0.33	447.67	198.70	201.01	445.35	-23.89
1	32	395	2.48-0.84	2.42	-0.77	-0.45	369.82	250.57	262.40	357.99	-35.64
1	32	396	2.17-0.98	2.14	-0.94	-0.32	361.25	211.27	349.51	223.01	-40.28
1	32	397	1.84-0.93	1.84	-0.93	-6.17e-03	415.22	14.88	414.46	15.64	-17.38
1	32	398	2.48-1.04	2.47	-1.03	0.21	454.64	-111.34	454.44	-111.14	-10.47
1	32	399	0.82-4.87	-4.86	0.81	0.23	666.31	218.08	630.80	253.59	-121.05
1	32	400	1.74-3.32	-3.28	1.70	0.45	787.01	422.85	452.40	757.46	-99.44



EGP CODE

GRE.EEC.R.73.IT.W.15235.12.024.01

PAGE

352 di/of 527

1	32	401	2.09-2.28	-2.20	2.01	0.58	1022.37	309.54	315.34	1016.57	-64.07
1	32	402	1.63-1.44	-1.39	1.58	0.39	1047.25	224.17	225.52	1045.90	-33.32
1	32	403	1.23-0.11	-0.11	1.23	-4.71e-02	936.04	183.83	185.13	934.75	-31.13
1	32	404	1.200.70	0.95	0.94	-0.25	782.11	168.30	168.63	781.78	-14.23
1	32	405	0.910.29	0.53	0.68	-0.30	652.16	132.94	132.95	652.15	1.88
1	32	406	0.96-0.23	0.36	0.37	-0.60	563.49	132.89	133.00	563.38	6.91
1	32	407	0.97-0.53	0.40	3.67e-02	-0.73	502.58	135.40	135.43	502.55	-3.22
1	32	408	1.42-0.48	1.31	-0.37	-0.44	446.04	179.13	181.89	443.29	26.98
1	32	409	2.62-0.81	2.60	-0.79	-0.26	377.72	249.10	264.58	362.24	41.85
1	32	410	2.44-0.99	2.41	-0.96	-0.33	370.43	219.67	357.63	232.46	42.02
1	32	411	2.20-0.61	2.14	-0.55	-0.41	430.07	29.00	427.67	31.41	30.95
1	32	412	1.96-0.61	1.93	-0.58	-0.27	447.09	-102.21	445.76	-100.88	27.07
1	32	413	1.91-5.64	-4.75	1.03	-2.43	678.83	-80.98	356.53	241.31	-375.51
1	32	414	2.79-4.12	-3.83	2.50	-1.38	950.46	118.44	259.28	809.62	-312.00
1	32	415	2.15-2.63	-2.63	2.15	-3.41e-02	1120.09	146.95	175.34	1091.71	-163.76
1	32	416	1.820.79	0.80	1.81	-0.12	1105.40	187.05	190.82	1101.63	-58.72
1	32	417	1.55-1.06	-0.93	1.42	-0.56	957.31	133.88	134.26	956.93	-17.78
1	32	418	1.41-0.15	1.02e-02	1.24	-0.48	790.77	132.27	132.28	790.76	-1.99
1	32	419	1.050.15	0.31	0.88	-0.35	658.88	118.40	118.48	658.80	6.46
1	32	420	1.00-5.51e-02	0.46	0.48	-0.53	573.83	115.97	116.55	573.26	16.22
1	32	421	1.22-0.29	0.82	0.10	-0.67	521.94	115.65	118.58	519.02	34.35
1	32	422	0.65-0.49	0.37	-0.21	-0.49	473.43	100.40	112.76	461.07	66.77
1	32	423	0.22-0.86	0.20	-0.84	-0.13	403.69	83.37	126.25	360.80	109.07
1	32	424	2.13-1.14	2.12	-1.13	-0.23	327.67	75.63	208.62	194.69	125.83
1	32	425	2.10-1.18	1.91	-0.99	-0.78	272.46	-73.06	254.82	-55.42	76.05
1	32	426	1.63-1.55	1.37	-1.29	-0.87	273.24	-176.99	263.47	-167.22	65.61
1	32	427	8.13-2.95	4.07	1.11	-5.34	619.48	-675.75	-270.04	213.78	-600.73
1	32	428	5.91-13.09	-11.97	4.80	-4.47	1044.36	-337.51	-190.12	896.97	-426.55
1	32	429	4.431.26	1.50	4.18	0.84	1301.46	26.46	40.27	1287.64	-132.00
1	32	430	3.170.30	0.86	2.61	-1.14	1178.29	123.23	123.62	1177.91	-20.09
1	32	431	2.84-1.35	-1.15	2.64	-0.89	975.63	103.20	103.21	975.62	3.04
1	32	432	2.10-0.27	-0.19	2.02	-0.43	795.22	115.24	115.29	795.17	6.15
1	32	433	1.32-1.21e-032.05e-03	1.32	-6.56e-02	-0.27	663.44	104.19	104.30	663.32	8.10
1	32	434	0.839.33e-02	0.21	0.71	-0.27	583.75	90.88	91.13	583.50	11.08
1	32	435	0.89-0.17	0.50	0.22	-0.51	542.53	75.47	76.53	541.48	22.22
1	32	436	1.01-0.16	0.92	-5.68e-02	-0.33	503.48	38.20	46.00	495.68	59.74
1	32	437	0.19-5.64e-038.55e-02	0.10	9.98e-02	403.09	-75.25	-44.09	371.92	118.05	
1	32	438	-1.80-3.17	-3.01	-1.96	0.43	229.78	-251.32	-174.89	153.35	175.87
1	32	439	8.541.77	8.02	2.28	-1.80	-8.13	-198.32	-24.81	-181.64	53.80
1	32	440	-1.07-7.27	-4.36	-3.99	-3.10	-176.12	-456.38	-221.75	-410.75	-103.47
1	32	441	32.36-19.14	20.74	-7.52	21.52	-96.18	-1790.24	-1510.74	-375.69	-628.79
1	32	442	17.36-0.67	12.07	4.63	8.21	1707.95	-290.86	-279.95	1697.04	-147.28
1	32	443	6.931.39	2.47	5.85	-2.19	1460.66	41.50	41.81	1460.35	21.03
1	32	444	6.52-2.92	-2.65	6.26	-1.55	1181.40	57.19	59.12	1179.47	46.55
1	32	445	4.51-1.47	-1.46	4.50	-0.31	971.82	98.54	99.83	970.53	33.61
1	32	446	2.84-0.84	-0.84	2.83	0.12	787.94	101.83	103.06	786.71	29.03
1	32	447	1.81-0.27	-0.18	1.72	0.42	657.63	97.34	97.71	657.25	14.52
1	32	448	0.940.20	0.25	0.90	0.18	583.52	82.15	82.16	583.51	-2.35
1	32	449	0.860.19	0.76	0.30	-0.24	549.98	58.17	58.19	549.95	-3.68
1	32	450	1.35-0.23	1.31	-0.20	-0.23	519.34	5.29	5.29	519.33	-1.82
1	32	451	1.860.12	1.75	0.23	-0.41	423.71	-120.43	-119.44	422.72	23.18
1	32	452	4.46-8.47	-1.73	-2.28	6.46	-16.43	-516.64	-491.49	-41.58	109.31
1	32	453	-13.50-33.81-25.39	-21.91	10.00	-682.77	-1211.55	-1081.97	-812.34	227.44	
1	32	454	25.35-5.18	14.51	5.66	14.61	-389.65	-1789.60	-1032.91	-1146.35	-697.67
1	32	455	54.71-27.06	54.58	-26.93	-3.32	2217.92	401.11	424.11	2194.91	203.15
1	32	456	14.10-1.68	-1.67	14.09	-0.32	1476.13	61.11	67.90	1469.33	97.80
1	32	457	8.490.60	0.60	8.49	7.26e-02	1200.27	146.10	151.50	1194.87	75.25
1	32	458	4.65-1.42	-1.38	4.61	0.50	960.28	117.44	119.40	958.31	40.67
1	32	459	3.10-0.98	-0.89	3.01	0.59	781.41	109.76	110.62	780.56	23.94
1	32	460	1.97-0.54	-0.35	1.78	0.66	651.50	97.29	97.31	651.48	3.19
1	32	461	1.16-5.21e-02	0.18	0.93	0.48	579.57	80.86	81.28	579.15	-14.58
1	32	462	0.690.23	0.66	0.27	0.12	546.75	53.33	54.30	545.77	-21.90
1	32	463	1.23-6.74e-02	1.23	-5.92e-02	-0.10	524.54	-3.35	-0.82	522.02	-36.43
1	32	464	0.10-1.90-3.86e-02	-1.76	-0.52	402.35	-182.07	-179.51	399.79	-38.60	
1	32	465	16.133.44	3.44	16.13	0.14	136.33	-422.28	-414.66	128.70	-64.81
1	32	466	52.20-3.59	-2.95	51.57	5.94	-1130.55	-1507.64	-1413.73	-1224.46	-163.08
1	32	467	14.41-21.38	-2.18	-4.79	-17.85	488.59	-1102.16	-571.18	-42.39	750.14
1	32	468	35.038.73	26.63	17.12	-12.26	1711.53	-128.55	-4.87	1587.84	460.75
1	32	469	10.39-0.40	1.39	8.60	4.01	1474.93	108.06	136.30	1446.69	194.43
1	32	470	8.33-2.91	-2.42	7.84	2.30	1157.24	101.68	110.49	1148.42	96.06
1	32	471	5.25-1.91	-1.63	4.96	1.40	946.18	119.55	123.01	942.72	53.36
1	32	472	3.32-1.21	-0.93	3.04	1.10	767.25	115.15	116.22	766.19	26.31
1	32	473	2.15-0.61	-0.27	1.81	0.91	640.81	105.53	105.53	640.81	-1.72
1	32	474	1.28-0.16	0.18	0.94	0.61	571.27	88.01	89.52	569.76	-26.97
1	32	475	0.770.25	0.67	0.35	0.21	542.01	62.75	67.47	537.28	-47.33
1	32	476	1.19-0.19	1.18	-0.19	-6.42e-02	519.08	8.72	22.37	505.42	-82.34



EGP CODE

GRE.EEC.R.73.IT.W.15235.12.024.01

PAGE

353 di/of 527

1	32	477	1.61-3.94e-02	1.60	-2.75e-02	-0.14	432.01	-116.66	-86.74	402.08	-124.59	
1	32	478	3.05-10.93	-1.86	-6.02	-6.68	86.12	-516.75	-376.36	-54.27	-254.81	
1	32	479	-13.02-19.90-14.97		-17.95	-3.10	-313.73	-967.14	-649.32	-631.54	-326.58	
1	32	480	16.55-12.06	-3.24	7.73	-13.21	104.49	-1000.82	-174.16	-722.17	479.95	
1	32	481	5.43-5.53	-2.54	2.44	4.89	934.53	-586.00	85.96	262.57	755.12	
1	32	482	8.85-6.68	-5.12	7.29	4.66	1206.60	-182.03	106.05	918.52	563.07	
1	32	483	7.131.75	2.71	6.18	2.06	1279.78	125.61	189.85	1215.54	264.60	
1	32	484	6.10-1.15	0.73	4.22	3.18	1108.72	192.92	210.39	1091.26	125.25	
1	32	485	4.49-2.33	-1.37	3.53	2.37	903.02	144.12	149.09	898.05	61.18	
1	32	486	3.16-1.57	-0.81	2.40	1.73	735.20	132.23	132.91	734.53	20.17	
1	32	487	2.21-0.85	-0.12	1.47	1.30	615.42	123.76	123.91	615.27	-8.55	
1	32	488	1.26-0.37	0.11	0.79	0.74	548.06	104.38	108.45	543.99	-42.29	
1	32	489	1.010.24	0.96	0.29	0.19	519.82	97.77	111.62	505.97	-75.17	
1	32	490	1.686.98e-03	1.68	1.04e-02	-7.60e-02	497.03	65.79	103.25	459.57	-121.45	
1	32	491	0.47-0.60-9.84e-02		-3.21e-02	-0.53	423.87	-56.06	29.59	338.22	-183.77	
1	32	492	0.27-1.70	-0.57	-0.86	-0.97	317.48	-164.90	-9.29	161.87	-225.49	
1	32	493	11.721.69	10.33	3.08	3.47	229.40	-131.27	211.54	-113.41	-78.25	
1	32	494	-1.73-10.75	-8.83	-3.65	3.69	51.29	-344.14	51.29	-344.14	1.05	
1	32	495	1.97-5.41	-4.27	0.82	2.67	940.81	-156.71	550.59	233.52	525.36	
1	32	496	3.48-4.15	-3.01	2.34	2.71	1042.93	120.13	405.76	757.31	426.61	
1	32	497	3.39-3.22	-1.93	2.10	2.62	1077.88	216.47	300.78	993.57	255.96	
1	32	498	4.09-1.42	0.67	1.99	2.67	1002.29	253.52	274.81	981.00	124.45	
1	32	499	3.62-1.48	0.47	1.67	2.48	849.89	216.63	220.82	845.70	51.36	
1	32	500	2.72-1.52	-0.14	1.34	1.99	700.90	165.61	165.96	700.55	13.68	
1	32	501	2.08-1.08	0.12	0.87	1.54	588.05	140.98	141.33	587.71	-12.47	
1	32	502	1.26-0.40	0.40	0.46	0.83	519.20	138.73	142.44	515.49	-37.37	
1	32	503	0.38-9.68e-02	0.15	0.14	0.24	484.12	125.81	139.34	470.58	-68.31	
1	32	504	0.21-7.16e-02	0.21	-6.37e-02	4.67e-02	459.55	122.97	160.63	421.88	-106.11	
1	32	505	-0.33-0.87	-0.79	-0.41	-0.18	418.58	103.06	180.49	341.16	-135.77	
1	32	506	3.19-0.55	3.19	-0.55	6.01e-04	409.31	121.77	320.73	210.35	-132.76	
1	32	507	2.16-0.76	2.12	-0.72	0.36	393.39	-18.03	377.51	-2.15	-79.25	
1	32	508	2.00-1.00	1.97	-0.97	0.30	412.02	-137.58	399.44	-125.00	-82.20	
1	32	509	4.88e-02	-5.03	-4.89	-0.10	0.86	881.18	97.39	767.76	210.81	275.74
1	32	510	0.67-3.94	-3.41	0.14	1.47	835.57	380.04	557.39	658.22	222.12	
1	32	511	1.35-3.36	-2.45	0.44	1.86	911.99	365.15	406.63	870.50	144.79	
1	32	512	1.77-2.96	-1.69	0.51	2.10	897.56	291.19	299.15	889.59	69.05	
1	32	513	1.97-2.49	-1.07	0.55	2.08	799.41	222.26	223.33	798.35	24.77	
1	32	514	2.33-1.36	0.50	0.47	1.84	674.82	185.25	185.26	674.82	2.01	
1	32	515	1.85-1.21	0.35	0.30	1.53	568.54	154.98	155.32	568.20	-11.92	
1	32	516	1.03-0.73	0.19	0.11	0.87	497.64	157.77	159.57	495.84	-24.66	
1	32	517	0.59-0.22	0.45	-8.12e-02	0.31	455.44	180.17	186.06	449.55	-39.82	
1	32	518	-0.25-1.41	-1.39	-0.27	0.14	422.28	168.75	180.71	410.32	-53.75	
1	32	519	2.94-0.43	2.94	-0.43	-4.43e-03	403.28	295.21	342.85	355.65	-53.65	
1	32	520	2.78-0.53	2.78	-0.53	-4.09e-02	454.63	246.61	443.07	258.17	-47.66	
1	32	521	1.82-0.14	1.81	-0.14	0.10	506.52	78.39	505.79	79.12	-17.59	
1	32	522	1.20-0.24	1.18	-0.22	0.16	517.87	-65.23	516.76	-64.12	-25.39	
1	32	523	-0.28-5.34	-5.33	-0.29	-0.21	816.65	195.78	816.38	196.05	12.93	
1	32	524	-0.33-3.90	-3.89	-0.34	0.17	620.93	596.60	596.98	620.55	3.01	
1	32	525	0.16-2.89	-2.67	-6.39e-02	0.79	824.24	430.86	431.17	823.93	-11.10	
1	32	526	0.67-2.38	-1.73	9.23e-03	1.26	854.14	312.69	313.83	853.01	-24.74	
1	32	527	1.15-2.09	-0.97	2.60e-02	1.54	779.25	232.80	233.24	778.82	-15.43	
1	32	528	2.16-1.09	1.03	3.85e-02	1.55	667.32	186.38	186.72	666.98	-12.82	
1	32	529	1.77-1.11	0.69	-2.33e-02	1.39	564.63	159.93	160.12	564.45	-8.73	
1	32	530	0.86-0.88	9.67e-02	-0.12	0.86	492.78	159.98	160.03	492.73	-4.06	
1	32	531	0.72-0.42	0.57	-0.27	0.38	448.25	204.44	204.45	448.24	1.68	
1	32	532	0.50-0.44	0.49	-0.43	7.17e-02	415.89	227.47	228.81	414.55	15.84	
1	32	533	2.69-0.47	2.66	-0.45	-0.28	385.20	347.91	364.05	369.06	18.48	
1	32	534	2.40-0.35	2.35	-0.30	-0.37	475.94	274.31	470.21	280.05	33.52	
1	32	535	1.55-0.30	1.48	-0.23	-0.36	535.15	95.80	530.25	100.69	46.11	
1	32	536	0.76-0.22	0.72	-0.18	-0.20	546.01	-50.08	542.18	-46.24	47.66	
1	32	537	0.55-5.92	-5.60	0.22	-1.41	814.34	84.29	708.20	190.43	-257.34	
1	32	538	0.73-4.48	-4.28	0.53	-1.01	802.95	343.93	520.93	625.94	-223.42	
1	32	539	0.53-2.83	-2.83	0.53	-5.92e-02	894.92	315.68	369.06	841.54	-167.54	
1	32	540	0.33-1.76	-1.66	0.23	0.44	893.03	249.75	266.57	876.22	-102.63	
1	32	541	0.35-1.15	-0.90	9.48e-02	0.56	803.44	195.92	200.73	798.63	-53.83	
1	32	542	0.94-0.26	0.64	3.86e-02	0.52	682.41	167.93	168.46	681.87	-16.58	
1	32	543	1.02-0.25	0.80	-2.96e-02	0.48	577.87	147.68	147.82	577.73	7.75	
1	32	544	0.58-0.15	0.56	-0.13	0.11	509.64	150.54	152.71	507.48	27.78	
1	32	545	0.56-0.34	0.52	-0.31	-0.17	472.82	164.06	171.92	464.96	48.63	
1	32	546	2.25-0.57	2.21	-0.54	-0.30	454.58	211.73	236.38	429.93	73.34	
1	32	547	2.47-0.83	2.37	-0.73	-0.57	442.80	250.64	317.42	376.02	91.50	
1	32	548	2.12-0.88	1.94	-0.69	-0.72	470.06	216.47	411.82	274.71	106.66	
1	32	549	1.47-0.69	1.09	-0.31	-0.82	493.85	63.75	470.44	87.15	97.56	
1	32	550	0.93-0.50	0.69	-0.25	-0.54	504.76	-79.00	485.03	-59.28	105.47	
1	32	551	2.82-7.13	-5.59	1.29	-3.59	793.41	-204.11	410.98	178.32	-485.00	
1	32	552	3.26-5.58	-5.14	2.82	-1.93	944.24	40.87	311.49	673.62	-413.80	



EGP CODE

GRE.EEC.R.73.IT.W.15235.12.024.01

PAGE

354 di/of 527

1	32	553	1.91-3.01	-3.01	1.91	-0.17	1028.94	116.07	213.66	931.34	-282.08
1	32	554	1.12-1.61	-1.61	1.12	2.34e-02	987.64	135.09	163.49	959.24	-152.99
1	32	555	0.74-0.95	-0.86	0.66	-0.37	857.86	132.89	140.81	849.94	-75.33
1	32	556	0.81-0.20	0.13	0.48	-0.47	715.42	131.55	133.78	713.20	-36.00
1	32	557	0.884.47e-03	0.58	0.30	-0.42	603.44	120.54	120.58	603.40	-4.32
1	32	558	1.23-0.25	0.87	0.11	-0.64	536.82	124.27	125.81	535.28	25.19
1	32	559	1.76-0.44	1.46	-0.14	-0.75	507.41	128.08	138.06	497.43	60.72
1	32	560	2.06-0.58	1.97	-0.49	-0.46	494.34	128.07	163.71	458.70	108.56
1	32	561	2.19-1.02	2.16	-0.99	-0.29	477.59	107.96	201.15	384.40	160.51
1	32	562	1.71-1.35	1.53	-1.17	-0.72	433.67	62.24	250.60	245.31	185.70
1	32	563	1.31-1.64	0.54	-0.88	-1.29	366.42	-47.76	295.54	23.12	155.99
1	32	564	0.97-1.40	0.66	-1.08	-0.80	365.10	-170.48	312.81	-118.18	158.98
1	32	565	7.30-6.22	-0.62	1.69	-6.66	668.01	-666.11	-141.04	142.94	-651.77
1	32	566	6.89-13.58	-12.78	6.08	-3.98	1018.26	-377.58	-118.58	759.26	-542.62
1	32	567	5.26-1.03	-0.62	4.85	1.55	1186.38	-31.95	34.68	1119.75	-277.02
1	32	568	2.55-1.58	-1.58	2.55	-5.31e-02	1092.18	38.33	53.51	1077.00	-125.56
1	32	569	1.94-1.16	-0.97	1.74	-0.75	911.68	77.91	83.11	906.48	-65.64
1	32	570	1.56-0.32-4.57e-02		1.28	-0.67	748.29	97.40	98.71	746.99	-29.10
1	32	571	1.18-3.69e-02	0.26	0.88	-0.53	631.45	93.64	93.64	631.45	-1.35
1	32	572	1.18-2.82e-02	0.60	0.55	-0.60	567.11	85.42	86.15	566.38	18.75
1	32	573	1.51-8.83e-02	1.16	0.27	-0.67	545.02	73.47	80.54	537.94	57.34
1	32	574	1.76-0.12	1.72	-8.27e-02	-0.25	529.82	38.58	62.29	506.11	105.29
1	32	575	2.19-0.85	2.11	-0.76	0.49	477.51	-50.35	23.53	403.63	183.14
1	32	576	1.29-1.78	0.92	-1.41	1.00	377.72	-195.72	-42.68	224.68	253.65
1	32	577	9.10-1.12	7.42	0.57	-3.79	105.36	-172.67	29.60	-96.91	123.79
1	32	578	-1.47-9.15	-6.64	-3.98	-3.60	-108.82	-359.26	-135.25	-332.82	76.96
1	32	579	21.37-16.97	17.70	-13.29	11.29	137.38	-1298.44	-979.50	-181.57	-596.85
1	32	580	17.99-6.61	1.38	10.01	11.52	1291.94	-567.01	-446.39	1171.32	-457.90
1	32	581	10.861.82	3.85	8.83	3.77	1404.77	-59.12	-46.19	1391.84	-136.97
1	32	582	3.890.56	0.56	3.89	2.89e-02	1143.21	30.51	32.77	1140.94	-50.18
1	32	583	3.16-1.27	-1.14	3.03	-0.75	942.02	53.45	54.22	941.25	-26.09
1	32	584	2.33-0.81	-0.65	2.18	-0.67	768.70	72.83	72.85	768.67	-3.87
1	32	585	1.69-0.16	4.20e-02	1.49	-0.58	649.59	77.18	77.18	649.59	0.81
1	32	586	1.40-3.94e-02	0.35	1.01	-0.64	588.61	60.54	60.65	588.51	7.38
1	32	587	1.603.48e-02	0.89	0.75	-0.78	569.44	33.14	34.32	568.26	25.20
1	32	588	1.670.63	1.55	0.75	-0.34	558.84	-28.67	-22.09	552.26	61.86
1	32	589	1.21-0.69	-0.18	0.70	0.84	488.40	-211.29	-190.94	468.04	117.59
1	32	590	-0.56-10.68	-4.47	-6.76	4.93	152.10	-577.31	-484.38	59.17	243.21
1	32	591	-11.06-22.15-16.08		-17.13	5.52	-356.45	-985.66	-758.83	-583.28	302.11
1	32	592	17.91-9.57	12.66	-4.32	10.81	-361.70	-976.01	-650.14	-687.57	-306.59
1	32	593	31.35-43.96	31.34	-43.94	0.98	1887.25	-377.33	-367.29	1877.21	150.48
1	32	594	9.53-3.33	8.46	-2.25	3.56	1422.93	-59.69	-56.90	1420.14	64.24
1	32	595	4.993.03	3.13	4.89	0.42	1170.04	85.45	85.86	1169.62	21.30
1	32	596	3.86-1.19	-1.18	3.86	-0.18	945.46	59.62	59.63	945.44	3.79
1	32	597	2.71-0.77	-0.77	2.70	-0.13	771.57	75.37	75.55	771.39	-10.97
1	32	598	1.83-0.11-9.48e-02		1.82	-0.15	654.16	75.40	76.19	653.37	-21.36
1	32	599	1.330.12	0.20	1.25	-0.31	595.43	54.94	56.54	593.84	-29.29
1	32	600	1.560.15	0.74	0.97	-0.70	578.73	22.63	24.20	577.16	-29.47
1	32	601	1.990.66	1.53	1.13	-0.63	567.19	-43.32	-42.13	566.00	-26.93
1	32	602	2.68-0.21	-0.18	2.66	-0.27	477.45	-252.96	-251.94	476.42	-27.32
1	32	603	17.516.18	6.26	17.42	-1.00	231.34	-548.26	-543.81	226.89	-58.74
1	32	604	27.357.18	7.98	26.55	3.94	-899.53	-1568.01	-1551.39	-916.15	-104.10
1	32	605	-1.57-9.26	-9.19	-1.64	-0.71	404.44	-151.40	239.14	13.89	-254.08
1	32	606	16.44-53.63	5.04	-42.24	25.85	-459.71	-1568.06	-1567.42	-460.35	-26.60
1	32	607	8.02-9.50	-8.26	6.77	-4.50	546.53	-344.66	379.76	-177.88	347.58
1	32	608	5.48-14.06	-10.86	2.27	-7.23	353.65	78.14	349.06	82.72	-35.24
1	32	609	45.3313.94	34.13	25.14	-15.04	931.37	239.93	271.44	899.86	-144.20
1	32	610	9.37-3.58	-3.55	9.34	-0.63	1137.14	-52.31	-51.93	1136.76	-21.32
1	32	611	7.72-0.46	-0.45	7.71	0.27	948.59	-25.21	-25.09	948.47	10.81
1	32	612	6.707.12e-02-027.61e-02		6.69	-0.18	790.99	-17.18	-16.25	790.05	27.43
1	32	613	5.309.11e-02	0.10	5.29	-0.26	653.27	-14.55	-13.16	651.87	30.45
1	32	614	4.175.05e-02-027.02e-02		4.15	-0.28	559.10	-13.21	-11.55	557.44	30.83
1	32	615	3.379.35e-03-033.78e-02		3.34	-0.31	510.79	-14.50	-13.91	510.20	17.63
1	32	616	2.91-6.66e-03-033.39e-02		2.87	-0.34	498.03	-21.47	-20.73	497.29	19.61
1	32	617	2.73-0.13-7.09e-02		2.67	-0.42	481.54	-37.18	-36.72	481.08	15.39
1	32	618	2.88-0.23-4.21e-03		2.65	-0.80	408.76	-57.52	-57.25	408.50	-11.05
1	32	619	5.72-12.17	1.12	-7.57	-7.82	730.86	-699.00	-107.78	139.64	704.14
1	32	620	24.501.48	9.19	16.79	-10.87	1269.09	-324.73	-83.04	1027.40	571.66
1	32	621	10.074.70	5.16	9.62	-1.50	1371.72	64.51	110.23	1325.99	240.17
1	32	622	5.962.05	2.51	5.50	1.26	1114.98	135.68	147.67	1102.99	107.69
1	32	623	4.37-0.97	-0.53	3.93	1.46	916.23	105.32	109.18	912.37	55.83
1	32	624	3.17-0.86	-0.39	2.69	1.30	751.51	104.15	105.07	750.59	24.39
1	32	625	2.29-0.55-6.48e-02		1.80	1.07	637.51	95.11	95.15	637.47	-4.71
1	32	626	1.47-3.95e-02	0.23	1.21	0.58	580.24	76.84	79.02	578.06	-33.07
1	32	627	0.900.70	0.75	0.85	-8.53e-02	563.63	53.14	60.82	555.96	-62.11
1	32	628	1.670.48	1.46	0.68	-0.45	558.61	-1.20	25.47	531.93	-119.25





EGP CODE

GRE.EEC.R.73.IT.W.15235.12.024.01

PAGE

355 di/of 527

1	32	629	1.07-1.40	-0.83	0.50	-1.03	488.89	-158.98	-106.22	436.12	-177.20	
1	32	630	-2.88-8.08	-4.58	-6.38	-2.44	245.84	-428.11	-269.16	86.89	-286.11	
1	32	631	-8.11-12.71	-9.80	-11.02	-2.22	9.93	-536.15	-214.02	-312.19	-268.59	
1	32	632	10.03-8.80	1.56	-0.33	-9.37	105.09	-315.37	77.14	-287.42	104.74	
1	32	633	5.30-8.91	-5.64	2.03	5.98	822.82	-381.71	264.14	176.96	600.69	
1	32	634	6.89-8.03	-7.34	6.20	3.14	1072.35	-70.06	225.45	776.83	500.27	
1	32	635	6.021.02	1.18	5.85	0.90	1140.66	159.65	240.67	1059.64	270.03	
1	32	636	4.65-0.56	0.46	3.63	2.07	1036.80	188.10	207.89	1017.02	128.06	
1	32	637	4.11-1.71	-0.31	2.71	2.49	868.25	157.17	162.92	862.50	63.68	
1	32	638	3.34-1.57	-0.19	1.96	2.20	718.34	136.74	137.45	717.63	20.35	
1	32	639	2.70-1.25	0.11	1.34	1.87	611.93	121.90	122.10	611.72	-10.13	
1	32	640	1.84-0.60	0.39	0.86	1.20	554.27	111.61	114.86	551.01	-37.81	
1	32	641	1.260.12	0.90	0.48	0.53	535.05	108.74	122.09	521.70	-74.25	
1	32	642	1.540.14	1.52	0.15	0.15	523.00	99.78	136.04	486.74	-118.45	
1	32	643	1.40-0.77	1.11	-0.48	-0.73	483.29	50.26	140.00	393.55	-175.52	
1	32	644	3.03-1.09	2.33	-0.40	-1.54	424.41	23.73	188.04	260.10	-197.07	
1	32	645	7.82-1.33	5.92	0.57	3.71	300.07	-25.62	283.33	-8.88	-71.92	
1	32	646	-0.47-5.79	-3.30	-2.96	2.65	222.42	-240.85	212.27	-230.70	-67.82	
1	32	647	2.50-5.82	-4.46	1.15	3.07	893.39	-52.39	654.14	186.86	411.14	
1	32	648	3.28-4.37	-3.55	2.46	2.36	925.97	222.68	490.84	657.81	341.59	
1	32	649	2.87-2.61	-1.78	2.04	1.97	975.41	277.83	361.46	891.79	226.59	
1	32	650	2.98-2.35	-1.04	1.68	2.29	930.03	241.59	262.68	908.93	118.64	
1	32	651	3.35-1.67	0.36	1.33	2.47	812.82	217.69	221.73	808.78	48.87	
1	32	652	3.00-1.60	0.33	1.06	2.27	685.55	168.58	168.86	685.28	11.88	
1	32	653	2.57-1.42	0.40	0.75	1.99	587.23	147.45	147.83	586.85	-12.81	
1	32	654	1.85-0.82	0.59	0.44	1.33	529.28	147.91	150.99	526.19	-34.14	
1	32	655	1.43-0.26	1.04	0.12	0.71	503.19	164.17	174.29	493.07	-57.70	
1	32	656	1.78-0.32	1.70	-0.23	0.41	487.37	199.43	225.68	461.12	-82.88	
1	32	657	2.11-0.61	2.11	-0.60	4.79e-02	462.91	236.11	294.86	404.17	-99.36	
1	32	658	1.72-0.86	1.70	-0.84	0.24	433.69	232.30	373.58	292.40	-92.15	
1	32	659	0.76-1.18	0.50	-0.92	0.66	451.82	80.22	442.92	89.13	-56.83	
1	32	660	0.54-0.86	0.49	-0.81	0.26	480.34	-75.96	473.12	-68.74	-62.97	
1	32	661	0.36-5.23	-5.04	0.17	1.01	841.27	134.98	796.75	179.49	171.63	
1	32	662	0.84-3.83	-3.44	0.46	1.29	735.45	463.50	597.07	601.88	135.95	
1	32	663	1.17-2.63	-2.04	0.58	1.37	824.08	415.91	432.81	807.18	81.31	
1	32	664	1.37-2.06	-1.19	0.49	1.50	842.12	309.66	311.91	839.87	34.54	
1	32	665	1.93-1.07	0.41	0.46	1.50	769.34	240.74	240.74	769.34	-1.37	
1	32	666	2.52-1.06	1.05	0.42	1.76	664.76	191.74	192.35	664.15	-16.90	
1	32	667	2.43-1.50	0.62	0.31	1.96	572.88	162.46	162.89	572.45	-13.37	
1	32	668	1.90-1.03	0.73	0.13	1.43	514.61	171.60	172.75	513.46	-19.88	
1	32	669	1.58-0.45	1.24	-0.11	0.76	486.88	203.89	208.94	481.82	-37.48	
1	32	670	1.81-0.42	1.77	-0.38	0.30	462.55	261.90	265.85	458.60	-27.86	
1	32	671	1.96-0.62	1.96	-0.62	3.45e-02	430.31	343.32	356.20	417.43	-30.90	
1	32	672	1.50-0.68	1.50	-0.68	4.08e-02	459.77	323.75	459.17	324.36	-9.08	
1	32	673	0.43-0.39	0.39	-0.36	0.17	533.58	132.82	532.43	133.97	21.43	
1	32	674	-0.18-0.43	-0.32	-0.28	0.12	558.58	-30.13	557.78	-29.32	21.78	
1	32	675	6.64e-02	-5.48	-5.45	3.81e-02	-0.39	814.00	129.79	775.61	168.18	-157.46
1	32	676	0.22-3.84	-3.84	0.22	-7.29e-02	715.74	446.96	578.01	584.68	-134.34	
1	32	677	0.26-2.23	-2.22	0.25	0.14	812.08	389.72	411.86	789.93	-94.14	
1	32	678	0.16-1.17	-1.17	0.16	3.26e-02	832.06	292.65	296.54	828.16	-45.68	
1	32	679	0.430.13	0.37	0.19	-0.12	763.73	230.27	230.45	763.56	-9.54	
1	32	680	1.050.19	1.02	0.22	0.15	663.28	186.61	187.19	662.71	16.60	
1	32	681	0.91-0.11	0.63	0.17	0.46	576.44	157.30	159.85	573.88	32.59	
1	32	682	0.773.04e-02	0.76	4.59e-02	0.11	522.59	165.37	170.20	517.76	41.24	
1	32	683	1.28-0.23	1.20	-0.15	-0.34	497.20	198.46	205.49	490.17	45.28	
1	32	684	1.60-0.55	1.45	-0.41	-0.54	481.95	245.70	256.30	471.35	48.91	
1	32	685	1.81-0.77	1.66	-0.62	-0.60	460.70	320.58	348.95	432.33	56.30	
1	32	686	1.26-0.78	1.11	-0.63	-0.53	461.56	323.72	447.67	337.61	41.49	
1	32	687	0.29-0.68-6.62e-02	-0.33	-0.47	515.73	141.28	513.75	143.26	27.12		
1	32	688	-0.19-0.97	-0.89	-0.26	-0.23	537.27	-26.04	536.15	-24.91	25.13	
1	32	689	1.06-6.40	-5.88	0.54	-1.89	777.93	-45.51	581.02	151.40	-351.24	
1	32	690	1.55-4.46	-4.34	1.43	-0.85	833.95	199.09	431.71	601.32	-305.89	
1	32	691	0.96-2.29	-2.21	0.89	-0.50	916.61	222.82	302.60	836.83	-221.33	
1	32	692	0.96-1.41	-1.13	0.68	-0.77	899.31	200.23	225.17	874.37	-129.66	
1	32	693	1.52-0.59	0.33	0.60	-1.05	800.71	192.82	200.47	793.06	-67.78	
1	32	694	1.62-0.51	0.59	0.52	-1.07	682.51	161.13	162.58	681.06	-27.44	
1	32	695	1.44-0.58	0.47	0.38	-1.01	590.14	141.75	141.75	590.14	0.28	
1	32	696	1.59-0.83	0.56	0.21	-1.20	538.46	142.85	144.11	537.20	22.28	
1	32	697	1.78-0.88	0.90	1.73e-03	-1.25	520.61	157.09	162.74	514.95	44.98	
1	32	698	1.64-0.67	1.23	-0.26	-0.88	515.41	184.47	203.09	496.80	76.24	
1	32	699	1.52-0.77	1.38	-0.62	-0.55	503.38	209.71	264.06	449.03	114.05	
1	32	700	1.11-1.01	0.88	-0.78	-0.66	475.62	192.46	334.20	333.88	141.58	
1	32	701	0.36-1.54	-0.59	-0.60	-0.95	448.17	61.98	392.43	117.72	135.72	
1	32	702	-0.48-1.24	-1.08	-0.65	-0.31	449.52	-96.81	408.80	-56.09	143.49	
1	32	703	1.63-7.67	-6.20	0.16	-3.40	629.83	-367.11	160.96	101.76	-497.59	
1	32	704	3.66-8.16	-7.75	3.25	-2.16	907.49	-135.59	112.58	659.32	-444.15	





EGP CODE

GRE.EEC.R.73.IT.W.15235.12.024.01

PAGE

356 di/of 527

1	32	705	3.28-0.84	-0.84	3.28	-0.13	1043.03	67.81	145.96	964.88	-264.78
1	32	706	2.55-0.27-4.14e-02		2.32	-0.77	985.62	135.89	155.87	965.64	-128.76
1	32	707	2.21-0.91	-0.33	1.63	-1.21	847.48	131.23	138.91	839.81	-73.76
1	32	708	1.83-0.78	-0.15	1.19	-1.12	711.35	123.89	125.52	709.72	-30.87
1	32	709	1.53-0.54	0.16	0.83	-0.98	614.48	116.14	116.14	614.48	-0.48
1	32	710	1.53-0.67	0.31	0.56	-1.09	566.50	107.41	108.86	565.05	25.75
1	32	711	1.57-0.61	0.60	0.35	-1.08	557.79	104.74	111.05	551.48	53.11
1	32	712	1.29-0.21	0.91	0.17	-0.66	561.96	91.41	113.71	539.66	99.98
1	32	713	1.14-0.15	1.12	-0.13	0.16	540.45	51.54	117.07	474.92	166.56
1	32	714	1.49-1.30	0.65	-0.46	1.28	484.32	-31.85	114.92	337.55	232.84
1	32	715	5.44-1.69	3.89	-0.14	-2.95	275.98	-76.46	162.10	37.43	164.83
1	32	716	-0.65-5.70	-4.19	-2.15	-2.31	159.88	-263.02	94.02	-197.16	153.35
1	32	717	11.90-14.36	10.72	-13.17	5.44	312.08	-820.12	-450.80	-57.24	-530.80
1	32	718	10.87-5.19	-1.47	7.15	6.77	1002.91	-467.77	-271.05	806.19	-500.61
1	32	719	9.261.75	2.51	8.50	2.26	1228.97	-14.54	20.20	1194.23	-204.93
1	32	720	4.020.58	0.60	4.00	-0.29	1049.09	77.67	84.49	1042.27	-81.13
1	32	721	3.03-0.45	-0.19	2.78	-0.91	884.25	98.75	102.16	880.83	-51.71
1	32	722	2.25-0.76	-0.41	1.90	-0.97	737.01	98.68	99.19	736.50	-18.05
1	32	723	1.72-0.56	-0.15	1.31	-0.88	637.09	93.48	93.48	637.09	0.83
1	32	724	1.62-0.62	5.95e-02	0.94	-1.03	591.73	79.49	79.90	591.32	14.55
1	32	725	1.65-0.54	0.34	0.77	-1.07	589.06	57.76	59.73	587.08	32.34
1	32	726	1.180.30	0.70	0.78	-0.44	600.89	9.11	19.45	590.56	77.52
1	32	727	1.05-0.34	-0.18	0.88	0.44	570.28	-124.11	-89.54	535.71	151.02
1	32	728	-1.96-4.30	-3.60	-2.66	1.07	376.14	-383.97	-271.04	263.20	270.35
1	32	729	-7.83-13.78	-11.72	-9.90	2.83	35.57	-630.59	-370.58	-224.44	324.97
1	32	730	12.54-10.78	9.94	-8.17	7.34	-250.25	-357.96	-251.65	-356.55	-12.24
1	32	731	-1.81-9.56	-6.25	-5.12	-3.84	162.55	-181.29	-168.44	149.70	-65.21
1	32	732	25.84-32.82	25.50	-32.49	-4.42	1521.92	-431.01	-430.28	1521.19	37.85
1	32	733	6.66-0.63	6.63	-0.60	-0.50	1268.15	-63.21	-62.89	1267.84	20.50
1	32	734	4.071.68	1.73	4.03	0.33	1079.91	69.00	69.01	1079.90	3.54
1	32	735	3.14-0.70	-0.70	3.13	0.17	897.48	78.46	78.51	897.44	5.96
1	32	736	2.22-0.58	-0.56	2.20	-0.22	747.81	88.03	88.32	747.53	-13.72
1	32	737	1.71-0.46	-0.29	1.53	-0.59	648.38	82.38	83.14	647.62	-20.75
1	32	738	1.75-0.67-7.01e-02		1.15	-1.05	605.18	65.29	66.47	604.00	-25.21
1	32	739	1.98-0.71	0.22	1.05	-1.28	606.54	35.91	37.30	605.16	-28.09
1	32	740	1.878.01e-02	0.65	1.29	-0.83	619.37	-24.80	-23.82	618.39	-25.02
1	32	741	2.58-6.88e-02-1.20e-02		2.52	-0.38	569.25	-193.73	-193.60	569.12	-9.82
1	32	742	13.366.00	6.01	13.35	-0.23	390.15	-459.41	-459.19	389.94	-13.63
1	32	743	14.5110.13	10.78	13.85	1.57	-501.31	-1366.61	-1363.57	-504.35	-51.14
1	32	744	7.11-5.82	2.23	-0.93	6.27	188.05	-158.97	154.05	-124.97	-103.16
1	32	745	27.8410.49	11.60	26.73	-4.25	-99.02	-566.67	-330.87	-334.82	-233.82
1	32	746	-2.59-13.77	-6.75	-9.62	-5.40	-80.12	-268.58	-267.95	-80.75	-10.82
1	32	747	14.05-7.96	8.97	-2.88	9.28	90.73	-138.60	-90.59	42.72	93.30
1	32	748	11.83-5.85	5.37	0.62	8.52	311.38	-640.73	43.63	-372.98	-428.07
1	32	749	37.1212.67	23.49	26.30	12.14	1075.34	169.15	291.03	953.46	309.18
1	32	750	15.660.61	1.94	14.33	4.26	1415.79	22.81	48.89	1389.71	188.81
1	32	751	2.41-0.67	-0.64	2.38	0.28	1211.70	23.15	31.84	1203.01	101.23
1	32	752	1.09-0.32	-0.32	1.08	-7.00e-02	1008.22	23.58	25.28	1006.52	40.89
1	32	753	0.40-0.25	-0.25	0.40	9.49e-03	815.62	16.69	16.74	815.57	6.06
1	32	754	-0.13-0.28	-0.20	-0.21	7.55e-02	672.23	12.29	12.65	671.87	-15.40
1	32	755	-0.15-0.72	-0.18	-0.69	0.12	582.22	5.37	8.61	578.98	-43.08
1	32	756	-0.13-0.97	-0.16	-0.94	0.16	524.73	-2.85	2.70	519.19	-53.79
1	32	757	5.45-12.25	-2.31	-4.50	-8.78	286.18	-739.86	-366.51	-87.17	493.64
1	32	758	21.39-2.53	7.29	11.56	-11.77	1176.10	-362.11	-211.47	1025.46	457.18
1	32	759	5.801.58	1.82	5.57	-0.96	1233.35	-9.71	18.20	1205.44	184.16
1	32	760	3.83-0.15	1.75e-02	3.66	0.79	1046.68	74.78	78.85	1042.60	62.79
1	32	761	3.01-0.96	-0.70	2.75	0.98	884.15	97.41	98.11	883.46	23.39
1	32	762	2.17-0.74	-0.54	1.96	0.74	740.30	99.77	99.80	740.27	-4.22
1	32	763	1.40-0.29	-0.27	1.39	0.15	645.87	87.49	91.16	642.20	-45.09
1	32	764	1.20-0.19-4.95e-02		1.05	-0.42	605.14	70.52	77.59	598.07	-61.07
1	32	765	1.36-0.16	0.25	0.95	-0.67	603.92	48.93	56.99	595.86	-66.39
1	32	766	1.92-0.21	0.60	1.11	-1.03	613.10	1.19	13.21	601.07	-84.95
1	32	767	2.28-1.16	-0.19	1.30	-1.55	576.56	-127.57	-103.79	552.78	-127.20
1	32	768	5.16e-02	-8.62	-3.28	-5.28	-4.22	332.34	-430.49	-333.53	235.39
1	32	769	-6.14-6.83	-6.82	-6.16	0.10	-12.48	-691.59	-421.09	-282.98	-332.46
1	32	770	7.80-5.61	0.74	1.45	-6.69	-115.09	-538.77	-198.04	-455.82	168.12
1	32	771	5.74-8.46	-4.63	1.91	6.30	671.83	-396.30	146.97	128.55	533.99
1	32	772	8.05-8.65	-8.07	7.48	3.05	952.22	-94.05	148.72	709.45	441.66
1	32	773	4.73-0.19	-0.18	4.72	-0.24	1070.80	107.35	166.22	1011.93	230.77
1	32	774	2.76-0.98	-0.75	2.53	0.90	992.34	139.91	152.27	979.99	101.88
1	32	775	2.32-0.64	-0.19	1.87	1.06	849.75	146.21	148.54	847.42	40.47
1	32	776	1.76-0.58	-0.19	1.37	0.87	718.96	129.63	129.63	718.96	0.38
1	32	777	1.03-0.13-9.36e-02		0.99	0.21	627.83	112.28	113.44	626.66	-24.46
1	32	778	0.87-3.76e-029.10e-02		0.74	-0.32	584.97	101.69	105.87	580.80	-44.72
1	32	779	0.830.17	0.41	0.60	-0.32	581.54	94.47	105.11	570.90	-71.21
1	32	780	1.23-4.15e-02	0.70	0.49	-0.63	584.52	77.99	101.01	561.50	-105.52

-254.09



EGP CODE

GRE.EEC.R.73.IT.W.15235.12.024.01

PAGE

357 di/of 527

1	32	781	1.76-0.75	0.83	0.18	-1.21	551.24	33.27	90.04	494.47	-161.81	
1	32	782	2.13-0.48	0.97	0.68	-1.30	474.28	-33.25	85.49	355.54	-214.85	
1	32	783	7.951.19	6.55	2.59	2.74	286.59	-16.66	217.65	52.28	-127.10	
1	32	784	-1.99-7.46	-7.26	-2.18	1.01	119.41	-253.68	84.57	-218.85	-108.54	
1	32	785	3.00-5.31	-3.52	1.20	3.43	798.60	-39.57	596.44	162.59	358.57	
1	32	786	3.54-4.48	-3.64	2.70	2.46	853.67	227.43	451.32	629.78	300.14	
1	32	787	2.39-2.56	-2.21	2.03	1.28	929.80	262.95	325.38	867.37	194.25	
1	32	788	1.49-1.46	-1.28	1.31	0.70	906.16	224.84	236.72	894.28	89.18	
1	32	789	1.02-0.59	-0.48	0.90	0.41	806.69	191.56	192.44	805.81	23.29	
1	32	790	0.730.14	0.17	0.71	0.11	695.06	161.72	162.03	694.75	-12.73	
1	32	791	0.78-0.15	0.11	0.52	-0.42	612.63	135.53	139.96	608.20	-45.76	
1	32	792	1.17-0.66	0.16	0.35	-0.91	570.00	128.45	137.75	560.70	-63.42	
1	32	793	1.22-0.71	0.33	0.18	-0.96	553.47	143.34	153.23	543.57	-62.92	
1	32	794	1.16-0.33	0.85	-2.32e-02	-0.60	549.98	173.66	193.32	528.32	-87.63	
1	32	795	1.02-0.40	0.89	-0.27	-0.42	518.47	211.99	250.84	479.61	-101.97	
1	32	796	1.15-0.35	1.12	-0.32	-0.20	468.68	228.78	338.63	358.83	-119.52	
1	32	797	0.40-8.39e-02	0.40	-8.12e-02	-3.62e-02	440.81	96.17	408.25	128.73	-100.81	
1	32	798	0.89-0.69	0.81	-0.61	-0.35	474.38	-75.00	451.74	-52.37	-109.19	
1	32	799	0.57-4.88	-4.48	0.17	1.42	799.13	135.59	765.54	169.17	145.46	
1	32	800	1.08-4.22	-3.68	0.54	1.60	700.61	458.92	567.79	591.74	120.25	
1	32	801	0.91-2.64	-2.37	0.63	0.95	815.46	397.48	409.89	803.05	70.95	
1	32	802	0.46-1.42	-1.39	0.43	0.24	844.11	292.36	293.44	843.03	24.41	
1	32	803	0.35-0.49	-0.46	0.32	-0.15	778.79	220.71	220.73	778.77	-3.31	
1	32	804	0.74-3.62e-02	0.45	0.26	-0.38	680.80	184.78	185.13	680.46	-13.11	
1	32	805	0.77-0.38	0.21	0.18	-0.57	598.58	157.47	158.37	597.67	-19.96	
1	32	806	1.12-0.78	0.27	6.83e-02	-0.94	551.46	160.41	162.22	549.66	-26.52	
1	32	807	1.26-1.18	0.17	-8.93e-02	-1.21	533.66	182.44	185.66	530.44	-33.51	
1	32	808	0.83-1.03	8.80e-02	-0.29	-0.91	521.95	230.28	234.35	517.87	-34.23	
1	32	809	1.06-0.61	0.93	-0.48	-0.44	485.55	331.44	337.56	479.42	-30.11	
1	32	810	0.82-0.53	0.79	-0.49	-0.22	446.51	372.35	441.79	377.07	-18.10	
1	32	811	7.23e-02	-0.31	3.05e-02	-0.27	-0.12	524.03	169.57	523.90	169.70	6.77
1	32	812	-0.25-0.51	-0.48	-0.28	-8.41e-02	560.32	-11.74	560.30	-11.73	2.63	
1	32	813	-0.23-5.58	-5.57	-0.24	0.23	783.67	117.73	736.73	164.67	-170.46	
1	32	814	5.61e-02	-3.82	-3.77	1.10e-02	0.42	716.92	422.91	549.63	590.19	-145.60
1	32	815	0.14-2.41	-2.40	0.14	0.14	821.69	376.50	395.77	802.42	-90.59	
1	32	816	0.19-1.50	-1.45	0.14	-0.28	848.96	281.35	286.75	843.55	-55.12	
1	32	817	0.66-0.26	0.23	0.18	-0.46	782.09	233.57	235.11	780.54	-29.07	
1	32	818	0.76-0.37	0.22	0.18	-0.57	683.05	187.03	187.19	682.89	-8.81	
1	32	819	0.75-0.49	0.14	0.11	-0.62	600.52	162.27	162.30	600.49	3.68	
1	32	820	0.91-0.76	0.15	4.51e-04	-0.83	553.64	164.90	165.23	553.31	11.37	
1	32	821	0.69-1.23	-0.39	-0.15	-0.96	536.72	177.51	178.44	535.79	18.26	
1	32	822	0.30-1.41	-0.78	-0.34	-0.83	527.31	215.81	218.32	524.80	27.87	
1	32	823	1.25-0.72	1.04	-0.51	-0.61	501.45	322.38	337.33	486.50	49.53	
1	32	824	0.70-0.68	0.57	-0.55	-0.41	457.67	357.81	433.21	382.27	42.94	
1	32	825	-1.32e-02	-0.79	-0.48	-0.33	-0.38	512.11	169.43	509.08	172.46	32.09
1	32	826	-0.22-1.29	-1.22	-0.29	-0.25	541.24	-12.38	539.51	-10.65	30.83	
1	32	827	0.11-5.75	-5.61	-2.09e-02	-0.87	745.24	-77.13	514.34	153.78	-369.56	
1	32	828	0.86-4.08	-3.96	0.75	-0.74	846.08	166.28	387.55	624.81	-318.53	
1	32	829	0.72-2.65	-2.50	0.58	-0.68	932.31	218.96	286.02	865.25	-208.18	
1	32	830	1.05-0.83	-0.45	0.67	-0.76	916.90	232.39	250.65	898.64	-110.30	
1	32	831	1.11-0.71	-0.22	0.62	-0.81	817.57	202.99	208.13	812.43	-55.96	
1	32	832	0.99-0.60	-0.13	0.53	-0.72	703.07	173.88	174.79	702.16	-22.02	
1	32	833	0.81-0.51-4.35e-02	0.34	-0.64	-0.64	616.36	153.11	153.11	616.36	1.42	
1	32	834	0.84-0.59	0.11	0.15	-0.72	572.05	152.53	153.56	571.02	20.81	
1	32	835	0.68-0.75-4.94e-02	-1.91e-02	-0.72	-0.72	563.09	156.33	160.91	558.50	42.96	
1	32	836	0.37-0.62-9.47e-02	-0.15	-0.49	-0.49	564.99	172.18	187.28	549.89	75.52	
1	32	837	-0.33-1.43	-1.34	-0.42	-0.29	546.78	165.30	208.01	504.08	120.28	
1	32	838	0.86-0.66	0.77	-0.58	-0.35	493.92	198.98	316.84	376.06	144.47	
1	32	839	0.17-0.98	-0.42	-0.39	-0.58	436.82	69.06	373.37	132.51	138.96	
1	32	840	-0.55-1.21	-1.06	-0.71	-0.28	437.93	-96.13	395.22	-53.41	144.88	
1	32	841	1.26-1.60	-0.20	-0.14	-1.43	594.66	-425.12	57.89	111.66	-509.18	
1	32	842	4.07-8.65	-7.53	2.95	-3.60	915.66	-166.07	55.87	693.72	-436.83	
1	32	843	2.93-0.83	-0.71	2.81	-0.67	1066.10	95.45	152.56	1008.99	-228.42	
1	32	844	2.68-1.04	-0.56	2.20	-1.25	998.40	170.79	186.74	982.45	-113.78	
1	32	845	2.04-1.17	-0.88	1.75	-0.92	860.32	162.92	168.18	855.07	-60.32	
1	32	846	1.45-0.81	-0.56	1.21	-0.70	730.82	149.62	150.73	729.71	-25.45	
1	32	847	1.02-0.51	-0.25	0.76	-0.57	639.57	138.47	138.47	639.57	0.80	
1	32	848	0.83-0.50	-0.12	0.45	-0.60	597.25	129.39	130.64	596.00	24.09	
1	32	849	0.68-0.49-6.93e-02	0.26	-0.56	-0.56	596.29	123.40	128.91	590.78	50.75	
1	32	850	0.41-0.22-1.58e-02	0.20	-0.29	-0.29	608.16	106.84	123.35	591.65	89.47	
1	32	851	0.41-0.52	-0.51	0.40	9.73e-02	584.93	43.64	89.56	539.01	150.82	
1	32	852	-7.68e-03	-1.57	-1.33	-0.25	0.57	494.61	-60.00	45.86	388.75	217.96
1	32	853	3.900.87	3.51	1.26	-1.01	265.14	-97.74	109.68	57.71	179.57	
1	32	854	-1.10-5.53	-4.40	-2.24	-1.93	66.43	-265.77	12.76	-212.10	122.26	
1	32	855	19.13-10.94	14.85	-6.66	10.50	-66.47	-1060.01	-827.17	-299.32	-420.86	
1	32	856	8.11-0.97	3.82	3.32	4.53	1148.88	-259.51	-168.42	1057.79	-346.41	



EGP CODE

GRE.EEC.R.73.IT.W.15235.12.024.01

PAGE

358 di/of 527

1	32	857	7.53-0.84	-0.48	7.16	-1.70	1192.74	64.14	82.30	1174.58	-142.00
1	32	858	4.73-2.52	-2.42	4.64	-0.81	1036.88	114.56	121.45	1029.99	-79.40
1	32	859	3.02-1.55	-1.50	2.98	-0.47	891.83	131.26	134.06	889.03	-46.03
1	32	860	1.89-1.01	-0.95	1.83	-0.43	756.21	129.11	129.72	755.60	-19.55
1	32	861	1.27-0.52	-0.41	1.16	-0.42	661.81	122.95	122.95	661.81	2.26
1	32	862	0.98-0.52	-0.29	0.75	-0.54	619.73	109.43	110.24	618.92	20.29
1	32	863	0.92-0.39-3.05e-02		0.56	-0.58	620.46	98.46	100.99	617.93	36.24
1	32	864	0.81-0.21 5.51e-02		0.55	-0.44	635.74	67.31	73.64	629.41	59.66
1	32	865	1.11-0.17-8.35e-02		1.02	-0.33	607.33	-20.05	-5.12	592.39	95.64
1	32	866	2.87-4.01	-0.92	-0.22	3.43	395.16	-265.19	-207.42	337.39	186.57
1	32	867	-10.77-16.35-14.63		-12.49	2.57	-29.08	-759.41	-570.16	-218.33	320.00
1	32	868	17.37-3.63 14.90		-1.16	6.76	-388.14	-805.21	-550.52	-642.83	-203.37
1	32	869	34.10-10.84 34.04		-10.78	-1.54	1464.59	181.04	181.71	1463.91	-29.39
1	32	870	10.96-3.14 -2.47		10.29	2.99	1208.51	71.31	73.29	1206.53	-47.34
1	32	871	5.53-0.59	-0.56	5.50	0.43	1059.91	140.22	144.04	1056.09	-59.14
1	32	872	3.04-1.45	-1.45	3.04	-3.13e-02	902.96	129.35	131.49	900.81	-40.65
1	32	873	2.01-0.98	-0.97	1.99	-0.21	767.87	121.73	122.00	767.60	-13.23
1	32	874	1.34-0.50	-0.45	1.28	-0.32	672.25	115.06	115.07	672.24	2.68
1	32	875	1.05-0.41	-0.22	0.86	-0.49	629.10	103.36	103.81	628.66	15.30
1	32	876	1.00-0.42-6.11e-02		0.65	-0.62	627.91	90.17	91.39	626.70	25.55
1	32	877	1.13-0.28	0.11	0.74	-0.63	641.63	61.34	62.57	640.39	26.73
1	32	878	0.65-0.35	-0.11	0.41	-0.43	596.25	-38.54	-36.74	594.45	33.72
1	32	879	12.740.78	1.42	12.10	-2.69	455.89	-204.49	-204.04	455.43	17.35
1	32	880	23.249.54	9.58	23.20	0.76	-363.05	-881.72	-881.71	-363.06	1.21
1	32	881	7.68-21.21 -11.61		-1.92	-13.61	-68.82	-698.71	-465.06	-302.46	304.27
1	32	882	19.240.82	15.15	4.91	-7.65	1231.04	-151.88	-133.15	1212.31	159.82
1	32	883	5.14-3.43	-1.02	2.72	3.85	1171.33	88.92	89.16	1171.08	16.32
1	32	884	5.13-2.52	-2.10	4.72	1.73	1048.10	104.94	106.33	1046.71	-36.17
1	32	885	3.24-1.29	-1.18	3.12	0.71	910.97	129.35	130.81	909.51	-33.78
1	32	886	2.03-0.78	-0.77	2.02	0.19	774.82	121.94	122.45	774.31	-18.21
1	32	887	1.36-0.47	-0.44	1.34	-0.21	678.87	112.11	112.14	678.83	4.25
1	32	888	1.05-0.45	-0.32	0.92	-0.42	634.67	99.98	100.32	634.33	13.48
1	32	889	0.95-0.25-3.54e-02		0.74	-0.46	631.65	91.02	91.04	631.63	3.04
1	32	890	0.96-0.55	-0.33	0.74	-0.53	639.33	57.69	57.95	639.07	12.22
1	32	891	1.893.49e-02 0.39		1.53	-0.73	602.85	-4.75	-4.75	602.85	-7.09e-02
1	32	892	4.45-7.57	-1.42	-1.70	-6.01	340.81	-248.19	-231.87	324.49	-96.67
1	32	893	-5.13-7.62	-5.18	-7.58	0.34	-34.86	-671.42	-535.43	-170.85	-260.91
1	32	894	6.82-9.93	-8.99	5.88	-3.85	-111.51	-958.18	-338.77	-730.93	375.19
1	32	895	3.84-7.52	-5.84	2.17	4.03	431.85	-162.00	126.72	143.13	296.81
1	32	896	7.15-5.27	-4.96	6.84	1.93	813.50	25.95	97.52	741.92	226.37
1	32	897	3.530.54	0.60	3.47	0.41	1075.82	119.42	122.26	1072.98	51.99
1	32	898	3.39-1.27	-0.39	2.51	1.82	1042.63	136.05	136.08	1042.59	-5.73
1	32	899	2.92-1.04	-0.46	2.34	1.40	916.11	131.38	131.51	915.97	-10.31
1	32	900	2.03-0.86	-0.62	1.78	0.80	785.50	116.96	117.08	785.38	-9.03
1	32	901	1.36-0.41	-0.36	1.31	0.30	689.20	107.26	107.56	688.90	-13.18
1	32	902	0.97-0.24	-0.24	0.97	4.56e-03	641.46	97.92	98.10	641.28	-9.83
1	32	903	0.78-0.16	-0.13	0.76	-0.14	631.69	90.04	90.04	631.69	0.58
1	32	904	0.83-0.45	-0.36	0.74	-0.32	623.53	68.63	68.76	623.39	-8.60
1	32	905	1.51-0.60 3.70e-02		0.87	-0.97	561.69	42.23	46.21	557.72	-45.27
1	32	906	0.71-1.61	-0.99	8.85e-02	-1.02	424.11	-31.85	-6.46	398.72	-104.57
1	32	907	6.713.63	6.30	4.04	1.05	201.45	28.69	173.89	56.26	-63.26
1	32	908	-1.18-7.23	-7.22	-1.18	-0.11	79.13	-211.87	77.80	-210.54	19.60
1	32	909	1.73-4.60	-4.41	1.53	1.11	402.63	110.33	351.35	161.61	111.17
1	32	910	3.78-4.44	-4.19	3.52	1.43	701.47	225.86	240.43	686.90	81.95
1	32	911	2.93-2.17	-1.88	2.65	1.17	979.60	163.05	163.72	978.93	23.36
1	32	912	2.62-0.33	0.32	1.97	1.22	1021.01	158.10	158.17	1020.94	7.86
1	32	913	2.35-0.53	0.11	1.71	1.20	917.58	140.80	140.80	917.58	5.03e-02
1	32	914	1.93-0.51-8.42e-02		1.50	0.93	788.69	124.11	124.12	788.68	-2.63
1	32	915	1.50-0.53	-0.25	1.22	0.70	691.76	107.32	107.33	691.74	-2.91
1	32	916	1.09-0.40	-0.25	0.94	0.44	642.24	97.54	97.58	642.20	-4.30
1	32	917	0.75-3.62e-024.85e-03		0.71	0.18	627.30	98.14	98.18	627.26	-4.54
1	32	918	0.50-0.35	-0.34	0.50	-7.78e-02	609.79	92.77	92.85	609.72	-6.21
1	32	919	0.44-0.53-7.59e-02		-1.71e-02	-0.48	543.60	110.13	110.50	543.23	-12.57
1	32	920	1.69-0.49	1.33	-0.14	-0.80	381.62	189.97	191.41	380.18	-16.52
1	32	921	1.04-0.80 6.49e-02		0.18	-0.92	247.61	100.12	247.47	100.25	-4.46
1	32	922	0.55-0.90	0.36	-0.71	-0.49	282.31	-86.84	282.31	-86.84	6.11e-02
1	32	923	1.11-3.27	-2.31	0.14	-1.81	290.77	87.10	261.35	116.52	-71.60
1	32	924	2.57-6.31	-6.31	2.57	0.10	674.93	122.04	135.42	661.54	-84.98
1	32	925	3.14-1.51	-1.15	2.77	1.25	992.51	132.09	132.97	991.63	-27.43
1	32	926	2.68-0.17	0.25	2.25	1.01	1027.16	147.07	147.30	1026.93	14.24
1	32	927	2.243.44e-02 0.50		1.78	0.90	916.44	144.38	144.97	915.84	21.38
1	32	928	1.86-0.23	0.15	1.49	0.81	785.66	129.24	129.27	785.63	4.33
1	32	929	1.48-0.47	-0.20	1.21	0.67	688.97	109.87	109.87	688.97	-1.29
1	32	930	1.13-0.36	-0.18	0.95	0.49	640.57	100.41	100.47	640.51	-5.75
1	32	931	0.83-0.21	-0.10	0.73	0.31	628.58	96.54	96.54	628.58	-0.75
1	32	932	0.52-0.22	-0.17	0.48	0.18	617.94	88.81	89.29	617.46	15.89



EGP CODE

GRE.EEC.R.73.IT.W.15235.12.024.01

PAGE

359 di/of 527

1	32	933	0.19-7.41e-02-2.20e-02	0.13	0.10	555.15	94.32	97.02	552.44	35.18		
1	32	934	0.93-0.49	0.71	-0.26	0.52	407.53	116.63	130.91	393.25	62.85	
1	32	935	3.93-0.97	2.78	0.18	-2.08	195.95	76.18	193.35	78.77	17.44	
1	32	936	-0.81-2.61	-2.20	-1.22	-0.76	169.19	-149.50	167.44	-147.75	23.55	
1	32	937	9.65-10.77	9.39	-10.50	2.31	56.64	-326.36	-227.15	-42.56	-167.79	
1	32	938	5.11-5.21	-3.09	2.99	4.17	757.32	-183.13	-132.77	706.95	-211.73	
1	32	939	7.111.88e-02	1.29	5.83	2.72	1112.98	77.14	77.18	1112.94	-6.68	
1	32	940	3.180.48	0.83	2.83	0.91	1039.44	125.40	127.22	1037.62	40.73	
1	32	941	2.490.15	0.46	2.18	0.80	909.82	140.09	142.62	907.29	44.02	
1	32	942	1.96-0.33-3.41e-02		1.66	0.77	775.53	132.07	132.76	774.85	20.98	
1	32	943	1.55-0.46	-0.19	1.28	0.68	679.72	118.53	118.53	679.71	1.93	
1	32	944	1.22-0.37	-0.16	1.00	0.54	635.05	107.11	107.28	634.88	-9.46	
1	32	945	0.99-0.20-3.44e-02		0.83	0.41	631.25	96.00	96.08	631.18	-6.33	
1	32	946	0.86-0.30	-0.20	0.76	0.31	636.88	60.38	60.38	636.88	0.56	
1	32	947	0.82-0.25	-0.19	0.75	0.26	590.66	-4.51	-3.25	589.40	27.38	
1	32	948	-1.52-2.77	-2.76	-1.53	9.43e-02	380.02	-155.02	-133.47	358.47	105.19	
1	32	949	-5.12-9.62	-8.12	-6.62	2.13	19.54	-311.97	-181.40	-111.03	161.98	
1	32	950	9.45-8.37	7.14	-6.06	5.99	-77.29	-327.05	-123.28	-281.06	-96.81	
1	32	951	-7.25e-02	-0.93	-0.12	-0.88	0.20	459.67	-19.28	-9.33	449.72	-68.31
1	32	952	18.61-21.70	17.84	-20.94	-5.51	1275.11	-233.56	-208.59	1250.15	192.45	
1	32	953	4.473.74e-02	4.47	3.75e-02	-2.08e-02	1151.84	35.97	57.26	1130.55	152.66	
1	32	954	3.410.90	1.28	3.03	0.90	1028.63	138.30	151.36	1015.57	107.02	
1	32	955	2.85-6.41e-02	0.41	2.38	1.07	881.30	158.82	165.57	874.55	69.52	
1	32	956	2.16-0.41	1.73e-02	1.73	0.96	747.91	156.56	158.45	746.02	33.40	
1	32	957	1.61-0.51	-0.17	1.27	0.78	656.33	142.72	142.75	656.30	4.24	
1	32	958	1.24-0.38	-0.15	1.02	0.56	617.36	129.51	130.27	616.59	-19.29	
1	32	959	1.05-0.36	-0.26	0.95	0.35	622.00	106.86	110.35	618.51	-42.25	
1	32	960	1.15-0.61	-0.59	1.13	0.17	639.11	51.88	58.01	632.98	-59.69	
1	32	961	1.98-0.30	-0.30	1.98	-2.33e-02	608.85	-57.37	-46.03	597.51	-86.17	
1	32	962	9.314.18	4.21	9.27	0.39	464.80	-260.54	-246.38	450.65	-100.34	
1	32	963	11.535.52	8.66	8.39	3.00	-214.65	-1023.63	-999.56	-238.72	-137.45	
1	32	964	-9.31e-02	-1.89	-0.66	-1.32	0.84	317.65	-45.62	-30.45	302.48	-72.66
1	32	965	-2.75-16.37	-7.77	-11.35	6.57	-96.52	-133.32	-105.85	-123.99	-16.01	
1	32	966	-12.00-20.99-15.34		-17.65	4.34	50.44	-488.85	34.41	-472.81	91.59	
1	32	967	27.174.28	5.55	25.90	5.24	-118.50	-429.29	-282.17	-265.62	155.17	
1	32	968	-13.68-43.49-31.97		-25.21	14.52	164.24	-230.36	-136.67	70.55	167.90	
1	32	969	12.59-2.33	11.78	-1.52	3.37	-200.77	-696.60	-333.96	-563.42	-219.77	
1	32	970	17.28-12.23	10.14	-5.08	12.64	70.00	-843.10	-558.88	-214.23	-422.78	
1	32	971	7.570.77	4.20	4.14	3.40	1024.44	-76.93	27.93	919.58	-323.26	
1	32	972	7.321.08	1.56	6.84	-1.67	1027.84	76.73	103.31	1001.26	-156.76	
1	32	973	6.15-0.71	6.20e-02	5.38	-2.17	895.05	98.80	105.73	888.12	-73.96	
1	32	974	4.89-0.12	0.27	4.50	-1.34	760.37	89.65	90.88	759.14	-28.69	
1	32	975	3.80-5.73e-02	0.26	3.49	-1.05	633.61	74.64	74.64	633.60	1.27	
1	32	976	3.02-2.68e-02	0.21	2.79	-0.81	547.03	63.70	64.98	545.75	24.84	
1	32	977	5.13-12.25	-6.41	-0.72	-8.21	459.08	-542.08	-28.23	-54.77	500.41	
1	32	978	17.82-0.95	6.96	9.92	-9.27	1106.69	-198.94	26.96	880.79	493.87	
1	32	979	4.640.94	0.96	4.61	0.31	1136.15	94.98	165.49	1065.65	261.60	
1	32	980	3.580.26	0.76	3.08	1.19	989.69	182.67	209.41	962.95	144.44	
1	32	981	2.89-0.35	0.37	2.17	1.35	850.71	196.41	207.98	839.14	86.23	
1	32	982	2.18-0.45	0.19	1.54	1.13	721.80	188.96	192.09	718.68	40.67	
1	32	983	1.58-0.53-7.37e-02		1.13	0.87	633.42	171.79	171.84	633.37	4.77	
1	32	984	1.17-0.41	-0.15	0.91	0.59	597.06	157.46	159.03	595.48	-26.27	
1	32	985	0.95-0.47	-0.40	0.88	0.31	603.34	136.01	143.41	595.95	-58.32	
1	32	986	1.07-0.61	-0.59	1.06	-0.15	627.50	90.31	112.08	605.73	-105.93	
1	32	987	1.75-0.58	-0.15	1.32	-0.90	621.08	5.28	55.28	571.08	-168.20	
1	32	988	0.81-5.90	-2.25	-2.84	-3.34	474.95	-256.17	-110.94	329.72	-291.69	
1	32	989	-2.08-4.95	-4.65	-2.38	0.89	226.28	-538.67	-188.66	-123.73	-381.10	
1	32	990	3.44-2.36	-0.75	1.83	-2.60	-6.96	-338.15	-7.11	-337.99	-7.16	
1	32	991	4.15-7.11	-5.04	2.08	4.37	798.37	-282.57	399.51	116.29	521.59	
1	32	992	6.97-5.68	-4.98	6.27	2.88	964.29	30.39	350.34	644.33	443.21	
1	32	993	3.91-2.26e-025.02e-02		3.84	0.53	1005.39	220.30	320.01	905.67	261.42	
1	32	994	2.90-0.23	0.55	2.11	1.36	927.44	268.14	305.29	890.29	152.03	
1	32	995	2.53-0.44	0.56	1.52	1.40	800.94	260.09	273.67	787.36	84.62	
1	32	996	1.67-0.27	0.31	1.09	0.89	683.55	238.23	240.94	680.85	34.62	
1	32	997	0.894.96e-02	0.13	0.81	0.24	602.86	219.01	219.44	602.44	-12.75	
1	32	998	0.66-3.71e-02-3.70e-02		0.66	-6.56e-03	570.47	203.61	209.57	564.51	-46.39	
1	32	999	0.62-0.21	-0.21	0.62	-6.29e-02	574.56	194.58	209.71	559.43	-74.30	
1	32	1000	0.85-0.62	-0.40	0.64	-0.52	596.21	172.92	211.77	557.35	-122.22	
1	32	1001	1.47-0.89-4.45e-03		0.58	-1.14	599.07	129.11	220.14	508.04	-185.72	
1	32	1002	2.38-0.44	0.77	1.17	-1.39	573.38	52.43	238.76	387.05	-249.70	
1	32	1003	5.631.57	5.00	2.19	1.47	469.00	-15.53	346.16	107.31	-210.78	
1	32	1004	-0.93-5.30	-5.10	-1.13	0.91	332.77	-237.98	248.89	-154.10	-202.08	
1	32	1005	1.91-4.60	-3.38	0.69	2.54	898.91	-37.26	724.76	136.88	364.29	
1	32	1006	2.67-3.69	-2.79	1.78	2.22	882.82	268.36	583.11	568.07	307.14	
1	32	1007	2.09-1.92	-1.20	1.37	1.54	893.97	357.17	468.44	782.70	217.60	
1	32	1008	1.75-0.45	0.37	0.94	1.06	842.77	365.40	396.02	812.15	116.96	





EGP CODE

GRE.EEC.R.73.IT.W.15235.12.024.01

PAGE

360 di/of 527

1	32	1009	1.312.25e-02	0.64	0.69	0.64	749.15	330.07	338.72	740.49	59.61	
1	32	1010	0.630.44	0.50	0.58	8.50e-02	647.86	292.66	292.92	647.60	9.68	
1	32	1011	0.99-0.16	0.35	0.47	-0.57	577.56	267.52	270.54	574.54	-30.44	
1	32	1012	1.09-0.51	0.19	0.39	-0.80	547.57	254.86	266.87	535.56	-58.06	
1	32	1013	0.99-0.64	2.88e-02	0.32	-0.80	543.76	261.55	281.06	524.25	-71.60	
1	32	1014	0.90-0.81	-0.13	0.23	-0.84	562.46	269.63	315.89	516.21	-106.79	
1	32	1015	0.95-0.60	0.26	9.15e-02	-0.77	569.81	284.19	375.88	478.13	-133.35	
1	32	1016	0.88-0.33	0.57	-2.24e-02	-0.52	579.26	243.14	454.78	367.62	-162.31	
1	32	1017	0.31-0.28-7.08e-02		9.99e-02	-0.28	576.05	82.56	512.09	146.51	-165.74	
1	32	1018	0.18-0.60-1.50e-02		-0.41	-0.34	598.72	-90.89	545.07	-37.24	-184.71	
1	32	1019	0.15-4.56	-4.26	-0.15	1.15	890.69	113.75	867.05	137.39	133.45	
1	32	1020	0.70-3.13	-2.45	2.56e-02	1.46	757.72	474.89	699.92	532.69	114.04	
1	32	1021	0.72-1.67	-1.02	7.06e-02	1.07	760.64	521.59	556.89	725.33	84.81	
1	32	1022	0.51-0.27	0.15	8.49e-02	0.39	771.92	445.63	454.08	763.46	51.83	
1	32	1023	0.770.12	0.73	0.17	-0.16	711.57	380.99	382.82	709.74	24.52	
1	32	1024	0.99-0.11	0.68	0.20	-0.50	626.52	334.48	335.36	625.64	16.02	
1	32	1025	1.20-0.40	0.54	0.27	-0.79	556.66	312.51	313.00	556.17	10.98	
1	32	1026	1.33-0.70	0.37	0.26	-1.01	516.48	314.00	314.14	516.33	-5.33	
1	32	1027	1.36-0.98	0.21	0.18	-1.17	508.60	332.07	338.98	501.70	-34.23	
1	32	1028	1.15-1.07	4.05e-02	3.44e-02	-1.11	522.86	358.86	388.95	492.77	-63.48	
1	32	1029	0.89-0.74	0.23	-8.14e-02	-0.80	538.39	388.90	466.37	460.92	-74.69	
1	32	1030	0.45-0.57	1.69e-02	-0.14	-0.50	590.83	326.36	550.06	367.13	-95.50	
1	32	1031	4.92e-02	-0.81	-0.71	-5.39e-02	-0.28	626.22	153.24	612.70	166.76	-78.83
1	32	1032	-0.17-1.30	-1.28	-0.19	-0.14	653.88	-27.01	639.27	-12.41	-98.65	
1	32	1033	-0.30-5.21	-5.17	-0.34	0.41	874.73	123.84	860.94	137.63	-100.83	
1	32	1034	-0.29-2.70	-2.59	-0.40	0.51	732.35	497.06	698.42	530.98	-82.65	
1	32	1035	-0.22-0.73	-0.67	-0.28	0.16	736.89	550.59	565.75	721.72	-50.94	
1	32	1036	0.72-0.18	0.60	-6.31e-02	-0.30	760.63	468.61	470.15	759.09	-21.11	
1	32	1037	1.19-0.18	0.83	0.18	-0.60	705.62	395.26	395.26	705.61	0.29	
1	32	1038	1.37-0.28	0.77	0.33	-0.79	621.73	352.38	352.68	621.42	9.04	
1	32	1039	1.44-0.43	0.62	0.40	-0.93	550.77	332.14	332.56	550.34	9.66	
1	32	1040	1.43-0.60	0.45	0.38	-1.01	510.15	334.96	335.35	509.76	8.26	
1	32	1041	1.32-0.73	0.29	0.29	-1.02	494.84	361.37	361.60	494.61	5.53	
1	32	1042	1.11-0.86	9.68e-02	0.15	-0.98	484.52	408.81	408.82	484.52	0.56	
1	32	1043	0.74-0.93	-0.18	-1.69e-02	-0.83	479.46	445.90	475.74	449.62	-10.54	
1	32	1044	0.23-0.97	-0.59	-0.15	-0.56	557.41	353.30	555.97	354.73	-17.07	
1	32	1045	3.32e-02	-1.36	-1.23	-9.72e-02	-0.41	623.81	154.97	621.06	157.72	-35.82
1	32	1046	-0.12-1.92	-1.88	-0.16	-0.25	644.92	-19.02	642.72	-16.82	-38.19	
1	32	1047	-0.14-5.17	-5.15	-0.15	-0.31	799.61	17.58	684.12	133.07	-277.45	
1	32	1048	0.42-2.63	-2.55	0.34	-0.50	803.23	327.74	568.55	562.42	-237.73	
1	32	1049	0.79-0.78	-0.33	0.34	-0.71	830.69	412.17	474.66	768.20	-149.16	
1	32	1050	1.71-0.24	0.84	0.63	-0.97	808.00	404.48	416.73	795.76	-69.22	
1	32	1051	1.96-0.31	0.82	0.82	-1.14	724.71	362.85	364.42	723.14	-23.80	
1	32	1052	1.92-0.25	0.71	0.96	-1.08	628.72	329.53	329.53	628.71	-0.94	
1	32	1053	1.76-0.27	0.57	0.92	-1.00	554.19	311.91	312.84	553.26	14.98	
1	32	1054	1.57-0.37	0.42	0.78	-0.96	513.69	312.55	314.60	511.64	20.21	
1	32	1055	1.32-0.45	0.27	0.60	-0.87	502.37	329.17	334.17	497.36	29.00	
1	32	1056	1.00-0.48	9.05e-02	0.43	-0.72	502.18	352.38	369.20	485.35	47.30	
1	32	1057	0.49-0.59	-0.23	0.13	-0.51	489.97	361.56	412.28	439.24	62.78	
1	32	1058	3.27e-02	-0.86	-0.69	-0.14	-0.35	497.11	297.32	468.62	325.81	69.86
1	32	1059	-6.80e-02	-1.38	-1.29	-0.16	-0.33	528.62	102.84	523.04	108.42	48.43
1	32	1060	-0.39-1.65	-1.59	-0.46	-0.28	545.62	-61.18	541.61	-57.18	49.13	
1	32	1061	1.22-1.03	-0.79	0.97	-0.70	640.27	-236.29	291.23	112.76	-429.10	
1	32	1062	3.49-7.24	-6.08	2.33	-3.33	840.38	25.04	243.32	622.11	-361.01	
1	32	1063	3.150.57	1.03	2.68	-0.99	927.15	257.60	312.35	872.40	-183.46	
1	32	1064	0.74-3.56	-2.28	-0.55	1.97	816.58	-41.58	752.88	22.12	224.95	
1	32	1065	3.25-0.31	0.57	2.37	-1.53	750.41	269.98	272.30	748.09	-33.32	
1	32	1066	2.77-0.16	0.50	2.12	-1.22	637.53	246.75	246.76	637.52	-2.28	
1	32	1067	2.28-0.10	0.40	1.78	-0.97	557.06	232.31	233.43	555.94	19.04	
1	32	1068	1.87-0.14	0.29	1.44	-0.83	515.20	231.46	233.41	513.25	23.44	
1	32	1069	1.49-0.19	0.17	1.13	-0.69	509.34	235.35	243.52	501.17	46.60	
1	32	1070	1.12-0.22	1.21e-03	0.90	-0.50	512.58	237.21	257.82	491.97	72.46	
1	32	1071	0.86-0.34	-0.30	0.83	-0.20	482.54	217.06	263.99	435.61	101.27	
1	32	1072	0.33-1.71	-1.64	0.26	0.38	407.16	138.24	248.91	296.50	132.34	
1	32	1073	1.951.23	1.87	1.31	0.22	328.40	6.58	302.29	32.68	87.86	
1	32	1074	0.39-3.44	-2.09	-0.96	-1.83	218.88	-181.52	218.27	-180.92	15.61	
1	32	1076	16.24-41.16	11.27	-36.19	-16.14	-224.19	-803.84	-703.17	-324.86	219.59	
1	32	1077	20.764.35	14.48	10.63	7.98	746.25	-231.89	405.37	108.99	466.08	
1	32	1078	0.26-7.79	-7.21	-0.31	2.08	856.15	-46.47	767.84	41.83	268.15	
1	32	1079	-0.47-8.18	-8.16	-0.50	0.43	977.78	14.13	963.45	28.46	116.62	
1	32	1080	-0.45-8.21	-8.21	-0.45	-0.21	951.13	9.91	938.19	22.86	-109.62	
1	32	1081	-0.12-7.30	-7.03	-0.39	-1.36	766.56	-41.98	703.67	20.91	-216.55	
1	32	1082	2.41-2.62e-02	0.15	2.23	-0.63	503.52	61.89	63.82	501.59	29.09	
1	32	1083	1.90-7.60e-025.24e-02		1.78	-0.49	496.97	59.62	66.56	490.03	54.65	
1	32	1084	1.57-0.13-3.52e-02		1.48	-0.39	497.55	53.76	67.93	483.38	78.04	
1	32	1085	1.62-0.68	-0.67	1.61	-0.17	454.26	18.00	39.93	432.33	95.32	





EGP CODE

GRE.EEC.R.73.IT.W.15235.12.024.01

PAGE

361 di/of 527

1	32	1086	2.03-3.23	-1.50	0.30	2.47	260.98	-97.51	-43.19	206.66	128.54	
1	32	1087	-6.23-17.73	-14.13	-9.83	5.34	-116.22	-523.21	-351.82	-287.61	200.95	
1	32	1088	10.581.83	5.53	6.88	-4.32	488.15	-247.91	200.08	40.15	-359.24	
1	32	1089	22.88-9.40	22.82	-9.34	1.43	1188.37	96.57	114.30	1170.63	-138.00	
1	32	1090	7.521.06	1.30	7.27	-1.24	1026.58	-57.05	-33.82	1003.35	-156.95	
1	32	1091	7.82-7.01e-029.09e-02		7.66	-1.12	920.09	-32.53	-25.84	913.40	-79.56	
1	32	1092	5.42-8.15e-025.81e-02		5.28	-0.86	756.09	-43.99	-42.50	754.61	-34.45	
1	32	1093	4.26-3.65e-028.77e-02		4.14	-0.72	624.99	-53.35	-53.35	624.98	-1.81	
1	32	1094	3.387.36e-048.43e-02		3.29	-0.52	534.75	-60.50	-59.55	533.80	23.71	
1	32	1095	2.692.23e-026.49e-02		2.65	-0.33	490.45	-62.38	-60.53	488.60	31.96	
1	32	1096	2.181.83e-023.05e-02		2.17	-0.16	484.08	-65.54	-58.83	477.37	60.37	
1	32	1097	1.79-3.36e-02-2.58e-02		1.78	-0.12	482.75	-72.82	-59.68	469.61	84.43	
1	32	1098	1.64-0.34	-0.25	1.55	-0.42	424.88	-100.56	-81.36	405.68	98.59	
1	32	1099	8.211.29	1.35	8.15	-0.64	226.43	-148.07	-138.63	216.99	58.71	
1	32	1100	12.981.02	1.61	12.40	2.59	-288.81	-563.39	-551.91	-300.29	-54.96	
1	32	1101	-5.52-29.58	-5.57	-29.54	-1.00	730.09	-116.14	-62.71	676.66	205.81	
1	32	1102	4.91-68.97	4.54	-68.60	-5.19	1478.59	-222.69	-220.79	1476.69	56.86	
1	32	1103	-8.64-38.09	-8.86	-37.86	-2.57	1185.82	-609.57	-607.22	1183.47	64.94	
1	32	1104	-6.54-45.19	-8.66	-43.07	-8.79	1309.02	-577.96	-577.93	1308.99	6.85	
1	32	1105	7.57-96.71	7.50	-96.64	2.67	2044.18	-209.78	-206.63	2041.04	84.11	
1	32	1106	-7.60-46.70	-7.94	-46.37	3.62	1528.91	-932.66	-926.32	1522.57	124.77	
1	32	1107	-4.84-35.72	-7.73	-32.83	-9.00	1231.40	-1045.58	-1045.57	1231.39	5.27	
1	32	1108	6.84-57.00	5.19	-55.35	-10.15	1239.16	-394.23	-394.07	1239.00	16.23	
1	32	1109	-5.96-23.14	-6.55	-22.55	-3.12	892.53	-796.76	-794.55	890.33	60.94	
1	32	1110	-5.04-29.54	-5.13	-29.45	-1.44	720.29	-205.69	-196.19	710.79	-93.33	
1	32	1111	36.1714.69	18.79	32.07	-8.44	371.82	-8.29	369.34	-5.81	30.55	
1	32	1112	-0.48-4.58	-0.58	-4.48	-0.64	667.03	-189.39	657.37	-179.72	90.46	
1	32	1113	0.29-0.43	0.29	-0.42	5.78e-02	611.16	-149.84	604.26	-142.94	72.12	
1	32	1114	0.67-2.26	-0.85	-0.74	-1.46	438.14	-143.13	438.13	-143.13	2.31	
1	32	1115	-5.65-8.37	-6.93	-7.08	-1.36	74.19	-259.73	72.01	-257.56	-26.86	
1	32	1116	28.404.38	4.44	28.33	1.21	158.33	-612.05	-608.33	154.61	-53.38	
1	32	1117	41.0918.76	22.07	37.79	-7.93	150.09	-495.05	-491.77	146.81	45.87	
1	32	1118	-1.21-4.79	-1.65	-4.36	-1.17	230.37	-228.62	220.05	-218.31	68.04	
1	32	1119	-0.45-1.82	-1.18	-1.09	0.68	378.75	-145.47	371.29	-138.01	62.08	
1	32	1120	0.29-1.97	-0.80	-0.89	-1.13	351.20	-150.07	350.92	-149.80	11.75	
1	32	1121	-4.83-8.55	-7.52	-5.85	-1.66	134.19	-196.77	125.07	-187.66	-54.16	
1	32	1122	18.456.51	6.66	18.29	-1.36	-129.87	-473.10	-366.88	-236.09	-158.67	
1	32	1123	-0.41-7.67	-7.63	-0.44	0.47	920.08	11.79	911.47	20.40	88.02	
1	32	1124	29.3815.96	16.71	28.63	-3.08	-75.03	-249.47	-163.73	-160.77	87.21	
1	32	1125	-5.34-6.31	-6.27	-5.37	0.18	333.79	-162.74	328.66	-157.60	50.24	
1	32	1126	0.44-1.60	-0.30	-0.86	0.98	459.34	-144.85	455.33	-140.84	49.05	
1	32	1127	0.37-1.78	-0.79	-0.62	-1.07	410.82	-151.42	408.33	-148.93	-37.34	
1	32	1128	-4.33-7.55	-6.10	-5.78	-1.60	267.93	-186.33	256.56	-174.96	-70.95	
1	32	1129	19.466.63	6.68	19.40	-0.84	-103.43	-446.17	-218.42	-331.19	-161.83	
1	32	1130	5.03-46.02	-2.82	-38.17	18.41	-379.58	-820.69	-811.95	-388.32	-61.49	
1	32	1131	36.9715.01	16.26	35.72	-5.09	-8.42	-401.11	-364.19	-45.34	114.61	
1	32	1132	-6.87-10.04	-9.85	-7.06	0.75	263.40	-211.58	251.39	-199.57	74.57	
1	32	1133	-0.49-4.81	-4.09	-1.21	1.61	400.41	-153.10	394.02	-146.71	59.12	
1	32	1134	0.54-0.94	0.51	-0.91	-0.21	438.15	-156.41	437.87	-156.14	12.82	
1	32	1135	-0.53-6.11	-5.16	-1.47	-2.09	175.57	-176.76	155.42	-156.61	-81.81	
1	32	1136	-9.52-16.99	-16.02	-10.48	-2.51	-192.20	-446.58	-287.39	-351.40	-123.10	
1	32	1137	42.273.20	4.17	41.30	6.10	424.80	-869.53	-865.15	420.41	-75.22	
1	32	1138	50.2821.54	22.96	48.86	-6.24	103.67	-609.77	-595.44	89.35	100.07	
1	32	1139	-4.42-8.25	-6.84	-5.84	-1.85	176.63	-255.24	152.49	-231.10	99.20	
1	32	1140	1.87-1.45	1.10	-0.68	1.40	461.23	-153.95	437.75	-130.47	117.86	
1	32	1141	0.11-0.57	-0.29	-0.17	0.33	518.76	-125.70	510.97	-117.91	70.41	
1	32	1142	0.20-0.47	-0.43	0.16	-0.16	541.92	-112.02	538.60	-108.70	46.46	
1	32	1143	0.24-1.16	-0.62	-0.30	-0.69	481.18	-115.89	481.11	-115.83	6.32	
1	32	1144	-0.16-5.88	-5.00	-1.04	-2.06	242.47	-134.43	239.15	-131.10	-35.24	
1	32	1145	-7.12-13.10	-12.68	-7.54	-1.53	-116.31	-238.42	-146.08	-208.64	-52.43	
1	32	1146	24.765.67	6.53	23.90	-3.96	-94.47	-945.14	-867.35	-172.26	-245.20	
1	32	1147	20.580.99	1.03	20.54	0.84	150.03	-301.55	-285.86	134.33	-82.71	
1	32	1148	25.8517.68	17.71	25.82	0.50	-192.59	-485.01	-314.67	-362.93	144.21	
1	32	1149	-4.38-8.23	-8.08	-4.52	-0.74	287.48	-119.43	278.28	-110.23	60.50	
1	32	1150	0.87-1.74	-0.53	-0.35	1.30	528.96	-123.30	519.71	-114.04	77.15	
1	32	1151	-9.94e-02	-1.63	-1.60	-0.13	0.21	587.00	-105.81	578.91	-97.71	74.43
1	32	1152	-5.29e-02	-2.09	-2.05	-8.80e-02	-0.27	557.35	-96.74	556.88	-96.26	-17.62
1	32	1153	0.20-2.67	-2.24	-0.22	-1.02	437.12	-106.81	437.05	-106.74	6.38	
1	32	1154	-2.73-7.10	-7.09	-2.73	0.17	96.63	-117.35	94.42	-115.14	21.63	
1	32	1155	13.530.77	6.84	7.47	-6.37	-311.70	-647.96	-549.88	-409.77	-152.84	
1	32	1156	24.01-24.66	19.01	-19.66	-14.78	-324.66	-1148.64	-1138.87	-334.43	89.18	
1	32	1157	25.6619.60	19.79	25.48	1.04	-94.43	-675.26	-641.65	-128.05	135.63	
1	32	1158	-1.99-5.08	-3.05	-4.02	-1.47	176.89	-130.77	176.89	-130.77	0.55	
1	32	1159	-0.48-3.81	-3.31	-0.99	1.19	454.40	-101.41	451.47	-98.47	40.26	
1	32	1160	-0.20-1.90	-1.85	-0.26	0.30	602.39	-94.54	598.40	-90.55	52.58	
1	32	1161	-0.21-2.67	-2.65	-0.23	-0.19	568.82	-94.74	568.52	-94.44	-14.08	



EGP CODE

GRE.EEC.R.73.IT.W.15235.12.024.01

PAGE

362 di/of 527

1	32	1162	-0.22-2.84	-2.53	-0.53	-0.84	424.53	-104.85	424.51	-104.83	-3.07	
1	32	1163	-4.64-5.39	-5.16	-4.87	0.34	82.46	-182.24	81.62	-181.40	14.93	
1	32	1164	20.47-0.30	0.92	19.24	-4.90	-26.62	-773.80	-764.46	-35.97	-83.03	
1	32	1165	35.8417.22	20.47	32.59	-7.07	191.12	-772.56	-772.56	191.11	2.22	
1	32	1166	-0.45-4.84	-1.47	-3.83	-1.85	71.33	-203.37	69.02	-201.06	25.12	
1	32	1167	-1.53-6.03	-6.02	-1.54	0.18	238.19	-123.70	233.58	-119.09	40.58	
1	32	1168	-2.50-5.53	-5.53	-2.50	-3.90e-02	150.75	-127.49	149.15	-125.89	21.08	
1	32	1169	7.59-1.60	2.45	3.54	-4.57	-211.02	-454.66	-334.67	-331.02	-121.81	
1	32	1170	20.772.72	15.85	7.64	8.04	561.13	-220.30	250.49	90.34	382.42	
1	32	1171	20.3916.14	16.20	20.33	0.50	-80.28	-473.35	-466.40	-87.23	51.79	
1	32	1172	-0.59-4.29	-1.99	-2.88	-1.80	334.69	-119.81	327.49	-112.61	-56.73	
1	32	1173	-0.57-3.97	-3.78	-0.77	0.78	552.13	-86.87	551.76	-86.49	-15.50	
1	32	1174	-0.13-2.79	-2.77	-0.15	0.21	667.86	-81.43	667.79	-81.36	7.16	
1	32	1175	-8.93e-02	-2.70	-2.70	-9.28e-02	-9.58e-02	675.87	-94.08	672.97	-91.17	-47.23
1	32	1176	-0.21-3.32	-3.21	-0.33	-0.58	565.14	-109.46	558.64	-102.95	-65.90	
1	32	1177	-6.09-6.23	-6.21	-6.11	-5.54e-02	256.80	-220.29	247.61	-211.10	-65.56	
1	32	1178	19.804.09	16.38	7.51	-6.49	465.02	-483.76	-112.65	93.91	-463.01	
1	32	1179	21.73-29.25	-28.19	20.66	-7.30	-318.37	-396.94	-390.42	-324.88	-21.67	
1	32	1180	38.04-5.59	-4.68	37.13	6.22	-376.92	-1199.68	-1194.47	-382.12	-65.25	
1	32	1181	31.53-17.28	-17.04	31.29	3.45	-307.34	-1430.42	-1423.90	-313.86	-85.33	
1	32	1182	35.89-16.11	-15.82	35.61	3.84	-397.15	-1614.37	-1611.50	-400.02	-58.98	
1	32	1183	55.631.14	1.19	55.58	1.69	-673.25	-1930.70	-1929.78	-674.17	-34.03	
1	32	1184	39.72-16.70	-16.49	39.50	3.49	-328.81	-2254.02	-2248.82	-334.01	-99.89	
1	32	1185	28.02-15.70	-15.13	27.45	4.96	-90.47	-1982.97	-1982.25	-91.19	-37.05	
1	32	1186	24.59-6.26	-2.31	20.63	10.31	-126.76	-1311.57	-1306.08	-132.24	-80.42	
1	32	1187	17.20-13.34	-13.33	17.19	-0.60	8.69	-1387.40	-1384.04	5.34	-68.37	
1	32	1188	19.27-22.17	-16.18	13.29	14.57	-84.12	-566.05	-552.25	-97.92	-80.38	
1	32	1189	-0.91-15.11	-4.98	-11.04	-6.42	454.90	-193.59	290.18	-28.87	282.28	
1	32	1190	6.78-2.10	0.50	4.17	4.04	1112.46	25.73	1042.10	96.09	267.42	
1	32	1191	-0.98-7.60	-7.58	-1.00	0.37	1179.93	66.59	1176.62	69.90	60.58	
1	32	1192	-1.12-6.76	-6.60	-1.28	-0.95	937.57	16.40	905.15	48.82	-169.76	
1	32	1193	2.01-3.68	-2.62	0.95	-2.22	406.49	-168.15	138.55	99.79	-286.67	
1	32	1194	0.59-42.09	-16.44	-25.06	20.90	-334.14	-1146.68	-1145.13	-335.70	35.56	
1	32	1195	14.85-18.34	10.04	-13.54	-11.68	-336.40	-968.73	-968.65	-336.49	7.30	
1	32	1196	15.931.79	11.20	6.51	6.67	537.86	-36.36	354.04	147.46	267.89	
1	32	1197	2.12e-02	-3.33	-2.72	-0.59	1.29	793.22	32.93	775.00	51.15	116.28
1	32	1198	0.38-2.47	-1.75	-0.33	-1.24	803.95	45.45	796.30	53.11	-75.81	
1	32	1199	10.432.48	7.40	5.51	-3.86	473.60	-116.54	295.00	62.06	-271.11	
1	32	1200	3.54-42.97	-4.56	-34.88	17.63	-259.37	-702.64	-697.97	-264.04	-45.26	
1	32	1201	-1.23-8.48	-8.45	-1.26	-0.46	710.19	-77.32	630.45	2.42	-237.56	
1	32	1202	15.81-23.92	12.63	-20.74	-10.78	-96.56	-485.06	-418.39	-163.23	146.48	
1	32	1203	17.872.79	13.26	7.40	6.94	721.30	-30.22	590.02	101.06	285.35	
1	32	1204	0.71-2.75	-1.81	-0.23	1.54	906.43	46.56	896.35	56.64	92.53	
1	32	1205	-7.45e-02	-5.89	-5.64	-0.33	-1.18	824.83	29.74	799.65	54.92	-139.26
1	32	1206	12.163.73	8.99	6.91	-4.09	605.90	-128.72	415.73	61.44	-321.77	
1	32	1207	2.58-46.09	-4.31	-39.21	16.96	-200.20	-597.03	-559.26	-237.97	-116.45	
1	32	1209	23.17-25.58	19.23	-21.64	-13.29	-197.73	-736.76	-703.97	-230.52	128.84	
1	32	1210	25.044.23	21.05	8.23	8.20	696.16	-65.54	501.01	129.61	332.51	
1	32	1211	2.19-2.31	0.27	-0.39	2.23	898.97	40.65	879.52	60.10	127.73	
1	32	1212	-0.17-6.79	-6.79	-0.17	1.28e-02	835.11	60.21	828.79	66.53	-69.72	
1	32	1213	0.69-2.52	-0.80	-1.04	-1.60	711.31	-85.33	584.54	41.44	-291.41	
1	32	1214	11.300.76	9.87	2.19	-3.61	384.36	-509.47	-292.23	167.13	-383.38	
1	32	1215	10.62-47.09	-7.89	-28.59	26.93	-548.54	-1895.38	-1892.34	-551.57	63.86	
1	32	1216	21.71-40.63	12.76	-31.68	-21.86	-524.39	-1575.52	-1571.83	-528.07	62.13	
1	32	1217	18.591.85	10.50	9.94	8.36	638.74	-441.48	5.76	191.50	532.07	
1	32	1218	-0.55-7.44	-6.86	-1.14	1.92	849.53	-110.81	684.99	53.73	361.85	
1	32	1219	-0.51-7.64	-7.63	-0.53	0.31	997.71	20.53	965.95	52.29	173.29	
1	32	1220	-0.59-7.75	-7.75	-0.59	-8.64e-02	1008.37	40.64	1008.20	40.82	12.95	
1	32	1221	-0.24-7.24	-7.18	-0.29	-0.64	910.58	11.13	882.40	39.32	-156.70	
1	32	1222	2.14-2.58-7.05e-02	-0.37	-0.37	-2.36	758.50	-104.71	620.23	33.56	-316.60	
1	35	1	4.19-2.05	0.19	1.95	3.00	-612.35	-966.94	-631.53	-947.76	80.20	
1	35	3	6.21-14.68	0.58	-9.06	9.27	-124.72	-731.70	-621.52	-234.90	-233.96	
1	35	5	0.38-21.85-3.13e-02		-21.44	3.00	-752.48	-1870.41	-1869.87	-753.02	24.62	
1	35	7	4.13-17.04	3.95	-16.86	1.94	-675.63	-1691.79	-1690.03	-677.39	-42.24	
1	35	9	6.62-20.96	4.23	-18.58	7.75	-634.63	-1779.03	-1770.20	-643.47	-100.16	
1	35	11	6.48-30.08	6.16	-29.76	-3.40	-823.44	-2628.31	-2628.15	-823.60	16.96	
1	35	13	10.42-21.22	9.74	-20.55	-4.57	-983.82	-2568.74	-2565.04	-987.51	76.45	
1	35	15	5.67-18.56	2.83	-15.72	7.79	-1045.07	-2327.09	-2318.67	-1053.49	-103.52	
1	35	17	0.34-21.53	-2.80	-18.38	7.67	-890.66	-2015.69	-2015.65	-890.70	6.51	
1	35	19	3.27-14.23-3.28e-02		-10.92	6.85	-841.67	-1798.22	-1726.88	-913.01	-251.30	
1	35	21	7.01-10.59	4.02	-7.59	-6.61	-355.06	-1309.53	-1157.41	-507.18	349.36	
1	35	23	1.71-2.05	-1.94	1.60	-0.64	-1355.92	-1590.27	-1583.69	-1362.51	-38.72	
1	35	25	2.880.72	0.94	2.66	-0.65	-1388.09	-1515.82	-1510.39	-1393.52	25.75	
1	35	27	3.37-1.73	-1.63	3.27	-0.71	-1451.90	-1557.80	-1548.42	-1461.27	30.08	
1	35	29	2.05-5.52	-5.35	1.88	1.10	-1647.28	-2072.20	-2055.53	-1663.95	82.50	
1	35	31	2.941.21	1.42	2.73	-0.57	-1781.24	-2172.72	-2170.02	-1783.94	-32.37	



EGP CODE

GRE.EEC.R.73.IT.W.15235.12.024.01

PAGE

363 di/of 527

1	35	33	2.71-0.75	1.08	0.88	-1.73	-1589.98	-2054.77	-2051.86	-1592.90	36.67	
1	35	35	2.92-6.06	-3.94	0.80	-3.81	-1269.91	-1752.15	-1737.40	-1284.66	-83.05	
1	35	37	1.12-0.34	0.32	0.46	-0.73	-1218.41	-1678.94	-1604.48	-1292.86	169.54	
1	35	39	5.14-1.74	2.11	1.29	-3.41	-779.51	-1177.83	-1010.84	-946.50	-196.55	
1	35	41	8.75-5.70	-4.56	7.61	3.90	515.76	-273.64	479.38	-237.26	-165.51	
1	35	42	-5.45-8.57	-6.43	-7.60	1.45	269.65	-169.61	225.09	-125.05	132.62	
1	35	43	15.60-7.95	-7.83	15.49	-1.67	-293.26	-523.34	-354.87	-461.74	101.88	
1	35	44	-0.96-5.20	-2.84	-3.32	2.11	333.01	35.94	221.40	147.54	143.87	
1	35	45	5.231.59	1.63	5.19	0.36	259.00	-104.43	-44.72	199.28	134.67	
1	35	46	-0.51-0.82	-0.54	-0.78	9.73e-02	430.39	176.10	228.03	378.46	102.51	
1	35	47	-0.39-1.59	-0.39	-1.59	-1.53e-02	374.92	-74.54	-41.55	341.93	117.21	
1	35	48	-0.41-0.78	-0.42	-0.77	-6.56e-02	483.36	186.97	206.66	463.67	73.82	
1	35	49	-0.27-1.12	-0.27	-1.12	2.73e-02	467.28	-55.41	-39.59	451.46	89.54	
1	35	50	-0.14-0.53	-0.36	-0.32	-0.19	529.23	181.27	188.51	522.00	49.67	
1	35	51	-0.21-0.61	-0.23	-0.59	-7.70e-02	515.88	-50.78	-44.40	509.50	59.76	
1	35	52	0.47-0.51	-0.28	0.25	-0.41	593.70	182.69	184.93	591.46	30.28	
1	35	53	0.10-0.34	-0.20	-3.75e-02	-0.21	580.56	-46.53	-44.98	579.01	31.16	
1	35	54	1.30-0.51	-0.18	0.97	-0.70	695.35	198.28	198.40	695.23	-7.72	
1	35	55	0.81-0.28	-0.17	0.70	-0.33	688.10	-37.06	-37.03	688.07	-4.78	
1	35	56	2.46-0.54-1.26e-02	1.93	-1.14	839.53	233.88	236.31	837.09	-38.32		
1	35	57	1.92-0.27	-0.13	1.78	-0.54	844.57	-18.92	-16.78	842.43	-42.93	
1	35	58	3.99-0.54	0.38	3.07	-1.82	1005.55	286.64	296.26	995.93	-82.59	
1	35	59	3.68-0.19 3.86e-02	3.45	-0.92	1036.95	5.94	16.33	1026.56	-103.02		
1	35	60	5.750.26	1.85	4.15	-2.49	1165.36	354.88	387.06	1133.18	-158.25	
1	35	61	5.880.15	0.90	5.13	-1.93	1236.28	33.86	65.21	1204.94	-191.58	
1	35	62	7.735.67	5.72	7.69	-0.29	1313.07	397.34	490.45	1219.97	-276.74	
1	35	63	8.98-4.39	7.14	-2.55	-4.61	1414.56	27.95	121.69	1320.82	-348.14	
1	35	64	26.495.03	11.97	19.55	10.04	1278.64	298.67	666.93	910.38	-474.62	
1	35	65	18.27-35.20	17.44	-34.37	6.62	1487.87	-70.69	50.21	1366.97	-416.91	
1	35	66	9.72-16.43	-6.09	-0.62	12.78	1001.82	-78.97	676.50	246.35	-495.75	
1	35	67	-0.37-1.89	-1.33	-0.93	-0.73	581.18	-173.03	572.87	-164.72	-78.71	
1	35	68	3.671.74	3.66	1.74	-0.10	610.50	109.67	609.52	110.65	-22.16	
1	35	69	-0.23-1.75	-1.27	-0.71	0.70	462.43	248.28	453.30	257.41	43.28	
1	35	70	-0.26-0.94	-0.89	-0.31	0.18	430.30	335.55	387.47	378.38	47.16	
1	35	71	-0.17-0.61	-0.56	-0.23	-0.14	474.96	329.05	339.07	464.93	36.90	
1	35	72	0.15-0.59	-0.43	-7.61e-03	-0.30	528.14	305.99	309.68	524.45	28.41	
1	35	73	0.70-0.59	-0.29	0.40	-0.55	594.05	302.75	303.00	593.80	8.61	
1	35	74	1.45-0.63-7.41e-02	0.90	-0.92	695.50	319.04	319.11	695.42	-5.21		
1	35	75	2.37-0.65	0.27	1.45	-1.39	831.43	360.52	361.32	830.62	-19.46	
1	35	76	3.46-0.60	0.90	1.96	-1.96	981.09	428.43	430.90	978.63	-36.80	
1	35	77	4.49-0.14	1.92	2.43	-2.30	1101.06	524.27	533.28	1092.04	-71.55	
1	35	78	4.951.38	2.84	3.50	-1.75	1096.82	624.53	673.37	1047.97	-143.82	
1	35	79	1.98-2.74	-2.32	1.55	-1.35	1037.75	488.19	811.80	714.13	-270.41	
1	35	80	3.48-6.14	-5.28	2.62	-2.75	1032.26	161.52	903.77	290.02	-308.83	
1	35	81	0.94-0.46	0.87	-0.39	0.29	621.14	-120.83	606.62	-106.32	-102.75	
1	35	82	0.78-0.66	0.40	-0.28	0.64	604.48	119.97	588.41	136.04	-86.77	
1	35	83	0.24-0.72	-0.31	-0.16	0.48	531.45	277.95	516.02	293.39	-60.62	
1	35	84	-0.14-0.84	-0.81	-0.17	0.15	451.73	378.79	432.41	398.11	-32.19	
1	35	85	7.44e-02	-0.71	-0.68	4.61e-02	-0.15	471.84	371.23	372.72	470.35	-12.16
1	35	86	0.38-0.63	-0.48	0.23	-0.36	527.80	342.51	342.52	527.79	1.47	
1	35	87	0.83-0.62	-0.27	0.48	-0.62	595.59	336.80	336.80	595.59	-0.17	
1	35	88	1.37-0.58 3.27e-02	0.76	-0.90	695.76	353.56	353.57	695.75	-1.02		
1	35	89	1.95-0.47	0.50	0.97	-1.19	831.19	391.23	391.24	831.18	1.85	
1	35	90	2.58-0.40	1.17	1.02	-1.49	976.11	450.70	450.85	975.96	8.96	
1	35	91	2.97-0.32	1.72	0.92	-1.60	1059.85	531.72	532.34	1059.22	18.15	
1	35	92	2.08-0.29	1.09	0.69	-1.17	970.04	661.29	661.69	969.64	11.09	
1	35	93	0.95-1.52	-1.46	0.89	-0.37	846.59	648.56	845.72	649.43	-13.10	
1	35	94	0.23-3.61	-3.61	0.22	-0.12	986.61	251.59	986.43	251.77	-11.45	
1	35	95	0.90-1.03	0.55	-0.68	0.74	476.15	-171.89	446.76	-142.51	-134.83	
1	35	96	0.75-0.81	0.42	-0.47	0.64	502.01	49.66	442.88	108.79	-152.49	
1	35	97	-2.20e-02	-0.65	-0.30	-0.38	0.31	504.77	198.92	402.98	300.71	-144.12
1	35	98	-0.16-0.86	-0.86	-0.16	3.29e-02	492.96	280.49	352.28	421.18	-100.50	
1	35	99	0.25-0.72	-0.67	0.21	-0.20	508.45	307.80	324.92	491.33	-56.05	
1	35	100	0.52-0.67	-0.51	0.36	-0.41	541.63	311.78	313.41	540.00	-19.31	
1	35	101	0.90-0.60	-0.28	0.57	-0.62	601.58	316.14	316.17	601.55	-3.12	
1	35	102	1.29-0.45 3.63e-02	0.80	-0.78	699.75	333.22	333.36	699.60	7.37		
1	35	103	1.59-0.16	0.48	0.95	-0.84	838.68	365.07	366.04	837.70	21.46	
1	35	104	1.750.24	1.09	0.90	-0.75	993.09	407.32	409.07	991.34	31.98	
1	35	105	1.830.45	1.51	0.78	-0.58	1093.29	441.72	451.62	1083.39	79.70	
1	35	106	0.69-3.81e-021.99e-02	0.63	-0.20	1023.72	462.47	505.31	980.88	149.04		
1	35	107	1.42-2.57	-2.47	1.33	0.61	873.50	414.66	656.74	631.42	229.07	
1	35	108	0.87-5.24	-4.75	0.39	1.65	848.52	108.81	741.56	215.78	260.16	
1	35	109	2.17-4.74	0.68	-3.25	2.83	51.21	-321.60	48.01	-318.41	-34.36	
1	35	110	3.121.73	3.04	1.81	-0.32	313.96	-91.21	166.91	55.84	-194.82	
1	35	111	-1.18-2.00	-1.99	-1.18	-4.04e-02	411.50	22.73	135.48	298.74	-176.41	
1	35	112	0.44-0.52	-0.51	0.44	3.64e-02	498.13	163.64	205.95	455.82	-111.18	



EGP CODE

GRE.EEC.R.73.IT.W.15235.12.024.01

PAGE

364 di/of 527

1	35	113	0.31-0.77	-0.70	0.24	-0.26	540.97	219.52	237.45	523.04	-73.78
1	35	114	0.64-0.75	-0.54	0.44	-0.49	558.23	253.77	254.83	557.17	-17.89
1	35	115	1.00-0.61	-0.33	0.72	-0.61	609.74	269.38	269.41	609.71	-3.38
1	35	116	1.39-0.40-6.83e-02		1.05	-0.70	704.85	288.40	288.61	704.64	9.34
1	35	117	1.75-9.49e-02	0.21	1.45	-0.68	844.68	313.83	314.20	844.32	13.88
1	35	118	1.870.58	0.61	1.83	-0.21	1012.86	340.30	341.27	1011.89	25.56
1	35	119	2.320.90	1.08	2.14	0.48	1167.42	337.25	344.15	1160.52	75.38
1	35	120	2.980.56	0.57	2.98	0.14	1155.11	242.17	290.98	1106.31	205.36
1	35	121	2.48-9.84	-8.74	1.37	3.52	855.72	-81.49	173.89	600.33	417.29
1	35	122	4.65-5.47	-2.14	1.31	4.76	605.63	-297.66	152.79	155.19	451.64
1	35	123	14.360.48	10.86	3.98	-6.03	-383.08	-1030.09	-608.20	-804.97	308.18
1	35	124	-7.99-18.09	-12.10	-13.98	-4.96	-68.53	-618.13	-479.25	-207.41	-238.84
1	35	125	2.23-2.12	-0.95	1.05	-1.93	312.54	-134.50	-96.96	275.00	-123.99
1	35	126	0.15-1.19	-1.13	8.58e-02	0.28	507.48	77.28	85.25	499.51	-58.00
1	35	127	0.27-0.74	-0.66	0.19	-0.26	548.45	158.85	163.35	543.95	-41.63
1	35	128	0.68-0.75	-0.57	0.50	-0.48	568.21	196.96	197.26	567.90	-10.65
1	35	129	1.12-0.62	-0.35	0.84	-0.63	614.10	219.71	219.72	614.09	-1.08
1	35	130	1.65-0.50	-0.19	1.33	-0.76	706.24	240.47	240.57	706.15	6.60
1	35	131	2.32-0.43	-0.16	2.04	-0.82	846.68	261.04	261.14	846.57	7.80
1	35	132	3.363.34e-02	0.12	3.27	-0.54	1018.72	282.37	282.37	1018.72	-2.01
1	35	133	4.59-0.58	-0.52	4.52	0.58	1185.02	263.16	264.02	1184.16	28.16
1	35	134	8.301.81	1.81	8.30	-6.70e-04	1397.67	169.30	175.17	1391.80	84.68
1	35	135	15.53-3.40	4.05	8.08	-9.25	1163.19	-360.69	-232.47	1034.98	423.02
1	35	136	26.48-13.41	22.11	-9.04	-12.46	-90.30	-1128.25	-829.59	-388.95	469.89
1	35	137	27.20-5.48	-5.42	27.14	-1.40	-351.56	-590.56	-585.54	-356.57	34.25
1	35	138	5.501.31	1.85	4.96	1.40	391.97	-94.55	-94.54	391.95	-2.39
1	35	139	-0.44-0.67	-0.53	-0.58	0.11	491.15	59.93	61.14	489.93	-22.88
1	35	140	0.43-0.38	-0.26	0.31	-0.29	548.71	145.05	145.36	548.40	-11.24
1	35	141	0.70-0.68	-0.48	0.50	-0.48	568.21	175.02	175.08	568.15	-4.85
1	35	142	1.19-0.62	-0.32	0.89	-0.68	613.87	197.79	197.80	613.87	0.52
1	35	143	1.76-0.59	-0.24	1.41	-0.84	705.95	219.01	219.06	705.91	4.82
1	35	144	2.54-0.49	-0.15	2.20	-0.96	847.82	244.85	244.92	847.74	6.63
1	35	145	3.63-0.37-7.41e-02		3.33	-1.05	1015.83	268.09	268.09	1015.83	0.35
1	35	146	6.790.38	0.49	6.68	-0.83	1206.82	287.88	287.91	1206.79	-4.63
1	35	147	6.55-2.61	-2.19	6.13	-1.91	1435.94	190.29	190.91	1435.32	-27.90
1	35	148	44.42-49.57	44.27	-49.42	3.76	1829.44	94.39	102.01	1821.82	-114.78
1	35	149	9.32-9.30	-6.42	6.44	6.73	7.51	-865.97	-170.36	-688.09	-351.75
1	35	150	-2.14-10.92	-3.19	-9.87	2.84	-31.26	-528.78	-391.72	-168.32	222.27
1	35	151	2.85-4.65	-1.31	-0.49	3.73	295.66	-120.91	-90.03	264.79	109.13
1	35	152	0.39-0.56	-0.54	0.37	0.13	491.15	66.34	67.54	489.95	22.59
1	35	153	0.30-0.61	-0.58	0.27	-0.18	538.26	130.29	130.34	538.22	4.21
1	35	154	0.76-0.59	-0.39	0.56	-0.48	565.07	161.82	161.82	565.07	0.84
1	35	155	1.25-0.63	-0.29	0.91	-0.73	612.19	181.50	181.51	612.17	2.53
1	35	156	1.87-0.66	-0.23	1.44	-0.94	703.01	201.23	201.26	702.98	3.96
1	35	157	2.70-0.57	-0.10	2.24	-1.14	840.48	226.84	226.85	840.47	2.18
1	35	158	4.05-0.60	-0.12	3.56	-1.42	1007.03	249.40	249.43	1007.00	-5.15
1	35	159	5.92-1.34	-0.58	5.16	-2.23	1170.34	250.38	251.01	1169.70	-24.18
1	35	160	6.74-3.63e-02	0.79	5.92	-2.22	1374.94	177.49	187.62	1364.81	-109.64
1	35	161	32.151.65	17.61	16.19	15.23	1283.77	-126.84	28.65	1128.28	-441.78
1	35	162	9.66-19.43	-7.19	-2.58	14.36	273.65	-602.44	-140.72	-188.07	-437.41
1	35	163	-1.68-5.10	-4.32	-2.46	-1.44	151.41	-292.76	145.48	-286.83	-50.98
1	35	164	6.223.49	6.22	3.49	3.21e-02	267.73	16.65	214.82	69.57	102.40
1	35	165	0.16-1.92	-0.88	-0.87	1.04	339.61	36.44	84.92	291.14	111.11
1	35	166	0.83-0.51	-0.20	0.53	0.57	453.18	107.11	117.35	442.94	58.65
1	35	167	0.37-0.40	-0.39	0.37	-6.42e-02	517.15	132.00	133.30	515.85	22.29
1	35	168	0.74-0.50	-0.30	0.55	-0.46	553.86	145.23	145.43	553.66	8.90
1	35	169	1.30-0.60	-0.18	0.88	-0.79	606.20	158.33	158.40	606.13	5.52
1	35	170	1.93-0.68-8.46e-02		1.33	-1.10	698.82	177.13	177.15	698.80	3.08
1	35	171	2.68-0.69	6.85e-02	1.92	-1.40	833.79	203.64	203.64	833.78	-2.43
1	35	172	3.60-0.71	0.27	2.62	-1.81	992.32	236.09	236.32	992.09	-13.25
1	35	173	4.37-0.68	0.61	3.08	-2.20	1134.22	263.20	265.16	1132.27	-41.21
1	35	174	4.991.15	1.52	4.61	-1.14	1124.06	244.57	271.27	1097.36	-150.88
1	35	175	4.74-5.43	-4.95	4.26	-2.16	846.30	95.26	297.00	644.56	-332.89
1	35	176	5.11-9.37	-6.77	2.51	-5.56	640.51	-131.08	310.37	199.06	-381.76
1	35	177	0.40-0.58	0.37	-0.55	0.17	355.58	-140.51	355.35	-140.28	10.61
1	35	178	1.21-0.37	1.00	-0.16	0.54	332.44	108.27	330.19	110.53	22.38
1	35	179	1.10-0.58	0.81	-0.28	0.64	319.85	244.03	264.11	299.78	33.45
1	35	180	0.35-0.38	0.22	-0.25	0.28	423.22	186.49	188.18	421.54	19.90
1	35	181	0.32-0.27	-0.16	0.21	-0.23	493.56	147.87	148.15	493.27	9.94
1	35	182	0.79-0.55	-0.23	0.47	-0.57	541.25	135.81	135.92	541.14	6.60
1	35	183	1.35-0.62-4.77e-02		0.78	-0.89	599.93	142.56	142.64	599.85	6.05
1	35	184	1.92-0.67	0.12	1.13	-1.19	694.91	160.64	160.68	694.86	5.01
1	35	185	2.51-0.58	0.43	1.49	-1.45	830.06	190.85	190.85	830.05	1.96
1	35	186	3.04-0.56	0.73	1.75	-1.72	979.40	230.99	231.02	979.37	-4.87
1	35	187	3.07-0.27	0.78	2.02	-1.55	1068.85	275.69	276.10	1068.44	-18.12
1	35	188	2.70-0.80	-0.32	2.23	-1.20	977.34	342.43	349.95	969.81	-68.71





EGP CODE

GRE.EEC.R.73.IT.W.15235.12.024.01

PAGE

365 di/of 527

1	35	189	3.03-2.55	-2.21	2.68	-1.35	710.17	426.01	505.93	630.24	-127.77	
1	35	190	1.86-3.32	-2.55	1.10	-1.84	660.44	174.05	612.79	221.70	-144.58	
1	35	191	7.04e-02	-1.21	-0.28	-0.85	0.57	333.61	-135.70	329.77	-131.86	-42.28
1	35	192	1.34-1.11	0.94	-0.71	0.91	339.97	106.69	327.70	118.96	-52.08	
1	35	193	0.94-0.89	0.87	-0.82	0.36	334.71	225.28	259.10	300.89	-50.57	
1	35	194	0.65-0.62	0.59	-0.55	-0.28	429.52	183.04	191.67	420.89	-45.30	
1	35	195	0.48-0.62	-0.17	2.96e-02	-0.54	493.14	133.37	136.00	490.51	-30.67	
1	35	196	0.95-0.66	-0.11	0.40	-0.76	539.45	123.81	123.81	539.45	0.63	
1	35	197	1.44-0.68	4.05e-02	0.72	-1.00	598.84	128.49	128.56	598.77	5.76	
1	35	198	1.93-0.66	0.23	1.04	-1.23	694.95	145.42	145.57	694.80	9.03	
1	35	199	2.33-0.58	0.39	1.36	-1.37	831.97	171.26	171.27	831.96	2.75	
1	35	200	2.79-0.24	0.84	1.71	-1.45	983.21	212.59	212.60	983.20	2.46	
1	35	201	2.52-0.46	7.92e-02	1.98	-1.15	1065.46	243.08	243.69	1064.84	22.51	
1	35	202	2.32-0.81	-0.70	2.21	-0.56	966.70	318.30	328.18	956.82	79.40	
1	35	203	2.69-2.42	-2.42	2.69	1.31e-02	683.54	414.35	486.06	611.83	119.00	
1	35	204	1.47-3.91	-3.60	1.15	1.25	616.61	183.81	588.19	212.22	107.19	
1	35	205	-0.10-5.46	-1.45	-4.11	2.33	106.65	-248.86	106.65	-248.86	0.55	
1	35	206	3.870.15	3.56	0.47	1.03	214.65	27.93	174.34	68.24	-76.83	
1	35	207	-0.87-2.06	-1.08	-1.85	-0.45	354.54	28.91	86.14	297.32	-123.94	
1	35	208	0.46-0.88	-0.10	-0.32	-0.66	459.78	73.78	96.12	437.44	-90.13	
1	35	209	0.76-0.95	-0.28	9.16e-02	-0.83	520.68	86.08	96.18	510.58	-65.47	
1	35	210	1.11-0.84	-0.16	0.43	-0.93	552.83	98.58	102.05	549.36	-39.50	
1	35	211	1.55-0.74	5.44e-02	0.76	-1.09	602.97	113.65	113.75	602.86	-7.21	
1	35	212	2.02-0.66	0.24	1.11	-1.27	697.80	131.50	131.50	697.79	-1.55	
1	35	213	2.39-0.46	0.39	1.54	-1.30	838.23	153.69	154.08	837.84	-16.27	
1	35	214	2.84-0.15	0.55	2.14	-1.27	1001.58	181.18	181.22	1001.54	-5.99	
1	35	215	3.79-0.13	0.23	3.44	-1.12	1132.82	194.55	196.89	1130.48	46.75	
1	35	216	4.83-1.58	-1.58	4.83	-6.90e-02	1082.58	165.88	199.07	1049.39	171.24	
1	35	217	3.30-7.60	-7.20	2.90	2.05	808.22	25.18	204.42	628.98	328.98	
1	35	218	6.47-8.13	-5.53	3.86	5.59	562.33	-132.33	239.80	190.20	346.44	
1	35	219	10.55-3.85	6.94	-0.24	-6.24	-127.23	-564.19	-230.19	-461.23	185.44	
1	35	220	-7.93-14.49	-9.22	-13.20	-2.61	-5.41	-458.56	-307.56	-156.42	-213.60	
1	35	221	-8.13e-02	-4.76	-3.00	-1.84	-2.26	287.62	-190.13	-145.67	243.16	-138.80
1	35	222	0.71-1.07	-0.66	0.30	-0.75	491.35	-18.99	-9.06	481.42	-70.49	
1	35	223	0.93-1.03	-0.46	0.36	-0.89	540.07	44.98	50.81	534.24	-53.41	
1	35	224	1.25-0.76	-7.00e-02	0.55	-0.96	564.62	79.70	84.34	559.98	-47.24	
1	35	225	1.65-0.73	5.96e-02	0.86	-1.12	607.31	103.04	103.09	607.26	5.10	
1	35	226	2.15-0.68	0.21	1.25	-1.32	700.26	121.31	121.87	699.69	-18.13	
1	35	227	2.57-0.46	0.34	1.77	-1.34	844.55	139.82	141.73	842.64	-36.65	
1	35	228	3.190.17	0.92	2.45	-1.30	1018.58	164.31	164.75	1018.13	-19.47	
1	35	229	4.400.19	0.98	3.62	-1.64	1188.14	147.03	147.58	1187.59	23.99	
1	35	230	14.416.13e-022.53		11.94	-5.41	1347.03	74.53	90.26	1331.29	140.60	
1	35	231	19.46-5.92	-2.82	16.36	-8.31	900.99	-375.58	-189.71	715.12	450.25	
1	35	232	14.70-16.66	13.37	-15.33	-6.32	176.87	-668.13	-368.48	-122.78	404.24	
1	35	233	-0.29-2.47	-2.47	-0.30	0.13	570.19	-94.54	569.88	-94.23	14.37	
1	35	234	21.661.24	1.36	21.54	-1.55	-292.33	-751.12	-738.45	-305.00	75.17	
1	35	235	8.524.15	4.34	8.32	0.90	385.78	-171.97	-169.60	383.41	36.29	
1	35	236	1.16-0.47	-0.46	1.15	0.12	485.34	-41.59	-41.58	485.33	2.26	
1	35	237	0.78-0.73	-0.57	0.62	-0.47	539.95	34.37	34.44	539.88	-5.86	
1	35	238	1.21-0.67	-0.12	0.66	-0.85	561.68	78.23	78.45	561.47	10.22	
1	35	239	1.70-0.68	8.91e-02	0.94	-1.11	605.81	101.90	102.02	605.69	7.76	
1	35	240	2.28-0.72	0.20	1.35	-1.39	696.92	121.26	121.26	696.92	-0.74	
1	35	241	2.78-0.56	0.32	1.90	-1.47	839.26	141.32	141.45	839.13	-9.50	
1	35	242	3.190.66	1.38	2.48	-1.14	1019.53	169.49	171.37	1017.66	-39.89	
1	35	243	3.061.47	2.58	1.96	-0.73	1215.46	167.11	168.46	1214.11	-37.51	
1	35	244	6.71-10.50	6.61	-10.41	-1.26	1427.06	51.38	54.96	1423.48	-70.06	
1	35	245	19.74-57.58	19.59	-57.44	3.31	1667.36	-459.52	-451.20	1659.04	-132.75	
1	35	246	0.97-0.27	-0.18	0.89	0.31	501.38	223.79	260.49	464.68	-94.03	
1	35	247	8.34-6.54	-3.71	5.51	5.84	140.99	-385.67	105.17	-349.84	-132.60	
1	35	248	-3.49-9.54	-3.61	-9.41	0.85	120.20	-385.55	-152.32	-113.04	252.11	
1	35	249	0.95-6.53	-2.84	-2.74	3.74	314.95	-176.18	-85.96	224.74	190.18	
1	35	250	1.13-1.42	-0.85	0.57	1.06	481.83	-1.23	16.83	463.77	91.63	
1	35	251	0.53-0.64	-0.62	0.51	-0.16	525.20	57.79	62.98	520.01	48.99	
1	35	252	1.09-0.57	-0.12	0.63	-0.74	549.04	90.89	91.44	548.50	15.79	
1	35	253	1.67-0.67	8.50e-02	0.92	-1.10	596.93	110.07	110.12	596.88	5.13	
1	35	254	2.36-0.77	0.25	1.34	-1.47	688.76	129.98	130.05	688.70	-5.90	
1	35	255	2.72-0.45	0.36	1.91	-1.38	828.64	154.46	154.76	828.34	-14.24	
1	35	256	2.840.32	0.49	2.66	-0.64	998.63	180.59	181.39	997.84	-25.56	
1	35	257	3.890.90	0.93	3.86	0.30	1169.10	195.27	200.98	1163.39	-74.33	
1	35	258	11.781.31	2.91	10.18	3.77	1340.82	149.11	186.02	1303.92	-206.44	
1	35	259	29.00-1.06	4.84	23.10	11.94	1071.15	-124.43	127.14	819.57	-487.33	
1	35	260	4.64-11.54	-1.52	-5.39	7.85	577.21	-382.29	126.68	68.24	-478.86	
1	35	261	-1.42-4.33	-2.54	-3.22	-1.41	254.13	-220.62	253.44	-219.93	18.12	
1	35	262	5.242.05	5.14	2.16	-0.56	342.23	76.21	316.81	101.63	78.20	
1	35	263	0.79-1.99	-0.14	-1.06	1.31	376.88	84.72	167.61	293.99	131.71	
1	35	264	0.74-1.12	-0.24	-0.14	0.93	441.16	108.03	134.01	415.17	89.33	





EGP CODE

GRE.EEC.R.73.IT.W.15235.12.024.01

PAGE

366 di/of 527

1	35	265	0.25-0.58	-0.56	0.23	-0.14	492.18	108.46	112.65	487.99	39.87	
1	35	266	0.93-0.71	-0.27	0.49	-0.73	530.16	109.19	109.76	529.59	15.51	
1	35	267	1.66-0.67	0.18	0.81	-1.12	585.11	124.58	124.66	585.03	6.19	
1	35	268	2.33-0.89	0.22	1.22	-1.53	679.76	140.81	140.84	679.72	-4.41	
1	35	269	2.40-0.53	0.14	1.74	-1.22	815.86	166.66	166.86	815.66	-11.40	
1	35	270	2.66-8.42e-029.75e-02		2.48	-0.68	973.58	211.00	211.48	973.09	-19.22	
1	35	271	3.91-7.14e-023.84e-02		3.80	-0.65	1106.12	259.98	263.84	1102.26	-57.04	
1	35	272	6.40-0.85	-0.67	6.22	-1.14	1096.82	280.72	323.46	1054.08	-181.81	
1	35	273	5.14-6.50	-5.90	4.55	-2.56	893.10	190.88	406.08	677.90	-323.74	
1	35	274	7.49-9.99	-6.77	4.27	-6.78	700.77	-54.92	417.68	228.17	-365.77	
1	35	275	1.10-0.75	1.10	-0.75	1.22e-02	435.53	-114.85	435.44	-114.76	7.00	
1	35	276	1.04-0.62	1.00	-0.59	0.23	390.48	131.68	389.30	132.86	17.43	
1	35	277	1.46-0.88	1.35	-0.77	0.49	335.67	277.32	314.62	298.37	28.02	
1	35	278	1.83-0.73	1.73	-0.63	0.50	407.04	234.18	238.72	402.49	27.66	
1	35	279	0.29-0.43-5.10e-02		-9.10e-02	0.36	469.22	150.72	153.39	466.55	29.04	
1	35	280	0.45-0.33	-0.20	0.32	0.29	518.09	123.30	125.57	515.82	29.86	
1	35	281	0.700.20	0.20	0.70	-1.81e-02	579.67	132.19	134.00	577.86	28.42	
1	35	282	1.241.95e-02	0.16	1.10	-0.39	676.57	146.56	147.71	675.42	24.68	
1	35	283	1.65-0.24	-0.12	1.53	-0.46	812.11	171.56	172.02	811.64	17.21	
1	35	284	2.17-0.53	-0.34	1.98	-0.69	959.35	219.25	219.27	959.33	3.96	
1	35	285	2.82-0.84	-0.46	2.44	-1.11	1045.32	289.84	290.28	1044.89	-18.04	
1	35	286	3.09-1.64	-1.21	2.66	-1.36	961.61	391.11	397.99	954.73	-62.27	
1	35	287	3.31-3.08	-2.66	2.89	-1.59	711.23	486.71	571.05	626.88	-108.73	
1	35	288	2.12-4.11	-3.28	1.28	-2.12	728.15	195.28	693.71	229.72	-131.02	
1	35	289	0.59-1.19	0.38	-0.98	0.57	402.23	-121.22	401.91	-120.89	-13.05	
1	35	290	1.26-1.28	1.00	-1.01	0.78	379.32	122.47	376.03	125.77	-28.90	
1	35	291	1.53-1.24	1.45	-1.16	0.46	351.13	242.16	301.97	291.32	-54.23	
1	35	292	1.94-0.95	1.88	-0.89	0.40	416.45	220.28	235.78	400.95	-52.93	
1	35	293	0.76-1.05-5.26e-02		-0.24	0.90	471.18	147.26	151.17	467.27	-35.34	
1	35	294	1.29-1.29	-0.22	0.23	1.27	517.98	124.87	125.44	517.41	-15.00	
1	35	295	1.53-0.66	0.21	0.66	1.07	580.09	133.84	134.03	579.89	-9.26	
1	35	296	1.53-0.28	0.15	1.10	0.77	679.03	146.87	146.88	679.01	-2.96	
1	35	297	1.68-0.30	-0.16	1.54	0.51	818.50	168.30	168.33	818.48	-4.07	
1	35	298	2.00-0.42	-0.42	2.00	-1.28e-02	970.18	207.42	207.75	969.85	15.81	
1	35	299	2.31-0.72	-0.69	2.28	-0.29	1055.99	265.49	267.77	1053.71	42.38	
1	35	300	2.36-1.27	-1.25	2.34	-0.24	975.88	348.01	367.53	956.36	108.97	
1	35	301	2.68-2.93	-2.93	2.68	-4.45e-02	754.36	406.43	538.10	622.69	168.75	
1	35	302	1.34-4.67	-4.47	1.14	1.07	720.28	154.95	649.51	225.73	187.09	
1	35	303	1.13-5.64	-0.14	-4.36	2.65	214.08	-238.28	213.96	-238.16	-7.37	
1	35	304	4.03-0.50	3.63	-9.46e-02	1.30	265.91	39.53	239.74	65.70	-72.38	
1	35	305	-0.82-2.41	-1.05	-2.18	-0.56	362.83	47.61	133.81	276.64	-140.50	
1	35	306	-0.38-0.76	-0.52	-0.61	0.18	439.94	86.89	115.80	411.03	-96.80	
1	35	307	1.04-0.86	0.34	-0.16	0.92	496.71	118.56	125.52	489.75	-50.83	
1	35	308	1.26-1.02-2.69e-02		0.26	1.13	534.71	113.18	114.85	533.04	-26.50	
1	35	309	1.49-0.56	0.21	0.72	0.99	590.75	124.93	125.27	590.41	-12.61	
1	35	310	1.49-4.45e-02	0.23	1.22	0.59	688.70	140.34	140.34	688.70	-1.14	
1	35	311	1.84-0.35	-0.31	1.80	0.28	832.62	152.12	152.40	832.34	13.80	
1	35	312	2.56-1.47e-037.77e-03		2.55	-0.15	1001.53	188.85	189.56	1000.81	24.11	
1	35	313	3.96-0.21	-0.19	3.94	-0.33	1142.36	210.86	218.11	1135.11	81.86	
1	35	314	5.22-2.23	-2.17	5.15	0.69	1117.85	169.86	225.46	1062.25	222.76	
1	35	315	2.87-6.30	-5.88	2.45	1.92	905.11	43.33	283.22	665.22	386.24	
1	35	316	6.00-9.08	-7.01	3.94	5.18	679.68	-134.29	329.62	215.77	402.98	
1	35	317	9.48-4.65	5.25	-0.42	-6.47	-45.12	-457.92	-106.01	-397.04	146.38	
1	35	318	-9.69-15.55	-11.05	-14.19	-2.47	32.25	-431.84	-234.29	-165.30	-229.46	
1	35	319	-1.25-5.25	-4.31	-2.20	-1.70	278.36	-206.17	-132.40	204.59	-174.07	
1	35	320	-4.73e-02	-1.59	-1.58	-5.81e-02	-0.13	473.61	-26.70	-9.56	456.46	-91.01
1	35	321	0.32-4.83e-02	0.19	7.45e-02	0.17	527.03	69.81	75.86	520.99	-52.23	
1	35	322	0.58-3.09e-02	0.14	0.41	0.28	553.40	96.83	98.27	551.97	-25.52	
1	35	323	0.860.16	0.17	0.85	8.75e-02	603.74	113.10	113.63	603.21	-16.13	
1	35	324	1.530.16	0.30	1.39	-0.41	701.05	132.10	133.36	699.78	-26.82	
1	35	325	2.28-0.23-2.98e-02		2.08	-0.67	848.11	144.82	145.02	847.90	-12.11	
1	35	326	3.310.30	0.62	3.00	-0.93	1032.88	171.14	171.16	1032.87	3.75	
1	35	327	4.931.48	2.00	4.41	-1.24	1220.76	178.61	182.40	1216.97	62.74	
1	35	328	15.091.63	3.77	12.96	-4.92	1391.29	96.89	131.16	1357.02	207.82	
1	35	329	21.96-2.97	-0.40	19.39	-7.58	978.65	-365.60	-106.14	719.19	530.53	
1	35	330	13.46-16.76	12.09	-15.39	-6.29	401.71	-666.95	-231.47	-33.77	525.11	
1	35	331	-5.14-7.07	-7.05	-5.16	-0.17	78.49	-196.60	77.46	-195.57	-16.83	
1	35	332	24.84-0.41	-0.41	24.84	-0.12	-411.72	-812.43	-808.09	-416.06	41.46	
1	35	333	9.213.52	3.73	9.00	1.08	352.93	-194.68	-194.22	352.47	15.83	
1	35	334	0.98-1.46	-1.40	0.93	0.37	472.31	-65.17	-65.16	472.31	1.06	
1	35	335	0.50-0.54	-0.51	0.47	-0.19	534.97	37.41	37.48	534.90	-5.82	
1	35	336	0.92-0.25	9.24e-02	0.58	-0.53	561.31	86.87	86.89	561.29	2.93	
1	35	337	1.52-0.44	0.13	0.95	-0.89	609.65	106.50	106.52	609.63	3.35	
1	35	338	2.22-0.50	0.25	1.46	-1.22	705.49	128.79	128.80	705.49	1.03	
1	35	339	2.72-0.71	-0.12	2.14	-1.29	854.56	138.62	138.62	854.55	-1.74	
1	35	340	3.551.35	2.06	2.84	-1.03	1045.17	187.40	188.38	1044.19	-28.99	



EGP CODE

GRE.EEC.R.73.IT.W.15235.12.024.01

PAGE

367 di/of 527

1	35	341	3.772.34	3.67	2.44	-0.37	1260.86	187.26	187.40	1260.73	-12.10	
1	35	342	7.14-10.81	6.99	-10.65	1.64	1509.91	52.54	53.62	1508.82	-39.79	
1	35	343	23.39-62.89	22.76	-62.26	7.35	1850.99	-437.09	-435.97	1849.87	-50.49	
1	35	344	18.770.94	1.85	17.86	3.93	11.67	-698.59	-691.30	4.38	71.60	
1	35	345	32.5916.00	20.04	28.54	7.12	209.04	-797.03	-797.02	209.03	-4.01	
1	35	346	0.63-4.64	-1.09	-2.92	2.47	64.69	-212.21	63.34	-210.85	-19.31	
1	35	347	-1.42-4.83	-4.83	-1.42	6.62e-02	236.45	-124.36	231.86	-119.77	-40.45	
1	35	348	-2.11-6.57	-6.54	-2.14	0.32	142.53	-124.00	140.84	-122.31	-21.12	
1	35	349	6.45-2.95	1.15	2.35	4.66	-206.75	-449.70	-319.64	-336.82	121.17	
1	35	350	19.791.51	1.59	19.71	-1.19	177.12	-292.79	-280.46	164.79	75.12	
1	35	351	19.7917.51	17.65	19.65	0.54	-63.55	-481.21	-477.34	-67.43	-40.05	
1	35	352	0.14-4.34	-2.05	-2.16	2.24	329.81	-128.45	321.84	-120.48	59.90	
1	35	353	-0.65-3.54	-3.37	-0.82	-0.68	551.48	-86.66	551.09	-86.27	15.76	
1	35	354	-0.22-2.74	-2.71	-0.25	-0.27	671.31	-83.21	669.24	-81.15	39.44	
1	35	355	-0.16-2.74	-2.74	-0.16	7.43e-02	676.64	-93.49	673.85	-90.69	46.30	
1	35	356	-0.45-3.54	-3.37	-0.62	0.71	571.09	-109.89	564.42	-103.22	67.06	
1	35	357	9.20-8.86	-5.67	6.01	6.89	77.34	-610.41	-31.03	-502.04	-250.57	
1	35	358	-4.27-12.07	-4.76	-11.58	1.89	8.87	-509.21	-285.05	-215.28	256.68	
1	35	359	1.11-8.80	-4.37	-3.32	4.93	266.05	-244.11	-167.39	189.32	182.36	
1	35	360	1.29-1.45	-0.79	0.64	1.17	472.07	-10.94	-1.30	462.42	67.57	
1	35	361	0.48-0.54	-0.53	0.47	0.10	525.92	55.98	59.32	522.58	39.47	
1	35	362	0.91-0.19	0.14	0.58	-0.51	555.05	96.47	96.65	554.87	9.17	
1	35	363	1.54-0.46	0.17	0.91	-0.93	606.91	112.92	112.92	606.91	-0.15	
1	35	364	2.12-0.45	0.28	1.39	-1.16	703.64	133.33	133.38	703.59	-5.67	
1	35	365	2.74-0.36	0.35	2.02	-1.31	851.84	155.47	155.86	851.45	-16.40	
1	35	366	3.040.21	0.44	2.80	-0.78	1034.65	175.88	176.54	1033.99	-23.78	
1	35	367	4.020.91	0.95	3.99	0.32	1223.19	179.41	182.52	1220.09	-56.82	
1	35	368	13.111.15	3.27	10.98	4.57	1456.35	127.83	152.71	1431.47	-180.13	
1	35	369	34.47-1.24	7.74	25.49	15.50	1220.48	-187.52	36.40	996.56	-514.92	
1	35	370	7.98-14.78	-0.51	-6.29	11.00	488.54	-532.53	-44.62	0.64	-510.03	
1	35	371	-2.05-5.96	-4.34	-3.66	-1.92	193.36	-268.13	192.69	-267.46	-17.58	
1	35	372	6.482.61	6.34	2.75	-0.72	314.73	35.25	285.25	64.73	85.85	
1	35	373	0.17-2.67	-0.94	-1.56	1.39	346.97	31.97	109.93	269.01	135.94	
1	35	374	1.98-0.91	1.24	-0.17	1.27	436.04	115.18	140.66	410.56	86.75	
1	35	375	0.64-0.13	0.28	0.22	0.38	497.92	114.90	119.63	493.19	42.32	
1	35	376	0.54-0.23	-0.16	0.47	-0.22	540.13	108.42	109.09	539.46	16.98	
1	35	377	1.31-0.25	0.27	0.79	-0.73	599.09	126.37	126.39	599.07	2.80	
1	35	378	2.00-0.43	0.37	1.21	-1.14	699.14	143.77	143.87	699.04	-7.43	
1	35	379	2.53-0.33	0.45	1.75	-1.28	842.63	170.19	170.47	842.35	-13.67	
1	35	380	2.90-0.59	-0.27	2.58	-0.99	1012.20	193.22	194.00	1011.41	-25.32	
1	35	381	4.21-0.56	-0.48	4.12	-0.62	1165.02	231.34	234.80	1161.55	-56.79	
1	35	382	7.20-2.07	-2.02	7.15	-0.70	1168.10	216.62	258.48	1126.24	-195.13	
1	35	383	6.93-7.95	-7.18	6.15	-3.30	941.94	89.39	321.04	710.29	-379.25	
1	35	384	10.29-9.84	-4.86	5.31	-8.68	742.96	-139.47	359.92	243.58	-437.36	
1	35	385	2.62-0.82	2.61	-0.81	-0.20	463.93	-130.06	463.57	-129.70	14.53	
1	35	386	1.48-0.58	1.48	-0.58	2.04e-02	386.90	108.16	383.57	111.49	30.28	
1	35	387	1.79-0.85	1.66	-0.72	0.56	341.37	245.50	303.33	283.53	46.90	
1	35	388	2.36-0.86	2.14	-0.64	0.81	405.43	224.60	232.91	397.12	37.86	
1	35	389	1.99-0.25	1.80	-5.62e-02	0.63	472.71	178.86	181.27	470.30	26.52	
1	35	390	0.60-0.36-7.83e-02	0.32	0.44	0.44	525.85	122.25	122.72	525.38	13.73	
1	35	391	0.670.26	0.26	0.67	8.50e-03	593.14	132.49	132.78	592.86	11.50	
1	35	392	1.250.22	0.45	1.01	-0.43	696.41	145.53	145.66	696.28	8.46	
1	35	393	1.66-0.23 2.92e-02	1.40	-0.65	838.53	170.98	170.98	838.52	2.46		
1	35	394	2.16-1.30	-1.01	1.87	-0.96	992.42	201.38	201.44	992.37	-6.60	
1	35	395	2.84-1.75	-1.40	2.49	-1.21	1085.11	268.56	269.86	1083.81	-32.57	
1	35	396	3.32-2.52	-2.12	2.92	-1.47	1005.53	360.62	373.69	992.46	-90.88	
1	35	397	4.20-4.14	-3.46	3.51	-2.29	759.40	428.55	531.24	656.71	-153.07	
1	35	398	3.05-5.33	-3.81	1.53	-3.23	708.58	173.08	639.70	241.96	-179.29	
1	35	399	2.32-0.75	2.29	-0.73	0.28	461.18	-120.50	459.90	-119.21	-27.29	
1	35	400	1.90-0.69	1.83	-0.63	0.42	404.27	120.16	399.63	124.80	-36.01	
1	35	401	1.89-0.94	1.85	-0.90	0.32	345.67	253.09	312.52	286.25	-44.39	
1	35	402	2.13-0.69	2.07	-0.63	0.41	406.60	220.93	228.74	398.78	-37.28	
1	35	403	1.42-0.52	1.09	-0.19	0.73	467.79	163.55	163.68	467.66	-6.34	
1	35	404	1.02-0.82-6.79e-02	0.27	0.27	0.91	524.16	119.12	119.13	524.15	-1.57	
1	35	405	1.14-0.23	0.26	0.64	0.66	593.83	129.20	129.26	593.77	-5.25	
1	35	406	1.130.31	0.46	0.97	0.32	699.23	136.60	136.60	699.23	4.35e-03	
1	35	407	1.280.56	0.60	1.24	0.15	844.88	174.17	175.11	843.94	25.07	
1	35	408	1.52-0.15	-0.11	1.48	-0.24	995.99	206.67	207.26	995.41	21.51	
1	35	409	1.80-1.68	-1.55	1.67	-0.67	1071.93	253.36	255.83	1069.45	44.93	
1	35	410	1.95-2.48	-2.36	1.83	-0.74	971.13	347.41	358.37	960.17	81.95	
1	35	411	1.34-3.67	-3.63	1.30	-0.45	699.55	452.49	523.11	628.93	111.62	
1	35	412	0.55-4.74	-4.73	0.55	-8.55e-02	677.98	211.45	644.32	245.12	120.71	
1	35	413	2.60-1.32	2.35	-1.08	0.95	291.80	-195.45	281.10	-184.74	-71.42	
1	35	414	1.55-1.09	1.37	-0.91	0.66	274.74	13.58	234.01	54.31	-94.76	
1	35	415	1.62-0.97	1.61	-0.96	0.15	360.08	94.14	186.71	267.51	-126.68	
1	35	416	4.90e-02	-0.79	-7.69e-03	-0.73	0.21	433.99	87.48	116.18	405.29	-95.50



EGP CODE

GRE.EEC.R.73.IT.W.15235.12.024.01

PAGE

368 di/of 527

1	35	417	1.95-0.21	1.78	-3.91e-02	0.59	494.52	130.44	138.22	486.74	-52.65
1	35	418	1.26-0.30	0.64	0.32	0.76	539.55	112.78	114.33	538.00	-25.66
1	35	419	1.15-0.15	0.23	0.78	0.59	602.25	114.99	115.26	601.98	-11.44
1	35	420	1.341.76e-03	0.12	1.22	0.38	706.19	121.54	121.55	706.18	-2.92
1	35	421	1.73-0.20-5.38e-02	0.12	1.59	0.51	856.36	140.27	140.35	856.29	7.18
1	35	422	2.010.45	0.72	1.75	0.59	1029.33	177.22	178.27	1028.27	29.99
1	35	423	2.010.95	0.98	1.98	0.18	1147.77	197.18	205.98	1138.97	91.04
1	35	424	2.13-2.77	-2.77	2.13	4.96e-02	1087.99	138.81	193.55	1033.25	221.27
1	35	425	3.42-4.29	-4.09	3.22	1.23	879.11	94.61	309.60	664.12	349.92
1	35	426	2.42-6.31	-5.28	1.38	2.82	678.25	-92.41	363.94	221.91	378.73
1	35	427	1.11-6.72	-0.65	-4.96	3.27	-150.12	-476.15	-193.30	-432.97	110.52
1	35	428	4.072.19	4.00	2.26	-0.35	113.00	-207.13	-65.23	-28.90	-159.03
1	35	429	-2.16-2.85	-2.76	-2.25	-0.24	292.67	-191.20	-136.35	237.82	-153.40
1	35	430	0.28-0.13	-0.11	0.27	8.03e-02	453.71	-37.82	-19.30	435.19	-93.58
1	35	431	1.56-6.00e-02	1.45	4.79e-02	0.40	521.93	70.57	74.71	517.79	-43.01
1	35	432	0.772.05e-02	0.34	0.45	0.37	555.65	81.82	82.39	555.08	-16.41
1	35	433	1.047.92e-028.77e-02	1.03	8.98e-02	609.19	96.43	96.54	609.08	-7.51	
1	35	434	1.72-0.10-9.21e-02	1.71	0.14	710.42	109.76	109.83	710.36	-6.25	
1	35	435	2.57-0.37	-0.27	2.48	0.53	863.25	118.51	118.52	863.23	-3.47
1	35	436	3.40-0.68	-0.43	3.14	0.99	1059.48	117.23	117.25	1059.46	5.00
1	35	437	3.930.44	1.00	3.37	1.28	1259.93	103.83	105.78	1257.98	47.43
1	35	438	4.941.32	1.40	4.85	-0.55	1276.95	-35.61	2.48	1238.86	220.31
1	35	439	5.14-13.65	-12.45	3.95	4.58	873.20	-490.70	-252.74	635.24	517.62
1	35	440	9.87-6.88	0.58	2.40	8.33	561.11	-703.37	-308.13	165.86	586.14
1	35	441	17.22-1.51	10.34	5.37	-9.03	-500.07	-1675.70	-1069.80	-1105.96	587.54
1	35	442	-8.49-26.12	-16.63	-17.98	-8.79	-354.87	-940.08	-858.85	-436.10	-202.34
1	35	443	3.32-4.08	-1.76	1.00	-3.43	211.67	-378.72	-365.34	198.29	-87.86
1	35	444	1.44-0.26	1.37	-0.19	0.33	479.89	-55.71	-55.40	479.58	-12.95
1	35	445	1.03-4.81e-02	1.00	-1.23e-02	0.19	533.33	29.49	29.53	533.28	4.97
1	35	446	0.630.41	0.48	0.55	-0.11	560.27	68.67	68.68	560.26	2.09
1	35	447	1.40-0.26-9.40e-02	1.23	1.23	-0.49	607.24	84.04	84.23	607.05	-9.87
1	35	448	2.21-0.57	-0.51	2.15	-0.40	703.44	97.32	97.57	703.19	-12.32
1	35	449	3.39-1.07	-1.07	3.39	-8.21e-02	857.63	100.82	102.18	856.27	-31.97
1	35	450	5.29-1.73	-1.71	5.27	0.35	1058.42	87.32	88.73	1057.01	-37.00
1	35	451	7.14-3.37	-3.02	6.79	1.88	1276.88	23.84	25.33	1275.40	-43.14
1	35	452	9.423.70	3.75	9.38	0.51	1631.35	-50.24	-50.22	1631.33	5.82
1	35	453	27.07-3.70	13.78	9.60	-15.24	1560.57	-645.92	-561.50	1476.16	423.25
1	35	454	37.24-18.77	28.43	-9.95	-20.40	-218.41	-1859.36	-1546.90	-530.87	644.28
1	35	455	36.78-9.26	-8.85	36.38	-4.28	-631.51	-985.66	-941.71	-675.46	116.76
1	35	456	6.402.64	2.65	6.39	0.19	356.57	-309.64	-306.36	353.29	46.64
1	35	457	-0.11-1.15	-0.17	-1.09	0.24	461.97	-104.70	-102.20	459.47	37.58
1	35	458	0.909.49e-02	0.89	0.11	-0.11	536.13	21.83	23.64	534.31	30.49
1	35	459	0.892.56e-02	0.40	0.52	-0.43	556.83	64.79	65.77	555.84	21.95
1	35	460	1.55-0.33-4.32e-02	1.26	1.26	-0.68	602.25	86.45	86.49	602.21	4.41
1	35	461	2.38-0.74	-0.56	2.21	-0.72	697.05	100.52	100.62	696.95	-7.90
1	35	462	3.65-1.20	-1.11	3.55	-0.66	851.68	110.41	111.85	850.24	-32.57
1	35	463	5.38-1.64	-1.60	5.33	-0.55	1046.04	107.48	110.29	1043.23	-51.28
1	35	464	10.310.97	0.97	10.31	-0.12	1305.13	139.19	145.72	1298.59	-87.06
1	35	465	9.42-3.14	-3.12	9.40	-0.53	1690.58	-25.35	-17.96	1683.19	-112.37
1	35	466	68.91-69.95	68.85	-69.89	2.74	2449.98	19.30	52.87	2416.41	-283.70
1	35	467	13.18-11.38	-6.42	8.21	9.86	-39.72	-975.00	-252.36	-762.36	-392.00
1	35	468	-7.61-18.14	-8.56	-17.19	3.02	-128.96	-861.18	-632.15	-357.99	339.47
1	35	469	2.68-6.50	-2.52	-1.30	4.54	255.00	-372.76	-284.02	166.26	218.71
1	35	470	1.35-0.14	1.35	-0.13	6.10e-02	483.03	-53.10	-31.70	461.63	104.96
1	35	471	0.864.71e-02	0.85	5.64e-02	-8.69e-02	530.10	34.42	43.69	520.84	67.14
1	35	472	0.981.05e-02	0.39	0.60	-0.47	550.32	72.96	76.16	547.12	38.94
1	35	473	1.65-0.55	-0.16	1.26	-0.84	592.95	90.95	91.30	592.60	13.28
1	35	474	2.53-0.92	-0.59	2.20	-1.00	685.48	105.89	105.95	685.42	-6.20
1	35	475	3.85-1.45	-1.15	3.55	-1.22	835.80	114.77	116.88	833.69	-38.94
1	35	476	6.04-2.18	-1.88	5.73	-1.56	1031.58	110.61	115.61	1026.59	-67.64
1	35	477	9.10-3.25	-2.66	8.50	-2.66	1259.47	77.93	91.13	1246.27	-124.18
1	35	478	12.851.24	2.05	12.04	-2.96	1623.58	-9.44	34.50	1579.64	-264.24
1	35	479	44.517.62	26.64	25.48	18.44	1619.45	-427.88	-143.15	1334.72	-708.42
1	35	480	16.81-21.46	2.68	-7.33	18.47	412.33	-1123.21	-539.72	-171.16	-745.32
1	35	481	-1.69-8.78	-6.00	-4.47	-3.46	68.22	-354.79	67.97	-354.54	-10.17
1	35	482	7.443.84	7.31	3.97	-0.67	274.04	-106.86	150.55	16.64	178.29
1	35	483	-0.53-2.02	-0.90	-1.64	0.64	358.61	-132.63	-4.68	230.66	215.60
1	35	484	0.46-0.46	-0.31	0.31	0.34	457.92	-20.36	39.10	398.45	157.81
1	35	485	1.280.18	1.28	0.18	2.23e-02	507.20	80.90	106.25	481.85	100.81
1	35	486	1.076.78e-02	0.63	0.51	-0.50	526.49	102.79	110.67	518.62	57.22
1	35	487	1.72-0.70-1.51e-02	1.04	1.04	-1.09	568.90	109.06	110.35	567.61	24.32
1	35	488	2.53-0.97	-0.21	1.77	-1.44	658.27	127.97	127.98	658.25	-2.81
1	35	489	3.55-1.84	-1.03	2.74	-1.93	798.84	134.53	136.36	797.01	-34.82
1	35	490	4.98-2.64	-1.56	3.91	-2.66	983.47	143.95	152.45	974.97	-84.03
1	35	491	6.92-1.19	0.91	4.82	-3.55	1192.24	181.40	209.37	1164.28	-165.79
1	35	492	8.111.15	2.61	6.65	-2.83	1297.25	65.03	182.80	1179.47	-362.28



EGP CODE

GRE.EEC.R.73.IT.W.15235.12.024.01

PAGE

369 di/of 527

1	35	493	5.22-6.33	-5.07	3.96	-3.59	1130.97	-305.45	110.91	714.61	-651.70	
1	35	494	6.03-8.32	-4.77	2.48	-6.19	893.45	-607.45	60.74	225.26	-745.92	
1	35	495	2.05-0.65	1.94	-0.55	-0.52	417.53	-156.82	402.80	-142.08	90.82	
1	35	496	2.26-0.43	2.21	-0.38	-0.39	390.67	56.59	354.35	92.91	103.99	
1	35	497	2.73-0.26	2.73	-0.26	3.35e-02	420.17	137.98	290.07	268.08	140.66	
1	35	498	0.31-0.35	0.29	-0.33	0.11	438.04	124.86	186.17	376.73	124.26	
1	35	499	0.20-2.09e-029.18e-028.90e-02		-0.11		468.53	123.38	149.00	442.90	90.49	
1	35	500	0.95-0.11	0.54	0.29	-0.52	493.68	135.60	143.05	486.23	51.11	
1	35	501	1.60-0.70	0.25	0.64	-1.13	541.10	138.91	139.80	540.21	18.93	
1	35	502	2.27-1.20	2.61e-02	1.05	-1.66	628.95	145.71	145.71	628.94	1.83	
1	35	503	3.15-1.26	0.42	1.47	-2.14	758.96	189.07	190.40	757.62	-27.55	
1	35	504	3.92-1.55	0.65	1.73	-2.68	916.45	234.78	242.93	908.30	-74.10	
1	35	505	4.92-0.91	2.17	1.84	-2.91	1053.15	291.13	328.70	1015.59	-164.96	
1	35	506	2.97-3.46	-2.12	1.63	-2.61	1083.49	199.11	336.42	946.18	-320.29	
1	35	507	3.27-4.25	-3.50	2.52	-2.25	1024.64	61.96	460.59	626.02	-474.18	
1	35	508	2.05-5.33	-4.15	0.87	-2.71	942.71	-169.81	556.95	215.94	-529.48	
1	35	509	1.35-0.26	1.34	-0.24	-0.16	521.09	-80.09	519.53	-78.53	30.66	
1	35	510	2.05-0.28	2.05	-0.28	-0.12	490.76	160.98	487.50	164.24	32.64	
1	35	511	2.50-0.42	2.50	-0.42	-3.78e-02	420.79	277.83	398.91	299.71	51.47	
1	35	512	2.44-0.33	2.43	-0.33	-5.12e-02	410.64	271.10	302.48	379.25	58.27	
1	35	513	1.98-0.20	1.96	-0.18	-0.19	436.51	217.29	228.49	425.31	48.27	
1	35	514	0.63-0.23	0.37	2.79e-02	-0.40	468.85	168.11	171.82	465.14	33.19	
1	35	515	1.37-0.60	0.52	0.25	-0.97	522.11	159.49	160.43	521.17	18.43	
1	35	516	2.17-1.03	0.73	0.41	-1.59	608.13	166.75	166.84	608.05	5.99	
1	35	517	2.43-1.35	0.60	0.48	-1.89	726.45	203.09	203.29	726.24	-10.33	
1	35	518	3.86-0.86	2.57	0.42	-2.10	850.52	322.78	325.70	847.61	-39.09	
1	35	519	1.48-3.15	-1.89	0.21	-2.06	925.28	319.59	336.08	908.79	-98.58	
1	35	520	0.87-3.49	-2.68	6.38e-02	-1.69	892.34	389.59	457.50	824.43	-171.84	
1	35	521	9.73e-02	-4.24	-3.81	-0.34	-1.30	840.11	339.98	638.69	541.40	-245.29
1	35	522	-7.02e-02	-5.04	-4.86	-0.25	-0.93	886.44	93.22	775.40	204.26	-275.23
1	35	523	0.89-0.21	0.87	-0.19	0.13	545.15	-63.36	541.99	-60.19	-43.76	
1	35	524	1.71-0.19	1.66	-0.15	0.28	516.68	183.58	511.87	188.40	-39.77	
1	35	525	2.10-0.47	2.07	-0.44	0.28	430.88	309.46	424.79	315.55	-26.51	
1	35	526	2.22-0.50	2.22	-0.50	0.11	387.93	317.58	318.62	386.89	-8.50	
1	35	527	1.98-0.38	1.96	-0.37	-0.21	426.98	234.42	234.73	426.67	-7.74	
1	35	528	0.38-0.46	0.11	-0.18	-0.39	462.51	178.49	178.49	462.51	0.57	
1	35	529	1.14-0.67	0.47	-5.29e-03	-0.87	517.52	160.87	160.94	517.44	5.20	
1	35	530	2.07-0.90	1.10	7.10e-02	-1.39	603.21	172.57	172.80	602.98	9.90	
1	35	531	1.90-1.15	0.70	5.51e-02	-1.49	715.40	196.15	196.50	715.06	13.33	
1	35	532	1.68-1.01	0.73	-6.30e-02	-1.28	822.67	299.60	299.81	822.45	10.62	
1	35	533	9.12e-02	-2.33	-1.92	-0.32	-0.91	866.55	352.55	353.16	865.94	17.73
1	35	534	-0.46-3.02	-2.90	-0.58	-0.55	778.39	486.64	486.82	778.21	7.34	
1	35	535	-0.59-4.34	-4.33	-0.60	-0.14	681.76	514.17	681.68	514.25	-3.71	
1	35	536	-0.38-5.36	-5.36	-0.38	4.03e-02	822.56	191.88	822.43	192.00	-8.93	
1	35	537	0.98-0.49	0.87	-0.39	0.38	507.93	-93.28	489.26	-74.61	-104.29	
1	35	538	1.31-0.66	1.03	-0.38	0.69	482.65	141.50	449.43	174.72	-101.14	
1	35	539	1.70-0.86	1.54	-0.70	0.61	448.15	236.69	368.06	316.77	-102.57	
1	35	540	2.03-0.75	1.98	-0.70	0.36	444.81	231.43	277.42	398.82	-87.74	
1	35	541	1.93-0.50	1.91	-0.48	0.20	457.69	193.85	208.60	442.94	-60.60	
1	35	542	0.58-0.26	0.54	-0.21	0.19	483.37	153.88	158.73	478.52	-39.69	
1	35	543	0.42-3.74e-02	0.38	3.78e-03	-0.13	532.77	142.67	144.15	531.29	-24.01	
1	35	544	0.91-0.15	0.64	0.13	-0.46	616.13	149.35	149.35	616.12	1.32	
1	35	545	0.97-7.17e-02	0.71	0.19	-0.45	732.47	184.44	185.87	731.05	27.93	
1	35	546	0.24-1.11	-1.08	0.21	-0.20	851.73	217.74	225.01	844.45	67.51	
1	35	547	0.25-1.83	-1.82	0.24	0.14	919.91	273.75	300.96	892.71	129.76	
1	35	548	0.40-3.06	-3.00	0.34	0.45	877.98	337.84	418.24	797.59	192.25	
1	35	549	0.36-4.82	-4.63	0.17	0.98	804.48	306.76	594.33	516.90	245.83	
1	35	550	0.18-5.82	-5.61	-4.13e-02	1.13	827.88	75.81	717.22	186.46	266.41	
1	35	551	1.26-1.21	0.99	-0.93	0.77	372.15	-184.62	320.90	-133.36	-160.96	
1	35	552	0.90-1.41	0.29	-0.80	1.02	383.32	8.76	274.46	117.62	-170.07	
1	35	553	1.14-1.19	1.03	-1.08	0.49	447.53	76.50	220.01	304.02	-180.70	
1	35	554	2.02-1.02	2.00	-1.00	0.27	485.09	114.23	181.87	417.46	-143.21	
1	35	555	1.96-0.51	1.83	-0.38	0.55	499.12	126.29	150.45	474.97	-91.77	
1	35	556	1.17-0.35	0.86	-3.51e-02	0.62	515.32	115.11	120.87	509.55	-47.69	
1	35	557	0.75-0.14	0.35	0.26	0.44	558.18	116.49	117.07	557.61	-15.93	
1	35	558	0.76-0.19	4.91e-02	0.53	0.41	643.04	117.10	117.66	642.48	17.13	
1	35	559	0.97-0.69	-0.52	0.81	0.49	771.03	129.58	133.73	766.88	51.43	
1	35	560	1.31-1.20	-1.07	1.18	0.56	919.81	141.89	155.82	905.88	103.14	
1	35	561	1.74-1.81	-1.71	1.64	0.59	1030.01	140.87	185.32	985.56	193.77	
1	35	562	2.31-3.08	-2.93	2.16	0.88	1029.20	97.34	240.82	885.72	336.33	
1	35	563	3.76-5.35	-4.96	3.37	1.84	923.26	-9.16	360.03	554.07	456.00	
1	35	564	2.74-7.35	-6.01	1.39	3.43	809.90	-222.33	419.55	168.02	500.55	
1	35	565	-0.79-8.30	-2.98	-6.11	3.41	-91.69	-359.59	-114.08	-337.20	-74.14	
1	35	566	4.501.54	4.28	1.75	0.76	227.63	-177.60	11.69	38.34	-202.17	
1	35	567	-1.54-2.75	-1.87	-2.42	-0.54	414.73	-196.48	-81.73	299.97	-238.68	
1	35	568	2.22-0.44	2.20	-0.42	-0.23	506.57	-12.28	39.52	454.76	-155.55	





EGP CODE

GRE.EEC.R.73.IT.W.15235.12.024.01

PAGE

370 di/of 527

1	35	569	1.82-0.11	1.68	1.97e-02	0.49	535.88	58.22	72.32	521.79	-80.83
1	35	570	0.942.43e-02	0.62	0.34	0.44	549.81	72.84	76.24	546.40	-40.15
1	35	571	0.855.63e-02	0.21	0.69	0.32	587.21	84.93	85.25	586.89	-12.61
1	35	572	1.27-0.31	-0.15	1.11	0.47	672.12	92.43	92.76	671.79	13.90
1	35	573	1.82-0.84	-0.70	1.67	0.61	809.18	89.49	92.35	806.32	45.24
1	35	574	2.59-1.33	-1.25	2.51	0.55	985.29	74.06	83.24	976.10	91.03
1	35	575	4.27-1.89	-1.89	4.27	8.97e-02	1160.09	20.35	47.74	1132.70	174.54
1	35	576	6.76-3.61	-3.60	6.75	0.33	1186.46	-135.54	-22.14	1073.07	370.21
1	35	577	5.84-11.03	-10.22	5.03	3.60	937.04	-467.42	-120.03	589.64	605.99
1	35	578	9.50-10.00	-5.09	4.59	8.47	649.51	-695.06	-172.48	126.93	655.41
1	35	579	13.15-4.60	8.64	-9.08e-02	-7.73	-441.77	-938.97	-672.39	-708.35	247.95
1	35	580	-9.90-19.03	-11.32	-17.60	-3.32	-102.08	-861.45	-684.89	-278.64	-320.78
1	35	581	1.34-7.69	-4.21	-2.14	-4.39	306.57	-449.39	-386.43	243.61	-208.89
1	35	582	1.00-3.57e-02	0.21	0.76	-0.44	531.14	-132.15	-120.93	519.92	-85.52
1	35	583	1.760.35	1.47	0.64	0.57	563.64	6.98	9.18	561.44	-34.96
1	35	584	1.250.26	0.75	0.76	0.50	573.63	48.62	49.07	573.19	-15.32
1	35	585	1.24-0.15-2.33e-02	1.11	1.11	0.40	607.40	62.08	62.16	607.32	-6.88
1	35	586	1.77-0.47	-0.36	1.66	0.48	690.96	73.90	73.97	690.90	6.18
1	35	587	2.51-0.96	-0.88	2.42	0.53	833.14	68.48	68.72	832.89	13.63
1	35	588	3.40-1.40	-1.40	3.39	0.17	1022.15	37.00	37.79	1021.36	27.98
1	35	589	5.080.26	0.52	4.82	-1.09	1225.64	-9.52	-5.13	1221.24	73.55
1	35	590	17.810.23	3.02	15.01	-6.43	1497.57	-183.30	-154.28	1468.56	218.92
1	35	591	26.61-7.54	-1.34	20.40	-13.17	1076.53	-878.97	-640.42	837.98	639.98
1	35	592	23.82-21.76	21.71	-19.65	-9.58	-3.27	-1358.32	-1014.67	-346.91	589.55
1	35	593	24.392.62	3.03	23.98	-2.98	-385.80	-1114.82	-1104.29	-396.33	86.97
1	35	594	10.515.86	6.00	10.38	0.78	429.88	-361.17	-360.10	428.81	29.06
1	35	595	1.67-1.19	-1.16	1.63	0.31	525.76	-183.64	-182.72	524.85	25.50
1	35	596	1.720.57	1.33	0.96	0.54	573.66	-5.52	-4.68	572.82	21.98
1	35	597	1.070.47	0.57	0.97	0.22	582.58	40.29	42.08	580.79	31.08
1	35	598	1.33-0.16	-0.16	1.33	6.10e-02	612.96	59.19	60.17	611.98	23.29
1	35	599	1.94-0.47	-0.47	1.94	4.05e-02	695.44	72.91	73.61	694.74	20.90
1	35	600	2.81-0.96	-0.96	2.81	0.11	836.96	68.99	69.11	836.83	9.87
1	35	601	3.81-1.37	-1.37	3.81	-0.13	1027.88	35.74	35.77	1027.85	-5.73
1	35	602	4.261.88	2.41	3.73	-1.00	1262.23	15.80	16.15	1261.88	-20.86
1	35	603	10.35-11.77	9.10	-10.52	-5.11	1561.47	-179.30	-175.90	1558.07	-76.87
1	35	604	29.93-71.93	29.90	-71.89	-1.96	1915.95	-903.49	-889.82	1902.28	-195.84
1	35	605	-6.56-8.33	-8.14	-6.76	0.56	255.61	-228.59	247.00	-219.98	64.00
1	35	606	22.995.74	6.42	22.30	3.37	-86.81	-928.10	-859.46	-155.45	230.29
1	35	607	10.18-15.00	-11.55	6.73	8.66	445.38	-11.79	411.05	22.55	120.49
1	35	608	9.44-7.26	-6.17	8.36	4.12	432.44	-384.82	326.88	-279.25	-274.10
1	35	609	6.77-3.35	3.55	-0.14	-4.71	146.32	-79.22	32.16	34.94	112.76
1	35	610	-4.94e-03	-7.17	-4.81	-2.36	3.36	260.30	-148.66	-141.03	252.67
1	35	611	2.79-0.32	-0.17	2.64	0.67	451.84	-49.97	-49.96	451.83	-1.51
1	35	612	2.77-0.10-4.80e-02	2.71	2.71	0.40	490.64	-30.84	-30.27	490.07	-17.23
1	35	613	3.039.35e-043.57e-02	3.00	3.00	0.32	499.76	-18.41	-17.66	499.01	-19.67
1	35	614	3.592.28e-024.63e-02	3.56	3.56	0.29	524.12	-13.60	-12.58	523.09	-23.45
1	35	615	4.476.10e-027.63e-02	4.45	4.45	0.26	590.10	-13.23	-11.71	588.58	-30.24
1	35	616	5.658.90e-029.73e-02	5.64	5.64	0.22	701.93	-15.71	-14.54	700.76	-29.05
1	35	617	7.015.76e-025.88e-02	7.01	9.14e-02	850.70	-18.94	-18.26	850.03	-24.22	
1	35	618	7.74-0.75	-0.74	7.73	-0.35	1009.98	-25.75	-25.75	1009.98	-0.69
1	35	619	9.28-6.01	-0.68	3.95	7.29	10.41	-349.75	-4.88	-334.46	-72.62
1	35	620	-6.46-11.74	-6.46	-11.73	0.16	126.96	-541.46	-283.05	-131.45	325.50
1	35	621	-0.34-5.99	-3.88	-2.46	2.74	351.38	-337.44	-217.17	231.11	261.50
1	35	622	1.17-1.80	-1.44	0.81	0.97	529.71	-117.15	-78.20	490.76	153.88
1	35	623	0.980.48	0.71	0.74	0.25	561.21	19.98	35.61	545.57	90.65
1	35	624	1.115.44e-02	0.25	0.92	-0.41	566.48	60.17	64.63	562.02	47.31
1	35	625	1.74-0.58	-0.13	1.30	-0.91	597.22	79.16	79.72	596.66	17.01
1	35	626	2.38-0.90	-0.42	1.90	-1.15	677.13	93.24	93.29	677.08	-5.80
1	35	627	3.17-1.29	-0.89	2.78	-1.26	813.46	94.91	97.08	811.29	-39.46
1	35	628	4.32-1.64	-1.31	3.98	-1.37	992.36	80.91	86.78	986.49	-72.91
1	35	629	5.891.50	1.70	5.70	-0.90	1197.57	81.56	105.23	1173.90	-160.80
1	35	630	14.722.94	4.27	13.39	3.73	1417.86	-52.23	34.90	1330.73	-347.13
1	35	631	32.461.23	6.28	27.42	11.49	1134.73	-493.12	-102.96	744.57	-694.91
1	35	632	6.70-13.51	3.85	-10.66	7.04	638.04	-775.23	-156.70	19.51	-701.12
1	35	633	-1.63-6.60	-3.20	-5.03	-2.31	198.94	-250.02	186.79	-237.86	72.87
1	35	634	4.981.27	4.37	1.87	-1.37	335.40	41.86	263.28	113.98	126.37
1	35	635	0.56-1.88	-0.19	-1.13	1.13	450.20	-8.65	118.41	323.15	205.32
1	35	636	0.88-0.48	0.44	-3.54e-02	0.64	500.67	52.33	114.54	438.46	154.99
1	35	637	0.940.23	0.84	0.33	-0.25	527.34	95.99	119.86	503.48	98.61
1	35	638	1.46-0.43	0.43	0.60	-0.94	537.52	106.86	113.22	531.17	51.92
1	35	639	2.19-1.16	6.63e-02	0.97	-1.61	571.74	111.55	112.92	570.37	25.05
1	35	640	2.73-1.49	-0.22	1.46	-1.93	648.77	123.86	123.89	648.74	-3.45
1	35	641	3.35-1.90	-0.65	2.11	-2.23	773.61	137.12	139.53	771.21	-39.02
1	35	642	4.17-2.27	-1.10	3.00	-2.48	933.92	151.13	162.40	922.64	-93.27
1	35	643	5.34-1.37	-0.56	4.53	-2.19	1091.35	171.30	207.00	1055.66	-177.67
1	35	644	7.62-2.00	-1.33	6.95	-2.45	1152.51	91.29	230.27	1013.52	-358.02

55.33





EGP CODE

GRE.EEC.R.73.IT.W.15235.12.024.01

PAGE

371 di/of 527

1	35	645	4.48-6.97	-6.31	3.82	-2.67	1041.27	-134.36	269.23	637.68	-558.20	
1	35	646	6.67-11.94	-9.05	3.79	-6.74	807.46	-404.18	226.57	176.71	-605.30	
1	35	647	0.40-0.78	0.26	-0.64	-0.39	477.78	-92.96	469.56	-84.73	68.01	
1	35	648	0.63-0.90	0.36	-0.64	-0.58	432.41	157.53	410.18	179.76	74.93	
1	35	649	1.41-0.66	1.39	-0.64	-0.21	435.83	239.56	332.60	342.78	98.00	
1	35	650	2.05-0.56	2.04	-0.55	-0.18	469.82	223.58	262.66	430.75	89.97	
1	35	651	0.75-0.38	0.45	-8.06e-02	-0.50	491.03	163.05	179.74	474.34	72.08	
1	35	652	1.31-0.74	0.33	0.24	-1.02	508.82	150.20	155.50	503.51	43.30	
1	35	653	2.04-1.27	0.22	0.56	-1.65	546.35	143.04	143.74	545.65	16.71	
1	35	654	2.52-1.65-3.87e-03	0.87	0.87	-2.03	621.18	149.49	149.50	621.17	1.79	
1	35	655	2.83-2.08	-0.45	1.20	-2.31	733.42	176.05	177.36	732.11	-27.01	
1	35	656	3.13-2.48	-0.88	1.53	-2.53	863.53	217.37	225.42	855.48	-71.67	
1	35	657	3.27-2.58	-1.12	1.82	-2.53	961.68	267.63	301.59	927.72	-149.72	
1	35	658	2.96-3.06	-1.90	1.80	-2.37	975.95	280.96	410.21	846.69	-270.41	
1	35	659	3.21-4.49	-3.71	2.43	-2.32	924.09	173.16	554.47	542.78	-375.42	
1	35	660	2.25-5.69	-4.48	1.04	-2.85	905.14	-62.97	661.97	180.20	-419.87	
1	35	661	-0.19-0.44	-0.28	-0.35	-0.12	556.20	-43.22	555.78	-42.80	-15.83	
1	35	662	0.46-0.38	0.44	-0.36	-0.15	503.64	222.56	503.47	222.72	-6.85	
1	35	663	1.24-0.63	1.24	-0.63	-7.65e-02	418.81	358.43	412.00	365.24	19.09	
1	35	664	1.73-0.57	1.73	-0.56	-7.94e-02	442.96	305.12	312.29	435.78	30.62	
1	35	665	0.55-0.34	0.53	-0.31	-0.15	473.49	216.47	222.66	467.29	39.41	
1	35	666	0.63-0.76	-0.11	-1.84e-02	-0.70	495.04	168.07	172.06	491.05	35.90	
1	35	667	1.82-1.29	0.29	0.24	-1.55	532.61	159.44	159.87	532.18	12.70	
1	35	668	2.28-1.71	0.15	0.42	-1.99	604.86	161.73	161.91	604.68	8.92	
1	35	669	2.11-1.89	-0.30	0.51	-1.96	706.39	192.07	192.25	706.21	9.69	
1	35	670	1.70-1.95	-0.75	0.50	-1.71	808.65	260.70	261.47	807.89	-20.48	
1	35	671	1.29-2.27	-1.35	0.37	-1.56	856.37	350.66	354.87	852.16	-45.96	
1	35	672	0.88-2.88	-2.24	0.24	-1.41	797.21	457.33	490.82	763.72	-101.29	
1	35	673	0.32-4.20	-3.83	-4.97e-02	-1.24	763.94	408.50	676.51	495.92	-153.08	
1	35	674	4.09e-02	-5.25	-5.09	-0.12	-0.90	848.80	132.56	803.05	178.31	-175.14
1	35	675	-0.26-0.91	-0.86	-0.31	0.17	535.21	-39.19	534.10	-38.08	-25.22	
1	35	676	0.36-0.65 4.80e-02	-0.34	0.47	0.47	491.80	228.00	487.71	232.09	-32.60	
1	35	677	1.13-0.84	0.91	-0.62	0.61	436.66	344.35	403.08	377.93	-44.41	
1	35	678	1.53-0.83	1.31	-0.62	0.68	465.71	286.83	302.67	449.86	-50.83	
1	35	679	0.97-0.82	0.52	-0.37	0.77	486.54	212.09	220.44	478.19	-47.15	
1	35	680	0.43-0.57-4.18e-02	-9.07e-02	0.50	0.50	503.42	164.46	170.16	497.72	-43.61	
1	35	681	0.405.15e-02	0.31	0.14	-0.15	539.15	153.62	157.53	535.24	-38.64	
1	35	682	0.71-0.26	0.17	0.28	-0.48	606.75	157.14	158.79	605.10	-27.20	
1	35	683	0.48-0.42	-0.28	0.33	-0.33	703.68	186.91	187.03	703.56	-7.78	
1	35	684	0.25-0.73	-0.73	0.25	-4.32e-02	801.37	250.87	251.77	800.47	22.15	
1	35	685	8.75e-02	-1.33	-1.33	8.73e-02	1.76e-02	845.26	331.37	337.75	838.88	56.91
1	35	686	-2.07e-02	-2.42	-2.42	-2.35e-02	-8.11e-02	787.16	430.12	470.04	747.23	112.52
1	35	687	-0.21-4.27	-4.27	-0.21	5.54e-02	742.09	393.10	655.68	479.51	150.63	
1	35	688	-0.16-5.49	-5.48	-0.18	0.26	822.92	126.63	781.56	167.99	164.58	
1	35	689	-0.44-1.31	-1.16	-0.59	0.33	446.43	-109.79	407.12	-70.49	-142.54	
1	35	690	0.34-1.39	-0.48	-0.57	0.86	450.00	127.34	367.93	209.41	-140.52	
1	35	691	0.93-1.04	0.67	-0.77	0.67	481.21	200.60	299.05	382.76	-133.91	
1	35	692	1.54-0.88	1.34	-0.68	0.66	507.82	199.03	235.38	471.47	-99.52	
1	35	693	1.13-0.97	0.39	-0.23	1.01	515.20	155.80	166.79	504.21	-61.88	
1	35	694	1.23-1.07	0.12	4.59e-02	1.15	523.76	140.19	143.29	520.66	-34.35	
1	35	695	1.28-0.80	0.19	0.29	1.04	554.19	136.24	137.19	553.23	-19.95	
1	35	696	1.28-0.74 4.05e-02	0.50	0.98	0.98	621.88	141.96	142.21	621.62	11.04	
1	35	697	1.32-1.02	-0.38	0.68	1.04	727.85	162.48	165.78	724.54	43.08	
1	35	698	1.37-1.32	-0.80	0.86	1.06	847.48	190.63	203.17	834.93	89.92	
1	35	699	1.31-1.70	-1.29	0.90	1.04	926.04	218.80	257.28	887.56	160.42	
1	35	700	1.09-2.45	-2.26	0.90	0.80	908.46	229.41	346.94	790.93	256.90	
1	35	701	1.69-4.59	-4.51	1.62	0.68	824.78	159.75	494.31	490.23	332.51	
1	35	702	0.99-6.56	-6.14	0.58	1.72	789.66	-55.76	585.27	148.62	361.96	
1	35	703	-0.62-5.61	-1.67	-4.57	2.03	170.43	-266.60	106.36	-202.53	-154.58	
1	35	704	2.570.40	2.19	0.78	0.83	357.61	-39.85	152.23	165.54	-198.62	
1	35	705	-0.37-1.71	-0.86	-1.22	-0.65	509.00	-30.32	77.40	401.28	-215.63	
1	35	706	7.34e-02 -3.88e-02	5.60e-02	-2.14e-02	-4.06e-02	555.78	42.04	89.79	508.03	-149.17	
1	35	707	1.14-0.41	0.55	0.18	0.75	559.07	92.71	105.55	546.23	-76.30	
1	35	708	1.22-0.51	0.34	0.37	0.86	558.26	101.61	106.06	553.81	-44.89	
1	35	709	1.20-0.55 2.66e-02	0.63	0.82	0.82	579.75	107.01	107.40	579.36	-13.58	
1	35	710	1.48-0.72	-0.19	0.95	0.94	647.49	116.31	116.67	647.14	13.64	
1	35	711	1.84-1.05	-0.59	1.38	1.06	762.19	122.26	126.02	758.42	48.95	
1	35	712	2.38-1.40	-1.01	2.00	1.14	905.83	123.50	136.86	892.47	101.35	
1	35	713	3.39-1.72	-1.59	3.26	0.81	1030.95	100.78	138.19	993.54	182.75	
1	35	714	4.67-2.81	-2.54	4.40	1.39	1032.98	13.31	135.50	910.79	331.16	
1	35	715	2.11-6.27	-6.08	1.92	1.24	852.43	-180.13	152.87	519.43	482.65	
1	35	716	4.05-10.40	-9.03	2.68	4.24	634.41	-374.35	157.00	103.06	503.66	
1	35	717	9.97-5.07	8.07	-3.17	-5.00	-266.10	-369.35	-269.84	-365.61	-19.31	
1	35	718	-8.63-11.56	-8.79	-11.40	-0.67	198.50	-576.09	-364.42	-13.17	-345.19	
1	35	719	0.41-3.54	-2.84	-0.29	-1.51	458.08	-281.57	-205.81	382.33	-224.26	
1	35	720	0.95-0.57	-0.55	0.93	-0.15	595.06	-77.63	-54.00	571.43	-123.84	



EGP CODE

GRE.EEC.R.73.IT.W.15235.12.024.01

PAGE

372 di/of 527

1	35	721	1.06-0.47	-0.14	0.73	0.63	596.03	21.57	26.38	591.23	-52.33	
1	35	722	1.26-0.44	4.40e-02	0.78	0.77	586.39	65.40	66.71	585.08	-26.07	
1	35	723	1.35-0.52	-0.16	0.99	0.74	604.07	81.67	81.91	603.83	-11.19	
1	35	724	1.73-0.75	-0.42	1.40	0.84	671.18	92.07	92.21	671.05	8.81	
1	35	725	2.27-1.07	-0.82	2.01	0.89	791.91	90.76	92.17	790.50	31.36	
1	35	726	3.01-1.27	-1.20	2.94	0.54	950.92	68.60	73.41	946.11	64.93	
1	35	727	4.47-0.19	-0.13	4.41	-0.52	1110.64	24.17	38.73	1096.07	124.94	
1	35	728	13.43-3.44e-03	1.64	11.79	-4.40	1240.11	-120.44	-56.49	1176.17	287.94	
1	35	729	17.50-6.19	-4.36	15.67	-6.32	821.58	-670.01	-359.29	510.86	605.74	
1	35	730	13.44-17.94	13.04	-17.54	-3.51	217.21	-886.61	-493.86	-175.53	528.46	
1	35	731	11.60-1.43	-1.21	11.38	1.67	1143.07	-60.32	-59.70	1142.45	27.33	
1	35	732	15.156.77	6.87	15.05	-0.91	-97.89	-938.60	-937.96	-98.54	23.24	
1	35	733	8.485.51	5.56	8.42	0.39	546.69	-293.65	-293.08	546.12	21.92	
1	35	734	1.96-0.85	-0.73	1.85	0.56	598.82	-128.63	-128.38	598.57	13.63	
1	35	735	1.45-7.97e-02	0.19	1.19	0.58	614.10	3.08	3.09	614.09	2.86	
1	35	736	1.28-0.31-6.29e-02		1.04	0.57	601.86	48.29	49.33	600.81	24.02	
1	35	737	1.44-0.54	-0.30	1.20	0.65	616.14	70.15	70.90	615.39	20.23	
1	35	738	1.81-0.75	-0.55	1.61	0.68	682.51	81.13	81.81	681.83	20.25	
1	35	739	2.35-1.02	-0.93	2.26	0.53	804.08	78.24	78.44	803.88	12.15	
1	35	740	3.06-1.24	-1.24	3.06	8.82e-03	967.19	48.85	48.94	967.11	9.03	
1	35	741	3.171.17	1.24	3.11	-0.35	1150.07	6.10	6.20	1149.96	-10.83	
1	35	742	7.03-6.70	6.90	-6.58	1.29	1350.41	-190.65	-189.30	1349.06	-45.65	
1	35	743	25.43-55.59	24.86	-55.02	6.75	1469.37	-913.13	-911.63	1467.86	-59.79	
1	35	744	52.1212.48	30.90	33.70	19.77	613.12	214.81	250.71	577.22	114.06	
1	35	745	-2.23-13.71	-7.10	-8.84	5.67	-66.07	-287.45	-287.14	-66.37	-8.26	
1	35	746	26.599.53	10.77	25.35	4.44	-107.34	-549.71	-301.87	-355.19	219.57	
1	35	747	11.10-3.13	4.95	3.03	-7.05	266.35	-647.74	31.99	-413.37	399.13	
1	35	748	18.75-2.49	12.84	3.42	-9.52	58.15	-267.61	-89.22	-120.24	-162.14	
1	35	749	-11.29-18.56-15.18		-14.67	-3.63	-3.27	-314.61	-32.83	-285.06	-91.26	
1	35	750	-0.99-12.30	-5.64	-7.65	-5.56	11.58	-112.27	-110.40	9.70	15.14	
1	35	751	-0.17-1.31	-0.50	-0.98	-0.52	389.12	-37.68	-24.60	376.04	73.56	
1	35	752	-7.57e-02	-0.98	-9.75e-02	-0.96	-0.14	486.40	-14.00	-6.09	478.49	62.41
1	35	753	-0.14-0.96	-0.16	-0.93	-0.13	544.64	0.31	4.66	540.29	48.47	
1	35	754	-0.15-0.60	-0.18	-0.57	-0.11	613.29	8.06	9.81	611.54	32.56	
1	35	755	3.77e-02	-0.22	-0.19	1.39e-01	-7.38e-02	724.51	13.45	13.59	724.37	10.00
1	35	756	0.76-0.24	-0.24	0.76	-3.77e-02	887.91	17.55	17.79	887.67	-14.59	
1	35	757	6.48-5.07	-2.38	3.79	4.88	-200.40	-526.29	-243.27	-483.42	-110.14	
1	35	758	-2.62-9.07	-2.75	-8.95	-0.90	166.02	-610.68	-426.66	-18.00	330.25	
1	35	759	1.89-6.34	-2.81	-1.64	4.07	450.54	-311.58	-244.47	383.43	215.97	
1	35	760	2.13-0.70	2.02e-03	1.43	1.22	603.91	-69.75	-52.70	586.86	105.79	
1	35	761	1.252.51e-02	0.22	1.06	0.44	607.71	23.84	30.70	600.85	62.91	
1	35	762	0.96-1.80e-02-1.76e-02		0.96	2.12e-02	596.89	60.60	64.47	593.02	45.36	
1	35	763	1.12-0.27	-0.27	1.12	2.43e-02	614.65	76.34	81.21	609.79	50.95	
1	35	764	1.49-0.53	-0.53	1.49	-4.12e-02	678.02	89.45	91.90	675.57	37.93	
1	35	765	2.15-0.96	-0.92	2.10	-0.39	794.31	94.41	94.42	794.30	2.93	
1	35	766	2.93-1.32	-1.29	2.91	-0.33	949.03	78.02	79.30	947.74	-33.44	
1	35	767	4.12-0.12	-0.12	4.12	-6.87e-02	1111.01	41.88	51.36	1101.53	-100.19	
1	35	768	10.060.13	1.03	9.16	2.86	1287.26	-122.10	-69.99	1235.16	-265.93	
1	35	769	29.21-3.26	4.60	21.35	13.91	1026.45	-542.23	-261.68	745.90	-601.16	
1	35	770	5.67-13.02	0.57	-7.91	8.33	219.90	-753.95	-353.77	-180.29	-479.14	
1	35	771	-3.20-5.25	-4.78	-3.67	-0.86	128.44	-254.13	96.48	-222.17	105.86	
1	35	772	4.543.88	4.26	4.16	-0.33	368.34	-2.77	181.67	183.89	185.55	
1	35	773	0.17-1.28	-0.67	-0.44	0.72	510.21	-42.38	46.87	420.96	203.35	
1	35	774	1.56-0.72	0.43	0.41	1.14	571.42	42.89	83.08	531.23	140.10	
1	35	775	1.06-0.49-1.15e-02		0.58	0.71	583.03	73.90	89.59	567.34	87.99	
1	35	776	0.76-0.17-6.44e-02		0.66	0.29	578.35	91.28	97.94	571.69	56.58	
1	35	777	0.86-0.20	-0.18	0.83	0.17	596.20	103.30	105.81	593.69	35.08	
1	35	778	1.17-0.43	-0.40	1.13	-0.24	658.75	115.31	115.66	658.40	13.71	
1	35	779	1.97-1.16	-0.78	1.59	-1.02	767.68	127.24	127.64	767.28	-16.02	
1	35	780	2.72-1.56	-1.16	2.32	-1.25	907.54	136.23	141.90	901.88	-65.87	
1	35	781	3.87-1.86	-1.61	3.63	-1.17	1041.27	125.57	149.80	1017.04	-146.97	
1	35	782	6.58-2.31	-2.10	6.36	-1.36	1073.41	48.44	155.61	966.24	-313.62	
1	35	783	6.14-6.66	-6.18	5.66	-2.43	886.76	-145.66	188.31	552.79	-482.97	
1	35	784	7.30-11.22	-7.58	3.66	-7.36	658.84	-416.99	125.22	116.63	-537.90	
1	35	785	0.74-0.49	0.63	-0.38	0.35	474.10	-88.30	450.90	-65.10	111.85	
1	35	786	0.330.11	0.29	0.14	8.10e-02	437.60	167.36	377.67	227.29	112.27	
1	35	787	0.90-0.22	0.81	-0.13	0.30	491.46	222.77	299.94	414.29	121.57	
1	35	788	1.32-0.77	0.81	-0.27	0.89	538.91	188.98	223.90	503.98	104.89	
1	35	789	1.35-0.84	0.43	8.05e-02	1.08	553.42	152.28	170.42	535.27	83.36	
1	35	790	1.15-0.98	-0.11	0.28	1.05	556.77	129.69	139.10	547.36	62.68	
1	35	791	1.13-0.73-6.01e-02		0.46	0.89	581.56	127.13	133.93	574.76	55.16	
1	35	792	0.81-0.27	-0.12	0.66	0.36	641.13	141.10	143.74	638.49	36.25	
1	35	793	0.98-0.42	-0.35	0.91	-0.31	738.42	170.76	170.92	738.27	-9.40	
1	35	794	1.71-1.50	-1.00	1.21	-1.17	853.85	203.60	207.50	849.95	-50.23	
1	35	795	2.41-2.20	-1.40	1.62	-1.74	938.16	243.76	270.40	911.52	-133.37	
1	35	796	2.72-3.21	-2.47	1.99	-1.96	921.87	262.18	364.29	819.76	-238.61	



EGP CODE

GRE.EEC.R.73.IT.W.15235.12.024.01

PAGE

373 di/of 527

1	35	797	3.70-4.22	-3.34	2.82	-2.49	842.90	184.71	514.94	512.67	-329.09	
1	35	798	2.77-5.43	-3.74	1.08	-3.32	807.18	-50.78	600.28	156.12	-367.02	
1	35	799	-0.19-0.51	-0.39	-0.32	0.16	561.12	-23.73	561.12	-23.73	-1.16	
1	35	800	0.11-0.27	6.64e-02	-0.22	0.12	491.73	263.81	491.73	263.82	-0.31	
1	35	801	0.70-0.54	0.55	-0.39	0.40	436.50	381.99	396.06	422.43	23.86	
1	35	802	1.21-0.89	0.70	-0.38	0.90	504.27	290.28	296.60	497.94	36.25	
1	35	803	1.30-1.06	0.44	-0.21	1.13	527.23	216.16	220.73	522.66	37.41	
1	35	804	1.08-1.33	-0.25	4.20e-03	1.20	537.33	163.73	166.13	534.93	29.83	
1	35	805	1.04-0.82	3.95e-02	0.18	0.93	565.58	153.32	154.58	564.32	22.75	
1	35	806	0.69-0.41	-2.40e-02	0.30	0.52	627.83	160.63	161.21	627.24	16.56	
1	35	807	0.54-0.14	3.16e-02	0.37	0.29	721.46	197.58	197.74	721.30	9.20	
1	35	808	0.53-0.20	-5.92e-02	0.39	-0.28	817.03	262.94	263.09	816.89	-8.93	
1	35	809	0.83-1.96	-1.51	0.38	-1.03	856.81	330.26	333.53	853.54	-41.34	
1	35	810	0.95-3.08	-2.51	0.37	-1.41	780.09	442.25	466.31	756.03	-86.89	
1	35	811	0.68-4.13	-3.60	0.15	-1.51	722.68	410.10	651.74	481.04	-130.93	
1	35	812	0.26-4.89	-4.58	-4.57e-02	-1.21	805.44	132.44	770.79	167.09	-148.73	
1	35	813	-0.22-1.19	-1.13	-0.28	0.24	542.41	-22.90	540.38	-20.88	-33.75	
1	35	814	3.54e-02	-0.62	-0.23	-0.35	0.32	488.14	261.52	481.62	268.03	-37.86
1	35	815	0.65-0.73	0.41	-0.49	0.52	465.74	351.91	389.82	427.82	-53.65	
1	35	816	1.11-0.80	0.75	-0.44	0.75	511.41	290.13	297.49	504.04	-39.69	
1	35	817	0.54-1.14	-0.34	-0.27	0.84	530.43	207.08	208.91	528.60	-24.27	
1	35	818	0.90-1.06	-9.11e-02	-6.81e-02	0.98	540.17	170.58	171.26	539.49	-15.82	
1	35	819	0.93-0.76	7.22e-02	0.10	0.84	567.84	160.22	160.43	567.63	-9.29	
1	35	820	0.75-0.46	6.98e-02	0.22	0.60	630.19	167.74	167.74	630.19	0.28	
1	35	821	0.95-0.15	0.56	0.25	0.53	724.71	209.84	210.32	724.23	15.71	
1	35	822	0.98-2.94e-02	0.78	0.17	0.40	821.87	275.09	278.06	818.90	40.16	
1	35	823	1.74e-03	-1.57	-1.57	1.01e-03	3.39e-02	861.15	314.52	322.41	853.26	65.17
1	35	824	-4.28e-02	-2.67	-2.61	-0.10	-0.39	795.53	406.69	448.80	753.42	120.83
1	35	825	-0.20-4.43	-4.39	-0.24	-0.40	727.37	372.82	623.28	476.91	161.46	
1	35	826	-0.24-5.70	-5.69	-0.25	-0.12	789.43	115.44	741.32	163.55	173.52	
1	35	827	-0.28-1.16	-0.86	-0.59	0.42	440.17	-106.60	395.86	-62.29	-149.20	
1	35	828	0.12-0.74	-0.19	-0.43	0.41	450.74	140.15	351.75	239.14	-144.72	
1	35	829	0.60-0.54	0.51	-0.44	0.31	518.73	201.11	286.55	433.28	-140.85	
1	35	830	5.25e-02	-0.72	-0.26	-0.40	0.38	556.49	179.60	210.43	525.65	-103.29
1	35	831	0.43-0.69	-0.16	-0.10	0.56	563.20	163.56	173.20	553.56	-61.31	
1	35	832	0.77-0.79	-7.10e-02	5.62e-02	0.78	562.93	151.70	154.43	560.21	-33.35	
1	35	833	0.89-0.65	-2.22e-02	0.27	0.75	584.75	150.50	150.91	584.35	-13.30	
1	35	834	0.88-0.57	-0.18	0.48	0.65	647.05	157.41	157.53	646.94	7.36	
1	35	835	1.10-0.57	-0.12	0.65	0.74	749.17	185.06	187.15	747.07	34.30	
1	35	836	1.23-0.69	-0.18	0.71	0.85	867.37	218.21	226.93	858.65	74.74	
1	35	837	1.55-0.12	0.82	0.61	0.83	946.42	266.61	297.32	915.71	141.19	
1	35	838	0.46-2.71	-2.61	0.36	0.56	921.32	205.23	315.17	811.38	258.15	
1	35	839	1.09-4.56	-4.54	1.07	0.32	817.15	120.98	442.02	496.11	347.03	
1	35	840	0.31-6.46	-6.32	0.17	0.97	746.23	-88.37	514.76	143.11	373.64	
1	35	841	6.40e-02	-4.99	-1.56	-3.37	2.36	50.07	-269.24	-5.35	-213.82	-120.94
1	35	842	2.540.67	1.23	1.98	-0.86	384.74	-83.36	95.36	206.01	-227.42	
1	35	843	-0.76-1.41	-1.36	-0.82	-0.18	530.51	-20.50	56.03	453.98	-190.56	
1	35	844	0.40-0.59	-0.59	0.39	5.53e-02	597.78	67.55	97.42	567.91	-122.25	
1	35	845	0.44-0.35	-0.12	0.20	0.36	603.15	114.77	125.54	592.38	-71.72	
1	35	846	0.77-0.57	-0.14	0.34	0.63	592.12	125.95	128.93	589.14	-37.18	
1	35	847	0.95-0.59	-0.23	0.59	0.65	608.61	131.37	131.82	608.17	-14.52	
1	35	848	1.17-0.60	-0.39	0.96	0.58	671.56	142.08	142.25	671.39	9.44	
1	35	849	1.69-0.88	-0.64	1.45	0.73	781.30	155.20	157.62	778.88	38.82	
1	35	850	2.37-1.25	-0.94	2.06	1.00	920.42	166.01	174.53	911.90	79.71	
1	35	851	3.23-1.04	-0.51	2.70	1.41	1047.77	159.88	184.22	1023.42	145.00	
1	35	852	3.49-1.35	-1.00	3.14	1.25	1053.22	39.31	138.01	954.52	300.54	
1	35	853	1.80-7.62	-6.79	0.97	2.68	804.11	-259.89	47.04	497.18	482.04	
1	35	854	2.09-4.84	-3.38	0.64	2.82	544.68	-468.78	-7.68	83.58	504.67	
1	35	855	10.880.16	9.72	1.32	-3.34	-465.29	-764.91	-605.64	-624.56	149.51	
1	35	856	-8.24-13.90	-9.49	-12.65	-2.35	187.19	-579.70	-448.90	56.39	-288.44	
1	35	857	3.00-2.64	-1.31	1.67	-2.40	502.83	-165.98	-126.80	463.65	-177.06	
1	35	858	0.83-0.28	-0.19	0.73	0.31	629.25	24.40	35.45	618.20	-81.00	
1	35	859	0.80-0.32	-7.40e-02	0.56	0.46	629.04	83.04	87.33	624.75	-48.19	
1	35	860	0.99-0.48	-0.14	0.64	0.63	615.64	104.80	106.24	614.19	-27.14	
1	35	861	1.12-0.59	-0.39	0.91	0.55	630.59	112.97	113.13	630.43	-9.19	
1	35	862	1.48-0.63	-0.55	1.40	0.40	694.74	125.83	125.92	694.65	7.30	
1	35	863	2.22-1.16	-1.11	2.17	0.41	809.35	130.22	131.61	807.97	30.66	
1	35	864	3.53-1.73	-1.69	3.49	0.47	955.95	125.99	130.17	951.77	58.74	
1	35	865	5.33-2.74	-2.65	5.24	0.85	1096.18	85.79	95.83	1086.14	100.23	
1	35	866	9.758.32e-02	0.19	9.64	1.03	1250.02	-19.10	9.03	1221.89	186.84	
1	35	867	12.07-3.18	1.44	7.45	-7.01	970.13	-576.40	-377.12	770.85	518.15	
1	35	868	24.13-13.05	22.05	-10.97	-8.56	-169.10	-1109.45	-860.05	-418.49	415.12	
1	35	869	20.543.25	3.25	20.54	-7.77e-02	-6.95	-494.55	-494.18	-7.32	-13.41	
1	35	870	7.200.47	1.17	6.50	2.06	578.65	-119.18	-118.59	578.06	-20.26	
1	35	871	0.79-0.46	-0.27	0.60	0.45	621.23	7.33	8.78	619.78	-29.78	
1	35	872	1.08-0.38	-4.02e-02	0.74	0.62	636.18	75.81	76.78	635.21	-23.27	



EGP CODE

GRE.EEC.R.73.IT.W.15235.12.024.01

PAGE

374 di/of 527

1	35	873	1.06-0.49	-0.16	0.74	0.63	624.01	96.70	97.42	623.29	-19.50
1	35	874	1.18-0.57	-0.43	1.03	0.49	640.42	104.89	105.01	640.30	-7.98
1	35	875	1.57-0.72	-0.69	1.54	0.27	705.51	116.04	116.08	705.47	4.71
1	35	876	2.35-1.13	-1.12	2.34	0.15	821.50	124.83	125.42	820.91	20.25
1	35	877	3.51-1.59	-1.59	3.51	-4.64e-02	965.80	124.92	127.68	963.05	48.02
1	35	878	6.56-0.43	-0.38	6.50	-0.62	1120.79	130.20	134.33	1116.66	63.86
1	35	879	9.49-4.10	-3.25	8.63	-3.30	1296.94	2.22	2.85	1296.30	28.60
1	35	880	44.40-37.24	44.21	-37.05	3.96	1472.72	-164.81	-164.69	1472.61	13.72
1	35	881	4.41-8.23	-8.02	4.20	1.62	-216.78	-880.80	-389.81	-707.77	-291.47
1	35	882	5.71e-02	-7.37	-0.39	-6.92	1.76	166.80	-498.79	-435.59	103.60
1	35	883	3.67-4.72	-1.65	0.60	4.04	475.55	-139.84	-133.05	468.76	64.28
1	35	884	1.54-9.65e-02	0.20	1.25	0.63	627.20	33.10	33.20	627.10	-7.84
1	35	885	0.88-0.51	-0.39	0.76	0.39	636.31	72.52	72.75	636.08	-11.34
1	35	886	0.95-0.44	-0.33	0.83	0.38	628.77	93.51	93.62	628.65	-7.75
1	35	887	1.20-0.53	-0.43	1.10	0.40	646.43	103.81	103.92	646.32	-7.80
1	35	888	1.61-0.60	-0.59	1.60	0.14	712.21	116.16	116.17	712.20	2.43
1	35	889	2.39-1.13	-1.12	2.38	-0.22	828.78	120.50	121.92	827.37	31.65
1	35	890	3.73-1.38	-1.26	3.61	-0.77	972.57	127.32	128.79	971.11	35.16
1	35	891	5.55-2.83	-2.28	5.00	-2.08	1104.85	91.55	92.51	1103.90	31.06
1	35	892	5.58-2.35	-0.16	3.39	-3.55	1224.23	8.00	10.30	1221.93	-52.86
1	35	893	26.88-2.65	15.54	8.70	14.36	1109.32	-328.06	-226.77	1008.03	-367.88
1	35	894	9.08-20.59	-10.22	-1.29	14.15	-121.37	-686.58	-424.68	-383.26	-281.85
1	35	895	-1.55-5.20	-5.20	-1.55	4.24e-02	83.38	-224.40	82.12	-223.14	-19.64
1	35	896	4.893.67	4.05	4.51	0.57	291.47	33.91	115.38	209.99	119.78
1	35	897	0.34-1.54	-0.92	-0.28	0.88	479.10	-4.52	7.81	466.78	76.22
1	35	898	1.29-0.77	-0.41	0.94	0.78	595.27	48.06	49.61	593.73	29.07
1	35	899	0.78-0.39	-0.37	0.76	0.13	628.40	76.13	76.15	628.38	2.99
1	35	900	0.86-0.18	-0.18	0.86	-6.73e-03	631.93	93.45	93.45	631.93	0.88
1	35	901	1.15-0.36	-0.35	1.14	-8.95e-02	654.95	101.62	101.91	654.67	12.48
1	35	902	1.64-0.58	-0.50	1.56	-0.41	722.86	111.98	112.40	722.44	16.00
1	35	903	2.35-0.95	-0.71	2.11	-0.86	836.63	122.45	122.57	836.52	8.98
1	35	904	3.27-1.02	-0.45	2.70	-1.44	973.33	137.14	137.20	973.27	6.75
1	35	905	3.83-1.18	-0.30	2.95	-1.91	1083.07	134.32	134.42	1082.97	-9.71
1	35	906	4.140.55	0.62	4.07	-0.48	1033.07	106.37	118.14	1021.31	-103.74
1	35	907	5.99-5.02	-4.87	5.84	-1.26	662.03	6.93	133.52	535.44	-258.66
1	35	908	4.77-10.12	-7.91	2.56	-5.29	405.80	-170.32	114.64	120.84	-288.05
1	35	909	0.16-0.69-9.64e-02	-0.43	0.39	0.77	278.13	-103.25	277.95	-103.06	8.49
1	35	910	1.17-0.37	0.45	0.34	0.77	236.75	207.42	231.32	212.84	11.38
1	35	911	1.37-0.40	0.97	-5.42e-03	0.74	455.14	161.30	162.84	453.60	21.21
1	35	912	0.20-0.68	-0.46	-1.73e-02	0.38	576.03	92.37	92.49	575.91	7.61
1	35	913	0.57-0.31	-0.31	0.57	-5.38e-02	618.62	89.70	89.77	618.55	5.85
1	35	914	0.87-0.48	-0.41	0.80	-0.30	630.50	90.21	90.28	630.42	6.20
1	35	915	1.30-0.46	-0.25	1.09	-0.57	656.60	102.70	102.75	656.54	5.51
1	35	916	1.77-0.64	-0.29	1.43	-0.85	725.24	114.35	114.37	725.21	4.12
1	35	917	2.20-0.98	-0.56	1.78	-1.07	838.79	123.39	123.40	838.79	1.98
1	35	918	2.75-0.50	0.15	2.09	-1.30	969.86	152.27	152.27	969.85	-2.48
1	35	919	2.80-0.55	-0.10	2.35	-1.14	1039.70	164.57	164.77	1039.51	-13.19
1	35	920	2.97-1.75	-1.57	2.79	-0.91	918.58	194.82	197.88	915.52	-46.94
1	35	921	4.25-4.31	-4.06	4.00	-1.45	582.72	267.81	298.71	551.82	-93.68
1	35	922	1.91-4.27	-3.94	1.58	-1.38	411.44	111.59	367.97	155.06	-105.57
1	35	923	-1.85-3.67	-2.30	-3.23	0.78	136.76	-160.99	135.26	-159.49	-21.10
1	35	924	1.46-0.15	0.87	0.44	0.77	239.04	124.01	157.51	205.54	-52.26
1	35	925	-0.50-0.96	-0.72	-0.74	-0.23	475.31	78.10	86.87	466.53	-58.38
1	35	926	0.28-0.46	-0.41	0.23	-0.19	587.11	79.75	80.82	586.03	-23.34
1	35	927	0.60-0.64	-0.55	0.51	-0.32	624.26	80.51	80.64	624.13	-8.40
1	35	928	0.94-0.62	-0.47	0.79	-0.46	630.70	89.91	90.05	630.56	8.74
1	35	929	1.33-0.47	-0.19	1.05	-0.65	654.48	105.28	105.34	654.41	5.96
1	35	930	1.73-0.61	-0.25	1.36	-0.85	722.32	116.14	116.14	722.32	0.25
1	35	931	2.10-0.67	-0.26	1.70	-0.98	836.09	127.73	127.89	835.93	-10.66
1	35	932	2.59-0.29	0.17	2.12	-1.06	968.20	143.66	144.18	967.69	-20.56
1	35	933	3.30-0.66	-0.35	2.99	-1.07	1046.36	146.00	146.01	1046.35	-3.49
1	35	934	3.66-2.51	-2.48	3.63	-0.37	927.27	127.06	131.12	923.21	56.81
1	35	935	2.18-4.52	-4.48	2.15	-0.49	552.06	160.76	194.18	518.64	109.36
1	35	936	2.99-7.17	-6.53	2.34	2.47	259.11	80.58	219.48	120.21	74.19
1	35	937	8.40-4.64	6.86	-3.10	-4.21	-83.75	-314.97	-110.86	-287.86	74.39
1	35	938	-5.52-8.04	-5.96	-7.60	-0.96	184.18	-265.41	-180.27	99.05	-176.15
1	35	939	0.13-2.50	-2.30	-6.66e-02	-0.70	469.05	-99.02	-88.83	458.87	-75.38
1	35	940	0.88-0.67	-0.55	0.76	-0.42	619.48	17.54	17.73	619.29	-10.50
1	35	941	0.91-0.66	-0.49	0.75	-0.48	636.55	68.54	68.54	636.54	1.36
1	35	942	1.09-0.48	-0.25	0.86	-0.56	629.68	97.63	97.86	629.46	10.95
1	35	943	1.38-0.51	-0.20	1.07	-0.71	647.43	112.39	112.48	647.35	6.76
1	35	944	1.75-0.59	-0.21	1.36	-0.87	712.44	123.57	123.63	712.38	-6.17
1	35	945	2.13-0.66	-0.29	1.76	-0.95	826.80	128.43	129.63	825.60	-28.93
1	35	946	2.68-0.30	8.25e-02	2.29	-1.00	966.54	128.61	130.58	964.57	-40.57
1	35	947	3.61-0.21	0.33	3.07	-1.33	1075.39	97.36	98.23	1074.51	-29.31
1	35	948	9.83-1.29	0.60	7.94	-4.17	1075.32	21.04	24.48	1071.89	60.05

195.12





EGP CODE

GRE.EEC.R.73.IT.W.15235.12.024.01

PAGE

375 di/of 527

1	35	949	9.73-6.35	-5.35	8.72	-3.89	534.13	-288.57	-182.23	427.79	276.00	
1	35	950	9.72-12.86	9.69	-12.84	-0.76	-25.75	-357.96	-254.70	-129.01	153.76	
1	35	951	1.71-0.27	-0.27	1.71	-5.84e-03	1094.54	25.48	28.38	1091.64	-55.64	
1	35	952	11.334.38	5.27	10.44	-2.33	128.88	-648.48	-629.56	109.96	119.78	
1	35	953	6.033.92	3.95	6.00	-0.25	581.12	-132.37	-119.16	567.91	96.16	
1	35	954	1.54-0.28	-0.28	1.54	-4.93e-02	629.97	1.40	10.98	620.39	77.01	
1	35	955	1.12-0.55	-0.50	1.06	-0.30	633.22	77.38	82.73	627.86	54.29	
1	35	956	1.12-0.41	-0.23	0.94	-0.49	616.44	117.64	120.02	614.06	34.33	
1	35	957	1.38-0.51	-0.18	1.05	-0.72	627.25	135.44	135.67	627.02	10.66	
1	35	958	1.77-0.62	-0.16	1.31	-0.94	687.86	147.13	147.58	687.41	-15.54	
1	35	959	2.28-0.45	9.29e-02	1.74	-1.09	798.95	157.30	160.64	795.61	-46.15	
1	35	960	2.83-0.21	0.33	2.29	-1.16	941.73	143.65	153.54	931.84	-88.28	
1	35	961	2.840.88	1.37	2.35	-0.85	1078.58	103.10	118.60	1063.08	-121.98	
1	35	962	4.63-4.03	4.55	-3.94	0.84	1193.29	-65.07	-37.71	1165.93	-183.53	
1	35	963	18.50-38.11	17.44	-37.05	7.67	1173.63	-595.47	-569.42	1147.59	-213.07	
1	35	964	4.07-0.55	-0.44	3.96	-0.70	1293.25	20.36	34.18	1279.43	-131.92	
1	35	965	23.813.25	5.42	21.64	-6.32	1440.91	45.10	74.90	1411.11	-201.77	
1	35	966	46.789.44	18.00	38.22	-15.69	734.19	-15.11	122.02	597.06	-289.74	
1	35	967	-14.08-43.54-34.28		-23.34	-13.68	166.24	-227.98	-131.49	69.75	-169.49	
1	35	968	26.235.03	6.12	25.13	-4.69	-125.70	-436.72	-274.93	-287.49	-155.39	
1	35	969	22.68-13.19	17.72	-8.23	-12.38	37.82	-852.29	-540.54	-273.93	424.62	
1	35	970	8.53-0.18	8.29	6.78e-02	-1.44	-246.35	-649.14	-338.91	-556.58	169.45	
1	35	971	-6.11-14.05	-9.64	-10.53	-3.94	57.68	-349.24	-226.60	-64.96	-186.72	
1	35	972	2.70-1.93	-1.32	2.09	-1.57	364.46	-45.50	-5.17	324.13	-122.09	
1	35	973	1.62-0.48	-0.45	1.59	0.25	483.75	35.15	55.81	463.08	-94.03	
1	35	974	1.63-0.12-1.66e-02		1.53	0.41	498.14	56.89	67.89	487.14	-68.79	
1	35	975	2.03-4.91e-028.12e-02		1.90	0.50	496.54	60.10	65.09	491.55	-46.41	
1	35	976	2.56-1.80e-02	0.16	2.39	0.65	514.80	62.26	63.30	513.76	-21.61	
1	35	977	4.17-4.46	-4.16	3.88	1.57	-43.76	-374.53	-48.03	-370.26	37.34	
1	35	978	-0.81-6.10	-1.33	-5.58	-1.58	348.02	-437.60	-189.26	99.68	365.28	
1	35	979	2.13-4.46	-1.99	-0.34	3.19	553.38	-148.93	-43.94	448.39	250.42	
1	35	980	1.63-0.80	-0.59	1.42	0.68	631.39	43.71	78.73	596.37	139.12	
1	35	981	1.03-0.46	-0.45	1.02	-0.12	616.98	115.40	129.28	603.10	82.27	
1	35	982	1.02-0.44	-0.29	0.87	-0.44	596.81	146.61	151.24	592.18	45.41	
1	35	983	1.30-0.49	-0.12	0.93	-0.73	605.83	163.64	164.05	605.43	13.32	
1	35	984	1.72-0.61-4.65e-02		1.16	-1.00	663.45	177.16	177.91	662.70	-19.10	
1	35	985	2.30-0.46	0.26	1.58	-1.21	771.12	192.35	198.38	765.09	-58.77	
1	35	986	2.79-0.37	0.19	2.23	-1.20	907.15	189.04	204.93	891.26	-105.66	
1	35	987	3.54-0.27-8.72e-02		3.35	-0.82	1041.98	143.90	182.03	1003.84	-181.09	
1	35	988	7.088.32e-02	0.20	6.96	0.90	1174.01	-3.11	103.70	1067.21	-338.11	
1	35	989	23.82-1.30	4.62	17.90	10.66	1020.01	-353.24	13.48	653.30	-607.55	
1	35	990	5.31-11.32	-2.67	-3.34	8.31	433.32	-520.96	11.92	-99.56	-473.88	
1	35	991	-1.57-4.38	-4.15	-1.80	-0.77	309.92	-243.15	221.82	-155.05	202.40	
1	35	992	4.083.25	3.45	3.88	0.36	527.33	24.88	316.96	235.25	247.88	
1	35	993	1.00-0.98	-0.30	0.31	0.94	593.10	61.95	207.71	447.34	237.01	
1	35	994	1.20-0.92	-0.43	0.71	0.90	602.23	142.79	208.26	536.76	160.60	
1	35	995	0.73-0.30	-0.24	0.68	0.23	586.60	182.38	209.23	559.75	100.65	
1	35	996	0.64-0.11	-0.10	0.64	3.49e-02	567.84	199.56	208.98	558.41	58.15	
1	35	997	0.692.98e-023.06e-02		0.69	-2.25e-02	577.57	209.97	212.78	574.76	32.01	
1	35	998	1.09-6.12e-02	0.17	0.86	-0.46	629.42	225.93	225.96	629.39	-3.40	
1	35	999	1.91-0.40	0.34	1.17	-1.08	727.83	245.91	252.21	721.52	-54.77	
1	35	1000	2.62-0.34	0.53	1.75	-1.35	853.25	266.93	289.29	830.89	-112.30	
1	35	1001	3.38-0.89	-0.29	2.78	-1.48	971.92	252.54	309.99	914.47	-195.00	
1	35	1002	5.41-1.86	-1.39	4.94	-1.79	1021.72	162.14	326.05	857.82	-337.68	
1	35	1003	4.74-4.49	-3.90	4.15	-2.26	925.41	-35.20	394.18	496.03	-477.60	
1	35	1004	4.67-9.72	-7.77	2.72	-4.92	765.17	-311.16	349.79	104.23	-523.97	
1	35	1005	8.39e-02	-0.52	-0.26	-0.18	0.30	597.19	-100.47	542.10	-45.38	188.14
1	35	1006	0.56-0.16	0.11	0.29	0.35	575.99	160.39	488.95	247.42	169.11	
1	35	1007	0.99-0.28	0.53	0.18	0.61	575.72	268.47	422.72	421.47	153.63	
1	35	1008	0.97-0.81	7.03e-02	8.92e-02	0.89	574.67	271.79	347.67	498.79	131.24	
1	35	1009	1.02-0.76-2.46e-02		0.28	0.88	552.70	264.76	297.22	520.25	91.06	
1	35	1010	1.04-0.58	0.11	0.35	0.80	542.45	257.41	274.06	525.79	66.85	
1	35	1011	1.13-0.47	0.24	0.42	0.80	554.02	259.03	266.58	546.47	46.60	
1	35	1012	0.826.68e-02	0.37	0.51	0.37	600.55	277.16	278.06	599.65	17.03	
1	35	1013	0.870.26	0.50	0.64	-0.30	686.85	306.29	309.38	683.76	-34.14	
1	35	1014	1.69-0.26	0.62	0.81	-0.97	791.04	349.30	364.55	775.79	-80.64	
1	35	1015	2.25-1.15	6.49e-02	1.04	-1.63	878.83	371.52	427.96	822.39	-159.51	
1	35	1016	2.29-2.37	-1.26	1.18	-1.98	899.30	347.42	514.09	732.62	-253.38	
1	35	1017	2.62-3.81	-2.93	1.73	-2.22	892.96	202.88	642.65	453.18	-331.78	
1	35	1018	1.70-4.73	-3.57	0.55	-2.47	903.57	-43.08	727.58	132.91	-368.28	
1	35	1019	-0.16-1.29	-1.27	-0.18	0.15	659.21	-42.01	638.56	-21.37	118.54	
1	35	1020	4.18e-02	-0.62	-0.46	-0.12	0.29	617.09	232.37	589.82	259.63	98.72
1	35	1021	0.69-0.53	0.25	-9.53e-02	0.58	567.65	361.39	518.07	410.97	88.13	
1	35	1022	1.16-0.90	0.28	-1.59e-02	1.02	531.00	381.07	433.91	478.15	71.63	
1	35	1023	1.33-1.10	0.12	0.11	1.22	516.87	346.16	365.87	497.16	54.55	
1	35	1024	1.39-0.85	0.27	0.28	1.12	509.39	322.97	326.58	505.77	25.70	





EGP CODE

GRE.EEC.R.73.IT.W.15235.12.024.01

PAGE

376 di/of 527

1	35	1025	1.29-0.57	0.41	0.31	0.93	528.27	311.35	311.37	528.26	-1.67	
1	35	1026	1.13-0.27	0.55	0.32	0.69	582.07	319.09	320.17	580.99	-16.80	
1	35	1027	0.913-13e-02	0.67	0.28	0.40	662.56	351.50	353.18	660.87	-22.84	
1	35	1028	0.760.15	0.72	0.18	-0.14	744.63	408.31	411.50	741.44	-32.60	
1	35	1029	0.83-0.86-7.70e-03	-2.19e-02	-0.85	-0.85	784.71	477.40	492.71	769.40	-66.85	
1	35	1030	0.70-2.12	-1.25	-0.18	-1.31	744.05	545.00	610.46	678.60	-93.51	
1	35	1031	0.25-3.64	-3.08	-0.32	-1.37	817.61	372.23	766.64	423.21	-141.79	
1	35	1032	-5.32e-03	-4.65	-4.42	-0.24	-1.01	899.31	106.15	869.00	136.46	-152.06
1	35	1033	-0.19-1.92	-1.88	-0.23	0.24	644.07	-29.27	642.23	-27.43	35.16	
1	35	1034	-1.08e-04	-1.03	-0.88	-0.16	0.37	603.42	249.44	601.28	251.57	27.43
1	35	1035	0.40-0.89	-0.32	-0.16	0.64	526.51	395.84	524.74	397.62	15.11	
1	35	1036	0.87-0.93-6.13e-02	9.87e-03	0.90	0.90	467.99	443.80	445.24	466.55	5.73	
1	35	1037	1.17-0.81	0.17	0.19	0.99	488.62	388.69	388.79	488.52	-3.20	
1	35	1038	1.36-0.68	0.34	0.34	1.02	498.21	348.06	348.47	497.81	-7.82	
1	35	1039	1.43-0.51	0.48	0.44	0.97	522.17	331.60	331.95	521.82	-8.20	
1	35	1040	1.42-0.34	0.63	0.44	0.87	575.77	338.58	339.01	575.34	-10.05	
1	35	1041	1.33-0.23	0.77	0.33	0.75	656.14	368.82	368.98	655.98	-6.76	
1	35	1042	1.10-0.18	0.82	0.11	0.53	873.25	423.98	424.08	737.16	5.46	
1	35	1043	0.50-0.21	0.47	-0.18	0.15	770.89	501.01	505.24	766.66	33.53	
1	35	1044	-0.28-1.14	-0.96	-0.47	-0.35	715.50	576.65	615.56	676.59	62.36	
1	35	1045	-0.44-3.62	-3.52	-0.54	-0.55	786.72	398.05	761.00	423.78	96.63	
1	35	1046	-0.36-5.39	-5.36	-0.39	-0.34	876.52	121.40	861.71	136.21	104.70	
1	35	1047	-0.19-1.62	-1.48	-0.34	0.43	544.50	-70.42	539.70	-65.62	-54.11	
1	35	1048	-7.45e-02	-1.01	-0.91	-0.17	0.29	520.50	198.85	509.04	210.32	-59.64
1	35	1049	0.17-0.68	-0.51	2.31e-03	0.34	488.59	336.00	445.57	379.02	-68.65	
1	35	1050	0.59-0.58	-0.16	0.17	0.56	494.01	357.95	390.45	461.50	-58.01	
1	35	1051	1.11-0.47	0.15	0.49	0.77	502.30	341.35	352.81	490.85	-41.38	
1	35	1052	1.42-0.43	0.31	0.67	0.91	504.10	320.82	324.70	500.22	-26.41	
1	35	1053	1.65-0.35	0.44	0.86	0.98	525.29	310.32	311.97	523.64	-18.78	
1	35	1054	1.83-0.26	0.58	1.00	1.02	579.62	317.93	318.25	579.30	-9.06	
1	35	1055	1.98-0.25	0.70	1.03	1.10	666.49	343.16	343.33	666.32	7.40	
1	35	1056	2.01-0.31	0.79	0.91	1.16	765.73	380.44	384.25	761.91	38.13	
1	35	1057	1.66-0.39	0.71	0.56	1.02	832.72	417.28	440.26	809.74	94.97	
1	35	1058	0.51-0.79	-0.41	0.13	0.59	827.34	402.53	507.36	722.50	183.15	
1	35	1059	0.52-3.28	-3.28	0.52	7.38e-02	810.52	255.93	619.16	447.30	263.65	
1	35	1060	-6.94e-02	-6.04	-6.03	-7.86e-02	0.23	796.91	7.98	677.65	127.25	282.61
1	35	1061	1.55-2.89 5.41e-02	-1.39	2.10	242.56	-189.74	242.02	-189.20	-15.35		
1	35	1062	2.52-0.47	0.26	1.79	-1.28	376.64	80.82	289.67	167.79	-134.77	
1	35	1063	-0.14-1.45	-1.43	-0.16	-0.16	436.22	169.04	250.12	355.15	-122.83	
1	35	1064	-0.61-3.48	-3.06	-1.02	-1.01	442.24	-101.37	439.15	-98.28	-40.87	
1	35	1065	1.24-0.20 7.10e-02	0.97	0.56	0.56	511.80	236.66	251.48	496.98	-62.12	
1	35	1066	1.59-0.16	0.21	1.22	0.71	508.35	233.17	238.60	502.92	-38.28	
1	35	1067	1.98-0.12	0.31	1.55	0.85	526.24	230.99	231.94	525.30	-16.69	
1	35	1068	2.43-0.13	0.39	1.91	1.03	583.93	237.12	237.40	583.65	-9.89	
1	35	1069	2.92-0.15	0.48	2.29	1.24	679.70	256.10	256.59	679.22	14.33	
1	35	1070	3.42-0.31	0.51	2.61	1.54	799.66	279.84	284.68	794.82	49.92	
1	35	1071	3.84-0.39	0.66	2.79	1.83	906.38	286.66	308.69	884.35	114.76	
1	35	1072	3.60-0.17	0.52	2.92	1.45	923.14	218.25	312.98	828.42	240.41	
1	35	1073	1.91-7.03	-5.77	0.65	3.11	764.95	-75.11	243.84	446.00	407.69	
1	35	1074	1.61-3.28	-2.75	1.09	1.52	621.71	-251.02	270.85	99.84	427.91	
1	35	1076	23.8617.80	17.80	23.86	6.37e-02	-196.94	-480.28	-317.89	-359.33	-140.15	
1	35	1077	-2.91-8.00	-7.77	-3.14	1.06	279.83	-119.18	271.48	-110.83	-57.11	
1	35	1078	1.29-1.42	0.41	-0.54	-1.27	535.17	-122.71	525.05	-112.60	-80.94	
1	35	1079	-0.11-1.42	-1.32	-0.22	-0.35	588.83	-103.14	581.38	-95.70	-71.38	
1	35	1080	-0.13-1.44	-1.39	-0.17	0.24	564.78	-95.47	564.27	-94.96	18.39	
1	35	1081	0.26-1.75	-1.01	-0.48	0.97	447.28	-106.53	447.27	-106.52	-2.39	
1	35	1082	3.22-4.22e-02	0.20	2.98	0.85	575.53	67.05	67.50	575.08	-15.15	
1	35	1083	4.03-5.82e-02	0.23	3.74	1.04	679.66	80.26	80.45	679.47	10.65	
1	35	1084	5.16-0.19	0.15	4.83	1.29	816.13	93.60	96.28	813.45	43.95	
1	35	1085	6.52-0.70-1.28e-02	5.83	5.83	2.11	944.52	92.62	105.58	931.56	104.29	
1	35	1086	9.641.64	1.70	9.58	0.72	1084.09	39.17	78.98	1044.28	200.04	
1	35	1087	11.510.73	3.45	8.79	-4.68	947.13	-292.05	-93.94	749.02	454.15	
1	35	1088	-2.37-7.77	-7.76	-2.37	-0.13	99.46	-117.79	97.42	-115.75	-20.98	
1	35	1089	13.13-2.41	-2.08	12.80	-2.24	-28.27	-343.69	-343.61	-28.35	-4.98	
1	35	1090	5.661.39	1.50	5.55	0.67	371.30	-113.13	-98.62	356.79	-82.58	
1	35	1091	1.54-0.25	-0.19	1.48	0.32	457.49	-85.45	-67.66	439.71	-96.64	
1	35	1092	1.89-1.76e-02-1.02e-02	1.89	0.12	485.04	-69.12	-58.74	474.65	-75.15		
1	35	1093	2.311.89e-023.91e-02	2.29	0.21	483.28	-64.19	-59.57	478.67	-50.05		
1	35	1094	2.871.43e-026.67e-02	2.82	0.38	502.43	-62.31	-60.78	500.90	-29.38		
1	35	1095	3.60-1.12e-027.94e-02	3.51	0.57	564.26	-58.22	-57.92	563.97	-13.50		
1	35	1096	4.53-5.39e-026.78e-02	4.41	0.74	672.86	-50.06	-49.78	672.58	14.20		
1	35	1097	5.77-0.12 3.20e-03	5.66	0.83	814.79	-42.50	-39.49	811.78	50.66		
1	35	1098	8.28-0.14-2.64e-02	8.16	0.97	976.77	-37.41	-26.16	965.51	106.25		
1	35	1099	5.031.30	1.30	5.03	-6.14e-02	1070.70	-85.74	-60.11	1045.07	170.24	
1	35	1100	25.56-24.52	25.35	-24.30	-3.28	1169.94	-85.06	-81.43	1166.30	67.47	
1	35	1101	21.87-32.59	-31.37	20.65	8.04	-335.50	-388.41	-379.98	-343.93	19.36	



EGP CODE

GRE.EEC.R.73.IT.W.15235.12.024.01

PAGE

377 di/of 527

1	35	1102	40.28-5.95	-4.96	39.29	-6.69	-388.55	-1182.59	-1175.39	-395.75	75.27	
1	35	1103	32.71-16.54	-16.25	32.42	-3.75	-310.12	-1433.75	-1426.39	-317.48	90.64	
1	35	1104	37.39-15.48	-15.12	37.03	-4.34	-400.94	-1620.03	-1616.88	-404.08	61.89	
1	35	1105	58.861.18	1.24	58.81	-1.80	-699.21	-1896.62	-1895.24	-700.59	40.62	
1	35	1106	41.04-16.18	-15.99	40.85	-3.31	-331.63	-2268.88	-2262.61	-337.90	110.03	
1	35	1107	29.12-15.13	-14.41	28.40	-5.60	-90.61	-1990.68	-1989.90	-91.38	38.46	
1	35	1108	26.04-6.59	-2.18	21.63	-11.16	-129.37	-1303.10	-1295.49	-136.98	94.19	
1	35	1109	17.86-13.05	-13.05	17.86	-5.34e-02	9.91	-1389.33	-1386.10	6.68	67.20	
1	35	1110	19.71-23.45	-17.82	14.07	-14.54	-90.93	-562.80	-546.05	-107.68	87.31	
1	35	1111	-3.12-20.04	-9.45	-13.71	8.18	470.77	-199.05	305.51	-33.79	-288.76	
1	35	1112	5.42-2.99	-1.30	3.74	-3.37	1132.18	30.59	1062.72	100.04	-267.74	
1	35	1113	-1.02-8.50	-8.50	-1.02	-0.22	1181.17	67.48	1178.89	69.77	-50.40	
1	35	1114	-0.30-6.57	-6.27	-0.60	1.35	933.46	18.95	902.75	49.66	164.76	
1	35	1115	4.51-1.60	0.88	2.02	3.00	395.04	-169.26	134.65	91.13	281.31	
1	35	1116	0.48-46.17	-17.95	-27.73	-22.80	-326.14	-1132.38	-1130.25	-328.26	-41.34	
1	35	1117	15.20-20.50	9.07	-14.37	13.47	-324.50	-965.22	-965.21	-324.51	2.07	
1	35	1118	16.122.00	11.67	6.45	-6.56	527.11	-32.93	352.43	141.75	-259.45	
1	35	1119	-1.44e-02	-4.65	-4.15	-0.52	-1.44	800.81	35.56	785.43	50.94	-107.40
1	35	1120	0.28-4.98	-4.66	-4.03e-02	1.25	772.73	46.11	764.56	54.28	76.62	
1	35	1121	12.562.78	8.76	6.57	4.77	463.39	-121.12	285.21	57.07	269.07	
1	35	1122	4.21-44.55	-3.63	-36.71	-17.91	-267.18	-713.98	-709.57	-271.59	44.16	
1	35	1123	-0.39-2.20	-2.13	-0.46	-0.36	594.06	-95.62	590.27	-91.83	-51.00	
1	35	1124	15.45-25.65	11.93	-22.13	11.50	-96.90	-486.61	-416.41	-167.10	-149.77	
1	35	1125	17.832.55	13.00	7.39	-7.10	721.11	-24.75	596.97	99.39	-277.82	
1	35	1126	0.13-6.39	-6.00	-0.26	-1.55	865.42	46.79	855.71	56.50	-88.62	
1	35	1127	4.25e-02	-6.90	-6.69	-0.17	1.18	844.74	31.98	819.37	57.36	141.36
1	35	1128	12.111.80	5.89	8.03	5.04	542.61	-152.08	331.90	58.62	319.34	
1	35	1129	2.92-48.01	-3.78	-41.30	-17.22	-206.19	-612.37	-570.01	-248.55	124.15	
1	35	1130	12.160.60	6.25	6.51	5.78	-325.48	-616.90	-542.47	-399.90	127.08	
1	35	1131	23.27-27.36	18.99	-23.08	14.09	-195.81	-739.90	-705.84	-229.87	-131.79	
1	35	1132	25.504.15	21.31	8.34	-8.48	687.23	-63.45	498.84	124.93	-325.47	
1	35	1133	1.78-2.76	-0.73	-0.24	-2.26	912.27	41.90	893.36	60.81	-126.89	
1	35	1134	-0.17-7.12	-7.12	-0.17	4.75e-02	856.92	58.90	851.07	64.75	68.06	
1	35	1135	1.78-2.65	-0.68	-0.19	2.20	706.48	-79.52	587.42	39.54	281.79	
1	35	1136	16.321.60	14.58	3.35	4.76	363.87	-503.30	-291.98	152.54	372.28	
1	35	1137	11.49-51.16	-8.42	-31.26	-29.17	-526.41	-1863.92	-1860.64	-529.69	-66.13	
1	35	1138	20.96-45.70	9.78	-34.53	24.90	-519.83	-1564.54	-1562.63	-521.74	-44.64	
1	35	1139	22.704.93	17.45	10.18	-8.11	673.73	-372.81	117.92	183.01	-522.26	
1	35	1140	-0.13-8.16	-7.59	-0.69	-2.05	841.44	-106.30	678.43	56.72	-357.66	
1	35	1141	-0.48-7.99	-7.97	-0.50	-0.43	1003.11	20.60	972.49	51.22	-170.74	
1	35	1142	-0.66-8.34	-8.34	-0.66	-8.48e-03	1019.25	41.04	1019.15	41.14	-9.66	
1	35	1143	-0.33-8.10	-8.07	-0.36	0.50	927.18	9.49	897.41	39.26	162.59	
1	35	1144	2.05-3.11	-1.25	0.18	2.48	763.54	-103.92	624.26	35.36	318.47	
1	35	1145	23.144.67	19.07	8.75	7.66	447.43	-488.59	-127.15	85.99	455.72	
1	35	1146	17.71-55.93	6.39	-44.62	-26.56	-467.66	-1577.96	-1577.48	-468.13	22.93	
1	35	1147	-3.28-37.36	-22.75	-17.89	-16.86	-185.99	-676.88	-652.53	-210.33	106.58	
1	35	1148	16.19-43.34	10.85	-38.00	17.02	-225.66	-816.63	-712.52	-329.77	-225.13	
1	35	1149	20.964.17	14.47	10.66	-8.18	740.99	-224.71	410.09	106.20	-458.32	
1	35	1150	0.27-8.35	-7.91	-0.17	-1.91	868.92	-40.28	785.13	43.51	-262.99	
1	35	1151	-0.45-8.78	-8.76	-0.47	-0.37	991.42	15.66	977.34	29.74	-116.36	
1	35	1152	-0.49-9.15	-9.15	-0.49	7.15e-02	961.51	9.76	947.71	23.56	113.78	
1	35	1153	3.55e-02	-8.33	-8.13	-0.16	1.28	775.92	-39.51	713.29	23.12	217.14
1	35	1154	12.781.91	6.85	7.84	5.41	482.04	-250.02	194.16	37.86	357.59	
1	35	1155	5.71-47.47	-1.92	-39.85	-18.64	-388.78	-840.50	-827.53	-401.75	75.45	
1	35	1156	23.8320.29	20.31	23.81	-0.28	-87.81	-668.18	-638.17	-117.82	-128.51	
1	35	1157	24.34-26.27	18.76	-20.69	15.85	-325.94	-1150.36	-1141.19	-335.11	-86.45	
1	35	1158	20.732.49	15.78	7.44	-8.11	546.33	-220.30	238.76	87.28	-375.76	
1	35	1159	0.59-4.34	-3.42	-0.32	-1.91	821.56	-39.78	758.79	22.99	-223.90	
1	35	1160	-0.49-8.40	-8.37	-0.51	-0.47	929.04	10.13	920.42	18.75	-88.60	
1	35	1161	-0.53-9.04	-9.04	-0.53	-4.18e-02	913.64	-1.49	897.33	14.82	121.10	
1	35	1162	-0.53-8.75	-8.69	-0.60	0.74	702.53	-73.91	624.00	4.62	234.11	
1	35	1163	3.32-4.03	-2.99	2.28	2.56	308.64	-348.20	-62.78	23.23	325.59	
1	35	1164	2.82-44.01	-14.57	-26.62	-22.63	-363.04	-1161.03	-1159.85	-364.22	-30.63	
1	35	1165	20.98-2.69	17.80	0.49	8.07	-266.21	-1069.79	-1068.64	-267.36	30.45	
1	35	1166	16.611.22	13.86	3.97	-5.90	301.99	-69.12	159.19	73.68	-180.56	
1	35	1167	0.58-0.80	9.79e-02	-0.32	-0.65	565.22	3.63	554.61	14.24	-76.45	
1	35	1168	7.081.90	4.40	4.58	2.59	315.05	-12.79	292.03	10.23	83.77	
1	35	1169	1.42-32.69	-4.25	-27.02	-12.70	-248.83	-478.27	-465.88	-261.22	-51.87	
1	35	1170	-0.85-4.77	-2.86	-2.76	1.96	175.02	-137.54	174.99	-137.51	3.04	
1	35	1171	17.56-14.59	13.70	-10.74	10.44	-177.70	-663.78	-616.48	-225.00	-144.05	
1	35	1172	13.855.85e-02	8.91	5.00	-6.61	649.64	-130.82	459.58	59.24	-334.99	
1	35	1173	-0.24-5.61	-5.25	-0.60	-1.34	898.25	-33.44	852.21	12.59	-201.92	
1	35	1174	-0.49-8.78	-8.76	-0.51	-0.42	1015.57	3.38	1006.90	12.05	-93.28	
1	35	1175	-0.56-9.66	-9.65	-0.56	-0.19	997.60	-1.10	989.84	6.66	87.69	
1	35	1176	-0.84-9.25	-9.25	-0.85	0.27	827.35	-41.85	789.69	-4.18	176.97	
1	35	1177	-0.74-7.76	-7.58	-0.92	1.10	407.94	-160.60	236.10	11.24	261.09	



EGP CODE

GRE.EEC.R.73.IT.W.15235.12.024.01

PAGE

378 di/of 527

1	35	1178	-6.48-13.89	-13.60	-6.77	1.44	-115.52	-241.30	-141.23	-215.59	50.72	
1	35	1179	-5.24-28.81	-5.26	-28.79	0.59	714.40	-123.88	-71.93	662.46	-202.10	
1	35	1180	4.38-63.53	4.03	-63.17	4.90	1433.82	-223.09	-221.63	1432.36	-49.23	
1	35	1181	-8.60-36.37	-8.80	-36.17	2.34	1170.14	-611.37	-609.25	1168.03	-61.30	
1	35	1182	-6.92-43.18	-8.86	-41.24	8.15	1291.97	-581.83	-581.80	1291.95	-6.50	
1	35	1183	7.45-88.81	7.42	-88.78	-1.86	1983.49	-203.26	-200.80	1981.03	-73.39	
1	35	1184	-8.30-44.47	-8.58	-44.19	-3.17	1510.14	-946.87	-941.50	1504.77	-114.68	
1	35	1185	-5.63-33.97	-8.30	-31.29	8.28	1216.38	-1052.31	-1052.29	1216.36	-6.12	
1	35	1186	5.98-52.29	4.54	-50.85	9.06	1199.63	-404.37	-404.29	1199.55	-10.84	
1	35	1187	-6.35-21.94	-6.72	-21.57	2.36	880.83	-799.09	-796.58	878.32	-64.94	
1	35	1188	-5.33-28.76	-5.64	-28.45	2.68	783.24	-208.61	-198.24	772.87	100.91	
1	35	1189	35.4414.25	19.02	30.67	8.85	369.90	7.44	366.97	10.36	-32.44	
1	35	1190	-0.64-4.25	-0.88	-4.00	0.91	666.80	-196.98	657.74	-187.92	-87.99	
1	35	1191	-2.70e-02	-0.49	-3.84e-02	-0.48	-7.22e-02	608.34	-148.46	601.68	-141.79	-70.71
1	35	1192	0.20-2.46	-1.33	-0.93	1.32	430.49	-144.41	430.48	-144.39	3.05	
1	35	1193	-6.24-9.21	-8.38	-7.08	1.33	74.80	-273.05	72.23	-270.48	29.81	
1	35	1194	25.934.75	4.85	25.83	-1.46	197.59	-609.64	-606.38	194.34	51.16	
1	35	1195	37.9917.88	22.01	33.86	8.12	182.54	-490.39	-488.00	180.16	-39.98	
1	35	1196	1.93e-02	-4.52	-1.04	-3.46	1.92	228.27	-242.12	218.97	-232.81	-65.50
1	35	1197	-0.49-1.22	-0.81	-0.90	-0.36	370.13	-146.62	361.77	-138.27	-65.17	
1	35	1198	-0.54-3.17	-2.61	-1.09	1.07	307.40	-150.41	307.29	-150.30	-7.26	
1	35	1199	-4.67-9.64	-8.94	-5.37	1.72	124.89	-198.20	115.67	-188.98	53.79	
1	35	1200	17.055.92	6.04	16.93	1.15	-130.20	-457.23	-358.83	-228.60	149.99	
1	35	1201	-0.41-2.75	-2.41	-0.74	0.82	425.99	-104.75	425.96	-104.71	4.49	
1	35	1202	28.2416.24	17.48	27.00	3.66	-78.58	-241.30	-164.79	-155.09	-81.21	
1	35	1203	-4.05-5.88	-5.81	-4.12	0.35	326.54	-165.17	322.15	-160.78	-46.24	
1	35	1204	-0.68-2.85	-2.45	-1.08	-0.84	408.08	-145.28	403.95	-141.15	-47.64	
1	35	1205	0.67-1.52	0.10	-0.95	0.96	425.04	-150.75	422.20	-147.91	40.36	
1	35	1206	-4.98-11.90	-11.52	-5.37	1.59	181.48	-189.95	166.82	-175.28	72.32	
1	35	1207	17.955.90	5.92	17.93	0.50	-111.97	-421.82	-211.40	-322.40	144.65	
1	35	1209	35.3915.22	17.01	33.61	5.73	-6.01	-395.06	-364.54	-36.54	-104.61	
1	35	1210	-5.60-9.37	-9.37	-5.60	-3.10e-03	256.76	-218.63	245.26	-207.13	-73.02	
1	35	1211	-0.49-3.95	-3.24	-1.19	-1.39	408.42	-152.85	402.22	-146.65	-58.68	
1	35	1212	1.47-1.07	1.47	-1.06	0.11	460.07	-157.27	459.93	-157.14	-9.24	
1	35	1213	-0.65-5.34	-4.43	-1.56	1.86	200.13	-180.82	178.09	-158.78	88.94	
1	35	1214	-9.28-17.99	-17.37	-9.89	2.23	-194.89	-451.41	-278.40	-367.90	120.19	
1	35	1215	37.542.98	3.95	36.56	-5.72	465.59	-865.39	-860.39	460.59	81.42	
1	35	1216	46.5921.29	23.37	44.51	6.95	157.85	-594.90	-585.00	147.95	-85.76	
1	35	1217	0.16-6.29	-1.09	-5.03	2.55	282.80	-272.58	265.04	-254.82	-97.71	
1	35	1218	1.78-0.92	1.28	-0.43	-1.05	455.67	-153.60	431.48	-129.41	-118.98	
1	35	1219	9.67e-02	-0.52	-0.19	-0.23	-0.31	522.38	-126.48	514.72	-118.82	-70.10
1	35	1220	0.12-0.33	-0.29	8.28e-02	0.12	548.04	-110.95	544.96	-107.87	-45.00	
1	35	1221	0.54-0.90	4.70e-02	-0.41	0.68	493.01	-115.53	492.94	-115.46	-6.45	
1	35	1222	-0.22-4.96	-3.95	-1.23	1.95	250.97	-135.01	247.19	-131.23	38.00	
1	51	1	4.17-7.81	-3.26	-0.39	-5.82	-340.81	-881.63	-423.59	-798.84	194.72	
1	51	3	12.80-20.34	-2.69	-4.85	16.54	-71.11	-810.44	-272.29	-609.26	-329.03	
1	51	5	11.94-21.19	2.48	-11.73	14.96	-942.68	-1674.26	-1663.28	-953.67	-88.98	
1	51	7	10.20-13.85	6.14	-9.79	9.01	-907.28	-1683.04	-1660.42	-929.90	-130.53	
1	51	9	8.11-20.43	-2.00	-10.31	13.65	-837.88	-1668.80	-1627.39	-879.29	-180.81	
1	51	11	15.48-20.99	12.33	-17.84	10.25	-1147.42	-2621.50	-2610.47	-1158.45	-127.00	
1	51	13	15.22-13.70	14.08	-12.56	5.62	-1345.10	-2601.03	-2599.63	-1346.50	-42.00	
1	51	15	6.04-22.81	-7.88	-8.90	14.42	-1178.38	-2164.75	-2126.06	-1217.07	-191.47	
1	51	17	5.09-32.66	-14.85	-12.72	18.84	-1043.76	-1905.79	-1896.59	-1052.96	-88.59	
1	51	19	5.27-21.81	-9.60	-6.93	13.48	-819.93	-1702.46	-1549.72	-972.67	-333.87	
1	51	21	20.26-9.05	17.27	-6.07	8.86	-593.74	-1761.70	-1734.91	-620.54	174.86	
1	51	23	4.75-5.34	-1.44	0.85	-4.91	-1175.25	-1573.98	-1573.92	-1175.32	5.02	
1	51	25	3.96-3.33	1.81	-1.18	-3.33	-1201.81	-1579.95	-1571.45	-1210.32	56.08	
1	51	27	3.61-6.89	-2.78	-0.49	-5.12	-1212.58	-1581.63	-1565.17	-1229.04	76.18	
1	51	29	3.09-1.47	0.52	1.10	-2.26	-1459.30	-2301.12	-2289.20	-1471.22	99.45	
1	51	31	8.30-2.50	7.76	-1.97	-2.34	-1614.13	-2363.58	-2363.51	-1614.20	-7.23	
1	51	33	5.08-7.40	-0.37	-1.95	-6.19	-1409.49	-2074.41	-2063.11	-1420.79	85.93	
1	51	35	5.73-11.59	-5.73	-0.14	-8.20	-1181.63	-1810.60	-1808.77	-1183.46	-33.82	
1	51	37	3.76-6.36	-1.44	-1.16	-5.05	-1057.32	-1654.97	-1554.84	-1157.45	223.19	
1	51	39	12.26-2.73	9.31	0.22	-5.96	-790.54	-1446.94	-1402.77	-834.71	-164.45	
1	51	41	18.00-22.85	-22.60	17.75	-3.18	1262.31	134.52	1230.92	165.90	185.50	
1	51	42	14.802.51	10.12	7.18	-5.97	1048.71	191.99	822.27	418.43	377.79	
1	51	43	10.85-9.91	-1.74	2.68	-10.14	495.42	-541.37	12.95	-58.91	517.15	
1	51	44	2.35-6.02	0.28	-3.95	3.61	903.02	208.09	546.60	564.50	347.35	
1	51	45	6.68-1.29	4.30	1.10	3.65	930.36	-87.14	163.39	679.83	438.35	
1	51	46	1.83-2.74	8.30e-02	-1.00	2.22	862.56	299.23	442.91	718.88	245.55	
1	51	47	0.54-3.46	-9.27e-02	-2.83	1.46	878.20	-19.89	90.57	767.74	294.96	
1	51	48	0.29-2.98	-0.84	-1.85	1.55	806.26	293.77	353.77	746.26	164.78	
1	51	49	-0.32-3.64	-0.52	-3.43	0.80	855.08	5.98	51.60	809.46	191.46	
1	51	50	-0.57-2.77	-1.02	-2.31	0.89	770.90	283.41	303.26	751.05	96.36	
1	51	51	-0.62-4.17	-0.66	-4.13	0.39	815.75	11.83	25.08	802.50	102.33	
1	51	52	-1.01-2.56	-1.04	-2.52	0.22	771.49	283.59	287.69	767.39	44.55	



EGP CODE

GRE.EEC.R.73.IT.W.15235.12.024.01

PAGE

379 di/of 527

1	51	53	-0.65-4.45	-0.66	-4.45	9.93e-02	815.94	16.85	17.22	815.57	17.07	
1	51	54	-0.86-2.45	-0.99	-2.32	-0.44	832.92	291.20	306.88	817.24	-90.82	
1	51	55	-0.64-4.35	-0.65	-4.35	-7.74e-02	884.00	17.71	28.56	873.15	-96.35	
1	51	56	5.69e-02	-2.56	-0.83	-1.66	-1.24	946.31	314.39	365.67	895.03	-172.56
1	51	57	-0.53-3.82	-0.60	-3.75	-0.47	1008.93	23.21	61.75	970.39	-191.07	
1	51	58	1.65-2.77	-0.38	-0.74	-2.20	1085.05	346.62	467.94	963.72	-273.62	
1	51	59	0.12-2.93	-0.34	-2.47	-1.09	1171.20	18.23	119.01	1070.42	-325.64	
1	51	60	4.22-2.34	1.45	0.43	-3.24	1246.82	385.50	639.41	992.91	-392.72	
1	51	61	2.27-2.92	0.63	-1.27	-2.41	1298.76	-4.35	202.26	1092.15	-475.98	
1	51	62	4.87-4.67	3.26	-3.05	-3.57	1373.05	314.89	827.34	860.60	-528.82	
1	51	63	11.54-4.54	8.19	-1.18	-6.54	1574.61	-113.38	352.22	1109.01	-754.42	
1	51	64	37.7910.39	22.53	25.65	13.61	1815.80	499.69	1500.71	814.78	-561.62	
1	51	65	16.21-28.90	4.86	-17.54	19.58	1281.58	-569.15	187.80	524.63	-909.91	
1	51	66	28.61-31.54	-29.46	26.53	10.99	2036.02	400.83	1872.66	564.20	-490.35	
1	51	67	2.30-5.48	-4.83	1.64	2.16	1094.46	38.52	1071.43	61.56	154.25	
1	51	68	5.804.58	5.26	5.12	0.61	1057.00	454.64	1031.94	479.70	120.28	
1	51	69	3.65-0.86	1.33	1.47	2.26	854.15	544.12	768.36	629.91	138.69	
1	51	70	2.23-2.88	-0.40	-0.25	2.55	775.12	513.02	606.13	682.02	125.44	
1	51	71	1.10-2.74	-0.86	-0.78	1.92	744.20	457.59	497.18	704.61	98.88	
1	51	72	5.79e-02	-2.37	-1.12	-1.19	1.22	727.49	417.95	436.73	708.70	73.90
1	51	73	-0.89-1.55	-1.14	-1.29	0.32	725.03	418.25	418.56	724.73	-9.68	
1	51	74	-0.32-1.80	-1.02	-1.10	-0.74	783.19	428.34	440.27	771.26	-63.97	
1	51	75	1.04-2.39	-0.71	-0.65	-1.71	875.89	471.83	505.23	842.49	-111.26	
1	51	76	2.77-2.66	9.51e-03	0.10	-2.71	976.65	557.63	622.17	912.11	-151.26	
1	51	77	4.64-2.61	1.21	0.82	-3.62	1075.77	679.47	809.17	946.07	-185.95	
1	51	78	7.511.31	4.47	4.36	-3.10	1221.94	775.36	1084.01	913.28	-206.33	
1	51	79	5.883.97	5.16	4.69	-0.93	1487.48	582.92	1414.25	656.15	-246.74	
1	51	80	3.82-5.15	-3.20	1.87	-3.70	1525.69	168.56	1448.87	245.38	-313.62	
1	51	81	2.32-0.85	1.56	-8.56e-02	1.36	986.91	55.60	985.27	57.24	-39.04	
1	51	82	3.29-1.87	1.10	0.32	2.55	851.96	410.47	849.76	412.67	-31.09	
1	51	83	3.31-2.49	0.46	0.36	2.90	730.51	603.41	725.76	608.16	-24.10	
1	51	84	2.24-3.07	-0.53	-0.30	2.66	673.22	591.69	591.80	673.11	3.01	
1	51	85	1.34-2.71	-0.88	-0.50	2.02	687.51	500.75	503.27	684.99	21.57	
1	51	86	0.42-2.05	-1.03	-0.59	1.22	685.86	449.27	454.24	680.89	33.93	
1	51	87	-0.53-1.10	-1.04	-0.58	0.16	693.03	439.66	440.14	692.55	-11.03	
1	51	88	0.27-1.56	-0.84	-0.45	-0.89	744.85	453.47	459.77	738.55	-42.38	
1	51	89	1.50-2.11	-0.39	-0.21	-1.80	824.31	504.52	513.29	815.54	-52.23	
1	51	90	3.02-2.69	0.29	4.12e-02	-2.85	902.42	596.62	603.17	895.87	-44.27	
1	51	91	4.63-2.87	1.22	0.54	-3.73	932.50	735.25	736.22	931.53	-13.82	
1	51	92	5.34-2.91	1.85	0.58	-4.07	924.63	828.37	920.41	832.59	19.72	
1	51	93	5.26-2.22	2.29	0.75	-3.66	1107.58	545.94	1107.58	545.94	1.53	
1	51	94	4.39-0.79	3.52	7.88e-02	-1.94	1264.53	202.17	1264.16	202.53	19.62	
1	51	95	1.40-1.73	0.75	-1.08	1.27	642.00	-47.00	609.65	-14.65	-145.73	
1	51	96	1.11-2.90	-0.59	-1.20	1.98	618.27	254.84	527.64	345.47	-157.24	
1	51	97	1.52-3.51	-0.89	-1.10	2.52	667.06	404.31	488.70	582.67	-122.69	
1	51	98	1.67-3.20	-0.82	-0.70	2.43	700.39	428.95	447.59	681.75	-68.65	
1	51	99	1.20-2.40	-0.80	-0.40	1.79	692.00	415.69	419.85	687.84	-33.64	
1	51	100	0.47-1.66	-0.92	-0.27	1.02	669.59	399.88	400.11	669.36	-7.87	
1	51	101	-0.11-0.88	-0.88	-0.11	4.92e-03	673.07	395.99	396.00	673.06	-1.78	
1	51	102	0.68-1.30	-0.64	1.38e-02	-0.93	719.82	411.42	411.67	719.57	-8.75	
1	51	103	1.65-1.76	-0.17	6.89e-02	-1.70	807.55	445.78	445.93	807.40	-7.17	
1	51	104	2.98-2.23	0.70	4.90e-02	-2.59	908.96	492.56	493.09	908.43	14.92	
1	51	105	3.85-3.00	1.07	-0.22	-3.36	958.93	515.56	527.84	946.65	72.76	
1	51	106	3.23-3.74	0.18	-0.69	-3.46	882.65	466.42	540.12	808.95	158.89	
1	51	107	3.35-2.29	1.07	-8.22e-03	-2.77	801.16	324.80	669.01	456.94	213.28	
1	51	108	3.91e-02	-2.62	-2.18	-0.40	-0.98	757.42	27.61	683.09	101.93	220.72
1	51	109	10.19-4.98	9.62	-4.42	2.88	-15.11	-267.51	-75.79	-206.83	-107.86	
1	51	110	-1.23-6.41	-5.87	-1.77	-1.58	391.07	-92.84	22.11	276.11	-205.94	
1	51	111	2.56e-02	-4.14	-2.66	-1.46	2.00	637.06	153.31	188.73	601.64	-126.01
1	51	112	1.80-2.11	-0.15	-0.16	1.95	716.68	279.40	286.99	709.09	-57.10	
1	51	113	0.85-1.93	-0.92	-0.16	1.34	699.51	306.34	309.16	696.69	-33.18	
1	51	114	0.50-1.24	-0.88	0.14	0.70	662.92	318.57	318.60	662.89	-3.27	
1	51	115	0.35-0.77	-0.76	0.35	-7.11e-02	659.47	324.97	324.99	659.44	-3.11	
1	51	116	1.01-1.00	-0.50	0.52	-0.87	705.59	337.55	337.63	705.51	-5.52	
1	51	117	1.84-1.44	-0.25	0.65	-1.57	800.10	351.86	351.99	799.98	-7.53	
1	51	118	2.76-1.54	0.60	0.61	-2.15	922.03	366.27	366.27	922.03	-8.87e-02	
1	51	119	3.91-1.43	1.63	0.85	-2.64	1010.10	316.16	318.45	1007.82	39.73	
1	51	120	1.92-3.30	-1.21	-0.16	-2.56	905.03	128.67	163.61	870.09	160.94	
1	51	121	-1.59-10.15	-8.63	-3.10	3.27	476.57	-283.52	-132.77	325.81	303.08	
1	51	122	11.35-1.76	11.27	-1.68	1.05	125.68	-423.95	-237.43	-60.83	260.25	
1	51	123	41.91-3.14	41.89	-3.11	-1.08	-750.52	-1393.38	-1350.76	-793.15	159.96	
1	51	124	-12.39-26.79	-23.02	-16.16	-6.33	210.52	-490.07	-474.83	195.28	-102.21	
1	51	125	4.33-4.27e-02	0.36	3.92	1.26	604.32	-9.82	-9.80	604.29	3.63	
1	51	126	1.43-2.21	-1.15	0.37	1.65	713.57	178.95	179.09	713.43	8.79	
1	51	127	1.22-1.36	-0.75	0.62	1.09	687.45	229.81	229.84	687.43	3.40	
1	51	128	0.84-1.05	-0.89	0.67	0.53	650.08	246.01	246.02	650.06	2.18	





EGP CODE

GRE.EEC.R.73.IT.W.15235.12.024.01

PAGE

380 di/of 527

1	51	129	0.85-0.67	-0.65	0.83	-0.17	643.62	256.93	256.94	643.61	-1.79
1	51	130	1.50-0.87	-0.43	1.06	-0.93	688.09	267.91	268.04	687.96	-7.28
1	51	131	2.34-1.49	-0.55	1.41	-1.64	782.35	270.54	271.37	781.52	-20.63
1	51	132	3.69-0.87	0.77	2.05	-2.19	907.25	284.84	287.77	904.33	-42.56
1	51	133	3.84-1.70	-0.23	2.37	-2.45	1002.58	200.81	204.38	999.01	-53.34
1	51	134	12.162.53	4.59	10.10	-3.95	1061.06	40.29	47.97	1053.38	-88.22
1	51	135	-11.20-30.24-27.56		-13.89	6.63	408.95	-847.81	-824.85	386.00	168.29
1	51	136	79.56-16.38	79.56	-16.38	0.48	-846.47	-2003.69	-1993.25	-856.91	109.42
1	51	137	18.92-0.12	5.29	13.51	-8.58	410.91	-371.50	-224.43	263.83	305.68
1	51	138	9.62-2.73	0.66	6.23	5.51	686.72	33.47	54.99	665.19	116.61
1	51	139	2.01-1.41	-0.41	1.01	1.55	700.53	171.14	174.83	696.84	44.05
1	51	140	1.61-0.95	-0.42	1.07	1.04	680.81	214.69	215.72	679.78	21.90
1	51	141	1.07-0.95	-0.85	0.97	0.45	641.96	216.48	216.68	641.76	9.18
1	51	142	1.10-0.61	-0.58	1.07	-0.25	635.07	225.53	225.53	635.07	-0.93
1	51	143	1.79-0.87	-0.41	1.33	-1.01	681.39	236.02	236.19	681.22	-8.71
1	51	144	2.80-1.19	-0.17	1.79	-1.74	778.13	251.45	252.36	777.22	-21.83
1	51	145	4.24-1.00	0.75	2.50	-2.47	899.75	272.77	277.13	895.39	-52.12
1	51	146	6.09-0.80	1.10	4.19	-3.08	1015.41	249.63	261.95	1003.10	-96.32
1	51	147	14.94-5.71	1.24	7.99	-9.76	1147.82	88.30	156.01	1080.11	-259.15
1	51	148	37.40-29.12	30.82	-22.55	19.85	1370.48	-431.76	-141.30	1080.01	-662.66
1	51	149	9.95-37.47	-37.47	9.95	-0.30	684.06	-299.87	682.03	-297.83	-44.69
1	51	150	19.541.80	17.74	3.60	-5.36	566.64	-186.04	25.08	355.52	338.14
1	51	151	4.71-8.10	-2.28	-1.12	6.38	625.77	51.86	123.63	554.00	189.85
1	51	152	3.46-1.70	-0.66	2.42	2.07	662.78	173.73	182.23	654.27	63.93
1	51	153	1.86-1.67	-1.19	1.39	1.20	647.41	189.20	191.01	645.60	28.78
1	51	154	1.31-0.88	-0.77	1.21	0.46	623.95	195.83	196.05	623.73	9.68
1	51	155	1.30-0.54	-0.48	1.24	-0.32	623.83	201.69	201.69	623.83	0.61
1	51	156	2.06-0.93	-0.39	1.52	-1.14	664.10	210.42	210.54	663.98	-7.51
1	51	157	3.35-0.94	0.34	2.08	-1.96	745.49	239.59	240.47	744.61	-21.09
1	51	158	4.91-1.26	0.66	2.99	-2.86	846.85	263.79	268.38	842.27	-51.50
1	51	159	7.63-1.43	1.48	4.72	-4.23	945.08	282.09	299.03	928.14	-104.60
1	51	160	7.56-9.64	0.23	-2.30	-8.50	1034.66	139.13	246.71	927.09	-291.14
1	51	161	53.379.02	38.43	23.96	20.97	1296.26	159.32	570.48	885.10	-546.27
1	51	162	17.80-62.09	-59.94	15.65	12.93	1407.95	70.29	1358.95	119.28	-251.28
1	51	163	1.52-12.18	-11.84	1.18	2.15	574.64	-89.85	557.48	-72.70	105.38
1	51	164	8.798.00	8.58	8.21	0.35	594.90	250.90	510.76	335.04	147.87
1	51	165	4.24-1.14	1.14	1.96	2.66	568.23	231.91	269.75	530.39	106.27
1	51	166	3.78-1.97	-0.18	1.99	2.66	609.68	214.61	223.04	601.26	57.07
1	51	167	2.40-1.34	-0.58	1.64	1.51	616.12	184.11	185.45	614.78	24.01
1	51	168	1.53-0.58	-0.42	1.37	0.57	605.06	171.42	171.60	604.88	8.84
1	51	169	1.50-0.29	-0.19	1.40	-0.40	608.95	168.71	168.73	608.93	2.69
1	51	170	2.44-0.81-3.26e-02		1.66	-1.39	648.84	180.03	180.04	648.82	-2.72
1	51	171	3.86-1.09	0.63	2.14	-2.36	722.45	213.11	213.36	722.19	-11.43
1	51	172	5.65-1.47	1.28	2.90	-3.46	804.09	259.09	260.56	802.61	-28.34
1	51	173	7.52-2.01	2.15	3.36	-4.73	865.52	333.94	341.03	858.43	-60.99
1	51	174	9.351.50	5.24	5.60	-3.92	877.02	412.58	451.69	837.90	-128.98
1	51	175	10.528.96	10.39	9.09	0.44	945.74	454.06	833.72	566.08	-206.23
1	51	176	4.32-14.92	-13.62	3.03	-4.82	924.03	67.54	832.84	158.73	-264.16
1	51	177	2.90-0.79	1.58	0.53	1.77	611.18	-13.49	610.84	-13.14	14.62
1	51	178	4.04-0.79	1.57	1.68	2.41	489.49	320.32	489.38	320.43	4.21
1	51	179	4.28-1.27	1.61	1.40	2.77	502.76	370.70	370.83	502.63	-4.23
1	51	180	3.48-1.39	1.11	0.97	2.43	583.77	245.18	245.36	583.59	-7.80
1	51	181	2.13-1.06-3.42e-02		1.11	1.49	599.76	174.23	174.26	599.73	-3.71
1	51	182	1.39-0.29-8.20e-02		1.18	0.55	594.25	147.84	147.84	594.25	0.38
1	51	183	1.49-4.43e-02	0.14	1.30	-0.50	601.54	142.27	142.28	601.53	2.72
1	51	184	2.68-0.66	0.51	1.51	-1.59	642.91	154.95	155.00	642.87	4.70
1	51	185	4.06-1.15	1.11	1.80	-2.59	716.81	184.51	184.67	716.65	9.25
1	51	186	5.57-1.74	1.80	2.03	-3.65	797.39	235.42	236.06	796.76	18.85
1	51	187	6.96-1.90	2.77	2.30	-4.42	837.86	319.99	322.43	835.42	35.45
1	51	188	7.56-1.41	3.48	2.67	-4.46	757.76	459.38	462.82	754.33	31.83
1	51	189	6.97-1.57	2.63	2.77	-4.27	610.41	482.57	610.31	482.67	3.59
1	51	190	6.49-1.10	4.42	0.97	-3.38	740.02	157.12	739.34	157.79	-19.84
1	51	191	0.14-2.12	-1.48	-0.49	1.02	398.55	-60.82	375.27	-37.55	-100.75
1	51	192	3.18-1.83	1.43	-8.22e-02	2.39	448.41	203.72	362.82	289.32	-116.69
1	51	193	3.22-1.97	1.49	-0.24	2.45	540.08	226.52	265.36	501.25	-103.29
1	51	194	2.68-1.28	1.34	5.93e-02	1.88	606.85	190.79	202.66	594.99	-69.25
1	51	195	1.81-0.49	0.73	0.59	1.15	611.80	140.99	143.80	608.99	-36.22
1	51	196	1.120.20	0.43	0.89	0.40	599.59	125.73	125.85	599.47	-7.53
1	51	197	1.496.35e-02	0.42	1.13	-0.62	604.03	118.95	118.97	604.02	2.23
1	51	198	2.81-0.67	0.82	1.32	-1.72	648.06	127.43	127.63	647.86	10.23
1	51	199	4.01-1.18	1.38	1.45	-2.59	731.44	145.92	146.64	730.72	20.56
1	51	200	5.33-1.61	2.19	1.53	-3.45	832.46	173.10	176.53	829.04	47.39
1	51	201	5.79-2.15	2.41	1.23	-3.93	878.44	186.78	201.88	863.33	101.10
1	51	202	6.00-2.19	2.72	1.09	-4.01	791.95	214.36	271.06	735.26	171.85
1	51	203	5.25-1.85	1.84	1.57	-3.55	605.93	197.02	378.70	424.25	203.18
1	51	204	0.99-1.59	-1.01	0.42	-1.07	485.67	11.54	399.85	97.36	182.54





EGP CODE

GRE.EEC.R.73.IT.W.15235.12.024.01

PAGE

381 di/of 527

1	51	205	1.12-4.62	0.31	-3.81	1.99	28.89	-230.58	-41.32	-160.37	-115.27
1	51	206	-1.25-3.22	-3.10	-1.37	0.47	313.23	-129.21	-40.17	224.19	-177.39
1	51	207	-0.48-3.18	-2.11	-1.55	1.32	568.79	-29.82	10.70	528.27	-150.38
1	51	208	2.02-0.72	1.10	0.19	1.29	653.05	74.46	86.14	641.37	-81.35
1	51	209	1.28-0.11	0.71	0.45	0.68	643.21	94.33	98.15	639.38	-45.65
1	51	210	0.940.40	0.51	0.83	0.21	613.97	97.68	98.68	612.97	-22.69
1	51	211	1.580.11	0.62	1.08	-0.70	611.15	100.38	100.40	611.13	-3.34
1	51	212	2.95-0.66	1.02	1.26	-1.80	656.59	107.26	107.28	656.56	3.81
1	51	213	3.99-1.00	1.58	1.41	-2.49	750.85	114.82	114.89	750.78	6.88
1	51	214	5.05-1.30	2.21	1.53	-3.16	869.24	111.59	112.79	868.04	30.09
1	51	215	5.99-1.23	2.54	2.21	-3.61	948.65	64.08	74.07	938.67	93.45
1	51	216	2.62-2.04	-0.37	0.95	-2.23	844.84	-86.94	-31.12	789.02	221.12
1	51	217	-0.74-3.22	-3.07	-0.89	-0.59	495.06	-317.01	-159.86	337.91	320.81
1	51	218	1.79-0.38	-0.10	1.52	0.72	222.15	-347.57	-122.38	-3.04	278.54
1	51	219	25.37-13.10	25.22	-12.95	-2.40	-503.33	-817.18	-808.60	-511.91	51.18
1	51	220	-11.87-17.96-16.42		-13.41	-2.65	182.35	-571.37	-496.23	107.21	-225.81
1	51	221	2.94-1.85	-1.50	2.59	1.25	585.10	-161.18	-153.41	577.33	-75.76
1	51	222	1.87-0.11	0.94	0.83	0.99	682.83	10.06	11.30	681.59	-28.86
1	51	223	1.190.32	0.64	0.87	0.42	656.99	63.81	64.33	656.47	-17.65
1	51	224	1.090.53	0.59	1.03	0.18	619.95	83.75	84.06	619.64	-12.91
1	51	225	1.710.21	0.72	1.20	-0.71	614.12	91.65	91.66	614.11	1.65
1	51	226	3.12-0.61	1.12	1.39	-1.86	659.27	98.08	98.24	659.12	-9.29
1	51	227	4.08-0.82	1.66	1.61	-2.45	757.22	99.68	100.27	756.64	-19.58
1	51	228	5.25-0.85	2.48	1.92	-3.04	885.19	86.75	87.07	884.87	-16.13
1	51	229	6.78-1.18	2.93	2.67	-3.98	992.70	6.53	6.53	992.70	-0.95
1	51	230	15.16-0.82	3.22	11.12	-6.94	1023.76	-163.42	-158.14	1018.49	78.93
1	51	231	-4.18-17.32	-17.09	-4.41	1.71	323.49	-943.47	-827.56	207.58	365.26
1	51	232	44.14-30.57	44.14	-30.57	0.14	-528.29	-1330.63	-1289.70	-569.22	176.54
1	51	233	-0.36-6.61	-6.61	-0.36	0.18	593.49	-74.01	584.39	-64.91	-77.42
1	51	234	13.15-1.02	7.23	4.89	-6.99	357.13	-644.92	-550.34	262.55	292.98
1	51	235	9.531.79	6.30	5.02	3.82	674.29	-84.70	-61.35	650.94	131.05
1	51	236	2.990.21	1.27	1.92	1.35	670.97	30.65	35.54	666.08	55.71
1	51	237	1.770.27	0.59	1.45	0.61	648.87	64.48	66.37	646.98	33.18
1	51	238	1.430.46	0.58	1.31	0.32	613.95	87.35	88.38	612.92	23.27
1	51	239	1.810.35	0.78	1.37	-0.67	608.40	95.91	96.49	607.82	17.16
1	51	240	3.33-0.60	1.18	1.56	-1.96	651.13	104.44	104.54	651.03	-7.34
1	51	241	4.32-0.75	1.69	1.88	-2.53	743.10	111.41	112.30	742.22	-23.63
1	51	242	5.49-0.51	2.72	2.27	-2.99	866.90	109.70	114.85	861.75	-62.22
1	51	243	6.96-0.60	4.16	2.20	-3.65	986.64	78.69	90.13	975.20	-101.28
1	51	244	12.41-6.48	9.11	-3.18	-7.18	1128.37	-116.98	-51.32	1062.71	-278.31
1	51	245	22.50-37.31	18.74	-33.55	14.52	1151.22	-834.30	-642.75	959.67	-586.20
1	51	246	2.24-0.37	0.35	1.51	1.17	469.32	69.10	69.19	469.24	5.89
1	51	247	12.23-21.71	-21.64	12.16	1.52	656.57	-33.93	645.29	-22.65	87.53
1	51	248	12.680.19	8.98	3.89	-5.71	545.53	-81.98	169.58	293.97	307.53
1	51	249	2.98-4.63	-0.22	-1.44	3.76	592.40	2.55	96.28	498.67	215.64
1	51	250	3.56-0.55	0.93	2.09	1.97	637.79	103.05	121.54	619.29	97.72
1	51	251	2.192.61e-02	0.57	1.64	0.94	621.00	110.59	115.36	616.23	49.11
1	51	252	1.680.37	0.62	1.43	0.51	595.91	108.21	109.24	594.88	22.43
1	51	253	1.840.44	0.85	1.42	-0.64	595.23	111.19	111.21	595.20	3.26
1	51	254	3.53-0.64	1.26	1.62	-2.08	636.86	121.75	121.93	636.68	-9.49
1	51	255	4.51-0.75	1.75	2.01	-2.63	719.73	141.65	142.89	718.49	-26.78
1	51	256	5.37-0.48	2.34	2.55	-2.92	820.54	172.02	177.24	815.33	-57.93
1	51	257	6.518.31e-02	3.34	3.25	-3.21	921.71	214.90	238.87	897.73	-127.96
1	51	258	5.250.25	4.04	1.45	-2.14	990.79	137.41	239.57	888.63	-277.03
1	51	259	37.898.65	19.97	26.56	14.24	1081.97	253.87	651.57	684.27	-413.73
1	51	260	17.20-27.56	-26.83	16.48	5.66	1208.04	197.63	1073.72	331.95	-343.04
1	51	261	0.81-6.34	-5.57	4.29e-02	2.21	518.78	-67.32	499.85	-48.38	103.62
1	51	262	6.284.16	4.24	6.19	0.42	570.03	309.07	526.28	352.81	97.48
1	51	263	3.920.32	1.99	2.25	1.79	563.35	278.40	318.74	523.02	99.33
1	51	264	3.28-0.80	1.14	1.35	2.04	586.43	221.65	232.57	575.51	62.16
1	51	265	2.18-0.15	0.69	1.34	1.12	588.95	168.37	170.51	586.81	29.92
1	51	266	1.630.27	0.67	1.23	0.62	578.83	130.60	131.02	578.41	13.68
1	51	267	1.810.49	1.02	1.29	-0.65	584.83	127.57	127.62	584.78	4.60
1	51	268	3.63-0.78	1.36	1.48	-2.21	626.57	138.32	138.33	626.55	-3.05
1	51	269	4.50-0.92	1.75	1.83	-2.71	701.28	168.00	168.18	701.10	-9.67
1	51	270	5.49-0.81	2.27	2.41	-3.15	786.38	241.67	242.41	785.63	-20.17
1	51	271	6.72-0.71	2.88	3.13	-3.71	848.05	330.72	334.57	844.21	-44.43
1	51	272	9.492.24	4.88	6.85	-3.49	855.17	461.62	492.78	824.01	-106.26
1	51	273	7.792.02	3.04	6.77	-2.20	824.30	462.19	723.03	563.47	-162.53
1	51	274	7.27-7.84	-3.63	3.07	-6.77	769.58	78.34	680.62	167.30	-231.47
1	51	275	2.80-0.54	2.03	0.23	1.40	591.81	-1.77	591.80	-1.76	-2.78
1	51	276	3.19-0.79	1.42	0.98	1.98	483.83	319.45	482.21	321.07	-16.26
1	51	277	3.45-0.78	1.82	0.85	2.06	505.20	372.65	375.57	502.28	-19.45
1	51	278	3.25-0.63	2.03	0.58	1.80	570.43	270.09	270.73	569.79	-13.93
1	51	279	2.19-0.50	1.01	0.69	1.33	580.35	185.45	185.46	580.34	-0.23
1	51	280	1.93-0.21	0.85	0.87	1.07	575.29	141.12	141.41	575.00	11.13



EGP CODE

GRE.EEC.R.73.IT.W.15235.12.024.01

PAGE

382 di/of 527

1	51	281	1.320.88	1.17	1.02	-0.21	585.03	134.34	134.74	584.62	13.54	
1	51	282	3.15-0.46	1.47	1.22	-1.80	629.19	143.31	143.90	628.61	16.83	
1	51	283	4.10-0.85	1.78	1.47	-2.47	706.47	171.09	172.15	705.41	23.79	
1	51	284	5.16-1.29	2.17	1.70	-3.22	791.77	233.03	235.35	789.45	35.98	
1	51	285	6.47-1.41	2.88	2.19	-3.93	837.68	324.85	330.05	832.48	51.38	
1	51	286	6.86-1.80	2.70	2.35	-4.33	760.40	456.25	464.45	752.20	49.26	
1	51	287	6.57-2.06	2.31	2.20	-4.32	616.99	470.03	611.73	475.29	27.30	
1	51	288	5.93-1.18	3.82	0.93	-3.25	743.59	154.97	743.57	154.98	-3.06	
1	51	289	-8.34e-02	-1.98	-1.42	-0.64	0.86	420.02	-53.91	395.51	-29.39	-104.96
1	51	290	2.68-1.64	1.39	-0.35	1.98	461.30	205.46	373.75	293.01	-121.38	
1	51	291	2.81-1.64	1.80	-0.63	1.87	542.75	224.94	276.27	491.42	-116.96	
1	51	292	2.76-1.08	2.02	-0.34	1.52	602.87	198.04	215.78	585.13	-82.87	
1	51	293	2.13-0.81	1.10	0.23	1.40	603.64	154.06	158.45	599.25	-44.23	
1	51	294	2.20-0.71	0.96	0.54	1.44	589.60	132.68	133.16	589.12	-14.68	
1	51	295	1.370.72	1.28	0.81	0.22	595.35	129.89	129.91	595.32	-3.53	
1	51	296	2.67-7.68e-02	1.57	1.02	-1.35	643.01	136.32	136.48	642.85	9.17	
1	51	297	3.57-0.52	1.85	1.20	-2.02	731.05	152.55	153.76	729.84	26.44	
1	51	298	4.61-1.03	2.23	1.36	-2.79	832.42	176.80	183.47	825.75	65.81	
1	51	299	5.05-1.65	2.37	1.03	-3.28	881.46	199.92	222.74	858.64	122.62	
1	51	300	5.46-1.93	2.65	0.87	-3.58	812.19	219.03	291.93	739.29	194.74	
1	51	301	4.78-2.00	1.38	1.40	-3.39	666.84	196.93	427.10	436.68	234.91	
1	51	302	0.77-2.30	-1.85	0.31	-1.09	575.48	2.50	461.65	116.33	228.61	
1	51	303	0.38-4.97	-0.77	-3.82	2.19	151.56	-211.75	82.73	-142.92	-142.36	
1	51	304	-0.44-1.94	-0.75	-1.63	0.61	359.81	-68.59	56.09	235.13	-194.60	
1	51	305	-0.88-2.12	-1.16	-1.85	0.52	577.07	5.13	66.66	515.54	-177.21	
1	51	306	1.71-0.72	0.99	-4.33e-03	1.11	645.06	86.46	104.95	626.57	-99.93	
1	51	307	2.05-0.62	1.24	0.19	1.22	637.80	114.72	119.27	633.25	-48.55	
1	51	308	2.17-0.59	1.07	0.50	1.35	611.23	114.33	115.19	610.36	-20.70	
1	51	309	1.370.71	1.31	0.77	0.19	611.99	117.85	117.93	611.91	-6.36	
1	51	310	2.75-0.15	1.63	0.97	-1.41	660.57	122.86	122.96	660.47	7.35	
1	51	311	3.53-0.52	1.80	1.21	-2.00	758.70	123.49	124.71	757.47	27.84	
1	51	312	4.58-0.78	2.33	1.46	-2.65	879.67	121.33	125.63	875.38	56.92	
1	51	313	5.38-0.63	2.47	2.27	-3.00	963.40	76.84	96.03	944.21	129.02	
1	51	314	1.78-1.35	-0.42	0.84	-1.43	881.05	-73.35	7.10	800.61	265.15	
1	51	315	1.08-1.81	0.40	-1.13	-1.22	596.85	-233.78	-14.98	378.05	365.88	
1	51	316	1.68-3.18	-3.18	1.68	7.29e-02	360.20	-306.71	22.45	31.04	333.43	
1	51	317	21.41-13.84	21.20	-13.63	-2.73	-434.46	-629.70	-629.02	-435.14	-11.47	
1	51	318	-11.40-17.15-15.19		-13.36	-2.73	219.93	-531.52	-411.13	99.53	-275.64	
1	51	319	2.54-2.11	-1.92	2.35	0.91	585.05	-155.78	-133.86	563.13	-125.52	
1	51	320	1.56-0.30	0.55	0.71	0.93	683.04	12.06	15.83	679.27	-50.15	
1	51	321	1.76-3.57e-02	1.10	0.62	0.86	661.79	81.48	82.06	661.21	-18.23	
1	51	322	1.530.28	1.06	0.75	0.60	626.88	100.78	100.78	626.87	1.81	
1	51	323	1.710.46	1.24	0.94	-0.61	623.79	108.77	108.77	623.79	0.61	
1	51	324	3.22-0.45	1.59	1.18	-1.82	672.95	114.68	114.89	672.74	-10.83	
1	51	325	3.98-0.68	1.83	1.47	-2.32	774.29	111.09	111.10	774.28	-2.49	
1	51	326	5.10-0.64	2.52	1.94	-2.85	910.98	95.87	95.93	910.91	7.55	
1	51	327	6.80-0.47	3.39	2.94	-3.63	1025.93	24.57	26.10	1024.40	39.10	
1	51	328	14.44-0.80	2.63	11.01	-6.37	1053.50	-169.45	-148.98	1033.03	156.86	
1	51	329	-1.42-14.57	-14.37	-1.63	1.63	418.35	-897.39	-716.40	237.36	453.19	
1	51	330	36.08-30.69	36.08	-30.68	-0.17	-349.68	-1195.29	-1084.49	-460.49	285.34	
1	51	331	-6.62-21.00	-19.31	-8.30	4.62	-149.94	-439.00	-401.80	-187.14	-96.80	
1	51	332	15.010.93	8.21	7.73	-7.04	275.43	-684.85	-614.01	204.59	251.01	
1	51	333	8.301.96	4.44	5.82	3.09	659.24	-132.74	-114.84	641.34	117.72	
1	51	334	2.69-2.05e-02	0.87	1.79	1.27	679.13	12.14	16.86	674.42	55.87	
1	51	335	1.987.23e-02	0.72	1.34	0.90	657.90	68.67	71.53	655.04	40.96	
1	51	336	1.270.86	0.96	1.18	-0.17	625.01	98.70	99.57	624.14	21.43	
1	51	337	2.75-0.37	1.15	1.23	-1.56	622.15	107.99	108.17	621.97	9.81	
1	51	338	3.67-0.72	1.49	1.46	-2.20	668.73	116.58	116.68	668.63	-7.42	
1	51	339	4.39-0.85	1.69	1.85	-2.62	764.65	116.50	117.11	764.04	-19.85	
1	51	340	5.63-0.29	3.03	2.30	-2.94	898.18	115.79	122.31	891.67	-71.10	
1	51	341	6.88-8.15e-02	4.58	2.21	-3.27	1022.85	79.19	88.14	1013.89	-91.50	
1	51	342	10.42-4.65	8.45	-2.68	-5.08	1160.30	-140.69	-85.68	1105.29	-261.81	
1	51	343	27.15-38.80	22.32	-33.97	17.19	1222.59	-822.64	-673.31	1073.27	-532.07	
1	51	344	0.70-42.34	-30.39	-11.26	19.28	-148.55	-1205.01	-1180.00	-173.55	160.60	
1	51	345	62.0926.73	54.47	34.35	14.53	44.90	-746.11	-741.62	40.40	59.45	
1	51	346	24.511.09	19.68	5.91	9.47	449.78	-87.81	438.61	-76.63	76.71	
1	51	347	0.28-2.64	-1.63	-0.73	1.39	388.65	-72.44	388.14	-71.93	-15.38	
1	51	348	-1.09-9.98	-9.04	-2.03	2.73	-45.25	-136.55	-59.83	-121.97	-33.45	
1	51	349	-5.26-33.56	-17.48	-21.34	14.02	-297.50	-770.40	-644.87	-423.03	208.82	
1	51	350	2.56-34.27	-28.59	-3.12	13.30	110.19	-791.34	-754.81	73.65	177.78	
1	51	351	43.0424.79	40.14	27.69	6.67	39.70	-296.38	-233.47	-23.21	131.09	
1	51	352	15.29-1.64	10.30	3.34	7.72	718.47	-54.41	682.46	-18.41	162.88	
1	51	353	-0.73-3.52	-3.46	-0.79	0.41	668.39	-56.46	664.64	-52.71	52.05	
1	51	354	-0.43-6.14	-6.14	-0.43	3.04e-02	591.99	-62.47	591.57	-62.05	16.57	
1	51	355	-0.24-6.47	-6.47	-0.25	0.22	470.17	-91.08	469.66	-90.56	-16.96	
1	51	356	-0.58-7.71	-7.51	-0.78	1.18	210.19	-125.76	198.19	-113.76	62.34	



EGP CODE

GRE.EEC.R.73.IT.W.15235.12.024.01

PAGE

383 di/of 527

1	51	357	11.53-25.37	-25.33	11.50	1.12	560.72	-143.89	559.58	-142.75	28.36
1	51	358	13.88-0.49	10.43	2.97	-6.14	520.60	-189.48	55.17	275.95	337.44
1	51	359	2.54-6.37	-1.77	-2.06	4.45	587.43	-71.65	14.36	501.42	222.01
1	51	360	3.51-0.44	0.89	2.18	1.87	655.74	76.91	93.87	638.78	97.62
1	51	361	2.36-0.15	0.64	1.57	1.17	643.10	102.46	111.68	633.88	70.02
1	51	362	1.320.92	0.92	1.31	5.14e-02	613.68	114.81	116.46	612.03	28.64
1	51	363	2.66-0.23	1.13	1.30	-1.44	613.61	119.15	119.16	613.60	-1.17
1	51	364	3.71-0.74	1.45	1.52	-2.23	659.14	129.28	129.53	658.89	-11.53
1	51	365	4.61-0.84	1.80	1.97	-2.72	749.57	145.41	146.95	748.03	-30.42
1	51	366	5.35-0.54	2.22	2.59	-2.94	862.76	162.99	169.99	855.76	-69.67
1	51	367	6.400.27	3.16	3.51	-3.06	978.32	171.38	195.47	954.23	-137.33
1	51	368	5.04-0.21	3.57	1.26	-2.36	1072.17	71.52	174.95	968.73	-304.63
1	51	369	44.478.73	23.99	29.21	17.68	1202.97	177.07	583.22	796.82	-501.71
1	51	370	17.03-34.22	-32.71	15.52	8.66	1168.20	124.45	1028.92	263.73	-354.93
1	51	371	0.64-8.02	-7.50	0.12	2.05	498.60	-92.54	473.86	-67.80	118.38
1	51	372	7.265.93	5.93	7.26	-4.20e-02	573.70	265.70	495.91	343.48	133.82
1	51	373	3.300.25	1.54	2.01	1.51	574.93	217.40	266.53	525.80	123.09
1	51	374	3.57-0.50	1.62	1.45	2.03	599.61	206.28	219.71	586.17	71.44
1	51	375	2.65-0.21	1.03	1.40	1.42	603.62	163.82	166.45	600.99	33.90
1	51	376	1.870.19	0.85	1.21	0.82	595.29	132.26	133.61	593.94	24.94
1	51	377	1.990.45	1.21	1.22	-0.77	602.45	131.95	132.28	602.12	12.57
1	51	378	3.78-0.84	1.52	1.42	-2.31	647.31	143.05	143.19	647.17	-8.35
1	51	379	4.74-1.05	1.85	1.84	-2.89	727.45	170.89	171.52	726.81	-18.78
1	51	380	5.60-1.09	1.93	2.59	-3.33	820.42	221.08	223.52	817.97	-38.20
1	51	381	6.64-0.82	2.31	3.51	-3.68	895.67	301.11	309.91	886.88	-71.78
1	51	382	9.322.05	3.96	7.41	-3.20	923.90	392.57	441.75	874.71	-153.99
1	51	383	9.013.85	4.48	8.37	-1.70	896.91	411.66	716.65	591.91	-234.47
1	51	384	7.88-9.69	-5.64	3.84	-7.40	840.01	31.64	691.29	180.36	-313.22
1	51	385	3.19-0.39	2.52	0.27	1.39	618.03	-2.17	616.92	-1.06	26.23
1	51	386	3.03-0.27	1.52	1.24	1.64	475.30	321.02	473.20	323.12	17.88
1	51	387	3.29-0.40	1.80	1.09	1.81	505.56	364.05	365.21	504.40	12.79
1	51	388	3.31-0.57	2.01	0.73	1.83	572.85	265.04	265.20	572.69	6.99
1	51	389	2.88-0.35	1.73	0.79	1.55	587.06	194.87	195.05	586.89	8.25
1	51	390	2.34-0.48	0.99	0.86	1.41	585.23	141.10	141.23	585.11	7.38
1	51	391	1.380.89	1.31	0.96	-0.17	598.04	135.19	135.25	597.98	5.59
1	51	392	3.48-0.71	1.64	1.13	-2.08	644.85	144.01	144.06	644.79	5.38
1	51	393	4.35-1.17	1.76	1.41	-2.75	723.76	172.96	173.09	723.64	8.31
1	51	394	5.21-1.79	1.65	1.77	-3.50	810.04	227.29	227.67	809.66	14.99
1	51	395	6.27-1.83	2.04	2.39	-4.05	857.14	328.09	328.77	856.46	18.89
1	51	396	6.64-1.78	2.14	2.72	-4.20	778.46	470.70	470.70	778.46	1.05
1	51	397	6.86-1.91	2.17	2.78	-4.37	627.85	493.36	618.25	502.96	-34.63
1	51	398	6.42-1.56	3.80	1.07	-3.75	755.15	163.76	748.10	170.81	-64.20
1	51	399	0.57-0.82	9.42e-02	-0.34	0.66	501.17	-31.61	483.86	-14.29	-94.47
1	51	400	2.36-0.90	1.52	-6.11e-02	1.43	457.31	237.68	391.65	303.34	-100.55
1	51	401	2.58-1.16	1.59	-0.17	1.66	531.51	271.74	310.10	493.15	-92.16
1	51	402	2.76-0.89	1.85	1.81e-02	1.58	594.79	200.81	211.79	583.82	-64.83
1	51	403	2.51-0.71	1.54	0.27	1.48	597.05	160.03	161.53	595.55	-25.54
1	51	404	2.37-0.75	1.11	0.52	1.53	592.04	127.34	127.42	591.95	-6.14
1	51	405	1.400.72	1.39	0.72	6.37e-02	604.00	124.73	124.75	603.99	-2.43
1	51	406	3.12-0.52	1.72	0.87	-1.77	653.51	129.03	129.10	653.44	6.11
1	51	407	3.98-0.91	2.11	0.96	-2.38	740.38	152.74	154.41	738.71	31.31
1	51	408	4.76-1.59	2.15	1.02	-3.13	837.63	179.76	184.80	832.60	57.32
1	51	409	5.12-2.43	1.69	0.99	-3.76	880.77	213.64	230.97	863.43	106.14
1	51	410	4.95-2.56	1.38	1.01	-3.75	795.74	269.62	319.12	746.24	153.60
1	51	411	3.67-2.00	0.87	0.79	-2.83	631.25	273.54	452.35	452.44	178.86
1	51	412	1.48-1.07	0.22	0.20	-1.28	604.38	77.21	539.42	142.18	173.29
1	51	413	0.36-1.44	-2.57e-02	-1.06	0.74	244.49	-189.83	142.75	-88.09	-183.95
1	51	414	0.31-1.56	-0.28	-0.97	0.87	382.69	-10.68	123.48	248.53	-186.48
1	51	415	0.97-1.66	0.24	-0.93	1.17	560.04	37.23	95.00	502.26	-163.91
1	51	416	1.69-1.21	0.99	-0.51	1.24	631.42	73.36	91.34	613.44	-98.54
1	51	417	2.48-0.56	1.89	2.98e-02	1.20	632.50	108.17	112.26	628.41	-46.12
1	51	418	2.38-0.56	1.42	0.40	1.38	612.13	104.82	105.46	611.49	-17.92
1	51	419	1.370.70	1.37	0.71	1.92e-02	616.61	105.23	105.31	616.54	-6.11
1	51	420	2.94-0.48	1.57	0.89	-1.68	667.46	106.59	106.60	667.45	2.49
1	51	421	3.44-0.69	1.84	0.91	-2.01	765.93	109.70	110.24	765.38	18.84
1	51	422	4.24-0.95	2.55	0.74	-2.44	886.26	106.86	110.59	882.52	53.81
1	51	423	4.81-1.61	2.68	0.52	-3.03	950.04	64.44	83.97	930.52	130.04
1	51	424	2.66-3.23	-0.75	0.17	-2.91	854.99	-64.51	11.02	779.46	252.47
1	51	425	2.23-1.70	-0.62	1.15	-1.75	616.87	-127.89	77.47	411.51	332.82
1	51	426	0.28-2.88	-2.88	0.28	0.14	407.45	-273.89	67.23	66.33	340.67
1	51	427	9.34-5.68	9.07	-5.41	2.01	-295.72	-591.47	-578.00	-309.19	-61.65
1	51	428	0.39-7.74	-6.58	-0.77	-2.84	263.41	-439.93	-358.25	181.73	-225.33
1	51	429	-0.80-3.21	-2.60	-1.41	1.04	562.92	-221.40	-201.32	542.84	-123.87
1	51	430	1.47-0.23	1.03	0.20	0.74	665.93	-33.89	-30.75	662.80	-46.74
1	51	431	2.06-0.19	1.60	0.28	0.91	656.34	57.14	57.21	656.27	-6.66
1	51	432	1.490.36	1.16	0.69	0.51	622.80	77.22	77.52	622.50	12.76



EGP CODE

GRE.EEC.R.73.IT.W.15235.12.024.01

PAGE

384 di/of 527

1	51	433	1.950.23	1.17	1.01	-0.86	618.50	88.08	88.14	618.44	5.94
1	51	434	3.01-0.39	1.32	1.30	-1.70	671.79	91.07	91.15	671.70	-7.09
1	51	435	3.32-0.20	1.57	1.55	-1.76	773.72	82.16	82.22	773.65	-6.93
1	51	436	3.47-7.85e-02	1.84	1.56	-1.77	919.00	47.08	47.15	918.92	-8.29
1	51	437	4.270.13	2.81	1.59	-1.98	1037.55	-48.02	-47.21	1036.75	29.57
1	51	438	3.27-2.67	-0.57	1.17	-2.84	935.41	-305.71	-278.45	908.15	181.90
1	51	439	0.48-15.40	-13.50	-1.42	5.15	414.31	-847.35	-719.80	286.77	380.33
1	51	440	15.56-2.63	14.37	-1.43	4.50	25.78	-1013.73	-886.27	-101.69	340.96
1	51	441	45.74-1.32	45.68	-1.26	-1.65	-983.71	-2120.16	-2026.62	-1077.24	312.33
1	51	442	-11.59-30.96	-24.27	-18.28	-9.21	121.53	-880.03	-876.48	117.97	-59.60
1	51	443	4.501.03	1.38	4.14	-1.05	562.98	-319.04	-317.22	561.16	40.00
1	51	444	1.390.46	0.91	0.94	0.46	682.68	-53.18	-47.70	677.20	63.26
1	51	445	1.830.57	1.23	1.17	0.63	655.09	30.19	34.60	650.68	52.31
1	51	446	1.700.55	1.01	1.24	-0.56	614.43	68.50	70.32	612.61	31.50
1	51	447	3.00-0.58	0.92	1.50	-1.76	607.52	81.89	81.96	607.45	-5.86
1	51	448	3.43-0.55	0.95	1.92	-1.93	655.21	85.17	85.77	654.60	-18.58
1	51	449	3.86-0.38	0.96	2.53	-1.97	763.01	68.23	76.34	754.91	-74.62
1	51	450	4.627.78e-02	1.10	3.59	-1.90	902.26	30.03	38.39	893.91	-84.97
1	51	451	4.37-0.44-9.48e-02		4.03	-1.25	1039.56	-91.68	-79.72	1027.60	-115.71
1	51	452	12.425.06	6.51	10.96	-2.93	1203.73	-300.12	-281.68	1185.30	-165.49
1	51	453	-12.36-24.95-23.46		-13.85	4.07	656.45	-1286.98	-1276.06	645.53	145.27
1	51	454	89.48-14.86	89.35	-14.73	-3.66	-1057.59	-2892.24	-2875.83	-1074.00	172.75
1	51	455	25.120.94	8.60	17.46	-11.25	328.83	-685.67	-506.96	150.12	386.47
1	51	456	9.871.20	2.39	8.67	2.99	698.19	-227.22	-196.30	667.27	166.30
1	51	457	1.980.55	0.84	1.69	0.58	675.13	-42.45	-22.59	655.28	117.69
1	51	458	1.630.90	1.03	1.51	0.28	647.19	44.63	51.84	639.98	65.52
1	51	459	2.120.14	0.83	1.43	-0.94	607.85	74.95	79.13	603.67	47.00
1	51	460	3.12-0.67	0.80	1.65	-1.85	598.63	90.04	90.04	598.63	1.23
1	51	461	3.62-0.75	0.77	2.10	-2.08	645.09	95.55	96.23	644.41	-19.30
1	51	462	4.27-0.67	0.76	2.84	-2.24	753.43	88.13	97.82	743.74	-79.69
1	51	463	5.25-0.41	0.92	3.92	-2.40	888.77	67.90	82.68	873.99	-109.16
1	51	464	8.171.44	2.53	7.09	-2.48	1055.69	36.21	66.95	1024.95	-174.33
1	51	465	15.92-2.74	1.54	11.64	-7.84	1317.44	-194.14	-115.21	1238.50	-336.28
1	51	466	53.83-41.67	49.29	-37.14	20.31	1751.80	-594.34	-272.89	1430.35	-806.75
1	51	467	10.99-31.44	-31.42	10.97	0.74	398.91	-356.81	398.90	-356.81	2.09
1	51	468	18.06-2.44	15.94	-0.32	-6.24	549.22	-505.74	-221.31	264.79	468.14
1	51	469	5.26-7.03	-1.48	-0.29	6.12	629.81	-209.32	-82.55	503.04	300.51
1	51	470	3.700.45	1.18	2.97	1.36	667.44	9.75	47.32	629.87	152.64
1	51	471	2.410.31	0.77	1.95	0.87	636.38	64.72	84.88	616.22	105.43
1	51	472	1.970.48	0.71	1.73	-0.54	593.62	90.11	97.33	586.40	59.87
1	51	473	3.25-0.79	0.62	1.84	-1.93	582.86	102.84	102.94	582.76	6.96
1	51	474	3.89-0.98	0.61	2.30	-2.29	626.98	110.71	111.46	626.23	-19.68
1	51	475	4.84-1.08	0.59	3.17	-2.67	733.43	106.49	121.64	718.28	-96.27
1	51	476	6.36-1.24	0.45	4.68	-3.16	861.19	103.17	125.80	838.56	-129.00
1	51	477	9.37-1.49	0.81	7.06	-4.44	1016.07	75.34	124.50	966.91	-209.36
1	51	478	10.40-6.49	1.88	2.02	-8.44	1215.25	-97.72	58.44	1059.08	-425.03
1	51	479	59.1711.44	41.79	28.82	22.97	1492.35	-145.63	344.92	1001.80	-750.24
1	51	480	16.52-49.39	-45.74	12.87	15.08	1102.13	-144.61	866.19	91.33	-488.35
1	51	481	-0.43-10.50	-10.48	-0.44	0.42	465.93	-211.83	377.40	-123.30	228.40
1	51	482	9.098.66	9.08	8.66	-3.50e-02	638.10	70.72	388.19	320.62	281.67
1	51	483	3.960.40	2.25	2.12	1.78	627.37	45.42	172.31	500.49	240.29
1	51	484	3.84-0.71	0.73	2.40	2.12	619.31	92.46	153.23	558.54	168.29
1	51	485	3.32-0.16	1.10	2.05	1.67	592.95	122.51	150.54	564.91	111.37
1	51	486	1.780.79	0.80	1.77	-9.82e-02	557.42	126.59	134.70	549.30	58.57
1	51	487	3.37-0.89	0.64	1.83	-2.05	551.14	127.48	128.01	550.61	14.97
1	51	488	4.20-1.27	0.72	2.21	-2.63	591.35	140.04	140.54	590.85	-14.99
1	51	489	5.26-1.76	0.58	2.92	-3.31	675.58	156.88	162.17	670.29	-52.11
1	51	490	6.84-2.14	0.74	3.96	-4.19	793.89	179.15	202.00	771.04	-116.29
1	51	491	9.01-1.92	2.50	4.59	-5.36	927.10	228.80	285.64	870.26	-190.95
1	51	492	11.252.36	6.41	7.20	-4.42	1049.90	212.54	366.67	895.77	-324.51
1	51	493	8.887.96	8.46	8.39	-0.46	1083.69	136.87	631.61	588.95	-472.92
1	51	494	4.01-12.69	-11.03	2.35	-5.00	965.87	-241.62	565.77	158.47	-568.36
1	51	495	2.77-0.14	2.19	0.44	1.16	655.74	-60.41	605.98	-10.65	182.11
1	51	496	3.460.51	2.50	1.47	1.38	582.09	210.19	492.42	299.87	159.09
1	51	497	4.070.38	2.88	1.57	1.73	578.17	284.17	391.55	470.79	141.56
1	51	498	3.10-0.60	1.21	1.30	1.85	563.28	233.20	272.58	523.90	107.00
1	51	499	2.74-0.63	0.73	1.38	1.65	542.82	187.41	203.40	526.82	73.68
1	51	500	1.640.57	0.87	1.34	0.49	519.55	166.95	168.74	517.76	25.07
1	51	501	2.68-0.45	0.83	1.40	-1.54	525.05	154.22	155.09	524.17	-18.02
1	51	502	4.14-1.63	0.88	1.62	-2.86	562.79	164.21	164.23	562.77	-2.94
1	51	503	5.27-2.03	1.26	1.98	-3.63	635.59	208.69	210.35	633.94	-26.55
1	51	504	6.46-2.45	1.73	2.28	-4.45	729.99	276.49	284.41	722.06	-59.43
1	51	505	7.81-2.06	3.26	2.50	-4.92	818.88	372.31	402.41	788.78	-111.96
1	51	506	7.05-2.10	2.56	2.40	-4.57	856.35	397.22	512.92	740.65	-199.34
1	51	507	6.43-1.70	2.14	2.58	-4.06	873.46	264.01	649.98	487.50	-293.70
1	51	508	5.85-1.67	3.39	0.79	-3.53	931.09	4.38	775.57	159.91	-346.32



EGP CODE

GRE.EEC.R.73.IT.W.15235.12.024.01

PAGE

385 di/of 527

1	51	509	1.27-0.19	1.12	-3.96e-02	0.45	653.00	6.39	648.83	10.56	51.77	
1	51	510	2.39-0.41	1.81	0.17	1.13	560.67	304.13	555.61	309.20	35.69	
1	51	511	2.93-0.55	2.04	0.35	1.52	485.65	417.37	444.68	458.34	33.45	
1	51	512	2.98-0.56	1.93	0.49	1.62	516.20	327.65	332.48	511.37	29.78	
1	51	513	2.72-0.50	1.63	0.59	1.52	515.42	243.94	246.58	512.77	26.68	
1	51	514	2.08-0.45	0.95	0.67	1.26	506.26	185.44	186.79	504.90	20.78	
1	51	515	1.690.16	1.09	0.76	-0.75	514.21	166.83	167.23	513.80	11.88	
1	51	516	3.99-1.83	1.31	0.86	-2.90	552.67	175.56	175.90	552.33	11.38	
1	51	517	4.78-2.41	1.44	0.93	-3.59	619.65	218.73	218.98	619.40	10.00	
1	51	518	5.98-2.50	2.56	0.92	-4.16	694.82	321.72	321.79	694.74	5.34	
1	51	519	5.29-3.47	1.09	0.73	-4.37	733.16	397.15	397.80	732.51	-14.77	
1	51	520	4.75-3.15	1.18	0.42	-3.93	677.22	512.30	529.08	660.45	-49.85	
1	51	521	3.50-2.53	1.00	-2.91e-02	-2.97	716.10	393.72	690.59	419.23	-87.02	
1	51	522	1.83-1.58	0.40	-0.15	-1.69	821.80	117.09	800.73	138.15	-120.00	
1	51	523	7.54e-02	-0.43	-0.18	-0.18	0.25	622.68	1.41	612.69	11.40	-78.14
1	51	524	1.31-0.71	0.71	-0.11	0.93	555.86	282.34	529.62	308.58	-80.55	
1	51	525	2.11-1.04	1.26	-0.19	1.40	511.76	370.57	425.96	456.37	-68.93	
1	51	526	2.47-1.03	1.62	-0.19	1.50	525.79	304.56	315.68	514.67	-48.33	
1	51	527	2.43-0.83	1.68	-8.19e-02	1.37	523.97	229.42	232.15	521.24	-28.22	
1	51	528	1.97-0.94	0.98	5.46e-02	1.38	514.61	177.74	177.92	514.43	-7.88	
1	51	529	1.45-5.74e-02	1.22	0.17	-0.54	523.77	157.50	157.54	523.73	3.84	
1	51	530	3.79-1.99	1.59	0.20	-2.81	564.69	164.46	165.79	563.36	23.01	
1	51	531	4.26-2.55	1.56	0.15	-3.33	634.12	190.89	195.43	629.58	44.63	
1	51	532	4.60-2.89	1.70	1.56e-02	-3.65	706.76	265.55	276.35	695.96	68.19	
1	51	533	3.86-3.44	0.61	-0.19	-3.63	737.42	330.23	353.41	714.24	94.34	
1	51	534	2.91-3.28	7.51e-03	-0.37	-3.09	680.65	423.13	476.55	627.23	104.42	
1	51	535	1.35-2.80	-1.04	-0.41	-2.05	673.16	349.82	632.46	390.53	107.26	
1	51	536	0.16-2.35	-1.89	-0.29	-0.96	749.47	106.56	734.53	121.50	96.85	
1	51	537	-0.23-1.19	-1.18	-0.24	9.87e-02	554.83	-75.61	487.14	-7.92	-195.18	
1	51	538	0.49-1.39	-0.68	-0.22	0.91	550.67	159.47	416.30	293.85	-185.77	
1	51	539	1.39-1.57	0.38	-0.56	1.41	571.45	212.60	321.94	462.10	-165.17	
1	51	540	2.07-1.44	1.33	-0.69	1.43	581.97	193.56	237.72	537.80	-123.31	
1	51	541	2.33-1.20	1.68	-0.55	1.37	565.76	167.23	181.24	551.75	-73.39	
1	51	542	1.98-1.07	1.25	-0.33	1.31	547.16	141.15	144.37	543.93	-36.06	
1	51	543	1.38-0.30	1.25	-0.17	-0.46	553.14	128.65	130.47	551.32	-27.72	
1	51	544	3.12-1.81	1.44	-0.13	-2.34	594.08	131.21	132.37	592.93	23.11	
1	51	545	3.53-2.17	1.56	-0.19	-2.71	672.49	146.56	154.18	664.87	62.86	
1	51	546	3.21-2.76	0.79	-0.34	-2.93	758.58	159.37	183.46	734.49	117.71	
1	51	547	2.88-3.05	0.22	-0.39	-2.95	807.04	177.55	240.10	744.49	188.31	
1	51	548	1.93-3.24	-1.12	-0.19	-2.55	777.96	192.10	334.58	635.49	251.34	
1	51	549	0.57-3.64	-3.03	-3.16e-02	-1.47	713.80	121.88	461.05	374.63	292.79	
1	51	550	-7.57e-02	-3.85	-3.83	-9.77e-02	-0.29	694.90	-51.32	542.48	101.10	300.84
1	51	551	-0.65-1.93	-1.93	-0.65	1.43e-02	378.61	-249.52	195.97	-66.89	-285.24	
1	51	552	3.47e-02	-2.56	-2.10	-0.42	0.99	492.20	-68.48	169.37	254.35	-277.10
1	51	553	0.53-2.06	-0.49	-1.04	1.26	600.46	-1.91	120.29	478.27	-242.23	
1	51	554	1.74-1.61	1.23	-1.09	1.20	637.33	60.59	111.67	586.25	-163.87	
1	51	555	2.26-1.24	1.66	-0.64	1.32	618.03	91.38	108.11	601.29	-92.39	
1	51	556	1.53-0.52	1.35	-0.34	0.58	592.03	91.80	99.05	584.79	-59.76	
1	51	557	1.74-0.68	1.18	-0.12	-1.02	587.83	95.20	96.62	586.41	-26.41	
1	51	558	2.48-1.40	1.10	-1.83e-02	-1.86	631.19	92.31	93.53	629.97	25.56	
1	51	559	2.57-1.68	0.91	-1.72e-02	-2.07	720.73	85.56	92.67	713.61	66.84	
1	51	560	2.62-2.00	0.63	-1.24e-02	-2.29	827.47	62.79	85.30	804.97	129.24	
1	51	561	2.26-2.55	-0.18	-0.10	-2.40	890.39	4.15	67.95	826.60	229.05	
1	51	562	1.68-3.36	-1.93	0.26	-2.27	846.61	-98.44	66.08	682.09	358.35	
1	51	563	1.96-4.91	-4.57	1.62	-1.50	694.57	-201.22	137.35	355.99	434.35	
1	51	564	0.54-6.72	-6.62	0.44	0.86	547.42	-366.19	136.17	45.06	454.53	
1	51	565	2.09-5.78	1.73	-5.42	1.65	-76.38	-549.27	-376.12	-249.53	-227.82	
1	51	566	0.27-4.35	-4.01	-6.49e-02	-1.21	353.71	-423.38	-262.07	192.39	-315.18	
1	51	567	-1.41-3.02	-2.62	-1.82	0.70	613.68	-252.53	-174.59	535.74	-247.86	
1	51	568	1.78-0.64	1.48	-0.34	0.79	682.83	-49.84	-27.09	660.08	-127.08	
1	51	569	2.08-0.76	1.50	-0.19	1.14	660.95	32.24	36.68	656.51	-52.64	
1	51	570	1.118.34e-02	1.09	0.10	-0.14	623.51	57.41	58.44	622.48	-24.11	
1	51	571	2.30-1.06	0.92	0.32	-1.65	616.63	67.34	67.53	616.44	-10.11	
1	51	572	2.37-1.09	0.78	0.49	-1.72	661.24	65.47	65.78	660.93	13.59	
1	51	573	2.43-1.18	0.58	0.67	-1.80	758.49	45.75	48.17	756.07	41.50	
1	51	574	2.59-1.42	0.27	0.91	-1.98	885.07	-2.22	3.89	878.96	73.40	
1	51	575	3.45-1.87	-0.36	1.94	-2.40	984.89	-120.17	-96.48	961.19	160.07	
1	51	576	2.18-4.66	-4.31	1.83	-1.49	905.83	-378.57	-277.08	804.35	346.47	
1	51	577	0.52-9.52	-9.30	0.30	1.47	512.53	-746.40	-515.14	281.27	487.50	
1	51	578	3.29-3.90	-1.90	1.29	3.22	180.31	-867.18	-593.46	-93.41	460.21	
1	51	579	31.96-12.51	31.75	-12.30	-3.05	-736.70	-1381.27	-1374.62	-743.34	65.10	
1	51	580	-14.23-20.40	-18.09	-16.53	-2.99	153.88	-962.35	-873.26	64.79	-302.50	
1	51	581	2.61-1.59	-1.52	2.54	-0.55	616.53	-385.70	-373.64	604.47	-109.25	
1	51	582	1.480.21	0.71	0.98	0.62	720.11	-120.70	-120.40	719.82	-15.75	
1	51	583	1.980.18	1.26	0.90	0.88	686.24	-1.30	-1.12	686.06	11.11	
1	51	584	1.280.47	0.90	0.86	-0.40	640.63	41.23	41.54	640.32	13.63	





EGP CODE

GRE.EEC.R.73.IT.W.15235.12.024.01

PAGE

386 di/of 527

1	51	585	2.35-0.84	0.55	0.96	-1.58	629.06	54.48	54.58	628.97	-7.53
1	51	586	2.52-0.92	0.40	1.20	-1.67	672.20	55.16	55.17	672.19	-2.49
1	51	587	2.78-1.01	0.18	1.59	-1.76	773.41	32.16	34.13	771.43	-38.22
1	51	588	3.40-1.27-3.23e-02		2.17	-2.06	911.40	-24.32	-23.87	910.95	-20.47
1	51	589	5.02-1.60	0.43	2.99	-3.05	1032.09	-153.98	-153.98	1032.09	1.24
1	51	590	15.88-1.97	1.22	12.69	-6.84	1113.04	-411.88	-406.48	1107.64	90.58
1	51	591	-4.93-23.67	-23.67	-4.93	2.00e-02	320.40	-1450.20	-1326.20	196.40	451.87
1	51	592	53.31-33.53	53.31	-33.53	2.80e-02	-792.06	-2033.77	-1988.96	-836.88	231.60
1	51	593	15.64-1.67	11.01	2.96	-7.66	359.82	-960.88	-872.03	270.97	330.83
1	51	594	10.943.11	7.60	6.45	3.87	748.46	-286.80	-262.97	724.63	155.25
1	51	595	3.16-1.99e-02	0.55	2.59	1.22	725.47	-109.37	-98.45	714.55	94.86
1	51	596	2.200.61	1.04	1.77	0.71	685.83	13.15	17.22	681.76	52.15
1	51	597	1.870.13	0.57	1.44	-0.76	640.32	49.92	53.62	636.62	46.57
1	51	598	2.61-0.96	0.21	1.44	-1.68	624.44	65.75	65.84	624.35	6.85
1	51	599	2.91-1.16	4.84e-02	1.71	-1.86	665.82	69.84	69.88	665.78	-4.83
1	51	600	3.38-1.28	-0.16	2.25	-1.99	765.76	54.51	58.46	761.82	-52.80
1	51	601	4.25-1.40	-0.19	3.05	-2.32	900.73	11.40	18.34	893.79	-78.29
1	51	602	6.18-0.61	2.02	3.55	-3.31	1051.53	-64.51	-50.61	1037.64	-123.75
1	51	603	14.27-7.92	9.15	-2.80	-9.35	1248.17	-331.59	-263.47	1180.05	-320.89
1	51	604	24.35-47.58	22.28	-45.52	12.01	1249.20	-1264.12	-1077.83	1062.91	-658.40
1	51	605	-9.13-24.94	-22.42	-11.66	5.79	-177.49	-437.50	-383.05	-231.94	105.79
1	51	606	4.86-31.58	-14.68	-12.04	18.17	-261.59	-1426.39	-1360.69	-327.29	268.73
1	51	607	25.62-59.38	-55.14	21.39	18.49	1276.97	399.08	1276.73	399.31	-14.28
1	51	608	18.36-29.46	-29.19	18.09	-3.57	813.14	-25.53	809.81	-22.20	-52.78
1	51	609	43.6510.11	33.38	20.38	-15.46	496.52	35.91	161.23	371.19	204.99
1	51	610	1.15-9.66	-8.37	-0.14	3.50	492.50	-302.95	-214.15	403.69	250.51
1	51	611	8.524.75e-02	0.21	8.36	1.16	420.65	-150.40	-101.28	371.54	160.10
1	51	612	8.960.38	0.40	8.95	0.32	365.70	-91.00	-72.70	347.40	89.57
1	51	613	9.010.53	0.54	9.01	0.23	322.68	-59.20	-54.65	318.14	41.42
1	51	614	9.390.52	0.52	9.39	0.24	307.46	-49.34	-48.87	306.99	-12.95
1	51	615	10.260.56	0.57	10.25	0.25	350.18	-72.37	-53.27	331.08	-87.78
1	51	616	11.580.65	0.66	11.57	0.24	436.07	-109.12	-67.96	394.90	-144.04
1	51	617	13.000.50	0.50	13.00	2.56e-02	563.57	-166.59	-95.25	492.24	-216.79
1	51	618	12.76-0.20-7.13e-02		12.63	-1.30	749.47	-231.08	-121.30	639.68	-309.19
1	51	619	10.35-13.90	-13.69	10.14	2.26	524.01	-96.24	451.46	-23.69	199.34
1	51	620	11.80-1.74	7.03	3.03	-6.47	588.49	-286.37	22.19	279.93	418.02
1	51	621	2.42-2.63	-0.15	-6.23e-02	2.52	657.05	-159.11	-25.00	522.94	302.44
1	51	622	3.86-0.78	0.31	2.78	1.96	699.65	-15.25	40.62	643.78	191.89
1	51	623	2.91-3.77e-02	0.71	2.16	1.28	658.07	61.39	86.01	633.45	118.68
1	51	624	1.930.11	0.24	1.80	-0.47	611.21	84.34	92.76	602.79	66.06
1	51	625	3.08-1.32	5.82e-03	1.75	-2.02	595.61	96.61	96.74	595.47	8.12
1	51	626	3.62-1.75	-0.15	2.03	-2.45	633.15	104.31	105.16	632.30	-21.13
1	51	627	4.33-2.10	-0.40	2.63	-2.83	724.31	102.84	113.23	713.93	-79.67
1	51	628	5.40-2.15	-0.30	3.55	-3.24	846.01	93.41	121.95	817.47	-143.77
1	51	629	6.88-0.83	1.39	4.66	-3.49	978.93	83.11	148.50	913.54	-233.04
1	51	630	5.072.45	2.83	4.69	-0.92	1090.65	-36.06	131.28	923.30	-400.68
1	51	631	36.496.48	15.11	27.86	13.59	1111.38	-61.39	432.16	617.83	-578.99
1	51	632	11.24-19.85	-19.17	10.56	4.54	1108.39	-84.30	765.22	258.87	-539.94
1	51	633	-0.99-4.84	-4.17	-1.66	1.46	471.41	-168.48	381.68	-78.75	222.18
1	51	634	5.793.01	3.01	5.78	-7.29e-02	610.49	184.79	442.31	352.97	208.11
1	51	635	3.910.81	2.12	2.60	1.53	656.45	160.54	275.94	541.05	209.55
1	51	636	3.38-0.61	1.04	1.73	1.96	633.94	164.98	213.62	585.30	142.98
1	51	637	2.79-0.43	0.68	1.68	1.53	609.01	148.06	171.31	585.76	100.89
1	51	638	1.550.21	0.27	1.49	-0.28	569.08	141.57	143.55	567.10	29.02
1	51	639	3.19-1.61	7.39e-02	1.50	-2.29	565.37	134.62	135.11	564.88	14.58
1	51	640	3.83-2.20	-0.10	1.72	-2.87	599.51	145.70	146.15	599.05	-14.42
1	51	641	4.63-2.72	-0.27	2.18	-3.46	673.86	171.44	176.46	668.83	-49.98
1	51	642	5.58-3.14	-0.44	2.89	-4.03	774.51	209.49	227.89	756.10	-100.31
1	51	643	6.57-2.61	0.23	3.73	-4.24	874.99	272.72	322.56	825.15	-165.93
1	51	644	9.43-3.64e-02	2.01	7.39	-3.90	958.26	303.72	452.85	809.14	-274.53
1	51	645	6.22-2.54	-1.98	5.66	-2.14	932.69	188.42	591.70	529.40	-370.83
1	51	646	5.79-10.06	-6.60	2.33	-6.55	792.26	-167.74	507.46	117.06	-438.52
1	51	647	1.98-0.52	1.22	0.24	1.15	665.66	-15.21	638.27	12.18	133.78
1	51	648	1.99-0.45	0.68	0.86	1.21	574.65	285.88	522.43	338.10	111.14
1	51	649	2.59-0.20	1.43	0.96	1.38	574.11	356.00	420.30	509.80	99.45
1	51	650	2.86-0.27	1.79	0.80	1.49	583.11	297.70	319.67	561.14	76.09
1	51	651	2.02-0.71	0.49	0.82	1.36	566.67	213.66	223.30	557.03	57.53
1	51	652	0.880.17	0.17	0.88	1.78e-02	543.20	175.60	176.58	542.22	18.94
1	51	653	2.56-1.42	0.19	0.96	-1.96	544.48	160.60	161.56	543.51	-19.20
1	51	654	3.57-2.48-1.37e-02		1.10	-2.97	576.22	170.74	170.75	576.22	-0.54
1	51	655	4.19-3.19	-0.33	1.33	-3.60	640.26	209.38	210.16	639.48	-18.31
1	51	656	4.79-3.80	-0.58	1.57	-4.16	718.72	278.16	282.26	714.62	-42.30
1	51	657	5.47-3.52-3.60e-02		1.99	-4.38	778.09	383.11	400.60	760.60	-81.26
1	51	658	5.10-3.67	-0.44	1.87	-4.23	783.02	451.26	538.35	695.93	-145.97
1	51	659	4.51-4.09	-1.44	1.86	-3.97	790.95	315.85	669.85	436.95	-207.06
1	51	660	3.56-3.30	-0.52	0.79	-3.37	876.44	46.55	791.17	131.81	-251.98



EGP CODE

GRE.EEC.R.73.IT.W.15235.12.024.01

PAGE

387 di/of 527

1	51	661	0.36-0.62	-0.10	-0.15	0.49	684.15	28.50	684.11	28.54	-4.99	
1	51	662	1.37-0.78	0.59	7.48e-03	1.03	580.57	339.66	579.86	340.37	-13.07	
1	51	663	2.03-0.94	1.15	-6.86e-02	1.35	498.93	451.90	452.73	498.11	-6.18	
1	51	664	2.34-0.86	1.52	-3.35e-02	1.40	550.70	335.51	335.51	550.70	-6.67e-02	
1	51	665	1.69-1.04	0.56	9.16e-02	1.34	551.88	236.88	237.35	551.42	12.10	
1	51	666	1.00-0.61	0.16	0.24	0.80	538.29	182.39	183.25	537.43	17.53	
1	51	667	1.53-0.86	0.31	0.36	-1.20	539.84	167.95	168.10	539.69	-7.38	
1	51	668	3.24-2.68	0.12	0.44	-2.95	572.98	173.56	174.10	572.45	14.60	
1	51	669	3.54-3.32	-0.24	0.46	-3.41	634.42	209.81	211.34	632.89	25.46	
1	51	670	3.68-3.82	-0.58	0.44	-3.72	699.51	283.89	285.59	697.80	26.58	
1	51	671	3.55-4.37	-1.13	0.31	-3.89	724.50	385.80	388.09	722.20	27.79	
1	51	672	3.07-4.39	-1.46	0.14	-3.64	638.73	528.14	528.71	638.16	7.90	
1	51	673	1.70-4.56	-2.82	-4.00e-02	-2.81	685.58	397.13	684.88	397.83	-14.15	
1	51	674	0.44-4.56	-3.98	-0.14	-1.61	787.66	122.46	785.55	124.57	-37.42	
1	51	675	-0.22-2.19	-2.15	-0.26	0.28	607.14	7.06e-02	587.29	19.92	-107.95	
1	51	676	0.47-1.81	-1.03	-0.31	1.08	555.45	277.71	500.35	332.80	-110.76	
1	51	677	1.26-1.79	6.47e-02	-0.59	1.49	562.06	328.41	390.08	500.40	-102.98	
1	51	678	1.24-1.86	2.63e-02	-0.64	1.51	589.52	252.61	273.84	568.29	-81.87	
1	51	679	1.65-1.54	0.55	-0.44	1.52	578.80	206.36	213.85	571.32	-52.27	
1	51	680	1.43-1.31	0.32	-0.20	1.35	557.60	166.74	168.99	555.35	-29.57	
1	51	681	0.66-0.34	0.37	-4.41e-02	-0.46	555.94	152.51	153.12	555.33	-15.66	
1	51	682	2.32-2.18	0.13	3.82e-03	-2.25	588.86	155.22	155.34	588.74	7.12	
1	51	683	2.40-2.73	-0.27	-5.79e-02	-2.56	654.28	177.35	180.35	651.29	37.68	
1	51	684	2.28-3.29	-0.74	-0.26	-2.77	726.27	220.03	232.98	713.32	79.91	
1	51	685	2.07-3.93	-1.40	-0.46	-2.96	761.01	274.68	310.36	725.32	126.81	
1	51	686	1.49-4.71	-2.76	-0.46	-2.88	727.41	325.19	426.63	625.97	174.68	
1	51	687	0.41-5.92	-5.12	-0.39	-2.10	695.68	245.19	568.33	372.53	202.86	
1	51	688	-0.11-6.50	-6.37	-0.24	-0.91	726.92	36.68	659.97	103.64	204.28	
1	51	689	-0.61-4.22	-4.21	-0.62	0.22	461.46	-141.17	340.98	-20.69	-241.01	
1	51	690	6.28e-02	-3.29	-2.65	-0.57	1.31	533.60	67.96	293.51	308.05	-232.71
1	51	691	0.26-2.32	-0.94	-1.12	1.29	612.56	116.61	215.17	513.99	-197.91	
1	51	692	0.79-1.78	2.54e-02	-1.01	1.18	643.08	132.91	170.02	605.98	-132.49	
1	51	693	1.41-1.50	0.45	-0.53	1.37	621.48	133.71	144.84	610.35	-72.84	
1	51	694	0.97-0.96	0.30	-0.29	0.92	590.31	126.96	129.45	587.82	-33.92	
1	51	695	0.62-0.50	0.23	-0.12	-0.53	586.74	120.18	123.66	583.25	-40.17	
1	51	696	1.49-1.55	-1.66e-02	-5.02e-02	-1.52	619.34	123.01	124.14	618.22	23.61	
1	51	697	1.50-2.04	-0.46	-8.07e-02	-1.76	695.92	125.86	132.91	688.87	63.00	
1	51	698	1.45-2.58	-0.97	-0.15	-1.97	785.80	123.83	146.69	762.93	120.88	
1	51	699	0.92-3.34	-1.87	-0.56	-2.03	834.84	104.82	166.57	773.09	203.13	
1	51	700	0.78-4.42	-3.08	-0.55	-2.27	799.30	66.09	218.16	647.23	297.28	
1	51	701	1.20-7.13	-6.38	0.45	-2.38	690.89	-11.09	325.24	354.56	350.68	
1	51	702	-0.10-9.37	-9.36	-0.12	-0.34	600.84	-179.03	357.59	64.22	361.29	
1	51	703	-0.80-5.33	-1.68	-4.46	1.79	170.60	-364.61	-46.50	-147.50	-262.80	
1	51	704	-1.12-2.21	-2.20	-1.13	-9.28e-02	454.85	-234.61	-51.10	271.35	-304.71	
1	51	705	-1.59-2.40	-2.39	-1.60	-5.17e-02	661.39	-116.07	-26.91	572.23	-247.73	
1	51	706	0.32-1.01	-0.62	-7.23e-02	0.61	705.31	-2.89	29.83	672.58	-148.67	
1	51	707	1.08-1.10	8.88e-02	-0.11	1.09	669.41	65.44	72.71	662.15	-65.82	
1	51	708	0.27-0.15	9.22e-02	2.69e-02	0.20	630.08	81.38	86.93	624.53	-54.88	
1	51	709	1.20-1.06	-7.05e-03	0.15	-1.13	613.18	92.91	93.07	613.02	-8.91	
1	51	710	1.42-1.47	-0.32	0.26	-1.41	649.80	92.06	92.63	649.23	17.81	
1	51	711	1.45-1.85	-0.79	0.38	-1.54	735.29	79.69	83.81	731.17	51.81	
1	51	712	1.55-2.33	-1.38	0.60	-1.67	844.25	46.23	60.00	830.48	103.93	
1	51	713	2.18-3.09	-2.35	1.44	-1.83	918.93	-37.47	3.33	878.13	193.29	
1	51	714	0.20-5.49	-5.47	0.18	-0.34	847.94	-221.85	-97.92	724.01	342.38	
1	51	715	-1.22-6.27	-5.86	-1.64	-1.39	557.15	-421.51	-156.19	291.84	435.04	
1	51	716	0.63-10.31	-10.29	0.62	-0.38	322.31	-503.67	-133.19	-48.16	410.79	
1	51	717	23.91-15.83	23.76	-15.68	-2.45	-401.72	-851.83	-808.16	-445.39	-133.23	
1	51	718	-11.26-15.82	-14.87	-12.22	-1.86	323.70	-737.56	-579.54	165.68	-377.80	
1	51	719	3.50-2.10	-2.03	3.43	0.61	687.62	-273.60	-240.14	654.16	-176.19	
1	51	720	1.35-1.11	-0.94	1.17	0.63	751.25	-82.59	-75.99	744.65	-73.90	
1	51	721	1.10-0.97	-0.63	0.75	0.77	704.01	13.10	13.49	703.62	-16.37	
1	51	722	0.67-0.41	-0.35	0.62	-0.24	651.27	59.18	59.18	651.27	-1.16	
1	51	723	1.49-1.20	-0.35	0.64	-1.25	633.73	75.26	75.42	633.57	-9.29	
1	51	724	1.59-1.51	-0.70	0.78	-1.36	669.78	75.20	75.23	669.75	4.46	
1	51	725	1.81-1.94	-1.20	1.06	-1.50	758.93	58.71	58.73	758.91	2.97	
1	51	726	2.43-2.56	-1.74	1.61	-1.85	882.93	5.42	6.68	881.67	33.16	
1	51	727	4.05-3.18	-1.88	2.75	-2.77	982.32	-105.91	-100.51	976.92	76.46	
1	51	728	12.38-4.54	-2.42	10.26	-5.61	981.21	-331.08	-295.01	945.14	214.56	
1	51	729	-3.71-22.50	-22.13	-4.08	2.62	318.74	-1141.87	-926.56	103.44	517.80	
1	51	730	32.52-33.30	32.46	-33.23	2.11	-463.06	-1377.82	-1274.23	-566.65	289.88	
1	51	731	6.39-8.63	-8.54	6.30	-1.12	973.83	-400.31	-294.37	867.90	-366.53	
1	51	732	17.30-1.97	13.46	1.88	-7.70	363.34	-851.87	-800.33	311.80	244.90	
1	51	733	8.153.15	5.27	6.03	2.47	782.42	-253.58	-236.47	765.31	132.05	
1	51	734	2.80-1.24	-0.79	2.35	1.27	750.75	-94.01	-87.60	744.34	73.32	
1	51	735	1.88-0.82	-0.59	1.65	0.76	709.23	16.12	17.83	707.51	34.46	
1	51	736	1.34-0.61	-0.53	1.25	-0.40	655.00	57.63	59.85	652.78	36.32	



EGP CODE

GRE.EEC.R.73.IT.W.15235.12.024.01

PAGE

388 di/of 527

1	51	737	1.71-1.22	-0.64	1.14	-1.16	633.18	76.60	76.65	633.13	5.44	
1	51	738	1.96-1.67	-1.01	1.29	-1.40	666.78	77.86	77.87	666.76	-3.20	
1	51	739	2.46-2.26	-1.51	1.71	-1.72	755.78	62.70	65.69	752.79	-45.47	
1	51	740	3.27-2.93	-1.98	2.32	-2.24	877.01	20.46	24.94	872.52	-61.81	
1	51	741	4.30-2.46	-0.81	2.65	-2.90	991.65	-71.28	-60.73	981.09	-105.40	
1	51	742	7.14-3.11	4.01	1.87e-02	-4.72	1102.69	-344.17	-288.21	1046.73	-278.99	
1	51	743	25.02-37.19	19.75	-31.92	17.32	974.57	-1198.77	-1052.70	828.50	-544.17	
1	51	744	91.8822.03	64.78	49.13	34.04	864.47	466.91	547.30	784.08	-159.67	
1	51	745	35.8817.42	32.56	20.74	-7.09	3.61	-732.55	-543.23	-185.72	-321.76	
1	51	746	40.0119.38	26.43	32.96	9.78	-63.09	-704.25	-422.09	-345.26	318.27	
1	51	747	28.74-10.08	27.70	-9.03	-6.28	-7.46	-918.60	-480.44	-445.62	455.24	
1	51	748	55.04-10.99	53.92	-9.87	8.50	-306.39	-1242.15	-919.90	-628.64	-444.64	
1	51	749	-11.89-26.81	-23.21	-15.50	-6.39	146.50	-195.70	-12.18	-37.02	170.65	
1	51	750	1.90-0.58	0.69	0.62	-1.24	688.64	-88.99	43.31	556.34	292.19	
1	51	751	-0.96-4.63	-1.03	-4.57	0.48	937.48	-19.80	48.91	868.76	247.09	
1	51	752	-0.54-6.08	-0.55	-6.07	9.42e-02	920.20	22.60	49.67	893.13	153.49	
1	51	753	-0.66-6.76	-0.66	-6.76	4.61e-02	886.13	37.95	46.44	877.65	84.41	
1	51	754	-0.65-7.09	-0.65	-7.09	6.48e-02	889.15	47.12	47.35	888.92	13.68	
1	51	755	-0.68-7.22	-0.68	-7.22	9.12e-02	959.29	46.15	53.06	952.38	-79.13	
1	51	756	-0.77-7.16	-0.77	-7.16	8.76e-02	1088.55	39.49	64.39	1063.65	-159.69	
1	51	757	9.93-21.98	-21.98	9.93	4.58e-02	373.69	-207.83	337.66	-171.80	140.20	
1	51	758	16.72-0.99	11.60	4.13	-8.03	626.91	-348.30	-99.61	378.22	425.07	
1	51	759	2.98-5.28	-1.21	-1.08	4.13	710.63	-175.45	-74.52	609.71	281.50	
1	51	760	3.61-1.30	-0.35	2.67	1.93	738.48	-0.79	28.18	709.51	143.46	
1	51	761	2.28-1.04	-0.60	1.84	1.13	689.37	60.27	71.75	677.89	84.21	
1	51	762	1.41-0.62	-0.59	1.38	-0.25	639.73	86.19	90.98	634.95	51.24	
1	51	763	1.91-1.45	-0.77	1.24	-1.34	619.18	97.99	98.78	618.39	20.36	
1	51	764	2.25-2.03	-1.16	1.39	-1.72	651.02	104.97	104.97	651.02	0.84	
1	51	765	2.94-2.76	-1.69	1.88	-2.22	733.22	106.25	110.21	729.27	-49.63	
1	51	766	3.72-3.33	-2.20	2.59	-2.58	839.13	92.77	106.48	825.41	-100.23	
1	51	767	5.06-3.16	-1.78	3.68	-3.07	951.93	59.07	100.03	910.97	-186.80	
1	51	768	2.63-4.04	-1.87	0.46	-3.12	1033.39	-129.12	22.08	882.19	-391.04	
1	51	769	39.944.01	17.04	26.91	17.28	1121.59	-117.37	351.49	652.73	-600.89	
1	51	770	14.38-37.08	-36.06	13.36	7.15	955.72	-42.38	789.20	124.14	-372.12	
1	51	771	0.39-8.34	-7.53	-0.41	2.53	483.24	-167.59	380.82	-65.17	237.00	
1	51	772	8.264.94	4.95	8.25	0.17	654.58	168.76	422.40	400.95	242.67	
1	51	773	3.300.84	1.58	2.56	1.13	689.03	137.97	223.82	603.18	199.84	
1	51	774	2.81-1.88	-0.76	1.70	2.00	683.21	125.09	160.25	648.05	135.60	
1	51	775	2.34-1.50	-0.64	1.48	1.60	651.51	127.78	141.86	637.43	84.73	
1	51	776	1.44-0.87	-0.57	1.14	0.78	611.97	128.81	132.24	608.54	40.57	
1	51	777	1.25-0.95	-0.73	1.04	-0.65	599.14	129.27	129.88	598.53	16.88	
1	51	778	2.22-2.17	-1.13	1.18	-1.87	627.56	138.99	139.05	627.50	-5.59	
1	51	779	3.11-3.20	-1.67	1.58	-2.70	694.60	160.14	162.56	692.18	-35.87	
1	51	780	4.10-3.94	-2.17	2.33	-3.33	782.18	191.84	204.08	769.94	-84.11	
1	51	781	5.08-4.51	-2.61	3.18	-3.82	864.98	231.58	271.20	825.36	-153.38	
1	51	782	8.32-1.75	-0.40	6.98	-3.42	934.63	270.01	399.40	805.24	-263.16	
1	51	783	8.160.43	0.53	8.06	-0.87	935.79	237.87	662.54	511.13	-340.65	
1	51	784	4.96-15.57	-13.20	2.60	-6.55	809.82	-144.96	563.59	101.27	-417.70	
1	51	785	3.33-0.71	2.15	0.46	1.84	703.89	-3.63	671.64	28.62	147.57	
1	51	786	3.12-0.33	1.23	1.56	1.72	602.03	312.38	535.81	378.59	121.63	
1	51	787	3.06-0.30	1.50	1.26	1.67	616.75	370.82	423.67	563.89	101.02	
1	51	788	2.03-1.96	-0.67	0.75	1.86	631.00	258.48	273.50	615.98	73.29	
1	51	789	1.93-1.71	-0.42	0.65	1.74	615.95	202.42	209.58	608.79	53.94	
1	51	790	1.74-1.67	-0.50	0.57	1.62	590.91	166.52	170.07	587.36	38.65	
1	51	791	0.59-0.63	-0.59	0.55	0.22	584.21	155.73	157.45	582.49	27.11	
1	51	792	1.69-1.96	-0.92	0.65	-1.65	611.77	167.49	167.98	611.28	14.71	
1	51	793	2.52-3.05	-1.41	0.87	-2.54	669.27	205.94	206.08	669.13	-7.82	
1	51	794	3.43-4.32	-2.08	1.19	-3.51	738.29	272.06	273.81	736.55	-28.49	
1	51	795	4.29-4.99	-2.41	1.72	-4.15	785.33	372.94	384.13	774.15	-67.00	
1	51	796	4.36-5.58	-3.24	2.02	-4.22	767.67	466.44	527.69	706.43	-121.24	
1	51	797	5.30-3.81	-0.85	2.34	-4.26	820.40	362.07	738.46	444.00	-175.61	
1	51	798	4.09-3.62	-0.32	0.79	-3.81	912.16	73.83	851.32	134.66	-217.49	
1	51	799	0.30-1.80	-1.33	-0.17	0.88	683.88	43.83	683.65	44.06	-12.10	
1	51	800	1.13-1.87	-0.74	3.18e-03	1.45	570.51	373.15	567.42	376.24	-24.52	
1	51	801	1.68-1.85	-0.15	-2.39e-02	1.76	553.30	443.64	446.33	550.61	-16.97	
1	51	802	1.41-2.32	-0.79	-0.13	1.83	612.21	314.04	314.32	611.93	-9.03	
1	51	803	1.40-1.93	-0.41	-0.12	1.66	607.85	235.97	235.98	607.85	1.80	
1	51	804	1.31-1.84	-0.46	-7.30e-02	1.56	587.60	185.27	185.54	587.32	10.48	
1	51	805	4.68e-02	-0.47	-0.39	-3.17e-02	0.19	584.15	169.49	169.87	583.78	12.39
1	51	806	1.23-1.97	-0.73	4.22e-03	-1.56	613.96	176.90	177.67	613.18	18.36	
1	51	807	1.80-2.89	-1.12	3.59e-02	-2.27	674.18	214.88	216.67	672.38	28.68	
1	51	808	2.46-3.99	-1.61	8.09e-02	-3.11	740.69	286.14	289.67	737.16	39.89	
1	51	809	2.75-5.45	-2.79	8.67e-02	-3.84	760.58	381.64	387.14	755.08	45.32	
1	51	810	2.47-6.30	-3.90	8.08e-02	-3.91	668.54	514.69	523.45	659.78	35.65	
1	51	811	1.87-5.32	-3.37	-7.44e-02	-3.20	725.50	404.73	724.17	406.05	20.57	
1	51	812	0.56-5.01	-4.28	-0.17	-1.88	830.63	126.49	830.61	126.50	-3.21	



EGP CODE

GRE.EEC.R.73.IT.W.15235.12.024.01

PAGE

389 di/of 527

1	51	813	-0.33-4.61	-4.51	-0.43	0.64	569.86	0.98	538.56	32.28	-129.73	
1	51	814	3.23e-02	-3.50	-2.91	-0.56	1.32	549.28	271.48	454.47	366.28	-131.71
1	51	815	0.48-2.90	-1.64	-0.78	1.64	608.26	295.10	352.63	550.73	-121.27	
1	51	816	0.80-2.38	-0.78	-0.79	1.59	644.54	245.78	266.00	624.32	-87.49	
1	51	817	0.64-2.06	-0.77	-0.66	1.35	632.65	195.45	201.39	626.71	-50.61	
1	51	818	0.87-1.74	-0.35	-0.52	1.30	606.50	171.51	172.59	605.42	-21.61	
1	51	819	-0.20-0.49	-0.26	-0.43	0.12	600.82	164.35	164.38	600.79	-3.48	
1	51	820	0.91-1.92	-0.58	-0.43	-1.41	633.47	168.57	169.31	632.72	18.63	
1	51	821	1.35-2.65	-0.79	-0.51	-2.00	701.74	190.15	194.97	696.92	49.46	
1	51	822	1.65-3.58	-1.24	-0.69	-2.60	777.48	228.39	245.16	760.71	94.47	
1	51	823	1.39-5.25	-2.98	-0.87	-3.15	807.67	254.52	296.57	765.62	146.60	
1	51	824	1.08-6.56	-4.67	-0.81	-3.30	764.96	288.18	402.97	650.16	203.85	
1	51	825	0.33-8.21	-7.31	-0.57	-2.62	710.80	211.31	536.91	385.20	237.95	
1	51	826	-0.20-9.18	-8.99	-0.39	-1.28	712.47	15.14	621.29	106.32	235.09	
1	51	827	-0.81-4.67	-4.45	-1.02	0.88	407.19	-174.22	250.77	-17.80	-257.83	
1	51	828	-0.66-3.55	-3.04	-1.16	1.10	537.65	28.89	226.35	340.20	-247.93	
1	51	829	-0.37-2.71	-1.76	-1.32	1.15	661.06	90.36	179.66	571.76	-207.34	
1	51	830	-2.82e-02	-2.27	-1.23	-1.07	1.12	701.71	118.67	152.08	668.30	-135.51
1	51	831	0.18-1.75	-0.79	-0.77	0.97	677.96	132.73	143.14	667.55	-74.63	
1	51	832	0.53-1.55	-0.40	-0.61	1.03	639.79	142.94	145.33	637.40	-34.36	
1	51	833	-0.25-0.51	-0.26	-0.50	6.82e-02	628.52	145.53	145.65	628.40	-7.66	
1	51	834	0.67-1.78	-0.65	-0.47	-1.22	663.82	145.52	146.37	662.97	20.93	
1	51	835	0.83-2.44	-1.07	-0.54	-1.62	743.35	147.76	153.31	737.80	57.22	
1	51	836	0.90-3.24	-1.64	-0.71	-2.02	838.20	141.06	159.47	819.80	111.77	
1	51	837	0.75-4.08	-2.23	-1.11	-2.35	887.65	112.37	166.79	833.23	198.07	
1	51	838	-0.17-6.66	-5.41	-1.42	-2.56	827.15	1.58	147.02	681.70	314.52	
1	51	839	0.37-9.11	-8.29	-0.44	-2.66	668.47	-98.37	219.84	350.26	377.84	
1	51	840	-0.46-11.88	-11.75	-0.59	-1.21	529.21	-258.99	225.51	44.71	383.59	
1	51	841	5.80-5.26	5.03	-4.49	2.82	0.27	-477.12	-304.74	-172.11	-229.30	
1	51	842	-0.52-7.37	-6.34	-1.55	-2.45	455.60	-331.06	-180.44	304.98	-309.52	
1	51	843	-1.12-3.14	-2.96	-1.31	0.58	695.85	-107.71	-47.40	635.53	-211.73	
1	51	844	0.14-1.78	-1.51	-0.12	0.66	756.76	20.51	40.99	736.27	-121.08	
1	51	845	4.36e-02	-1.37	-0.96	-0.36	0.64	721.64	86.41	93.99	714.06	-68.98
1	51	846	0.42-1.27	-0.57	-0.28	0.84	671.08	112.83	114.18	669.73	-27.44	
1	51	847	-0.19-0.43	-0.42	-0.20	4.08e-02	656.39	124.25	124.43	656.20	-9.97	
1	51	848	0.67-1.59	-0.82	-9.93e-02	-1.07	692.71	123.59	123.96	692.34	14.46	
1	51	849	0.85-2.21	-1.40	3.73e-02	-1.35	778.50	115.58	118.30	775.78	42.41	
1	51	850	0.95-2.93	-2.15	0.17	-1.56	891.31	88.74	97.02	883.03	81.10	
1	51	851	1.39-3.45	-2.76	0.71	-1.69	969.37	4.78	28.03	946.12	147.94	
1	51	852	-0.51-6.66	-6.43	-0.74	-1.18	872.21	-220.69	-131.18	782.69	299.69	
1	51	853	-3.22-14.56	-13.91	-3.87	2.63	463.23	-644.17	-436.16	255.23	432.53	
1	51	854	0.59-1.96	0.53	-1.90	-0.38	119.90	-737.67	-516.16	-101.60	375.35	
1	51	855	38.88-7.68	38.88	-7.68	-0.21	-732.50	-1443.78	-1440.97	-735.31	44.58	
1	51	856	-11.76-22.52	-19.31	-14.97	-4.92	340.30	-663.38	-611.14	288.06	-222.94	
1	51	857	5.14-0.40	-0.39	5.14	-8.65e-02	718.46	-164.33	-158.04	712.17	-74.26	
1	51	858	1.17-2.06	-1.84	0.95	0.81	779.03	-6.65	-4.02	776.41	-45.32	
1	51	859	0.86-1.38	-1.12	0.60	0.72	738.16	63.23	63.82	737.58	-19.88	
1	51	860	0.78-1.16	-0.70	0.32	0.83	689.72	94.68	94.74	689.66	-6.07	
1	51	861	0.30-0.57	-0.57	0.30	3.96e-02	674.52	108.29	108.33	674.48	4.86	
1	51	862	1.02-1.52	-0.97	0.47	-1.04	710.50	110.40	110.43	710.48	3.98	
1	51	863	1.49-2.35	-1.74	0.88	-1.40	795.62	97.20	97.59	795.23	16.55	
1	51	864	2.34-3.20	-2.59	1.73	-1.73	908.61	63.08	63.70	908.00	22.81	
1	51	865	3.37-4.95	-4.40	2.82	-2.06	989.32	-37.78	-36.77	988.31	32.15	
1	51	866	12.29-2.06	-1.45	11.68	-2.89	1022.86	-212.80	-211.33	1021.38	42.62	
1	51	867	-12.23-33.32	-31.13	-14.41	6.42	320.74	-1170.26	-1093.25	243.73	329.99	
1	51	868	66.40-24.72	66.38	-24.70	1.42	-910.21	-2134.79	-2117.55	-927.45	144.27	
1	51	869	20.485.60	14.13	11.96	-7.36	485.50	-413.84	-353.40	425.06	225.18	
1	51	870	10.64-3.40	-0.19	7.43	5.89	782.59	-82.28	-76.42	776.73	70.96	
1	51	871	2.34-0.69	-0.18	1.82	1.14	769.80	28.33	28.47	769.65	10.43	
1	51	872	1.42-1.44	-1.09	1.07	0.94	738.62	75.12	75.12	738.62	0.78	
1	51	873	1.04-1.12	-0.71	0.63	0.84	693.47	96.30	96.35	693.43	5.08	
1	51	874	0.56-0.63	-0.63	0.56	2.91e-02	679.74	104.63	104.65	679.73	2.81	
1	51	875	1.24-1.56	-1.08	0.76	-1.06	715.17	105.05	105.06	715.16	-2.24	
1	51	876	1.91-2.41	-1.77	1.28	-1.53	797.22	100.59	100.64	797.16	-6.32	
1	51	877	3.00-3.44	-2.65	2.22	-2.10	900.64	87.46	87.54	900.56	-7.95	
1	51	878	5.34-3.55	-2.47	4.25	-2.91	989.22	45.90	47.01	988.10	-32.47	
1	51	879	15.05-10.97	-5.01	9.10	-10.93	1081.19	-131.72	-98.74	1048.21	-197.28	
1	51	880	39.52-23.78	32.84	-17.09	19.45	1067.26	-690.56	-504.94	881.64	-540.22	
1	51	881	5.57-41.68	-41.32	5.21	-4.10	394.78	-418.38	392.76	-416.37	-40.47	
1	51	882	22.931.53	21.12	3.35	-5.97	610.80	-304.84	-183.08	489.05	310.91	
1	51	883	4.82-8.61	-3.08	-0.70	6.61	708.01	-49.66	-21.15	679.50	144.18	
1	51	884	3.69-1.20	-0.27	2.76	1.92	763.66	65.02	66.04	762.64	26.67	
1	51	885	1.66-1.63	-1.24	1.27	1.06	735.53	90.32	90.42	735.44	7.85	
1	51	886	1.14-1.08	-0.78	0.84	0.76	695.29	102.94	103.05	695.18	8.09	
1	51	887	0.72-0.66	-0.66	0.72	-7.97e-03	682.62	107.94	107.94	682.62	0.51	
1	51	888	1.41-1.54	-1.06	0.93	-1.09	717.69	111.99	112.04	717.64	-5.53	





EGP CODE

GRE.EEC.R.73.IT.W.15235.12.024.01

PAGE

390 di/of 527

1	51	889	2.27-2.55	-1.78	1.50	-1.77	797.37	113.86	113.88	797.35	-3.89
1	51	890	3.63-3.77	-2.63	2.50	-2.67	893.70	113.50	113.95	893.25	-18.73
1	51	891	6.54-4.69	-2.70	4.54	-4.29	975.44	105.24	109.23	971.45	-58.76
1	51	892	5.48-14.01	-5.18	-3.35	-9.70	994.73	-56.87	9.50	928.36	-255.72
1	51	893	50.072.60	34.92	17.75	22.13	1137.55	-122.82	200.08	814.65	-550.19
1	51	894	12.19-79.50	-76.90	9.58	15.23	1063.93	-159.52	1041.56	-137.15	-163.93
1	51	895	2.10-15.89	-15.48	1.69	2.70	402.92	-86.48	377.13	-60.69	109.34
1	51	896	8.818.10	8.14	8.78	0.15	541.18	209.17	340.11	410.24	162.26
1	51	897	3.79-0.81	1.50	1.49	2.30	660.66	119.57	134.26	645.97	87.93
1	51	898	3.09-2.73	-1.37	1.73	2.46	719.74	86.35	88.46	717.64	36.47
1	51	899	1.91-1.56	-1.01	1.35	1.27	717.35	94.87	95.13	717.09	12.53
1	51	900	1.24-0.86	-0.62	0.99	0.67	690.88	103.27	103.41	690.74	8.98
1	51	901	0.97-0.57	-0.54	0.94	-0.21	682.26	109.38	109.41	682.24	3.51
1	51	902	1.80-1.59	-0.93	1.14	-1.34	716.54	113.90	113.91	716.53	-2.58
1	51	903	2.73-2.65	-1.49	1.57	-2.22	789.68	121.02	121.23	789.48	-11.75
1	51	904	4.11-3.67	-1.84	2.29	-3.30	868.25	135.59	136.36	867.49	-23.61
1	51	905	5.45-4.99	-2.16	2.63	-4.64	910.67	165.54	169.39	906.81	-53.47
1	51	906	6.54-1.15	1.20	4.19	-3.55	875.70	239.53	265.41	849.82	-125.69
1	51	907	10.383.81	4.17	10.01	1.51	758.75	344.92	609.45	494.22	-198.73
1	51	908	4.12-24.44	-23.73	3.41	-4.45	742.33	24.28	651.61	115.00	-238.56
1	51	909	1.20-4.18	-3.33	0.35	1.97	321.04	-19.47	318.87	-17.31	27.08
1	51	910	4.07-1.00	1.34	1.72	2.53	360.93	312.64	314.68	358.89	9.70
1	51	911	3.97-1.13	2.00	0.85	2.48	606.62	211.69	211.69	606.62	0.48
1	51	912	2.29-1.96	-0.12	0.44	2.11	704.23	119.22	119.23	704.23	1.66
1	51	913	1.75-0.96-7.57e-02		0.86	1.27	710.02	121.25	121.36	709.92	7.74
1	51	914	1.06-0.80	-0.64	0.89	0.53	685.65	102.81	102.99	685.47	10.24
1	51	915	1.09-0.49	-0.36	0.97	-0.43	677.34	113.09	113.09	677.33	1.49
1	51	916	1.97-1.55	-0.71	1.13	-1.50	712.06	118.63	118.74	711.95	-8.08
1	51	917	2.75-2.60	-1.21	1.36	-2.34	786.42	126.20	126.44	786.18	-12.51
1	51	918	3.76-3.44	-1.30	1.61	-3.29	869.76	149.00	149.14	869.62	-9.88
1	51	919	4.08-4.34	-1.74	1.49	-3.89	893.80	181.77	181.83	893.74	6.46
1	51	920	5.11-3.27	-0.28	2.12	-4.02	766.55	290.76	291.31	766.00	16.24
1	51	921	5.26-7.60	-5.67	3.33	-4.59	447.05	389.91	391.76	445.19	-10.12
1	51	922	2.57-6.00	-4.39	0.96	-3.35	501.24	104.88	498.86	107.27	-30.67
1	51	923	0.65-4.39	-0.27	-3.47	1.95	68.66	-114.50	62.75	-108.59	-32.35
1	51	924	-0.55-3.80	-2.99	-1.36	1.41	325.77	-31.05	-9.20	303.92	-85.56
1	51	925	0.17-2.76	-1.53	-1.05	1.45	626.91	26.72	33.98	619.65	-65.59
1	51	926	1.87-1.40-5.87e-02		0.53	1.61	729.94	88.51	88.75	729.70	-12.34
1	51	927	1.42-0.58	0.23	0.61	0.98	719.54	105.75	105.82	719.47	6.48
1	51	928	0.95-0.33	-0.22	0.83	0.36	681.51	109.87	110.14	681.23	12.53
1	51	929	1.16-0.36	-0.18	0.98	-0.48	668.34	117.29	117.30	668.33	2.65
1	51	930	1.94-1.37	-0.55	1.12	-1.43	703.64	121.31	121.53	703.42	-11.32
1	51	931	2.62-2.27	-0.91	1.26	-2.19	786.19	125.32	126.03	785.48	-21.63
1	51	932	3.37-3.07	-1.06	1.37	-2.98	887.27	114.48	115.03	886.72	-20.65
1	51	933	4.14-3.90	-1.73	1.97	-3.57	935.35	96.55	96.91	935.00	17.25
1	51	934	1.19-6.00	-5.07	0.25	-2.41	781.65	-14.00	-0.29	767.95	103.53
1	51	935	0.88-5.02	-2.91	-1.23	-2.83	390.15	-16.90	44.94	328.30	146.11
1	51	936	1.08-7.29	-7.09	0.88	-1.26	134.95	-53.42	83.19	-1.66	84.09
1	51	937	23.93-14.81	23.75	-14.63	-2.62	-374.49	-612.69	-599.38	-387.80	54.72
1	51	938	-9.40-14.19	-12.50	-11.09	-2.29	239.24	-419.92	-375.88	195.20	-164.60
1	51	939	3.71-1.96	-1.04	2.79	2.10	665.38	-111.68	-111.53	665.23	-10.62
1	51	940	2.29-0.34	1.02	0.93	1.32	759.15	33.27	34.90	757.52	34.33
1	51	941	1.505.36e-02	0.62	0.93	0.71	724.67	95.56	97.17	723.06	31.78
1	51	942	1.060.23	0.29	1.00	0.21	670.52	123.13	124.19	669.46	24.07
1	51	943	1.29-0.26-7.51e-02		1.11	-0.50	650.85	125.61	125.64	650.81	4.41
1	51	944	2.01-1.02	-0.24	1.23	-1.32	685.34	132.18	132.81	684.71	-18.69
1	51	945	2.56-1.99	-0.81	1.38	-1.99	773.67	123.68	126.68	770.67	-44.04
1	51	946	3.31-2.65	-0.94	1.61	-2.69	894.88	91.13	96.09	889.92	-62.94
1	51	947	4.49-3.62	-1.25	2.12	-3.69	977.27	5.50	10.03	972.74	-66.21
1	51	948	11.45-4.90	-1.89	8.44	-6.34	918.95	-133.63	-133.56	918.88	8.84
1	51	949	-6.09-21.67	-20.84	-6.92	3.50	182.37	-758.20	-684.27	108.44	253.12
1	51	950	30.43-29.55	30.28	-29.40	3.01	-494.89	-1027.06	-1026.45	-495.50	17.99
1	51	951	-0.62-6.58	-0.62	-6.58	-4.05e-02	1256.26	26.93	89.16	1194.04	-269.48
1	51	952	15.94-2.84	10.39	2.71	-8.57	562.71	-646.11	-517.93	434.53	372.17
1	51	953	7.601.69	4.42	4.86	2.95	758.76	-129.54	-70.70	699.92	220.92
1	51	954	3.200.23	1.33	2.09	1.43	738.47	39.20	67.11	710.55	136.90
1	51	955	2.110.13	0.57	1.67	0.82	692.45	107.81	121.11	679.16	87.16
1	51	956	1.490.25	0.32	1.43	0.27	637.23	143.13	147.91	632.45	48.37
1	51	957	1.51-0.12 2.16e-02		1.37	-0.46	615.52	147.72	147.93	615.31	9.95
1	51	958	2.19-0.74-1.65e-02		1.47	-1.27	647.33	156.55	158.17	645.71	-28.17
1	51	959	3.13-1.02	0.39	1.72	-1.96	731.29	165.55	174.61	722.24	-70.99
1	51	960	3.64-2.35	-0.78	2.07	-2.64	847.89	99.76	124.06	823.59	-132.63
1	51	961	4.63-2.05	0.46	2.12	-3.24	947.69	41.08	87.25	901.52	-199.30
1	51	962	7.19-3.43	3.51	0.25	-5.05	1062.91	-217.16	-78.35	924.10	-398.02
1	51	963	22.47-30.52	14.86	-22.92	18.58	1017.78	-941.22	-666.99	743.56	-679.71
1	51	964	-0.92-4.73	-1.29	-4.35	-1.13	1370.55	-50.61	98.03	1221.91	-434.90





EGP CODE

GRE.EEC.R.73.IT.W.15235.12.024.01

PAGE

391 di/of 527

1	51	965	14.585.33	7.34	12.57	-3.82	1250.89	-38.44	236.94	975.51	-528.42	
1	51	966	0.25-32.34	-30.61	-1.49	7.31	176.36	-600.82	-269.49	-154.97	-384.35	
1	51	967	-18.69-65.34	-56.91	-27.11	-17.94	372.43	-298.76	76.61	-2.95	-333.23	
1	51	968	-2.86-30.44	-26.84	-6.46	9.29	-2.98	-213.37	-91.76	-124.60	103.90	
1	51	969	60.91-26.53	60.86	-26.49	-2.07	-751.44	-2098.36	-2084.74	-765.06	134.73	
1	51	970	34.34-10.75	34.34	-10.75	0.13	-586.04	-1404.54	-1299.20	-691.37	274.08	
1	51	971	-9.29-25.37	-19.70	-14.96	-7.68	41.00	-637.48	-637.18	40.71	14.18	
1	51	972	6.84-0.11	-9.44e-02	6.83	0.29	416.11	-223.91	-210.63	402.82	91.25	
1	51	973	4.18-0.48	-0.46	4.16	0.31	449.76	-106.60	-99.22	442.38	63.65	
1	51	974	4.690.71	0.79	4.61	0.57	418.53	-51.22	-47.35	414.66	42.45	
1	51	975	5.030.88	0.93	4.99	0.41	377.61	-32.91	-32.11	376.80	18.12	
1	51	976	5.530.97	1.00	5.50	0.40	365.56	-31.97	-31.50	365.08	13.69	
1	51	977	11.61-24.75	-24.68	11.54	-1.66	647.97	-166.01	567.97	-86.01	242.33	
1	51	978	17.841.82	13.40	6.26	-7.17	737.36	-220.78	125.30	391.29	460.24	
1	51	979	4.22-5.08	-0.51	-0.35	4.65	747.40	-72.67	91.10	583.62	327.85	
1	51	980	4.21-0.44	0.97	2.79	2.14	719.86	110.05	170.51	659.40	182.25	
1	51	981	2.60-6.60e-02	0.55	1.98	1.12	659.13	157.09	181.51	634.71	108.01	
1	51	982	1.700.21	0.33	1.58	0.41	604.31	172.22	179.56	596.97	55.85	
1	51	983	1.544.37e-02	0.15	1.43	-0.39	583.01	171.80	172.12	582.70	11.40	
1	51	984	2.22-0.64	6.31e-02	1.52	-1.23	611.91	181.82	183.81	609.92	-29.21	
1	51	985	3.27-1.01	0.41	1.85	-2.02	690.52	197.68	210.92	677.29	-79.68	
1	51	986	3.95-2.32	-0.79	2.42	-2.70	795.36	171.04	207.46	758.94	-146.31	
1	51	987	5.39-2.32	-0.37	3.43	-3.35	916.82	142.63	232.26	827.20	-247.70	
1	51	988	3.54-4.90	-1.56	0.20	-4.13	1033.31	-48.36	187.45	797.50	-446.61	
1	51	989	39.266.89	19.12	27.03	15.70	1253.14	13.78	602.41	664.51	-618.90	
1	51	990	18.23-40.20	-38.86	16.89	8.73	1276.05	52.34	1093.35	235.05	-436.11	
1	51	991	1.61-7.88	-7.28	1.00	2.31	627.20	-182.41	479.50	-34.71	312.67	
1	51	992	8.435.50	6.02	7.91	1.11	762.22	155.60	533.26	384.56	294.06	
1	51	993	4.930.43	2.28	3.08	2.22	712.23	178.13	337.14	553.23	244.22	
1	51	994	4.19-1.12	0.93	2.14	2.58	660.06	210.09	285.96	584.19	168.47	
1	51	995	3.02-0.45	0.71	1.86	1.64	605.00	210.32	240.63	574.69	105.09	
1	51	996	1.985.99e-02	0.55	1.48	0.84	559.10	208.31	217.20	550.21	55.12	
1	51	997	1.330.43	0.43	1.33	2.88e-02	542.53	206.62	207.81	541.34	19.97	
1	51	998	1.97-0.25	0.33	1.39	-0.98	566.70	212.42	213.42	565.70	-18.81	
1	51	999	3.23-1.09	0.45	1.69	-2.07	632.26	238.01	249.80	620.46	-67.17	
1	51	1000	4.66-1.58	0.76	2.33	-3.02	722.96	275.80	314.00	684.76	-125.00	
1	51	1001	5.57-2.99	-0.47	3.05	-3.90	817.57	286.20	373.74	730.03	-197.12	
1	51	1002	8.48-0.93	1.00	6.54	-3.80	924.34	294.90	497.51	721.72	-294.08	
1	51	1003	7.571.42	1.80	7.19	-1.48	1016.64	224.98	757.97	483.65	-371.31	
1	51	1004	4.30-14.04	-12.29	2.55	-5.39	927.40	-135.92	678.60	112.87	-450.17	
1	51	1005	2.71-0.97	1.21	0.53	1.81	715.59	-55.67	644.43	15.49	223.20	
1	51	1006	3.85-0.88	1.37	1.59	2.36	655.93	226.58	548.87	333.64	185.75	
1	51	1007	4.28-1.05	1.62	1.61	2.67	627.27	327.33	462.03	492.56	149.19	
1	51	1008	3.94-1.43	1.18	1.33	2.68	595.49	310.25	367.80	537.93	114.47	
1	51	1009	3.23-1.08	0.91	1.24	2.15	552.48	266.45	289.34	529.59	77.61	
1	51	1010	2.37-0.36	0.87	1.14	1.36	520.04	244.80	253.73	511.12	48.76	
1	51	1011	1.450.43	0.83	1.06	0.50	509.13	235.94	238.03	507.04	23.80	
1	51	1012	1.500.30	0.73	1.07	-0.58	530.70	244.00	244.05	530.65	-3.92	
1	51	1013	2.73-0.87	0.65	1.20	-1.78	584.60	269.19	274.17	579.62	-39.31	
1	51	1014	4.10-1.91	0.79	1.40	-2.99	653.18	333.00	349.36	636.83	-70.49	
1	51	1015	5.24-2.78	0.67	1.79	-3.98	717.21	399.89	446.27	670.84	-112.10	
1	51	1016	5.39-3.51	5.40e-02	1.82	-4.36	751.20	419.41	568.62	602.00	-165.05	
1	51	1017	4.94-4.23	-1.10	1.81	-4.35	796.65	260.41	680.80	376.26	-220.69	
1	51	1018	3.50-3.47	-0.53	0.55	-3.44	874.60	21.78	783.91	112.47	-262.90	
1	51	1019	0.39-2.25	-1.82	-5.22e-02	0.98	601.85	-13.15	583.89	4.81	103.56	
1	51	1020	1.88-2.21	-0.61	0.28	2.00	548.85	272.15	520.72	300.29	83.62	
1	51	1021	3.32-1.91	0.91	0.50	2.61	523.16	386.84	458.55	451.45	68.07	
1	51	1022	3.59-1.87	1.07	0.65	2.72	522.32	358.29	376.14	504.46	51.09	
1	51	1023	3.27-1.39	1.10	0.77	2.33	509.31	303.64	310.69	502.26	37.41	
1	51	1024	2.63-0.56	1.20	0.86	1.59	488.48	268.81	270.30	486.99	18.03	
1	51	1025	1.700.39	1.23	0.86	0.63	484.72	251.34	251.34	484.72	0.95	
1	51	1026	1.400.59	1.18	0.81	-0.36	510.23	251.77	252.34	509.65	-12.18	
1	51	1027	2.23-0.49	1.02	0.72	-1.35	560.55	272.83	274.24	559.14	-20.08	
1	51	1028	3.21-1.76	0.84	0.61	-2.48	613.69	321.18	322.53	612.35	-19.80	
1	51	1029	3.63-3.34	-9.74e-02	0.39	-3.48	630.38	387.06	389.85	627.59	-25.89	
1	51	1030	3.36-4.33	-1.11	0.14	-3.79	562.07	471.51	487.43	546.15	-34.47	
1	51	1031	1.86-5.10	-3.12	-0.12	-3.14	605.96	306.83	595.46	317.34	-55.05	
1	51	1032	0.48-5.07	-4.41	-0.18	-1.80	676.64	68.54	668.01	77.17	-71.92	
1	51	1033	-5.74e-02	-4.64	-4.48	-0.21	0.83	453.84	-21.86	452.76	-20.79	-22.62
1	51	1034	0.85-3.41	-2.49	-6.20e-02	1.75	421.83	267.14	421.02	267.95	-11.18	
1	51	1035	2.01-2.77	-0.64	-0.11	2.37	416.01	366.61	367.14	415.48	-5.09	
1	51	1036	3.02-1.91	0.73	0.37	2.46	482.72	319.56	319.59	482.69	-2.13	
1	51	1037	3.04-1.16	1.22	0.65	2.08	487.99	282.51	282.55	487.96	-2.53	
1	51	1038	2.71-0.37	1.44	0.90	1.52	473.48	255.52	255.79	473.21	-7.65	
1	51	1039	2.050.49	1.52	1.02	0.74	470.80	240.09	240.12	470.78	-2.53	
1	51	1040	1.530.93	1.51	0.95	-9.42e-02	498.83	234.66	235.44	498.06	-14.31	



EGP CODE

GRE.EEC.R.73.IT.W.15235.12.024.01

PAGE

392 di/of 527

1	51	1041	1.999.83e-02	1.39	0.70	-0.88	553.49	239.45	240.29	552.65	-16.26	
1	51	1042	2.49-1.12	1.03	0.34	-1.77	608.07	253.74	253.75	608.06	1.39	
1	51	1043	2.54-2.70	-0.22	5.69e-02	-2.62	620.76	269.94	273.63	617.07	35.80	
1	51	1044	1.66-4.67	-2.54	-0.47	-2.99	542.61	300.66	325.26	518.01	73.12	
1	51	1045	0.60-7.05	-6.13	-0.31	-2.48	465.92	226.91	401.83	291.00	105.88	
1	51	1046	-8.87e-02	-8.65	-8.46	-0.27	-1.23	482.41	25.97	453.25	55.13	111.62
1	51	1047	-0.30-4.79	-4.54	-0.55	1.04	215.69	-94.60	197.80	-76.71	-72.34	
1	51	1048	-6.66e-02	-3.80	-3.26	-0.61	1.32	292.55	135.12	219.11	208.56	-78.54
1	51	1049	1.04-2.65	-1.33	-0.27	1.77	404.13	182.32	198.71	387.73	-58.03	
1	51	1050	2.35-1.44	0.53	0.38	1.89	473.63	207.03	209.51	471.14	-25.62	
1	51	1051	2.81-0.50	1.22	1.09	1.65	480.96	213.27	213.48	480.76	-7.38	
1	51	1052	2.830.16	1.48	1.52	1.34	460.48	207.66	207.66	460.48	0.61	
1	51	1053	2.510.85	1.58	1.78	0.83	456.57	196.78	198.43	454.93	-20.60	
1	51	1054	1.911.49	1.61	1.79	0.19	489.00	184.97	189.53	484.44	-36.98	
1	51	1055	1.821.20	1.52	1.50	-0.31	552.47	173.98	178.40	548.04	-40.68	
1	51	1056	1.930.28	1.19	1.02	-0.82	619.87	155.59	156.39	619.07	-19.20	
1	51	1057	1.60-1.42	0.11	7.05e-02	-1.51	633.71	109.84	112.27	631.29	35.56	
1	51	1058	0.63-4.08	-2.88	-0.57	-2.05	551.39	26.17	56.73	520.82	122.96	
1	51	1059	0.45-7.92	-7.29	-0.18	-2.20	360.96	-32.09	77.89	250.98	176.45	
1	51	1060	-0.12-11.47	-11.36	-0.22	-1.07	202.38	-154.93	45.36	2.09	177.34	
1	51	1061	6.92-3.72	6.16	-2.96	2.73	-208.85	-279.57	-275.69	-212.73	16.11	
1	51	1062	-0.47-9.33	-8.42	-1.37	-2.69	185.23	-220.11	-197.74	162.86	-92.56	
1	51	1063	0.32-2.51	-2.15	-3.71e-02	0.95	377.61	-24.57	-21.68	374.73	-33.96	
1	51	1064	-0.82-2.38	-2.35	-0.85	0.21	696.42	-44.82	696.40	-44.81	3.27	
1	51	1065	2.940.34	0.97	2.30	1.12	466.70	110.11	110.97	465.84	17.52	
1	51	1066	3.300.86	1.26	2.91	0.90	434.78	119.94	120.79	433.93	16.36	
1	51	1067	3.481.17	1.35	3.30	0.62	425.31	116.96	117.71	424.56	15.24	
1	51	1068	3.571.29	1.38	3.48	0.45	464.26	97.94	107.42	454.78	-58.16	
1	51	1069	3.461.32	1.34	3.43	0.22	538.26	76.23	87.95	526.53	-72.66	
1	51	1070	3.040.96	0.96	3.04	2.09e-02	634.99	35.84	47.46	623.37	-82.63	
1	51	1071	2.460.30	0.32	2.44	-0.20	681.54	-49.34	-45.00	677.20	-56.19	
1	51	1072	0.70-2.85	-2.80	0.64	-0.43	573.01	-215.25	-211.43	569.18	54.77	
1	51	1073	-1.67-17.74	-16.20	-3.21	4.73	210.59	-670.63	-621.53	161.49	202.13	
1	51	1074	3.86-0.39	3.81	-0.34	0.43	-38.11	-673.19	-627.14	-84.15	164.69	
1	51	1076	33.6521.43	33.30	21.78	2.05	-69.09	-269.13	-105.62	-232.61	77.28	
1	51	1077	9.40-2.47	4.54	2.39	5.83	630.38	-16.99	614.06	-0.68	101.48	
1	51	1078	-0.28-0.59	-0.38	-0.50	-0.14	722.44	-56.67	722.28	-56.51	-11.36	
1	51	1079	-0.34-1.87	-1.86	-0.34	-0.11	765.16	-59.10	761.08	-55.01	-57.88	
1	51	1080	-0.17-1.75	-1.74	-0.18	0.10	680.94	-68.49	675.39	-62.94	-64.24	
1	51	1081	-0.37-2.81	-2.73	-0.45	0.43	426.75	-100.13	406.60	-79.99	-101.03	
1	51	1082	5.980.97	1.04	5.91	0.59	408.37	-55.33	-40.49	393.53	-81.62	
1	51	1083	6.320.95	1.01	6.26	0.56	489.03	-83.37	-60.24	465.90	-112.71	
1	51	1084	6.880.80	0.82	6.87	0.32	614.76	-135.10	-100.17	579.83	-158.03	
1	51	1085	6.92-0.97	-0.88	6.83	0.86	719.29	-239.74	-200.44	679.99	-190.11	
1	51	1086	14.630.93	1.29	14.28	-2.17	856.38	-385.49	-348.22	819.11	-211.88	
1	51	1087	-8.07-28.06	-23.01	-13.12	8.69	245.16	-1138.67	-1137.38	243.87	42.19	
1	51	1088	-0.87-9.41	-9.16	-1.12	1.44	-30.31	-277.19	-192.11	-115.38	-117.32	
1	51	1089	16.98-2.09	7.39	7.50	-9.53	566.78	-464.43	-366.61	468.97	302.16	
1	51	1090	8.80-0.40	0.11	8.29	2.11	423.85	-269.06	-238.99	393.78	141.18	
1	51	1091	6.22-0.23	-0.21	6.20	0.34	421.56	-158.48	-149.45	412.53	71.78	
1	51	1092	5.750.34	0.34	5.75	5.32e-02	374.95	-128.08	-125.53	372.40	35.70	
1	51	1093	6.220.45	0.46	6.22	6.72e-02	338.00	-116.06	-115.60	337.54	14.53	
1	51	1094	6.740.48	0.49	6.72	0.27	325.60	-116.37	-115.59	324.82	-18.48	
1	51	1095	7.310.47	0.51	7.28	0.48	364.57	-133.30	-120.51	351.78	-78.76	
1	51	1096	7.920.41	0.47	7.87	0.65	444.37	-152.68	-131.21	422.90	-111.16	
1	51	1097	8.570.30	0.33	8.54	0.46	562.56	-188.70	-154.67	528.53	-156.24	
1	51	1098	11.20-0.48	-0.48	11.20	0.12	730.33	-238.68	-195.49	687.14	-199.96	
1	51	1099	8.41-2.49	-1.00	6.93	-3.74	825.39	-431.42	-349.10	743.07	-310.95	
1	51	1100	30.93-26.42	27.06	-22.55	14.38	1092.87	-657.91	-420.09	855.05	-599.85	
1	51	1101	3.71-29.61	-28.28	2.39	-6.51	314.40	-327.65	55.64	-68.89	314.93	
1	51	1102	29.60-26.72	-2.37	5.25	-27.90	332.98	-917.26	-792.16	207.88	375.18	
1	51	1103	24.07-22.48	-10.44	12.02	-20.38	252.20	-1326.62	-1198.73	124.30	430.77	
1	51	1104	29.77-19.72	-6.02	16.07	-22.15	184.54	-1524.90	-1436.85	96.50	377.84	
1	51	1105	29.44-16.46	-1.42	14.39	-21.55	182.43	-1375.97	-1298.21	104.67	339.31	
1	51	1106	21.00-24.77	-17.34	13.57	-16.88	279.36	-1869.69	-1782.12	191.79	424.89	
1	51	1107	25.14-25.18	-11.12	11.08	-22.58	379.44	-1834.27	-1778.74	323.92	346.17	
1	51	1108	34.57-31.15	4.62	-1.19	-32.73	334.20	-1266.22	-1172.02	240.00	376.68	
1	51	1109	19.28-20.42	-10.10	8.96	-17.42	365.79	-1391.47	-1295.34	269.66	399.61	
1	51	1110	20.51-34.58	-18.19	4.12	-25.19	221.03	-667.57	-594.48	147.94	244.15	
1	51	1111	37.7620.82	26.80	31.78	-8.10	1335.91	22.21	1166.90	191.21	-439.84	
1	51	1112	15.76-0.75	11.61	3.40	-7.16	1879.66	62.20	1822.51	119.35	-317.19	
1	51	1113	-0.39-1.61	-0.78	-1.23	-0.57	1418.60	40.15	1418.14	40.61	-25.32	
1	51	1114	0.21-0.93	-0.55	-0.17	-0.54	822.27	-33.77	800.93	-12.43	133.47	
1	51	1115	-4.62-17.26	-13.76	-8.12	-5.66	-28.78	-376.94	-307.19	-98.53	139.35	
1	51	1116	-13.62-82.58	-59.12	-37.08	-32.67	-140.62	-1193.41	-1167.34	-166.70	-163.63	
1	51	1117	70.1828.28	66.95	31.51	-11.18	-39.14	-415.36	-357.57	-96.92	-135.65	



EGP CODE

GRE.EEC.R.73.IT.W.15235.12.024.01

PAGE

393 di/of 527

1	51	1118	36.454.58	30.04	10.99	-12.78	1067.37	108.31	1034.74	140.95	-173.88	
1	51	1119	2.99-1.83	2.16	-1.00	-1.82	953.86	16.04	953.41	16.49	20.49	
1	51	1120	0.898.19e-02	0.89	8.23e-02	-1.78e-02	630.61	-46.02	597.64	-13.05	145.68	
1	51	1121	2.780.21	1.41	1.58	-1.28	30.41	-407.85	-282.91	-94.53	197.85	
1	51	1122	-9.27-65.06	-25.84	-48.48	-25.50	-412.60	-1200.43	-1156.76	-456.27	-180.28	
1	51	1123	-0.53-6.13	-6.13	-0.53	-6.05e-02	716.67	-56.80	711.70	-51.84	-61.80	
1	51	1124	47.7320.10	46.72	21.11	-5.20	383.39	-151.01	191.31	41.08	-256.43	
1	51	1125	23.550.58	18.86	5.27	-9.26	1073.25	77.53	1045.39	105.39	-164.21	
1	51	1126	1.12-1.68	8.67e-02	-0.65	-1.35	872.72	9.47	871.32	10.87	34.70	
1	51	1127	-9.59e-02	-0.94	-0.94	-9.59e-02	1.48e-03	651.84	-56.62	604.76	-9.54	176.46
1	51	1128	3.890.96	1.01	3.84	-0.37	111.21	-370.75	-178.09	-81.45	236.08	
1	51	1129	-9.48-64.21	-22.95	-50.74	-23.58	-456.64	-1075.84	-1045.32	-487.16	-134.03	
1	51	1130	-0.57-34.61	-12.86	-22.32	16.35	-446.96	-1015.53	-950.84	-511.65	180.54	
1	51	1131	55.2820.78	54.61	21.45	-4.77	169.13	-324.84	-133.58	-22.12	-240.61	
1	51	1132	30.482.15	25.50	7.13	-10.79	1054.31	69.25	999.66	123.91	-225.50	
1	51	1133	3.01-1.60	2.30	-0.90	-1.66	955.54	20.80	955.36	20.98	-12.94	
1	51	1134	-0.21-1.69	-1.54	-0.36	-0.44	719.23	-25.80	695.37	-1.94	131.17	
1	51	1135	-8.86e-02	-1.22	-1.22	-8.89e-02	1.82e-02	276.27	-206.50	117.39	-47.62	226.84
1	51	1136	-4.92-15.26	-10.82	-9.36	-5.12	-49.10	-1005.04	-967.65	-86.49	185.32	
1	51	1137	-8.27-85.63	-56.82	-37.08	-37.40	-219.83	-1866.89	-1847.75	-238.97	-176.52	
1	51	1138	61.5917.75	61.59	17.75	-1.60e-02	-209.25	-900.08	-852.40	-256.93	-175.12	
1	51	1139	36.344.85	29.27	11.93	-13.15	798.60	-9.93	798.97	169.70	-381.19	
1	51	1140	0.98-2.82	-0.78	-1.06	-1.90	944.20	-2.38	911.19	30.63	-173.66	
1	51	1141	-0.19-2.94	-2.75	-0.39	-0.70	958.89	12.43	958.37	12.95	-22.12	
1	51	1142	-0.33-4.34	-4.27	-0.40	-0.53	884.54	-12.35	875.39	-3.20	90.14	
1	51	1143	-0.27-5.41	-5.40	-0.28	-0.25	703.70	-69.89	651.57	-17.76	193.94	
1	51	1144	0.52-2.50	-2.31	0.34	0.72	392.05	-198.95	231.85	-38.75	262.71	
1	51	1145	1.070.63	0.90	0.81	0.21	3.42	-848.49	-748.25	-96.82	274.50	
1	51	1146	-2.90-73.34	-25.08	-51.16	-32.72	-480.08	-1905.48	-1860.06	-525.50	-250.36	
1	51	1147	-16.50-75.69	-56.95	-35.24	-27.54	-120.02	-1234.61	-1210.13	-144.51	-163.36	
1	51	1148	37.676.37	37.58	6.47	1.71	225.50	-413.51	-48.73	-139.28	-316.28	
1	51	1149	19.83-4.53e-02	13.21	6.58	-9.37	992.57	8.80	883.02	118.35	-309.47	
1	51	1150	-2.31e-02	-5.41	-5.00	-0.43	-1.43	919.24	0.28	906.74	12.79	-106.47
1	51	1151	-0.33-7.23	-7.16	-0.40	-0.69	925.75	-1.98	925.52	-1.75	14.74	
1	51	1152	-0.35-9.25	-9.21	-0.38	-0.53	804.15	-45.35	776.44	-17.65	150.89	
1	51	1153	-1.23e-02	-9.43	-9.43	-1.42e-02	0.13	527.56	-111.54	447.19	-31.17	211.91
1	51	1154	4.16-5.59	-5.58	4.14	0.38	74.11	-498.89	-340.90	-83.89	256.07	
1	51	1155	-10.95-67.57	-26.95	-51.58	-25.50	-559.90	-1338.03	-1286.54	-611.39	-193.44	
1	51	1156	43.0925.85	42.20	26.75	3.82	-88.55	-483.24	-477.43	-94.35	47.50	
1	51	1157	48.6220.46	48.51	20.57	-1.75	-29.47	-568.85	-475.28	-123.05	-204.24	
1	51	1158	23.17-0.33	15.88	6.96	-10.87	944.20	21.27	847.96	117.52	-282.07	
1	51	1159	-0.73-7.12	-6.78	-1.08	-1.45	947.19	5.61	940.30	12.50	-80.27	
1	51	1160	-0.48-10.18	-10.13	-0.53	-0.67	924.60	-5.51	922.06	-2.97	48.48	
1	51	1161	-0.49-11.72	-11.69	-0.53	-0.59	771.88	-65.47	731.41	-24.99	179.58	
1	51	1162	-0.22-12.75	-12.72	-0.25	-0.66	397.36	-174.88	276.92	-54.44	233.27	
1	51	1163	-4.89-25.76	-24.36	-6.29	-5.23	-73.35	-783.98	-712.72	-144.61	213.45	
1	51	1164	-16.37-86.44	-60.05	-42.76	-33.96	-343.59	-1556.66	-1518.22	-382.04	-212.52	
1	51	1165	76.9231.33	71.04	37.21	-15.28	-149.57	-758.75	-750.98	-157.34	-68.37	
1	51	1166	32.823.33	25.78	10.37	-12.57	774.51	45.40	744.28	75.62	-145.34	
1	51	1167	-0.58-5.50	-5.07	-1.00	-1.39	631.16	-6.72	631.16	-6.72	-6.65e-02	
1	51	1168	2.54-6.89	-6.62	2.28	-1.56	-6.08	-172.91	-88.94	-90.05	83.41	
1	51	1169	-15.81-61.32	-31.29	-45.84	-21.56	-369.90	-1037.00	-925.17	-481.72	-249.18	
1	51	1170	16.72-0.82	12.28	3.62	7.63	621.74	-39.50	595.46	-13.22	129.18	
1	51	1171	46.7823.63	45.30	25.12	-5.67	218.74	-340.67	-89.58	-32.35	-278.24	
1	51	1172	20.39-1.48	12.83	6.08	-10.40	1041.21	22.18	957.88	105.52	-279.25	
1	51	1173	-0.95-7.96	-7.69	-1.23	-1.35	837.54	-15.69	826.14	-4.30	-97.95	
1	51	1174	-0.47-10.80	-10.75	-0.51	-0.71	785.40	-17.25	785.38	-17.23	3.93	
1	51	1175	-0.47-12.43	-12.41	-0.49	-0.49	534.12	-70.83	515.59	-52.31	104.22	
1	51	1176	0.14-12.60	-12.59	0.13	-0.31	87.30	-85.93	76.75	-75.38	41.44	
1	51	1177	-7.84-28.44	-26.67	-9.61	-5.77	-157.12	-801.54	-799.64	-159.02	34.93	
1	51	1178	-4.70-13.38	-12.26	-5.83	2.91	-161.70	-517.26	-498.45	-180.51	-79.59	
1	51	1179	-9.45-18.44	-14.55	-13.34	4.46	328.01	-216.03	-4.29	116.27	-265.26	
1	51	1180	6.29-41.36	-1.42	-33.66	17.54	941.74	-472.09	-440.72	910.38	-208.23	
1	51	1181	-1.64-26.69	-11.76	-16.56	12.29	782.61	-890.31	-846.89	739.19	-265.98	
1	51	1182	3.43-30.45	-8.90	-18.12	16.30	835.39	-967.63	-942.62	810.38	-210.87	
1	51	1183	4.64-49.90	2.32	-47.58	11.02	1265.78	-641.93	-617.53	1241.38	-214.37	
1	51	1184	-7.94-25.28	-12.55	-20.67	7.66	996.32	-1306.87	-1270.15	959.60	-288.50	
1	51	1185	6.29-26.85	-7.63	-12.93	16.36	857.71	-1398.72	-1381.34	840.33	-197.29	
1	51	1186	17.49-39.17	7.50	-29.17	21.60	792.69	-801.01	-777.90	769.58	-190.52	
1	51	1187	3.36-18.91	-5.70	-9.85	10.94	680.37	-1049.27	-1011.40	642.49	-253.13	
1	51	1188	0.88-29.95	-11.13	-17.94	15.03	846.85	-342.22	-340.62	845.25	-43.62	
1	51	1189	41.7120.69	28.52	33.88	10.16	871.41	28.90	803.32	97.00	229.65	
1	51	1190	11.78-1.75	8.23	1.80	5.95	1322.21	-51.59	1307.94	-37.31	139.31	
1	51	1191	6.10e-04	-1.07	-0.36	-0.71	0.51	1071.50	-47.72	1071.20	-47.42	18.30
1	51	1192	-0.61-4.25	-3.37	-1.50	1.56	621.39	-86.36	620.45	-85.42	-25.75	
1	51	1193	-7.78-23.05	-20.22	-10.62	5.94	-160.13	-209.42	-166.43	-203.13	-16.45	



EGP CODE

GRE.EEC.R.73.IT.W.15235.12.024.01

PAGE

394 di/of 527

1	51	1194	3.23-40.95	-33.80	-3.92	16.27	75.26	-902.52	-879.23	51.97	149.13	
1	51	1195	57.2627.31	48.85	35.71	13.46	86.36	-336.61	-322.90	72.66	74.88	
1	51	1196	22.260.33	17.00	5.59	9.36	715.28	-58.80	712.65	-56.17	45.06	
1	51	1197	1.98-0.91	1.48	-0.41	1.09	693.05	-71.41	690.16	-68.52	-46.92	
1	51	1198	-0.61-3.10	-2.77	-0.93	0.84	425.70	-104.34	416.72	-95.36	-68.42	
1	51	1199	-3.13-13.74	-12.36	-4.52	3.58	-121.97	-208.83	-168.07	-162.73	-43.35	
1	51	1200	-2.15-30.11	-17.49	-14.77	13.92	-278.56	-858.55	-783.20	-353.91	195.00	
1	51	1201	-0.95-7.20	-6.98	-1.17	1.14	302.11	-119.47	271.29	-88.65	-109.73	
1	51	1202	40.0924.35	35.03	29.41	7.35	123.82	-89.75	80.04	-45.97	86.22	
1	51	1203	10.20-2.16	6.61	1.42	5.61	739.88	-40.74	737.07	-37.93	46.73	
1	51	1204	0.24-0.76	0.22	-0.74	0.14	653.16	-78.88	650.13	-75.85	-47.03	
1	51	1205	-0.64-2.12	-1.87	-0.89	0.55	448.99	-100.77	443.42	-95.20	-55.04	
1	51	1206	-2.59-13.28	-12.48	-3.39	2.81	-52.67	-175.94	-77.40	-151.21	-49.36	
1	51	1207	-2.64-27.16	-15.07	-14.72	12.26	-332.30	-747.19	-654.05	-425.44	173.11	
1	51	1209	45.5927.14	39.17	33.56	8.79	16.28	-198.16	-174.36	-7.52	67.36	
1	51	1210	11.59-2.27	7.75	1.57	6.20	677.59	-62.33	673.43	-58.17	55.33	
1	51	1211	-0.31-0.92	-0.31	-0.92	-5.20e-02	691.31	-77.38	689.38	-75.45	-38.48	
1	51	1212	0.80-0.90	0.80	-0.90	9.55e-02	582.43	-101.79	575.74	-95.10	-67.32	
1	51	1213	-0.96-5.18	-4.30	-1.84	1.71	127.27	-128.09	118.69	-119.52	-46.01	
1	51	1214	-10.19-27.51	-24.70	-13.00	6.38	-269.77	-708.99	-708.92	-269.85	5.77	
1	51	1215	9.08-38.02	-32.65	3.72	14.96	200.56	-1335.02	-1319.70	185.24	152.62	
1	51	1216	54.1533.75	49.05	38.85	8.83	20.68	-582.34	-575.72	14.06	62.85	
1	51	1217	20.71-1.11	15.31	4.30	9.42	620.26	-84.09	605.06	-68.89	102.33	
1	51	1218	1.21-0.50	1.08	-0.37	0.46	688.48	-59.61	688.21	-59.33	-14.25	
1	51	1219	-0.31-1.36	-1.34	-0.33	-0.13	722.82	-66.67	719.74	-63.59	-49.25	
1	51	1220	-9.95e-02	-1.72	-1.72	-0.10	3.48e-02	685.39	-73.90	677.51	-66.02	-76.91
1	51	1221	-0.22-1.53	-1.48	-0.28	0.26	546.39	-92.96	531.72	-78.28	-95.75	
1	51	1222	-0.54-3.17	-2.74	-0.97	0.97	216.00	-127.55	188.19	-99.74	-93.71	
1	67	1	6.38-3.04-1.55e-02		3.36	4.40	-587.45	-1089.00	-595.10	-1081.35	61.44	
1	67	3	8.47-19.86	0.58	-11.97	12.70	47.23	-699.27	-576.36	-75.68	-276.85	
1	67	5	1.54-27.86	0.89	-27.21	4.31	-587.54	-1892.62	-1892.50	-587.66	12.60	
1	67	7	5.35-22.03	5.08	-21.75	2.72	-496.42	-1715.72	-1713.51	-498.62	-51.81	
1	67	9	8.32-26.96	5.37	-24.02	9.76	-425.54	-1802.25	-1791.80	-435.99	-119.44	
1	67	11	9.77-38.14	9.57	-37.93	-3.12	-603.68	-2725.53	-2725.21	-604.00	26.03	
1	67	13	13.09-27.06	12.46	-26.43	-5.00	-786.42	-2642.16	-2639.07	-789.51	75.69	
1	67	15	6.46-23.28	2.93	-19.75	9.61	-897.60	-2359.86	-2349.52	-907.94	-122.51	
1	67	17	0.72-26.29	-3.01	-22.55	9.32	-782.88	-2054.39	-2054.23	-783.04	-14.11	
1	67	19	3.95-17.91	-0.37	-13.59	8.71	-732.12	-1804.69	-1729.87	-806.94	-273.22	
1	67	21	8.96-12.94	5.74	-9.72	-7.75	-264.87	-1365.12	-1227.71	-402.28	363.73	
1	67	23	2.56-2.26	-2.02	2.31	-1.06	-1445.34	-1523.11	-1503.29	-1465.15	-33.89	
1	67	25	5.493.93e-02	0.20	5.33	-0.92	-1456.92	-1532.08	-1470.55	-1518.45	28.95	
1	67	27	6.16-3.43	-3.43	6.16	-3.38e-02	-1484.00	-1604.96	-1489.38	-1599.58	24.94	
1	67	29	2.65-6.78	-6.78	2.65	-4.35e-02	-1747.21	-1992.37	-1934.39	-1805.18	104.18	
1	67	31	6.33-0.60	6.04e-02	5.67	-2.03	-1925.41	-2098.10	-2096.12	-1927.39	-18.37	
1	67	33	3.47-0.65	-0.21	3.03	-1.27	-1681.71	-1989.25	-1985.70	-1685.25	32.83	
1	67	35	3.19-6.92	-4.89	1.16	-4.04	-1332.76	-1694.84	-1673.36	-1354.24	-85.53	
1	67	37	1.91-0.54	-0.52	1.89	-0.22	-1268.44	-1655.14	-1566.40	-1357.18	162.60	
1	67	39	8.51-3.82	3.09	1.60	-6.12	-864.19	-1186.35	-1030.32	-1020.22	-161.00	
1	67	41	13.24-8.20	-5.72	10.77	6.85	628.28	-389.48	547.36	-308.56	-275.33	
1	67	42	-6.84-12.99	-9.01	-10.83	2.93	234.45	-363.35	215.52	-344.42	104.67	
1	67	43	22.88-14.23	-14.13	22.77	-1.97	-427.57	-858.15	-447.51	-838.22	90.48	
1	67	44	-2.43-7.52	-4.44	-5.51	2.49	276.53	-130.72	204.38	-58.57	155.50	
1	67	45	5.670.92	0.93	5.66	-0.22	115.83	-168.07	-57.60	5.37	138.42	
1	67	46	-0.88-1.97	-0.94	-1.91	-0.25	357.76	119.06	225.39	251.43	118.64	
1	67	47	-0.59-3.39	-0.61	-3.37	-0.25	259.19	-103.87	-47.32	202.65	131.65	
1	67	48	-0.54-1.84	-0.62	-1.76	-0.31	423.75	171.89	209.52	386.12	89.79	
1	67	49	-0.35-2.39	-0.36	-2.38	-6.85e-02	401.67	-64.80	-38.76	375.63	107.09	
1	67	50	-0.30-1.22	-0.49	-1.02	-0.38	501.53	181.78	194.73	488.58	63.04	
1	67	51	-0.27-1.51	-0.29	-1.49	-0.16	491.36	-51.25	-40.67	480.78	75.02	
1	67	52	0.33-0.89	-0.38	-0.18	-0.60	601.89	190.69	194.80	597.78	40.94	
1	67	53	-9.14e-02	-0.81	-0.25	-0.65	-0.30	594.20	-41.80	-39.06	591.46	41.69
1	67	54	1.37-0.78	-0.24	0.82	-0.93	740.00	212.45	212.56	739.88	-7.76	
1	67	55	0.60-0.44	-0.21	0.38	-0.43	740.68	-28.43	-28.42	740.67	-2.81	
1	67	56	2.86-0.77-2.01e-02		2.11	-1.47	924.80	255.53	258.58	921.75	-45.07	
1	67	57	2.01-0.37	-0.16	1.79	-0.68	940.56	-5.80	-3.27	938.03	-48.88	
1	67	58	4.82-0.74	0.49	3.60	-2.30	1135.28	318.69	330.77	1123.19	-98.61	
1	67	59	4.26-0.24	7.37e-02	3.95	-1.15	1184.36	25.31	38.32	1171.36	-122.09	
1	67	60	7.050.34	2.39	5.00	-3.09	1348.11	404.54	444.80	1307.85	-190.70	
1	67	61	6.960.16	1.17	5.95	-2.42	1448.95	63.74	103.37	1409.32	-230.94	
1	67	62	9.927.60	7.61	9.91	-9.73e-02	1573.37	472.44	582.52	1463.29	-330.27	
1	67	63	10.51-7.18	8.44	-5.11	-5.69	1718.65	62.77	186.14	1595.28	-434.82	
1	67	64	35.737.89	17.47	26.15	13.23	1597.86	401.58	830.51	1168.92	-573.71	
1	67	65	22.33-46.37	21.16	-45.20	8.88	1941.17	23.58	187.26	1777.49	-535.79	
1	67	66	12.92-21.59	-8.68	7.92e-03	16.70	1286.60	-95.65	820.18	370.77	-653.58	
1	67	67	4.73e-02	-2.41	-0.84	-1.53	-1.18	584.65	-272.44	560.34	-248.13	-142.28
1	67	68	5.321.72	5.27	1.76	-0.39	645.66	-27.22	639.55	-21.11	-63.82	





EGP CODE

GRE.EEC.R.73.IT.W.15235.12.024.01

PAGE

395 di/of 527

1	67	69	-0.86-2.52	-1.99	-1.39	0.77	461.94	98.58	457.31	103.22	40.78	
1	67	70	-0.86-1.45	-1.45	-0.86	-3.43e-02	411.75	232.33	391.09	252.98	57.26	
1	67	71	-0.42-1.23	-0.88	-0.76	-0.40	416.78	312.67	344.22	385.22	47.85	
1	67	72	-8.94e-03	-1.08	-0.64	-0.45	-0.53	495.25	308.89	317.08	487.06	38.20
1	67	73	0.70-0.98	-0.41	0.13	-0.79	595.72	313.61	314.10	595.23	11.78	
1	67	74	1.69-0.97	-0.12	0.83	-1.24	734.65	335.07	335.18	734.55	-6.62	
1	67	75	2.89-0.97	0.33	1.59	-1.82	909.64	383.80	385.00	908.45	-25.04	
1	67	76	4.32-0.87	1.14	2.30	-2.53	1101.06	462.34	465.69	1097.70	-46.14	
1	67	77	5.66-0.19	2.49	2.97	-2.91	1265.50	574.14	585.51	1254.13	-87.93	
1	67	78	6.261.98	3.82	4.42	-2.12	1288.82	694.65	752.36	1231.11	-175.96	
1	67	79	2.51-3.77	-3.15	1.89	-1.88	1236.13	544.42	907.66	872.89	-345.41	
1	67	80	4.60-7.28	-6.01	3.32	-3.68	1219.25	196.00	1026.32	388.93	-400.25	
1	67	81	2.14-0.60	2.07	-0.52	0.44	585.55	-194.22	565.89	-174.57	-122.23	
1	67	82	1.33-0.99	0.86	-0.53	0.93	601.10	-1.25	583.28	16.57	-102.04	
1	67	83	0.18-1.08	-0.52	-0.38	0.63	535.11	145.12	523.17	157.06	-67.19	
1	67	84	-0.43-1.33	-1.32	-0.44	0.12	444.20	273.40	438.17	279.43	-31.51	
1	67	85	-0.14-1.17	-1.09	-0.22	-0.28	393.43	372.54	376.79	389.19	-8.40	
1	67	86	0.29-1.03	-0.73	-4.76e-03	-0.55	487.76	348.08	348.38	487.47	6.44	
1	67	87	0.91-0.99	-0.40	0.32	-0.88	593.37	346.52	346.52	593.37	0.74	
1	67	88	1.67-0.93	1.53e-02	0.72	-1.25	730.71	368.46	368.50	730.67	-3.70	
1	67	89	2.47-0.80	0.63	1.04	-1.62	905.14	412.00	412.02	905.12	-3.34	
1	67	90	3.34-0.69	1.49	1.16	-2.01	1090.93	478.36	478.37	1090.92	2.07	
1	67	91	3.88-0.54	2.21	1.12	-2.14	1208.25	566.28	566.44	1208.10	9.90	
1	67	92	2.81-0.43	1.48	0.90	-1.60	1126.01	711.45	711.48	1125.98	-3.18	
1	67	93	1.27-1.69	-1.57	1.15	-0.57	935.41	770.89	926.34	779.96	-37.55	
1	67	94	0.38-4.16	-4.15	0.37	-0.21	1099.69	324.10	1097.92	325.86	-36.97	
1	67	95	2.15-1.54	1.56	-0.95	1.36	410.83	-235.78	392.13	-217.08	-108.35	
1	67	96	1.54-1.46	0.98	-0.91	1.17	462.32	-61.73	421.11	-20.51	-141.07	
1	67	97	6.16e-02	-1.20	-0.40	-0.74	0.61	466.78	88.55	396.27	159.06	-147.30
1	67	98	-0.42-1.36	-1.34	-0.45	0.16	433.76	214.26	346.19	301.83	-107.49	
1	67	99	5.20e-02	-1.07	-1.03	7.80e-03	-0.22	441.00	291.57	321.73	410.84	-59.98
1	67	100	0.44-1.00	-0.75	0.18	-0.55	500.58	313.11	314.89	498.79	-18.21	
1	67	101	1.01-0.93	-0.40	0.48	-0.86	596.89	323.07	323.09	596.87	-2.51	
1	67	102	1.59-0.75	4.21e-02	0.80	-1.11	731.05	345.97	346.06	730.97	5.81	
1	67	103	2.06-0.42	0.63	1.01	-1.23	908.41	384.73	385.33	907.80	17.77	
1	67	104	2.373.79e-02	1.43	0.98	-1.14	1104.50	433.60	434.27	1103.83	21.19	
1	67	105	2.530.32	1.96	0.89	-0.97	1238.44	471.00	477.62	1231.82	70.97	
1	67	106	0.98-0.17	5.61e-02	0.75	-0.45	1169.47	494.99	528.39	1136.07	146.32	
1	67	107	1.68-2.99	-2.91	1.60	0.61	979.72	486.10	706.23	759.59	245.36	
1	67	108	1.14-6.33	-5.78	0.59	1.95	930.14	159.72	805.23	284.62	283.96	
1	67	109	4.04-6.50	1.87	-4.33	4.26	-2.51	-434.02	-10.41	-426.12	57.85	
1	67	110	4.801.10	4.77	1.12	0.30	220.49	-176.67	142.55	-98.73	-157.74	
1	67	111	-2.08-2.77	-2.74	-2.11	0.14	293.32	-64.57	98.29	130.46	-178.22	
1	67	112	0.21-0.86	-0.74	9.21e-02	0.34	397.74	117.68	182.84	332.58	-118.34	
1	67	113	-5.93e-02	-1.02	-0.96	-0.12	-0.23	472.60	196.87	224.76	444.71	-83.14
1	67	114	0.54-1.04	-0.72	0.22	-0.63	517.13	250.19	251.10	516.23	-15.52	
1	67	115	1.11-0.89	-0.42	0.64	-0.85	603.26	273.21	273.23	603.24	-2.71	
1	67	116	1.69-0.64	-5.42e-02	1.11	-1.01	732.72	299.49	299.65	732.56	8.23	
1	67	117	2.20-0.26	0.32	1.62	-1.04	909.22	333.17	333.24	909.16	6.13	
1	67	118	2.250.70	0.87	2.08	-0.49	1119.89	369.77	369.89	1119.76	9.64	
1	67	119	2.501.39	1.48	2.41	0.30	1322.65	375.38	378.92	1319.11	57.83	
1	67	120	3.540.92	0.93	3.54	-0.14	1326.55	281.13	321.15	1286.54	200.58	
1	67	121	2.39-13.61	-12.16	0.94	4.59	994.45	-116.48	144.36	733.61	470.89	
1	67	122	6.69-5.94	-1.16	1.91	6.12	721.87	-337.41	143.44	241.01	527.39	
1	67	123	21.10-1.11	14.54	5.45	-10.13	-302.13	-1291.84	-659.24	-934.72	475.30	
1	67	124	-10.45-25.84	-17.72	-18.57	-7.69	-328.45	-781.64	-593.17	-516.91	-223.36	
1	67	125	1.55-2.17	-1.03	0.42	-1.71	124.96	-217.39	-164.16	71.73	-124.06	
1	67	126	-0.42-1.73	-1.32	-0.83	0.61	389.80	39.21	49.26	379.75	-58.51	
1	67	127	-0.20-0.95	-0.79	-0.36	-0.30	472.48	138.58	144.91	466.14	-45.56	
1	67	128	0.57-1.04	-0.70	0.23	-0.66	526.80	189.46	189.67	526.59	-8.53	
1	67	129	1.26-0.88	-0.41	0.79	-0.89	605.94	221.21	221.21	605.94	-8.19e-02	
1	67	130	2.00-0.72	-0.18	1.46	-1.08	730.96	250.27	250.35	730.88	6.00	
1	67	131	2.84-0.60	-0.12	2.36	-1.19	906.52	279.67	279.68	906.51	2.28	
1	67	132	4.070.12	0.32	3.87	-0.86	1119.62	314.79	315.24	1119.17	-18.97	
1	67	133	5.31-0.48	-0.43	5.26	0.53	1334.03	311.94	312.05	1333.92	10.69	
1	67	134	10.822.50	2.68	10.65	-1.19	1656.51	247.80	249.90	1654.41	54.32	
1	67	135	20.35-2.85	6.06	11.44	-11.28	1443.99	-311.28	-194.75	1327.46	436.99	
1	67	136	34.56-18.19	28.84	-12.48	-16.40	50.20	-1367.03	-982.62	-334.21	630.10	
1	67	137	36.40-13.79	-13.70	36.31	-2.11	-716.35	-842.55	-782.10	-776.80	63.05	
1	67	138	5.401.28	2.62	4.06	1.93	209.24	-155.38	-155.10	208.96	10.08	
1	67	139	-0.69-1.83	-0.71	-1.82	0.14	364.64	19.78	21.09	363.34	-21.19	
1	67	140	0.20-0.64	-0.24	-0.20	-0.42	471.11	126.93	127.12	470.92	-8.16	
1	67	141	0.64-0.97	-0.57	0.24	-0.69	525.94	166.23	166.25	525.92	-2.55	
1	67	142	1.37-0.89	-0.37	0.85	-0.96	604.81	198.17	198.18	604.80	1.75	
1	67	143	2.15-0.83	-0.25	1.56	-1.18	729.69	227.86	227.90	729.65	4.56	
1	67	144	3.14-0.66	-0.10	2.58	-1.34	906.99	264.58	264.60	906.96	3.78	





EGP CODE

GRE.EEC.R.73.IT.W.15235.12.024.01

PAGE

396 di/of 527

1	67	145	4.45-0.46	2.76e-02	3.96	-1.47	1113.44	302.67	302.76	1113.35	-8.38	
1	67	146	8.370.52	0.69	8.20	-1.16	1362.12	350.46	350.80	1361.78	-18.58	
1	67	147	5.75-3.69	-2.89	4.95	-2.63	1680.88	273.82	275.86	1678.83	-53.58	
1	67	148	53.31-66.99	53.05	-66.73	5.57	2361.68	310.24	325.18	2346.73	-174.45	
1	67	149	13.85-14.72	-9.91	9.05	10.68	212.76	-1030.25	-43.40	-774.09	-502.78	
1	67	150	-2.96-15.08	-5.13	-12.92	4.65	-227.49	-691.81	-456.42	-462.88	232.14	
1	67	151	2.64-5.88	-1.57	-1.67	4.26	122.12	-206.43	-141.65	57.33	130.72	
1	67	152	-0.38-0.52	-0.48	-0.42	-5.80e-02	368.19	35.11	37.97	365.33	30.72	
1	67	153	-5.00e-02	-0.86	-0.66	-0.25	-0.35	457.04	112.13	112.33	456.84	8.22
1	67	154	0.76-0.88	-0.44	0.33	-0.72	521.40	153.66	153.69	521.37	3.29	
1	67	155	1.48-0.92	-0.33	0.89	-1.04	602.13	181.28	181.32	602.09	4.18	
1	67	156	2.30-0.92	-0.24	1.62	-1.31	725.38	208.86	208.90	725.34	4.40	
1	67	157	3.36-0.76-4.53e-02		2.64	-1.56	896.85	245.20	245.20	896.85	0.75	
1	67	158	5.00-0.72-1.28e-02		4.29	-1.89	1101.75	282.53	282.62	1101.66	-8.72	
1	67	159	7.22-1.57	-0.52	6.17	-2.85	1313.75	306.17	307.03	1312.89	-29.45	
1	67	160	7.970.63	1.20	7.40	-1.97	1627.22	269.38	279.97	1616.62	-119.48	
1	67	161	43.804.30	25.14	22.96	19.72	1633.01	12.73	183.83	1461.91	-497.95	
1	67	162	12.37-27.78	-12.15	-3.26	19.57	587.27	-650.09	-10.29	-52.53	-618.32	
1	67	163	-1.61-6.72	-5.22	-3.12	-2.33	190.80	-414.73	157.56	-381.48	-137.93	
1	67	164	9.383.51	9.33	3.56	-0.55	257.06	-89.51	244.99	-77.43	63.56	
1	67	165	-3.29e-02	-2.74	-1.09	-1.69	1.32	210.70	-26.28	66.20	118.22	115.60
1	67	166	0.54-0.56	-0.25	0.22	0.50	330.40	79.21	98.65	310.96	67.12	
1	67	167	0.18-0.61	-0.50	7.89e-02	-0.26	432.74	116.80	119.03	430.51	26.43	
1	67	168	0.83-0.81	-0.38	0.40	-0.72	507.77	137.46	137.81	507.42	11.38	
1	67	169	1.61-0.92	-0.21	0.89	-1.14	594.77	157.31	157.44	594.63	7.65	
1	67	170	2.43-0.99-7.51e-02		1.52	-1.51	720.78	183.15	183.19	720.74	4.77	
1	67	171	3.38-0.95	0.14	2.29	-1.88	890.40	218.17	218.17	890.39	-1.04	
1	67	172	4.52-0.93	0.42	3.18	-2.35	1087.97	262.56	262.69	1087.84	-10.37	
1	67	173	5.40-0.81	0.85	3.74	-2.75	1277.37	306.12	307.38	1276.11	-34.97	
1	67	174	6.311.86	2.32	5.84	-1.36	1297.96	305.77	330.72	1273.01	-155.36	
1	67	175	5.62-7.39	-6.74	4.98	-2.83	1023.18	124.63	351.50	796.30	-390.37	
1	67	176	7.05-11.20	-7.74	3.58	-7.15	820.85	-123.18	395.66	302.01	-469.68	
1	67	177	1.19-0.82	1.19	-0.82	7.52e-02	324.32	-213.37	323.42	-212.46	-22.07	
1	67	178	2.08-0.74	1.94	-0.59	0.62	324.66	-18.08	324.63	-18.05	-3.36	
1	67	179	1.58-0.95	1.32	-0.70	0.76	270.39	148.44	265.57	153.26	23.76	
1	67	180	0.35-0.66	0.28	-0.59	0.25	297.16	177.94	180.59	294.51	17.58	
1	67	181	0.34-0.57	-0.26	3.16e-02	-0.43	405.62	136.85	137.24	405.23	10.22	
1	67	182	0.96-0.91	-0.34	0.39	-0.86	493.13	127.71	127.90	492.95	8.16	
1	67	183	1.71-0.97-6.98e-02		0.81	-1.27	587.94	140.59	140.75	587.78	8.28	
1	67	184	2.47-1.01	0.17	1.30	-1.65	717.56	164.86	164.96	717.46	7.43	
1	67	185	3.25-0.88	0.58	1.79	-1.97	889.31	201.62	201.65	889.28	4.62	
1	67	186	3.94-0.82	0.96	2.16	-2.31	1078.51	247.92	247.92	1078.51	-1.03	
1	67	187	3.99-0.38	1.02	2.58	-2.04	1203.49	295.46	295.59	1203.36	-10.77	
1	67	188	3.53-0.95	-0.30	2.88	-1.58	1122.87	367.42	373.52	1116.77	-67.62	
1	67	189	3.88-3.00	-2.50	3.39	-1.77	832.26	481.07	555.42	757.90	-143.47	
1	67	190	2.53-3.82	-2.81	1.53	-2.32	745.62	232.20	684.09	293.74	-166.75	
1	67	191	0.89-1.87	0.31	-1.29	1.13	273.20	-207.31	270.30	-204.41	-37.23	
1	67	192	2.43-1.88	1.95	-1.40	1.36	317.19	-15.73	308.60	-7.15	-52.78	
1	67	193	1.51-1.53	1.43	-1.45	0.48	278.00	130.86	251.68	157.18	-56.39	
1	67	194	0.86-1.08	0.77	-1.00	-0.40	319.34	160.66	184.07	295.93	-56.28	
1	67	195	0.50-1.02	-0.31	-0.20	-0.76	408.36	116.87	122.40	402.83	-39.78	
1	67	196	1.15-1.04	-0.20	0.30	-1.07	491.54	114.85	114.86	491.52	2.12	
1	67	197	1.83-1.06	3.48e-02	0.74	-1.40	587.18	125.47	125.61	587.04	8.20	
1	67	198	2.52-1.04	0.30	1.18	-1.72	718.46	147.99	148.24	718.21	11.83	
1	67	199	3.06-0.94	0.50	1.62	-1.92	893.14	177.64	177.65	893.14	1.70	
1	67	200	3.72-0.50	1.11	2.11	-2.05	1085.82	223.04	223.05	1085.82	-1.12	
1	67	201	3.34-0.78	5.52e-02	2.50	-1.66	1201.61	245.81	246.33	1201.09	22.35	
1	67	202	3.00-1.00	-0.81	2.82	-0.84	1110.90	321.64	333.09	1099.44	94.41	
1	67	203	3.38-2.77	-2.77	3.38	-8.19e-02	801.39	439.71	512.78	728.33	145.21	
1	67	204	1.90-4.62	-4.27	1.56	1.45	672.29	235.41	631.75	275.95	126.75	
1	67	205	1.38-7.76	-0.90	-5.48	3.95	57.72	-355.13	46.63	-344.03	66.77	
1	67	206	6.29-1.01	5.86	-0.58	1.73	156.17	-88.08	149.22	-81.13	-40.61	
1	67	207	-1.09-3.34	-1.29	-3.14	-0.64	228.21	-43.95	49.45	134.82	-129.21	
1	67	208	0.35-1.43	-0.19	-0.89	-0.82	348.98	28.92	69.42	308.48	-106.41	
1	67	209	0.74-1.43	-0.45	-0.24	-1.08	445.01	57.51	76.41	426.11	-83.47	
1	67	210	1.29-1.27	-0.25	0.27	-1.25	510.01	83.90	90.44	503.47	-52.39	
1	67	211	1.95-1.14	6.78e-02	0.74	-1.51	592.06	109.61	109.80	591.87	-9.72	
1	67	212	2.62-1.05	0.33	1.23	-1.78	721.26	133.83	133.86	721.24	-3.86	
1	67	213	3.14-0.81	0.53	1.80	-1.87	899.59	160.02	161.08	898.54	-27.94	
1	67	214	3.74-0.41	0.75	2.58	-1.86	1105.68	191.66	192.14	1105.19	-20.95	
1	67	215	4.90-0.31	0.34	4.25	-1.71	1282.35	204.37	205.69	1281.04	37.64	
1	67	216	5.88-1.98	-1.96	5.86	-0.42	1244.78	165.60	197.91	1212.47	183.91	
1	67	217	3.88-10.39	-9.75	3.23	2.96	958.07	-22.95	177.28	757.84	395.39	
1	67	218	8.50-9.23	-5.78	5.05	7.02	672.90	-165.75	236.83	270.33	418.99	
1	67	219	14.61-5.17	8.74	0.70	-9.04	-87.87	-777.57	-285.84	-579.59	312.01	
1	67	220	-9.30-21.32	-12.19	-18.43	-5.14	-205.38	-580.76	-386.71	-399.44	-187.58	



EGP CODE

GRE.EEC.R.73.IT.W.15235.12.024.01

PAGE

397 di/of 527

1	67	221	-0.64-6.96	-4.09	-3.51	-3.15	100.16	-283.94	-215.98	32.21	-146.57	
1	67	222	0.35-1.65	-1.00	-0.30	-0.94	370.75	-67.96	-51.92	354.71	-82.34	
1	67	223	0.86-1.56	-0.66	-4.51e-02	-1.17	463.33	13.70	24.54	452.49	-68.98	
1	67	224	1.44-1.19-8.93e-02		0.34	-1.30	524.83	62.44	71.59	515.68	-64.41	
1	67	225	2.06-1.14	0.10	0.82	-1.56	596.86	98.91	99.02	596.75	7.31	
1	67	226	2.77-1.08	0.32	1.37	-1.85	723.40	123.98	125.15	722.23	-26.43	
1	67	227	3.32-0.80	0.49	2.03	-1.91	905.19	148.08	152.07	901.19	-54.83	
1	67	228	4.123.15e-02	1.29	2.86	-1.89	1120.41	185.07	186.54	1118.94	-37.01	
1	67	229	5.586.67e-02	1.35	4.30	-2.33	1341.26	175.98	176.05	1341.20	8.61	
1	67	230	19.150.45	3.89	15.70	-7.25	1592.52	122.85	134.48	1580.89	130.26	
1	67	231	25.10-6.05	-2.15	21.20	-10.30	1107.65	-406.98	-215.56	916.22	503.28	
1	67	232	19.17-21.45	17.03	-19.31	-9.08	269.45	-844.86	-482.20	-93.21	522.10	
1	67	233	-0.24-1.74	-1.72	-0.26	0.17	497.63	-118.56	495.84	-116.78	33.10	
1	67	234	33.19-2.78	-2.65	33.07	-2.11	-653.20	-916.93	-871.54	-698.59	99.55	
1	67	235	10.913.88	4.11	10.68	1.26	198.75	-234.39	-229.56	193.92	45.47	
1	67	236	0.77-0.89	-0.87	0.76	0.16	353.25	-87.48	-87.47	353.25	-1.47	
1	67	237	0.57-1.14	-0.80	0.23	-0.68	458.40	5.82	6.12	458.10	-11.58	
1	67	238	1.39-1.09	-0.14	0.44	-1.20	517.74	65.02	65.36	517.40	12.39	
1	67	239	2.13-1.08	0.15	0.90	-1.56	595.12	98.57	98.79	594.90	10.40	
1	67	240	2.92-1.13	0.32	1.48	-1.94	718.50	125.82	125.82	718.50	-2.10e-02	
1	67	241	3.55-0.90	0.47	2.18	-2.05	895.48	154.62	154.78	895.32	-10.83	
1	67	242	4.050.73	1.93	2.84	-1.59	1117.33	200.29	203.25	1114.37	-52.02	
1	67	243	3.901.42	3.36	1.96	-1.02	1369.93	221.09	223.05	1367.97	-47.44	
1	67	244	7.34-15.43	7.20	-15.29	-1.79	1671.56	121.38	126.93	1666.00	-92.63	
1	67	245	22.76-74.10	22.54	-73.89	4.57	2153.94	-337.94	-324.75	2140.74	-180.87	
1	67	246	1.11-0.81	-0.33	0.63	0.82	416.36	189.48	225.82	380.03	-83.21	
1	67	247	12.61-10.00	-6.02	8.63	8.61	269.98	-515.15	179.61	-424.78	-250.57	
1	67	248	-3.56-13.95	-4.34	-13.17	2.74	-12.47	-500.87	-173.86	-339.48	229.73	
1	67	249	0.80-9.52	-3.90	-4.82	5.14	154.80	-284.46	-136.89	7.24	207.47	
1	67	250	0.87-2.11	-1.28	4.65e-02	1.33	360.32	-46.79	-18.82	332.36	102.97	
1	67	251	0.25-0.99	-0.89	0.15	-0.33	443.32	31.48	39.35	435.45	56.40	
1	67	252	1.28-0.99	-0.16	0.45	-1.09	503.33	79.30	79.96	502.67	16.74	
1	67	253	2.11-1.09	0.13	0.89	-1.56	585.46	107.53	107.61	585.37	6.19	
1	67	254	3.04-1.19	0.37	1.48	-2.04	710.04	135.18	135.23	710.00	-5.32	
1	67	255	3.44-0.71	0.52	2.22	-1.89	884.48	168.29	168.49	884.29	-11.73	
1	67	256	3.400.44	0.69	3.14	-0.83	1093.59	206.90	207.29	1093.20	-18.57	
1	67	257	4.681.21	1.28	4.62	0.48	1313.75	242.94	247.42	1309.26	-69.14	
1	67	258	15.452.12	4.39	13.18	5.01	1576.63	230.03	263.87	1542.79	-210.77	
1	67	259	38.470.74	8.63	30.58	15.34	1327.41	-42.83	224.38	1060.20	-542.91	
1	67	260	6.48-15.75	-3.86	-5.42	11.09	804.50	-424.23	207.35	172.92	-614.12	
1	67	261	-0.50-6.14	-2.35	-4.29	-2.64	247.64	-310.30	242.44	-305.09	-53.63	
1	67	262	8.241.54	8.05	1.73	-1.12	341.65	-38.13	339.18	-35.67	30.49	
1	67	263	1.02-3.10	3.88e-03	-2.09	1.77	274.22	13.34	155.25	132.32	129.94	
1	67	264	0.62-1.68	-0.39	-0.67	1.14	326.84	71.20	116.14	281.90	97.30	
1	67	265	3.85e-02	-0.96	-0.85	-7.39e-02	-0.32	405.87	89.42	95.17	400.12	42.27
1	67	266	1.11-1.20	-0.42	0.33	-1.09	482.40	97.93	98.59	481.74	15.88	
1	67	267	2.14-1.10	0.23	0.81	-1.60	573.04	123.05	123.18	572.91	7.61	
1	67	268	3.02-1.36	0.29	1.37	-2.13	702.00	144.79	144.80	701.98	-2.97	
1	67	269	3.02-0.80	0.16	2.06	-1.66	873.58	175.60	175.67	873.51	-6.93	
1	67	270	3.25-0.13	0.10	3.02	-0.85	1070.86	229.23	229.30	1070.79	-7.82	
1	67	271	4.85-5.33e-026.09e-02		4.73	-0.74	1247.20	290.30	292.23	1245.28	-42.89	
1	67	272	7.95-0.88	-0.70	7.78	-1.23	1259.10	324.11	363.38	1219.83	-187.55	
1	67	273	6.47-8.87	-7.96	5.56	-3.63	1057.28	217.59	450.04	824.83	-375.71	
1	67	274	9.97-11.82	-7.46	5.61	-8.72	839.18	-40.98	476.04	322.16	-433.30	
1	67	275	2.36-1.18	2.33	-1.16	-0.29	397.54	-184.51	396.52	-183.50	-24.26	
1	67	276	2.09-1.28	2.08	-1.27	0.19	376.45	10.92	376.33	11.03	-6.59	
1	67	277	2.21-1.52	2.10	-1.41	0.64	316.22	155.60	314.55	157.26	16.27	
1	67	278	2.46-1.24	2.34	-1.13	0.65	290.50	226.42	239.78	277.14	26.03	
1	67	279	0.18-0.76	-0.18	-0.39	0.46	382.32	136.14	141.06	377.40	34.44	
1	67	280	0.37-0.56	-0.36	0.17	0.38	470.99	110.59	114.90	466.68	39.16	
1	67	281	0.690.22	0.22	0.69	-3.60e-02	569.47	128.73	132.27	565.94	39.32	
1	67	282	1.47-5.03e-02	0.18	1.24	-0.54	701.69	147.48	149.83	699.34	36.00	
1	67	283	2.01-0.41	-0.23	1.84	-0.63	874.28	173.84	174.97	873.14	28.19	
1	67	284	2.73-0.82	-0.56	2.47	-0.93	1060.77	224.37	224.61	1060.54	14.15	
1	67	285	3.62-1.23	-0.73	3.12	-1.47	1179.27	298.73	298.83	1179.17	-9.06	
1	67	286	4.03-2.14	-1.54	3.44	-1.82	1102.98	408.54	413.82	1097.71	-60.31	
1	67	287	4.26-3.68	-3.08	3.66	-2.09	816.24	541.43	611.39	746.27	-119.72	
1	67	288	2.81-4.83	-3.76	1.74	-2.65	800.68	253.11	756.79	296.99	-148.67	
1	67	289	1.68-1.80	1.35	-1.47	1.02	344.11	-193.48	343.84	-193.22	11.88	
1	67	290	2.35-2.13	2.04	-1.82	1.13	353.66	-0.24	353.15	0.27	-13.43	
1	67	291	2.32-2.06	2.21	-1.95	0.69	312.52	128.27	293.39	147.40	-56.21	
1	67	292	2.65-1.61	2.55	-1.51	0.64	321.10	187.63	233.42	275.31	-63.37	
1	67	293	0.95-1.74	-0.18	-0.62	1.33	386.45	128.81	136.63	378.63	-44.20	
1	67	294	1.64-2.00	-0.38	1.97e-02	1.81	469.97	112.88	113.87	468.99	-18.71	
1	67	295	1.96-1.09	0.25	0.63	1.51	569.19	131.27	131.63	568.83	-12.56	
1	67	296	1.89-0.49	0.17	1.22	1.06	704.47	147.92	147.97	704.42	-5.42	



EGP CODE

GRE.EEC.R.73.IT.W.15235.12.024.01

PAGE

398 di/of 527

1	67	297	2.04-0.48	-0.28	1.84	0.67	882.95	168.72	168.84	882.83	-9.26	
1	67	298	2.48-0.67	-0.67	2.48	-8.98e-02	1075.82	206.65	206.90	1075.57	14.78	
1	67	299	2.96-1.13	-1.06	2.90	-0.52	1194.17	262.32	264.56	1191.93	45.64	
1	67	300	3.05-1.68	-1.64	3.01	-0.42	1122.05	344.76	367.06	1099.75	129.76	
1	67	301	3.43-3.49	-3.49	3.42	-0.12	876.17	423.17	560.07	739.27	208.03	
1	67	302	1.77-5.64	-5.41	1.54	1.27	794.86	184.03	688.87	290.02	231.32	
1	67	303	3.10-7.88	1.06	-5.83	4.27	176.48	-343.61	167.51	-334.65	67.71	
1	67	304	6.36-1.78	5.81	-1.23	2.05	220.07	-90.86	217.96	-88.75	-25.54	
1	67	305	-1.18-3.87	-1.35	-3.70	-0.65	245.84	-40.13	97.17	108.54	-142.87	
1	67	306	-0.56-1.63	-0.79	-1.39	0.44	325.14	36.63	84.92	276.85	-107.71	
1	67	307	1.40-1.65	0.43	-0.67	1.42	413.76	99.16	110.02	402.89	-57.44	
1	67	308	1.61-1.70-6.51e-02	-2.82e-02	1.65	489.16	101.08	103.60	486.64	-31.17		
1	67	309	1.88-0.95	0.28	0.65	1.41	581.02	121.69	122.29	580.42	-16.59	
1	67	310	1.78-0.13	0.32	1.33	0.80	714.57	142.27	142.31	714.53	-4.83	
1	67	311	2.16-0.49	-0.45	2.12	0.32	897.13	152.91	153.05	896.99	10.18	
1	67	312	3.12-5.60e-02-1.74e-02	3.08	-0.35	1110.36	194.56	194.79	1110.13	14.47		
1	67	313	4.97-0.35	-0.26	4.89	-0.67	1298.03	215.42	221.02	1292.43	77.67	
1	67	314	6.33-2.93	-2.90	6.30	0.53	1288.17	156.42	213.08	1231.51	246.81	
1	67	315	3.49-8.65	-7.95	2.80	2.82	1070.54	-4.51	263.32	802.71	464.97	
1	67	316	7.91-10.63	-7.88	5.16	6.59	802.39	-171.64	331.15	299.60	486.76	
1	67	317	13.30-6.26	6.46	0.58	-9.32	0.23	-675.85	-156.29	-519.33	285.17	
1	67	318	-11.78-22.94-14.66	-20.07	-4.88	-160.79	-558.36	-309.75	-409.39	-192.44		
1	67	319	-2.57-7.73	-6.04	-4.26	-2.42	86.97	-319.84	-211.29	-21.58	-179.93	
1	67	320	-0.94-2.29	-2.29	-0.94	-3.72e-02	345.68	-84.08	-60.00	321.60	-98.84	
1	67	321	0.40-0.66	0.27	-0.53	0.34	445.27	45.55	54.61	436.22	-59.47	
1	67	322	0.60-0.30	0.23	7.05e-02	0.44	509.11	84.96	87.07	507.00	-29.82	
1	67	323	0.790.24	0.27	0.76	0.14	594.71	109.16	110.12	593.76	-21.48	
1	67	324	1.780.19	0.45	1.52	-0.60	727.82	134.69	137.50	725.00	-40.76	
1	67	325	2.77-0.37-1.22e-02	2.41	-1.00	911.97	151.52	152.42	911.08	-26.02		
1	67	326	4.150.28	0.88	3.55	-1.40	1141.87	189.85	190.06	1141.66	-14.13	
1	67	327	6.251.83	2.77	5.30	-1.81	1386.10	214.45	216.45	1384.10	48.37	
1	67	328	19.842.61	5.53	16.92	-6.46	1647.28	145.37	174.33	1618.31	206.55	
1	67	329	28.51-2.06	1.25	25.20	-9.51	1190.27	-407.38	-133.06	915.96	602.51	
1	67	330	17.61-21.46	15.36	-19.20	-9.11	515.58	-848.54	-334.15	1.19	661.13	
1	67	331	-6.82-9.77	-9.42	-7.18	0.96	50.51	-256.92	42.89	-249.29	47.82	
1	67	332	37.65-5.54	-5.54	37.65	7.48e-02	-823.32	-1002.38	-963.25	-862.45	73.99	
1	67	333	11.842.90	3.29	11.45	1.83	146.26	-262.14	-260.30	144.42	27.33	
1	67	334	0.47-2.28	-2.19	0.38	0.49	331.31	-120.19	-120.14	331.26	4.81	
1	67	335	9.46e-02	-0.82	-0.70	-2.29e-02	-0.31	448.96	9.06	9.15	448.88	-6.05
1	67	336	1.01-0.55	0.17	0.29	-0.78	515.89	75.10	75.16	515.82	5.28	
1	67	337	1.86-0.75	0.23	0.88	-1.26	599.53	102.71	102.76	599.48	5.02	
1	67	338	2.81-0.82	0.40	1.60	-1.71	729.44	134.12	134.12	729.44	0.92	
1	67	339	3.39-1.05	-0.13	2.47	-1.80	915.25	149.01	149.03	915.23	-3.84	
1	67	340	4.541.65	2.89	3.30	-1.43	1150.65	224.38	226.36	1148.66	-42.86	
1	67	341	5.012.42	4.88	2.55	-0.56	1429.00	250.49	250.85	1428.65	-20.39	
1	67	342	7.87-16.00	7.74	-15.87	1.75	1780.32	127.56	129.97	1777.91	-63.12	
1	67	343	27.30-81.28	26.40	-80.38	9.81	2400.05	-294.85	-291.97	2397.17	-88.09	
1	67	344	24.050.24	0.43	23.86	2.09	79.81	-637.21	-623.75	66.35	97.33	
1	67	345	43.6417.97	25.23	36.38	11.56	303.89	-722.79	-722.71	303.81	9.27	
1	67	346	6.29e-02	-5.38	-1.91	-3.41	2.62	105.69	-270.85	96.64	-261.80	-57.67
1	67	347	-1.54-6.15	-6.15	-1.54	0.12	194.34	-158.48	180.80	-144.94	-67.78	
1	67	348	-3.32-9.71	-9.49	-3.54	1.16	78.38	-155.41	78.04	-155.07	-8.84	
1	67	349	7.85-2.19	-0.13	5.80	4.05	-201.16	-502.40	-335.72	-367.84	149.76	
1	67	350	24.561.51	1.85	24.22	-2.81	265.87	-295.67	-263.47	233.67	130.56	
1	67	351	29.3819.45	21.10	27.72	3.70	-16.03	-417.90	-408.45	-25.47	-60.87	
1	67	352	-1.23-5.07	-3.15	-3.15	1.92	341.96	-148.24	341.86	-148.15	6.76	
1	67	353	-0.48-3.67	-3.30	-0.84	-1.02	498.19	-105.62	497.15	-104.57	-25.08	
1	67	354	-0.13-2.07	-1.99	-0.21	-0.38	588.71	-101.50	587.14	-99.93	32.89	
1	67	355	-8.58e-02	-1.88	-1.88	-8.88e-02	7.34e-02	581.58	-119.12	575.24	-112.77	66.36
1	67	356	-0.15-3.07	-2.72	-0.50	0.95	485.29	-149.98	461.77	-126.46	119.95	
1	67	357	13.93-13.75	-9.03	9.21	10.41	247.46	-782.44	60.86	-595.84	-396.69	
1	67	358	-4.35-17.58	-5.98	-15.95	4.36	-151.26	-667.01	-320.79	-497.48	242.27	
1	67	359	0.99-12.39	-5.94	-5.47	6.68	82.95	-367.50	-233.77	-50.79	205.81	
1	67	360	1.12-2.12	-1.16	0.16	1.48	339.12	-54.15	-38.06	323.04	77.88	
1	67	361	9.00e-02	-0.74	-0.74	8.89e-02	3.00e-02	439.61	29.95	35.87	433.69	48.89
1	67	362	1.07-0.50	0.21	0.36	-0.78	507.79	86.79	87.06	507.52	10.70	
1	67	363	1.93-0.80	0.26	0.87	-1.33	595.88	110.69	110.69	595.88	-0.41	
1	67	364	2.69-0.74	0.42	1.54	-1.62	727.20	139.14	139.22	727.13	-6.67	
1	67	365	3.46-0.57	0.52	2.36	-1.79	912.56	169.83	170.32	912.07	-19.04	
1	67	366	3.660.29	0.64	3.31	-1.03	1138.16	202.66	203.23	1137.59	-23.16	
1	67	367	4.851.27	1.34	4.77	0.52	1382.48	227.47	230.07	1379.89	-54.72	
1	67	368	17.611.82	4.97	14.46	6.31	1732.99	218.10	240.78	1710.30	-183.99	
1	67	369	45.940.82	12.74	34.02	19.90	1544.52	-90.87	149.56	1304.08	-579.13	
1	67	370	10.46-20.20	-2.88	-6.87	15.20	762.38	-601.00	38.64	122.75	-680.39	
1	67	371	-1.42-8.58	-5.04	-4.96	-3.58	209.48	-385.91	189.29	-365.72	-107.76	
1	67	372	10.211.94	9.93	2.22	-1.50	320.78	-91.51	317.90	-88.63	34.34	



EGP CODE

GRE.EEC.R.73.IT.W.15235.12.024.01

PAGE

399 di/of 527

1	67	373	0.34-4.09	-0.97	-2.79	2.02	225.98	-45.29	91.66	89.04	135.63
1	67	374	2.55-1.51	1.72	-0.68	1.64	317.41	83.28	133.56	267.14	96.14
1	67	375	0.61-0.31	0.35	-5.93e-02	0.41	408.18	100.51	108.33	400.35	48.44
1	67	376	0.52-0.45	-0.25	0.33	-0.39	490.44	97.72	98.72	489.44	19.79
1	67	377	1.66-0.50	0.37	0.79	-1.06	586.85	125.80	125.82	586.83	3.36
1	67	378	2.58-0.72	0.50	1.36	-1.59	723.21	149.39	149.51	723.10	-8.20
1	67	379	3.23-0.53	0.61	2.09	-1.73	904.43	182.32	182.54	904.21	-12.48
1	67	380	3.59-0.82	-0.40	3.18	-1.28	1116.99	209.25	209.67	1116.58	-19.48
1	67	381	5.25-0.72	-0.63	5.17	-0.70	1320.96	260.42	262.32	1319.06	-44.86
1	67	382	9.02-2.48	-2.43	8.97	-0.71	1352.07	254.27	293.47	1312.87	-203.71
1	67	383	8.55-10.87	-9.73	7.42	-4.56	1131.41	96.48	355.11	872.78	-448.08
1	67	384	13.67-11.41	-4.74	7.00	-11.08	921.18	-139.69	430.12	351.37	-528.98
1	67	385	4.40-1.35	4.29	-1.25	-0.78	446.13	-204.67	445.38	-203.92	-22.06
1	67	386	2.78-1.31	2.77	-1.30	-0.21	376.87	-20.65	376.84	-20.62	3.55
1	67	387	2.77-1.49	2.63	-1.35	0.75	313.71	124.15	305.82	132.04	37.87
1	67	388	3.28-1.39	3.00	-1.11	1.10	291.52	208.72	236.73	263.51	39.18
1	67	389	2.69-0.53	2.45	-0.30	0.83	380.97	178.34	183.37	375.95	31.52
1	67	390	0.63-0.59	-0.17	0.21	0.58	474.12	112.04	112.87	473.29	17.37
1	67	391	0.680.32	0.32	0.68	-6.61e-03	580.72	131.39	131.95	580.16	15.91
1	67	392	1.540.20	0.59	1.16	-0.61	721.91	148.26	148.55	721.62	12.92
1	67	393	2.07-0.40-2.24e-02	1.70	-0.89	0.93	903.65	176.05	176.11	903.58	6.74
1	67	394	2.75-1.88	-1.49	2.36	-1.28	1099.62	203.95	203.95	1099.62	-1.05
1	67	395	3.67-2.44	-1.99	3.22	-1.60	1228.28	275.97	276.76	1227.49	-27.52
1	67	396	4.31-3.28	-2.75	3.77	-1.94	1158.72	376.73	388.26	1147.19	-94.26
1	67	397	5.37-5.13	-4.21	4.45	-2.97	882.50	470.48	565.19	787.80	-173.35
1	67	398	3.97-6.53	-4.63	2.07	-4.04	783.50	223.50	691.65	315.36	-207.37
1	67	399	3.91-1.07	3.88	-1.04	0.37	421.97	-194.51	421.63	-194.17	-14.47
1	67	400	3.15-1.19	3.06	-1.11	0.59	387.88	-4.68	385.55	-2.35	-30.16
1	67	401	2.90-1.55	2.84	-1.50	0.51	321.82	127.61	309.86	139.57	-46.70
1	67	402	3.02-1.18	2.91	-1.08	0.64	295.44	200.88	227.35	268.96	-42.45
1	67	403	1.95-0.95	1.47	-0.47	1.08	373.55	158.20	158.26	373.49	-3.51
1	67	404	1.31-1.32	-0.14	0.14	1.31	471.82	108.44	108.45	471.82	0.32
1	67	405	1.42-0.45	0.33	0.64	0.92	581.46	127.79	127.89	581.35	-6.79
1	67	406	1.350.36	0.61	1.10	0.42	725.74	136.65	136.65	725.74	-1.18
1	67	407	1.520.74	0.77	1.49	0.15	913.02	180.83	182.20	911.64	31.67
1	67	408	1.94-0.33	-0.25	1.86	-0.41	1106.07	210.36	210.96	1105.47	23.19
1	67	409	2.38-2.44	-2.22	2.17	-0.99	1213.61	249.68	252.37	1210.92	50.86
1	67	410	2.58-3.33	-3.13	2.39	-1.06	1117.94	343.84	356.23	1105.55	97.14
1	67	411	1.74-4.63	-4.56	1.67	-0.64	814.81	471.99	538.60	748.21	135.64
1	67	412	0.78-5.92	-5.92	0.77	-0.14	730.71	262.66	679.28	314.09	146.37
1	67	413	4.40-2.10	3.88	-1.58	1.76	244.04	-274.04	243.65	-273.65	-14.30
1	67	414	2.82-2.08	2.49	-1.75	1.23	221.65	-109.87	211.98	-100.20	-55.80
1	67	415	2.52-1.74	2.48	-1.70	0.40	267.57	10.17	175.77	101.97	-123.30
1	67	416	0.15-1.48-2.48e-02	-1.31	0.50	0.50	316.65	44.72	94.34	267.03	-105.03
1	67	417	2.80-0.70	2.48	-0.38	1.01	407.04	122.10	135.53	393.60	-60.39
1	67	418	1.74-0.73	0.90	0.11	1.17	490.01	106.45	108.89	487.57	-30.53
1	67	419	1.41-0.33	0.34	0.74	0.85	590.89	112.88	113.36	590.42	-15.02
1	67	420	1.531.28e-02	0.18	1.36	0.48	732.80	121.13	121.20	732.72	-6.78
1	67	421	2.02-0.25-9.16e-02	1.86	0.57	0.57	924.34	142.51	142.52	924.34	1.92
1	67	422	2.360.69	0.94	2.10	0.60	1143.92	186.52	187.10	1143.34	23.64
1	67	423	2.491.29	1.29	2.49	7.68e-03	1303.63	206.01	213.49	1296.16	90.29
1	67	424	2.69-3.72	-3.72	2.69	-0.11	1255.62	118.84	174.56	1199.90	245.44
1	67	425	4.21-5.36	-5.14	3.99	1.45	1033.95	72.89	302.95	803.90	410.09
1	67	426	3.09-7.89	-6.69	1.89	3.43	774.74	-119.35	359.49	295.90	445.91
1	67	427	2.71-9.42	-0.22	-6.49	5.19	-90.91	-708.86	-228.59	-571.18	257.15
1	67	428	6.491.19	6.47	1.21	0.32	-22.20	-275.74	-76.36	-221.58	-103.91
1	67	429	-3.43-3.96	-3.70	-3.68	-0.26	108.52	-269.15	-188.45	27.81	-154.81
1	67	430	0.30-0.76	-0.15	-0.31	0.53	318.11	-85.06	-55.57	288.62	-104.97
1	67	431	2.36-0.78	2.12	-0.55	0.83	433.93	58.74	65.43	427.23	-49.66
1	67	432	1.04-0.35	0.58	0.11	0.65	507.76	73.07	73.93	506.90	-19.29
1	67	433	0.990.20	0.23	0.96	0.16	597.94	93.56	93.76	597.74	-9.97
1	67	434	1.91-3.41e-02-2.37e-02	1.90	0.14	0.14	735.61	112.06	112.24	735.42	-10.66
1	67	435	3.00-0.39	-0.29	2.90	0.58	928.04	124.54	124.70	927.88	-11.09
1	67	436	3.98-0.80	-0.55	3.73	1.07	1174.25	127.04	127.11	1174.17	-8.82
1	67	437	4.480.81	1.34	3.95	1.30	1438.97	125.58	126.26	1438.30	29.80
1	67	438	6.281.97	2.18	6.06	-0.94	1489.47	-17.16	17.78	1454.53	226.76
1	67	439	5.49-18.90	-17.26	3.85	6.10	1054.37	-611.86	-346.11	788.63	610.06
1	67	440	13.75-7.42	2.83	3.51	10.58	736.87	-843.37	-378.78	272.28	719.94
1	67	441	25.82-5.29	13.00	7.53	-15.31	-342.77	-2034.98	-1100.20	-1277.55	841.45
1	67	442	-11.10-36.92-24.54	-23.48	-12.90	-730.36	-1141.91	-1000.91	-871.37	-195.32	-195.32
1	67	443	2.57-4.57	-2.28	0.28	-3.33	-32.46	-478.47	-456.86	-54.07	-95.76
1	67	444	2.48-1.77	2.30	-1.59	0.86	339.78	-82.87	-82.15	339.06	-17.47
1	67	445	1.71-1.00	1.64	-0.93	0.42	444.67	13.36	13.40	444.63	4.08
1	67	446	0.898.60e-02	0.88	9.49e-02	-8.41e-02	513.46	60.76	60.76	513.46	0.61
1	67	447	1.46-0.27	4.50e-02	1.15	-0.67	595.86	80.42	80.82	595.46	-14.43
1	67	448	2.52-0.65	-0.54	2.41	-0.58	726.06	99.49	99.90	725.66	-15.97





EGP CODE

GRE.EEC.R.73.IT.W.15235.12.024.01

PAGE

400 di/of 527

1	67	449	4.01-1.32	-1.31	4.01	-0.18	918.46	107.54	109.73	916.27	-42.07	
1	67	450	6.37-2.17	-2.16	6.36	0.31	1166.29	100.69	103.04	1163.94	-49.99	
1	67	451	8.41-4.24	-3.86	8.03	2.16	1448.94	45.94	48.94	1445.93	-64.90	
1	67	452	12.325.02	5.19	12.15	-1.10	1969.89	28.40	28.95	1969.33	-32.81	
1	67	453	36.28-2.39	19.26	14.63	-19.20	1997.00	-585.57	-507.30	1918.74	442.73	
1	67	454	48.40-25.42	36.88	-13.90	-26.79	16.01	-2236.55	-1780.36	-440.18	905.25	
1	67	455	49.35-22.00	-21.58	48.93	-5.46	-1093.44	-1365.66	-1208.94	-1250.16	134.54	
1	67	456	5.253.33	3.72	4.86	0.77	134.15	-385.88	-380.74	129.01	51.45	
1	67	457	-0.13-3.06	-0.19	-3.00	0.39	313.49	-155.33	-152.13	310.29	38.60	
1	67	458	1.48-0.79	1.47	-0.78	-0.13	449.90	2.20	4.67	447.43	33.12	
1	67	459	1.09-0.27	0.77	4.88e-02	-0.58	510.31	55.49	56.92	508.88	25.42	
1	67	460	1.73-0.42	0.13	1.18	-0.94	590.42	84.34	84.39	590.37	4.94	
1	67	461	2.78-0.90	-0.60	2.49	-0.99	718.70	104.46	104.58	718.58	-8.33	
1	67	462	4.39-1.50	-1.35	4.24	-0.93	911.22	121.64	123.54	909.32	-38.67	
1	67	463	6.50-2.10	-2.03	6.43	-0.79	1149.39	129.17	132.79	1145.77	-60.64	
1	67	464	12.751.31	1.32	12.75	-0.20	1485.95	203.45	212.29	1477.12	-106.10	
1	67	465	8.21-4.37	-4.24	8.08	-1.29	2005.32	52.28	62.80	1994.80	-142.93	
1	67	466	83.34-94.46	83.27	-94.39	3.60	3193.72	309.95	354.86	3148.81	-357.08	
1	67	467	19.42-18.59	-10.91	11.75	15.26	248.43	-1209.11	-82.77	-877.90	-610.78	
1	67	468	-11.03-25.48	-13.48	-23.03	5.42	-402.83	-1059.75	-724.77	-737.81	328.39	
1	67	469	1.55-8.36	-3.26	-3.54	4.95	44.32	-495.28	-356.61	-94.35	235.79	
1	67	470	2.28-1.63	2.26	-1.62	-0.24	351.90	-86.36	-54.69	320.23	113.47	
1	67	471	1.49-0.89	1.46	-0.86	-0.25	446.54	16.95	30.47	433.02	74.98	
1	67	472	1.23-0.32	0.75	0.16	-0.71	505.04	64.83	69.49	500.38	45.03	
1	67	473	1.91-0.75-4.31e-02		1.20	-1.18	580.85	88.79	89.35	580.30	16.56	
1	67	474	3.01-1.17	-0.66	2.50	-1.37	705.92	110.20	110.22	705.89	-3.74	
1	67	475	4.68-1.85	-1.42	4.25	-1.63	892.36	126.19	128.44	890.11	-41.46	
1	67	476	7.39-2.79	-2.37	6.98	-2.01	1132.40	132.49	137.51	1127.39	-70.62	
1	67	477	11.08-4.11	-3.33	10.30	-3.35	1425.42	120.55	134.05	1411.92	-132.06	
1	67	478	15.742.37	2.88	15.22	-2.57	1945.49	85.85	129.24	1902.10	-280.72	
1	67	479	60.1812.70	37.32	35.56	23.72	2060.01	-297.23	14.20	1748.59	-798.20	
1	67	480	21.05-30.33	-0.33	-8.95	25.33	765.91	-1287.41	-497.73	-23.77	-998.94	
1	67	481	-1.50-11.46	-7.40	-5.56	-4.89	149.20	-511.90	107.53	-470.24	-160.65	
1	67	482	11.083.39	10.62	3.85	-1.83	221.54	-183.72	195.04	-157.22	100.18	
1	67	483	-1.14-3.13	-1.29	-2.99	0.52	211.60	-206.14	-26.44	31.90	206.83	
1	67	484	-0.32-0.40	-0.39	-0.34	-3.59e-02	339.81	-71.40	13.96	254.45	166.78	
1	67	485	1.95-0.40	1.91	-0.37	-0.28	431.09	64.79	102.22	393.67	110.94	
1	67	486	1.55-0.32	1.01	0.22	-0.85	482.97	97.16	108.64	471.49	65.56	
1	67	487	2.19-1.07 8.55e-02		1.03	-1.56	556.75	107.11	109.26	554.60	31.01	
1	67	488	3.17-1.31	-0.19	2.04	-1.94	677.62	133.63	133.65	677.60	3.65	
1	67	489	4.40-2.43	-1.34	3.32	-2.49	852.32	143.11	144.25	851.18	-28.40	
1	67	490	6.15-3.46	-2.11	4.79	-3.34	1079.88	161.12	167.93	1073.06	-78.83	
1	67	491	8.51-1.36	1.26	5.89	-4.36	1349.25	232.05	256.76	1324.53	-164.32	
1	67	492	10.121.89	3.63	8.39	-3.36	1504.29	122.05	242.48	1383.85	-389.82	
1	67	493	6.29-9.13	-7.39	4.55	-4.88	1365.63	-341.12	134.39	890.12	-765.16	
1	67	494	8.97-9.58	-4.46	3.84	-8.30	1134.38	-678.82	107.71	347.84	-898.61	
1	67	495	3.77-0.97	3.54	-0.73	-1.02	395.77	-214.00	395.77	-214.00	-0.70	
1	67	496	3.71-0.92	3.56	-0.76	-0.84	364.22	-40.59	361.36	-37.74	33.89	
1	67	497	3.93-0.59	3.91	-0.57	-0.29	356.15	67.84	301.81	122.18	112.75	
1	67	498	0.39-0.70	0.35	-0.66	-0.20	341.59	87.57	177.00	252.16	121.32	
1	67	499	0.45-0.46	0.10	-0.11	-0.44	394.84	102.55	139.37	358.02	96.98	
1	67	500	1.39-0.46	0.75	0.18	-0.88	450.18	130.44	141.06	439.55	57.31	
1	67	501	2.14-1.12	0.35	0.67	-1.62	528.77	139.80	141.23	527.33	23.59	
1	67	502	2.96-1.69 2.25e-02		1.25	-2.24	648.44	148.06	148.26	648.24	10.00	
1	67	503	4.05-1.68	0.55	1.82	-2.79	811.77	203.19	203.76	811.20	-18.58	
1	67	504	4.99-1.97	0.83	2.18	-3.41	1007.30	259.37	265.23	1001.45	-65.92	
1	67	505	6.33-1.01	2.92	2.40	-3.66	1181.94	334.47	368.78	1147.64	-167.02	
1	67	506	3.83-4.57	-2.93	2.19	-3.33	1234.93	214.81	355.71	1094.03	-351.97	
1	67	507	4.28-5.34	-4.31	3.25	-2.98	1188.31	63.48	496.29	755.51	-547.27	
1	67	508	2.81-6.44	-4.90	1.27	-3.44	1085.13	-185.16	612.05	287.93	-614.12	
1	67	509	2.89-0.27	2.86	-0.25	-0.29	479.31	-136.69	478.28	-135.65	-25.23	
1	67	510	3.39-0.33	3.37	-0.31	-0.27	480.89	65.34	480.50	65.73	-12.67	
1	67	511	3.66-0.53	3.65	-0.52	-0.21	406.51	181.59	403.42	184.68	26.17	
1	67	512	3.39-0.44	3.37	-0.42	-0.26	344.91	237.80	307.65	275.06	51.01	
1	67	513	2.72-0.32	2.66	-0.25	-0.44	366.56	213.73	232.31	347.98	49.94	
1	67	514	0.91-0.48	0.42	4.51e-03	-0.66	426.23	165.00	170.65	420.58	38.00	
1	67	515	1.86-0.94	0.62	0.29	-1.39	511.05	160.77	162.43	509.39	24.06	
1	67	516	2.90-1.46	0.92	0.52	-2.17	628.49	169.01	169.37	628.13	12.83	
1	67	517	3.19-1.84	0.70	0.65	-2.51	779.09	208.58	208.59	779.08	-2.55	
1	67	518	5.13-1.05	3.46	0.63	-2.75	934.53	356.30	358.12	932.71	-32.39	
1	67	519	1.95-4.27	-2.73	0.41	-2.69	1032.90	325.21	340.08	1018.02	-101.51	
1	67	520	1.25-4.61	-3.59	0.23	-2.22	1004.36	400.61	467.21	937.77	-189.13	
1	67	521	0.26-5.29	-4.68	-0.35	-1.74	937.34	370.83	673.18	635.00	-282.61	
1	67	522	1.21e-02	-6.05	-5.79	-0.25	-1.23	977.05	118.39	836.42	259.02	-317.77
1	67	523	2.28-0.19	2.25	-0.17	0.25	492.50	-118.27	486.10	-111.87	-62.21	
1	67	524	2.95-0.16	2.89	-9.79e-02	0.44	501.91	93.36	494.10	101.16	-55.93	





EGP CODE

GRE.EEC.R.73.IT.W.15235.12.024.01

PAGE

401 di/of 527

1	67	525	3.15-0.54	3.11	-0.50	0.37	429.50	206.71	423.34	212.87	-36.53
1	67	526	3.10-0.58	3.10	-0.58	9.55e-02	323.19	288.68	319.29	292.57	-10.92
1	67	527	2.67-0.46	2.63	-0.42	-0.35	355.98	233.92	234.71	355.19	-9.79
1	67	528	0.49-0.70-6.97e-04		-0.21	-0.58	420.69	176.50	176.51	420.68	1.48
1	67	529	1.52-0.99	0.50	1.83e-02	-1.23	507.37	160.59	160.75	507.21	7.43
1	67	530	2.79-1.28	1.39	0.13	-1.93	624.68	174.60	175.01	624.28	13.53
1	67	531	2.55-1.61	0.81	0.14	-2.05	768.28	194.00	194.56	767.72	17.94
1	67	532	2.26-1.36	0.87	2.88e-02	-1.76	903.73	313.45	313.79	903.40	14.01
1	67	533	0.24-3.27	-2.74	-0.28	-1.25	965.73	349.83	350.78	964.78	24.06
1	67	534	-0.45-4.02	-3.84	-0.62	-0.77	877.69	489.65	489.90	877.43	9.98
1	67	535	-0.65-5.38	-5.37	-0.66	-0.24	711.61	596.53	711.39	596.75	-5.03
1	67	536	-0.42-6.44	-6.44	-0.42	1.98e-02	878.58	239.36	878.35	239.59	-12.16
1	67	537	2.37-0.74	2.15	-0.52	0.80	447.02	-140.31	435.89	-129.18	-80.09
1	67	538	2.52-1.02	2.08	-0.58	1.17	446.58	63.33	427.31	82.60	-83.74
1	67	539	2.68-1.23	2.44	-0.98	0.94	408.03	163.78	361.20	210.61	-96.15
1	67	540	2.85-1.01	2.77	-0.93	0.55	379.78	197.90	274.40	303.27	-89.79
1	67	541	2.58-0.67	2.55	-0.63	0.33	394.84	184.27	206.68	372.43	-64.93
1	67	542	0.69-0.39	0.60	-0.29	0.31	445.73	147.40	154.53	438.60	-45.57
1	67	543	0.44-7.54e-02	0.38	-9.87e-03	-0.17	525.30	139.15	141.72	522.73	-31.38
1	67	544	1.18-0.28	0.74	0.16	-0.67	638.73	146.86	146.88	638.71	-3.12
1	67	545	1.30-0.20	0.83	0.27	-0.70	786.48	185.00	186.11	785.37	25.79
1	67	546	0.40-1.73	-1.66	0.33	-0.38	935.31	211.86	218.73	928.44	70.15
1	67	547	0.40-2.59	-2.59	0.40	5.90e-02	1024.40	263.87	291.86	996.42	143.18
1	67	548	0.58-4.00	-3.95	0.53	0.48	983.67	330.16	412.36	901.48	216.70
1	67	549	0.49-6.01	-5.78	0.26	1.20	889.63	322.50	610.64	601.49	283.53
1	67	550	0.27-7.15	-6.88	1.87e-03	1.39	895.88	92.96	754.37	234.48	305.94
1	67	551	2.87-2.14	2.16	-1.43	1.75	301.32	-219.35	281.30	-199.33	-100.11
1	67	552	2.10-2.46	1.26	-1.62	1.77	303.65	-50.61	250.51	2.54	-126.50
1	67	553	1.96-1.98	1.79	-1.80	0.82	358.22	26.14	207.33	177.03	-165.34
1	67	554	2.82-1.59	2.75	-1.53	0.52	402.47	84.24	176.32	310.38	-144.31
1	67	555	2.70-0.92	2.44	-0.67	0.92	434.50	114.49	146.84	402.16	-96.46
1	67	556	1.60-0.72	1.09	-0.20	0.96	478.07	107.63	114.91	470.79	-51.42
1	67	557	0.95-0.35	0.39	0.21	0.65	551.04	113.03	113.88	550.19	-19.23
1	67	558	0.87-0.33-2.83e-02	0.56	0.56	0.52	666.28	112.95	113.39	665.84	15.76
1	67	559	1.11-1.00	-0.84	0.95	0.56	826.83	125.37	128.99	823.22	50.25
1	67	560	1.56-1.70	-1.60	1.45	0.57	1010.63	135.28	147.76	998.16	103.75
1	67	561	2.15-2.52	-2.45	2.08	0.57	1150.07	128.79	171.35	1107.51	204.09
1	67	562	2.89-3.99	-3.84	2.74	1.00	1160.41	75.35	223.16	1012.60	372.21
1	67	563	4.66-6.65	-6.16	4.18	2.28	1049.18	-37.55	354.95	656.67	522.00
1	67	564	3.45-9.15	-7.57	1.87	4.17	902.45	-261.92	418.64	221.89	573.82
1	67	565	0.77-11.56	-2.88	-7.91	5.63	-138.61	-447.31	-144.94	-440.98	43.75
1	67	566	7.614.82e-02	7.22	0.44	1.68	93.20	-203.23	4.22	-114.24	-135.87
1	67	567	-1.98-4.41	-2.29	-4.10	-0.81	270.77	-258.70	-123.01	135.08	-231.16
1	67	568	3.00-1.13	3.00	-1.13	-7.99e-02	401.33	-41.35	26.62	333.36	-159.60
1	67	569	2.55-0.70	2.28	-0.43	0.90	464.44	48.02	64.69	447.77	-81.63
1	67	570	1.29-0.37	0.83	8.47e-02	0.74	512.33	64.63	68.51	508.46	-41.45
1	67	571	0.95-7.07e-02	0.28	0.60	0.49	580.29	80.79	81.23	579.85	-14.82
1	67	572	1.41-0.46	-0.23	1.18	0.62	695.12	91.39	91.61	694.91	11.35
1	67	573	2.06-1.15	-0.99	1.90	0.71	864.97	88.76	91.00	862.72	41.70
1	67	574	3.02-1.83	-1.77	2.96	0.54	1081.25	73.60	80.95	1073.91	85.70
1	67	575	5.21-2.65	-2.64	5.20	-0.19	1305.63	17.37	40.48	1282.53	170.96
1	67	576	8.17-4.67	-4.67	8.17	4.91e-02	1352.87	-151.60	-40.04	1241.31	394.20
1	67	577	6.87-15.36	-14.12	5.63	5.11	1102.35	-573.51	-188.90	717.74	704.72
1	67	578	12.90-11.11	-4.45	6.24	10.75	795.28	-801.94	-218.16	211.50	769.18
1	67	579	17.91-6.83	9.73	1.35	-11.64	-337.20	-1202.11	-698.32	-840.98	426.53
1	67	580	-11.67-27.87-15.39		-24.15	-6.81	-375.20	-975.42	-769.74	-580.87	-284.86
1	67	581	0.86-10.79	-5.79	-4.13	-5.77	97.07	-546.75	-466.71	17.04	-212.42
1	67	582	0.47-0.27	0.17	3.21e-02	-0.37	410.83	-170.95	-158.14	398.03	-85.36
1	67	583	2.45-0.30	2.05	9.64e-02	0.97	489.20	-5.21	-3.19	487.18	-31.54
1	67	584	1.62-1.00e-01	1.09	0.43	0.79	535.65	41.98	42.35	535.28	-13.47
1	67	585	1.28-0.25	2.46e-02	1.00	0.59	600.02	57.65	57.77	599.89	-8.16
1	67	586	1.94-0.62	-0.44	1.77	0.65	712.56	75.14	75.16	712.53	4.09
1	67	587	2.84-1.28	-1.17	2.73	0.67	887.47	73.35	73.41	887.41	6.99
1	67	588	3.88-1.93	-1.93	3.88	0.10	1118.00	45.69	45.91	1117.78	15.15
1	67	589	6.110.17	0.69	5.60	-1.67	1377.36	21.40	23.78	1374.98	56.79
1	67	590	23.920.39	4.57	19.74	-9.00	1777.34	-123.84	-102.13	1755.63	202.00
1	67	591	34.33-7.624.36e-02		26.66	-16.21	1345.53	-916.74	-674.20	1103.00	699.89
1	67	592	29.85-27.62	26.57	-24.34	-13.33	128.19	-1624.58	-1183.28	-313.11	760.76
1	67	593	37.93-3.22	-2.71	37.42	-4.56	-824.96	-1276.34	-1249.61	-851.70	106.55
1	67	594	12.925.54	5.59	12.88	0.60	233.13	-421.88	-419.66	230.91	38.07
1	67	595	1.05-2.04	-1.97	0.98	0.44	397.78	-237.52	-235.59	395.85	35.01
1	67	596	2.223.20e-02	1.87	0.38	0.80	499.99	-19.02	-17.20	498.17	30.69
1	67	597	1.100.39	0.87	0.62	0.33	546.35	31.84	35.55	542.65	43.49
1	67	598	1.23-0.15	-0.14	1.23	9.98e-02	605.67	55.15	57.08	603.74	32.52
1	67	599	2.08-0.57	-0.56	2.08	5.96e-02	716.33	75.86	77.18	715.02	29.02
1	67	600	3.18-1.26	-1.25	3.18	0.14	889.18	78.17	78.40	888.95	13.53



EGP CODE

GRE.EEC.R.73.IT.W.15235.12.024.01

PAGE

402 di/of 527

1	67	601	4.35-1.90	-1.90	4.35	-0.19	1120.57	51.87	51.93	1120.50	-8.35
1	67	602	4.892.05	2.98	3.95	-1.33	1420.40	70.11	70.73	1419.78	-28.99
1	67	603	11.26-17.64	9.77	-16.15	-6.38	1831.38	-105.94	-100.48	1825.93	-102.62
1	67	604	34.23-91.86	34.20	-91.83	-2.03	2485.97	-777.12	-756.67	2465.52	-257.48
1	67	605	-7.57-11.06	-10.05	-8.58	1.58	199.99	-314.63	158.98	-273.62	139.37
1	67	606	33.033.71	3.71	33.03	5.38e-02	9.52	-875.32	-759.81	-106.00	298.11
1	67	607	13.18-21.32	-16.16	8.02	12.30	504.75	93.20	495.27	102.68	61.72
1	67	608	12.52-9.83	-8.36	11.05	5.54	497.60	-432.82	389.76	-324.98	-297.83
1	67	609	3.49-5.30	1.02	-2.82	-3.95	134.22	-247.56	-2.51	-110.83	183.05
1	67	610	-0.79-9.33	-5.57	-4.55	4.24	111.81	-206.39	-171.08	76.50	99.95
1	67	611	2.56-0.30-5.93e-02		2.31	0.80	333.76	-63.24	-62.33	332.85	18.97
1	67	612	2.74-0.11-1.98e-02		2.65	0.50	406.87	-39.14	-38.87	406.60	-11.10
1	67	613	3.282.60e-028.13e-02		3.23	0.42	445.09	-24.11	-23.18	444.16	-20.84
1	67	614	4.125.68e-029.46e-02		4.09	0.39	493.36	-18.76	-16.89	491.49	-30.89
1	67	615	5.310.11	0.14	5.29	0.37	581.78	-18.92	-15.54	578.41	-44.92
1	67	616	6.820.15	0.17	6.80	0.32	716.95	-21.63	-18.41	713.72	-48.69
1	67	617	8.470.12	0.13	8.47	0.18	896.50	-24.20	-21.57	893.86	-49.22
1	67	618	9.22-0.84	-0.83	9.20	-0.36	1102.32	-28.49	-27.90	1101.73	-25.85
1	67	619	13.85-9.26	-3.03	7.62	10.25	170.45	-490.29	85.10	-404.94	-221.61
1	67	620	-7.94-16.95	-8.37	-16.52	1.93	-39.73	-601.55	-287.89	-353.39	279.00
1	67	621	-1.51-9.09	-5.57	-5.03	3.78	174.77	-435.80	-268.65	7.61	272.24
1	67	622	0.41-2.62	-2.17	-4.14e-02	1.08	417.86	-169.25	-115.74	364.35	168.98
1	67	623	1.010.15	0.98	0.17	0.15	491.87	2.31	24.81	469.36	102.52
1	67	624	1.18-0.19	0.38	0.61	-0.68	528.77	52.24	58.65	522.35	54.92
1	67	625	2.02-0.93	-0.14	1.23	-1.31	587.90	77.20	78.12	586.98	21.61
1	67	626	2.81-1.27	-0.54	2.08	-1.56	695.35	97.80	97.81	695.34	-2.03
1	67	627	3.75-1.74	-1.20	3.21	-1.64	862.36	104.98	106.97	860.38	-38.70
1	67	628	5.12-2.25	-1.83	4.69	-1.72	1079.32	98.94	103.87	1074.38	-69.38
1	67	629	7.022.02	2.26	6.78	-1.07	1340.56	134.03	156.75	1317.84	-164.02
1	67	630	18.874.39	6.17	17.09	4.75	1662.46	25.51	111.81	1576.16	-365.82
1	67	631	42.953.92	10.73	36.15	14.81	1399.19	-457.25	-30.51	972.45	-781.09
1	67	632	8.14-16.89	2.37	-11.12	10.54	868.47	-886.08	-127.79	110.19	-869.17
1	67	633	-0.42-8.67	-2.83	-6.26	-3.75	197.63	-317.80	195.45	-315.62	-33.46
1	67	634	7.720.60	6.93	1.39	-2.23	304.71	-19.53	297.63	-12.45	47.42
1	67	635	0.37-2.91	-0.26	-2.28	1.29	336.19	-49.05	111.27	175.87	189.90
1	67	636	0.69-0.87	0.48	-0.67	0.53	404.77	20.65	106.11	319.31	159.77
1	67	637	1.34-0.33	1.07	-5.11e-02	-0.62	461.16	83.98	116.79	428.35	106.29
1	67	638	1.94-1.01	0.55	0.39	-1.47	499.93	102.91	111.47	491.37	57.67
1	67	639	2.84-1.85	5.21e-02	0.94	-2.30	562.36	111.04	113.34	560.06	32.14
1	67	640	3.46-2.18	-0.34	1.62	-2.65	666.24	128.12	128.15	666.22	3.39
1	67	641	4.18-2.65	-0.96	2.49	-2.95	820.11	145.26	146.85	818.52	-32.74
1	67	642	5.14-3.10	-1.60	3.64	-3.18	1015.91	165.07	174.45	1006.54	-88.80
1	67	643	6.55-1.79	-0.83	5.59	-2.66	1216.99	200.55	232.42	1185.12	-177.14
1	67	644	9.33-2.49	-1.81	8.65	-2.75	1308.83	116.84	259.70	1165.97	-387.14
1	67	645	5.84-9.76	-8.63	4.71	-4.04	1228.83	-159.37	294.98	774.48	-651.38
1	67	646	9.22-14.11	-10.07	5.18	-8.83	971.44	-452.68	255.11	263.66	-712.05
1	67	647	1.77-1.29	1.41	-0.94	-0.98	447.96	-136.81	447.90	-136.76	-5.52
1	67	648	1.60-1.52	1.25	-1.17	-0.99	406.58	85.71	405.83	86.46	15.54
1	67	649	2.14-1.12	2.08	-1.06	-0.46	370.30	200.93	337.64	233.58	66.82
1	67	650	2.75-0.96	2.68	-0.89	-0.48	388.49	215.42	270.41	333.50	80.58
1	67	651	1.06-0.90	0.45	-0.29	-0.91	427.43	153.54	175.80	405.17	74.84
1	67	652	1.78-1.35	0.30	0.13	-1.56	472.47	148.09	155.38	465.18	48.09
1	67	653	2.71-1.99	0.17	0.56	-2.34	536.88	143.74	144.86	535.76	20.97
1	67	654	3.28-2.42	-0.14	1.00	-2.79	638.68	151.09	151.27	638.50	9.38
1	67	655	3.63-2.94	-0.77	1.46	-3.09	778.62	180.18	180.84	777.96	-19.79
1	67	656	3.98-3.43	-1.39	1.94	-3.31	938.63	224.57	230.91	932.28	-67.00
1	67	657	4.17-3.49	-1.71	2.39	-3.24	1063.58	280.07	312.18	1031.47	-155.31
1	67	658	3.89-4.01	-2.53	2.40	-3.09	1094.22	294.82	430.18	958.86	-299.81
1	67	659	4.26-5.50	-4.38	3.14	-3.11	1046.53	180.27	590.64	636.16	-432.53
1	67	660	3.01-6.74	-5.17	1.43	-3.59	1017.36	-68.15	716.90	232.31	-485.67
1	67	661	0.78-0.51	0.71	-0.45	-0.29	518.63	-92.45	512.77	-86.59	-59.56
1	67	662	1.29-0.55	1.24	-0.50	-0.28	494.39	142.35	489.23	147.51	-42.30
1	67	663	1.92-0.85	1.91	-0.84	-0.16	411.73	277.06	411.73	277.06	0.24
1	67	664	2.31-0.76	2.30	-0.74	-0.19	366.36	303.08	315.05	354.39	24.78
1	67	665	0.60-0.52	0.53	-0.44	-0.29	416.23	210.60	220.70	406.12	44.45
1	67	666	0.81-1.25	-0.36	-8.85e-02	-1.02	462.67	162.17	169.08	455.76	45.03
1	67	667	2.41-1.96	0.22	0.24	-2.18	524.39	159.36	160.13	523.61	16.77
1	67	668	3.03-2.52	2.06e-02	0.49	-2.77	622.96	160.19	160.70	622.44	15.38
1	67	669	2.77-2.74	-0.62	0.65	-2.68	751.32	189.42	190.21	750.53	21.04
1	67	670	2.23-2.78	-1.25	0.70	-2.31	877.61	262.60	262.98	877.23	-15.19
1	67	671	1.75-3.16	-2.00	0.59	-2.09	942.29	354.85	358.03	939.11	-43.10
1	67	672	1.29-3.79	-2.93	0.44	-1.90	885.19	469.12	502.18	852.13	-112.53
1	67	673	0.56-5.12	-4.58	2.10e-02	-1.67	834.24	446.72	711.71	569.25	-180.19
1	67	674	0.15-6.17	-5.94	-8.25e-02	-1.18	920.50	159.17	859.05	220.63	-207.39
1	67	675	0.12-0.62	-0.11	-0.39	0.34	481.19	-80.08	481.15	-80.04	-4.87
1	67	676	1.05-0.83	0.69	-0.47	0.73	467.20	159.59	466.02	160.78	-19.07



EGP CODE

GRE.EEC.R.73.IT.W.15235.12.024.01

PAGE

403 di/of 527

1	67	677	1.77-1.15	1.45	-0.83	0.91	412.48	281.02	398.20	295.30	-40.92	
1	67	678	2.08-1.17	1.72	-0.81	1.02	405.67	269.80	300.78	374.69	-57.01	
1	67	679	1.26-1.26	0.52	-0.52	1.15	437.18	201.80	217.00	421.99	-57.84	
1	67	680	0.52-0.96	-0.26	-0.18	0.74	476.20	155.45	165.98	465.67	-57.14	
1	67	681	0.39-3.18e-02	0.25	0.11	-0.20	535.95	149.00	156.50	528.45	-53.33	
1	67	682	0.87-0.52	4.41e-02	0.31	-0.68	627.03	152.53	155.96	623.60	-40.18	
1	67	683	0.62-0.80	-0.58	0.40	-0.51	747.91	181.94	182.42	747.44	-16.42	
1	67	684	0.36-1.23	-1.21	0.35	-0.14	868.20	248.03	248.72	867.50	20.75	
1	67	685	0.20-1.96	-1.96	0.20	-6.65e-02	927.79	326.46	333.14	921.11	63.03	
1	67	686	8.79e-02	-3.18	-3.17	7.68e-02	-0.19	874.13	427.36	472.07	829.42	134.08
1	67	687	-0.20-5.18	-5.18	-0.20	8.51e-03	809.31	418.53	681.49	546.35	183.33	
1	67	688	-0.15-6.48	-6.47	-0.16	0.28	886.61	147.46	827.92	206.14	199.83	
1	67	689	0.16-1.62	-0.58	-0.88	0.88	378.36	-139.84	355.86	-117.34	-105.61	
1	67	690	0.99-1.99	5.23e-02	-1.06	1.39	391.50	79.38	342.56	128.31	-113.48	
1	67	691	1.51-1.67	1.07	-1.23	1.10	411.24	166.94	287.12	291.06	-122.13	
1	67	692	2.12-1.47	1.72	-1.06	1.14	438.01	183.97	229.51	392.47	-97.44	
1	67	693	1.60-1.70	0.37	-0.47	1.60	461.77	142.88	155.76	448.89	-62.79	
1	67	694	1.68-1.78	6.96e-03	-0.11	1.73	494.67	133.20	136.96	490.91	-36.66	
1	67	695	1.67-1.32	0.13	0.22	1.50	549.57	133.01	134.60	547.98	-25.67	
1	67	696	1.58-1.15	-7.63e-02	0.51	1.33	640.94	139.74	139.91	640.77	9.22	
1	67	697	1.56-1.46	-0.67	0.77	1.33	772.30	159.98	163.14	769.14	43.91	
1	67	698	1.58-1.82	-1.26	1.02	1.26	918.05	185.03	197.64	905.44	95.30	
1	67	699	1.51-2.31	-1.91	1.12	1.16	1016.65	207.64	247.19	977.10	174.44	
1	67	700	1.34-3.17	-2.99	1.15	0.89	1005.06	214.83	337.88	882.00	286.53	
1	67	701	2.10-5.57	-5.48	2.02	0.80	912.62	152.50	502.38	562.74	378.86	
1	67	702	1.26-7.94	-7.48	0.79	2.01	857.97	-65.15	605.23	187.60	411.62	
1	67	703	0.93-7.40	-0.76	-5.71	3.35	91.88	-289.59	71.20	-268.90	-86.38	
1	67	704	4.36-0.59	3.87	-0.10	1.47	254.87	-61.28	133.38	60.20	-153.78	
1	67	705	-0.88-2.65	-1.15	-2.38	-0.63	408.50	-73.33	46.95	288.22	-208.53	
1	67	706	8.32e-02	-0.71	-3.12e-02	-0.60	0.28	477.67	8.82	66.57	419.92	-154.08
1	67	707	1.61-1.15	0.66	-0.21	1.31	505.27	79.12	93.31	491.08	-76.46	
1	67	708	1.63-1.10	0.40	0.13	1.36	530.99	93.61	99.04	525.56	-48.43	
1	67	709	1.48-0.97	-1.21e-02	0.52	1.20	575.49	103.15	103.71	574.94	-16.20	
1	67	710	1.75-1.09	-0.30	0.97	1.27	666.54	115.80	116.03	666.31	11.23	
1	67	711	2.11-1.46	-0.87	1.52	1.33	806.54	121.99	125.32	803.21	47.59	
1	67	712	2.71-1.88	-1.46	2.29	1.33	979.54	122.57	134.85	967.25	101.87	
1	67	713	3.96-2.32	-2.22	3.86	0.76	1136.12	95.72	130.59	1101.25	187.25	
1	67	714	5.33-3.63	-3.44	5.13	1.30	1146.84	-2.82	119.40	1024.63	354.35	
1	67	715	2.45-8.63	-8.26	2.08	1.99	967.80	-236.21	122.79	608.80	550.78	
1	67	716	5.43-11.93	-10.09	3.60	5.33	727.06	-423.41	145.77	157.88	575.20	
1	67	717	12.83-5.87	9.50	-2.54	-7.16	-260.53	-494.42	-302.59	-452.36	89.83	
1	67	718	-10.36-17.25	-11.56	-16.06	-2.61	29.67	-635.28	-418.10	-187.51	-311.85	
1	67	719	-0.64-5.31	-4.05	-1.90	-2.07	309.58	-349.82	-263.79	223.55	-222.10	
1	67	720	0.22-0.89	-0.89	0.22	4.12e-02	508.46	-116.33	-89.17	481.30	-127.41	
1	67	721	1.11-1.07	-0.21	0.24	1.07	541.00	2.58	7.05	536.52	-48.87	
1	67	722	1.48-0.91	8.59e-02	0.49	1.18	558.56	56.88	58.13	557.30	-25.07	
1	67	723	1.53-0.85	-0.19	0.88	1.06	599.73	78.09	78.44	599.39	-13.38	
1	67	724	1.96-1.06	-0.55	1.44	1.14	689.41	93.35	93.41	689.35	6.16	
1	67	725	2.56-1.45	-1.09	2.21	1.13	835.11	95.26	96.26	834.11	27.25	
1	67	726	3.37-1.72	-1.66	3.31	0.58	1024.89	75.87	79.45	1021.31	58.18	
1	67	727	5.22-0.41	-0.26	5.07	-0.91	1224.17	43.32	54.52	1212.96	114.47	
1	67	728	17.170.28	2.50	14.94	-5.71	1419.56	-86.62	-30.33	1363.27	285.68	
1	67	729	21.96-6.38	-4.17	19.76	-7.59	962.17	-727.00	-407.01	642.19	661.90	
1	67	730	16.35-21.85	15.55	-21.05	-5.47	275.55	-1062.18	-617.84	-168.78	630.05	
1	67	731	14.72-1.26	-0.84	14.30	2.55	1325.76	-58.42	-58.32	1325.67	11.42	
1	67	732	24.803.11	3.15	24.75	-0.98	-424.62	-1046.45	-1042.10	-428.96	51.78	
1	67	733	10.455.00	5.18	10.27	0.96	402.88	-342.15	-340.24	400.98	37.59	
1	67	734	1.59-1.52	-1.32	1.40	0.75	503.28	-169.39	-168.56	502.46	23.55	
1	67	735	1.34-0.29	0.27	0.78	0.77	558.33	-12.65	-12.57	558.25	6.77	
1	67	736	1.26-0.50	-2.83e-02	0.79	0.78	574.60	39.12	41.44	572.28	35.14	
1	67	737	1.54-0.77	-0.34	1.12	0.89	611.33	67.17	68.69	609.81	28.77	
1	67	738	2.02-1.02	-0.69	1.68	0.95	699.56	83.83	85.08	698.31	27.72	
1	67	739	2.63-1.36	-1.22	2.49	0.75	844.92	86.39	86.70	844.61	15.37	
1	67	740	3.40-1.70	-1.70	3.40	2.72e-02	1038.13	63.05	63.15	1038.03	9.77	
1	67	741	3.341.22	1.36	3.20	-0.54	1267.06	44.51	44.83	1266.74	-19.74	
1	67	742	6.98-10.58	6.91	-10.51	1.13	1542.57	-140.74	-137.51	1539.35	-73.59	
1	67	743	28.49-69.45	27.68	-68.63	8.89	1865.40	-825.46	-821.39	1861.33	-104.60	
1	67	744	65.0217.24	39.92	42.33	23.86	783.12	259.72	297.44	745.40	135.36	
1	67	745	-3.17-17.79	-7.39	-13.56	6.63	-21.18	-301.71	-301.31	-21.57	10.50	
1	67	746	36.7014.05	16.74	34.01	7.33	-82.51	-656.46	-325.88	-413.08	283.65	
1	67	747	16.24-6.22	7.23	2.79	-11.01	275.89	-817.33	-10.92	-530.51	480.93	
1	67	748	24.82-3.76	18.18	2.88	-12.07	-20.53	-283.73	-193.20	-111.06	-125.03	
1	67	749	-17.46-33.37	-25.97	-24.86	-7.94	-63.96	-604.64	-110.04	-558.56	-150.97	
1	67	750	-1.45-17.17	-6.63	-11.99	-7.39	-127.31	-256.31	-128.41	-255.20	11.88	
1	67	751	-0.35-2.47	-0.54	-2.29	-0.59	266.37	-57.15	-28.48	237.69	91.95	
1	67	752	-8.74e-02	-2.11	-9.73e-02	-2.10	-0.14	418.03	-22.20	-6.44	402.27	81.80



EGP CODE

GRE.EEC.R.73.IT.W.15235.12.024.01

PAGE

404 di/of 527

1	67	753	-0.18-1.96	-0.20	-1.95	-0.16	522.55	-1.47	6.87	514.21	65.59
1	67	754	-0.21-1.40	-0.22	-1.39	-0.15	631.38	10.07	13.36	628.09	45.12
1	67	755	-0.21-0.61	-0.25	-0.58	-0.11	782.71	18.54	18.83	782.42	14.84
1	67	756	0.38-0.33	-0.32	0.37	-8.23e-02	991.61	25.49	25.80	991.29	-17.51
1	67	757	10.30-9.02	-5.39	6.67	7.55	-32.62	-633.88	-130.67	-535.83	-222.12
1	67	758	-3.23-12.14	-3.30	-12.07	0.78	6.87	-655.12	-432.47	-215.78	312.76
1	67	759	1.82-8.90	-3.78	-3.31	5.35	307.15	-374.70	-282.90	215.35	232.74
1	67	760	2.07-1.11	-0.10	1.07	1.48	518.06	-97.12	-72.53	493.47	120.51
1	67	761	1.046.70e-03	0.29	0.76	0.46	553.69	9.86	20.45	543.10	75.14
1	67	762	0.79-1.51e-033.22e-03	0.78	-6.10e-02	569.76	52.90	59.49	563.17	57.98	
1	67	763	1.07-0.34	-0.34	1.07	2.70e-03	612.53	71.55	80.89	603.20	70.46
1	67	764	1.58-0.69	-0.68	1.58	-3.77e-02	696.25	91.31	96.60	690.96	56.31
1	67	765	2.40-1.28	-1.22	2.34	-0.47	833.82	104.29	104.51	833.59	12.89
1	67	766	3.31-1.79	-1.76	3.29	-0.34	1016.49	95.81	96.67	1015.63	-28.22
1	67	767	4.72-0.18	-0.18	4.72	3.59e-02	1218.46	81.72	90.94	1209.24	-101.99
1	67	768	13.070.42	1.82	11.67	3.97	1483.75	-55.60	-2.93	1431.08	-279.83
1	67	769	38.21-1.72	8.40	28.09	17.37	1274.98	-474.19	-170.82	971.61	-662.28
1	67	770	6.61-17.35	-2.59	-8.15	11.65	435.69	-814.10	-287.89	-90.52	-617.05
1	67	771	-2.85-7.13	-5.42	-4.56	-2.10	125.23	-286.11	124.19	-285.08	20.63
1	67	772	7.483.63	7.17	3.94	-1.04	303.47	7.22	223.78	86.90	131.36
1	67	773	0.18-2.04	-0.60	-1.27	1.06	408.79	-62.14	43.43	303.23	196.39
1	67	774	1.69-1.10	0.52	7.41e-02	1.38	491.84	25.43	78.65	438.63	148.28
1	67	775	0.99-0.68-8.47e-02	0.40	0.80	0.80	530.73	61.61	83.24	509.11	98.37
1	67	776	0.66-0.23	-0.13	0.56	0.29	551.23	84.85	95.00	541.08	68.04
1	67	777	0.86-0.30	-0.27	0.82	0.20	591.03	102.22	106.79	586.46	47.06
1	67	778	1.28-0.61	-0.56	1.23	-0.30	674.41	119.17	120.33	673.26	25.29
1	67	779	2.32-1.60	-1.10	1.81	-1.31	805.33	136.01	136.06	805.28	-5.80
1	67	780	3.22-2.12	-1.63	2.74	-1.54	971.83	152.34	156.59	967.58	-58.84
1	67	781	4.64-2.48	-2.21	4.37	-1.36	1140.38	151.86	173.41	1118.83	-144.36
1	67	782	7.93-2.72	-2.50	7.71	-1.53	1199.67	84.69	193.82	1090.54	-331.31
1	67	783	7.33-9.10	-8.34	6.57	-3.45	1036.58	-150.09	223.64	662.85	-551.20
1	67	784	9.65-12.79	-8.03	4.89	-9.18	807.26	-442.14	173.57	191.55	-624.63
1	67	785	1.64-0.66	1.63	-0.65	-0.17	452.40	-113.00	446.59	-107.20	57.00
1	67	786	1.25-0.32	1.21	-0.28	-0.23	400.75	132.24	382.30	150.70	67.93
1	67	787	1.49-0.51	1.44	-0.46	0.31	418.92	216.57	310.11	325.37	100.89
1	67	788	1.67-1.10	1.07	-0.51	1.14	469.83	184.37	229.21	424.99	103.87
1	67	789	1.65-1.19	0.50	-3.72e-02	1.39	505.84	145.09	171.07	479.86	93.26
1	67	790	1.38-1.42	-0.25	0.22	1.38	532.15	122.87	137.87	517.15	76.92
1	67	791	1.41-1.11	-0.17	0.46	1.22	580.45	122.58	135.25	567.78	75.13
1	67	792	0.98-0.50	-0.25	0.74	0.55	660.00	141.36	147.60	653.75	56.55
1	67	793	1.14-0.64	-0.57	1.07	-0.34	776.44	178.07	178.08	776.43	2.47
1	67	794	2.09-2.07	-1.47	1.49	-1.46	915.32	213.65	215.94	913.02	-40.09
1	67	795	3.04-2.95	-1.97	2.05	-2.22	1022.03	259.44	284.03	997.44	-134.70
1	67	796	3.48-4.11	-3.15	2.51	-2.52	1017.69	283.27	386.46	914.51	-255.22
1	67	797	4.63-5.04	-3.84	3.43	-3.19	944.17	208.81	559.05	593.93	-367.26
1	67	798	3.51-6.38	-4.31	1.44	-4.02	900.06	-41.70	656.71	201.65	-412.26
1	67	799	0.34-0.42	0.33	-0.42	-2.97e-02	531.51	-63.52	529.05	-61.05	-38.23
1	67	800	0.65-0.37	0.65	-0.37	-1.21e-02	486.07	196.10	482.27	199.90	-32.97
1	67	801	1.14-0.74	0.99	-0.59	0.51	399.33	347.04	398.50	347.86	6.51
1	67	802	1.66-1.25	0.95	-0.55	1.25	437.67	292.98	300.63	430.01	32.39
1	67	803	1.73-1.54	0.51	-0.32	1.58	479.09	216.40	223.19	472.30	41.70
1	67	804	1.42-1.94	-0.46	-6.23e-02	1.67	510.60	160.45	164.34	506.71	36.68
1	67	805	1.35-1.25-5.58e-02	0.15	1.29	1.29	561.00	153.11	155.46	558.65	30.87
1	67	806	0.87-0.69	-0.15	0.32	0.74	645.19	161.33	162.73	643.80	25.94
1	67	807	0.68-0.33-8.54e-02	0.44	0.43	0.43	761.19	201.35	202.07	760.47	20.10
1	67	808	0.66-0.35	-0.21	0.51	-0.35	877.81	271.38	271.38	877.81	0.83
1	67	809	1.12-2.71	-2.13	0.54	-1.37	932.02	334.68	336.90	929.79	-36.37
1	67	810	1.31-4.01	-3.24	0.54	-1.87	855.89	455.84	478.06	833.66	-91.63
1	67	811	0.95-5.03	-4.30	0.23	-1.96	781.02	451.51	687.32	545.21	-148.65
1	67	812	0.39-5.77	-5.37	-3.53e-03	-1.52	867.70	160.58	824.12	204.16	-170.05
1	67	813	-0.13-0.85	-0.67	-0.31	0.32	493.86	-58.91	493.47	-58.52	-14.73
1	67	814	0.40-0.74	0.14	-0.48	0.48	464.65	201.08	462.16	203.58	-25.51
1	67	815	1.10-1.06	0.73	-0.68	0.82	425.67	312.43	384.11	353.98	-54.58
1	67	816	1.63-1.24	1.02	-0.63	1.17	450.36	284.59	296.64	438.31	-43.04
1	67	817	0.80-1.77	-0.54	-0.43	1.28	483.58	199.86	202.52	480.93	-27.30
1	67	818	1.24-1.64	-0.21	-0.18	1.44	514.54	166.83	167.88	513.50	-19.04
1	67	819	1.22-1.17 1.17e-02	3.92e-02	1.20	564.02	160.03	160.41	563.65	-12.31	
1	67	820	0.92-0.72 4.79e-04	0.20	0.81	648.27	168.53	168.53	648.27	-1.10	
1	67	821	1.16-0.24 0.66	0.27	0.67	765.46	215.12	215.69	764.89	17.70	
1	67	822	1.16-5.71e-03 0.95	0.20	0.45	884.54	283.69	287.47	880.76	47.51	
1	67	823	4.33e-02 -2.24	-2.24	4.13e-02	-6.82e-02	938.18	306.86	316.08	928.96	75.74
1	67	824	4.79e-02 -3.56	-3.45	-6.05e-02	-0.62	878.02	398.57	447.82	828.76	145.57
1	67	825	-0.18-5.50	-5.44	-0.25	-0.58	793.58	385.80	641.42	537.97	197.22
1	67	826	-0.24-6.89	-6.89	-0.25	-0.18	845.14	129.33	776.36	198.11	210.96
1	67	827	0.25-1.43	-0.40	-0.79	0.82	373.78	-134.29	348.08	-108.59	-111.35
1	67	828	0.64-1.29	0.18	-0.82	0.82	387.19	98.92	326.50	159.61	-117.52





EGP CODE

GRE.EEC.R.73.IT.W.15235.12.024.01

PAGE

405 di/of 527

1	67	829	1.08-1.09	0.81	-0.82	0.71	449.58	170.81	272.65	347.74	-134.23
1	67	830	0.26-1.40	-0.39	-0.76	0.81	492.89	156.31	194.22	454.98	-106.41
1	67	831	0.69-1.31	-0.25	-0.37	1.00	518.19	150.02	161.80	506.41	-64.80
1	67	832	1.08-1.34	-0.12	-0.14	1.21	539.46	145.27	148.71	536.02	-36.67
1	67	833	1.15-1.04-5.23e-02		0.16	1.09	582.43	149.10	149.72	581.81	-16.48
1	67	834	1.02-0.83	-0.27	0.45	0.85	666.20	157.33	157.39	666.15	5.23
1	67	835	1.24-0.76	-0.21	0.69	0.89	791.38	187.53	189.46	789.44	34.12
1	67	836	1.32-0.85	-0.32	0.78	0.93	934.13	220.30	228.85	925.57	77.69
1	67	837	1.721.65e-02	1.04	0.69	0.83	1033.24	272.92	304.11	1002.04	150.82
1	67	838	0.49-3.60	-3.53	0.42	0.51	1015.23	182.77	299.21	898.80	288.74
1	67	839	1.28-5.70	-5.68	1.27	0.28	903.49	99.72	437.40	565.81	396.72
1	67	840	0.44-7.98	-7.84	0.30	1.07	805.80	-110.69	516.03	179.09	426.15
1	67	841	0.98-6.46	-1.16	-4.32	3.37	-54.75	-294.72	-62.45	-287.02	-42.29
1	67	842	2.251.08	2.10	1.23	-0.39	273.23	-105.46	66.37	101.39	-188.53
1	67	843	-1.72-1.91	-1.86	-1.78	8.29e-02	427.93	-64.10	19.09	344.73	-184.42
1	67	844	0.15-1.03	-0.75	-0.12	0.50	524.62	35.88	69.66	490.84	-123.96
1	67	845	0.60-0.92-7.10e-02		-0.25	0.76	557.67	99.70	111.96	545.41	-73.92
1	67	846	0.98-1.04	-0.11	5.23e-02	1.00	569.14	118.71	122.14	565.71	-39.16
1	67	847	1.10-0.90	-0.26	0.46	0.93	606.87	128.71	129.35	606.23	-17.53
1	67	848	1.29-0.80	-0.47	0.96	0.76	691.05	143.00	143.08	690.97	6.63
1	67	849	1.87-1.10	-0.83	1.59	0.86	823.72	158.08	160.09	821.71	36.54
1	67	850	2.63-1.55	-1.24	2.31	1.10	989.74	170.87	178.32	982.29	77.70
1	67	851	3.55-1.19	-0.69	3.05	1.46	1148.33	168.74	190.37	1126.69	143.96
1	67	852	3.86-1.61	-1.33	3.58	1.21	1166.46	35.43	134.07	1067.83	319.11
1	67	853	1.59-10.73	-9.62	0.48	3.53	902.30	-337.17	-10.41	575.54	546.11
1	67	854	3.30-4.87	-2.65	1.07	3.64	626.18	-549.31	-57.39	134.26	579.88
1	67	855	15.29-0.96	12.37	1.96	-6.24	-421.18	-969.71	-671.22	-719.68	273.19
1	67	856	-11.04-20.14-14.31		-16.88	-4.37	-19.01	-675.13	-540.02	-154.12	-265.32
1	67	857	2.15-2.85	-1.52	0.82	-2.21	366.91	-222.10	-181.39	326.19	-149.42
1	67	858	0.64-0.75	6.72e-02	-0.18	0.68	551.25	0.14	10.94	540.44	-76.40
1	67	859	0.80-0.72	9.90e-02	-1.70e-02	0.76	580.28	69.56	73.65	576.20	-45.49
1	67	860	1.08-0.80-4.32e-02		0.32	0.93	591.37	98.12	99.58	589.91	-26.74
1	67	861	1.17-0.80	-0.42	0.78	0.78	628.23	110.07	110.27	628.02	-10.36
1	67	862	1.58-0.76	-0.63	1.45	0.53	713.83	127.84	127.87	713.80	4.44
1	67	863	2.48-1.45	-1.39	2.41	0.49	851.40	134.02	135.09	850.32	27.76
1	67	864	4.04-2.18	-2.13	4.00	0.50	1024.67	132.96	136.36	1021.26	54.99
1	67	865	6.07-3.41	-3.33	5.99	0.88	1197.94	97.87	106.16	1189.65	95.16
1	67	866	12.060.40	0.40	12.06	0.15	1426.66	16.15	37.91	1404.90	173.82
1	67	867	15.07-2.67	2.34	10.05	-7.99	1142.50	-590.70	-396.85	948.64	546.27
1	67	868	30.52-17.15	27.76	-14.39	-11.14	-109.50	-1344.25	-1041.20	-412.54	531.36
1	67	869	26.96-2.88	-2.86	26.94	-0.74	-301.12	-639.72	-637.98	-302.86	24.17
1	67	870	6.830.56	1.68	5.71	2.40	453.60	-159.53	-159.53	453.59	-0.85
1	67	871	0.23-0.95	-0.31	-0.41	0.59	535.52	-21.57	-21.04	534.98	-17.33
1	67	872	1.03-0.68	0.12	0.23	0.85	585.58	63.35	63.85	585.08	-16.17
1	67	873	1.10-0.73-6.47e-02		0.43	0.88	598.29	90.70	91.36	597.63	-18.23
1	67	874	1.20-0.73	-0.46	0.92	0.68	637.39	102.41	102.57	637.24	-9.07
1	67	875	1.66-0.88	-0.82	1.61	0.36	724.25	117.89	117.90	724.24	1.91
1	67	876	2.64-1.41	-1.40	2.63	0.19	863.56	130.50	130.87	863.18	16.55
1	67	877	4.02-2.04	-2.04	4.02	-7.69e-02	1033.42	135.94	138.48	1030.89	47.59
1	67	878	7.77-0.62	-0.53	7.69	-0.85	1227.43	161.82	165.43	1223.82	61.90
1	67	879	9.14-5.58	-4.33	7.89	-4.11	1465.15	40.71	40.79	1465.07	10.91
1	67	880	51.55-49.33	51.19	-48.96	6.07	1835.70	-33.16	-32.58	1835.13	-32.74
1	67	881	6.90-13.23	-12.16	5.83	4.53	-38.24	-986.06	-259.64	-764.66	-401.04
1	67	882	-0.23-9.43	-1.32	-8.34	2.96	-7.59	-577.03	-473.58	-111.04	219.56
1	67	883	3.47-5.69	-2.12	-9.85e-02	4.47	342.91	-184.85	-170.10	328.16	86.97
1	67	884	1.182.68e-02	0.59	0.62	0.58	544.42	20.02	20.04	544.40	3.80
1	67	885	0.50-0.59	-0.35	0.26	0.45	583.56	61.47	61.49	583.54	-3.44
1	67	886	0.78-0.54	-0.30	0.55	0.50	602.26	87.93	87.96	602.23	-3.60
1	67	887	1.18-0.65	-0.47	1.00	0.54	642.92	102.26	102.42	642.77	-9.15
1	67	888	1.70-0.70	-0.68	1.68	0.20	730.79	119.44	119.44	730.79	-0.51
1	67	889	2.69-1.42	-1.40	2.67	-0.28	870.99	126.35	127.97	869.38	34.63
1	67	890	4.32-1.73	-1.57	4.16	-0.97	1041.07	141.83	143.23	1039.67	35.51
1	67	891	6.45-3.55	-2.85	5.75	-2.56	1206.73	114.42	115.25	1205.90	30.06
1	67	892	5.96-2.24	-0.23	3.95	-3.53	1402.31	61.49	64.29	1399.51	-61.15
1	67	893	36.44-1.12	22.11	13.20	18.24	1370.55	-231.10	-119.03	1258.49	-408.58
1	67	894	10.59-28.78	-16.25	-1.95	18.34	122.75	-719.45	-314.02	-282.68	-420.81
1	67	895	-1.93-6.69	-6.63	-1.99	-0.54	130.81	-303.68	115.93	-288.80	-79.02
1	67	896	6.574.53	6.55	4.55	0.19	231.79	28.48	150.76	109.52	99.54
1	67	897	0.21-2.23	-1.08	-0.94	1.22	364.42	-20.59	-1.60	345.42	83.38
1	67	898	1.05-0.96	-0.57	0.67	0.79	505.81	32.63	35.80	502.64	38.60
1	67	899	0.47-0.46	-0.46	0.47	3.07e-02	571.30	66.09	66.21	571.18	7.64
1	67	900	0.67-0.16	-0.15	0.66	-7.07e-02	602.78	89.30	89.33	602.75	4.21
1	67	901	1.09-0.39	-0.38	1.08	-0.13	650.34	100.81	101.40	649.75	18.01
1	67	902	1.78-0.71	-0.59	1.65	-0.54	741.26	115.14	115.80	740.60	20.34
1	67	903	2.71-1.24	-0.89	2.36	-1.12	879.05	129.43	129.54	878.94	9.09
1	67	904	3.87-1.35	-0.59	3.11	-1.84	1043.28	151.76	151.83	1043.21	7.63





EGP CODE

GRE.EEC.R.73.IT.W.15235.12.024.01

PAGE

406 di/of 527

1	67	905	4.50-1.57	-0.46	3.39	-2.34	1186.34	157.40	157.43	1186.31	-5.59	
1	67	906	5.081.04	1.13	4.99	-0.62	1158.39	147.56	158.78	1147.16	-105.92	
1	67	907	6.79-6.61	-6.43	6.62	-1.53	784.10	22.28	166.14	640.24	-298.16	
1	67	908	6.12-11.96	-9.32	3.48	-6.38	536.94	-171.37	170.23	195.33	-353.93	
1	67	909	0.53-0.95	0.39	-0.80	0.44	271.60	-155.22	271.12	-154.74	-14.29	
1	67	910	1.72-0.62	1.33	-0.23	0.87	237.49	118.81	237.12	119.18	-6.63	
1	67	911	1.92-0.85	1.59	-0.53	0.90	350.25	166.63	168.28	348.60	17.32	
1	67	912	-9.08e-02	-1.03	-0.69	-0.43	0.45	486.93	81.49	81.60	486.82	6.73
1	67	913	0.35-0.47	-0.45	0.33	-0.13	559.39	81.33	81.45	559.26	7.66	
1	67	914	0.80-0.67	-0.52	0.65	-0.44	599.91	84.23	84.38	599.76	8.87	
1	67	915	1.41-0.64	-0.27	1.04	-0.79	650.77	102.72	102.83	650.66	7.63	
1	67	916	2.06-0.89	-0.33	1.51	-1.15	743.03	118.49	118.53	742.99	5.21	
1	67	917	2.61-1.36	-0.74	1.99	-1.44	882.09	128.95	128.95	882.08	2.30	
1	67	918	3.36-0.76	0.18	2.41	-1.73	1042.39	165.54	165.55	1042.39	-2.20	
1	67	919	3.44-0.85	-0.22	2.81	-1.51	1138.76	176.71	176.85	1138.62	-11.67	
1	67	920	3.65-2.24	-1.98	3.39	-1.21	1025.96	204.85	207.73	1023.08	-48.55	
1	67	921	5.14-5.31	-4.98	4.81	-1.84	676.17	285.72	317.61	644.28	-106.94	
1	67	922	2.47-5.25	-4.83	2.05	-1.75	456.87	145.13	396.57	205.43	-123.13	
1	67	923	-1.29-4.95	-2.17	-4.07	1.56	98.52	-218.84	98.08	-218.39	-11.90	
1	67	924	2.37-0.72	1.99	-0.33	1.02	179.58	73.93	143.59	109.92	-50.07	
1	67	925	-0.73-1.75	-0.85	-1.63	-0.33	376.81	54.22	68.93	362.10	-67.30	
1	67	926	-0.13-0.69	-0.59	-0.22	-0.21	502.45	63.95	66.11	500.29	-30.71	
1	67	927	0.36-0.91	-0.77	0.22	-0.40	567.65	68.12	68.46	567.31	-13.05	
1	67	928	0.88-0.86	-0.61	0.63	-0.61	600.48	83.15	83.36	600.27	10.44	
1	67	929	1.48-0.66	-0.20	1.01	-0.88	648.05	105.46	105.57	647.95	7.67	
1	67	930	2.02-0.87	-0.27	1.43	-1.17	739.18	120.27	120.27	739.18	0.83	
1	67	931	2.52-0.97	-0.33	1.88	-1.35	878.56	134.63	134.88	878.31	-13.68	
1	67	932	3.18-0.53	0.23	2.43	-1.49	1040.44	153.86	154.77	1039.53	-28.45	
1	67	933	4.06-1.01	-0.48	3.54	-1.54	1147.84	152.40	152.51	1147.73	-10.40	
1	67	934	4.29-3.36	-3.28	4.21	-0.76	1032.50	116.27	120.10	1028.67	59.11	
1	67	935	2.31-5.85	-5.84	2.30	-0.34	638.55	143.05	181.07	600.52	131.89	
1	67	936	3.75-8.15	-7.41	3.02	2.87	282.51	104.45	217.46	169.51	85.74	
1	67	937	10.64-5.23	8.41	-3.00	-5.51	-91.86	-421.48	-152.79	-360.55	127.95	
1	67	938	-6.43-11.94	-7.76	-10.61	-2.36	66.00	-317.40	-219.59	-31.81	-167.13	
1	67	939	-0.57-3.57	-3.07	-1.07	-1.11	346.65	-144.35	-129.84	332.14	-83.15	
1	67	940	0.47-1.00	-0.82	0.29	-0.48	538.99	-7.30	-6.80	538.49	-16.48	
1	67	941	0.69-0.92	-0.66	0.42	-0.60	583.64	54.37	54.40	583.61	-4.17	
1	67	942	1.09-0.68	-0.28	0.69	-0.74	600.49	92.36	92.58	600.28	10.49	
1	67	943	1.56-0.72	-0.19	1.02	-0.96	640.42	112.45	112.57	640.29	8.07	
1	67	944	2.06-0.83	-0.21	1.43	-1.19	727.32	128.20	128.26	727.25	-6.26	
1	67	945	2.54-0.95	-0.34	1.94	-1.32	866.15	135.91	137.60	864.46	-35.09	
1	67	946	3.24-0.52	0.14	2.58	-1.43	1034.80	140.73	143.72	1031.81	-51.63	
1	67	947	4.41-0.48	0.43	3.50	-1.90	1176.46	111.42	113.36	1174.52	-45.48	
1	67	948	12.59-1.29	1.20	10.10	-5.32	1219.61	42.70	44.42	1217.89	44.91	
1	67	949	11.92-7.16	-6.00	10.76	-4.57	624.11	-332.24	-227.61	519.48	298.52	
1	67	950	12.33-15.93	12.20	-15.80	-1.92	-13.57	-467.58	-353.63	-127.53	196.85	
1	67	951	1.53-0.34	-0.34	1.53	-6.62e-02	1255.04	38.56	42.73	1250.88	-71.07	
1	67	952	17.212.42	2.84	16.80	-2.45	-86.54	-743.43	-713.32	-116.65	137.36	
1	67	953	7.253.80	3.81	7.24	0.14	468.65	-168.68	-152.67	452.64	99.73	
1	67	954	1.26-0.54	-0.54	1.26	-6.19e-02	549.89	-25.60	-14.84	539.12	77.96	
1	67	955	0.95-0.77	-0.64	0.82	-0.45	582.35	62.07	67.98	576.44	55.14	
1	67	956	1.17-0.59	-0.24	0.82	-0.71	588.28	111.83	114.62	585.49	36.36	
1	67	957	1.60-0.73	-0.16	1.03	-1.00	619.25	135.12	135.43	618.94	12.26	
1	67	958	2.12-0.87	-0.14	1.40	-1.28	699.71	151.97	152.42	699.27	-15.55	
1	67	959	2.77-0.63	0.21	1.93	-1.47	832.29	169.40	173.08	828.61	-49.28	
1	67	960	3.40-0.35	0.51	2.54	-1.58	1000.83	161.12	172.89	989.07	-98.69	
1	67	961	3.380.79	1.74	2.42	-1.25	1171.32	133.93	152.41	1152.84	-137.23	
1	67	962	4.61-6.52	4.59	-6.51	0.40	1341.09	-32.93	3.88	1304.28	-221.88	
1	67	963	20.70-47.34	19.30	-45.93	9.69	1460.33	-521.02	-482.86	1422.17	-272.30	
1	67	964	4.67-0.71	-0.47	4.44	-1.11	1521.37	34.70	54.89	1501.17	-172.08	
1	67	965	32.005.13	8.65	28.48	-9.08	1772.54	85.66	131.22	1726.97	-273.47	
1	67	966	56.8611.99	21.41	47.44	-18.28	948.64	-67.87	107.51	773.26	-384.08	
1	67	967	-21.17-59.37-45.49	-35.05	-18.38	312.62	-250.15	-78.48	140.95	-259.12		
1	67	968	35.508.66	10.94	33.22	-7.48	-116.12	-521.02	-283.03	-354.10	-199.31	
1	67	969	28.33-16.83	22.86	-11.35	-14.74	83.89	-1065.49	-722.46	-259.14	525.93	
1	67	970	12.90-1.60	11.47	-0.17	-4.33	-213.98	-860.49	-425.40	-649.07	303.29	
1	67	971	-8.12-20.27	-14.01	-14.38	-6.08	-168.80	-436.22	-338.13	-266.88	-128.87	
1	67	972	2.13-2.24	-1.79	1.68	-1.33	213.37	-84.06	-57.85	187.16	-84.31	
1	67	973	1.37-0.86	-0.58	1.09	0.75	383.48	7.82	23.75	367.55	-75.70	
1	67	974	1.63-0.35	1.56e-02	1.26	0.77	428.57	37.90	47.74	418.73	-61.23	
1	67	975	2.22-0.17	0.14	1.91	0.80	452.39	45.67	51.05	447.02	-46.44	
1	67	976	2.95-6.75e-02	0.24	2.64	0.91	491.73	50.74	52.24	490.23	-25.63	
1	67	977	6.91-7.61	-6.74	6.04	3.45	40.47	-409.23	35.90	-404.66	-45.10	
1	67	978	-1.38-7.65	-1.43	-7.60	-0.55	234.72	-475.73	-196.22	-44.79	347.06	
1	67	979	2.05-6.16	-2.59	-1.53	4.07	447.97	-201.17	-73.84	320.64	257.76	
1	67	980	1.46-1.06	-0.80	1.20	0.76	559.49	18.50	59.67	518.32	143.44	



EGP CODE

GRE.EEC.R.73.IT.W.15235.12.024.01

PAGE

407 di/of 527

1	67	981	0.92-0.62	-0.57	0.86	-0.28	567.66	101.40	117.33	551.73	84.69	
1	67	982	1.11-0.66	-0.35	0.80	-0.67	568.70	139.85	145.27	563.28	47.91	
1	67	983	1.57-0.74	-0.11	0.94	-1.03	596.97	162.65	163.19	596.43	15.35	
1	67	984	2.12-0.86-9.06e-04		1.26	-1.35	673.24	181.86	182.54	672.56	-18.30	
1	67	985	2.85-0.64	0.44	1.77	-1.61	801.03	205.52	211.75	794.80	-60.59	
1	67	986	3.34-0.47	0.35	2.52	-1.57	959.44	210.25	226.59	943.11	-109.40	
1	67	987	4.08-0.28-1.78e-02		3.82	-1.04	1124.50	175.16	215.02	1084.63	-190.40	
1	67	988	8.780.44	0.67	8.55	1.38	1318.72	47.19	158.24	1207.66	-359.00	
1	67	989	30.970.42	8.14	23.25	13.28	1220.55	-281.83	111.01	827.71	-660.21	
1	67	990	6.50-15.37	-6.18	-2.69	10.79	626.48	-532.01	111.29	-16.82	-575.69	
1	67	991	-1.54-5.36	-4.57	-2.33	-1.55	259.88	-244.99	217.05	-202.17	140.67	
1	67	992	5.623.86	5.61	3.87	-0.14	474.79	24.19	339.23	159.74	206.65	
1	67	993	1.06-1.36	-0.15	-0.15	1.21	520.55	32.81	199.26	354.10	231.25	
1	67	994	1.15-1.17	-0.58	0.56	1.02	537.97	117.85	195.66	460.15	163.20	
1	67	995	0.65-0.37	-0.34	0.63	0.15	540.74	166.91	199.16	508.49	104.95	
1	67	996	0.63-0.15	-0.15	0.63	-4.67e-02	540.93	191.00	202.90	529.03	63.41	
1	67	997	0.744.15e-024.63e-02		0.74	-5.75e-02	569.31	206.05	210.70	564.65	40.84	
1	67	998	1.30-9.34e-02	0.24	0.96	-0.60	637.56	228.33	228.38	637.51	4.68	
1	67	999	2.38-0.53	0.49	1.36	-1.39	753.57	256.02	261.42	748.17	-51.53	
1	67	1000	3.22-0.37	0.78	2.07	-1.68	899.46	287.72	308.72	878.46	-111.39	
1	67	1001	4.04-1.03	-0.30	3.30	-1.78	1043.50	280.46	335.70	988.27	-197.73	
1	67	1002	6.47-2.09	-1.56	5.93	-2.07	1116.26	194.40	360.40	950.26	-354.22	
1	67	1003	5.70-6.07	-5.23	4.86	-3.02	1042.96	-24.40	436.99	581.57	-528.76	
1	67	1004	6.20-11.28	-8.64	3.56	-6.26	883.94	-320.41	401.06	162.47	-590.24	
1	67	1005	0.52-0.29	0.52	-0.29	-1.77e-02	550.10	-115.36	514.47	-79.74	149.79	
1	67	1006	0.876.16e-02	0.83	0.11	0.18	529.99	129.71	475.50	184.21	137.27	
1	67	1007	1.33-0.27	0.98	8.13e-02	0.67	523.75	241.02	417.75	347.02	136.87	
1	67	1008	1.15-1.02	9.00e-02	3.96e-02	1.08	524.66	245.98	339.41	431.22	131.56	
1	67	1009	1.21-1.01-9.88e-02		0.29	1.09	511.85	246.18	287.51	470.52	96.29	
1	67	1010	1.29-0.81	8.38e-02	0.39	1.04	519.92	243.51	267.36	496.07	77.61	
1	67	1011	1.47-0.71	0.27	0.48	1.08	548.79	249.38	262.49	535.67	61.28	
1	67	1012	1.07-1.10e-02	0.46	0.60	0.54	609.88	274.02	277.00	606.90	31.50	
1	67	1013	1.040.37	0.64	0.78	-0.33	710.96	310.39	312.14	709.20	-26.46	
1	67	1014	2.11-0.27	0.83	1.01	-1.19	832.41	361.85	373.86	820.40	-74.21	
1	67	1015	2.85-1.40	0.11	1.34	-2.04	937.29	388.02	440.59	884.72	-161.58	
1	67	1016	2.96-2.92	-1.49	1.52	-2.53	965.42	367.66	531.44	801.64	-266.60	
1	67	1017	3.33-4.51	-3.29	2.11	-2.84	963.11	225.37	674.51	513.97	-360.03	
1	67	1018	2.24-5.45	-3.97	0.76	-3.03	972.47	-31.56	772.52	168.39	-400.97	
1	67	1019	-0.18-0.74	-0.74	-0.18	2.72e-02	598.64	-73.42	579.64	-54.42	111.37	
1	67	1020	0.14-0.35-8.72e-02		-0.12	0.24	578.09	180.11	555.87	202.33	91.38	
1	67	1021	1.03-0.56	0.54	-7.70e-02	0.73	538.04	307.01	500.80	344.25	84.95	
1	67	1022	1.58-1.19	0.37	2.52e-02	1.38	491.77	346.35	421.80	416.32	72.66	
1	67	1023	1.77-1.55	6.03e-02	0.17	1.66	477.68	326.52	354.82	449.38	58.97	
1	67	1024	1.84-1.23	0.26	0.35	1.53	480.87	313.22	317.69	476.39	27.03	
1	67	1025	1.70-0.86	0.47	0.38	1.28	517.20	304.16	304.24	517.12	-4.15	
1	67	1026	1.49-0.44	0.67	0.39	0.95	589.22	313.21	314.49	587.94	-18.76	
1	67	1027	1.20-1.47e-02	0.83	0.35	0.56	687.21	347.47	348.67	686.01	-20.11	
1	67	1028	0.960.23	0.92	0.27	-0.16	785.51	406.43	408.08	783.86	-24.96	
1	67	1029	1.12-1.09-1.84e-02		4.62e-02	-1.11	835.06	477.95	489.12	823.90	-62.16	
1	67	1030	1.03-2.66	-1.49	-0.14	-1.72	781.19	565.30	611.79	734.70	-88.75	
1	67	1031	0.44-4.33	-3.54	-0.35	-1.77	843.65	410.43	784.32	469.76	-148.95	
1	67	1032	8.04e-02	-5.36	-5.04	-0.24	-1.28	932.79	131.44	900.46	163.77	-157.68
1	67	1033	-0.15-1.63	-1.57	-0.21	0.28	571.83	-68.87	566.75	-63.79	56.83	
1	67	1034	0.17-1.05	-0.76	-0.11	0.52	560.01	185.05	554.46	190.60	45.26	
1	67	1035	0.72-1.22	-0.34	-0.16	0.97	497.54	322.96	493.58	326.92	26.00	
1	67	1036	1.30-1.41	-0.15	3.53e-02	1.35	426.87	398.18	422.48	402.57	10.33	
1	67	1037	1.63-1.29	0.12	0.23	1.46	439.98	373.13	373.33	439.78	-3.64	
1	67	1038	1.84-1.09	0.35	0.39	1.47	468.15	335.25	336.09	467.30	-10.55	
1	67	1039	1.88-0.81	0.56	0.51	1.35	510.47	320.80	321.46	509.81	-11.17	
1	67	1040	1.82-0.53	0.77	0.51	1.17	582.42	328.38	329.13	581.67	-13.82	
1	67	1041	1.67-0.32	0.95	0.39	0.95	681.26	357.92	358.21	680.97	-9.65	
1	67	1042	1.34-0.18	1.02	0.14	0.62	779.83	411.52	411.62	779.73	6.09	
1	67	1043	0.61-0.18	0.60	-0.17	8.88e-02	826.69	485.66	491.06	821.29	42.58	
1	67	1044	-0.19-1.48	-1.16	-0.51	-0.56	769.02	564.78	602.09	731.70	78.92	
1	67	1045	-0.45-4.36	-4.20	-0.61	-0.76	804.66	423.17	758.86	468.97	124.00	
1	67	1046	-0.38-6.37	-6.33	-0.41	-0.45	896.65	137.32	872.06	161.91	134.42	
1	67	1047	-1.69e-02	-1.56	-1.16	-0.42	0.68	458.97	-111.45	458.86	-111.35	-7.73
1	67	1048	8.81e-03	-1.30	-0.92	-0.37	0.59	456.16	130.27	454.49	131.94	-23.30
1	67	1049	0.37-1.22	-0.71	-0.14	0.74	423.53	274.62	404.38	293.77	-49.85	
1	67	1050	0.93-1.19	-0.32	6.04e-02	1.04	427.32	320.93	359.80	388.44	-51.23	
1	67	1051	1.57-0.99	0.12	0.46	1.27	451.46	318.42	331.87	438.01	-40.10	
1	67	1052	1.90-0.85	0.35	0.69	1.37	471.98	304.44	309.20	467.22	-27.84	
1	67	1053	2.13-0.65	0.54	0.94	1.37	512.18	296.28	298.96	509.50	-23.92	
1	67	1054	2.28-0.43	0.72	1.13	1.34	585.06	304.75	305.76	584.05	-16.82	
1	67	1055	2.40-0.33	0.89	1.18	1.36	691.03	329.42	329.42	691.03	-1.34	
1	67	1056	2.36-0.32	1.00	1.04	1.34	809.89	364.21	366.41	807.68	31.26	



EGP CODE

GRE.EEC.R.73.IT.W.15235.12.024.01

PAGE

408 di/of 527

1	67	1057	1.85-0.33	0.89	0.63	1.08	891.80	397.44	416.87	872.37	96.07	
1	67	1058	0.43-0.84	-0.55	0.13	0.54	886.57	377.30	475.55	788.31	200.96	
1	67	1059	0.60-4.01	-4.01	0.60	-4.80e-02	850.53	242.48	591.78	501.23	300.64	
1	67	1060	1.97e-03	-7.40	-7.39	-5.17e-03	0.23	809.09	-3.37	650.71	155.01	321.86
1	67	1061	2.68-3.79	1.03	-2.14	2.81	171.68	-273.63	157.41	-259.36	78.43	
1	67	1062	1.92-0.30	0.43	1.20	-1.04	263.76	34.62	231.22	67.16	-79.99	
1	67	1063	-0.78-2.10	-2.09	-0.79	0.14	321.16	121.26	198.42	243.99	-97.32	
1	67	1064	-0.34-4.17	-3.39	-1.12	-1.55	418.31	-138.30	400.03	-120.02	-99.18	
1	67	1065	1.54-0.67	6.12e-02	0.81	1.04	452.69	213.80	228.41	438.08	-57.25	
1	67	1066	1.95-0.48	0.26	1.21	1.12	471.21	216.46	222.29	465.37	-38.10	
1	67	1067	2.41-0.31	0.40	1.70	1.20	508.72	217.40	218.72	507.40	-19.53	
1	67	1068	2.93-0.22	0.52	2.18	1.34	586.52	223.60	224.85	585.28	-21.21	
1	67	1069	3.47-0.17	0.64	2.66	1.51	702.09	243.11	243.11	702.09	-1.77e-02	
1	67	1070	4.00-0.30	0.67	3.03	1.80	844.83	266.45	268.41	842.87	33.59	
1	67	1071	4.36-0.34	0.83	3.19	2.04	975.70	270.85	286.03	960.52	102.31	
1	67	1072	3.965.82e-03	0.68	3.29	1.49	1001.04	195.56	279.57	917.04	246.18	
1	67	1073	1.68-9.78	-8.29	0.19	3.86	819.29	-157.60	154.56	507.13	455.52	
1	67	1074	2.39-3.24	-2.26	1.41	2.14	663.19	-318.33	202.40	142.46	489.85	
1	67	1076	39.1420.50	21.54	38.10	4.29	-60.72	-482.90	-193.82	-349.79	-196.16	
1	67	1077	-5.69-11.47	-11.47	-5.69	8.77e-02	340.86	-201.35	287.85	-148.34	-161.04	
1	67	1078	2.99-1.60	1.98	-0.59	-1.90	528.63	-178.02	492.66	-142.05	-155.33	
1	67	1079	0.42-0.58	1.41e-02	-0.17	-0.49	530.88	-140.29	510.60	-120.01	-114.87	
1	67	1080	0.24-0.44-8.41e-02		-0.11	0.34	487.69	-121.46	485.30	-119.07	38.07	
1	67	1081	1.25-1.75	5.32e-03	-0.50	1.48	381.15	-136.14	378.64	-133.63	35.93	
1	67	1082	3.80-5.60e-02	0.30	3.45	1.11	573.53	55.39	57.13	571.79	-29.98	
1	67	1083	4.79-2.89e-02	0.35	4.41	1.29	698.69	69.67	69.80	698.57	-8.87	
1	67	1084	6.13-0.15	0.25	5.73	1.53	861.39	83.52	84.01	860.91	19.38	
1	67	1085	7.61-0.75	4.79e-02	6.82	2.45	1020.13	84.59	91.49	1013.23	80.03	
1	67	1086	11.962.34	2.34	11.96	6.31e-02	1226.44	38.88	66.23	1199.09	178.12	
1	67	1087	14.041.38	4.70	10.72	-5.57	1098.80	-313.20	-134.55	920.15	469.39	
1	67	1088	-4.27-11.45	-11.27	-4.45	1.13	45.43	-165.12	33.97	-153.65	47.78	
1	67	1089	17.50-6.88	-6.18	16.80	-4.06	-220.03	-466.13	-446.20	-239.97	67.14	
1	67	1090	5.871.00	1.35	5.52	1.26	222.90	-135.63	-132.26	219.53	-34.60	
1	67	1091	1.04-0.54	-0.26	0.76	0.61	346.26	-101.30	-87.90	332.86	-76.27	
1	67	1092	1.69-3.89e-021.72e-02		1.63	0.31	410.16	-80.45	-71.01	400.72	-67.40	
1	67	1093	2.421.45e-027.61e-02		2.35	0.38	435.06	-72.81	-67.81	430.06	-50.14	
1	67	1094	3.251.49e-02	0.11	3.15	0.55	476.51	-69.64	-67.23	474.10	-36.17	
1	67	1095	4.22-1.99e-03	0.13	4.09	0.73	559.16	-65.13	-63.84	557.87	-28.35	
1	67	1096	5.38-3.70e-02	0.12	5.23	0.90	689.35	-55.79	-55.75	689.31	-5.69	
1	67	1097	6.88-9.65e-024.30e-02		6.74	0.98	857.78	-46.70	-45.97	857.04	25.71	
1	67	1098	9.96-0.16-1.96e-02		9.82	1.17	1063.06	-36.02	-30.06	1057.10	80.69	
1	67	1099	4.521.05	1.08	4.49	-0.30	1205.13	-87.57	-69.82	1187.38	150.43	
1	67	1100	30.56-32.14	30.43	-32.00	-2.92	1453.68	-15.13	-14.40	1452.95	32.81	
1	67	1101	31.69-38.24	-37.09	30.54	8.90	-414.38	-564.42	-414.41	-564.39	2.07	
1	67	1102	61.95-8.17	-7.02	60.80	-8.91	-749.33	-1375.54	-1357.22	-767.65	105.53	
1	67	1103	46.98-18.02	-17.56	46.52	-5.48	-601.85	-1607.20	-1591.04	-618.00	126.42	
1	67	1104	53.60-16.25	-15.90	53.25	-4.91	-737.12	-1844.74	-1835.23	-746.63	102.20	
1	67	1105	90.16-0.71	-0.48	89.93	-4.54	-1244.47	-2226.31	-2222.96	-1247.82	57.26	
1	67	1106	58.66-18.37	-17.88	58.18	-6.07	-702.15	-2531.85	-2521.90	-712.10	134.56	
1	67	1107	41.49-16.16	-15.46	40.79	-6.32	-351.71	-2187.01	-2184.09	-354.64	73.22	
1	67	1108	41.09-7.02	-3.02	37.09	-13.28	-399.07	-1505.79	-1488.66	-416.20	136.63	
1	67	1109	26.09-14.08	-14.06	26.07	-0.89	-160.77	-1517.30	-1510.27	-167.81	97.44	
1	67	1110	29.10-27.17	-20.44	22.36	-18.27	-213.20	-670.72	-623.68	-260.24	138.95	
1	67	1111	-5.29-27.84	-12.85	-20.28	10.65	595.75	-253.43	363.90	-21.57	-378.32	
1	67	1112	7.85-2.66	-0.41	5.60	-4.31	1330.49	58.39	1222.67	166.21	-354.30	
1	67	1113	-1.18-9.88	-9.87	-1.19	-0.31	1338.15	110.78	1333.16	115.77	-78.05	
1	67	1114	-6.03e-02	-7.50	-7.03	-0.53	1.82	1042.63	47.66	1002.03	88.25	196.84
1	67	1115	5.58-1.18	1.21	3.19	3.23	470.89	-207.21	109.93	153.75	338.34	
1	67	1116	-4.03-64.08	-26.81	-41.30	-29.14	-420.36	-1255.19	-1252.19	-423.36	-49.97	
1	67	1117	17.62-28.75	11.06	-22.19	16.16	-411.09	-1019.64	-1018.95	-411.77	-20.40	
1	67	1118	21.753.73	16.17	9.30	-8.33	678.07	-10.80	443.71	223.56	-326.37	
1	67	1119	0.38-5.13	-4.31	-0.44	-1.96	918.39	68.56	896.35	90.60	-135.07	
1	67	1120	0.65-5.55	-5.06	0.16	1.68	858.37	82.29	846.06	94.60	96.98	
1	67	1121	16.174.47	11.70	8.94	5.69	532.37	-160.79	272.55	99.04	335.55	
1	67	1122	1.53-59.84	-8.09	-50.21	-22.31	-287.11	-835.91	-826.88	-296.14	69.83	
1	67	1123	-0.26-1.66	-1.44	-0.48	-0.51	542.76	-124.75	531.43	-113.42	-86.25	
1	67	1124	17.50-33.57	13.75	-29.81	13.33	-33.38	-536.97	-419.86	-150.50	-212.75	
1	67	1125	23.644.20	17.76	10.08	-8.93	864.67	-7.53	699.10	158.04	-342.05	
1	67	1126	0.44-7.38	-6.77	-0.17	-2.10	962.89	83.34	949.17	97.05	-108.96	
1	67	1127	0.26-8.00	-7.68	-5.80e-02	1.59	932.34	57.21	891.49	98.06	184.61	
1	67	1128	15.643.21	8.08	10.77	6.07	615.03	-210.97	305.09	98.97	399.93	
1	67	1129	0.23-64.08	-7.99	-55.86	-21.47	-195.89	-746.96	-691.59	-251.26	165.67	
1	67	1130	15.133.68	5.55	13.27	4.23	-286.32	-665.95	-533.31	-418.96	181.00	
1	67	1131	27.32-37.13	22.62	-32.43	16.76	-182.79	-802.82	-732.22	-253.39	-196.95	
1	67	1132	33.846.48	28.61	11.70	-10.75	853.14	-54.97	600.09	198.07	-407.14	
1	67	1133	3.16-2.98	0.26	-8.00e-02	-3.07	1040.09	77.18	1013.15	104.12	-158.80	



EGP CODE

GRE.EEC.R.73.IT.W.15235.12.024.01

PAGE

409 di/of 527

1	67	1134	-1.58e-02	-8.37	-8.37	-1.64e-02	7.08e-02	940.85	99.82	931.97	108.70	85.97
1	67	1135	3.16-2.81	0.25	0.10	2.99	818.23	-97.47	644.68	76.08	358.88	
1	67	1136	21.093.40	19.15	5.34	5.53	501.00	-608.72	-352.76	245.05	467.47	
1	67	1137	9.31-73.06	-15.61	-48.14	-37.84	-714.41	-2087.90	-2083.93	-718.38	-73.71	
1	67	1138	23.54-60.94	11.32	-48.71	29.73	-628.90	-1724.77	-1717.54	-636.12	-88.70	
1	67	1139	30.057.79	23.90	13.94	-9.95	874.92	-428.98	170.74	275.20	-649.85	
1	67	1140	0.14-9.86	-9.00	-0.72	-2.81	981.06	-130.74	753.67	96.65	-448.45	
1	67	1141	-0.52-9.32	-9.28	-0.57	-0.61	1119.12	42.57	1075.66	86.03	-211.89	
1	67	1142	-0.83-9.78	-9.78	-0.83	-1.22e-02	1115.38	70.90	1115.21	71.07	-13.29	
1	67	1143	-0.32-9.57	-9.52	-0.37	0.70	1012.71	26.54	969.97	69.28	200.80	
1	67	1144	3.38-3.41	-0.50	0.47	3.36	869.41	-126.56	676.40	66.46	393.68	
1	67	1145	29.357.04	24.65	11.73	9.10	556.00	-597.46	-177.99	136.52	554.87	
1	67	1146	16.96-74.06	3.60	-60.70	-32.21	-537.35	-1765.79	-1762.90	-540.25	59.52	
1	67	1147	-7.47-50.68	-30.67	-27.48	-21.54	-248.64	-806.64	-778.60	-276.69	121.91	
1	67	1148	17.41-54.22	11.69	-48.51	19.41	-139.45	-910.22	-744.39	-305.29	-316.73	
1	67	1149	26.986.25	19.50	13.74	-9.95	904.51	-266.55	481.71	156.25	-562.47	
1	67	1150	0.53-9.92	-9.23	-0.15	-2.58	974.93	-41.82	856.63	76.49	-326.03	
1	67	1151	-0.51-10.14	-10.11	-0.54	-0.53	1086.15	34.64	1064.95	55.84	-147.80	
1	67	1152	-0.57-10.64	-10.64	-0.57	0.10	1044.01	25.44	1022.34	47.11	146.98	
1	67	1153	0.17-9.80	-9.50	-0.13	1.70	840.11	-40.61	751.71	47.79	264.66	
1	67	1154	15.623.25	8.94	9.93	6.17	543.09	-313.81	167.44	61.84	425.18	
1	67	1155	2.88-60.53	-6.01	-51.63	-22.02	-398.16	-952.92	-932.79	-418.29	103.74	
1	67	1156	36.0022.36	23.55	34.81	3.85	-11.39	-545.45	-494.78	-62.06	-156.50	
1	67	1157	27.01-33.25	21.29	-27.53	17.66	-337.82	-1219.93	-1194.58	-363.17	-147.39	
1	67	1158	26.254.02	20.26	10.01	-9.86	684.01	-237.11	307.33	139.57	-452.85	
1	67	1159	1.19-4.87	-3.45	-0.24	-2.57	930.38	-33.76	846.92	49.71	-271.12	
1	67	1160	-0.52-9.83	-9.79	-0.57	-0.66	1007.86	29.54	995.69	41.70	-108.40	
1	67	1161	-0.59-10.63	-10.63	-0.59	-5.32e-02	982.20	10.23	956.29	36.15	156.59	
1	67	1162	-0.48-10.41	-10.31	-0.58	0.98	750.67	-89.53	636.87	24.28	287.52	
1	67	1163	3.86-4.92	-4.21	3.15	2.39	350.30	-449.49	-154.08	54.89	386.01	
1	67	1164	-1.33-59.02	-21.92	-38.43	-27.64	-438.70	-1284.46	-1283.02	-440.15	-34.90	
1	67	1165	25.18-6.66	22.08	-3.56	9.45	-361.00	-1108.60	-1107.57	-362.04	27.76	
1	67	1166	22.032.83	18.54	6.31	-7.40	413.27	-46.53	230.64	136.10	-224.99	
1	67	1167	1.63-0.58	1.16	-0.10	-0.91	646.27	26.92	630.78	42.41	-96.72	
1	67	1168	8.743.11	5.88	5.96	2.82	322.55	-0.56	290.13	31.85	97.07	
1	67	1169	-1.13-42.25	-7.92	-35.46	-15.28	-253.85	-546.51	-535.82	-264.54	-54.90	
1	67	1170	-3.52-6.31	-5.44	-4.39	1.29	230.13	-187.84	217.62	-175.32	-71.22	
1	67	1171	19.77-18.18	16.09	-14.50	11.24	-150.87	-692.63	-604.17	-239.33	-200.24	
1	67	1172	17.750.96	11.86	6.86	-8.02	765.56	-131.08	532.80	101.69	-393.10	
1	67	1173	-3.05e-02	-6.25	-5.66	-0.61	-1.81	974.96	-25.81	916.15	32.99	-235.35
1	67	1174	-0.55-10.23	-10.20	-0.59	-0.58	1068.23	18.77	1057.10	29.90	-107.46	
1	67	1175	-0.65-11.34	-11.34	-0.66	-0.24	1028.37	8.86	1014.82	22.41	116.77	
1	67	1176	-0.84-10.79	-10.77	-0.86	0.41	831.53	-46.13	774.99	10.42	215.48	
1	67	1177	-0.54-9.54	-9.47	-0.60	0.76	405.03	-219.61	142.13	43.29	308.38	
1	67	1178	-9.00-21.79	-20.68	-10.10	3.59	-79.69	-404.82	-198.92	-285.59	156.68	
1	67	1179	-0.55-39.04	-0.81	-38.77	3.18	919.28	-55.08	18.00	846.19	-256.66	
1	67	1180	6.04-83.86	5.59	-83.40	6.38	1802.25	-20.25	-17.65	1799.66	-68.75	
1	67	1181	-6.71-49.98	-6.99	-49.69	3.51	1469.33	-450.50	-446.74	1465.57	-84.90	
1	67	1182	-4.90-58.57	-6.98	-56.49	10.37	1631.93	-385.51	-385.25	1631.67	-23.08	
1	67	1183	8.31-117.68	8.30	-117.68	-0.88	2520.15	151.49	155.98	2515.67	-102.95	
1	67	1184	-7.10-61.29	-7.29	-61.10	-3.23	1880.28	-680.44	-672.43	1872.27	-143.05	
1	67	1185	-4.08-45.69	-6.78	-42.99	10.25	1480.65	-874.60	-874.32	1480.36	-25.89	
1	67	1186	7.84-66.68	6.31	-65.16	10.56	1462.66	-238.52	-238.29	1462.43	-19.93	
1	67	1187	-4.51-29.87	-5.27	-29.11	4.31	1058.02	-691.73	-686.91	1053.20	-91.68	
1	67	1188	-4.08-36.42	-4.17	-36.32	1.70	967.71	-153.35	-140.27	954.63	120.37	
1	67	1189	48.9919.07	26.50	41.56	12.93	463.55	21.80	451.19	34.16	-72.87	
1	67	1190	0.34-5.34	0.20	-5.20	0.87	678.10	-258.89	655.46	-236.26	-143.85	
1	67	1191	1.84-0.39	1.84	-0.38	-0.10	535.81	-192.08	524.22	-180.49	-91.10	
1	67	1192	1.36-2.50	-0.22	-0.92	1.90	342.34	-186.08	339.57	-183.32	38.11	
1	67	1193	-7.41-13.39	-11.27	-9.53	2.86	46.17	-375.83	21.71	-351.36	98.62	
1	67	1194	34.634.09	4.73	33.98	-4.39	308.08	-521.03	-515.55	302.60	67.18	
1	67	1195	53.4321.31	29.02	45.71	13.72	293.08	-349.47	-347.53	291.14	-35.30	
1	67	1196	-0.40-5.39	-1.20	-4.60	1.83	284.67	-329.66	255.39	-300.38	-130.88	
1	67	1197	0.34-1.15	9.20e-02	-0.90	-0.56	324.94	-197.45	301.83	-174.34	-107.42	
1	67	1198	-0.17-3.64	-2.56	-1.25	1.60	205.79	-191.87	205.79	-191.87	-4.97e-02	
1	67	1199	-6.22-14.63	-12.98	-7.86	3.34	77.80	-289.02	34.80	-246.03	117.99	
1	67	1200	25.025.48	5.53	24.97	-1.01	-78.25	-496.41	-337.00	-237.66	203.09	
1	67	1201	7.67e-02	-2.54	-1.78	-0.69	1.19	361.75	-133.03	357.25	-128.53	46.97
1	67	1202	41.8418.54	21.44	38.94	7.70	14.67	-220.18	-68.55	-136.96	-112.33	
1	67	1203	-6.01-8.56	-8.47	-6.10	-0.48	337.55	-230.16	313.97	-206.58	-113.28	
1	67	1204	-0.36-3.07	-2.20	-1.23	-1.27	330.68	-192.81	317.57	-179.71	-81.78	
1	67	1205	2.09-1.73	1.45	-1.09	1.43	345.98	-198.49	336.86	-189.37	69.85	
1	67	1206	-6.98-17.30	-16.23	-8.04	3.14	136.37	-290.49	74.91	-229.02	149.87	
1	67	1207	27.245.48	5.63	27.09	-1.79	-46.45	-500.99	-190.32	-357.12	211.42	
1	67	1209	50.7216.09	19.85	46.96	10.78	71.50	-312.57	-255.83	14.77	-136.28	
1	67	1210	-7.72-14.29	-14.11	-7.90	-1.08	285.23	-309.25	243.06	-267.08	-152.62	





EGP CODE

GRE.EEC.R.73.IT.W.15235.12.024.01

PAGE

410 di/of 527

1	67	1211	-0.13-4.84	-3.63	-1.35	-2.06	344.19	-205.53	325.01	-186.34	-100.89	
1	67	1212	3.38-1.25	3.38	-1.25	0.14	384.36	-202.22	384.34	-202.20	-3.14	
1	67	1213	-0.27-6.66	-5.20	-1.72	2.68	145.25	-276.47	70.25	-201.47	161.26	
1	67	1214	-11.86-26.22-24.83		-13.25	4.25	-171.97	-645.84	-334.96	-482.86	225.10	
1	67	1215	49.92-0.65	1.69	47.58	-10.62	672.22	-686.48	-679.72	665.45	95.65	
1	67	1216	67.4024.39	29.72	62.07	14.17	307.01	-361.72	-346.42	291.71	-99.99	
1	67	1217	-0.72-8.00	-1.42	-7.30	2.15	438.57	-398.71	375.66	-335.80	-220.72	
1	67	1218	3.87-0.81	3.30	-0.24	-1.53	481.22	-238.42	406.44	-163.64	-219.61	
1	67	1219	1.58-0.27	1.49	-0.18	-0.41	460.16	-177.96	434.46	-152.26	-125.45	
1	67	1220	1.370.19	1.34	0.22	0.18	458.27	-144.55	451.54	-137.81	-63.36	
1	67	1221	1.97-0.80	1.59	-0.42	0.95	404.67	-148.14	404.13	-147.59	17.36	
1	67	1222	0.25-6.36	-4.71	-1.40	2.86	180.55	-198.54	148.63	-166.62	105.27	
1	70	1	1.09-2.10	0.95	-1.96	-0.65	-582.21	-931.97	-826.18	-688.00	160.66	
1	70	3	1.10-2.56	0.81	-2.26	1.00	-597.87	-946.54	-837.67	-706.75	-161.58	
1	70	5	-2.78-9.27	-2.80	-9.25	-0.33	-1345.20	-2185.40	-2180.40	-1350.20	64.59	
1	70	7	1.67-6.22	1.67	-6.22	-3.73e-02	-1312.13	-1962.92	-1962.26	-1312.79	-20.72	
1	70	9	3.29-8.01	1.96	-6.69	3.63	-1353.69	-2076.69	-2069.82	-1360.57	-70.15	
1	70	11	-0.28-14.96	-2.87	-12.37	-5.59	-1613.05	-2897.35	-2897.35	-1613.05	1.06	
1	70	13	5.62-9.55	4.00	-7.93	-4.69	-1750.49	-2914.25	-2904.45	-1760.29	106.31	
1	70	15	4.97-9.13	3.47	-7.64	4.35	-1671.86	-2734.09	-2728.24	-1677.70	-78.55	
1	70	17	-0.40-12.85	-2.71	-10.53	4.84	-1349.22	-2322.92	-2318.77	-1353.37	63.45	
1	70	19	2.43-6.70	1.35	-5.62	2.95	-1298.12	-2144.52	-2066.00	-1376.63	-245.54	
1	70	21	3.13-6.13	-0.42	-2.59	-4.50	-607.40	-1431.54	-1145.35	-893.59	392.37	
1	70	23	1.28e-03	-2.14	-2.01	-0.13	0.52	-1283.77	-2152.62	-2148.37	-1288.01	-60.60
1	70	25	3.77-5.22	3.77	-5.22	5.01e-02	-1268.04	-1937.85	-1937.24	-1268.65	20.21	
1	70	27	4.92-6.18	3.90	-5.17	-3.21	-1306.94	-2050.70	-2046.14	-1311.50	58.02	
1	70	29	4.51-6.45	-2.03	8.98e-02	5.38	-1549.38	-2865.94	-2865.25	-1550.08	30.23	
1	70	31	7.67-7.35	6.43	-6.10	4.14	-1692.45	-2880.51	-2873.38	-1699.57	-91.74	
1	70	33	6.93-7.08	5.78	-5.93	-3.84	-1615.34	-2702.32	-2698.37	-1619.29	65.42	
1	70	35	3.57-5.39	-1.80	-2.46e-02	-4.39	-1294.32	-2299.51	-2291.41	-1302.42	-89.86	
1	70	37	4.11-4.99	3.26	-4.14	-2.65	-1251.85	-2109.34	-2040.37	-1320.83	233.21	
1	70	39	4.90-4.74	-0.47	0.63	4.79	-598.51	-1380.71	-1124.35	-854.87	-367.16	
1	70	41	3.31-5.67	-2.07	-0.29	-4.40	409.25	-82.01	366.78	-39.53	138.07	
1	70	42	3.29-2.65 2.06e-02	0.62	-2.95	673.21	128.06	290.25	511.02	249.22		
1	70	43	10.22-3.56 10.12	-3.47	-1.16	622.28	-156.06	-120.03	586.25	163.55		
1	70	44	3.820.58	1.57	2.84	1.49	813.97	263.60	302.75	774.81	141.47	
1	70	45	7.052.42	4.31	5.17	2.28	840.23	-21.10	7.87	811.25	155.30	
1	70	46	3.306.85e-02	0.64	2.73	1.23	813.65	252.76	263.42	802.99	76.57	
1	70	47	3.898.44e-02	0.22	3.75	0.71	817.14	-25.74	-13.66	805.07	100.16	
1	70	48	2.54-4.62e-02	0.16	2.33	0.70	755.37	216.42	219.67	752.12	41.72	
1	70	49	2.78-0.10-5.97e-02	2.74	0.34	745.00	-36.42	-32.34	740.93	56.27		
1	70	50	2.08-2.07e-023.59e-02	2.02	0.34	689.29	186.54	187.32	688.50	19.84		
1	70	51	2.25-7.64e-02-6.34e-02	2.24	0.17	668.78	-48.15	-47.16	667.80	26.52		
1	70	52	1.882.01e-035.92e-03	1.88	8.57e-02	652.66	171.96	172.00	652.62	4.43		
1	70	53	2.04-5.86e-02-5.78e-02	2.04	4.11e-02	627.62	-54.55	-54.49	627.57	6.04		
1	70	54	1.915.87e-031.69e-02	1.89	-0.14	662.61	175.20	175.38	662.43	-9.53		
1	70	55	2.08-5.82e-02-5.45e-02	2.08	-8.98e-02	638.53	-53.19	-52.98	638.32	-12.08		
1	70	56	2.14-1.30e-026.94e-02	2.06	-0.41	714.94	195.46	196.85	713.55	-26.85		
1	70	57	2.37-7.57e-02-5.24e-02	2.35	-0.24	697.29	-44.83	-43.18	695.64	-34.95		
1	70	58	2.64-3.97e-02 0.21	2.39	-0.79	784.16	227.92	233.02	779.06	-53.00		
1	70	59	3.00-9.63e-02-3.18e-02	2.94	-0.44	778.10	-34.06	-28.19	772.23	-68.79		
1	70	60	3.340.11	0.71	2.74	-1.26	825.29	258.40	274.99	808.70	-95.55	
1	70	61	4.230.12	0.33	4.02	-0.90	831.66	-32.12	-16.23	815.78	-116.06	
1	70	62	3.280.88	1.36	2.80	-0.96	787.34	237.77	302.06	723.04	-176.63	
1	70	63	7.412.53	5.00	4.93	-2.44	795.79	-55.12	-21.76	762.43	-165.15	
1	70	64	4.99-3.28	-2.24	3.96	2.74	602.77	39.03	305.97	335.83	-281.48	
1	70	65	10.56-9.58	10.47	-9.50	1.29	470.75	-346.30	-316.75	441.20	-152.55	
1	70	66	3.07-5.21	0.53	-2.67	3.82	415.97	-82.64	379.84	-46.51	-129.27	
1	70	67	0.84-3.20	-3.15	0.78	0.48	721.98	61.26	705.81	77.44	102.10	
1	70	68	2.47-0.59	-0.39	2.26	0.77	679.69	455.04	612.14	522.59	103.02	
1	70	69	1.800.33	0.75	1.38	0.66	759.65	482.75	497.09	745.30	61.38	
1	70	70	2.130.16	0.74	1.55	0.90	795.36	414.64	416.63	793.37	27.50	
1	70	71	1.890.14	0.42	1.62	0.64	756.05	352.54	352.91	755.68	12.24	
1	70	72	1.690.13	0.21	1.61	0.34	699.01	310.59	310.66	698.95	5.04	
1	70	73	1.600.12	0.12	1.59	9.60e-02	665.71	291.54	291.55	665.71	1.01	
1	70	74	1.600.13	0.14	1.59	-0.13	674.88	296.06	296.08	674.86	-2.46	
1	70	75	1.700.16	0.26	1.60	-0.38	721.91	323.98	324.13	721.77	-7.55	
1	70	76	1.920.15	0.48	1.59	-0.68	778.88	374.27	375.03	778.12	-17.55	
1	70	77	2.199.55e-02 0.74	1.54	-0.97	796.16	443.21	447.43	791.94	-38.36		
1	70	78	2.33-8.51e-02 0.58	1.66	-1.08	724.73	505.21	539.02	690.92	-79.25		
1	70	79	1.00-0.20	-0.20	1.00	-4.01e-02	698.50	351.95	663.21	387.24	-104.82	
1	70	80	1.20-4.37	-4.33	1.15	-0.52	715.74	60.02	699.38	76.37	-102.26	
1	70	81	-2.21e-02	-2.58	-2.58	-2.68e-02	-0.11	831.32	94.95	826.03	100.24	-62.19
1	70	82	0.56-0.85	-0.84	0.55	-0.12	702.23	496.06	685.89	512.41	-55.70	
1	70	83	0.680.32	0.36	0.64	0.12	745.90	543.19	556.58	732.51	-50.34	
1	70	84	1.070.49	0.70	0.86	0.28	799.79	453.55	457.98	795.36	-38.92	





EGP CODE

GRE.EEC.R.73.IT.W.15235.12.024.01

PAGE

411 di/of 527

1	70	85	1.240.42	0.52	1.15	0.26	766.52	389.13	390.77	764.88	-24.76
1	70	86	1.340.28	0.30	1.31	0.16	710.48	348.64	349.08	710.04	-12.65
1	70	87	1.370.19	0.20	1.37	6.14e-02	677.07	330.68	330.70	677.04	-2.84
1	70	88	1.360.21	0.21	1.36	-3.96e-02	686.23	335.21	335.32	686.11	6.32
1	70	89	1.300.33	0.35	1.28	-0.14	733.13	362.33	363.09	732.36	16.78
1	70	90	1.180.49	0.59	1.08	-0.24	788.09	412.52	414.91	785.70	29.88
1	70	91	1.030.45	0.75	0.73	-0.29	797.19	487.59	494.10	790.67	44.43
1	70	92	0.450.21	0.29	0.37	-0.12	704.06	575.96	605.53	674.49	53.98
1	70	93	0.40-1.41	-1.40	0.39	0.16	751.21	382.18	742.50	390.90	56.05
1	70	94	-0.13-2.74	-2.74	-0.13	0.11	832.05	98.49	826.95	103.59	60.94
1	70	95	0.43-2.76	-2.37	3.61e-02	-1.05	765.07	-10.77	677.42	76.88	-245.59
1	70	96	1.24-1.45	-1.13	0.93	-0.86	756.49	317.82	562.97	511.34	-217.81
1	70	97	1.15-0.20	7.59e-02	0.87	-0.54	830.06	393.16	464.31	758.91	-161.31
1	70	98	1.140.34	0.54	0.94	-0.35	846.64	378.56	399.86	825.34	-97.55
1	70	99	1.230.36	0.41	1.19	-0.19	794.66	351.07	357.71	788.02	-53.86
1	70	100	1.310.23	0.23	1.30	-5.90e-02	728.80	328.06	329.73	727.14	-25.76
1	70	101	1.340.15	0.15	1.34	1.04e-02	691.43	316.66	316.74	691.34	-5.56
1	70	102	1.350.16	0.16	1.34	5.98e-02	701.55	319.74	320.18	701.11	12.93
1	70	103	1.320.25	0.27	1.30	0.15	754.57	336.75	339.79	751.53	35.52
1	70	104	1.280.36	0.47	1.17	0.31	822.33	363.53	374.07	811.80	68.73
1	70	105	1.240.23	0.62	0.85	0.49	855.44	390.32	423.63	822.14	119.92
1	70	106	0.94-0.31	4.27e-02	0.59	0.57	807.32	385.77	499.84	693.25	187.28
1	70	107	1.20-1.84	-1.64	1.00	0.76	749.61	238.64	609.87	378.38	227.76
1	70	108	0.38-3.10	-2.64	-7.24e-02	1.18	763.77	-9.69	677.21	76.87	243.84
1	70	109	-0.25-3.17	-2.81	-0.62	-0.97	437.61	-255.33	213.73	-31.45	-324.06
1	70	110	5.56-2.35	-1.53	4.73	-2.42	765.35	14.19	247.42	532.13	-347.56
1	70	111	1.88-0.22	-2.33e-02	1.69	-0.61	903.04	179.05	242.01	840.08	-204.00
1	70	112	2.33-0.20	0.20	1.92	-0.92	899.47	263.48	283.08	879.87	-109.91
1	70	113	1.85-3.69e-02	7.99e-02	1.74	-0.46	826.67	281.96	288.41	820.22	-58.92
1	70	114	1.589.17e-03	2.78e-02	1.56	-0.17	749.22	279.99	281.66	747.55	-27.96
1	70	115	1.487.78e-03	7.93e-03	1.48	-1.50e-02	707.19	276.22	276.31	707.11	-6.01
1	70	116	1.515.21e-03	1.25e-02	1.50	0.10	718.53	277.39	277.84	718.08	14.12
1	70	117	1.67-7.38e-03	4.11e-02	1.63	0.28	778.86	281.93	284.99	775.79	38.91
1	70	118	2.05-9.18e-02	0.10	1.85	0.62	861.34	279.48	289.75	851.08	76.60
1	70	119	2.68-0.32	0.25	2.11	1.18	917.22	245.96	276.86	886.32	140.66
1	70	120	2.59-0.67	-0.30	2.22	1.04	879.16	124.98	228.95	775.19	260.00
1	70	121	3.66-0.43	-0.12	3.35	1.08	648.37	-41.29	273.78	333.30	343.54
1	70	122	0.40-6.29	-5.77	-0.12	1.80	414.35	-270.83	188.53	-45.01	322.07
1	70	123	7.00-4.35	2.29	0.36	5.59	-435.11	-695.69	-590.24	-540.55	-127.90
1	70	124	3.49-4.15	2.61	-3.26	2.45	801.32	-349.95	-241.28	692.64	-336.61
1	70	125	5.26-2.50	-0.81	3.56	-3.20	943.95	41.41	66.98	918.37	-149.77
1	70	126	3.45-0.81	-0.69	3.32	-0.73	928.96	180.23	186.35	922.84	-67.41
1	70	127	2.35-0.31	-0.29	2.33	-0.23	847.05	222.50	224.80	844.75	-37.82
1	70	128	1.81-0.15	-0.15	1.81	-5.34e-02	763.32	231.06	231.74	762.64	-18.95
1	70	129	1.61-0.10	-0.10	1.61	1.17e-02	718.63	230.99	231.02	718.59	-4.25
1	70	130	1.65-0.11	-0.11	1.65	5.20e-02	730.72	231.16	231.35	730.53	9.62
1	70	131	1.94-0.17	-0.16	1.93	0.13	795.28	229.37	230.54	794.12	25.65
1	70	132	2.62-0.36	-0.32	2.58	0.34	885.67	211.33	214.74	882.26	47.84
1	70	133	3.89-0.97	-0.79	3.72	0.91	951.05	142.32	151.38	941.99	85.11
1	70	134	5.75-2.73	-0.28	3.30	3.84	913.72	-67.98	-28.25	873.99	193.46
1	70	135	4.81-6.37	-1.21	-0.35	-5.58	623.89	-616.93	-395.57	402.53	475.05
1	70	136	8.51-2.00	7.13	-0.62	-3.54	-494.46	-659.88	-553.29	-601.05	79.18
1	70	137	20.025.72	20.00	5.74	0.47	841.29	-109.73	-107.51	839.07	-45.94
1	70	138	9.497.55e-02	27.64e-02	9.49	9.10e-02	1004.33	52.81	54.54	1002.60	-40.51
1	70	139	3.513.48e-02	23.54e-02	3.51	4.27e-02	933.75	172.38	173.79	932.33	-32.80
1	70	140	2.33-0.26	-0.26	2.33	4.84e-02	850.16	205.24	206.06	849.34	-22.97
1	70	141	1.82-0.18	-0.18	1.82	4.57e-02	766.26	211.93	212.23	765.96	-12.91
1	70	142	1.62-0.12	-0.12	1.62	3.22e-02	721.36	211.42	211.44	721.34	-3.09
1	70	143	1.66-0.13	-0.13	1.66	1.59e-02	733.53	211.69	211.77	733.45	6.63
1	70	144	1.94-0.19	-0.19	1.94	4.15e-03	798.43	210.52	210.99	797.96	16.54
1	70	145	2.57-0.27	-0.27	2.57	-1.95e-03	888.83	194.75	195.78	887.80	26.67
1	70	146	4.000.17	0.17	3.99	-2.19e-02	955.47	138.17	139.79	953.85	36.32
1	70	147	11.92-0.36	-0.36	11.92	-0.15	992.19	-35.37	-33.53	990.36	43.39
1	70	148	29.50-8.27	29.48	-8.25	-0.92	656.57	-536.18	-534.79	655.17	40.75
1	70	149	6.07-3.07	3.02	-1.77e-02	-4.31	-520.40	-603.16	-592.08	-531.48	28.18
1	70	150	3.09-3.86	2.25	-3.02	-2.27	752.09	-333.59	-277.38	695.87	240.56
1	70	151	5.05-2.38	-0.72	3.38	3.10	924.77	30.26	35.21	919.81	66.37
1	70	152	3.44-0.86	-0.71	3.29	0.78	927.46	152.54	152.54	927.45	1.62
1	70	153	2.36-0.35	-0.31	2.32	0.32	850.04	190.45	190.54	849.95	-7.99
1	70	154	1.81-0.17	-0.16	1.80	0.15	767.75	197.38	197.46	767.67	-6.77
1	70	155	1.60-0.11	-0.10	1.60	5.26e-02	723.40	196.86	196.87	723.39	-1.90
1	70	156	1.64-0.11	-0.11	1.64	-2.19e-02	735.43	197.23	197.25	735.40	3.58
1	70	157	1.94-0.18	-0.17	1.93	-0.12	799.40	196.38	196.47	799.31	7.31
1	70	158	2.61-0.37	-0.33	2.58	-0.33	887.60	180.91	180.95	887.56	5.38
1	70	159	3.85-0.96	-0.79	3.68	-0.88	946.68	118.19	118.37	946.51	-11.97
1	70	160	5.46-2.56	-0.12	3.02	-3.69	886.61	-70.58	-59.40	875.43	-102.84



EGP CODE

GRE.EEC.R.73.IT.W.15235.12.024.01

PAGE

412 di/of 527

1	70	161	4.34-6.62	-1.41	-0.86	5.47	536.53	-569.34	-425.28	392.47	-372.24
1	70	162	7.29-1.49	6.80	-1.00	2.01	-555.38	-610.07	-564.81	-600.64	20.66
1	70	163	-0.34-3.00	-2.48	-0.86	1.06	276.04	-169.16	137.83	-30.96	205.98
1	70	164	5.07-2.37	-1.83	4.54	1.93	648.33	40.65	159.62	529.37	241.12
1	70	165	1.81-0.39	-0.31	1.72	0.42	868.04	126.31	145.32	849.03	117.22
1	70	166	2.33-0.33	6.35e-02	1.94	0.94	897.45	180.26	182.80	894.91	42.60
1	70	167	1.89-0.15	1.70e-02	1.72	0.55	837.03	187.08	187.34	836.77	12.95
1	70	168	1.57-3.01e-02	1.55e-02	1.52	0.27	763.23	181.27	181.28	763.22	2.66
1	70	169	1.441.26e-02	1.65e-02	1.44	7.49e-02	721.85	176.66	176.66	721.85	0.10
1	70	170	1.481.13e-02	1.63e-02	1.47	-8.58e-02	733.09	178.26	178.26	733.08	-1.06
1	70	171	1.68-2.78e-02	2.19e-02	1.63	-0.29	792.11	184.91	184.97	792.04	-6.08
1	70	172	2.06-0.13	5.48e-02	1.88	-0.60	868.75	188.96	189.72	867.99	-22.66
1	70	173	2.61-0.30	0.18	2.13	-1.08	906.88	172.95	178.82	901.01	-65.35
1	70	174	2.42-0.63	-0.43	2.22	-0.75	822.71	96.50	136.53	782.68	-165.73
1	70	175	3.49-0.54	-0.43	3.38	-0.66	503.67	20.15	189.73	334.10	-230.73
1	70	176	0.66-6.18	-5.47	-5.27e-02	-2.09	253.71	-180.12	114.86	-41.27	-202.38
1	70	177	0.36-2.08	-1.96	0.25	0.52	554.95	48.00	528.17	74.79	113.41
1	70	178	1.45-1.61	-1.54	1.38	0.44	579.18	343.96	406.91	516.23	104.14
1	70	179	1.33-0.57	-0.46	1.23	0.44	788.20	292.09	301.44	778.85	67.44
1	70	180	1.284.39e-02	0.24	1.08	0.45	856.78	234.81	236.15	855.44	28.88
1	70	181	1.300.17	0.29	1.19	0.34	819.51	197.80	197.95	819.36	9.76
1	70	182	1.270.18	0.21	1.24	0.17	755.55	174.61	174.62	755.54	2.63
1	70	183	1.260.16	0.16	1.26	4.19e-02	717.43	164.33	164.33	717.42	0.44
1	70	184	1.290.16	0.16	1.29	-7.12e-02	727.77	167.51	167.51	727.77	-0.86
1	70	185	1.350.19	0.22	1.31	-0.20	781.28	184.11	184.15	781.24	-4.63
1	70	186	1.390.22	0.34	1.28	-0.35	844.47	213.82	214.21	844.08	-15.69
1	70	187	1.310.17	0.38	1.10	-0.44	854.53	258.35	261.27	851.61	-41.60
1	70	188	1.08-0.37	-0.29	1.00	-0.32	729.46	322.03	340.32	711.17	-84.35
1	70	189	1.40-1.73	-1.69	1.36	-0.37	534.19	306.63	457.75	383.07	-107.48
1	70	190	0.38-2.51	-2.26	0.13	-0.82	554.50	51.62	529.27	76.85	-109.77
1	70	191	0.79-2.47	-2.07	0.39	-1.07	592.70	75.88	583.00	85.58	-70.12
1	70	192	1.55-1.89	-1.86	1.52	-0.31	555.81	410.01	447.20	518.62	-63.56
1	70	193	1.25-0.56	-0.56	1.25	6.49e-02	776.57	319.91	324.44	772.04	-45.25
1	70	194	1.030.29	0.29	1.03	2.84e-02	850.31	241.72	242.57	849.46	-22.63
1	70	195	1.130.38	0.38	1.13	-1.17e-02	816.34	193.68	193.85	816.17	-10.22
1	70	196	1.200.29	0.29	1.20	-1.53e-02	753.87	165.49	165.52	753.84	-4.06
1	70	197	1.230.23	0.23	1.23	-1.80e-02	716.19	153.41	153.41	716.19	-0.45
1	70	198	1.250.22	0.22	1.25	-1.90e-02	726.37	156.97	156.98	726.36	2.68
1	70	199	1.270.28	0.28	1.27	-6.04e-03	778.91	176.47	176.55	778.83	6.99
1	70	200	1.250.37	0.37	1.25	4.64e-02	839.64	213.48	213.82	839.30	14.58
1	70	201	1.200.30	0.33	1.17	0.16	845.39	273.60	275.06	843.93	28.86
1	70	202	1.18-0.41	-0.38	1.15	0.19	716.70	363.95	372.07	708.58	52.90
1	70	203	1.48-1.84	-1.80	1.44	0.36	536.97	361.44	504.40	394.01	68.24
1	70	204	0.64-2.59	-2.24	0.29	1.01	596.38	79.24	585.37	90.25	74.65
1	70	205	0.73-4.77	-3.44	-0.59	-2.35	420.24	-90.65	314.98	14.61	-206.63
1	70	206	4.38-2.77	-2.64	4.25	-0.96	649.43	167.82	283.99	533.25	-206.04
1	70	207	2.08-0.56	-0.56	2.08	2.70e-02	854.99	179.44	207.36	827.08	-134.47
1	70	208	1.790.21	0.28	1.71	-0.33	887.24	183.13	188.22	882.15	-59.65
1	70	209	1.580.26	0.32	1.52	-0.27	832.13	166.09	167.01	831.20	-24.81
1	70	210	1.440.22	0.24	1.42	-0.15	760.40	149.38	149.51	760.27	-8.93
1	70	211	1.380.18	0.19	1.37	-5.95e-02	719.57	140.68	140.68	719.57	-1.14
1	70	212	1.390.18	0.18	1.39	1.91e-02	730.55	143.02	143.07	730.51	5.17
1	70	213	1.490.20	0.21	1.48	0.12	788.17	155.85	156.24	787.78	15.61
1	70	214	1.720.19	0.23	1.68	0.25	860.95	175.20	177.29	858.85	37.84
1	70	215	2.20-6.05e-03	7.92e-02	2.11	0.42	891.49	193.12	203.32	881.29	83.80
1	70	216	3.46-0.95	-0.71	3.21	1.01	813.43	187.13	237.55	763.02	170.39
1	70	217	2.92-0.94	-0.93	2.91	-0.20	560.44	151.73	329.52	382.66	202.62
1	70	218	2.32-6.98	-6.07	1.41	2.76	411.17	-93.72	302.24	15.21	207.68
1	70	219	3.08-3.20	2.88	-3.00	1.10	27.33	-297.42	-105.06	-165.03	-159.58
1	70	220	3.96-6.24	-2.33	5.02e-02	4.96	694.90	-270.49	-128.56	552.98	-341.86
1	70	221	3.19-0.21	-0.21	3.19	-2.60e-02	933.14	11.83	35.34	909.63	-145.27
1	70	222	2.640.35	0.40	2.59	-0.33	931.98	110.82	113.78	929.02	-49.27
1	70	223	2.100.18	0.21	2.06	-0.25	852.20	133.79	134.23	851.77	-17.68
1	70	224	1.740.12	0.13	1.73	-0.13	768.73	133.23	133.28	768.68	-5.49
1	70	225	1.570.10	0.10	1.57	-4.93e-02	723.75	129.60	129.60	723.75	-0.54
1	70	226	1.589.88e-02	2.91e-02	1.58	1.98e-02	735.88	130.16	130.17	735.86	3.15
1	70	227	1.760.10	0.11	1.76	9.47e-02	800.41	132.98	133.15	800.24	10.58
1	70	228	2.140.14	0.15	2.12	0.17	888.97	126.27	127.39	887.85	29.24
1	70	229	2.720.21	0.22	2.71	8.03e-02	948.38	82.34	88.90	941.81	75.10
1	70	230	3.76-1.26	-0.97	3.47	-1.16	890.87	-68.30	-23.51	846.08	202.38
1	70	231	7.46-7.45	-5.89	5.90	-4.56	514.83	-379.74	-145.79	280.88	393.13
1	70	232	5.44-6.67	5.42	-6.65	0.58	-8.43	-298.60	-99.02	-208.01	134.46
1	70	233	-0.50-5.69	-5.69	-0.50	3.46e-02	924.02	-48.47	922.37	-46.82	-40.02
1	70	234	14.85-9.29	14.85	-9.29	-0.16	828.43	-483.76	-483.57	828.24	15.80
1	70	235	6.433.30	6.43	3.30	-1.81e-02	1017.84	-20.18	-19.96	1017.63	14.80
1	70	236	2.970.89	0.89	2.97	3.15e-02	950.72	85.40	85.59	950.53	12.84



EGP CODE

GRE.EEC.R.73.IT.W.15235.12.024.01

PAGE

413 di/of 527

1	70	237	2.330.18	0.18	2.33	3.08e-02	859.10	121.63	121.74	858.99	9.22
1	70	238	1.888.29e-028.31e-02		1.88	1.99e-02	770.05	127.88	127.92	770.01	5.24
1	70	239	1.677.14e-027.14e-02		1.67	6.79e-03	723.07	126.43	126.44	723.06	1.19
1	70	240	1.686.77e-026.77e-02		1.68	-5.44e-03	735.75	126.20	126.22	735.74	-2.88
1	70	241	1.887.38e-027.39e-02		1.88	-1.53e-02	803.69	124.56	124.63	803.62	-6.97
1	70	242	2.290.18	0.18	2.29	-2.15e-02	899.99	106.15	106.30	899.84	-10.93
1	70	243	2.740.96	0.96	2.74	-1.81e-02	974.13	37.58	37.80	973.91	-14.32
1	70	244	6.812.36	6.81	2.36	4.85e-02	982.99	-143.92	-143.70	982.77	-15.61
1	70	245	16.13-21.62	16.13	-21.62	0.18	592.91	-918.67	-918.52	592.77	-14.70
1	70	246	2.91-0.36	0.36	2.19	-1.36	841.65	340.51	390.26	791.90	-149.85
1	70	247	2.95-3.15	2.55	-2.76	-1.49	69.01	-326.87	-94.94	-162.92	195.00
1	70	248	4.12-6.38	-2.37	0.12	-5.10	722.44	-283.78	-116.12	554.79	374.96
1	70	249	3.38-0.15	-0.14	3.37	0.22	942.27	13.97	48.65	907.59	176.04
1	70	250	2.760.32	0.41	2.67	0.44	929.66	116.62	123.44	922.83	74.17
1	70	251	2.160.17	0.22	2.11	0.32	845.68	139.54	141.31	843.91	35.31
1	70	252	1.780.13	0.15	1.76	0.18	760.57	138.08	138.47	760.19	15.42
1	70	253	1.600.13	0.13	1.60	6.34e-02	715.09	133.87	133.89	715.07	2.81
1	70	254	1.610.12	0.12	1.61	-3.29e-02	727.28	134.66	134.78	727.16	-8.55
1	70	255	1.800.11	0.12	1.79	-0.13	792.65	138.34	139.21	791.79	-23.81
1	70	256	2.190.13	0.16	2.17	-0.22	883.79	132.27	135.65	880.41	-50.29
1	70	257	2.790.21	0.22	2.78	-0.16	949.23	87.22	99.73	936.73	-103.08
1	70	258	3.82-1.08	-0.88	3.62	0.97	906.16	-69.50	-8.99	845.65	-235.33
1	70	259	7.65-7.58	-6.02	6.08	4.62	553.49	-399.99	-133.82	287.32	-427.71
1	70	260	5.48-6.62	5.47	-6.62	-0.19	34.95	-325.00	-85.96	-204.09	-170.01
1	70	261	0.70-4.82	-3.67	-0.46	2.25	475.65	-111.22	345.55	18.88	243.77
1	70	262	4.56-2.80	-2.62	4.38	1.14	690.06	160.15	313.37	536.84	240.25
1	70	263	2.20-0.54	-0.53	2.19	0.16	863.68	191.11	233.24	821.55	162.98
1	70	264	1.950.17	0.31	1.80	0.49	879.86	198.55	208.47	869.95	81.61
1	70	265	1.690.26	0.37	1.58	0.37	818.32	178.65	181.09	815.87	39.49
1	70	266	1.500.26	0.30	1.47	0.21	744.52	158.31	158.80	744.03	16.87
1	70	267	1.430.24	0.24	1.42	7.38e-02	703.18	147.71	147.73	703.17	2.99
1	70	268	1.450.22	0.23	1.45	-3.80e-02	714.13	150.71	150.86	713.98	-9.28
1	70	269	1.560.22	0.24	1.54	-0.16	772.53	166.54	167.68	771.39	-26.22
1	70	270	1.820.19	0.26	1.75	-0.33	848.82	189.73	194.49	844.06	-55.81
1	70	271	2.31-2.34e-02	0.11	2.18	-0.54	889.30	208.77	226.80	871.27	-109.29
1	70	272	3.59-0.98	-0.66	3.27	-1.16	833.05	194.23	265.81	761.48	-201.50
1	70	273	2.85-0.89	-0.89	2.85	6.62e-02	611.86	136.22	360.83	387.24	-237.45
1	70	274	2.26-7.12	-6.28	1.43	-2.67	466.86	-113.63	334.19	19.04	-243.75
1	70	275	0.78-2.68	-2.34	0.45	1.02	671.83	75.69	652.92	94.59	104.46
1	70	276	1.68-2.06	-2.01	1.62	0.44	609.25	420.60	507.07	522.78	94.00
1	70	277	1.34-0.57	-0.56	1.33	0.15	774.24	360.98	372.71	762.50	68.64
1	70	278	1.130.35	0.38	1.10	0.15	833.13	273.83	276.30	830.65	37.14
1	70	279	1.210.46	0.48	1.19	0.13	794.86	213.18	213.73	794.30	17.94
1	70	280	1.260.39	0.40	1.26	7.35e-02	731.92	175.55	175.66	731.81	7.61
1	70	281	1.300.32	0.32	1.30	3.00e-02	694.40	159.21	159.21	694.40	1.38
1	70	282	1.320.30	0.30	1.32	-7.01e-03	704.26	164.07	164.10	704.23	-4.08
1	70	283	1.340.34	0.35	1.34	-5.45e-02	756.29	190.44	190.68	756.05	-11.65
1	70	284	1.350.40	0.42	1.33	-0.13	818.35	239.12	240.19	817.28	-24.79
1	70	285	1.320.31	0.38	1.24	-0.26	832.17	312.19	316.58	827.78	-47.57
1	70	286	1.23-0.39	-0.34	1.17	-0.30	727.49	405.78	427.22	706.05	-80.24
1	70	287	1.47-1.95	-1.89	1.41	-0.46	616.07	357.78	570.12	403.73	-98.78
1	70	288	0.64-2.85	-2.48	0.28	-1.07	677.58	80.93	657.95	100.56	-106.44
1	70	289	0.59-2.58	-2.41	0.42	-0.72	686.43	82.55	670.89	98.10	-95.62
1	70	290	1.53-1.92	-1.91	1.52	-0.19	608.02	438.83	521.25	525.59	-84.57
1	70	291	1.33-0.47	-0.46	1.32	-0.15	772.41	373.77	383.28	762.90	-60.83
1	70	292	1.240.31	0.39	1.16	-0.26	831.97	281.13	283.09	830.01	-32.77
1	70	293	1.300.41	0.47	1.25	-0.22	794.37	217.21	217.65	793.93	-16.03
1	70	294	1.320.36	0.38	1.31	-0.12	731.86	178.02	178.11	731.77	-6.89
1	70	295	1.340.30	0.30	1.34	-3.31e-02	694.51	161.10	161.11	694.51	-1.17
1	70	296	1.360.28	0.28	1.36	4.23e-02	704.35	166.04	166.07	704.32	3.92
1	70	297	1.390.32	0.33	1.38	0.12	756.13	193.20	193.41	755.92	10.85
1	70	298	1.420.36	0.41	1.37	0.23	817.54	243.94	244.82	816.67	22.42
1	70	299	1.400.28	0.40	1.27	0.35	830.34	321.22	324.70	826.87	41.90
1	70	300	1.19-0.30	-0.24	1.14	0.28	724.48	421.94	439.44	706.99	70.62
1	70	301	1.27-1.84	-1.82	1.26	0.21	622.39	370.53	585.70	407.21	88.84
1	70	302	0.47-2.71	-2.51	0.27	0.78	692.42	88.76	676.39	104.80	97.06
1	70	303	0.31-4.74	-3.82	-0.61	-1.95	525.98	-88.94	405.82	31.22	-243.82
1	70	304	3.92-2.32	-2.22	3.82	-0.79	702.69	197.98	354.61	546.06	-233.50
1	70	305	2.43-0.35	-0.28	2.35	-0.44	865.79	221.45	265.98	821.26	-163.43
1	70	306	2.210.11	0.29	2.03	-0.59	879.42	215.02	225.67	868.77	-83.43
1	70	307	1.880.19	0.31	1.76	-0.43	818.44	187.93	190.60	815.77	-40.90
1	70	308	1.640.20	0.23	1.60	-0.23	745.09	164.37	164.90	744.56	-17.58
1	70	309	1.530.18	0.19	1.53	-6.61e-02	703.94	152.60	152.61	703.92	-3.13
1	70	310	1.550.17	0.18	1.55	7.27e-02	714.89	155.73	155.90	714.73	9.69
1	70	311	1.690.17	0.20	1.65	0.22	773.06	173.12	174.36	771.81	27.32
1	70	312	1.970.13	0.23	1.88	0.41	848.63	200.42	205.60	843.45	57.72



EGP CODE

GRE.EEC.R.73.IT.W.15235.12.024.01

PAGE

414 di/of 527

1	70	313	2.50-5.42e-02	0.12	2.32	0.64	888.15	228.53	247.83	868.85	111.18
1	70	314	3.73-0.82	-0.33	3.24	1.41	835.72	230.33	304.70	761.36	198.72
1	70	315	2.30-0.83	-0.78	2.26	-0.38	638.00	167.30	404.78	400.51	235.34
1	70	316	2.04-6.70	-6.06	1.40	2.28	520.41	-86.44	399.35	34.63	242.51
1	70	317	2.76-3.56	2.62	-3.42	0.94	228.48	-275.95	29.09	-76.56	-246.62
1	70	318	4.19-5.94	-2.62	0.88	4.75	743.02	-250.11	-53.55	546.46	-395.69
1	70	319	4.020.15	0.16	4.01	0.17	954.69	34.65	77.16	912.19	-193.14
1	70	320	3.120.31	0.38	3.04	-0.44	935.45	127.14	136.33	926.26	-85.72
1	70	321	2.409.11e-02	0.14	2.36	-0.33	849.56	147.25	149.64	847.17	-40.93
1	70	322	1.965.22e-026.72e-02		1.94	-0.17	763.51	145.09	145.59	763.00	-17.74
1	70	323	1.755.17e-025.27e-02		1.75	-4.07e-02	717.64	140.70	140.72	717.63	-3.32
1	70	324	1.764.75e-025.02e-02		1.76	6.78e-02	730.00	141.36	141.51	729.85	9.52
1	70	325	1.974.23e-025.93e-02		1.95	0.18	796.06	145.01	146.13	794.94	27.03
1	70	326	2.407.89e-02	0.12	2.37	0.29	888.34	139.57	144.06	883.85	57.84
1	70	327	3.070.25	0.26	3.05	0.22	955.96	97.57	114.23	939.30	118.41
1	70	328	4.55-1.09	-0.67	4.14	-1.47	918.19	-45.39	28.44	844.36	256.30
1	70	329	7.75-6.96	-5.92	6.71	-3.77	592.84	-340.73	-44.48	296.59	434.52
1	70	330	5.02-7.35	4.96	-7.30	0.84	198.26	-282.83	33.54	-118.11	228.28
1	70	331	3.15-4.73	-1.32	-0.26	-3.91	325.97	-203.29	201.46	-78.78	-224.48
1	70	332	16.24-9.25	16.22	-9.22	-0.79	860.12	-502.35	-500.45	858.21	-50.87
1	70	333	6.723.47	6.34	3.86	-1.05	1040.25	-30.90	-30.64	1039.98	-16.94
1	70	334	3.190.86	0.86	3.19	6.96e-02	964.49	84.60	84.74	964.35	-11.11
1	70	335	2.500.10	0.11	2.50	0.13	867.97	125.39	125.46	867.90	-7.09
1	70	336	2.029.92e-031.40e-02		2.02	9.07e-02	775.88	133.82	133.84	775.85	-3.97
1	70	337	1.799.13e-031.05e-02		1.79	4.92e-02	727.61	133.12	133.12	727.60	-1.09
1	70	338	1.801.10e-021.11e-02		1.80	1.12e-02	740.66	132.69	132.70	740.66	1.73
1	70	339	2.031.72e-021.75e-02		2.03	-2.40e-02	810.64	129.80	129.84	810.61	4.54
1	70	340	2.480.13	0.13	2.48	-3.86e-02	910.71	108.41	108.48	910.64	7.45
1	70	341	3.020.97	0.98	3.01	0.12	990.30	34.08	34.21	990.17	11.20
1	70	342	7.482.44	6.77	3.15	1.75	1009.98	-158.93	-158.47	1009.51	23.35
1	70	343	18.11-22.52	18.04	-22.46	1.62	631.41	-955.27	-953.40	629.54	54.44
1	70	344	16.81-4.97	7.17	4.67	10.82	-181.42	-1058.46	-1058.39	-181.48	-7.72
1	70	345	16.165.87	9.26	12.77	-4.84	-24.44	-1203.16	-1202.67	-24.93	-24.01
1	70	346	2.91-3.85	1.48	-2.42	2.76	44.33	-172.98	-21.34	-107.32	99.79
1	70	347	-1.47-1.80	-1.78	-1.50	-8.43e-02	450.45	-73.45	447.91	-70.91	36.42
1	70	348	3.73-0.89	1.28	1.56	-2.30	379.13	-62.82	369.17	-52.86	-65.60
1	70	349	9.70-10.52	6.27	-7.08	7.60	-270.66	-371.42	-334.19	-307.88	48.63
1	70	350	11.46-0.73	0.80	9.93	4.05	8.88	-423.61	-399.18	-15.55	-99.85
1	70	351	16.99-5.09	11.87	3.47e-02	-9.32	-202.14	-800.86	-799.55	-203.44	27.92
1	70	352	4.69-3.14	1.25	0.30	3.89	430.87	-180.31	316.19	-65.63	238.62
1	70	353	-0.98-4.41	-4.39	-1.00	0.24	839.71	-72.51	816.35	-49.15	144.09
1	70	354	-0.44-5.83	-5.83	-0.44	1.16e-02	1042.39	-44.55	1038.35	-40.51	66.13
1	70	355	-0.43-6.36	-6.36	-0.43	8.69e-02	1091.33	-41.15	1091.16	-40.98	-13.65
1	70	356	-1.20-6.46	-6.46	-1.20	8.52e-02	981.04	-60.83	972.54	-52.33	-93.72
1	70	357	4.42-3.36	3.40	-2.34	-2.63	-162.89	-436.43	-312.40	-286.93	136.18
1	70	358	4.21-7.25	-2.29	-0.74	-5.68	736.97	-362.59	-230.39	604.77	357.61
1	70	359	2.94-0.60	-0.48	2.82	0.64	958.97	-25.39	-2.26	935.84	149.11
1	70	360	2.740.20	0.29	2.64	0.48	950.38	102.55	105.33	947.61	48.43
1	70	361	2.219.15e-02	0.15	2.15	0.34	862.44	135.93	136.37	862.00	17.79
1	70	362	1.836.37e-028.77e-02		1.81	0.20	774.17	138.78	138.83	774.11	5.70
1	70	363	1.656.99e-027.51e-02		1.65	9.13e-02	727.30	136.02	136.02	727.30	0.48
1	70	364	1.667.21e-027.21e-02		1.66	-8.75e-03	739.94	136.46	136.48	739.92	-3.53
1	70	365	1.876.54e-027.23e-02		1.86	-0.11	807.53	137.91	138.09	807.34	-11.12
1	70	366	2.297.35e-029.21e-02		2.27	-0.20	902.35	126.35	127.45	901.24	-29.23
1	70	367	2.898.50e-029.56e-02		2.88	-0.17	971.51	68.63	74.59	965.55	-73.11
1	70	368	3.17-1.14	-1.11	3.13	0.41	924.16	-121.28	-78.85	881.72	-206.32
1	70	369	8.34-8.80	-6.27	5.81	6.08	537.88	-519.43	-287.87	306.32	-437.28
1	70	370	6.92-6.05	6.87	-5.99	0.86	-217.75	-419.96	-301.27	-336.45	-99.56
1	70	371	1.62-5.03	-3.15	-0.25	2.99	413.05	-159.46	250.51	3.08	258.14
1	70	372	5.86-3.57	-3.27	5.56	1.64	696.68	93.67	245.70	544.65	261.84
1	70	373	2.24-1.04	-1.02	2.22	-0.27	887.48	144.39	182.35	849.53	163.60
1	70	374	1.828.80e-02	0.18	1.73	0.39	904.97	177.09	184.70	897.36	74.03
1	70	375	1.630.17	0.27	1.53	0.37	840.49	169.72	171.15	839.05	31.02
1	70	376	1.470.18	0.23	1.43	0.24	764.38	155.22	155.42	764.18	11.09
1	70	377	1.390.19	0.20	1.38	0.10	722.05	146.75	146.75	722.04	1.42
1	70	378	1.410.20	0.20	1.41	-2.49e-02	733.50	149.16	149.23	733.43	-6.27
1	70	379	1.540.19	0.21	1.52	-0.17	793.79	161.54	162.12	793.21	-19.11
1	70	380	1.820.13	0.20	1.74	-0.35	872.89	177.09	180.21	869.78	-46.46
1	70	381	2.35-0.11	5.19e-03	2.24	-0.51	916.07	180.63	195.20	901.49	-102.50
1	70	382	3.78-1.34	-1.19	3.63	-0.86	855.92	136.03	203.14	788.81	-209.30
1	70	383	4.15-0.95	-0.93	4.14	-0.30	594.96	77.16	289.61	382.50	-254.70
1	70	384	3.07-7.87	-6.49	1.70	-3.63	398.10	-170.95	229.71	-2.56	-259.74
1	70	385	1.32-2.72	-1.86	0.46	1.65	657.30	64.02	626.96	94.37	130.71
1	70	386	1.92-2.23	-2.07	1.77	0.79	627.06	386.35	483.02	530.39	118.00
1	70	387	1.38-0.86	-0.86	1.37	0.12	793.93	336.88	352.45	778.35	82.92
1	70	388	1.030.12	0.13	1.02	8.46e-02	854.03	258.83	261.54	851.32	40.09





EGP CODE

GRE.EEC.R.73.IT.W.15235.12.024.01

PAGE

415 di/of 527

1	70	389	1.090.32	0.34	1.07	0.12	816.91	203.73	204.13	816.50	15.69	
1	70	390	1.150.31	0.33	1.14	9.23e-02	754.08	169.59	169.63	754.04	4.95	
1	70	391	1.190.28	0.29	1.19	5.45e-02	716.49	154.80	154.80	716.49	0.40	
1	70	392	1.210.29	0.30	1.21	1.30e-02	726.82	159.09	159.11	726.81	-2.92	
1	70	393	1.210.34	0.35	1.20	-5.66e-02	779.71	182.70	182.83	779.57	-9.08	
1	70	394	1.220.34	0.38	1.19	-0.18	841.87	226.55	227.44	840.98	-23.37	
1	70	395	1.270.12	0.22	1.17	-0.33	853.68	292.60	297.64	848.64	-52.94	
1	70	396	1.36-0.68	-0.59	1.28	-0.41	746.80	374.59	403.00	718.39	-98.82	
1	70	397	1.88-2.05	-1.87	1.70	-0.84	617.78	331.90	543.38	406.30	-125.44	
1	70	398	1.13-2.90	-2.10	0.34	-1.61	661.10	65.63	628.82	97.92	-134.84	
1	70	399	0.16-1.97	-1.97	0.16	7.61e-02	694.17	99.13	684.29	109.02	-76.06	
1	70	400	0.92-1.44	-1.44	0.92	-5.12e-02	592.37	463.61	525.18	530.80	-64.32	
1	70	401	1.05-0.66	-0.63	1.03	-0.20	773.02	372.93	378.93	767.02	-48.62	
1	70	402	1.011.54e-029.24e-02		0.93	-0.27	843.85	270.27	271.90	842.22	-30.55	
1	70	403	1.080.25	0.32	1.01	-0.23	813.68	204.86	205.32	813.21	-16.78	
1	70	404	1.160.27	0.29	1.14	-0.14	753.82	167.55	167.66	753.71	-7.86	
1	70	405	1.210.25	0.25	1.21	-2.03e-02	717.17	152.07	152.08	717.16	-1.78	
1	70	406	1.240.26	0.27	1.23	9.28e-02	727.36	156.57	156.60	727.34	3.71	
1	70	407	1.220.32	0.36	1.17	0.19	778.96	181.48	181.67	778.77	10.79	
1	70	408	1.120.37	0.45	1.04	0.23	837.52	229.70	230.48	836.74	21.73	
1	70	409	0.920.26	0.32	0.86	0.19	840.84	308.65	311.36	838.13	37.86	
1	70	410	0.81-0.41	-0.40	0.80	9.79e-02	717.86	423.72	434.67	706.91	55.69	
1	70	411	0.63-1.52	-1.51	0.63	5.59e-02	610.93	385.78	589.45	407.27	66.14	
1	70	412	5.66e-02	-2.14	-2.13	5.53e-02	5.33e-02	695.40	105.90	686.25	115.06	72.90
1	70	413	1.07-2.41	-1.68	0.34	-1.42	602.42	-64.60	464.09	73.73	-270.43	
1	70	414	2.00-1.94	-1.66	1.72	-1.00	695.93	183.92	347.85	531.99	-238.88	
1	70	415	1.64-0.77	-0.59	1.46	-0.63	849.85	206.20	252.17	803.89	-165.75	
1	70	416	1.60-0.16	0.17	1.26	-0.69	887.67	187.25	198.24	876.67	-87.07	
1	70	417	1.68-6.70e-02	0.19	1.42	-0.62	836.01	164.58	167.00	833.59	-40.24	
1	70	418	1.571.81e-02	0.10	1.48	-0.36	765.31	146.14	146.57	764.88	-16.29	
1	70	419	1.515.86e-026.40e-02		1.50	-8.80e-02	724.70	137.15	137.17	724.68	-3.05	
1	70	420	1.546.87e-028.85e-02		1.52	0.17	735.89	139.96	140.07	735.78	8.04	
1	70	421	1.675.55e-02	0.19	1.53	0.44	793.78	154.08	155.02	792.85	24.42	
1	70	422	1.817.48e-03	0.36	1.46	0.71	866.41	176.18	180.65	861.94	55.37	
1	70	423	1.71-5.86e-02	0.43	1.23	0.79	895.33	199.55	218.46	876.41	113.15	
1	70	424	1.41-0.57	-0.36	1.20	0.61	809.51	210.31	285.55	734.28	198.55	
1	70	425	2.12-1.99	-1.75	1.88	0.96	644.22	143.34	396.15	391.41	250.43	
1	70	426	1.16-2.98	-2.06	0.24	1.72	599.12	-62.37	463.88	72.87	266.78	
1	70	427	0.51-3.73	-2.09	-1.13	-2.07	226.88	-422.18	-122.50	-72.79	-323.57	
1	70	428	7.39-3.37	-2.64	6.66	-2.71	731.50	-219.02	-45.73	558.21	-367.00	
1	70	429	2.04-0.40	-0.38	2.02	-0.25	941.31	-47.21	-12.64	906.74	-181.60	
1	70	430	3.12-0.51	8.31e-02	2.53	-1.34	946.22	73.29	80.34	939.18	-78.11	
1	70	431	2.60-0.42	-0.16	2.34	-0.85	864.85	110.36	111.70	863.52	-31.66	
1	70	432	2.15-0.30	-0.22	2.08	-0.43	778.98	117.89	118.08	778.79	-11.15	
1	70	433	1.95-0.23	-0.22	1.95	-0.11	732.69	117.91	117.92	732.68	-1.72	
1	70	434	2.00-0.22	-0.20	1.98	0.18	745.28	118.26	118.31	745.24	5.54	
1	70	435	2.30-0.27	-0.16	2.19	0.52	812.06	117.16	117.65	811.58	18.36	
1	70	436	2.87-0.37-3.14e-02		2.53	0.99	903.89	102.80	105.58	901.11	47.11	
1	70	437	3.57-0.46	0.31	2.79	1.59	966.02	47.38	60.76	952.64	110.06	
1	70	438	2.74-0.67	-0.57	2.64	0.55	907.85	-113.20	-48.34	842.99	249.04	
1	70	439	5.93-0.63	-0.42	5.72	1.15	548.28	-246.10	-22.25	324.43	357.37	
1	70	440	1.44-8.00	-6.36	-0.19	3.57	196.94	-446.11	-158.75	90.41	319.71	
1	70	441	11.80-7.05	4.58	0.17	9.17	-772.81	-1211.61	-1204.07	-780.35	-57.02	
1	70	442	4.55-6.01	4.13	-5.60	2.06	864.75	-651.64	-600.18	813.29	-274.56	
1	70	443	6.91-3.55	-0.54	3.90	-4.74	994.86	-170.49	-164.22	988.60	-85.22	
1	70	444	4.83-1.37	-1.10	4.57	-1.26	974.81	10.69	10.69	974.81	-1.97	
1	70	445	3.36-0.73	-0.66	3.30	-0.50	876.64	78.98	79.07	876.55	8.59	
1	70	446	2.57-0.52	-0.51	2.55	-0.20	780.98	100.54	100.62	780.90	7.26	
1	70	447	2.25-0.43	-0.43	2.25	-5.41e-02	730.89	105.43	105.43	730.89	2.05	
1	70	448	2.30-0.42	-0.42	2.30	6.05e-02	744.47	104.26	104.29	744.45	-3.83	
1	70	449	2.75-0.49	-0.48	2.73	0.23	817.26	94.47	94.55	817.18	-7.79	
1	70	450	3.72-0.70	-0.62	3.64	0.59	921.78	59.15	59.19	921.74	-5.73	
1	70	451	5.43-1.46	-1.10	5.08	1.53	1003.85	-43.06	-42.89	1003.68	13.37	
1	70	452	7.91-4.21	0.31	3.39	5.86	963.34	-309.78	-296.97	950.53	127.06	
1	70	453	5.66-9.40	4.80e-02	-3.80	-7.28	653.90	-979.89	-829.24	503.25	472.69	
1	70	454	12.66-2.93	9.48	0.24	-6.28	-885.11	-1171.82	-1171.24	-885.69	-12.91	
1	70	455	29.856.99	29.72	7.12	-1.71	944.13	-316.92	-310.47	937.69	89.92	
1	70	456	13.59-4.90e-020.15		13.40	-1.62	1097.54	-145.06	-143.68	1096.17	41.27	
1	70	457	5.07-4.47e-02-4.01e-02		5.06	-0.15	978.60	23.04	24.92	976.72	42.36	
1	70	458	3.36-0.61	-0.61	3.36	-7.92e-02	873.46	79.68	80.71	872.42	28.71	
1	70	459	2.58-0.55	-0.55	2.58	-4.30e-02	776.41	99.59	99.97	776.04	15.89	
1	70	460	2.26-0.46	-0.46	2.26	-1.82e-02	725.82	104.27	104.29	725.80	3.73	
1	70	461	2.31-0.45	-0.45	2.31	1.09e-03	739.54	103.03	103.14	739.44	-8.24	
1	70	462	2.76-0.52	-0.52	2.76	2.78e-02	813.20	93.25	93.84	812.61	-20.50	
1	70	463	3.69-0.54	-0.54	3.69	6.14e-02	919.56	59.55	60.85	918.26	-33.47	
1	70	464	5.740.25	0.26	5.74	0.11	1010.04	-27.61	-25.42	1007.86	-47.59	





EGP CODE

GRE.EEC.R.73.IT.W.15235.12.024.01

PAGE

416 di/of 527

1	70	465	16.82-0.49	-0.31	16.64	1.75	1102.40	-261.07	-259.70	1101.03	-43.21	
1	70	466	43.15-11.40	43.14	-11.39	0.70	776.86	-836.08	-825.80	766.58	-128.35	
1	70	467	8.79-3.24	6.28	-0.73	-4.89	-445.17	-915.93	-825.56	-535.54	185.41	
1	70	468	6.29-4.94	4.67	-3.32	-3.95	888.34	-626.79	-477.46	739.00	451.61	
1	70	469	8.08-3.08	-0.78	5.79	4.51	1015.30	-163.28	-123.03	975.05	214.03	
1	70	470	5.07-1.27	-1.09	4.90	1.04	966.55	17.42	28.13	955.84	100.24	
1	70	471	3.42-0.75	-0.70	3.37	0.45	863.23	83.35	87.52	859.06	56.84	
1	70	472	2.55-0.54	-0.53	2.53	0.20	766.16	104.72	105.94	764.95	28.36	
1	70	473	2.20-0.44	-0.44	2.20	4.11e-02	715.79	109.62	109.68	715.72	6.17	
1	70	474	2.26-0.43	-0.43	2.25	-9.99e-02	729.44	108.32	108.67	729.09	-14.71	
1	70	475	2.73-0.53	-0.50	2.71	-0.27	802.84	98.22	100.37	800.69	-38.86	
1	70	476	3.79-0.75	-0.68	3.72	-0.55	909.59	62.84	69.00	903.43	-71.97	
1	70	477	5.68-1.33	-1.12	5.47	-1.20	998.73	-36.59	-21.20	983.34	-125.30	
1	70	478	8.51-2.93	0.10	5.47	-5.05	995.48	-301.10	-241.25	935.63	-272.06	
1	70	479	7.32-6.84	-0.17	0.66	7.07	683.29	-912.75	-639.08	409.62	-601.57	
1	70	480	13.44-4.31	13.23	-4.10	1.93	-548.55	-859.30	-784.99	-622.86	-132.55	
1	70	481	-1.97-3.16	-3.12	-2.02	0.23	415.38	-498.82	-35.10	-48.34	457.06	
1	70	482	6.89-2.21	-1.13	5.81	2.94	825.34	-225.66	45.32	554.36	459.75	
1	70	483	3.02-0.39	0.15	2.48	1.25	955.90	-37.07	54.69	864.13	287.58	
1	70	484	3.56-0.80-1.69e-02		2.77	1.67	920.02	84.71	117.59	887.14	162.44	
1	70	485	2.68-0.58	-0.23	2.33	1.01	825.04	122.51	134.27	813.28	90.13	
1	70	486	2.05-0.35	-0.23	1.94	0.51	735.12	129.95	133.07	731.99	43.38	
1	70	487	1.75-0.21	-0.20	1.74	0.12	688.14	129.58	129.73	688.00	9.10	
1	70	488	1.80-0.21	-0.18	1.78	-0.24	700.91	129.74	130.63	700.02	-22.53	
1	70	489	2.21-0.36	-0.18	2.04	-0.65	769.23	128.52	134.32	763.42	-60.71	
1	70	490	2.98-0.60	-0.14	2.51	-1.21	867.62	113.24	131.58	849.29	-116.16	
1	70	491	4.07-0.85	0.18	3.04	-1.99	949.13	55.93	105.30	899.76	-204.11	
1	70	492	4.20-0.80	0.16	3.24	-1.97	945.20	-104.29	36.23	804.68	-357.40	
1	70	493	3.600.92	1.05	3.47	-0.58	687.04	-269.91	64.63	352.49	-456.31	
1	70	494	-0.68-7.33	-7.06	-0.96	-1.33	388.21	-524.96	-67.61	-69.15	-456.58	
1	70	495	0.33-2.85	-2.50	-1.82e-02	0.99	753.36	-160.62	519.87	72.87	398.61	
1	70	496	1.33-1.74	-1.37	0.95	1.00	803.93	107.69	406.55	505.07	344.62	
1	70	497	1.60-0.86	-0.15	0.89	1.11	863.55	190.33	309.45	744.43	256.92	
1	70	498	1.81-0.57	0.31	0.93	1.15	842.98	203.12	245.39	800.71	158.94	
1	70	499	1.68-0.35	0.23	1.10	0.92	770.08	187.58	201.51	756.15	89.01	
1	70	500	1.34-6.35e-02	0.17	1.11	0.52	695.28	167.76	171.23	691.81	42.62	
1	70	501	1.100.15	0.17	1.08	0.14	655.06	156.85	157.00	654.90	8.86	
1	70	502	1.150.13	0.19	1.09	-0.25	666.15	159.83	160.80	665.18	-22.10	
1	70	503	1.46-9.99e-02	0.25	1.11	-0.65	724.43	175.68	182.23	717.88	-59.59	
1	70	504	1.86-0.41	0.38	1.08	-1.08	805.16	197.03	219.00	783.20	-113.46	
1	70	505	2.02-0.67	0.53	0.83	-1.34	865.37	207.15	269.87	802.65	-193.27	
1	70	506	1.35-0.81	5.80e-03	0.53	-1.05	855.54	173.74	344.58	684.70	-295.45	
1	70	507	1.19-1.93	-1.79	1.06	-0.64	778.22	49.92	453.10	375.05	-362.06	
1	70	508	0.33-3.21	-2.77	-0.11	-1.17	751.37	-160.89	519.60	70.88	-397.13	
1	70	509	-0.21-3.06	-3.04	-0.23	0.23	829.84	41.68	768.27	103.25	211.50	
1	70	510	2.71e-03	-1.56	-1.47	-9.38e-02	0.38	741.47	361.52	612.97	490.03	179.75
1	70	511	0.38-0.73	-0.36	7.04e-03	0.52	753.85	396.33	463.97	686.22	140.02	
1	70	512	0.82-0.43	0.26	0.14	0.62	761.11	322.29	342.56	740.83	92.12	
1	70	513	0.95-0.17	0.45	0.32	0.56	717.92	250.35	256.38	711.89	52.75	
1	70	514	0.820.12	0.48	0.46	0.35	661.60	201.52	202.91	660.21	25.24	
1	70	515	0.610.40	0.48	0.53	9.86e-02	629.10	179.63	179.69	629.04	5.21	
1	70	516	0.670.35	0.51	0.51	-0.16	638.33	185.43	185.81	637.95	-13.09	
1	70	517	0.917.27e-02	0.57	0.41	-0.41	685.05	218.76	221.46	682.35	-35.34	
1	70	518	1.04-0.23	0.60	0.21	-0.61	743.40	278.09	287.91	733.58	-66.87	
1	70	519	0.86-0.51	0.42	-7.26e-02	-0.64	771.83	356.17	387.77	740.22	-110.18	
1	70	520	0.16-0.79	-0.37	-0.25	-0.47	747.40	411.96	521.78	637.59	-157.41	
1	70	521	-0.20-2.01	-1.96	-0.25	-0.28	766.35	286.27	675.52	377.10	-188.03	
1	70	522	-0.25-3.16	-3.14	-0.27	-0.25	830.70	46.69	769.81	107.58	-209.85	
1	70	523	-0.25-3.19	-3.17	-0.27	-0.24	840.97	108.41	840.97	108.42	1.97	
1	70	524	-0.19-1.68	-1.65	-0.21	-0.18	676.13	484.00	676.13	484.00	-0.15	
1	70	525	-0.16-0.55	-0.55	-0.16	2.57e-02	667.15	513.79	513.84	667.10	-2.70	
1	70	526	0.26-0.17	0.19	-9.53e-02	0.16	719.94	375.63	375.68	719.89	-4.04	
1	70	527	0.58-1.07e-02	0.53	4.27e-02	0.17	695.99	275.23	275.27	695.95	-3.71	
1	70	528	0.650.17	0.63	0.19	0.11	649.15	213.25	213.27	649.13	-2.32	
1	70	529	0.650.28	0.65	0.28	3.71e-02	620.23	186.71	186.71	620.23	-0.54	
1	70	530	0.670.27	0.67	0.27	-3.40e-02	628.56	193.79	193.79	628.55	1.22	
1	70	531	0.710.13	0.70	0.15	-8.77e-02	669.68	234.85	234.87	669.66	2.71	
1	70	532	0.66-7.77e-02	0.65	-6.23e-02	-0.11	715.77	312.12	312.15	715.74	3.58	
1	70	533	0.32-0.29	0.31	-0.28	-6.20e-02	719.26	427.87	427.91	719.22	3.43	
1	70	534	-0.39-0.57	-0.56	-0.40	4.69e-02	623.34	577.98	578.09	623.22	2.29	
1	70	535	-0.42-2.10	-2.09	-0.44	0.14	743.22	376.82	743.22	376.82	0.97	
1	70	536	-0.31-3.29	-3.28	-0.32	0.13	843.40	113.99	843.40	113.99	0.52	
1	70	537	0.23-3.11	-2.86	-2.21e-02	-0.88	827.79	41.32	768.88	100.23	-207.03	
1	70	538	0.54-2.11	-1.89	0.31	-0.74	739.99	356.40	613.04	483.35	-180.50	
1	70	539	0.35-0.87	-0.76	0.24	-0.34	754.14	387.48	461.28	680.34	-147.01	
1	70	540	0.35-7.38e-02	0.15	0.13	-0.21	763.11	312.81	336.97	738.94	-101.47	



EGP CODE

GRE.EEC.R.73.IT.W.15235.12.024.01

PAGE

417 di/of 527

1	70	541	0.620.12	0.54	0.20	-0.19	721.00	241.78	249.57	713.21	-60.58	
1	70	542	0.680.28	0.63	0.33	-0.13	664.88	194.30	196.19	662.98	-29.81	
1	70	543	0.640.41	0.63	0.41	-3.59e-02	632.22	173.30	173.38	632.14	-6.16	
1	70	544	0.670.39	0.64	0.42	8.15e-02	641.31	179.21	179.74	640.78	15.67	
1	70	545	0.770.23	0.66	0.34	0.21	687.89	212.03	215.61	684.32	41.10	
1	70	546	0.802.28e-03	0.60	0.20	0.35	745.88	270.82	282.92	733.78	74.84	
1	70	547	0.61-0.28	0.26	6.32e-02	0.44	773.95	348.89	384.85	737.98	118.30	
1	70	548	0.32-0.92	-0.65	5.22e-02	0.51	750.17	405.34	521.58	633.94	163.01	
1	70	549	0.23-2.25	-2.08	5.82e-02	0.62	769.02	283.07	677.25	374.84	190.19	
1	70	550	7.50e-03	-3.11	-2.97	-0.13	0.64	833.36	45.21	772.08	106.49	211.05
1	70	551	1.73-3.54	-2.31	0.51	-2.22	747.11	-161.37	520.57	65.17	-393.05	
1	70	552	2.17-2.93	-2.62	1.86	-1.21	795.43	96.48	404.26	487.66	-346.98	
1	70	553	1.32-1.10	-1.00	1.22	-0.48	860.90	169.07	298.64	731.33	-269.92	
1	70	554	1.04-5.86e-02	0.25	0.73	-0.50	846.08	181.37	229.10	798.35	-171.60	
1	70	555	1.170.11	0.50	0.78	-0.51	775.83	168.88	184.87	759.84	-97.19	
1	70	556	1.060.28	0.50	0.84	-0.34	701.39	152.36	156.33	697.42	-46.52	
1	70	557	0.910.44	0.46	0.88	-0.11	660.87	143.30	143.46	660.70	-9.33	
1	70	558	0.960.41	0.45	0.92	0.15	671.74	146.25	147.42	670.57	24.75	
1	70	559	1.190.22	0.47	0.95	0.42	729.80	160.52	168.20	722.11	65.68	
1	70	560	1.46-2.36e-02	0.45	0.98	0.69	809.55	179.88	205.05	784.38	123.34	
1	70	561	1.58-0.31	0.28	1.00	0.87	867.47	189.87	259.32	798.03	205.51	
1	70	562	1.47-1.01	-0.71	1.17	0.81	856.17	159.84	340.50	675.51	305.22	
1	70	563	2.21-2.60	-2.35	1.96	1.07	779.21	45.33	455.19	369.36	364.42	
1	70	564	1.48-3.64	-2.53	0.36	2.11	755.15	-164.55	523.13	67.47	399.45	
1	70	565	0.37-5.98	-3.93	-1.68	-2.97	411.10	-516.55	-41.33	-64.12	-463.68	
1	70	566	7.29-4.23	-3.84	6.90	-2.08	790.61	-240.24	35.04	515.33	-456.07	
1	70	567	2.62-1.01	-1.00	2.61	0.17	953.35	-86.56	19.69	847.10	-314.97	
1	70	568	2.395.34e-02	0.37	2.07	-0.80	926.12	43.36	80.30	889.18	-176.76	
1	70	569	2.105.97e-02	0.36	1.80	-0.72	833.49	91.15	103.68	820.96	-95.62	
1	70	570	1.760.12	0.25	1.63	-0.45	742.92	105.47	108.62	739.77	-44.70	
1	70	571	1.560.18	0.20	1.55	-0.15	695.19	108.16	108.28	695.06	-8.65	
1	70	572	1.600.16	0.18	1.59	0.15	707.81	107.75	108.73	706.82	24.30	
1	70	573	1.906.42e-02	0.18	1.78	0.45	776.38	102.54	108.88	770.05	65.04	
1	70	574	2.40-5.11e-02	0.21	2.14	0.76	874.41	80.51	101.06	853.85	126.07	
1	70	575	3.14-0.22	0.11	2.81	0.99	952.03	17.00	73.74	895.30	223.22	
1	70	576	4.80-1.43	-1.14	4.51	1.32	944.05	-136.27	21.45	786.33	381.45	
1	70	577	4.94-0.52	-0.52	4.94	-8.11e-02	673.94	-265.54	64.17	344.23	448.38	
1	70	578	2.36-9.81	-8.46	1.01	3.82	395.71	-539.79	-70.36	-73.72	467.75	
1	70	579	7.96-5.10	7.27	-4.41	2.92	-289.34	-871.01	-740.90	-419.45	-242.39	
1	70	580	5.74-8.78	-1.65	-1.39	7.26	787.65	-761.15	-570.77	597.27	-508.54	
1	70	581	4.20-0.57	-0.25	3.88	-1.20	1017.29	-275.07	-226.41	968.62	-246.01	
1	70	582	3.800.31	0.51	3.61	-0.80	981.58	-48.44	-37.80	970.94	-104.16	
1	70	583	3.004.13e-02	0.15	2.89	-0.55	873.39	39.64	42.97	870.06	-52.62	
1	70	584	2.42-4.47e-02-1.98e-03		2.38	-0.32	772.93	72.69	73.52	772.10	-24.09	
1	70	585	2.14-5.38e-02-4.74e-02		2.13	-0.12	720.89	82.16	82.19	720.86	-4.42	
1	70	586	2.17-6.52e-02-6.32e-02		2.17	6.72e-02	734.65	79.31	79.59	734.37	13.62	
1	70	587	2.51-7.74e-02-5.31e-02		2.49	0.25	809.78	61.28	63.06	808.00	36.46	
1	70	588	3.16-1.27e-024.09e-02		3.11	0.41	919.27	10.27	16.12	913.42	72.68	
1	70	589	4.040.19	0.24	4.00	0.42	1010.50	-115.02	-97.24	992.71	140.36	
1	70	590	4.35-1.01	-1.01	4.35	-0.14	988.37	-423.37	-346.01	911.02	321.28	
1	70	591	10.17-9.95	-6.49	6.71	-7.59	555.43	-976.13	-670.88	250.18	611.83	
1	70	592	12.20-9.90	12.19	-9.88	-0.55	-380.58	-839.21	-726.41	-493.38	197.51	
1	70	593	22.77-12.42	22.72	-12.37	1.29	921.56	-898.52	-897.29	920.34	47.26	
1	70	594	9.724.91	9.12	5.50	1.58	1112.46	-252.41	-252.36	1112.41	7.99	
1	70	595	4.461.27	1.27	4.46	-3.48e-02	998.98	-63.17	-63.17	998.98	2.11	
1	70	596	3.448.55e-029.08e-02		3.43	-0.13	885.25	27.34	27.34	885.25	0.21	
1	70	597	2.73-0.12	-0.11	2.73	-8.91e-02	782.21	64.88	64.88	782.21	-3.53e-02	
1	70	598	2.40-0.15	-0.15	2.40	-4.60e-02	729.11	76.16	76.16	729.11	0.20	
1	70	599	2.42-0.15	-0.15	2.42	-1.08e-02	743.22	72.36	72.36	743.22	0.59	
1	70	600	2.78-0.13	-0.13	2.78	1.83e-02	820.10	50.12	50.12	820.10	0.94	
1	70	601	3.489.27e-029.28e-02		3.48	2.04e-02	932.88	-9.78	-9.78	932.88	0.95	
1	70	602	4.321.41	1.42	4.30	-0.22	1030.16	-147.37	-147.37	1030.16	-0.74	
1	70	603	10.813.62	9.76	4.67	-2.54	1085.14	-436.89	-436.73	1084.98	-15.63	
1	70	604	25.32-29.43	25.22	-29.33	-2.34	661.17	-1485.26	-1483.95	659.86	-53.02	
1	70	605	-0.56-6.17	-4.14	-2.59	-2.69	590.98	-140.81	548.53	-98.36	-171.06	
1	70	606	25.14-11.29	17.93	-4.09	14.51	-327.22	-1371.41	-1368.58	-330.05	54.28	
1	70	607	4.35-0.38	-0.23	4.20	-0.85	424.38	-399.70	233.42	-208.74	347.71	
1	70	608	1.69-0.96	-0.94	1.67	0.20	340.56	-310.91	194.07	-164.42	-271.98	
1	70	609	20.542.42	13.59	9.38	-8.81	557.03	145.30	167.68	534.65	-93.35	
1	70	610	4.82-3.85	-3.64	4.61	1.34	859.17	-83.72	-78.11	853.56	-72.54	
1	70	611	4.79-0.61	-0.58	4.76	0.39	899.61	-26.25	-21.59	894.96	-65.49	
1	70	612	4.00-0.14	-0.13	3.99	0.15	823.07	-11.51	-9.67	821.22	-39.20	
1	70	613	3.39-8.40e-02-8.28e-02		3.38	6.44e-02	739.91	-4.77	-4.26	739.40	-19.44	
1	70	614	3.10-7.94e-02-7.93e-02		3.10	1.37e-02	694.93	-2.02	-1.99	694.91	-4.30	
1	70	615	3.16-7.97e-02-7.94e-02		3.16	-3.17e-02	706.85	-2.66	-2.53	706.72	9.65	
1	70	616	3.56-8.53e-02-8.33e-02		3.56	-8.54e-02	771.02	-6.76	-5.89	770.14	26.08	



EGP CODE

GRE.EEC.R.73.IT.W.15235.12.024.01

PAGE

418 di/of 527

1	70	617	4.28-0.14	-0.14	4.27	-0.18	858.75	-15.04	-12.40	856.12	47.91	
1	70	618	5.08-0.64	-0.61	5.05	-0.43	913.14	-31.49	-25.40	907.05	75.59	
1	70	619	6.39-6.35	6.39	-6.34	-0.30	157.20	-594.94	-280.41	-157.33	371.00	
1	70	620	5.03-6.79	-2.34	0.58	-5.73	793.22	-597.13	-331.12	527.22	546.89	
1	70	621	5.350.54	0.54	5.35	8.30e-02	1017.64	-181.36	-108.54	944.82	286.38	
1	70	622	4.270.43	0.63	4.06	0.86	970.06	-5.19	15.33	949.54	139.96	
1	70	623	3.243.19e-02	0.17	3.11	0.64	863.72	63.58	70.32	856.98	73.12	
1	70	624	2.56-3.92e-02	1.06e-02	2.51	0.36	765.80	88.48	90.18	764.10	33.90	
1	70	625	2.24-3.27e-02	2.86e-02	2.24	9.60e-02	715.02	94.99	95.06	714.95	6.65	
1	70	626	2.26-4.63e-02	3.67e-02	2.25	-0.15	728.48	92.51	93.04	727.96	-18.28	
1	70	627	2.61-7.36e-02	1.39e-02	2.55	-0.40	801.78	78.38	81.81	798.35	-49.71	
1	70	628	3.29-5.28e-03	0.12	3.17	-0.62	908.39	37.05	48.40	897.04	-98.79	
1	70	629	4.230.38	0.48	4.13	-0.59	998.27	-65.74	-32.43	964.96	-185.29	
1	70	630	6.00-0.94	-0.52	5.58	1.65	984.73	-308.07	-192.98	869.65	-368.16	
1	70	631	9.11-7.68	-6.42	7.85	4.42	612.94	-718.81	-344.89	239.01	-598.46	
1	70	632	9.68-12.05	9.48	-11.85	-2.07	100.58	-600.66	-277.72	-222.37	-349.52	
1	70	633	-1.26-6.00	-5.09	-2.17	1.87	530.21	-349.72	204.99	-24.50	424.74	
1	70	634	4.50-2.71	-2.54	4.33	1.09	799.59	-61.87	213.09	524.63	401.58	
1	70	635	2.88-0.29	4.64e-03	2.58	0.92	935.88	44.13	158.94	821.06	298.67	
1	70	636	2.88-2.24e-02	0.54	2.31	1.15	902.99	117.37	157.71	862.65	173.40	
1	70	637	2.405.50e-02	0.45	2.01	0.88	816.11	133.65	147.38	802.38	95.82	
1	70	638	1.950.17	0.33	1.79	0.51	730.63	131.84	135.28	727.19	45.28	
1	70	639	1.700.25	0.26	1.69	0.15	685.27	128.19	128.33	685.13	8.82	
1	70	640	1.730.23	0.25	1.70	-0.19	697.21	128.99	130.07	696.13	-24.73	
1	70	641	2.030.11	0.28	1.85	-0.55	762.09	132.86	139.86	755.10	-65.98	
1	70	642	2.55-4.99e-02	0.34	2.16	-0.92	853.94	130.82	153.65	831.11	-126.43	
1	70	643	3.28-0.26	0.28	2.74	-1.28	925.60	105.06	167.70	862.96	-217.89	
1	70	644	4.83-1.06-5.34e-02		3.82	-2.22	926.43	19.07	185.77	759.73	-351.38	
1	70	645	2.57-0.73	-0.50	2.35	0.83	723.68	-97.97	252.15	373.56	-406.32	
1	70	646	1.26-8.62	-8.10	0.74	-2.22	525.39	-352.74	194.10	-21.44	-425.63	
1	70	647	0.79-3.80	-3.28	0.26	1.46	787.53	-60.14	646.09	81.31	316.05	
1	70	648	1.24-2.42	-2.30	1.12	0.65	780.73	224.59	509.26	496.06	277.99	
1	70	649	1.02-0.58	-0.37	0.81	0.55	829.16	275.95	381.02	724.09	216.99	
1	70	650	1.42-5.50e-02	0.63	0.73	0.73	820.90	250.45	286.46	784.89	138.73	
1	70	651	1.490.15	0.71	0.93	0.66	760.05	210.07	221.69	748.43	79.09	
1	70	652	1.290.38	0.64	1.03	0.41	692.00	177.95	180.77	689.18	37.98	
1	70	653	1.110.54	0.57	1.08	0.12	654.13	162.68	162.80	654.01	7.46	
1	70	654	1.140.51	0.56	1.09	-0.16	664.08	167.07	167.93	663.21	-20.71	
1	70	655	1.360.32	0.60	1.08	-0.46	717.62	190.73	196.43	711.92	-54.48	
1	70	656	1.624.50e-02	0.65	1.01	-0.76	789.16	229.81	248.81	770.16	-101.32	
1	70	657	1.72-0.28	0.59	0.84	-0.99	836.86	272.68	326.82	782.71	-166.18	
1	70	658	1.10-0.70	-0.24	0.65	-0.78	824.10	281.69	433.90	671.89	-243.71	
1	70	659	1.13-2.45	-2.37	1.05	-0.52	781.70	169.96	569.03	382.63	-291.32	
1	70	660	0.64-3.77	-3.28	0.15	-1.38	796.87	-58.12	651.39	87.35	-321.27	
1	70	661	-2.79e-02	-3.53	-3.49	-7.09e-02	0.39	836.01	87.18	817.03	106.16	117.70
1	70	662	0.21-1.97	-1.94	0.17	0.26	703.07	441.29	653.81	490.55	102.32	
1	70	663	0.19-0.52	-0.47	0.14	0.18	715.58	463.47	494.03	685.01	82.29	
1	70	664	0.613.95e-02	0.49	0.16	0.24	749.62	353.44	361.47	741.59	55.82	
1	70	665	0.910.26	0.80	0.36	0.23	717.54	264.72	267.12	715.13	32.93	
1	70	666	0.890.49	0.81	0.57	0.16	665.28	208.66	209.23	664.71	16.11	
1	70	667	0.780.66	0.76	0.68	4.62e-02	633.67	184.51	184.53	633.65	3.22	
1	70	668	0.800.64	0.76	0.69	-7.03e-02	642.05	191.43	191.60	641.88	-8.74	
1	70	669	0.900.47	0.80	0.58	-0.19	686.02	229.70	230.83	684.88	-22.73	
1	70	670	0.950.21	0.80	0.35	-0.29	738.16	300.27	304.20	734.22	-41.32	
1	70	671	0.70-0.11	0.53	6.11e-02	-0.33	752.64	401.50	414.17	739.97	-65.50	
1	70	672	3.32e-02	-0.59	-0.44	-0.11	-0.26	699.31	499.87	559.15	640.02	-91.15
1	70	673	-0.13-2.28	-2.25	-0.15	-0.23	753.54	352.53	722.41	383.65	-107.29	
1	70	674	-0.18-3.57	-3.54	-0.20	-0.28	841.74	94.38	822.16	113.96	-119.37	
1	70	675	-4.37e-02	-3.54	-3.50	-8.22e-02	-0.36	832.88	94.19	820.72	106.36	-94.00
1	70	676	0.19-1.97	-1.94	0.15	-0.27	690.39	456.94	657.35	489.97	-81.37	
1	70	677	0.18-0.54	-0.48	0.12	-0.19	703.49	477.12	497.28	683.33	-64.47	
1	70	678	0.592.77e-02	0.47	0.14	-0.23	744.07	359.36	364.10	739.33	-42.44	
1	70	679	0.880.25	0.80	0.33	-0.21	714.18	267.72	269.02	712.87	-24.12	
1	70	680	0.870.48	0.81	0.53	-0.14	662.93	210.29	210.57	662.64	-11.40	
1	70	681	0.780.63	0.77	0.65	-4.66e-02	631.72	185.61	185.62	631.71	-2.19	
1	70	682	0.780.63	0.76	0.65	4.70e-02	640.01	192.65	192.74	639.92	6.23	
1	70	683	0.860.47	0.80	0.54	0.15	683.38	231.73	232.33	682.78	16.46	
1	70	684	0.900.21	0.79	0.32	0.25	734.18	304.08	306.30	731.96	30.83	
1	70	685	0.66-0.11	0.51	3.74e-02	0.30	745.55	409.25	416.98	737.81	50.42	
1	70	686	1.51e-02	-0.61	-0.46	-0.13	0.26	681.84	519.23	562.51	638.56	71.86
1	70	687	-0.14-2.29	-2.26	-0.17	0.25	746.06	363.09	725.98	383.18	85.36	
1	70	688	-0.19-3.58	-3.56	-0.21	0.28	838.28	101.53	825.79	114.02	95.11	
1	70	689	0.73-3.78	-3.29	0.24	-1.41	782.72	-39.69	660.14	82.89	-292.90	
1	70	690	1.19-2.41	-2.29	1.06	-0.66	765.98	250.82	522.16	494.64	-257.21	
1	70	691	0.97-0.63	-0.41	0.76	-0.55	813.54	297.50	392.28	718.77	-199.81	
1	70	692	1.33-8.56e-02	0.58	0.66	-0.70	809.28	263.81	295.02	778.07	-126.70	



EGP CODE

GRE.EEC.R.73.IT.W.15235.12.024.01

PAGE

419 di/of 527

1	70	693	1.390.14	0.69	0.83	-0.62	751.67	217.88	227.64	741.90	-71.54
1	70	694	1.190.38	0.64	0.93	-0.38	685.65	182.62	184.93	683.33	-34.06
1	70	695	1.010.56	0.59	0.97	-0.12	648.67	166.05	166.14	648.58	-6.62
1	70	696	1.030.54	0.58	0.98	0.14	658.42	170.75	171.46	657.71	18.60
1	70	697	1.240.33	0.61	0.96	0.42	710.66	196.36	201.10	705.92	49.13
1	70	698	1.494.77e-02	0.63	0.91	0.71	779.75	239.33	255.51	763.56	92.11
1	70	699	1.59-0.30	0.53	0.76	0.94	823.74	288.55	336.15	776.15	152.34
1	70	700	1.04-0.75	-0.31	0.59	0.77	807.17	305.84	445.73	667.28	224.86
1	70	701	1.07-2.47	-2.38	0.98	0.55	769.58	194.20	582.22	381.56	269.63
1	70	702	0.59-3.76	-3.30	0.13	1.33	791.17	-37.24	665.28	88.64	297.39
1	70	703	-0.99-5.84	-4.98	-1.85	-1.85	538.69	-313.11	241.57	-15.99	-405.96
1	70	704	4.36-2.71	-2.53	4.18	-1.11	790.31	-26.93	241.08	522.30	-383.67
1	70	705	2.72-0.37-9.71e-02	0.47	2.45	-0.87	920.25	72.13	181.79	810.59	-284.57
1	70	706	2.68-5.85e-02	0.43	2.15	-1.08	889.58	135.32	173.39	851.50	-165.13
1	70	707	2.215.18e-02	0.43	1.83	-0.82	805.33	145.00	157.82	792.50	-91.13
1	70	708	1.770.19	0.35	1.61	-0.48	721.85	139.26	142.45	718.66	-43.01
1	70	709	1.520.28	0.30	1.51	-0.15	677.46	133.95	134.08	677.33	-8.38
1	70	710	1.550.26	0.29	1.52	0.17	689.18	135.17	136.17	688.18	23.47
1	70	711	1.830.13	0.30	1.67	0.50	752.72	141.58	148.09	746.22	62.70
1	70	712	2.33-4.71e-02	0.31	1.97	0.85	842.31	144.41	165.81	820.91	120.32
1	70	713	3.05-0.30	0.21	2.54	1.20	911.44	126.09	185.48	852.06	207.63
1	70	714	4.56-1.12	-0.18	3.63	2.11	910.59	49.99	210.15	750.43	334.94
1	70	715	2.42-0.79	-0.64	2.27	-0.69	718.04	-64.14	281.08	372.81	388.39
1	70	716	1.36-8.33	-7.82	0.84	2.17	533.42	-315.63	231.31	-13.51	406.49
1	70	717	5.49-5.71	5.46	-5.68	0.59	177.52	-547.43	-224.99	-144.92	-360.26
1	70	718	4.86-6.74	-2.50	0.62	5.59	787.38	-541.51	-279.22	525.10	-528.92
1	70	719	5.030.44	0.44	5.03	-8.04e-02	1002.64	-145.09	-72.39	929.94	-279.56
1	70	720	3.950.37	0.55	3.77	-0.79	956.40	17.67	38.56	935.50	-138.47
1	70	721	2.973.87e-02	0.16	2.84	-0.59	852.62	78.35	85.32	845.65	-73.13
1	70	722	2.329.08e-044.91e-02	0.16	2.27	-0.33	756.60	98.58	100.36	754.81	-34.21
1	70	723	2.012.18e-022.62e-02	0.16	2.01	-9.35e-02	706.72	103.13	103.21	706.64	-6.78
1	70	724	2.038.20e-031.65e-02	0.16	2.02	0.13	719.98	101.19	101.73	719.44	18.41
1	70	725	2.36-3.50e-021.87e-02	0.16	2.31	0.35	792.02	90.14	93.70	788.47	49.84
1	70	726	3.00-5.67e-03	0.10	2.89	0.56	896.55	54.88	66.50	884.93	98.20
1	70	727	3.920.30	0.38	3.84	0.52	984.11	-38.00	-4.38	950.49	182.30
1	70	728	5.66-0.98	-0.59	5.27	-1.56	971.13	-264.59	-150.08	856.62	358.31
1	70	729	8.84-7.65	-6.43	7.61	-4.33	616.30	-659.65	-290.07	246.72	578.77
1	70	730	8.67-11.08	8.53	-10.94	1.65	126.79	-552.80	-221.39	-204.62	339.70
1	70	731	4.82-3.04	-2.94	4.72	-0.87	805.25	-89.49	-82.53	798.29	78.60
1	70	732	21.19-11.87	21.16	-11.84	-0.96	902.97	-820.18	-818.08	900.87	-60.10
1	70	733	8.974.59	8.50	5.06	-1.35	1092.31	-208.42	-208.07	1091.96	-21.29
1	70	734	4.091.17	1.17	4.09	6.51e-02	986.82	-34.47	-34.29	986.64	-13.65
1	70	735	3.149.76e-02	0.10	3.14	0.13	876.66	45.88	45.97	876.58	-8.37
1	70	736	2.48-6.58e-02-6.32e-02	0.10	2.48	8.21e-02	775.92	77.44	77.47	775.89	-4.55
1	70	737	2.17-8.57e-02-8.50e-02	0.10	2.17	3.92e-02	723.85	86.23	86.24	723.85	-1.25
1	70	738	2.19-9.46e-02-9.45e-02	0.10	2.19	5.62e-03	737.72	83.12	83.12	737.71	1.88
1	70	739	2.52-8.70e-02-8.67e-02	0.10	2.52	-2.53e-02	813.12	64.86	64.90	813.08	5.10
1	70	740	3.179.19e-029.24e-02	0.10	3.17	-3.89e-02	923.20	12.84	12.82	923.12	8.69
1	70	741	3.951.28	1.29	3.94	0.15	1016.75	-111.82	-111.66	1016.58	13.69
1	70	742	9.923.39	9.07	4.25	2.20	1064.11	-381.47	-380.88	1063.52	29.30
1	70	743	23.49-27.96	23.42	-27.88	1.92	647.23	-1378.62	-1376.57	645.18	64.45
1	70	744	24.304.35e-0210.00	0.10	14.34	11.93	264.77	108.60	176.53	196.84	77.42
1	70	745	6.44-8.34	-7.21	5.31	3.92	-171.18	-350.52	-304.65	-217.05	-78.25
1	70	746	5.14-7.49	-5.98	3.62	-4.11	-189.25	-333.94	-286.25	-236.94	68.01
1	70	747	6.17-2.92	-1.08	4.33	3.65	302.78	-266.21	158.59	-122.02	247.49
1	70	748	7.68-2.69	-0.77	5.76	-4.03	384.14	-345.31	193.50	-154.66	-320.50
1	70	749	23.535.31	15.02	13.83	9.09	513.41	190.30	209.70	494.01	76.76
1	70	750	4.24-4.17	-3.99	4.06	-1.22	794.10	-81.84	-80.93	793.19	28.21
1	70	751	3.03-0.55	-0.51	2.99	-0.39	842.27	-19.01	-17.68	840.94	33.83
1	70	752	2.51-0.12	-0.11	2.50	-0.15	772.20	-6.34	-5.97	771.83	17.05
1	70	753	2.14-6.50e-02-6.28e-02	0.10	2.14	-6.94e-02	693.99	-0.92	-0.85	693.93	6.91
1	70	754	1.97-5.68e-02-5.67e-02	0.10	1.97	-1.55e-02	651.37	1.27	1.28	651.37	1.52
1	70	755	2.01-5.77e-02-5.72e-02	0.10	2.01	3.30e-02	662.59	0.78	0.79	662.58	-2.65
1	70	756	2.30-6.76e-02-6.43e-02	0.10	2.30	8.75e-02	723.12	-2.46	-2.34	723.00	-9.26
1	70	757	6.97-4.70	6.38	-4.11	-2.56	-274.60	-758.68	-642.74	-390.53	206.59
1	70	758	5.18-8.41	-1.94	-1.30	-6.78	763.63	-667.09	-497.56	594.10	462.40
1	70	759	3.76-0.61	-0.34	3.50	1.05	997.49	-217.97	-179.26	958.78	213.44
1	70	760	3.470.28	0.46	3.29	0.74	971.03	-14.97	-7.92	963.98	83.08
1	70	761	2.746.33e-02	0.16	2.64	0.50	868.24	60.19	62.06	866.38	38.75
1	70	762	2.21-4.21e-043.79e-02	0.16	2.17	0.29	770.88	86.01	86.41	770.48	16.53
1	70	763	1.96-4.78e-038.22e-04	0.16	1.95	0.10	720.14	92.52	92.53	720.13	2.73
1	70	764	1.98-1.69e-02-1.51e-02	0.16	1.98	-6.04e-02	733.60	90.46	90.60	733.46	-9.55
1	70	765	2.29-3.66e-02-1.44e-02	0.16	2.27	-0.23	806.77	77.12	78.08	805.82	-26.35
1	70	766	2.892.15e-045.07e-02	0.16	2.84	-0.38	912.42	35.52	39.11	908.84	-55.92
1	70	767	3.690.14	0.18	3.65	-0.39	997.48	-73.81	-61.13	984.80	-115.84
1	70	768	3.95-1.12	-1.11	3.94	0.22	965.66	-353.70	-289.51	901.46	-283.87





EGP CODE

GRE.EEC.R.73.IT.W.15235.12.024.01

PAGE

420 di/of 527

1	70	769	9.54-9.74	-6.57	6.37	7.14	534.27	-865.56	-587.12	255.84	-558.78	
1	70	770	10.78-9.13	10.77	-9.12	0.30	-360.45	-729.90	-630.59	-459.76	-163.79	
1	70	771	0.62-6.00	-3.92	-1.46	3.07	395.99	-410.93	34.07	-49.02	401.31	
1	70	772	6.83-4.22	-3.86	6.46	1.97	758.20	-147.33	89.33	521.53	397.86	
1	70	773	2.43-1.06	-1.05	2.41	-0.19	932.62	-22.60	60.88	849.14	269.77	
1	70	774	2.167.05e-02	0.33	1.90	0.69	918.91	80.90	106.72	893.09	144.82	
1	70	775	1.920.11	0.36	1.68	0.63	834.81	112.79	120.62	826.97	74.81	
1	70	776	1.640.16	0.26	1.53	0.38	748.70	118.36	120.15	746.91	33.55	
1	70	777	1.480.19	0.21	1.47	0.13	702.67	117.53	117.59	702.60	6.17	
1	70	778	1.520.18	0.19	1.51	-0.12	714.88	118.02	118.58	714.31	-18.36	
1	70	779	1.760.10	0.20	1.67	-0.39	780.80	118.30	122.11	776.99	-50.10	
1	70	780	2.20-9.69e-03	0.21	1.98	-0.67	872.98	107.53	121.07	859.44	-100.88	
1	70	781	2.87-0.22	6.59e-02	2.59	-0.89	940.22	63.10	104.63	898.69	-186.28	
1	70	782	4.48-1.49	-1.23	4.21	-1.23	916.73	-60.81	67.92	788.01	-330.55	
1	70	783	4.70-0.81	-0.81	4.70	-1.16e-02	644.05	-168.49	122.52	353.05	-389.58	
1	70	784	2.53-9.58	-8.18	1.12	-3.87	381.17	-431.23	7.03	-57.08	-404.93	
1	70	785	1.64-3.58	-2.40	0.47	2.18	719.27	-77.75	566.33	75.19	313.85	
1	70	786	2.07-2.88	-2.59	1.77	1.16	751.34	191.06	439.44	502.96	278.33	
1	70	787	1.25-1.05	-0.98	1.18	0.39	837.47	234.74	323.83	748.39	213.91	
1	70	788	0.945.01e-02	0.24	0.75	0.36	845.59	216.96	245.65	816.91	131.18	
1	70	789	1.070.23	0.47	0.83	0.38	787.54	187.01	195.59	778.96	71.26	
1	70	790	1.030.34	0.46	0.91	0.26	718.05	161.99	163.94	716.10	32.89	
1	70	791	0.970.40	0.42	0.96	8.17e-02	678.99	149.81	149.89	678.92	6.31	
1	70	792	1.010.39	0.41	0.99	-0.11	689.53	153.53	154.11	688.95	-17.59	
1	70	793	1.150.29	0.44	1.00	-0.32	745.09	172.74	176.69	741.14	-47.39	
1	70	794	1.340.10	0.44	1.00	-0.55	817.72	203.39	217.48	803.62	-91.98	
1	70	795	1.44-0.20	0.26	0.98	-0.74	859.69	235.03	278.61	816.11	-159.14	
1	70	796	1.39-0.99	-0.73	1.13	-0.74	822.61	238.33	369.31	691.63	-243.67	
1	70	797	2.11-2.64	-2.38	1.85	-1.08	736.44	140.62	494.07	382.99	-292.69	
1	70	798	1.41-3.70	-2.63	0.34	-2.08	726.51	-79.87	568.63	78.01	-319.98	
1	70	799	0.20-3.07	-2.85	-2.45e-02	0.83	805.06	89.73	785.29	109.49	117.25	
1	70	800	0.53-1.95	-1.79	0.37	0.61	681.98	444.93	621.34	505.56	103.43	
1	70	801	0.41-0.71	-0.68	0.38	0.18	738.04	437.84	463.92	711.96	84.55	
1	70	802	0.330.16	0.16	0.33	2.35e-02	781.78	329.97	337.36	774.39	57.30	
1	70	803	0.490.43	0.48	0.44	2.05e-02	749.82	248.05	250.27	747.60	33.25	
1	70	804	0.590.52	0.53	0.58	2.30e-02	695.09	197.44	197.95	694.58	15.90	
1	70	805	0.670.51	0.51	0.67	5.10e-03	661.99	175.75	175.77	661.97	3.12	
1	70	806	0.680.52	0.52	0.68	-3.07e-02	671.23	181.81	181.95	671.08	-8.47	
1	70	807	0.660.49	0.57	0.59	-8.44e-02	718.03	215.93	216.92	717.03	-22.29	
1	70	808	0.660.32	0.56	0.43	-0.16	772.54	279.73	283.23	769.04	-41.40	
1	70	809	0.502.48e-02	0.29	0.24	-0.24	784.03	374.29	385.58	772.75	-67.06	
1	70	810	0.31-0.73	-0.57	0.16	-0.37	710.44	477.93	525.86	662.51	-94.06	
1	70	811	0.23-2.17	-2.03	8.83e-02	-0.56	724.50	356.70	688.30	392.90	-109.56	
1	70	812	-4.10e-03	-3.12	-2.99	-0.13	-0.61	809.38	94.82	788.19	116.01	-121.20
1	70	813	-0.18-2.98	-2.98	-0.18	4.57e-02	819.81	99.88	805.84	113.84	-99.30	
1	70	814	9.44e-02	-1.49	-1.49	8.98e-02	-8.50e-02	680.81	471.24	639.91	512.14	-83.07
1	70	815	0.35-0.55	-0.44	0.24	-0.30	730.70	466.91	481.72	715.88	-60.73	
1	70	816	0.70-0.15	0.20	0.35	-0.42	777.64	350.58	353.67	774.55	-36.22	
1	70	817	0.839.27e-02	0.42	0.51	-0.37	746.74	263.22	263.95	746.01	-18.84	
1	70	818	0.790.30	0.45	0.64	-0.22	692.95	208.99	209.14	692.80	-8.48	
1	70	819	0.720.43	0.44	0.71	-6.67e-02	660.41	185.61	185.62	660.40	-1.76	
1	70	820	0.730.44	0.46	0.70	8.04e-02	669.63	191.92	191.96	669.59	4.26	
1	70	821	0.790.34	0.52	0.61	0.22	715.87	228.14	228.44	715.57	12.19	
1	70	822	0.830.14	0.55	0.42	0.34	769.42	295.74	297.06	768.10	24.98	
1	70	823	0.63-0.12	0.37	0.15	0.36	778.94	396.17	401.59	773.53	45.20	
1	70	824	4.52e-02	-0.50	-0.40	-5.60e-02	0.21	697.58	511.58	543.30	665.85	69.96
1	70	825	-0.15-1.95	-1.94	-0.16	6.15e-02	729.48	374.44	706.93	396.99	86.60	
1	70	826	-0.25-3.14	-3.14	-0.25	5.45e-02	821.27	105.94	807.99	119.21	96.54	
1	70	827	0.20-2.83	-2.61	-1.68e-02	-0.79	767.59	-43.47	632.63	91.48	-302.07	
1	70	828	1.17-1.66	-1.40	0.91	-0.82	773.54	252.04	499.68	525.90	-260.42	
1	70	829	1.40-0.76	-0.25	0.89	-0.92	838.80	303.15	382.14	759.81	-189.93	
1	70	830	1.56-0.41	0.22	0.93	-0.92	839.79	273.20	297.00	815.99	-113.66	
1	70	831	1.47-0.19	0.22	1.06	-0.72	781.21	229.64	236.66	774.19	-61.83	
1	70	832	1.235.05e-02	0.21	1.07	-0.41	713.42	194.82	196.46	711.78	-29.09	
1	70	833	1.070.20	0.22	1.06	-0.11	675.66	178.08	178.16	675.59	-6.02	
1	70	834	1.090.21	0.24	1.06	0.17	686.19	182.60	183.05	685.74	15.01	
1	70	835	1.296.11e-02	0.29	1.07	0.48	740.62	207.69	210.86	737.45	40.98	
1	70	836	1.57-0.19	0.36	1.02	0.82	812.18	248.46	259.98	800.66	79.76	
1	70	837	1.67-0.46	0.42	0.80	1.05	855.12	292.18	329.46	817.84	139.99	
1	70	838	1.11-0.73	-0.12	0.50	0.86	824.02	304.00	426.02	701.99	220.38	
1	70	839	1.00-1.96	-1.85	0.88	0.58	760.66	190.53	554.25	396.94	274.00	
1	70	840	0.16-3.21	-2.91	-0.14	0.95	766.29	-42.07	633.24	90.98	299.75	
1	70	841	-1.02-3.24	-3.20	-1.06	-0.30	487.34	-321.73	172.24	-6.62	-394.53	
1	70	842	6.18-2.14	-1.17	5.21	-2.67	824.58	-50.82	202.70	571.06	-397.06	
1	70	843	2.72-0.48-4.75e-02		2.28	-1.10	940.45	96.09	176.19	860.34	-247.43	
1	70	844	3.06-0.70-8.75e-02		2.45	-1.38	914.47	169.67	197.12	887.02	-140.32	





EGP CODE

GRE.EEC.R.73.IT.W.15235.12.024.01

PAGE

421 di/of 527

1	70	845	2.32-0.44	-0.17	2.05	-0.83	829.69	177.09	186.60	820.18	-78.20
1	70	846	1.81-0.21	-0.12	1.72	-0.42	746.23	167.15	169.63	743.75	-37.81
1	70	847	1.57-7.79e-02	-7.07e-02	1.56	-0.11	701.98	159.67	159.78	701.86	-7.96
1	70	848	1.61-7.57e-02	-5.57e-02	1.59	0.18	714.13	161.71	162.41	713.43	19.65
1	70	849	1.92-0.21	-7.05e-02	1.79	0.52	778.47	171.61	176.23	773.85	52.76
1	70	850	2.54-0.45	-7.74e-02	2.17	0.98	869.22	178.42	193.36	854.28	100.50
1	70	851	3.45-0.74	6.96e-02	2.64	1.65	940.07	156.87	198.64	898.30	175.98
1	70	852	3.69-0.89	-0.10	2.90	1.73	928.36	49.16	174.18	803.34	307.06
1	70	853	3.240.38	0.60	3.02	0.77	709.11	-95.68	233.71	379.72	395.71
1	70	854	-0.18-6.72	-6.52	-0.38	1.12	463.02	-341.36	145.60	-23.94	393.16
1	70	855	7.41-3.75	3.93	-0.27	5.17	-282.14	-678.91	-532.23	-428.83	-191.53
1	70	856	4.95-4.30	3.28	-2.62	3.57	881.20	-414.92	-257.29	723.57	-423.63
1	70	857	6.84-2.70	-0.93	5.08	-3.70	1004.64	-31.66	14.29	958.69	-213.32
1	70	858	4.34-1.10	-0.96	4.20	-0.86	964.12	99.67	113.99	949.79	-110.35
1	70	859	2.96-0.59	-0.55	2.92	-0.40	869.43	135.71	141.54	863.59	-65.16
1	70	860	2.25-0.38	-0.36	2.24	-0.20	777.76	140.62	142.35	776.03	-33.16
1	70	861	1.97-0.28	-0.28	1.97	-5.06e-02	729.58	138.97	139.06	729.49	-7.21
1	70	862	2.02-0.28	-0.27	2.02	9.14e-02	742.71	139.49	139.99	742.21	17.37
1	70	863	2.40-0.37	-0.34	2.38	0.25	812.81	139.95	142.98	809.78	45.09
1	70	864	3.26-0.59	-0.52	3.19	0.49	913.15	126.10	134.54	904.71	81.08
1	70	865	4.81-1.16	-0.98	4.64	1.01	993.46	63.67	83.57	973.56	134.57
1	70	866	7.13-2.55	-0.22	4.80	4.14	985.26	-139.67	-73.11	918.70	265.42
1	70	867	6.38-6.10	-1.08	1.36	-6.12	711.50	-663.38	-384.84	432.95	552.61
1	70	868	10.77-3.56	10.20	-3.00	-2.79	-346.20	-639.62	-491.96	-493.85	146.71
1	70	869	24.276.14	24.05	6.36	2.00	914.04	-158.07	-141.36	897.32	-132.82
1	70	870	11.33-0.23	-4.29e-02	11.14	1.47	1067.86	-24.21	-17.91	1061.57	-82.69
1	70	871	4.33-7.43e-02	-7.20e-02	4.33	0.10	979.16	93.09	99.22	973.03	-73.45
1	70	872	2.94-0.46	-0.46	2.94	-3.10e-04	884.06	123.32	126.54	880.84	-49.34
1	70	873	2.32-0.39	-0.39	2.32	-2.64e-02	791.99	128.91	129.99	790.90	-26.76
1	70	874	2.08-0.32	-0.32	2.08	-1.19e-02	743.17	128.07	128.12	743.11	-6.00
1	70	875	2.13-0.32	-0.32	2.13	2.18e-02	756.42	128.44	128.76	756.10	14.17
1	70	876	2.48-0.38	-0.38	2.48	4.49e-02	827.19	127.88	129.67	825.41	35.24
1	70	877	3.22-0.41	-0.41	3.22	3.60e-02	927.25	113.61	117.78	923.08	58.12
1	70	878	4.870.17	0.17	4.87	-4.09e-02	1006.58	60.08	67.26	999.40	82.14
1	70	879	13.95-0.63	-0.45	13.76	-1.62	1063.93	-111.04	-104.57	1057.47	86.92
1	70	880	35.25-9.52	35.20	-9.47	-1.52	752.11	-594.85	-575.15	732.42	161.69
1	70	881	9.55-6.23	2.99	0.33	-7.77	-641.97	-866.65	-864.49	-644.13	-21.93
1	70	882	2.94-4.89	2.53	-4.48	-1.75	816.71	-424.33	-401.47	793.85	166.88
1	70	883	5.59-2.85	-0.57	3.30	3.75	974.72	-46.82	-46.70	974.60	11.03
1	70	884	4.11-1.10	-0.92	3.94	0.94	977.90	74.53	76.71	975.72	-44.33
1	70	885	2.96-0.52	-0.50	2.93	0.30	890.99	115.14	116.94	889.19	-37.39
1	70	886	2.35-0.37	-0.36	2.35	7.43e-02	800.31	123.71	124.42	799.59	-21.96
1	70	887	2.12-0.32	-0.32	2.12	7.73e-03	751.72	123.96	124.00	751.68	-5.06
1	70	888	2.18-0.32	-0.32	2.18	-1.51e-02	764.85	124.21	124.43	764.63	11.81
1	70	889	2.51-0.36	-0.35	2.51	-8.46e-02	834.97	122.45	123.55	833.87	28.02
1	70	890	3.26-0.50	-0.47	3.23	-0.34	932.72	105.36	107.39	930.69	40.92
1	70	891	4.57-1.14	-0.91	4.35	-1.11	1001.29	39.69	41.38	999.60	40.30
1	70	892	6.33-3.32	0.20	2.81	-4.64	936.24	-149.39	-147.78	934.63	-41.70
1	70	893	4.30-8.57	-1.06	-3.21	6.35	604.07	-678.77	-583.31	508.62	-336.66
1	70	894	9.46-2.40	6.32	0.74	5.24	-689.32	-886.87	-841.58	-734.60	83.04
1	70	895	0.98-3.21	-1.91	-0.32	1.94	148.27	-183.94	2.56	-38.24	164.85
1	70	896	6.43-3.21	-2.79	6.00	1.97	639.48	-41.06	32.15	566.28	210.86
1	70	897	2.07-0.58	-0.58	2.07	2.26e-02	919.54	28.28	33.77	914.06	69.71
1	70	898	2.74-0.22	9.80e-02	2.42	0.91	961.48	96.89	96.93	961.44	6.01
1	70	899	2.40-0.17	-7.66e-02	2.30	0.49	894.35	116.38	116.51	894.22	-10.05
1	70	900	2.16-0.20	-0.18	2.14	0.20	811.77	119.08	119.19	811.65	-8.92
1	70	901	2.06-0.23	-0.23	2.06	2.78e-02	765.56	118.26	118.27	765.55	-2.17
1	70	902	2.11-0.23	-0.22	2.11	-9.76e-02	777.94	119.07	119.11	777.89	5.40
1	70	903	2.31-0.19	-0.17	2.28	-0.27	843.57	120.47	120.62	843.42	10.21
1	70	904	2.65-0.14	-1.36e-02	2.53	-0.57	929.16	115.07	115.11	929.12	5.65
1	70	905	3.07-9.76e-02	0.28	2.70	-1.03	971.00	86.49	87.15	970.34	-24.12
1	70	906	2.61-0.70	-0.69	2.60	-0.15	864.43	-2.73	14.20	847.51	-119.97
1	70	907	5.42-1.03	-0.92	5.31	-0.82	451.58	-38.32	65.08	348.18	-199.91
1	70	908	2.01-6.96	-5.49	0.54	-3.32	122.30	-196.13	-25.21	-48.62	-158.78
1	70	909	0.77-1.58	-1.53	0.73	0.31	389.01	39.04	366.65	61.39	85.58
1	70	910	2.63-2.28	-2.20	2.55	0.64	559.11	241.21	258.53	541.78	72.17
1	70	911	2.05-0.76	-0.70	1.99	0.41	849.01	170.84	173.12	846.73	39.28
1	70	912	1.710.23	0.28	1.66	0.27	933.73	138.52	138.75	933.51	13.35
1	70	913	1.870.16	0.18	1.85	0.19	888.40	127.23	127.23	888.39	2.42
1	70	914	1.92-1.67e-02	-1.35e-02	1.91	7.80e-02	813.94	120.27	120.27	813.94	-0.27
1	70	915	1.93-0.11	-0.11	1.93	-1.37e-02	770.22	116.81	116.81	770.22	0.17
1	70	916	1.97-0.12	-0.11	1.96	-9.42e-02	781.89	118.31	118.31	781.89	1.18
1	70	917	2.04-1.70e-02	-5.16e-04	2.02	-0.18	843.05	124.71	124.71	843.04	0.75
1	70	918	2.070.18	0.22	2.03	-0.27	916.65	135.17	135.20	916.62	-4.63
1	70	919	1.920.35	0.39	1.88	-0.24	929.94	153.32	153.94	929.32	-21.85
1	70	920	1.95-0.45	-0.43	1.93	-0.22	775.00	198.59	203.76	769.83	-54.33



EGP CODE

GRE.EEC.R.73.IT.W.15235.12.024.01

PAGE

422 di/of 527

1	70	921	2.85-1.99	-1.92	2.78	-0.59	442.69	262.10	305.72	399.08	-77.30
1	70	922	0.77-1.96	-1.83	0.64	-0.57	387.43	44.21	368.08	63.56	-79.17
1	70	923	-0.16-4.06	-3.12	-1.10	-1.67	296.49	5.87	286.23	16.13	-53.63
1	70	924	3.39-2.44	-2.44	3.39	0.11	555.48	216.78	231.19	541.07	-68.36
1	70	925	2.25-0.40	-0.40	2.25	6.05e-02	863.47	152.07	154.40	861.14	-40.68
1	70	926	2.080.20	0.21	2.07	-0.18	934.81	136.43	136.44	934.81	-2.73
1	70	927	1.970.16	0.17	1.96	-0.14	886.88	127.58	127.63	886.83	6.33
1	70	928	1.912.26e-035.63e-03		1.90	-8.00e-02	812.27	121.47	121.52	812.23	5.71
1	70	929	1.88-8.79e-02-8.60e-02		1.88	-6.12e-02	768.69	118.27	118.27	768.68	2.01
1	70	930	1.90-8.46e-02-8.28e-02		1.90	-6.01e-02	780.38	119.31	119.32	780.37	-2.06
1	70	931	1.971.14e-021.23e-02		1.97	-4.16e-02	841.41	124.43	124.45	841.38	-4.53
1	70	932	2.090.16	0.16	2.09	2.84e-02	914.89	132.76	132.76	914.89	-1.79
1	70	933	2.390.12	0.13	2.38	0.15	929.48	147.88	148.13	929.23	14.05
1	70	934	3.26-0.55	-0.41	3.12	0.72	791.09	181.06	186.72	785.42	58.51
1	70	935	2.81-1.35	-1.07	2.53	-1.05	418.67	251.39	278.14	391.92	61.32
1	70	936	1.72-5.78	-5.18	1.12	2.03	290.78	13.23	279.62	24.39	54.53
1	70	937	3.65-4.03	3.52	-3.90	-0.97	40.43	-131.34	7.02e-02	-90.98	-72.82
1	70	938	2.90-4.55	-1.92	0.26	3.56	610.73	-178.51	-95.31	527.53	-242.37
1	70	939	3.45-0.33	-0.27	3.39	0.49	924.99	12.78	17.44	920.32	-65.04
1	70	940	2.830.29	0.32	2.80	-0.31	958.94	91.29	91.37	958.86	8.25
1	70	941	2.343.41e-025.46e-02		2.32	-0.22	889.39	117.65	118.21	888.83	20.76
1	70	942	2.02-8.25e-02-7.65e-02		2.02	-0.11	806.92	124.53	124.87	806.58	15.23
1	70	943	1.88-0.13	-0.13	1.88	-6.47e-02	761.09	125.25	125.28	761.06	4.21
1	70	944	1.89-0.12	-0.12	1.88	-4.06e-02	773.47	124.75	124.83	773.38	-7.57
1	70	945	2.04-6.66e-02-6.66e-02		2.04	7.16e-03	838.66	121.63	122.02	838.27	-16.70
1	70	946	2.356.07e-026.46e-02		2.34	9.45e-02	923.69	107.87	108.20	923.36	-16.45
1	70	947	2.800.27	0.27	2.80	5.53e-02	966.04	65.53	65.66	965.92	10.66
1	70	948	4.05-1.59	-0.98	3.44	-1.74	857.73	-47.85	-32.98	842.86	115.09
1	70	949	5.88-5.73	-4.88	5.03	-3.02	406.76	-226.50	-78.54	258.80	267.96
1	70	950	5.03-7.18	4.45	-6.60	2.60	15.71	-149.23	-2.65	-130.87	51.88
1	70	951	2.82-0.12	-0.11	2.81	0.17	805.06	-8.98	-8.42	804.50	-21.40
1	70	952	15.14-7.56	14.86	-7.29	-2.49	839.01	-504.53	-498.40	832.88	90.55
1	70	953	6.582.93	5.66	3.85	-1.58	1029.02	-51.55	-41.26	1018.73	104.95
1	70	954	3.130.64	0.64	3.13	-1.84e-02	969.51	75.21	84.37	960.36	90.03
1	70	955	2.43-2.78e-02-2.13e-02		2.42	0.13	877.87	127.86	133.16	872.56	62.84
1	70	956	1.95-0.11	-0.11	1.95	8.57e-02	786.92	145.65	147.55	785.02	34.86
1	70	957	1.73-0.12	-0.12	1.73	4.41e-03	738.57	149.67	149.78	738.47	7.96
1	70	958	1.74-0.12	-0.12	1.74	-8.14e-02	751.64	148.08	148.65	751.07	-18.60
1	70	959	1.98-0.13	-0.12	1.97	-0.14	821.38	138.48	141.61	818.26	-46.08
1	70	960	2.43-3.37e-02-2.74e-02		2.42	-0.12	919.20	106.64	113.58	912.27	-74.73
1	70	961	3.020.69	0.71	3.01	0.18	992.01	20.69	31.43	981.26	-101.61
1	70	962	7.401.87	5.95	3.32	2.43	991.81	-180.61	-170.81	982.02	-106.72
1	70	963	17.14-19.70	16.85	-19.41	3.27	595.93	-947.75	-943.55	591.73	-80.34
1	70	964	3.59-0.51	-0.47	3.56	0.38	853.10	-22.34	-20.56	851.33	-39.39
1	70	965	5.80-3.41	-3.37	5.75	0.63	743.92	-82.33	-81.35	742.94	-28.54
1	70	966	28.263.50	12.24	19.51	-11.84	290.93	131.93	207.55	215.32	-79.40
1	70	967	7.99-8.25	-7.82	7.57	-2.59	-97.29	-336.82	-315.05	-119.06	68.85
1	70	968	7.02-7.84	-7.24	6.42	2.93	-117.61	-322.32	-303.61	-136.33	-58.99
1	70	969	11.26-5.48	6.03	-0.25	-7.76	11.71	-452.85	-94.61	-346.53	195.16
1	70	970	8.44-7.45	0.16	0.83	7.94	12.12	-490.51	-140.18	-338.21	-230.98
1	70	971	3.44-1.74	2.29	-0.59	2.15	814.12	-153.50	85.55	575.07	-417.33
1	70	972	5.64-1.39-4.73e-03		4.26	-2.80	908.85	60.21	158.31	810.75	-217.34
1	70	973	4.39-0.53-9.78e-02		3.95	-1.39	873.87	121.70	163.98	831.59	-173.24
1	70	974	3.28-0.22-5.91e-02		3.12	-0.73	786.37	122.29	140.11	768.56	-107.31
1	70	975	2.71-7.73e-02-2.37e-02		2.66	-0.38	702.04	111.96	117.29	696.72	-55.79
1	70	976	2.47-1.41e-02-1.01e-02		2.47	-9.93e-02	657.57	105.37	105.66	657.29	-12.51
1	70	977	5.26-4.33	2.91	-1.98	-4.13	-16.91	-604.88	-317.27	-304.52	293.91
1	70	978	4.50-6.54	-1.57	-0.47	-5.49	812.31	-452.90	-210.30	569.72	498.08
1	70	979	3.84-0.85	-0.54	3.53	1.17	989.15	-52.05	29.18	907.92	279.25
1	70	980	2.86-3.52e-028.84e-02		2.74	0.59	949.82	110.16	139.10	920.89	153.16
1	70	981	2.14-8.52e-02-1.29e-02		2.07	0.39	854.21	163.22	175.40	842.03	90.93
1	70	982	1.68-6.04e-02-3.27e-02		1.66	0.22	762.85	178.44	182.19	759.10	46.66
1	70	983	1.47-3.36e-02-3.19e-02		1.47	5.03e-02	714.80	181.21	181.40	714.61	10.04
1	70	984	1.50-5.34e-02-4.59e-02		1.49	-0.11	727.72	180.15	181.30	726.57	-25.05
1	70	985	1.75-0.12-8.15e-02		1.71	-0.25	797.15	173.05	179.76	790.43	-64.39
1	70	986	2.25-0.18	-0.12	2.20	-0.36	896.34	145.76	163.77	878.33	-114.85
1	70	987	3.04-0.22	-0.18	3.00	-0.37	976.40	63.72	104.91	935.22	-189.45
1	70	988	3.92-1.17	-1.15	3.90	-0.34	967.76	-168.03	-50.14	849.88	-346.41
1	70	989	8.21-7.55	-5.39	6.06	5.41	649.57	-643.79	-279.48	285.26	-581.78
1	70	990	8.35-6.80	7.85	-6.30	2.71	-53.20	-579.12	-291.61	-340.71	-261.81
1	70	991	0.30-4.54	-3.84	-0.40	1.70	589.90	-331.99	273.85	-15.95	437.58
1	70	992	5.77-3.13	-2.61	5.25	2.09	845.05	-33.84	297.51	513.70	425.94
1	70	993	2.14-0.84	-0.81	2.11	0.31	933.64	120.71	254.35	800.00	301.30
1	70	994	1.93-0.23	6.81e-02	1.63	0.75	897.23	212.76	266.11	843.89	183.49
1	70	995	1.54-6.21e-02	0.16	1.31	0.56	809.83	237.16	257.95	789.04	107.13
1	70	996	1.227.21e-02	0.16	1.13	0.31	725.33	238.78	244.73	719.38	53.44



EGP CODE

GRE.EEC.R.73.IT.W.15235.12.024.01

PAGE

423 di/of 527

1	70	997	1.060.15	0.15	1.05	7.94e-02	680.61	236.55	236.83	680.33	11.23	
1	70	998	1.090.11	0.13	1.07	-0.14	692.59	237.18	238.98	690.79	-28.59	
1	70	999	1.32-2.34e-029.08e-02		1.21	-0.37	757.00	239.28	250.24	746.04	-74.53	
1	70	1000	1.74-0.23 7.94e-03		1.51	-0.64	848.72	232.70	264.42	817.00	-136.15	
1	70	1001	2.43-0.54	-0.21	2.10	-0.93	923.89	194.26	271.86	846.28	-224.94	
1	70	1002	3.79-1.49	-1.09	3.38	-1.40	931.94	74.97	267.17	739.74	-357.45	
1	70	1003	3.36-0.58	-0.52	3.30	-0.49	765.93	-85.76	331.31	348.87	-425.76	
1	70	1004	1.56-7.57	-7.01	1.00	-2.19	575.03	-346.99	253.67	-25.63	-439.35	
1	70	1005	0.82-3.40	-2.80	0.21	1.48	874.97	-75.61	724.71	74.65	346.79	
1	70	1006	1.44-2.44	-2.14	1.14	1.03	852.33	236.12	605.13	483.33	302.03	
1	70	1007	0.99-0.95	-0.73	0.77	0.61	859.74	342.02	493.79	707.97	235.67	
1	70	1008	0.87-0.19	0.16	0.52	0.50	827.43	353.65	411.55	769.52	155.18	
1	70	1009	0.885.14e-02	0.35	0.57	0.40	757.42	333.23	354.26	736.38	92.10	
1	70	1010	0.760.24	0.38	0.62	0.23	686.50	311.06	316.80	680.76	46.05	
1	70	1011	0.660.35	0.36	0.64	5.55e-02	648.02	299.60	299.87	647.75	9.69	
1	70	1012	0.700.30	0.34	0.66	-0.12	658.39	302.85	304.54	656.70	-24.46	
1	70	1013	0.850.13	0.32	0.66	-0.32	713.53	320.15	330.74	702.95	-63.65	
1	70	1014	1.05-0.12	0.26	0.66	-0.55	789.77	345.46	377.55	757.68	-115.01	
1	70	1015	1.18-0.48 5.99e-02		0.63	-0.78	850.31	361.52	445.09	766.74	-184.02	
1	70	1016	1.02-1.11	-0.73	0.64	-0.81	866.68	323.66	538.01	652.32	-265.43	
1	70	1017	1.38-2.56	-2.34	1.16	-0.90	860.05	160.92	656.58	364.39	-317.58	
1	70	1018	0.63-3.56	-3.01	8.00e-02	-1.42	879.14	-76.39	727.00	75.75	-349.61	
1	70	1019	-7.04e-02	-3.41	-3.29	-0.19	0.61	961.85	68.11	931.08	98.88	162.94
1	70	1020	0.13-1.88	-1.72	-3.25e-02	0.55	837.83	423.87	783.57	478.12	139.70	
1	70	1021	0.12-0.63	-0.52	9.74e-03	0.27	770.03	540.00	639.59	670.44	113.98	
1	70	1022	0.29-1.75e-03	0.21	7.55e-02	0.13	754.58	492.00	519.76	726.81	80.75	
1	70	1023	0.490.21	0.47	0.23	6.93e-02	711.66	424.32	433.37	702.60	50.20	
1	70	1024	0.510.37	0.51	0.38	3.13e-02	657.71	376.98	379.35	655.34	25.69	
1	70	1025	0.490.46	0.49	0.46	-7.07e-04	626.45	355.70	355.81	626.34	5.48	
1	70	1026	0.510.43	0.49	0.46	-3.64e-02	635.06	361.42	362.10	634.38	-13.62	
1	70	1027	0.540.32	0.49	0.37	-9.12e-02	679.40	394.06	398.41	675.05	-34.96	
1	70	1028	0.530.10	0.44	0.19	-0.18	734.93	451.74	465.71	720.96	-61.32	
1	70	1029	0.36-0.23	0.16	-3.01e-02	-0.28	766.81	522.32	565.62	723.51	-93.34	
1	70	1030	4.12e-02	-0.88	-0.68	-0.17	-0.39	790.67	528.07	696.82	621.92	-125.85
1	70	1031	-7.82e-02	-2.35	-2.24	-0.19	-0.49	885.84	325.66	844.03	367.47	-147.23
1	70	1032	-0.17-3.48	-3.41	-0.24	-0.47	964.99	72.02	933.52	103.49	-164.65	
1	70	1033	-0.29-3.40	-3.39	-0.30	0.20	983.96	101.10	982.49	102.57	-36.02	
1	70	1034	-0.23-1.44	-1.44	-0.23	7.14e-03	835.25	478.29	832.56	480.98	-30.88	
1	70	1035	9.76e-02	-0.42	-0.26	-6.53e-02	-0.24	699.70	654.36	685.95	668.11	-20.84
1	70	1036	0.60-0.14	0.33	0.14	-0.36	721.31	561.06	561.72	720.64	-10.30	
1	70	1037	0.760.10	0.51	0.36	-0.32	695.94	470.03	470.10	695.87	-4.04	
1	70	1038	0.730.31	0.52	0.52	-0.21	649.54	411.96	411.96	649.53	-1.34	
1	70	1039	0.630.47	0.50	0.60	-6.43e-02	621.28	386.43	386.43	621.28	-0.25	
1	70	1040	0.640.45	0.50	0.59	7.75e-02	629.21	393.08	393.08	629.20	0.58	
1	70	1041	0.710.29	0.52	0.48	0.21	669.06	431.96	431.98	669.04	2.23	
1	70	1042	0.725.42e-02	0.51	0.27	0.31	714.50	503.48	503.66	714.32	6.16	
1	70	1043	0.49-0.23	0.30	-3.86e-02	0.32	719.79	606.79	608.57	718.00	14.09	
1	70	1044	-0.19-0.56	-0.46	-0.30	0.17	748.63	615.52	743.74	620.41	25.03	
1	70	1045	-0.37-2.12	-2.12	-0.37	-5.78e-02	895.34	368.28	893.39	370.24	32.03	
1	70	1046	-0.34-3.52	-3.52	-0.34	-0.13	985.73	105.51	984.34	106.90	34.96	
1	70	1047	-6.54e-02	-2.94	-2.92	-9.22e-02	-0.28	935.94	28.00	875.54	88.40	-226.26
1	70	1048	0.77-1.30	-1.08	0.55	-0.65	852.87	383.56	745.64	490.79	-197.04	
1	70	1049	1.29-0.59 6.37e-02		0.63	-0.90	811.29	507.35	622.65	695.98	-147.48	
1	70	1050	1.52-0.30	0.43	0.78	-0.89	780.63	487.55	521.78	746.40	-94.13	
1	70	1051	1.46-4.76e-02	0.44	0.97	-0.70	724.40	434.60	445.45	713.56	-55.01	
1	70	1052	1.250.20	0.40	1.06	-0.41	664.44	391.80	394.59	661.66	-27.43	
1	70	1053	1.100.36	0.37	1.08	-0.11	631.25	371.40	371.54	631.11	-5.94	
1	70	1054	1.120.33	0.38	1.08	0.18	640.38	376.64	377.41	639.61	14.23	
1	70	1055	1.300.14	0.40	1.04	0.48	688.03	406.83	411.94	682.92	37.57	
1	70	1056	1.51-0.14	0.45	0.93	0.79	751.80	456.47	473.55	734.72	68.94	
1	70	1057	1.55-0.46	0.43	0.67	1.00	799.17	506.18	559.65	745.69	113.17	
1	70	1058	1.01-0.74-1.37e-02		0.28	0.86	825.91	487.18	669.79	643.30	168.85	
1	70	1059	0.55-1.79	-1.70	0.46	0.46	883.42	287.60	799.30	371.73	207.47	
1	70	1060	-0.27-3.18	-3.15	-0.30	0.30	936.21	29.38	876.38	89.21	225.11	
1	70	1061	0.84-3.12	-3.10	0.82	0.28	698.67	-140.50	535.90	22.28	-331.82	
1	70	1062	5.40-1.38	-0.33	4.35	-2.45	858.96	165.16	503.40	520.72	-346.79	
1	70	1063	2.71-0.20	0.42	2.09	-1.19	878.53	310.87	432.78	756.62	-233.12	
1	70	1064	-0.94-2.90	-2.80	-1.04	0.44	684.17	-79.03	660.40	-55.25	132.59	
1	70	1065	2.41-0.16	0.22	2.03	-0.92	763.55	322.68	342.35	743.88	-91.01	
1	70	1066	2.004.66e-02	0.18	1.86	-0.50	688.07	299.71	305.41	682.37	-46.69	
1	70	1067	1.790.16	0.18	1.78	-0.13	647.97	287.35	287.64	647.68	-10.32	
1	70	1068	1.830.14	0.17	1.80	0.22	658.80	290.42	292.03	657.19	24.27	
1	70	1069	2.10-1.09e-02	0.18	1.91	0.60	716.67	307.85	317.83	706.69	63.10	
1	70	1070	2.58-0.26	0.20	2.12	1.05	798.80	331.59	360.45	769.94	112.46	
1	70	1071	3.19-0.54	0.31	2.34	1.56	866.89	339.61	409.86	796.63	179.19	
1	70	1072	3.39-0.71	0.13	2.55	1.66	881.42	273.91	450.42	704.90	275.82	



EGP CODE

GRE.EEC.R.73.IT.W.15235.12.024.01

PAGE

424 di/of 527

1	70	1073	3.321.15e-02	0.91	2.42	1.47	812.67	87.26	546.44	353.50	349.64
1	70	1074	0.34-5.03	-5.03	0.34	-0.14	680.77	-152.56	517.48	10.73	330.77
1	70	1076	17.33-19.21	11.79	-13.67	-13.10	-464.94	-774.44	-773.97	-465.42	12.06
1	70	1077	7.50-1.55	2.11	3.84	4.44	427.09	-170.01	283.09	-26.01	255.43
1	70	1078	-0.52-4.51	-4.47	-0.56	0.40	766.52	-70.41	745.20	-49.09	131.87
1	70	1079	-0.42-6.01	-6.01	-0.42	6.55e-03	933.69	-45.59	931.43	-43.34	46.96
1	70	1080	-0.41-6.04	-6.04	-0.41	-1.44e-02	936.72	-44.54	935.25	-43.08	-37.92
1	70	1081	-0.54-4.63	-4.60	-0.57	-0.37	778.21	-66.76	760.02	-48.58	-122.62
1	70	1082	2.51-2.49e-02-1.29e-02	2.50	0.17	0.17	669.43	106.92	108.40	667.95	28.79
1	70	1083	2.84-0.11-3.82e-02	2.76	0.46	0.46	733.50	115.53	124.64	724.38	74.49
1	70	1084	3.51-0.29	-0.11	3.32	0.82	825.02	123.63	148.80	799.84	130.48
1	70	1085	4.74-0.66	-0.19	4.27	1.53	898.72	109.78	165.90	842.60	202.80
1	70	1086	5.94-1.45	0.13	4.36	3.02	893.41	3.58	132.62	764.37	313.33
1	70	1087	5.73-1.72	-0.28	4.29	-2.94	740.77	-342.08	13.68	385.01	508.59
1	70	1088	6.77-1.76	1.63	3.37	-4.18	442.22	-154.66	317.97	-30.41	-242.33
1	70	1089	12.361.85	11.35	2.86	3.10	730.67	-129.54	-56.63	657.76	-239.59
1	70	1090	7.622.19	2.44	7.37	-1.13	929.63	-61.85	9.00	858.78	-255.39
1	70	1091	4.66-5.32e-02-0.22.40e-02	4.58	-0.60	-0.60	882.88	-36.76	1.11	845.00	-182.75
1	70	1092	3.61-0.13-6.84e-02	3.54	-0.49	-0.49	792.40	-30.91	-14.34	775.83	-115.62
1	70	1093	3.03-6.66e-02-3.74e-02	3.00	-0.30	-0.30	703.68	-33.21	-28.27	698.74	-60.09
1	70	1094	2.78-2.68e-02-2.46e-02	2.77	-7.85e-02	-7.85e-02	656.92	-35.73	-35.47	656.66	-13.51
1	70	1095	2.82-3.37e-02-2.62e-02	2.82	0.15	0.15	669.28	-35.15	-33.81	667.93	30.76
1	70	1096	3.17-8.64e-02-4.52e-02	3.13	0.36	0.36	736.49	-32.36	-23.95	728.09	79.95
1	70	1097	3.84-0.17-9.22e-02	3.77	0.54	0.54	832.40	-33.03	-9.88	809.24	139.65
1	70	1098	5.07-9.11e-02-3.09e-02	5.01	0.55	0.55	905.56	-49.36	-1.11	857.30	209.16
1	70	1099	8.382.35	2.42	8.31	0.64	891.44	-100.32	-21.08	812.20	268.90
1	70	1100	16.74-6.49	15.56	-5.31	-5.11	572.36	-321.71	-279.68	530.33	189.24
1	70	1101	-2.39-24.64	-21.87	-5.16	7.34	251.92	-351.85	-342.25	242.32	75.55
1	70	1102	-0.54-19.57	-0.64	-19.48	-1.37	652.62	-888.34	-888.34	652.61	-2.43
1	70	1103	-4.02-18.00	-17.96	-4.05	0.67	529.98	-1235.11	-1235.11	529.97	2.81
1	70	1104	-4.06-19.34	-18.33	-5.07	-3.80	555.23	-1309.76	-1308.72	554.19	-44.01
1	70	1105	6.59-27.38	5.24	-26.02	6.64	827.56	-1333.57	-1333.57	827.56	1.98e-02
1	70	1106	-2.43-18.01	-16.50	-3.94	4.61	739.83	-1991.99	-1990.83	738.68	56.24
1	70	1107	-2.40-18.52	-16.90	-4.02	-4.85	700.62	-1847.76	-1846.58	699.44	-54.83
1	70	1108	1.09-25.55	-1.24	-23.22	-7.53	693.95	-998.90	-998.77	693.82	-14.70
1	70	1109	-3.65-15.16	-14.64	-4.17	2.38	543.89	-1303.17	-1303.16	543.88	-3.54
1	70	1110	-5.83-18.73	-14.31	-10.25	-6.12	359.27	-417.20	-411.90	353.96	-63.96
1	70	1111	4.60-2.25	-1.06	3.42	2.59	216.02	-100.51	190.24	-74.74	-86.56
1	70	1112	-0.66-4.81	-4.35	-1.12	-1.31	782.12	-83.94	777.29	-79.11	-64.51
1	70	1113	-0.76-6.32	-6.32	-0.76	1.93e-02	929.37	-54.91	928.87	-54.40	22.28
1	70	1114	-0.96-5.39	-5.38	-0.97	0.22	775.60	-69.51	763.00	-56.90	102.44
1	70	1115	2.86-3.65	0.42	-1.21	3.15	292.06	-161.47	212.29	-81.70	172.67
1	70	1116	16.18-2.18	5.40	8.60	-9.04	-110.65	-1021.15	-1021.02	-110.78	-10.92
1	70	1117	15.16-2.12	5.53	7.51	8.58	-124.07	-1021.94	-1018.63	-127.38	54.43
1	70	1118	2.90-3.01	0.85	-0.97	-2.81	196.72	-129.38	146.43	-79.09	-117.78
1	70	1119	-0.92-4.62	-4.61	-0.93	-0.21	620.83	-62.46	617.46	-59.09	-47.87
1	70	1120	-0.68-4.54	-4.53	-0.70	0.23	683.99	-58.66	682.52	-57.19	33.01
1	70	1121	4.65-1.83	2.13	0.69	3.16	419.40	-97.29	384.15	-62.04	130.27
1	70	1122	14.54-7.19	10.30	-2.95	-8.62	-248.23	-510.16	-509.58	-248.81	-12.23
1	70	1123	-0.52-5.08	-5.08	-0.52	3.11e-02	902.75	-49.30	900.35	-46.90	47.71
1	70	1124	14.45-7.25	10.10	-2.91	8.68	-247.69	-498.55	-498.54	-247.70	-2.16
1	70	1125	4.49-2.10	1.68	0.71	-3.26	458.92	-102.50	417.43	-61.01	-146.88
1	70	1126	-0.64-5.11	-5.10	-0.65	-0.23	763.89	-57.85	761.25	-55.21	-46.53
1	70	1127	-0.55-5.32	-5.31	-0.56	0.20	783.95	-56.78	781.82	-54.65	42.26
1	70	1128	4.23-2.11	0.76	1.36	3.15	524.75	-93.22	486.41	-54.88	149.06
1	70	1129	12.99-9.23	9.29	-5.54	-8.27	-269.69	-348.43	-327.28	-290.84	34.90
1	70	1130	16.36-17.04	11.27	-11.94	12.01	-424.10	-692.85	-691.10	-425.85	-21.60
1	70	1131	18.44-3.62	13.39	1.42	9.27	-197.83	-782.62	-781.82	-198.63	21.68
1	70	1132	6.24-2.27	4.24	-0.28	-3.61	356.16	-129.47	302.16	-75.46	-152.68
1	70	1133	-0.80-4.00	-3.98	-0.82	-0.30	734.65	-63.07	730.30	-58.71	-58.79
1	70	1134	-0.68-5.01	-5.01	-0.68	-1.31e-02	798.22	-56.49	797.16	-55.43	30.02
1	70	1135	-1.19-3.74	-3.70	-1.23	0.32	568.01	-84.82	547.64	-64.44	113.52
1	70	1136	6.06-4.01	4.43	-2.38	3.70	39.15	-313.92	-172.69	-102.08	172.97
1	70	1137	23.494.60	12.46	15.63	-9.31	-62.18	-1603.22	-1602.56	-62.84	-31.91
1	70	1138	21.76-11.51	7.80	2.46	16.42	-285.70	-1454.70	-1451.45	-288.94	61.51
1	70	1139	5.98-3.19	1.97	0.83	-4.55	218.67	-298.51	-17.76	-62.08	-257.64
1	70	1140	-0.77-5.17	-5.16	-0.79	-0.22	643.72	-92.27	605.05	-53.60	-164.20
1	70	1141	-0.42-5.99	-5.99	-0.42	5.13e-02	887.95	-51.61	880.28	-43.94	-84.56
1	70	1142	-0.31-6.01	-6.01	-0.31	1.88e-03	959.53	-41.30	959.53	-41.30	2.85e-02
1	70	1143	-0.43-5.62	-5.62	-0.43	-2.87e-02	890.47	-51.69	882.79	-44.01	84.69
1	70	1144	-0.69-3.89	-3.85	-0.73	0.36	648.46	-91.76	609.71	-53.00	164.89
1	70	1145	10.13-1.81	6.99	1.34	5.26	235.80	-293.81	-2.41	-55.60	263.46
1	70	1146	26.11-12.24	18.06	-4.19	-15.62	-338.39	-1379.86	-1375.92	-342.33	-63.93
1	70	1147	11.66-5.33	-2.92	9.26	-5.92	-17.77	-417.96	-396.87	-38.86	89.42
1	70	1148	18.17-19.83	12.18	-13.83	13.85	-475.26	-784.66	-784.43	-475.49	-8.38
1	70	1149	7.93-1.64	2.70	3.59	-4.76	423.19	-166.94	283.57	-27.32	-250.80





EGP CODE

GRE.EEC.R.73.IT.W.15235.12.024.01

PAGE

425 di/of 527

1	70	1150	-0.28-5.73	-5.72	-0.29	-0.28	771.45	-70.08	749.82	-48.45	-133.18
1	70	1151	-0.36-6.76	-6.76	-0.36	1.32e-02	939.34	-46.02	937.01	-43.69	-47.85
1	70	1152	-0.36-6.76	-6.76	-0.36	-1.62e-03	942.28	-44.93	940.77	-43.42	38.54
1	70	1153	-0.31-5.78	-5.76	-0.32	0.27	782.97	-66.35	764.56	-47.94	123.68
1	70	1154	7.18-1.81	2.20	3.16	4.47	439.26	-151.53	318.97	-31.23	237.90
1	70	1155	17.06-17.76	11.49	-12.19	-12.76	-435.95	-700.87	-699.67	-437.15	17.83
1	70	1156	23.16-9.85	16.53	-3.22	-13.22	-301.00	-1235.00	-1232.01	-303.99	-52.77
1	70	1157	24.16-10.58	16.80	-3.22	14.19	-309.96	-1243.79	-1239.75	-314.00	61.24
1	70	1158	9.11-1.87	6.20	1.05	-4.85	251.24	-232.45	77.60	-58.81	-232.03
1	70	1159	-0.68-4.16	-4.13	-0.72	-0.35	684.87	-78.66	660.66	-54.44	-133.81
1	70	1160	-0.46-5.89	-5.89	-0.46	-5.01e-03	905.44	-49.84	902.87	-47.27	-49.46
1	70	1161	-0.45-6.23	-6.23	-0.45	-1.59e-02	925.49	-48.69	923.92	-47.12	39.06
1	70	1162	-0.82-5.65	-5.64	-0.83	0.18	749.07	-74.52	729.65	-55.11	124.94
1	70	1163	4.03-3.69	0.34	-3.11e-03	3.85	323.48	-193.36	202.03	-71.91	219.13
1	70	1164	17.74-8.09	4.95	4.71	-12.91	-212.64	-1051.96	-1051.86	-212.74	-8.86
1	70	1165	18.505.82	9.41	14.91	5.71	-30.44	-1190.75	-1190.31	-30.88	22.60
1	70	1166	4.27-3.77	3.10	-2.60	-2.84	34.27	-165.33	-25.29	-105.77	-91.33
1	70	1167	-1.16-3.12	-3.12	-1.16	-3.97e-02	447.68	-72.42	445.51	-70.25	-33.50
1	70	1168	3.73-1.39	1.12	1.22	2.56	373.58	-66.72	364.54	-57.67	62.46
1	70	1169	10.65-9.86	7.22	-6.43	-7.65	-271.03	-379.14	-349.04	-301.12	-48.45
1	70	1170	8.14-1.82	4.96	1.36	4.64	261.23	-236.85	83.73	-59.35	238.55
1	70	1171	16.93-7.11	10.54	-0.72	10.62	-224.82	-797.62	-797.09	-225.35	-17.36
1	70	1172	5.37-2.78	2.31	0.27	-3.95	428.96	-173.69	317.06	-61.79	-234.34
1	70	1173	-0.71-5.14	-5.13	-0.72	-0.19	840.70	-71.68	817.19	-48.17	-144.57
1	70	1174	-0.39-6.28	-6.28	-0.39	1.35e-03	1044.57	-44.90	1040.43	-40.76	-67.04
1	70	1175	-0.40-6.64	-6.63	-0.40	-7.60e-02	1092.76	-41.41	1092.60	-41.26	13.35
1	70	1176	-1.01-6.66	-6.66	-1.01	-7.92e-02	980.76	-60.14	972.32	-51.70	93.34
1	70	1177	-0.40-5.54	-3.56	-2.39	2.50	596.10	-135.26	553.95	-93.11	170.43
1	70	1178	9.06-1.81	5.60	1.64	-5.06	245.41	-298.67	3.47	-56.73	-270.37
1	70	1179	-2.09-23.76	-20.89	-4.96	-7.34	251.83	-356.59	-346.10	241.35	-79.19
1	70	1180	-0.68-17.42	-0.80	-17.30	1.40	634.26	-902.33	-902.33	634.26	2.13
1	70	1181	-3.64-18.44	-18.41	-3.67	-0.69	522.91	-1235.62	-1235.62	522.90	-3.46
1	70	1182	-3.95-19.54	-18.79	-4.70	3.34	547.52	-1310.36	-1309.51	546.67	39.72
1	70	1183	5.96-24.21	4.84	-23.08	-5.72	805.78	-1352.12	-1352.12	805.78	-0.76
1	70	1184	-2.43-18.31	-17.28	-3.46	-3.91	730.88	-1993.16	-1992.27	729.99	-49.29
1	70	1185	-2.39-18.81	-17.63	-3.57	4.23	691.90	-1848.49	-1847.54	690.96	49.04
1	70	1186	0.74-22.90	-1.41	-20.75	6.80	674.50	-1013.61	-1013.46	674.36	15.67
1	70	1187	-3.10-15.57	-14.80	-3.87	-3.01	536.68	-1304.45	-1304.43	536.66	-5.97
1	70	1188	-4.36-18.14	-12.60	-9.90	6.76	357.36	-427.47	-421.86	351.75	66.10
1	70	1189	5.04-8.90e-02	0.56	4.39	-1.71	213.91	-85.33	183.82	-55.24	89.99
1	70	1190	-0.81-4.99	-4.54	-1.26	1.29	779.11	-87.21	774.16	-82.27	65.27
1	70	1191	-0.92-5.91	-5.91	-0.92	8.57e-03	929.78	-55.41	929.27	-54.90	-22.38
1	70	1192	-1.22-5.08	-5.07	-1.23	-0.19	778.81	-70.66	765.94	-57.78	-103.78
1	70	1193	1.96-4.44	-1.19	-1.30	-3.20	296.27	-168.56	213.85	-86.13	-177.54
1	70	1194	14.78-0.19	6.78	7.81	7.47	-91.49	-1026.92	-1026.92	-91.49	0.35
1	70	1195	13.58-1.20	6.01	6.37	-7.39	-111.84	-1029.25	-1026.85	-114.23	-46.83
1	70	1196	2.01-3.58	-0.61	-0.95	2.79	203.49	-135.97	149.49	-81.97	124.16
1	70	1197	-1.17-3.85	-3.84	-1.18	0.16	622.70	-63.41	619.00	-59.72	50.23
1	70	1198	-0.88-3.39	-3.35	-0.92	-0.31	683.34	-59.01	681.96	-57.62	-32.07
1	70	1199	4.30-1.67	1.70	0.93	-2.96	423.78	-98.22	386.60	-61.04	-134.26
1	70	1200	14.00-6.81	10.14	-2.95	8.09	-242.21	-502.65	-502.37	-242.49	8.57
1	70	1201	-1.14-5.23	-5.22	-1.14	-0.15	751.25	-76.14	731.41	-56.31	-126.56
1	70	1202	14.10-6.56	10.26	-2.72	-8.03	-237.62	-494.55	-494.37	-237.80	6.82
1	70	1203	4.13-2.02	1.22	0.89	3.07	460.73	-104.77	416.88	-60.92	151.25
1	70	1204	-0.87-3.86	-3.83	-0.90	0.28	759.76	-58.37	757.09	-55.70	46.64
1	70	1205	-0.77-4.05	-4.03	-0.79	-0.27	779.14	-57.20	776.99	-55.04	-42.42
1	70	1206	3.99-1.94	0.53	1.52	-2.93	524.76	-94.39	484.24	-53.88	-153.10
1	70	1207	12.56-8.68	9.25	-5.37	7.70	-259.57	-345.04	-322.44	-282.17	-37.70
1	70	1209	17.74-3.06	13.28	1.40	-8.54	-190.14	-777.41	-777.02	-190.54	-15.22
1	70	1210	5.51-2.17	3.37	-2.38e-02	3.45	363.35	-132.39	306.61	-75.65	157.83
1	70	1211	-1.00-2.89	-2.82	-1.06	0.35	734.62	-63.47	730.36	-59.20	58.16
1	70	1212	-0.75-4.14	-4.13	-0.75	3.71e-02	797.82	-56.28	796.67	-55.13	-31.23
1	70	1213	-1.47-3.15	-3.11	-1.51	-0.26	572.80	-86.36	551.66	-65.23	-116.11
1	70	1214	4.11-4.38	1.95	-2.22	-3.70	48.23	-321.04	-167.61	-105.20	-181.98
1	70	1215	20.935.07	12.70	13.30	7.93	-51.52	-1613.95	-1613.35	-52.12	30.64
1	70	1216	20.55-8.69	9.69	2.16	-14.13	-254.94	-1460.03	-1458.49	-256.48	-43.06
1	70	1217	4.79-4.42	-0.22	0.60	4.59	223.55	-308.56	-15.54	-69.47	264.68
1	70	1218	-1.14-4.78	-4.77	-1.15	0.19	647.51	-94.16	608.43	-55.08	165.70
1	70	1219	-0.46-5.60	-5.60	-0.47	-6.15e-02	887.22	-51.46	879.48	-43.72	84.89
1	70	1220	-0.32-5.56	-5.56	-0.32	-1.36e-02	957.06	-40.87	957.06	-40.87	0.97
1	70	1221	-0.49-4.85	-4.85	-0.49	1.66e-03	887.14	-51.00	879.79	-43.65	-82.74
1	70	1222	-0.95-2.63	-2.51	-1.07	-0.44	647.41	-92.09	609.27	-53.96	-163.54
1	72	1	0.87-1.76	0.76	-1.66	-0.51	-540.97	-831.92	-743.79	-629.11	133.70
1	72	3	0.86-2.09	0.64	-1.88	0.77	-557.06	-845.65	-755.02	-647.69	-133.95
1	72	5	-2.41-7.50	-2.42	-7.48	-0.29	-1197.56	-1891.47	-1886.83	-1202.20	56.55
1	72	7	1.26-4.97	1.26	-4.97	-1.83e-02	-1160.50	-1698.39	-1697.73	-1161.16	-18.86





EGP CODE

GRE.EEC.R.73.IT.W.15235.12.024.01

PAGE

426 di/of 527

1	72	9	2.57-6.41	1.51	-5.35	2.91	-1196.02	-1792.48	-1787.23	-1201.26	-55.69	
1	72	11	-0.42-11.98	-2.44	-9.95	-4.39	-1420.06	-2488.64	-2488.62	-1420.08	-4.36	
1	72	13	4.48-7.58	3.18	-6.28	-3.74	-1529.82	-2492.80	-2485.43	-1537.20	83.94	
1	72	15	3.95-7.27	2.75	-6.06	3.47	-1464.30	-2343.55	-2339.55	-1468.50	-60.64	
1	72	17	-0.50-10.31	-2.32	-8.49	3.81	-1194.49	-2004.86	-2000.55	-1198.81	58.96	
1	72	19	1.86-5.38	0.97	-4.48	2.38	-1153.13	-1856.97	-1789.92	-1220.18	-206.63	
1	72	21	2.50-4.95	-0.33	-2.12	-3.62	-569.10	-1252.72	-1014.87	-806.95	325.62	
1	72	23	-4.59e-02	-1.93	-1.82	-0.16	0.45	-1138.92	-1860.74	-1856.86	-1142.80	-52.78
1	72	25	2.97-4.24	2.96	-4.24	3.52e-02	-1118.68	-1675.74	-1675.15	-1119.28	18.20	
1	72	27	3.89-5.00	3.07	-4.19	-2.56	-1151.71	-1769.12	-1765.69	-1155.13	45.86	
1	72	29	3.41-5.26	-1.85	-1.56e-03	4.23	-1358.28	-2459.27	-2458.52	-1359.02	28.71	
1	72	31	6.12-5.89	5.13	-4.91	3.30	-1475.39	-2462.83	-2457.52	-1480.70	-72.24	
1	72	33	5.52-5.69	4.61	-4.78	-3.06	-1411.27	-2315.26	-2312.48	-1414.05	50.03	
1	72	35	2.66-4.40	-1.64	-9.13e-02	-3.44	-1141.21	-1982.37	-1974.77	-1148.81	-79.58	
1	72	37	3.22-4.03	2.53	-3.34	-2.12	-1109.71	-1825.14	-1766.76	-1168.09	195.85	
1	72	39	3.97-3.86	-0.40	0.51	3.89	-558.12	-1208.08	-995.25	-770.95	-305.01	
1	72	41	2.71-4.74	-1.71	-0.32	-3.66	351.67	-88.11	319.59	-56.03	114.36	
1	72	42	2.64-2.17-1.13e-02	0.48	0.48	-2.39	578.72	117.45	256.27	439.89	211.57	
1	72	43	8.43-2.93	8.35	-2.85	-0.94	529.11	-151.79	-123.25	500.56	136.46	
1	72	44	3.110.43	1.25	2.29	1.23	716.56	239.02	271.30	684.28	119.89	
1	72	45	5.831.98	3.55	4.26	1.90	731.65	-31.88	-8.74	708.50	130.91	
1	72	46	2.666.11e-03	0.49	2.17	1.02	725.45	231.48	240.14	716.80	64.82	
1	72	47	3.174.86e-02	0.17	3.05	0.59	722.09	-34.19	-24.60	712.49	84.66	
1	72	48	2.00-8.29e-029.23e-02	1.83	0.58	0.58	678.66	200.82	203.43	676.05	35.21	
1	72	49	2.23-0.10-6.82e-02	2.19	0.28	0.28	663.84	-43.09	-39.88	660.63	47.56	
1	72	50	1.61-5.77e-02-8.19e-03	1.56	0.28	0.28	622.56	175.17	175.79	621.94	16.68	
1	72	51	1.78-8.24e-02-7.11e-02	1.77	0.14	0.14	599.20	-53.21	-52.44	598.44	22.37	
1	72	52	1.44-3.65e-02-3.31e-02	1.44	7.11e-02	7.11e-02	591.05	162.58	162.61	591.02	3.72	
1	72	53	1.60-6.72e-02-6.65e-02	1.60	3.41e-02	3.41e-02	563.84	-58.76	-58.72	563.80	5.08	
1	72	54	1.46-3.38e-02-2.40e-02	1.45	-0.12	-0.12	599.64	165.39	165.54	599.49	-8.00	
1	72	55	1.63-6.71e-02-6.37e-02	1.63	-7.51e-02	-7.51e-02	573.25	-57.57	-57.41	573.08	-10.17	
1	72	56	1.67-5.25e-021.93e-02	1.59	-0.34	-0.34	644.52	182.90	184.01	643.41	-22.61	
1	72	57	1.88-8.23e-02-6.20e-02	1.86	-0.20	-0.20	623.59	-50.31	-49.02	622.30	-29.52	
1	72	58	2.10-7.86e-02 0.14	1.88	-0.65	-0.65	702.60	210.67	214.78	698.49	-44.78	
1	72	59	2.42-0.10-4.52e-02	2.36	-0.37	-0.37	691.39	-41.07	-36.42	686.74	-58.19	
1	72	60	2.704.05e-02 0.55	2.19	-1.04	-1.04	732.91	235.96	249.52	719.34	-80.96	
1	72	61	3.467.96e-02 0.26	3.28	-0.75	-0.75	731.78	-39.90	-27.24	719.12	-98.02	
1	72	62	2.670.67	1.07	2.27	-0.79	688.05	215.54	269.14	634.46	-149.84	
1	72	63	6.112.06	4.10	4.07	-2.03	687.10	-62.12	-35.55	660.54	-138.55	
1	72	64	4.07-2.69	-1.86	3.25	2.21	511.94	35.70	268.31	279.33	-238.05	
1	72	65	8.68-7.83	8.62	-7.77	1.03	386.15	-320.38	-296.85	362.62	-126.76	
1	72	66	2.51-4.38	0.40	-2.27	3.17	357.86	-87.81	330.71	-60.66	-106.60	
1	72	67	0.65-2.72	-2.67	0.60	0.40	635.71	37.83	623.61	49.93	84.20	
1	72	68	1.98-0.56	-0.38	1.80	0.64	600.59	404.26	549.32	455.53	86.24	
1	72	69	1.410.20	0.56	1.05	0.55	674.42	441.60	453.71	662.32	51.68	
1	72	70	1.675.43e-02 0.56	1.17	0.75	0.75	713.11	384.21	385.80	711.52	22.81	
1	72	71	1.454.87e-02 0.29	1.21	0.53	0.53	682.35	331.13	331.41	682.07	9.85	
1	72	72	1.264.67e-02 0.12	1.19	0.28	0.28	633.95	294.99	295.04	633.90	3.91	
1	72	73	1.184.09e-024.65e-02	1.17	7.96e-02	7.96e-02	605.26	278.53	278.53	605.26	0.77	
1	72	74	1.185.04e-026.02e-02	1.17	-0.10	-0.10	613.18	282.44	282.46	613.17	-1.89	
1	72	75	1.276.72e-02 0.15	1.19	-0.31	-0.31	653.57	306.58	306.68	653.46	-5.96	
1	72	76	1.485.53e-02 0.34	1.20	-0.57	-0.57	701.23	349.80	350.38	700.65	-14.32	
1	72	77	1.724.75e-03 0.55	1.18	-0.80	-0.80	711.44	408.47	411.91	708.01	-32.08	
1	72	78	1.86-0.14	0.42	1.30	-0.90	639.91	459.32	488.84	610.39	-66.78	
1	72	79	0.78-0.23	-0.23	0.78	-3.33e-02	617.55	304.81	590.94	331.42	-87.26	
1	72	80	0.96-3.69	-3.64	0.92	-0.43	630.70	37.47	618.45	49.73	-84.38	
1	72	81	-5.50e-02	-2.23	-2.22	-5.85e-02	-8.68e-02	735.68	66.33	731.11	70.91	-55.14
1	72	82	0.39-0.78	-0.77	0.38	-9.86e-02	631.12	435.92	617.71	449.33	-49.37	
1	72	83	0.460.19	0.23	0.42	9.92e-02	665.57	496.89	509.67	652.79	-44.65	
1	72	84	0.770.31	0.51	0.58	0.23	718.43	421.72	425.83	714.32	-34.69	
1	72	85	0.890.27	0.36	0.80	0.21	692.66	366.57	368.09	691.14	-22.24	
1	72	86	0.950.15	0.18	0.92	0.14	645.07	331.65	332.07	644.65	-11.43	
1	72	87	0.978.70e-029.00e-02	0.96	5.09e-02	5.09e-02	616.27	316.12	316.14	616.25	-2.57	
1	72	88	0.960.10	0.10	0.96	-3.33e-02	624.20	320.04	320.15	624.09	5.74	
1	72	89	0.920.20	0.22	0.90	-0.12	664.49	343.48	344.19	663.77	15.17	
1	72	90	0.840.32	0.41	0.75	-0.20	710.50	386.66	388.89	708.27	26.79	
1	72	91	0.760.27	0.55	0.48	-0.24	714.05	450.64	456.70	707.99	39.49	
1	72	92	0.298.72e-02 0.16	0.21	-9.61e-02	-9.61e-02	627.88	521.26	550.94	598.19	47.79	
1	72	93	0.27-1.25	-1.24	0.26	0.13	671.57	329.52	664.18	336.92	49.74	
1	72	94	-0.14-2.35	-2.35	-0.14	8.50e-02	736.35	69.74	731.94	74.15	54.02	
1	72	95	0.29-2.37	-2.06	-1.48e-02	-0.85	672.94	-20.91	601.93	50.09	-210.30	
1	72	96	0.93-1.27	-1.02	0.67	-0.71	669.35	288.30	510.53	447.13	-187.87	
1	72	97	0.83-0.26-1.70e-02	0.59	-0.45	-0.45	738.45	364.81	428.46	674.81	-140.46	
1	72	98	0.820.18	0.37	0.63	-0.29	759.07	354.80	373.86	740.01	-85.69	
1	72	99	0.860.21	0.25	0.81	-0.16	717.18	331.80	337.78	711.21	-47.61	
1	72	100	0.900.11	0.11	0.90	-4.82e-02	661.11	312.17	313.67	659.61	-22.85	



EGP CODE

GRE.EEC.R.73.IT.W.15235.12.024.01

PAGE

427 di/of 527

1	72	101	0.923.99e-024.00e-02	0.92	8.82e-03	628.87	302.38	302.46	628.80	-4.94
1	72	102	0.934.83e-025.11e-02	0.92	4.91e-02	637.64	305.03	305.42	637.24	11.49
1	72	103	0.920.12 0.14	0.90	0.12	683.24	319.59	322.34	680.49	31.48
1	72	104	0.910.20 0.31	0.80	0.25	740.29	342.33	351.80	730.82	60.65
1	72	105	0.917.97e-02 0.43	0.57	0.41	764.53	364.29	394.09	734.73	105.07
1	72	106	0.68-0.35-4.44e-02	0.37	0.47	715.83	355.83	458.35	613.32	162.47
1	72	107	0.90-1.60 -1.44	0.73	0.62	662.30	211.29	548.74	324.86	195.76
1	72	108	0.26-2.64 -2.28	-0.10	0.95	672.02	-19.51	601.86	50.65	208.80
1	72	109	-0.29-2.69 -2.41	-0.57	-0.77	378.87	-225.68	199.18	-46.00	-276.30
1	72	110	4.45-2.01 -1.33	3.76	-1.99	666.24	25.55	232.39	459.39	-299.56
1	72	111	1.44-0.28 -0.10	1.26	-0.52	798.53	174.86	230.79	742.59	-178.21
1	72	112	1.77-0.27 7.40e-02	1.43	-0.76	803.81	249.95	267.38	786.38	-96.68
1	72	113	1.35-0.13-2.52e-02	1.25	-0.38	744.42	267.23	272.96	738.69	-51.97
1	72	114	1.11-8.37e-02-6.71e-02	1.09	-0.14	678.40	266.14	267.62	676.91	-24.70
1	72	115	1.02-8.31e-02-8.30e-02	1.02	-1.20e-02	642.15	263.09	263.16	642.07	-5.31
1	72	116	1.05-8.59e-02-7.93e-02	1.04	8.60e-02	651.96	264.05	264.45	651.56	12.47
1	72	117	1.19-9.95e-02-5.64e-02	1.15	0.23	703.87	267.64	270.36	701.15	34.34
1	72	118	1.52-0.18-6.43e-03	1.35	0.51	773.49	264.65	273.76	764.38	67.48
1	72	119	2.07-0.37 0.11	1.59	0.97	816.57	233.87	261.34	789.11	123.49
1	72	120	2.03-0.65 -0.33	1.71	0.87	772.54	126.45	218.81	680.18	226.15
1	72	121	2.89-0.45 -0.19	2.63	0.89	562.63	-28.76	253.01	280.86	295.37
1	72	122	0.24-5.22 -4.81	-0.17	1.44	359.89	-237.22	178.78	-56.10	274.49
1	72	123	5.56-3.51 1.73	0.33	4.48	-384.59	-609.60	-501.18	-493.01	-112.43
1	72	124	2.78-3.37 2.08	-2.66	1.96	684.52	-298.44	-204.11	590.19	-289.53
1	72	125	4.21-2.15 -0.76	2.81	-2.63	831.21	48.08	70.03	809.25	-129.27
1	72	126	2.67-0.77 -0.66	2.56	-0.60	828.38	171.83	177.18	823.03	-59.00
1	72	127	1.75-0.35 -0.33	1.73	-0.19	761.34	210.41	212.41	759.34	-33.11
1	72	128	1.29-0.22 -0.22	1.29	-4.21e-02	689.90	218.71	219.30	689.31	-16.57
1	72	129	1.12-0.18 -0.18	1.12	1.05e-02	651.34	218.94	218.98	651.30	-3.71
1	72	130	1.15-0.18 -0.18	1.15	4.27e-02	661.80	219.04	219.20	661.64	8.42
1	72	131	1.40-0.24 -0.23	1.39	0.11	717.37	217.01	218.02	716.37	22.44
1	72	132	1.97-0.39 -0.36	1.94	0.28	793.78	200.15	203.12	790.81	41.88
1	72	133	3.05-0.89 -0.74	2.90	0.75	844.59	137.82	145.75	836.66	74.46
1	72	134	4.63-2.33 -0.34	2.63	3.15	798.69	-48.61	-14.31	764.40	166.98
1	72	135	3.81-5.12 -1.01	-0.30	-4.45	517.09	-531.90	-340.13	325.32	405.45
1	72	136	6.78-1.60 5.68	-0.50	-2.83	-424.57	-585.24	-469.18	-540.62	71.96
1	72	137	16.204.55 16.18	4.56	0.41	722.75	-99.84	-97.92	720.84	-39.68
1	72	138	7.65-6.08e-02-6.01e-02	7.65	7.37e-02	880.62	54.62	56.11	879.13	-35.04
1	72	139	2.72-7.45e-02-7.41e-02	2.72	3.47e-02	832.07	162.31	163.51	830.87	-28.36
1	72	140	1.72-0.31 -0.31	1.72	4.00e-02	763.63	193.15	193.84	762.94	-19.85
1	72	141	1.28-0.24 -0.24	1.28	3.79e-02	692.02	199.87	200.12	691.77	-11.16
1	72	142	1.11-0.19 -0.19	1.11	2.71e-02	653.26	199.72	199.73	653.25	-2.67
1	72	143	1.15-0.20 -0.20	1.15	1.39e-02	663.80	199.89	199.96	663.73	5.73
1	72	144	1.39-0.25 -0.25	1.39	4.52e-03	719.68	198.42	198.81	719.28	14.30
1	72	145	1.93-0.32 -0.32	1.93	-1.73e-04	796.11	183.46	184.33	795.24	23.05
1	72	146	3.123.22e-023.23e-02	3.12	-1.61e-02	847.93	131.25	132.63	846.55	31.42
1	72	147	9.64-0.41 -0.41	9.64	-0.12	862.19	-24.87	-23.28	860.59	37.58
1	72	148	23.81-6.66 23.79	-6.64	-0.80	542.70	-471.54	-470.32	541.48	35.18
1	72	149	4.80-2.40 2.48	-8.23e-02	-3.36	-469.43	-525.69	-509.44	-485.68	25.50
1	72	150	2.38-3.09 1.73	-2.44	-1.77	640.34	-288.64	-240.44	592.14	206.04
1	72	151	4.01-2.06 -0.69	2.64	2.54	813.80	33.60	37.82	809.58	57.22
1	72	152	2.65-0.81 -0.69	2.53	0.63	826.15	143.41	143.42	826.14	2.15
1	72	153	1.74-0.38 -0.35	1.71	0.26	763.00	178.24	178.31	762.93	-6.48
1	72	154	1.27-0.24 -0.23	1.26	0.12	692.83	185.11	185.17	692.76	-5.65
1	72	155	1.10-0.18 -0.18	1.09	4.35e-02	654.56	184.94	184.95	654.55	-1.60
1	72	156	1.13-0.18 -0.18	1.13	-1.63e-02	664.97	185.20	185.22	664.95	3.00
1	72	157	1.38-0.24 -0.24	1.38	-9.82e-02	720.02	184.02	184.09	719.95	6.05
1	72	158	1.96-0.40 -0.37	1.92	-0.27	794.51	169.40	169.43	794.48	4.10
1	72	159	3.00-0.89 -0.75	2.86	-0.72	839.89	112.48	112.66	839.71	-11.25
1	72	160	4.36-2.20 -0.21	2.37	-3.02	774.29	-55.65	-46.08	764.71	-88.64
1	72	161	3.36-5.30 -1.21	-0.73	4.32	438.64	-494.60	-371.52	315.56	-315.77
1	72	162	5.85-1.26 5.51	-0.93	1.51	-482.15	-544.82	-485.93	-541.04	14.91
1	72	163	-0.42-2.56 -2.15	-0.83	0.84	228.93	-156.38	119.45	-46.90	173.77
1	72	164	4.00-2.05 -1.61	3.57	1.57	558.65	39.27	143.05	454.86	207.68
1	72	165	1.34-0.44 -0.36	1.26	0.35	764.83	117.10	134.05	747.88	103.40
1	72	166	1.74-0.38-4.90e-02	1.41	0.77	799.13	165.35	167.71	796.77	38.59
1	72	167	1.35-0.23-8.39e-02	1.21	0.45	750.60	172.33	172.59	750.34	12.23
1	72	168	1.07-0.13-8.39e-02	1.03	0.22	687.85	167.77	167.79	687.84	2.80
1	72	169	0.96-8.65e-02-8.28e-02	0.96	6.19e-02	652.21	163.92	163.92	652.21	0.20
1	72	170	0.99-8.76e-02-8.32e-02	0.99	-6.93e-02	661.93	165.27	165.28	661.92	-1.16
1	72	171	1.16-0.12-7.91e-02	1.12	-0.23	712.62	170.78	170.85	712.56	-5.93
1	72	172	1.50-0.21-5.36e-02	1.35	-0.50	777.07	173.59	174.31	776.35	-20.87
1	72	173	1.99-0.36 4.57e-02	1.58	-0.89	804.57	158.25	163.59	799.23	-58.51
1	72	174	1.85-0.63 -0.46	1.68	-0.63	719.69	90.30	125.65	684.35	-144.91
1	72	175	2.73-0.56 -0.47	2.64	-0.52	428.90	17.50	166.76	279.64	-197.80
1	72	176	0.42-5.16 -4.59	-0.15	-1.68	210.76	-164.18	100.86	-54.28	-170.67



EGP CODE

GRE.EEC.R.73.IT.W.15235.12.024.01

PAGE

428 di/of 527

1	72	177	0.24-1.83	-1.75	0.15	0.42	474.78	24.97	453.03	46.71	96.47
1	72	178	1.07-1.44	-1.39	1.01	0.36	503.41	300.94	356.22	448.13	90.20
1	72	179	0.94-0.58	-0.49	0.85	0.36	696.39	259.98	268.30	688.07	59.67
1	72	180	0.87-7.91e-029.70e-02		0.70	0.37	763.14	211.55	212.81	761.88	26.37
1	72	181	0.873.36e-02	0.14	0.77	0.28	734.38	179.76	179.92	734.22	9.38
1	72	182	0.825.19e-027.87e-02		0.79	0.14	680.20	159.67	159.68	680.19	2.75
1	72	183	0.813.61e-023.77e-02		0.81	3.42e-02	647.44	150.71	150.71	647.44	0.48
1	72	184	0.833.42e-023.83e-02		0.83	-5.68e-02	656.37	153.47	153.47	656.37	-0.99
1	72	185	0.895.59e-028.76e-02		0.86	-0.16	702.22	167.89	167.93	702.18	-4.66
1	72	186	0.957.63e-02	0.18	0.85	-0.28	755.00	193.53	193.91	754.61	-14.70
1	72	187	0.912.59e-02	0.21	0.73	-0.36	758.74	231.59	234.27	756.06	-37.49
1	72	188	0.74-0.41	-0.34	0.68	-0.27	641.11	285.00	301.10	625.01	-73.98
1	72	189	1.04-1.54	-1.51	1.01	-0.29	461.00	262.77	397.70	326.07	-92.42
1	72	190	0.26-2.18	-1.99	6.14e-02	-0.66	474.57	28.45	454.05	48.97	-93.46
1	72	191	0.57-2.15	-1.85	0.26	-0.86	506.44	48.93	499.01	56.36	-57.81
1	72	192	1.14-1.67	-1.65	1.12	-0.24	481.02	359.08	389.64	450.46	-52.85
1	72	193	0.86-0.56	-0.56	0.86	5.88e-02	685.42	283.31	286.89	681.83	-37.80
1	72	194	0.650.15	0.15	0.65	1.94e-02	756.65	216.27	216.93	756.00	-18.81
1	72	195	0.710.21	0.21	0.71	-1.51e-02	730.82	174.61	174.74	730.69	-8.37
1	72	196	0.760.14	0.14	0.76	-1.64e-02	678.00	150.00	150.02	677.98	-3.25
1	72	197	0.788.80e-028.84e-02		0.78	-1.58e-02	645.66	139.42	139.42	645.66	-0.34
1	72	198	0.808.51e-028.54e-02		0.80	-1.34e-02	654.44	142.52	142.53	654.43	2.16
1	72	199	0.820.13	0.13	0.82		699.41	159.55	159.61	699.35	5.68
1	72	200	0.820.20	0.21	0.82	4.46e-02	749.98	191.75	192.01	749.72	12.04
1	72	201	0.800.15	0.18	0.77	0.14	749.97	243.65	244.80	748.82	24.09
1	72	202	0.81-0.43	-0.41	0.79	0.15	629.07	320.73	327.19	622.61	44.17
1	72	203	1.10-1.63	-1.61	1.07	0.27	461.90	310.44	436.55	335.79	56.54
1	72	204	0.45-2.25	-1.98	0.18	0.81	509.56	52.29	501.09	60.75	61.64
1	72	205	0.36-4.01	-2.98	-0.67	-1.86	352.02	-89.73	268.51	-6.22	-172.97
1	72	206	3.41-2.37	-2.27	3.31	-0.75	557.75	148.62	247.00	459.38	-174.84
1	72	207	1.53-0.54	-0.54	1.53	1.14e-02	750.88	160.40	183.92	727.36	-115.47
1	72	208	1.296.90e-02	0.14	1.22	-0.28	787.79	163.62	167.91	783.50	-51.55
1	72	209	1.100.11	0.16	1.04	-0.23	744.01	149.05	149.82	743.24	-21.42
1	72	210	0.977.64e-029.59e-02		0.95	-0.13	683.22	134.59	134.70	683.11	-7.66
1	72	211	0.915.00e-025.30e-02		0.90	-5.04e-02	648.15	127.03	127.03	648.15	-0.98
1	72	212	0.924.64e-024.68e-02		0.92	1.82e-02	657.63	129.07	129.11	657.59	4.41
1	72	213	1.026.04e-027.13e-02		1.01	0.10	706.99	140.22	140.53	706.67	13.40
1	72	214	1.225.31e-029.56e-02		1.18	0.22	767.92	156.88	158.63	766.17	32.64
1	72	215	1.63-0.10-2.41e-02		1.55	0.36	788.79	172.01	180.61	780.19	72.32
1	72	216	2.67-0.87	-0.65	2.46	0.84	709.17	166.65	209.17	666.64	145.81
1	72	217	2.25-0.88	-0.87	2.23	-0.20	475.46	130.89	283.70	322.65	171.18
1	72	218	1.70-5.82	-5.12	1.00	2.18	344.99	-91.17	258.45	-4.62	173.95
1	72	219	2.59-2.78	2.47	-2.65	0.80	11.60	-270.22	-93.15	-165.47	-136.19
1	72	220	3.05-5.05	-1.90	-9.95e-02	3.95	590.92	-233.79	-113.38	470.51	-291.22
1	72	221	2.49-0.26	-0.26	2.49	-5.64e-02	817.04	11.34	31.12	797.26	-124.69
1	72	222	2.010.19	0.23	1.96	-0.29	826.11	98.61	101.13	823.60	-42.66
1	72	223	1.534.01e-027.09e-02		1.50	-0.21	761.19	119.57	119.94	760.83	-15.27
1	72	224	1.22-5.95e-034.95e-03		1.21	-0.11	690.21	119.53	119.56	690.17	-4.69
1	72	225	1.07-1.75e-02-1.59e-02		1.07	-4.18e-02	651.52	116.51	116.51	651.52	-0.45
1	72	226	1.08-2.08e-02-2.05e-02		1.08	1.84e-02	661.98	116.99	117.00	661.97	2.67
1	72	227	1.24-1.81e-02-1.25e-02		1.24	8.39e-02	717.37	119.26	119.40	717.23	9.06
1	72	228	1.579.02e-032.32e-02		1.56	0.15	791.95	112.85	113.79	791.01	25.24
1	72	229	2.087.59e-027.99e-02		2.07	8.92e-02	837.42	73.48	79.03	831.87	64.91
1	72	230	2.95-1.10	-0.89	2.74	-0.90	774.16	-58.70	-20.80	736.25	173.59
1	72	231	5.83-6.00	-4.77	4.60	-3.60	426.59	-328.82	-129.33	227.09	333.02
1	72	232	4.53-5.67	4.50	-5.64	0.57	-15.39	-271.16	-87.73	-198.82	115.19
1	72	233	-0.43-4.73	-4.73	-0.43	2.95e-02	787.34	-41.22	785.93	-39.81	-34.23
1	72	234	12.04-7.62	12.04	-7.62	-0.15	707.10	-422.34	-422.16	706.92	14.22
1	72	235	5.202.62	5.20	2.63	-2.37e-02	888.41	-20.25	-20.05	888.21	13.46
1	72	236	2.290.63	0.63	2.29	2.18e-02	842.17	75.17	75.35	841.99	11.71
1	72	237	1.734.62e-024.65e-02		1.73	2.25e-02	767.01	108.29	108.40	766.91	8.41
1	72	238	1.34-3.42e-02-3.41e-02		1.34	1.47e-02	691.15	114.39	114.43	691.11	4.79
1	72	239	1.16-4.40e-02-4.40e-02		1.16	5.19e-03	650.69	113.36	113.36	650.69	1.09
1	72	240	1.16-4.73e-02-4.73e-02		1.16	-3.57e-03	661.65	113.14	113.15	661.63	-2.62
1	72	241	1.35-4.24e-02-4.24e-02		1.35	-1.05e-02	720.02	111.42	111.49	719.95	-6.35
1	72	242	1.714.26e-024.27e-02		1.71	-1.45e-02	801.34	94.59	94.73	801.20	-9.95
1	72	243	2.120.68	0.68	2.12	-1.05e-02	859.50	33.09	33.30	859.30	-13.03
1	72	244	5.481.89	5.48	1.89	5.10e-02	851.57	-128.72	-128.51	851.37	-14.18
1	72	245	13.01-17.46	13.01	-17.46	0.18	484.87	-797.87	-797.73	484.74	-13.18
1	72	246	2.31-0.37	0.24	1.70	-1.13	747.30	315.33	356.73	705.91	-127.16
1	72	247	2.45-2.67	2.17	-2.39	-1.17	48.66	-296.63	-84.62	-163.34	168.10
1	72	248	3.22-5.19	-1.94	-3.84e-02	-4.10	615.86	-246.39	-102.73	472.20	321.30
1	72	249	2.67-0.21	-0.19	2.65	0.22	825.08	12.61	42.41	795.28	152.73
1	72	250	2.110.16	0.24	2.04	0.38	823.82	103.13	109.11	817.83	65.41
1	72	251	1.593.61e-028.48e-02		1.54	0.27	755.11	124.13	125.70	753.54	31.41
1	72	252	1.267.10e-032.52e-02		1.24	0.15	682.64	123.37	123.71	682.30	13.80



EGP CODE

GRE.EEC.R.73.IT.W.15235.12.024.01

PAGE

429 di/of 527

1	72	253	1.102.13e-034.67e-03	1.10	5.29e-02	643.49	119.88	119.89	643.47	2.54
1	72	254	1.11-3.81e-03-3.14e-03	1.11	-2.74e-02	654.02	120.54	120.65	653.91	-7.60
1	72	255	1.28-9.65e-03-2.18e-04	1.27	-0.11	710.17	123.51	124.27	709.40	-21.15
1	72	256	1.626.72e-032.91e-02	1.60	-0.19	787.07	117.57	120.54	784.11	-44.45
1	72	257	2.157.36e-028.45e-02	2.14	-0.15	837.96	77.09	87.99	827.06	-90.41
1	72	258	3.02-0.94 -0.79	2.87	0.74	787.75	-60.46	-8.42	735.71	-203.56
1	72	259	6.01-6.13 -4.89	4.77	3.68	461.80	-347.72	-119.00	233.09	-364.47
1	72	260	4.56-5.58 4.55	-5.57	-0.21	22.83	-294.40	-76.56	-195.01	-147.14
1	72	261	0.35-4.04 -3.15	-0.54	1.77	399.54	-108.45	293.43	-2.33	206.51
1	72	262	3.58-2.37 -2.23	3.44	0.90	593.83	139.65	270.99	462.49	205.92
1	72	263	1.64-0.52 -0.51	1.63	0.14	758.30	168.86	205.10	722.07	141.58
1	72	264	1.433.77e-02 0.17	1.30	0.41	780.73	175.72	184.37	772.08	71.83
1	72	265	1.200.11 0.21	1.10	0.31	731.08	158.89	161.05	728.93	35.06
1	72	266	1.030.11 0.15	0.99	0.17	668.38	141.40	141.83	667.95	15.08
1	72	267	0.959.53e-029.97e-02	0.95	6.19e-02	632.85	132.21	132.23	632.83	2.71
1	72	268	0.978.51e-028.62e-02	0.97	-3.20e-02	642.30	134.81	134.95	642.17	-8.25
1	72	269	1.088.29e-02 0.10	1.06	-0.14	692.39	148.48	149.48	691.40	-23.27
1	72	270	1.315.57e-02 0.12	1.24	-0.28	756.53	168.31	172.46	752.37	-49.27
1	72	271	1.74-0.11 6.10e-03	1.62	-0.46	786.37	184.12	199.75	770.74	-95.74
1	72	272	2.79-0.88 -0.60	2.52	-0.96	726.31	170.87	232.28	664.90	-174.18
1	72	273	2.19-0.81 -0.81	2.19	9.12e-02	520.93	114.95	309.26	326.62	-202.80
1	72	274	1.65-5.91 -5.28	1.02	-2.10	392.81	-109.50	284.52	-1.21	-206.57
1	72	275	0.57-2.31 -2.06	0.31	0.82	571.99	48.61	556.35	64.24	89.09
1	72	276	1.25-1.80 -1.76	1.21	0.34	527.55	364.90	438.57	453.88	80.96
1	72	277	0.93-0.55 -0.54	0.92	0.13	682.77	316.19	326.23	672.72	59.85
1	72	278	0.740.19 0.23	0.71	0.13	740.43	241.85	244.02	738.26	32.86
1	72	279	0.790.28 0.31	0.77	0.11	710.50	189.49	189.98	710.01	16.08
1	72	280	0.820.23 0.23	0.81	6.25e-02	657.17	156.77	156.87	657.08	6.89
1	72	281	0.840.17 0.17	0.84	2.56e-02	624.97	142.51	142.51	624.97	1.26
1	72	282	0.860.15 0.15	0.86	-6.00e-03	633.48	146.73	146.75	633.45	-3.68
1	72	283	0.890.19 0.19	0.89	-4.64e-02	678.04	169.66	169.87	677.82	-10.47
1	72	284	0.910.23 0.25	0.89	-0.11	729.94	211.83	212.77	729.00	-22.10
1	72	285	0.910.16 0.23	0.84	-0.22	737.38	274.63	278.46	733.55	-41.91
1	72	286	0.85-0.41 -0.36	0.81	-0.24	637.98	353.99	372.24	619.73	-69.63
1	72	287	1.09-1.70 -1.66	1.04	-0.35	529.07	305.30	490.34	344.03	-84.66
1	72	288	0.46-2.44 -2.16	0.18	-0.85	576.89	53.41	560.65	69.65	-90.75
1	72	289	0.42-2.25 -2.11	0.29	-0.58	583.99	55.05	571.80	67.24	-79.38
1	72	290	1.13-1.68 -1.67	1.12	-0.14	524.52	382.48	450.81	456.19	-70.97
1	72	291	0.92-0.47 -0.46	0.91	-0.12	680.55	327.72	335.43	672.84	-51.57
1	72	292	0.830.16 0.24	0.75	-0.22	739.06	248.37	249.97	737.46	-28.01
1	72	293	0.870.24 0.30	0.81	-0.18	709.85	193.09	193.46	709.48	-13.75
1	72	294	0.870.20 0.22	0.85	-9.89e-02	656.95	159.00	159.07	656.88	-5.91
1	72	295	0.870.15 0.15	0.87	-2.72e-02	624.92	144.23	144.24	624.91	-1.01
1	72	296	0.900.14 0.14	0.89	3.56e-02	633.40	148.53	148.55	633.37	3.35
1	72	297	0.930.17 0.18	0.92	0.10	677.70	172.16	172.33	677.53	9.29
1	72	298	0.970.20 0.25	0.92	0.19	728.97	216.16	216.88	728.25	19.19
1	72	299	0.980.13 0.25	0.86	0.29	735.38	282.72	285.56	732.54	35.74
1	72	300	0.82-0.33 -0.28	0.78	0.22	634.51	368.68	382.83	620.36	59.68
1	72	301	0.93-1.62 -1.61	0.92	0.16	533.31	317.40	503.76	346.95	74.21
1	72	302	0.32-2.34 -2.18	0.17	0.63	589.09	60.65	576.49	73.26	80.63
1	72	303	3.04e-02 -3.98	-3.28	-0.67	-1.52	441.92	-88.11	345.44	8.38
1	72	304	3.04-1.98 -1.91	2.96	-0.62	602.64	174.13	306.68	470.09	-198.06
1	72	305	1.82-0.36 -0.29	1.75	-0.37	758.54	196.08	233.59	721.03	-140.32
1	72	306	1.64-8.97e-03 0.16	1.47	-0.50	779.34	190.45	199.47	770.32	-72.33
1	72	307	1.355.45e-02 0.16	1.24	-0.36	730.50	167.22	169.48	728.24	-35.61
1	72	308	1.136.32e-029.85e-02	1.10	-0.19	668.37	146.88	147.33	667.92	-15.34
1	72	309	1.045.37e-025.68e-02	1.04	-5.49e-02	633.06	136.67	136.69	633.04	-2.75
1	72	310	1.054.46e-024.84e-02	1.05	6.15e-02	642.50	139.39	139.53	642.36	8.42
1	72	311	1.183.86e-027.05e-02	1.15	0.19	692.27	154.45	155.50	691.22	23.75
1	72	312	1.431.11e-02 0.10	1.34	0.35	755.56	177.95	182.33	751.19	50.09
1	72	313	1.88-0.14 2.01e-02	1.72	0.54	784.22	201.91	218.22	767.90	96.08
1	72	314	2.91-0.75 -0.33	2.49	1.17	726.90	203.38	266.03	664.25	169.92
1	72	315	1.75-0.78 -0.73	1.70	-0.34	541.42	143.63	347.20	337.85	198.84
1	72	316	1.48-5.58 -5.10	0.99	1.78	437.93	-85.11	340.59	12.23	203.56
1	72	317	2.35-3.07 2.25	-2.98	0.71	183.51	-249.69	22.30	-88.47	-209.40
1	72	318	3.23-4.81 -2.14	0.56	3.79	631.48	-214.06	-47.05	464.47	-336.63
1	72	319	3.164.65e-024.97e-02	3.16	0.10	833.55	31.15	67.21	797.49	-166.24
1	72	320	2.400.16 0.22	2.33	-0.38	827.33	112.51	120.35	819.50	-74.44
1	72	321	1.78-2.37e-021.97e-02	1.74	-0.28	757.38	131.02	133.06	755.35	-35.63
1	72	322	1.40-5.50e-02-4.10e-02	1.38	-0.14	684.34	129.67	130.10	683.91	-15.45
1	72	323	1.22-5.51e-02-5.42e-02	1.22	-3.40e-02	644.95	126.04	126.06	644.94	-2.90
1	72	324	1.23-5.88e-02-5.62e-02	1.22	5.78e-02	655.60	126.60	126.73	655.47	8.26
1	72	325	1.41-6.37e-02-4.75e-02	1.40	0.15	712.18	129.53	130.48	711.23	23.48
1	72	326	1.79-3.36e-028.77e-04	1.76	0.25	789.77	124.18	127.99	785.96	50.22
1	72	327	2.370.11 0.13	2.35	0.20	842.07	86.57	100.75	827.89	102.53
1	72	328	3.59-0.94 -0.63	3.28	-1.15	795.69	-38.34	24.44	732.91	220.05





EGP CODE

GRE.EEC.R.73.IT.W.15235.12.024.01

PAGE

430 di/of 527

1	72	329	6.07-5.62	-4.81	5.25	-2.97	494.58	-292.91	-40.14	241.81	367.65	
1	72	330	4.19-6.21	4.14	-6.16	0.75	160.40	-254.58	26.34	-120.53	194.06	
1	72	331	2.58-3.91	-1.20	-0.13	-3.20	275.54	-168.27	171.99	-64.72	-187.71	
1	72	332	13.16-7.58	13.14	-7.56	-0.64	731.74	-438.28	-436.74	730.20	-42.37	
1	72	333	5.432.76	5.12	3.08	-0.86	905.44	-29.66	-29.45	905.24	-13.89	
1	72	334	2.470.61	0.62	2.47	6.10e-02	852.32	74.37	74.48	852.22	-9.03	
1	72	335	1.87-1.05e-02-3.98e-03	1.86	0.11		773.24	111.57	111.62	773.19	-5.74	
1	72	336	1.45-8.95e-02-8.57e-02	1.44	7.62e-02		694.95	119.66	119.68	694.94	-3.21	
1	72	337	1.25-9.05e-02-8.92e-02	1.25	4.13e-02		653.48	119.34	119.34	653.47	-0.88	
1	72	338	1.26-8.88e-02-8.88e-02	1.26	9.24e-03		664.73	118.93	118.94	664.72	1.39	
1	72	339	1.46-8.34e-02-8.31e-02	1.46	-2.05e-02		724.71	116.06	116.08	724.69	3.66	
1	72	340	1.851.01e-021.07e-02	1.85	-3.34e-02		809.05	96.52	96.57	809.00	6.02	
1	72	341	2.340.70	0.70	2.33	9.57e-02	871.58	29.93	30.03	871.48	9.11	
1	72	342	6.031.94	5.45	2.53	1.43	872.29	-141.77	-141.40	871.92	19.36	
1	72	343	14.61-18.17	14.56	-18.12	1.31	514.72	-828.71	-827.17	513.18	45.45	
1	72	344	13.59-4.52	5.83	3.24	8.96	-156.34	-900.36	-900.34	-156.36	3.97	
1	72	345	12.884.29	7.46	9.71	-4.15	-25.32	-1027.43	-1026.23	-26.52	-34.77	
1	72	346	2.25-3.05	1.05	-1.85	2.22	34.42	-141.73	-18.98	-88.32	80.97	
1	72	347	-1.18-1.57	-1.55	-1.19	-7.56e-02	381.65	-61.57	379.66	-59.58	29.66	
1	72	348	3.11-0.75	0.94	1.42	-1.92	321.57	-50.89	313.28	-42.60	-54.95	
1	72	349	7.62-9.49	4.65	-6.51	6.48	-230.76	-328.33	-290.13	-268.96	47.62	
1	72	350	9.38-0.71	0.59	8.08	3.39	0.45	-360.84	-344.09	-16.30	-75.96	
1	72	351	13.77-4.73	9.52	-0.49	-7.78	-177.58	-680.28	-679.82	-178.04	15.18	
1	72	352	3.80-2.64	0.83	0.33	3.21	376.68	-148.51	281.86	-53.69	202.01	
1	72	353	-0.81-3.75	-3.74	-0.82	0.19	734.01	-61.24	714.43	-41.67	123.22	
1	72	354	-0.37-4.89	-4.89	-0.37	1.06e-02	912.90	-38.23	909.41	-34.73	57.54	
1	72	355	-0.37-5.31	-5.31	-0.37	7.72e-02	957.29	-35.39	957.19	-35.29	-10.03	
1	72	356	-1.00-5.37	-5.37	-1.00	8.02e-02	860.59	-51.59	853.92	-44.92	-77.70	
1	72	357	3.62-2.79	2.89	-2.06	-2.04	-153.66	-390.30	-271.89	-272.07	118.32	
1	72	358	3.29-5.86	-1.85	-0.72	-4.54	624.69	-315.98	-203.24	511.95	305.52	
1	72	359	2.30-0.59	-0.47	2.19	0.56	837.65	-21.70	-1.97	817.92	128.72	
1	72	360	2.096.91e-02 0.15	2.00	0.40		840.14	90.84	93.31	837.67	42.95	
1	72	361	1.62-2.30e-022.82e-02	1.57	0.29		768.28	121.07	121.47	767.87	16.16	
1	72	362	1.29-4.56e-02-2.34e-02	1.27	0.17		693.27	124.16	124.21	693.22	5.35	
1	72	363	1.13-3.96e-02-3.46e-02	1.13	7.63e-02		653.01	121.98	121.98	653.01	0.52	
1	72	364	1.14-3.71e-02-3.71e-02	1.14	-7.29e-03		663.90	122.34	122.35	663.88	-3.24	
1	72	365	1.32-4.25e-02-3.61e-02	1.32	-9.33e-02		721.83	123.27	123.44	721.66	-10.12	
1	72	366	1.69-3.51e-02-1.78e-02	1.67	-0.17		801.69	112.42	113.41	800.70	-26.13	
1	72	367	2.22-2.10e-02-9.88e-03	2.21	-0.16		855.49	60.75	65.98	850.26	-64.25	
1	72	368	2.49-1.00	-0.98	2.46	0.28	801.17	-105.75	-69.49	764.90	-177.69	
1	72	369	6.54-7.06	-5.05	4.53	4.83	442.40	-452.16	-254.33	244.58	-371.26	
1	72	370	5.72-5.10	5.69	-5.07	0.60	-195.10	-377.40	-261.92	-310.58	-87.84	
1	72	371	1.08-4.19	-2.71	-0.40	2.37	342.19	-149.00	210.50	-17.30	217.59	
1	72	372	4.61-2.99	-2.76	4.38	1.31	596.91	81.53	211.68	466.76	223.91	
1	72	373	1.66-0.92	-0.90	1.64	-0.22	777.09	127.84	160.59	744.35	142.09	
1	72	374	1.32-2.19e-026.72e-02	1.23	0.33		800.92	156.77	163.47	794.23	65.32	
1	72	375	1.153.82e-02 0.14	1.05	0.31		748.97	151.07	152.36	747.68	27.79	
1	72	376	0.995.24e-029.60e-02	0.95	0.20		684.44	138.82	139.01	684.25	10.13	
1	72	377	0.926.09e-026.95e-02	0.91	8.54e-02		648.11	131.57	131.57	648.11	1.37	
1	72	378	0.936.65e-026.70e-02	0.93	-2.15e-02		657.97	133.64	133.70	657.91	-5.67	
1	72	379	1.055.91e-028.07e-02	1.03	-0.14		709.58	144.19	144.71	709.05	-17.18	
1	72	380	1.309.97e-037.97e-02	1.23	-0.29		775.95	157.16	159.92	773.19	-41.27	
1	72	381	1.76-0.18-7.44e-02	1.66	-0.43		807.86	159.22	171.93	795.14	-89.93	
1	72	382	2.93-1.16	-1.03	2.80	-0.71	743.93	119.84	177.54	686.23	-180.78	
1	72	383	3.24-0.85	-0.84	3.23	-0.20	503.60	63.53	246.76	320.38	-216.93	
1	72	384	2.29-6.50	-5.43	1.22	-2.88	330.36	-157.37	193.82	-20.83	-218.98	
1	72	385	0.99-2.32	-1.66	0.32	1.33	557.08	38.32	532.19	63.21	110.87	
1	72	386	1.44-1.92	-1.80	1.32	0.62	541.29	334.29	416.65	458.92	101.32	
1	72	387	0.96-0.80	-0.79	0.96	9.38e-02	698.22	294.62	308.00	684.84	72.24	
1	72	388	0.641.52e-022.40e-02	0.64	7.40e-02		757.07	228.48	230.89	754.65	35.66	
1	72	389	0.680.17	0.19	0.66	0.11	728.25	181.21	181.59	727.87	14.36	
1	72	390	0.720.17	0.18	0.70	7.97e-02	675.14	151.68	151.72	675.10	4.73	
1	72	391	0.740.14	0.15	0.74	4.62e-02	642.94	138.84	138.84	642.94	0.45	
1	72	392	0.760.15	0.15	0.76	9.55e-03	651.82	142.55	142.57	651.80	-2.73	
1	72	393	0.770.19	0.19	0.76	-5.01e-02	697.00	163.00	163.13	696.87	-8.41	
1	72	394	0.800.19	0.22	0.76	-0.15	748.85	200.79	201.61	748.04	-21.13	
1	72	395	0.876.95e-03 0.10	0.77	-0.27		754.46	257.19	261.64	750.02	-46.81	
1	72	396	0.96-0.64	-0.57	0.89	-0.33	653.04	326.27	350.50	628.82	-85.62	
1	72	397	1.42-1.78	-1.63	1.28	-0.65	528.41	282.49	465.94	344.95	-107.05	
1	72	398	0.84-2.46	-1.84	0.22	-1.29	560.34	40.16	533.85	66.65	-114.35	
1	72	399	8.54e-02	-1.74	-1.73	8.32e-02	6.26e-02	588.79	68.42	581.16	76.05	-62.54
1	72	400	0.64-1.30	-1.30	0.64	-4.09e-02	509.69	402.95	452.85	459.79	-53.26	
1	72	401	0.69-0.63	-0.61	0.67	-0.16	679.89	326.31	331.02	675.17	-40.55	
1	72	402	0.64-8.19e-02-1.08e-02	0.57	-0.21		747.85	238.84	240.13	746.57	-25.56	
1	72	403	0.680.10	0.17	0.61	-0.19	725.06	182.47	182.84	724.70	-14.04	
1	72	404	0.720.13	0.15	0.70	-0.11	674.59	150.06	150.14	674.51	-6.57	





EGP CODE

GRE.EEC.R.73.IT.W.15235.12.024.01

PAGE

431 di/of 527

1	72	405	0.760.12	0.12	0.76	-1.59e-02	643.24	136.55	136.55	643.24	-1.48	
1	72	406	0.780.13	0.14	0.77	7.53e-02	651.99	140.46	140.48	651.97	3.10	
1	72	407	0.770.17	0.21	0.73	0.15	695.99	162.14	162.29	695.84	9.03	
1	72	408	0.720.21	0.29	0.64	0.19	744.64	203.92	204.53	744.03	18.18	
1	72	409	0.580.12	0.18	0.52	0.15	742.94	271.72	273.85	740.81	31.64	
1	72	410	0.52-0.43	-0.42	0.51	7.84e-02	627.90	369.33	377.92	619.31	46.33	
1	72	411	0.42-1.35	-1.35	0.42	4.54e-02	522.39	329.54	505.44	346.49	54.59	
1	72	412	2.88e-03	-1.87	-1.86	1.82e-03	4.44e-02	589.94	74.35	582.88	81.42	59.94
1	72	413	0.78-2.07	-1.51	0.22	-1.14	503.34	-66.00	392.87	44.48	-225.15	
1	72	414	1.49-1.68	-1.46	1.28	-0.80	595.73	163.62	301.05	458.31	-201.24	
1	72	415	1.17-0.72	-0.58	1.02	-0.51	743.41	183.62	221.85	705.18	-141.20	
1	72	416	1.12-0.24	5.67e-02	0.83	-0.56	784.65	167.06	176.24	775.46	-74.76	
1	72	417	1.17-0.16	7.11e-02	0.94	-0.50	743.98	147.35	149.38	741.95	-34.72	
1	72	418	1.06-7.94e-02	6.83e-04	0.98	-0.29	684.34	131.27	131.63	683.99	-14.09	
1	72	419	1.00-3.86e-02	-3.35e-02	0.99	-7.21e-02	649.62	123.42	123.43	649.60	-2.64	
1	72	420	1.03-3.18e-02	-1.33e-02	1.01	0.14	659.22	125.86	125.95	659.13	6.95	
1	72	421	1.15-5.19e-02	6.94e-02	1.03	0.36	708.57	138.17	138.95	707.78	21.11	
1	72	422	1.30-0.10	0.21	0.98	0.58	769.05	157.38	161.12	765.30	47.72	
1	72	423	1.24-0.16	0.27	0.81	0.64	788.47	177.69	193.49	772.67	96.96	
1	72	424	1.00-0.56	-0.38	0.82	0.49	703.34	187.27	249.88	640.74	168.49	
1	72	425	1.60-1.72	-1.54	1.42	0.75	545.28	125.37	340.10	330.54	209.90	
1	72	426	0.86-2.53	-1.81	0.14	1.38	500.97	-63.78	392.81	44.39	222.23	
1	72	427	0.20-3.15	-1.82	-1.13	-1.64	172.91	-365.68	-107.88	-84.89	-269.05	
1	72	428	5.82-2.83	-2.24	5.24	-2.17	619.85	-185.01	-38.46	473.29	-310.61	
1	72	429	1.49-0.41	-0.39	1.47	-0.20	820.22	-36.71	-7.22	790.73	-156.21	
1	72	430	2.38-0.52	-9.94e-03	1.87	-1.10	834.48	67.11	73.14	828.45	-67.76	
1	72	431	1.92-0.44	-0.21	1.70	-0.70	768.74	99.56	100.70	767.59	-27.62	
1	72	432	1.54-0.33	-0.27	1.47	-0.35	696.14	106.29	106.45	695.97	-9.77	
1	72	433	1.36-0.27	-0.27	1.36	-9.08e-02	656.52	106.38	106.38	656.51	-1.52	
1	72	434	1.40-0.26	-0.25	1.39	0.15	667.33	106.66	106.70	667.29	4.84	
1	72	435	1.66-0.31	-0.21	1.57	0.43	724.32	105.59	106.01	723.90	16.03	
1	72	436	2.15-0.40	-0.11	1.86	0.82	801.18	92.82	95.20	798.80	40.99	
1	72	437	2.75-0.48	0.18	2.09	1.31	848.39	44.41	55.85	836.95	95.24	
1	72	438	2.07-0.62	-0.54	1.99	0.45	784.47	-93.47	-38.20	729.20	213.24	
1	72	439	4.64-0.59	-0.44	4.49	0.87	456.77	-210.36	-20.44	266.86	301.05	
1	72	440	0.99-6.61	-5.30	-0.33	2.87	148.93	-384.09	-137.26	-97.89	265.78	
1	72	441	9.33-5.48	3.82	2.40e-02	7.16	-690.90	-1041.04	-1034.23	-697.71	-48.36	
1	72	442	3.66-4.82	3.35	-4.51	1.60	725.52	-565.81	-523.07	682.78	-231.00	
1	72	443	5.55-3.01	-0.48	3.02	-3.90	865.16	-147.25	-142.15	860.06	-71.69	
1	72	444	3.78-1.21	-0.98	3.55	-1.04	859.06	11.38	11.39	859.05	-1.83	
1	72	445	2.54-0.68	-0.63	2.49	-0.41	778.95	71.65	71.73	778.87	7.32	
1	72	446	1.87-0.51	-0.50	1.86	-0.17	697.89	90.86	90.93	697.82	6.24	
1	72	447	1.61-0.44	-0.44	1.60	-4.46e-02	654.98	95.27	95.28	654.97	1.76	
1	72	448	1.65-0.43	-0.43	1.65	4.97e-02	666.64	94.23	94.25	666.62	-3.31	
1	72	449	2.02-0.49	-0.47	2.01	0.19	728.84	85.47	85.54	728.77	-6.70	
1	72	450	2.84-0.66	-0.59	2.78	0.48	816.62	54.14	54.18	816.59	-4.83	
1	72	451	4.28-1.28	-0.98	3.97	1.26	880.77	-35.76	-35.62	880.63	11.63	
1	72	452	6.37-3.54	0.19	2.64	4.80	830.94	-268.31	-257.76	820.38	107.18	
1	72	453	4.44-7.49	9.75e-02	-3.14	-5.74	522.66	-848.22	-723.48	397.92	394.26	
1	72	454	10.06-2.33	7.77	-4.12e-02	-4.80	-782.82	-1006.39	-1006.09	-783.13	-8.21	
1	72	455	24.365.37	24.25	5.48	-1.40	799.79	-287.13	-281.87	794.52	75.46	
1	72	456	11.02-0.169	9.92e-03	10.85	-1.35	950.70	-126.36	-125.17	949.51	35.80	
1	72	457	3.97-0.12	-0.11	3.96	-0.13	862.26	21.43	23.02	860.67	36.50	
1	72	458	2.54-0.59	-0.58	2.54	-6.99e-02	776.22	72.13	73.00	775.34	24.81	
1	72	459	1.88-0.53	-0.53	1.88	-3.81e-02	693.93	90.00	90.31	693.62	13.76	
1	72	460	1.62-0.47	-0.47	1.62	-1.56e-02	650.57	94.23	94.25	650.55	3.23	
1	72	461	1.66-0.46	-0.46	1.66	2.27e-03	662.37	93.13	93.22	662.28	-7.15	
1	72	462	2.03-0.51	-0.51	2.03	2.62e-02	725.33	84.37	84.86	724.84	-17.75	
1	72	463	2.82-0.53	-0.53	2.82	5.59e-02	814.75	54.32	55.42	813.64	-28.91	
1	72	464	4.530.13	0.13	4.52	9.67e-02	886.02	-23.38	-21.53	884.17	-40.95	
1	72	465	13.63-0.48	-0.33	13.48	1.45	945.96	-228.90	-227.70	944.76	-37.57	
1	72	466	34.95-9.31	34.94	-9.30	0.63	631.93	-734.26	-725.95	623.61	-106.24	
1	72	467	7.07-2.57	5.13	-0.64	-3.86	-402.35	-791.19	-706.95	-486.59	160.19	
1	72	468	5.13-4.02	3.87	-2.75	-3.16	746.27	-543.35	-416.62	619.54	383.89	
1	72	469	6.51-2.61	-0.70	4.60	3.72	882.22	-140.96	-106.95	848.21	183.42	
1	72	470	3.97-1.12	-0.98	3.83	0.85	851.82	17.06	26.20	842.68	86.89	
1	72	471	2.59-0.70	-0.66	2.55	0.36	767.29	75.34	78.88	763.75	49.36	
1	72	472	1.86-0.53	-0.52	1.85	0.16	685.02	94.40	95.43	683.99	24.65	
1	72	473	1.57-0.45	-0.45	1.57	3.31e-02	641.85	98.83	98.88	641.80	5.36	
1	72	474	1.62-0.44	-0.44	1.61	-8.00e-02	653.59	97.67	97.97	653.29	-12.79	
1	72	475	2.02-0.52	-0.50	2.00	-0.22	716.31	88.64	90.47	714.49	-33.76	
1	72	476	2.90-0.69	-0.64	2.85	-0.45	806.03	57.25	62.50	800.78	-62.46	
1	72	477	4.48-1.17	-0.99	4.31	-0.98	876.26	-30.30	-17.12	863.08	-108.51	
1	72	478	6.88-2.50	1.02e-02	4.37	-4.15	857.92	-260.75	-209.94	807.10	-232.96	
1	72	479	5.81-5.44	-2.91e-02	0.40	5.62	555.40	-788.44	-556.44	323.41	-507.88	
1	72	480	10.94-3.61	10.79	-3.46	1.47	-483.73	-744.44	-672.34	-555.83	-116.61	



EGP CODE

GRE.EEC.R.73.IT.W.15235.12.024.01

PAGE

432 di/of 527

1	72	481	-1.80-2.66	-2.64	-1.82	0.13	336.55	-431.22	-32.22	-62.45	383.59	
1	72	482	5.45-1.86	-1.00	4.58	2.36	701.71	-190.28	40.27	471.16	390.51	
1	72	483	2.32-0.40	5.66e-02	1.86	1.02	832.40	-27.86	50.45	754.09	247.45	
1	72	484	2.75-0.75	-9.46e-02	2.09	1.37	811.65	76.87	104.89	783.63	140.74	
1	72	485	2.00-0.57	-0.28	1.70	0.82	734.15	109.88	119.87	724.16	78.34	
1	72	486	1.46-0.38	-0.28	1.36	0.42	658.02	116.53	119.18	655.37	37.79	
1	72	487	1.21-0.26	-0.25	1.20	0.10	617.79	116.29	116.42	617.67	7.94	
1	72	488	1.25-0.26	-0.24	1.23	-0.19	628.76	116.42	117.17	628.01	-19.62	
1	72	489	1.60-0.39	-0.24	1.45	-0.53	687.10	115.24	120.16	682.18	-52.83	
1	72	490	2.25-0.59	-0.20	1.86	-0.99	769.66	101.73	117.32	754.07	-100.84	
1	72	491	3.17-0.79	6.65e-02	2.32	-1.63	833.62	51.80	93.91	791.51	-176.50	
1	72	492	3.30-0.73	8.01e-02	2.49	-1.61	816.52	-85.60	34.33	696.59	-306.28	
1	72	493	2.780.70	0.79	2.70	-0.42	577.22	-230.57	54.82	291.83	-386.12	
1	72	494	-0.74-6.05	-5.84	-0.94	-1.02	314.93	-451.84	-58.56	-78.35	-383.26	
1	72	495	0.20-2.41	-2.15	-6.76e-02	0.79	631.19	-147.01	439.78	44.40	335.14	
1	72	496	0.96-1.50	-1.21	0.67	0.79	688.51	97.99	350.42	436.08	292.14	
1	72	497	1.16-0.80	-0.21	0.58	0.90	754.40	170.37	270.23	654.54	219.89	
1	72	498	1.33-0.59	0.17	0.58	0.94	745.68	180.64	216.17	710.15	137.16	
1	72	499	1.20-0.41	9.85e-02	0.69	0.75	686.73	166.92	178.67	674.98	77.26	
1	72	500	0.90-0.17	4.96e-02	0.69	0.43	623.44	149.71	152.63	620.51	37.13	
1	72	501	0.682.52e-024.49e-02		0.66	0.11	588.98	140.23	140.36	588.85	7.74	
1	72	502	0.734.95e-036.66e-02		0.66	-0.20	598.50	142.82	143.64	597.69	-19.26	
1	72	503	1.01-0.20	0.12	0.69	-0.54	648.29	156.58	162.11	642.76	-51.85	
1	72	504	1.37-0.46	0.22	0.69	-0.88	715.88	175.14	193.65	697.38	-98.31	
1	72	505	1.52-0.66	0.35	0.51	-1.09	762.17	184.27	236.96	709.47	-166.37	
1	72	506	0.97-0.75	-7.42e-02	0.29	-0.84	742.24	156.20	299.64	598.80	-251.96	
1	72	507	0.86-1.65	-1.55	0.76	-0.49	660.48	44.83	387.95	317.36	-305.79	
1	72	508	0.20-2.70	-2.36	-0.14	-0.93	629.84	-146.95	439.65	43.24	-334.01	
1	72	509	-0.22-2.60	-2.58	-0.23	0.18	701.92	21.26	651.35	71.82	178.50	
1	72	510	-9.50e-02	-1.38	-1.30	-0.17	0.30	636.86	315.48	526.35	426.00	152.66
1	72	511	0.18-0.70	-0.39	-0.14	0.42	662.04	347.24	402.69	606.59	119.91	
1	72	512	0.55-0.49	0.12	-6.44e-02	0.51	676.32	283.25	300.07	659.49	79.56	
1	72	513	0.64-0.30	0.28	6.18e-02	0.46	642.05	221.32	226.38	636.98	45.89	
1	72	514	0.53-6.63e-02	0.30	0.16	0.29	594.27	179.17	180.34	593.09	22.08	
1	72	515	0.350.16	0.30	0.21	8.14e-02	566.33	160.22	160.28	566.27	4.57	
1	72	516	0.410.12	0.33	0.20	-0.13	574.28	165.25	165.57	573.95	-11.46	
1	72	517	0.61-0.11	0.38	0.12	-0.34	614.31	194.06	196.34	612.03	-30.85	
1	72	518	0.73-0.35	0.40	-2.49e-02	-0.50	663.19	245.22	253.44	654.97	-58.03	
1	72	519	0.59-0.56	0.25	-0.23	-0.52	683.20	312.41	338.52	657.09	-94.87	
1	72	520	1.58e-02	-0.74	-0.40	-0.33	-0.38	651.14	360.87	451.10	560.90	-134.35
1	72	521	-0.25-1.73	-1.70	-0.28	-0.22	653.75	245.35	577.36	321.74	-159.25	
1	72	522	-0.24-2.67	-2.66	-0.26	-0.20	702.73	25.58	652.68	75.63	-177.17	
1	72	523	-0.25-2.71	-2.69	-0.26	-0.19	713.19	76.65	713.18	76.66	2.47	
1	72	524	-0.25-1.47	-1.46	-0.26	-0.14	580.05	421.59	580.05	421.59	0.63	
1	72	525	-0.27-0.55	-0.55	-0.27	3.17e-02	590.79	445.28	445.30	590.78	-1.58	
1	72	526	0.11-0.31	5.87e-02	-0.26	0.14	641.72	328.56	328.58	641.70	-2.85	
1	72	527	0.38-0.21	0.34	-0.17	0.14	623.20	242.77	242.79	623.18	-2.74	
1	72	528	0.44-7.83e-02	0.42	-6.03e-02	9.49e-02	583.35	189.42	189.43	583.34	-1.74	
1	72	529	0.442.96e-03	0.44	5.17e-03	3.10e-02	558.44	166.47	166.47	558.44	-0.41	
1	72	530	0.46-5.01e-03	0.46	-3.20e-03	-2.89e-02	565.62	172.59	172.59	565.62	0.92	
1	72	531	0.49-0.10	0.48	-9.28e-02	-7.49e-02	600.94	208.03	208.04	600.93	2.02	
1	72	532	0.45-0.26	0.44	-0.25	-9.23e-02	639.64	274.39	274.41	639.62	2.57	
1	72	533	0.17-0.40	0.16	-0.40	-5.97e-02	639.41	372.92	372.94	639.39	2.27	
1	72	534	-0.45-0.56	-0.55	-0.45	2.73e-02	549.29	499.05	499.08	549.26	1.19	
1	72	535	-0.42-1.82	-1.81	-0.43	0.10	634.88	322.15	634.88	322.15	2.45e-02	
1	72	536	-0.29-2.78	-2.77	-0.29	9.90e-02	715.24	81.43	715.24	81.43	-0.40	
1	72	537	0.13-2.64	-2.45	-6.04e-02	-0.70	699.14	21.71	651.57	69.28	-173.09	
1	72	538	0.32-1.82	-1.65	0.15	-0.57	633.92	312.55	526.20	420.28	-151.71	
1	72	539	0.12-0.79	-0.71	4.63e-02	-0.26	660.75	340.95	400.33	601.36	-124.36	
1	72	540	0.15-0.19	3.43e-02	-7.99e-02	-0.16	677.00	275.81	295.33	657.49	-86.31	
1	72	541	0.40-9.27e-02	0.35	-4.42e-02	-0.15	643.97	214.28	220.60	637.65	-51.74	
1	72	542	0.452.26e-02	0.43	4.95e-02	-0.10	596.55	173.07	174.61	595.01	-25.53	
1	72	543	0.430.11	0.43	0.11	-2.91e-02	568.56	154.80	154.87	568.50	-5.28	
1	72	544	0.450.11	0.44	0.12	6.52e-02	576.38	159.92	160.36	575.95	13.42	
1	72	545	0.521.32e-03	0.45	6.70e-02	0.17	616.18	188.42	191.33	613.27	35.17	
1	72	546	0.54-0.17	0.41	-3.26e-02	0.28	664.51	239.35	249.17	654.69	63.86	
1	72	547	0.37-0.36	0.13	-0.12	0.34	683.82	306.97	335.98	654.81	100.46	
1	72	548	0.11-0.83	-0.62	-9.34e-02	0.39	651.70	356.64	450.78	557.57	137.53	
1	72	549	8.28e-02	-1.92	-1.80	-3.80e-02	0.48	654.49	243.79	578.55	319.72	159.43
1	72	550	-4.46e-02	-2.63	-2.53	-0.14	0.50	703.76	25.18	654.27	74.67	176.45
1	72	551	1.29-2.97	-2.03	0.35	-1.77	624.33	-146.33	439.99	38.01	-328.75	
1	72	552	1.61-2.47	-2.24	1.38	-0.93	679.42	90.15	348.27	421.30	-292.36	
1	72	553	0.89-0.96	-0.89	0.82	-0.36	750.30	153.70	261.12	642.88	-229.24	
1	72	554	0.69-0.15	0.14	0.40	-0.40	746.78	162.91	202.44	707.25	-146.69	
1	72	555	0.80-4.06e-02	0.33	0.43	-0.42	690.43	151.30	164.55	677.18	-83.46	
1	72	556	0.690.11	0.32	0.47	-0.28	627.71	136.60	139.89	624.42	-40.07	



EGP CODE

GRE.EEC.R.73.IT.W.15235.12.024.01

PAGE

433 di/of 527

1	72	557	0.530.26	0.29	0.50	-8.94e-02	593.12	128.58	128.72	592.98	-8.06
1	72	558	0.580.23	0.29	0.53	0.12	602.43	131.17	132.14	601.47	21.31
1	72	559	0.805.99e-02	0.30	0.56	0.35	651.85	143.74	150.10	645.49	56.49
1	72	560	1.03-0.14	0.30	0.60	0.56	718.31	160.94	181.79	697.45	105.78
1	72	561	1.13-0.35	0.16	0.63	0.70	762.27	170.46	228.03	704.70	175.38
1	72	562	1.03-0.88	-0.65	0.79	0.63	740.75	145.84	296.08	590.51	258.47
1	72	563	1.66-2.20	-2.02	1.48	0.81	659.29	42.48	389.36	312.40	305.99
1	72	564	1.09-3.05	-2.19	0.24	1.68	631.21	-148.58	442.22	40.41	334.15
1	72	565	-5.34e-02	-4.95	-3.36	-1.64	-2.29	331.33	-444.29	-37.58	-75.38
1	72	566	5.71-3.49	-3.20	5.41	-1.63	670.65	-200.54	31.80	438.32	-385.26
1	72	567	1.94-0.87	-0.86	1.94	0.14	828.01	-68.14	21.46	738.41	-268.83
1	72	568	1.78-4.17e-02	0.24	1.50	-0.66	814.92	42.43	73.53	783.81	-151.85
1	72	569	1.54-4.99e-02	0.22	1.27	-0.59	739.77	83.32	93.85	729.25	-82.44
1	72	570	1.242.22e-03	0.12	1.12	-0.37	663.38	95.54	98.18	660.74	-38.63
1	72	571	1.065.91e-027.48e-02		1.04	-0.12	622.65	97.79	97.90	622.54	-7.51
1	72	572	1.104.50e-025.88e-02		1.08	0.12	633.45	97.46	98.28	632.63	20.96
1	72	573	1.35-3.88e-026.92e-02		1.24	0.37	691.83	93.05	98.36	686.52	56.09
1	72	574	1.78-0.13	9.98e-02	1.55	0.62	773.74	74.17	91.42	756.49	108.50
1	72	575	2.40-0.25	2.90e-02	2.11	0.82	834.05	19.66	67.45	786.25	191.41
1	72	576	3.73-1.20	-0.95	3.48	1.08	813.18	-110.89	22.28	680.01	324.53
1	72	577	3.83-0.49	-0.49	3.83	-0.16	564.24	-225.17	54.14	284.94	377.46
1	72	578	1.61-8.06	-7.04	0.58	2.98	319.58	-462.41	-60.89	-81.95	390.85
1	72	579	6.62-4.29	6.15	-3.82	2.21	-268.51	-750.31	-633.34	-385.49	-206.58
1	72	580	4.52-7.04	-1.25	-1.27	5.78	660.31	-652.87	-492.37	499.82	-430.12
1	72	581	3.33-0.54	-0.25	3.04	-1.02	881.42	-234.29	-193.49	840.63	-209.41
1	72	582	2.960.18	0.35	2.79	-0.67	862.30	-38.82	-29.80	853.28	-89.71
1	72	583	2.27-5.11e-024.28e-02		2.17	-0.46	774.10	37.80	40.62	771.28	-45.51
1	72	584	1.77-0.12-8.52e-02		1.73	-0.26	689.25	66.65	67.35	688.55	-20.88
1	72	585	1.54-0.13	-0.12	1.53	-9.77e-02	644.81	74.93	74.96	644.79	-3.86
1	72	586	1.56-0.14	-0.14	1.56	5.46e-02	656.61	72.47	72.71	656.37	11.76
1	72	587	1.85-0.15	-0.13	1.83	0.21	720.60	56.78	58.28	719.11	31.49
1	72	588	2.41-9.17e-02-4.45e-02		2.36	0.34	812.30	12.37	17.31	807.36	62.67
1	72	589	3.168.15e-02	0.13	3.11	0.36	883.82	-96.48	-81.42	868.77	120.55
1	72	590	3.45-0.87	-0.87	3.45	-4.28e-02	849.36	-362.31	-297.20	784.26	273.21
1	72	591	7.92-7.88	-5.12	5.16	-6.00	449.25	-836.83	-579.13	191.55	514.79
1	72	592	10.12-8.34	10.12	-8.33	-0.29	-340.98	-723.32	-620.56	-443.74	169.50
1	72	593	18.47-10.15	18.44	-10.11	1.04	776.61	-773.95	-772.95	775.61	39.47
1	72	594	7.903.95	7.42	4.42	1.29	960.41	-219.53	-219.49	960.37	6.70
1	72	595	3.500.96	0.97	3.50	-3.36e-02	877.10	-52.93	-52.93	877.10	1.74
1	72	596	2.63-1.20e-02-7.28e-03		2.62	-0.11	784.30	26.62	26.62	784.30	0.13
1	72	597	2.03-0.18	-0.18	2.03	-7.40e-02	697.25	59.61	59.61	697.25	-6.48e-02
1	72	598	1.75-0.21	-0.21	1.75	-3.81e-02	651.91	69.55	69.55	651.91	0.16
1	72	599	1.77-0.21	-0.21	1.77	-8.91e-03	664.00	66.27	66.27	664.00	0.51
1	72	600	2.07-0.19	-0.19	2.07	1.56e-02	729.50	46.84	46.84	729.50	0.82
1	72	601	2.67-6.54e-03-6.41e-03		2.67	1.89e-02	823.97	-5.53	-5.53	823.97	0.82
1	72	602	3.401.07	1.08	3.39	-0.17	900.48	-125.81	-125.81	900.47	-0.65
1	72	603	8.752.92	7.90	3.77	-2.06	929.11	-379.06	-378.93	928.98	-13.24
1	72	604	20.44-23.67	20.36	-23.59	-1.88	530.98	-1275.32	-1274.23	529.89	-44.33
1	72	605	-0.50-5.09	-3.45	-2.14	-2.20	517.50	-116.90	483.90	-83.29	-142.08
1	72	606	20.24-10.41	14.18	-4.35	12.20	-284.79	-1164.45	-1160.40	-288.84	59.52
1	72	607	3.76-0.27	-0.11	3.60	-0.80	358.79	-341.56	207.99	-190.75	287.88
1	72	608	1.49-0.78	-0.74	1.45	0.28	285.31	-269.56	173.68	-157.94	-222.43
1	72	609	16.881.98	11.19	7.66	-7.24	462.85	116.36	133.74	445.48	-75.63
1	72	610	3.91-3.19	-3.01	3.73	1.12	746.67	-70.96	-66.26	741.97	-61.79
1	72	611	3.86-0.51	-0.49	3.84	0.33	791.01	-22.71	-18.89	787.19	-55.60
1	72	612	3.19-0.12	-0.12	3.19	0.13	729.59	-10.09	-8.59	728.09	-33.27
1	72	613	2.68-7.94e-02-7.82e-02		2.68	5.79e-02	659.42	-4.24	-3.83	659.01	-16.47
1	72	614	2.43-7.53e-02-7.52e-02		2.43	1.24e-02	620.99	-1.84	-1.82	620.97	-3.64
1	72	615	2.49-7.56e-02-7.53e-02		2.48	-2.87e-02	631.21	-2.41	-2.30	631.11	8.17
1	72	616	2.83-8.06e-02-7.86e-02		2.83	-7.66e-02	685.89	-5.98	-5.27	685.18	22.12
1	72	617	3.43-0.13	-0.12	3.43	-0.16	759.10	-13.15	-11.00	756.95	40.69
1	72	618	4.11-0.54	-0.51	4.08	-0.37	799.50	-27.22	-22.21	794.50	64.13
1	72	619	5.44-5.46	5.44	-5.46	-0.16	116.29	-515.70	-240.72	-158.69	313.32
1	72	620	3.88-5.46	-1.85	0.27	-4.55	667.86	-508.38	-283.52	442.99	462.53
1	72	621	4.250.38	0.38	4.25	0.11	881.44	-153.75	-92.16	819.84	244.88
1	72	622	3.340.27	0.45	3.16	0.73	852.22	-1.62	15.80	834.80	120.68
1	72	623	2.47-6.24e-025.65e-02		2.35	0.54	765.68	58.37	64.07	759.97	63.26
1	72	624	1.89-0.12-7.46e-02		1.85	0.30	683.05	80.20	81.64	681.62	29.39
1	72	625	1.62-0.11	-0.11	1.61	7.99e-02	639.72	85.94	86.00	639.66	5.79
1	72	626	1.63-0.12	-0.11	1.63	-0.12	651.25	83.82	84.26	650.81	-15.82
1	72	627	1.94-0.15-9.42e-02		1.88	-0.33	713.64	71.50	74.39	710.75	-42.98
1	72	628	2.51-9.21e-021.73e-02		2.40	-0.52	802.81	35.49	45.09	793.21	-85.26
1	72	629	3.310.23	0.32	3.23	-0.51	873.15	-53.79	-25.54	844.90	-159.33
1	72	630	4.76-0.79	-0.48	4.45	1.28	846.30	-262.47	-164.96	748.79	-314.02
1	72	631	7.07-6.11	-5.13	6.08	3.46	505.37	-612.41	-295.80	188.76	-503.64
1	72	632	8.11-10.15	7.93	-9.98	-1.78	71.90	-519.77	-238.09	-209.77	-295.50



EGP CODE

GRE.EEC.R.73.IT.W.15235.12.024.01

PAGE

434 di/of 527

1	72	633	-1.36-4.99	-4.33	-2.02	1.39	437.08	-304.85	172.34	-40.11	355.43	
1	72	634	3.46-2.27	-2.15	3.33	0.83	680.01	-47.66	184.07	448.28	339.01	
1	72	635	2.18-0.30-4.33e-02		1.92	0.76	813.05	44.32	140.78	716.59	254.65	
1	72	636	2.20-0.12	0.38	1.70	0.95	794.99	106.18	140.09	761.09	149.01	
1	72	637	1.79-6.04e-02	0.29	1.44	0.73	724.73	119.92	131.45	713.21	82.69	
1	72	638	1.404.08e-02	0.19	1.25	0.42	652.71	118.23	121.12	649.82	39.18	
1	72	639	1.170.12	0.13	1.16	0.12	614.02	115.02	115.14	613.91	7.67	
1	72	640	1.209.94e-02	0.12	1.17	-0.16	624.25	115.75	116.65	623.35	-21.36	
1	72	641	1.46-8.44e-03	0.15	1.30	-0.45	679.44	119.20	125.06	673.59	-56.95	
1	72	642	1.91-0.14	0.20	1.57	-0.76	756.06	117.61	136.74	736.93	-108.85	
1	72	643	2.52-0.31	0.17	2.05	-1.06	811.40	95.72	148.32	758.80	-186.76	
1	72	644	3.78-0.93-7.85e-02		2.93	-1.81	798.77	22.72	162.90	658.59	-298.56	
1	72	645	1.97-0.72	-0.49	1.73	0.75	608.63	-81.95	214.78	311.91	-341.86	
1	72	646	0.75-7.14	-6.78	0.39	-1.66	433.93	-306.40	163.93	-36.40	-356.35	
1	72	647	0.55-3.22	-2.82	0.15	1.16	661.47	-62.51	546.73	52.23	264.40	
1	72	648	0.87-2.07	-1.99	0.78	0.48	667.56	199.17	437.60	429.13	234.16	
1	72	649	0.66-0.56	-0.38	0.49	0.43	723.50	244.88	331.46	636.93	184.23	
1	72	650	1.02-0.18	0.44	0.40	0.60	725.36	221.85	251.57	695.65	118.66	
1	72	651	1.07-1.52e-02	0.51	0.55	0.54	676.84	186.51	196.13	667.22	68.01	
1	72	652	0.880.18	0.44	0.62	0.34	619.52	158.52	160.86	617.18	32.77	
1	72	653	0.690.35	0.39	0.66	0.10	587.17	145.21	145.30	587.08	6.47	
1	72	654	0.720.32	0.38	0.67	-0.13	595.71	149.02	149.74	595.00	-17.85	
1	72	655	0.940.14	0.41	0.66	-0.38	641.30	169.62	174.33	636.59	-46.90	
1	72	656	1.17-9.44e-02	0.46	0.62	-0.63	700.86	203.63	219.33	685.16	-86.95	
1	72	657	1.26-0.35	0.41	0.50	-0.81	736.36	241.14	285.79	691.71	-141.83	
1	72	658	0.74-0.65	-0.27	0.37	-0.62	713.81	249.79	375.68	587.91	-206.32	
1	72	659	0.79-2.10	-2.05	0.74	-0.38	662.88	147.66	486.13	324.41	-244.59	
1	72	660	0.44-3.18	-2.81	7.20e-02	-1.09	669.36	-60.47	551.23	57.66	-268.81	
1	72	661	-6.67e-02	-3.01	-2.97	-9.90e-02	0.31	707.44	59.10	692.21	74.34	98.21
1	72	662	6.28e-02	-1.73	-1.71	3.99e-02	0.20	602.48	384.51	560.66	426.33	85.83
1	72	663	-4.62e-03	-0.52	-0.48	-4.61e-02	0.14	629.14	404.08	428.11	605.12	69.50
1	72	664	0.40-0.14	0.32	-6.00e-02	0.19	665.86	309.72	316.16	659.43	47.44	
1	72	665	0.641.66e-02	0.58	8.18e-02	0.19	640.94	233.58	235.53	638.99	28.12	
1	72	666	0.630.20	0.58	0.24	0.13	596.71	185.21	185.67	596.25	13.80	
1	72	667	0.550.32	0.54	0.33	3.79e-02	569.61	164.29	164.31	569.60	2.77	
1	72	668	0.550.32	0.54	0.34	-5.76e-02	576.83	170.26	170.40	576.70	-7.48	
1	72	669	0.630.19	0.57	0.25	-0.15	614.45	203.33	204.25	613.52	-19.44	
1	72	670	0.67-1.53e-02	0.58	8.06e-02	-0.24	657.98	264.08	267.25	654.81	-35.23	
1	72	671	0.47-0.25	0.35	-0.13	-0.26	666.35	350.76	360.86	656.25	-55.55	
1	72	672	-0.11-0.58	-0.46	-0.23	-0.20	609.17	436.01	482.58	562.59	-76.78	
1	72	673	-0.19-1.97	-1.96	-0.21	-0.17	642.26	301.59	616.68	327.17	-89.78	
1	72	674	-0.19-3.03	-3.01	-0.20	-0.22	712.24	65.28	696.52	81.00	-99.62	
1	72	675	-7.89e-02	-3.01	-2.98	-0.11	-0.29	705.39	64.53	695.38	74.55	-79.48
1	72	676	4.87e-02	-1.73	-1.71	2.45e-02	-0.21	592.45	397.19	563.67	425.97	-69.22
1	72	677	-1.18e-02	-0.54	-0.49	-5.91e-02	-0.15	620.02	414.69	430.86	603.85	-55.30
1	72	678	0.38-0.15	0.30	-7.59e-02	-0.18	661.60	314.46	318.39	657.67	-36.72	
1	72	679	0.625.18e-03	0.57	5.90e-02	-0.17	638.31	236.05	237.15	637.21	-21.05	
1	72	680	0.620.18	0.58	0.21	-0.11	594.85	186.59	186.83	594.61	-10.01	
1	72	681	0.550.29	0.55	0.30	-3.89e-02	568.06	165.25	165.26	568.05	-1.94	
1	72	682	0.550.30	0.54	0.30	3.87e-02	575.21	171.32	171.39	575.14	5.46	
1	72	683	0.610.18	0.57	0.22	0.12	612.36	205.03	205.54	611.85	14.40	
1	72	684	0.64-1.48e-02	0.57	5.56e-02	0.20	654.89	267.18	269.04	653.03	26.81	
1	72	685	0.43-0.25	0.34	-0.15	0.24	660.94	356.89	363.25	654.58	43.50	
1	72	686	-0.12-0.60	-0.47	-0.25	0.21	595.73	451.20	485.42	561.51	61.44	
1	72	687	-0.20-1.99	-1.97	-0.22	0.19	636.64	309.95	619.72	326.87	72.41	
1	72	688	-0.19-3.04	-3.02	-0.21	0.22	709.93	70.81	699.64	81.10	80.42	
1	72	689	0.51-3.20	-2.83	0.14	-1.12	658.83	-46.46	558.66	53.71	-246.20	
1	72	690	0.83-2.07	-1.98	0.74	-0.50	656.37	220.44	448.50	428.31	-217.73	
1	72	691	0.62-0.60	-0.42	0.45	-0.43	711.45	262.43	340.97	632.91	-170.58	
1	72	692	0.95-0.20	0.40	0.35	-0.58	716.33	232.84	258.84	690.33	-109.06	
1	72	693	0.99-3.19e-02	0.49	0.47	-0.51	670.27	193.04	201.23	662.08	-61.98	
1	72	694	0.810.17	0.44	0.54	-0.32	614.49	162.51	164.46	612.54	-29.63	
1	72	695	0.620.35	0.40	0.57	-0.10	582.83	148.14	148.22	582.75	-5.80	
1	72	696	0.630.34	0.39	0.58	0.12	591.21	152.21	152.80	590.62	16.16	
1	72	697	0.850.14	0.41	0.57	0.34	635.81	174.39	178.36	631.84	42.63	
1	72	698	1.07-9.57e-02	0.43	0.54	0.58	693.51	211.53	225.05	679.99	79.60	
1	72	699	1.17-0.37	0.36	0.44	0.77	726.21	254.14	293.70	686.65	130.81	
1	72	700	0.69-0.69	-0.33	0.33	0.61	700.73	269.44	385.67	584.50	191.36	
1	72	701	0.75-2.12	-2.06	0.69	0.40	654.02	167.12	497.30	323.84	227.47	
1	72	702	0.40-3.17	-2.83	5.61e-02	1.06	665.99	-44.08	563.03	58.88	250.01	
1	72	703	-1.12-4.86	-4.24	-1.74	-1.39	445.82	-275.59	202.99	-32.76	-340.90	
1	72	704	3.36-2.27	-2.14	3.23	-0.85	673.71	-19.01	207.63	447.07	-325.01	
1	72	705	2.06-0.37	-0.13	1.82	-0.72	801.15	67.53	160.04	708.64	-243.54	
1	72	706	2.04-0.15	0.32	1.57	-0.90	784.61	121.24	153.42	752.43	-142.52	
1	72	707	1.63-6.68e-02	0.28	1.29	-0.68	716.31	129.57	140.41	705.46	-79.02	
1	72	708	1.255.20e-02	0.20	1.10	-0.39	645.80	124.63	127.33	643.10	-37.42	





EGP CODE

GRE.EEC.R.73.IT.W.15235.12.024.01

PAGE

435 di/of 527

1	72	709	1.030.14	0.16	1.01	-0.12	607.85	120.05	120.16	607.74	-7.33
1	72	710	1.050.13	0.15	1.03	0.14	617.91	121.12	121.96	617.07	20.38
1	72	711	1.309.72e-03	0.16	1.15	0.41	672.09	126.68	132.16	666.61	54.39
1	72	712	1.73-0.14	0.18	1.42	0.71	747.02	129.09	147.14	728.97	104.06
1	72	713	2.34-0.34	0.10	1.90	0.99	800.51	113.28	163.39	750.40	178.69
1	72	714	3.57-0.98	-0.19	2.78	1.72	786.83	48.25	183.43	651.65	285.60
1	72	715	1.84-0.76	-0.59	1.67	-0.63	605.45	-54.41	239.16	311.89	327.92
1	72	716	0.84-6.91	-6.55	0.48	1.63	442.25	-276.77	195.06	-29.59	341.51
1	72	717	4.69-4.93	4.67	-4.91	0.41	134.91	-477.36	-194.47	-147.98	-305.25
1	72	718	3.75-5.43	-1.98	0.31	4.45	664.67	-462.44	-240.11	442.34	-448.51
1	72	719	4.000.29	0.30	3.99	-0.11	870.25	-123.28	-61.58	808.55	-239.77
1	72	720	3.080.21	0.38	2.92	-0.66	841.77	17.81	35.61	823.96	-119.81
1	72	721	2.25-6.04e-024.97e-02		2.14	-0.49	757.13	71.06	76.99	751.19	-63.51
1	72	722	1.70-9.06e-02-4.72e-02		1.65	-0.28	675.93	88.97	90.49	674.42	-29.78
1	72	723	1.43-7.14e-02-6.74e-02		1.43	-7.80e-02	633.28	93.07	93.14	633.22	-5.93
1	72	724	1.45-8.27e-02-7.53e-02		1.44	0.11	644.66	91.39	91.86	644.20	16.00
1	72	725	1.73-0.12-7.18e-02		1.69	0.29	706.11	81.67	84.69	703.10	43.27
1	72	726	2.28-9.57e-022.85e-04		2.19	0.47	793.72	50.72	60.59	783.86	85.06
1	72	727	3.060.16	0.23	2.99	0.45	862.42	-30.34	-1.72	833.80	157.27
1	72	728	4.49-0.83	-0.54	4.20	-1.21	836.44	-226.15	-128.82	739.11	306.50
1	72	729	6.88-6.11	-5.15	5.92	-3.40	509.94	-563.86	-250.05	196.13	488.36
1	72	730	7.27-9.36	7.15	-9.23	1.42	95.26	-481.11	-191.07	-194.79	288.18
1	72	731	3.92-2.51	-2.43	3.83	-0.73	693.84	-75.64	-69.81	688.02	66.70
1	72	732	17.20-9.71	17.17	-9.69	-0.76	762.74	-708.14	-706.38	760.99	-50.79
1	72	733	7.283.69	6.91	4.06	-1.09	945.05	-182.00	-181.71	944.75	-18.25
1	72	734	3.210.88	0.88	3.20	6.15e-02	868.04	-28.27	-28.11	867.88	-11.76
1	72	735	2.39-6.15e-03-8.09e-04		2.38	0.11	778.01	42.69	42.76	777.94	-7.24
1	72	736	1.82-0.14	-0.14	1.82	6.92e-02	692.75	70.60	70.62	692.72	-3.94
1	72	737	1.56-0.16	-0.16	1.56	3.25e-02	648.20	78.42	78.42	648.20	-1.08
1	72	738	1.58-0.17	-0.17	1.58	3.65e-03	660.11	75.72	75.72	660.10	1.64
1	72	739	1.86-0.16	-0.16	1.86	-2.33e-02	724.46	59.67	59.70	724.43	4.44
1	72	740	2.42-1.15e-02-1.09e-02		2.42	-3.69e-02	816.84	13.98	14.05	816.77	7.56
1	72	741	3.100.96	0.97	3.09	0.12	890.48	-95.42	-95.28	890.33	11.89
1	72	742	8.032.74	7.34	3.43	1.78	913.15	-332.04	-331.53	912.65	25.11
1	72	743	18.97-22.51	18.91	-22.45	1.53	521.37	-1186.32	-1184.58	519.63	54.46
1	72	744	19.841.95e-028.15		11.72	9.75	203.36	86.86	140.80	149.42	58.09
1	72	745	5.13-6.94	-6.04	4.24	3.16	-154.10	-302.29	-264.22	-192.17	-64.75
1	72	746	4.06-6.22	-5.00	2.84	-3.33	-169.41	-288.55	-249.02	-208.94	56.10
1	72	747	5.28-2.32	-0.84	3.80	3.01	255.12	-232.23	143.86	-120.97	204.56
1	72	748	6.55-2.09	-0.53	4.99	-3.33	326.89	-296.87	174.55	-144.53	-267.99
1	72	749	19.504.38	12.45	11.43	7.54	431.12	155.62	170.08	416.66	61.44
1	72	750	3.51-3.48	-3.32	3.35	-1.04	696.26	-69.39	-68.64	695.51	23.97
1	72	751	2.49-0.47	-0.43	2.45	-0.33	746.16	-16.61	-15.53	745.09	28.60
1	72	752	2.03-0.11	-0.10	2.02	-0.14	689.51	-5.70	-5.41	689.21	14.34
1	72	753	1.71-6.29e-02-6.08e-02		1.71	-6.19e-02	623.07	-0.94	-0.89	623.01	5.74
1	72	754	1.56-5.58e-02-5.57e-02		1.56	-1.38e-02	586.40	1.00	1.01	586.40	1.25
1	72	755	1.60-5.67e-02-5.61e-02		1.60	2.97e-02	596.09	0.56	0.57	596.08	-2.18
1	72	756	1.85-6.51e-02-6.19e-02		1.84	7.82e-02	648.02	-2.30	-2.21	647.93	-7.73
1	72	757	5.79-3.95	5.40	-3.56	-1.92	-255.41	-655.72	-550.37	-360.75	176.27
1	72	758	4.06-6.76	-1.51	-1.20	-5.41	641.72	-573.16	-430.13	498.69	391.55
1	72	759	2.97-0.58	-0.34	2.73	0.90	866.20	-185.59	-153.15	833.76	181.84
1	72	760	2.690.14	0.30	2.53	0.62	854.63	-9.99	-4.01	848.65	71.68
1	72	761	2.05-3.76e-025.03e-02		1.97	0.42	770.80	55.67	57.25	769.21	33.58
1	72	762	1.60-9.07e-02-5.63e-02		1.57	0.24	688.43	78.34	78.68	688.09	14.36
1	72	763	1.38-9.38e-02-8.87e-02		1.38	8.64e-02	645.02	84.09	84.10	645.01	2.40
1	72	764	1.41-0.10	-0.10	1.41	-5.02e-02	656.58	82.31	82.43	656.46	-8.25
1	72	765	1.67-0.12-9.89e-02		1.65	-0.19	719.02	70.63	71.43	718.22	-22.79
1	72	766	2.18-8.63e-02-4.08e-02		2.14	-0.32	807.63	34.22	37.25	804.60	-48.29
1	72	767	2.873.47e-027.65e-02		2.83	-0.34	874.16	-61.10	-50.36	863.42	-99.64
1	72	768	3.11-0.97	-0.96	3.11	0.12	831.75	-303.03	-249.00	777.71	-241.66
1	72	769	7.43-7.74	-5.22	4.90	5.65	433.13	-743.34	-507.96	197.75	-470.65
1	72	770	8.93-7.69	8.93	-7.69	9.03e-02	-323.50	-631.35	-539.60	-415.25	-140.81
1	72	771	0.18-4.97	-3.35	-1.44	2.39	320.61	-355.51	27.27	-62.17	335.09
1	72	772	5.35-3.50	-3.23	5.07	1.55	644.57	-121.14	78.71	444.71	336.28
1	72	773	1.79-0.92	-0.91	1.78	-0.16	811.86	-13.31	57.10	741.45	230.53
1	72	774	1.60-3.20e-02 0.20		1.36	0.57	810.12	74.83	96.59	788.36	124.60
1	72	775	1.39-1.48e-02 0.21		1.17	0.52	742.05	102.18	108.76	735.46	64.59
1	72	776	1.142.96e-02 0.13		1.04	0.32	669.31	106.91	108.41	667.81	29.05
1	72	777	0.996.92e-028.16e-02		0.98	0.11	629.96	106.14	106.20	629.90	5.38
1	72	778	1.025.60e-026.67e-02		1.01	-0.10	640.43	106.58	107.05	639.96	-15.85
1	72	779	1.24-1.19e-027.66e-02		1.15	-0.32	696.65	106.88	110.07	693.46	-43.26
1	72	780	1.62-0.10 9.62e-02		1.42	-0.55	773.75	97.62	108.99	762.38	-86.94
1	72	781	2.18-0.26-9.69e-03		1.93	-0.74	825.41	95.36	94.36	790.40	-159.96
1	72	782	3.47-1.26	-1.04	3.24	-1.01	791.49	-46.25	62.46	682.78	-281.52
1	72	783	3.65-0.74	-0.74	3.65	7.18e-02	540.34	-142.34	104.62	293.38	-328.03
1	72	784	1.77-7.89	-6.81	0.69	-3.04	309.21	-371.13	5.58	-67.50	-338.20





EGP CODE

GRE.EEC.R.73.IT.W.15235.12.024.01

PAGE

436 di/of 527

1	72	785	1.23-3.01	-2.10	0.32	1.74	603.79	-76.39	480.55	46.86	261.99	
1	72	786	1.53-2.44	-2.22	1.31	0.90	643.21	171.36	379.50	435.06	234.29	
1	72	787	0.84-0.93	-0.88	0.79	0.29	731.93	210.01	283.56	658.38	181.60	
1	72	788	0.59-5.87e-02	0.12	0.41	0.29	747.82	193.59	217.28	724.13	112.11	
1	72	789	0.716-3.0e-02	0.31	0.46	0.31	701.64	167.13	174.22	694.55	61.16	
1	72	790	0.650-0.17	0.29	0.52	0.21	643.01	145.17	146.78	641.40	28.30	
1	72	791	0.580-0.24	0.25	0.56	6.72e-02	609.61	134.48	134.54	609.55	5.45	
1	72	792	0.610-0.22	0.25	0.59	-9.01e-02	618.66	137.72	138.19	618.18	-15.12	
1	72	793	0.750-0.12	0.27	0.60	-0.26	666.03	154.52	157.79	662.77	-40.73	
1	72	794	0.92-3.43e-02	0.28	0.61	-0.45	726.58	181.36	193.01	714.93	-78.86	
1	72	795	1.02-0.26	0.14	0.61	-0.59	757.19	209.30	245.32	721.17	-135.79	
1	72	796	0.96-0.88	-0.67	0.76	-0.58	713.69	213.22	321.74	605.18	-206.23	
1	72	797	1.58-2.24	-2.05	1.39	-0.83	624.66	123.90	423.89	324.66	-245.41	
1	72	798	1.05-3.11	-2.28	0.22	-1.66	609.96	-77.69	482.57	49.70	-267.15	
1	72	799	0.11-2.62	-2.44	-6.33e-02	0.66	683.04	61.79	667.51	77.33	97.00	
1	72	800	0.32-1.70	-1.58	0.20	0.48	585.64	388.82	534.88	439.59	86.11	
1	72	801	0.17-0.67	-0.65	0.16	0.13	649.43	383.30	403.75	628.98	70.88	
1	72	802	8.13e-02	4.12e-02	4.33e-02	7.92e-02	8.87e-03	694.49	290.56	296.41	688.64	48.25
1	72	803	0.310-0.15	0.31	0.15	1.23e-02	669.83	219.89	221.65	668.07	28.06	
1	72	804	0.350-0.25	0.34	0.25	1.72e-02	623.54	175.99	176.39	623.13	13.43	
1	72	805	0.330-0.32	0.33	0.32	3.76e-03	595.14	157.10	157.12	595.12	2.64	
1	72	806	0.360-0.31	0.34	0.33	-2.48e-02	603.09	162.36	162.48	602.97	-7.16	
1	72	807	0.410-0.23	0.37	0.27	-6.74e-02	643.11	192.00	192.79	642.32	-18.83	
1	72	808	0.439-2.8e-02	0.37	0.15	-0.12	688.60	247.22	250.01	685.81	-34.94	
1	72	809	0.28-0.11	0.15	1.51e-02	-0.18	694.21	328.60	337.52	685.29	-56.40	
1	72	810	0.11-0.68	-0.56	-1.08e-02	-0.28	620.12	418.16	455.80	582.49	-78.64	
1	72	811	8.73e-02	-1.87	-1.77	-1.52e-02	-0.44	618.92	306.28	589.75	335.45	-90.94
1	72	812	-5.24e-02	-2.65	-2.56	-0.15	-0.48	686.64	66.31	669.98	82.97	-100.29
1	72	813	-0.19-2.55	-2.54	-0.19	3.88e-02	696.95	69.31	685.16	81.10	-85.20	
1	72	814	-1.86e-02	-1.33	-1.33	-2.25e-02	-7.17e-02	587.19	408.96	550.76	445.40	-71.88
1	72	815	0.15-0.56	-0.46	5.10e-02	-0.25	645.19	406.38	418.91	632.66	-53.24	
1	72	816	0.43-0.26	6.77e-02	0.10	-0.35	691.91	307.55	310.28	689.19	-32.27	
1	72	817	0.53-7.64e-02	0.25	0.21	-0.30	667.78	232.63	233.31	667.11	-17.07	
1	72	818	0.470-0.10	0.27	0.30	-0.18	622.09	185.80	185.94	621.95	-7.79	
1	72	819	0.380-0.24	0.27	0.35	-5.53e-02	594.11	165.53	165.54	594.10	-1.62	
1	72	820	0.390-0.25	0.29	0.35	6.60e-02	602.06	171.00	171.03	602.03	3.93	
1	72	821	0.490-0.12	0.33	0.28	0.18	641.71	202.35	202.63	641.43	11.13	
1	72	822	0.56-5.24e-02	0.36	0.14	0.28	686.61	260.61	261.80	685.42	22.48	
1	72	823	0.40-0.25	0.21	-5.04e-02	0.30	691.08	346.45	351.16	686.37	40.01	
1	72	824	-8.29e-02	-0.52	-0.42	-0.18	0.18	612.02	444.35	470.69	585.68	61.02
1	72	825	-0.21-1.70	-1.69	-0.21	5.04e-02	625.24	319.64	605.73	339.15	74.71	
1	72	826	-0.24-2.67	-2.67	-0.24	4.34e-02	698.25	74.56	687.02	85.79	82.95	
1	72	827	0.10-2.41	-2.24	-6.35e-02	-0.63	648.42	-50.30	537.24	60.88	-255.58	
1	72	828	0.84-1.45	-1.24	0.63	-0.66	665.69	220.37	430.83	455.23	-222.32	
1	72	829	1.01-0.73	-0.30	0.58	-0.75	735.94	266.37	333.07	669.23	-163.93	
1	72	830	1.13-0.46	8.79e-02	0.58	-0.76	744.94	240.60	260.90	724.64	-99.12	
1	72	831	1.03-0.28	8.97e-02	0.66	-0.59	697.71	203.16	209.20	691.66	-54.35	
1	72	832	0.81-7.27e-02	8.97e-02	0.65	-0.33	640.15	173.13	174.55	638.73	-25.70	
1	72	833	0.657-0.09e-02	8.97e-02	0.64	-9.18e-02	607.69	158.66	158.72	607.63	-5.34	
1	72	834	0.677-1.1e-02	0.11	0.64	0.14	616.77	162.56	162.95	616.38	13.27	
1	72	835	0.87-6.85e-02	0.14	0.66	0.39	663.42	184.23	186.97	660.68	36.13	
1	72	836	1.12-0.28	0.20	0.64	0.67	723.51	219.33	229.23	713.62	69.93	
1	72	837	1.23-0.50	0.25	0.48	0.86	755.66	256.87	288.57	723.96	121.69	
1	72	838	0.78-0.70	-0.18	0.27	0.70	718.17	266.93	369.98	615.12	189.42	
1	72	839	0.72-1.69	-1.61	0.63	0.45	649.27	163.25	475.30	337.22	233.00	
1	72	840	6.59e-02	-2.71	-2.48	-0.16	0.76	647.59	-48.84	537.85	60.91	253.74
1	72	841	-0.98-2.74	-2.72	-1.00	-0.19	402.94	-284.52	144.42	-25.99	-333.00	
1	72	842	4.91-1.82	-1.04	4.13	-2.16	704.95	-42.05	174.88	488.03	-339.10	
1	72	843	2.09-0.49	-0.12	1.72	-0.90	822.05	85.84	154.60	753.29	-214.24	
1	72	844	2.34-0.68	-0.16	1.83	-1.13	809.02	149.81	173.40	785.43	-122.47	
1	72	845	1.71-0.47	-0.23	1.47	-0.68	739.76	156.88	165.05	731.59	-68.54	
1	72	846	1.27-0.27	-0.19	1.18	-0.34	668.88	148.61	150.74	666.74	-33.24	
1	72	847	1.06-0.16	-0.15	1.05	-8.85e-02	630.86	142.24	142.34	630.76	-7.01	
1	72	848	1.09-0.16	-0.14	1.07	0.15	641.33	143.99	144.59	640.73	17.28	
1	72	849	1.37-0.27	-0.15	1.25	0.42	696.45	152.38	156.35	692.48	46.31	
1	72	850	1.89-0.47	-0.16	1.58	0.80	772.82	157.79	170.63	759.98	87.93	
1	72	851	2.67-0.71	-3.34e-02	1.99	1.35	828.27	138.33	174.23	792.37	153.23	
1	72	852	2.89-0.82	-0.15	2.23	1.42	805.44	45.11	152.41	698.14	264.70	
1	72	853	2.520-0.25	0.42	2.35	0.60	600.15	-83.52	199.44	317.20	336.73	
1	72	854	-0.29-5.57	-5.43	-0.43	0.86	383.46	-299.86	122.82	-39.21	331.92	
1	72	855	5.97-3.04	3.19	-0.26	4.16	-257.84	-596.06	-459.06	-394.85	-166.03	
1	72	856	4.02-3.51	2.69	-2.18	2.87	745.09	-362.88	-228.37	610.58	-361.85	
1	72	857	5.50-2.31	-0.84	4.03	-3.04	876.11	-28.10	10.96	837.06	-183.82	
1	72	858	3.37-0.99	-0.88	3.26	-0.70	851.93	87.80	100.10	839.63	-96.15	
1	72	859	2.22-0.58	-0.54	2.18	-0.32	774.34	120.39	125.39	769.34	-56.96	
1	72	860	1.62-0.40	-0.39	1.61	-0.16	696.46	125.23	126.72	694.98	-29.05	



EGP CODE

GRE.EEC.R.73.IT.W.15235.12.024.01

PAGE

437 di/of 527

1	72	861	1.38-0.32	-0.32	1.38	-4.03e-02	655.08	123.99	124.06	655.01	-6.33
1	72	862	1.42-0.32	-0.32	1.42	7.19e-02	666.39	124.40	124.83	665.96	15.22
1	72	863	1.75-0.39	-0.37	1.73	0.20	726.44	124.50	127.10	723.85	39.46
1	72	864	2.47-0.57	-0.52	2.42	0.39	810.97	111.68	118.92	803.73	70.80
1	72	865	3.78-1.04	-0.89	3.64	0.81	874.21	55.85	72.97	857.09	117.13
1	72	866	5.75-2.19	-0.28	3.84	3.40	852.67	-122.66	-65.85	795.86	228.43
1	72	867	5.07-4.87	-0.83	1.02	-4.88	585.42	-577.20	-339.60	347.83	468.81
1	72	868	8.76-2.99	8.32	-2.54	-2.24	-305.80	-564.70	-424.59	-445.91	129.01
1	72	869	19.804.73	19.61	4.92	1.68	778.00	-149.81	-135.87	764.05	-112.90
1	72	870	9.18-0.32	-0.15	9.01	1.24	928.70	-22.56	-17.11	923.25	-71.78
1	72	871	3.37-0.15	-0.15	3.37	0.10	864.89	81.78	87.01	859.67	-63.75
1	72	872	2.19-0.47	-0.47	2.19	1.10e-02	787.09	109.63	112.37	784.35	-43.02
1	72	873	1.67-0.41	-0.41	1.67	-1.56e-02	708.90	115.05	115.98	707.98	-23.41
1	72	874	1.47-0.35	-0.35	1.47	-8.35e-03	667.00	114.48	114.53	666.95	-5.26
1	72	875	1.51-0.35	-0.35	1.51	1.49e-02	678.41	114.77	115.05	678.13	12.40
1	72	876	1.80-0.40	-0.40	1.80	2.94e-02	739.01	114.02	115.54	737.49	30.80
1	72	877	2.43-0.42	-0.42	2.43	1.70e-02	823.25	100.80	104.36	819.69	50.61
1	72	878	3.825.01e-025.08e-02		3.82	-5.30e-02	885.44	52.12	58.25	879.31	71.18
1	72	879	11.30-0.62	-0.46	11.14	-1.37	917.15	-100.13	-94.51	911.52	75.43
1	72	880	28.54-7.79	28.49	-7.74	-1.34	616.67	-527.80	-511.46	600.32	135.79
1	72	881	7.50-4.85	2.47	0.18	-6.07	-579.13	-749.04	-746.90	-581.26	-18.93
1	72	882	2.31-3.92	2.00	-3.61	-1.35	689.21	-372.05	-353.27	670.43	139.94
1	72	883	4.47-2.45	-0.52	2.54	3.11	850.82	-41.41	-41.34	850.74	8.07
1	72	884	3.19-1.00	-0.84	3.03	0.79	863.80	66.23	68.09	861.95	-38.45
1	72	885	2.21-0.52	-0.49	2.18	0.25	793.08	102.62	104.16	791.54	-32.57
1	72	886	1.69-0.39	-0.39	1.69	6.51e-02	716.16	110.54	111.15	715.55	-19.20
1	72	887	1.50-0.35	-0.35	1.50	7.31e-03	674.49	110.91	110.94	674.46	-4.44
1	72	888	1.55-0.35	-0.35	1.55	-1.41e-02	685.79	111.09	111.27	685.60	10.34
1	72	889	1.83-0.38	-0.38	1.83	-7.40e-02	745.78	109.31	110.25	744.84	24.48
1	72	890	2.46-0.50	-0.47	2.43	-0.29	827.93	93.77	95.51	826.20	35.60
1	72	891	3.58-1.03	-0.83	3.38	-0.92	880.88	35.29	36.73	879.43	34.91
1	72	892	5.08-2.83	8.52e-02	2.16	-3.82	811.02	-131.26	-130.02	809.77	-34.23
1	72	893	3.32-6.86	-0.87	-2.67	5.01	486.39	-592.17	-513.54	407.75	-280.41
1	72	894	7.39-1.86	5.11	0.43	3.99	-613.47	-768.54	-727.19	-654.82	68.57
1	72	895	0.64-2.75	-1.68	-0.43	1.57	109.91	-166.72	-1.89	-54.92	135.75
1	72	896	5.06-2.74	-2.40	4.72	1.60	543.73	-33.79	27.91	482.03	178.39
1	72	897	1.51-0.57	-0.57	1.51	3.09e-02	803.56	27.50	32.20	798.86	60.22
1	72	898	2.06-0.28-9.39e-04		1.77	0.76	849.44	87.08	87.12	849.41	5.28
1	72	899	1.75-0.23	-0.14	1.66	0.41	795.97	104.34	104.46	795.86	-8.82
1	72	900	1.53-0.25	-0.23	1.52	0.16	726.22	106.84	106.94	726.12	-7.87
1	72	901	1.45-0.27	-0.27	1.45	2.37e-02	686.68	106.17	106.18	686.67	-1.93
1	72	902	1.49-0.27	-0.27	1.49	-8.20e-02	697.31	106.86	106.90	697.28	4.75
1	72	903	1.66-0.25	-0.22	1.64	-0.22	753.32	107.98	108.10	753.20	8.99
1	72	904	1.97-0.20-9.33e-02		1.86	-0.48	824.79	103.00	103.04	824.76	4.96
1	72	905	2.35-0.19	0.15	2.01	-0.86	854.57	77.69	78.25	854.00	-21.00
1	72	906	1.96-0.66	-0.65	1.95	-0.14	749.49	0.50	14.94	735.05	-102.99
1	72	907	4.27-0.96	-0.88	4.19	-0.64	376.19	-33.69	54.03	288.46	-168.11
1	72	908	1.52-5.80	-4.60	0.32	-2.71	88.75	-175.07	-24.32	-62.00	-130.56
1	72	909	0.56-1.45	-1.42	0.53	0.26	326.29	16.56	309.57	33.28	69.99
1	72	910	2.00-2.00	-1.92	1.93	0.54	480.06	210.58	224.56	466.08	59.77
1	72	911	1.49-0.72	-0.67	1.44	0.35	744.13	151.91	153.71	742.33	32.59
1	72	912	1.200.10	0.15	1.15	0.22	825.84	124.39	124.56	825.67	10.71
1	72	913	1.314.59e-026.62e-02		1.29	0.16	791.04	114.56	114.56	791.04	1.54
1	72	914	1.34-9.66e-02-9.37e-02		1.33	6.40e-02	728.36	108.46	108.46	728.36	-0.55
1	72	915	1.34-0.18	-0.18	1.34	-1.17e-02	691.02	105.41	105.41	691.02	6.20e-02
1	72	916	1.38-0.18	-0.18	1.37	-7.80e-02	701.04	106.72	106.72	701.04	1.16
1	72	917	1.44-9.83e-02-8.33e-02		1.43	-0.15	753.13	112.30	112.30	753.13	1.01
1	72	918	1.485.99e-029.66e-02		1.44	-0.23	814.21	121.38	121.40	814.19	-3.38
1	72	919	1.370.20	0.24	1.34	-0.20	819.69	137.04	137.51	819.22	-17.91
1	72	920	1.43-0.47	-0.45	1.41	-0.19	675.26	175.42	179.53	671.15	-45.15
1	72	921	2.21-1.76	-1.70	2.15	-0.49	373.01	225.97	262.73	336.25	-63.67
1	72	922	0.57-1.75	-1.65	0.47	-0.47	325.35	21.48	310.91	35.92	-64.64
1	72	923	-0.39-3.44	-2.73	-1.11	-1.29	249.16	-14.42	240.84	-6.10	-46.09
1	72	924	2.59-2.12	-2.11	2.58	0.13	477.40	186.96	199.94	464.43	-60.00
1	72	925	1.64-0.41	-0.41	1.64	3.81e-02	756.96	135.07	137.29	754.74	-37.06
1	72	926	1.517.73e-029.47e-02		1.49	-0.16	827.44	122.58	122.61	827.41	-4.04
1	72	927	1.404.59e-025.74e-02		1.39	-0.12	790.34	115.35	115.38	790.31	4.48
1	72	928	1.34-8.45e-02-8.10e-02		1.33	-7.04e-02	727.46	110.20	110.24	727.43	4.46
1	72	929	1.31-0.16	-0.16	1.31	-5.22e-02	690.19	107.46	107.47	690.18	1.62
1	72	930	1.33-0.16	-0.16	1.33	-4.87e-02	700.23	108.36	108.37	700.23	-1.57
1	72	931	1.39-7.65e-02-7.59e-02		1.39	-3.06e-02	752.27	112.73	112.75	752.26	-3.32
1	72	932	1.514.90e-024.97e-02		1.51	3.01e-02	813.37	119.70	119.70	813.37	-0.39
1	72	933	1.761.31e-022.28e-02		1.75	0.13	820.10	132.05	132.34	819.81	14.04
1	72	934	2.49-0.53	-0.41	2.37	0.60	689.32	159.00	164.21	684.11	52.30
1	72	935	2.18-1.25	-0.99	1.92	-0.91	353.72	212.85	237.55	329.02	53.57
1	72	936	1.19-4.86	-4.41	0.74	1.59	244.89	-7.10	235.82	1.97	46.95



EGP CODE

GRE.EEC.R.73.IT.W.15235.12.024.01

PAGE

438 di/of 527

1	72	937	3.16-3.60	3.04	-3.47	-0.92	26.69	-133.34	-4.54	-102.11	-63.43	
1	72	938	2.12-3.63	-1.56	4.06e-02	2.76	520.03	-155.95	-84.22	448.30	-208.20	
1	72	939	2.69-0.38	-0.33	2.64	0.37	809.94	12.08	16.31	805.71	-57.95	
1	72	940	2.160.14	0.18	2.12	-0.28	849.12	82.99	83.03	849.08	5.48	
1	72	941	1.73-6.60e-02-4.54e-02		1.70	-0.19	793.37	107.36	107.78	792.95	17.03	
1	72	942	1.45-0.16	-0.15	1.44	-9.97e-02	723.56	113.97	114.24	723.29	12.75	
1	72	943	1.32-0.20	-0.20	1.32	-5.60e-02	684.27	114.82	114.84	684.25	3.54	
1	72	944	1.33-0.19	-0.19	1.33	-3.18e-02	694.92	114.36	114.42	694.85	-6.36	
1	72	945	1.46-0.15	-0.15	1.46	1.23e-02	750.66	111.35	111.65	750.36	-13.89	
1	72	946	1.74-4.26e-02-3.79e-02		1.73	9.06e-02	821.87	98.55	98.79	821.63	-13.10	
1	72	947	2.140.13	0.13	2.14	6.94e-02	852.38	59.93	60.09	852.23	11.08	
1	72	948	3.17-1.39	-0.92	2.70	-1.39	745.84	-41.63	-28.45	732.66	101.03	
1	72	949	4.50-4.58	-3.94	3.86	-2.33	336.58	-198.93	-71.19	208.83	228.23	
1	72	950	4.22-6.16	3.70	-5.65	2.25	8.27	-147.93	-6.59	-133.07	45.83	
1	72	951	2.30-0.11-9.96e-02		2.29	0.15	716.90	-8.04	-7.59	716.45	-18.06	
1	72	952	12.29-6.16	12.05	-5.92	-2.11	716.57	-439.34	-434.07	711.30	77.87	
1	72	953	5.332.31	4.56	3.08	-1.31	898.61	-43.90	-35.13	889.84	90.47	
1	72	954	2.430.43	0.43	2.43	-2.10e-02	859.32	70.88	78.62	851.59	77.70	
1	72	955	1.82-0.12	-0.12	1.81	9.84e-02	784.41	118.73	123.19	779.94	54.32	
1	72	956	1.40-0.19	-0.19	1.40	6.66e-02	707.11	135.06	136.66	705.51	30.18	
1	72	957	1.21-0.20	-0.20	1.21	1.74e-03	665.56	138.85	138.94	665.47	6.90	
1	72	958	1.23-0.20	-0.20	1.22	-6.68e-02	676.83	137.43	137.91	676.35	-16.09	
1	72	959	1.43-0.20	-0.20	1.42	-0.11	736.61	128.69	131.32	733.98	-39.84	
1	72	960	1.83-0.13	-0.12	1.82	-9.95e-02	819.01	99.92	105.75	813.17	-64.52	
1	72	961	2.360.46	0.48	2.35	0.15	875.72	22.70	31.79	866.64	-87.56	
1	72	962	5.991.45	4.77	2.67	2.01	859.56	-157.58	-149.20	851.18	-91.93	
1	72	963	13.89-15.87	13.63	-15.61	2.76	486.93	-823.56	-819.92	483.29	-68.99	
1	72	964	2.96-0.43	-0.40	2.93	0.33	752.71	-19.52	-18.08	751.27	-33.32	
1	72	965	4.81-2.82	-2.78	4.77	0.56	647.08	-69.68	-68.86	646.27	-24.16	
1	72	966	23.302.84	10.04	16.10	-9.77	228.08	108.90	167.80	169.18	-59.59	
1	72	967	6.56-6.95	-6.62	6.23	-2.08	-92.38	-291.93	-274.05	-110.26	56.99	
1	72	968	5.76-6.61	-6.14	5.29	2.38	-109.31	-280.02	-264.80	-124.52	-48.64	
1	72	969	9.32-4.51	5.08	-0.27	-6.37	-5.65	-407.26	-87.71	-325.21	161.93	
1	72	970	6.95-6.08	0.23	0.64	6.51	-7.44	-437.73	-126.06	-319.11	-192.28	
1	72	971	2.79-1.38	1.87	-0.47	1.73	687.33	-133.31	66.24	487.78	-352.05	
1	72	972	4.61-1.20-4.27e-02		3.46	-2.32	788.71	55.35	135.76	708.30	-229.14	
1	72	973	3.53-0.48	-0.12	3.17	-1.14	769.44	108.44	142.88	735.00	-146.90	
1	72	974	2.59-0.22-8.52e-02		2.46	-0.60	698.83	108.79	123.23	684.40	-91.15	
1	72	975	2.11-0.10-5.54e-02		2.06	-0.31	627.90	99.56	103.85	623.61	-47.43	
1	72	976	1.90-4.74e-02-4.40e-02		1.90	-8.11e-02	590.04	93.66	93.89	589.82	-10.63	
1	72	977	4.28-3.53	2.39	-1.64	-3.35	-24.27	-532.96	-270.02	-287.21	254.20	
1	72	978	3.60-5.33	-1.25	-0.48	-4.45	694.07	-389.06	-179.62	484.63	427.77	
1	72	979	3.10-0.79	-0.51	2.82	1.00	866.87	-37.45	32.10	797.31	240.96	
1	72	980	2.22-0.12-1.73e-02		2.12	0.49	843.04	105.05	129.92	818.16	133.19	
1	72	981	1.59-0.17	-0.11	1.53	0.32	764.51	152.54	162.97	754.08	79.21	
1	72	982	1.20-0.15	-0.13	1.17	0.18	686.77	166.43	169.63	683.57	40.68	
1	72	983	1.01-0.13	-0.13	1.01	4.00e-02	645.45	169.07	169.24	645.29	8.78	
1	72	984	1.03-0.15	-0.14	1.03	-8.81e-02	656.60	168.12	169.10	655.62	-21.81	
1	72	985	1.25-0.20	-0.17	1.22	-0.21	716.15	161.62	167.35	710.43	-56.05	
1	72	986	1.69-0.25	-0.20	1.64	-0.30	799.84	137.03	152.45	784.43	-99.91	
1	72	987	2.38-0.28	-0.24	2.34	-0.32	863.07	63.99	99.42	827.64	-164.49	
1	72	988	3.17-1.03	-1.00	3.15	-0.35	842.17	-139.42	-38.08	740.82	-298.68	
1	72	989	6.53-6.08	-4.36	4.80	4.34	544.18	-555.95	-240.57	228.80	-497.49	
1	72	990	6.88-5.62	6.48	-5.21	2.21	-51.23	-510.47	-247.50	-314.20	-227.19	
1	72	991	5.05e-02	-3.77	-3.26	-0.46	1.30	503.36	-291.98	243.46	-32.08	373.04
1	72	992	4.59-2.60	-2.18	4.17	1.69	732.16	-20.17	268.56	443.42	365.86	
1	72	993	1.63-0.75	-0.72	1.60	0.27	821.88	118.61	234.64	705.85	261.02	
1	72	994	1.46-0.29-2.70e-02		1.19	0.62	798.79	199.51	245.73	752.57	159.88	
1	72	995	1.11-0.16 3.97e-02		0.91	0.46	726.86	221.49	239.47	708.88	93.62	
1	72	996	0.83-4.88e-023.36e-02		0.75	0.26	654.89	223.30	228.44	649.76	46.79	
1	72	997	0.681.69e-022.34e-02		0.67	6.51e-02	616.40	221.50	221.75	616.15	9.86	
1	72	998	0.71-1.30e-026.34e-03		0.69	-0.12	626.74	222.02	223.57	625.19	-24.99	
1	72	999	0.92-0.13-2.56e-02		0.81	-0.31	682.05	223.62	233.07	672.60	-65.14	
1	72	1000	1.28-0.29-8.76e-02		1.08	-0.53	759.51	217.31	244.72	732.09	-118.79	
1	72	1001	1.87-0.54	-0.26	1.58	-0.78	819.23	182.76	250.02	751.97	-195.67	
1	72	1002	2.98-1.28	-0.94	2.64	-1.17	815.03	77.57	244.72	647.87	-308.75	
1	72	1003	2.60-0.51	-0.47	2.55	-0.37	659.53	-70.37	295.10	294.06	-364.95	
1	72	1004	1.09-6.25	-5.84	0.68	-1.68	491.53	-303.49	227.25	-39.22	-374.52	
1	72	1005	0.59-2.87	-2.41	0.12	1.18	758.69	-75.78	634.67	48.24	296.83	
1	72	1006	1.06-2.07	-1.83	0.83	0.82	747.06	214.77	539.20	422.64	259.69	
1	72	1007	0.68-0.85	-0.67	0.50	0.49	761.68	314.64	446.80	629.52	203.99	
1	72	1008	0.59-0.27 5.00e-02		0.27	0.41	740.07	326.84	377.23	689.67	135.22	
1	72	1009	0.59-7.98e-02 0.20		0.31	0.33	682.43	309.88	328.24	664.07	80.64	
1	72	1010	0.477.37e-02 0.21		0.33	0.19	621.90	290.97	295.99	616.88	40.45	
1	72	1011	0.360.18	0.19	0.35	4.59e-02	588.69	281.13	281.37	588.45	8.54	
1	72	1012	0.400.14	0.18	0.36	-9.73e-02	597.67	283.92	285.39	596.19	-21.47	



EGP CODE

GRE.EEC.R.73.IT.W.15235.12.024.01

PAGE

439 di/of 527

1	72	1013	0.55-9.63e-03	0.17	0.37	-0.26	645.13	298.72	307.96	635.89	-55.82	
1	72	1014	0.72-0.22	0.12	0.38	-0.45	709.62	320.17	348.14	681.65	-100.55	
1	72	1015	0.84-0.50-2.92e-02		0.37	-0.64	757.75	332.91	405.68	684.98	-160.06	
1	72	1016	0.71-0.98	-0.67	0.40	-0.66	764.22	296.58	483.87	576.93	-229.14	
1	72	1017	1.02-2.17	-2.01	0.85	-0.70	750.39	143.07	581.07	312.38	-272.33	
1	72	1018	0.44-3.00	-2.58	1.59e-02	-1.13	762.22	-76.03	636.66	49.53	-299.13	
1	72	1019	-0.10-2.89	-2.80	-0.19	0.49	842.07	44.18	816.12	70.13	141.53	
1	72	1020	1.18e-02	-1.62	-1.49	-0.11	0.43	742.62	374.40	696.78	420.24	121.56
1	72	1021	-1.99e-02	-0.60	-0.50	-0.11	0.21	688.13	487.61	576.88	598.86	99.65
1	72	1022	0.14-0.13	8.98e-02	-8.09e-02	9.91e-02	678.63	450.54	475.36	653.82	71.02	
1	72	1023	0.312.19e-02	0.30	3.28e-02	5.49e-02	643.61	393.23	401.37	635.47	44.40	
1	72	1024	0.330.14	0.32	0.14	2.51e-02	597.46	352.65	354.80	595.32	22.82	
1	72	1025	0.310.20	0.31	0.20	-3.88e-04	570.42	334.34	334.44	570.31	4.89	
1	72	1026	0.310.19	0.30	0.20	-2.90e-02	577.89	339.26	339.87	577.27	-12.10	
1	72	1027	0.340.11	0.31	0.14	-7.32e-02	616.14	367.30	371.23	612.22	-31.01	
1	72	1028	0.34-5.57e-02	0.28	4.39e-03	-0.14	663.14	416.58	429.11	650.61	-54.15	
1	72	1029	0.19-0.30	5.36e-02	-0.16	-0.22	687.70	475.64	514.38	648.96	-81.94	
1	72	1030	-8.04e-02	-0.80	-0.63	-0.25	-0.30	704.41	473.31	624.92	552.81	-109.78
1	72	1031	-0.15-2.01	-1.93	-0.23	-0.38	781.51	281.92	746.30	317.14	-127.88	
1	72	1032	-0.18-2.95	-2.90	-0.24	-0.37	844.68	47.68	818.18	74.18	-142.88	
1	72	1033	-0.27-2.88	-2.87	-0.28	0.15	863.65	72.47	862.74	73.38	-26.87	
1	72	1034	-0.26-1.25	-1.25	-0.26	-7.24e-03	743.14	421.14	741.43	422.85	-23.43	
1	72	1035	-3.13e-03	-0.44	-0.29	-0.16	-0.21	627.46	588.97	619.42	597.00	-15.64
1	72	1036	0.41-0.23	0.19	-1.74e-02	-0.30	648.99	513.87	514.26	648.60	-7.25	
1	72	1037	0.53-4.59e-02	0.33	0.15	-0.27	629.73	435.86	435.89	629.70	-2.40	
1	72	1038	0.480.13	0.34	0.27	-0.17	590.32	385.83	385.83	590.32	-0.56	
1	72	1039	0.380.27	0.32	0.33	-5.29e-02	565.95	363.77	363.77	565.95	-7.80e-02	
1	72	1040	0.390.26	0.32	0.32	6.52e-02	572.81	369.51	369.51	572.81	0.18	
1	72	1041	0.480.11	0.34	0.24	0.18	607.05	403.08	403.08	607.04	1.13	
1	72	1042	0.50-8.51e-02	0.34	7.68e-02	0.26	645.03	464.58	464.67	644.94	4.02	
1	72	1043	0.33-0.31	0.17	-0.15	0.27	645.51	552.96	554.11	644.36	10.27	
1	72	1044	-0.23-0.55	-0.45	-0.34	0.15	670.90	548.69	667.89	551.70	18.93	
1	72	1045	-0.37-1.82	-1.82	-0.37	-3.90e-02	792.45	318.50	791.22	319.73	24.13	
1	72	1046	-0.31-2.97	-2.97	-0.32	-0.10	865.16	76.36	864.30	77.22	26.07	
1	72	1047	-8.72e-02	-2.48	-2.45	-0.11	-0.23	816.27	13.55	769.72	60.09	-187.61
1	72	1048	0.58-1.14	-0.94	0.39	-0.54	750.11	344.79	665.70	429.20	-164.58	
1	72	1049	0.99-0.57-8.30e-03		0.43	-0.75	718.53	464.42	563.68	619.27	-123.97	
1	72	1050	1.16-0.34	0.29	0.53	-0.74	698.20	449.91	478.53	669.58	-79.29	
1	72	1051	1.09-0.14	0.29	0.66	-0.58	652.99	404.45	413.41	644.04	-46.32	
1	72	1052	0.907.47e-02	0.25	0.72	-0.34	602.27	367.43	369.72	599.99	-23.07	
1	72	1053	0.760.22	0.23	0.74	-9.44e-02	573.80	349.74	349.86	573.68	-5.00	
1	72	1054	0.780.20	0.24	0.74	0.15	581.66	354.29	354.92	581.02	11.96	
1	72	1055	0.952.58e-02	0.26	0.71	0.40	622.40	380.45	384.65	618.19	31.62	
1	72	1056	1.14-0.21	0.30	0.64	0.66	675.69	423.29	437.45	661.54	58.07	
1	72	1057	1.20-0.47	0.29	0.44	0.83	711.96	465.52	510.64	666.84	95.31	
1	72	1058	0.77-0.69-6.77e-02		0.15	0.72	728.94	443.62	603.12	569.45	141.66	
1	72	1059	0.40-1.53	-1.45	0.32	0.38	774.83	253.66	709.36	319.13	172.73	
1	72	1060	-0.25-2.67	-2.65	-0.28	0.25	816.61	14.99	770.45	61.15	186.74	
1	72	1061	0.65-2.59	-2.57	0.63	0.23	598.63	-127.51	471.08	4.13e-02	-276.31	
1	72	1062	4.41-1.18	-0.30	3.53	-2.04	741.06	156.68	449.00	448.74	-292.19	
1	72	1063	2.18-0.23	0.30	1.65	-1.00	770.56	288.63	391.63	667.56	-197.56	
1	72	1064	-0.76-2.46	-2.38	-0.83	0.36	581.39	-65.80	561.95	-46.37	110.45	
1	72	1065	1.88-0.20	0.13	1.55	-0.76	684.00	300.06	316.30	667.76	-77.27	
1	72	1066	1.52-2.30e-029.66e-02		1.40	-0.41	620.32	280.07	284.75	615.64	-39.65	
1	72	1067	1.337.97e-028.91e-02		1.33	-0.11	586.08	269.26	269.50	585.84	-8.76	
1	72	1068	1.366.17e-028.82e-02		1.34	0.18	595.35	271.95	273.27	594.04	20.60	
1	72	1069	1.60-7.24e-029.09e-02		1.44	0.50	644.64	287.18	295.40	636.42	53.57	
1	72	1070	2.02-0.29	0.11	1.63	0.87	713.24	307.78	331.66	689.36	95.46	
1	72	1071	2.56-0.51	0.20	1.84	1.30	766.31	314.27	373.01	707.57	152.00	
1	72	1072	2.75-0.65	6.67e-02	2.04	1.39	768.14	255.30	405.80	617.65	233.52	
1	72	1073	2.70-2.60e-02	0.74	1.93	1.23	698.70	82.99	483.78	297.92	293.50	
1	72	1074	0.24-4.16	-4.16	0.24	-0.12	583.87	-136.75	455.94	-8.83	275.36	
1	72	1076	13.78-16.77	9.10	-12.09	-11.01	-399.76	-656.02	-656.01	-399.78	1.83	
1	72	1077	6.24-1.32	1.60	3.33	3.68	360.28	-138.43	240.97	-19.12	212.76	
1	72	1078	-0.41-3.77	-3.74	-0.45	0.33	649.89	-58.72	632.34	-41.17	110.11	
1	72	1079	-0.35-5.00	-5.00	-0.35	5.35e-03	792.81	-38.56	790.96	-36.71	39.16	
1	72	1080	-0.35-5.02	-5.02	-0.35	-1.19e-02	795.49	-37.74	794.26	-36.51	-32.01	
1	72	1081	-0.43-3.88	-3.85	-0.46	-0.31	660.06	-55.89	644.97	-40.80	-102.84	
1	72	1082	1.94-5.67e-02-4.64e-02		1.93	0.14	600.17	95.06	96.25	598.98	24.48	
1	72	1083	2.22-0.13-6.77e-02		2.15	0.38	654.57	102.78	110.14	647.21	63.31	
1	72	1084	2.79-0.28	-0.12	2.63	0.67	730.79	110.07	130.52	710.35	110.79	
1	72	1085	3.83-0.59	-0.19	3.44	1.25	787.67	98.12	143.96	741.82	171.79	
1	72	1086	4.87-1.24	5.81e-02	3.57	2.50	769.32	6.03	112.23	663.12	264.17	
1	72	1087	4.67-1.32	-0.21	3.56	-2.33	612.37	-299.20	1.53	311.64	428.60	
1	72	1088	5.65-1.50	1.21	2.94	-3.46	373.51	-126.30	270.18	-22.97	-202.41	
1	72	1089	10.171.50	9.32	2.35	2.58	615.14	-128.67	-70.20	556.67	-200.19	





EGP CODE

GRE.EEC.R.73.IT.W.15235.12.024.01

PAGE

440 di/of 527

1	72	1090	6.231.78	1.98	6.03	-0.92	801.73	-65.37	-7.96	744.32	-215.60
1	72	1091	3.75-6.53e-02-5.10e-04	3.69	-0.49	773.30	-42.95	-12.36	742.71	-155.03	
1	72	1092	2.86-0.13-7.56e-02	2.81	-0.41	700.45	-38.20	-24.89	687.14	-98.26	
1	72	1093	2.38-7.48e-02-4.96e-02	2.35	-0.25	625.91	-40.61	-36.67	621.97	-51.09	
1	72	1094	2.16-4.09e-02-3.90e-02	2.16	-6.46e-02	586.15	-43.02	-42.81	585.94	-11.49	
1	72	1095	2.20-4.69e-02-4.03e-02	2.19	0.12	596.69	-42.46	-41.39	595.62	26.15	
1	72	1096	2.50-9.16e-02-5.62e-02	2.46	0.30	653.70	-39.70	-32.98	646.98	67.97	
1	72	1097	3.07-0.16-9.56e-02	3.00	0.44	733.48	-39.84	-21.19	714.83	118.63	
1	72	1098	4.10-9.81e-02-4.79e-02	4.05	0.46	789.49	-53.79	-14.75	750.44	177.21	
1	72	1099	6.861.90	1.96	6.81	0.51	762.02	-99.33	-35.17	697.87	226.16
1	72	1100	13.72-5.26	12.74	-4.27	-4.21	466.53	-299.83	-266.06	432.75	157.31
1	72	1101	-1.89-20.42	-18.06	-4.25	6.17	221.37	-311.96	-303.88	213.29	65.13
1	72	1102	0.14-15.474.76e-02	-15.38	-1.21	556.01	-754.56	-754.56	556.01	-0.66	
1	72	1103	-2.96-14.01	-13.98	-2.99	0.59	451.57	-1059.27	-1059.27	451.57	1.71
1	72	1104	-2.93-15.06	-14.21	-3.79	-3.11	472.29	-1120.46	-1119.46	471.29	-39.74
1	72	1105	6.55-21.37	5.47	-20.30	5.38	697.47	-1128.64	-1128.64	697.47	-0.66
1	72	1106	-1.36-13.58	-12.27	-2.68	3.78	625.17	-1690.63	-1689.53	624.07	50.36
1	72	1107	-1.36-14.11	-12.69	-2.79	-4.01	593.06	-1571.19	-1570.06	591.93	-49.48
1	72	1108	1.75-20.14	-0.17	-18.22	-6.19	586.57	-848.27	-848.17	586.46	-12.35
1	72	1109	-2.57-11.75	-11.23	-3.09	2.11	464.82	-1119.17	-1119.13	464.78	-7.93
1	72	1110	-4.58-15.35	-11.59	-8.34	-5.14	311.16	-360.99	-357.28	307.45	-49.81
1	72	1111	3.79-1.96	-0.99	2.82	2.16	185.43	-85.82	166.01	-66.40	-69.93
1	72	1112	-0.58-4.06	-3.69	-0.95	-1.07	689.92	-71.68	686.17	-67.93	-53.31
1	72	1113	-0.64-5.32	-5.32	-0.64	2.20e-02	821.10	-47.38	820.65	-46.92	19.86
1	72	1114	-0.80-4.58	-4.57	-0.80	0.18	687.13	-59.10	676.71	-48.67	87.57
1	72	1115	2.23-3.04	0.14	-0.95	2.58	264.00	-132.18	200.21	-68.39	145.61
1	72	1116	13.00-2.02	4.38	6.60	-7.42	-94.66	-866.00	-865.58	-95.08	-18.10
1	72	1117	12.15-2.14	4.40	5.61	7.12	-106.79	-873.45	-869.15	-111.09	57.28
1	72	1118	2.26-2.47	0.52	-0.73	-2.28	169.63	-106.25	128.98	-65.60	-97.79
1	72	1119	-0.75-3.92	-3.91	-0.76	-0.17	533.45	-52.91	530.66	-50.12	-40.37
1	72	1120	-0.56-3.85	-3.84	-0.57	0.19	586.67	-49.65	585.50	-48.48	27.28
1	72	1121	3.78-1.52	1.58	0.68	2.61	359.00	-79.30	330.17	-50.47	108.65
1	72	1122	11.66-6.61	8.07	-3.03	-7.25	-216.53	-437.54	-436.00	-218.07	-18.38
1	72	1123	-0.44-4.23	-4.23	-0.44	2.56e-02	768.92	-41.75	766.99	-39.82	39.49
1	72	1124	11.58-6.60	7.94	-2.95	7.28	-216.22	-426.46	-426.32	-216.36	5.44
1	72	1125	3.65-1.76	1.21	0.68	-2.69	391.78	-84.24	357.24	-49.70	-123.49
1	72	1126	-0.52-4.30	-4.29	-0.53	-0.19	652.52	-48.98	650.29	-46.75	-39.49
1	72	1127	-0.45-4.47	-4.46	-0.46	0.17	669.64	-47.98	667.93	-46.27	35.03
1	72	1128	3.48-1.79	0.48	1.21	2.61	447.72	-76.04	416.34	-44.65	124.31
1	72	1129	10.35-8.22	7.23	-5.10	-6.94	-238.32	-292.26	-278.90	-251.68	23.29
1	72	1130	13.04-14.95	8.72	-10.63	10.11	-366.33	-587.91	-587.42	-366.82	-10.40
1	72	1131	14.85-3.73	10.63	0.50	7.79	-175.01	-670.17	-668.47	-176.72	29.01
1	72	1132	5.01-1.81	3.30	-9.99e-02	-2.96	302.44	-106.13	257.46	-61.15	-127.88
1	72	1133	-0.65-3.39	-3.36	-0.67	-0.24	625.25	-53.21	621.61	-49.56	-49.59
1	72	1134	-0.57-4.19	-4.19	-0.57	-1.10e-02	679.50	-47.87	678.66	-47.03	24.71
1	72	1135	-0.96-3.17	-3.14	-0.99	0.26	481.80	-70.76	465.23	-54.19	94.24
1	72	1136	4.80-3.15	3.43	-1.79	3.00	31.07	-260.85	-146.68	-83.10	142.46
1	72	1137	18.903.03	10.11	11.82	-7.89	-58.22	-1364.50	-1363.00	-59.72	-44.28
1	72	1138	17.57-10.04	6.35	1.19	13.56	-242.68	-1235.04	-1230.82	-246.90	64.54
1	72	1139	4.87-2.59	1.48	0.80	-3.72	183.10	-247.64	-14.49	-50.05	-214.64
1	72	1140	-0.63-4.30	-4.29	-0.64	-0.18	545.79	-77.16	513.69	-45.06	-137.72
1	72	1141	-0.35-4.96	-4.96	-0.35	4.38e-02	754.59	-43.68	748.17	-37.27	-71.28
1	72	1142	-0.27-4.98	-4.98	-0.27	1.86e-03	815.61	-35.08	815.61	-35.08	-0.28
1	72	1143	-0.36-4.67	-4.67	-0.36	-2.44e-02	756.26	-43.60	749.94	-37.29	70.76
1	72	1144	-0.54-3.29	-3.25	-0.58	0.29	549.11	-76.30	517.18	-44.37	137.66
1	72	1145	8.20-1.40	5.50	1.30	4.32	198.32	-242.52	-1.04	-43.16	219.41
1	72	1146	21.03-11.17	14.30	-4.44	-13.10	-293.91	-1171.68	-1166.46	-299.13	-67.48
1	72	1147	9.54-4.51	-2.49	7.51	-4.94	-21.60	-356.27	-342.19	-35.67	67.17
1	72	1148	14.48-17.25	9.43	-12.20	11.61	-407.75	-664.58	-664.57	-407.75	0.96
1	72	1149	6.56-1.40	2.06	3.11	-3.95	357.15	-136.08	241.43	-20.37	-209.01
1	72	1150	-0.22-4.79	-4.78	-0.23	-0.23	654.11	-58.48	636.30	-40.67	-111.23
1	72	1151	-0.31-5.61	-5.61	-0.31	1.11e-02	797.58	-38.92	795.67	-37.01	-39.90
1	72	1152	-0.30-5.61	-5.61	-0.30	-1.50e-03	800.18	-38.07	798.92	-36.80	32.53
1	72	1153	-0.24-4.82	-4.81	-0.25	0.22	664.13	-55.58	648.85	-40.29	103.75
1	72	1154	5.96-1.54	1.66	2.76	3.71	371.16	-123.89	271.08	-23.80	198.82
1	72	1155	13.61-15.52	8.91	-10.82	-10.72	-375.62	-594.66	-594.40	-375.88	7.53
1	72	1156	18.65-9.13	13.08	-3.56	-11.12	-262.23	-1050.12	-1045.87	-266.48	-57.69
1	72	1157	19.46-9.71	13.32	-3.56	11.89	-269.51	-1057.63	-1052.29	-274.85	64.67
1	72	1158	7.37-1.45	4.87	1.05	-3.98	212.10	-190.61	67.69	-46.21	-193.13
1	72	1159	-0.55-3.51	-3.48	-0.58	-0.29	582.12	-65.53	562.32	-45.72	-111.51
1	72	1160	-0.39-4.90	-4.90	-0.39	-3.88e-03	771.24	-42.21	769.18	-40.14	-40.94
1	72	1161	-0.39-5.17	-5.17	-0.39	-1.41e-02	788.65	-41.41	787.30	-40.06	33.46
1	72	1162	-0.68-4.71	-4.71	-0.68	0.14	637.63	-62.78	621.39	-46.54	105.41
1	72	1163	3.27-3.04	0.15	7.65e-02	3.16	273.71	-160.14	172.56	-58.99	183.44
1	72	1164	14.30-7.06	3.99	3.24	-10.67	-182.01	-895.41	-894.96	-182.46	-18.01
1	72	1165	14.744.35	7.64	11.45	4.83	-30.34	-1017.34	-1016.16	-31.52	34.10





EGP CODE

GRE.EEC.R.73.IT.W.15235.12.024.01

PAGE

441 di/of 527

1	72	1166	3.34-2.99	2.36	-2.01	-2.28	26.22	-135.46	-22.22	-87.02	-74.07	
1	72	1167	-0.92-2.68	-2.68	-0.92	-2.71e-02	379.54	-60.77	377.85	-59.08	-27.23	
1	72	1168	3.09-1.18	0.78	1.13	2.13	316.90	-54.42	309.36	-46.88	52.36	
1	72	1169	8.44-8.87	5.50	-5.93	-6.50	-231.36	-333.89	-302.70	-262.54	-47.17	
1	72	1170	6.62-1.42	3.88	1.31	3.81	220.21	-194.10	72.70	-46.60	198.38	
1	72	1171	13.67-6.44	8.37	-1.14	8.86	-196.85	-677.46	-677.38	-196.93	-6.23	
1	72	1172	4.33-2.32	1.68	0.32	-3.25	375.47	-143.03	282.84	-50.41	-198.61	
1	72	1173	-0.59-4.35	-4.34	-0.59	-0.16	734.94	-60.56	715.24	-40.86	-123.63	
1	72	1174	-0.33-5.25	-5.25	-0.33	-1.31e-04	914.75	-38.52	911.17	-34.95	-58.27	
1	72	1175	-0.34-5.53	-5.53	-0.34	-6.84e-02	958.48	-35.62	958.38	-35.52	9.81	
1	72	1176	-0.84-5.54	-5.54	-0.85	-7.60e-02	860.35	-51.03	853.72	-44.40	77.42	
1	72	1177	-0.36-4.58	-2.98	-1.97	2.05	521.63	-112.27	488.24	-78.88	141.60	
1	72	1178	7.36-1.41	4.40	1.56	-4.15	206.08	-246.38	3.74	-44.04	-224.97	
1	72	1179	-1.64-19.72	-17.27	-4.09	-6.19	221.41	-315.74	-306.93	212.60	-68.22	
1	72	1180	1.98e-02	-13.75	-8.91e-02	-13.64	1.22	540.09	-765.52	-765.52	540.09	0.32
1	72	1181	-2.66-14.39	-14.35	-2.69	-0.60	445.42	-1059.11	-1059.10	445.42	-2.28	
1	72	1182	-2.86-15.24	-14.60	-3.50	2.75	465.59	-1120.35	-1119.52	464.76	36.19	
1	72	1183	6.02-18.84	5.12	-17.95	-4.62	678.82	-1143.31	-1143.31	678.82	0.44	
1	72	1184	-1.39-13.83	-12.92	-2.30	-3.23	617.44	-1690.89	-1690.03	616.57	-44.64	
1	72	1185	-1.38-14.35	-13.31	-2.42	3.52	585.52	-1571.10	-1570.17	584.59	44.73	
1	72	1186	1.45-18.01	-0.31	-16.24	5.59	569.86	-859.83	-859.71	569.75	12.81	
1	72	1187	-2.11-12.10	-11.36	-2.85	-2.61	458.45	-1119.66	-1119.66	458.45	-4.86e-02	
1	72	1188	-3.37-14.87	-10.19	-8.06	5.65	309.67	-369.28	-365.33	305.72	51.62	
1	72	1189	4.15-0.21	0.33	3.62	-1.43	183.41	-73.17	160.86	-50.63	72.63	
1	72	1190	-0.70-4.19	-3.84	-1.06	1.06	687.50	-74.28	683.66	-70.44	53.95	
1	72	1191	-0.77-4.99	-4.99	-0.77	1.82e-03	821.40	-47.78	820.95	-47.32	-19.97	
1	72	1192	-1.01-4.32	-4.31	-1.02	-0.16	689.67	-60.03	679.03	-49.39	-88.67	
1	72	1193	1.53-3.71	-1.15	-1.03	-2.62	267.20	-137.97	201.38	-72.14	-149.45	
1	72	1194	11.91-0.38	5.53	5.99	6.14	-78.54	-870.47	-870.38	-78.64	8.81	
1	72	1195	10.88-1.46	4.74	4.68	-6.17	-96.91	-879.23	-875.92	-100.23	-50.79	
1	72	1196	1.58-2.95	-0.67	-0.71	2.26	175.15	-111.57	131.54	-67.96	102.96	
1	72	1197	-0.96-3.27	-3.27	-0.96	0.13	534.85	-53.67	531.80	-50.62	42.30	
1	72	1198	-0.72-2.89	-2.86	-0.75	-0.26	585.99	-49.91	584.89	-48.80	-26.47	
1	72	1199	3.52-1.38	1.25	0.88	-2.44	362.57	-79.87	332.19	-49.49	-111.89	
1	72	1200	11.20-6.33	7.91	-3.05	6.84	-212.00	-431.10	-429.99	-213.11	15.54	
1	72	1201	-0.93-4.36	-4.36	-0.94	-0.12	639.29	-64.10	622.71	-47.53	-106.70	
1	72	1202	11.31-6.03	8.08	-2.80	-6.75	-208.04	-423.07	-423.06	-208.05	-1.68	
1	72	1203	3.39-1.69	0.86	0.83	2.54	393.10	-86.01	356.65	-49.56	127.03	
1	72	1204	-0.71-3.27	-3.24	-0.73	0.23	648.94	-49.39	646.69	-47.14	39.56	
1	72	1205	-0.63-3.42	-3.40	-0.64	-0.22	665.51	-48.30	663.77	-46.57	-35.14	
1	72	1206	3.31-1.65	0.31	1.35	-2.42	447.61	-76.81	414.47	-43.67	-127.60	
1	72	1207	9.99-7.78	7.19	-4.98	6.48	-230.38	-289.41	-274.98	-244.81	-25.37	
1	72	1209	14.29-3.28	10.53	0.48	-7.20	-168.74	-665.65	-664.52	-169.87	-23.66	
1	72	1210	4.45-1.73	2.61	0.11	2.83	308.25	-108.43	261.08	-61.26	132.03	
1	72	1211	-0.81-2.46	-2.41	-0.87	0.29	625.08	-53.51	621.52	-49.95	49.04	
1	72	1212	-0.62-3.47	-3.47	-0.63	3.08e-02	679.05	-47.69	678.14	-46.78	-25.70	
1	72	1213	-1.19-2.67	-2.64	-1.22	-0.21	485.60	-72.01	468.42	-54.83	-96.35	
1	72	1214	3.24-3.48	1.41	-1.65	-2.99	38.29	-266.53	-142.50	-85.74	-149.75	
1	72	1215	16.883.32	10.26	9.94	6.78	-49.33	-1372.97	-1371.60	-50.70	42.60	
1	72	1216	16.64-7.77	7.89	0.97	-11.71	-217.57	-1238.95	-1236.60	-219.92	-48.95	
1	72	1217	3.93-3.62	-0.29	0.61	3.75	186.93	-255.81	-12.71	-56.18	220.30	
1	72	1218	-0.93-3.97	-3.96	-0.94	0.16	548.77	-78.69	516.35	-46.26	138.90	
1	72	1219	-0.39-4.64	-4.64	-0.39	-5.20e-02	753.90	-43.54	747.44	-37.08	71.53	
1	72	1220	-0.27-4.61	-4.61	-0.27	-1.15e-02	813.50	-34.72	813.50	-34.72	1.10	
1	72	1221	-0.41-4.04	-4.04	-0.41	1.98e-03	753.43	-43.02	747.38	-36.98	-69.14	
1	72	1222	-0.76-2.24	-2.15	-0.86	-0.36	548.08	-76.55	516.68	-45.14	-136.50	
1	73	1	0.81-1.68	0.72	-1.58	-0.48	-530.66	-806.91	-723.19	-614.38	126.96	
1	73	3	0.79-1.98	0.60	-1.78	0.71	-546.85	-820.43	-734.36	-632.93	-127.04	
1	73	5	-2.31-7.06	-2.33	-7.04	-0.28	-1160.65	-1817.99	-1813.44	-1165.21	54.54	
1	73	7	1.15-4.66	1.15	-4.66	-1.36e-02	-1122.59	-1632.25	-1631.59	-1123.25	-18.39	
1	73	9	2.39-6.02	1.39	-5.01	2.73	-1156.59	-1721.43	-1716.58	-1161.44	-52.07	
1	73	11	-0.45-11.23	-2.33	-9.35	-4.09	-1371.80	-2386.47	-2386.44	-1371.83	-5.72	
1	73	13	4.19-7.09	2.98	-5.87	-3.50	-1474.65	-2387.45	-2380.67	-1481.42	78.35	
1	73	15	3.69-6.80	2.57	-5.67	3.25	-1412.40	-2245.93	-2242.13	-1416.20	-56.16	
1	73	17	-0.53-9.68	-2.22	-7.98	3.55	-1155.79	-1925.36	-1920.99	-1160.17	57.84	
1	73	19	1.72-5.04	0.87	-4.20	2.24	-1116.88	-1785.09	-1720.90	-1181.07	-196.91	
1	73	21	2.35-4.65	-0.31	-2.00	-3.40	-559.52	-1208.02	-982.25	-785.29	308.93	
1	73	23	-5.76e-02	-1.88	-1.77	-0.17	0.43	-1102.71	-1787.77	-1783.98	-1106.50	-50.83
1	73	25	2.76-3.99	2.76	-3.99	3.14e-02	-1081.34	-1610.22	-1609.63	-1081.94	17.69	
1	73	27	3.63-4.71	2.87	-3.94	-2.40	-1112.90	-1698.73	-1695.58	-1116.04	42.82	
1	73	29	3.13-4.96	-1.81	-2.44e-02	3.95	-1310.49	-2357.61	-2356.84	-1311.26	28.33	
1	73	31	5.73-5.53	4.81	-4.61	3.08	-1421.12	-2358.42	-2353.56	-1425.98	-67.37	
1	73	33	5.17-5.34	4.32	-4.50	-2.86	-1360.25	-2218.50	-2216.01	-1362.74	46.18	
1	73	35	2.44-4.15	-1.60	-0.11	-3.21	-1102.93	-1903.09	-1895.61	-1110.41	-77.01	
1	73	37	3.00-3.79	2.35	-3.14	-1.99	-1074.17	-1754.09	-1698.35	-1129.90	186.51	
1	73	39	3.73-3.64	-0.38	0.47	3.66	-548.03	-1164.92	-962.97	-749.98	-289.48	



EGP CODE

GRE.EEC.R.73.IT.W.15235.12.024.01

PAGE

442 di/of 527

1	73	41	2.56-4.51	-1.62	-0.33	-3.47	337.37	-89.74	307.79	-60.16	108.44	
1	73	42	2.48-2.05-1.92e-02		0.45	-2.25	555.10	114.79	247.78	422.11	202.16	
1	73	43	7.98-2.78	7.91	-2.70	-0.89	505.84	-150.75	-124.05	479.14	129.69	
1	73	44	2.930.39	1.17	2.15	1.17	692.22	232.86	263.43	661.65	114.49	
1	73	45	5.531.87	3.36	4.03	1.80	704.53	-34.60	-12.89	682.82	124.81	
1	73	46	2.50-9.55e-03	0.45	2.03	0.97	703.41	226.16	234.32	695.25	61.89	
1	73	47	2.993.96e-02	0.15	2.88	0.56	698.34	-36.32	-27.33	689.35	80.78	
1	73	48	1.87-9.21e-027.60e-02		1.70	0.55	659.49	196.92	199.37	657.04	33.58	
1	73	49	2.09-0.10-7.03e-02		2.06	0.27	643.56	-44.77	-41.76	640.55	45.38	
1	73	50	1.49-6.70e-02-1.92e-02		1.44	0.27	605.88	172.33	172.91	605.30	15.89	
1	73	51	1.66-8.39e-02-7.31e-02		1.65	0.14	581.81	-54.47	-53.76	581.10	21.33	
1	73	52	1.33-4.61e-02-4.28e-02		1.32	6.74e-02	575.65	160.23	160.26	575.62	3.54	
1	73	53	1.49-6.93e-02-6.86e-02		1.48	3.24e-02	547.89	-59.81	-59.77	547.86	4.84	
1	73	54	1.35-4.37e-02-3.42e-02		1.34	-0.11	583.90	162.94	163.08	583.76	-7.61	
1	73	55	1.52-6.93e-02-6.60e-02		1.51	-7.14e-02	556.93	-58.67	-58.52	556.78	-9.70	
1	73	56	1.55-6.24e-026.83e-03		1.48	-0.33	626.92	179.75	180.79	625.88	-21.55	
1	73	57	1.76-8.39e-02-6.44e-02		1.74	-0.19	605.17	-51.69	-50.48	603.96	-28.16	
1	73	58	1.96-8.84e-02 0.12		1.75	-0.62	682.21	206.36	210.22	678.35	-42.73	
1	73	59	2.27-0.10-4.85e-02		2.22	-0.35	669.72	-42.83	-38.48	665.36	-55.54	
1	73	60	2.542.31e-02 0.50		2.06	-0.99	709.82	230.34	243.15	697.01	-77.32	
1	73	61	3.266.84e-02 0.24		3.10	-0.71	706.82	-41.86	-30.00	694.96	-93.51	
1	73	62	2.510.62	0.99	2.14	-0.75	663.24	209.98	260.90	612.31	-143.14	
1	73	63	5.791.94	3.88	3.86	-1.92	659.96	-63.89	-39.00	635.06	-131.90	
1	73	64	3.84-2.54	-1.76	3.07	2.08	489.27	34.83	258.89	265.21	-227.20	
1	73	65	8.21-7.39	8.15	-7.33	0.96	365.01	-313.92	-291.88	342.97	-120.32	
1	73	66	2.37-4.17	0.37	-2.17	3.01	343.42	-89.19	318.43	-64.20	-100.93	
1	73	67	0.61-2.60	-2.55	0.56	0.38	614.19	31.93	603.06	43.05	79.72	
1	73	68	1.85-0.55	-0.38	1.69	0.61	580.96	391.42	533.62	438.76	82.05	
1	73	69	1.310.17	0.51	0.97	0.53	653.11	431.32	442.86	641.57	49.26	
1	73	70	1.552.85e-02 0.51		1.07	0.71	692.54	376.60	378.09	691.06	21.64	
1	73	71	1.342.49e-02 0.26		1.11	0.50	663.93	325.77	326.03	663.67	9.25	
1	73	72	1.162.56e-029.26e-02		1.09	0.27	617.68	291.10	291.14	617.64	3.63	
1	73	73	1.072.16e-022.71e-02		1.07	7.54e-02	590.15	275.27	275.27	590.15	0.71	
1	73	74	1.083.04e-023.99e-02		1.07	-9.95e-02	597.76	279.04	279.05	597.75	-1.74	
1	73	75	1.174.45e-02 0.13		1.08	-0.30	636.48	302.23	302.32	636.39	-5.56	
1	73	76	1.373.07e-02 0.30		1.10	-0.54	681.82	343.68	344.22	681.28	-13.51	
1	73	77	1.61-1.80e-02 0.51		1.08	-0.76	690.26	399.79	403.03	687.02	-30.52	
1	73	78	1.74-0.15	0.38	1.21	-0.85	618.72	447.84	476.29	590.26	-63.67	
1	73	79	0.72-0.24	-0.24	0.72	-3.15e-02	597.41	292.93	572.87	317.46	-82.87	
1	73	80	0.90-3.51	-3.47	0.86	-0.41	609.49	31.79	598.21	43.07	-79.91	
1	73	81	-6.32e-02	-2.14	-2.13	-6.64e-02	-8.11e-02	711.77	59.18	707.38	63.58	-53.38
1	73	82	0.34-0.76	-0.76	0.34	-9.25e-02	613.37	420.85	600.67	433.56	-47.79	
1	73	83	0.410.15	0.19	0.37	9.40e-02	645.52	485.29	497.95	632.85	-43.22	
1	73	84	0.700.27	0.46	0.51	0.22	698.10	413.76	417.79	694.06	-33.63	
1	73	85	0.800.23	0.31	0.71	0.20	674.20	360.93	362.43	672.70	-21.61	
1	73	86	0.850.12	0.15	0.82	0.13	628.72	327.41	327.82	628.31	-11.13	
1	73	87	0.876.07e-026.36e-02		0.86	4.83e-02	601.08	312.48	312.50	601.05	-2.50	
1	73	88	0.867.61e-027.74e-02		0.86	-3.17e-02	608.69	316.25	316.36	608.59	5.60	
1	73	89	0.830.17	0.19	0.81	-0.11	647.34	338.76	339.47	646.63	14.76	
1	73	90	0.760.28	0.37	0.67	-0.19	691.10	380.20	382.39	688.91	26.01	
1	73	91	0.690.23	0.50	0.42	-0.23	693.27	441.40	447.35	687.31	38.26	
1	73	92	0.245.74e-02 0.13		0.17	-9.14e-02	608.96	507.46	537.29	579.12	46.24	
1	73	93	0.23-1.21	-1.20	0.22	0.12	651.67	316.35	644.60	323.42	48.17	
1	73	94	-0.14-2.26	-2.25	-0.15	7.96e-02	712.42	62.56	708.19	66.79	52.30	
1	73	95	0.26-2.27	-1.98	-2.75e-02	-0.80	649.98	-23.52	583.06	43.39	-201.47	
1	73	96	0.85-1.23	-0.99	0.60	-0.67	647.66	280.84	497.41	431.08	-180.39	
1	73	97	0.76-0.27-4.02e-02		0.53	-0.43	715.56	357.71	419.49	653.78	-135.25	
1	73	98	0.740.14	0.32	0.55	-0.28	737.18	348.86	367.36	718.68	-82.72	
1	73	99	0.760.17	0.21	0.72	-0.15	697.81	326.98	332.79	692.00	-46.04	
1	73	100	0.807.61e-027.90e-02		0.80	-4.55e-02	644.19	308.20	309.66	642.72	-22.13	
1	73	101	0.821.29e-021.30e-02		0.82	8.42e-03	613.24	298.81	298.88	613.16	-4.79	
1	73	102	0.822.07e-022.33e-02		0.82	4.64e-02	621.66	301.35	301.73	621.28	11.13	
1	73	103	0.829.22e-02 0.11		0.80	0.11	665.40	315.31	317.98	662.73	30.47	
1	73	104	0.820.16	0.26	0.71	0.24	719.78	337.03	346.23	710.58	58.62	
1	73	105	0.834.25e-02 0.38		0.49	0.39	741.81	357.77	386.71	712.88	101.36	
1	73	106	0.61-0.36-6.62e-02		0.32	0.45	693.00	348.32	447.98	593.33	156.27	
1	73	107	0.82-1.54	-1.39	0.67	0.59	640.57	204.36	533.45	311.47	187.76	
1	73	108	0.23-2.53	-2.19	-0.11	0.90	649.15	-22.04	583.02	44.09	200.04	
1	73	109	-0.30-2.57	-2.31	-0.56	-0.72	364.36	-218.45	195.55	-49.63	-264.37	
1	73	110	4.17-1.93	-1.28	3.52	-1.88	641.50	28.34	228.64	441.21	-287.56	
1	73	111	1.33-0.29	-0.12	1.16	-0.50	772.41	173.80	227.99	718.22	-171.76	
1	73	112	1.63-0.29 4.21e-02		1.31	-0.72	779.89	246.57	263.45	763.01	-93.37	
1	73	113	1.23-0.15-5.15e-02		1.13	-0.36	723.86	263.55	269.10	718.31	-50.23	
1	73	114	0.99-0.11-9.08e-02		0.98	-0.13	660.69	262.68	264.11	659.25	-23.88	
1	73	115	0.91-0.11	-0.11	0.91	-1.13e-02	625.88	259.80	259.88	625.81	-5.14	
1	73	116	0.93-0.11	-0.10	0.92	8.15e-02	635.32	260.72	261.10	634.93	12.06	



EGP CODE

GRE.EEC.R.73.IT.W.15235.12.024.01

PAGE

443 di/of 527

1	73	117	1.07-0.12-8.08e-02	1.03	0.22	685.12	264.07	266.70	682.48	33.19
1	73	118	1.39-0.20-3.39e-02	1.23	0.48	751.53	260.94	269.77	742.70	65.20
1	73	119	1.92-0.39 7.46e-02	1.46	0.92	791.41	230.85	257.46	764.80	119.19
1	73	120	1.89-0.65 -0.34	1.58	0.83	745.90	126.81	216.28	656.43	217.69
1	73	121	2.70-0.45 -0.20	2.46	0.85	541.28	-25.72	247.81	267.75	283.32
1	73	122	0.20-4.95 -4.57	-0.18	1.35	346.45	-228.99	176.34	-58.88	262.59
1	73	123	5.20-3.30 1.59	0.32	4.20	-371.45	-588.59	-478.91	-481.13	-108.56
1	73	124	2.60-3.17 1.94	-2.52	1.83	655.33	-285.57	-194.82	564.57	-277.76
1	73	125	3.94-2.06 -0.74	2.63	-2.49	803.02	49.74	70.79	781.97	-124.15
1	73	126	2.48-0.75 -0.65	2.38	-0.56	803.23	169.73	174.88	798.08	-56.89
1	73	127	1.59-0.36 -0.34	1.58	-0.17	739.91	207.39	209.31	737.99	-31.93
1	73	128	1.15-0.24 -0.24	1.15	-3.93e-02	671.54	215.63	216.19	670.98	-15.98
1	73	129	0.99-0.20 -0.20	0.99	1.02e-02	634.51	215.93	215.96	634.48	-3.58
1	73	130	1.02-0.20 -0.20	1.02	4.04e-02	644.57	216.00	216.16	644.42	8.11
1	73	131	1.26-0.25 -0.25	1.25	0.10	697.90	213.92	214.89	696.93	21.64
1	73	132	1.81-0.40 -0.37	1.78	0.26	770.80	197.36	200.22	767.94	40.39
1	73	133	2.84-0.87 -0.73	2.70	0.71	817.98	136.70	144.35	810.33	71.80
1	73	134	4.35-2.23 -0.35	2.47	2.97	769.94	-43.76	-10.83	737.00	160.36
1	73	135	3.56-4.81 -0.96	-0.29	-4.17	490.41	-510.66	-326.27	306.02	388.05
1	73	136	6.35-1.50 5.32	-0.47	-2.66	-406.73	-566.94	-448.16	-525.52	70.15
1	73	137	15.244.26 15.23	4.27	0.39	693.12	-97.36	-95.52	691.28	-38.11
1	73	138	7.19-9.48e-02-9.42e-02	7.19	6.93e-02	849.69	55.07	56.50	848.26	-33.67
1	73	139	2.52-0.10 -0.10	2.52	3.27e-02	806.65	159.79	160.94	805.50	-27.25
1	73	140	1.57-0.32 -0.32	1.57	3.79e-02	742.00	190.13	190.79	741.34	-19.07
1	73	141	1.15-0.26 -0.26	1.15	3.60e-02	673.46	196.85	197.09	673.22	-10.72
1	73	142	0.99-0.21 -0.21	0.99	2.58e-02	636.24	196.79	196.80	636.22	-2.57
1	73	143	1.02-0.22 -0.22	1.02	1.34e-02	646.37	196.94	197.01	646.30	5.51
1	73	144	1.25-0.27 -0.27	1.25	4.61e-03	699.99	195.39	195.77	699.61	13.74
1	73	145	1.76-0.33 -0.33	1.76	2.72e-04	772.93	180.64	181.47	772.10	22.15
1	73	146	2.91-2.11e-03-2.04e-03	2.91	-1.46e-02	821.05	129.52	130.84	819.73	30.19
1	73	147	9.07-0.42 -0.42	9.07	-0.12	829.69	-22.25	-20.71	828.15	36.13
1	73	148	22.38-6.26 22.36	-6.24	-0.77	514.23	-455.38	-454.20	513.05	33.79
1	73	149	4.48-2.24 2.35	-9.85e-02	-3.13	-455.64	-507.38	-488.78	-474.23	24.83
1	73	150	2.20-2.90 1.60	-2.30	-1.64	612.40	-277.40	-231.21	566.21	197.41
1	73	151	3.75-1.98 -0.68	2.45	2.40	786.05	34.44	38.48	782.02	54.93
1	73	152	2.45-0.79 -0.68	2.34	0.60	800.82	141.13	141.14	800.82	2.29
1	73	153	1.59-0.39 -0.36	1.56	0.25	741.24	175.18	175.25	741.18	-6.10
1	73	154	1.14-0.25 -0.24	1.13	0.11	674.09	182.04	182.10	674.03	-5.38
1	73	155	0.97-0.20 -0.20	0.97	4.13e-02	637.35	181.96	181.97	637.35	-1.53
1	73	156	1.00-0.20 -0.20	1.00	-1.49e-02	647.36	182.19	182.21	647.34	2.86
1	73	157	1.24-0.26 -0.25	1.24	-9.20e-02	700.17	180.93	180.99	700.11	5.73
1	73	158	1.79-0.41 -0.38	1.76	-0.25	771.24	166.52	166.55	771.21	3.78
1	73	159	2.79-0.87 -0.74	2.66	-0.68	813.19	111.06	111.23	813.01	-11.07
1	73	160	4.09-2.11 -0.24	2.21	-2.85	746.21	-51.92	-42.75	737.04	-85.09
1	73	161	3.11-4.97 -1.16	-0.70	4.03	414.16	-475.91	-358.08	296.33	-301.65
1	73	162	5.49-1.21 5.19	-0.91	1.38	-463.32	-529.03	-466.20	-526.15	13.47
1	73	163	-0.45-2.45 -2.07	-0.82	0.78	217.27	-153.30	114.85	-50.88	165.72
1	73	164	3.74-1.97 -1.55	3.32	1.48	536.23	38.91	138.91	436.24	199.32
1	73	165	1.22-0.45 -0.38	1.15	0.33	739.03	114.79	131.23	722.60	99.95
1	73	166	1.60-0.40-7.71e-02	1.28	0.73	774.55	161.62	163.93	772.24	37.59
1	73	167	1.22-0.25 -0.11	1.08	0.43	729.00	168.64	168.90	728.74	12.05
1	73	168	0.95-0.15 -0.11	0.91	0.21	669.01	164.40	164.41	668.99	2.83
1	73	169	0.84-0.11 -0.11	0.83	5.87e-02	634.80	160.74	160.74	634.80	0.22
1	73	170	0.87-0.11 -0.11	0.86	-6.51e-02	644.14	162.03	162.03	644.13	-1.18
1	73	171	1.04-0.15 -0.10	0.99	-0.22	692.75	167.25	167.32	692.68	-5.89
1	73	172	1.36-0.23-8.07e-02	1.21	-0.47	754.15	169.74	170.46	753.44	-20.42
1	73	173	1.83-0.37 1.21e-02	1.44	-0.84	779.00	154.58	159.79	773.79	-56.80
1	73	174	1.70-0.63 -0.47	1.54	-0.59	693.94	88.76	122.93	659.76	-139.70
1	73	175	2.54-0.56 -0.48	2.46	-0.49	410.23	16.82	161.02	266.02	-189.57
1	73	176	0.36-4.90 -4.37	-0.17	-1.58	200.14	-160.31	97.36	-57.53	-162.74
1	73	177	0.20-1.77 -1.69	0.12	0.39	454.75	19.19	434.25	39.69	92.24
1	73	178	0.97-1.40 -1.35	0.92	0.34	484.47	290.18	343.55	431.10	86.72
1	73	179	0.84-0.58 -0.49	0.75	0.34	673.44	251.96	260.02	665.38	57.72
1	73	180	0.77-0.11 6.15e-02	0.60	0.35	739.73	205.73	206.97	738.49	25.74
1	73	181	0.76-1.82e-03 0.10	0.66	0.26	713.09	175.25	175.41	712.93	9.28
1	73	182	0.711.85e-024.51e-02	0.68	0.13	661.36	155.93	155.95	661.35	2.78
1	73	183	0.694.64e-036.16e-03	0.69	3.23e-02	629.94	147.31	147.31	629.94	0.49
1	73	184	0.722.73e-036.71e-03	0.71	-5.32e-02	638.52	149.96	149.97	638.52	-1.02
1	73	185	0.782.22e-025.33e-02	0.74	-0.15	682.45	163.83	163.87	682.41	-4.66
1	73	186	0.843.92e-02 0.14	0.74	-0.27	732.63	188.45	188.84	732.24	-14.45
1	73	187	0.81-1.08e-02 0.17	0.63	-0.34	734.79	224.90	227.52	732.17	-36.46
1	73	188	0.66-0.42 -0.36	0.60	-0.25	619.02	275.75	291.30	603.47	-71.39
1	73	189	0.95-1.50 -1.46	0.92	-0.28	442.73	251.78	382.69	311.82	-88.66
1	73	190	0.22-2.10 -1.92	4.35e-02	-0.62	454.60	22.64	435.24	42.00	-89.38
1	73	191	0.51-2.08 -1.79	0.23	-0.81	484.89	42.18	478.01	49.06	-54.74
1	73	192	1.04-1.61 -1.60	1.02	-0.22	462.33	346.34	375.25	433.42	-50.17



EGP CODE

GRE.EEC.R.73.IT.W.15235.12.024.01

PAGE

444 di/of 527

1	73	193	0.76-0.56	-0.56	0.76	5.73e-02	662.63	274.15	277.50	659.28	-35.94
1	73	194	0.560.11	0.11	0.56	1.72e-02	733.24	209.90	210.51	732.63	-17.86
1	73	195	0.610.17	0.17	0.61	-1.60e-02	709.44	169.84	169.96	709.32	-7.91
1	73	196	0.650.10	0.11	0.65	-1.67e-02	659.03	146.13	146.15	659.01	-3.05
1	73	197	0.675.35e-025.39e-02		0.67	-1.52e-02	628.03	135.92	135.92	628.03	-0.31
1	73	198	0.695.07e-025.10e-02		0.69	-1.20e-02	636.46	138.91	138.92	636.45	2.03
1	73	199	0.719.77e-029.77e-02		0.71	1.51e-03	679.53	155.32	155.38	679.48	5.35
1	73	200	0.720.16	0.17	0.71	4.41e-02	727.57	186.32	186.56	727.33	11.40
1	73	201	0.710.11	0.14	0.68	0.13	726.12	236.17	237.24	725.04	22.89
1	73	202	0.72-0.44	-0.42	0.70	0.14	607.17	309.92	315.97	601.12	41.99
1	73	203	1.00-1.58	-1.56	0.98	0.25	443.16	297.66	419.58	321.23	53.62
1	73	204	0.41-2.17	-1.92	0.16	0.76	487.87	45.54	480.02	53.38	58.38
1	73	205	0.27-3.82	-2.86	-0.69	-1.74	335.04	-89.58	256.90	-11.43	-164.55
1	73	206	3.17-2.27	-2.18	3.07	-0.70	534.83	143.83	237.75	440.91	-167.04
1	73	207	1.39-0.54	-0.54	1.39	7.53e-03	724.85	155.64	178.06	702.43	-110.72
1	73	208	1.163.40e-02	0.10	1.10	-0.27	762.93	158.75	162.84	758.84	-49.52
1	73	209	0.986.85e-02	0.13	0.92	-0.22	721.98	144.79	145.53	721.25	-20.57
1	73	210	0.854.10e-026.08e-02		0.83	-0.12	663.93	130.90	131.00	663.83	-7.35
1	73	211	0.791.68e-021.98e-02		0.79	-4.82e-02	630.30	123.61	123.62	630.30	-0.94
1	73	212	0.801.35e-021.39e-02		0.80	1.80e-02	639.40	125.58	125.62	639.36	4.21
1	73	213	0.902.62e-023.74e-02		0.89	9.81e-02	686.69	136.31	136.61	686.39	12.84
1	73	214	1.101.86e-026.12e-02		1.06	0.21	744.66	152.30	153.96	743.00	31.34
1	73	215	1.49-0.13-5.00e-02		1.41	0.35	763.12	166.74	174.94	754.92	69.46
1	73	216	2.48-0.84	-0.64	2.28	0.80	683.10	161.52	202.08	642.55	139.66
1	73	217	2.08-0.86	-0.85	2.07	-0.21	454.23	125.68	272.25	307.65	163.32
1	73	218	1.54-5.53	-4.88	0.89	2.04	328.52	-90.60	247.50	-9.58	165.51
1	73	219	2.48-2.67	2.37	-2.57	0.73	7.82	-263.57	-90.17	-165.58	-130.35
1	73	220	2.82-4.75	-1.80	-0.14	3.69	564.93	-224.62	-109.58	449.89	-278.56
1	73	221	2.32-0.28	-0.28	2.32	-6.41e-02	788.02	11.21	30.07	769.16	-119.55
1	73	222	1.860.14	0.19	1.81	-0.28	799.65	95.56	97.96	797.25	-41.01
1	73	223	1.396.20e-033.69e-02		1.36	-0.20	738.44	116.02	116.36	738.10	-14.67
1	73	224	1.09-3.70e-02-2.60e-02		1.08	-0.11	670.58	116.10	116.14	670.54	-4.49
1	73	225	0.95-4.76e-02-4.60e-02		0.95	-4.00e-02	633.46	113.24	113.24	633.46	-0.43
1	73	226	0.96-5.07e-02-5.04e-02		0.96	1.80e-02	643.51	113.70	113.71	643.50	2.54
1	73	227	1.11-4.84e-02-4.27e-02		1.11	8.12e-02	696.61	115.83	115.96	696.48	8.68
1	73	228	1.43-2.30e-02-8.64e-03		1.42	0.14	767.70	109.50	110.39	766.81	24.24
1	73	229	1.924.15e-024.59e-02		1.92	9.14e-02	809.68	71.26	76.56	804.38	62.36
1	73	230	2.75-1.06	-0.87	2.55	-0.84	744.98	-56.31	-20.12	708.80	166.39
1	73	231	5.42-5.63	-4.50	4.28	-3.36	404.53	-316.09	-125.21	213.65	317.99
1	73	232	4.30-5.42	4.27	-5.39	0.56	-17.04	-264.39	-84.90	-196.53	110.37
1	73	233	-0.41-4.49	-4.49	-0.41	2.82e-02	753.18	-39.41	751.82	-38.05	-32.79
1	73	234	11.34-7.20	11.34	-7.20	-0.15	676.77	-406.99	-406.81	676.59	13.83
1	73	235	4.892.46	4.89	2.46	-2.51e-02	856.06	-20.27	-20.08	855.86	13.12
1	73	236	2.120.57	0.57	2.12	1.94e-02	815.04	72.62	72.79	814.86	11.43
1	73	237	1.581.28e-021.31e-02		1.58	2.04e-02	743.99	104.96	105.06	743.89	8.21
1	73	238	1.20-6.35e-02-6.33e-02		1.20	1.34e-02	671.43	111.02	111.06	671.39	4.67
1	73	239	1.03-7.29e-02-7.29e-02		1.03	4.79e-03	632.60	110.09	110.09	632.59	1.07
1	73	240	1.03-7.61e-02-7.60e-02		1.03	-3.11e-03	643.12	109.88	109.89	643.11	-2.56
1	73	241	1.21-7.15e-02-7.14e-02		1.21	-9.29e-03	699.10	108.14	108.20	699.03	-6.19
1	73	242	1.568.78e-038.88e-03		1.56	-1.28e-02	776.68	91.70	91.84	776.54	-9.70
1	73	243	1.960.61	0.61	1.96	-8.60e-03	830.84	31.97	32.17	830.64	-12.71
1	73	244	5.151.77	5.15	1.77	5.16e-02	818.72	-124.92	-124.72	818.52	-13.82
1	73	245	12.24-16.42	12.23	-16.42	0.18	457.86	-767.67	-767.54	457.73	-12.80
1	73	246	2.16-0.37	0.21	1.58	-1.07	723.72	309.03	348.35	684.41	-121.48
1	73	247	2.33-2.56	2.08	-2.30	-1.08	43.68	-289.17	-82.05	-163.45	161.37
1	73	248	2.99-4.90	-1.83	-7.81e-02	-3.85	589.22	-237.04	-99.38	451.56	307.89
1	73	249	2.49-0.22	-0.20	2.47	0.22	795.79	12.27	40.85	767.20	146.90
1	73	250	1.950.12	0.20	1.88	0.36	797.36	99.75	105.53	791.58	63.23
1	73	251	1.452.61e-035.03e-02		1.40	0.26	732.46	120.28	121.80	730.95	30.44
1	73	252	1.12-2.46e-02-6.78e-03		1.11	0.14	663.15	119.69	120.02	662.82	13.39
1	73	253	0.98-2.90e-02-2.65e-02		0.97	5.02e-02	625.59	116.38	116.39	625.57	2.48
1	73	254	0.98-3.46e-02-3.39e-02		0.98	-2.61e-02	635.70	117.01	117.11	635.60	-7.37
1	73	255	1.15-4.02e-02-3.10e-02		1.14	-0.10	689.54	119.80	120.53	688.81	-20.49
1	73	256	1.48-2.47e-02-2.67e-03		1.46	-0.18	762.89	113.90	116.76	760.03	-43.00
1	73	257	1.994.00e-025.13e-02		1.98	-0.15	810.14	74.56	85.06	799.65	-87.24
1	73	258	2.82-0.90	-0.77	2.69	0.68	758.15	-58.20	-8.28	708.22	-195.62
1	73	259	5.60-5.77	-4.61	4.44	3.44	438.89	-334.66	-115.30	219.53	-348.66
1	73	260	4.33-5.32	4.32	-5.31	-0.22	19.86	-286.82	-74.22	-192.74	-141.43
1	73	261	0.27-3.84	-3.02	-0.56	1.65	380.56	-107.80	280.40	-7.63	197.19
1	73	262	3.33-2.26	-2.13	3.20	0.84	569.77	134.52	260.40	443.90	197.34
1	73	263	1.50-0.51	-0.50	1.49	0.14	731.96	163.30	198.06	697.20	136.24
1	73	264	1.314.54e-03	0.14	1.17	0.40	755.94	170.01	178.34	747.61	69.38
1	73	265	1.087.24e-02	0.17	0.98	0.30	709.27	153.95	156.04	707.19	33.96
1	73	266	0.917.49e-02	0.11	0.88	0.16	649.35	137.17	137.59	648.93	14.63
1	73	267	0.845.97e-026.42e-02		0.83	5.89e-02	615.26	128.34	128.36	615.25	2.64
1	73	268	0.855.03e-025.15e-02		0.85	-3.06e-02	624.34	130.84	130.97	624.21	-7.99





EGP CODE

GRE.EEC.R.73.IT.W.15235.12.024.01

PAGE

445 di/of 527

1	73	269	0.964.79e-026.72e-02	0.94	-0.13	672.36	143.96	144.93	671.40	-22.54		
1	73	270	1.182.18e-028.59e-02	1.12	-0.26	733.45	162.95	166.96	729.45	-47.64		
1	73	271	1.60-0.14-1.92e-02	1.48	-0.44	760.63	177.96	192.99	745.61	-92.36		
1	73	272	2.59-0.85	-0.59	2.33	699.62	165.03	223.90	640.75	-167.34		
1	73	273	2.03-0.79	-0.79	2.02	9.74e-02	498.20	109.63	296.37	311.46	-194.14	
1	73	274	1.50-5.61	-5.03	0.92	-1.96	374.35	-108.52	272.10	-6.27	-197.28	
1	73	275	0.51-2.22	-1.99	0.28	0.77	547.03	41.83	532.21	56.65	85.25	
1	73	276	1.14-1.73	-1.69	1.10	0.32	507.13	350.97	421.44	436.66	77.70	
1	73	277	0.83-0.55	-0.54	0.82	0.12	659.90	304.99	314.61	650.28	57.65	
1	73	278	0.640.16	0.19	0.61	0.13	717.26	233.85	235.95	715.16	31.80	
1	73	279	0.690.24	0.27	0.66	0.10	689.41	183.56	184.05	688.93	15.62	
1	73	280	0.710.19	0.19	0.70	5.98e-02	638.49	152.08	152.17	638.39	6.71	
1	73	281	0.730.13	0.13	0.73	2.44e-02	607.61	138.33	138.33	607.61	1.23	
1	73	282	0.750.12	0.12	0.75	-5.75e-03	615.78	142.39	142.42	615.75	-3.58	
1	73	283	0.780.15	0.15	0.77	-4.44e-02	658.48	164.46	164.67	658.27	-10.17	
1	73	284	0.800.19	0.21	0.78	-0.11	707.84	205.01	205.92	706.93	-21.42	
1	73	285	0.810.12	0.19	0.73	-0.21	713.68	265.24	268.93	710.00	-40.49	
1	73	286	0.76-0.41	-0.37	0.71	-0.23	615.60	341.05	358.50	598.15	-66.98	
1	73	287	0.99-1.64	-1.60	0.95	-0.33	507.33	292.18	470.40	329.10	-81.12	
1	73	288	0.41-2.34	-2.08	0.15	-0.80	551.72	46.53	536.33	61.92	-86.83	
1	73	289	0.37-2.16	-2.04	0.25	-0.54	558.40	48.16	547.03	59.53	-75.32	
1	73	290	1.03-1.62	-1.62	1.02	-0.13	503.64	368.40	433.21	438.83	-67.57	
1	73	291	0.82-0.47	-0.46	0.81	-0.12	657.59	316.20	323.47	650.32	-49.26	
1	73	292	0.730.12	0.20	0.65	-0.21	715.84	240.18	241.69	714.32	-26.82	
1	73	293	0.760.20	0.25	0.71	-0.17	688.72	187.06	187.41	688.37	-13.18	
1	73	294	0.750.16	0.18	0.74	-9.38e-02	638.22	154.25	154.31	638.16	-5.67	
1	73	295	0.760.11	0.11	0.76	-2.57e-02	607.52	140.02	140.02	607.52	-0.97	
1	73	296	0.780.10	0.10	0.78	3.39e-02	615.66	144.15	144.17	615.64	3.21	
1	73	297	0.820.13	0.14	0.80	9.80e-02	658.10	166.90	167.06	657.93	8.89	
1	73	298	0.860.16	0.21	0.81	0.18	706.83	209.21	209.89	706.15	18.38	
1	73	299	0.879.73e-02	0.21	0.76	0.28	711.64	273.09	275.78	708.96	34.20	
1	73	300	0.73-0.34	-0.29	0.68	0.21	612.03	355.36	368.68	598.71	56.94	
1	73	301	0.85-1.56	-1.55	0.84	0.14	511.05	304.11	483.27	331.89	70.55	
1	73	302	0.29-2.25	-2.10	0.14	0.59	563.28	53.61	551.52	65.37	76.52	
1	73	303	-3.92e-02	-3.79	-3.14	-0.68	-1.41	420.97	-87.96	330.34	2.66	-194.70
1	73	304	2.82-1.90	-1.83	2.75	-0.58	577.63	168.17	294.70	451.10	-189.21	
1	73	305	1.67-0.36	-0.30	1.60	-0.36	731.73	189.74	225.50	695.98	-134.54	
1	73	306	1.50-3.90e-02	0.13	1.34	-0.48	754.32	184.30	192.92	745.70	-69.56	
1	73	307	1.222.00e-02	0.13	1.11	-0.34	708.51	162.04	164.20	706.35	-34.29	
1	73	308	1.012.96e-026.47e-02	0.97	-0.18	649.19	142.50	142.93	648.76	-14.78		
1	73	309	0.912.15e-022.45e-02	0.91	-5.21e-02	615.34	132.69	132.71	615.32	-2.65		
1	73	310	0.931.28e-021.66e-02	0.92	5.87e-02	624.40	135.31	135.44	624.27	8.10		
1	73	311	1.056.50e-033.82e-02	1.02	0.18	672.08	149.78	150.78	671.08	22.85		
1	73	312	1.30-2.00e-026.95e-02	1.21	0.33	732.30	172.33	176.51	728.12	48.19		
1	73	313	1.73-0.16-4.93e-03	1.57	0.52	758.23	195.25	210.82	742.67	92.31		
1	73	314	2.70-0.74	-0.33	2.30	1.10	699.70	196.64	256.37	639.97	162.73	
1	73	315	1.61-0.77	-0.72	1.56	-0.34	517.28	137.71	332.80	322.19	189.71	
1	73	316	1.34-5.30	-4.86	0.89	1.66	417.36	-84.83	325.90	6.63	193.82	
1	73	317	2.25-2.95	2.16	-2.87	0.65	172.36	-243.22	20.60	-91.45	-200.09	
1	73	318	2.99-4.53	-2.02	0.48	3.55	603.59	-205.05	-45.43	443.97	-321.86	
1	73	319	2.952.02e-022.25e-02	2.95	8.27e-02	803.27	30.27	64.72	768.82	-159.51		
1	73	320	2.220.12	0.18	2.16	-0.36	800.31	108.86	116.36	792.81	-71.62	
1	73	321	1.63-5.25e-02-9.89e-03	1.59	-0.26	734.34	126.96	128.91	732.40	-34.30		
1	73	322	1.26-8.19e-02-6.80e-02	1.24	-0.14	664.55	125.81	126.22	664.14	-14.88		
1	73	323	1.09-8.18e-02-8.09e-02	1.08	-3.24e-02	626.78	122.38	122.40	626.76	-2.80		
1	73	324	1.09-8.54e-02-8.28e-02	1.09	5.53e-02	637.00	122.91	123.04	636.88	7.95		
1	73	325	1.27-9.03e-02-7.42e-02	1.26	0.15	691.21	125.66	126.56	690.31	22.60		
1	73	326	1.64-6.19e-02-2.77e-02	1.60	0.24	765.13	120.33	123.97	761.49	48.32		
1	73	327	2.197.36e-029.25e-02	2.17	0.20	813.60	83.82	97.39	800.04	98.56		
1	73	328	3.35-0.90	-0.61	3.06	-1.07	765.07	-36.58	23.44	705.05	210.98	
1	73	329	5.65-5.28	-4.53	4.89	-2.77	470.02	-280.97	-39.06	228.11	350.93	
1	73	330	3.99-5.93	3.93	-5.87	0.73	151.00	-247.59	24.54	-121.13	185.51	
1	73	331	2.44-3.71	-1.17	-9.93e-02	-3.03	262.93	-159.52	164.62	-61.20	-178.51	
1	73	332	12.39-7.16	12.38	-7.14	-0.61	699.65	-422.26	-420.81	698.20	-40.25	
1	73	333	5.112.59	4.82	2.88	-0.81	871.74	-29.34	-29.15	871.55	-13.12	
1	73	334	2.290.55	0.55	2.28	5.89e-02	824.28	71.81	71.91	824.19	-8.51	
1	73	335	1.71-3.93e-02-3.30e-02	1.70	0.10	749.56	108.11	108.16	749.51	-5.40		
1	73	336	1.30-0.11	-0.11	1.30	7.25e-02	674.72	116.12	116.14	674.71	-3.03	
1	73	337	1.12-0.12	-0.11	1.11	3.93e-02	634.94	115.89	115.89	634.94	-0.83	
1	73	338	1.12-0.11	-0.11	1.12	8.75e-03	645.74	115.50	115.50	645.74	1.31	
1	73	339	1.32-0.11	-0.11	1.32	-1.96e-02	703.23	112.62	112.64	703.21	3.44	
1	73	340	1.70-2.01e-02-1.95e-02	1.70	-3.21e-02	783.64	93.55	93.60	783.59	5.66		
1	73	341	2.170.63	0.63	2.17	8.94e-02	841.89	28.90	28.99	841.80	8.59	
1	73	342	5.661.82	5.11	2.37	1.35	837.87	-137.47	-137.13	837.52	18.36	
1	73	343	13.74-17.08	13.69	-17.03	1.23	485.55	-797.07	-795.62	484.10	43.20	
1	73	344	12.79-4.41	5.49	2.89	8.50	-150.01	-860.89	-860.83	-150.08	6.89	





EGP CODE

GRE.EEC.R.73.IT.W.15235.12.024.01

PAGE

446 di/of 527

1	73	345	12.073.89	7.01	8.95	-3.97	-25.46	-983.58	-982.11	-26.92	-37.45	
1	73	346	2.09-2.85	0.95	-1.71	2.08	31.95	-133.92	-18.40	-83.57	76.26	
1	73	347	-1.10-1.51	-1.49	-1.12	-7.34e-02	364.45	-58.60	362.59	-56.75	27.97	
1	73	348	2.96-0.72	0.85	1.39	-1.82	307.18	-47.91	299.31	-40.03	-52.29	
1	73	349	7.10-9.23	4.25	-6.37	6.20	-220.77	-317.58	-279.12	-259.23	47.37	
1	73	350	8.87-0.70	0.54	7.62	3.22	-1.58	-345.22	-330.32	-16.48	-69.98	
1	73	351	12.96-4.64	8.93	-0.62	-7.40	-171.39	-650.19	-649.89	-171.69	12.00	
1	73	352	3.58-2.51	0.73	0.34	3.04	363.15	-140.58	273.28	-50.71	192.86	
1	73	353	-0.77-3.59	-3.57	-0.78	0.18	707.58	-58.43	688.95	-39.80	118.00	
1	73	354	-0.35-4.66	-4.66	-0.35	1.03e-02	880.53	-36.64	877.17	-33.29	55.39	
1	73	355	-0.35-5.05	-5.04	-0.35	7.47e-02	923.78	-33.95	923.69	-33.87	-9.13	
1	73	356	-0.95-5.10	-5.10	-0.95	7.90e-02	830.48	-49.28	824.26	-43.07	-73.70	
1	73	357	3.42-2.65	2.76	-1.99	-1.89	-151.15	-378.96	-261.76	-268.35	113.85	
1	73	358	3.05-5.51	-1.74	-0.72	-4.25	596.62	-304.33	-196.46	488.75	292.49	
1	73	359	2.14-0.58	-0.47	2.03	0.54	807.33	-20.78	-1.89	788.44	123.62	
1	73	360	1.933.59e-02	0.12	1.84	0.39	812.58	87.91	90.31	810.19	41.58	
1	73	361	1.47-5.18e-02-1.76e-03		1.42	0.27	744.74	117.35	117.75	744.34	15.76	
1	73	362	1.15-7.30e-02-5.11e-02		1.13	0.16	673.05	120.50	120.55	673.00	5.26	
1	73	363	1.00-6.69e-02-6.20e-02		1.00	7.25e-02	634.43	118.47	118.47	634.43	0.54	
1	73	364	1.01-6.44e-02-6.44e-02		1.01	-6.93e-03	644.89	118.80	118.82	644.87	-3.17	
1	73	365	1.19-6.95e-02-6.32e-02		1.18	-8.88e-02	700.40	119.61	119.78	700.24	-9.87	
1	73	366	1.54-6.23e-02-4.53e-02		1.52	-0.16	776.52	108.94	109.90	775.56	-25.35	
1	73	367	2.05-4.75e-02-3.62e-02		2.04	-0.15	826.48	58.78	63.83	821.43	-62.04	
1	73	368	2.32-0.97	-0.95	2.30	0.25	770.42	-101.87	-67.15	735.70	-170.53	
1	73	369	6.09-6.62	-4.74	4.21	4.51	418.54	-435.35	-245.95	229.14	-354.76	
1	73	370	5.42-4.87	5.39	-4.84	0.54	-189.30	-366.90	-252.09	-304.11	-84.91	
1	73	371	0.95-3.98	-2.60	-0.43	2.21	324.54	-146.44	200.50	-22.40	207.45	
1	73	372	4.29-2.85	-2.63	4.08	1.22	571.97	78.50	203.17	447.29	214.43	
1	73	373	1.51-0.89	-0.88	1.50	-0.20	749.50	123.70	155.15	718.05	136.71	
1	73	374	1.19-4.97e-023.85e-02		1.11	0.32	774.91	151.69	158.16	768.44	63.14	
1	73	375	1.034.25e-03	0.10	0.93	0.30	726.09	146.40	147.66	724.83	26.99	
1	73	376	0.871.89e-026.26e-02		0.83	0.19	664.45	134.72	134.90	664.27	9.89	
1	73	377	0.802.85e-023.72e-02		0.79	8.13e-02	629.63	127.77	127.78	629.63	1.35	
1	73	378	0.813.43e-023.49e-02		0.81	-2.07e-02	639.09	129.76	129.82	639.03	-5.51	
1	73	379	0.932.66e-024.83e-02		0.91	-0.14	688.52	139.86	140.36	688.02	-16.70	
1	73	380	1.17-2.05e-024.85e-02		1.10	-0.28	751.72	152.18	154.85	749.04	-39.97	
1	73	381	1.61-0.19-9.43e-02		1.51	-0.41	780.81	153.86	166.11	768.55	-86.78	
1	73	382	2.72-1.12	-0.99	2.60	-0.67	715.93	115.79	171.14	660.58	-173.65	
1	73	383	3.01-0.83	-0.82	3.00	-0.17	480.77	60.12	236.05	304.85	-207.49	
1	73	384	2.10-6.16	-5.16	1.10	-2.69	313.49	-154.04	184.85	-25.40	-208.79	
1	73	385	0.90-2.23	-1.61	0.28	1.25	532.04	31.89	508.50	55.42	105.91	
1	73	386	1.32-1.85	-1.74	1.21	0.58	519.85	321.27	400.06	441.06	97.15	
1	73	387	0.86-0.78	-0.78	0.85	8.68e-02	674.29	284.06	296.88	661.46	69.58	
1	73	388	0.55-1.21e-02-2.85e-03		0.54	7.14e-02	732.83	220.89	223.23	730.48	34.55	
1	73	389	0.580.13	0.16	0.55	0.10	706.08	175.58	175.95	705.71	14.03	
1	73	390	0.610.13	0.14	0.60	7.66e-02	655.40	147.21	147.25	655.36	4.67	
1	73	391	0.630.11	0.11	0.63	4.41e-02	624.55	134.84	134.84	624.55	0.47	
1	73	392	0.650.12	0.12	0.65	8.69e-03	633.07	138.42	138.43	633.05	-2.68	
1	73	393	0.660.15	0.16	0.65	-4.84e-02	676.32	158.07	158.21	676.19	-8.25	
1	73	394	0.700.15	0.19	0.66	-0.14	725.60	194.35	195.15	724.80	-20.57	
1	73	395	0.77-2.27e-027.20e-02		0.67	-0.26	729.66	248.34	252.64	725.36	-45.28	
1	73	396	0.86-0.63	-0.56	0.79	-0.31	629.61	314.19	337.37	606.42	-82.32	
1	73	397	1.30-1.71	-1.58	1.17	-0.61	506.07	270.13	446.59	329.62	-102.45	
1	73	398	0.77-2.35	-1.78	0.19	-1.21	535.16	33.78	510.11	58.83	-109.22	
1	73	399	6.64e-02	-1.68	-1.68	6.43e-02	5.93e-02	562.46	60.73	555.38	67.81	-59.16
1	73	400	0.58-1.26	-1.26	0.57	-3.83e-02	489.02	387.78	434.77	442.04	-50.49	
1	73	401	0.61-0.63	-0.61	0.59	-0.15	656.61	314.65	319.04	652.21	-38.53	
1	73	402	0.54-0.11-3.67e-02		0.47	-0.20	723.86	230.98	232.19	722.65	-24.32	
1	73	403	0.586.82e-02	0.14	0.51	-0.18	702.91	176.87	177.21	702.57	-13.36	
1	73	404	0.619.81e-02	0.12	0.59	-0.10	654.79	145.69	145.76	654.71	-6.25	
1	73	405	0.648.61e-028.65e-02		0.64	-1.48e-02	624.76	132.66	132.67	624.76	-1.41	
1	73	406	0.669.31e-02	0.10	0.65	7.10e-02	633.15	136.43	136.45	633.13	2.95	
1	73	407	0.670.13	0.17	0.62	0.14	675.25	157.30	157.44	675.10	8.58	
1	73	408	0.620.16	0.25	0.54	0.18	721.42	197.47	198.04	720.85	17.30	
1	73	409	0.498.31e-02	0.14	0.43	0.14	718.47	262.48	264.47	716.48	30.09	
1	73	410	0.44-0.44	-0.43	0.44	7.35e-02	605.42	355.72	363.73	597.41	43.99	
1	73	411	0.37-1.31	-1.31	0.37	4.27e-02	500.26	315.47	484.44	331.29	51.71	
1	73	412	-1.05e-02	-1.80	-1.80	-1.15e-02	4.21e-02	563.59	66.45	557.04	73.01	56.70
1	73	413	0.71-1.98	-1.46	0.18	-1.06	478.64	-66.41	375.06	37.17	-213.84	
1	73	414	1.36-1.62	-1.42	1.16	-0.75	570.68	158.55	289.35	439.88	-191.83	
1	73	415	1.05-0.71	-0.57	0.91	-0.47	716.81	177.97	214.27	680.51	-135.07	
1	73	416	1.01-0.26	2.82e-02	0.72	-0.53	758.90	162.01	170.75	750.16	-71.68	
1	73	417	1.05-0.18	4.17e-02	0.82	-0.48	720.97	143.04	144.97	719.04	-33.35	
1	73	418	0.93-0.10-2.53e-02		0.85	-0.28	664.10	127.56	127.90	663.76	-13.54	
1	73	419	0.87-6.29e-02-5.79e-02		0.86	-6.82e-02	630.85	119.99	120.00	630.84	-2.54	
1	73	420	0.90-5.71e-02-3.88e-02		0.88	0.13	640.05	122.34	122.42	639.96	6.68	



EGP CODE

GRE.EEC.R.73.IT.W.15235.12.024.01

PAGE

447 di/of 527

1	73	421	1.02-7.94e-023.98e-02	0.90	0.34	687.26	134.19	134.93	686.52	20.28	
1	73	422	1.17-0.13	0.17	0.86	0.55	744.71	152.68	156.24	741.15	45.80
1	73	423	1.12-0.18	0.23	0.71	0.61	761.76	172.22	187.25	746.73	92.91
1	73	424	0.89-0.55	-0.39	0.73	0.46	676.81	181.51	240.96	617.35	160.98
1	73	425	1.47-1.65	-1.49	1.31	0.70	520.55	120.87	326.09	315.33	199.77
1	73	426	0.79-2.41	-1.75	0.12	1.30	476.49	-64.19	375.04	37.27	211.09
1	73	427	0.12-3.00	-1.75	-1.13	-1.53	159.47	-351.62	-104.23	-87.92	-255.42
1	73	428	5.43-2.69	-2.15	4.88	-2.04	591.94	-176.51	-36.64	452.06	-296.52
1	73	429	1.35-0.41	-0.40	1.33	-0.19	789.94	-34.09	-5.87	761.72	-149.86
1	73	430	2.20-0.52-3.32e-02		1.71	-1.04	806.55	65.57	71.35	800.77	-65.18
1	73	431	1.76-0.45	-0.23	1.54	-0.66	744.71	96.85	97.95	743.61	-26.61
1	73	432	1.38-0.34	-0.28	1.32	-0.33	675.42	103.39	103.55	675.27	-9.43
1	73	433	1.21-0.28	-0.28	1.21	-8.60e-02	637.47	103.49	103.50	637.47	-1.47
1	73	434	1.25-0.28	-0.26	1.24	0.14	647.84	103.76	103.80	647.80	4.67
1	73	435	1.50-0.32	-0.23	1.41	0.40	702.38	102.70	103.09	701.98	15.45
1	73	436	1.97-0.41	-0.13	1.69	0.77	775.50	90.33	92.61	773.22	39.46
1	73	437	2.55-0.49	0.15	1.92	1.23	818.99	43.66	54.62	808.03	91.53
1	73	438	1.90-0.60	-0.53	1.82	0.43	753.62	-88.54	-35.67	700.75	204.29
1	73	439	4.32-0.58	-0.44	4.19	0.80	433.89	-201.43	-19.99	252.46	286.97
1	73	440	0.87-6.26	-5.03	-0.36	2.70	136.99	-368.64	-131.89	-99.77	252.30
1	73	441	8.71-5.09	3.64	-1.27e-02	6.66	-670.41	-998.41	-991.77	-677.05	-46.19
1	73	442	3.44-4.52	3.15	-4.23	1.49	690.71	-544.35	-503.79	650.15	-220.11
1	73	443	5.21-2.87	-0.47	2.81	-3.69	832.74	-141.45	-136.63	827.92	-68.31
1	73	444	3.51-1.17	-0.95	3.29	-0.98	830.12	11.56	11.56	830.11	-1.79
1	73	445	2.34-0.67	-0.62	2.29	-0.39	754.52	69.82	69.89	754.45	7.00
1	73	446	1.70-0.51	-0.50	1.69	-0.16	677.11	88.44	88.50	677.05	5.99
1	73	447	1.45-0.44	-0.44	1.44	-4.23e-02	636.00	92.74	92.74	635.99	1.69
1	73	448	1.49-0.44	-0.43	1.49	4.70e-02	647.18	91.73	91.74	647.16	-3.18
1	73	449	1.84-0.49	-0.47	1.83	0.18	706.73	83.22	83.28	706.67	-6.42
1	73	450	2.62-0.65	-0.58	2.56	0.46	790.34	52.89	52.92	790.31	-4.61
1	73	451	3.99-1.23	-0.95	3.70	1.19	850.01	-33.94	-33.80	849.86	11.20
1	73	452	5.99-3.37	0.16	2.46	4.54	797.84	-257.94	-247.95	787.85	102.21
1	73	453	4.14-7.01	0.11	-2.97	-5.36	489.85	-815.30	-697.04	371.59	374.65
1	73	454	9.41-2.18	7.35	-0.11	-4.43	-757.25	-965.04	-964.80	-757.49	-7.03
1	73	455	22.984.97	22.89	5.07	-1.32	763.70	-279.68	-274.71	758.73	71.85
1	73	456	10.37-0.18-2.44e-02		10.21	-1.29	913.99	-121.68	-120.54	912.84	34.44
1	73	457	3.69-0.14	-0.13	3.69	-0.13	833.17	21.03	22.54	831.66	35.03
1	73	458	2.33-0.58	-0.58	2.33	-6.76e-02	751.91	70.24	71.07	751.07	23.84
1	73	459	1.71-0.53	-0.53	1.71	-3.68e-02	673.31	87.60	87.90	673.01	13.23
1	73	460	1.45-0.47	-0.47	1.45	-1.49e-02	631.76	91.72	91.74	631.74	3.10
1	73	461	1.50-0.46	-0.46	1.50	2.57e-03	643.07	90.65	90.74	642.99	-6.87
1	73	462	1.85-0.51	-0.51	1.85	2.58e-02	703.36	82.15	82.62	702.89	-17.07
1	73	463	2.60-0.52	-0.52	2.60	5.45e-02	788.54	53.01	54.06	787.49	-27.77
1	73	464	4.229.45e-029.67e-02		4.22	9.40e-02	855.02	-22.32	-20.56	853.25	-39.29
1	73	465	12.84-0.48	-0.34	12.69	1.38	906.86	-220.86	-219.70	905.69	-36.16
1	73	466	32.90-8.78	32.89	-8.77	0.61	595.69	-708.81	-700.99	587.87	-100.71
1	73	467	6.64-2.41	4.85	-0.61	-3.61	-391.50	-760.15	-677.30	-474.36	153.88
1	73	468	4.84-3.79	3.67	-2.61	-2.96	710.75	-522.49	-401.41	589.67	366.96
1	73	469	6.12-2.50	-0.68	4.30	3.52	848.95	-135.38	-102.93	816.49	175.77
1	73	470	3.70-1.09	-0.95	3.56	0.80	823.14	16.97	25.72	814.39	83.55
1	73	471	2.39-0.69	-0.65	2.35	0.34	743.30	73.33	76.72	739.92	47.49
1	73	472	1.69-0.53	-0.52	1.68	0.15	664.73	91.82	92.80	663.75	23.73
1	73	473	1.41-0.45	-0.45	1.41	3.11e-02	623.37	96.13	96.18	623.32	5.16
1	73	474	1.46-0.45	-0.44	1.45	-7.51e-02	634.62	95.01	95.29	634.34	-12.31
1	73	475	1.84-0.52	-0.50	1.82	-0.20	694.68	86.25	87.99	692.94	-32.49
1	73	476	2.68-0.68	-0.63	2.63	-0.42	780.14	55.85	60.87	775.12	-60.08
1	73	477	4.18-1.13	-0.96	4.02	-0.93	845.64	-28.72	-16.10	833.02	-104.31
1	73	478	6.47-2.39-1.27e-02		4.09	-3.92	823.54	-250.67	-202.11	774.97	-223.18
1	73	479	5.43-5.09	7.41e-03	0.34	5.26	523.43	-757.36	-535.78	301.86	-484.46
1	73	480	10.32-3.44	10.18	-3.30	1.36	-467.34	-715.91	-644.18	-539.07	-112.63
1	73	481	-1.76-2.54	-2.52	-1.77	0.10	316.89	-414.37	-31.50	-65.98	365.22
1	73	482	5.09-1.78	-0.97	4.28	2.21	670.80	-181.44	39.00	450.36	373.19
1	73	483	2.15-0.41	3.29e-02	1.71	0.96	801.52	-25.56	49.38	726.58	237.42
1	73	484	2.55-0.74	-0.11	1.92	1.29	784.57	74.90	101.72	757.75	135.31
1	73	485	1.83-0.57	-0.29	1.55	0.78	711.43	106.72	116.27	701.88	75.40
1	73	486	1.32-0.39	-0.29	1.22	0.39	638.75	113.18	115.71	636.22	36.39
1	73	487	1.07-0.27	-0.27	1.06	9.47e-02	600.21	112.97	113.09	600.09	7.65
1	73	488	1.12-0.28	-0.25	1.09	-0.18	610.72	113.09	113.81	610.00	-18.90
1	73	489	1.45-0.40	-0.25	1.30	-0.50	666.57	111.92	116.62	661.87	-50.85
1	73	490	2.07-0.59	-0.21	1.69	-0.93	745.17	98.85	113.76	730.26	-97.01
1	73	491	2.95-0.78	3.90e-02	2.14	-1.54	804.75	50.77	91.07	764.45	-169.60
1	73	492	3.07-0.71	5.97e-02	2.30	-1.52	784.34	-80.92	33.86	669.56	-293.50
1	73	493	2.580.64	0.72	2.50	-0.38	549.77	-220.74	52.37	276.67	-368.57
1	73	494	-0.75-5.73	-5.54	-0.93	-0.94	296.66	-433.60	-56.30	-80.65	-364.93
1	73	495	0.16-2.30	-2.06	-7.99e-02	0.73	600.69	-143.64	419.76	37.28	319.27
1	73	496	0.86-1.44	-1.17	0.59	0.74	659.66	95.56	336.39	418.83	279.02



EGP CODE

GRE.EEC.R.73.IT.W.15235.12.024.01

PAGE

448 di/of 527

1	73	497	1.05-0.78	-0.23	0.50	0.84	727.13	165.36	260.43	632.07	210.63		
1	73	498	1.21-0.59	0.13	0.49	0.88	721.36	175.01	208.86	687.51	131.72		
1	73	499	1.08-0.43	6.57e-02	0.59	0.71	665.89	161.76	172.96	654.69	74.33		
1	73	500	0.79-0.19	1.90e-02	0.58	0.41	605.48	145.19	147.99	602.69	35.76		
1	73	501	0.57-5.63e-031.43e-02		0.55	0.11	572.46	136.08	136.20	572.33	7.46		
1	73	502	0.62-2.69e-023.49e-02		0.56	-0.19	581.59	138.57	139.35	580.82	-18.55		
1	73	503	0.90-0.23	8.37e-02	0.59	-0.51	629.26	151.80	157.07	623.98	-49.91		
1	73	504	1.24-0.47	0.18	0.59	-0.83	693.57	169.66	187.31	675.92	-94.52		
1	73	505	1.40-0.66	0.30	0.43	-1.03	736.38	178.53	228.74	686.17	-159.64		
1	73	506	0.88-0.74-9.42e-02		0.23	-0.79	713.92	151.81	288.41	577.33	-241.09		
1	73	507	0.78-1.58	-1.49	0.69	-0.45	631.05	43.56	371.67	302.94	-291.73		
1	73	508	0.17-2.57	-2.25	-0.15	-0.87	599.50	-143.50	419.67	36.33	-318.23		
1	73	509	-0.22-2.48	-2.47	-0.23	0.17	669.95	16.14	622.12	63.97	170.25		
1	73	510	-0.12-1.33	-1.26	-0.19	0.28	610.72	303.97	504.69	409.99	145.88		
1	73	511	0.13-0.70	-0.40	-0.17	0.40	639.12	334.94	387.37	586.69	114.89		
1	73	512	0.48-0.51	8.39e-02	-0.12	0.48	655.13	273.48	289.45	639.16	76.41		
1	73	513	0.56-0.33	0.24	-3.75e-03	0.43	623.08	214.06	218.89	618.25	44.18		
1	73	514	0.46-0.12	0.25	8.62e-02	0.27	577.44	173.58	174.70	576.31	21.28		
1	73	515	0.299.08e-02	0.26	0.13	7.71e-02	550.63	155.37	155.42	550.58	4.42		
1	73	516	0.355.09e-02	0.28	0.12	-0.12	558.26	160.20	160.51	557.96	-11.05		
1	73	517	0.54-0.16	0.33	5.28e-02	-0.32	596.63	187.89	190.06	594.45	-29.72		
1	73	518	0.66-0.38	0.35	-8.29e-02	-0.47	643.14	237.00	244.82	635.32	-55.82		
1	73	519	0.52-0.58	0.21	-0.26	-0.50	661.06	301.45	326.20	636.31	-91.04		
1	73	520	-2.01e-02	-0.73	-0.40	-0.35	-0.36	627.11	348.06	433.43	541.73	-128.59	
1	73	521	-0.26-1.67	-1.63	-0.29	-0.21	625.60	235.12	552.82	307.90	-152.06		
1	73	522	-0.24-2.55	-2.53	-0.26	-0.18	670.75	20.29	623.39	67.64	-169.00		
1	73	523	-0.24-2.58	-2.57	-0.26	-0.18	681.24	68.70	681.23	68.72	2.59		
1	73	524	-0.26-1.42	-1.41	-0.28	-0.13	556.03	405.98	556.03	405.99	0.83		
1	73	525	-0.29-0.55	-0.55	-0.30	3.32e-02	571.71	428.15	428.16	571.69	-1.30		
1	73	526	7.41e-02	-0.34	2.69e-02	-0.30	0.13	622.17	316.79	316.81	622.15	-2.55	
1	73	527	0.33-0.26	0.29	-0.22	0.14	605.00	234.66	234.67	604.99	-2.50		
1	73	528	0.39-0.14	0.37	-0.12	9.05e-02	566.90	183.46	183.47	566.89	-1.60		
1	73	529	0.39-6.56e-02	0.39	-6.37e-02	2.95e-02	542.99	161.41	161.41	542.99	-0.38		
1	73	530	0.41-7.27e-02	0.40	-7.11e-02	-2.76e-02	549.89	167.29	167.29	549.89	0.85		
1	73	531	0.44-0.16	0.43	-0.15	-7.17e-02	583.75	201.33	201.34	583.74	1.84		
1	73	532	0.40-0.30	0.39	-0.29	-8.89e-02	620.61	264.96	264.97	620.60	2.32		
1	73	533	0.13-0.43	0.13	-0.43	-5.91e-02	619.45	359.19	359.20	619.44	1.99		
1	73	534	-0.46-0.56	-0.55	-0.47	2.24e-02	530.79	479.31	479.33	530.78	0.91		
1	73	535	-0.42-1.75	-1.74	-0.43	9.41e-02	607.79	308.48	607.79	308.48	-0.21		
1	73	536	-0.29-2.65	-2.65	-0.29	9.16e-02	683.20	73.29	683.20	73.29	-0.64		
1	73	537	0.11-2.52	-2.34	-7.00e-02	-0.66	667.00	16.79	622.24	61.54	-164.61		
1	73	538	0.27-1.74	-1.59	0.12	-0.53	607.41	301.59	504.49	404.51	-144.51		
1	73	539	6.88e-02	-0.77	-0.70	-2.75e-03	-0.23	637.44	329.27	385.10	581.61	-118.70	
1	73	540	9.88e-02	-0.23	6.04e-03	-0.13	-0.15	655.49	266.54	284.92	637.12	-82.52	
1	73	541	0.35-0.15	0.31	-0.11	-0.14	624.72	207.40	213.36	618.76	-49.53		
1	73	542	0.40-4.30e-02	0.38	-2.03e-02	-9.78e-02	579.47	167.76	169.22	578.02	-24.46		
1	73	543	0.383.63e-02	0.38	3.85e-02	-2.74e-02	552.65	150.18	150.24	552.59	-5.06		
1	73	544	0.403.49e-02	0.39	4.56e-02	6.12e-02	560.15	155.10	155.51	559.74	12.86		
1	73	545	0.46-5.89e-02	0.40	-2.22e-03	0.16	598.25	182.52	185.26	595.50	33.68		
1	73	546	0.48-0.21	0.36	-9.16e-02	0.26	644.18	231.48	240.74	634.92	61.11		
1	73	547	0.31-0.38	9.87e-02	-0.17	0.32	661.31	296.47	323.77	634.01	95.99		
1	73	548	5.97e-02	-0.81	-0.62	-0.13	0.36	627.13	344.43	433.08	538.48	131.16	
1	73	549	4.71e-02	-1.84	-1.73	-6.21e-02	0.44	625.86	233.96	553.88	305.94	151.74	
1	73	550	-5.75e-02	-2.51	-2.42	-0.15	0.47	671.39	20.15	624.82	66.72	167.80	
1	73	551	1.18-2.83	-1.96	0.31	-1.65	593.67	-142.61	419.85	31.22	-312.68		
1	73	552	1.47-2.35	-2.14	1.26	-0.86	650.41	88.56	334.27	404.71	-278.71		
1	73	553	0.79-0.93	-0.86	0.72	-0.33	722.67	149.83	251.74	620.76	-219.07		
1	73	554	0.60-0.17	0.11	0.32	-0.37	721.97	158.28	195.78	684.47	-140.47		
1	73	555	0.71-7.95e-02	0.29	0.34	-0.39	669.08	146.90	159.47	656.51	-80.03		
1	73	556	0.605.83e-02	0.28	0.38	-0.27	609.29	132.66	135.78	606.17	-38.45		
1	73	557	0.440.21	0.25	0.40	-8.46e-02	576.18	124.91	125.04	576.05	-7.74		
1	73	558	0.480.19	0.24	0.43	0.11	585.11	127.40	128.32	584.19	20.45		
1	73	559	0.701.83e-02	0.26	0.46	0.33	632.37	139.54	145.57	626.33	54.19		
1	73	560	0.92-0.16	0.26	0.50	0.53	695.51	156.19	175.98	675.72	101.39		
1	73	561	1.02-0.36	0.13	0.54	0.66	735.99	165.59	220.21	681.37	167.85		
1	73	562	0.92-0.85	-0.63	0.70	0.58	711.91	142.33	284.98	569.26	246.79		
1	73	563	1.52-2.10	-1.94	1.36	0.74	629.31	41.76	372.90	298.17	291.39		
1	73	564	1.00-2.90	-2.10	0.20	1.57	600.26	-144.62	421.99	33.65	317.82		
1	73	565	-0.16-4.69	-3.21	-1.63	-2.12	311.44	-426.27	-36.64	-78.19	-368.27		
1	73	566	5.31-3.31	-3.04	5.04	-1.52	640.66	-190.61	30.99	419.07	-367.56		
1	73	567	1.78-0.83	-0.83	1.77	0.14	796.68	-63.54	21.90	711.24	-257.30		
1	73	568	1.63-6.60e-02	0.21	1.36	-0.62	787.12	42.19	71.84	757.47	-145.63		
1	73	569	1.40-7.79e-02	0.18	1.14	-0.56	716.35	81.36	91.39	706.32	-79.15		
1	73	570	1.11-2.77e-029.20e-02		0.99	-0.35	643.50	93.05	95.57	640.98	-37.12		
1	73	571	0.942.90e-024.45e-02		0.92	-0.12	604.51	95.20	95.30	604.41	-7.23		
1	73	572	0.971.60e-022.96e-02		0.96	0.11	614.87	94.88	95.66	614.09	20.13		



EGP CODE

GRE.EEC.R.73.IT.W.15235.12.024.01

PAGE

449 di/of 527

1	73	573	1.22-6.50e-024.04e-02	1.11	0.35	670.69	90.68	95.72	665.64	53.86
1	73	574	1.63-0.15 7.17e-02	1.41	0.59	748.58	72.58	89.01	732.15	104.10
1	73	575	2.21-0.26 9.80e-03	1.94	0.78	804.56	20.31	65.87	758.99	183.45
1	73	576	3.46-1.14 -0.91	3.22	1.02	780.47	-104.55	22.49	653.43	310.30
1	73	577	3.56-0.49 -0.48	3.55	-0.18	536.82	-215.08	51.63	270.12	359.73
1	73	578	1.42-7.63 -6.68	0.47	2.76	300.58	-443.10	-58.52	-84.00	371.62
1	73	579	6.29-4.09 5.87	-3.67	2.03	-263.20	-720.24	-606.45	-376.99	-197.63
1	73	580	4.21-6.61 -1.15	-1.24	5.41	628.48	-625.80	-472.77	475.45	-410.52
1	73	581	3.11-0.54 -0.25	2.83	-0.98	847.46	-224.10	-185.26	808.63	-200.26
1	73	582	2.750.14 0.31	2.58	-0.63	832.48	-36.42	-27.80	823.86	-86.10
1	73	583	2.08-7.43e-021.64e-02	1.99	-0.43	749.28	37.34	40.04	746.59	-43.73
1	73	584	1.61-0.14 -0.11	1.57	-0.25	668.33	65.14	65.81	667.66	-20.08
1	73	585	1.38-0.15 -0.14	1.38	-9.26e-02	625.79	73.13	73.15	625.77	-3.72
1	73	586	1.41-0.16 -0.16	1.41	5.15e-02	637.10	70.76	70.99	636.87	11.29
1	73	587	1.69-0.17 -0.14	1.67	0.19	698.31	55.66	57.09	696.88	30.25
1	73	588	2.22-0.11-6.58e-02	2.17	0.32	785.55	12.89	17.60	780.84	60.16
1	73	589	2.945.44e-029.74e-02	2.89	0.35	852.16	-91.84	-77.47	837.78	115.60
1	73	590	3.22-0.84 -0.84	3.22	-1.96e-02	814.61	-347.04	-285.00	752.57	261.19
1	73	591	7.36-7.36 -4.78	4.78	-5.60	422.70	-802.00	-556.19	176.89	490.53
1	73	592	9.60-7.95 9.60	-7.95	-0.23	-330.98	-694.45	-594.10	-431.33	162.49
1	73	593	17.40-9.58 17.36	-9.55	0.98	740.37	-742.81	-741.86	739.42	37.52
1	73	594	7.443.71 6.99	4.15	1.21	922.40	-211.31	-211.27	922.36	6.38
1	73	595	3.260.89 0.89	3.26	-3.33e-02	846.63	-50.37	-50.37	846.63	1.65
1	73	596	2.43-3.63e-02-3.18e-02	2.42	-0.11	759.06	26.44	26.44	759.06	0.11
1	73	597	1.85-0.20 -0.19	1.85	-7.02e-02	676.01	58.29	58.29	676.01	-7.22e-02
1	73	598	1.59-0.22 -0.22	1.58	-3.61e-02	632.61	67.90	67.90	632.61	0.15
1	73	599	1.60-0.23 -0.23	1.60	-8.43e-03	644.19	64.74	64.74	644.19	0.49
1	73	600	1.90-0.21 -0.21	1.90	1.49e-02	706.85	46.02	46.02	706.85	0.79
1	73	601	2.46-3.13e-02-3.12e-02	2.46	1.85e-02	796.74	-4.46	-4.46	796.74	0.79
1	73	602	3.170.98 1.00	3.16	-0.16	868.05	-120.42	-120.42	868.05	-0.63
1	73	603	8.242.74 7.43	3.55	-1.94	890.11	-364.60	-364.48	889.98	-12.64
1	73	604	19.23-22.23 19.15	-22.15	-1.77	498.43	-1222.84	-1221.80	497.40	-42.16
1	73	605	-0.48-4.82 -3.27	-2.03	-2.08	499.16	-110.95	467.74	-79.53	-134.84
1	73	606	19.01-10.19 13.24	-4.42	11.63	-274.10	-1112.79	-1108.36	-278.53	60.83
1	73	607	3.61-0.24-7.80e-02	3.45	-0.78	342.50	-327.13	201.63	-186.26	272.92
1	73	608	1.44-0.73 -0.69	1.40	0.30	271.67	-259.40	168.59	-156.32	-210.05
1	73	609	15.961.87 10.59	7.24	-6.84	439.32	109.11	125.25	423.18	-71.20
1	73	610	3.68-3.03 -2.86	3.50	1.06	718.54	-67.77	-63.30	714.08	-59.10
1	73	611	3.63-0.49 -0.47	3.61	0.32	763.86	-21.83	-18.22	760.25	-53.13
1	73	612	2.99-0.12 -0.11	2.99	0.13	706.22	-9.73	-8.32	704.80	-31.79
1	73	613	2.50-7.83e-02-7.70e-02	2.50	5.62e-02	639.30	-4.11	-3.72	638.92	-15.73
1	73	614	2.27-7.42e-02-7.42e-02	2.27	1.21e-02	602.50	-1.80	-1.78	602.48	-3.48
1	73	615	2.32-7.46e-02-7.43e-02	2.32	-2.79e-02	612.30	-2.34	-2.12	612.20	7.80
1	73	616	2.65-7.95e-02-7.74e-02	2.64	-7.45e-02	664.61	-5.78	-5.14	663.95	21.13
1	73	617	3.22-0.13 -0.12	3.21	-0.15	734.19	-12.68	-10.65	732.16	38.89
1	73	618	3.87-0.51 -0.49	3.84	-0.36	771.09	-26.15	-21.42	766.36	61.26
1	73	619	5.20-5.24 5.20	-5.24	-0.12	106.14	-495.96	-230.80	-159.03	298.90
1	73	620	3.59-5.12 -1.72	0.19	-4.25	636.52	-486.20	-271.62	421.94	441.44
1	73	621	3.970.34 0.34	3.97	0.12	847.39	-146.85	-88.06	788.60	234.51
1	73	622	3.110.22 0.40	2.93	0.69	822.76	-0.72	15.91	806.12	115.85
1	73	623	2.28-8.62e-022.91e-02	2.16	0.51	741.17	57.06	62.51	735.72	60.79
1	73	624	1.72-0.14-9.59e-02	1.68	0.28	662.37	78.13	79.50	661.00	28.26
1	73	625	1.46-0.13 -0.13	1.46	7.58e-02	620.90	83.68	83.74	620.84	5.57
1	73	626	1.48-0.14 -0.13	1.47	-0.12	631.94	81.64	82.06	631.52	-15.20
1	73	627	1.77-0.17 -0.11	1.72	-0.31	691.61	69.78	72.54	688.85	-41.30
1	73	628	2.32-0.11-7.80e-03	2.21	-0.50	776.41	35.10	44.26	767.26	-81.88
1	73	629	3.090.19 0.28	3.00	-0.49	841.87	-50.80	-23.82	814.89	-152.84
1	73	630	4.45-0.75 -0.47	4.16	1.19	811.70	-251.07	-157.96	718.58	-300.49
1	73	631	6.56-5.72 -4.81	5.64	3.22	478.48	-585.82	-283.53	176.19	-479.94
1	73	632	7.71-9.68 7.54	-9.51	-1.71	64.79	-499.60	-228.19	-206.62	-281.99
1	73	633	-1.39-4.73 -4.14	-1.98	1.27	413.84	-293.68	164.17	-44.01	338.10
1	73	634	3.20-2.16 -2.05	3.08	0.77	650.12	-44.11	176.82	429.20	323.36
1	73	635	2.00-0.30-5.52e-02	1.75	0.71	782.35	44.36	136.24	690.47	243.65
1	73	636	2.03-0.14 0.34	1.55	0.90	768.00	103.38	135.68	735.70	142.91
1	73	637	1.64-8.99e-02 0.25	1.29	0.69	701.89	116.49	127.47	690.92	79.41
1	73	638	1.268.38e-03 0.15	1.11	0.40	633.23	114.83	117.58	630.48	37.66
1	73	639	1.048.62e-02 0.10	1.03	0.12	596.21	111.73	111.85	596.10	7.38
1	73	640	1.066.76e-029.10e-02	1.04	-0.15	606.00	112.44	113.29	605.15	-20.51
1	73	641	1.32-3.78e-02 0.12	1.16	-0.43	658.78	115.79	121.35	653.21	-54.69
1	73	642	1.75-0.16 0.17	1.42	-0.72	731.60	114.31	132.52	713.39	-104.45
1	73	643	2.33-0.32 0.14	1.88	-1.00	782.86	93.38	143.48	732.76	-178.98
1	73	644	3.51-0.90-8.48e-02	2.70	-1.71	766.86	23.63	157.18	633.31	-285.35
1	73	645	1.81-0.72 -0.48	1.58	0.73	579.87	-77.94	205.44	296.50	-255.74
1	73	646	0.63-6.77 -6.45	0.30	-1.52	411.11	-294.86	156.39	-40.14	-339.03
1	73	647	0.49-3.07 -2.71	0.13	1.09	629.99	-63.14	521.89	44.96	251.49
1	73	648	0.77-1.99 -1.91	0.70	0.44	639.27	192.81	419.69	412.39	223.20





EGP CODE

GRE.EEC.R.73.IT.W.15235.12.024.01

PAGE

450 di/of 527

1	73	649	0.57-0.55	-0.39	0.41	0.40	697.12	237.09	319.07	615.14	176.05	
1	73	650	0.92-0.21	0.39	0.32	0.56	701.49	214.69	242.85	673.33	113.64	
1	73	651	0.96-5.92e-02	0.45	0.45	0.51	656.05	180.61	189.74	646.92	65.24	
1	73	652	0.780.13	0.39	0.52	0.32	601.40	153.66	155.88	599.18	31.47	
1	73	653	0.590.30	0.34	0.55	9.74e-02	570.44	140.84	140.93	570.35	6.22	
1	73	654	0.620.27	0.33	0.56	-0.13	578.62	144.51	145.19	577.94	-17.13	
1	73	655	0.838.79e-02	0.36	0.56	-0.36	622.23	164.34	168.80	617.76	-45.01	
1	73	656	1.06-0.13	0.41	0.52	-0.59	678.80	197.08	211.96	663.91	-83.36	
1	73	657	1.15-0.37	0.37	0.41	-0.76	711.25	233.24	275.53	668.96	-135.75	
1	73	658	0.65-0.64	-0.28	0.30	-0.57	686.25	241.79	361.12	566.92	-196.97	
1	73	659	0.71-2.01	-1.97	0.67	-0.34	633.18	142.08	465.40	309.86	-232.91	
1	73	660	0.39-3.03	-2.69	5.15e-02	-1.02	637.52	-61.09	526.19	50.23	-255.70	
1	73	661	-7.63e-02	-2.87	-2.84	-0.11	0.29	675.31	52.07	661.00	66.38	93.34
1	73	662	2.71e-02	-1.67	-1.65	6.54e-03	0.19	577.34	370.31	537.37	410.28	81.71
1	73	663	-5.27e-02	-0.52	-0.48	-9.16e-02	0.13	607.58	389.19	411.63	585.14	66.30
1	73	664	0.34-0.18	0.27	-0.12	0.18	644.93	298.78	304.83	638.89	45.34	
1	73	665	0.58-4.58e-02	0.52	1.17e-02	0.18	621.79	225.79	227.63	619.95	26.92	
1	73	666	0.560.12	0.53	0.16	0.12	579.57	179.34	179.78	579.13	13.22	
1	73	667	0.490.24	0.49	0.24	3.59e-02	553.60	159.24	159.25	553.58	2.65	
1	73	668	0.490.23	0.48	0.25	-5.45e-02	560.53	164.97	165.10	560.40	-7.17	
1	73	669	0.570.12	0.51	0.17	-0.15	596.55	196.74	197.61	595.68	-18.62	
1	73	670	0.61-7.22e-02	0.52	1.31e-02	-0.22	637.94	255.02	258.01	634.95	-33.71	
1	73	671	0.41-0.28	0.31	-0.18	-0.25	644.79	338.06	347.54	635.32	-53.06	
1	73	672	-0.15-0.58	-0.46	-0.26	-0.19	586.70	419.98	463.44	543.24	-73.19	
1	73	673	-0.21-1.90	-1.88	-0.23	-0.16	614.44	288.85	590.25	313.05	-85.40	
1	73	674	-0.19-2.89	-2.88	-0.20	-0.20	679.88	57.99	665.11	72.76	-94.68	
1	73	675	-8.77e-02	-2.88	-2.85	-0.11	-0.27	673.52	57.12	664.04	66.59	-75.85
1	73	676	1.42e-02	-1.67	-1.65	-7.65e-03	-0.19	567.97	382.24	540.25	409.97	-66.18
1	73	677	-5.84e-02	-0.54	-0.49	-0.10	-0.14	599.17	399.06	414.25	583.98	-53.00
1	73	678	0.33-0.20	0.26	-0.13	-0.17	640.98	303.23	306.96	637.25	-35.29	
1	73	679	0.56-5.73e-02	0.51	-9.59e-03	-0.17	619.34	228.13	229.19	618.29	-20.28	
1	73	680	0.550.10	0.53	0.13	-0.11	577.83	180.66	180.90	577.60	-9.66	
1	73	681	0.500.21	0.49	0.21	-3.69e-02	552.14	160.16	160.17	552.13	-1.87	
1	73	682	0.490.21	0.49	0.22	3.66e-02	559.01	165.99	166.06	558.94	5.27	
1	73	683	0.550.11	0.51	0.14	0.11	594.61	198.36	198.84	594.12	13.88	
1	73	684	0.57-7.30e-02	0.51	-1.02e-02	0.19	635.07	257.95	259.73	633.30	25.81	
1	73	685	0.38-0.29	0.29	-0.20	0.23	639.79	343.80	349.81	633.77	41.77	
1	73	686	-0.16-0.59	-0.48	-0.27	0.19	574.26	434.14	466.15	542.24	58.83	
1	73	687	-0.22-1.91	-1.89	-0.24	0.17	609.29	296.66	593.16	312.79	69.17	
1	73	688	-0.19-2.90	-2.89	-0.21	0.21	677.84	63.13	668.10	72.87	76.75	
1	73	689	0.46-3.06	-2.71	0.11	-1.04	627.88	-48.17	533.29	46.42	-234.53	
1	73	690	0.74-1.98	-1.90	0.66	-0.46	628.97	212.85	430.09	411.72	-207.86	
1	73	691	0.54-0.59	-0.42	0.37	-0.40	685.95	253.64	328.14	611.45	-163.27	
1	73	692	0.85-0.24	0.35	0.27	-0.54	693.11	225.08	249.79	668.40	-104.65	
1	73	693	0.89-7.64e-02	0.43	0.38	-0.48	649.92	186.83	194.62	642.12	-59.58	
1	73	694	0.720.12	0.39	0.44	-0.30	596.70	157.48	159.34	594.84	-28.53	
1	73	695	0.520.30	0.35	0.47	-9.64e-02	566.37	143.67	143.74	566.29	-5.59	
1	73	696	0.540.28	0.34	0.48	0.11	574.41	147.57	148.14	573.85	15.55	
1	73	697	0.759.03e-02	0.37	0.47	0.33	617.11	168.89	172.67	613.32	41.00	
1	73	698	0.97-0.13	0.39	0.45	0.55	671.96	204.57	217.44	659.10	76.47	
1	73	699	1.06-0.39	0.32	0.35	0.72	701.84	245.52	283.08	664.27	125.42	
1	73	700	0.60-0.68	-0.34	0.26	0.57	674.14	260.32	370.65	563.80	182.99	
1	73	701	0.67-2.03	-1.98	0.62	0.36	625.13	160.35	476.07	309.41	216.94	
1	73	702	0.35-3.03	-2.71	3.69e-02	0.99	634.72	-45.81	537.47	51.44	238.16	
1	73	703	-1.16-4.61	-4.05	-1.71	-1.27	422.64	-266.26	193.34	-36.96	-324.63	
1	73	704	3.11-2.17	-2.05	2.99	-0.79	644.56	-17.03	199.26	428.26	-310.35	
1	73	705	1.89-0.37	-0.14	1.66	-0.68	771.38	66.37	154.60	683.15	-233.28	
1	73	706	1.88-0.17	0.28	1.42	-0.85	758.37	117.71	148.42	727.66	-136.86	
1	73	707	1.49-9.71e-02	0.24	1.16	-0.65	694.05	125.71	136.06	683.70	-76.00	
1	73	708	1.121.73e-02	0.16	0.98	-0.37	626.79	120.98	123.56	624.21	-36.02	
1	73	709	0.910.11	0.13	0.89	-0.11	590.45	116.58	116.68	590.34	-7.07	
1	73	710	0.929.30e-02	0.11	0.90	0.13	600.09	117.61	118.41	599.29	19.60	
1	73	711	1.17-2.18e-02	0.12	1.02	0.39	651.93	122.95	128.17	646.71	52.32	
1	73	712	1.59-0.17	0.14	1.28	0.67	723.21	125.26	142.47	705.99	100.00	
1	73	713	2.16-0.35	7.77e-02	1.74	0.94	772.79	110.07	157.87	724.98	171.46	
1	73	714	3.32-0.94	-0.19	2.57	1.63	755.90	47.81	176.75	626.95	273.27	
1	73	715	1.70-0.75	-0.58	1.53	-0.62	577.31	-51.98	228.68	296.66	312.80	
1	73	716	0.72-6.56	-6.23	0.39	1.50	419.50	-267.11	186.00	-33.60	325.27	
1	73	717	4.49-4.74	4.48	-4.72	0.37	124.33	-459.92	-186.84	-148.75	-291.50	
1	73	718	3.48-5.10	-1.86	0.24	4.16	633.99	-442.67	-230.33	421.65	-428.41	
1	73	719	3.740.26	0.26	3.74	-0.12	837.15	-117.83	-58.88	778.20	-229.82	
1	73	720	2.870.18	0.33	2.71	-0.63	813.11	17.84	34.88	796.08	-115.14	
1	73	721	2.07-8.53e-02	0.22	1.96	-0.47	733.25	69.23	74.91	727.58	-61.11	
1	73	722	1.54-0.11-7.13e-02		1.50	-0.26	655.76	86.57	88.02	654.32	-28.67	
1	73	723	1.29-9.48e-02-9.08e-02		1.28	-7.41e-02	614.92	90.56	90.62	614.86	-5.71	
1	73	724	1.30-0.11-9.82e-02		1.29	0.10	625.84	88.94	89.39	625.39	15.39	





EGP CODE

GRE.EEC.R.73.IT.W.15235.12.024.01

PAGE

451 di/of 527

1	73	725	1.58-0.14-9.45e-02	1.53	0.28	684.63	79.55	82.43	681.76	41.63	
1	73	726	2.10-0.12-2.53e-02	2.01	0.45	768.02	49.68	59.12	758.59	81.78	
1	73	727	2.850.13 0.20	2.78	0.43	832.00	-28.43	-1.05	804.62	151.02	
1	73	728	4.20-0.79 -0.53	3.93	-1.12	802.76	-216.54	-123.51	709.73	293.55	
1	73	729	6.39-5.72 -4.83	5.49	-3.16	483.36	-539.91	-240.04	183.49	465.76	
1	73	730	6.92-8.92 6.80	-8.81	1.36	87.42	-463.24	-183.49	-192.33	275.30	
1	73	731	3.69-2.38 -2.30	3.61	-0.70	665.99	-72.18	-66.63	660.45	63.73	
1	73	732	16.20-9.17 16.18	-9.15	-0.71	727.69	-680.13	-678.46	726.02	-48.47	
1	73	733	6.863.46 6.51	3.81	-1.03	908.24	-175.40	-175.12	907.95	-17.49	
1	73	734	2.980.81 0.81	2.98	6.06e-02	838.34	-26.72	-26.57	838.19	-11.29	
1	73	735	2.20-3.21e-02-2.69e-02	2.19	0.11	753.34	41.89	41.96	753.27	-6.95	
1	73	736	1.66-0.16 -0.16	1.66	6.59e-02	671.95	68.89	68.91	671.93	-3.78	
1	73	737	1.41-0.18 -0.18	1.41	3.08e-02	629.29	76.47	76.47	629.28	-1.03	
1	73	738	1.42-0.19 -0.19	1.42	3.15e-03	640.70	73.87	73.87	640.70	1.58	
1	73	739	1.70-0.18 -0.18	1.70	-2.28e-02	702.29	58.37	58.40	702.26	4.28	
1	73	740	2.23-3.74e-02-3.68e-02	2.23	-3.64e-02	790.25	14.27	14.33	790.19	7.27	
1	73	741	2.890.88 0.89	2.88	0.11	858.91	-91.32	-91.19	858.77	11.43	
1	73	742	7.552.57 6.90	3.22	1.68	875.41	-319.68	-319.19	874.93	24.06	
1	73	743	17.84-21.15 17.79	-21.10	1.43	489.90	-1138.24	-1136.58	488.24	51.96	
1	73	744	18.731.35e-027.68	11.06	9.21	188.05	81.39	131.87	137.57	53.26	
1	73	745	4.81-6.59 -5.75	3.97	2.97	-149.83	-290.23	-254.12	-185.94	-61.37	
1	73	746	3.80-5.90 -4.75	2.65	-3.14	-164.44	-277.20	-239.71	-201.94	53.12	
1	73	747	5.06-2.17 -0.78	3.67	2.85	243.36	-223.90	140.18	-120.71	193.82	
1	73	748	6.27-1.94 -0.47	4.80	-3.15	312.67	-284.85	169.81	-141.99	-254.86	
1	73	749	18.494.15 11.81	10.83	7.16	410.57	146.92	160.17	397.32	57.61	
1	73	750	3.33-3.31 -3.16	3.18	-1.00	671.80	-66.28	-65.57	671.09	22.91	
1	73	751	2.35-0.45 -0.41	2.31	-0.32	722.13	-16.01	-15.00	721.12	27.29	
1	73	752	1.91-0.11-9.74e-02	1.90	-0.13	668.84	-5.55	-5.27	668.56	13.66	
1	73	753	1.60-6.24e-02-6.03e-02	1.60	-6.00e-02	605.33	-0.94	-0.90	605.28	5.45	
1	73	754	1.46-5.56e-02-5.55e-02	1.46	-1.34e-02	570.16	0.94	0.94	570.16	1.19	
1	73	755	1.50-5.64e-02-5.59e-02	1.50	2.88e-02	579.47	0.51	0.51	579.46	-2.06	
1	73	756	1.73-6.45e-02-6.13e-02	1.73	7.59e-02	629.25	-2.26	-2.18	629.16	-7.35	
1	73	757	5.50-3.77 5.15	-3.42	-1.76	-250.49	-630.10	-527.28	-353.30	168.70	
1	73	758	3.78-6.35 -1.40	-1.17	-5.06	611.24	-549.68	-413.27	474.83	373.83	
1	73	759	2.77-0.57 -0.34	2.53	0.86	833.38	-177.50	-146.62	802.50	173.94	
1	73	760	2.490.11 0.26	2.34	0.59	825.53	-8.75	-3.03	819.81	68.83	
1	73	761	1.88-6.30e-022.24e-02	1.80	0.40	746.43	54.53	56.04	744.92	32.29	
1	73	762	1.45-0.11-7.99e-02	1.42	0.23	667.81	76.43	76.75	667.49	13.82	
1	73	763	1.24-0.12 -0.11	1.24	8.19e-02	626.24	81.98	81.99	626.23	2.31	
1	73	764	1.26-0.12 -0.12	1.26	-4.76e-02	637.32	80.27	80.38	637.21	-7.93	
1	73	765	1.52-0.14 -0.12	1.50	-0.18	697.08	69.01	69.77	696.32	-21.90	
1	73	766	2.01-0.11-6.36e-02	1.96	-0.30	781.43	33.90	36.78	778.54	-46.38	
1	73	767	2.678.64e-035.01e-02	2.62	-0.33	843.34	-57.93	-47.67	833.08	-95.59	
1	73	768	2.91-0.93 -0.93	2.90	9.28e-02	798.27	-290.37	-238.87	746.78	-231.10	
1	73	769	6.90-7.24 -4.88	4.54	5.28	407.84	-712.79	-488.17	183.23	-448.62	
1	73	770	8.47-7.33 8.47	-7.33	3.66e-02	-314.13	-606.84	-516.85	-404.12	-135.06	
1	73	771	6.83e-02 -4.72	-3.21	-1.44	2.22	301.83	-341.71	25.57	-65.46	318.53
1	73	772	4.97-3.33 -3.07	4.72	1.44	616.16	-114.59	76.06	425.51	320.89	
1	73	773	1.63-0.89 -0.88	1.62	-0.15	781.67	-10.99	56.16	714.52	220.72	
1	73	774	1.46-5.82e-02 0.17	1.23	0.54	782.92	73.31	94.05	762.18	119.54	
1	73	775	1.26-4.59e-02 0.18	1.04	0.49	718.86	99.52	105.80	712.58	62.04	
1	73	776	1.01-2.55e-039.56e-02	0.91	0.30	649.46	104.04	105.48	648.03	27.92	
1	73	777	0.873.76e-025.00e-02	0.86	0.10	611.78	103.30	103.35	611.73	5.18	
1	73	778	0.902.54e-023.60e-02	0.89	-9.57e-02	621.82	103.72	104.17	621.38	-15.22	
1	73	779	1.11-4.07e-024.62e-02	1.02	-0.30	675.61	104.02	107.06	672.57	-41.55	
1	73	780	1.48-0.13 6.70e-02	1.28	-0.52	748.95	95.14	105.97	738.11	-83.45	
1	73	781	2.01-0.27-2.86e-02	1.77	-0.70	796.71	58.42	91.80	763.33	-153.39	
1	73	782	3.22-1.20 -0.99	3.00	-0.95	760.18	-42.61	61.10	656.48	-269.26	
1	73	783	3.39-0.72 -0.72	3.38	9.27e-02	514.42	-135.81	100.15	278.46	-312.65	
1	73	784	1.58-7.47 -6.47	0.58	-2.83	291.28	-356.16	5.21	-70.10	-321.52	
1	73	785	1.13-2.87 -2.03	0.28	1.63	574.97	-76.10	459.10	39.78	249.03	
1	73	786	1.40-2.33 -2.13	1.20	0.84	616.18	166.43	364.52	418.09	223.27	
1	73	787	0.74-0.90 -0.86	0.69	0.27	705.57	203.80	273.50	635.88	173.53	
1	73	788	0.51-8.74e-029.02e-02	0.33	0.27	723.38	187.73	210.19	700.93	107.35	
1	73	789	0.621.92e-02 0.26	0.37	0.30	680.17	162.15	168.88	673.45	58.64	
1	73	790	0.550.12 0.25	0.43	0.20	624.26	140.96	142.49	622.73	27.15	
1	73	791	0.480.20 0.21	0.46	6.36e-02	592.26	130.64	130.70	592.20	5.24	
1	73	792	0.510.18 0.21	0.48	-8.51e-02	600.94	133.76	134.22	600.49	-14.51	
1	73	793	0.658.06e-02 0.23	0.50	-0.25	646.27	149.97	153.06	643.17	-39.06	
1	73	794	0.82-6.94e-02 0.24	0.52	-0.42	703.81	175.84	186.89	692.76	-75.58	
1	73	795	0.91-0.28 0.11	0.52	-0.56	731.57	202.86	237.00	697.43	-129.95	
1	73	796	0.86-0.85 -0.66	0.67	-0.54	686.47	206.93	309.84	583.56	-196.87	
1	73	797	1.45-2.14 -1.97	1.27	-0.77	596.72	119.72	406.35	310.08	-233.59	
1	73	798	0.96-2.96 -2.19	0.19	-1.55	580.87	-77.19	461.06	42.62	-253.94	
1	73	799	8.72e-02 -2.50	-2.34	-7.30e-02	0.62	652.55	54.79	638.06	69.28	91.94
1	73	800	0.27-1.63 -1.52	0.16	0.45	561.56	374.79	513.26	423.09	81.78	



EGP CODE

GRE.EEC.R.73.IT.W.15235.12.024.01

PAGE

452 di/of 527

1	73	801	0.12-0.66	-0.65	9.96e-02	0.11	627.30	369.64	388.71	608.23	67.46	
1	73	802	2.09e-02	9.98e-03	1.38e-02	1.70e-02	5.21e-03	672.67	280.70	286.18	667.20	45.99
1	73	803	0.277.30e-02	0.26	7.35e-02	1.02e-02	649.84	212.85	214.50	648.19	26.77	
1	73	804	0.300.17	0.30	0.17	1.57e-02	605.65	170.62	171.00	605.27	12.81	
1	73	805	0.280.23	0.28	0.23	3.42e-03	578.43	152.44	152.46	578.41	2.51	
1	73	806	0.300.23	0.29	0.24	-2.33e-02	586.06	157.50	157.61	585.95	-6.83	
1	73	807	0.350.16	0.33	0.19	-6.32e-02	624.38	186.02	186.76	623.65	-17.97	
1	73	808	0.373.21e-02	0.33	7.71e-02	-0.11	667.61	239.09	241.70	665.01	-33.32	
1	73	809	0.23-0.15	0.12	-4.00e-02	-0.17	671.76	317.17	325.51	663.42	-53.74	
1	73	810	5.57e-02	-0.67	-0.56	-5.26e-02	-0.26	597.59	403.17	438.28	562.48	-74.79
1	73	811	5.23e-02	-1.79	-1.70	-4.10e-02	-0.40	592.54	293.66	565.11	321.09	-86.29
1	73	812	-6.44e-02	-2.53	-2.45	-0.15	-0.45	655.98	59.17	640.43	74.72	-95.07
1	73	813	-0.19-2.44	-2.44	-0.19	3.71e-02	666.24	61.67	654.99	72.92	-81.68	
1	73	814	-4.68e-02	-1.29	-1.29	-5.06e-02	-6.83e-02	563.80	393.39	528.47	428.72	-69.08
1	73	815	0.10-0.56	-0.46	3.48e-03	-0.24	623.82	391.25	403.20	611.86	-51.36	
1	73	816	0.37-0.29	3.54e-02	4.14e-02	-0.33	670.48	296.80	299.43	667.85	-31.28	
1	73	817	0.46-0.12	0.21	0.13	-0.29	648.03	224.99	225.64	647.38	-16.63	
1	73	818	0.404.88e-02	0.23	0.22	-0.17	604.38	180.00	180.14	604.24	-7.61	
1	73	819	0.300.19	0.23	0.26	-5.25e-02	577.53	160.51	160.52	577.53	-1.59	
1	73	820	0.310.19	0.24	0.26	6.24e-02	585.17	165.77	165.80	585.13	3.85	
1	73	821	0.426.46e-02	0.29	0.20	0.17	623.17	195.90	196.18	622.89	10.86	
1	73	822	0.49-0.10	0.31	7.37e-02	0.27	665.90	251.82	252.98	664.75	21.85	
1	73	823	0.35-0.28	0.17	-9.99e-02	0.28	669.12	334.02	338.55	664.59	38.72	
1	73	824	-0.11-0.52	-0.43	-0.21	0.17	590.66	427.52	452.53	565.64	58.78	
1	73	825	-0.22-1.63	-1.63	-0.22	4.76e-02	599.18	305.94	580.43	324.69	71.74	
1	73	826	-0.24-2.55	-2.55	-0.24	4.07e-02	667.50	66.71	656.77	77.44	79.55	
1	73	827	7.84e-02	-2.31	-2.15	-7.52e-02	-0.59	618.65	-52.03	513.39	53.23	-243.96
1	73	828	0.76-1.40	-1.20	0.57	-0.62	638.72	212.46	413.62	437.56	-212.80	
1	73	829	0.91-0.72	-0.31	0.51	-0.70	710.23	257.16	320.81	646.59	-157.43	
1	73	830	1.02-0.48	5.48e-02	0.49	-0.72	721.23	232.45	251.88	701.80	-95.49	
1	73	831	0.92-0.30	5.62e-02	0.56	-0.56	676.83	196.53	202.34	671.03	-52.48	
1	73	832	0.70-0.10	4.69e-02	0.55	-0.31	621.83	167.71	169.07	620.47	-24.86	
1	73	833	0.553.71e-02	25.24e-02	0.53	-8.68e-02	590.70	153.80	153.86	590.64	-5.17	
1	73	834	0.573.61e-02	27.06e-02	0.53	0.13	599.41	157.55	157.92	599.04	12.83	
1	73	835	0.76-0.10	0.11	0.55	0.37	644.12	178.37	181.00	641.48	34.92	
1	73	836	1.01-0.31	0.16	0.54	0.63	701.35	212.05	221.54	691.86	67.47	
1	73	837	1.13-0.51	0.21	0.40	0.81	730.80	248.03	278.35	700.48	117.12	
1	73	838	0.70-0.69	-0.20	0.22	0.66	691.72	257.66	355.97	593.40	181.68	
1	73	839	0.65-1.63	-1.55	0.57	0.42	621.43	156.43	455.57	322.29	222.74	
1	73	840	4.36e-02	-2.59	-2.38	-0.17	0.71	617.94	-50.55	514.00	53.39	242.24
1	73	841	-0.96-2.62	-2.60	-0.98	-0.17	381.89	-275.27	137.46	-30.84	-317.62	
1	73	842	4.59-1.74	-1.01	3.86	-2.03	675.05	-39.86	167.92	467.27	-324.61	
1	73	843	1.93-0.49	-0.14	1.58	-0.85	792.46	83.27	149.21	726.52	-205.94	
1	73	844	2.17-0.67	-0.18	1.68	-1.07	782.66	144.84	167.47	760.03	-118.00	
1	73	845	1.56-0.47	-0.25	1.33	-0.64	717.28	151.82	159.66	709.44	-66.12	
1	73	846	1.13-0.29	-0.21	1.05	-0.32	649.54	143.98	146.02	647.49	-32.09	
1	73	847	0.93-0.18	-0.17	0.92	-8.36e-02	613.08	137.89	137.98	612.99	-6.78	
1	73	848	0.96-0.18	-0.16	0.94	0.14	623.13	139.56	140.14	622.55	16.68	
1	73	849	1.23-0.28	-0.17	1.11	0.40	675.94	147.57	151.38	672.14	44.70	
1	73	850	1.73-0.48	-0.18	1.43	0.76	748.73	152.63	164.95	736.41	84.79	
1	73	851	2.48-0.70	-5.92e-02	1.83	1.28	800.32	133.70	168.13	765.88	147.55	
1	73	852	2.69-0.80	-0.17	2.06	1.34	774.71	44.10	146.97	671.84	254.12	
1	73	853	2.330.22	0.37	2.18	0.55	572.92	-80.48	190.87	301.57	321.98	
1	73	854	-0.31-5.28	-5.15	-0.44	0.80	363.62	-289.53	117.12	-43.03	316.61	
1	73	855	5.61-2.86	3.00	-0.25	3.91	-251.60	-575.52	-440.76	-386.36	-159.66	
1	73	856	3.79-3.32	2.54	-2.07	2.70	711.06	-349.87	-221.15	582.34	-346.40	
1	73	857	5.16-2.21	-0.82	3.77	-2.88	843.98	-27.21	10.13	806.65	-176.44	
1	73	858	3.13-0.97	-0.86	3.03	-0.66	823.88	84.84	96.63	812.09	-92.60	
1	73	859	2.03-0.57	-0.54	2.00	-0.30	750.57	116.56	121.35	745.78	-54.91	
1	73	860	1.46-0.41	-0.40	1.45	-0.15	676.13	121.39	122.81	674.71	-28.03	
1	73	861	1.23-0.33	-0.33	1.23	-3.77e-02	636.46	120.24	120.31	636.39	-6.11	
1	73	862	1.27-0.33	-0.33	1.27	6.71e-02	647.31	120.63	121.04	646.90	14.69	
1	73	863	1.58-0.40	-0.38	1.56	0.19	704.85	120.64	123.12	702.36	38.05	
1	73	864	2.27-0.57	-0.52	2.22	0.37	785.42	108.07	115.01	778.48	68.23	
1	73	865	3.52-1.01	-0.87	3.38	0.77	844.39	53.89	70.32	827.97	112.76	
1	73	866	5.41-2.10	-0.29	3.60	3.21	819.52	-118.41	-64.03	765.15	219.18	
1	73	867	4.74-4.56	-0.76	0.94	-4.57	553.91	-555.66	-328.29	326.55	447.86	
1	73	868	8.26-2.84	7.85	-2.43	-2.11	-295.56	-546.11	-407.75	-433.93	124.59	
1	73	869	18.684.38	18.50	4.56	1.59	743.99	-147.75	-134.49	730.73	-107.91	
1	73	870	8.64-0.34	-0.18	8.48	1.19	893.91	-22.14	-16.91	888.68	-69.05	
1	73	871	3.13-0.17	-0.17	3.13	0.10	836.32	78.95	83.95	831.32	-61.33	
1	73	872	2.01-0.47	-0.47	2.01	1.38e-02	762.85	106.20	108.83	760.22	-41.44	
1	73	873	1.51-0.41	-0.41	1.51	-1.30e-02	688.13	111.59	112.47	687.25	-22.57	
1	73	874	1.31-0.36	-0.36	1.31	-7.47e-03	647.96	111.09	111.13	647.91	-5.07	
1	73	875	1.35-0.36	-0.36	1.35	1.32e-02	658.90	111.36	111.62	658.64	11.96	
1	73	876	1.63-0.40	-0.40	1.63	2.56e-02	716.96	110.56	112.01	715.51	29.69	



EGP CODE

GRE.EEC.R.73.IT.W.15235.12.024.01

PAGE

453 di/of 527

1	73	877	2.23-0.43	-0.43	2.23	1.22e-02	797.25	97.59	101.01	793.84	48.74
1	73	878	3.551.92e-022.01e-02		3.55	-5.60e-02	855.15	50.13	55.99	849.29	68.44
1	73	879	10.64-0.62	-0.47	10.49	-1.30	880.45	-97.40	-91.99	875.04	72.56
1	73	880	26.86-7.36	26.81	-7.31	-1.29	582.81	-511.04	-495.53	567.30	129.32
1	73	881	6.99-4.51	2.34	0.15	-5.64	-563.40	-719.65	-717.50	-565.55	-18.18
1	73	882	2.15-3.68	1.87	-3.40	-1.25	657.34	-358.99	-341.22	639.57	133.20
1	73	883	4.19-2.35	-0.51	2.35	2.94	819.84	-40.06	-40.00	819.78	7.33
1	73	884	2.96-0.97	-0.82	2.81	0.75	835.28	64.15	65.93	833.50	-36.98
1	73	885	2.02-0.52	-0.49	2.00	0.24	768.60	99.49	100.97	767.12	-31.36
1	73	886	1.53-0.39	-0.39	1.53	6.27e-02	695.12	107.25	107.83	694.54	-18.51
1	73	887	1.35-0.36	-0.36	1.35	7.20e-03	655.18	107.65	107.68	655.15	-4.28
1	73	888	1.39-0.35	-0.35	1.39	-1.39e-02	666.02	107.81	107.99	665.84	9.97
1	73	889	1.66-0.38	-0.38	1.66	-7.14e-02	723.49	106.03	106.93	722.58	23.60
1	73	890	2.26-0.50	-0.47	2.24	-0.27	801.73	90.88	92.53	800.08	34.27
1	73	891	3.33-1.00	-0.81	3.14	-0.88	850.78	34.19	35.57	849.39	33.56
1	73	892	4.77-2.71	5.70e-02	2.00	-3.61	779.71	-126.74	-125.58	778.56	-32.36
1	73	893	3.08-6.44	-0.82	-2.53	4.68	456.97	-570.53	-496.09	382.54	-266.34
1	73	894	6.88-1.72	4.81	0.35	3.68	-594.38	-739.08	-698.59	-634.87	64.96
1	73	895	0.55-2.63	-1.63	-0.45	1.48	100.45	-162.55	-3.00	-59.09	128.47
1	73	896	4.72-2.62	-2.30	4.40	1.50	519.79	-31.97	26.85	460.97	170.28
1	73	897	1.37-0.57	-0.57	1.37	3.30e-02	774.57	27.31	31.81	770.07	57.84
1	73	898	1.89-0.30	-2.57e-02	1.61	0.73	821.44	84.63	84.67	821.40	5.10
1	73	899	1.59-0.25	-0.16	1.50	0.39	771.37	101.33	101.44	771.26	-8.51
1	73	900	1.38-0.26	-0.25	1.36	0.16	704.83	103.79	103.88	704.73	-7.60
1	73	901	1.30-0.28	-0.28	1.30	2.26e-02	666.96	103.15	103.16	666.95	-1.87
1	73	902	1.34-0.28	-0.28	1.33	-7.82e-02	677.16	103.80	103.84	677.12	4.59
1	73	903	1.50-0.26	-0.23	1.48	-0.21	730.76	104.85	104.97	730.64	8.69
1	73	904	1.80-0.22	-0.11	1.69	-0.45	798.70	99.99	100.02	798.67	4.79
1	73	905	2.17-0.21	0.11	1.84	-0.81	825.47	75.48	76.03	824.92	-20.22
1	73	906	1.80-0.65	-0.64	1.79	-0.14	720.75	1.30	15.12	706.93	-98.75
1	73	907	3.98-0.94	-0.87	3.91	-0.59	357.34	-32.54	51.27	273.53	-160.16
1	73	908	1.40-5.51	-4.38	0.26	-2.56	80.49	-169.94	-24.10	-65.35	-123.50
1	73	909	0.51-1.42	-1.39	0.48	0.25	310.67	10.89	295.31	26.25	66.10
1	73	910	1.85-1.93	-1.85	1.78	0.51	460.30	202.91	216.06	447.15	56.67
1	73	911	1.35-0.71	-0.66	1.30	0.33	717.91	147.18	148.86	716.23	30.92
1	73	912	1.077.14e-02	0.12	1.02	0.21	798.87	120.86	121.01	798.72	10.05
1	73	913	1.171.82e-023.82e-02		1.15	0.15	766.70	111.39	111.40	766.70	1.32
1	73	914	1.19-0.12	-0.11	1.19	6.04e-02	706.97	105.50	105.50	706.97	-0.62
1	73	915	1.20-0.19	-0.19	1.20	-1.12e-02	671.22	102.57	102.57	671.22	3.45e-02
1	73	916	1.23-0.20	-0.19	1.22	-7.39e-02	680.82	103.82	103.82	680.82	1.16
1	73	917	1.29-0.12	-0.10	1.28	-0.14	730.66	109.19	109.19	730.65	1.08
1	73	918	1.333.08e-026.68e-02		1.30	-0.21	788.60	117.93	117.95	788.58	-3.07
1	73	919	1.240.17	0.20	1.20	-0.19	792.12	132.97	133.40	791.69	-16.92
1	73	920	1.30-0.47	-0.45	1.28	-0.18	650.33	169.62	173.47	646.48	-42.85
1	73	921	2.05-1.71	-1.65	1.99	-0.47	355.59	216.93	251.98	320.54	-60.26
1	73	922	0.52-1.70	-1.61	0.43	-0.45	309.87	15.76	296.61	29.01	-61.01
1	73	923	-0.45-3.29	-2.63	-1.11	-1.20	237.34	-19.50	229.49	-11.65	-44.20
1	73	924	2.39-2.03	-2.03	2.38	0.13	457.89	179.51	192.13	445.27	-57.91
1	73	925	1.49-0.41	-0.41	1.49	3.25e-02	730.33	130.82	133.01	728.14	-36.15
1	73	926	1.364.73e-026.50e-02		1.34	-0.15	800.59	119.12	119.15	800.56	-4.37
1	73	927	1.261.74e-022.90e-02		1.24	-0.12	766.20	112.29	112.32	766.18	4.02
1	73	928	1.19-0.11	-0.10	1.19	-6.80e-02	706.26	107.39	107.42	706.23	4.14
1	73	929	1.17-0.18	-0.18	1.16	-5.00e-02	670.56	104.76	104.76	670.56	1.52
1	73	930	1.18-0.18	-0.17	1.18	-4.58e-02	680.19	105.63	105.63	680.19	-1.45
1	73	931	1.25-9.85e-02-9.79e-02		1.25	-2.79e-02	729.99	109.81	109.82	729.98	-3.01
1	73	932	1.362.10e-022.17e-02		1.36	3.05e-02	787.98	116.43	116.43	787.98	-3.46e-02
1	73	933	1.61-1.26e-02-2.78e-03		1.60	0.13	792.75	128.09	128.39	792.45	14.03
1	73	934	2.30-0.53	-0.41	2.18	0.57	663.88	153.48	158.58	658.79	50.75
1	73	935	2.02-1.23	-0.97	1.77	-0.87	337.50	203.19	227.40	313.29	51.63
1	73	936	1.06-4.63	-4.22	0.65	1.48	233.43	-12.20	224.87	-3.64	45.05
1	73	937	3.04-3.49	2.91	-3.36	-0.91	23.39	-133.97	-5.69	-104.89	-61.08
1	73	938	1.92-3.40	-1.47	-1.48e-02	2.56	497.36	-150.31	-81.45	428.49	-199.65
1	73	939	2.49-0.39	-0.35	2.45	0.34	781.17	11.91	16.03	777.05	-56.17
1	73	940	1.990.10	0.14	1.95	-0.27	821.67	80.91	80.95	821.64	4.79
1	73	941	1.57-9.12e-02-7.03e-02		1.55	-0.19	769.37	104.78	105.17	768.98	16.10
1	73	942	1.30-0.18	-0.17	1.30	-9.66e-02	702.72	111.33	111.58	702.47	12.13
1	73	943	1.18-0.22	-0.21	1.18	-5.38e-02	665.06	112.21	112.23	665.04	3.38
1	73	944	1.19-0.21	-0.21	1.19	-2.95e-02	675.28	111.76	111.82	675.22	-6.06
1	73	945	1.32-0.17	-0.17	1.32	1.36e-02	728.66	108.78	109.06	728.38	-13.19
1	73	946	1.58-6.85e-02-6.36e-02		1.58	8.96e-02	796.42	96.22	96.44	796.20	-12.27
1	73	947	1.979.24e-029.53e-02		1.97	7.29e-02	823.97	58.53	58.70	823.81	11.18
1	73	948	2.95-1.34	-0.90	2.51	-1.30	717.87	-40.08	-27.32	705.11	97.52
1	73	949	4.16-4.29	-3.70	3.56	-2.16	319.04	-192.05	-69.35	196.34	218.30
1	73	950	4.01-5.91	3.52	-5.41	2.16	6.45	-147.64	-7.57	-133.62	44.32
1	73	951	2.16-0.11-9.68e-02		2.16	0.15	694.86	-7.80	-7.38	694.43	-17.22
1	73	952	11.58-5.81	11.35	-5.58	-2.02	685.96	-423.04	-417.99	680.91	74.70



EGP CODE

GRE.EEC.R.73.IT.W.15235.12.024.01

PAGE

454 di/of 527

1	73	953	5.012.16	4.29	2.88	-1.24	866.01	-41.99	-33.60	857.62	86.85	
1	73	954	2.260.38	0.38	2.26	-2.17e-02	831.77	69.80	77.18	824.39	74.62	
1	73	955	1.66-0.14	-0.14	1.66	9.14e-02	761.04	116.45	120.70	756.79	52.20	
1	73	956	1.27-0.21	-0.21	1.26	6.18e-02	687.15	132.42	133.94	685.63	29.01	
1	73	957	1.09-0.21	-0.21	1.09	1.08e-03	647.31	136.15	136.23	647.22	6.64	
1	73	958	1.10-0.22	-0.22	1.09	-6.31e-02	658.12	134.77	135.23	657.66	-15.47	
1	73	959	1.29-0.22	-0.22	1.29	-0.11	715.41	126.25	128.74	712.91	-38.28	
1	73	960	1.68-0.15	-0.15	1.67	-9.33e-02	793.96	98.24	103.80	788.40	-61.96	
1	73	961	2.190.41	0.42	2.18	0.14	846.65	23.21	31.88	837.98	-84.05	
1	73	962	5.631.35	4.47	2.51	1.91	826.50	-151.82	-143.80	818.47	-88.23	
1	73	963	13.08-14.92	12.83	-14.67	2.64	459.68	-792.51	-789.01	456.18	-66.15	
1	73	964	2.81-0.41	-0.38	2.78	0.31	727.62	-18.82	-17.46	726.26	-31.81	
1	73	965	4.57-2.68	-2.64	4.53	0.54	622.87	-66.52	-65.74	622.10	-23.06	
1	73	966	22.062.68	9.49	15.25	-9.25	212.38	103.12	157.86	157.64	-54.63	
1	73	967	6.20-6.62	-6.32	5.90	-1.95	-91.16	-280.70	-263.80	-108.06	54.02	
1	73	968	5.45-6.31	-5.86	5.00	2.24	-107.23	-269.44	-255.10	-121.57	-46.05	
1	73	969	8.83-4.27	4.84	-0.28	-6.03	-9.86	-396.00	-85.98	-319.88	153.62	
1	73	970	6.58-5.74	0.25	0.59	6.16	-12.18	-424.69	-122.53	-314.33	-182.60	
1	73	971	2.63-1.30	1.77	-0.44	1.62	655.64	-128.27	61.41	465.96	-335.73	
1	73	972	4.35-1.15-5.21e-02		3.25	-2.19	758.70	54.11	130.13	682.68	-218.59	
1	73	973	3.31-0.46	-0.12	2.97	-1.08	743.36	105.10	137.60	710.85	-140.32	
1	73	974	2.42-0.22-9.17e-02		2.29	-0.57	676.96	105.41	119.01	663.36	-87.12	
1	73	975	1.96-0.11-6.34e-02		1.91	-0.30	609.37	96.46	100.50	605.33	-45.34	
1	73	976	1.76-5.58e-02-5.25e-02		1.76	-7.66e-02	573.16	90.74	90.95	572.95	-10.17	
1	73	977	4.03-3.33	2.26	-1.56	-3.15	-25.96	-515.13	-258.20	-282.89	244.28	
1	73	978	3.38-5.03	-1.17	-0.49	-4.19	664.51	-373.10	-171.95	463.36	410.19	
1	73	979	2.91-0.77	-0.50	2.64	0.96	836.30	-33.80	32.83	769.66	231.39	
1	73	980	2.06-0.15-4.37e-02		1.96	0.46	816.34	103.77	127.63	792.48	128.19	
1	73	981	1.46-0.19	-0.13	1.40	0.31	742.08	149.87	159.86	732.09	76.28	
1	73	982	1.07-0.17	-0.15	1.05	0.17	667.75	163.43	166.50	664.69	39.19	
1	73	983	0.90-0.15	-0.15	0.90	3.74e-02	628.11	166.04	166.19	627.96	8.46	
1	73	984	0.92-0.17	-0.16	0.91	-8.33e-02	638.82	165.11	166.05	637.88	-21.00	
1	73	985	1.13-0.22	-0.19	1.10	-0.20	695.90	158.77	164.25	690.43	-53.97	
1	73	986	1.55-0.27	-0.22	1.50	-0.28	775.72	134.85	149.62	760.95	-96.17	
1	73	987	2.21-0.29	-0.25	2.17	-0.30	834.74	64.05	98.05	800.74	-158.25	
1	73	988	2.99-0.99	-0.96	2.96	-0.35	810.77	-132.27	-35.06	713.55	-286.75	
1	73	989	6.11-5.72	-4.10	4.49	4.07	517.85	-534.00	-230.84	214.69	-476.42	
1	73	990	6.52-5.32	6.14	-4.94	2.08	-50.62	-493.43	-236.47	-307.58	-218.53	
1	73	991	-1.11e-02	-3.58	-3.12	-0.47	1.20	481.81	-282.06	235.86	-36.11	356.90
1	73	992	4.30-2.47	-2.07	3.90	1.60	703.95	-16.77	261.32	425.86	350.84	
1	73	993	1.50-0.72	-0.69	1.47	0.26	793.93	118.09	229.71	682.31	250.96	
1	73	994	1.34-0.30-5.08e-02		1.09	0.59	774.18	196.19	240.64	729.74	153.98	
1	73	995	1.00-0.18 8.55e-03		0.81	0.44	706.12	217.58	234.85	688.84	90.24	
1	73	996	0.73-7.93e-02-1.14e-03		0.65	0.24	637.28	219.43	224.37	632.35	45.13	
1	73	997	0.58-1.55e-02-9.15e-03		0.58	6.15e-02	600.35	217.74	217.97	600.11	9.52	
1	73	998	0.62-4.43e-02-2.52e-02		0.60	-0.11	610.28	218.23	219.72	608.80	-24.09	
1	73	999	0.81-0.15-5.47e-02		0.71	-0.29	663.31	219.70	228.77	654.23	-62.79	
1	73	1000	1.17-0.31	-0.11	0.97	-0.50	737.20	213.46	239.80	710.87	-114.45	
1	73	1001	1.73-0.54	-0.27	1.46	-0.74	793.07	179.88	244.56	728.39	-188.36	
1	73	1002	2.78-1.23	-0.90	2.45	-1.11	785.80	78.22	239.11	624.91	-296.58	
1	73	1003	2.41-0.50	-0.46	2.37	-0.34	632.97	-66.56	286.05	280.36	-349.75	
1	73	1004	0.97-5.92	-5.55	0.60	-1.55	470.74	-292.71	220.65	-42.61	-358.31	
1	73	1005	0.53-2.74	-2.31	0.10	1.10	729.67	-75.87	612.16	41.64	284.34	
1	73	1006	0.96-1.97	-1.76	0.75	0.76	720.77	209.41	522.72	407.46	249.10	
1	73	1007	0.60-0.82	-0.65	0.43	0.47	737.16	307.80	435.05	609.91	196.07	
1	73	1008	0.52-0.28 2.28e-02		0.21	0.39	718.23	320.13	368.65	669.71	130.23	
1	73	1009	0.52-0.11	0.16	0.24	0.31	663.68	304.04	321.73	645.99	77.77	
1	73	1010	0.403.12e-02	0.17	0.26	0.18	605.75	285.95	290.79	600.90	39.05	
1	73	1011	0.290.14	0.15	0.27	4.35e-02	573.86	276.52	276.75	573.63	8.25	
1	73	1012	0.339.59e-02	0.14	0.28	-9.21e-02	582.49	279.18	280.61	581.07	-20.73	
1	73	1013	0.47-4.64e-02	0.13	0.30	-0.25	628.03	293.37	302.27	619.13	-53.86	
1	73	1014	0.64-0.24 8.98e-02		0.31	-0.43	689.58	313.85	340.78	662.64	-96.93	
1	73	1015	0.76-0.50-5.15e-02		0.31	-0.61	734.61	325.76	395.83	664.54	-154.07	
1	73	1016	0.64-0.95	-0.65	0.34	-0.62	738.61	289.81	470.33	558.08	-220.07	
1	73	1017	0.93-2.07	-1.92	0.78	-0.65	723.01	138.56	562.19	299.38	-261.01	
1	73	1018	0.39-2.86	-2.47	-1.09e-04	-1.06	733.04	-75.99	614.08	42.97	-286.52	
1	73	1019	-0.11-2.76	-2.68	-0.19	0.45	812.13	38.19	787.38	62.94	136.18	
1	73	1020	-1.80e-02	-1.55	-1.44	-0.13	0.40	718.83	362.03	675.08	405.77	117.03
1	73	1021	-5.60e-02	-0.59	-0.50	-0.14	0.20	667.67	474.50	561.20	580.97	96.07
1	73	1022	9.90e-02	-0.16	6.03e-02	-0.12	9.21e-02	659.65	440.18	464.25	635.57	68.59
1	73	1023	0.26-2.66e-02	0.25	-1.72e-02	5.13e-02	626.60	385.46	393.37	618.69	42.95	
1	73	1024	0.288.19e-02	0.28	8.47e-02	2.36e-02	582.40	346.57	348.66	580.31	22.10	
1	73	1025	0.260.14	0.26	0.14	-3.09e-04	556.41	329.00	329.09	556.31	4.74	
1	73	1026	0.260.13	0.26	0.14	-2.72e-02	563.59	333.71	334.31	562.99	-11.72	
1	73	1027	0.295.52e-02	0.26	7.77e-02	-6.87e-02	600.33	360.61	364.43	596.51	-30.02	
1	73	1028	0.29-9.56e-02	0.23	-4.25e-02	-0.13	645.19	407.79	419.96	633.02	-52.36	





EGP CODE

GRE.EEC.R.73.IT.W.15235.12.024.01

PAGE

455 di/of 527

1	73	1029	0.15-0.32	2.62e-02	-0.19	-0.21	667.93	463.97	501.58	630.32	-79.09	
1	73	1030	-0.11-0.78	-0.62	-0.27	-0.28	682.87	459.61	606.95	535.53	-105.76	
1	73	1031	-0.16-1.93	-1.85	-0.24	-0.36	755.44	270.98	721.87	304.55	-123.04	
1	73	1032	-0.19-2.82	-2.77	-0.23	-0.35	814.61	41.59	789.35	66.85	-137.44	
1	73	1033	-0.27-2.74	-2.74	-0.28	0.14	833.59	65.30	832.80	66.09	-24.58	
1	73	1034	-0.27-1.21	-1.21	-0.27	-1.08e-02	720.13	406.83	718.64	408.32	-21.56	
1	73	1035	-2.80e-02	-0.45	-0.29	-0.18	-0.20	609.57	572.44	602.79	579.22	-14.34
1	73	1036	0.36-0.26	0.16	-5.62e-02	-0.29	630.92	502.07	502.40	630.59	-6.49	
1	73	1037	0.47-8.31e-02	0.29	9.30e-02	-0.26	613.18	427.32	427.34	613.16	-1.99	
1	73	1038	0.428.42e-02	0.30	0.21	-0.16	575.52	379.30	379.30	575.52	-0.36	
1	73	1039	0.320.22	0.28	0.26	-5.00e-02	552.12	358.11	358.11	552.12	-3.53e-02	
1	73	1040	0.330.21	0.28	0.26	6.21e-02	558.71	363.62	363.62	558.71	7.62e-02	
1	73	1041	0.426.34e-02	0.30	0.18	0.17	591.55	395.86	395.86	591.55	0.85	
1	73	1042	0.45-0.12	0.30	2.95e-02	0.25	627.66	454.85	454.92	627.59	3.49	
1	73	1043	0.28-0.33	0.14	-0.18	0.26	626.95	539.49	540.50	625.95	9.32	
1	73	1044	-0.25-0.55	-0.45	-0.35	0.15	651.52	531.93	648.93	534.52	17.41	
1	73	1045	-0.37-1.74	-1.74	-0.37	-3.43e-02	766.75	306.03	765.68	307.10	22.16	
1	73	1046	-0.30-2.83	-2.83	-0.31	-9.40e-02	835.03	69.06	834.29	69.80	23.85	
1	73	1047	-9.27e-02	-2.36	-2.34	-0.11	-0.22	786.44	9.84	743.27	53.01	-177.94
1	73	1048	0.53-1.09	-0.91	0.35	-0.52	724.51	335.01	645.72	413.81	-156.47	
1	73	1049	0.92-0.57-2.63e-02	0.25	0.38	-0.72	695.35	453.68	548.94	600.09	-118.10	
1	73	1050	1.07-0.35	0.25	0.46	-0.71	677.60	440.50	467.72	650.38	-75.58	
1	73	1051	1.00-0.16	0.25	0.59	-0.55	635.14	396.91	405.39	626.66	-44.15	
1	73	1052	0.814.31e-02	0.22	0.64	-0.32	586.73	361.34	363.51	584.57	-21.98	
1	73	1053	0.670.18	0.20	0.65	-8.94e-02	559.43	344.33	344.43	559.33	-4.76	
1	73	1054	0.690.16	0.20	0.65	0.14	566.97	348.70	349.30	566.38	11.39	
1	73	1055	0.86-4.09e-03	0.22	0.63	0.38	605.99	373.85	377.83	602.01	30.13	
1	73	1056	1.05-0.23	0.26	0.56	0.62	656.67	415.00	428.42	643.24	55.35	
1	73	1057	1.11-0.47	0.25	0.39	0.79	690.16	455.35	498.39	647.12	90.85	
1	73	1058	0.71-0.68-8.12e-02	0.12	0.12	0.69	704.74	432.69	586.45	550.98	134.87	
1	73	1059	0.36-1.46	-1.38	0.28	0.36	747.79	245.07	686.88	305.98	164.04	
1	73	1060	-0.25-2.54	-2.52	-0.27	0.23	786.80	11.31	743.96	54.14	177.14	
1	73	1061	0.60-2.46	-2.44	0.58	0.22	573.77	-124.41	454.88	-5.52	-262.44	
1	73	1062	4.17-1.13	-0.29	3.32	-1.94	711.62	154.52	435.39	430.75	-278.54	
1	73	1063	2.04-0.23	0.27	1.54	-0.95	743.57	283.07	381.34	645.30	-188.67	
1	73	1064	-0.71-2.35	-2.28	-0.78	0.34	555.69	-62.50	537.34	-44.15	104.92	
1	73	1065	1.74-0.21	0.10	1.43	-0.72	664.11	294.40	309.78	648.73	-73.83	
1	73	1066	1.40-4.05e-027.47e-02	1.28	1.28	-0.39	603.38	275.15	279.59	598.95	-37.89	
1	73	1067	1.225.85e-026.76e-02	1.21	1.21	-0.10	570.61	264.73	264.96	570.38	-8.37	
1	73	1068	1.254.10e-026.67e-02	1.22	1.22	0.17	579.49	267.33	268.58	578.25	19.69	
1	73	1069	1.48-8.79e-026.93e-02	1.32	1.32	0.47	626.63	282.01	289.79	618.85	51.19	
1	73	1070	1.88-0.29	8.63e-02	1.51	0.82	691.85	301.82	324.46	669.21	91.21	
1	73	1071	2.40-0.51	0.17	1.72	1.23	741.17	307.93	363.80	685.30	145.21	
1	73	1072	2.60-0.64	5.08e-02	1.91	1.32	739.83	250.65	394.64	595.83	222.94	
1	73	1073	2.55-3.55e-02	0.70	1.81	1.17	670.29	81.84	468.11	284.03	279.46	
1	73	1074	0.22-3.94	-3.94	0.21	-0.12	559.79	-132.95	440.55	-13.71	261.51	
1	73	1076	12.90-16.16	8.43	-11.69	-10.48	-383.37	-626.52	-626.52	-383.37	-0.73	
1	73	1077	5.93-1.26	1.47	3.20	3.49	343.57	-130.53	230.44	-17.39	202.09	
1	73	1078	-0.39-3.59	-3.56	-0.42	0.31	620.73	-55.80	604.13	-39.20	104.67	
1	73	1079	-0.33-4.75	-4.75	-0.33	5.05e-03	757.59	-36.81	755.85	-35.06	37.21	
1	73	1080	-0.33-4.77	-4.77	-0.33	-1.12e-02	760.18	-36.04	759.01	-34.87	-30.54	
1	73	1081	-0.41-3.69	-3.66	-0.43	-0.29	630.52	-53.17	616.21	-38.86	-97.89	
1	73	1082	1.79-6.47e-02-5.48e-02	1.78	1.78	0.14	582.86	92.10	93.22	581.74	23.40	
1	73	1083	2.06-0.13-7.50e-02	2.00	2.00	0.36	634.84	99.59	106.52	627.91	60.51	
1	73	1084	2.61-0.28	-0.13	2.46	0.63	707.25	106.67	125.95	687.97	105.86	
1	73	1085	3.60-0.57	-0.20	3.23	1.19	759.93	95.18	138.48	716.63	164.04	
1	73	1086	4.60-1.19	4.08e-02	3.37	2.37	738.32	6.62	107.13	637.81	251.88	
1	73	1087	4.40-1.22	-0.20	3.38	-2.17	580.27	-288.48	-1.51	293.30	408.60	
1	73	1088	5.37-1.43	1.11	2.83	-3.29	356.33	-119.21	258.23	-21.11	-192.43	
1	73	1089	9.631.41	8.81	2.22	2.45	586.29	-128.49	-73.59	531.39	-190.34	
1	73	1090	5.881.68	1.87	5.69	-0.87	769.79	-66.28	-12.20	715.70	-205.66	
1	73	1091	3.53-6.84e-02-6.63e-03	3.47	3.47	-0.47	745.94	-44.52	-15.72	717.14	-148.10	
1	73	1092	2.68-0.13-7.74e-02	2.62	2.62	-0.39	677.47	-40.03	-27.52	664.96	-93.91	
1	73	1093	2.21-7.68e-02-5.27e-02	2.19	2.19	-0.23	606.47	-42.46	-38.76	602.78	-48.84	
1	73	1094	2.01-4.44e-02-4.25e-02	2.00	2.00	-6.11e-02	568.45	-44.85	-44.65	568.26	-10.98	
1	73	1095	2.04-5.02e-02-4.38e-02	2.04	2.04	0.11	578.55	-44.29	-43.28	577.54	25.00	
1	73	1096	2.33-9.29e-02-5.90e-02	2.29	2.29	0.28	633.02	-41.55	-35.23	626.70	64.98	
1	73	1097	2.87-0.16-9.65e-02	2.81	2.81	0.42	708.77	-41.56	-24.02	691.23	113.37	
1	73	1098	3.86-9.99e-02-5.21e-02	3.81	3.81	0.43	760.50	-54.93	-18.16	723.72	169.22	
1	73	1099	6.481.79	1.84	6.43	0.48	729.70	-99.12	-38.70	669.28	215.47	
1	73	1100	12.97-4.95	12.03	-4.01	-3.99	440.09	-294.38	-262.65	408.36	149.32	
1	73	1101	-1.77-19.36	-17.11	-4.02	5.88	213.73	-301.98	-294.29	206.03	62.53	
1	73	1102	0.31-14.45	0.22	-14.35	-1.17	531.86	-721.12	-721.12	531.86	-0.21	
1	73	1103	-2.69-13.01	-12.98	-2.72	0.57	431.97	-1015.31	-1015.31	431.96	1.43	
1	73	1104	-2.65-14.00	-13.17	-3.47	-2.94	451.55	-1073.13	-1072.15	450.57	-38.67	
1	73	1105	6.54-19.87	5.53	-18.86	5.06	664.95	-1077.41	-1077.41	664.95	-0.83	





EGP CODE

GRE.EEC.R.73.IT.W.15235.12.024.01

PAGE

456 di/of 527

1	73	1106	-1.10-12.48	-11.21	-2.36	3.58	596.50	-1615.28	-1614.20	595.42	48.89
1	73	1107	-1.10-13.01	-11.64	-2.48	-3.80	566.17	-1502.05	-1500.93	565.05	-48.15
1	73	1108	1.91-18.78	0.10	-16.97	-5.85	559.72	-810.61	-810.51	559.62	-11.76
1	73	1109	-2.30-10.90	-10.38	-2.82	2.04	445.06	-1073.18	-1073.13	445.00	-9.03
1	73	1110	-4.26-14.51	-10.91	-7.86	-4.89	299.15	-346.96	-343.63	295.82	-46.27
1	73	1111	3.59-1.89	-0.97	2.67	2.05	177.82	-82.19	159.95	-64.32	-65.78
1	73	1112	-0.57-3.87	-3.52	-0.91	-1.01	666.87	-68.61	663.39	-65.13	-50.51
1	73	1113	-0.61-5.07	-5.07	-0.61	2.27e-02	794.04	-45.50	793.60	-45.05	19.25
1	73	1114	-0.75-4.37	-4.36	-0.76	0.17	665.01	-56.50	655.13	-46.62	83.86
1	73	1115	2.07-2.89	7.10e-02	-0.89	2.43	257.04	-124.91	197.20	-65.07	138.84
1	73	1116	12.20-1.98	4.12	6.10	-7.02	-90.62	-827.25	-826.72	-91.16	-19.90
1	73	1117	11.40-2.15	4.11	5.14	6.76	-102.40	-836.39	-831.78	-107.02	58.00
1	73	1118	2.11-2.34	0.44	-0.67	-2.15	162.87	-100.48	124.62	-62.22	-92.80
1	73	1119	-0.71-3.74	-3.73	-0.72	-0.16	511.61	-50.53	508.96	-47.88	-38.49
1	73	1120	-0.53-3.68	-3.67	-0.54	0.18	562.34	-47.39	561.24	-46.30	25.85
1	73	1121	3.56-1.44	1.44	0.68	2.47	343.91	-74.81	316.68	-47.58	103.25
1	73	1122	10.93-6.47	7.51	-3.05	-6.91	-208.49	-419.50	-417.61	-210.39	-19.91
1	73	1123	-0.41-4.02	-4.02	-0.41	2.42e-02	735.46	-39.86	733.65	-38.05	37.43
1	73	1124	10.87-6.43	7.40	-2.96	6.93	-208.25	-408.53	-408.26	-208.52	7.34
1	73	1125	3.45-1.67	1.10	0.68	-2.55	375.00	-79.67	342.19	-46.87	-117.64
1	73	1126	-0.49-4.10	-4.09	-0.50	-0.18	624.68	-46.76	622.55	-44.63	-37.73
1	73	1127	-0.43-4.26	-4.25	-0.43	0.16	641.07	-45.79	639.46	-44.17	33.22
1	73	1128	3.30-1.71	0.41	1.18	2.47	428.47	-71.75	398.82	-42.10	118.12
1	73	1129	9.69-7.96	6.72	-4.99	-6.61	-230.46	-278.23	-266.80	-241.89	20.38
1	73	1130	12.20-14.42	8.08	-10.30	9.63	-351.78	-561.77	-561.50	-352.06	-7.60
1	73	1131	13.96-3.75	9.94	0.27	7.42	-169.22	-642.15	-640.13	-171.24	30.84
1	73	1132	4.71-1.70	3.06	-5.60e-02	-2.80	289.01	-100.30	246.29	-57.58	-121.68
1	73	1133	-0.61-3.23	-3.21	-0.63	-0.23	597.90	-50.74	594.43	-47.27	-47.29
1	73	1134	-0.54-3.99	-3.99	-0.54	-1.04e-02	649.82	-45.72	649.03	-44.94	23.38
1	73	1135	-0.90-3.02	-2.99	-0.93	0.24	460.25	-67.25	444.63	-51.63	89.42
1	73	1136	4.48-2.94	3.18	-1.64	2.82	29.06	-247.59	-140.18	-78.36	134.83
1	73	1137	17.762.63	9.52	10.86	-7.53	-57.14	-1304.91	-1303.11	-58.94	-47.37
1	73	1138	16.53-9.68	5.98	0.87	12.85	-231.87	-1180.18	-1175.66	-236.38	65.30
1	73	1139	4.60-2.45	1.36	0.79	-3.51	174.21	-234.92	-13.67	-47.04	-203.89
1	73	1140	-0.59-4.08	-4.07	-0.60	-0.17	521.30	-73.38	490.84	-42.92	-131.09
1	73	1141	-0.34-4.70	-4.70	-0.34	4.19e-02	721.25	-41.70	715.15	-35.60	-67.96
1	73	1142	-0.26-4.72	-4.72	-0.26	1.86e-03	779.63	-33.52	779.63	-33.52	-0.36
1	73	1143	-0.35-4.43	-4.43	-0.35	-2.33e-02	722.70	-41.57	716.73	-35.60	67.28
1	73	1144	-0.51-3.13	-3.11	-0.54	0.28	524.27	-72.44	494.05	-42.21	130.85
1	73	1145	7.72-1.30	5.13	1.29	4.08	188.95	-229.70	-0.69	-40.05	208.40
1	73	1146	19.76-10.91	13.36	-4.50	-12.47	-282.71	-1119.72	-1114.10	-288.33	-68.36
1	73	1147	9.01-4.31	-2.38	7.08	-4.69	-22.48	-340.93	-328.53	-34.88	61.60
1	73	1148	13.56-16.61	8.74	-11.80	11.05	-390.78	-634.65	-634.61	-390.82	3.29
1	73	1149	6.23-1.34	1.89	2.99	-3.74	340.64	-128.37	230.90	-18.63	-198.56
1	73	1150	-0.20-4.55	-4.54	-0.22	-0.22	624.77	-55.58	607.92	-38.72	-105.75
1	73	1151	-0.29-5.32	-5.32	-0.29	1.05e-02	762.14	-37.15	760.34	-35.34	-37.92
1	73	1152	-0.29-5.32	-5.32	-0.29	-1.46e-03	764.66	-36.35	763.45	-35.15	31.03
1	73	1153	-0.23-4.59	-4.58	-0.24	0.21	634.43	-52.88	619.93	-38.38	98.77
1	73	1154	5.65-1.47	1.52	2.66	3.52	354.14	-116.98	259.11	-21.95	189.05
1	73	1155	12.75-14.96	8.26	-10.47	-10.21	-360.45	-568.20	-568.08	-360.56	4.95
1	73	1156	17.52-8.95	12.22	-3.65	-10.59	-252.45	-1003.99	-999.34	-257.10	-58.92
1	73	1157	18.29-9.49	12.45	-3.65	11.32	-259.31	-1011.17	-1005.42	-265.07	65.53
1	73	1158	6.93-1.35	4.54	1.04	-3.76	202.31	-180.16	65.22	-43.06	-183.41
1	73	1159	-0.51-3.35	-3.32	-0.54	-0.28	556.44	-62.25	537.73	-43.54	-105.94
1	73	1160	-0.37-4.65	-4.65	-0.37	-3.60e-03	737.69	-40.30	735.75	-38.36	-38.81
1	73	1161	-0.37-4.91	-4.91	-0.37	-1.37e-02	754.45	-39.59	753.15	-38.29	32.05
1	73	1162	-0.64-4.48	-4.47	-0.64	0.13	609.78	-59.85	594.33	-44.40	100.52
1	73	1163	3.08-2.88	0.10	9.64e-02	2.98	261.26	-151.83	165.20	-55.77	174.52
1	73	1164	13.44-6.81	3.76	2.87	-10.11	-174.29	-856.34	-855.73	-174.89	-20.29
1	73	1165	13.813.98	7.20	10.59	4.61	-30.23	-974.07	-972.62	-31.68	36.97
1	73	1166	3.10-2.79	2.17	-1.86	-2.15	24.21	-128.00	-21.45	-82.33	-69.75
1	73	1167	-0.86-2.57	-2.57	-0.86	-2.40e-02	362.51	-57.86	360.94	-56.29	-25.66
1	73	1168	2.93-1.13	0.69	1.10	2.02	302.73	-51.34	295.57	-44.18	49.84
1	73	1169	7.89-8.62	5.07	-5.81	-6.21	-221.41	-322.61	-291.12	-252.90	-46.85
1	73	1170	6.23-1.32	3.62	1.30	3.60	209.95	-183.42	69.94	-43.41	188.34
1	73	1171	12.85-6.28	7.82	-1.25	8.42	-189.80	-647.48	-647.45	-189.82	-3.45
1	73	1172	4.07-2.21	1.53	0.33	-3.08	362.11	-135.38	274.29	-47.57	-189.67
1	73	1173	-0.56-4.15	-4.14	-0.56	-0.15	708.50	-57.78	689.75	-39.03	-118.39
1	73	1174	-0.32-5.00	-5.00	-0.32	-5.01e-04	882.29	-36.93	878.86	-33.49	-56.08
1	73	1175	-0.32-5.25	-5.25	-0.33	-6.65e-02	924.91	-34.17	924.83	-34.09	8.93
1	73	1176	-0.80-5.26	-5.26	-0.80	-7.52e-02	830.25	-48.76	824.07	-42.58	73.44
1	73	1177	-0.36-4.34	-2.83	-1.87	1.93	503.04	-106.55	471.81	-75.32	134.39
1	73	1178	6.94-1.31	4.09	1.54	-3.92	196.25	-233.31	3.81	-40.87	-213.62
1	73	1179	-1.53-18.71	-16.37	-3.87	-5.90	213.81	-305.53	-297.14	205.41	-65.48
1	73	1180	0.19-12.838	7.9e-02	-12.72	1.17	516.55	-731.31	-731.31	516.55	-0.13
1	73	1181	-2.41-13.37	-13.34	-2.44	-0.58	426.05	-1014.98	-1014.98	426.04	-1.98



EGP CODE

GRE.EEC.R.73.IT.W.15235.12.024.01

PAGE

457 di/of 527

1	73	1182	-2.58-14.16	-13.55	-3.20	2.60	445.10	-1072.85	-1072.03	444.28	35.30
1	73	1183	6.03-17.50	5.20	-16.66	-4.35	647.09	-1091.10	-1091.10	647.08	0.73
1	73	1184	-1.13-12.71	-11.84	-2.01	-3.05	589.08	-1615.32	-1614.47	588.22	-43.48
1	73	1185	-1.13-13.24	-12.23	-2.14	3.34	558.93	-1501.75	-1500.83	558.00	43.66
1	73	1186	1.63-16.79-4.15e-02		-15.12	5.29	543.70	-821.39	-821.28	543.59	12.10
1	73	1187	-1.87-11.23	-10.50	-2.60	-2.51	438.90	-1073.47	-1073.47	438.90	1.43
1	73	1188	-3.13-14.06	-9.58	-7.60	5.37	297.77	-354.75	-351.20	294.22	48.00
1	73	1189	3.93-0.23	0.27	3.42	-1.36	175.83	-70.18	155.12	-49.48	68.29
1	73	1190	-0.68-3.99	-3.66	-1.01	1.00	664.61	-71.05	661.04	-67.48	51.12
1	73	1191	-0.73-4.75	-4.75	-0.73	1.32e-04	794.31	-45.87	793.86	-45.42	-19.36
1	73	1192	-0.96-4.12	-4.12	-0.96	-0.15	667.39	-57.37	657.30	-47.29	-84.89
1	73	1193	1.43-3.53	-1.14	-0.96	-2.48	259.99	-130.38	198.26	-68.65	-142.43
1	73	1194	11.19-0.43	5.22	5.53	5.81	-75.27	-831.40	-831.24	-75.43	10.92
1	73	1195	10.20-1.53	4.42	4.25	-5.87	-93.12	-841.78	-838.18	-96.72	-51.78
1	73	1196	1.47-2.80	-0.69	-0.65	2.13	168.07	-105.48	127.05	-64.45	97.67
1	73	1197	-0.90-3.13	-3.12	-0.91	0.12	512.89	-51.24	510.00	-48.34	40.32
1	73	1198	-0.68-2.77	-2.74	-0.71	-0.25	561.65	-47.63	560.62	-46.60	-25.07
1	73	1199	3.32-1.31	1.14	0.87	-2.31	347.28	-75.29	318.59	-46.60	-106.30
1	73	1200	10.50-6.21	7.36	-3.07	6.52	-204.33	-413.34	-411.90	-205.76	17.28
1	73	1201	-0.88-4.15	-4.14	-0.89	-0.12	611.30	-61.09	595.54	-45.33	-101.73
1	73	1202	10.61-5.90	7.53	-2.82	-6.43	-200.54	-405.30	-405.23	-200.61	-3.81
1	73	1203	3.20-1.61	0.77	0.82	2.41	376.20	-81.32	341.59	-46.72	120.98
1	73	1204	-0.67-3.12	-3.10	-0.69	0.22	621.23	-47.15	619.09	-45.00	37.79
1	73	1205	-0.59-3.26	-3.25	-0.61	-0.21	637.10	-46.08	635.47	-44.45	-33.32
1	73	1206	3.14-1.57	0.26	1.31	-2.30	428.32	-72.41	397.02	-41.11	-121.22
1	73	1207	9.35-7.56	6.67	-4.88	6.18	-223.06	-275.52	-263.11	-235.47	-22.29
1	73	1209	13.43-3.33	9.84	0.25	-6.87	-163.30	-637.80	-636.40	-164.70	-25.78
1	73	1210	4.18-1.62	2.41	0.15	2.67	294.47	-102.44	249.69	-57.66	125.57
1	73	1211	-0.77-2.35	-2.30	-0.82	0.28	597.70	-51.03	594.31	-47.64	46.76
1	73	1212	-0.59-3.31	-3.31	-0.59	2.92e-02	649.36	-45.55	648.51	-44.70	-24.32
1	73	1213	-1.12-2.55	-2.52	-1.15	-0.20	463.80	-68.42	447.61	-52.23	-91.40
1	73	1214	3.02-3.25	1.28	-1.51	-2.81	35.81	-252.92	-136.23	-80.88	-141.69
1	73	1215	15.882.87	9.65	9.10	6.49	-48.70	-1312.81	-1311.16	-50.35	45.59
1	73	1216	15.66-7.55	7.44	0.67	-11.10	-208.17	-1183.74	-1181.12	-210.78	-50.43
1	73	1217	3.72-3.42	-0.31	0.62	3.54	177.77	-242.62	-12.00	-52.85	209.20
1	73	1218	-0.87-3.77	-3.76	-0.88	0.15	524.09	-74.82	493.33	-44.06	132.19
1	73	1219	-0.37-4.40	-4.40	-0.37	-4.97e-02	720.58	-41.57	714.42	-35.42	68.19
1	73	1220	-0.26-4.38	-4.38	-0.26	-1.10e-02	777.62	-33.18	777.61	-33.18	1.14
1	73	1221	-0.39-3.83	-3.83	-0.39	2.06e-03	720.00	-41.03	714.28	-35.31	-65.74
1	73	1222	-0.72-2.14	-2.06	-0.80	-0.34	523.26	-72.67	493.53	-42.94	-129.73

M_G	N max	N min	N 1	N 2	N 1-2	M max	M min	M 1	M 2	M 1-2
	-117.68	-76.90	-117.68	-37.84		-3901.36	-3888.02	-2366.26	-998.94	
	91.88	89.35	89.93	34.04	3193.72		1872.66	3148.81	905.25	

## 18. VERIFICHE ELEMENTI TRAVE E/O PILASTRO IN C.A.

### 18.1. LEGENDA TABELLA VERIFICHE ELEMENTI TRAVE E/O PILASTRO IN C.A.

In tabella vengono riportati per ogni elemento il numero identificativo ed il codice di verifica con le sigle **Ok** o **NV**.

Nel caso in cui si sia proceduto alla progettazione con il metodo degli stati limite (**S.L.**) vengono riportati: il rapporto  $x/d$ , le verifiche per sollecitazioni proporzionali e la verifica per compressione media con l'indicazione delle combinazioni in cui si sono attinti i rispettivi valori.

Nel caso in cui si sia proceduto alla progettazione con le tensioni ammissibili (**T.A.**) vengono riportate le massime tensioni nell'elemento (massima compressione nel calcestruzzo, massima compressione media nel calcestruzzo, massima tensione nell'acciaio, massima tensione tangenziale) con l'indicazione delle combinazioni in cui si sono attinti i rispettivi valori.

Nel caso in cui la struttura abbia comportamento dissipativo e sia prevista la progettazione con il criterio della gerarchia delle resistenze (**G.R.**) vengono riportate le verifiche di sovreresistenza e del nodo.

Per gli elementi tipo pilastro sono riportati numero e diametro dei ferri di vertice, numero e diametro di ferri disposti lungo i lati L1 (paralleli alla base della sezione) e lungo i lati L2 (paralleli all'altezza della sezione).

Per gli elementi tipo trave sono riportati infine le quantità di armatura inferiore e superiore.

#### Schema della distribuzione delle armature longitudinali

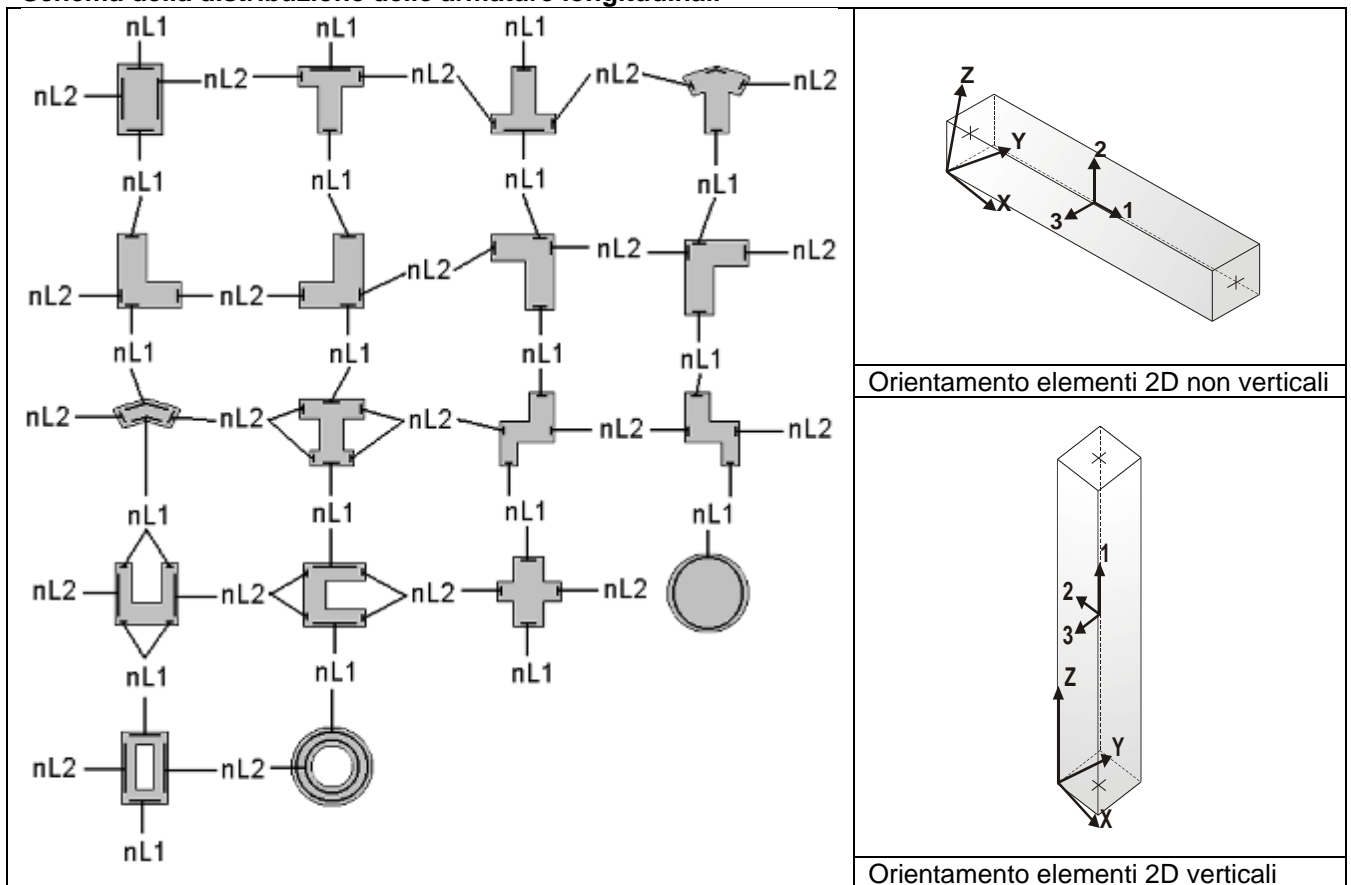

## 18.2. PROGETTAZIONE DELLE FONDAZIONI

Il D.M.17/01/2018 - par: 7.2.5 prevede:

“Sia per CD“A” sia per CD“B” il dimensionamento delle strutture di fondazione e la verifica di sicurezza del complesso fondazione-terreno devono essere eseguiti assumendo come azione in fondazione, trasmessa dagli elementi soprastanti, una tra le seguenti:

- quella derivante dall’analisi strutturale eseguita ipotizzando comportamento strutturale non dissipativo;
- [...];
- quella trasferita dagli elementi soprastanti nell’ipotesi di comportamento strutturale dissipativo, amplificata di un coefficiente pari a 1,30 in CD“A” e 1,10 in CD“B”;

Nel contesto visualizzazione risultati e nella stampa della relazione sulle fondazioni PRO\_SAP mostra le sollecitazioni che derivano dall’analisi non incrementate sia in termini di pressioni sul terreno che in termini di sollecitazioni.

La progettazione degli elementi strutturali con proprietà fondazione è effettuata da PRO\_SAP (per travi e platee) o da PRO\_CAD Plinti (per plinti e pali di fondazione) incrementando le sollecitazioni delle combinazioni con sisma di un coefficiente pari 1.1 in CDB e 1.3 in CDA per pali, plinti, travi e platee.

Per i bicchieri dei plinti di fondazione prefabbricati l’incremento delle sollecitazioni ha un fattore pari a 1.2 in CDB e 1.35 in CDA.

N.B.: nel caso di comportamento strutturale non dissipativo la progettazione viene effettuata senza nessun incremento.

Le verifiche geotecniche vengono effettuate dal modulo geotecnico incrementando automaticamente le sollecitazioni del fattore 1.1 in CDB e 1.3 in CDA per pali, plinti, travi e platee.

N.B.: nel caso di comportamento strutturale non dissipativo le verifiche geotecniche vengono effettuate senza nessun incremento.

### Simbologia adottata nelle tabelle di verifica

Per le verifiche agli S.L. dei pilastri è presente una tabella con i simboli di seguito descritti:

M_P X Y	Numero della pilastrata (P) e posizione in pianta (X,Y)
Pilas.	numero identificativo dell’elemento D2
Note	Codici identificativi delle sezione (s) e materiale (m) pilastro
Stato	Codici relativi all’esito delle verifiche effettuate appresso descritte
Quota	Quota sezione di verifica
%Af	Percentuale di area di armatura rispetto a quella di calcestruzzo
r. snell.	Rapporto di snellezza $\lambda$ su $\lambda^*$ : valore superiore a 1 per elementi snelli nel caso in cui viene effettuata la verifica con il metodo diretto dello stato di equilibrio
Armat. long.	Numero e diametro (d) dei ferri di armatura longitudinale distinti in ferri di vertice + ferri di lato nelle posizioni nL1 e nL2, come da schemi in figura precedente
V N/M	Verifica a pressoflessione con rapporto $E_d/R_d$ : valore minore o uguale a 1 per verifica positiva
V N sis	Verifica a compressione solo calcestruzzo con rapporto $N_{sd}/N_{rd}$ ed $N_{rd}$ calcolato come al punto 7.4.4.2.1: valore minore o uguale a 1 per verifica positiva
Staffe	Dati tratto di staffatura oggetto di verifica, nello specifico: numero delle braccia, diametro, passo, lunghezza L tratto
V V/T cls	Verifica a taglio/torsione con rapporto $V_{ed}/V_{rd}$ : valore minore o uguale a 1 per verifica positiva
Rif. cmb.	Riferimento combinazioni da cui si generano le verifiche più gravose per il pilastro

Per le verifiche alla G.R. dei pilastri è presente una tabella con i simboli di seguito descritti:

Pilas.	numero identificativo dell’elemento D2 pilastro
sovr. Xi (Xf)	Verifica sovreresistenza come da formula 7.4.4 in direzione X, alla base (i) ed alla sommità (f): rapporto tra i momenti resistenti dei pilastri e delle travi. La verifica è positiva se maggiore del $\gamma_{Rd}$ adottato
sovr. Yi (Yf)	Verifica sovreresistenza come da formula 7.4.4 in direzione Y, alla base (i) ed alla sommità (f): rapporto tra i momenti resistenti dei pilastri e delle travi. La verifica è positiva se maggiore del $\gamma_{Rd}$ adottato
M 2-2 i (f)	Valore del momento resistente 2-2 alla base (i) ed alla sommità (f) con massimo momento in presenza dello sforzo normale di calcolo

M 3-3 i (f)	Valore del momento resistente 3-3 alla base (i) ed alla sommità (f) con massimo momento in presenza dello sforzo normale di calcolo
Luce per V	Luce di calcolo per la definizione del taglio (generato dai momenti resistenti)
V M2-2 (M3-3)	Valore del taglio generato dai momenti resistenti 2-2 (3-3)

**Per le verifiche dei dettagli costruttivi per la duttilità è presente una tabella con i simboli di seguito descritti: (Non presente nel caso di comportamento strutturale non dissipativo)**

Pilas	Numero identificativo D2 pilastro
ni	Sforzo assiale adimensionalizzato di progetto relativo alla combinazione sismica SLV
alfaomega	Prodotto tra il coefficiente di efficacia del confinamento e il rapporto meccanico dell'armatura trasversale di confinamento all'interno del nodo
V.7.4.29 2-2 (3-3)	Rapporto tra la domanda di staffe minima nel nodo e il rapporto meccanico dell'armatura trasversale di confinamento inserito all'interno del nodo in direzione 2 (3)
V. 7.4.29 Stato	Codici relativi all'esito della verifica 7.4.29
dmu_fi 2-2 (3-3)	Domanda in duttilità di curvatura in direzione 2 (3)
cmu_fi 2-2 (3-3)	Capacità in duttilità di curvatura in direzione 2 (3)
V. dutt. 2-2 (3-3)	Rapporto tra la domanda in duttilità di curvatura e la capacità in duttilità di curvatura in direzione 2 (3)

**Per le verifiche nodi trave-pilastro di elementi nuovi è presente una tabella con i simboli di seguito descritti:**

Nodo	Numero identificativo del nodo trave-pilastro
Stato	Esito delle verifiche
Pilastro	Numero identificativo D2 pilastro
Diam st	Diametro staffe nodo
Passo	Passo staffe nodo
n. br. 2 (3)	Numero braccia staffe per il taglio in direzione 2 (3)
Bj2 (3)	Larghezza effettiva del nodo per il taglio in direzione 2 (3)
Hjc2 (3)	Distanza tra le giaciture più esterne delle armature del pilastro per il taglio in direzione 2 (3)
V. 7.4.8	Rapporto tra il taglio Vjbd e il taglio resistente come da formula 7.4.8
V. Ash	Rapporto tra il passo staffe calcolato secondo il capitolo 7.4.4.3.1. e il passo staffe effettivamente inserita nel nodo. Nel caso di valore indica passo staffe utilizzato deriva dalle formule presenti nel paragrafo 7.4.4.3.1. Nel caso di valore minore di 1 il passo staffe utilizzato deriva del pilastro superiore o inferiore al nodo
7.4.10	Check passo staffe valutato in funzione della formula 7.4.10: <ul style="list-style-type: none"> <li>• SI il passo staffe è calcolato utilizzando la formula 7.4.10;</li> <li>• NO il passo staffe è calcolato utilizzando le formule 7.4.11 e/o 7.4.12;</li> <li>• NR calcolo passo staffe non richiesto;</li> </ul>
Rif. comb.	Riferimento combinazioni da cui si generano le verifiche più gravose per il nodo

**Per le verifiche nodi trave-pilastro di elementi esistenti è presente una tabella con i simboli di seguito descritti:**

Pilastro I	Numero identificativo D2 del pilastro inferiore.
Pilastro S	Numero identificativo D2 del pilastro superiore.
Nodo	Numero identificativo del nodo trave-pilastro.
SL cod	Stato limite di riferimento e relativo esito delle verifiche.
ver. (+)	Fattore di sicurezza nei riguardi della verifica di resistenza a compressione (verificato se < 1.00).
V +	Azione di Taglio presente al di sopra del nodo nella verifica di resistenza a compressione.
V + af s	Sollecitazione di trazione presente nell' armatura longitudinale superiore della trave nella verifica di resistenza a compressione.
N +	Azione Assiale presente al di sopra del nodo nella verifica di resistenza a compressione.
ver. (-)	Fattore di sicurezza nei riguardi della verifica di resistenza a trazione (verificato se < 1.00).
V -	Azione di Taglio presente al di sopra del nodo nella verifica di resistenza a trazione.
V - af s	Sollecitazione di trazione presente nell' armatura longitudinale superiore della trave nella verifica di resistenza a trazione.
N -	Azione Assiale presente al di sopra del nodo nella verifica di resistenza a trazione.
AreaV2	Area resistente del nodo in direzione 2 ( $A_{j2}=b_{j2} \cdot h_{jc2}$ ).



AreaV3	Area resistente del nodo in direzione 3 ( $A_{j3}=b_{j3} \cdot h_{j3}$ ).
Rif. comb.	Combinazione (direzione) di riferimento nella verifica di trazione.

**Per le verifiche agli S.L. delle travi è presente una tabella con i simboli di seguito descritti:**

M_T Z P P	Numero della travata (T), quota media (Z), n° pilastrata iniziale (P) e finale (P) (nodo in assenza di pilastrata)
Trave	numero identificativo dell'elemento D2
Note	Codici identificativi sezione (s) e materiale (m) trave; sono inoltre presenti le sigle relative all'esito delle verifiche effettuate appresso descritte
%Af	Percentuale di area di armatura rispetto a quella di calcestruzzo
Af inf.	Area di armatura longitudinale posta all'intradosso
Af sup	Area di armatura longitudinale posta all'estradosso
Af long.	Area complessiva armatura longitudinale
x/d	rapporto tra posizione dell'asse neutro e altezza utile
V N/M	Verifica a pressoflessione rapporto $E_d/R_d$ : valore minore o uguale a 1 per verifica positiva
Staffe	Dati tratto di staffatura oggetto di verifica, nello specifico: numero delle braccia, diametro, passo, lunghezza L tratto
V V/T cls	Verifica a taglio/torsione con rapporto $V_{ed}/V_{rd}$ : valore minore o uguale a 1 per verifica positiva
Rif. cmb.	Riferimento combinazioni da cui si generano le verifiche più gravose per la trave

**Per le verifiche alla G.R. delle travi è presente una tabella con i simboli di seguito descritti:**

Trave	numero identificativo dell'elemento D2 trave
M negativo i (f)	Valore del momento resistente negativo all'estremità iniziale i (finale f) della trave
M positivo i (f)	Valore del momento resistente positivo all'estremità iniziale i (finale f) della trave
Luce per V	Luce di calcolo per la definizione del taglio (generato dai momenti resistenti)
V M-i M+f	Taglio generato dai momenti resistenti negativo i e positivo f
V M+i M-f	Taglio generato dai momenti resistenti positivo i e negativo f
V <sub>Ed, min</sub>	Valore di taglio minimo per verifica condizioni p.to 7.4.4.1.1 armatura diagonale (solo per CD "A")
V <sub>Ed, max</sub>	Valore di taglio massimo per verifica condizioni p.to 7.4.4.1.1 armatura diagonale (solo per CD "A")
V <sub>r1</sub>	Valore di taglio come da formula 7.4.1 per armatura diagonale (solo per CD "A")
A <sub>s</sub>	Area singolo ordine armature diagonali come da formula 7.4.2 (solo per CD "A")

**Per le verifiche a taglio ciclico di travi e pilastri esistenti è presente una tabella con i simboli di seguito descritti:**

Trave/Pilastro	Numero identificativo dell'elemento D2 trave/pilastro
V. SLV	Codice relativo all'esito delle verifiche
Nodo	Numero identificativo del nodo di verifica
Ver. VC	Fattore di sicurezza nei confronti della verifica a taglio ciclico (verificato se < 1.00)
Direz.	Direzione di verifica
N fr	Valore di sforzo normale calcolato con fattore di comportamento fragile
V fr	Valore di taglio calcolato con fattore di comportamento fragile
M fr	Valore di momento calcolato con fattore di comportamento fragile
N dutt	Valore di sforzo normale calcolato con fattore di comportamento duttile
LV	Lunghezza di taglio
Mud,pl	Parte plastica della domanda di duttilità
V cic	Resistenza a taglio in condizioni cicliche (C8.7.2.8)
Cmb	Riferimento combinazioni da cui si generano le verifiche più gravose

**Per le verifiche alle T.A. di pilastri e travi è presente una tabella con i simboli di seguito descritti:**

M_P X Y	Numero della pilastrata (P) e posizione in pianta (X, Y)
M_T Z P P	Numero della travata, quota media pilastrata iniziale e finale (nodo in assenza di pilastrata)
Pilas. o Trave	numero identificativo dell'elemento D2
Note	Viene riportato il codice relativo alla sezione(s) e relativo al materiale(m); nella terza riga viene riportato il valore delle snellezze in direzione 2-2 e 3-3
Stato	Codici di verifica relativi alle tensioni normali e alle tensioni tangenziali
Quota	Ascissa del punto di verifica
%Af	Percentuale di area di armatura rispetto a quella di calcestruzzo

Armat. long.	Numero e diametro dei ferri di armatura longitudinale: ferri di vertice + ferri di lato (come da fig. precedente)
Af inf.	Area di armatura longitudinale posta all'intradosso della trave
Af sup	Area di armatura longitudinale posta all'estradosso della trave
Sc max	Massima tensione di compressione del calcestruzzo
Sc med	Massima tensione media di compressione del calcestruzzo
Sf max	Tensione massima nell'acciaio
staffe	Vengono riportati i dati del tratto di staffatura in cui cade la sezione di verifica; in particolare: numero dei bracci, diametro, passo, lunghezza tratto
Tau max	Tensione massima tangenziale nel cls
Rif. comb	Combinazioni in cui si generano i seguenti valori di tensione: Sc max, Sc med, Sf max, Tau max
AfV	area dell'armatura atta ad assorbire le azioni di taglio
AfT	area dell'armatura atta ad assorbire le azioni di torsione
Scorr. P	Scorrimento dei piegati
Af long.	Area del ferro longitudinale aggiuntivo per assorbire la torsione

Con riferimento al **Documento di Affidabilità** "Test di validazione del software di calcolo PRO\_SAP e dei moduli aggiuntivi PRO\_SAP Modulo Geotecnico, PRO\_CAD nodi acciaio e PRO\_MST" - versione Maggio 2011, disponibile per il download sul sito [www.2si.it](http://www.2si.it), si segnalano i seguenti esempi applicativi:

Test N°	Titolo
24	TENSIONI E ROTAZIONI RISPETTO ALLA CORDA DI ELEMENTI TRAVE
27	FRECCIA DI ELEMENTI TRAVE
41	GERARCHIA DELLE RESISTENZE PER TRAVI IN C.A.
42	GERARCHIA DELLE RESISTENZE PER PILASTRI IN C.A.
43	VERIFICA ALLE TA DI STRUTTURE IN C.A.
44	VERIFICA AGLI SLU DI STRUTTURE IN C.A.
46	VERIFICA A PUNZONAMENTO ALLO SLU DI TRAVI IN C.A.
47	PROGETTAZIONE A TAGLIO DI STRUTTURE IN C.A. SECONDO IL D.M. 9/1/96
48	PROGETTAZIONE A TAGLIO DI STRUTTURE IN C.A. SECONDO IL D.M. 14/1/2008
49	VERIFICA ALLO SLE (TENSIONI E FESSURAZIONE) DI STRUTTURE IN C.A.
50	VERIFICA ALLO SLE (DEFORMAZIONE) DI STRUTTURE IN C.A.
52	SOVRARESISTENZE
53	DETTAGLI COSTRUTTIVI C.A.: LIMITI D'ARMATURA PILASTRI E NODI TRAVE-PILASTRO
68	VALUTAZIONE EFFETTO P- $\delta$ SU PILASTRATA
69	VALUTAZIONE EFFETTO P- $\delta$ SU TELAIO 3D
120	PROGETTO E VERIFICA DI TRAVI PREM

		<b>M<sub>P</sub>=1 X=0.0 Y=0.0</b>						
Pilas.	NoteStato	Quota	%Afr. snell.Armat. long.V N/M	V N sis	Staffe V V/T cls L=cm	V V/T acc	Rif. cmb	
1	s=1,m=5	ok,ok 150.0	0.01.79 0.254d16 2+2 d16 1.790.254d16 2+2 d160.13 300.01.79 0.254d16 2+2 d16	0.32 0.043+3d8/15 L=2000.41 0.40	0.043+3d8/12 L=50 L=2000.41 0.033+3d8/12 L=50	0.41 0.352,12,18,14 0.41	0.2910,12,18,14 0.2930,12,18,14	
		[b=1.0;1.0]	<b>M<sub>P</sub>=2 X=324.8 Y=0.0</b>					
12	s=1,m=5	ok,ok 150.0	0.01.79 0.324d16 2+2 d16 1.790.324d16 2+2 d160.18 300.01.79 0.324d16 2+2 d16	0.35 0.053+3d8/15 L=2000.39 0.51	0.063+3d8/12 L=50 L=2000.39 0.053+3d8/12 L=50	0.39 0.352,30,20,21 0.39	0.2930,30,20,21 0.2930,30,20,21	
		[b=1.0;1.0]	<b>M<sub>P</sub>=3 X=650.0 Y=0.0</b>					
13	s=1,m=5	ok,ok 150.0	0.01.79 0.324d16 2+2 d16 1.790.324d16 2+2 d160.19 300.01.79 0.324d16 2+2 d16	0.38 0.063+3d8/15 L=2000.40 0.55	0.063+3d8/12 L=50 L=2000.40 0.053+3d8/12 L=50	0.40 0.342,30,18,35 0.40	0.2930,30,18,35 0.2932,30,18,35	
		[b=1.0;1.0]	<b>M<sub>P</sub>=4X=1009.9 Y=0.0</b>					



EGP CODE

GRE.EEC.R.73.IT.W.15235.12.024.01

PAGE

463 di/of 527

Pilas. 14	NoteStato s=1,m=5	Quota ok,ok 150.0	%Afr. snell.Armat. long.V N/M 0.01.79 0.334d16 2+2 d16 1.790.334d16 2+2 d160.20 300.01.79 0.334d16 2+2 d16	V N sis 0.43 0.063+3d8/15 L=2000.40 0.60 0.053+3d8/12 L=50	Staffe V V/T cls 0.063+3d8/12 L=50 0.053+3d8/12 L=50	V V/T acc 0.40 0.342,32,18,27 0.40 0.2932,32,18,27	Rif. cmb 0.2930,32,18,27 0.2932,32,18,27
	[b=1.0;1.0]		<b>M_P= 5X=1370.2 Y=0.0</b>				
Pilas. 15	NoteStato s=1,m=5	Quota ok,ok 150.0	%Afr. snell.Armat. long.V N/M 0.01.79 0.354d16 2+2 d16 1.790.354d16 2+2 d160.22 300.01.79 0.354d16 2+2 d16	V N sis 0.47 0.063+3d8/15 L=2000.41 0.66 0.063+3d8/12 L=50	Staffe V V/T cls 0.073+3d8/12 L=50 0.063+3d8/12 L=50	V V/T acc 0.41 0.362,30,14,26 0.41 0.3032,30,14,26	Rif. cmb 0.3032,30,14,26 0.3032,30,14,26
	[b=1.0;1.0]		<b>M_P= 6X=1840.0 Y=0.0</b>				
Pilas. 16	NoteStato s=1,m=5	Quota ok,ok 150.0	%Afr. snell.Armat. long.V N/M 0.01.79 0.374d16 2+2 d16 1.790.374d16 2+2 d160.23 300.01.79 0.374d16 2+2 d16	V N sis 0.47 0.073+3d8/15 L=2000.42 0.69 0.073+3d8/12 L=50	Staffe V V/T cls 0.073+3d8/12 L=50 0.073+3d8/12 L=50	V V/T acc 0.42 0.36 2,28,8,26 0.42 0.30 2,28,8,26	Rif. cmb 0.3024,28,8,26 0.30 2,28,8,26
	[b=1.0;1.0]		<b>M_P= 7X=2309.8 Y=0.0</b>				
Pilas. 17	NoteStato s=1,m=5	Quota ok,ok 150.0	%Afr. snell.Armat. long.V N/M 0.01.79 0.364d16 2+2 d16 1.790.364d16 2+2 d160.22 300.01.79 0.364d16 2+2 d16	V N sis 0.51 0.073+3d8/15 L=2000.41 0.70 0.073+3d8/12 L=50	Staffe V V/T cls 0.073+3d8/12 L=50 0.073+3d8/12 L=50	V V/T acc 0.41 0.362,28,10,30 0.41 0.3022,28,10,30	Rif. cmb 0.3022,28,10,30 0.3022,28,10,30
	[b=1.0;1.0]		<b>M_P= 8X=2729.9 Y=0.0</b>				
Pilas. 18	NoteStato s=1,m=5	Quota ok,ok 150.0	%Afr. snell.Armat. long.V N/M 0.01.79 0.334d16 2+2 d16 1.790.334d16 2+2 d160.20 300.01.79 0.334d16 2+2 d16	V N sis 0.42 0.063+3d8/15 L=2000.40 0.59 0.053+3d8/12 L=50	Staffe V V/T cls 0.063+3d8/12 L=50 0.053+3d8/12 L=50	V V/T acc 0.40 0.34 2,24,6,36 0.40 0.2922,24,6,36	Rif. cmb 0.2924,24,6,36 0.2922,24,6,36
	[b=1.0;1.0]		<b>M_P= 9X=3009.8 Y=0.0</b>				
Pilas. 19	NoteStato s=1,m=5	Quota ok,ok 150.0	%Afr. snell.Armat. long.V N/M 0.01.79 0.334d16 2+2 d16 1.790.334d16 2+2 d160.19 300.01.79 0.334d16 2+2 d16	V N sis 0.39 0.063+3d8/15 L=2000.40 0.55 0.053+3d8/12 L=50	Staffe V V/T cls 0.063+3d8/12 L=50 0.053+3d8/12 L=50	V V/T acc 0.40 0.34 2,22,6,22 0.40 0.2924,22,6,22	Rif. cmb 0.2924,22,6,22 0.2924,22,6,22
	[b=1.0;1.0]		<b>M_P= 10X=3424.9 Y=0.0</b>				
Pilas. 20	NoteStato s=1,m=5	Quota ok,ok 150.0	%Afr. snell.Armat. long.V N/M 0.01.79 0.274d16 2+2 d16 1.790.274d16 2+2 d160.15 300.01.79 0.274d16 2+2 d16	V N sis 0.34 0.043+3d8/15 L=2000.42 0.45 0.043+3d8/12 L=50	Staffe V V/T cls 0.043+3d8/12 L=50 0.043+3d8/12 L=50	V V/T acc 0.42 0.36 2,6,14,17 0.42 0.3024,6,14,17	Rif. cmb 0.3024,6,14,17 0.3024,6,14,17
	[b=1.0;1.0]		<b>M_P= 11 X=0.0 Y=630.0</b>				
Pilas. 2	NoteStato s=1,m=5	Quota ok,ok 150.0	%Afr. snell.Armat. long.V N/M 0.01.79 0.254d16 2+2 d16 1.790.254d16 2+2 d160.13 300.01.79 0.254d16 2+2 d16	V N sis 0.32 0.043+3d8/15 L=2000.41 0.40 0.033+3d8/12 L=50	Staffe V V/T cls 0.043+3d8/12 L=50 0.033+3d8/12 L=50	V V/T acc 0.41 0.35 2,19,9,5 0.41 0.29 33,19,9,5	Rif. cmb 0.29 17,19,9,5 0.29 33,19,9,5
	[b=1.0;1.0]		<b>M_P= 12X=324.8 Y=630.0</b>				
Pilas. 3	NoteStato s=1,m=5	Quota ok,ok 150.0	%Afr. snell.Armat. long.V N/M 0.01.79 0.324d16 2+2 d16 1.790.324d16 2+2 d160.18 300.01.79 0.324d16 2+2 d16	V N sis 0.35 0.053+3d8/15 L=2000.39 0.51 0.053+3d8/12 L=50	Staffe V V/T cls 0.063+3d8/12 L=50 0.053+3d8/12 L=50	V V/T acc 0.39 0.342,33,11,26 0.39 0.2933,33,11,26	Rif. cmb 0.2933,33,11,26 0.2933,33,11,26
	[b=1.0;1.0]		<b>M_P= 13X=650.0 Y=630.0</b>				
Pilas. 4	NoteStato s=1,m=5	Quota ok,ok 150.0	%Afr. snell.Armat. long.V N/M 0.01.79 0.324d16 2+2 d16 1.790.324d16 2+2 d160.19 300.01.79 0.324d16 2+2 d16	V N sis 0.38 0.063+3d8/15 L=2000.40 0.55 0.053+3d8/12 L=50	Staffe V V/T cls 0.063+3d8/12 L=50 0.053+3d8/12 L=50	V V/T acc 0.40 0.34 2,33,9,32 0.40 0.2935,33,9,32	Rif. cmb 0.2933,33,9,32 0.2935,33,9,32
	[b=1.0;1.0]		<b>M_P= 14X=1009.9Y=630.0</b>				
Pilas. 5	NoteStato s=1,m=5	Quota ok,ok 150.0	%Afr. snell.Armat. long.V N/M 0.01.79 0.334d16 2+2 d16 1.790.334d16 2+2 d160.20 300.01.79 0.334d16 2+2 d16	V N sis 0.42 0.063+3d8/15 L=2000.40 0.60 0.053+3d8/12 L=50	Staffe V V/T cls 0.063+3d8/12 L=50 0.053+3d8/12 L=50	V V/T acc 0.40 0.342,35,19,26 0.40 0.2935,35,19,26	Rif. cmb 0.2933,35,19,26 0.2935,35,19,26
	[b=1.0;1.0]		<b>M_P= 15X=1370.2Y=630.0</b>				
Pilas. 6	NoteStato s=1,m=5	Quota ok,ok 150.0	%Afr. snell.Armat. long.V N/M 0.01.79 0.354d16 2+2 d16 1.790.354d16 2+2 d160.22 300.01.79 0.354d16 2+2 d16	V N sis 0.47 0.063+3d8/15 L=2000.41 0.66 0.063+3d8/12 L=50	Staffe V V/T cls 0.073+3d8/12 L=50 0.063+3d8/12 L=50	V V/T acc 0.41 0.362,33,15,21 0.41 0.3035,33,15,21	Rif. cmb 0.3035,33,15,21 0.3035,33,15,21
	[b=1.0;1.0]		<b>M_P= 16X=1840.0Y=630.0</b>				
Pilas. 7	NoteStato s=1,m=5	Quota ok,ok 150.0	%Afr. snell.Armat. long.V N/M 0.01.79 0.374d16 2+2 d16 1.790.374d16 2+2 d160.23 300.01.79 0.374d16 2+2 d16	V N sis 0.47 0.073+3d8/15 L=2000.42 0.69 0.073+3d8/12 L=50	Staffe V V/T cls 0.073+3d8/12 L=50 0.073+3d8/12 L=50	V V/T acc 0.42 0.362,27,15,27 0.42 0.302,27,15,27	Rif. cmb 0.3027,27,15,27 0.302,27,15,27
	[b=1.0;1.0]		<b>M_P= 17X=2309.8Y=630.0</b>				
Pilas. 8	NoteStato s=1,m=5	Quota ok,ok 150.0	%Afr. snell.Armat. long.V N/M 0.01.79 0.364d16 2+2 d16 1.790.364d16 2+2 d160.22 300.01.79 0.364d16 2+2 d16	V N sis 0.51 0.073+3d8/15 L=2000.41 0.70 0.073+3d8/12 L=50	Staffe V V/T cls 0.073+3d8/12 L=50 0.073+3d8/12 L=50	V V/T acc 0.41 0.362,23,17,33 0.41 0.3025,23,17,33	Rif. cmb 0.3025,23,17,33 0.3025,23,17,33
	[b=1.0;1.0]		<b>M_P= 18X=2729.9Y=630.0</b>				
Pilas. 9	NoteStato s=1,m=5	Quota ok,ok 150.0	%Afr. snell.Armat. long.V N/M 0.01.79 0.334d16 2+2 d16 1.790.334d16 2+2 d160.20 300.01.79 0.334d16 2+2 d16	V N sis 0.42 0.063+3d8/15 L=2000.40 0.59 0.053+3d8/12 L=50	Staffe V V/T cls 0.063+3d8/12 L=50 0.053+3d8/12 L=50	V V/T acc 0.40 0.342,27,13,31 0.40 0.2925,27,13,31	Rif. cmb 0.2927,27,13,31 0.2925,27,13,31
	[b=1.0;1.0]		<b>M_P= 19X=3009.8Y=630.0</b>				
Pilas.	NoteStato	Quota	%Afr. snell.Armat. long.V N/M	V N sis	Staffe V V/T cls	V V/T acc	Rif. cmb



EGP CODE

GRE.EEC.R.73.IT.W.15235.12.024.01

PAGE

464 di/of 527

10	s=1,m=5	ok,ok	0.01.79	0.334d16 2+2 d16	0.39	0.063+3d8/12 L=50	0.40	0.2927,25,13,28
		150.0	1.790.334d16 2+2 d160.19		0.063+3d8/15 L=2000.40		0.342,25,13,28	
	[b=1.0;1.0]		300.01.79	0.334d16 2+2 d16	0.55	0.053+3d8/12 L=50	0.40	0.2927,25,13,28
			<b>M_P= 20X=3424.9Y=630.0</b>					

Pilas.	NoteStato	Quota	%Afr. snell.Armat. long.V N/M	V N sis	Staffe V V/T cls	V V/T acc	Rif. cmb	
11	s=1,m=5	ok,ok	0.01.79	0.274d16 2+2 d16	0.34	0.043+3d8/12 L=50	0.43	0.3027,13,7,10
		150.0	1.790.274d16 2+2 d160.15		0.043+3d8/15 L=2000.43		0.36 2,13,7,10	
	[b=1.0;1.0]		300.01.79	0.274d16 2+2 d16	0.45	0.043+3d8/12 L=50	0.43	0.3027,13,7,10

<b>Pilas.</b>	<b>%Afr. snell.</b>	<b>V N/M</b>	<b>V N sis</b>	<b>V V/T cls</b>	<b>V V/T acc</b>
	1.790.37	0.70	0.07	0.43	0.36

Pilas.	sovr. Xi	sovr. Xf	sovr. Yi	sovr. Yf	M 2-2 i	M 2-2 f	M 3-3 i	M 3-3 f	Luce per V	V M2-2	V M3-3
					daN cm	daN cm	daN cm	cm	daN	daN	
1	0.0	0.0	0.0	0.0	7.994e+05	7.922e+05	7.994e+05	7.922e+05	240.00	7327.83	7327.83
2	0.0	0.0	0.0	0.0	7.995e+05	7.923e+05	7.995e+05	7.923e+05	240.00	7328.87	7328.87
3	0.0	0.0	0.0	0.0	8.192e+05	8.120e+05	8.192e+05	8.120e+05	240.00	7509.23	7509.23
4	0.0	0.0	0.0	0.0	8.197e+05	8.126e+05	8.197e+05	8.126e+05	240.00	7514.28	7514.28
5	0.0	0.0	0.0	0.0	8.222e+05	8.150e+05	8.222e+05	8.150e+05	240.00	7536.79	7536.79
6	0.0	0.0	0.0	0.0	8.306e+05	8.235e+05	8.306e+05	8.235e+05	240.00	7614.04	7614.04
7	0.0	0.0	0.0	0.0	8.374e+05	8.303e+05	8.374e+05	8.303e+05	240.00	7676.46	7676.46
8	0.0	0.0	0.0	0.0	8.350e+05	8.279e+05	8.350e+05	8.279e+05	240.00	7654.18	7654.18
9	0.0	0.0	0.0	0.0	8.209e+05	8.137e+05	8.209e+05	8.137e+05	240.00	7524.84	7524.84
10	0.0	0.0	0.0	0.0	8.222e+05	8.150e+05	8.222e+05	8.150e+05	240.00	7536.46	7536.46
11	0.0	0.0	0.0	0.0	8.035e+05	7.962e+05	8.035e+05	7.962e+05	240.00	7365.17	7365.17
12	0.0	0.0	0.0	0.0	8.192e+05	8.120e+05	8.192e+05	8.120e+05	240.00	7509.38	7509.38
13	0.0	0.0	0.0	0.0	8.197e+05	8.125e+05	8.197e+05	8.125e+05	240.00	7514.11	7514.11
14	0.0	0.0	0.0	0.0	8.222e+05	8.150e+05	8.222e+05	8.150e+05	240.00	7536.68	7536.68
15	0.0	0.0	0.0	0.0	8.306e+05	8.235e+05	8.306e+05	8.235e+05	240.00	7614.19	7614.19
16	0.0	0.0	0.0	0.0	8.374e+05	8.303e+05	8.374e+05	8.303e+05	240.00	7676.33	7676.33
17	0.0	0.0	0.0	0.0	8.350e+05	8.279e+05	8.350e+05	8.279e+05	240.00	7654.22	7654.22
18	0.0	0.0	0.0	0.0	8.210e+05	8.138e+05	8.210e+05	8.138e+05	240.00	7525.38	7525.38
19	0.0	0.0	0.0	0.0	8.221e+05	8.150e+05	8.221e+05	8.150e+05	240.00	7535.93	7535.93
20	0.0	0.0	0.0	0.0	8.034e+05	7.961e+05	8.034e+05	7.961e+05	240.00	7364.18	7364.18

<b>Pilas.</b>	<b>M 2-2 i</b>	<b>M 2-2 f</b>	<b>M 3-3 i</b>	<b>M 3-3 f</b>	<b>V M2-2</b>	<b>V M3-3</b>
	8.374e+05	8.303e+05	8.374e+05	8.303e+05	7676.46	7676.46

Pilas.	nid	alfaomegaV. 2-2	3-3	V. 7.4.29 Stato	V. 7.4.29 2-2	dmu_fi 3-3	dmu_fi 2-2	cmu_fi 3-3	cmu_fi 2-2	V. dut. 3-3	V. dut. 2-2
1	0.03	0.08	0.0	0.0	ok	14.0	15.9	15.2	15.2	0.92	1.05
	0.02	0.08	0.0	0.0	ok			15.8	15.8	0.89	1.01
2	0.03	0.08	0.0	0.0	ok	14.0	15.9	15.2	15.2	0.92	1.05
	0.02	0.08	0.0	0.0	ok			15.7	15.7	0.89	1.01
3	0.04	0.08	0.02	0.08	ok	14.0	15.9	13.7	13.7	1.02	1.16
	0.03	0.08	0.0	0.03	ok			14.2	14.2	0.98	1.12
4	0.04	0.08	0.02	0.09	ok	14.0	15.9	13.7	13.7	1.02	1.16
	0.03	0.08	0.0	0.03	ok			14.2	14.2	0.99	1.12
5	0.04	0.08	0.04	0.10	ok	14.0	15.9	13.5	13.5	1.03	1.17
	0.04	0.08	0.0	0.05	ok			14.0	14.0	1.00	1.13
6	0.04	0.08	0.10	0.17	ok	14.0	15.9	13.0	13.0	1.08	1.22
	0.04	0.08	0.05	0.11	ok			13.4	13.4	1.04	1.18
7	0.05	0.08	0.14	0.22	ok	14.0	15.9	12.6	12.6	1.11	1.26
	0.04	0.08	0.10	0.17	ok			13.0	13.0	1.07	1.22
8	0.05	0.08	0.13	0.20	ok	14.0	15.9	12.7	12.7	1.10	1.25
	0.04	0.08	0.08	0.15	ok			13.2	13.2	1.06	1.21
9	0.04	0.08	0.03	0.09	ok	14.0	15.9	13.6	13.6	1.03	1.17
	0.03	0.08	0.0	0.04	ok			14.1	14.1	0.99	1.13
10	0.04	0.08	0.04	0.10	ok	14.0	15.9	13.5	13.5	1.03	1.17
	0.04	0.08	0.0	0.05	ok			14.0	14.0	1.00	1.13
11	0.03	0.08	0.0	0.0	ok	14.0	15.9	14.8	14.8	0.94	1.07
	0.02	0.08	0.0	0.0	ok			15.4	15.4	0.91	1.03
12	0.04	0.08	0.02	0.08	ok	14.0	15.9	13.7	13.7	1.02	1.16
	0.03	0.08	0.0	0.03	ok			14.2	14.2	0.98	1.12
13	0.04	0.08	0.02	0.09	ok	14.0	15.9	13.7	13.7	1.02	1.16
	0.03	0.08	0.0	0.03	ok			14.2	14.2	0.99	1.12
14	0.04	0.08	0.04	0.10	ok	14.0	15.9	13.5	13.5	1.03	1.17
	0.04	0.08	0.0	0.05	ok			14.0	14.0	1.00	1.13
15	0.04	0.08	0.10	0.17	ok	14.0	15.9	13.0	13.0	1.08	1.22
	0.04	0.08	0.05	0.11	ok			13.4	13.4	1.04	1.18
16	0.05	0.08	0.14	0.22	ok	14.0	15.9	12.6	12.6	1.11	1.26
	0.04	0.08	0.10	0.17	ok			13.0	13.0	1.07	1.22
17	0.05	0.08	0.13	0.20	ok	14.0	15.9	12.7	12.7	1.10	1.25
	0.04	0.08	0.08	0.15	ok			13.2	13.2	1.06	1.21
18	0.04	0.08	0.03	0.10	ok	14.0	15.9	13.6	13.6	1.03	1.17
	0.03	0.08	0.0	0.04	ok			14.1	14.1	0.99	1.13



EGP CODE

GRE.EEC.R.73.IT.W.15235.12.024.01

PAGE

465 di/of 527

19	0.04	0.08	0.04	0.10	ok	14.0	15.9	13.5	13.5	1.03	1.17
	0.04	0.08	0.0	0.05	ok			14.0	14.0	1.00	1.13
20	0.03	0.08	0.0	0.0	ok	14.0	15.9	14.9	14.9	0.94	1.07
	0.02	0.08	0.0	0.0	ok			15.4	15.4	0.91	1.03
		<b>2-2</b>	<b>3-3</b>						<b>2-2</b>	<b>3-3</b>	
		0.14	0.22						1.11	1.26	

Nodo	Conf.StatoPilas.	Diam	st	Passon.	br. 2	Bj2	Hjc2	n. br. 3	Bj3	Hjc3	V. 7.4.8	V. Ash	7.4.10Rif. cmb
		mm	cm	cm	cm	cm	cm		cm	cm			
2	NO ok	1	810.0	3	30.0	22.8	3	30.0	22.8	0.3	0.9	NO	5,9
4	NO ok	2	810.0	3	30.0	22.8	3	30.0	22.8	0.3	0.9	NO	5,18
6	NO ok	3	85.0	3	30.0	22.8	3	30.0	22.8	0.5	0.9	NO	5,5
8	NO ok	4	85.0	3	30.0	22.8	3	30.0	22.8	0.5	0.9	NO	5,5
10	NO ok	5	85.0	3	30.0	22.8	3	30.0	22.8	0.5	0.9	NO	5,5
12	NO ok	6	85.0	3	30.0	22.8	3	30.0	22.8	0.5	0.9	NO	5,5
14	NO ok	7	85.0	3	30.0	22.8	3	30.0	22.8	0.5	0.9	NO	5,5
16	NO ok	8	85.0	3	30.0	22.8	3	30.0	22.8	0.5	0.9	NO	5,5
18	NO ok	9	85.0	3	30.0	22.8	3	30.0	22.8	0.5	0.9	NO	5,5
20	NO ok	10	85.0	3	30.0	22.8	3	30.0	22.8	0.5	0.9	NO	5,5
22	NO ok	11	810.0	3	30.0	22.8	3	30.0	22.8	0.3	0.9	NO	5,16
24	NO ok	12	85.0	3	30.0	22.8	3	30.0	22.8	0.5	0.9	NO	5,5
26	NO ok	13	85.0	3	30.0	22.8	3	30.0	22.8	0.5	0.9	NO	5,5
28	NO ok	14	85.0	3	30.0	22.8	3	30.0	22.8	0.5	0.9	NO	5,5
30	NO ok	15	85.0	3	30.0	22.8	3	30.0	22.8	0.5	0.9	NO	5,5
32	NO ok	16	85.0	3	30.0	22.8	3	30.0	22.8	0.5	0.9	NO	5,5
34	NO ok	17	85.0	3	30.0	22.8	3	30.0	22.8	0.5	0.9	NO	5,5
36	NO ok	18	85.0	3	30.0	22.8	3	30.0	22.8	0.5	0.9	NO	5,5
38	NO ok	19	85.0	3	30.0	22.8	3	30.0	22.8	0.5	0.9	NO	5,5
40	NO ok	20	810.0	3	30.0	22.8	3	30.0	22.8	0.3	0.9	NO	5,7

Nodo	Passo	V. 7.4.8	V. Ash
	5.00		
		0.52	0.89

Trave	NotePos.	%Af	Af inf.	Af. sup	M_T= 1 Z=300.0 Af long.	x/d	P=1 V N/M	P=10 V V/T cls	V V/T acc	Staffe L=cm	Rif. cmb
22	ok,ok0.0	0.33	4.04.0	0.0	0.10	0.31	0.24	0.112d8/8	L=50	8,25,36	
	s=2,m=5	162.4	0.33	4.0	4.0	0.0	0.10	0.08	0.22	0.26	2d8/20 L=195 5,25,36
		324.8	0.33	4.04.0	0.0	0.10	0.27	0.112d8/8	L=50	5,25,36	
26	ok,ok0.0	0.33	4.04.0	0.0	0.10	0.24	0.19	0.112d8/8	L=50	8,25,36	
	s=2,m=5	162.4	0.33	4.0	4.0	0.0	0.10	0.03	0.17	0.26	2d8/20 L=195 11,25,36
		324.8	0.33	4.04.0	0.0	0.10	0.25	0.112d8/8	L=50	5,25,36	
28	ok,ok0.0	0.33	4.04.0	0.0	0.10	0.24	0.17	0.102d8/8	L=50	8,29,36	
	s=2,m=5	180.1	0.33	4.0	4.0	0.0	0.10	0.04	0.15	0.23	2d8/20 L=230 1,29,36
		360.3	0.33	4.04.0	0.0	0.10	0.25	0.102d8/8	L=50	5,29,36	
30	ok,ok0.0	0.33	4.04.0	0.0	0.10	0.25	0.19	0.102d8/8	L=50	8,25,36	
	s=2,m=5	180.1	0.33	4.0	4.0	0.0	0.10	0.03	0.17	0.23	2d8/20 L=230 1,25,36
		360.3	0.33	4.04.0	0.0	0.10	0.29	0.102d8/8	L=50	10,25,36	
32	ok,ok0.0	0.33	4.04.0	0.0	0.10	0.26	0.17	0.092d8/8	L=50	8,25,36	
	s=2,m=5	234.9	0.33	4.0	4.0	0.0	0.10	0.07	0.15	0.17	2d8/20 L=340 2,25,36
		469.8	0.33	4.04.0	0.0	0.10	0.30	0.092d8/8	L=50	10,25,36	
34	ok,ok0.0	0.33	4.04.0	0.0	0.10	0.30	0.16	0.092d8/8	L=50	8,29,36	
	s=2,m=5	234.9	0.33	4.0	4.0	0.0	0.10	0.07	0.14	0.17	2d8/20 L=340 2,29,36
		469.8	0.33	4.04.0	0.0	0.10	0.29	0.092d8/8	L=50	10,29,36	
36	ok,ok0.0	0.33	4.04.0	0.0	0.10	0.29	0.18	0.092d8/8	L=50	8,29,36	
	s=2,m=5	210.0	0.33	4.0	4.0	0.0	0.10	0.06	0.16	0.19	2d8/20 L=290 2,29,36
		420.1	0.33	4.04.0	0.0	0.10	0.24	0.092d8/8	L=50	10,29,36	
38	ok,ok0.0	0.33	4.04.0	0.0	0.10	0.26	0.20	0.132d8/8	L=50	11,27,36	
	s=2,m=5	140.0	0.33	4.0	4.0	0.0	0.10	0.01	0.19	0.30	2d8/20 L=150 12,27,36
		279.9	0.33	4.04.0	0.0	0.10	0.26	0.132d8/8	L=50	10,27,36	
21	ok,ok0.0	0.33	4.04.0	0.0	0.10	0.29	0.19	0.092d8/8	L=50	8,35,36	
	s=2,m=5	207.5	0.33	4.0	4.0	0.0	0.10	0.11	0.17	0.20	2d8/20 L=285 8,35,36
		415.1	0.33	4.04.0	0.0	0.10	0.31	0.092d8/8	L=50	5,35,36	
					<b>M_T= 2 Z=300.0</b>		<b>P=11</b>	<b>P=20</b>			
Trave	NotePos.	%Af	Af inf.	Af. sup	Af long.	x/d	V N/M	V V/T cls	V V/T acc	Staffe	Rif. cmb
23	ok,ok0.0	0.33	4.04.0	0.0	0.10	0.31	0.24	0.112d8/8	L=50	15,22,36	
	s=2,m=5	162.4	0.33	4.0	4.0	0.0	0.10	0.08	0.22	0.26	2d8/20 L=195 14,22,36
		324.8	0.33	4.04.0	0.0	0.10	0.27	0.112d8/8	L=50	14,22,36	
27	ok,ok0.0	0.33	4.04.0	0.0	0.10	0.24	0.19	0.112d8/8	L=50	15,22,36	
	s=2,m=5	162.4	0.33	4.0	4.0	0.0	0.10	0.03	0.17	0.26	2d8/20 L=195 20,22,36
		324.8	0.33	4.04.0	0.0	0.10	0.25	0.112d8/8	L=50	14,22,36	
29	ok,ok0.0	0.33	4.04.0	0.0	0.10	0.24	0.17	0.102d8/8	L=50	15,34,36	
	s=2,m=5	180.1	0.33	4.0	4.0	0.0	0.10	0.04	0.15	0.23	2d8/20 L=230 1,34,36
		360.3	0.33	4.04.0	0.0	0.10	0.25	0.102d8/8	L=50	14,34,36	





EGP CODE

GRE.EEC.R.73.IT.W.15235.12.024.01

PAGE

466 di/of 527

31	ok,ok0.0	0.33	4.04.0	0.0	0.10	0.25	0.19	0.102d8/8 L=50	15,22,36		
	s=2,m=5	180.1	0.33	4.0	4.0	0.0	0.10	0.03 0.17	0.23	2d8/20 L=230	1,22,36
		360.3	0.33	4.04.0	0.0	0.10	0.29	0.102d8/8 L=50	17,22,36		
33	ok,ok0.0	0.33	4.04.0	0.0	0.10	0.27	0.17	0.092d8/8 L=50	15,22,36		
	s=2,m=5	234.9	0.33	4.0	4.0	0.0	0.10	0.07 0.15	0.17	2d8/20 L=340	2,22,36
		469.8	0.33	4.04.0	0.0	0.10	0.30	0.092d8/8 L=50	17,22,36		
35	ok,ok0.0	0.33	4.04.0	0.0	0.10	0.30	0.16	0.092d8/8 L=50	15,34,36		
	s=2,m=5	234.9	0.33	4.0	4.0	0.0	0.10	0.07 0.14	0.17	2d8/20 L=340	2,34,36
		469.8	0.33	4.04.0	0.0	0.10	0.29	0.092d8/8 L=50	17,34,36		
37	ok,ok0.0	0.33	4.04.0	0.0	0.10	0.29	0.18	0.092d8/8 L=50	15,34,36		
	s=2,m=5	210.0	0.33	4.0	4.0	0.0	0.10	0.06 0.16	0.19	2d8/20 L=290	2,34,36
		420.1	0.33	4.04.0	0.0	0.10	0.24	0.092d8/8 L=50	17,34,36		
39	ok,ok0.0	0.33	4.04.0	0.0	0.10	0.26	0.20	0.132d8/8 L=50	15,24,36		
	s=2,m=5	140.0	0.33	4.0	4.0	0.0	0.10	0.01 0.19	0.30	2d8/20 L=150	15,24,36
		279.9	0.33	4.04.0	0.0	0.10	0.26	0.132d8/8 L=50	17,24,36		
40	ok,ok0.0	0.33	4.04.0	0.0	0.10	0.29	0.19	0.092d8/8 L=50	15,32,36		
	s=2,m=5	207.5	0.33	4.0	4.0	0.0	0.10	0.11 0.17	0.20	2d8/20 L=285	15,32,36
		415.1	0.33	4.04.0	0.0	0.10	0.31	0.092d8/8 L=50	14,32,36		
						<b>M_T= 3 Z=300.0</b>	<b>P=10</b>	<b>P=20</b>			
Trave	NotePos.	%Af	Af inf.	Af. sup	Af long.	x/d	V N/M	V V/T cls	V V/T acc	Staffe	Rif. cmb
24	ok,ok0.0	0.33	4.04.0	0.0	0.10	0.56	0.21	0.122d8/8 L=50	26,14,36		
	s=2,m=5	315.0	0.33	4.0	4.0	0.0	0.10	0.84 0.12	0.13	2d8/20 L=250	2,14,36
49	ok,ok0.0	0.33	4.04.0	0.0	0.10	0.84	0.12	0.132d8/20 L=250	2,5,36		
	s=2,m=5	315.0	0.33	4.0	4.0	0.0	0.10	0.56 0.21	0.12	2d8/8 L=50	21,5,36
						<b>M_T= 4 Z=300.0</b>	<b>P=1</b>	<b>P=11</b>			
Trave	NotePos.	%Af	Af inf.	Af. sup	Af long.	x/d	V N/M	V V/T cls	V V/T acc	Staffe	Rif. cmb
25	ok,ok0.0	0.33	4.04.0	0.0	0.10	0.48	0.19	0.112d8/8 L=50	36,16,36		
	s=2,m=5	315.0	0.33	4.0	4.0	0.0	0.10	0.73 0.11	0.13	2d8/20 L=250	2,16,36
50	ok,ok0.0	0.33	4.04.0	0.0	0.10	0.73	0.11	0.132d8/20 L=250	2,11,36		
	s=2,m=5	315.0	0.33	4.0	4.0	0.0	0.10	0.48 0.19	0.11	2d8/8 L=50	31,11,36
						<b>M_T= 5 Z=300.0</b>	<b>P=2</b>	<b>P=12</b>			
Trave	NotePos.	%Af	Af inf.	Af. sup	Af long.	x/d	V N/M	V V/T cls	V V/T acc	Staffe	Rif. cmb
41	ok,ok0.0	0.50	6.04.0	0.0	0.10	0.72	0.21	0.172d8/8 L=50	2,2,2		
	s=2,m=5	315.0	0.50	6.0	4.0	0.0	0.12	0.78 0.09	0.15	2d8/20 L=500	2,13,36
		630.0	0.50	6.04.0	0.0	0.10	0.72	0.172d8/8 L=50	2,2,2		
						<b>M_T= 6 Z=300.0</b>	<b>P=3</b>	<b>P=13</b>			
Trave	NotePos.	%Af	Af inf.	Af. sup	Af long.	x/d	V N/M	V V/T cls	V V/T acc	Staffe	Rif. cmb
42	ok,ok0.0	0.50	6.04.0	0.0	0.10	0.74	0.22	0.182d8/8 L=50	32,2,2		
	s=2,m=5	315.0	0.50	6.0	4.0	0.0	0.12	0.82 0.09	0.15	2d8/20 L=500	2,20,36
		630.0	0.50	6.04.0	0.0	0.10	0.74	0.182d8/8 L=50	35,2,2		
						<b>M_T= 7 Z=300.0</b>	<b>P=4</b>	<b>P=14</b>			
Trave	NotePos.	%Af	Af inf.	Af. sup	Af long.	x/d	V N/M	V V/T cls	V V/T acc	Staffe	Rif. cmb
43	ok,ok0.0	0.50	6.04.0	0.0	0.10	0.79	0.23	0.182d8/8 L=50	34,2,2		
	s=2,m=5	315.0	0.50	6.0	4.0	0.0	0.12	0.86 0.09	0.15	2d8/20 L=500	2,20,36
		630.0	0.50	6.04.0	0.0	0.10	0.79	0.182d8/8 L=50	35,2,2		
						<b>M_T= 8 Z=300.0</b>	<b>P=5</b>	<b>P=15</b>			
Trave	NotePos.	%Af	Af inf.	Af. sup	Af long.	x/d	V N/M	V V/T cls	V V/T acc	Staffe	Rif. cmb
44	ok,ok0.0	0.50	6.04.0	0.0	0.10	0.89	0.26	0.212d8/8 L=50	34,2,2		
	s=2,m=5	315.0	0.50	6.0	4.0	0.0	0.12	0.96 0.09	0.15	2d8/20 L=500	2,13,36
		630.0	0.50	6.04.0	0.0	0.10	0.89	0.212d8/8 L=50	35,2,2		
						<b>M_T= 9 Z=300.0</b>	<b>P=6</b>	<b>P=16</b>			
Trave	NotePos.	%Af	Af inf.	Af. sup	Af long.	x/d	V N/M	V V/T cls	V V/T acc	Staffe	Rif. cmb
45	ok,ok0.0	0.67	8.04.0	0.0	0.10	0.95	0.29	0.232d8/8 L=50	2,2,2		
	s=2,m=5	315.0	0.67	8.0	4.0	0.0	0.14	0.81 0.11	0.18	2d8/20 L=500	2,13,36
		630.0	0.67	8.04.0	0.0	0.10	0.95	0.232d8/8 L=50	2,2,2		
						<b>M_T= 10 Z=300.0</b>	<b>P=7</b>	<b>P=17</b>			
Trave	NotePos.	%Af	Af inf.	Af. sup	Af long.	x/d	V N/M	V V/T cls	V V/T acc	Staffe	Rif. cmb
46	ok,ok0.0	0.67	8.04.0	0.0	0.10	0.95	0.27	0.222d8/8 L=50	28,2,2		
	s=2,m=5	315.0	0.67	8.0	4.0	0.0	0.14	0.77 0.11	0.18	2d8/20 L=500	2,19,36
		630.0	0.67	8.04.0	0.0	0.10	0.95	0.222d8/8 L=50	23,2,2		
						<b>M_T= 11 Z=300.0</b>	<b>P=8</b>	<b>P=18</b>			
Trave	NotePos.	%Af	Af inf.	Af. sup	Af long.	x/d	V N/M	V V/T cls	V V/T acc	Staffe	Rif. cmb
47	ok,ok0.0	0.50	6.04.0	0.0	0.10	0.78	0.22	0.182d8/8 L=50	22,2,2		
	s=2,m=5	315.0	0.50	6.0	4.0	0.0	0.12	0.84 0.09	0.15	2d8/20 L=500	2,14,36
		630.0	0.50	6.04.0	0.0	0.10	0.78	0.182d8/8 L=50	25,2,2		
						<b>M_T= 12 Z=300.0</b>	<b>P=9</b>	<b>P=19</b>			
Trave	NotePos.	%Af	Af inf.	Af. sup	Af long.	x/d	V N/M	V V/T cls	V V/T acc	Staffe	Rif. cmb
48	ok,ok0.0	0.50	6.04.0	0.0	0.10	0.76	0.22	0.182d8/8 L=50	24,2,2		
	s=2,m=5	315.0	0.50	6.0	4.0	0.0	0.12	0.82 0.09	0.15	2d8/20 L=500	2,15,36
		630.0	0.50	6.04.0	0.0	0.10	0.76	0.182d8/8 L=50	27,2,2		
Trave		%Af	Af inf.	Af. sup	Af long.	x/d	V N/M	V V/T cls	V V/T acc		
		0.67	8.04	4.02	0.0	0.14	0.96	0.29	0.30		
<b>TraveM negativo i</b>	<b>M positivo iM negativo fM positivo f</b>	<b>Luce per VV M-i M+fV M+i M-fVEd,min</b>	<b>VEEd,max</b>	<b>Vr1</b>	<b>As</b>						
daN cm	daN cmdaN cm daN cm	cm daN daN daN daN	daN	daN	cm2						

21	5.505e+05	5.505e+055.505e+055.505e+05	385.08	3144.93	3144.93	0.0	0.0	0.0	0.0
22	5.505e+05	5.505e+055.505e+055.505e+05	294.79	4108.19	4108.19	0.0	0.0	0.0	0.0
23	5.505e+05	5.505e+055.505e+055.505e+05	294.79	4108.19	4108.19	0.0	0.0	0.0	0.0
24	5.505e+05	5.505e+055.505e+055.505e+05	599.98	2018.45	2018.45	0.0	0.0	0.0	0.0
25	5.505e+05	5.505e+055.505e+055.505e+05	599.98	2018.45	2018.45	0.0	0.0	0.0	0.0
26	5.505e+05	5.505e+055.505e+055.505e+05	294.79	4108.18	4108.18	0.0	0.0	0.0	0.0
27	5.505e+05	5.505e+055.505e+055.505e+05	294.79	4108.18	4108.18	0.0	0.0	0.0	0.0
28	5.505e+05	5.505e+055.505e+055.505e+05	330.30	3666.54	3666.54	0.0	0.0	0.0	0.0
29	5.505e+05	5.505e+055.505e+055.505e+05	330.30	3666.54	3666.54	0.0	0.0	0.0	0.0
30	5.505e+05	5.505e+055.505e+055.505e+05	330.29	3666.54	3666.54	0.0	0.0	0.0	0.0
31	5.505e+05	5.505e+055.505e+055.505e+05	330.29	3666.54	3666.54	0.0	0.0	0.0	0.0
32	5.505e+05	5.505e+055.505e+055.505e+05	439.83	2753.44	2753.44	0.0	0.0	0.0	0.0
33	5.505e+05	5.505e+055.505e+055.505e+05	439.83	2753.44	2753.44	0.0	0.0	0.0	0.0
34	5.505e+05	5.505e+055.505e+055.505e+05	439.83	2753.44	2753.44	0.0	0.0	0.0	0.0
35	5.505e+05	5.505e+055.505e+055.505e+05	439.83	2753.44	2753.44	0.0	0.0	0.0	0.0
36	5.505e+05	5.505e+055.505e+055.505e+05	390.08	3104.58	3104.58	0.0	0.0	0.0	0.0
37	5.505e+05	5.505e+055.505e+055.505e+05	390.08	3104.58	3104.58	0.0	0.0	0.0	0.0
38	5.505e+05	5.505e+055.505e+055.505e+05	249.92	4845.75	4845.75	0.0	0.0	0.0	0.0
39	5.505e+05	5.505e+055.505e+055.505e+05	249.92	4845.75	4845.75	0.0	0.0	0.0	0.0
40	5.505e+05	5.505e+055.505e+055.505e+05	385.08	3144.93	3144.93	0.0	0.0	0.0	0.0
41	5.505e+05	8.095e+055.505e+058.095e+05	599.98	2493.37	2493.37	0.0	0.0	0.0	0.0
42	5.505e+05	8.095e+055.505e+058.095e+05	599.98	2493.37	2493.37	0.0	0.0	0.0	0.0
43	5.505e+05	8.095e+055.505e+058.095e+05	599.98	2493.37	2493.37	0.0	0.0	0.0	0.0
44	5.505e+05	8.095e+055.505e+058.095e+05	599.98	2493.37	2493.37	0.0	0.0	0.0	0.0
45	5.506e+05	1.066e+065.506e+051.066e+06	599.98	2964.63	2964.63	0.0	0.0	0.0	0.0
46	5.506e+05	1.066e+065.506e+051.066e+06	599.98	2964.63	2964.63	0.0	0.0	0.0	0.0
47	5.505e+05	8.095e+055.505e+058.095e+05	599.98	2493.37	2493.37	0.0	0.0	0.0	0.0
48	5.505e+05	8.095e+055.505e+058.095e+05	599.98	2493.37	2493.37	0.0	0.0	0.0	0.0
49	5.505e+05	5.505e+055.505e+055.505e+05	599.98	2018.45	2018.45	0.0	0.0	0.0	0.0
50	5.505e+05	5.505e+055.505e+055.505e+05	599.98	2018.45	2018.45	0.0	0.0	0.0	0.0

TraveM negativo i	M positivo iM negativo fM positivo f	V M-i M+f	V M+i M-f	VEd,min	VEd,max	Vr1	As
5.506e+05	1.066e+065.506e+051.066e+06	4845.75	4845.75	0.0	0.0	0.0	0.0

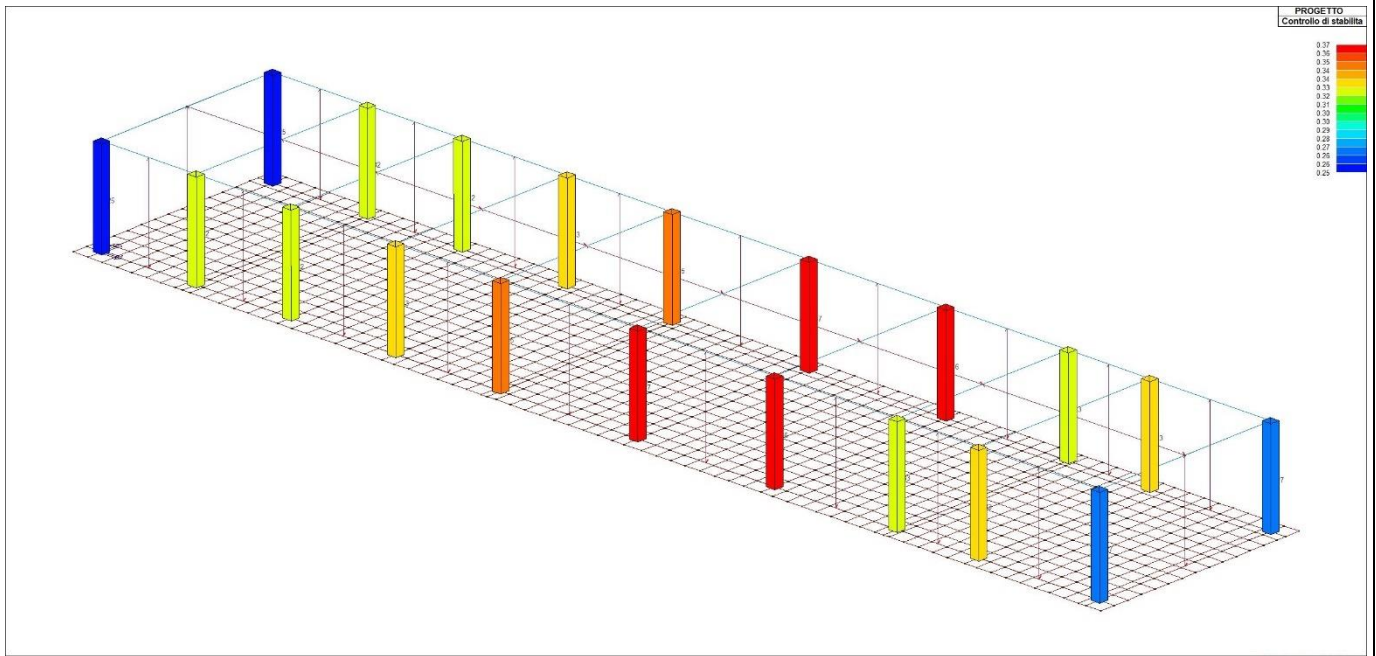

71\_PRO\_CA\_PIL\_STAB

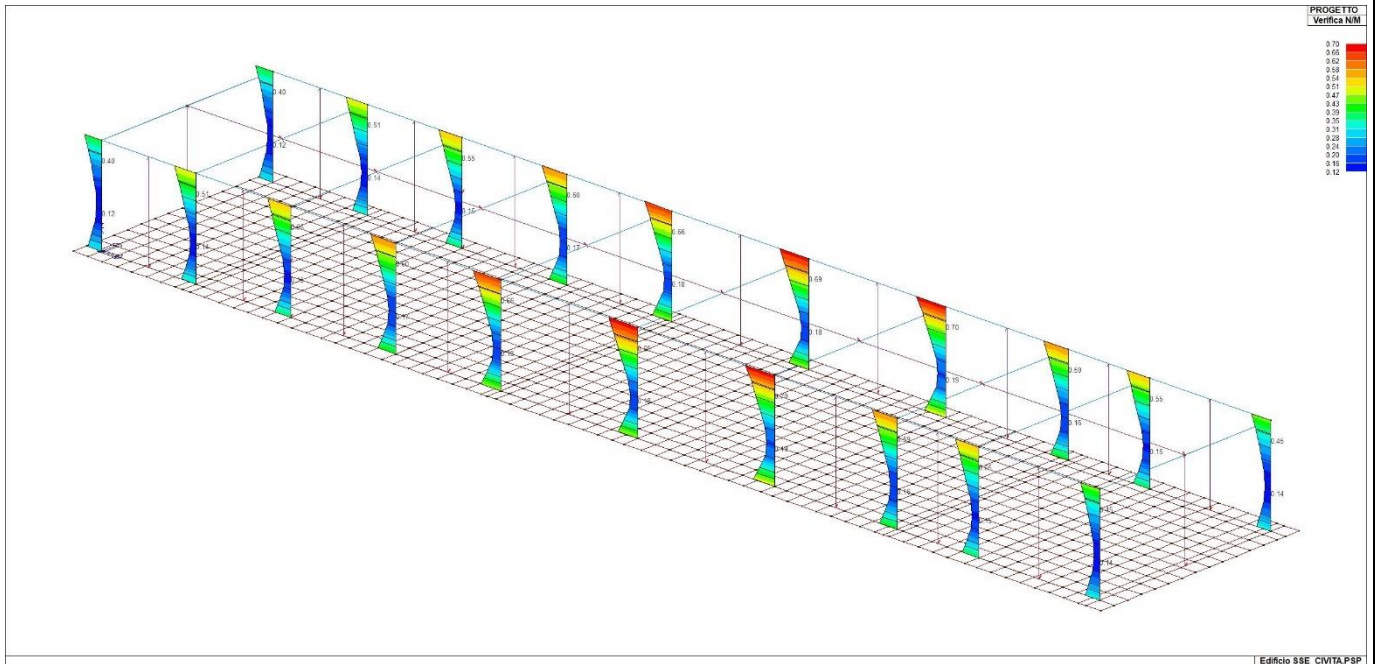

71\_PRO\_CA\_PIL\_VER\_NM

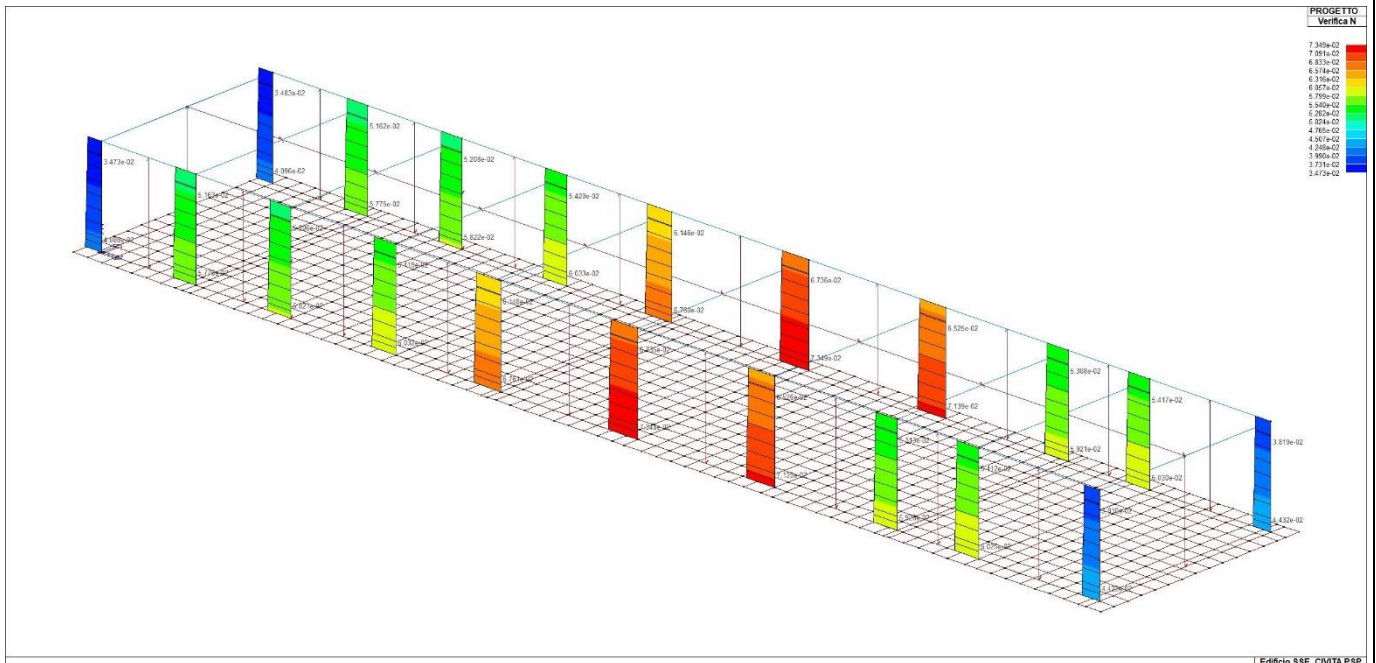

71\_PRO\_CA\_PIL\_VER\_NSIS



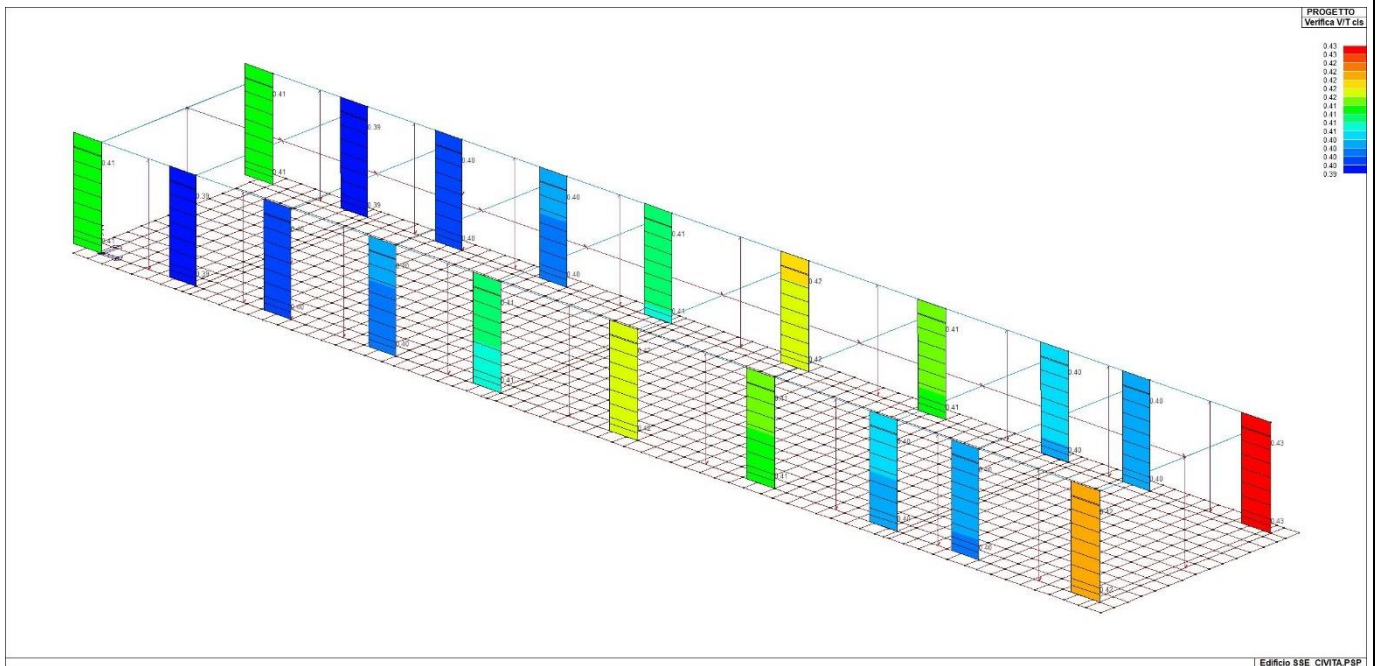

71\_PRO\_CA\_PIL\_VER\_VRCD

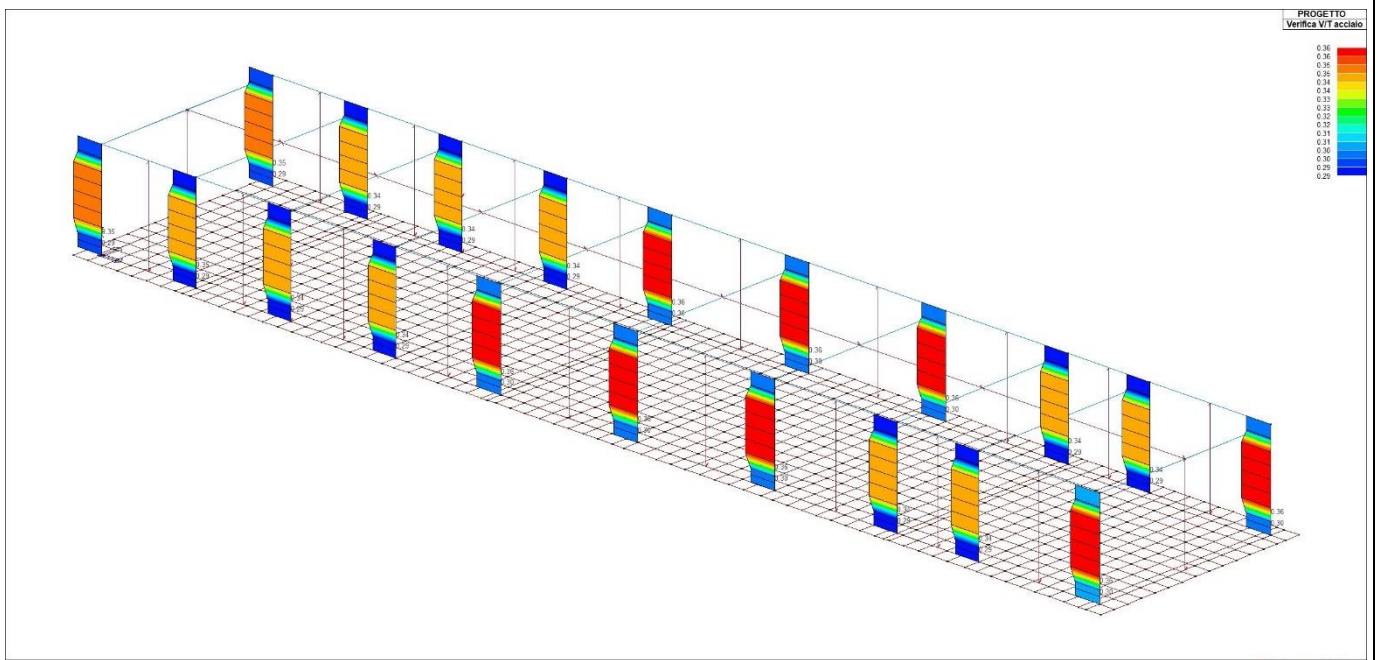

71\_PRO\_CA\_PIL\_VER\_VRSD





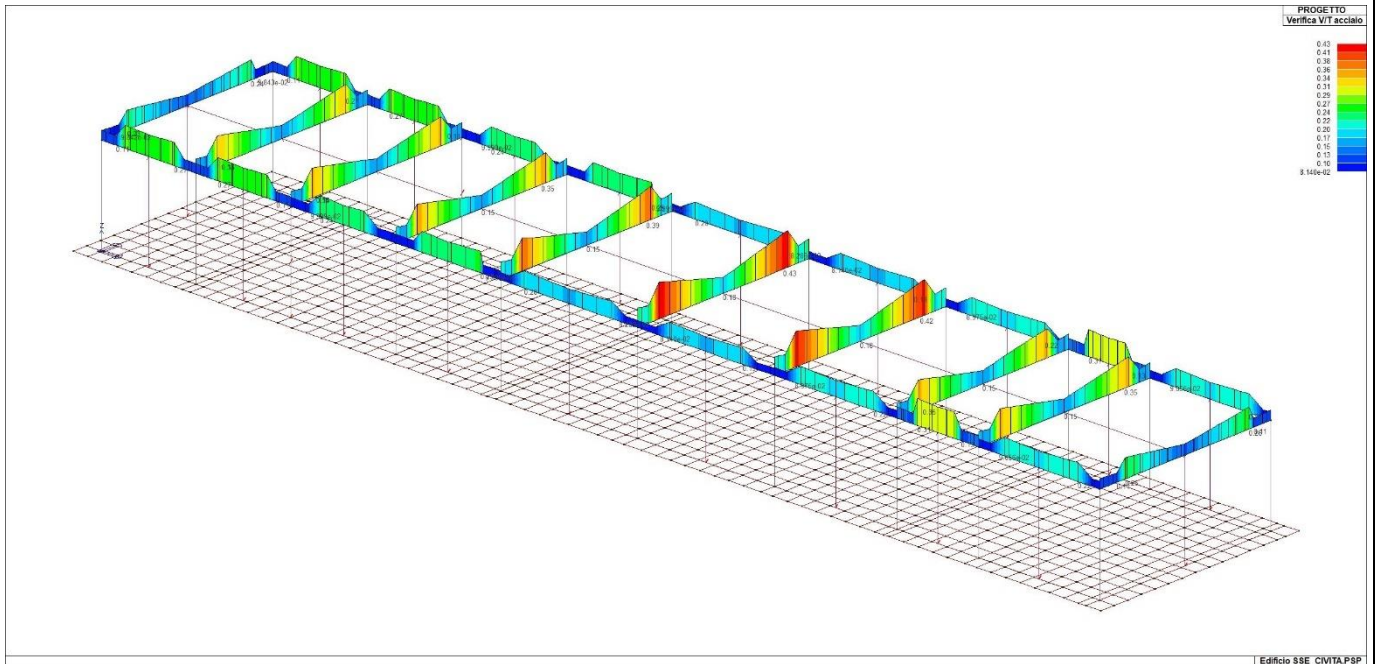

Edificio SSE CIVITA' P&P

71\_PRO\_CA\_TRV\_VER\_VRSD

## 19. VERIFICHE ELEMENTI PARETE E/O GUSCIO IN C.A.

### 19.1. LEGENDA TABELLA VERIFICHE ELEMENTI PARETE E GUSCIO IN C.A.

Per le pareti in c.a., in ottemperanza al cap. 7 del DM 17-01-18, viene effettuata una doppia progettazione: sia come *Singolo Elemento* sia come *Parete Sismica* o *Parete Debolmente Armata*.

Per la progettazione come *Singolo Elemento* di ogni elemento vengono riportati il codice dello stato di verifica con le sigle **Ok e NV**, il rapporto  $x/d$ , la verifica per sollecitazioni ultime (verifica a compressione media gli sforzi membranali, verifica a presso-flessionale e verifica a sollecitazioni taglianti), gli sforzi membranali e flessionali, il quantitativo di armatura nella direzione principale e secondaria sia inferiore che superiore e il quantitativo di armatura a taglio.

Per la progettazione come *Parete Sismica* o *Parete Debolmente Armata* vengono riportate invece le caratteristiche geometriche della parete e delle zone dissipative (quest'ultime solo nel caso di parete sismica), i coefficienti di verifica a compressione assiale, pressoflessione e sollecitazioni taglianti.

Inoltre vengono riportate per ogni quota significativa l'armatura principale e secondaria, l'armatura in zona confinata (solo per parete sismica) e non confinata, l'armatura concentrata all'estremità (per pareti debolmente armate), lo sforzo assiale aggiuntivo per  $q$  superiore a 2 e i valori di involuppo di taglio e momento. Per le pareti debolmente armate viene riportato anche lo stato di verifica relativo alla snellezza.

Le azioni derivate dall'analisi, in ogni combinazione di calcolo, sono elaborate come previsto al punto 7.4.4.5.1: traslazione del momento, incremento e variazione diagramma taglio, incremento e decremento sforzo assiale

La progettazione nel caso dei gusci viene effettuata una progettazione come *Singolo Elemento*, riportando in tabella il rapporto  $x/d$ , la verifica per sollecitazioni ultime, (verifica a compressione media gli sforzi membranali, verifica a presso-flessionale e verifica a sollecitazioni taglianti) di ogni elemento.

Per ogni elemento, viene riportata inoltre la maglia di armatura necessaria in relazione alle risultanze della progettazione dei nodi dell'elemento stesso. Le quantità di armature necessarie sono armature (disposte rispettivamente in direzione principale e secondaria, inferiore e superiore) distribuite nell'elemento ed espresse in centimetri quadri per sviluppo lineare pari ad un metro.

Nel caso dei gusci viene effettuata, inoltre, la verifica a punzonamento, riportando in tabella il codice dello stato di verifica, il coefficiente di verifica per piastre prive di armature a taglio lungo il perimetro resistente e lungo il perimetro del pilastro, coefficiente di incremento dovuto ai momenti flettenti, fattore di amplificazione per le fondazioni, il fattore di amplificazione dell'altezza utile per individuare il perimetro di verifica lungo il quale l'armatura a taglio non è richiesta, il quantitativo di armatura a punzonamento, il numero di serie di armature, il numero di braccia di armatura ed il riferimento alla combinazione più gravosa.

#### Simbologia adottata nelle tabelle di verifica

Per gli elementi con progettazione "*Singolo Elemento ...*" è presente una tabella con i simboli di seguito descritti:

Macro Guscio	Numero del macroelemento di tipo guscio (elementi non verticali contigui ed analoghi per proprietà)
Macro Setto	Numero del macroelemento di tipo setto (elementi verticali contigui ed analoghi per proprietà)
Spessore	Spessore della parete
Id Materiale	Codice del materiale assegnato all'elemento
Id Criterio	Codice del criterio di progetto assegnato all'elemento
Progettazione	Sigla tipo di Elemento: - Singolo Elemento; - Singolo Elemento FONDAZIONE; - Singolo Elemento NON DISSIPATIVO

Per gli elementi con progettazione "*Parete Sismica o Parete Debolmente Armata*" è presente una tabella con i simboli di seguito descritti:

Parete	Numero della PARETE SISMICA
Parete PDA	Numero della PARETE DEBOLMENTE ARMATA
H totale	Altezza complessiva della parete
Spessore	Spessore della parete
H critica	Altezza come da punto 7.4.4.5.1 per traslazione momento (solo in Parete Sismica)

H critica V	Altezza della zona dissipativa (solo in Parete Sismica)
L totale	Larghezza di base della parete
L confinata	Lunghezza della zona dissipativa (solo in Parete Sismica)
Verif. N	Verifica di cui al punto 7.4.4.5.1 compressione semplice
Verif. N-M	Verifica di cui al punto 7.4.4.5.1 pressoflessione
Fattore V	Fattore di amplificazione del taglio di cui al punto 7.4.4.5.1
Diagramma V	Diagramma elaborato per effetto modi superiori come da fig. 7.4.4
Verif. V	Verifica di cui al punto 7.4.4.5.1 taglio (compressione cls, trazione acciaio, scorrimento in zona critica) (solo in Parete Sismica)
Verifica Snellezza	Verifica di cui al punto 7.4.4.5.1 limitazione compressione per prevenire l'instabilità (solo in Parete Debolmente Armata)
Prog. composta	Sigla per la progettazione composta

Per le verifiche degli elementi con progettazione “Singolo Elemento ...” e Progettazione Composta è presente una tabella con i simboli di seguito descritti:

Nodo	numero del nodo
Stato	codice di verifica dell'elemento <b>ok</b> o <b>NV</b>
x/d	rapporto tra posizione dell'asse neutro e altezza utile alla rottura della sezione (per sola flessione)
V N/M	Verifica delle sollecitazioni Normali (momento e sforzo normale)
Ver. rid	Rapporto Nd/Nu (Nu ottenuto con riduzione del 25% di fcd)
Af pr+	quantità di armatura richiesta in direzione principale relativa alla faccia positiva (estradosso piastre) (valore derivante da calcolo o minimo normativo)
Af pr-	quantità di armatura richiesta in direzione principale relativa alla faccia negativa (intradosso piastre) (valore derivante da calcolo o minimo normativo)
Af sec+	quantità di armatura richiesta in direzione secondaria relativa alla faccia positiva (estradosso piastre) (valore derivante da calcolo o minimo normativo)
Af sec-	quantità di armatura richiesta in direzione secondaria relativa alla faccia negativa (intradosso piastre) (valore derivante da calcolo o minimo normativo)
Nz No Nzo	Sforzi membranali per pareti e/o setti verticali
Mz Mo Mzo	Sforzi flessionali per pareti e/o setti verticali
Nx Ny Nxy	Sforzi membranali per gusci orizzontali
Mx Mx Mxy	Sforzi flessionali per gusci orizzontali

Nodo	numero del nodo
Stato	codice di verifica dell'elemento <b>ok</b> o <b>NV</b>
Max tau	Tensione tangenziale Massima
Ver V pr	Verifica a taglio nella direzione principale lato calcestruzzo
Ver V sec	Verifica a taglio nella direzione secondaria lato calcestruzzo
Af V pr	Armatura nella direzione principale
V pr-	Verifica dell'armatura nella direzione principale
Af V sec	Armatura nella direzione secondaria
V sec-	Verifica dell'armatura nella direzione secondaria

Per le verifiche degli elementi con progettazione “Parete Sismica o Parete Debolmente Armata”, oltre alla tabella con le verifiche per gli elementi con progettazione “Singolo Elemento ...”, è presente una tabella con i simboli di seguito descritti:

Quota	Ascissa verticale di riferimento
Af conf.	Numero e diametro armatura presente in una zona confinata
Af std	Diametro e passo armatura in zona non confinata (doppia maglia)
Af estremi	Diametro dei ferri di estremità del pannello; se posto uguale 0, viene utilizzato il diametro standard
Af V (ori)	Diametro e passo armatura orizzontale (doppia maglia)
Ver. N	Rapporto tra azione di calcolo e resistenza a compressione (normalizzato a 1 in quanto da confrontare con 40% in CDB e 35 % in CDA)
Ver. N/M	Rapporto tra azione di calcolo e resistenza a pressoflessione
Ver. V acc(7)	Rapporto tra azione di calcolo e resistenza a taglio-trazione per alfaS minore di 2 secondo paragrafo 7.4.4.5.1
Ver. V cls	Rapporto tra azione di calcolo e resistenza a taglio-compressione

Ver. V acc	Rapporto tra azione di calcolo e resistenza a taglio-trazione
Ver. V scorr.	Rapporto tra azione di calcolo e resistenza a taglio scorrimento
N add	Sforzo assiale di cui al punto 7.4.4.5.1 da sommare e sottrarre nelle verifiche quando q supera 2
N invil M invil	Inviluppo del Momento e Sforzo Normale come al punto 7.4.4.5.1 (informativo) (solo in Parete Sismica)

Quota	Ascissa verticale di riferimento
N v.N	Valore dello sforzo assiale per cui Ver. N attinge il massimo valore
N v.M/N, M v.M/N	Valore dello sforzo assiale e momento per cui Ver. N/M attinge il massimo valore
N v.M/N, M v.M/N Mo v.M/N	Valore dello sforzo assiale e dei momenti per cui Ver. N/M attinge il massimo valore (per le pareti estese debolmente armate)
N v.Vcls, V v.Vcls,	Valore dello sforzo assiale e taglio per cui Ver. V. cls attinge il massimo valore
N v.Vacc, M v.Vacc, V v.Vacc,	Valore dello sforzo assiale, momento e taglio per cui Ver. V. acc attinge il massimo valore
N v.Vscorr, M v.Vscorr, V v.Vscorr,	Valore dello sforzo assiale, momento e taglio per cui Ver. V. scorr.e attinge il massimo valore
N v.N	Valore dello sforzo assiale per cui Ver. N attinge il massimo valore
N v.M/N, M v.M/N	Valore dello sforzo assiale e momento per cui Ver. N/M attinge il massimo valore
N v.M/N, M v.M/N Mo v.M/N	Valore dello sforzo assiale e dei momenti per cui Ver. N/M attinge il massimo valore (per le pareti estese debolmente armate)
N v.Vcls, V v.Vcls,	Valore dello sforzo assiale e taglio per cui Ver. V. cls attinge il massimo valore

Quota	Ascissa verticale di riferimento
CtgT Vcls	Valore di ctg(teta) adottato nella verifica V compressione cls
Vrsd Vcls	Valore della resistenza a taglio trazione (armatura di calcolo)
Vrcd Vcls	Valore della resistenza a taglio compressione
CtgT Vacc	Valore di ctg(teta) adottato nella verifica V trazione armatura
Vrsd Vacc	Valore della resistenza a taglio trazione (armatura presente)
Vrcd Vacc	Valore della resistenza a taglio compressione
Vdd	Valore del contributo alla resistenza allo scorrimento come da [7.4.20]
Vid	Valore del contributo alla resistenza allo scorrimento come da [7.4.21]
A s.i.	Somma delle aree di armature
Incli.	Angolo di inclinazione delle armature
Dist.	Distanza alla base tra le armature inclinate

Quota	Ascissa verticale di riferimento
V[7.4.16]	Verifica a taglio-trazione dell'armatura dell'anima (7.4.16)
N M V	Sollecitazioni di calcolo della condizione più gravosa
Alfas	Rapporto di Taglio
Vrd,c	Resistenza a taglio degli elementi non armati
VRd,s	Resistenza a taglio nei confronti dello scorrimento
V[7.4.17]	Verifica a taglio-trazione dell'armatura dell'anima (7.4.17)
roH	Rapporto tra l'armatura orizzontale e l'area della sezione relativa di calcestruzzo
roV	Rapporto tra l'armatura verticale e l'area della sezione relativa di calcestruzzo
roN	Sforzo normale adimensionalizzato Ned/(bw fyd)

**Per la verifica a Punzonamento è presente una tabella con i simboli di seguito descritti:**

Nodo	numero del nodo
Stato	codice di verifica dell'elemento <b>ok</b> o <b>NV</b>
V. 6.47	Fattore di sicurezza per la verifica per piastre prive di armature a taglio lungo il perimetro resistente U1
V. 6.53	Fattore di sicurezza per la verifica per piastre prive di armature a taglio lungo il perimetro del pilastro U0
Beta	Fattore di incremento dovuto ai momenti flettenti
f. a fon	fattore di amplificazione per le fondazioni (solo per gusci di fondazione)

f. Uout	fattore di amplificazione dell'altezza utile per individuare il perimetro di verifica lungo il quale l'armatura a taglio non è richiesta
Aw tot	Quantitativo di armatura per la verifica di piastre munite di armatura (formula 6.52 dell'EC2)
Asw,min	Quantitativo minimo di armatura previsto dai dettagli costruttivi (formula 9.11 dell'EC2)
n. x serie	Numero di serie di armature
n.ser 0(R)	Numero di braccia delle armatura in direzione 0 (o numero di braccia radiale)
n.ser 90	Numero di braccia delle armatura in direzione 90 (solo se armatura cruciforme)
Rif. cmb	Riferimento combinazioni da cui si generano le verifiche più gravose

## 19.2. PROGETTAZIONE DELLE FONDAZIONI

Il D.M.17/01/2018 - par: 7.2.5 prevede:

“Sia per CD“A” sia per CD“B” il dimensionamento delle strutture di fondazione e la verifica di sicurezza del complesso fondazione-terreno devono essere eseguiti assumendo come azione in fondazione, trasmessa dagli elementi soprastanti, una tra le seguenti:

- quella derivante dall'analisi strutturale eseguita ipotizzando comportamento strutturale non dissipativo;
- [...];
- quella trasferita dagli elementi soprastanti nell'ipotesi di comportamento strutturale dissipativo, amplificata di un coefficiente pari a 1,30 in CD“A” e 1,10 in CD“B”;

Nel contesto visualizzazione risultati e nella stampa della relazione sulle fondazioni PRO\_SAP mostra le sollecitazioni che derivano dall'analisi non incrementate sia in termini di pressioni sul terreno che in termini di sollecitazioni.

La progettazione degli elementi strutturali con proprietà fondazione è effettuata da PRO\_SAP (per travi e platee) o da PRO\_CAD Plinti (per plinti e pali di fondazione) incrementando le sollecitazioni delle combinazioni con sisma di un coefficiente pari 1.1 in CDB e 1.3 in CDA per pali, plinti, travi e platee.

Per i bicchieri dei plinti di fondazione prefabbricati l'incremento delle sollecitazioni ha un fattore pari a 1.2 in CDB e 1.35 in CDA.

N.B.: nel caso di comportamento strutturale non dissipativo la progettazione viene effettuata senza nessun incremento.

Le verifiche geotecniche vengono effettuate dal modulo geotecnico incrementando automaticamente le sollecitazioni del fattore 1.1 in CDB e 1.3 in CDA per pali, plinti, travi e platee.

N.B.: nel caso di comportamento strutturale non dissipativo le verifiche geotecniche vengono effettuate senza nessun incremento.

Macro Guscio	Spessore	Id Materiale	Id Criterio	Progettazione
	cm			
1	40.00	1	2	Singolo elemento

Nodo	Statox/d	V N/M	ver. rid	Af pr-	Af pr+	Af sec-	Af sec+	N x	N y	N xy	M x	M y	M xy
								daN/cm	daN/cm	daN	daN	daN	
1	ok 0.08	0.9	2.60e-02	5.7	5.7	5.7	5.7	107.7	66.0	-47.9	-3990.5	-1871.0	1097.5
3	ok 0.08	1.0	2.94e-02	5.7	5.7	5.7	5.7	121.4	70.0	51.3	-4159.6	-1900.4	-1127.7
5	ok 0.09	1.0	5.75e-02	8.7	5.7	8.2	5.7	191.5	138.3	90.3	-6349.5	-3502.3	-1430.3
7	ok 0.08	1.0	3.94e-02	6.3	5.7	6.3	5.7	123.3	88.3	67.9	-4732.1	-2721.1	-1137.9
9	ok 0.08	1.0	4.46e-02	6.9	5.7	6.9	5.7	140.6	97.5	79.1	-5169.9	-3018.7	-1188.0
11	ok 0.10	1.0	7.77e-02	10.5	5.7	10.5	5.7	110.4	275.7	-140.0	-5120.5	-5712.7	2410.2
13	ok 0.09	1.0	5.01e-02	7.8	5.7	7.8	5.7	149.5	114.3	-87.7	-5973.9	-3540.1	1296.6
15	ok 0.09	1.0	5.35e-02	8.1	5.7	7.9	5.7	153.8	117.6	89.6	-5851.5	-3551.0	-1305.9
17	ok 0.09	1.0	6.88e-02	9.5	5.7	8.9	5.7	218.3	160.6	104.3	-6456.7	-3754.8	-1597.7
19	ok 0.08	1.0	4.18e-02	7.0	5.7	6.8	5.7	150.9	92.1	73.8	-5174.2	-2871.4	-1300.8
21	ok 0.09	1.0	4.25e-02	7.9	5.7	7.2	5.7	175.5	109.6	-80.1	-5485.2	-2685.1	1614.9
23	ok 0.09	1.0	4.24e-02	7.9	5.7	7.5	5.7	148.2	123.4	-80.2	-6090.9	-3425.5	1322.1
25	ok 0.08	1.0	3.27e-02	6.0	5.7	6.0	5.7	109.2	83.2	-62.7	-4550.5	-2675.6	1102.2
27	ok 0.08	1.0	3.66e-02	6.5	5.7	6.5	5.7	121.7	92.1	-73.2	-4980.2	-2968.4	1153.2
29	ok 0.10	1.0	5.54e-02	10.3	5.7	9.7	5.7	84.1	253.0	124.6	-5166.1	-5626.2	-2240.9
31	ok 0.09	1.0	4.14e-02	7.9	5.7	7.4	5.7	78.3	164.9	102.1	-4603.9	-4468.5	-1533.5
33	ok 0.09	1.0	4.42e-02	8.0	5.7	7.6	5.7	78.8	173.9	-105.9	-4391.1	-4586.6	1559.7





EGP CODE

GRE.EEC.R.73.IT.W.15235.12.024.01

PAGE

476 di/of 527

35	ok 0.09	1.0	4.89e-02	9.1	5.7	8.3	5.7	170.0	143.5	-93.0	-6148.1	-3655.9	1459.0
37	ok 0.08	1.0	3.48e-02	6.5	5.7	6.5	5.7	130.3	87.6	-67.3	-5005.7	-2813.8	1272.3
39	ok 0.08	1.0	3.41e-02	7.1	5.7	6.9	5.7	137.2	100.6	73.3	-5333.0	-2644.5	-1541.3
41	ok 0.08	0.6	1.87e-02	5.7	5.7	5.7	5.7	-90.8	0.9	7.6	3424.4	691.8	633.1
42	ok 0.08	0.4	2.13e-02	5.7	5.7	5.7	5.7	52.1	0.3	0.7	1776.8	995.6	907.5
43	ok 0.08	0.5	1.69e-02	5.7	5.7	5.7	5.7	55.5	-3.6	14.2	1395.4	1201.3	1322.4
44	ok 0.08	0.3	5.47e-03	5.7	5.7	5.7	5.7	7.4	1.6	4.4	1203.9	1163.6	530.2
45	ok 0.08	0.3	5.28e-03	5.7	5.7	5.7	5.7	2.7	-6.4	8.6	670.2	1294.8	1071.8
46	ok 0.08	0.2	1.01e-03	5.7	5.7	5.7	5.7	0.4	-0.3	4.7	849.6	1141.2	465.6
47	ok 0.08	0.3	1.96e-03	5.7	5.7	5.7	5.7	1.4	-4.5	2.5	480.3	1363.7	617.7
48	ok 0.08	0.2	9.77e-04	5.7	5.7	5.7	5.7	-1.2	-2.0	3.5	622.3	1097.6	346.8
49	ok 0.08	0.2	1.56e-03	5.7	5.7	5.7	5.7	-1.7	-5.5	2.3	300.5	1288.3	475.5
50	ok 0.08	0.2	9.26e-04	5.7	5.7	5.7	5.7	-2.0	-3.3	2.3	489.5	1030.5	227.5
51	ok 0.08	0.2	1.52e-03	5.7	5.7	5.7	5.7	-1.8	-7.1	0.6	201.9	1171.3	285.8
52	ok 0.08	0.1	9.31e-04	5.7	5.7	5.7	5.7	-2.2	-4.4	0.7	421.5	951.6	132.3
53	ok 0.08	0.1	1.47e-03	5.7	5.7	5.7	5.7	-1.9	-7.9	0.1	148.7	1061.6	147.9
54	ok 0.08	0.1	9.39e-04	5.7	5.7	5.7	5.7	-2.0	-4.2	-1.8	438.5	987.9	-162.7
55	ok 0.08	0.1	1.47e-03	5.7	5.7	5.7	5.7	-1.8	-7.7	-0.4	162.0	1106.8	-190.1
56	ok 0.08	0.2	9.60e-04	5.7	5.7	5.7	5.7	-1.7	-3.0	-2.8	526.2	1077.2	-267.7
57	ok 0.08	0.2	1.50e-03	5.7	5.7	5.7	5.7	-1.7	-6.5	-1.7	230.3	1234.1	-342.5
58	ok 0.08	0.2	1.03e-03	5.7	5.7	5.7	5.7	-0.7	-1.7	-4.1	683.4	1128.5	-394.2
59	ok 0.08	0.2	1.47e-03	5.7	5.7	5.7	5.7	-1.4	-4.4	-2.8	343.7	1341.1	-557.9
60	ok 0.08	0.3	1.15e-03	5.7	5.7	5.7	5.7	3.8	7.1	-4.2	612.0	1790.7	-274.1
61	ok 0.08	0.3	1.58e-03	5.7	5.7	5.7	5.7	2.2	-3.4	-3.1	569.4	1406.4	-707.8
62	ok 0.08	0.4	7.90e-03	5.7	5.7	5.7	5.7	13.1	18.9	1.3	912.5	2172.9	-377.0
63	ok 0.08	0.4	8.00e-03	5.7	5.7	5.7	5.7	21.3	3.2	-15.3	482.1	1680.2	-1371.4
64	ok 0.08	0.5	2.53e-02	5.7	5.7	5.7	5.7	57.3	3.6	-0.1	2429.5	888.7	-969.3
65	ok 0.08	0.6	1.94e-02	5.7	5.7	5.7	5.7	53.9	-85.2	74.0	1294.3	3372.7	-648.1
66	ok 0.08	0.7	2.03e-02	5.7	5.7	5.7	5.7	-84.8	72.4	85.8	3835.4	1497.9	-376.6
67	ok 0.08	0.3	6.30e-03	5.7	5.7	5.7	5.7	-25.5	-3.0	-6.8	2045.6	428.9	550.3
68	ok 0.08	0.3	4.87e-03	5.7	5.7	5.7	5.7	15.5	19.1	-5.9	2108.1	1076.4	354.6
69	ok 0.08	0.3	1.92e-03	5.7	5.7	5.7	5.7	9.1	10.8	-1.1	1381.4	1219.7	332.1
70	ok 0.08	0.2	8.80e-04	5.7	5.7	5.7	5.7	1.0	1.7	4.7	977.6	1103.5	297.6
71	ok 0.08	0.2	9.10e-04	5.7	5.7	5.7	5.7	-0.3	0.4	3.5	729.4	1014.3	241.7
72	ok 0.08	0.1	8.69e-04	5.7	5.7	5.7	5.7	-1.3	-1.2	2.3	587.3	935.6	171.4
73	ok 0.08	0.1	7.70e-04	5.7	5.7	5.7	5.7	-1.5	-2.1	0.6	517.6	863.0	107.8
74	ok 0.08	0.1	8.10e-04	5.7	5.7	5.7	5.7	-1.4	-2.0	-1.7	534.8	896.1	-129.7
75	ok 0.08	0.2	8.99e-04	5.7	5.7	5.7	5.7	-1.0	-1.1	-2.7	626.1	977.1	-197.9
76	ok 0.08	0.2	9.28e-04	5.7	5.7	5.7	5.7	0.1	0.3	-4.1	799.2	1053.3	-271.2
77	ok 0.08	0.2	9.31e-04	5.7	5.7	5.7	5.7	3.7	4.7	-4.3	754.0	1700.9	-164.3
78	ok 0.08	0.3	2.10e-03	5.7	5.7	5.7	5.7	9.2	2.0	-5.5	1562.2	1064.6	-392.1
79	ok 0.08	0.3	3.97e-03	5.7	5.7	5.7	5.7	10.4	9.1	6.4	2269.2	916.2	-378.5
80	ok 0.08	0.3	4.37e-03	5.7	5.7	5.7	5.7	-18.5	-7.5	5.1	2075.8	365.3	-560.3
81	ok 0.08	0.3	3.00e-03	5.7	5.7	5.7	5.7	8.0	0.7	5.7	1877.0	462.0	38.0
82	ok 0.08	0.2	1.97e-03	5.7	5.7	5.7	5.7	-0.6	1.0	2.1	1029.7	1332.7	91.2
83	ok 0.08	0.2	1.40e-03	5.7	5.7	5.7	5.7	2.6	2.6	2.5	792.9	1510.7	40.7
84	ok 0.08	0.2	1.06e-03	5.7	5.7	5.7	5.7	2.5	2.1	2.8	575.9	1536.9	15.5
85	ok 0.08	0.2	8.96e-04	5.7	5.7	5.7	5.7	-0.4	0.1	4.5	741.4	1005.7	102.6
86	ok 0.08	0.1	7.93e-04	5.7	5.7	5.7	5.7	-1.1	-0.6	2.9	615.5	897.8	98.7
87	ok 0.08	0.1	6.37e-04	5.7	5.7	5.7	5.7	-1.5	-1.1	1.6	550.6	811.0	77.7
88	ok 0.08	0.1	6.85e-04	5.7	5.7	5.7	5.7	-1.4	-1.0	-1.9	567.3	845.2	-87.5
89	ok 0.08	0.2	8.23e-04	5.7	5.7	5.7	5.7	-0.8	-0.5	-3.3	652.2	945.8	-107.2
90	ok 0.08	0.2	9.15e-04	5.7	5.7	5.7	5.7	2.0	1.6	-3.7	587.9	1440.3	-15.4
91	ok 0.08	0.2	1.20e-03	5.7	5.7	5.7	5.7	3.6	1.9	-3.6	718.9	1587.0	-4.1
92	ok 0.08	0.2	1.51e-03	5.7	5.7	5.7	5.7	2.5	1.0	-3.5	883.1	1487.2	-47.1
93	ok 0.08	0.2	2.10e-03	5.7	5.7	5.7	5.7	-0.9	0.5	-2.4	1176.5	1182.2	-118.5
94	ok 0.08	0.3	3.79e-03	5.7	5.7	5.7	5.7	10.9	0.6	-7.1	1904.1	440.9	-8.8
95	ok 0.08	0.2	2.19e-03	5.7	5.7	5.7	5.7	-4.2	1.5	-0.7	1180.6	756.0	-287.2
96	ok 0.08	0.2	1.72e-03	5.7	5.7	5.7	5.7	-2.1	0.7	1.0	804.6	1324.4	-133.8
97	ok 0.08	0.2	1.34e-03	5.7	5.7	5.7	5.7	1.6	1.5	1.4	599.9	1519.7	-100.4
98	ok 0.08	0.2	1.15e-03	5.7	5.7	5.7	5.7	2.5	1.6	2.5	534.3	1566.3	-32.9
99	ok 0.08	0.2	9.17e-04	5.7	5.7	5.7	5.7	2.0	1.0	2.6	484.5	1335.8	-18.2
100	ok 0.08	0.1	7.41e-04	5.7	5.7	5.7	5.7	0.3	1.8	-3.99e-02	471.0	1004.7	-34.5
101	ok 0.08	0.1	5.54e-04	5.7	5.7	5.7	5.7	0.2	1.8	-8.10e-03	453.7	954.8	-7.1
102	ok 0.08	0.1	5.99e-04	5.7	5.7	5.7	5.7	0.2	1.8	7.74e-02	458.3	968.6	17.1
103	ok 0.08	0.2	7.62e-04	5.7	5.7	5.7	5.7	0.7	1.2	-1.9	439.8	1165.7	24.1
104	ok 0.08	0.2	8.94e-04	5.7	5.7	5.7	5.7	1.9	1.1	-1.2	512.3	1454.6	-17.8
105	ok 0.08	0.2	1.18e-03	5.7	5.7	5.7	5.7	2.8	1.5	-2.4	566.4	1612.4	62.7
106	ok 0.08	0.2	1.34e-03	5.7	5.7	5.7	5.7	1.6	0.7	-2.5	667.8	1498.6	116.3
107	ok 0.08	0.2	1.98e-03	5.7	5.7	5.7	5.7	-3.3	0.6	-0.8	938.6	1167.7	138.8
108	ok 0.08	0.2	2.16e-03	5.7	5.7	5.7	5.7	-4.6	3.0	0.7	1181.6	699.3	302.5
109	ok 0.08	0.3	1.15e-02	5.7	5.7	5.7	5.7	-58.1	-13.4	11.2	1288.6	207.8	-663.4
110	ok 0.08	0.2	7.37e-03	5.7	5.7	5.7	5.7	-6.1	9.9	-4.1	431.5	1489.6	-394.1
111	ok 0.08	0.3	1.91e-03	5.7	5.7	5.7	5.7	5.7	8.7	5.0	486.6	1812.9	-116.0
112	ok 0.08	0.2	1.32e-03	5.7	5.7	5.7	5.7	2.9	1.8	1.3	437.3	1655.2	8.6
113	ok 0.08	0.2	9.45e-04	5.7	5.7	5.7	5.7	0.3	2.3	0.2	431.8	1334.2	40.1



EGP CODE

GRE.EEC.R.73.IT.W.15235.12.024.01

PAGE

477 di/of 527

114	ok 0.08	0.1	6.12e-04	5.7	5.7	5.7	5.73.54e-02	2.1	-0.2	403.5	1033.1	-37.3
115	ok 0.08	0.1	4.30e-04	5.7	5.7	5.7	5.7-1.64e-02	1.9	-5.39e-02	395.9	976.9	-7.8
116	ok 0.08	0.1	4.80e-04	5.7	5.7	5.7	5.7-1.40e-03	2.0	0.1	398.2	992.3	18.7
117	ok 0.08	0.2	6.37e-04	5.7	5.7	5.7	5.7 0.3	2.3	-1.9	394.5	1147.7	-40.5
118	ok 0.08	0.2	1.01e-03	5.7	5.7	5.7	5.7 0.3	2.8	0.5	465.3	1472.9	9.0
119	ok 0.08	0.3	1.48e-03	5.7	5.7	5.7	5.7 0.9	3.3	1.4	538.0	1808.8	5.3
120	ok 0.08	0.3	1.92e-03	5.7	5.7	5.7	5.7 5.1	12.8	-2.0	549.6	1684.0	272.6
121	ok 0.08	0.3	7.20e-03	5.7	5.7	5.7	5.7 15.6	25.5	-19.4	1340.4	803.2	459.1
122	ok 0.08	0.3	1.24e-02	5.7	5.7	5.7	5.7 -57.8	12.7	26.1	1290.7	494.3	609.4
123	ok 0.08	0.9	3.18e-02	5.7	5.7	5.7	5.7 139.6	25.5	-61.5	-3719.2	-1738.8	664.7
124	ok 0.08	0.5	2.85e-02	5.7	5.7	5.7	5.7 60.9	27.5	23.9	1064.4	2370.6	525.9
125	ok 0.08	0.3	8.02e-03	5.7	5.7	5.7	5.7 13.0	9.7	3.3	542.3	2239.7	143.7
126	ok 0.08	0.2	1.26e-03	5.7	5.7	5.7	5.7 -1.4	7.0	-2.5	460.5	1624.8	14.5
127	ok 0.08	0.2	7.67e-04	5.7	5.7	5.7	5.7 0.5	5.2	1.9	391.3	1306.9	50.7
128	ok 0.08	0.1	5.32e-04	5.7	5.7	5.7	5.7 -0.3	2.4	-6.18e-02	333.1	1054.8	-25.5
129	ok 0.08	0.1	4.15e-04	5.7	5.7	5.7	5.7 -0.2	2.1	-3.72e-02	332.2	993.8	-5.6
130	ok 0.08	0.1	4.73e-04	5.7	5.7	5.7	5.7 -0.2	2.2	0.1	332.7	1010.6	12.9
131	ok 0.08	0.2	5.84e-04	5.7	5.7	5.7	5.7 0.4	3.6	-2.1	336.6	1127.0	-53.6
132	ok 0.08	0.2	9.75e-04	5.7	5.7	5.7	5.7 0.7	6.3	-1.9	422.5	1442.2	-53.6
133	ok 0.08	0.3	1.21e-03	5.7	5.7	5.7	5.7 -2.8	9.1	7.2	434.8	1757.9	124.2
134	ok 0.08	0.4	1.10e-02	5.7	5.7	5.7	5.7 15.7	10.7	-1.3	632.3	2587.6	139.8
135	ok 0.08	0.6	3.51e-02	5.7	5.7	5.7	5.7 117.1	46.2	-32.4	1216.1	2672.7	-71.3
136	ok 0.08	1.0	3.88e-02	6.2	5.7	6.2	5.7 175.9	19.4	97.0	-4038.9	-2134.6	-768.9
137	ok 0.08	0.7	1.95e-02	5.7	5.7	5.7	5.7 48.9	1.5	6.6	715.4	1753.5	284.4
138	ok 0.08	0.3	3.58e-03	5.7	5.7	5.7	5.7 -0.1	12.0	11.8	456.8	2014.8	97.5
139	ok 0.08	0.3	1.74e-03	5.7	5.7	5.7	5.7 2.0	12.0	5.60e-02	472.1	1682.9	81.2
140	ok 0.08	0.2	7.46e-04	5.7	5.7	5.7	5.7 0.8	5.1	2.4	369.8	1286.5	19.7
141	ok 0.08	0.1	5.18e-04	5.7	5.7	5.7	5.7 -0.3	2.4	8.45e-02	303.6	1058.1	-18.3
142	ok 0.08	0.1	4.21e-04	5.7	5.7	5.7	5.7 -0.2	2.1	-6.66e-02	301.8	996.6	-5.1
143	ok 0.08	0.1	4.82e-04	5.7	5.7	5.7	5.7 -0.2	2.2	0.1	302.6	1013.5	9.8
144	ok 0.08	0.2	6.54e-04	5.7	5.7	5.7	5.7 0.4	4.1	-2.3	331.2	1126.7	-3.9
145	ok 0.08	0.2	9.18e-04	5.7	5.7	5.7	5.7 1.0	6.0	-2.7	399.0	1412.9	-60.8
146	ok 0.08	0.3	2.38e-03	5.7	5.7	5.7	5.7 2.3	15.3	0.3	514.6	1865.3	-90.0
147	ok 0.08	0.3	6.33e-03	5.7	5.7	5.7	5.7 -8.3	-12.0	13.7	588.0	2563.8	-151.1
148	ok 0.08	1.0	3.39e-02	5.7	5.7	5.7	5.7 43.2	-180.6	-39.8	808.3	4779.9	-735.5
149	ok 0.08	0.9	2.88e-02	5.7	5.7	5.7	5.7 125.0	16.5	61.7	-4345.3	-1897.0	-551.0
150	ok 0.08	0.5	2.72e-02	5.7	5.7	5.7	5.7 60.4	29.6	-25.7	950.9	2397.8	-613.4
151	ok 0.08	0.3	7.74e-03	5.7	5.7	5.7	5.7 11.1	11.1	-4.3	422.2	2267.1	-204.0
152	ok 0.08	0.2	1.40e-03	5.7	5.7	5.7	5.73.85e-02	9.8	4.8	440.6	1578.1	39.7
153	ok 0.08	0.2	8.86e-04	5.7	5.7	5.7	5.7 0.4	6.2	2.6	358.7	1276.5	21.0
154	ok 0.08	0.1	5.49e-04	5.7	5.7	5.7	5.7 -0.3	2.4	0.2	282.8	1061.6	-10.7
155	ok 0.08	0.1	4.23e-04	5.7	5.7	5.7	5.7 -0.2	2.1	0.1	281.9	1000.2	-2.8
156	ok 0.08	0.1	4.80e-04	5.7	5.7	5.7	5.7 -0.2	2.2	-6.93e-02	282.5	1017.1	5.6
157	ok 0.08	0.2	7.39e-04	5.7	5.7	5.7	5.7 0.5	4.2	-2.4	313.2	1106.3	-8.6
158	ok 0.08	0.2	1.03e-03	5.7	5.7	5.7	5.7 0.6	7.1	-2.9	389.2	1402.4	-28.8
159	ok 0.08	0.3	1.52e-03	5.7	5.7	5.7	5.7 -2.5	9.2	-5.7	466.1	1764.4	-55.9
160	ok 0.08	0.4	1.12e-02	5.7	5.7	5.7	5.7 17.3	11.2	2.3	675.0	2556.4	-62.8
161	ok 0.08	0.6	3.41e-02	5.7	5.7	5.7	5.7 -60.1	-91.8	-36.1	-2350.5	-1410.0	-422.1
162	ok 0.08	1.0	3.56e-02	6.3	5.7	6.2	5.7 160.7	6.9	-96.1	-4668.9	-2401.2	619.2
163	ok 0.08	0.3	1.05e-02	5.7	5.7	5.7	5.7 7.3	-18.5	-5.1	-470.8	-1020.2	-605.2
164	ok 0.08	0.3	9.36e-03	5.7	5.7	5.7	5.7 -3.5	11.3	3.1	424.4	1485.5	293.5
165	ok 0.08	0.3	2.16e-03	5.7	5.7	5.7	5.7 0.5	10.3	2.2	347.6	1738.9	108.0
166	ok 0.08	0.2	1.42e-03	5.7	5.7	5.7	5.7 -0.5	4.2	4.9	427.6	1596.1	30.2
167	ok 0.08	0.2	1.23e-03	5.7	5.7	5.7	5.7 1.0	4.5	3.3	336.8	1272.7	0.2
168	ok 0.08	0.1	8.17e-04	5.7	5.7	5.7	5.7-5.26e-02	2.1	0.4	254.8	1055.5	3.9
169	ok 0.08	0.1	4.82e-04	5.7	5.7	5.7	5.7-4.41e-02	1.9	0.2	249.7	997.0	-0.1
170	ok 0.08	0.1	5.80e-04	5.7	5.7	5.7	5.7-5.19e-02	2.0	-9.05e-02	250.9	1013.5	-1.5
171	ok 0.08	0.2	9.03e-04	5.7	5.7	5.7	5.77.66e-02	2.8	-0.9	252.5	1145.2	11.7
172	ok 0.08	0.2	1.28e-03	5.7	5.7	5.7	5.7 -1.4	3.6	-0.9	285.2	1472.7	15.2
173	ok 0.08	0.3	1.47e-03	5.7	5.7	5.7	5.7 -0.2	5.4	-4.9	461.7	1725.4	-52.8
174	ok 0.08	0.3	2.33e-03	5.7	5.7	5.7	5.7 6.2	13.8	3.0	532.0	1687.0	-224.9
175	ok 0.08	0.4	9.36e-03	5.7	5.7	5.7	5.7 -16.6	0.8	0.8	454.8	1125.0	-617.0
176	ok 0.08	0.3	1.14e-02	5.7	5.7	5.7	5.7 34.8	-11.4	-24.1	-1507.4	-765.2	138.4
177	ok 0.08	0.2	2.37e-03	5.7	5.7	5.7	5.7 -2.9	2.7	4.6	893.7	708.2	251.1
178	ok 0.08	0.2	2.22e-03	5.7	5.7	5.7	5.7 -3.6	3.5	2.7	605.9	1288.7	161.4
179	ok 0.08	0.2	1.92e-03	5.7	5.7	5.7	5.7 -0.4	5.4	2.9	430.5	1490.3	75.2
180	ok 0.08	0.2	1.63e-03	5.7	5.7	5.7	5.7 2.5	4.4	2.3	382.4	1519.8	-11.2
181	ok 0.08	0.2	1.31e-03	5.7	5.7	5.7	5.7 0.5	1.8	0.3	258.1	1326.5	22.5
182	ok 0.08	0.1	9.49e-04	5.7	5.7	5.7	5.7 0.2	1.7	0.3	243.1	1045.1	4.5
183	ok 0.08	0.1	5.85e-04	5.7	5.7	5.7	5.7 0.1	1.6	0.2	229.5	990.5	1.6
184	ok 0.08	0.1	6.77e-04	5.7	5.7	5.7	5.7 0.1	1.7	-6.86e-02	233.7	1006.2	-1.4
185	ok 0.08	0.2	1.03e-03	5.7	5.7	5.7	5.7 0.3	2.0	-0.7	241.3	1151.0	-5.6
186	ok 0.08	0.2	1.36e-03	5.7	5.7	5.7	5.7 0.5	2.4	-0.2	280.5	1442.4	-38.0
187	ok 0.08	0.2	1.64e-03	5.7	5.7	5.7	5.7 2.3	4.3	-1.7	406.8	1577.5	-15.5
188	ok 0.08	0.2	1.99e-03	5.7	5.7	5.7	5.7 -0.2	4.8	-2.9	473.3	1404.0	-119.0
189	ok 0.08	0.2	2.33e-03	5.7	5.7	5.7	5.7 -3.3	3.2	-3.0	725.4	1126.9	-193.7



EGP CODE

GRE.EEC.R.73.IT.W.15235.12.024.01

PAGE

478 di/of 527

190	ok 0.08	0.2	3.32e-03	5.7	5.7	5.7	5.7	-3.4	5.0	-0.5	889.8	682.5	-211.2
191	ok 0.08	0.1	2.28e-03	5.7	5.7	5.7	5.7	-7.3	3.0	-6.7	891.4	672.4	-189.4
192	ok 0.08	0.2	1.99e-03	5.7	5.7	5.7	5.7	-8.7	3.3	-3.2	584.3	1264.6	-95.4
193	ok 0.08	0.2	1.62e-03	5.7	5.7	5.7	5.7	-4.1	5.3	-2.4	358.9	1475.0	-60.2
194	ok 0.08	0.2	1.44e-03	5.7	5.7	5.7	5.7	0.7	4.1	-0.3	357.0	1530.6	71.1
195	ok 0.08	0.2	1.31e-03	5.7	5.7	5.7	5.7	0.5	2.3	0.1	288.7	1316.2	84.9
196	ok 0.08	0.1	9.51e-04	5.7	5.7	5.7	5.7	0.3	1.4	-0.2	229.7	1038.4	-8.4
197	ok 0.08	0.1	6.24e-04	5.7	5.7	5.7	5.7	0.2	1.5	-0.1	213.3	988.6	-1.7
198	ok 0.08	0.1	7.27e-04	5.7	5.7	5.7	5.7	0.2	1.7	-4.89e-02	218.1	1004.0	4.3
199	ok 0.08	0.2	1.05e-03	5.7	5.7	5.7	5.7	0.3	2.1	-0.6	251.0	1142.6	-87.3
200	ok 0.08	0.2	1.40e-03	5.7	5.7	5.7	5.7	0.4	3.1	8.22e-02	322.1	1423.6	-81.4
201	ok 0.08	0.2	1.47e-03	5.7	5.7	5.7	5.7	-2.3	4.5	1.5	346.6	1569.5	-68.6
202	ok 0.08	0.2	1.87e-03	5.7	5.7	5.7	5.7	-5.1	3.3	1.6	461.7	1442.9	21.0
203	ok 0.08	0.2	2.21e-03	5.7	5.7	5.7	5.7	-6.7	3.4	3.9	652.8	1103.8	149.3
204	ok 0.08	0.1	2.30e-03	5.7	5.7	5.7	5.7	-7.2	2.6	6.9	908.2	608.2	203.0
205	ok 0.08	0.2	6.64e-03	5.7	5.7	5.7	5.7	-5.2	9.8	-6.6	744.7	821.0	-403.4
206	ok 0.08	0.2	5.43e-03	5.7	5.7	5.7	5.7	-23.5	16.9	-12.6	416.6	1317.1	-432.7
207	ok 0.08	0.3	2.09e-03	5.7	5.7	5.7	5.7	3.7	5.3	-0.8	516.3	1556.5	-34.3
208	ok 0.08	0.2	1.59e-03	5.7	5.7	5.7	5.7	0.7	5.4	-0.5	420.7	1611.4	22.2
209	ok 0.08	0.2	1.21e-03	5.7	5.7	5.7	5.7	0.6	3.5	0.2	310.0	1302.3	72.6
210	ok 0.08	0.1	9.12e-04	5.7	5.7	5.7	5.7	0.2	2.2	0.9	227.5	1015.7	89.0
211	ok 0.08	0.1	6.23e-04	5.7	5.7	5.7	5.7	0.2	1.7	-0.2	194.7	993.3	-2.7
212	ok 0.08	0.1	7.43e-04	5.7	5.7	5.7	5.7	0.2	1.8	2.33e-03	198.1	1009.7	7.3
213	ok 0.08	0.2	1.04e-03	5.7	5.7	5.7	5.7	0.2	2.6	-0.7	254.8	1124.4	-80.0
214	ok 0.08	0.2	1.33e-03	5.7	5.7	5.7	5.7	0.6	4.3	0.2	347.1	1421.4	-54.9
215	ok 0.08	0.3	1.78e-03	5.7	5.7	5.7	5.7	0.7	7.9	0.3	462.9	1699.3	13.3
216	ok 0.08	0.3	1.91e-03	5.7	5.7	5.7	5.7	-3.3	15.8	-1.69e-02	497.0	1593.5	202.1
217	ok 0.08	0.2	5.11e-03	5.7	5.7	5.7	5.7	-2.6	17.9	-2.8	1403.1	979.6	116.3
218	ok 0.08	0.2	5.84e-03	5.7	5.7	5.7	5.7	-7.3	8.6	5.2	739.9	828.3	419.5
219	ok 0.08	0.6	2.04e-02	5.7	5.7	5.7	5.7	94.7	-0.6	-50.9	-2694.1	-1310.7	274.4
220	ok 0.08	0.5	2.01e-02	5.7	5.7	5.7	5.7	66.4	36.5	31.5	941.5	2310.9	104.9
221	ok 0.08	0.4	7.16e-03	5.7	5.7	5.7	5.7	-2.5	15.4	7.6	411.8	2235.5	-185.8
222	ok 0.08	0.2	1.49e-03	5.7	5.7	5.7	5.7	1.4	6.2	-0.7	392.5	1630.4	-19.1
223	ok 0.08	0.2	1.14e-03	5.7	5.7	5.7	5.7	0.7	4.3	0.4	301.2	1295.5	49.4
224	ok 0.08	0.1	8.96e-04	5.7	5.7	5.7	5.7	0.2	2.8	1.0	209.8	1009.1	93.6
225	ok 0.08	0.1	6.30e-04	5.7	5.7	5.7	5.75.99e-02		2.0	-0.2	179.2	998.8	-1.8
226	ok 0.08	0.1	7.56e-04	5.7	5.7	5.7	5.76.52e-02		2.1	3.81e-03	180.4	1016.7	4.4
227	ok 0.08	0.2	1.02e-03	5.7	5.7	5.7	5.7	1.9	3.0	-3.1	226.5	1127.5	-84.6
228	ok 0.08	0.2	1.32e-03	5.7	5.7	5.7	5.7	3.0	4.2	-2.9	298.9	1456.6	-64.0
229	ok 0.08	0.3	1.88e-03	5.7	5.7	5.7	5.7	1.8	7.0	-0.1	421.4	1784.7	71.8
230	ok 0.08	0.4	1.06e-02	5.7	5.7	5.7	5.7	2.2	28.9	-16.9	369.2	2370.4	313.4
231	ok 0.08	0.5	2.35e-02	5.7	5.7	5.7	5.7	62.2	57.3	-43.5	967.3	2314.6	104.3
232	ok 0.08	0.7	2.28e-02	5.7	5.7	5.7	5.7	116.2	-41.9	-26.4	-2837.9	-826.1	-715.2
233	ok 0.08	0.2	2.68e-03	5.7	5.7	5.7	5.7	-11.7	-0.8	-1.1	1426.0	178.4	-239.8
234	ok 0.08	0.6	1.98e-02	5.7	5.7	5.7	5.7	-28.9	23.8	-59.0	-1308.9	-159.7	922.1
235	ok 0.08	0.3	6.71e-03	5.7	5.7	5.7	5.7	4.0	-24.8	16.7	435.9	2096.2	-19.1
236	ok 0.08	0.2	1.38e-03	5.7	5.7	5.7	5.7	2.3	3.9	0.8	397.7	1708.5	41.1
237	ok 0.08	0.2	1.11e-03	5.7	5.7	5.7	5.7	0.6	4.1	0.8	292.9	1309.1	69.2
238	ok 0.08	0.1	8.80e-04	5.7	5.7	5.7	5.75.47e-02		2.5	6.00e-03	178.2	1063.6	5.9
239	ok 0.08	0.1	6.59e-04	5.7	5.7	5.7	5.72.90e-02		2.2	6.10e-02	175.2	998.4	1.7
240	ok 0.08	0.1	7.85e-04	5.7	5.7	5.7	5.72.77e-02		2.2	1.60e-02	175.2	1016.2	-4.1
241	ok 0.08	0.2	1.03e-03	5.7	5.7	5.7	5.7	2.0	3.2	-3.3	231.3	1108.1	-18.7
242	ok 0.08	0.2	1.26e-03	5.7	5.7	5.7	5.7	3.0	3.7	-3.3	275.6	1424.8	-108.4
243	ok 0.08	0.3	1.70e-03	5.7	5.7	5.7	5.7	2.1	-0.2	-1.7	418.6	1887.5	-25.9
244	ok 0.08	0.3	1.13e-02	5.7	5.7	5.7	5.7	6.5	-48.5	-35.3	321.2	2478.5	-281.8
245	ok 0.08	0.8	2.74e-02	5.7	5.7	5.7	5.7	-6.0	122.1	65.6	-2101.3	-3078.9	-212.7
246	ok 0.08	0.2	9.38e-04	5.7	5.7	5.7	5.7	0.3	3.4	-4.7	937.2	1120.7	-491.5
247	ok 0.08	0.6	2.04e-02	5.7	5.7	5.7	5.7	80.9	-0.1	49.7	-2644.4	-1281.6	-254.3
248	ok 0.08	0.5	2.09e-02	5.7	5.7	5.7	5.7	68.6	36.9	-32.6	925.1	2292.3	-79.8
249	ok 0.08	0.4	7.25e-03	5.7	5.7	5.7	5.7	0.4	16.2	-8.2	405.9	2221.9	213.3
250	ok 0.08	0.2	1.45e-03	5.7	5.7	5.7	5.7	3.3	6.4	0.1	379.1	1621.2	15.7
251	ok 0.08	0.2	1.19e-03	5.7	5.7	5.7	5.7	2.8	4.8	1.4	298.0	1271.0	-29.5
252	ok 0.08	0.1	9.76e-04	5.7	5.7	5.7	5.7	0.1	2.4	0.3	191.2	1051.1	21.3
253	ok 0.08	0.1	7.30e-04	5.7	5.7	5.7	5.7	0.1	2.1	0.1	185.3	987.5	3.6
254	ok 0.08	0.1	8.35e-04	5.7	5.7	5.7	5.79.43e-02		2.1	-2.18e-02	186.0	1005.2	-11.5
255	ok 0.08	0.2	1.04e-03	5.7	5.7	5.7	5.7	0.5	2.8	1.0	220.1	1128.8	65.6
256	ok 0.08	0.2	1.27e-03	5.7	5.7	5.7	5.7	1.0	4.1	2.4	318.8	1465.7	41.6
257	ok 0.08	0.3	1.62e-03	5.7	5.7	5.7	5.7	4.9	7.4	1.1	442.1	1766.4	-97.0
258	ok 0.08	0.4	1.08e-02	5.7	5.7	5.7	5.7	12.5	27.9	5.2	586.3	2334.8	-171.6
259	ok 0.08	0.5	2.45e-02	5.7	5.7	5.7	5.7	64.5	57.8	45.1	937.7	2308.6	-126.8
260	ok 0.08	0.7	2.11e-02	5.7	5.7	5.7	5.7	100.0	-78.2	53.9	-3050.3	-880.4	248.8
261	ok 0.08	0.2	5.23e-03	5.7	5.7	5.7	5.7	-3.5	10.5	6.1	712.6	819.4	450.9
262	ok 0.08	0.2	5.87e-03	5.7	5.7	5.7	5.7	-19.8	17.1	12.7	422.7	1304.5	471.1
263	ok 0.08	0.3	2.49e-03	5.7	5.7	5.7	5.7	-0.5	10.3	-5.4	296.5	1639.7	185.0
264	ok 0.08	0.2	1.52e-03	5.7	5.7	5.7	5.7	4.1	6.0	-0.5	444.2	1581.7	-5.6
265	ok 0.08	0.2	1.31e-03	5.7	5.7	5.7	5.7	3.1	4.1	2.9	327.6	1271.0	38.5



EGP CODE

GRE.EEC.R.73.IT.W.15235.12.024.01

PAGE

479 di/of 527

266	ok 0.08	0.1	1.10e-03	5.7	5.7	5.7	5.7	0.3	2.0	0.3	217.8	1029.8	23.4
267	ok 0.08	0.1	8.08e-04	5.7	5.7	5.7	5.7	0.2	1.8	0.2	202.8	971.5	5.1
268	ok 0.08	0.1	8.56e-04	5.7	5.7	5.7	5.7	0.2	1.9	-2.63e-02	207.1	987.8	-12.6
269	ok 0.08	0.2	1.04e-03	5.7	5.7	5.7	5.7	0.6	2.6	0.9	246.2	1135.0	-31.7
270	ok 0.08	0.2	1.36e-03	5.7	5.7	5.7	5.7	2.8	4.8	1.3	363.3	1400.8	29.7
271	ok 0.08	0.3	1.54e-03	5.7	5.7	5.7	5.7	3.7	8.3	1.7	482.7	1684.9	-23.9
272	ok 0.08	0.3	2.79e-03	5.7	5.7	5.7	5.7	-0.6	16.0	0.6	497.2	1580.8	-236.4
273	ok 0.08	0.2	5.37e-03	5.7	5.7	5.7	5.7	-4.4	13.2	-4.1	554.6	1231.2	-351.9
274	ok 0.08	0.2	5.41e-03	5.7	5.7	5.7	5.7	-4.4	9.1	-4.9	737.9	830.6	-464.7
275	ok 0.08	0.2	2.77e-03	5.7	5.7	5.7	5.7	-3.9	3.5	6.1	920.9	662.6	230.8
276	ok 0.08	0.2	2.21e-03	5.7	5.7	5.7	5.7	-4.8	4.3	2.8	628.3	1240.9	132.1
277	ok 0.08	0.2	1.93e-03	5.7	5.7	5.7	5.7	-2.0	6.2	2.9	430.8	1449.0	85.9
278	ok 0.08	0.2	1.64e-03	5.7	5.7	5.7	5.7	-1.1	5.0	1.7	298.5	1488.5	22.0
279	ok 0.08	0.2	1.35e-03	5.7	5.7	5.7	5.7	1.5	2.7	-1.5	285.4	1301.7	-40.0
280	ok 0.08	0.1	1.06e-03	5.7	5.7	5.7	5.7	2.5	2.4	-1.1	213.1	998.6	-103.0
281	ok 0.08	0.1	8.02e-04	5.7	5.7	5.7	5.7	0.4	1.6	0.1	218.5	959.7	2.9
282	ok 0.08	0.1	8.94e-04	5.7	5.7	5.7	5.7	0.3	1.7	1.72e-02	225.0	974.6	-5.9
283	ok 0.08	0.2	1.10e-03	5.7	5.7	5.7	5.7	-1.9	2.6	1.6	187.4	1125.1	73.0
284	ok 0.08	0.2	1.31e-03	5.7	5.7	5.7	5.7	-3.2	3.6	1.4	216.3	1407.6	-66.7
285	ok 0.08	0.2	1.67e-03	5.7	5.7	5.7	5.7	-4.4	4.3	1.8	284.6	1538.9	-74.0
286	ok 0.08	0.2	1.94e-03	5.7	5.7	5.7	5.7	-3.0	4.0	-2.0	479.3	1416.6	-100.9
287	ok 0.08	0.2	2.24e-03	5.7	5.7	5.7	5.7	-3.5	4.0	-4.0	743.4	1103.0	-162.0
288	ok 0.08	0.2	3.34e-03	5.7	5.7	5.7	5.7	-4.4	2.6	-6.5	934.1	607.7	-243.1
289	ok 0.08	0.2	2.11e-03	5.7	5.7	5.7	5.7	-6.9	3.9	-6.3	955.1	670.4	-278.7
290	ok 0.08	0.2	2.00e-03	5.7	5.7	5.7	5.7	-8.1	4.4	-3.4	625.6	1255.9	-151.0
291	ok 0.08	0.2	1.68e-03	5.7	5.7	5.7	5.7	-5.4	6.2	-3.5	431.3	1463.2	-77.4
292	ok 0.08	0.2	1.49e-03	5.7	5.7	5.7	5.7	-4.4	5.2	-2.1	286.9	1505.7	12.0
293	ok 0.08	0.2	1.30e-03	5.7	5.7	5.7	5.7	1.6	3.4	-1.7	282.7	1286.5	112.1
294	ok 0.08	0.1	9.91e-04	5.7	5.7	5.7	5.7	0.5	1.8	-0.2	244.0	1013.4	-10.7
295	ok 0.08	0.1	7.95e-04	5.7	5.7	5.7	5.7	0.3	1.7	-0.1	221.2	959.9	-2.7
296	ok 0.08	0.1	8.99e-04	5.7	5.7	5.7	5.7	0.3	1.8	3.04e-02	227.8	974.8	5.8
297	ok 0.08	0.2	1.15e-03	5.7	5.7	5.7	5.7	-2.4	2.9	2.6	185.8	1116.6	-119.3
298	ok 0.08	0.2	1.36e-03	5.7	5.7	5.7	5.7	-3.4	4.0	1.6	219.6	1389.2	-101.5
299	ok 0.08	0.2	1.50e-03	5.7	5.7	5.7	5.7	-4.4	5.4	3.2	344.5	1545.7	3.8
300	ok 0.08	0.2	1.89e-03	5.7	5.7	5.7	5.7	-6.0	4.3	3.2	495.7	1434.9	77.2
301	ok 0.08	0.2	2.14e-03	5.7	5.7	5.7	5.7	-4.4	4.0	-2.0	694.9	1120.7	193.0
302	ok 0.08	0.2	2.13e-03	5.7	5.7	5.7	5.7	-7.7	3.2	6.6	964.4	613.4	288.0
303	ok 0.08	0.2	5.59e-03	5.7	5.7	5.7	5.7	-7.2	9.3	-6.1	773.5	874.6	-514.3
304	ok 0.08	0.3	4.74e-03	5.7	5.7	5.7	5.7	-21.1	15.3	-13.5	473.9	1352.5	-527.8
305	ok 0.08	0.3	2.37e-03	5.7	5.7	5.7	5.7	6.5	16.0	3.5	596.8	1704.7	-159.0
306	ok 0.08	0.2	1.62e-03	5.7	5.7	5.7	5.7	2.6	6.8	-1.0	487.1	1630.2	-4.6
307	ok 0.08	0.2	1.23e-03	5.7	5.7	5.7	5.7	1.6	4.8	-3.8	351.7	1302.8	6.0
308	ok 0.08	0.1	9.52e-04	5.7	5.7	5.7	5.7	0.3	2.2	-0.3	226.4	1030.9	-24.6
309	ok 0.08	0.1	7.75e-04	5.7	5.7	5.7	5.7	0.2	2.0	-0.2	209.7	972.8	-5.4
310	ok 0.08	0.1	8.86e-04	5.7	5.7	5.7	5.7	0.2	2.0	7.32e-02	214.2	989.1	13.2
311	ok 0.08	0.2	1.12e-03	5.7	5.7	5.7	5.7	0.2	2.3	0.3	238.9	1068.8	38.3
312	ok 0.08	0.2	1.40e-03	5.7	5.7	5.7	5.7	2.0	5.4	0.3	397.3	1427.7	-41.9
313	ok 0.08	0.3	1.77e-03	5.7	5.7	5.7	5.7	3.1	9.0	1.0	534.2	1718.3	52.9
314	ok 0.08	0.3	1.89e-03	5.7	5.7	5.7	5.7	-5.1	16.3	0.9	473.9	1609.7	269.6
315	ok 0.08	0.3	4.74e-03	5.7	5.7	5.7	5.7	-23.2	11.3	14.7	574.9	1269.3	636.7
316	ok 0.08	0.2	5.72e-03	5.7	5.7	5.7	5.7	-8.0	6.6	4.7	806.6	886.4	534.9
317	ok 0.08	0.6	2.07e-02	5.7	5.7	5.7	5.7	-85.4	63.9	62.7	2628.8	960.1	-209.2
318	ok 0.08	0.4	1.96e-02	5.7	5.7	5.7	5.7	69.5	38.8	28.4	956.9	2388.8	-19.8
319	ok 0.08	0.4	6.70e-03	5.7	5.7	5.7	5.7	3.8	18.6	6.5	526.4	2340.9	-237.8
320	ok 0.08	0.3	1.50e-03	5.7	5.7	5.7	5.7	3.4	8.2	-1.8	456.5	1684.4	-63.5
321	ok 0.08	0.2	1.14e-03	5.7	5.7	5.7	5.7	1.8	6.0	-1.1	340.4	1309.5	18.9
322	ok 0.08	0.1	9.49e-04	5.7	5.7	5.7	5.72.77e-02		2.6	-0.3	201.5	1056.0	-25.1
323	ok 0.08	0.1	7.58e-04	5.7	5.7	5.7	5.71.82e-03		2.3	-2.14e-02	195.1	992.6	-4.5
324	ok 0.08	0.1	8.72e-04	5.7	5.7	5.7	5.73.19e-03		2.3	8.79e-02	196.2	1009.9	13.3
325	ok 0.08	0.2	1.10e-03	5.7	5.7	5.7	5.7	2.9	3.7	-2.7	259.2	1153.4	-58.2
326	ok 0.08	0.2	1.37e-03	5.7	5.7	5.7	5.7	4.7	5.4	-2.4	345.4	1508.0	-26.2
327	ok 0.08	0.3	1.84e-03	5.7	5.7	5.7	5.7	4.3	8.6	1.2	489.0	1854.6	119.0
328	ok 0.08	0.4	1.00e-02	5.7	5.7	5.7	5.7	9.8	31.9	-16.4	490.0	2420.7	380.9
329	ok 0.08	0.5	2.26e-02	5.7	5.7	5.7	5.7	63.6	58.2	-39.2	970.5	2315.6	273.0
330	ok 0.08	0.6	2.16e-02	5.7	5.7	5.7	5.7	-101.5	-32.1	10.8	2699.2	844.8	568.3
331	ok 0.08	0.5	1.61e-02	5.7	5.7	5.7	5.7	88.1	25.6	-39.2	1919.5	324.7	-598.1
332	ok 0.08	0.7	2.20e-02	5.7	5.7	5.7	5.7	-22.8	115.1	67.4	-1678.7	-2649.3	-258.1
333	ok 0.08	0.3	7.93e-03	5.7	5.7	5.7	5.7	1.2	-27.3	13.2	351.6	2233.6	-111.0
334	ok 0.08	0.3	1.31e-03	5.7	5.7	5.7	5.7	3.9	4.9	-0.1	437.9	1781.7	-49.4
335	ok 0.08	0.2	1.14e-03	5.7	5.7	5.7	5.7	1.6	4.9	-0.4	324.0	1341.8	-35.1
336	ok 0.08	0.1	9.84e-04	5.7	5.7	5.7	5.7-5.14e-02		2.7	0.2	187.5	1073.1	-4.2
337	ok 0.08	0.1	7.43e-04	5.7	5.7	5.7	5.7-5.65e-02		2.4	2.56e-02	186.5	1006.0	-1.3
338	ok 0.08	0.1	9.00e-04	5.7	5.7	5.7	5.7-4.90e-02		2.4	2.80e-02	186.0	1024.4	1.8
339	ok 0.08	0.2	1.06e-03	5.7	5.7	5.7	5.7	2.6	3.6	-2.1	257.7	1141.2	-23.1
340	ok 0.08	0.2	1.31e-03	5.7	5.7	5.7	5.7	4.5	4.4	-3.0	308.7	1484.5	-102.5
341	ok 0.08	0.3	1.48e-03	5.7	5.7	5.7	5.7	4.1	0.7	-0.3	457.9	1989.6	52.3





EGP CODE

GRE.EEC.R.73.IT.W.15235.12.024.01

PAGE

480 di/of 527

342	ok 0.08	0.3	1.35e-02	5.7	5.7	5.7	5.7	0.7	-51.4	49.4	370.2	2734.5	321.6
343	ok 0.08	0.9	3.10e-02	5.7	5.7	5.7	5.7	-15.9	137.8	-78.3	-2273.2	-3527.5	225.7
344	ok 0.08	0.5	2.63e-02	5.7	5.7	5.7	5.7	-86.1	-74.3	43.0	-3025.9	-657.2	538.0
345	ok 0.08	0.5	2.69e-02	5.7	5.7	5.7	5.7	3.7	-35.7	-51.3	-2224.8	-1115.1	-77.3
346	ok 0.08	0.4	1.66e-02	5.7	5.7	5.7	5.7	-65.4	-28.9	-25.4	-1560.4	-219.7	98.7
347	ok 0.08	0.2	2.86e-03	5.7	5.7	5.7	5.7	8.7	1.0	-3.8	1006.1	232.6	77.0
348	ok 0.08	0.3	7.84e-03	5.7	5.7	5.7	5.7	45.2	15.1	-23.1	1538.5	274.1	-275.3
349	ok 0.08	0.4	2.02e-02	5.7	5.7	5.7	5.7	-50.0	-43.7	27.3	-1512.6	-635.0	656.9
350	ok 0.08	0.5	2.57e-02	5.7	5.7	5.7	5.7	87.1	40.3	-26.3	2080.5	156.0	-566.2
351	ok 0.08	0.4	2.09e-02	5.7	5.7	5.7	5.7	-45.1	-60.2	-34.0	-2266.2	-521.5	-512.3
352	ok 0.08	0.4	1.02e-02	5.7	5.7	5.7	5.7	4.9	14.0	6.0	963.5	388.0	568.0
353	ok 0.08	0.2	2.45e-03	5.7	5.7	5.7	5.7	-2.0	-0.5	7.4	1322.7	155.5	521.1
354	ok 0.08	0.2	3.16e-03	5.7	5.7	5.7	5.7	-12.1	-0.6	2.1	1587.3	143.6	245.5
355	ok 0.08	0.3	3.29e-03	5.7	5.7	5.7	5.7	-14.4	-1.3	-0.5	1889.5	194.5	-283.9
356	ok 0.08	0.4	3.75e-03	5.7	5.7	5.7	5.7	7.2	-1.2	-4.9	2456.3	142.4	-273.0
357	ok 0.08	0.7	2.38e-02	5.7	5.7	5.7	5.7	99.6	-69.6	-54.0	-3256.6	-1034.3	-371.4
358	ok 0.08	0.5	2.34e-02	5.7	5.7	5.7	5.7	84.8	41.4	-40.3	1056.4	2583.9	-243.9
359	ok 0.08	0.4	8.99e-03	5.7	5.7	5.7	5.7	14.2	21.3	-8.6	442.6	2487.0	-111.4
360	ok 0.08	0.2	1.49e-03	5.7	5.7	5.7	5.7	5.8	6.3	0.4	423.2	1696.9	24.9
361	ok 0.08	0.2	1.14e-03	5.7	5.7	5.7	5.7	2.4	3.8	-1.1	267.8	1353.6	-57.6
362	ok 0.08	0.1	9.86e-04	5.7	5.7	5.7	5.7	2.5	3.4	2.7	234.7	1021.7	21.7
363	ok 0.08	0.1	7.78e-04	5.7	5.7	5.7	5.7	5.74.77e-02	2.1	0.2	189.6	1004.9	0.5
364	ok 0.08	0.1	8.91e-04	5.7	5.7	5.7	5.7	5.75.11e-02	2.2	-4.33e-02	190.5	1022.6	-4.2
365	ok 0.08	0.2	1.10e-03	5.7	5.7	5.7	5.7	2.6	3.5	-2.2	264.4	1143.4	-38.6
366	ok 0.08	0.2	1.25e-03	5.7	5.7	5.7	5.7	2.4	4.2	2.1	349.1	1518.4	65.1
367	ok 0.08	0.3	1.88e-03	5.7	5.7	5.7	5.7	3.5	6.9	5.1	420.4	1932.7	15.6
368	ok 0.08	0.5	1.39e-02	5.7	5.7	5.7	5.7	18.2	32.0	6.6	660.9	2711.3	-121.0
369	ok 0.08	0.6	2.76e-02	5.7	5.7	5.7	5.7	-45.6	59.6	3.2	-751.6	2559.1	-629.0
370	ok 0.08	0.8	2.44e-02	5.7	5.7	5.7	5.7	117.3	-79.3	60.3	-3559.1	-1095.2	300.0
371	ok 0.08	0.2	6.39e-03	5.7	5.7	5.7	5.7	-0.8	-7.6	19.8	803.0	584.9	894.0
372	ok 0.08	0.3	7.48e-03	5.7	5.7	5.7	5.7	-6.7	16.1	3.1	404.3	1531.5	339.4
373	ok 0.08	0.3	3.17e-03	5.7	5.7	5.7	5.7	2.4	13.0	-8.3	332.2	1790.1	162.2
374	ok 0.08	0.2	1.57e-03	5.7	5.7	5.7	5.7	5.6	6.2	-0.6	465.2	1682.0	-1.3
375	ok 0.08	0.2	1.33e-03	5.7	5.7	5.7	5.7	2.3	2.7	-1.0	299.3	1378.2	-46.8
376	ok 0.08	0.1	1.11e-03	5.7	5.7	5.7	5.7	0.2	1.9	0.3	213.9	1057.3	15.6
377	ok 0.08	0.1	8.59e-04	5.7	5.7	5.7	5.7	0.2	1.8	0.2	202.1	997.3	3.0
378	ok 0.08	0.1	9.33e-04	5.7	5.7	5.7	5.7	0.2	1.9	-5.61e-03	205.5	1014.3	-8.5
379	ok 0.08	0.2	1.16e-03	5.7	5.7	5.7	5.7	1.9	2.7	-1.2	262.6	1171.2	-23.0
380	ok 0.08	0.2	1.28e-03	5.7	5.7	5.7	5.7	2.7	4.3	2.9	336.4	1520.8	34.2
381	ok 0.08	0.3	1.71e-03	5.7	5.7	5.7	5.7	6.2	9.4	1.0	517.3	1806.4	-29.5
382	ok 0.08	0.3	2.81e-03	5.7	5.7	5.7	5.7	-4.5	18.9	2.3	388.3	1732.0	-269.6
383	ok 0.08	0.3	7.08e-03	5.7	5.7	5.7	5.7	-6.8	15.9	-4.4	455.1	1349.6	-429.8
384	ok 0.08	0.3	7.40e-03	5.7	5.7	5.7	5.7	-4.7	13.0	-6.9	597.1	891.2	-553.7
385	ok 0.08	0.2	2.45e-03	5.7	5.7	5.7	5.7	-6.2	4.0	8.0	805.6	722.8	311.5
386	ok 0.08	0.2	2.20e-03	5.7	5.7	5.7	5.7	-5.4	4.4	2.9	605.5	1313.4	182.9
387	ok 0.08	0.2	2.03e-03	5.7	5.7	5.7	5.7	-3.1	6.4	2.7	415.0	1528.7	110.9
388	ok 0.08	0.2	1.64e-03	5.7	5.7	5.7	5.7	-3.0	5.3	-0.2	268.8	1560.8	-31.0
389	ok 0.08	0.2	1.42e-03	5.7	5.7	5.7	5.7	-2.1	3.0	1.1	205.6	1328.8	-54.2
390	ok 0.08	0.1	1.11e-03	5.7	5.7	5.7	5.7	0.4	1.5	0.1	232.8	1043.7	7.9
391	ok 0.08	0.1	8.92e-04	5.7	5.7	5.7	5.7	0.3	1.5	0.2	213.1	989.7	1.7
392	ok 0.08	0.1	9.25e-04	5.7	5.7	5.7	5.7	0.3	1.6	4.62e-02	218.8	1005.4	-4.3
393	ok 0.08	0.2	1.17e-03	5.7	5.7	5.7	5.7	2.2	2.3	1.1	252.7	1172.8	27.7
394	ok 0.08	0.2	1.45e-03	5.7	5.7	5.7	5.7	-4.4	3.3	1.3	180.1	1473.6	-42.0
395	ok 0.08	0.2	1.59e-03	5.7	5.7	5.7	5.7	-2.9	5.6	-2.4	322.6	1610.0	-31.8
396	ok 0.08	0.2	1.88e-03	5.7	5.7	5.7	5.7	-3.5	4.7	-2.5	466.8	1486.7	-101.0
397	ok 0.08	0.2	2.20e-03	5.7	5.7	5.7	5.7	-4.9	4.4	-4.4	696.8	1169.7	-282.2
398	ok 0.08	0.2	3.20e-03	5.7	5.7	5.7	5.7	-5.2	3.2	-8.3	848.7	651.0	-334.7
399	ok 0.08	0.1	2.12e-03	5.7	5.7	5.7	5.7	-9.8	2.0	-3.1	825.0	708.8	-216.1
400	ok 0.08	0.2	1.97e-03	5.7	5.7	5.7	5.7	-8.7	4.0	-3.1	556.7	1279.0	-110.4
401	ok 0.08	0.2	1.73e-03	5.7	5.7	5.7	5.7	-6.7	4.7	-3.2	381.9	1467.9	-48.1
402	ok 0.08	0.2	1.58e-03	5.7	5.7	5.7	5.7	-5.4	3.6	-2.3	257.1	1530.2	10.4
403	ok 0.08	0.2	1.40e-03	5.7	5.7	5.7	5.7	2.5	2.6	-3.4	316.0	1343.4	18.8
404	ok 0.08	0.1	1.11e-03	5.7	5.7	5.7	5.7	0.4	1.5	-0.2	230.3	1043.3	-12.3
405	ok 0.08	0.1	8.99e-04	5.7	5.7	5.7	5.7	0.3	1.5	-0.1	209.6	990.6	-3.5
406	ok 0.08	0.1	9.31e-04	5.7	5.7	5.7	5.7	0.3	1.6	0.1	215.5	1006.1	5.6
407	ok 0.08	0.2	1.12e-03	5.7	5.7	5.7	5.7	3.5	2.2	-0.8	252.6	1168.9	85.2
408	ok 0.08	0.2	1.44e-03	5.7	5.7	5.7	5.7	3.2	3.0	3.3	363.4	1453.0	-16.2
409	ok 0.08	0.2	1.59e-03	5.7	5.7	5.7	5.7	-6.1	3.7	2.2	297.1	1566.2	1.1
410	ok 0.08	0.2	1.75e-03	5.7	5.7	5.7	5.7	-7.4	3.2	2.2	432.8	1452.4	58.8
411	ok 0.08	0.2	2.11e-03	5.7	5.7	5.7	5.7	-9.3	3.3	3.0	662.4	1126.8	139.5
412	ok 0.08	0.1	2.13e-03	5.7	5.7	5.7	5.7	-9.2	0.8	3.7	857.3	660.2	207.0
413	ok 0.08	0.2	2.49e-03	5.7	5.7	5.7	5.7	-11.9	7.0	-4.2	660.1	862.5	-482.6
414	ok 0.08	0.2	1.77e-03	5.7	5.7	5.7	5.7	-8.2	3.8	-3.2	502.2	1399.0	-376.4
415	ok 0.08	0.2	1.49e-03	5.7	5.7	5.7	5.7	-4.8	6.3	-3.3	343.8	1627.7	-185.6
416	ok 0.08	0.2	1.58e-03	5.7	5.7	5.7	5.7	4.6	5.2	-2.5	428.1	1642.6	-28.6
417	ok 0.08	0.2	1.38e-03	5.7	5.7	5.7	5.7	-4.2	3.1	-4.1	201.1	1358.7	17.5





EGP CODE

GRE.EEC.R.73.IT.W.15235.12.024.01

PAGE

481 di/of 527

418	ok 0.08	0.1	1.09e-03	5.7	5.7	5.7	5.78.91e-02	2.0	-0.5	201.7	1058.7	-23.0	
419	ok 0.08	0.1	8.74e-04	5.7	5.7	5.7	5.71.44e-02	1.9	-0.2	189.3	1001.0	-5.3	
420	ok 0.08	0.1	9.39e-04	5.7	5.7	5.7	5.75.79e-02	2.0	0.2	193.2	1017.8	11.1	
421	ok 0.08	0.2	1.15e-03	5.7	5.7	5.7	5.7	1.7	3.1	3.4	240.8	1164.3	-17.1
422	ok 0.08	0.2	1.45e-03	5.7	5.7	5.7	5.7	3.3	3.6	3.5	319.1	1475.9	-4.8
423	ok 0.08	0.2	1.60e-03	5.7	5.7	5.7	5.7	5.5	5.3	2.7	472.3	1709.9	68.8
424	ok 0.08	0.2	1.55e-03	5.7	5.7	5.7	5.7	-5.4	5.7	3.6	403.3	1528.1	293.2
425	ok 0.08	0.2	1.83e-03	5.7	5.7	5.7	5.7	-8.8	10.2	7.0	569.6	1048.6	557.1
426	ok 0.08	0.2	2.30e-03	5.7	5.7	5.7	5.7	-9.8	8.0	3.7	669.7	801.6	519.3
427	ok 0.08	0.4	1.31e-02	5.7	5.7	5.7	5.7	55.1	-24.8	-20.4	-1630.5	-926.5	275.3
428	ok 0.08	0.3	9.36e-03	5.7	5.7	5.7	5.7	-38.8	0.4	6.8	-564.7	1555.9	-517.0
429	ok 0.08	0.3	3.63e-03	5.7	5.7	5.7	5.7	12.8	14.7	9.6	295.9	2123.1	-116.3
430	ok 0.08	0.3	1.64e-03	5.7	5.7	5.7	5.7	4.4	4.6	-2.8	344.9	1764.3	17.4
431	ok 0.08	0.2	1.33e-03	5.7	5.7	5.7	5.7	-4.2	5.8	-3.9	206.4	1365.5	12.0
432	ok 0.08	0.1	1.02e-03	5.7	5.7	5.7	5.7	-0.4	2.9	-0.6	164.0	1077.3	-15.7
433	ok 0.08	0.1	8.67e-04	5.7	5.7	5.7	5.7	-0.3	2.5	-0.2	165.0	1011.7	-2.0
434	ok 0.08	0.1	9.04e-04	5.7	5.7	5.7	5.7	-0.3	2.7	0.2	164.2	1030.4	7.7
435	ok 0.08	0.2	1.07e-03	5.7	5.7	5.7	5.7	1.8	4.8	2.7	230.7	1161.9	-25.9
436	ok 0.08	0.2	1.32e-03	5.7	5.7	5.7	5.7	3.5	6.1	3.3	296.5	1521.7	-26.0
437	ok 0.08	0.3	1.79e-03	5.7	5.7	5.7	5.7	5.7	5.7	3.2	366.7	1948.5	31.5
438	ok 0.08	0.3	3.85e-03	5.7	5.7	5.7	5.7	12.3	18.4	-6.8	461.7	2015.7	323.7
439	ok 0.08	0.4	9.82e-03	5.7	5.7	5.7	5.7	-44.7	-5.2	-4.3	-901.2	1083.9	962.9
440	ok 0.08	0.4	1.56e-02	5.7	5.7	5.7	5.7	-62.6	15.0	29.8	1422.5	568.5	674.4
441	ok 0.08	1.0	3.41e-02	6.2	5.7	5.9	5.7	139.4	35.0	-61.1	-4698.1	-2067.2	885.2
442	ok 0.08	0.7	3.57e-02	5.7	5.7	5.7	5.7	93.8	14.6	54.1	1150.6	3525.9	-447.4
443	ok 0.08	0.4	9.58e-03	5.7	5.7	5.7	5.7	24.4	7.7	6.1	478.9	2667.7	293.6
444	ok 0.08	0.3	1.82e-03	5.7	5.7	5.7	5.7	-7.8	11.0	-6.1	175.9	1768.8	97.2
445	ok 0.08	0.2	1.16e-03	5.7	5.7	5.7	5.7	-2.6	8.8	0.3	187.1	1368.7	67.2
446	ok 0.08	0.2	9.97e-04	5.7	5.7	5.7	5.7	-0.7	3.4	-0.2	143.8	1080.4	10.7
447	ok 0.08	0.1	7.98e-04	5.7	5.7	5.7	5.7	-0.6	3.0	-0.1	149.8	1011.0	3.1
448	ok 0.08	0.1	8.70e-04	5.7	5.7	5.7	5.7	-0.6	3.1	0.1	148.5	1030.0	-5.7
449	ok 0.08	0.2	1.06e-03	5.7	5.7	5.7	5.7	-1.9	6.3	-0.7	159.1	1147.2	-73.2
450	ok 0.08	0.2	1.25e-03	5.7	5.7	5.7	5.7	-3.1	10.4	-0.2	190.2	1533.3	-81.3
451	ok 0.08	0.3	2.37e-03	5.7	5.7	5.7	5.7	-8.8	10.8	8.8	204.5	2003.2	-87.2
452	ok 0.08	0.5	1.36e-02	5.7	5.7	5.7	5.7	32.1	23.7	-5.8	518.2	3360.0	-333.6
453	ok 0.08	0.8	4.29e-02	5.7	5.7	5.7	5.7	139.6	65.8	-66.2	1107.3	3586.1	-950.0
454	ok 0.08	1.0	4.23e-02	7.3	5.7	6.4	5.7	23.8	13.5	114.0	-2002.8	-3365.0	-2337.8
455	ok 0.08	1.0	2.75e-02	6.0	5.7	6.0	5.7	63.0	-143.1	49.3	1601.9	5684.8	1042.6
456	ok 0.08	0.4	3.53e-03	5.7	5.7	5.7	5.7	1.4	18.5	11.7	336.2	2392.7	212.9
457	ok 0.08	0.3	2.61e-03	5.7	5.7	5.7	5.7	7.4	18.6	-1.8	430.1	1845.1	154.3
458	ok 0.08	0.2	1.07e-03	5.7	5.7	5.7	5.7	-2.6	8.2	1.2	205.3	1321.1	58.2
459	ok 0.08	0.2	8.74e-04	5.7	5.7	5.7	5.7	-0.7	3.4	-1.10e-02	141.8	1072.2	21.5
460	ok 0.08	0.1	8.52e-04	5.7	5.7	5.7	5.7	-0.7	3.0	7.00e-02	146.7	1003.2	5.6
461	ok 0.08	0.1	9.09e-04	5.7	5.7	5.7	5.7	-0.7	3.1	-7.30e-02	145.6	1022.2	-11.3
462	ok 0.08	0.2	9.58e-04	5.7	5.7	5.7	5.7	-1.9	6.8	-1.0	155.2	1135.1	-77.2
463	ok 0.08	0.2	1.15e-03	5.7	5.7	5.7	5.7	-3.2	9.4	-1.0	208.1	1473.4	-96.1
464	ok 0.08	0.3	3.59e-03	5.7	5.7	5.7	5.7	9.1	24.2	2.8	490.7	2108.0	-197.1
465	ok 0.08	0.4	7.73e-03	5.7	5.7	5.7	5.7	-8.2	-14.2	22.2	474.8	3200.7	-268.0
466	ok 0.09	1.0	4.64e-02	6.7	5.7	8.2	5.7	85.5	-255.6	-69.8	1195.3	6495.7	-983.4
467	ok 0.08	0.9	3.14e-02	5.7	5.7	5.7	5.7	124.5	-89.0	-74.3	-4529.6	-1604.3	-205.1
468	ok 0.08	0.6	3.36e-02	5.7	5.7	5.7	5.7	98.1	47.0	-33.4	1169.7	2985.1	-560.2
469	ok 0.08	0.4	7.97e-03	5.7	5.7	5.7	5.7	20.5	19.3	-2.1	465.8	2720.1	-60.6
470	ok 0.08	0.3	1.60e-03	5.7	5.7	5.7	5.7	-5.9	15.7	4.6	226.8	1712.0	130.9
471	ok 0.08	0.2	1.03e-03	5.7	5.7	5.7	5.7	-2.9	10.0	2.1	201.4	1305.5	72.1
472	ok 0.08	0.1	9.07e-04	5.7	5.7	5.7	5.7	-0.8	3.4	0.3	150.6	1058.8	37.1
473	ok 0.08	0.1	8.51e-04	5.7	5.7	5.7	5.7	-0.7	2.9	0.1	155.0	990.4	8.1
474	ok 0.08	0.1	9.01e-04	5.7	5.7	5.7	5.7	-0.6	3.0	-0.2	153.9	1009.2	-19.3
475	ok 0.08	0.2	9.66e-04	5.7	5.7	5.7	5.7	-1.8	6.9	-2.1	170.0	1105.8	-53.1
476	ok 0.08	0.2	1.20e-03	5.7	5.7	5.7	5.7	-3.6	11.6	-2.2	204.0	1462.7	-88.8
477	ok 0.08	0.3	1.70e-03	5.7	5.7	5.7	5.7	-6.2	15.9	-6.9	285.6	1961.9	-192.9
478	ok 0.08	0.5	1.13e-02	5.7	5.7	5.7	5.7	29.1	25.3	1.1	696.1	3175.3	-220.8
479	ok 0.08	0.7	3.83e-02	5.7	5.7	5.7	5.7	-47.3	51.3	3.7	-1279.0	2945.1	-754.1
480	ok 0.08	1.0	3.25e-02	6.0	5.7	6.0	5.7	10.1	-2.9	-102.9	-1267.3	-2630.3	2135.0
481	ok 0.08	0.3	9.42e-03	5.7	5.7	5.7	5.7	24.4	-20.8	27.2	-507.3	354.2	1399.2
482	ok 0.08	0.3	7.98e-03	5.7	5.7	5.7	5.7	-31.9	8.0	27.5	-458.9	1295.8	877.4
483	ok 0.08	0.3	3.25e-03	5.7	5.7	5.7	5.7	9.3	14.0	-4.3	322.5	1987.5	308.3
484	ok 0.08	0.2	1.52e-03	5.7	5.7	5.7	5.7	6.7	7.0	4.9	395.1	1663.4	102.1
485	ok 0.08	0.2	1.19e-03	5.7	5.7	5.7	5.7	-2.4	6.8	4.2	234.8	1256.7	47.5
486	ok 0.08	0.1	1.03e-03	5.7	5.7	5.7	5.7	-0.4	2.6	0.7	184.1	1014.7	58.8
487	ok 0.08	0.1	9.32e-04	5.7	5.7	5.7	5.7	-0.3	2.3	0.1	179.5	953.2	12.1
488	ok 0.08	0.1	9.79e-04	5.7	5.7	5.7	5.7	-0.3	2.4	-0.3	180.8	970.1	-30.4
489	ok 0.08	0.2	1.05e-03	5.7	5.7	5.7	5.7	-0.3	2.8	-0.9	185.7	1058.3	-82.3
490	ok 0.08	0.2	1.28e-03	5.7	5.7	5.7	5.7	-3.2	7.1	-4.1	249.0	1422.4	-82.6
491	ok 0.08	0.3	1.63e-03	5.7	5.7	5.7	5.7	7.9	8.3	-5.6	419.3	1836.3	-167.3
492	ok 0.08	0.3	3.29e-03	5.7	5.7	5.7	5.7	13.6	18.5	0.8	531.9	1891.0	-502.7
493	ok 0.08	0.3	8.02e-03	5.7	5.7	5.7	5.7	-33.7	7.6	-28.7	-653.3	1119.1	-1081.2



EGP CODE

GRE.EEC.R.73.IT.W.15235.12.024.01

PAGE

482 di/of 527

494	ok 0.08	0.3	1.04e-02	5.7	5.7	5.7	5.7	21.1	26.5	4.8	-634.3	543.3	-1276.4
495	ok 0.08	0.2	2.35e-03	5.7	5.7	5.7	5.7	-7.5	5.0	4.0	762.7	759.5	741.3
496	ok 0.08	0.2	2.03e-03	5.7	5.7	5.7	5.7	-4.8	2.1	5.2	510.8	1248.6	564.6
497	ok 0.08	0.2	1.72e-03	5.7	5.7	5.7	5.7	-3.0	4.1	5.8	385.1	1469.8	354.1
498	ok 0.08	0.2	1.49e-03	5.7	5.7	5.7	5.7	6.7	4.4	4.7	478.9	1460.4	124.3
499	ok 0.08	0.2	1.35e-03	5.7	5.7	5.7	5.7	-2.4	3.1	5.1	243.3	1193.9	28.2
500	ok 0.08	0.1	1.18e-03	5.7	5.7	5.7	5.7	0.2	1.5	0.7	234.8	961.1	58.0
501	ok 0.08	0.1	1.01e-03	5.7	5.7	5.7	5.7	0.2	1.4	0.3	215.8	908.3	12.9
502	ok 0.08	0.1	1.04e-03	5.7	5.7	5.7	5.7	0.2	1.4	-0.3	220.9	923.7	-29.7
503	ok 0.08	0.1	1.19e-03	5.7	5.7	5.7	5.7	0.3	1.5	-0.9	249.4	997.4	-81.3
504	ok 0.08	0.2	1.35e-03	5.7	5.7	5.7	5.7	3.9	2.0	-1.5	306.8	1359.7	-95.5
505	ok 0.08	0.2	1.54e-03	5.7	5.7	5.7	5.7	7.5	3.9	-5.4	523.6	1519.8	-204.6
506	ok 0.08	0.2	1.69e-03	5.7	5.7	5.7	5.7	-4.1	3.4	-5.7	441.2	1380.0	-484.8
507	ok 0.08	0.2	2.20e-03	5.7	5.7	5.7	5.7	-5.5	1.9	-5.3	570.0	1105.2	-662.3
508	ok 0.08	0.2	3.18e-03	5.7	5.7	5.7	5.7	-7.5	6.3	-3.6	770.5	703.4	-768.3
509	ok 0.08	0.2	2.29e-03	5.7	5.7	5.7	5.7	-7.4	-0.7	4.0	954.1	562.6	479.6
510	ok 0.08	0.2	1.94e-03	5.7	5.7	5.7	5.7	-5.5	0.8	4.0	630.8	1055.2	332.9
511	ok 0.08	0.2	1.57e-03	5.7	5.7	5.7	5.7	-4.7	1.4	4.1	453.8	1211.3	218.4
512	ok 0.08	0.2	1.37e-03	5.7	5.7	5.7	5.7	-5.3	0.2	6.16e-02	263.8	1277.5	169.8
513	ok 0.08	0.2	1.26e-03	5.7	5.7	5.7	5.7	0.6	0.5	0.8	348.7	990.6	73.6
514	ok 0.08	0.1	1.21e-03	5.7	5.7	5.7	5.7	0.6	0.6	0.5	277.3	918.5	35.0
515	ok 0.08	0.1	1.04e-03	5.7	5.7	5.7	5.7	0.6	0.6	0.2	246.3	873.5	8.0
516	ok 0.08	0.1	1.06e-03	5.7	5.7	5.7	5.7	0.6	0.6	-0.2	254.4	887.0	-17.8
517	ok 0.08	0.1	1.20e-03	5.7	5.7	5.7	5.7	2.5	0.3	-0.6	278.9	1012.9	-30.8
518	ok 0.08	0.2	1.32e-03	5.7	5.7	5.7	5.7	3.9	0.2	-0.3	385.8	1221.3	-93.1
519	ok 0.08	0.2	1.35e-03	5.7	5.7	5.7	5.7	-6.0	6.04e-03	0.1	294.2	1300.5	-213.8
520	ok 0.08	0.2	1.66e-03	5.7	5.7	5.7	5.7	-7.9	-0.4	0.4	437.5	1222.9	-280.6
521	ok 0.08	0.2	2.13e-03	5.7	5.7	5.7	5.7	-5.8	-0.6	-3.7	750.7	907.2	-392.4
522	ok 0.08	0.2	2.29e-03	5.7	5.7	5.7	5.7	-7.2	-1.3	-4.2	973.0	523.5	-479.8
523	ok 0.08	0.1	1.88e-03	5.7	5.7	5.7	5.7	-11.3	-1.1	-0.7	980.0	510.3	186.7
524	ok 0.08	0.1	1.64e-03	5.7	5.7	5.7	5.7	-9.3	-1.1	-0.2	634.0	967.8	152.1
525	ok 0.08	0.2	1.44e-03	5.7	5.7	5.7	5.7	-7.2	1.83e-02	-7.47e-02	409.4	1143.1	101.6
526	ok 0.08	0.2	1.27e-03	5.7	5.7	5.7	5.7	-5.3	0.3	-0.1	293.8	1185.2	56.7
527	ok 0.08	0.1	1.21e-03	5.7	5.7	5.7	5.7	0.7	0.1	0.2	374.9	968.6	-8.2
528	ok 0.08	0.1	1.17e-03	5.7	5.7	5.7	5.7	0.8	0.3	0.1	291.6	903.2	-4.7
529	ok 0.08	0.1	1.00e-03	5.7	5.7	5.7	5.7	0.8	0.3	-4.08e-02	256.1	861.4	-1.7
530	ok 0.08	0.1	1.03e-03	5.7	5.7	5.7	5.7	0.9	0.3	-7.54e-02	265.5	874.1	2.2
531	ok 0.08	0.1	1.16e-03	5.7	5.7	5.7	5.7	2.6	8.45e-02	-0.4	287.4	970.0	-13.8
532	ok 0.08	0.2	1.29e-03	5.7	5.7	5.7	5.7	4.0	3.62e-03	-1.75e-02	405.7	1144.5	-41.0
533	ok 0.08	0.2	1.37e-03	5.7	5.7	5.7	5.7	-6.0	-0.1	0.4	329.8	1200.0	-87.7
534	ok 0.08	0.1	1.53e-03	5.7	5.7	5.7	5.7	-7.9	-1.2	0.3	478.0	1112.5	-123.6
535	ok 0.08	0.1	1.73e-03	5.7	5.7	5.7	5.7	-9.9	-1.3	0.8	762.9	850.4	-169.0
536	ok 0.08	0.1	1.86e-03	5.7	5.7	5.7	5.7	-11.2	-1.3	0.4	987.0	474.7	-190.0
537	ok 0.08	0.2	1.95e-03	5.7	5.7	5.7	5.7	-6.4	0.6	-5.8	949.5	470.1	-467.5
538	ok 0.08	0.2	1.57e-03	5.7	5.7	5.7	5.7	-4.7	1.5	-5.1	685.3	925.5	-348.3
539	ok 0.08	0.2	1.26e-03	5.7	5.7	5.7	5.7	-3.3	2.1	-4.8	484.3	1084.8	-250.2
540	ok 0.08	0.2	1.17e-03	5.7	5.7	5.7	5.7	-2.5	1.6	-3.4	346.0	1141.3	-133.7
541	ok 0.08	0.2	1.13e-03	5.7	5.7	5.7	5.7	0.7	0.3	-0.3	339.5	992.4	-84.6
542	ok 0.08	0.1	1.09e-03	5.7	5.7	5.7	5.7	0.8	0.4	-0.2	268.2	922.3	-41.4
543	ok 0.08	0.1	9.34e-04	5.7	5.7	5.7	5.7	0.8	0.5	-0.1	237.9	877.8	-9.3
544	ok 0.08	0.1	9.76e-04	5.7	5.7	5.7	5.7	0.8	0.5	8.90e-02	246.3	890.9	21.4
545	ok 0.08	0.1	1.13e-03	5.7	5.7	5.7	5.7	0.8	0.5	0.3	294.2	952.1	57.2
546	ok 0.08	0.2	1.19e-03	5.7	5.7	5.7	5.7	0.8	0.3	0.6	384.3	1020.7	104.5
547	ok 0.08	0.2	1.26e-03	5.7	5.7	5.7	5.7	-2.8	1.4	5.0	395.7	1162.7	166.4
548	ok 0.08	0.2	1.34e-03	5.7	5.7	5.7	5.7	-3.6	1.1	5.1	548.8	1072.0	260.0
549	ok 0.08	0.2	1.66e-03	5.7	5.7	5.7	5.7	-5.0	1.0	5.1	789.8	802.1	404.9
550	ok 0.08	0.2	1.96e-03	5.7	5.7	5.7	5.7	-6.4	-1.1	5.7	965.7	427.1	480.1
551	ok 0.08	0.2	2.28e-03	5.7	5.7	5.7	5.7	-6.6	6.6	-6.2	745.0	600.9	-696.4
552	ok 0.08	0.2	1.85e-03	5.7	5.7	5.7	5.7	-6.8	3.5	-4.4	516.4	1075.4	-555.3
553	ok 0.08	0.2	1.33e-03	5.7	5.7	5.7	5.7	-3.7	5.8	-4.3	392.1	1300.2	-392.2
554	ok 0.08	0.2	1.15e-03	5.7	5.7	5.7	5.7	-2.8	4.6	-2.1	277.6	1324.7	-197.8
555	ok 0.08	0.2	1.03e-03	5.7	5.7	5.7	5.7	0.6	1.1	-0.8	252.2	1056.0	-133.0
556	ok 0.08	0.1	9.28e-04	5.7	5.7	5.7	5.7	0.6	1.1	-0.5	214.7	969.0	-63.4
557	ok 0.08	0.1	8.46e-04	5.7	5.7	5.7	5.7	0.6	1.1	-0.2	197.6	916.3	-13.6
558	ok 0.08	0.1	9.02e-04	5.7	5.7	5.7	5.7	0.5	1.2	0.2	202.8	931.2	33.4
559	ok 0.08	0.1	1.03e-03	5.7	5.7	5.7	5.7	0.6	1.3	0.6	230.5	1003.3	89.7
560	ok 0.08	0.2	1.11e-03	5.7	5.7	5.7	5.7	-3.4	3.3	3.6	243.6	1258.3	87.2
561	ok 0.08	0.2	1.11e-03	5.7	5.7	5.7	5.7	-2.6	4.9	3.9	333.1	1370.3	243.1
562	ok 0.08	0.2	1.29e-03	5.7	5.7	5.7	5.7	-4.0	5.6	6.2	450.5	1226.6	501.4
563	ok 0.08	0.2	1.64e-03	5.7	5.7	5.7	5.7	-5.5	5.4	5.1	621.2	980.6	595.9
564	ok 0.08	0.2	2.51e-03	5.7	5.7	5.7	5.7	-6.7	7.3	5.3	755.1	565.5	730.5
565	ok 0.08	0.3	8.76e-03	5.7	5.7	5.7	5.7	28.5	-23.3	-22.5	-1079.3	-449.1	-514.2
566	ok 0.08	0.3	7.84e-03	5.7	5.7	5.7	5.7	-38.1	16.8	-24.4	-565.0	1172.0	-860.2
567	ok 0.08	0.3	3.08e-03	5.7	5.7	5.7	5.7	-2.6	14.5	-2.7	189.0	1671.7	-381.1
568	ok 0.08	0.2	1.05e-03	5.7	5.7	5.7	5.7	-3.9	6.7	-0.4	224.6	1562.2	-151.7
569	ok 0.08	0.2	9.47e-04	5.7	5.7	5.7	5.7	-3.1	4.5	-3.4	176.8	1219.9	-81.1



EGP CODE

GRE.EEC.R.73.IT.W.15235.12.024.01

PAGE

483 di/of 527

570	ok 0.08	0.1	8.53e-04	5.7	5.7	5.7	5.7	0.3	2.2	-0.6	151.3	1025.7	-60.5
571	ok 0.08	0.1	7.70e-04	5.7	5.7	5.7	5.7	0.2	2.0	-0.3	150.5	962.2	-12.6
572	ok 0.08	0.1	8.37e-04	5.7	5.7	5.7	5.7	0.2	2.1	0.2	151.3	979.7	32.6
573	ok 0.08	0.2	9.26e-04	5.7	5.7	5.7	5.7	0.2	2.4	0.7	151.4	1067.8	88.2
574	ok 0.08	0.2	9.80e-04	5.7	5.7	5.7	5.7	-3.6	5.7	1.4	184.2	1359.2	124.6
575	ok 0.08	0.3	1.20e-03	5.7	5.7	5.7	5.7	-4.3	10.4	0.4	241.9	1694.7	208.3
576	ok 0.08	0.3	2.15e-03	5.7	5.7	5.7	5.7	-5.6	21.0	-0.7	229.1	1652.6	538.4
577	ok 0.08	0.3	7.03e-03	5.7	5.7	5.7	5.7	5.9	29.3	-10.0	1237.4	1083.4	447.6
578	ok 0.08	0.3	8.32e-03	5.7	5.7	5.7	5.7	13.3	-12.5	26.1	-1191.6	-462.0	499.7
579	ok 0.08	0.7	2.80e-02	5.7	5.7	5.7	5.7	92.3	12.4	-51.1	-3384.5	-1617.1	528.7
580	ok 0.08	0.6	2.50e-02	5.7	5.7	5.7	5.7	-59.6	-2.7	-41.5	-1394.8	1286.6	-1364.5
581	ok 0.08	0.4	1.01e-02	5.7	5.7	5.7	5.7	-6.5	18.8	8.9	152.2	2453.7	-358.7
582	ok 0.08	0.2	1.46e-03	5.7	5.7	5.7	5.7	3.3	6.0	1.4	256.1	1695.7	-35.3
583	ok 0.08	0.2	7.82e-04	5.7	5.7	5.7	5.7	-3.1	5.8	-3.3	142.5	1259.8	-82.9
584	ok 0.08	0.1	7.70e-04	5.7	5.7	5.7	5.7	-2.20e-02	3.2	-0.4	107.0	1068.4	-31.2
585	ok 0.08	0.1	6.87e-04	5.7	5.7	5.7	5.7	-0.1	2.8	-0.2	117.6	997.2	-5.8
586	ok 0.08	0.1	7.63e-04	5.7	5.7	5.7	5.7	-0.1	2.9	0.1	114.5	1016.2	17.8
587	ok 0.08	0.2	8.17e-04	5.7	5.7	5.7	5.7	-2.3	4.4	3.1	130.1	1072.0	63.7
588	ok 0.08	0.2	8.05e-04	5.7	5.7	5.7	5.7	-2.8	5.4	-0.5	129.6	1447.9	-62.3
589	ok 0.08	0.3	2.06e-03	5.7	5.7	5.7	5.7	4.5	9.5	-0.4	311.0	1844.4	187.6
590	ok 0.08	0.5	1.54e-02	5.7	5.7	5.7	5.7	19.3	35.7	-6.3	466.2	2776.5	275.9
591	ok 0.08	0.7	2.80e-02	5.7	5.7	5.7	5.7	-51.4	71.3	-1.4	-1310.6	2677.3	880.4
592	ok 0.08	0.8	2.83e-02	5.7	5.7	5.7	5.7	124.1	-94.7	-61.9	-3952.4	-1236.0	-287.7
593	ok 0.08	0.7	2.37e-02	5.7	5.7	5.7	5.7	-18.3	124.6	-72.5	-2013.2	-2718.8	311.6
594	ok 0.08	0.3	8.20e-03	5.7	5.7	5.7	5.7	6.0	-24.1	27.8	261.7	2290.4	-52.8
595	ok 0.08	0.3	9.99e-04	5.7	5.7	5.7	5.7	6.0	6.9	4.2	275.1	1748.5	141.6
596	ok 0.08	0.2	6.85e-04	5.7	5.7	5.7	5.7	-2.5	6.3	6.41e-02	135.9	1292.5	35.9
597	ok 0.08	0.1	6.53e-04	5.7	5.7	5.7	5.7	-0.2	3.7	-0.2	94.8	1083.1	-1.1
598	ok 0.08	0.1	6.54e-04	5.7	5.7	5.7	5.7	-0.3	3.2	-2.86e-02	109.8	1009.4	7.43e-02
599	ok 0.08	0.1	6.99e-04	5.7	5.7	5.7	5.7	-0.3	3.2	-2.03e-02	104.9	1029.2	1.3
600	ok 0.08	0.2	7.18e-04	5.7	5.7	5.7	5.7	-2.2	4.6	1.8	101.0	1083.9	127.7
601	ok 0.08	0.2	7.29e-04	5.7	5.7	5.7	5.7	-3.0	5.9	0.1	133.5	1444.8	-47.9
602	ok 0.08	0.3	1.20e-03	5.7	5.7	5.7	5.7	5.9	2.5	-3.4	329.8	1981.3	40.1
603	ok 0.08	0.3	1.43e-02	5.7	5.7	5.7	5.7	3.3	-52.7	-44.0	227.0	2844.3	112.2
604	ok 0.08	0.9	3.37e-02	5.7	5.7	5.7	5.7	-10.9	149.2	82.1	-2706.1	-3677.1	-225.0
605	ok 0.08	0.6	1.66e-02	5.7	5.7	5.7	5.7	82.6	22.5	-37.9	2882.8	277.0	-750.4
606	ok 0.08	0.4	2.42e-02	5.7	5.7	5.7	5.7	-42.5	-76.1	37.5	-2971.7	-657.8	591.2
607	ok 0.08	0.6	1.94e-02	5.7	5.7	5.7	5.7	-17.5	91.3	45.7	570.6	245.8	-258.2
608	ok 0.08	0.5	1.56e-02	5.7	5.7	5.7	5.7	6.0	-39.2	37.6	-283.7	-1474.1	-855.9
609	ok 0.08	0.6	2.56e-02	5.7	5.7	5.7	5.7	54.2	58.4	-26.4	730.0	2972.1	-988.4
610	ok 0.08	0.5	7.54e-03	5.7	5.7	5.7	5.7	1.5	39.9	-13.6	235.9	2958.4	-551.9
611	ok 0.08	0.3	2.38e-03	5.7	5.7	5.7	5.7	-2.0	-6.4	-2.1	162.6	1499.7	-671.8
612	ok 0.08	0.2	2.42e-03	5.7	5.7	5.7	5.7	-1.2	-9.9	0.1	137.1	1420.3	-419.4
613	ok 0.08	0.2	2.15e-03	5.7	5.7	5.7	5.7	-1.3	-9.9	0.2	104.7	1257.7	-247.6
614	ok 0.08	0.1	1.81e-03	5.7	5.7	5.7	5.7	-1.1	-9.5	8.44e-02	85.0	1123.9	-122.5
615	ok 0.08	0.1	1.87e-03	5.7	5.7	5.7	5.7	-1.0	-9.4	-3.34e-02	90.9	1174.3	160.5
616	ok 0.08	0.2	2.14e-03	5.7	5.7	5.7	5.7	-1.2	-9.4	-0.1	113.9	1330.5	300.3
617	ok 0.08	0.3	2.25e-03	5.7	5.7	5.7	5.7	-1.0	-8.7	0.2	155.9	1505.9	489.5
618	ok 0.08	0.3	2.22e-03	5.7	5.7	5.7	5.7	-2.5	9.2	1.3	149.5	2314.1	397.2
619	ok 0.08	0.6	2.41e-02	5.7	5.7	5.7	5.7	24.7	61.0	17.9	394.3	1338.2	1217.9
620	ok 0.08	0.5	2.08e-02	5.7	5.7	5.7	5.7	-35.6	37.8	-4.4	-740.6	2271.4	648.6
621	ok 0.08	0.4	7.48e-03	5.7	5.7	5.7	5.7	3.4	22.0	-8.0	320.8	2375.7	340.0
622	ok 0.08	0.3	1.20e-03	5.7	5.7	5.7	5.7	4.5	9.9	1.8	350.0	1652.3	128.1
623	ok 0.08	0.2	9.55e-04	5.7	5.7	5.7	5.7	2.9	6.9	4.1	257.8	1224.9	60.1
624	ok 0.08	0.1	7.95e-04	5.7	5.7	5.7	5.7	-5.22e-02	3.4	0.6	127.2	1059.1	46.7
625	ok 0.08	0.1	6.60e-04	5.7	5.7	5.7	5.7	-0.1	3.0	0.1	133.9	990.4	9.0
626	ok 0.08	0.1	6.66e-04	5.7	5.7	5.7	5.7	-0.1	3.0	-0.2	131.2	1008.8	-25.0
627	ok 0.08	0.2	7.02e-04	5.7	5.7	5.7	5.7	-3.49e-02	3.5	-0.5	119.3	1102.6	-64.3
628	ok 0.08	0.2	7.37e-04	5.7	5.7	5.7	5.7	-3.0	7.0	-3.4	160.3	1390.9	-99.4
629	ok 0.08	0.3	1.73e-03	5.7	5.7	5.7	5.7	5.5	10.6	-0.2	355.7	1833.6	-186.6
630	ok 0.08	0.4	1.11e-02	5.7	5.7	5.7	5.7	15.1	35.3	4.7	476.1	2431.1	-342.1
631	ok 0.08	0.5	2.35e-02	5.7	5.7	5.7	5.7	-29.8	62.7	-5.1	-654.2	2335.1	-972.6
632	ok 0.08	0.6	2.51e-02	5.7	5.7	5.7	5.7	14.8	-40.2	-23.2	-649.0	-1225.2	-1220.0
633	ok 0.08	0.2	6.43e-03	5.7	5.7	5.7	5.7	-7.4	9.8	6.8	537.7	813.1	772.6
634	ok 0.08	0.3	5.21e-03	5.7	5.7	5.7	5.7	-21.5	18.7	14.4	239.3	1308.2	801.0
635	ok 0.08	0.3	2.71e-03	5.7	5.7	5.7	5.7	8.5	7.3	1.1	485.0	1503.7	200.5
636	ok 0.08	0.2	1.24e-03	5.7	5.7	5.7	5.7	4.5	7.3	0.7	445.0	1557.1	91.8
637	ok 0.08	0.2	9.70e-04	5.7	5.7	5.7	5.7	-2.2	5.1	4.4	217.8	1178.2	53.1
638	ok 0.08	0.1	8.47e-04	5.7	5.7	5.7	5.7	0.4	2.4	0.7	187.0	1009.0	61.6
639	ok 0.08	0.1	7.26e-04	5.7	5.7	5.7	5.7	0.3	2.2	0.3	177.4	949.0	13.0
640	ok 0.08	0.1	7.15e-04	5.7	5.7	5.7	5.7	0.3	2.3	-0.2	179.9	965.5	-33.2
641	ok 0.08	0.2	8.06e-04	5.7	5.7	5.7	5.7	0.3	2.5	-0.8	193.0	1047.8	-90.0
642	ok 0.08	0.2	9.03e-04	5.7	5.7	5.7	5.7	-2.8	5.9	-3.8	244.7	1340.5	-106.8
643	ok 0.08	0.3	1.58e-03	5.7	5.7	5.7	5.7	4.9	9.9	-0.5	476.9	1648.1	-168.6
644	ok 0.08	0.3	2.19e-03	5.7	5.7	5.7	5.7	-3.5	18.4	-1.5	348.3	1559.9	-457.1
645	ok 0.08	0.3	4.65e-03	5.7	5.7	5.7	5.7	-6.9	14.1	-5.6	368.2	1145.9	-706.4



EGP CODE

GRE.EEC.R.73.IT.W.15235.12.024.01

PAGE

484 di/of 527

646	ok 0.08	0.2	6.44e-03	5.7	5.7	5.7	5.7	-7.8	7.6	-4.6	579.9	837.9	-798.8
647	ok 0.08	0.2	2.26e-03	5.7	5.7	5.7	5.7	-7.4	3.1	8.0	837.9	568.7	568.8
648	ok 0.08	0.2	1.55e-03	5.7	5.7	5.7	5.7	-5.4	2.6	4.0	586.5	1031.7	461.1
649	ok 0.08	0.2	1.34e-03	5.7	5.7	5.7	5.7	-3.3	4.6	4.2	444.7	1242.6	329.9
650	ok 0.08	0.2	1.20e-03	5.7	5.7	5.7	5.7	-3.4	4.3	2.9	289.7	1354.5	109.9
651	ok 0.08	0.2	1.03e-03	5.7	5.7	5.7	5.7	0.9	1.3	1.0	302.2	1040.4	109.0
652	ok 0.08	0.1	9.17e-04	5.7	5.7	5.7	5.7	0.8	1.4	0.6	247.7	957.8	52.1
653	ok 0.08	0.1	7.76e-04	5.7	5.7	5.7	5.7	0.7	1.4	0.2	223.7	907.2	11.1
654	ok 0.08	0.1	7.52e-04	5.7	5.7	5.7	5.7	0.7	1.4	-0.2	230.5	921.2	-28.1
655	ok 0.08	0.1	8.94e-04	5.7	5.7	5.7	5.7	0.8	1.5	-0.7	268.6	989.5	-75.0
656	ok 0.08	0.2	1.01e-03	5.7	5.7	5.7	5.7	-2.6	3.2	-3.0	252.6	1261.0	-73.3
657	ok 0.08	0.2	1.10e-03	5.7	5.7	5.7	5.7	-3.3	4.3	-4.1	346.4	1388.0	-153.2
658	ok 0.08	0.2	1.25e-03	5.7	5.7	5.7	5.7	-3.8	3.9	-5.8	504.8	1165.4	-417.6
659	ok 0.08	0.2	1.58e-03	5.7	5.7	5.7	5.7	-5.9	3.5	-4.0	691.5	937.2	-481.2
660	ok 0.08	0.2	2.38e-03	5.7	5.7	5.7	5.7	-6.1	2.8	-7.7	825.8	452.5	-691.8
661	ok 0.08	0.1	1.88e-03	5.7	5.7	5.7	5.7	-7.2	0.3	4.3	983.7	459.9	326.7
662	ok 0.08	0.2	1.42e-03	5.7	5.7	5.7	5.7	-5.0	1.1	-1.2	697.2	912.7	242.6
663	ok 0.08	0.2	1.23e-03	5.7	5.7	5.7	5.7	-5.0	1.1	-1.7	422.3	1205.0	98.7
664	ok 0.08	0.2	1.16e-03	5.7	5.7	5.7	5.7	-3.4	1.3	-1.40e-02	254.2	1243.4	102.7
665	ok 0.08	0.2	1.02e-03	5.7	5.7	5.7	5.7	1.1	0.5	0.4	363.6	994.9	47.5
666	ok 0.08	0.1	8.57e-04	5.7	5.7	5.7	5.7	1.1	0.8	0.2	286.1	924.5	23.1
667	ok 0.08	0.1	7.59e-04	5.7	5.7	5.7	5.7	1.0	0.8	0.1	253.1	879.6	5.3
668	ok 0.08	0.1	7.78e-04	5.7	5.7	5.7	5.7	1.0	0.9	-7.24e-02	262.5	892.3	-12.2
669	ok 0.08	0.1	9.48e-04	5.7	5.7	5.7	5.7	1.0	0.8	-0.3	315.1	952.7	-32.6
670	ok 0.08	0.2	1.06e-03	5.7	5.7	5.7	5.7	-2.8	1.2	1.3	246.6	1200.6	-56.8
671	ok 0.08	0.2	1.19e-03	5.7	5.7	5.7	5.7	-4.1	1.2	1.3	334.8	1269.1	-90.3
672	ok 0.08	0.2	1.29e-03	5.7	5.7	5.7	5.7	-6.1	0.6	-0.3	416.9	1174.9	-182.0
673	ok 0.08	0.1	1.57e-03	5.7	5.7	5.7	5.7	-5.5	0.4	-4.1	807.6	791.8	-279.8
674	ok 0.08	0.1	1.89e-03	5.7	5.7	5.7	5.7	-7.3	-0.7	-4.3	993.5	433.8	-331.2
675	ok 0.08	0.1	2.05e-03	5.7	5.7	5.7	5.7	-8.3	0.5	-4.3	1023.9	563.6	-266.9
676	ok 0.08	0.2	1.69e-03	5.7	5.7	5.7	5.7	-6.6	1.4	-2.8	691.2	1045.7	-206.3
677	ok 0.08	0.2	1.38e-03	5.7	5.7	5.7	5.7	-4.5	2.1	-3.5	466.4	1195.7	-117.6
678	ok 0.08	0.2	1.20e-03	5.7	5.7	5.7	5.7	-4.4	1.3	4.22e-02	265.9	1256.9	-118.1
679	ok 0.08	0.2	1.12e-03	5.7	5.7	5.7	5.7	1.1	0.5	-0.4	366.1	991.8	-35.4
680	ok 0.08	0.1	9.49e-04	5.7	5.7	5.7	5.7	1.0	0.7	-0.2	287.8	921.7	-16.6
681	ok 0.08	0.1	7.86e-04	5.7	5.7	5.7	5.7	1.0	0.8	-0.2	254.5	877.0	-4.0
682	ok 0.08	0.1	8.24e-04	5.7	5.7	5.7	5.7	1.0	0.8	3.32e-02	263.9	889.6	8.7
683	ok 0.08	0.1	9.08e-04	5.7	5.7	5.7	5.7	1.0	0.7	0.2	317.0	949.8	24.0
684	ok 0.08	0.2	1.04e-03	5.7	5.7	5.7	5.7	-3.5	1.2	-1.6	246.7	1214.2	48.8
685	ok 0.08	0.2	1.20e-03	5.7	5.7	5.7	5.7	-4.0	1.4	2.7	379.7	1275.7	78.9
686	ok 0.08	0.2	1.38e-03	5.7	5.7	5.7	5.7	-7.1	0.6	0.4	436.7	1193.3	219.7
687	ok 0.08	0.2	1.80e-03	5.7	5.7	5.7	5.7	-6.4	0.7	3.8	822.4	922.7	225.8
688	ok 0.08	0.1	2.05e-03	5.7	5.7	5.7	5.7	-8.3	-0.8	4.4	1035.7	526.5	268.2
689	ok 0.08	0.2	2.58e-03	5.7	5.7	5.7	5.7	-6.7	3.6	-8.2	842.3	608.6	-662.4
690	ok 0.08	0.2	1.84e-03	5.7	5.7	5.7	5.7	-5.8	3.1	-4.0	597.4	1170.3	-444.3
691	ok 0.08	0.2	1.50e-03	5.7	5.7	5.7	5.7	-3.6	5.0	-4.1	441.8	1373.5	-304.3
692	ok 0.08	0.2	1.28e-03	5.7	5.7	5.7	5.7	-4.7	2.9	-0.1	201.4	1409.5	-197.0
693	ok 0.08	0.2	1.17e-03	5.7	5.7	5.7	5.7	0.9	1.2	-0.9	310.1	1031.4	-98.6
694	ok 0.08	0.1	1.00e-03	5.7	5.7	5.7	5.7	0.8	1.2	-0.5	253.2	949.8	-46.7
695	ok 0.08	0.1	8.15e-04	5.7	5.7	5.7	5.7	0.7	1.2	-0.3	228.1	899.8	-10.0
696	ok 0.08	0.1	8.15e-04	5.7	5.7	5.7	5.7	0.7	1.3	0.2	235.1	913.7	25.1
697	ok 0.08	0.1	9.35e-04	5.7	5.7	5.7	5.7	0.8	1.3	0.6	274.8	981.2	67.6
698	ok 0.08	0.2	1.02e-03	5.7	5.7	5.7	5.7	-2.9	3.4	2.6	256.3	1296.7	53.1
699	ok 0.08	0.2	1.19e-03	5.7	5.7	5.7	5.7	-3.2	4.5	3.6	352.3	1441.2	165.6
700	ok 0.08	0.2	1.44e-03	5.7	5.7	5.7	5.7	-4.4	4.3	5.8	496.4	1289.9	398.2
701	ok 0.08	0.2	1.97e-03	5.7	5.7	5.7	5.7	-6.9	4.1	3.7	715.2	1069.0	450.3
702	ok 0.08	0.2	2.97e-03	5.7	5.7	5.7	5.7	-6.6	3.4	8.1	864.3	544.2	692.5
703	ok 0.08	0.2	6.09e-03	5.7	5.7	5.7	5.7	-6.6	9.8	-7.2	562.4	892.2	-871.7
704	ok 0.08	0.3	5.93e-03	5.7	5.7	5.7	5.7	-23.9	17.9	-17.1	242.1	1407.1	-841.9
705	ok 0.08	0.3	3.04e-03	5.7	5.7	5.7	5.7	3.7	12.8	3.6	271.8	1702.8	-381.0
706	ok 0.08	0.2	1.17e-03	5.7	5.7	5.7	5.7	5.9	7.8	-1.4	477.9	1646.0	-93.3
707	ok 0.08	0.2	1.11e-03	5.7	5.7	5.7	5.7	-2.6	5.4	-2.9	223.0	1272.1	-37.0
708	ok 0.08	0.1	9.23e-04	5.7	5.7	5.7	5.7	0.4	2.2	-0.7	196.5	997.3	-58.4
709	ok 0.08	0.1	7.55e-04	5.7	5.7	5.7	5.7	0.3	1.9	-0.3	185.0	938.4	-12.4
710	ok 0.08	0.1	7.75e-04	5.7	5.7	5.7	5.7	0.3	2.0	0.2	188.0	954.7	31.4
711	ok 0.08	0.2	8.81e-04	5.7	5.7	5.7	5.7	0.3	2.3	0.7	203.9	1035.7	85.4
712	ok 0.08	0.2	9.77e-04	5.7	5.7	5.7	5.7	-2.9	6.2	2.8	246.8	1405.6	76.0
713	ok 0.08	0.3	1.18e-03	5.7	5.7	5.7	5.7	-4.9	10.7	0.8	286.2	1750.5	194.3
714	ok 0.08	0.3	2.69e-03	5.7	5.7	5.7	5.7	-3.5	18.9	1.5	360.0	1650.3	505.5
715	ok 0.08	0.3	5.37e-03	5.7	5.7	5.7	5.7	-24.2	13.9	17.7	339.3	1333.7	990.8
716	ok 0.08	0.3	6.86e-03	5.7	5.7	5.7	5.7	-7.0	7.3	4.8	606.0	915.0	904.1
717	ok 0.08	0.6	2.58e-02	5.7	5.7	5.7	5.7	72.3	-2.4	-54.4	-2383.7	-1291.6	320.8
718	ok 0.08	0.5	2.26e-02	5.7	5.7	5.7	5.7	-38.5	38.9	5.4	-670.3	2483.1	-658.9
719	ok 0.08	0.4	8.23e-03	5.7	5.7	5.7	5.7	6.6	25.0	10.4	414.1	2594.6	-346.4
720	ok 0.08	0.3	1.32e-03	5.7	5.7	5.7	5.7	6.4	10.3	-1.5	415.2	1760.8	-132.1
721	ok 0.08	0.2	9.68e-04	5.7	5.7	5.7	5.7	4.0	7.4	-1.9	319.7	1319.1	-82.6





EGP CODE

GRE.EEC.R.73.IT.W.15235.12.024.01

PAGE

485 di/of 527

722	ok 0.08	0.1	7.98e-04	5.7	5.7	5.7	5.7-6.07e-03	3.1	-0.5	140.8	1046.3	-46.9
723	ok 0.08	0.1	6.61e-04	5.7	5.7	5.7	5.7-3.82e-02	2.7	-9.93e-02	144.8	979.0	-9.1
724	ok 0.08	0.1	7.13e-04	5.7	5.7	5.7	5.7-4.74e-02	2.7	0.2	142.8	997.1	25.0
725	ok 0.08	0.2	8.08e-04	5.7	5.7	5.7	5.7 -1.9	5.0	2.2	155.5	1113.5	62.9
726	ok 0.08	0.2	9.00e-04	5.7	5.7	5.7	5.7 -3.4	7.4	1.2	183.6	1478.7	72.6
727	ok 0.08	0.3	1.88e-03	5.7	5.7	5.7	5.7 7.6	11.3	-0.2	430.0	1966.0	197.9
728	ok 0.08	0.5	1.23e-02	5.7	5.7	5.7	5.7 14.6	42.5	-22.6	358.2	2723.2	532.4
729	ok 0.08	0.6	2.50e-02	5.7	5.7	5.7	5.7 -32.2	66.0	4.5	-566.3	2573.7	1021.6
730	ok 0.08	0.6	2.68e-02	5.7	5.7	5.7	5.7 89.6	-54.3	-25.8	-2631.6	-719.4	-629.2
731	ok 0.08	0.6	1.11e-02	5.7	5.7	5.7	5.7 12.1	59.5	20.1	295.7	3058.4	550.3
732	ok 0.08	0.8	2.67e-02	5.7	5.7	5.7	5.7 -23.5	140.1	80.5	-2147.1	-3243.5	-288.2
733	ok 0.08	0.3	9.04e-03	5.7	5.7	5.7	5.7 4.7	-29.1	-31.1	321.8	2482.3	-8.8
734	ok 0.08	0.3	1.15e-03	5.7	5.7	5.7	5.7 7.0	6.5	0.8	386.0	1887.2	-47.9
735	ok 0.08	0.2	8.42e-04	5.7	5.7	5.7	5.7 -2.9	6.4	-1.1	156.3	1364.7	-34.9
736	ok 0.08	0.1	6.77e-04	5.7	5.7	5.7	5.7 -0.2	3.4	0.2	111.8	1074.3	-4.9
737	ok 0.08	0.1	6.09e-04	5.7	5.7	5.7	5.7 -0.2	2.9	2.03e-02	123.4	1002.0	-1.4
738	ok 0.08	0.1	7.10e-04	5.7	5.7	5.7	5.7 -0.2	2.9	1.27e-02	119.5	1021.5	2.0
739	ok 0.08	0.2	7.98e-04	5.7	5.7	5.7	5.7 -1.8	4.7	1.0	120.6	1144.3	77.2
740	ok 0.08	0.2	9.52e-04	5.7	5.7	5.7	5.7 -2.9	5.9	2.1	126.8	1527.2	98.8
741	ok 0.08	0.3	1.57e-03	5.7	5.7	5.7	5.7 6.6	1.7	3.2	428.1	2135.4	-28.7
742	ok 0.08	0.4	1.60e-02	5.7	5.7	5.7	5.7 5.3	-63.2	58.2	263.6	3090.3	324.0
743	ok 0.08	1.0	3.74e-02	5.9	5.7	5.9	5.7 -15.8	168.3	-93.5	-2835.3	-4222.7	249.1
744	ok 0.08	0.6	2.87e-02	5.7	5.7	5.7	5.7 82.1	85.7	31.6	686.1	3020.7	523.3
745	ok 0.08	0.3	1.73e-02	5.7	5.7	5.7	5.7 -67.5	-79.7	30.2	8.1	364.9	566.2
746	ok 0.08	0.3	1.70e-02	5.7	5.7	5.7	5.7 -26.3	-56.5	-17.6	-263.7	305.6	-307.8
747	ok 0.08	0.5	1.56e-02	5.7	5.7	5.7	5.7 55.2	-43.0	-57.6	-1482.7	-1496.6	709.3
748	ok 0.08	0.5	1.94e-02	5.7	5.7	5.7	5.7 70.3	-39.1	72.4	-1606.7	-1494.0	-742.5
749	ok 0.08	0.6	2.41e-02	5.7	5.7	5.7	5.7 81.5	77.9	32.0	779.9	2814.3	601.6
750	ok 0.08	0.5	9.94e-03	5.7	5.7	5.7	5.7 0.6	42.9	17.0	67.1	2695.0	66.7
751	ok 0.08	0.3	2.37e-03	5.7	5.7	5.7	5.7 -1.8	-8.6	2.7	154.0	1485.8	655.0
752	ok 0.08	0.2	2.39e-03	5.7	5.7	5.7	5.7 -1.0	-12.5	0.1	137.3	1446.9	411.4
753	ok 0.08	0.2	2.37e-03	5.7	5.7	5.7	5.7 -1.2	-12.9	-0.2	105.7	1291.2	245.9
754	ok 0.08	0.1	2.19e-03	5.7	5.7	5.7	5.7 -1.1	-12.5	-0.1	87.8	1161.5	125.4
755	ok 0.08	0.1	2.20e-03	5.7	5.7	5.7	5.7 -1.0	-12.3	5.84e-02	93.3	1212.8	-161.3
756	ok 0.08	0.2	2.32e-03	5.7	5.7	5.7	5.7 -1.2	-12.3	-2.45e-02	114.3	1362.7	-296.7
757	ok 0.08	0.7	2.88e-02	5.7	5.7	5.7	5.7 110.0	-83.8	-58.7	-3612.1	-1154.2	-381.5
758	ok 0.08	0.6	2.72e-02	5.7	5.7	5.7	5.7 99.6	52.2	-51.9	1017.9	2943.4	-320.3
759	ok 0.08	0.4	1.07e-02	5.7	5.7	5.7	5.7 -2.9	21.4	-13.7	283.0	2715.0	262.4
760	ok 0.08	0.3	1.55e-03	5.7	5.7	5.7	5.7 4.2	7.7	1.9	380.1	1776.3	86.9
761	ok 0.08	0.2	9.73e-04	5.7	5.7	5.7	5.7 4.4	5.0	-0.7	218.1	1372.9	-84.2
762	ok 0.08	0.1	7.44e-04	5.7	5.7	5.7	5.72.32e-02	2.9	0.4	124.1	1065.9	21.1
763	ok 0.08	0.1	5.85e-04	5.7	5.7	5.7	5.7-5.77e-02	2.6	0.2	131.4	995.9	3.6
764	ok 0.08	0.1	6.85e-04	5.7	5.7	5.7	5.7-7.04e-02	2.6	-0.1	129.1	1014.6	-12.4
765	ok 0.08	0.2	8.62e-04	5.7	5.7	5.7	5.7 -1.8	4.1	0.8	137.2	1164.7	54.4
766	ok 0.08	0.2	9.85e-04	5.7	5.7	5.7	5.7 -3.2	5.6	1.5	149.2	1556.5	34.6
767	ok 0.08	0.3	2.23e-03	5.7	5.7	5.7	5.7 5.1	9.5	0.4	407.7	1998.4	-147.7
768	ok 0.08	0.6	1.67e-02	5.7	5.7	5.7	5.7 20.7	39.3	6.6	628.6	3043.1	-207.9
769	ok 0.08	0.7	2.97e-02	5.7	5.7	5.7	5.7 -52.5	72.8	2.1	-1151.2	2945.5	-856.3
770	ok 0.08	0.8	2.96e-02	5.7	5.7	5.7	5.7 128.0	-96.3	65.7	-3910.7	-1214.9	259.6
771	ok 0.08	0.3	8.17e-03	5.7	5.7	5.7	5.7 -8.4	14.1	10.6	417.4	922.3	833.3
772	ok 0.08	0.3	8.44e-03	5.7	5.7	5.7	5.7 -40.5	-1.0	-6.4	-480.8	1268.7	744.0
773	ok 0.08	0.3	3.39e-03	5.7	5.7	5.7	5.7 5.6	16.3	-8.5	232.0	1886.1	301.6
774	ok 0.08	0.3	1.37e-03	5.7	5.7	5.7	5.7 -6.0	6.9	1.0	249.4	1727.9	83.2
775	ok 0.08	0.2	1.13e-03	5.7	5.7	5.7	5.7 -3.9	4.6	1.9	201.7	1326.9	-5.9
776	ok 0.08	0.1	8.64e-04	5.7	5.7	5.7	5.7 0.3	2.1	0.6	166.6	1034.9	45.7
777	ok 0.08	0.1	6.82e-04	5.7	5.7	5.7	5.7 0.2	1.9	0.3	162.9	972.0	9.3
778	ok 0.08	0.1	7.05e-04	5.7	5.7	5.7	5.7 0.2	2.0	-0.2	164.5	989.4	-24.8
779	ok 0.08	0.2	9.35e-04	5.7	5.7	5.7	5.7 -2.5	3.5	-1.5	141.8	1122.2	60.2
780	ok 0.08	0.2	1.16e-03	5.7	5.7	5.7	5.7 -4.5	6.0	-1.3	226.6	1472.7	-27.0
781	ok 0.08	0.3	1.38e-03	5.7	5.7	5.7	5.7 -6.7	10.9	-0.5	273.1	1875.5	-147.8
782	ok 0.08	0.3	2.40e-03	5.7	5.7	5.7	5.7 -8.2	22.2	1.3	287.1	1821.6	-456.8
783	ok 0.08	0.3	7.91e-03	5.7	5.7	5.7	5.7 -9.9	18.4	-6.5	359.0	1408.2	-694.3
784	ok 0.08	0.3	9.03e-03	5.7	5.7	5.7	5.7 -8.2	14.2	-8.3	464.1	932.2	-854.0
785	ok 0.08	0.2	2.57e-03	5.7	5.7	5.7	5.7 -9.1	7.2	6.6	892.0	753.9	528.5
786	ok 0.08	0.2	2.15e-03	5.7	5.7	5.7	5.7 -8.3	3.9	4.6	613.4	1277.8	430.7
787	ok 0.08	0.2	1.39e-03	5.7	5.7	5.7	5.7 -4.6	6.3	4.4	444.0	1496.3	273.9
788	ok 0.08	0.2	1.26e-03	5.7	5.7	5.7	5.7 -5.0	4.9	1.9	281.8	1518.5	84.1
789	ok 0.08	0.2	1.23e-03	5.7	5.7	5.7	5.7 0.6	1.2	0.6	266.4	1081.2	98.5
790	ok 0.08	0.1	9.80e-04	5.7	5.7	5.7	5.7 0.6	1.2	0.4	224.8	993.6	45.3
791	ok 0.08	0.1	7.34e-04	5.7	5.7	5.7	5.7 0.5	1.2	0.2	206.1	940.2	9.5
792	ok 0.08	0.1	8.06e-04	5.7	5.7	5.7	5.7 0.5	1.3	-0.1	211.7	955.4	-23.9
793	ok 0.08	0.2	1.08e-03	5.7	5.7	5.7	5.7 1.9	2.4	-0.2	257.2	1093.2	68.8
794	ok 0.08	0.2	1.24e-03	5.7	5.7	5.7	5.7 -4.1	3.6	-2.8	263.5	1393.5	-27.8
795	ok 0.08	0.2	1.43e-03	5.7	5.7	5.7	5.7 -4.9	5.3	-3.6	343.0	1571.9	-135.1
796	ok 0.08	0.2	1.55e-03	5.7	5.7	5.7	5.7 -6.4	6.0	-6.5	472.7	1412.6	-378.0
797	ok 0.08	0.2	1.84e-03	5.7	5.7	5.7	5.7 -7.2	4.2	-6.7	709.4	1141.0	-511.3





EGP CODE

GRE.EEC.R.73.IT.W.15235.12.024.01

PAGE

486 di/of 527

798	ok 0.08	0.2	2.79e-03	5.7	5.7	5.7	5.7	-9.0	7.9	-6.0	904.4	705.5	-559.9
799	ok 0.08	0.2	2.17e-03	5.7	5.7	5.7	5.7	-8.7	0.7	6.3	1079.7	642.5	255.6
800	ok 0.08	0.2	1.92e-03	5.7	5.7	5.7	5.7	-8.0	1.7	4.8	717.1	1161.1	172.9
801	ok 0.08	0.2	1.57e-03	5.7	5.7	5.7	5.7	-4.2	1.6	2.0	474.8	1329.9	96.1
802	ok 0.08	0.2	1.42e-03	5.7	5.7	5.7	5.7	-4.2	2.0	1.8	311.5	1386.4	33.0
803	ok 0.08	0.2	1.27e-03	5.7	5.7	5.7	5.7	2.5	1.4	0.5	326.3	1226.7	-9.2
804	ok 0.08	0.1	1.05e-03	5.7	5.7	5.7	5.7	0.7	0.8	5.17e-02	270.5	964.2	23.0
805	ok 0.08	0.1	7.88e-04	5.7	5.7	5.7	5.7	0.6	0.8	9.26e-02	241.0	917.1	5.2
806	ok 0.08	0.1	8.24e-04	5.7	5.7	5.7	5.7	0.6	0.9	-2.17e-02	249.1	931.0	-12.0
807	ok 0.08	0.2	1.08e-03	5.7	5.7	5.7	5.7	3.2	1.3	2.6	264.5	1081.3	-46.5
808	ok 0.08	0.2	1.36e-03	5.7	5.7	5.7	5.7	4.8	1.6	2.9	366.2	1308.6	-64.7
809	ok 0.08	0.2	1.56e-03	5.7	5.7	5.7	5.7	-3.4	1.8	-1.6	299.4	1389.8	-112.5
810	ok 0.08	0.2	1.75e-03	5.7	5.7	5.7	5.7	-4.7	1.4	-3.4	538.2	1321.2	-129.5
811	ok 0.08	0.2	2.08e-03	5.7	5.7	5.7	5.7	-6.5	1.1	-4.5	832.2	1021.5	-234.6
812	ok 0.08	0.2	2.17e-03	5.7	5.7	5.7	5.7	-8.6	-0.2	-6.3	1097.2	601.9	-259.6
813	ok 0.08	0.2	2.65e-03	5.7	5.7	5.7	5.7	-5.7	-0.6	-2.7	1096.3	629.1	-236.8
814	ok 0.08	0.2	2.20e-03	5.7	5.7	5.7	5.7	-8.8	0.6	2.5	692.7	1173.6	-159.0
815	ok 0.08	0.2	1.74e-03	5.7	5.7	5.7	5.7	-6.4	0.5	0.7	444.9	1340.6	-150.0
816	ok 0.08	0.2	1.43e-03	5.7	5.7	5.7	5.7	-4.8	1.0	0.4	309.3	1388.1	-116.7
817	ok 0.08	0.2	1.38e-03	5.7	5.7	5.7	5.7	2.3	0.9	0.3	343.4	1237.4	-50.3
818	ok 0.08	0.1	1.10e-03	5.7	5.7	5.7	5.7	0.5	0.9	-0.3	285.4	961.5	-12.6
819	ok 0.08	0.1	8.29e-04	5.7	5.7	5.7	5.7	0.5	0.8	-0.2	254.1	914.7	-3.5
820	ok 0.08	0.1	8.76e-04	5.7	5.7	5.7	5.7	0.6	0.9	7.65e-02	262.5	928.7	6.0
821	ok 0.08	0.1	1.14e-03	5.7	5.7	5.7	5.7	1.9	0.8	1.88e-02	286.6	1098.4	30.5
822	ok 0.08	0.2	1.42e-03	5.7	5.7	5.7	5.7	2.9	0.8	-0.2	391.8	1328.0	64.4
823	ok 0.08	0.2	1.52e-03	5.7	5.7	5.7	5.7	-5.5	0.7	-1.5	345.8	1412.9	104.0
824	ok 0.08	0.2	1.88e-03	5.7	5.7	5.7	5.7	-7.3	0.1	-1.8	517.2	1332.1	128.5
825	ok 0.08	0.2	2.45e-03	5.7	5.7	5.7	5.7	-4.5	0.5	2.7	851.8	1015.0	180.1
826	ok 0.08	0.2	2.66e-03	5.7	5.7	5.7	5.7	-5.8	-1.1	3.1	1112.0	591.2	226.9
827	ok 0.08	0.2	2.70e-03	5.7	5.7	5.7	5.7	-5.5	4.5	-2.8	969.5	779.8	-517.7
828	ok 0.08	0.2	2.29e-03	5.7	5.7	5.7	5.7	-3.2	2.1	-4.1	628.9	1293.4	-409.4
829	ok 0.08	0.2	1.89e-03	5.7	5.7	5.7	5.7	-1.6	4.1	-4.6	468.9	1501.6	-244.1
830	ok 0.08	0.2	1.53e-03	5.7	5.7	5.7	5.7	5.4	4.3	-3.8	503.0	1498.8	-71.7
831	ok 0.08	0.2	1.36e-03	5.7	5.7	5.7	5.7	-1.6	3.0	-3.9	286.2	1243.2	-16.5
832	ok 0.08	0.1	1.08e-03	5.7	5.7	5.7	5.7	0.2	1.4	-0.6	268.1	987.1	-39.8
833	ok 0.08	0.1	8.03e-04	5.7	5.7	5.7	5.7	0.2	1.3	-0.2	243.7	935.2	-9.2
834	ok 0.08	0.1	8.50e-04	5.7	5.7	5.7	5.7	0.3	1.4	0.2	250.2	950.5	20.2
835	ok 0.08	0.2	1.12e-03	5.7	5.7	5.7	5.7	1.7	1.6	0.4	263.4	1127.3	29.0
836	ok 0.08	0.2	1.39e-03	5.7	5.7	5.7	5.7	2.8	1.8	0.2	332.5	1415.0	80.9
837	ok 0.08	0.2	1.66e-03	5.7	5.7	5.7	5.7	6.2	3.7	4.2	552.6	1555.9	104.2
838	ok 0.08	0.2	1.93e-03	5.7	5.7	5.7	5.7	-2.2	3.1	4.6	506.5	1410.7	341.2
839	ok 0.08	0.2	2.51e-03	5.7	5.7	5.7	5.7	-3.7	1.6	4.3	729.7	1147.8	484.4
840	ok 0.08	0.2	3.66e-03	5.7	5.7	5.7	5.7	-5.7	5.4	2.6	976.4	726.3	535.1
841	ok 0.08	0.3	9.24e-03	5.7	5.7	5.7	5.7	-3.8	-16.0	-14.2	510.5	576.9	-1275.9
842	ok 0.08	0.3	8.31e-03	5.7	5.7	5.7	5.7	-3.7	14.7	-4.9	389.0	1651.6	-535.3
843	ok 0.08	0.3	2.82e-03	5.7	5.7	5.7	5.7	5.9	12.1	4.4	388.6	1932.4	-284.3
844	ok 0.08	0.2	1.54e-03	5.7	5.7	5.7	5.7	-2.2	6.1	-5.8	426.9	1672.1	-128.0
845	ok 0.08	0.2	1.31e-03	5.7	5.7	5.7	5.7	3.1	6.2	-3.9	336.5	1269.3	-25.5
846	ok 0.08	0.1	9.80e-04	5.7	5.7	5.7	5.7	-0.2	2.3	-0.6	232.3	1029.7	-51.3
847	ok 0.08	0.1	7.03e-04	5.7	5.7	5.7	5.7	-0.1	2.0	-0.2	220.2	970.1	-10.4
848	ok 0.08	0.1	7.78e-04	5.7	5.7	5.7	5.7	-0.1	2.1	0.2	222.6	987.3	26.5
849	ok 0.08	0.2	1.05e-03	5.7	5.7	5.7	5.7	1.3	3.5	0.9	241.5	1155.3	19.7
850	ok 0.08	0.2	1.36e-03	5.7	5.7	5.7	5.7	2.3	5.0	1.2	301.6	1502.1	50.3
851	ok 0.08	0.3	1.61e-03	5.7	5.7	5.7	5.7	-2.5	7.4	6.0	448.2	1832.7	165.2
852	ok 0.08	0.3	2.95e-03	5.7	5.7	5.7	5.7	10.8	16.5	-1.0	630.2	1840.4	423.3
853	ok 0.08	0.4	7.89e-03	5.7	5.7	5.7	5.7	23.6	24.6	-16.4	1594.0	1040.1	430.0
854	ok 0.08	0.3	1.00e-02	5.7	5.7	5.7	5.7	-37.2	12.8	24.0	1369.8	505.5	626.5
855	ok 0.08	0.9	2.83e-02	5.7	5.7	5.7	5.7	113.9	21.2	-60.9	-3883.4	-1820.3	630.0
856	ok 0.08	0.6	3.02e-02	5.7	5.7	5.7	5.7	79.8	40.9	29.8	1183.6	2784.0	446.3
857	ok 0.08	0.4	7.59e-03	5.7	5.7	5.7	5.7	15.0	18.1	2.8	504.3	2589.8	31.8
858	ok 0.08	0.3	1.51e-03	5.7	5.7	5.7	5.7	-3.7	13.9	-3.8	330.1	1695.8	-153.7
859	ok 0.08	0.2	9.67e-04	5.7	5.7	5.7	5.7	-1.9	8.9	-3.0	267.7	1323.1	-91.0
860	ok 0.08	0.2	7.54e-04	5.7	5.7	5.7	5.7	-0.5	3.0	-0.3	198.9	1072.6	-43.4
861	ok 0.08	0.1	5.81e-04	5.7	5.7	5.7	5.7	-0.4	2.6	-0.1	194.0	1007.9	-9.5
862	ok 0.08	0.1	6.86e-04	5.7	5.7	5.7	5.7	-0.4	2.7	0.2	195.5	1025.8	22.8
863	ok 0.08	0.2	8.44e-04	5.7	5.7	5.7	5.7	-2.4	5.2	0.8	204.0	1187.5	29.2
864	ok 0.08	0.2	1.08e-03	5.7	5.7	5.7	5.7	-2.3	10.2	3.3	288.8	1471.1	111.4
865	ok 0.08	0.3	1.63e-03	5.7	5.7	5.7	5.7	-4.0	13.9	6.4	413.3	1917.7	218.3
866	ok 0.08	0.5	1.08e-02	5.7	5.7	5.7	5.7	23.3	22.1	-1.4	769.0	2957.7	225.5
867	ok 0.08	0.7	3.58e-02	5.7	5.7	5.7	5.7	134.2	62.7	-40.6	1435.1	3108.5	29.1
868	ok 0.08	1.0	3.26e-02	5.9	5.7	5.9	5.7	161.1	-84.6	-74.2	-4638.2	-1523.8	-219.5
869	ok 0.08	0.9	2.44e-02	5.7	5.7	5.7	5.7	48.5	-127.2	-39.2	1513.9	5087.7	-1016.4
870	ok 0.08	0.4	4.02e-03	5.7	5.7	5.7	5.7	1.5	15.3	-10.3	434.1	2287.0	-247.9
871	ok 0.08	0.3	2.25e-03	5.7	5.7	5.7	5.7	5.3	16.5	1.4	450.6	1828.0	-231.1
872	ok 0.08	0.2	9.05e-04	5.7	5.7	5.7	5.7	-1.2	7.6	-3.1	242.1	1344.3	-156.8
873	ok 0.08	0.2	7.04e-04	5.7	5.7	5.7	5.7	-0.6	3.1	-2.42e-02	181.6	1091.6	-35.2



EGP CODE

GRE.EEC.R.73.IT.W.15235.12.024.01

PAGE

487 di/of 527

874	ok 0.08	0.1	5.56e-04	5.7	5.7	5.7	5.7	-0.5	2.7	-0.1	178.0	1025.6	-8.6
875	ok 0.08	0.1	6.35e-04	5.7	5.7	5.7	5.7	-0.5	2.8	0.1	179.3	1043.7	19.2
876	ok 0.08	0.2	8.05e-04	5.7	5.7	5.7	5.7	-1.4	6.2	2.5	217.3	1165.4	47.5
877	ok 0.08	0.2	1.00e-03	5.7	5.7	5.7	5.7	-1.4	8.7	3.4	261.1	1489.2	173.8
878	ok 0.08	0.3	3.12e-03	5.7	5.7	5.7	5.7	6.8	21.0	-2.5	519.4	2057.6	246.5
879	ok 0.08	0.4	7.26e-03	5.7	5.7	5.7	5.7	-9.7	-13.5	-19.1	555.1	2974.2	314.1
880	ok 0.08	1.0	4.14e-02	6.6	5.7	7.1	5.7	66.3	-225.2	55.8	1153.5	5769.1	953.1
881	ok 0.08	1.0	3.42e-02	5.8	5.7	5.8	5.7	161.6	-46.3	-71.7	-4691.1	-1637.6	-325.4
882	ok 0.08	0.6	3.14e-02	5.7	5.7	5.7	5.7	83.8	30.4	-26.6	1191.6	2727.8	-917.6
883	ok 0.08	0.4	9.18e-03	5.7	5.7	5.7	5.7	18.8	7.1	-6.1	494.7	2546.7	-357.2
884	ok 0.08	0.3	1.37e-03	5.7	5.7	5.7	5.7	-1.5	8.7	1.5	196.8	1746.0	-133.8
885	ok 0.08	0.2	1.10e-03	5.7	5.7	5.7	5.7	-1.6	8.1	-2.4	236.5	1396.6	-146.4
886	ok 0.08	0.2	7.26e-04	5.7	5.7	5.7	5.7	-0.6	3.1	7.59e-02	175.1	1104.5	-30.6
887	ok 0.08	0.1	4.99e-04	5.7	5.7	5.7	5.7	-0.5	2.8	6.01e-02	174.1	1038.0	-7.1
888	ok 0.08	0.1	5.84e-04	5.7	5.7	5.7	5.7	-0.5	2.9	-4.73e-02	174.9	1056.2	16.4
889	ok 0.08	0.2	8.37e-04	5.7	5.7	5.7	5.7	-1.5	6.0	2.1	207.8	1183.6	110.5
890	ok 0.08	0.2	1.22e-03	5.7	5.7	5.7	5.7	-1.9	9.5	2.3	255.7	1553.7	162.0
891	ok 0.08	0.3	1.77e-03	5.7	5.7	5.7	5.7	-7.3	9.4	-7.3	289.7	1977.7	132.6
892	ok 0.08	0.5	1.28e-02	5.7	5.7	5.7	5.7	25.3	20.7	6.1	543.4	3134.1	403.1
893	ok 0.08	0.7	3.80e-02	5.7	5.7	5.7	5.7	114.2	55.1	56.5	1096.1	3272.2	918.6
894	ok 0.08	1.0	4.28e-02	7.1	5.7	6.5	5.7	186.9	26.8	-101.7	-4802.3	-2395.8	920.1
895	ok 0.08	0.4	1.31e-02	5.7	5.7	5.7	5.7	8.0	-21.9	-5.6	-473.7	-1189.8	-838.9
896	ok 0.08	0.3	9.00e-03	5.7	5.7	5.7	5.7	-37.2	1.7	-6.7	-418.5	1575.5	305.3
897	ok 0.08	0.3	3.09e-03	5.7	5.7	5.7	5.7	8.8	14.2	-9.0	291.5	2106.9	-14.6
898	ok 0.08	0.3	1.64e-03	5.7	5.7	5.7	5.7	-1.3	3.8	1.9	252.4	1879.0	-137.0
899	ok 0.08	0.2	9.73e-04	5.7	5.7	5.7	5.7	-1.6	4.8	2.7	212.4	1454.9	-53.8
900	ok 0.08	0.2	7.42e-04	5.7	5.7	5.7	5.7	-0.3	2.9	0.2	166.6	1119.5	-13.5
901	ok 0.08	0.1	5.23e-04	5.7	5.7	5.7	5.7	-0.4	2.7	8.14e-02	164.5	1055.3	-3.0
902	ok 0.08	0.1	6.07e-04	5.7	5.7	5.7	5.7	-0.4	2.8	-0.1	165.9	1072.7	7.9
903	ok 0.08	0.2	8.25e-04	5.7	5.7	5.7	5.7	1.0	4.7	-3.3	219.5	1235.8	23.0
904	ok 0.08	0.2	1.10e-03	5.7	5.7	5.7	5.7	-1.5	5.7	-1.9	233.1	1627.8	70.1
905	ok 0.08	0.3	1.76e-03	5.7	5.7	5.7	5.7	-1.8	5.7	-1.4	241.4	2056.4	119.6
906	ok 0.08	0.3	3.21e-03	5.7	5.7	5.7	5.7	12.0	5.5	-5.4	496.9	1899.1	-34.4
907	ok 0.08	0.4	9.48e-03	5.7	5.7	5.7	5.7	-42.6	-3.1	4.7	-697.1	1147.8	-679.1
908	ok 0.08	0.4	1.54e-02	5.7	5.7	5.7	5.7	24.7	22.7	-0.9	-515.2	586.9	-883.8
909	ok 0.08	0.2	2.33e-03	5.7	5.7	5.7	5.7	-8.8	6.8	5.3	602.7	857.2	228.8
910	ok 0.08	0.2	1.79e-03	5.7	5.7	5.7	5.7	-10.2	5.4	2.2	399.7	1508.0	141.1
911	ok 0.08	0.3	1.44e-03	5.7	5.7	5.7	5.7	-3.2	7.0	-0.8	186.6	1766.2	104.7
912	ok 0.08	0.3	1.61e-03	5.7	5.7	5.7	5.7	3.5	6.2	0.8	246.5	1792.4	81.4
913	ok 0.08	0.2	1.03e-03	5.7	5.7	5.7	5.7	1.2	3.6	4.4	264.0	1480.5	-10.1
914	ok 0.08	0.2	7.00e-04	5.7	5.7	5.7	5.7	0.8	2.9	3.1	191.1	1126.9	-9.0
915	ok 0.08	0.1	5.31e-04	5.7	5.7	5.7	5.7	-0.2	2.5	-6.21e-02	162.9	1061.8	0.2
916	ok 0.08	0.1	6.07e-04	5.7	5.7	5.7	5.7	-0.2	2.6	-0.2	164.9	1078.2	2.2
917	ok 0.08	0.2	8.68e-04	5.7	5.7	5.7	5.7	0.9	3.8	-3.8	219.8	1257.6	4.7
918	ok 0.08	0.2	1.21e-03	5.7	5.7	5.7	5.7	2.8	4.8	-3.3	276.9	1617.8	1.3
919	ok 0.08	0.3	1.64e-03	5.7	5.7	5.7	5.7	3.3	6.9	-0.9	303.0	1866.7	2.6
920	ok 0.08	0.2	1.46e-03	5.7	5.7	5.7	5.7	-3.2	8.1	-2.2	298.6	1659.0	-94.7
921	ok 0.08	0.2	2.01e-03	5.7	5.7	5.7	5.7	-9.8	6.2	-2.4	514.8	1352.8	-173.8
922	ok 0.08	0.1	2.60e-03	5.7	5.7	5.7	5.7	-6.3	7.3	-6.1	656.0	777.8	-233.5
923	ok 0.08	0.2	4.00e-03	5.7	5.7	5.7	5.7	-5.2	7.6	-2.0	546.4	875.2	-135.2
924	ok 0.08	0.2	4.58e-03	5.7	5.7	5.7	5.7	-19.2	3.6	5.1	315.8	1378.9	-184.8
925	ok 0.08	0.3	2.36e-03	5.7	5.7	5.7	5.7	3.2	14.1	5.4	350.9	1805.2	37.7
926	ok 0.08	0.3	1.25e-03	5.7	5.7	5.7	5.7	2.9	6.5	1.1	344.3	1779.5	78.6
927	ok 0.08	0.2	1.00e-03	5.7	5.7	5.7	5.7	1.6	3.9	3.8	239.5	1466.4	92.7
928	ok 0.08	0.2	6.98e-04	5.7	5.7	5.7	5.7	1.1	2.9	2.8	207.7	1118.0	114.1
929	ok 0.08	0.1	5.44e-04	5.7	5.7	5.7	5.7	-0.2	2.5	-0.1	166.1	1059.6	2.9
930	ok 0.08	0.1	5.96e-04	5.7	5.7	5.7	5.7	-0.2	2.5	-6.97e-02	167.6	1076.1	-3.7
931	ok 0.08	0.2	7.66e-04	5.7	5.7	5.7	5.7	1.5	3.5	-3.1	233.7	1249.1	-106.5
932	ok 0.08	0.2	1.08e-03	5.7	5.7	5.7	5.7	2.5	5.1	-3.3	278.9	1609.0	-81.3
933	ok 0.08	0.3	1.60e-03	5.7	5.7	5.7	5.7	3.4	8.9	-1.6	367.3	1859.9	-70.5
934	ok 0.08	0.3	2.24e-03	5.7	5.7	5.7	5.7	-0.2	8.3	-0.9	376.4	1721.2	-45.8
935	ok 0.08	0.2	4.28e-03	5.7	5.7	5.7	5.7	-22.6	11.9	10.2	382.2	1286.7	237.9
936	ok 0.08	0.2	4.51e-03	5.7	5.7	5.7	5.7	-6.4	6.4	0.3	575.9	885.1	129.8
937	ok 0.08	0.5	1.67e-02	5.7	5.7	5.7	5.7	75.7	-9.6	-53.5	-2352.1	-1251.2	212.9
938	ok 0.08	0.4	1.89e-02	5.7	5.7	5.7	5.7	58.9	34.3	27.1	780.2	2297.9	166.9
939	ok 0.08	0.4	6.35e-03	5.7	5.7	5.7	5.7	10.5	16.4	6.2	427.5	2282.8	86.6
940	ok 0.08	0.3	1.21e-03	5.7	5.7	5.7	5.7	1.3	6.2	3.6	320.0	1804.9	131.2
941	ok 0.08	0.2	8.40e-04	5.7	5.7	5.7	5.7	1.9	4.8	2.7	296.5	1414.4	114.6
942	ok 0.08	0.2	6.92e-04	5.7	5.7	5.7	5.7	0.5	3.2	3.1	218.0	1087.4	128.7
943	ok 0.08	0.1	5.49e-04	5.7	5.7	5.7	5.7	-0.3	2.5	-3.81e-02	177.1	1050.4	5.7
944	ok 0.08	0.1	5.92e-04	5.7	5.7	5.7	5.7	-0.2	2.5	-7.01e-02	176.5	1067.9	-9.8
945	ok 0.08	0.2	7.38e-04	5.7	5.7	5.7	5.7	0.7	3.5	-3.4	239.4	1214.3	-123.1
946	ok 0.08	0.2	9.44e-04	5.7	5.7	5.7	5.7	2.3	5.0	-3.1	319.3	1566.1	-109.2
947	ok 0.08	0.3	1.40e-03	5.7	5.7	5.7	5.7	1.7	7.3	-4.4	325.5	1956.1	-124.8
948	ok 0.08	0.4	9.15e-03	5.7	5.7	5.7	5.7	5.7	29.2	-18.7	318.4	2343.0	129.3
949	ok 0.08	0.5	2.20e-02	5.7	5.7	5.7	5.7	-26.4	46.3	0.3	-233.3	2124.4	424.6



EGP CODE

GRE.EEC.R.73.IT.W.15235.12.024.01

PAGE

488 di/of 527

950	ok 0.08	0.6	1.87e-02	5.7	5.7	5.7	5.7	-91.0	-20.9	18.8	2633.8	907.1	395.4
951	ok 0.08	0.2	2.27e-03	5.7	5.7	5.7	5.7	-0.8	-11.1	-0.4	156.3	1529.9	-480.1
952	ok 0.08	0.6	1.97e-02	5.7	5.7	5.7	5.7	-12.1	100.8	-51.9	-1497.5	-2281.6	176.4
953	ok 0.08	0.3	6.90e-03	5.7	5.7	5.7	5.7	-0.4	-20.6	-20.1	419.4	2115.6	203.7
954	ok 0.08	0.2	9.60e-04	5.7	5.7	5.7	5.7	3.2	5.0	-9.11e-02	429.7	1727.1	171.7
955	ok 0.08	0.2	7.90e-04	5.7	5.7	5.7	5.7	1.9	4.6	3.2	286.1	1322.2	146.8
956	ok 0.08	0.1	6.76e-04	5.7	5.7	5.7	5.7	-0.2	2.5	0.3	209.0	1081.7	48.6
957	ok 0.08	0.1	5.44e-04	5.7	5.7	5.7	5.7	-0.2	2.3	-2.52e-02	214.3	1020.9	11.1
958	ok 0.08	0.1	5.88e-04	5.7	5.7	5.7	5.7	-0.2	2.3	-0.1	212.8	1038.6	-25.9
959	ok 0.08	0.2	7.21e-04	5.7	5.7	5.7	5.7	1.0	3.3	-3.3	272.2	1137.3	-52.8
960	ok 0.08	0.2	8.12e-04	5.7	5.7	5.7	5.7	0.9	4.0	-3.1	334.5	1465.9	-165.6
961	ok 0.08	0.3	1.47e-03	5.7	5.7	5.7	5.7	3.1	1.3	1.7	460.5	1905.1	-147.2
962	ok 0.08	0.3	1.19e-02	5.7	5.7	5.7	5.7	8.2	-46.5	-28.4	327.9	2515.2	-496.1
963	ok 0.08	0.8	2.79e-02	5.7	5.7	5.7	5.7	57.1	-129.7	94.0	894.5	4694.2	-419.9
964	ok 0.08	0.3	2.20e-03	5.7	5.7	5.7	5.7	-0.2	8.5	-3.7	131.6	2125.4	-308.1
965	ok 0.08	0.6	1.35e-02	5.7	5.7	5.7	5.7	17.0	73.0	-24.8	236.9	2784.8	-439.2
966	ok 0.08	0.7	2.60e-02	5.7	5.7	5.7	5.7	75.2	101.2	-37.9	711.1	2836.6	-492.6
967	ok 0.08	0.3	1.65e-02	5.7	5.7	5.7	5.7	-85.8	-46.0	-27.1	270.7	57.2	-554.1
968	ok 0.08	0.2	1.60e-02	5.7	5.7	5.7	5.7	64.7	60.9	-25.8	-720.7	-317.8	-577.3
969	ok 0.08	1.0	3.10e-02	5.7	5.7	5.7	5.7	134.5	-16.7	78.2	-4242.7	-1994.0	-704.6
970	ok 0.08	0.9	2.65e-02	5.7	5.7	5.7	5.7	109.1	3.1	-55.3	-3953.3	-1521.8	619.9
971	ok 0.08	0.5	2.88e-02	5.7	5.7	5.7	5.7	93.3	26.5	12.9	1594.7	2405.6	-439.6
972	ok 0.08	0.4	6.53e-03	5.7	5.7	5.7	5.7	-6.5	6.6	-5.2	504.6	2289.2	-692.4
973	ok 0.08	0.3	1.23e-03	5.7	5.7	5.7	5.7	-0.2	1.2	-4.3	764.5	1205.6	-626.8
974	ok 0.08	0.2	1.30e-03	5.7	5.7	5.7	5.7	-1.8	-1.7	-2.5	540.6	1135.2	-447.9
975	ok 0.08	0.2	9.11e-04	5.7	5.7	5.7	5.7	-2.3	-2.9	-1.2	412.4	1041.0	-273.5
976	ok 0.08	0.1	8.94e-04	5.7	5.7	5.7	5.7	-2.3	-4.1	-0.7	343.1	947.6	-143.1
977	ok 0.08	0.7	2.36e-02	5.7	5.7	5.7	5.7	102.8	7.1	50.0	-3158.2	-1473.7	-398.8
978	ok 0.08	0.5	2.37e-02	5.7	5.7	5.7	5.7	78.8	38.3	-34.5	1118.2	2375.5	30.6
979	ok 0.08	0.4	7.63e-03	5.7	5.7	5.7	5.7	-6.0	14.9	-5.6	413.4	2265.2	405.5
980	ok 0.08	0.2	8.91e-04	5.7	5.7	5.7	5.7	2.1	6.4	2.0	438.9	1599.9	165.7
981	ok 0.08	0.2	8.50e-04	5.7	5.7	5.7	5.7	1.4	4.3	3.6	357.0	1264.2	96.1
982	ok 0.08	0.1	6.41e-04	5.7	5.7	5.7	5.7	-9.19e-02	2.2	0.3	259.9	1049.9	62.1
983	ok 0.08	0.1	5.28e-04	5.7	5.7	5.7	5.7	-0.1	1.9	0.1	258.4	988.1	13.6
984	ok 0.08	0.1	5.62e-04	5.7	5.7	5.7	5.7	-0.1	2.0	-0.2	258.5	1004.9	-33.5
985	ok 0.08	0.2	6.95e-04	5.7	5.7	5.7	5.7	1.0	3.0	-3.4	302.0	1089.9	-60.1
986	ok 0.08	0.2	7.45e-04	5.7	5.7	5.7	5.7	0.9	4.3	-3.5	367.4	1391.9	-130.9
987	ok 0.08	0.3	1.37e-03	5.7	5.7	5.7	5.7	2.6	7.7	-0.6	474.8	1766.7	-245.9
988	ok 0.08	0.4	1.20e-02	5.7	5.7	5.7	5.7	11.6	28.3	3.7	663.1	2504.4	-342.2
989	ok 0.08	0.6	2.80e-02	5.7	5.7	5.7	5.7	80.5	64.3	51.8	1192.1	2573.0	-210.7
990	ok 0.08	0.8	2.62e-02	5.7	5.7	5.7	5.7	128.3	-79.5	62.3	-3567.4	-1226.2	245.6
991	ok 0.08	0.3	7.66e-03	5.7	5.7	5.7	5.7	-6.5	11.3	8.4	726.7	784.7	772.2
992	ok 0.08	0.3	6.83e-03	5.7	5.7	5.7	5.7	-23.0	19.6	16.0	458.4	1281.1	762.7
993	ok 0.08	0.3	2.22e-03	5.7	5.7	5.7	5.7	-2.0	12.2	3.3	434.7	1620.1	320.0
994	ok 0.08	0.2	1.11e-03	5.7	5.7	5.7	5.7	0.9	5.2	1.0	511.5	1523.8	119.9
995	ok 0.08	0.2	1.00e-03	5.7	5.7	5.7	5.7	1.4	3.4	3.7	407.3	1204.8	76.6
996	ok 0.08	0.1	6.63e-04	5.7	5.7	5.7	5.7	0.1	1.5	0.4	345.1	997.3	73.0
997	ok 0.08	0.1	4.97e-04	5.7	5.7	5.7	5.7	0.1	1.3	0.2	334.7	942.0	16.3
998	ok 0.08	0.1	5.22e-04	5.7	5.7	5.7	5.7	5.79.45e-02	1.4	-0.2	337.6	957.5	-38.8
999	ok 0.08	0.2	7.18e-04	5.7	5.7	5.7	5.7	5.74.24e-02	1.6	-0.5	352.2	1034.1	-102.0
1000	ok 0.08	0.2	1.00e-03	5.7	5.7	5.7	5.7	0.7	3.1	0.2	396.8	1405.3	-91.5
1001	ok 0.08	0.2	1.33e-03	5.7	5.7	5.7	5.7	0.7	7.8	-1.4	558.9	1633.7	-196.4
1002	ok 0.08	0.3	2.05e-03	5.7	5.7	5.7	5.7	-2.8	16.9	-0.5	585.0	1590.6	-468.3
1003	ok 0.08	0.3	6.37e-03	5.7	5.7	5.7	5.7	-6.9	13.2	-6.0	615.1	1217.1	-649.0
1004	ok 0.08	0.3	6.95e-03	5.7	5.7	5.7	5.7	-8.3	10.2	-6.7	726.8	788.0	-790.3
1005	ok 0.08	0.2	2.08e-03	5.7	5.7	5.7	5.7	-7.4	3.4	3.1	1124.2	636.9	544.2
1006	ok 0.08	0.2	1.87e-03	5.7	5.7	5.7	5.7	-5.9	1.9	1.1	800.3	1166.7	411.2
1007	ok 0.08	0.2	1.34e-03	5.7	5.7	5.7	5.7	-2.3	2.2	0.8	566.2	1339.9	322.4
1008	ok 0.08	0.2	1.27e-03	5.7	5.7	5.7	5.7	0.8	1.5	-0.5	481.3	1398.7	140.2
1009	ok 0.08	0.2	9.73e-04	5.7	5.7	5.7	5.7	0.4	0.8	0.6	494.0	1022.3	127.9
1010	ok 0.08	0.1	7.59e-04	5.7	5.7	5.7	5.7	0.4	0.8	0.3	445.3	945.3	63.5
1011	ok 0.08	0.1	5.24e-04	5.7	5.7	5.7	5.7	0.4	0.8	0.2	423.1	898.2	14.7
1012	ok 0.08	0.1	5.29e-04	5.7	5.7	5.7	5.7	0.4	0.8	-0.3	429.3	910.0	-35.4
1013	ok 0.08	0.1	7.32e-04	5.7	5.7	5.7	5.7	0.3	0.9	-0.4	463.6	976.0	-88.2
1014	ok 0.08	0.2	9.64e-04	5.7	5.7	5.7	5.7	0.8	1.0	-0.2	442.7	1317.4	-94.0
1015	ok 0.08	0.2	1.29e-03	5.7	5.7	5.7	5.7	0.8	1.8	-0.6	527.3	1436.9	-223.3
1016	ok 0.08	0.2	1.36e-03	5.7	5.7	5.7	5.7	-2.8	1.2	-0.5	646.9	1341.5	-319.9
1017	ok 0.08	0.2	1.61e-03	5.7	5.7	5.7	5.7	-6.6	2.0	-1.3	925.2	1036.1	-479.8
1018	ok 0.08	0.2	2.54e-03	5.7	5.7	5.7	5.7	-8.2	4.6	-2.9	1138.0	600.5	-557.0
1019	ok 0.08	0.2	1.90e-03	5.7	5.7	5.7	5.7	-8.2	-1.0	3.0	1286.4	570.0	319.7
1020	ok 0.08	0.2	1.49e-03	5.7	5.7	5.7	5.7	-2.6	-0.1	-0.6	1083.1	1092.0	109.6
1021	ok 0.08	0.2	1.14e-03	5.7	5.7	5.7	5.7	-0.8	-0.4	-2.9	784.4	1257.0	73.3
1022	ok 0.08	0.2	1.09e-03	5.7	5.7	5.7	5.7	1.1	7.29e-02	-2.8	619.5	1298.9	57.6
1023	ok 0.08	0.2	9.71e-04	5.7	5.7	5.7	5.7	1.2	-0.2	-3.0	514.8	1169.4	44.6
1024	ok 0.08	0.1	7.74e-04	5.7	5.7	5.7	5.7	0.6	0.5	4.96e-03	532.7	910.1	36.7
1025	ok 0.08	0.1	5.50e-04	5.7	5.7	5.7	5.7	0.6	0.6	3.62e-02	503.8	869.2	7.2



EGP CODE

GRE.EEC.R.73.IT.W.15235.12.024.01

PAGE

489 di/of 527

1026	ok 0.08	0.1	5.76e-04	5.7	5.7	5.7	5.7	0.6	0.6	-6.42e-02	512.1	880.6	-18.2
1027	ok 0.08	0.1	7.58e-04	5.7	5.7	5.7	5.7	0.9	-0.1	2.8	474.9	1047.1	-30.4
1028	ok 0.08	0.2	9.39e-04	5.7	5.7	5.7	5.7	1.5	-0.2	2.8	563.1	1249.2	-49.4
1029	ok 0.08	0.2	1.16e-03	5.7	5.7	5.7	5.7	1.1	-1.00e-01	2.0	682.0	1321.3	-65.5
1030	ok 0.08	0.2	1.22e-03	5.7	5.7	5.7	5.7	-0.8	-0.8	2.1	896.6	1246.3	-75.1
1031	ok 0.08	0.2	1.68e-03	5.7	5.7	5.7	5.7	-4.4	-0.8	-1.88e-02	1210.6	962.2	-84.0
1032	ok 0.08	0.2	1.91e-03	5.7	5.7	5.7	5.7	-9.1	-1.6	-3.3	1303.8	535.3	-309.4
1033	ok 0.08	0.3	2.47e-03	5.7	5.7	5.7	5.7	-5.3	-1.5	-1.7	1584.5	628.0	-297.9
1034	ok 0.08	0.2	1.77e-03	5.7	5.7	5.7	5.7	-1.6	-0.7	-2.6	1165.2	1130.3	-202.5
1035	ok 0.08	0.2	1.25e-03	5.7	5.7	5.7	5.7	1.3	0.4	-2.8	889.2	1272.9	-134.1
1036	ok 0.08	0.2	9.78e-04	5.7	5.7	5.7	5.7	1.6	0.3	-3.6	719.0	1327.9	-54.6
1037	ok 0.08	0.2	9.31e-04	5.7	5.7	5.7	5.7	1.2	0.1	-3.3	549.0	1172.9	-6.2
1038	ok 0.08	0.1	7.90e-04	5.7	5.7	5.7	5.7	0.6	0.5	-4.57e-02	578.8	897.1	4.3
1039	ok 0.08	0.1	6.26e-04	5.7	5.7	5.7	5.7	0.7	0.7	-0.1	547.3	860.4	0.4
1040	ok 0.08	0.1	6.59e-04	5.7	5.7	5.7	5.7	0.7	0.8	0.1	556.0	872.4	0.7
1041	ok 0.08	0.1	8.09e-04	5.7	5.7	5.7	5.7	0.7	0.1	3.6	537.8	1053.6	2.4
1042	ok 0.08	0.2	9.27e-04	5.7	5.7	5.7	5.7	1.5	-0.2	3.9	648.5	1262.0	26.6
1043	ok 0.08	0.2	9.72e-04	5.7	5.7	5.7	5.7	2.1	-0.5	3.6	793.6	1347.1	83.1
1044	ok 0.08	0.2	1.40e-03	5.7	5.7	5.7	5.7	1.3	-0.9	3.5	997.6	1274.6	140.8
1045	ok 0.08	0.2	2.14e-03	5.7	5.7	5.7	5.7	-2.9	-1.4	1.9	1321.9	998.0	241.7
1046	ok 0.08	0.3	2.53e-03	5.7	5.7	5.7	5.7	-5.9	-2.1	1.8	1589.9	583.4	302.4
1047	ok 0.08	0.3	2.47e-03	5.7	5.7	5.7	5.7	5.5	0.4	-3.6	2245.4	489.3	-488.0
1048	ok 0.08	0.3	1.92e-03	5.7	5.7	5.7	5.7	7.4	2.5	-4.4	1808.2	889.3	-369.2
1049	ok 0.08	0.2	1.31e-03	5.7	5.7	5.7	5.7	4.6	2.7	-5.4	1482.4	1018.8	-273.7
1050	ok 0.08	0.2	8.89e-04	5.7	5.7	5.7	5.7	0.6	2.2	-5.4	1112.7	1033.2	-225.4
1051	ok 0.08	0.2	8.80e-04	5.7	5.7	5.7	5.7	-1.1	1.4	-4.2	846.6	928.4	-182.8
1052	ok 0.08	0.1	8.05e-04	5.7	5.7	5.7	5.7	-1.6	0.2	-2.8	684.0	823.9	-129.0
1053	ok 0.08	0.1	6.79e-04	5.7	5.7	5.7	5.7	-1.9	-0.7	-2.0	603.1	754.4	-80.3
1054	ok 0.08	0.1	7.07e-04	5.7	5.7	5.7	5.7	-1.7	-0.7	2.1	623.7	783.2	98.6
1055	ok 0.08	0.2	8.21e-04	5.7	5.7	5.7	5.7	-1.4	0.1	3.2	731.1	864.2	152.0
1056	ok 0.08	0.2	8.91e-04	5.7	5.7	5.7	5.7	1.0	1.4	5.2	665.1	1349.3	105.0
1057	ok 0.08	0.2	9.66e-04	5.7	5.7	5.7	5.7	2.7	1.7	5.1	824.0	1521.9	230.9
1058	ok 0.08	0.3	1.44e-03	5.7	5.7	5.7	5.7	5.4	1.4	6.0	1643.7	979.1	335.4
1059	ok 0.08	0.3	2.14e-03	5.7	5.7	5.7	5.7	7.6	3.7	5.8	1950.0	725.8	458.4
1060	ok 0.08	0.4	3.63e-03	5.7	5.7	5.7	5.7	10.5	-0.8	5.5	2282.8	482.7	474.8
1061	ok 0.08	0.4	1.06e-02	5.7	5.7	5.7	5.7	-49.2	22.4	-30.6	2407.7	607.8	-881.4
1062	ok 0.08	0.4	9.96e-03	5.7	5.7	5.7	5.7	29.8	10.5	-1.8	2263.4	1099.3	-636.3
1063	ok 0.08	0.3	2.19e-03	5.7	5.7	5.7	5.7	3.1	10.3	-3.9	790.6	1843.7	-467.0
1064	ok 0.08	0.3	4.04e-03	5.7	5.7	5.7	5.7	13.5	0.9	9.9	1346.3	176.5	624.0
1065	ok 0.08	0.2	8.29e-04	5.7	5.7	5.7	5.7	-1.5	1.4	-4.3	759.9	986.4	-289.7
1066	ok 0.08	0.1	8.21e-04	5.7	5.7	5.7	5.7	-2.2	-0.6	-2.9	613.0	906.1	-190.3
1067	ok 0.08	0.1	7.76e-04	5.7	5.7	5.7	5.7	-2.4	-1.8	-2.1	535.7	834.1	-106.9
1068	ok 0.08	0.1	7.94e-04	5.7	5.7	5.7	5.7	-2.3	-1.7	2.2	555.9	865.7	135.9
1069	ok 0.08	0.2	8.35e-04	5.7	5.7	5.7	5.7	-1.9	-0.5	3.3	656.6	947.9	227.5
1070	ok 0.08	0.2	8.61e-04	5.7	5.7	5.7	5.7	-0.4	1.6	3.8	764.1	1021.9	409.3
1071	ok 0.08	0.3	1.01e-03	5.7	5.7	5.7	5.7	1.3	5.9	6.6	727.5	1796.2	354.1
1072	ok 0.08	0.3	1.85e-03	5.7	5.7	5.7	5.7	8.5	12.4	0.7	923.5	1770.1	626.9
1073	ok 0.08	0.5	1.03e-02	5.7	5.7	5.7	5.7	36.0	18.8	-22.5	2699.2	953.1	750.3
1074	ok 0.08	0.4	1.25e-02	5.7	5.7	5.7	5.7	-44.6	15.6	24.1	2473.6	551.5	823.9
1076	ok 0.08	0.4	2.20e-02	5.7	5.7	5.7	5.7	-49.4	-44.9	-36.9	-2055.8	-732.9	-840.4
1077	ok 0.08	0.4	7.72e-03	5.7	5.7	5.7	5.7	12.5	12.7	5.2	940.5	286.5	543.7
1078	ok 0.08	0.2	2.88e-03	5.7	5.7	5.7	5.7	-10.9	-0.9	1.3	1150.5	169.1	267.3
1079	ok 0.08	0.2	2.43e-03	5.7	5.7	5.7	5.7	-12.0	-0.6	1.8	1300.0	140.1	186.6
1080	ok 0.08	0.2	2.44e-03	5.7	5.7	5.7	5.7	-12.2	-0.7	-2.1	1311.5	143.0	-253.1
1081	ok 0.08	0.2	3.33e-03	5.7	5.7	5.7	5.7	-11.2	-0.9	-1.6	1172.8	184.3	-340.7
1082	ok 0.08	0.1	9.03e-04	5.7	5.7	5.7	5.7	-2.2	-3.9	0.9	361.0	986.1	184.5
1083	ok 0.08	0.2	9.31e-04	5.7	5.7	5.7	5.7	-2.1	-2.5	2.5	449.4	1095.7	329.3
1084	ok 0.08	0.2	1.34e-03	5.7	5.7	5.7	5.7	-1.4	-1.2	3.4	598.8	1176.6	519.4
1085	ok 0.08	0.3	1.26e-03	5.7	5.7	5.7	5.7	1.9	10.0	5.9	535.8	1934.4	445.7
1086	ok 0.08	0.5	1.02e-02	5.7	5.7	5.7	5.7	17.2	20.1	0.2	913.2	2684.7	619.8
1087	ok 0.08	0.6	3.33e-02	5.7	5.7	5.7	5.7	114.2	74.7	-104.9	1890.8	2475.1	1338.0
1088	ok 0.08	0.4	8.83e-03	5.7	5.7	5.7	5.7	51.5	20.1	-28.2	1578.7	303.3	-623.5
1089	ok 0.08	0.7	1.71e-02	5.7	5.7	5.7	5.7	43.4	-78.3	-23.3	542.7	4243.6	-640.4
1090	ok 0.08	0.4	3.22e-03	5.7	5.7	5.7	5.7	-2.9	-3.3	5.2	385.0	2205.6	-721.8
1091	ok 0.08	0.3	2.98e-03	5.7	5.7	5.7	5.7	1.9	14.9	-5.3	298.7	1954.9	-345.7
1092	ok 0.08	0.2	1.29e-03	5.7	5.7	5.7	5.7	-1.9	-3.2	-1.6	286.2	1250.4	-518.5
1093	ok 0.08	0.2	1.26e-03	5.7	5.7	5.7	5.7	-1.6	-4.8	-0.4	190.4	1116.1	-309.8
1094	ok 0.08	0.1	1.16e-03	5.7	5.7	5.7	5.7	-1.6	-5.7	-0.3	139.5	1007.1	-150.3
1095	ok 0.08	0.1	1.18e-03	5.7	5.7	5.7	5.7	-1.6	-5.4	0.5	152.6	1050.8	199.8
1096	ok 0.08	0.2	1.23e-03	5.7	5.7	5.7	5.7	-1.4	-4.3	0.7	218.5	1179.1	374.0
1097	ok 0.08	0.3	1.39e-03	5.7	5.7	5.7	5.7	-1.7	-2.3	2.5	324.8	1309.4	609.7
1098	ok 0.08	0.3	2.94e-03	5.7	5.7	5.7	5.7	2.5	16.4	4.9	377.4	2147.9	450.5
1099	ok 0.08	0.4	8.38e-03	5.7	5.7	5.7	5.7	-9.8	-19.9	-19.1	366.0	2694.4	907.9
1100	ok 0.08	0.8	2.61e-02	5.7	5.7	5.7	5.7	94.0	-103.4	-115.1	2032.7	4399.5	551.7
1101	ok 0.08	0.3	1.73e-02	5.7	5.7	5.7	5.7	-85.4	3.2	45.1	-1490.4	37.4	-450.4
1102	ok 0.08	0.6	2.72e-02	5.7	5.7	5.7	5.7	-123.8	2.3	50.7	-880.9	-82.5	-298.6





EGP CODE

GRE.EEC.R.73.IT.W.15235.12.024.01

PAGE

490 di/of 527

1103	ok 0.08	0.4	1.84e-02	5.7	5.7	5.7	5.7	-93.0	6.3	46.4	-1745.1	-169.9	-483.8
1104	ok 0.08	0.5	2.07e-02	5.7	5.7	5.7	5.7	-76.3	14.2	-45.9	-2166.2	-196.3	446.1
1105	ok 0.08	0.7	3.90e-02	5.7	5.7	5.7	5.7	-39.1	146.3	81.7	-3050.8	-2371.0	365.6
1106	ok 0.08	0.5	2.26e-02	5.7	5.7	5.7	5.7	-41.9	91.5	60.1	-3282.9	-1482.7	13.4
1107	ok 0.08	0.6	2.48e-02	5.7	5.7	5.7	5.7	-46.5	103.1	-67.0	-3324.7	-1773.4	12.8
1108	ok 0.08	0.6	3.40e-02	5.7	5.7	5.7	5.7	-122.9	2.9	-54.8	-1343.2	-246.4	315.1
1109	ok 0.08	0.4	1.89e-02	5.7	5.7	5.7	5.7	-77.9	14.2	-39.8	-1851.3	-62.6	470.8
1110	ok 0.08	0.4	2.26e-02	5.7	5.7	5.7	5.7	-29.6	77.9	19.0	-454.0	-1220.2	421.9
1111	ok 0.08	0.5	2.17e-02	5.7	5.7	5.7	5.7	46.5	48.6	-15.8	2628.1	585.5	-689.1
1112	ok 0.08	0.5	8.21e-03	5.7	5.7	5.7	5.7	36.7	7.3	-20.2	3007.1	292.6	-728.6
1113	ok 0.08	0.3	3.17e-03	5.7	5.7	5.7	5.7	2.0	-1.8	-1.6	2089.0	131.3	-194.2
1114	ok 0.08	0.2	3.04e-03	5.7	5.7	5.7	5.7	-12.2	-0.5	0.8	1434.1	216.3	141.8
1115	ok 0.08	0.4	1.15e-02	5.7	5.7	5.7	5.7	-3.6	12.7	5.6	749.4	449.8	424.2
1116	ok 0.08	0.5	2.77e-02	5.7	5.7	5.7	5.7	-12.6	-67.2	-12.9	-1651.3	-564.6	-50.4
1117	ok 0.08	0.5	2.92e-02	5.7	5.7	5.7	5.7	-77.9	-72.2	36.0	-2984.2	-574.9	471.5
1118	ok 0.08	0.5	1.44e-02	5.7	5.7	5.7	5.7	-64.3	-19.0	21.0	-1926.0	-306.5	-164.8
1119	ok 0.08	0.2	2.93e-03	5.7	5.7	5.7	5.7	7.7	-1.1	-4.8	1450.7	118.4	-42.1
1120	ok 0.08	0.1	2.47e-03	5.7	5.7	5.7	5.7	-9.5	0.7	6.3	1085.7	190.4	240.1
1121	ok 0.08	0.4	6.23e-03	5.7	5.7	5.7	5.7	-25.1	-8.7	-12.9	-1226.8	-383.5	18.4
1122	ok 0.08	0.4	2.06e-02	5.7	5.7	5.7	5.7	-30.6	-40.2	-27.2	-1967.4	-583.8	-656.2
1123	ok 0.08	0.2	2.58e-03	5.7	5.7	5.7	5.7	-14.7	-6.97e-02	3.0	1332.5	182.9	238.8
1124	ok 0.08	0.4	2.18e-02	5.7	5.7	5.7	5.7	-47.8	-41.7	27.9	-1957.5	-605.1	677.0
1125	ok 0.08	0.4	7.70e-03	5.7	5.7	5.7	5.7	46.6	12.0	-23.7	1883.3	276.8	-384.8
1126	ok 0.08	0.2	2.78e-03	5.7	5.7	5.7	5.7	-7.5	0.7	-6.3	1097.5	181.6	-268.6
1127	ok 0.08	0.1	2.71e-03	5.7	5.7	5.7	5.7	-10.5	0.6	6.0	1107.2	187.4	314.0
1128	ok 0.08	0.3	6.65e-03	5.7	5.7	5.7	5.7	-11.9	11.5	5.3	821.4	288.6	364.0
1129	ok 0.08	0.4	2.12e-02	5.7	5.7	5.7	5.7	-27.9	-39.3	-25.2	-1770.0	-663.4	-692.4
1130	ok 0.08	0.4	2.44e-02	5.7	5.7	5.7	5.7	-54.8	-39.2	36.3	-1934.6	-713.3	863.9
1131	ok 0.08	0.4	2.36e-02	5.7	5.7	5.7	5.7	-38.1	-64.6	25.4	-2312.4	-534.3	494.4
1132	ok 0.08	0.4	9.98e-03	5.7	5.7	5.7	5.7	-23.1	-4.3	8.8	-1414.6	-271.9	-224.8
1133	ok 0.08	0.2	3.83e-03	5.7	5.7	5.7	5.7	14.0	1.1	-8.2	1367.0	185.8	-361.8
1134	ok 0.08	0.1	2.50e-03	5.7	5.7	5.7	5.7	-14.7	0.4	2.5	1191.4	212.5	190.2
1135	ok 0.08	0.3	4.21e-03	5.7	5.7	5.7	5.7	-13.6	-0.5	1.9	984.5	205.5	289.9
1136	ok 0.08	0.4	1.39e-02	5.7	5.7	5.7	5.7	-19.1	-14.5	-9.0	-1031.9	-171.9	-553.3
1137	ok 0.08	0.6	2.95e-02	5.7	5.7	5.7	5.7	14.0	-80.6	-12.2	-2675.8	-1054.2	11.0
1138	ok 0.08	0.6	3.09e-02	5.7	5.7	5.7	5.7	-71.0	-85.0	41.9	-3384.4	-704.0	597.5
1139	ok 0.08	0.5	1.24e-02	5.7	5.7	5.7	5.7	20.2	15.0	-7.0	-1255.4	196.0	-903.7
1140	ok 0.08	0.2	3.40e-03	5.7	5.7	5.7	5.7	-10.7	-1.3	-1.3	1059.3	193.9	-489.7
1141	ok 0.08	0.2	2.58e-03	5.7	5.7	5.7	5.7	-11.3	-0.6	-1.9	1282.9	157.6	-397.3
1142	ok 0.08	0.2	2.53e-03	5.7	5.7	5.7	5.7	-15.3	-1.3	-3.63e-02	1282.2	125.7	-205.7
1143	ok 0.08	0.2	2.29e-03	5.7	5.7	5.7	5.7	-10.1	-3.72e-02	2.5	1217.8	124.1	392.5
1144	ok 0.08	0.2	3.71e-03	5.7	5.7	5.7	5.7	10.0	1.4	8.9	1172.4	130.7	694.2
1145	ok 0.08	0.4	9.78e-03	5.7	5.7	5.7	5.7	-11.7	-0.7	-5.5	-1790.2	-240.4	354.3
1146	ok 0.08	0.4	2.54e-02	5.7	5.7	5.7	5.7	-31.1	-79.6	-32.1	-3054.1	-685.2	-584.5
1147	ok 0.08	0.5	2.85e-02	5.7	5.7	5.7	5.7	65.5	39.4	17.8	2080.0	155.5	523.9
1148	ok 0.08	0.4	2.30e-02	5.7	5.7	5.7	5.7	-40.3	-45.0	33.0	-2159.7	-767.7	848.9
1149	ok 0.08	0.4	7.30e-03	5.7	5.7	5.7	5.7	11.8	12.5	-5.8	941.0	273.7	-538.2
1150	ok 0.08	0.2	2.97e-03	5.7	5.7	5.7	5.7	-12.5	-1.2	-1.2	1197.8	171.0	-240.6
1151	ok 0.08	0.2	2.62e-03	5.7	5.7	5.7	5.7	-13.4	-0.6	-1.8	1347.6	146.1	-172.9
1152	ok 0.08	0.2	2.66e-03	5.7	5.7	5.7	5.7	-12.9	-0.6	1.8	1341.3	149.0	252.9
1153	ok 0.08	0.2	3.43e-03	5.7	5.7	5.7	5.7	-12.7	-1.2	1.1	1192.5	185.9	332.6
1154	ok 0.08	0.4	8.53e-03	5.7	5.7	5.7	5.7	15.2	14.7	6.4	1022.4	315.1	643.5
1155	ok 0.08	0.4	2.55e-02	5.7	5.7	5.7	5.7	-46.1	-39.2	-32.5	-2035.0	-749.1	-876.4
1156	ok 0.08	0.4	2.57e-02	5.7	5.7	5.7	5.7	-39.8	-70.9	-36.1	-2833.6	-619.7	-573.9
1157	ok 0.08	0.4	2.70e-02	5.7	5.7	5.7	5.7	-28.4	-74.0	30.9	-2914.9	-646.3	572.4
1158	ok 0.08	0.4	1.07e-02	5.7	5.7	5.7	5.7	20.1	17.4	-9.0	898.3	452.0	-670.9
1159	ok 0.08	0.3	4.19e-03	5.7	5.7	5.7	5.7	11.5	1.7	-10.2	1346.2	180.5	-618.0
1160	ok 0.08	0.2	2.82e-03	5.7	5.7	5.7	5.7	-11.9	-0.8	-2.9	1367.3	165.6	-262.5
1161	ok 0.08	0.2	2.92e-03	5.7	5.7	5.7	5.7	-12.9	-0.8	1.3	1427.0	175.8	234.4
1162	ok 0.08	0.2	3.28e-03	5.7	5.7	5.7	5.7	-8.8	-0.7	6.5	1050.1	170.5	602.1
1163	ok 0.08	0.5	1.31e-02	5.7	5.7	5.7	5.7	-55.9	-13.5	-16.8	-1849.7	-289.7	297.1
1164	ok 0.08	0.5	2.91e-02	5.7	5.7	5.7	5.7	-74.6	-80.7	-38.6	-3015.6	-664.2	-515.9
1165	ok 0.08	0.6	3.03e-02	5.7	5.7	5.7	5.7	7.6	-68.4	8.5	-2011.0	-826.7	6.2
1166	ok 0.08	0.4	1.36e-02	5.7	5.7	5.7	5.7	-13.2	-13.3	7.0	-721.8	-658.0	406.3
1167	ok 0.08	0.2	3.05e-03	5.7	5.7	5.7	5.7	7.6	0.8	-7.4	979.3	206.0	-361.1
1168	ok 0.08	0.3	6.04e-03	5.7	5.7	5.7	5.7	-30.6	-3.8	-10.5	-1004.3	-346.5	17.3
1169	ok 0.08	0.4	2.07e-02	5.7	5.7	5.7	5.7	-38.7	-43.2	-23.2	-1601.4	-652.4	-669.8
1170	ok 0.08	0.4	1.09e-02	5.7	5.7	5.7	5.7	-26.8	-8.8	-12.0	-1670.0	-253.8	302.4
1171	ok 0.08	0.4	2.21e-02	5.7	5.7	5.7	5.7	-36.1	-63.6	29.5	-2342.0	-561.7	511.5
1172	ok 0.08	0.4	7.65e-03	5.7	5.7	5.7	5.7	2.8	13.2	-6.4	933.5	372.9	-564.6
1173	ok 0.08	0.2	2.69e-03	5.7	5.7	5.7	5.7	-3.1	4.28e-02	-7.4	1334.8	159.9	-515.5
1174	ok 0.08	0.2	3.41e-03	5.7	5.7	5.7	5.7	-13.9	-0.9	-1.8	1594.7	141.2	-254.8
1175	ok 0.08	0.3	3.57e-03	5.7	5.7	5.7	5.7	-15.5	-1.3	0.6	1894.6	194.8	285.2
1176	ok 0.08	0.4	3.58e-03	5.7	5.7	5.7	5.7	2.1	-3.6	2.2	2517.7	145.8	454.4
1177	ok 0.08	0.6	1.28e-02	5.7	5.7	5.7	5.7	64.4	17.4	30.0	2906.6	306.1	759.0
1178	ok 0.08	0.4	1.03e-02	5.7	5.7	5.7	5.7	66.6	22.5	-35.2	1516.4	308.4	-668.2





EGP CODE

GRE.EEC.R.73.IT.W.15235.12.024.01

PAGE

491 di/of 527

1179	ok 0.08	0.3	1.78e-02	5.7	5.7	5.7	5.7	-76.1	45.5	-54.4	-1295.8	-959.6	169.9
1180	ok 0.08	0.5	2.49e-02	5.7	5.7	5.7	5.7	23.2	105.6	34.5	-1960.0	-1565.7	591.1
1181	ok 0.08	0.4	1.85e-02	5.7	5.7	5.7	5.7	-1.5	75.6	-34.4	-1799.2	-1180.5	-354.3
1182	ok 0.08	0.4	1.98e-02	5.7	5.7	5.7	5.7	-45.5	78.7	53.4	-2467.8	-1447.8	-5.3
1183	ok 0.08	0.7	3.55e-02	5.7	5.7	5.7	5.7	25.2	151.2	-57.1	-3172.0	-2322.4	-669.0
1184	ok 0.08	0.5	2.16e-02	5.7	5.7	5.7	5.7	-43.5	90.0	-56.6	-3301.1	-1481.1	-73.8
1185	ok 0.08	0.6	2.38e-02	5.7	5.7	5.7	5.7	-8.7	107.2	49.4	-3003.0	-1754.1	357.3
1186	ok 0.08	0.6	3.10e-02	5.7	5.7	5.7	5.7	17.8	130.2	51.0	-2443.2	-2028.8	594.6
1187	ok 0.08	0.4	1.87e-02	5.7	5.7	5.7	5.7	-1.2	73.1	-44.2	-2004.0	-1238.8	-307.1
1188	ok 0.08	0.4	2.71e-02	5.7	5.7	5.7	5.7	36.2	-89.2	-71.2	645.0	1866.5	592.9
1189	ok 0.08	0.5	2.04e-02	5.7	5.7	5.7	5.7	62.3	50.2	23.9	2545.9	551.8	726.0
1190	ok 0.08	0.6	1.14e-02	5.7	5.7	5.7	5.7	51.2	13.1	27.6	2904.5	272.9	720.5
1191	ok 0.08	0.3	3.01e-03	5.7	5.7	5.7	5.7	3.4	-0.9	2.6	2047.3	134.2	210.7
1192	ok 0.08	0.2	2.71e-03	5.7	5.7	5.7	5.7	-11.2	-1.2	-0.6	1441.3	215.7	-145.5
1193	ok 0.08	0.4	1.45e-02	5.7	5.7	5.7	5.7	73.6	24.9	-38.2	1416.6	260.8	-495.8
1194	ok 0.08	0.5	2.48e-02	5.7	5.7	5.7	5.7	-70.8	-53.8	39.9	-2265.7	-305.9	418.4
1195	ok 0.08	0.4	2.62e-02	5.7	5.7	5.7	5.7	-92.7	-66.7	-41.5	-3016.4	-581.2	-511.9
1196	ok 0.08	0.5	1.74e-02	5.7	5.7	5.7	5.7	-82.7	-25.2	-26.3	-1942.4	-293.1	162.6
1197	ok 0.08	0.2	3.81e-03	5.7	5.7	5.7	5.7	0.4	-0.3	5.7	1094.6	167.1	346.0
1198	ok 0.08	0.2	2.32e-03	5.7	5.7	5.7	5.7	-0.9	0.5	-6.3	1202.4	188.4	-241.5
1199	ok 0.08	0.4	7.66e-03	5.7	5.7	5.7	5.7	41.0	16.2	-27.6	1808.6	269.7	-378.1
1200	ok 0.08	0.3	1.98e-02	5.7	5.7	5.7	5.7	-40.9	-39.7	31.3	-1882.3	-553.6	652.1
1201	ok 0.08	0.2	3.85e-03	5.7	5.7	5.7	5.7	-7.0	-1.7	-6.3	1068.0	162.5	-621.8
1202	ok 0.08	0.4	2.10e-02	5.7	5.7	5.7	5.7	-57.2	-40.9	-31.9	-1868.6	-568.5	-671.8
1203	ok 0.08	0.4	9.97e-03	5.7	5.7	5.7	5.7	11.0	11.6	4.9	1046.5	315.5	332.7
1204	ok 0.08	0.2	2.71e-03	5.7	5.7	5.7	5.7	6.6	0.5	6.2	1316.9	176.8	271.9
1205	ok 0.08	0.1	2.63e-03	5.7	5.7	5.7	5.7	-10.0	0.5	-5.9	1053.1	182.7	-318.6
1206	ok 0.08	0.4	7.07e-03	5.7	5.7	5.7	5.7	35.0	14.8	-24.9	1804.8	259.5	-410.2
1207	ok 0.08	0.4	2.03e-02	5.7	5.7	5.7	5.7	-37.4	-39.1	28.8	-1670.6	-627.7	670.8
1209	ok 0.08	0.3	2.25e-02	5.7	5.7	5.7	5.7	-49.2	-61.9	-30.5	-2241.6	-508.1	-499.1
1210	ok 0.08	0.4	1.20e-02	5.7	5.7	5.7	5.7	22.3	14.8	6.6	1054.7	416.0	434.9
1211	ok 0.08	0.2	3.83e-03	5.7	5.7	5.7	5.7	16.2	0.5	7.9	1369.7	182.6	366.4
1212	ok 0.08	0.1	2.45e-03	5.7	5.7	5.7	5.7	-14.5	0.4	-2.1	1151.6	215.5	-198.8
1213	ok 0.08	0.3	3.94e-03	5.7	5.7	5.7	5.7	15.8	-0.1	-8.6	1266.2	161.4	-644.4
1214	ok 0.08	0.5	1.69e-02	5.7	5.7	5.7	5.7	-62.4	-28.3	23.2	-2002.9	-224.5	-223.4
1215	ok 0.08	0.6	2.61e-02	5.7	5.7	5.7	5.7	-70.9	-57.7	43.7	-3376.2	-499.7	407.5
1216	ok 0.08	0.5	2.80e-02	5.7	5.7	5.7	5.7	-82.9	-78.4	-46.5	-3389.8	-699.5	-618.3
1217	ok 0.08	0.5	1.55e-02	5.7	5.7	5.7	5.7	-66.0	-17.9	-19.5	-2012.2	-247.1	344.6
1218	ok 0.08	0.2	3.42e-03	5.7	5.7	5.7	5.7	-10.6	-1.2	1.0	1054.2	195.8	484.5
1219	ok 0.08	0.2	2.43e-03	5.7	5.7	5.7	5.7	-11.1	-0.7	1.5	1274.5	160.5	401.7
1220	ok 0.08	0.2	2.37e-03	5.7	5.7	5.7	5.7	-14.3	-1.2	0.1	1265.9	125.2	204.4
1221	ok 0.08	0.2	2.16e-03	5.7	5.7	5.7	5.7	-10.0	3.13e-03	-2.6	1183.2	124.4	-388.1
1222	ok 0.08	0.2	3.61e-03	5.7	5.7	5.7	5.7	11.7	0.5	-8.7	1164.2	126.0	-698.9

Nodo	x/d	V N/M	ver. rid	Af pr-	Af pr+	Af sec-	Af sec+	N x	N y	N xy	M x	M y	M xy
	0.10	0.99	0.0810.51	5.65	10.50	5.65	218.25	275.74	-123.78	-139.96	-6456.67	-5712.73	-2337.81
									124.64	3835.45	6495.68	2410.25	

Nodo	Stato daN/cm2	Max tau	Ver V pr	Ver V sec	Af V pr	Af V sec daN/cm	V pr daN/cm	V sec
10k	0.0							
30k	0.0							
50k	0.0							
70k	0.0							
90k	0.0							
110k	0.0							
130k	0.0							
150k	0.0							
170k	0.0							
190k	0.0							
210k	0.0							
230k	0.0							
250k	0.0							
270k	0.0							
290k	0.0							
310k	0.0							
330k	0.0							
350k	0.0							
370k	0.0							
390k	0.0							
410k	0.0							
420k	0.0							
430k	0.0							
440k	0.63							
450k	0.54							
460k	0.36							



EGP CODE

GRE.EEC.R.73.IT.W.15235.12.024.01

PAGE

492 di/of 527

47ok	0.48
48ok	0.32
49ok	0.40
50ok	0.28
51ok	0.36
52ok	0.24
53ok	0.34
54ok	0.25
55ok	0.35
56ok	0.29
57ok	0.36
58ok	0.33
59ok	0.42
60ok	0.41
61ok	0.49
62ok	0.73
63ok	0.0
64ok	0.0
65ok	0.0
66ok	0.0
67ok	0.58
68ok	0.73
69ok	0.43
70ok	0.22
71ok	0.18
72ok	0.15
73ok	0.13
74ok	0.13
75ok	0.16
76ok	0.19
77ok	0.26
78ok	0.50
79ok	0.91
80ok	0.66
81ok	0.50
82ok	0.47
83ok	0.30
84ok	0.19
85ok	0.17
86ok	0.14
87ok	0.11
88ok	0.13
89ok	0.15
90ok	0.18
91ok	0.22
92ok	0.33
93ok	0.53
94ok	0.57
95ok	0.53
96ok	0.59
97ok	0.31
98ok	0.15
99ok	0.15
100	ok 0.14
101	ok 0.12
102	ok 0.13
103	ok 0.15
104	ok 0.16
105	ok 0.19
106	ok 0.39
107	ok 0.69
108	ok 0.58
109	ok 0.0
110	ok 0.0
111	ok 0.48
112	ok 0.22
113	ok 0.15
114	ok 0.15
115	ok 0.12
116	ok 0.14
117	ok 0.15
118	ok 0.16
119	ok 0.27
120	ok 0.67
121	ok 0.0
122	ok 0.0



EGP CODE

GRE.EEC.R.73.IT.W.15235.12.024.01

PAGE

493 di/of 527

123	ok	0.0
124	ok	0.0
125	ok	0.84
126	ok	0.28
127	ok	0.16
128	ok	0.15
129	ok	0.12
130	ok	0.13
131	ok	0.16
132	ok	0.17
133	ok	0.38
134	ok	0.0
135	ok	0.0
136	ok	0.0
137	ok	0.0
138	ok	0.54
139	ok	0.29
140	ok	0.17
141	ok	0.15
142	ok	0.12
143	ok	0.13
144	ok	0.16
145	ok	0.17
146	ok	0.39
147	ok	0.0
148	ok	0.0
149	ok	0.0
150	ok	0.0
151	ok	0.84
152	ok	0.28
153	ok	0.17
154	ok	0.15
155	ok	0.13
156	ok	0.14
157	ok	0.16
158	ok	0.18
159	ok	0.38
160	ok	0.0
161	ok	0.0
162	ok	0.0
163	ok	0.0
164	ok	0.0
165	ok	0.56
166	ok	0.22
167	ok	0.16
168	ok	0.14
169	ok	0.12
170	ok	0.13
171	ok	0.15
172	ok	0.16
173	ok	0.28
174	ok	0.77
175	ok	0.0
176	ok	0.0
177	ok	0.45
178	ok	0.56
179	ok	0.26
180	ok	0.15
181	ok	0.14
182	ok	0.14
183	ok	0.11
184	ok	0.13
185	ok	0.14
186	ok	0.15
187	ok	0.17
188	ok	0.35
189	ok	0.65
190	ok	0.52
191	ok	0.40
192	ok	0.45
193	ok	0.23
194	ok	0.13
195	ok	0.13
196	ok	0.14
197	ok	0.11
198	ok	0.13



EGP CODE

GRE.EEC.R.73.IT.W.15235.12.024.01

PAGE

494 di/of 527

199	ok	0.14
200	ok	0.14
201	ok	0.16
202	ok	0.29
203	ok	0.52
204	ok	0.45
205	ok	0.58
206	ok	0.72
207	ok	0.38
208	ok	0.18
209	ok	0.16
210	ok	0.14
211	ok	0.12
212	ok	0.13
213	ok	0.15
214	ok	0.15
215	ok	0.22
216	ok	0.48
217	ok	0.99
218	ok	0.66
219	ok	0.0
220	ok	0.0
221	ok	0.67
222	ok	0.26
223	ok	0.16
224	ok	0.15
225	ok	0.12
226	ok	0.13
227	ok	0.16
228	ok	0.16
229	ok	0.33
230	ok	0.86
231	ok	0.0
232	ok	0.0
233	ok	1.07
234	ok	0.0
235	ok	0.45
236	ok	0.27
237	ok	0.18
238	ok	0.15
239	ok	0.12
240	ok	0.13
241	ok	0.16
242	ok	0.18
243	ok	0.35
244	ok	0.0
245	ok	0.0
246	ok	0.27
247	ok	0.0
248	ok	0.0
249	ok	0.66
250	ok	0.26
251	ok	0.17
252	ok	0.15
253	ok	0.12
254	ok	0.13
255	ok	0.16
256	ok	0.16
257	ok	0.33
258	ok	0.86
259	ok	0.0
260	ok	0.0
261	ok	0.58
262	ok	0.72
263	ok	0.39
264	ok	0.18
265	ok	0.16
266	ok	0.14
267	ok	0.12
268	ok	0.13
269	ok	0.15
270	ok	0.16
271	ok	0.22
272	ok	0.48
273	ok	1.00
274	ok	0.64



EGP CODE

GRE.EEC.R.73.IT.W.15235.12.024.01

PAGE

495 di/of 527

275	ok	0.37
276	ok	0.44
277	ok	0.22
278	ok	0.15
279	ok	0.14
280	ok	0.14
281	ok	0.11
282	ok	0.13
283	ok	0.14
284	ok	0.15
285	ok	0.15
286	ok	0.28
287	ok	0.51
288	ok	0.43
289	ok	0.37
290	ok	0.42
291	ok	0.22
292	ok	0.14
293	ok	0.14
294	ok	0.14
295	ok	0.12
296	ok	0.13
297	ok	0.15
298	ok	0.15
299	ok	0.16
300	ok	0.27
301	ok	0.48
302	ok	0.42
303	ok	0.53
304	ok	0.69
305	ok	0.39
306	ok	0.20
307	ok	0.17
308	ok	0.15
309	ok	0.12
310	ok	0.13
311	ok	0.16
312	ok	0.17
313	ok	0.21
314	ok	0.49
315	ok	0.91
316	ok	0.62
317	ok	0.0
318	ok	0.0
319	ok	0.65
320	ok	0.29
321	ok	0.18
322	ok	0.16
323	ok	0.13
324	ok	0.14
325	ok	0.17
326	ok	0.18
327	ok	0.36
328	ok	0.81
329	ok	0.0
330	ok	0.0
331	ok	3.55
332	ok	0.0
333	ok	0.53
334	ok	0.32
335	ok	0.20
336	ok	0.16
337	ok	0.13
338	ok	0.14
339	ok	0.17
340	ok	0.20
341	ok	0.42
342	ok	0.0
343	ok	0.0
344	ok	0.0
345	ok	0.0
346	ok	0.0
347	ok	1.47
348	ok	1.66
349	ok	0.0
350	ok	0.0





EGP CODE

GRE.EEC.R.73.IT.W.15235.12.024.01

PAGE

496 di/of 527

351	ok	0.0
352	ok	3.03
353	ok	1.86
354	ok	1.04
355	ok	1.00
356	ok	2.00
357	ok	0.0
358	ok	0.0
359	ok	0.80
360	ok	0.28
361	ok	0.18
362	ok	0.16
363	ok	0.12
364	ok	0.14
365	ok	0.17
366	ok	0.18
367	ok	0.37
368	ok	0.0
369	ok	0.0
370	ok	0.0
371	ok	0.75
372	ok	0.80
373	ok	0.45
374	ok	0.21
375	ok	0.17
376	ok	0.15
377	ok	0.12
378	ok	0.13
379	ok	0.16
380	ok	0.17
381	ok	0.25
382	ok	0.62
383	ok	1.12
384	ok	0.85
385	ok	0.38
386	ok	0.47
387	ok	0.25
388	ok	0.16
389	ok	0.15
390	ok	0.14
391	ok	0.12
392	ok	0.13
393	ok	0.15
394	ok	0.16
395	ok	0.18
396	ok	0.30
397	ok	0.55
398	ok	0.44
399	ok	0.33
400	ok	0.38
401	ok	0.21
402	ok	0.14
403	ok	0.14
404	ok	0.14
405	ok	0.12
406	ok	0.13
407	ok	0.14
408	ok	0.15
409	ok	0.15
410	ok	0.25
411	ok	0.45
412	ok	0.37
413	ok	0.45
414	ok	0.56
415	ok	0.33
416	ok	0.17
417	ok	0.15
418	ok	0.15
419	ok	0.12
420	ok	0.13
421	ok	0.15
422	ok	0.16
423	ok	0.23
424	ok	0.39
425	ok	0.66
426	ok	0.47



EGP CODE

GRE.EEC.R.73.IT.W.15235.12.024.01

PAGE

497 di/of 527

427	ok	0.0
428	ok	0.0
429	ok	0.58
430	ok	0.28
431	ok	0.18
432	ok	0.15
433	ok	0.13
434	ok	0.14
435	ok	0.16
436	ok	0.20
437	ok	0.34
438	ok	0.89
439	ok	0.0
440	ok	0.0
441	ok	0.0
442	ok	0.0
443	ok	1.07
444	ok	0.34
445	ok	0.20
446	ok	0.16
447	ok	0.13
448	ok	0.14
449	ok	0.18
450	ok	0.23
451	ok	0.47
452	ok	0.0
453	ok	0.0
454	ok	0.0
455	ok	0.0
456	ok	0.75
457	ok	0.38
458	ok	0.20
459	ok	0.16
460	ok	0.13
461	ok	0.14
462	ok	0.18
463	ok	0.21
464	ok	0.53
465	ok	0.0
466	ok	0.0
467	ok	0.0
468	ok	0.0
469	ok	1.08
470	ok	0.36
471	ok	0.19
472	ok	0.16
473	ok	0.13
474	ok	0.14
475	ok	0.18
476	ok	0.22
477	ok	0.49
478	ok	0.0
479	ok	0.0
480	ok	0.0
481	ok	0.0
482	ok	0.93
483	ok	0.53
484	ok	0.28
485	ok	0.19
486	ok	0.15
487	ok	0.12
488	ok	0.14
489	ok	0.17
490	ok	0.20
491	ok	0.32
492	ok	0.81
493	ok	0.0
494	ok	0.0
495	ok	0.43
496	ok	0.52
497	ok	0.34
498	ok	0.18
499	ok	0.16
500	ok	0.14
501	ok	0.11
502	ok	0.13



EGP CODE

GRE.EEC.R.73.IT.W.15235.12.024.01

PAGE

498 di/of 527

503	ok	0.15
504	ok	0.16
505	ok	0.23
506	ok	0.39
507	ok	0.61
508	ok	0.49
509	ok	0.31
510	ok	0.34
511	ok	0.19
512	ok	0.14
513	ok	0.13
514	ok	0.13
515	ok	0.10
516	ok	0.11
517	ok	0.13
518	ok	0.14
519	ok	0.15
520	ok	0.22
521	ok	0.42
522	ok	0.35
523	ok	0.25
524	ok	0.28
525	ok	0.13
526	ok	0.12
527	ok	0.11
528	ok	0.12
529	ok	0.10
530	ok	0.11
531	ok	0.12
532	ok	0.12
533	ok	0.12
534	ok	0.15
535	ok	0.34
536	ok	0.29
537	ok	0.29
538	ok	0.34
539	ok	0.18
540	ok	0.13
541	ok	0.12
542	ok	0.12
543	ok	0.10
544	ok	0.11
545	ok	0.13
546	ok	0.13
547	ok	0.15
548	ok	0.21
549	ok	0.42
550	ok	0.35
551	ok	0.40
552	ok	0.49
553	ok	0.31
554	ok	0.17
555	ok	0.13
556	ok	0.13
557	ok	0.10
558	ok	0.11
559	ok	0.14
560	ok	0.14
561	ok	0.22
562	ok	0.35
563	ok	0.58
564	ok	0.48
565	ok	0.86
566	ok	0.88
567	ok	0.51
568	ok	0.23
569	ok	0.16
570	ok	0.14
571	ok	0.11
572	ok	0.12
573	ok	0.14
574	ok	0.17
575	ok	0.28
576	ok	0.72
577	ok	1.20
578	ok	0.97



EGP CODE

GRE.EEC.R.73.IT.W.15235.12.024.01

PAGE

499 di/of 527

579	ok	0.0
580	ok	0.0
581	ok	0.89
582	ok	0.30
583	ok	0.16
584	ok	0.15
585	ok	0.11
586	ok	0.12
587	ok	0.16
588	ok	0.19
589	ok	0.40
590	ok	0.0
591	ok	0.0
592	ok	0.0
593	ok	0.0
594	ok	0.57
595	ok	0.35
596	ok	0.18
597	ok	0.14
598	ok	0.12
599	ok	0.13
600	ok	0.15
601	ok	0.22
602	ok	0.46
603	ok	0.0
604	ok	0.0
605	ok	0.0
606	ok	0.0
607	ok	0.0
608	ok	0.0
609	ok	0.0
610	ok	2.68
611	ok	1.65
612	ok	1.11
613	ok	0.74
614	ok	0.49
615	ok	0.56
616	ok	0.85
617	ok	1.27
618	ok	1.93
619	ok	0.0
620	ok	0.0
621	ok	0.70
622	ok	0.32
623	ok	0.17
624	ok	0.15
625	ok	0.11
626	ok	0.13
627	ok	0.16
628	ok	0.20
629	ok	0.39
630	ok	0.86
631	ok	0.0
632	ok	0.0
633	ok	0.64
634	ok	0.74
635	ok	0.44
636	ok	0.20
637	ok	0.17
638	ok	0.14
639	ok	0.11
640	ok	0.12
641	ok	0.15
642	ok	0.16
643	ok	0.23
644	ok	0.55
645	ok	1.08
646	ok	0.70
647	ok	0.35
648	ok	0.42
649	ok	0.26
650	ok	0.15
651	ok	0.13
652	ok	0.13
653	ok	0.10
654	ok	0.12



EGP CODE

GRE.EEC.R.73.IT.W.15235.12.024.01

PAGE

500 di/of 527

655	ok	0.14
656	ok	0.15
657	ok	0.19
658	ok	0.29
659	ok	0.53
660	ok	0.41
661	ok	0.27
662	ok	0.31
663	ok	0.16
664	ok	0.13
665	ok	0.12
666	ok	0.12
667	ok	0.10
668	ok	0.11
669	ok	0.13
670	ok	0.13
671	ok	0.13
672	ok	0.18
673	ok	0.39
674	ok	0.32
675	ok	0.26
676	ok	0.31
677	ok	0.16
678	ok	0.13
679	ok	0.13
680	ok	0.12
681	ok	0.10
682	ok	0.11
683	ok	0.13
684	ok	0.13
685	ok	0.13
686	ok	0.17
687	ok	0.38
688	ok	0.31
689	ok	0.35
690	ok	0.42
691	ok	0.27
692	ok	0.16
693	ok	0.14
694	ok	0.14
695	ok	0.11
696	ok	0.12
697	ok	0.15
698	ok	0.15
699	ok	0.20
700	ok	0.30
701	ok	0.51
702	ok	0.41
703	ok	0.62
704	ok	0.72
705	ok	0.48
706	ok	0.21
707	ok	0.18
708	ok	0.15
709	ok	0.12
710	ok	0.13
711	ok	0.16
712	ok	0.18
713	ok	0.24
714	ok	0.59
715	ok	1.04
716	ok	0.68
717	ok	0.0
718	ok	0.0
719	ok	0.75
720	ok	0.34
721	ok	0.19
722	ok	0.16
723	ok	0.13
724	ok	0.14
725	ok	0.17
726	ok	0.22
727	ok	0.42
728	ok	0.87
729	ok	0.0
730	ok	0.0





EGP CODE

GRE.EEC.R.73.IT.W.15235.12.024.01

PAGE

501 di/of 527

731	ok	3.04
732	ok	0.0
733	ok	0.62
734	ok	0.38
735	ok	0.21
736	ok	0.16
737	ok	0.13
738	ok	0.14
739	ok	0.17
740	ok	0.24
741	ok	0.50
742	ok	0.0
743	ok	0.0
744	ok	0.0
745	ok	0.0
746	ok	0.0
747	ok	0.0
748	ok	0.0
749	ok	0.0
750	ok	2.66
751	ok	1.57
752	ok	1.03
753	ok	0.69
754	ok	0.46
755	ok	0.52
756	ok	0.79
757	ok	0.0
758	ok	0.0
759	ok	0.95
760	ok	0.33
761	ok	0.19
762	ok	0.17
763	ok	0.13
764	ok	0.14
765	ok	0.18
766	ok	0.21
767	ok	0.44
768	ok	0.0
769	ok	0.0
770	ok	0.0
771	ok	0.82
772	ok	0.86
773	ok	0.54
774	ok	0.25
775	ok	0.18
776	ok	0.15
777	ok	0.12
778	ok	0.14
779	ok	0.16
780	ok	0.19
781	ok	0.30
782	ok	0.76
783	ok	1.18
784	ok	0.94
785	ok	0.37
786	ok	0.49
787	ok	0.31
788	ok	0.17
789	ok	0.15
790	ok	0.15
791	ok	0.12
792	ok	0.13
793	ok	0.15
794	ok	0.16
795	ok	0.22
796	ok	0.35
797	ok	0.57
798	ok	0.45
799	ok	0.27
800	ok	0.34
801	ok	0.19
802	ok	0.14
803	ok	0.13
804	ok	0.13
805	ok	0.11
806	ok	0.12



EGP CODE

GRE.EEC.R.73.IT.W.15235.12.024.01

PAGE

502 di/of 527

807	ok	0.14
808	ok	0.14
809	ok	0.14
810	ok	0.21
811	ok	0.42
812	ok	0.31
813	ok	0.31
814	ok	0.33
815	ok	0.18
816	ok	0.15
817	ok	0.14
818	ok	0.14
819	ok	0.11
820	ok	0.12
821	ok	0.14
822	ok	0.15
823	ok	0.15
824	ok	0.21
825	ok	0.39
826	ok	0.34
827	ok	0.44
828	ok	0.51
829	ok	0.30
830	ok	0.18
831	ok	0.16
832	ok	0.15
833	ok	0.12
834	ok	0.13
835	ok	0.16
836	ok	0.17
837	ok	0.20
838	ok	0.35
839	ok	0.60
840	ok	0.49
841	ok	0.0
842	ok	0.91
843	ok	0.52
844	ok	0.25
845	ok	0.19
846	ok	0.16
847	ok	0.13
848	ok	0.14
849	ok	0.17
850	ok	0.20
851	ok	0.29
852	ok	0.73
853	ok	0.0
854	ok	0.0
855	ok	0.0
856	ok	0.0
857	ok	0.96
858	ok	0.33
859	ok	0.19
860	ok	0.17
861	ok	0.13
862	ok	0.15
863	ok	0.18
864	ok	0.20
865	ok	0.44
866	ok	0.0
867	ok	0.0
868	ok	0.0
869	ok	0.0
870	ok	0.67
871	ok	0.34
872	ok	0.19
873	ok	0.16
874	ok	0.13
875	ok	0.15
876	ok	0.18
877	ok	0.20
878	ok	0.47
879	ok	0.0
880	ok	0.0
881	ok	0.0
882	ok	0.0



EGP CODE

GRE.EEC.R.73.IT.W.15235.12.024.01

PAGE

503 di/of 527

883	ok	0.96
884	ok	0.31
885	ok	0.19
886	ok	0.16
887	ok	0.13
888	ok	0.15
889	ok	0.18
890	ok	0.21
891	ok	0.42
892	ok	0.0
893	ok	0.0
894	ok	0.0
895	ok	0.0
896	ok	0.0
897	ok	0.55
898	ok	0.25
899	ok	0.17
900	ok	0.16
901	ok	0.13
902	ok	0.14
903	ok	0.16
904	ok	0.18
905	ok	0.29
906	ok	0.82
907	ok	0.0
908	ok	0.0
909	ok	0.49
910	ok	0.53
911	ok	0.28
912	ok	0.15
913	ok	0.15
914	ok	0.15
915	ok	0.13
916	ok	0.14
917	ok	0.16
918	ok	0.17
919	ok	0.19
920	ok	0.33
921	ok	0.63
922	ok	0.57
923	ok	0.60
924	ok	0.73
925	ok	0.35
926	ok	0.17
927	ok	0.15
928	ok	0.15
929	ok	0.13
930	ok	0.14
931	ok	0.16
932	ok	0.16
933	ok	0.19
934	ok	0.42
935	ok	0.94
936	ok	0.69
937	ok	0.0
938	ok	0.0
939	ok	0.60
940	ok	0.27
941	ok	0.16
942	ok	0.15
943	ok	0.13
944	ok	0.14
945	ok	0.16
946	ok	0.17
947	ok	0.33
948	ok	0.80
949	ok	0.0
950	ok	0.0
951	ok	1.19
952	ok	0.0
953	ok	0.50
954	ok	0.30
955	ok	0.18
956	ok	0.15
957	ok	0.12
958	ok	0.13



EGP CODE

GRE.EEC.R.73.IT.W.15235.12.024.01

PAGE

504 di/of 527

959	ok	0.16
960	ok	0.20
961	ok	0.39
962	ok	0.0
963	ok	0.0
964	ok	1.87
965	ok	3.03
966	ok	0.0
967	ok	0.0
968	ok	0.0
969	ok	0.0
970	ok	0.0
971	ok	0.0
972	ok	0.86
973	ok	0.42
974	ok	0.34
975	ok	0.30
976	ok	0.26
977	ok	0.0
978	ok	0.0
979	ok	0.77
980	ok	0.27
981	ok	0.17
982	ok	0.15
983	ok	0.12
984	ok	0.13
985	ok	0.16
986	ok	0.18
987	ok	0.36
988	ok	0.0
989	ok	0.0
990	ok	0.0
991	ok	0.84
992	ok	0.87
993	ok	0.46
994	ok	0.22
995	ok	0.16
996	ok	0.14
997	ok	0.12
998	ok	0.13
999	ok	0.15
1000	ok	0.16
1001	ok	0.27
1002	ok	0.57
1003	ok	1.14
1004	ok	0.91
1005	ok	0.46
1006	ok	0.53
1007	ok	0.30
1008	ok	0.16
1009	ok	0.13
1010	ok	0.13
1011	ok	0.11
1012	ok	0.12
1013	ok	0.14
1014	ok	0.14
1015	ok	0.20
1016	ok	0.37
1017	ok	0.60
1018	ok	0.52
1019	ok	0.36
1020	ok	0.39
1021	ok	0.24
1022	ok	0.16
1023	ok	0.13
1024	ok	0.13
1025	ok	0.11
1026	ok	0.13
1027	ok	0.14
1028	ok	0.14
1029	ok	0.18
1030	ok	0.27
1031	ok	0.45
1032	ok	0.39
1033	ok	0.38
1034	ok	0.36



EGP CODE

GRE.EEC.R.73.IT.W.15235.12.024.01

PAGE

505 di/of 527

1035	ok	0.23
1036	ok	0.19
1037	ok	0.16
1038	ok	0.14
1039	ok	0.11
1040	ok	0.12
1041	ok	0.15
1042	ok	0.17
1043	ok	0.20
1044	ok	0.26
1045	ok	0.41
1046	ok	0.42
1047	ok	0.49
1048	ok	0.51
1049	ok	0.29
1050	ok	0.21
1051	ok	0.18
1052	ok	0.14
1053	ok	0.11
1054	ok	0.12
1055	ok	0.15
1056	ok	0.19
1057	ok	0.22
1058	ok	0.34
1059	ok	0.59
1060	ok	0.57
1061	ok	0.0
1062	ok	0.0
1063	ok	0.56
1064	ok	2.10
1065	ok	0.20
1066	ok	0.16
1067	ok	0.13
1068	ok	0.14
1069	ok	0.17
1070	ok	0.21
1071	ok	0.31
1072	ok	0.77
1073	ok	0.0
1074	ok	0.0
1076	ok	0.0
1077	ok	3.02
1078	ok	1.84
1079	ok	1.08
1080	ok	1.02
1081	ok	1.88
1082	ok	0.27
1083	ok	0.32
1084	ok	0.36
1085	ok	0.49
1086	ok	0.0
1087	ok	0.0
1088	ok	3.20
1089	ok	0.0
1090	ok	0.78
1091	ok	0.61
1092	ok	0.47
1093	ok	0.44
1094	ok	0.42
1095	ok	0.43
1096	ok	0.43
1097	ok	0.50
1098	ok	0.65
1099	ok	0.0
1100	ok	0.0
1101	ok	0.0
1102	ok	0.0
1103	ok	0.0
1104	ok	0.0
1105	ok	0.0
1106	ok	0.0
1107	ok	0.0
1108	ok	0.0
1109	ok	0.0
1110	ok	0.0
1111	ok	0.0





EGP CODE

GRE.EEC.R.73.IT.W.15235.12.024.01

PAGE

506 di/of 527

1112	ok	2.11
1113	ok	0.88
1114	ok	1.58
1115	ok	0.0
1116	ok	0.0
1117	ok	0.0
1118	ok	0.0
1119	ok	1.47
1120	ok	1.18
1121	ok	2.30
1122	ok	0.0
1123	ok	1.11
1124	ok	0.0
1125	ok	2.38
1126	ok	1.24
1127	ok	1.26
1128	ok	2.49
1129	ok	0.0
1130	ok	0.0
1131	ok	0.0
1132	ok	2.68
1133	ok	1.49
1134	ok	1.06
1135	ok	2.20
1136	ok	0.0
1137	ok	0.0
1138	ok	0.0
1139	ok	3.82
1140	ok	2.47
1141	ok	1.48
1142	ok	0.76
1143	ok	1.42
1144	ok	2.26
1145	ok	3.36
1146	ok	0.0
1147	ok	0.0
1148	ok	0.0
1149	ok	3.03
1150	ok	1.89
1151	ok	1.12
1152	ok	1.07
1153	ok	1.93
1154	ok	3.20
1155	ok	0.0
1156	ok	0.0
1157	ok	0.0
1158	ok	3.40
1159	ok	2.16
1160	ok	1.16
1161	ok	1.10
1162	ok	2.12
1163	ok	3.43
1164	ok	0.0
1165	ok	0.0
1166	ok	0.0
1167	ok	1.46
1168	ok	1.69
1169	ok	0.0
1170	ok	3.48
1171	ok	0.0
1172	ok	2.98
1173	ok	1.90
1174	ok	1.10
1175	ok	1.04
1176	ok	2.02
1177	ok	0.0
1178	ok	3.42
1179	ok	0.0
1180	ok	0.0
1181	ok	0.0
1182	ok	0.0
1183	ok	0.0
1184	ok	0.0
1185	ok	0.0
1186	ok	0.0
1187	ok	0.0



EGP CODE

GRE.EEC.R.73.IT.W.15235.12.024.01

PAGE

507 di/of 527

1188	ok	0.0
1189	ok	0.0
1190	ok	2.11
1191	ok	0.83
1192	ok	1.57
1193	ok	0.0
1194	ok	0.0
1195	ok	0.0
1196	ok	0.0
1197	ok	1.47
1198	ok	1.10
1199	ok	2.30
1200	ok	0.0
1201	ok	2.11
1202	ok	0.0
1203	ok	2.39
1204	ok	1.19
1205	ok	1.21
1206	ok	2.48
1207	ok	0.0
1209	ok	0.0
1210	ok	2.73
1211	ok	1.44
1212	ok	1.00
1213	ok	2.21
1214	ok	0.0
1215	ok	0.0
1216	ok	0.0
1217	ok	3.96
1218	ok	2.47
1219	ok	1.44
1220	ok	0.72
1221	ok	1.36
1222	ok	2.21

**Nodo**                      **Max tau**   **Ver V pr**   **Ver V sec**                      **Af V pr**                      **Af V sec**                      **V pr**                      **V sec**  
 3.96

<b>Nodo Stato</b>	<b>V 6.50</b>	<b>V 6.53</b>	<b>Beta</b>	<b>f. a fon</b>	<b>f. Uout</b>	<b>Aw tot</b>	<b>Asw,min</b>	<b>n. x serie</b>	<b>n.ser 0(R)</b>	<b>n.ser 90</b>	<b>Rif. cmb</b>
						cm2	cm2				
1 ok	0.0	0.04	0.0	0.0	0.0	0.0	0.0	0	0	0	1
3 ok	0.0	0.04	0.0	0.0	0.0	0.0	0.0	0	0	0	1
5 ok	0.05	0.06	1.15	2.00	0.0	0.0	0.0	0	0	0	2
7 ok	0.05	0.06	1.16	2.00	0.0	0.0	0.0	0	0	0	2
9 ok	0.06	0.07	1.17	2.00	0.0	0.0	0.0	0	0	0	2
11 ok	0.07	0.08	1.17	2.00	0.0	0.0	0.0	0	0	0	2
13 ok	0.09	0.08	1.17	2.00	0.0	0.0	0.0	0	0	0	2
15 ok	0.08	0.08	1.17	2.00	0.0	0.0	0.0	0	0	0	2
17 ok	0.05	0.07	1.17	2.00	0.0	0.0	0.0	0	0	0	2
19 ok	0.06	0.07	1.15	2.00	0.0	0.0	0.0	0	0	0	2
21 ok	6.96e-03	0.04	1.16	2.00	0.0	0.0	0.0	0	0	0	4
23 ok	0.05	0.06	1.15	2.00	0.0	0.0	0.0	0	0	0	2
25 ok	0.05	0.06	1.16	2.00	0.0	0.0	0.0	0	0	0	2
27 ok	0.06	0.07	1.17	2.00	0.0	0.0	0.0	0	0	0	2
29 ok	0.07	0.08	1.17	2.00	0.0	0.0	0.0	0	0	0	2
31 ok	0.09	0.08	1.17	2.00	0.0	0.0	0.0	0	0	0	2
33 ok	0.08	0.08	1.17	2.00	0.0	0.0	0.0	0	0	0	2
35 ok	0.05	0.07	1.17	2.00	0.0	0.0	0.0	0	0	0	2
37 ok	0.06	0.07	1.15	2.00	0.0	0.0	0.0	0	0	0	2
39 ok	6.65e-03	0.04	1.16	2.00	0.0	0.0	0.0	0	0	0	4



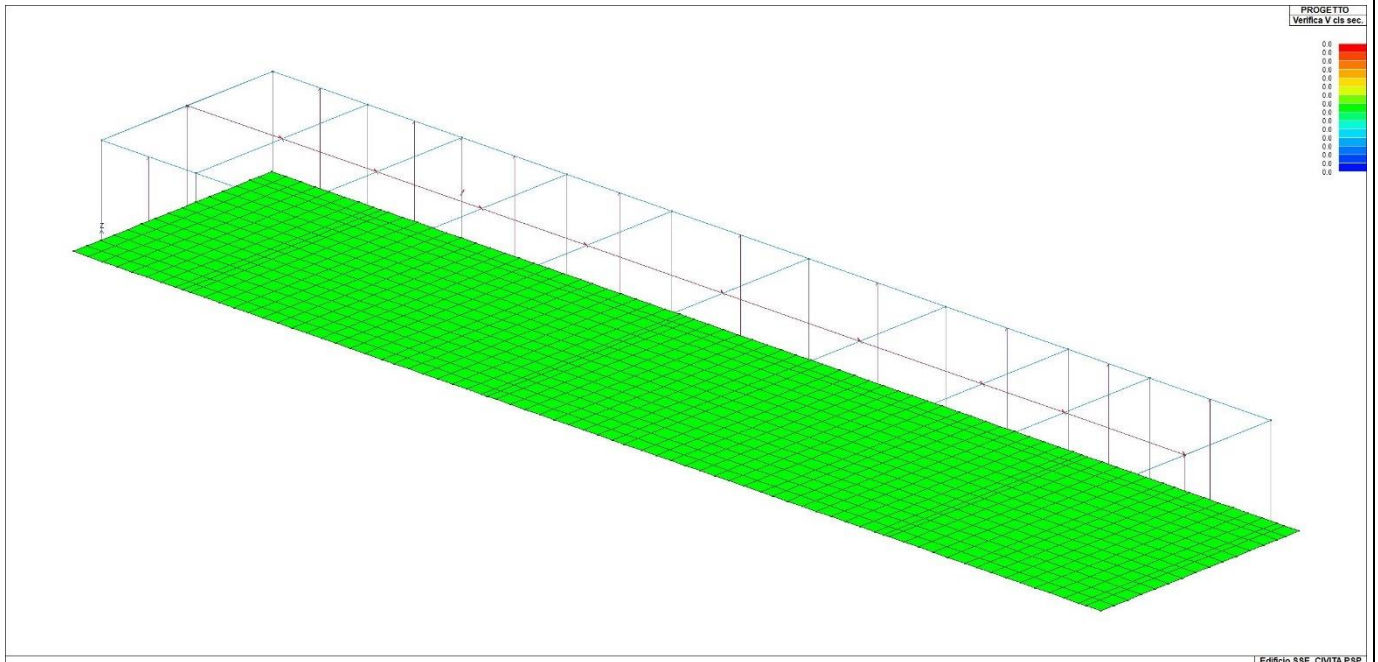

72\_PRO\_CA\_D3\_VER\_VII

## 20. STATI LIMITE D' ESERCIZIO

### 20.1. LEGENDA TABELLA STATI LIMITE D' ESERCIZIO

In tabella vengono riportati i valori di interesse per il controllo degli stati limite d'esercizio.

In particolare vengono riportati, in relazione al tipo di elemento strutturale, i risultati relativi alle tre categorie di combinazione considerate:

- Combinazioni rare
- Combinazioni frequenti
- Combinazioni quasi permanenti.

I valori di interesse sono i seguenti:

<b>rRfck</b>	rapporto tra la massima compressione nel calcestruzzo e la tensione fck in combinazioni rare [normalizzato a 1]
<b>rRfyk</b>	rapporto tra la massima tensione nell'acciaio e la tensione fyk in combinazioni rare [normalizzato a 1]
<b>rPfck</b>	rapporto tra la massima compressione nel calcestruzzo e la tensione fck in combinazioni quasi permanenti [normalizzato a 1]
<b>wR</b>	apertura caratteristica delle fessure in combinazioni rare [mm]
<b>wF</b>	apertura caratteristica delle fessure in combinazioni frequenti [mm]
<b>wP</b>	apertura caratteristica delle fessure in combinazioni quasi permanenti [mm]
<b>dR</b>	massima deformazione in combinazioni rare
<b>dF</b>	massima deformazione in combinazioni frequenti
<b>dP</b>	massima deformazione in combinazioni quasi permanenti

Per ognuno dei nove valori soprariportati viene indicata (Rif.cmb) la combinazione in cui si è verificato.

In relazione al tipo di elemento strutturale i valori sono selezionati nel modo seguente:

pilastr	<b>rRfck</b>	<b>rRfyk</b>	<b>rPfck</b>	per sezioni significative
travi	<b>rRfck</b>	<b>rRfyk</b>	<b>rPfck</b>	per sezioni significative
	<b>wR</b>	<b>wF</b>	<b>wP</b>	per sezioni significative
	<b>dR</b>	<b>dF</b>	<b>dP</b>	massimi in campata
setti e gusci	<b>rRfck</b>	<b>rRfyk</b>	<b>rPfck</b>	massimi nei nodi dell'elemento
	<b>wR</b>	<b>wF</b>	<b>wP</b>	massimi nei nodi dell'elemento

Si precisa che i valori di massima deformazione per travi sono riferiti al piano verticale (piano locale 1-2 con momenti flettenti 3-3).





EGP CODE

GRE.EEC.R.73.IT.W.15235.12.024.01

PAGE

511 di/of 527

Pilas. cm	Pos.	rRfck	rRfyk	rPfck cm	Rif. cmb	Pos.	rRfck	rRfyk	rPfck	Rif. cmb
1	0.0	0.090.06	0.09	70,70,73	150.0	0.11	0.08	0.12	70,70,73	
300.0	0.27	0.330.29	70,70,73							
2	0.0	0.090.06	0.09	70,70,73	150.0	0.11	0.08	0.12	70,70,73	
300.0	0.27	0.330.29	70,70,73							
3	0.0	0.130.08	0.13	70,70,73	150.0	0.14	0.09	0.15	70,70,73	
300.0	0.40	0.460.41	70,70,73							
4	0.0	0.140.09	0.14	70,70,73	150.0	0.15	0.10	0.16	70,70,73	
300.0	0.43	0.510.45	70,70,73							
5	0.0	0.150.10	0.15	70,70,73	150.0	0.16	0.11	0.17	70,70,73	
300.0	0.45	0.540.47	70,70,73							
6	0.0	0.170.11	0.17	70,70,73	150.0	0.18	0.12	0.19	70,70,73	
300.0	0.51	0.600.53	70,70,73							
7	0.0	0.190.12	0.19	70,70,73	150.0	0.19	0.12	0.20	70,70,73	
300.0	0.56	0.650.57	70,70,73							
8	0.0	0.180.12	0.18	70,70,73	150.0	0.19	0.12	0.19	70,70,73	
300.0	0.53	0.620.54	70,70,73							
9	0.0	0.150.10	0.15	70,70,73	150.0	0.16	0.11	0.17	70,70,73	
300.0	0.45	0.530.47	70,70,73							
10	0.0	0.140.09	0.14	70,70,73	150.0	0.16	0.10	0.17	70,70,73	
300.0	0.43	0.500.45	70,70,73							
11	0.0	0.110.07	0.11	70,70,73	150.0	0.13	0.09	0.14	70,70,73	
300.0	0.32	0.380.35	70,70,73							
12	0.0	0.130.08	0.13	70,70,73	150.0	0.14	0.09	0.15	70,70,73	
300.0	0.40	0.460.41	70,70,73							
13	0.0	0.140.09	0.14	70,70,73	150.0	0.15	0.10	0.16	70,70,73	
300.0	0.43	0.510.45	70,70,73							
14	0.0	0.150.10	0.15	70,70,73	150.0	0.16	0.11	0.17	70,70,73	
300.0	0.45	0.540.47	70,70,73							
15	0.0	0.170.11	0.17	70,70,73	150.0	0.18	0.12	0.19	70,70,73	
300.0	0.51	0.600.53	70,70,73							
16	0.0	0.200.12	0.19	70,70,73	150.0	0.19	0.12	0.20	70,70,73	
300.0	0.56	0.650.57	70,70,73							
17	0.0	0.190.12	0.18	70,70,73	150.0	0.19	0.12	0.19	70,70,73	
300.0	0.53	0.620.54	70,70,73							
18	0.0	0.150.10	0.15	70,70,73	150.0	0.16	0.11	0.17	70,70,73	
300.0	0.45	0.530.47	70,70,73							
19	0.0	0.140.09	0.14	70,70,73	150.0	0.16	0.10	0.17	70,70,73	
300.0	0.43	0.500.45	70,70,73							
20	0.0	0.110.07	0.11	70,70,73	150.0	0.13	0.09	0.14	70,70,73	
300.0	0.32	0.380.35	70,70,73							

Pilas.	rRfck	rRfyk	rPfck	rRfck	rRfyk	rPfck
0.56	0.650.57					

Trave	Pos.	rRfck	rRfyk	rPfck	Rif. cmb	wR	wF	wP	Rif. cmb	dR	dF	dP	Rif. cmb
	cm					mm	mm	mm		cm	cm	cm	
21	0.0	0.04	0.09	0.0569,69,73	0.0	0.0	0.0	0.0	0,0,0	-0.02	-0.02	-0.02	69,71,73
	207.50	0.03	0.08	0.0470,70,73	0.0	0.0	0.0	0.0	0,0,0				
	415.19	0.08e-03	0.02	0.0169,69,73	0.0	0.0	0.0	0.0	0,0,0				
22	0.03.55e-03	0.21e-03	4.47e-03	70,70,73	0.0	0.0	0.0	0.0	0,0,0	0,0,0	-7.99e-03	-7.88e-03	-7.85e-03 70,72,73
	162.40	0.02	0.04	0.0270,70,73	0.0	0.0	0.0	0.0	0,0,0				
	324.80	0.03	0.07	0.0469,69,73	0.0	0.0	0.0	0.0	0,0,0				
23	0.03.50e-03	0.39.12e-03	4.42e-03	70,70,73	0.0	0.0	0.0	0.0	0,0,0	0,0,0	-8.01e-03	-7.89e-03	-7.87e-03 70,72,73
	162.40	0.02	0.04	0.0270,70,73	0.0	0.0	0.0	0.0	0,0,0				
	324.80	0.03	0.07	0.0469,69,73	0.0	0.0	0.0	0.0	0,0,0				
24	0.0	0.18	0.38	0.1970,70,73	0.0	0.0	0.0	0.0	0,0,0	-0.95	-0.78	-0.70	70,72,73
	315.00	0.31	0.72	0.3370,70,73	0.21	0.20	0.18	70,72,73					
25	0.0	0.14	0.31	0.1570,70,73	0.0	0.0	0.0	0.0	0,0,0	-0.73	-0.54	-0.49	70,72,73
	315.00	0.27	0.61	0.2970,70,73	0.18	0.16	0.15	70,72,73					
26	0.0	0.03	0.07	0.0469,69,73	0.0	0.0	0.0	0.0	0,0,0	-2.28e-03	-2.20e-03	-2.18e-03	70,72,73
	162.48	0.77e-03	0.02	0.0170,70,73	0.0	0.0	0.0	0.0	0,0,0				
	324.80	0.02	0.06	0.0370,69,73	0.0	0.0	0.0	0.0	0,0,0				
27	0.0	0.03	0.07	0.0469,69,73	0.0	0.0	0.0	0.0	0,0,0	-2.28e-03	-2.20e-03	-2.18e-03	70,72,73
	162.48	0.76e-03	0.02	0.0170,70,73	0.0	0.0	0.0	0.0	0,0,0				
	324.80	0.02	0.06	0.0370,69,73	0.0	0.0	0.0	0.0	0,0,0				
28	0.0	0.03	0.06	0.0369,70,73	0.0	0.0	0.0	0.0	0,0,0	-6.57e-03	-6.60e-03	-6.61e-03	70,72,73
	180.10	0.02	0.04	0.0269,69,73	0.0	0.0	0.0	0.0	0,0,0				
	360.30	0.03	0.07	0.0470,70,73	0.0	0.0	0.0	0.0	0,0,0				
29	0.0	0.03	0.06	0.0369,70,73	0.0	0.0	0.0	0.0	0,0,0	-6.57e-03	-6.60e-03	-6.61e-03	70,72,73
	180.10	0.02	0.04	0.0269,69,73	0.0	0.0	0.0	0.0	0,0,0				
	360.30	0.03	0.07	0.0470,70,73	0.0	0.0	0.0	0.0	0,0,0				
30	0.0	0.03	0.07	0.0470,70,73	0.0	0.0	0.0	0.0	0,0,0	-3.90e-03	-3.17e-03	-2.99e-03	70,72,73
	180.10	0.01	0.03	0.0169,69,73	0.0	0.0	0.0	0.0	0,0,0				



360.30.04	0.09	0.0569,69,73	0.0	0.0	0.0	0,0,0				
31 0.0 0.03	0.07	0.0470,70,73	0.0	0.0	0.0	0,0,0	-3.89e-03	-3.16e-03	-2.98e-03	70,72,73
180.10.01	0.03	0.0169,69,73	0.0	0.0	0.0	0,0,0				
360.30.04	0.09	0.0569,69,73	0.0	0.0	0.0	0,0,0				
32 0.0 0.04	0.10	0.0569,69,73	0.0	0.0	0.0	0,0,0	-0.02	-0.02	-0.02	70,72,73
234.90.03	0.06	0.0470,70,73	0.0	0.0	0.0	0,0,0				
469.80.05	0.12	0.0769,69,73	0.0	0.0	0.0	0,0,0				
33 0.0 0.04	0.10	0.0569,69,73	0.0	0.0	0.0	0,0,0	-0.02	-0.02	-0.02	70,72,73
234.90.03	0.06	0.0470,70,73	0.0	0.0	0.0	0,0,0				
469.80.05	0.12	0.0769,69,73	0.0	0.0	0.0	0,0,0				
34 0.0 0.05	0.12	0.0769,69,73	0.0	0.0	0.0	0,0,0	-0.02	-0.02	-0.02	69,71,73
234.90.02	0.06	0.0370,70,73	0.0	0.0	0.0	0,0,0				
469.80.05	0.11	0.0669,70,73	0.0	0.0	0.0	0,0,0				
35 0.0 0.05	0.12	0.0769,69,73	0.0	0.0	0.0	0,0,0	-0.02	-0.02	-0.02	69,71,73
234.90.02	0.06	0.0370,70,73	0.0	0.0	0.0	0,0,0				
469.80.05	0.11	0.0669,70,73	0.0	0.0	0.0	0,0,0				
36 0.0 0.04	0.11	0.0669,69,73	0.0	0.0	0.0	0,0,0	-0.01	-0.01	-0.01	69,71,73
210.00.02	0.05	0.0370,70,73	0.0	0.0	0.0	0,0,0				
420.10.03	0.07	0.0470,70,73	0.0	0.0	0.0	0,0,0				
37 0.0 0.04	0.11	0.0669,69,73	0.0	0.0	0.0	0,0,0	-0.01	-0.01	-0.01	69,71,73
210.00.02	0.05	0.0370,70,73	0.0	0.0	0.0	0,0,0				
420.10.03	0.07	0.0470,70,73	0.0	0.0	0.0	0,0,0				
38 0.0 0.02	0.06	0.0370,70,73	0.0	0.0	0.0	0,0,0	2.88e-03	2.83e-03	2.82e-03	70,72,73
140.02.71e-037.38e-033.41e-0370,70,73			0.0	0.0	0.0	0,0,0				
279.90.03	0.08	0.0470,70,73	0.0	0.0	0.0	0,0,0				
39 0.0 0.02	0.06	0.0370,70,73	0.0	0.0	0.0	0,0,0	2.89e-03	2.84e-03	2.82e-03	70,72,73
140.02.73e-037.44e-033.44e-0370,70,73			0.0	0.0	0.0	0,0,0				
279.90.03	0.08	0.0470,70,73	0.0	0.0	0.0	0,0,0				
40 0.0 0.04	0.09	0.0569,69,73	0.0	0.0	0.0	0,0,0	-0.02	-0.02	-0.02	69,71,73
207.50.03	0.08	0.0470,70,73	0.0	0.0	0.0	0,0,0				
415.19.05e-03	0.02	0.0169,69,73	0.0	0.0	0.0	0,0,0				
41 0.0 0.25	0.60	0.2670,70,73	0.18	0.15	0.14	70,72,73	-1.23	-1.04	-0.97	70,72,73
315.00.36	0.65	0.3870,70,73	0.17	0.15	0.14	70,72,73				
630.00.25	0.60	0.2670,70,73	0.18	0.15	0.14	70,72,73				
42 0.0 0.26	0.61	0.2770,70,73	0.18	0.15	0.14	70,72,73	-1.33	-1.17	-1.04	70,72,73
315.00.39	0.69	0.4070,70,73	0.18	0.17	0.15	70,72,73				
630.00.26	0.61	0.2770,70,73	0.18	0.15	0.14	70,72,73				
43 0.0 0.27	0.62	0.2770,70,73	0.19	0.15	0.14	70,72,73	-1.42	-1.24	-1.15	70,72,73
315.00.41	0.73	0.4270,70,73	0.20	0.18	0.16	70,72,73				
630.00.27	0.62	0.2770,70,73	0.19	0.15	0.14	70,72,73				
44 0.0 0.30	0.71	0.3170,70,73	0.21	0.18	0.17	70,72,73	-1.64	-1.40	-1.31	70,72,73
315.00.45	0.81	0.4670,70,73	0.23	0.20	0.19	70,72,73				
630.00.30	0.71	0.3170,70,73	0.21	0.18	0.17	70,72,73				
45 0.0 0.32	0.80	0.3370,70,73	0.24	0.22	0.20	70,72,73	-1.51	-1.28	-1.19	70,72,73
315.00.46	0.68	0.4670,70,73	0.17	0.15	0.14	70,72,73				
630.00.32	0.80	0.3370,70,73	0.24	0.22	0.20	70,72,73				
46 0.0 0.31	0.76	0.3170,70,73	0.23	0.20	0.19	70,72,73	-1.43	-1.21	-1.13	70,72,73
315.00.44	0.65	0.4470,70,73	0.16	0.14	0.13	70,72,73				
630.00.31	0.76	0.3170,70,73	0.23	0.20	0.19	70,72,73				
47 0.0 0.26	0.60	0.2770,70,73	0.18	0.15	0.14	70,72,73	-1.39	-1.21	-1.13	70,72,73
315.00.40	0.71	0.4170,70,73	0.19	0.17	0.16	70,72,73				
630.00.26	0.60	0.2770,70,73	0.18	0.15	0.14	70,72,73				
48 0.0 0.27	0.63	0.2770,70,73	0.19	0.15	0.15	70,72,73	-1.33	-1.16	-1.04	70,72,73
315.00.39	0.69	0.4070,70,73	0.19	0.17	0.15	70,72,73				
630.00.27	0.63	0.2770,70,73	0.19	0.15	0.15	70,72,73				
49 0.0 0.31	0.72	0.3370,70,73	0.21	0.20	0.18	70,72,73	-0.95	-0.78	-0.70	70,72,73
315.00.18	0.38	0.1970,70,73	0.0	0.0	0.0	0,0,0				
50 0.0 0.27	0.61	0.2970,70,73	0.18	0.16	0.15	70,72,73	-0.73	-0.54	-0.49	70,72,73
315.00.14	0.31	0.1670,70,73	0.0	0.0	0.0	0,0,0				

**Trave**    **rRfck**    **rRfyk**    **rPfck**            **wR**            **wF**            **wP**                    **dR**            **dF**            **dP**  
                  0.46            0.81    0.46                    0.24            0.22            0.20                    2.89e-03    2.84e-03    2.82e-03

<b>Guscio</b>	<b>rRfck</b>	<b>rRfyk</b>	<b>rPfck</b>	<b>Rif. cmb</b>	<b>wR</b>	<b>wF</b>	<b>wP</b>	<b>Rif. cmb</b>
				mm	mm	mm		
10.06	0.17	0.07	70,70,73	0.0	0.0	0.0	0,0,0	
20.04	0.14	0.05	70,70,73	0.0	0.0	0.0	0,0,0	
30.04	0.13	0.05	70,70,73	0.0	0.0	0.0	0,0,0	
40.04	0.13	0.05	70,70,73	0.0	0.0	0.0	0,0,0	
50.04	0.11	0.05	70,70,73	0.0	0.0	0.0	0,0,0	
60.04	0.10	0.04	70,70,73	0.0	0.0	0.0	0,0,0	
70.03	0.10	0.04	70,70,73	0.0	0.0	0.0	0,0,0	
80.04	0.11	0.04	70,70,73	0.0	0.0	0.0	0,0,0	
90.04	0.12	0.05	70,70,73	0.0	0.0	0.0	0,0,0	
100.04	0.13	0.05	70,70,73	0.0	0.0	0.0	0,0,0	
110.04	0.13	0.05	70,70,73	0.0	0.0	0.0	0,0,0	



EGP CODE

GRE.EEC.R.73.IT.W.15235.12.024.01

PAGE

513 di/of 527

120.04	0.13	0.05	70,70,73	0.0	0.0	0.0	0,0,0
130.07	0.18	0.08	70,70,73	0.0	0.0	0.0	0,0,0
140.04	0.13	0.04	70,70,73	0.0	0.0	0.0	0,0,0
150.04	0.12	0.05	70,70,73	0.0	0.0	0.0	0,0,0
160.04	0.13	0.05	70,70,73	0.0	0.0	0.0	0,0,0
170.04	0.12	0.05	70,70,73	0.0	0.0	0.0	0,0,0
180.04	0.11	0.05	70,70,73	0.0	0.0	0.0	0,0,0
190.04	0.10	0.04	70,70,73	0.0	0.0	0.0	0,0,0
200.04	0.10	0.04	70,70,73	0.0	0.0	0.0	0,0,0
210.04	0.11	0.04	70,70,73	0.0	0.0	0.0	0,0,0
220.04	0.12	0.05	70,70,73	0.0	0.0	0.0	0,0,0
230.04	0.13	0.05	70,70,73	0.0	0.0	0.0	0,0,0
240.04	0.13	0.05	70,70,73	0.0	0.0	0.0	0,0,0
250.04	0.13	0.04	70,70,73	0.0	0.0	0.0	0,0,0
260.04	0.13	0.04	70,70,73	0.0	0.0	0.0	0,0,0
270.04	0.11	0.05	70,70,73	0.0	0.0	0.0	0,0,0
280.04	0.11	0.05	70,70,73	0.0	0.0	0.0	0,0,0
290.04	0.12	0.05	70,70,73	0.0	0.0	0.0	0,0,0
300.04	0.12	0.05	70,70,73	0.0	0.0	0.0	0,0,0
310.04	0.11	0.05	70,70,73	0.0	0.0	0.0	0,0,0
320.04	0.11	0.04	70,70,73	0.0	0.0	0.0	0,0,0
330.04	0.10	0.04	70,70,73	0.0	0.0	0.0	0,0,0
340.04	0.11	0.05	70,70,73	0.0	0.0	0.0	0,0,0
350.04	0.12	0.05	70,70,73	0.0	0.0	0.0	0,0,0
360.04	0.12	0.05	70,70,73	0.0	0.0	0.0	0,0,0
370.04	0.12	0.05	70,70,73	0.0	0.0	0.0	0,0,0
380.04	0.11	0.05	70,70,73	0.0	0.0	0.0	0,0,0
390.04	0.11	0.05	70,70,73	0.0	0.0	0.0	0,0,0
400.04	0.11	0.05	70,70,73	0.0	0.0	0.0	0,0,0
410.04	0.12	0.05	70,70,73	0.0	0.0	0.0	0,0,0
420.04	0.13	0.05	70,70,73	0.0	0.0	0.0	0,0,0
430.04	0.12	0.05	70,70,73	0.0	0.0	0.0	0,0,0
440.04	0.12	0.05	70,70,73	0.0	0.0	0.0	0,0,0
450.04	0.11	0.04	70,70,73	0.0	0.0	0.0	0,0,0
460.04	0.10	0.04	70,70,73	0.0	0.0	0.0	0,0,0
470.04	0.11	0.05	70,70,73	0.0	0.0	0.0	0,0,0
480.04	0.12	0.05	70,70,73	0.0	0.0	0.0	0,0,0
490.04	0.12	0.05	70,70,73	0.0	0.0	0.0	0,0,0
500.04	0.13	0.05	70,70,73	0.0	0.0	0.0	0,0,0
510.04	0.12	0.05	70,70,73	0.0	0.0	0.0	0,0,0
520.04	0.11	0.05	70,70,73	0.0	0.0	0.0	0,0,0
530.04	0.12	0.05	70,70,73	0.0	0.0	0.0	0,0,0
540.05	0.13	0.05	70,70,73	0.0	0.0	0.0	0,0,0
550.05	0.14	0.05	70,70,73	0.0	0.0	0.0	0,0,0
560.05	0.13	0.05	70,70,73	0.0	0.0	0.0	0,0,0
570.04	0.12	0.05	70,70,73	0.0	0.0	0.0	0,0,0
580.04	0.11	0.05	70,70,73	0.0	0.0	0.0	0,0,0
590.04	0.11	0.04	70,70,73	0.0	0.0	0.0	0,0,0
600.04	0.12	0.05	70,70,73	0.0	0.0	0.0	0,0,0
610.04	0.13	0.05	70,70,73	0.0	0.0	0.0	0,0,0
620.05	0.14	0.05	70,70,73	0.0	0.0	0.0	0,0,0
630.05	0.14	0.06	70,70,73	0.0	0.0	0.0	0,0,0
640.05	0.13	0.05	70,70,73	0.0	0.0	0.0	0,0,0
650.04	0.11	0.05	70,70,73	0.0	0.0	0.0	0,0,0
660.04	0.17	0.05	70,70,73	0.0	0.0	0.0	0,0,0
670.05	0.15	0.06	70,70,73	0.0	0.0	0.0	0,0,0
680.05	0.15	0.06	70,70,73	0.0	0.0	0.0	0,0,0
690.05	0.14	0.06	70,70,73	0.0	0.0	0.0	0,0,0
700.04	0.13	0.05	70,70,73	0.0	0.0	0.0	0,0,0
710.04	0.11	0.05	70,70,73	0.0	0.0	0.0	0,0,0
720.04	0.11	0.04	70,70,73	0.0	0.0	0.0	0,0,0
730.04	0.12	0.05	70,70,73	0.0	0.0	0.0	0,0,0
740.05	0.13	0.05	70,70,73	0.0	0.0	0.0	0,0,0
750.05	0.15	0.06	70,70,73	0.0	0.0	0.0	0,0,0
760.05	0.15	0.06	70,70,73	0.0	0.0	0.0	0,0,0
770.05	0.15	0.05	70,70,73	0.0	0.0	0.0	0,0,0
780.07	0.14	0.07	70,70,73	0.0	0.0	0.0	0,0,0
790.12	0.35	0.14	70,70,73	0.0	0.0	0.0	0,0,0
800.05	0.21	0.06	70,70,73	0.0	0.0	0.0	0,0,0
810.05	0.15	0.06	70,70,73	0.0	0.0	0.0	0,0,0
820.05	0.14	0.06	70,70,73	0.0	0.0	0.0	0,0,0
830.04	0.13	0.05	70,70,73	0.0	0.0	0.0	0,0,0
840.04	0.11	0.05	70,70,73	0.0	0.0	0.0	0,0,0
850.04	0.11	0.05	70,70,73	0.0	0.0	0.0	0,0,0
860.04	0.12	0.05	70,70,73	0.0	0.0	0.0	0,0,0
870.05	0.13	0.05	70,70,73	0.0	0.0	0.0	0,0,0



EGP CODE

GRE.EEC.R.73.IT.W.15235.12.024.01

PAGE

514 di/of 527

880.05	0.15	0.06	70,70,73	0.0	0.0	0.0	0,0,0
890.05	0.15	0.06	70,70,73	0.0	0.0	0.0	0,0,0
900.05	0.23	0.06	70,70,73	0.0	0.0	0.0	0,0,0
910.13	0.33	0.14	70,70,73	0.0	0.0	0.0	0,0,0
920.12	0.33	0.13	70,70,73	0.0	0.0	0.0	0,0,0
930.05	0.22	0.06	70,70,73	0.0	0.0	0.0	0,0,0
940.05	0.15	0.06	70,70,73	0.0	0.0	0.0	0,0,0
950.05	0.14	0.06	70,70,73	0.0	0.0	0.0	0,0,0
960.04	0.13	0.05	70,70,73	0.0	0.0	0.0	0,0,0
970.04	0.11	0.05	70,70,73	0.0	0.0	0.0	0,0,0
980.04	0.11	0.05	70,70,73	0.0	0.0	0.0	0,0,0
990.04	0.12	0.05	70,70,73	0.0	0.0	0.0	0,0,0
100	0.05	0.13	0.05	70,70,73	0.0	0.0	0,0,0
101	0.05	0.15	0.06	70,70,73	0.0	0.0	0,0,0
102	0.05	0.15	0.06	70,70,73	0.0	0.0	0,0,0
103	0.05	0.24	0.06	70,70,73	0.0	0.0	0,0,0
104	0.12	0.31	0.13	70,70,73	0.0	0.0	0,0,0
105	0.04	0.15	0.04	70,70,73	0.0	0.0	0,0,0
106	0.05	0.15	0.05	70,70,73	0.0	0.0	0,0,0
107	0.05	0.15	0.06	70,70,73	0.0	0.0	0,0,0
108	0.05	0.14	0.06	70,70,73	0.0	0.0	0,0,0
109	0.04	0.13	0.05	70,70,73	0.0	0.0	0,0,0
110	0.04	0.11	0.05	70,70,73	0.0	0.0	0,0,0
111	0.04	0.11	0.05	70,70,73	0.0	0.0	0,0,0
112	0.04	0.12	0.05	70,70,73	0.0	0.0	0,0,0
113	0.05	0.13	0.05	70,70,73	0.0	0.0	0,0,0
114	0.05	0.15	0.06	70,70,73	0.0	0.0	0,0,0
115	0.05	0.15	0.06	70,70,73	0.0	0.0	0,0,0
116	0.05	0.15	0.05	70,70,73	0.0	0.0	0,0,0
117	0.06	0.13	0.07	70,70,73	0.0	0.0	0,0,0
118	0.03	0.09	0.03	70,70,73	0.0	0.0	0,0,0
119	0.05	0.13	0.05	70,70,73	0.0	0.0	0,0,0
120	0.05	0.14	0.05	70,70,73	0.0	0.0	0,0,0
121	0.05	0.13	0.05	70,70,73	0.0	0.0	0,0,0
122	0.04	0.12	0.05	70,70,73	0.0	0.0	0,0,0
123	0.04	0.11	0.05	70,70,73	0.0	0.0	0,0,0
124	0.04	0.11	0.04	70,70,73	0.0	0.0	0,0,0
125	0.04	0.12	0.05	70,70,73	0.0	0.0	0,0,0
126	0.05	0.13	0.05	70,70,73	0.0	0.0	0,0,0
127	0.05	0.13	0.05	70,70,73	0.0	0.0	0,0,0
128	0.05	0.14	0.05	70,70,73	0.0	0.0	0,0,0
129	0.04	0.12	0.05	70,70,73	0.0	0.0	0,0,0
130	0.03	0.08	0.03	70,70,73	0.0	0.0	0,0,0
131	0.03	0.08	0.03	70,70,73	0.0	0.0	0,0,0
132	0.04	0.12	0.05	70,70,73	0.0	0.0	0,0,0
133	0.04	0.13	0.05	70,70,73	0.0	0.0	0,0,0
134	0.04	0.13	0.05	70,70,73	0.0	0.0	0,0,0
135	0.04	0.12	0.05	70,70,73	0.0	0.0	0,0,0
136	0.04	0.11	0.05	70,70,73	0.0	0.0	0,0,0
137	0.04	0.11	0.04	70,70,73	0.0	0.0	0,0,0
138	0.04	0.12	0.05	70,70,73	0.0	0.0	0,0,0
139	0.04	0.12	0.05	70,70,73	0.0	0.0	0,0,0
140	0.04	0.13	0.05	70,70,73	0.0	0.0	0,0,0
141	0.04	0.13	0.05	70,70,73	0.0	0.0	0,0,0
142	0.04	0.11	0.04	70,70,73	0.0	0.0	0,0,0
143	0.03	0.08	0.03	70,70,73	0.0	0.0	0,0,0
144	0.03	0.09	0.04	70,70,73	0.0	0.0	0,0,0
145	0.04	0.12	0.05	70,70,73	0.0	0.0	0,0,0
146	0.05	0.13	0.05	70,70,73	0.0	0.0	0,0,0
147	0.05	0.13	0.05	70,70,73	0.0	0.0	0,0,0
148	0.04	0.12	0.05	70,70,73	0.0	0.0	0,0,0
149	0.04	0.11	0.05	70,70,73	0.0	0.0	0,0,0
150	0.04	0.11	0.04	70,70,73	0.0	0.0	0,0,0
151	0.04	0.12	0.05	70,70,73	0.0	0.0	0,0,0
152	0.04	0.13	0.05	70,70,73	0.0	0.0	0,0,0
153	0.05	0.13	0.05	70,70,73	0.0	0.0	0,0,0
154	0.05	0.13	0.05	70,70,73	0.0	0.0	0,0,0
155	0.04	0.12	0.05	70,70,73	0.0	0.0	0,0,0
156	0.03	0.08	0.03	70,70,73	0.0	0.0	0,0,0
157	0.04	0.16	0.04	70,70,73	0.0	0.0	0,0,0
158	0.05	0.17	0.05	70,70,73	0.0	0.0	0,0,0
159	0.05	0.15	0.06	70,70,73	0.0	0.0	0,0,0
160	0.05	0.14	0.06	70,70,73	0.0	0.0	0,0,0
161	0.04	0.13	0.05	70,70,73	0.0	0.0	0,0,0
162	0.04	0.11	0.05	70,70,73	0.0	0.0	0,0,0
163	0.04	0.11	0.04	70,70,73	0.0	0.0	0,0,0



EGP CODE

GRE.EEC.R.73.IT.W.15235.12.024.01

PAGE

515 di/of 527

164	0.04	0.12	0.05	70,70,73	0.0	0.0	0.0	0,0,0
165	0.05	0.13	0.05	70,70,73	0.0	0.0	0.0	0,0,0
166	0.05	0.14	0.06	70,70,73	0.0	0.0	0.0	0,0,0
167	0.05	0.14	0.06	70,70,73	0.0	0.0	0.0	0,0,0
168	0.04	0.19	0.05	70,70,73	0.0	0.0	0.0	0,0,0
169	0.05	0.14	0.05	70,70,73	0.0	0.0	0.0	0,0,0
170	0.11	0.33	0.12	70,70,73	0.0	0.0	0.0	0,0,0
171	0.06	0.22	0.06	70,70,73	0.0	0.0	0.0	0,0,0
172	0.05	0.15	0.06	70,70,73	0.0	0.0	0.0	0,0,0
173	0.05	0.14	0.06	70,70,73	0.0	0.0	0.0	0,0,0
174	0.04	0.13	0.05	70,70,73	0.0	0.0	0.0	0,0,0
175	0.04	0.12	0.05	70,70,73	0.0	0.0	0.0	0,0,0
176	0.04	0.11	0.04	70,70,73	0.0	0.0	0.0	0,0,0
177	0.04	0.12	0.05	70,70,73	0.0	0.0	0.0	0,0,0
178	0.05	0.13	0.05	70,70,73	0.0	0.0	0.0	0,0,0
179	0.05	0.15	0.06	70,70,73	0.0	0.0	0.0	0,0,0
180	0.05	0.15	0.06	70,70,73	0.0	0.0	0.0	0,0,0
181	0.05	0.21	0.06	70,70,73	0.0	0.0	0.0	0,0,0
182	0.12	0.34	0.13	70,70,73	0.0	0.0	0.0	0,0,0
183	0.11	0.33	0.13	70,70,73	0.0	0.0	0.0	0,0,0
184	0.06	0.21	0.06	70,70,73	0.0	0.0	0.0	0,0,0
185	0.05	0.15	0.06	70,70,73	0.0	0.0	0.0	0,0,0
186	0.05	0.14	0.06	70,70,73	0.0	0.0	0.0	0,0,0
187	0.04	0.13	0.05	70,70,73	0.0	0.0	0.0	0,0,0
188	0.04	0.12	0.05	70,70,73	0.0	0.0	0.0	0,0,0
189	0.04	0.11	0.04	70,70,73	0.0	0.0	0.0	0,0,0
190	0.04	0.12	0.05	70,70,73	0.0	0.0	0.0	0,0,0
191	0.05	0.13	0.05	70,70,73	0.0	0.0	0.0	0,0,0
192	0.05	0.15	0.06	70,70,73	0.0	0.0	0.0	0,0,0
193	0.05	0.15	0.06	70,70,73	0.0	0.0	0.0	0,0,0
194	0.05	0.21	0.06	70,70,73	0.0	0.0	0.0	0,0,0
195	0.12	0.34	0.13	70,70,73	0.0	0.0	0.0	0,0,0
196	0.04	0.16	0.04	70,70,73	0.0	0.0	0.0	0,0,0
197	0.05	0.17	0.05	70,70,73	0.0	0.0	0.0	0,0,0
198	0.05	0.15	0.06	70,70,73	0.0	0.0	0.0	0,0,0
199	0.05	0.14	0.06	70,70,73	0.0	0.0	0.0	0,0,0
200	0.04	0.13	0.05	70,70,73	0.0	0.0	0.0	0,0,0
201	0.04	0.11	0.05	70,70,73	0.0	0.0	0.0	0,0,0
202	0.04	0.11	0.04	70,70,73	0.0	0.0	0.0	0,0,0
203	0.04	0.12	0.05	70,70,73	0.0	0.0	0.0	0,0,0
204	0.05	0.13	0.05	70,70,73	0.0	0.0	0.0	0,0,0
205	0.05	0.14	0.06	70,70,73	0.0	0.0	0.0	0,0,0
206	0.05	0.14	0.06	70,70,73	0.0	0.0	0.0	0,0,0
207	0.05	0.19	0.05	70,70,73	0.0	0.0	0.0	0,0,0
208	0.05	0.14	0.05	70,70,73	0.0	0.0	0.0	0,0,0
209	0.03	0.10	0.04	70,70,73	0.0	0.0	0.0	0,0,0
210	0.04	0.13	0.05	70,70,73	0.0	0.0	0.0	0,0,0
211	0.05	0.13	0.05	70,70,73	0.0	0.0	0.0	0,0,0
212	0.05	0.13	0.05	70,70,73	0.0	0.0	0.0	0,0,0
213	0.04	0.12	0.05	70,70,73	0.0	0.0	0.0	0,0,0
214	0.04	0.11	0.05	70,70,73	0.0	0.0	0.0	0,0,0
215	0.04	0.11	0.04	70,70,73	0.0	0.0	0.0	0,0,0
216	0.04	0.11	0.05	70,70,73	0.0	0.0	0.0	0,0,0
217	0.04	0.13	0.05	70,70,73	0.0	0.0	0.0	0,0,0
218	0.05	0.13	0.05	70,70,73	0.0	0.0	0.0	0,0,0
219	0.05	0.13	0.05	70,70,73	0.0	0.0	0.0	0,0,0
220	0.04	0.12	0.05	70,70,73	0.0	0.0	0.0	0,0,0
221	0.04	0.09	0.04	70,70,73	0.0	0.0	0.0	0,0,0
222	0.04	0.09	0.04	70,70,73	0.0	0.0	0.0	0,0,0
223	0.04	0.11	0.05	70,70,73	0.0	0.0	0.0	0,0,0
224	0.04	0.12	0.05	70,70,73	0.0	0.0	0.0	0,0,0
225	0.04	0.12	0.05	70,70,73	0.0	0.0	0.0	0,0,0
226	0.04	0.12	0.05	70,70,73	0.0	0.0	0.0	0,0,0
227	0.04	0.11	0.04	70,70,73	0.0	0.0	0.0	0,0,0
228	0.04	0.10	0.04	70,70,73	0.0	0.0	0.0	0,0,0
229	0.04	0.11	0.05	70,70,73	0.0	0.0	0.0	0,0,0
230	0.04	0.12	0.05	70,70,73	0.0	0.0	0.0	0,0,0
231	0.04	0.12	0.05	70,70,73	0.0	0.0	0.0	0,0,0
232	0.04	0.12	0.05	70,70,73	0.0	0.0	0.0	0,0,0
233	0.04	0.11	0.04	70,70,73	0.0	0.0	0.0	0,0,0
234	0.04	0.09	0.04	70,70,73	0.0	0.0	0.0	0,0,0
235	0.04	0.10	0.04	70,70,73	0.0	0.0	0.0	0,0,0
236	0.04	0.13	0.05	70,70,73	0.0	0.0	0.0	0,0,0
237	0.05	0.13	0.05	70,70,73	0.0	0.0	0.0	0,0,0
238	0.05	0.13	0.05	70,70,73	0.0	0.0	0.0	0,0,0
239	0.04	0.12	0.05	70,70,73	0.0	0.0	0.0	0,0,0





EGP CODE

GRE.EEC.R.73.IT.W.15235.12.024.01

PAGE

516 di/of 527

240	0.04	0.11	0.05	70,70,73	0.0	0.0	0.0	0,0,0
241	0.04	0.11	0.04	70,70,73	0.0	0.0	0.0	0,0,0
242	0.04	0.12	0.05	70,70,73	0.0	0.0	0.0	0,0,0
243	0.04	0.13	0.05	70,70,73	0.0	0.0	0.0	0,0,0
244	0.05	0.13	0.05	70,70,73	0.0	0.0	0.0	0,0,0
245	0.05	0.13	0.05	70,70,73	0.0	0.0	0.0	0,0,0
246	0.04	0.12	0.05	70,70,73	0.0	0.0	0.0	0,0,0
247	0.04	0.09	0.04	70,70,73	0.0	0.0	0.0	0,0,0
248	0.04	0.16	0.05	70,70,73	0.0	0.0	0.0	0,0,0
249	0.05	0.18	0.05	70,70,73	0.0	0.0	0.0	0,0,0
250	0.05	0.15	0.06	70,70,73	0.0	0.0	0.0	0,0,0
251	0.05	0.14	0.06	70,70,73	0.0	0.0	0.0	0,0,0
252	0.04	0.13	0.05	70,70,73	0.0	0.0	0.0	0,0,0
253	0.04	0.11	0.05	70,70,73	0.0	0.0	0.0	0,0,0
254	0.04	0.11	0.04	70,70,73	0.0	0.0	0.0	0,0,0
255	0.04	0.12	0.05	70,70,73	0.0	0.0	0.0	0,0,0
256	0.05	0.13	0.05	70,70,73	0.0	0.0	0.0	0,0,0
257	0.05	0.14	0.06	70,70,73	0.0	0.0	0.0	0,0,0
258	0.05	0.15	0.06	70,70,73	0.0	0.0	0.0	0,0,0
259	0.05	0.20	0.05	70,70,73	0.0	0.0	0.0	0,0,0
260	0.04	0.13	0.04	70,70,73	0.0	0.0	0.0	0,0,0
261	0.11	0.33	0.13	70,70,73	0.0	0.0	0.0	0,0,0
262	0.06	0.20	0.06	70,70,73	0.0	0.0	0.0	0,0,0
263	0.05	0.15	0.06	70,70,73	0.0	0.0	0.0	0,0,0
264	0.05	0.15	0.06	70,70,73	0.0	0.0	0.0	0,0,0
265	0.05	0.13	0.05	70,70,73	0.0	0.0	0.0	0,0,0
266	0.04	0.12	0.05	70,70,73	0.0	0.0	0.0	0,0,0
267	0.04	0.11	0.05	70,70,73	0.0	0.0	0.0	0,0,0
268	0.04	0.12	0.05	70,70,73	0.0	0.0	0.0	0,0,0
269	0.05	0.14	0.05	70,70,73	0.0	0.0	0.0	0,0,0
270	0.05	0.15	0.06	70,70,73	0.0	0.0	0.0	0,0,0
271	0.05	0.15	0.06	70,70,73	0.0	0.0	0.0	0,0,0
272	0.05	0.18	0.06	70,70,73	0.0	0.0	0.0	0,0,0
273	0.12	0.34	0.13	70,70,73	0.0	0.0	0.0	0,0,0
274	0.04	0.12	0.05	70,70,73	0.0	0.0	0.0	0,0,0
275	0.04	0.11	0.04	70,70,73	0.0	0.0	0.0	0,0,0
276	0.03	0.10	0.04	70,70,73	0.0	0.0	0.0	0,0,0
277	0.04	0.11	0.04	70,70,73	0.0	0.0	0.0	0,0,0
278	0.04	0.13	0.05	70,70,73	0.0	0.0	0.0	0,0,0
279	0.05	0.14	0.05	70,70,73	0.0	0.0	0.0	0,0,0
280	0.05	0.14	0.05	70,70,73	0.0	0.0	0.0	0,0,0
281	0.05	0.15	0.05	70,70,73	0.0	0.0	0.0	0,0,0
282	0.05	0.21	0.05	70,70,73	0.0	0.0	0.0	0,0,0
283	0.07	0.12	0.07	70,70,73	0.0	0.0	0.0	0,0,0
284	0.05	0.22	0.05	70,70,73	0.0	0.0	0.0	0,0,0
285	0.05	0.14	0.05	70,70,73	0.0	0.0	0.0	0,0,0
286	0.05	0.14	0.05	70,70,73	0.0	0.0	0.0	0,0,0
287	0.12	0.37	0.14	70,70,73	0.0	0.0	0.0	0,0,0
288	0.06	0.25	0.06	70,70,73	0.0	0.0	0.0	0,0,0
289	0.05	0.15	0.06	70,70,73	0.0	0.0	0.0	0,0,0
290	0.05	0.15	0.06	70,70,73	0.0	0.0	0.0	0,0,0
291	0.05	0.13	0.05	70,70,73	0.0	0.0	0.0	0,0,0
292	0.04	0.12	0.05	70,70,73	0.0	0.0	0.0	0,0,0
293	0.04	0.11	0.04	70,70,73	0.0	0.0	0.0	0,0,0
294	0.04	0.12	0.05	70,70,73	0.0	0.0	0.0	0,0,0
295	0.05	0.14	0.05	70,70,73	0.0	0.0	0.0	0,0,0
296	0.05	0.15	0.06	70,70,73	0.0	0.0	0.0	0,0,0
297	0.05	0.15	0.06	70,70,73	0.0	0.0	0.0	0,0,0
298	0.06	0.26	0.06	70,70,73	0.0	0.0	0.0	0,0,0
299	0.13	0.38	0.14	70,70,73	0.0	0.0	0.0	0,0,0
300	0.05	0.17	0.05	70,70,73	0.0	0.0	0.0	0,0,0
301	0.05	0.18	0.06	70,70,73	0.0	0.0	0.0	0,0,0
302	0.05	0.15	0.06	70,70,73	0.0	0.0	0.0	0,0,0
303	0.05	0.14	0.06	70,70,73	0.0	0.0	0.0	0,0,0
304	0.04	0.13	0.05	70,70,73	0.0	0.0	0.0	0,0,0
305	0.04	0.12	0.05	70,70,73	0.0	0.0	0.0	0,0,0
306	0.04	0.11	0.04	70,70,73	0.0	0.0	0.0	0,0,0
307	0.04	0.12	0.05	70,70,73	0.0	0.0	0.0	0,0,0
308	0.05	0.13	0.05	70,70,73	0.0	0.0	0.0	0,0,0
309	0.05	0.15	0.06	70,70,73	0.0	0.0	0.0	0,0,0
310	0.05	0.15	0.06	70,70,73	0.0	0.0	0.0	0,0,0
311	0.05	0.20	0.05	70,70,73	0.0	0.0	0.0	0,0,0
312	0.07	0.16	0.07	70,70,73	0.0	0.0	0.0	0,0,0
313	0.03	0.10	0.04	70,70,73	0.0	0.0	0.0	0,0,0
314	0.05	0.13	0.05	70,70,73	0.0	0.0	0.0	0,0,0
315	0.05	0.14	0.05	70,70,73	0.0	0.0	0.0	0,0,0



EGP CODE

GRE.EEC.R.73.IT.W.15235.12.024.01

PAGE

517 di/of 527

316	0.05	0.13	0.05	70,70,73	0.0	0.0	0.0	0,0,0
317	0.04	0.12	0.05	70,70,73	0.0	0.0	0.0	0,0,0
318	0.04	0.11	0.05	70,70,73	0.0	0.0	0.0	0,0,0
319	0.04	0.11	0.04	70,70,73	0.0	0.0	0.0	0,0,0
320	0.04	0.12	0.05	70,70,73	0.0	0.0	0.0	0,0,0
321	0.05	0.13	0.05	70,70,73	0.0	0.0	0.0	0,0,0
322	0.05	0.14	0.05	70,70,73	0.0	0.0	0.0	0,0,0
323	0.05	0.14	0.05	70,70,73	0.0	0.0	0.0	0,0,0
324	0.04	0.13	0.05	70,70,73	0.0	0.0	0.0	0,0,0
325	0.03	0.10	0.04	70,70,73	0.0	0.0	0.0	0,0,0
326	0.04	0.09	0.04	70,70,73	0.0	0.0	0.0	0,0,0
327	0.04	0.12	0.05	70,70,73	0.0	0.0	0.0	0,0,0
328	0.04	0.13	0.05	70,70,73	0.0	0.0	0.0	0,0,0
329	0.04	0.12	0.05	70,70,73	0.0	0.0	0.0	0,0,0
330	0.04	0.12	0.05	70,70,73	0.0	0.0	0.0	0,0,0
331	0.04	0.11	0.05	70,70,73	0.0	0.0	0.0	0,0,0
332	0.04	0.11	0.04	70,70,73	0.0	0.0	0.0	0,0,0
333	0.04	0.11	0.05	70,70,73	0.0	0.0	0.0	0,0,0
334	0.04	0.12	0.05	70,70,73	0.0	0.0	0.0	0,0,0
335	0.04	0.13	0.05	70,70,73	0.0	0.0	0.0	0,0,0
336	0.04	0.13	0.05	70,70,73	0.0	0.0	0.0	0,0,0
337	0.04	0.11	0.04	70,70,73	0.0	0.0	0.0	0,0,0
338	0.04	0.09	0.04	70,70,73	0.0	0.0	0.0	0,0,0
339	0.04	0.10	0.04	70,70,73	0.0	0.0	0.0	0,0,0
340	0.04	0.13	0.05	70,70,73	0.0	0.0	0.0	0,0,0
341	0.05	0.13	0.05	70,70,73	0.0	0.0	0.0	0,0,0
342	0.05	0.13	0.05	70,70,73	0.0	0.0	0.0	0,0,0
343	0.04	0.12	0.05	70,70,73	0.0	0.0	0.0	0,0,0
344	0.04	0.11	0.05	70,70,73	0.0	0.0	0.0	0,0,0
345	0.04	0.11	0.04	70,70,73	0.0	0.0	0.0	0,0,0
346	0.04	0.12	0.05	70,70,73	0.0	0.0	0.0	0,0,0
347	0.05	0.13	0.05	70,70,73	0.0	0.0	0.0	0,0,0
348	0.05	0.13	0.05	70,70,73	0.0	0.0	0.0	0,0,0
349	0.05	0.13	0.05	70,70,73	0.0	0.0	0.0	0,0,0
350	0.04	0.12	0.05	70,70,73	0.0	0.0	0.0	0,0,0
351	0.04	0.09	0.04	70,70,73	0.0	0.0	0.0	0,0,0
352	0.04	0.11	0.04	70,70,73	0.0	0.0	0.0	0,0,0
353	0.05	0.14	0.06	70,70,73	0.0	0.0	0.0	0,0,0
354	0.05	0.14	0.06	70,70,73	0.0	0.0	0.0	0,0,0
355	0.05	0.14	0.06	70,70,73	0.0	0.0	0.0	0,0,0
356	0.04	0.13	0.05	70,70,73	0.0	0.0	0.0	0,0,0
357	0.04	0.12	0.05	70,70,73	0.0	0.0	0.0	0,0,0
358	0.04	0.11	0.05	70,70,73	0.0	0.0	0.0	0,0,0
359	0.04	0.12	0.05	70,70,73	0.0	0.0	0.0	0,0,0
360	0.05	0.14	0.05	70,70,73	0.0	0.0	0.0	0,0,0
361	0.05	0.14	0.06	70,70,73	0.0	0.0	0.0	0,0,0
362	0.05	0.15	0.06	70,70,73	0.0	0.0	0.0	0,0,0
363	0.05	0.14	0.05	70,70,73	0.0	0.0	0.0	0,0,0
364	0.04	0.11	0.04	70,70,73	0.0	0.0	0.0	0,0,0
365	0.07	0.20	0.07	70,70,73	0.0	0.0	0.0	0,0,0
366	0.05	0.17	0.06	70,70,73	0.0	0.0	0.0	0,0,0
367	0.05	0.16	0.06	70,70,73	0.0	0.0	0.0	0,0,0
368	0.05	0.15	0.06	70,70,73	0.0	0.0	0.0	0,0,0
369	0.05	0.13	0.05	70,70,73	0.0	0.0	0.0	0,0,0
370	0.04	0.12	0.05	70,70,73	0.0	0.0	0.0	0,0,0
371	0.04	0.11	0.05	70,70,73	0.0	0.0	0.0	0,0,0
372	0.04	0.12	0.05	70,70,73	0.0	0.0	0.0	0,0,0
373	0.05	0.14	0.05	70,70,73	0.0	0.0	0.0	0,0,0
374	0.05	0.16	0.06	70,70,73	0.0	0.0	0.0	0,0,0
375	0.05	0.17	0.06	70,70,73	0.0	0.0	0.0	0,0,0
376	0.07	0.18	0.08	70,70,73	0.0	0.0	0.0	0,0,0
377	0.10	0.20	0.11	70,70,73	0.0	0.0	0.0	0,0,0
378	0.15	0.42	0.16	70,70,73	0.0	0.0	0.0	0,0,0
379	0.06	0.29	0.07	70,70,73	0.0	0.0	0.0	0,0,0
380	0.05	0.16	0.06	70,70,73	0.0	0.0	0.0	0,0,0
381	0.05	0.15	0.06	70,70,73	0.0	0.0	0.0	0,0,0
382	0.05	0.13	0.05	70,70,73	0.0	0.0	0.0	0,0,0
383	0.04	0.12	0.05	70,70,73	0.0	0.0	0.0	0,0,0
384	0.04	0.11	0.04	70,70,73	0.0	0.0	0.0	0,0,0
385	0.04	0.12	0.05	70,70,73	0.0	0.0	0.0	0,0,0
386	0.05	0.14	0.05	70,70,73	0.0	0.0	0.0	0,0,0
387	0.05	0.16	0.06	70,70,73	0.0	0.0	0.0	0,0,0
388	0.05	0.16	0.06	70,70,73	0.0	0.0	0.0	0,0,0
389	0.06	0.34	0.06	70,70,73	0.0	0.0	0.0	0,0,0
390	0.15	0.36	0.16	70,70,73	0.0	0.0	0.0	0,0,0
391	0.16	0.44	0.17	70,70,73	0.0	0.0	0.0	0,0,0



EGP CODE

GRE.EEC.R.73.IT.W.15235.12.024.01

PAGE

518 di/of 527

392	0.06	0.27	0.07	70,70,73	0.0	0.0	0.0	0,0,0
393	0.05	0.17	0.06	70,70,73	0.0	0.0	0.0	0,0,0
394	0.05	0.15	0.06	70,70,73	0.0	0.0	0.0	0,0,0
395	0.05	0.13	0.05	70,70,73	0.0	0.0	0.0	0,0,0
396	0.04	0.12	0.05	70,70,73	0.0	0.0	0.0	0,0,0
397	0.04	0.11	0.04	70,70,73	0.0	0.0	0.0	0,0,0
398	0.04	0.12	0.05	70,70,73	0.0	0.0	0.0	0,0,0
399	0.05	0.14	0.05	70,70,73	0.0	0.0	0.0	0,0,0
400	0.05	0.16	0.06	70,70,73	0.0	0.0	0.0	0,0,0
401	0.05	0.17	0.06	70,70,73	0.0	0.0	0.0	0,0,0
402	0.06	0.30	0.07	70,70,73	0.0	0.0	0.0	0,0,0
403	0.15	0.37	0.16	70,70,73	0.0	0.0	0.0	0,0,0
404	0.06	0.20	0.07	70,70,73	0.0	0.0	0.0	0,0,0
405	0.05	0.19	0.06	70,70,73	0.0	0.0	0.0	0,0,0
406	0.05	0.17	0.06	70,70,73	0.0	0.0	0.0	0,0,0
407	0.05	0.15	0.06	70,70,73	0.0	0.0	0.0	0,0,0
408	0.04	0.13	0.05	70,70,73	0.0	0.0	0.0	0,0,0
409	0.04	0.12	0.05	70,70,73	0.0	0.0	0.0	0,0,0
410	0.04	0.11	0.04	70,70,73	0.0	0.0	0.0	0,0,0
411	0.04	0.12	0.05	70,70,73	0.0	0.0	0.0	0,0,0
412	0.05	0.14	0.05	70,70,73	0.0	0.0	0.0	0,0,0
413	0.05	0.16	0.06	70,70,73	0.0	0.0	0.0	0,0,0
414	0.05	0.17	0.06	70,70,73	0.0	0.0	0.0	0,0,0
415	0.06	0.21	0.06	70,70,73	0.0	0.0	0.0	0,0,0
416	0.10	0.17	0.10	70,70,73	0.0	0.0	0.0	0,0,0
417	0.04	0.13	0.05	70,70,73	0.0	0.0	0.0	0,0,0
418	0.05	0.14	0.06	70,70,73	0.0	0.0	0.0	0,0,0
419	0.05	0.14	0.05	70,70,73	0.0	0.0	0.0	0,0,0
420	0.05	0.14	0.05	70,70,73	0.0	0.0	0.0	0,0,0
421	0.04	0.12	0.05	70,70,73	0.0	0.0	0.0	0,0,0
422	0.04	0.11	0.04	70,70,73	0.0	0.0	0.0	0,0,0
423	0.04	0.11	0.04	70,70,73	0.0	0.0	0.0	0,0,0
424	0.04	0.12	0.05	70,70,73	0.0	0.0	0.0	0,0,0
425	0.04	0.13	0.05	70,70,73	0.0	0.0	0.0	0,0,0
426	0.05	0.14	0.06	70,70,73	0.0	0.0	0.0	0,0,0
427	0.05	0.15	0.06	70,70,73	0.0	0.0	0.0	0,0,0
428	0.05	0.14	0.05	70,70,73	0.0	0.0	0.0	0,0,0
429	0.04	0.12	0.05	70,70,73	0.0	0.0	0.0	0,0,0
430	0.04	0.12	0.05	70,70,73	0.0	0.0	0.0	0,0,0
431	0.05	0.13	0.05	70,70,73	0.0	0.0	0.0	0,0,0
432	0.04	0.13	0.05	70,70,73	0.0	0.0	0.0	0,0,0
433	0.04	0.12	0.05	70,70,73	0.0	0.0	0.0	0,0,0
434	0.04	0.11	0.05	70,70,73	0.0	0.0	0.0	0,0,0
435	0.04	0.10	0.04	70,70,73	0.0	0.0	0.0	0,0,0
436	0.03	0.10	0.04	70,70,73	0.0	0.0	0.0	0,0,0
437	0.04	0.11	0.04	70,70,73	0.0	0.0	0.0	0,0,0
438	0.04	0.12	0.05	70,70,73	0.0	0.0	0.0	0,0,0
439	0.04	0.13	0.05	70,70,73	0.0	0.0	0.0	0,0,0
440	0.05	0.13	0.05	70,70,73	0.0	0.0	0.0	0,0,0
441	0.04	0.13	0.05	70,70,73	0.0	0.0	0.0	0,0,0
442	0.04	0.11	0.05	70,70,73	0.0	0.0	0.0	0,0,0
443	0.04	0.11	0.05	70,70,73	0.0	0.0	0.0	0,0,0
444	0.04	0.11	0.04	70,70,73	0.0	0.0	0.0	0,0,0
445	0.04	0.11	0.05	70,70,73	0.0	0.0	0.0	0,0,0
446	0.04	0.11	0.05	70,70,73	0.0	0.0	0.0	0,0,0
447	0.04	0.10	0.04	70,70,73	0.0	0.0	0.0	0,0,0
448	0.03	0.10	0.04	70,70,73	0.0	0.0	0.0	0,0,0
449	0.03	0.09	0.04	70,70,73	0.0	0.0	0.0	0,0,0
450	0.04	0.10	0.04	70,70,73	0.0	0.0	0.0	0,0,0
451	0.04	0.11	0.04	70,70,73	0.0	0.0	0.0	0,0,0
452	0.04	0.11	0.05	70,70,73	0.0	0.0	0.0	0,0,0
453	0.04	0.11	0.05	70,70,73	0.0	0.0	0.0	0,0,0
454	0.04	0.11	0.04	70,70,73	0.0	0.0	0.0	0,0,0
455	0.04	0.11	0.05	70,70,73	0.0	0.0	0.0	0,0,0
456	0.04	0.11	0.05	70,70,73	0.0	0.0	0.0	0,0,0
457	0.04	0.11	0.04	70,70,73	0.0	0.0	0.0	0,0,0
458	0.04	0.11	0.05	70,70,73	0.0	0.0	0.0	0,0,0
459	0.04	0.11	0.05	70,70,73	0.0	0.0	0.0	0,0,0
460	0.04	0.10	0.04	70,70,73	0.0	0.0	0.0	0,0,0
461	0.03	0.10	0.04	70,70,73	0.0	0.0	0.0	0,0,0
462	0.03	0.09	0.04	70,70,73	0.0	0.0	0.0	0,0,0
463	0.04	0.10	0.04	70,70,73	0.0	0.0	0.0	0,0,0
464	0.04	0.11	0.04	70,70,73	0.0	0.0	0.0	0,0,0
465	0.04	0.11	0.05	70,70,73	0.0	0.0	0.0	0,0,0
466	0.04	0.11	0.05	70,70,73	0.0	0.0	0.0	0,0,0
467	0.04	0.11	0.04	70,70,73	0.0	0.0	0.0	0,0,0



EGP CODE

GRE.EEC.R.73.IT.W.15235.12.024.01

PAGE

519 di/of 527

468	0.04	0.11	0.05	70,70,73	0.0	0.0	0.0	0,0,0
469	0.04	0.12	0.05	70,70,73	0.0	0.0	0.0	0,0,0
470	0.04	0.13	0.05	70,70,73	0.0	0.0	0.0	0,0,0
471	0.04	0.12	0.05	70,70,73	0.0	0.0	0.0	0,0,0
472	0.04	0.12	0.05	70,70,73	0.0	0.0	0.0	0,0,0
473	0.04	0.11	0.05	70,70,73	0.0	0.0	0.0	0,0,0
474	0.04	0.10	0.04	70,70,73	0.0	0.0	0.0	0,0,0
475	0.04	0.10	0.04	70,70,73	0.0	0.0	0.0	0,0,0
476	0.04	0.11	0.04	70,70,73	0.0	0.0	0.0	0,0,0
477	0.04	0.12	0.05	70,70,73	0.0	0.0	0.0	0,0,0
478	0.04	0.13	0.05	70,70,73	0.0	0.0	0.0	0,0,0
479	0.05	0.13	0.05	70,70,73	0.0	0.0	0.0	0,0,0
480	0.04	0.13	0.05	70,70,73	0.0	0.0	0.0	0,0,0
481	0.04	0.11	0.05	70,70,73	0.0	0.0	0.0	0,0,0
482	0.04	0.13	0.05	70,70,73	0.0	0.0	0.0	0,0,0
483	0.05	0.14	0.05	70,70,73	0.0	0.0	0.0	0,0,0
484	0.05	0.14	0.06	70,70,73	0.0	0.0	0.0	0,0,0
485	0.05	0.14	0.05	70,70,73	0.0	0.0	0.0	0,0,0
486	0.04	0.12	0.05	70,70,73	0.0	0.0	0.0	0,0,0
487	0.04	0.11	0.04	70,70,73	0.0	0.0	0.0	0,0,0
488	0.04	0.11	0.04	70,70,73	0.0	0.0	0.0	0,0,0
489	0.04	0.12	0.05	70,70,73	0.0	0.0	0.0	0,0,0
490	0.05	0.13	0.05	70,70,73	0.0	0.0	0.0	0,0,0
491	0.05	0.14	0.06	70,70,73	0.0	0.0	0.0	0,0,0
492	0.05	0.15	0.06	70,70,73	0.0	0.0	0.0	0,0,0
493	0.05	0.14	0.05	70,70,73	0.0	0.0	0.0	0,0,0
494	0.04	0.12	0.05	70,70,73	0.0	0.0	0.0	0,0,0
495	0.08	0.21	0.09	70,70,73	0.0	0.0	0.0	0,0,0
496	0.05	0.21	0.06	70,70,73	0.0	0.0	0.0	0,0,0
497	0.05	0.16	0.06	70,70,73	0.0	0.0	0.0	0,0,0
498	0.05	0.15	0.06	70,70,73	0.0	0.0	0.0	0,0,0
499	0.05	0.13	0.05	70,70,73	0.0	0.0	0.0	0,0,0
500	0.04	0.12	0.05	70,70,73	0.0	0.0	0.0	0,0,0
501	0.04	0.11	0.04	70,70,73	0.0	0.0	0.0	0,0,0
502	0.04	0.12	0.05	70,70,73	0.0	0.0	0.0	0,0,0
503	0.05	0.14	0.05	70,70,73	0.0	0.0	0.0	0,0,0
504	0.05	0.15	0.06	70,70,73	0.0	0.0	0.0	0,0,0
505	0.05	0.16	0.06	70,70,73	0.0	0.0	0.0	0,0,0
506	0.06	0.25	0.07	70,70,73	0.0	0.0	0.0	0,0,0
507	0.11	0.19	0.11	70,70,73	0.0	0.0	0.0	0,0,0
508	0.17	0.51	0.18	70,70,73	0.0	0.0	0.0	0,0,0
509	0.06	0.32	0.07	70,70,73	0.0	0.0	0.0	0,0,0
510	0.05	0.16	0.06	70,70,73	0.0	0.0	0.0	0,0,0
511	0.05	0.15	0.06	70,70,73	0.0	0.0	0.0	0,0,0
512	0.05	0.14	0.05	70,70,73	0.0	0.0	0.0	0,0,0
513	0.04	0.12	0.05	70,70,73	0.0	0.0	0.0	0,0,0
514	0.04	0.11	0.04	70,70,73	0.0	0.0	0.0	0,0,0
515	0.04	0.12	0.05	70,70,73	0.0	0.0	0.0	0,0,0
516	0.05	0.14	0.06	70,70,73	0.0	0.0	0.0	0,0,0
517	0.05	0.16	0.06	70,70,73	0.0	0.0	0.0	0,0,0
518	0.05	0.16	0.06	70,70,73	0.0	0.0	0.0	0,0,0
519	0.07	0.34	0.08	70,70,73	0.0	0.0	0.0	0,0,0
520	0.17	0.49	0.19	70,70,73	0.0	0.0	0.0	0,0,0
521	0.04	0.13	0.05	70,70,73	0.0	0.0	0.0	0,0,0
522	0.05	0.22	0.05	70,70,73	0.0	0.0	0.0	0,0,0
523	0.04	0.13	0.05	70,70,73	0.0	0.0	0.0	0,0,0
524	0.04	0.13	0.05	70,70,73	0.0	0.0	0.0	0,0,0
525	0.04	0.12	0.05	70,70,73	0.0	0.0	0.0	0,0,0
526	0.04	0.10	0.04	70,70,73	0.0	0.0	0.0	0,0,0
527	0.03	0.10	0.04	70,70,73	0.0	0.0	0.0	0,0,0
528	0.04	0.11	0.04	70,70,73	0.0	0.0	0.0	0,0,0
529	0.04	0.12	0.05	70,70,73	0.0	0.0	0.0	0,0,0
530	0.04	0.13	0.05	70,70,73	0.0	0.0	0.0	0,0,0
531	0.04	0.13	0.05	70,70,73	0.0	0.0	0.0	0,0,0
532	0.04	0.21	0.05	70,70,73	0.0	0.0	0.0	0,0,0
533	0.05	0.14	0.05	70,70,73	0.0	0.0	0.0	0,0,0
534	0.16	0.45	0.17	70,70,73	0.0	0.0	0.0	0,0,0
535	0.06	0.24	0.07	70,70,73	0.0	0.0	0.0	0,0,0
536	0.05	0.16	0.06	70,70,73	0.0	0.0	0.0	0,0,0
537	0.05	0.15	0.06	70,70,73	0.0	0.0	0.0	0,0,0
538	0.05	0.14	0.05	70,70,73	0.0	0.0	0.0	0,0,0
539	0.04	0.12	0.05	70,70,73	0.0	0.0	0.0	0,0,0
540	0.04	0.11	0.04	70,70,73	0.0	0.0	0.0	0,0,0
541	0.04	0.12	0.05	70,70,73	0.0	0.0	0.0	0,0,0
542	0.05	0.14	0.06	70,70,73	0.0	0.0	0.0	0,0,0
543	0.05	0.16	0.06	70,70,73	0.0	0.0	0.0	0,0,0



EGP CODE

GRE.EEC.R.73.IT.W.15235.12.024.01

PAGE

520 di/of 527

544	0.05	0.16	0.06	70,70,73	0.0	0.0	0.0	0,0,0
545	0.08	0.26	0.09	70,70,73	0.0	0.0	0.0	0,0,0
546	0.16	0.46	0.17	70,70,73	0.0	0.0	0.0	0,0,0
547	0.06	0.18	0.06	70,70,73	0.0	0.0	0.0	0,0,0
548	0.05	0.22	0.06	70,70,73	0.0	0.0	0.0	0,0,0
549	0.05	0.16	0.06	70,70,73	0.0	0.0	0.0	0,0,0
550	0.05	0.15	0.06	70,70,73	0.0	0.0	0.0	0,0,0
551	0.04	0.13	0.05	70,70,73	0.0	0.0	0.0	0,0,0
552	0.04	0.12	0.05	70,70,73	0.0	0.0	0.0	0,0,0
553	0.04	0.11	0.04	70,70,73	0.0	0.0	0.0	0,0,0
554	0.04	0.12	0.05	70,70,73	0.0	0.0	0.0	0,0,0
555	0.05	0.14	0.05	70,70,73	0.0	0.0	0.0	0,0,0
556	0.05	0.15	0.06	70,70,73	0.0	0.0	0.0	0,0,0
557	0.05	0.16	0.06	70,70,73	0.0	0.0	0.0	0,0,0
558	0.05	0.25	0.06	70,70,73	0.0	0.0	0.0	0,0,0
559	0.07	0.16	0.08	70,70,73	0.0	0.0	0.0	0,0,0
560	0.04	0.12	0.05	70,70,73	0.0	0.0	0.0	0,0,0
561	0.05	0.14	0.05	70,70,73	0.0	0.0	0.0	0,0,0
562	0.05	0.14	0.05	70,70,73	0.0	0.0	0.0	0,0,0
563	0.05	0.13	0.05	70,70,73	0.0	0.0	0.0	0,0,0
564	0.04	0.12	0.05	70,70,73	0.0	0.0	0.0	0,0,0
565	0.04	0.11	0.04	70,70,73	0.0	0.0	0.0	0,0,0
566	0.04	0.10	0.04	70,70,73	0.0	0.0	0.0	0,0,0
567	0.04	0.11	0.05	70,70,73	0.0	0.0	0.0	0,0,0
568	0.04	0.13	0.05	70,70,73	0.0	0.0	0.0	0,0,0
569	0.05	0.14	0.05	70,70,73	0.0	0.0	0.0	0,0,0
570	0.05	0.14	0.05	70,70,73	0.0	0.0	0.0	0,0,0
571	0.05	0.14	0.05	70,70,73	0.0	0.0	0.0	0,0,0
572	0.04	0.12	0.05	70,70,73	0.0	0.0	0.0	0,0,0
573	0.04	0.11	0.05	70,70,73	0.0	0.0	0.0	0,0,0
574	0.04	0.12	0.05	70,70,73	0.0	0.0	0.0	0,0,0
575	0.04	0.12	0.05	70,70,73	0.0	0.0	0.0	0,0,0
576	0.04	0.12	0.05	70,70,73	0.0	0.0	0.0	0,0,0
577	0.04	0.11	0.05	70,70,73	0.0	0.0	0.0	0,0,0
578	0.04	0.10	0.04	70,70,73	0.0	0.0	0.0	0,0,0
579	0.03	0.10	0.04	70,70,73	0.0	0.0	0.0	0,0,0
580	0.04	0.11	0.04	70,70,73	0.0	0.0	0.0	0,0,0
581	0.04	0.12	0.05	70,70,73	0.0	0.0	0.0	0,0,0
582	0.04	0.12	0.05	70,70,73	0.0	0.0	0.0	0,0,0
583	0.04	0.12	0.05	70,70,73	0.0	0.0	0.0	0,0,0
584	0.04	0.12	0.05	70,70,73	0.0	0.0	0.0	0,0,0
585	0.04	0.11	0.05	70,70,73	0.0	0.0	0.0	0,0,0
586	0.04	0.11	0.05	70,70,73	0.0	0.0	0.0	0,0,0
587	0.04	0.10	0.04	70,70,73	0.0	0.0	0.0	0,0,0
588	0.04	0.11	0.05	70,70,73	0.0	0.0	0.0	0,0,0
589	0.04	0.11	0.04	70,70,73	0.0	0.0	0.0	0,0,0
590	0.04	0.10	0.04	70,70,73	0.0	0.0	0.0	0,0,0
591	0.03	0.10	0.04	70,70,73	0.0	0.0	0.0	0,0,0
592	0.03	0.09	0.04	70,70,73	0.0	0.0	0.0	0,0,0
593	0.04	0.10	0.04	70,70,73	0.0	0.0	0.0	0,0,0
594	0.04	0.11	0.04	70,70,73	0.0	0.0	0.0	0,0,0
595	0.04	0.11	0.04	70,70,73	0.0	0.0	0.0	0,0,0
596	0.04	0.11	0.05	70,70,73	0.0	0.0	0.0	0,0,0
597	0.04	0.10	0.04	70,70,73	0.0	0.0	0.0	0,0,0
598	0.04	0.11	0.05	70,70,73	0.0	0.0	0.0	0,0,0
599	0.04	0.11	0.05	70,70,73	0.0	0.0	0.0	0,0,0
600	0.04	0.12	0.05	70,70,73	0.0	0.0	0.0	0,0,0
601	0.04	0.12	0.05	70,70,73	0.0	0.0	0.0	0,0,0
602	0.04	0.12	0.05	70,70,73	0.0	0.0	0.0	0,0,0
603	0.04	0.11	0.05	70,70,73	0.0	0.0	0.0	0,0,0
604	0.04	0.10	0.04	70,70,73	0.0	0.0	0.0	0,0,0
605	0.03	0.10	0.04	70,70,73	0.0	0.0	0.0	0,0,0
606	0.04	0.10	0.04	70,70,73	0.0	0.0	0.0	0,0,0
607	0.04	0.11	0.05	70,70,73	0.0	0.0	0.0	0,0,0
608	0.04	0.12	0.05	70,70,73	0.0	0.0	0.0	0,0,0
609	0.04	0.12	0.05	70,70,73	0.0	0.0	0.0	0,0,0
610	0.04	0.12	0.05	70,70,73	0.0	0.0	0.0	0,0,0
611	0.04	0.11	0.05	70,70,73	0.0	0.0	0.0	0,0,0
612	0.04	0.12	0.04	70,70,73	0.0	0.0	0.0	0,0,0
613	0.05	0.13	0.05	70,70,73	0.0	0.0	0.0	0,0,0
614	0.05	0.14	0.05	70,70,73	0.0	0.0	0.0	0,0,0
615	0.05	0.13	0.05	70,70,73	0.0	0.0	0.0	0,0,0
616	0.04	0.12	0.05	70,70,73	0.0	0.0	0.0	0,0,0
617	0.04	0.11	0.04	70,70,73	0.0	0.0	0.0	0,0,0
618	0.04	0.10	0.04	70,70,73	0.0	0.0	0.0	0,0,0
619	0.04	0.11	0.05	70,70,73	0.0	0.0	0.0	0,0,0





EGP CODE

GRE.EEC.R.73.IT.W.15235.12.024.01

PAGE

521 di/of 527

620	0.04	0.13	0.05	70,70,73	0.0	0.0	0.0	0,0,0
621	0.05	0.14	0.05	70,70,73	0.0	0.0	0.0	0,0,0
622	0.05	0.14	0.05	70,70,73	0.0	0.0	0.0	0,0,0
623	0.05	0.13	0.05	70,70,73	0.0	0.0	0.0	0,0,0
624	0.04	0.11	0.04	70,70,73	0.0	0.0	0.0	0,0,0
625	0.06	0.18	0.06	70,70,73	0.0	0.0	0.0	0,0,0
626	0.05	0.21	0.06	70,70,73	0.0	0.0	0.0	0,0,0
627	0.05	0.16	0.06	70,70,73	0.0	0.0	0.0	0,0,0
628	0.05	0.15	0.06	70,70,73	0.0	0.0	0.0	0,0,0
629	0.04	0.13	0.05	70,70,73	0.0	0.0	0.0	0,0,0
630	0.04	0.11	0.05	70,70,73	0.0	0.0	0.0	0,0,0
631	0.04	0.11	0.04	70,70,73	0.0	0.0	0.0	0,0,0
632	0.04	0.12	0.05	70,70,73	0.0	0.0	0.0	0,0,0
633	0.05	0.14	0.05	70,70,73	0.0	0.0	0.0	0,0,0
634	0.05	0.15	0.06	70,70,73	0.0	0.0	0.0	0,0,0
635	0.05	0.16	0.06	70,70,73	0.0	0.0	0.0	0,0,0
636	0.05	0.24	0.05	70,70,73	0.0	0.0	0.0	0,0,0
637	0.07	0.16	0.07	70,70,73	0.0	0.0	0.0	0,0,0
638	0.15	0.43	0.16	70,70,73	0.0	0.0	0.0	0,0,0
639	0.06	0.23	0.07	70,70,73	0.0	0.0	0.0	0,0,0
640	0.05	0.16	0.06	70,70,73	0.0	0.0	0.0	0,0,0
641	0.05	0.15	0.06	70,70,73	0.0	0.0	0.0	0,0,0
642	0.05	0.13	0.05	70,70,73	0.0	0.0	0.0	0,0,0
643	0.04	0.12	0.05	70,70,73	0.0	0.0	0.0	0,0,0
644	0.04	0.11	0.04	70,70,73	0.0	0.0	0.0	0,0,0
645	0.04	0.12	0.05	70,70,73	0.0	0.0	0.0	0,0,0
646	0.05	0.14	0.05	70,70,73	0.0	0.0	0.0	0,0,0
647	0.05	0.15	0.06	70,70,73	0.0	0.0	0.0	0,0,0
648	0.05	0.16	0.06	70,70,73	0.0	0.0	0.0	0,0,0
649	0.07	0.24	0.08	70,70,73	0.0	0.0	0.0	0,0,0
650	0.15	0.40	0.16	70,70,73	0.0	0.0	0.0	0,0,0
651	0.05	0.14	0.05	70,70,73	0.0	0.0	0.0	0,0,0
652	0.05	0.21	0.06	70,70,73	0.0	0.0	0.0	0,0,0
653	0.05	0.15	0.05	70,70,73	0.0	0.0	0.0	0,0,0
654	0.05	0.14	0.05	70,70,73	0.0	0.0	0.0	0,0,0
655	0.04	0.13	0.05	70,70,73	0.0	0.0	0.0	0,0,0
656	0.04	0.11	0.04	70,70,73	0.0	0.0	0.0	0,0,0
657	0.04	0.11	0.04	70,70,73	0.0	0.0	0.0	0,0,0
658	0.04	0.12	0.05	70,70,73	0.0	0.0	0.0	0,0,0
659	0.04	0.13	0.05	70,70,73	0.0	0.0	0.0	0,0,0
660	0.05	0.14	0.05	70,70,73	0.0	0.0	0.0	0,0,0
661	0.05	0.15	0.05	70,70,73	0.0	0.0	0.0	0,0,0
662	0.05	0.18	0.05	70,70,73	0.0	0.0	0.0	0,0,0
663	0.05	0.15	0.06	70,70,73	0.0	0.0	0.0	0,0,0
664	0.16	0.48	0.17	70,70,73	0.0	0.0	0.0	0,0,0
665	0.06	0.30	0.07	70,70,73	0.0	0.0	0.0	0,0,0
666	0.05	0.15	0.06	70,70,73	0.0	0.0	0.0	0,0,0
667	0.05	0.15	0.06	70,70,73	0.0	0.0	0.0	0,0,0
668	0.05	0.13	0.05	70,70,73	0.0	0.0	0.0	0,0,0
669	0.04	0.12	0.05	70,70,73	0.0	0.0	0.0	0,0,0
670	0.04	0.11	0.04	70,70,73	0.0	0.0	0.0	0,0,0
671	0.04	0.12	0.05	70,70,73	0.0	0.0	0.0	0,0,0
672	0.05	0.14	0.05	70,70,73	0.0	0.0	0.0	0,0,0
673	0.05	0.15	0.06	70,70,73	0.0	0.0	0.0	0,0,0
674	0.05	0.16	0.06	70,70,73	0.0	0.0	0.0	0,0,0
675	0.07	0.32	0.08	70,70,73	0.0	0.0	0.0	0,0,0
676	0.16	0.42	0.17	70,70,73	0.0	0.0	0.0	0,0,0
677	0.07	0.20	0.08	70,70,73	0.0	0.0	0.0	0,0,0
678	0.05	0.20	0.06	70,70,73	0.0	0.0	0.0	0,0,0
679	0.05	0.16	0.06	70,70,73	0.0	0.0	0.0	0,0,0
680	0.05	0.15	0.06	70,70,73	0.0	0.0	0.0	0,0,0
681	0.05	0.13	0.05	70,70,73	0.0	0.0	0.0	0,0,0
682	0.04	0.12	0.05	70,70,73	0.0	0.0	0.0	0,0,0
683	0.04	0.11	0.04	70,70,73	0.0	0.0	0.0	0,0,0
684	0.04	0.12	0.05	70,70,73	0.0	0.0	0.0	0,0,0
685	0.05	0.14	0.05	70,70,73	0.0	0.0	0.0	0,0,0
686	0.05	0.15	0.06	70,70,73	0.0	0.0	0.0	0,0,0
687	0.05	0.16	0.06	70,70,73	0.0	0.0	0.0	0,0,0
688	0.06	0.24	0.06	70,70,73	0.0	0.0	0.0	0,0,0
689	0.10	0.18	0.10	70,70,73	0.0	0.0	0.0	0,0,0
690	0.04	0.12	0.04	70,70,73	0.0	0.0	0.0	0,0,0
691	0.05	0.13	0.05	70,70,73	0.0	0.0	0.0	0,0,0
692	0.05	0.14	0.05	70,70,73	0.0	0.0	0.0	0,0,0
693	0.05	0.14	0.05	70,70,73	0.0	0.0	0.0	0,0,0
694	0.04	0.12	0.05	70,70,73	0.0	0.0	0.0	0,0,0
695	0.04	0.11	0.05	70,70,73	0.0	0.0	0.0	0,0,0



EGP CODE

GRE.EEC.R.73.IT.W.15235.12.024.01

PAGE

522 di/of 527

696	0.04	0.11	0.04	70,70,73	0.0	0.0	0.0	0,0,0
697	0.04	0.12	0.05	70,70,73	0.0	0.0	0.0	0,0,0
698	0.05	0.13	0.05	70,70,73	0.0	0.0	0.0	0,0,0
699	0.05	0.14	0.05	70,70,73	0.0	0.0	0.0	0,0,0
700	0.05	0.14	0.06	70,70,73	0.0	0.0	0.0	0,0,0
701	0.05	0.13	0.05	70,70,73	0.0	0.0	0.0	0,0,0
702	0.04	0.12	0.04	70,70,73	0.0	0.0	0.0	0,0,0
703	0.04	0.11	0.05	70,70,73	0.0	0.0	0.0	0,0,0
704	0.04	0.12	0.05	70,70,73	0.0	0.0	0.0	0,0,0
705	0.04	0.12	0.05	70,70,73	0.0	0.0	0.0	0,0,0
706	0.04	0.12	0.05	70,70,73	0.0	0.0	0.0	0,0,0
707	0.04	0.11	0.05	70,70,73	0.0	0.0	0.0	0,0,0
708	0.04	0.11	0.04	70,70,73	0.0	0.0	0.0	0,0,0
709	0.04	0.10	0.04	70,70,73	0.0	0.0	0.0	0,0,0
710	0.04	0.11	0.04	70,70,73	0.0	0.0	0.0	0,0,0
711	0.04	0.12	0.05	70,70,73	0.0	0.0	0.0	0,0,0
712	0.04	0.13	0.05	70,70,73	0.0	0.0	0.0	0,0,0
713	0.04	0.13	0.05	70,70,73	0.0	0.0	0.0	0,0,0
714	0.04	0.12	0.05	70,70,73	0.0	0.0	0.0	0,0,0
715	0.04	0.11	0.05	70,70,73	0.0	0.0	0.0	0,0,0
716	0.04	0.11	0.05	70,70,73	0.0	0.0	0.0	0,0,0
717	0.04	0.11	0.04	70,70,73	0.0	0.0	0.0	0,0,0
718	0.04	0.11	0.05	70,70,73	0.0	0.0	0.0	0,0,0
719	0.04	0.11	0.05	70,70,73	0.0	0.0	0.0	0,0,0
720	0.04	0.11	0.05	70,70,73	0.0	0.0	0.0	0,0,0
721	0.04	0.10	0.04	70,70,73	0.0	0.0	0.0	0,0,0
722	0.04	0.10	0.04	70,70,73	0.0	0.0	0.0	0,0,0
723	0.04	0.10	0.04	70,70,73	0.0	0.0	0.0	0,0,0
724	0.04	0.11	0.05	70,70,73	0.0	0.0	0.0	0,0,0
725	0.04	0.11	0.05	70,70,73	0.0	0.0	0.0	0,0,0
726	0.04	0.11	0.05	70,70,73	0.0	0.0	0.0	0,0,0
727	0.04	0.10	0.04	70,70,73	0.0	0.0	0.0	0,0,0
728	0.04	0.11	0.05	70,70,73	0.0	0.0	0.0	0,0,0
729	0.04	0.11	0.05	70,70,73	0.0	0.0	0.0	0,0,0
730	0.04	0.12	0.05	70,70,73	0.0	0.0	0.0	0,0,0
731	0.04	0.12	0.05	70,70,73	0.0	0.0	0.0	0,0,0
732	0.04	0.12	0.05	70,70,73	0.0	0.0	0.0	0,0,0
733	0.04	0.11	0.05	70,70,73	0.0	0.0	0.0	0,0,0
734	0.04	0.11	0.04	70,70,73	0.0	0.0	0.0	0,0,0
735	0.04	0.10	0.04	70,70,73	0.0	0.0	0.0	0,0,0
736	0.04	0.11	0.04	70,70,73	0.0	0.0	0.0	0,0,0
737	0.04	0.12	0.05	70,70,73	0.0	0.0	0.0	0,0,0
738	0.04	0.12	0.05	70,70,73	0.0	0.0	0.0	0,0,0
739	0.04	0.13	0.05	70,70,73	0.0	0.0	0.0	0,0,0
740	0.04	0.12	0.05	70,70,73	0.0	0.0	0.0	0,0,0
741	0.04	0.11	0.05	70,70,73	0.0	0.0	0.0	0,0,0
742	0.04	0.12	0.05	70,70,73	0.0	0.0	0.0	0,0,0
743	0.05	0.14	0.05	70,70,73	0.0	0.0	0.0	0,0,0
744	0.05	0.14	0.05	70,70,73	0.0	0.0	0.0	0,0,0
745	0.05	0.14	0.05	70,70,73	0.0	0.0	0.0	0,0,0
746	0.04	0.12	0.05	70,70,73	0.0	0.0	0.0	0,0,0
747	0.04	0.11	0.05	70,70,73	0.0	0.0	0.0	0,0,0
748	0.04	0.11	0.04	70,70,73	0.0	0.0	0.0	0,0,0
749	0.04	0.12	0.05	70,70,73	0.0	0.0	0.0	0,0,0
750	0.05	0.13	0.05	70,70,73	0.0	0.0	0.0	0,0,0
751	0.05	0.14	0.06	70,70,73	0.0	0.0	0.0	0,0,0
752	0.05	0.14	0.06	70,70,73	0.0	0.0	0.0	0,0,0
753	0.05	0.14	0.05	70,70,73	0.0	0.0	0.0	0,0,0
754	0.04	0.12	0.04	70,70,73	0.0	0.0	0.0	0,0,0
755	0.05	0.20	0.05	70,70,73	0.0	0.0	0.0	0,0,0
756	0.05	0.17	0.06	70,70,73	0.0	0.0	0.0	0,0,0
757	0.05	0.16	0.06	70,70,73	0.0	0.0	0.0	0,0,0
758	0.05	0.15	0.06	70,70,73	0.0	0.0	0.0	0,0,0
759	0.05	0.13	0.05	70,70,73	0.0	0.0	0.0	0,0,0
760	0.04	0.12	0.05	70,70,73	0.0	0.0	0.0	0,0,0
761	0.04	0.11	0.05	70,70,73	0.0	0.0	0.0	0,0,0
762	0.04	0.12	0.05	70,70,73	0.0	0.0	0.0	0,0,0
763	0.05	0.14	0.05	70,70,73	0.0	0.0	0.0	0,0,0
764	0.05	0.15	0.06	70,70,73	0.0	0.0	0.0	0,0,0
765	0.05	0.16	0.06	70,70,73	0.0	0.0	0.0	0,0,0
766	0.05	0.19	0.06	70,70,73	0.0	0.0	0.0	0,0,0
767	0.07	0.17	0.08	70,70,73	0.0	0.0	0.0	0,0,0
768	0.14	0.38	0.15	70,70,73	0.0	0.0	0.0	0,0,0
769	0.06	0.23	0.06	70,70,73	0.0	0.0	0.0	0,0,0
770	0.05	0.16	0.06	70,70,73	0.0	0.0	0.0	0,0,0
771	0.05	0.15	0.06	70,70,73	0.0	0.0	0.0	0,0,0



EGP CODE

GRE.EEC.R.73.IT.W.15235.12.024.01

PAGE

523 di/of 527

772	0.05	0.13	0.05	70,70,73	0.0	0.0	0.0	0,0,0
773	0.04	0.12	0.05	70,70,73	0.0	0.0	0.0	0,0,0
774	0.04	0.11	0.05	70,70,73	0.0	0.0	0.0	0,0,0
775	0.04	0.13	0.05	70,70,73	0.0	0.0	0.0	0,0,0
776	0.05	0.14	0.06	70,70,73	0.0	0.0	0.0	0,0,0
777	0.05	0.16	0.06	70,70,73	0.0	0.0	0.0	0,0,0
778	0.05	0.16	0.06	70,70,73	0.0	0.0	0.0	0,0,0
779	0.06	0.26	0.06	70,70,73	0.0	0.0	0.0	0,0,0
780	0.13	0.33	0.14	70,70,73	0.0	0.0	0.0	0,0,0
781	0.12	0.35	0.13	70,70,73	0.0	0.0	0.0	0,0,0
782	0.06	0.26	0.06	70,70,73	0.0	0.0	0.0	0,0,0
783	0.05	0.16	0.06	70,70,73	0.0	0.0	0.0	0,0,0
784	0.05	0.15	0.06	70,70,73	0.0	0.0	0.0	0,0,0
785	0.05	0.13	0.05	70,70,73	0.0	0.0	0.0	0,0,0
786	0.04	0.12	0.05	70,70,73	0.0	0.0	0.0	0,0,0
787	0.04	0.12	0.05	70,70,73	0.0	0.0	0.0	0,0,0
788	0.04	0.13	0.05	70,70,73	0.0	0.0	0.0	0,0,0
789	0.05	0.14	0.06	70,70,73	0.0	0.0	0.0	0,0,0
790	0.05	0.16	0.06	70,70,73	0.0	0.0	0.0	0,0,0
791	0.05	0.16	0.06	70,70,73	0.0	0.0	0.0	0,0,0
792	0.06	0.29	0.06	70,70,73	0.0	0.0	0.0	0,0,0
793	0.12	0.31	0.13	70,70,73	0.0	0.0	0.0	0,0,0
794	0.05	0.16	0.05	70,70,73	0.0	0.0	0.0	0,0,0
795	0.05	0.16	0.06	70,70,73	0.0	0.0	0.0	0,0,0
796	0.05	0.16	0.06	70,70,73	0.0	0.0	0.0	0,0,0
797	0.05	0.15	0.06	70,70,73	0.0	0.0	0.0	0,0,0
798	0.05	0.14	0.05	70,70,73	0.0	0.0	0.0	0,0,0
799	0.04	0.12	0.05	70,70,73	0.0	0.0	0.0	0,0,0
800	0.04	0.12	0.05	70,70,73	0.0	0.0	0.0	0,0,0
801	0.04	0.13	0.05	70,70,73	0.0	0.0	0.0	0,0,0
802	0.05	0.14	0.06	70,70,73	0.0	0.0	0.0	0,0,0
803	0.05	0.15	0.06	70,70,73	0.0	0.0	0.0	0,0,0
804	0.05	0.16	0.06	70,70,73	0.0	0.0	0.0	0,0,0
805	0.05	0.16	0.06	70,70,73	0.0	0.0	0.0	0,0,0
806	0.08	0.14	0.08	70,70,73	0.0	0.0	0.0	0,0,0
807	0.03	0.09	0.03	70,70,73	0.0	0.0	0.0	0,0,0
808	0.05	0.14	0.05	70,70,73	0.0	0.0	0.0	0,0,0
809	0.05	0.15	0.06	70,70,73	0.0	0.0	0.0	0,0,0
810	0.05	0.14	0.06	70,70,73	0.0	0.0	0.0	0,0,0
811	0.05	0.13	0.05	70,70,73	0.0	0.0	0.0	0,0,0
812	0.04	0.12	0.05	70,70,73	0.0	0.0	0.0	0,0,0
813	0.04	0.12	0.05	70,70,73	0.0	0.0	0.0	0,0,0
814	0.04	0.13	0.05	70,70,73	0.0	0.0	0.0	0,0,0
815	0.05	0.14	0.06	70,70,73	0.0	0.0	0.0	0,0,0
816	0.05	0.14	0.06	70,70,73	0.0	0.0	0.0	0,0,0
817	0.05	0.15	0.06	70,70,73	0.0	0.0	0.0	0,0,0
818	0.04	0.13	0.05	70,70,73	0.0	0.0	0.0	0,0,0
819	0.02	0.08	0.03	70,70,73	0.0	0.0	0.0	0,0,0
820	0.03	0.09	0.03	70,70,73	0.0	0.0	0.0	0,0,0
821	0.04	0.13	0.05	70,70,73	0.0	0.0	0.0	0,0,0
822	0.05	0.14	0.06	70,70,73	0.0	0.0	0.0	0,0,0
823	0.05	0.14	0.06	70,70,73	0.0	0.0	0.0	0,0,0
824	0.05	0.13	0.05	70,70,73	0.0	0.0	0.0	0,0,0
825	0.04	0.12	0.05	70,70,73	0.0	0.0	0.0	0,0,0
826	0.04	0.12	0.05	70,70,73	0.0	0.0	0.0	0,0,0
827	0.04	0.13	0.05	70,70,73	0.0	0.0	0.0	0,0,0
828	0.05	0.14	0.05	70,70,73	0.0	0.0	0.0	0,0,0
829	0.05	0.14	0.06	70,70,73	0.0	0.0	0.0	0,0,0
830	0.05	0.14	0.06	70,70,73	0.0	0.0	0.0	0,0,0
831	0.04	0.12	0.05	70,70,73	0.0	0.0	0.0	0,0,0
832	0.02	0.07	0.03	70,70,73	0.0	0.0	0.0	0,0,0
833	0.03	0.14	0.04	70,70,73	0.0	0.0	0.0	0,0,0
834	0.05	0.16	0.05	70,70,73	0.0	0.0	0.0	0,0,0
835	0.05	0.15	0.06	70,70,73	0.0	0.0	0.0	0,0,0
836	0.05	0.14	0.06	70,70,73	0.0	0.0	0.0	0,0,0
837	0.05	0.13	0.05	70,70,73	0.0	0.0	0.0	0,0,0
838	0.04	0.12	0.05	70,70,73	0.0	0.0	0.0	0,0,0
839	0.04	0.12	0.05	70,70,73	0.0	0.0	0.0	0,0,0
840	0.04	0.13	0.05	70,70,73	0.0	0.0	0.0	0,0,0
841	0.05	0.14	0.06	70,70,73	0.0	0.0	0.0	0,0,0
842	0.05	0.15	0.06	70,70,73	0.0	0.0	0.0	0,0,0
843	0.05	0.15	0.06	70,70,73	0.0	0.0	0.0	0,0,0
844	0.04	0.16	0.05	70,70,73	0.0	0.0	0.0	0,0,0
845	0.03	0.13	0.03	70,70,73	0.0	0.0	0.0	0,0,0
846	0.10	0.31	0.11	70,70,73	0.0	0.0	0.0	0,0,0
847	0.06	0.19	0.06	70,70,73	0.0	0.0	0.0	0,0,0



EGP CODE

GRE.EEC.R.73.IT.W.15235.12.024.01

PAGE

524 di/of 527

848	0.05	0.15	0.06	70,70,73	0.0	0.0	0.0	0,0,0
849	0.05	0.15	0.06	70,70,73	0.0	0.0	0.0	0,0,0
850	0.05	0.13	0.05	70,70,73	0.0	0.0	0.0	0,0,0
851	0.04	0.12	0.05	70,70,73	0.0	0.0	0.0	0,0,0
852	0.04	0.12	0.05	70,70,73	0.0	0.0	0.0	0,0,0
853	0.04	0.13	0.05	70,70,73	0.0	0.0	0.0	0,0,0
854	0.05	0.14	0.06	70,70,73	0.0	0.0	0.0	0,0,0
855	0.05	0.15	0.06	70,70,73	0.0	0.0	0.0	0,0,0
856	0.05	0.15	0.06	70,70,73	0.0	0.0	0.0	0,0,0
857	0.06	0.17	0.06	70,70,73	0.0	0.0	0.0	0,0,0
858	0.11	0.31	0.12	70,70,73	0.0	0.0	0.0	0,0,0
859	0.08	0.19	0.08	70,70,73	0.0	0.0	0.0	0,0,0
860	0.02	0.06	0.03	70,70,73	0.0	0.0	0.0	0,0,0
861	0.02	0.06	0.03	70,70,73	0.0	0.0	0.0	0,0,0
862	0.04	0.08	0.04	70,70,73	0.0	0.0	0.0	0,0,0
863	0.11	0.45	0.12	70,70,73	0.0	0.0	0.0	0,0,0
864	0.11	0.40	0.12	70,70,73	0.0	0.0	0.0	0,0,0
865	0.13	0.49	0.14	70,70,73	0.0	0.0	0.0	0,0,0
866	0.08	0.15	0.09	70,70,73	0.0	0.0	0.0	0,0,0
867	0.05	0.13	0.05	70,70,73	0.0	0.0	0.0	0,0,0
868	0.06	0.14	0.06	70,70,73	0.0	0.0	0.0	0,0,0
869	0.06	0.14	0.07	70,70,73	0.0	0.0	0.0	0,0,0
870	0.06	0.14	0.07	70,70,73	0.0	0.0	0.0	0,0,0
871	0.05	0.13	0.06	70,70,73	0.0	0.0	0.0	0,0,0
872	0.14	0.38	0.15	70,70,73	0.0	0.0	0.0	0,0,0
873	0.06	0.22	0.06	70,70,73	0.0	0.0	0.0	0,0,0
874	0.05	0.15	0.06	70,70,73	0.0	0.0	0.0	0,0,0
875	0.05	0.15	0.06	70,70,73	0.0	0.0	0.0	0,0,0
876	0.05	0.13	0.05	70,70,73	0.0	0.0	0.0	0,0,0
877	0.04	0.12	0.05	70,70,73	0.0	0.0	0.0	0,0,0
878	0.04	0.11	0.05	70,70,73	0.0	0.0	0.0	0,0,0
879	0.04	0.12	0.05	70,70,73	0.0	0.0	0.0	0,0,0
880	0.05	0.14	0.06	70,70,73	0.0	0.0	0.0	0,0,0
881	0.05	0.15	0.06	70,70,73	0.0	0.0	0.0	0,0,0
882	0.05	0.15	0.06	70,70,73	0.0	0.0	0.0	0,0,0
883	0.05	0.23	0.06	70,70,73	0.0	0.0	0.0	0,0,0
884	0.14	0.37	0.15	70,70,73	0.0	0.0	0.0	0,0,0
885	0.05	0.20	0.05	70,70,73	0.0	0.0	0.0	0,0,0
886	0.05	0.18	0.06	70,70,73	0.0	0.0	0.0	0,0,0
887	0.05	0.15	0.06	70,70,73	0.0	0.0	0.0	0,0,0
888	0.05	0.14	0.06	70,70,73	0.0	0.0	0.0	0,0,0
889	0.04	0.13	0.05	70,70,73	0.0	0.0	0.0	0,0,0
890	0.04	0.11	0.05	70,70,73	0.0	0.0	0.0	0,0,0
891	0.04	0.11	0.04	70,70,73	0.0	0.0	0.0	0,0,0
892	0.04	0.12	0.05	70,70,73	0.0	0.0	0.0	0,0,0
893	0.05	0.13	0.05	70,70,73	0.0	0.0	0.0	0,0,0
894	0.05	0.15	0.06	70,70,73	0.0	0.0	0.0	0,0,0
895	0.05	0.15	0.06	70,70,73	0.0	0.0	0.0	0,0,0
896	0.05	0.21	0.06	70,70,73	0.0	0.0	0.0	0,0,0
897	0.07	0.18	0.08	70,70,73	0.0	0.0	0.0	0,0,0
898	0.05	0.13	0.05	70,70,73	0.0	0.0	0.0	0,0,0
899	0.05	0.14	0.05	70,70,73	0.0	0.0	0.0	0,0,0
900	0.05	0.14	0.05	70,70,73	0.0	0.0	0.0	0,0,0
901	0.05	0.13	0.05	70,70,73	0.0	0.0	0.0	0,0,0
902	0.04	0.12	0.05	70,70,73	0.0	0.0	0.0	0,0,0
903	0.04	0.11	0.04	70,70,73	0.0	0.0	0.0	0,0,0
904	0.04	0.10	0.04	70,70,73	0.0	0.0	0.0	0,0,0
905	0.04	0.11	0.05	70,70,73	0.0	0.0	0.0	0,0,0
906	0.04	0.13	0.05	70,70,73	0.0	0.0	0.0	0,0,0
907	0.05	0.14	0.05	70,70,73	0.0	0.0	0.0	0,0,0
908	0.05	0.14	0.06	70,70,73	0.0	0.0	0.0	0,0,0
909	0.05	0.14	0.05	70,70,73	0.0	0.0	0.0	0,0,0
910	0.05	0.13	0.05	70,70,73	0.0	0.0	0.0	0,0,0
911	0.05	0.13	0.06	70,70,73	0.0	0.0	0.0	0,0,0
912	0.04	0.13	0.05	70,70,73	0.0	0.0	0.0	0,0,0
913	0.04	0.12	0.05	70,70,73	0.0	0.0	0.0	0,0,0
914	0.04	0.12	0.05	70,70,73	0.0	0.0	0.0	0,0,0
915	0.04	0.11	0.05	70,70,73	0.0	0.0	0.0	0,0,0
916	0.04	0.10	0.04	70,70,73	0.0	0.0	0.0	0,0,0
917	0.03	0.10	0.04	70,70,73	0.0	0.0	0.0	0,0,0
918	0.04	0.10	0.04	70,70,73	0.0	0.0	0.0	0,0,0
919	0.04	0.11	0.05	70,70,73	0.0	0.0	0.0	0,0,0
920	0.04	0.12	0.05	70,70,73	0.0	0.0	0.0	0,0,0
921	0.04	0.13	0.05	70,70,73	0.0	0.0	0.0	0,0,0
922	0.05	0.13	0.05	70,70,73	0.0	0.0	0.0	0,0,0
923	0.05	0.13	0.06	70,70,73	0.0	0.0	0.0	0,0,0



EGP CODE

GRE.EEC.R.73.IT.W.15235.12.024.01

PAGE

525 di/of 527

924	0.05	0.13	0.06	70,70,73	0.0	0.0	0.0	0,0,0
925	0.04	0.12	0.05	70,70,73	0.0	0.0	0.0	0,0,0
926	0.04	0.11	0.05	70,70,73	0.0	0.0	0.0	0,0,0
927	0.04	0.11	0.05	70,70,73	0.0	0.0	0.0	0,0,0
928	0.04	0.10	0.04	70,70,73	0.0	0.0	0.0	0,0,0
929	0.03	0.10	0.04	70,70,73	0.0	0.0	0.0	0,0,0
930	0.03	0.09	0.04	70,70,73	0.0	0.0	0.0	0,0,0
931	0.04	0.10	0.04	70,70,73	0.0	0.0	0.0	0,0,0
932	0.04	0.11	0.04	70,70,73	0.0	0.0	0.0	0,0,0
933	0.04	0.11	0.05	70,70,73	0.0	0.0	0.0	0,0,0
934	0.04	0.11	0.05	70,70,73	0.0	0.0	0.0	0,0,0
935	0.05	0.12	0.05	70,70,73	0.0	0.0	0.0	0,0,0
936	0.05	0.13	0.06	70,70,73	0.0	0.0	0.0	0,0,0
937	0.05	0.13	0.06	70,70,73	0.0	0.0	0.0	0,0,0
938	0.04	0.12	0.05	70,70,73	0.0	0.0	0.0	0,0,0
939	0.04	0.12	0.05	70,70,73	0.0	0.0	0.0	0,0,0
940	0.04	0.11	0.05	70,70,73	0.0	0.0	0.0	0,0,0
941	0.04	0.11	0.04	70,70,73	0.0	0.0	0.0	0,0,0
942	0.03	0.10	0.04	70,70,73	0.0	0.0	0.0	0,0,0
943	0.03	0.09	0.04	70,70,73	0.0	0.0	0.0	0,0,0
944	0.04	0.10	0.04	70,70,73	0.0	0.0	0.0	0,0,0
945	0.04	0.11	0.05	70,70,73	0.0	0.0	0.0	0,0,0
946	0.04	0.12	0.05	70,70,73	0.0	0.0	0.0	0,0,0
947	0.04	0.12	0.05	70,70,73	0.0	0.0	0.0	0,0,0
948	0.05	0.12	0.05	70,70,73	0.0	0.0	0.0	0,0,0
949	0.05	0.13	0.06	70,70,73	0.0	0.0	0.0	0,0,0
950	0.05	0.13	0.05	70,70,73	0.0	0.0	0.0	0,0,0
951	0.05	0.13	0.05	70,70,73	0.0	0.0	0.0	0,0,0
952	0.05	0.13	0.05	70,70,73	0.0	0.0	0.0	0,0,0
953	0.04	0.13	0.05	70,70,73	0.0	0.0	0.0	0,0,0
954	0.04	0.11	0.05	70,70,73	0.0	0.0	0.0	0,0,0
955	0.04	0.10	0.04	70,70,73	0.0	0.0	0.0	0,0,0
956	0.03	0.10	0.04	70,70,73	0.0	0.0	0.0	0,0,0
957	0.04	0.11	0.04	70,70,73	0.0	0.0	0.0	0,0,0
958	0.04	0.12	0.05	70,70,73	0.0	0.0	0.0	0,0,0
959	0.04	0.13	0.05	70,70,73	0.0	0.0	0.0	0,0,0
960	0.05	0.13	0.05	70,70,73	0.0	0.0	0.0	0,0,0
961	0.05	0.13	0.05	70,70,73	0.0	0.0	0.0	0,0,0
962	0.05	0.13	0.05	70,70,73	0.0	0.0	0.0	0,0,0
963	0.13	0.48	0.14	70,70,73	0.0	0.0	0.0	0,0,0
964	0.09	0.15	0.09	70,70,73	0.0	0.0	0.0	0,0,0
965	0.04	0.11	0.05	70,70,73	0.0	0.0	0.0	0,0,0
966	0.05	0.12	0.05	70,70,73	0.0	0.0	0.0	0,0,0
967	0.05	0.12	0.05	70,70,73	0.0	0.0	0.0	0,0,0
968	0.05	0.12	0.05	70,70,73	0.0	0.0	0.0	0,0,0
969	0.04	0.11	0.04	70,70,73	0.0	0.0	0.0	0,0,0
970	0.09	0.19	0.10	70,70,73	0.0	0.0	0.0	0,0,0
971	0.15	0.52	0.16	70,70,73	0.0	0.0	0.0	0,0,0
972	0.08	0.29	0.09	70,70,73	0.0	0.0	0.0	0,0,0
973	0.15	0.50	0.16	70,70,73	0.0	0.0	0.0	0,0,0
974	0.08	0.16	0.09	70,70,73	0.0	0.0	0.0	0,0,0
975	0.04	0.11	0.05	70,70,73	0.0	0.0	0.0	0,0,0
976	0.10	0.27	0.11	70,70,73	0.0	0.0	0.0	0,0,0
977	0.05	0.16	0.05	70,70,73	0.0	0.0	0.0	0,0,0
978	0.05	0.15	0.05	70,70,73	0.0	0.0	0.0	0,0,0
979	0.05	0.14	0.05	70,70,73	0.0	0.0	0.0	0,0,0
980	0.04	0.12	0.05	70,70,73	0.0	0.0	0.0	0,0,0
981	0.04	0.11	0.04	70,70,73	0.0	0.0	0.0	0,0,0
982	0.03	0.10	0.04	70,70,73	0.0	0.0	0.0	0,0,0
983	0.04	0.11	0.04	70,70,73	0.0	0.0	0.0	0,0,0
984	0.04	0.13	0.05	70,70,73	0.0	0.0	0.0	0,0,0
985	0.05	0.14	0.05	70,70,73	0.0	0.0	0.0	0,0,0
986	0.05	0.15	0.05	70,70,73	0.0	0.0	0.0	0,0,0
987	0.05	0.16	0.05	70,70,73	0.0	0.0	0.0	0,0,0
988	0.10	0.25	0.11	70,70,73	0.0	0.0	0.0	0,0,0
989	0.08	0.32	0.09	70,70,73	0.0	0.0	0.0	0,0,0
990	0.04	0.11	0.05	70,70,73	0.0	0.0	0.0	0,0,0
991	0.05	0.12	0.06	70,70,73	0.0	0.0	0.0	0,0,0
992	0.05	0.12	0.06	70,70,73	0.0	0.0	0.0	0,0,0
993	0.04	0.11	0.05	70,70,73	0.0	0.0	0.0	0,0,0
994	0.08	0.15	0.08	70,70,73	0.0	0.0	0.0	0,0,0
995	0.12	0.47	0.13	70,70,73	0.0	0.0	0.0	0,0,0
996	0.12	0.44	0.13	70,70,73	0.0	0.0	0.0	0,0,0
997	0.07	0.15	0.07	70,70,73	0.0	0.0	0.0	0,0,0
998	0.03	0.08	0.04	70,70,73	0.0	0.0	0.0	0,0,0
999	0.04	0.09	0.04	70,70,73	0.0	0.0	0.0	0,0,0





EGP CODE

GRE.EEC.R.73.IT.W.15235.12.024.01

PAGE

526 di/of 527

1000	0.04	0.09	0.04	70,70,73	0.0	0.0	0.0	0,0,0
1001	0.06	0.10	0.06	70,70,73	0.0	0.0	0.0	0,0,0
1002	0.11	0.46	0.12	70,70,73	0.0	0.0	0.0	0,0,0
1003	0.12	0.47	0.12	70,70,73	0.0	0.0	0.0	0,0,0
1004	0.06	0.10	0.06	70,70,73	0.0	0.0	0.0	0,0,0
1005	0.04	0.10	0.04	70,70,73	0.0	0.0	0.0	0,0,0
1006	0.04	0.10	0.05	70,70,73	0.0	0.0	0.0	0,0,0
1007	0.04	0.10	0.05	70,70,73	0.0	0.0	0.0	0,0,0
1008	0.06	0.10	0.06	70,70,73	0.0	0.0	0.0	0,0,0
1009	0.12	0.48	0.13	70,70,73	0.0	0.0	0.0	0,0,0
1010	0.04	0.14	0.05	70,70,73	0.0	0.0	0.0	0,0,0
1011	0.12	0.48	0.13	70,70,73	0.0	0.0	0.0	0,0,0
1012	0.07	0.13	0.07	70,70,73	0.0	0.0	0.0	0,0,0
1013	0.04	0.10	0.04	70,70,73	0.0	0.0	0.0	0,0,0
1014	0.04	0.10	0.05	70,70,73	0.0	0.0	0.0	0,0,0
1015	0.04	0.10	0.05	70,70,73	0.0	0.0	0.0	0,0,0
1016	0.03	0.09	0.04	70,70,73	0.0	0.0	0.0	0,0,0
1017	0.10	0.26	0.11	70,70,73	0.0	0.0	0.0	0,0,0
1018	0.15	0.49	0.16	70,70,73	0.0	0.0	0.0	0,0,0
1019	0.14	0.48	0.15	70,70,73	0.0	0.0	0.0	0,0,0
1020	0.10	0.21	0.10	70,70,73	0.0	0.0	0.0	0,0,0
1021	0.04	0.11	0.04	70,70,73	0.0	0.0	0.0	0,0,0
1022	0.05	0.12	0.05	70,70,73	0.0	0.0	0.0	0,0,0
1023	0.05	0.12	0.06	70,70,73	0.0	0.0	0.0	0,0,0
1024	0.05	0.12	0.06	70,70,73	0.0	0.0	0.0	0,0,0
1025	0.05	0.12	0.05	70,70,73	0.0	0.0	0.0	0,0,0
1026	0.04	0.12	0.04	70,70,73	0.0	0.0	0.0	0,0,0
1027	0.10	0.22	0.11	70,70,73	0.0	0.0	0.0	0,0,0
1028	0.15	0.55	0.16	70,70,73	0.0	0.0	0.0	0,0,0
1029	0.06	0.24	0.07	70,70,73	0.0	0.0	0.0	0,0,0
1030	0.15	0.55	0.16	70,70,73	0.0	0.0	0.0	0,0,0
1031	0.09	0.17	0.09	70,70,73	0.0	0.0	0.0	0,0,0
1032	0.04	0.12	0.05	70,70,73	0.0	0.0	0.0	0,0,0
1033	0.05	0.12	0.05	70,70,73	0.0	0.0	0.0	0,0,0
1034	0.05	0.12	0.05	70,70,73	0.0	0.0	0.0	0,0,0
1035	0.05	0.12	0.05	70,70,73	0.0	0.0	0.0	0,0,0
1036	0.04	0.11	0.05	70,70,73	0.0	0.0	0.0	0,0,0
1037	0.08	0.16	0.09	70,70,73	0.0	0.0	0.0	0,0,0
1038	0.14	0.50	0.15	70,70,73	0.0	0.0	0.0	0,0,0
1039	0.08	0.29	0.09	70,70,73	0.0	0.0	0.0	0,0,0
1040	0.14	0.51	0.15	70,70,73	0.0	0.0	0.0	0,0,0
1041	0.09	0.20	0.10	70,70,73	0.0	0.0	0.0	0,0,0
1042	0.04	0.11	0.04	70,70,73	0.0	0.0	0.0	0,0,0
1043	0.05	0.12	0.05	70,70,73	0.0	0.0	0.0	0,0,0
1044	0.05	0.12	0.05	70,70,73	0.0	0.0	0.0	0,0,0
1045	0.05	0.12	0.05	70,70,73	0.0	0.0	0.0	0,0,0
1046	0.04	0.11	0.05	70,70,73	0.0	0.0	0.0	0,0,0
1047	0.08	0.16	0.09	70,70,73	0.0	0.0	0.0	0,0,0
1048	0.13	0.46	0.13	70,70,73	0.0	0.0	0.0	0,0,0
1049	0.13	0.47	0.14	70,70,73	0.0	0.0	0.0	0,0,0
1050	0.08	0.19	0.08	70,70,73	0.0	0.0	0.0	0,0,0
1051	0.02	0.06	0.03	70,70,73	0.0	0.0	0.0	0,0,0
1052	0.02	0.06	0.03	70,70,73	0.0	0.0	0.0	0,0,0
1053	0.04	0.08	0.04	70,70,73	0.0	0.0	0.0	0,0,0
1054	0.11	0.45	0.12	70,70,73	0.0	0.0	0.0	0,0,0
1055	0.13	0.48	0.14	70,70,73	0.0	0.0	0.0	0,0,0
1056	0.12	0.48	0.13	70,70,73	0.0	0.0	0.0	0,0,0
1057	0.08	0.15	0.09	70,70,73	0.0	0.0	0.0	0,0,0
1058	0.05	0.13	0.05	70,70,73	0.0	0.0	0.0	0,0,0
1059	0.06	0.14	0.06	70,70,73	0.0	0.0	0.0	0,0,0
1060	0.06	0.14	0.07	70,70,73	0.0	0.0	0.0	0,0,0
1061	0.06	0.14	0.07	70,70,73	0.0	0.0	0.0	0,0,0
1062	0.05	0.13	0.06	70,70,73	0.0	0.0	0.0	0,0,0
1063	0.05	0.12	0.05	70,70,73	0.0	0.0	0.0	0,0,0
1064	0.10	0.39	0.11	70,70,73	0.0	0.0	0.0	0,0,0
1065	0.08	0.31	0.09	70,70,73	0.0	0.0	0.0	0,0,0
1066	0.04	0.10	0.05	70,70,73	0.0	0.0	0.0	0,0,0
1067	0.05	0.12	0.06	70,70,73	0.0	0.0	0.0	0,0,0
1068	0.05	0.12	0.06	70,70,73	0.0	0.0	0.0	0,0,0
1069	0.04	0.11	0.05	70,70,73	0.0	0.0	0.0	0,0,0
1070	0.08	0.15	0.08	70,70,73	0.0	0.0	0.0	0,0,0
1071	0.13	0.50	0.14	70,70,73	0.0	0.0	0.0	0,0,0
1072	0.12	0.46	0.13	70,70,73	0.0	0.0	0.0	0,0,0
1073	0.07	0.15	0.07	70,70,73	0.0	0.0	0.0	0,0,0
1074	0.03	0.08	0.04	70,70,73	0.0	0.0	0.0	0,0,0
1075	0.04	0.09	0.04	70,70,73	0.0	0.0	0.0	0,0,0

1076	0.04	0.09	0.04	70,70,73	0.0	0.0	0.0	0,0,0
1077	0.06	0.10	0.06	70,70,73	0.0	0.0	0.0	0,0,0
1078	0.12	0.48	0.13	70,70,73	0.0	0.0	0.0	0,0,0
1079	0.12	0.49	0.13	70,70,73	0.0	0.0	0.0	0,0,0
1080	0.06	0.10	0.06	70,70,73	0.0	0.0	0.0	0,0,0
1081	0.04	0.10	0.04	70,70,73	0.0	0.0	0.0	0,0,0
1082	0.04	0.10	0.04	70,70,73	0.0	0.0	0.0	0,0,0
1083	0.04	0.10	0.05	70,70,73	0.0	0.0	0.0	0,0,0
1084	0.06	0.10	0.06	70,70,73	0.0	0.0	0.0	0,0,0
1085	0.12	0.49	0.13	70,70,73	0.0	0.0	0.0	0,0,0
1086	0.07	0.12	0.08	70,70,73	0.0	0.0	0.0	0,0,0
1087	0.13	0.50	0.14	70,70,73	0.0	0.0	0.0	0,0,0
1088	0.07	0.12	0.07	70,70,73	0.0	0.0	0.0	0,0,0
1089	0.04	0.10	0.04	70,70,73	0.0	0.0	0.0	0,0,0
1090	0.04	0.10	0.05	70,70,73	0.0	0.0	0.0	0,0,0
1091	0.04	0.11	0.05	70,70,73	0.0	0.0	0.0	0,0,0
1092	0.03	0.09	0.04	70,70,73	0.0	0.0	0.0	0,0,0
1093	0.10	0.26	0.11	70,70,73	0.0	0.0	0.0	0,0,0
1094	0.15	0.50	0.16	70,70,73	0.0	0.0	0.0	0,0,0
1095	0.15	0.49	0.16	70,70,73	0.0	0.0	0.0	0,0,0
1096	0.10	0.22	0.11	70,70,73	0.0	0.0	0.0	0,0,0
1097	0.04	0.11	0.04	70,70,73	0.0	0.0	0.0	0,0,0
1098	0.05	0.12	0.05	70,70,73	0.0	0.0	0.0	0,0,0
1099	0.05	0.13	0.05	70,70,73	0.0	0.0	0.0	0,0,0
1100	0.05	0.13	0.05	70,70,73	0.0	0.0	0.0	0,0,0
1101	0.05	0.12	0.05	70,70,73	0.0	0.0	0.0	0,0,0
1102	0.04	0.12	0.04	70,70,73	0.0	0.0	0.0	0,0,0
1103	0.10	0.21	0.11	70,70,73	0.0	0.0	0.0	0,0,0
1104	0.16	0.56	0.17	70,70,73	0.0	0.0	0.0	0,0,0
1105	0.06	0.23	0.07	70,70,73	0.0	0.0	0.0	0,0,0
1106	0.16	0.56	0.17	70,70,73	0.0	0.0	0.0	0,0,0
1107	0.09	0.17	0.09	70,70,73	0.0	0.0	0.0	0,0,0
1108	0.04	0.11	0.05	70,70,73	0.0	0.0	0.0	0,0,0
1109	0.05	0.12	0.05	70,70,73	0.0	0.0	0.0	0,0,0
1110	0.05	0.12	0.05	70,70,73	0.0	0.0	0.0	0,0,0
<b>Guscio</b>	<b>rRfck</b>	<b>rRfyk</b>	<b>rPfck</b>		<b>wR</b>	<b>wF</b>	<b>wP</b>	
0.17	0.56	0.19		0.0	0.0	0.0		

## 21. CONCLUSIONI

Considerato quanto sopra la struttura è idonea allo scopo per cui è stata progettata. Si precisa ancora una volta che il calcolo ha carattere preliminare, dovrà essere verificato in fase esecutiva considerando i carichi effettivamente trasmessi e le indagini geognostiche eseguite.

Il Tecnico

Ing. Leonardo Sblendido

