

CARATTERISTICHE DEI MATERIALI

- TUTTI I MATERIALI DEVONO ESSERE CONFORMI AL D.M. 14.01.2008
- CALCESTRUZZO MAGRO PER SOTTOFONDO
- CONFORME ALLA EN 206-1:2005
- CLASSE DI RESISTENZA MINIMA A COMPRESIONE: C 12/15
- CALCESTRUZZO PER GETTO IN OPERA ELEVAZIONI SPALLE E PILE
- A PRESTAZIONE GARANTITA CONFORME ALLA UNI EN 206-1:2006
- CLASSE DI RESISTENZA MINIMA A COMPRESIONE: C 28/35
- CLASSE DI CONSISTENZA SLUMP: S4
- CLASSE DI ESPOSIZIONE: XC2(0)
- DIMENSIONE MASSIMA DEGLI AGGREGATI: Dmax 31
- CLASSE DI CONTENUTO IN CLORURI: Cl 0,20
- RAPPORTO A/C MAX: 0,60
- CONTENUTO MINIMO DI CEMENTO 280 Kg/m³
- COPRIFERRO: 50mm
- COPRIFERRO BAGGIOLI: 30mm

- ACCIAIO DI ARMATURA
- ARMATURA ORDINARIA: B450C

SPALLA "SPN" - PILE "P3N" - "P4N.1"
ARMATURA BAGGIOLI

SEZIONE TRASVERSALE

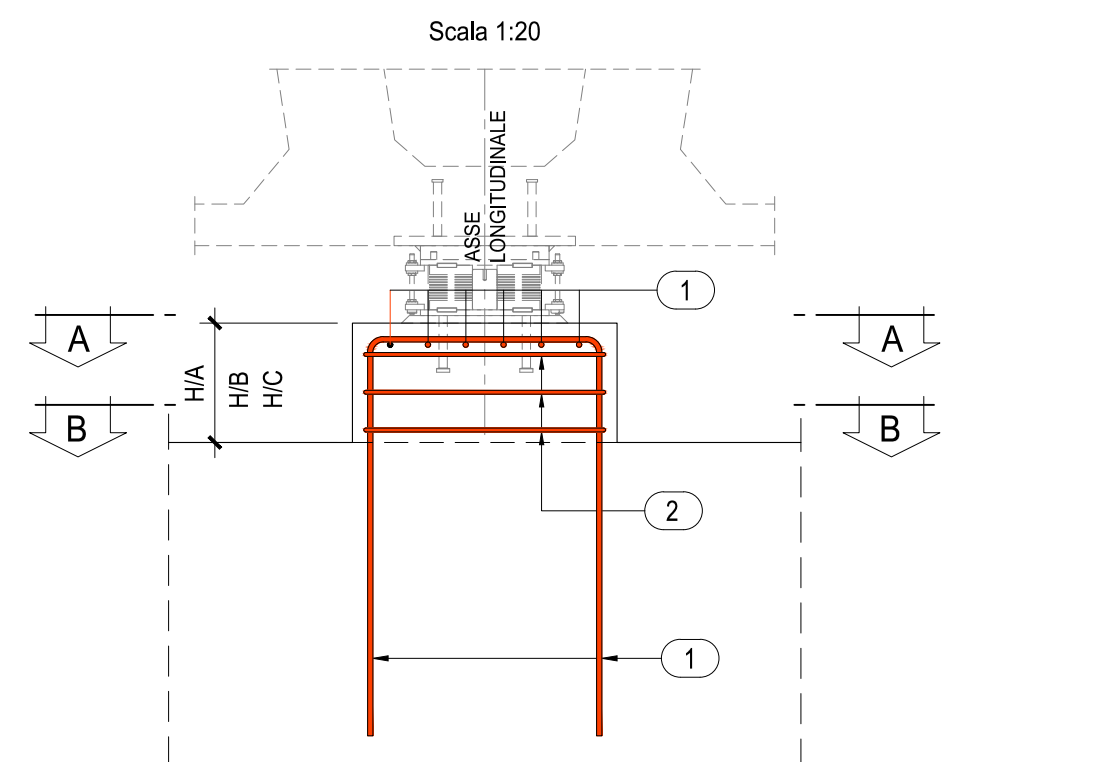

	HA (mm)	HB (mm)	HC (mm)
APP. "SPN.2"	322	410	476
APP. "P3N.1"	423	363	292
APP. "P3N.2"	467	407	355
APP. "P4N.1"	422	363	303

SEZIONE ORIZZONTALE A-A

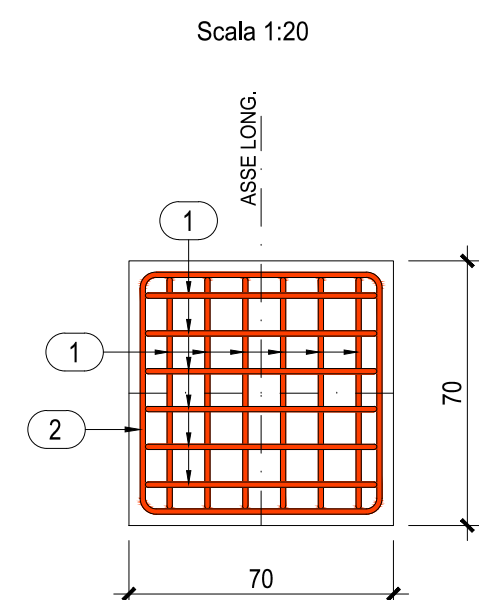

SEZIONE ORIZZONTALE B-B

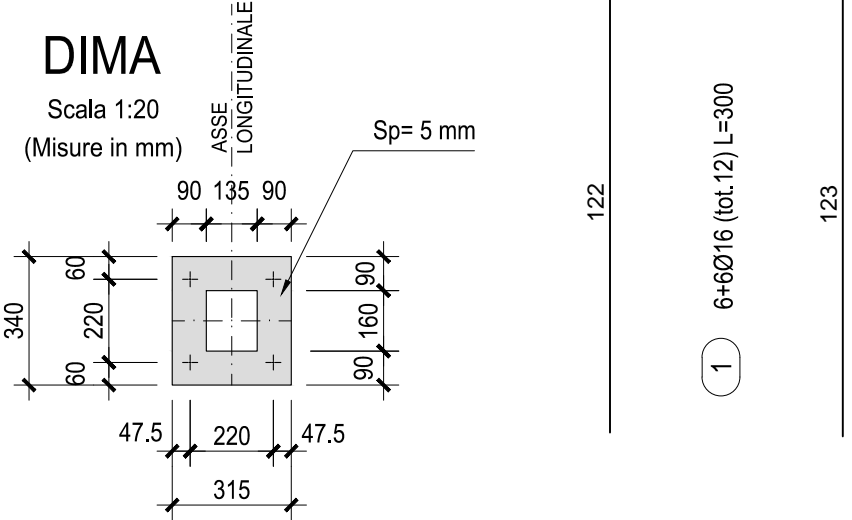
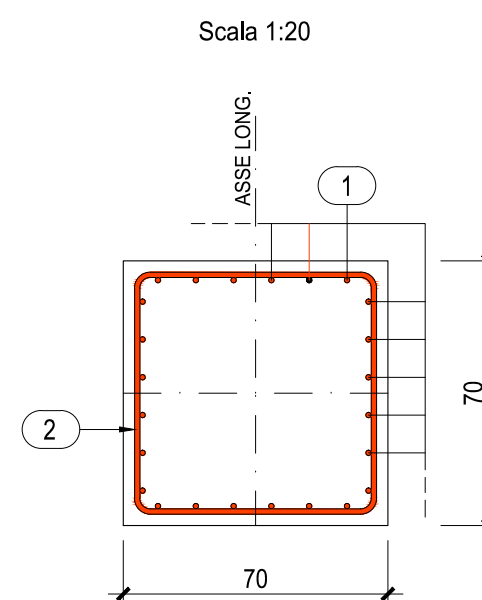

PILA "P5N"
ARMATURA BAGGIOLI "P5N.1/A" - "P5N.1/C"

SEZIONE A-A

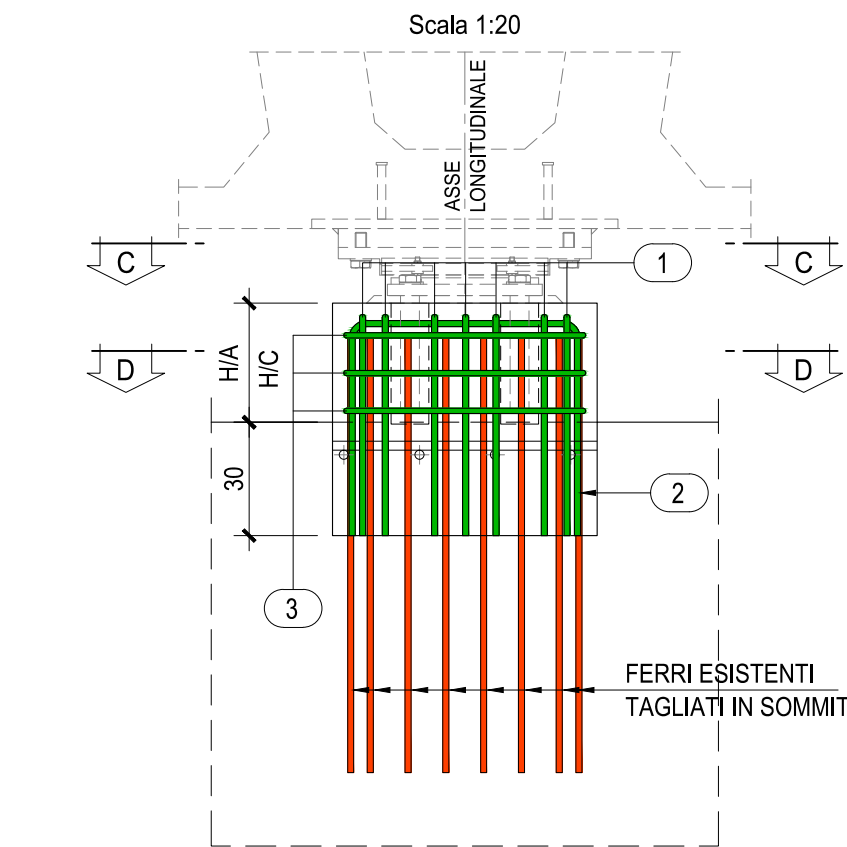

SEZIONE B-B

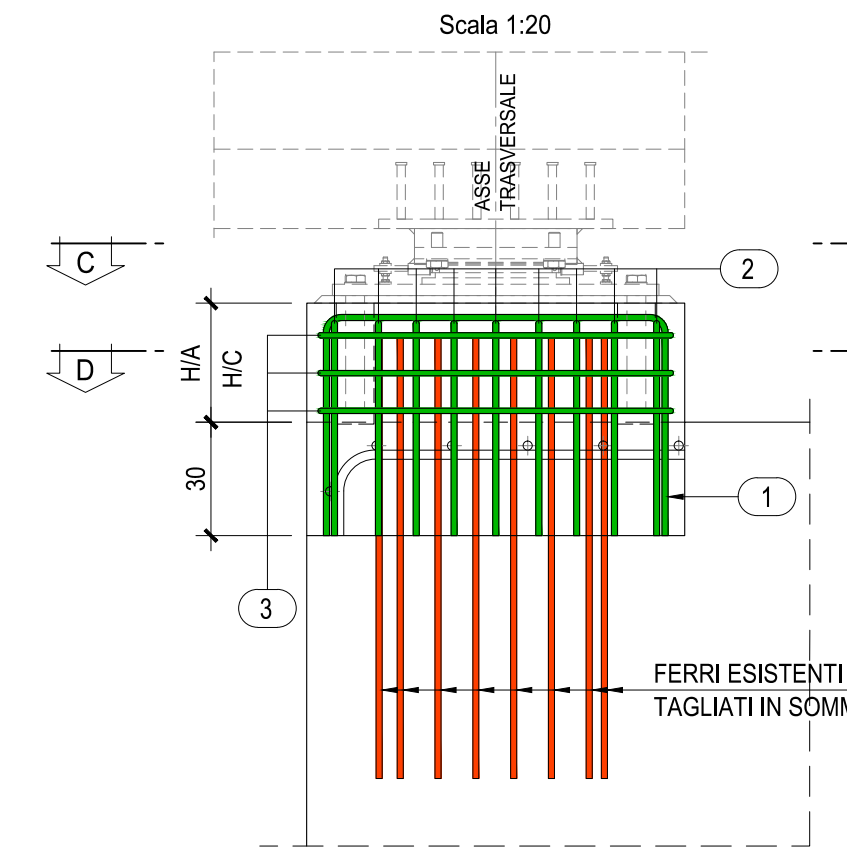

SEZIONE ORIZZONTALE C-C

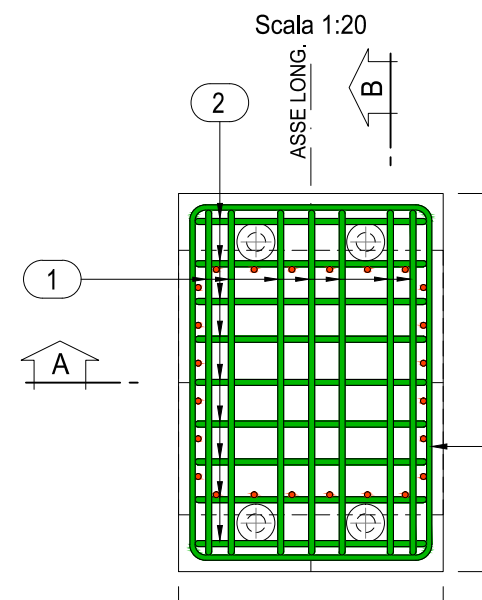

SEZIONE ORIZZONTALE D-D

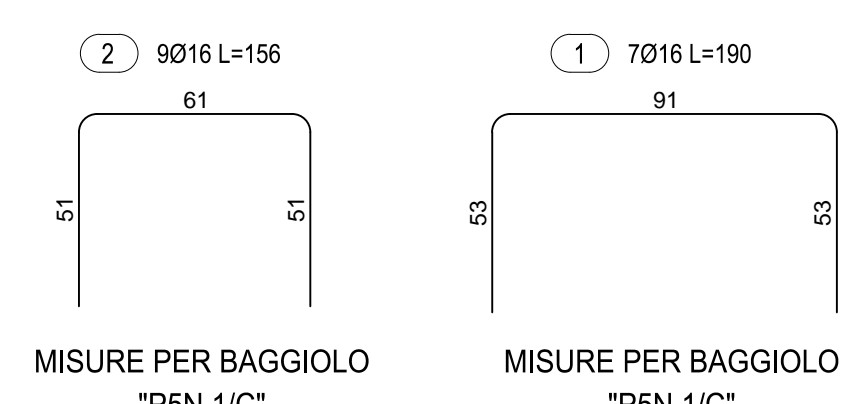
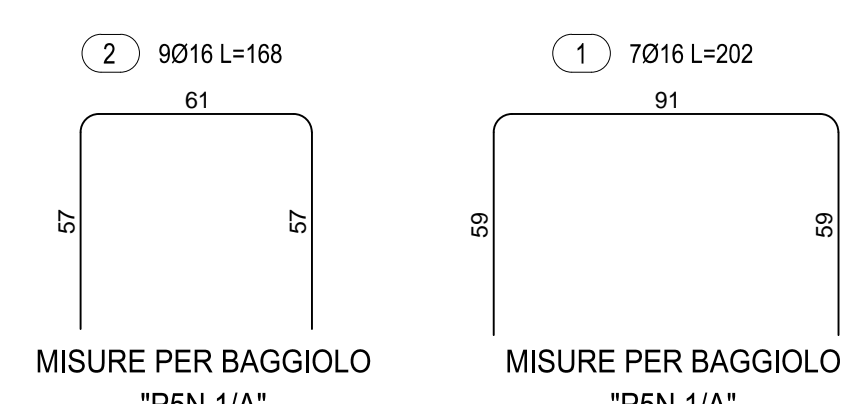
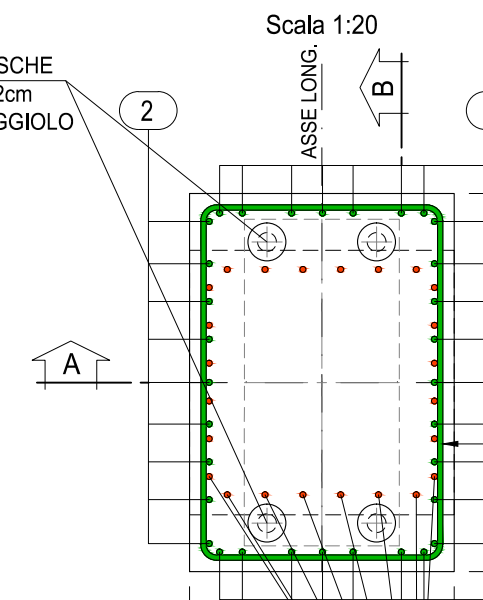

	HA (mm)	HC (mm)
APP. "P5N.1"	315	254

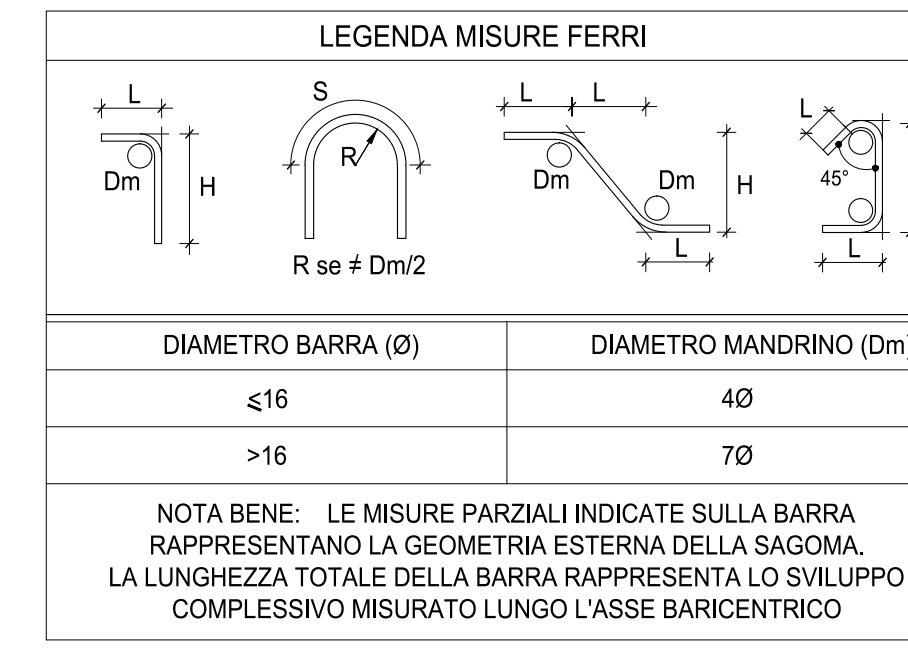
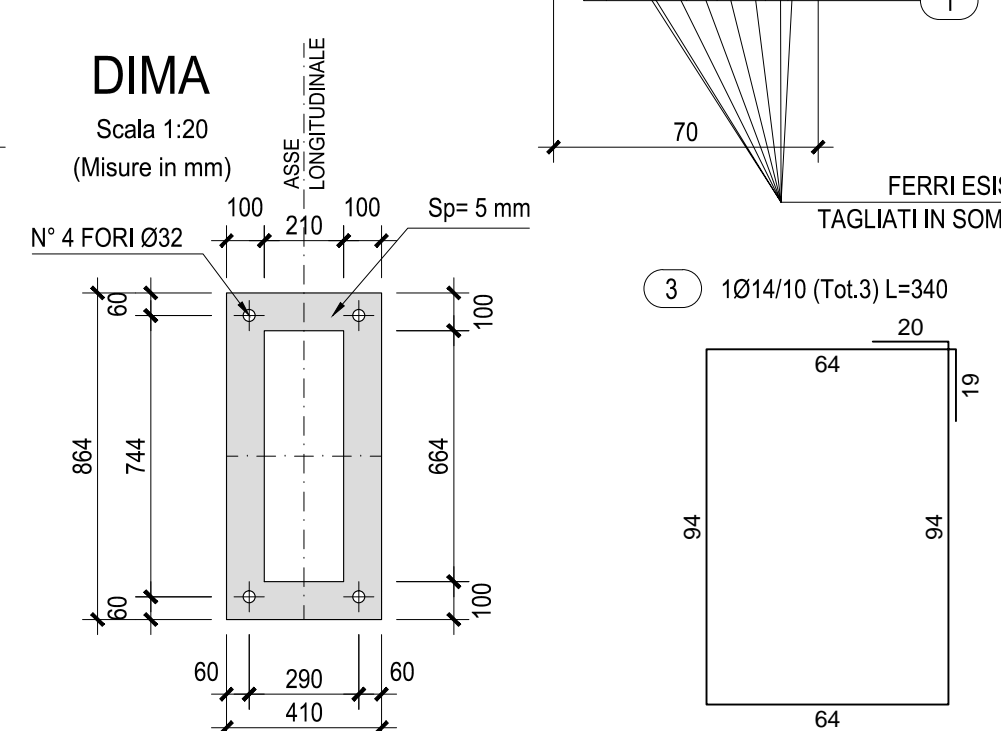

PILA "P4N.2"
ARMATURA BAGGIOLI "P4N.2/A" - "P4N.2/C"

SEZIONE TRASVERSALE

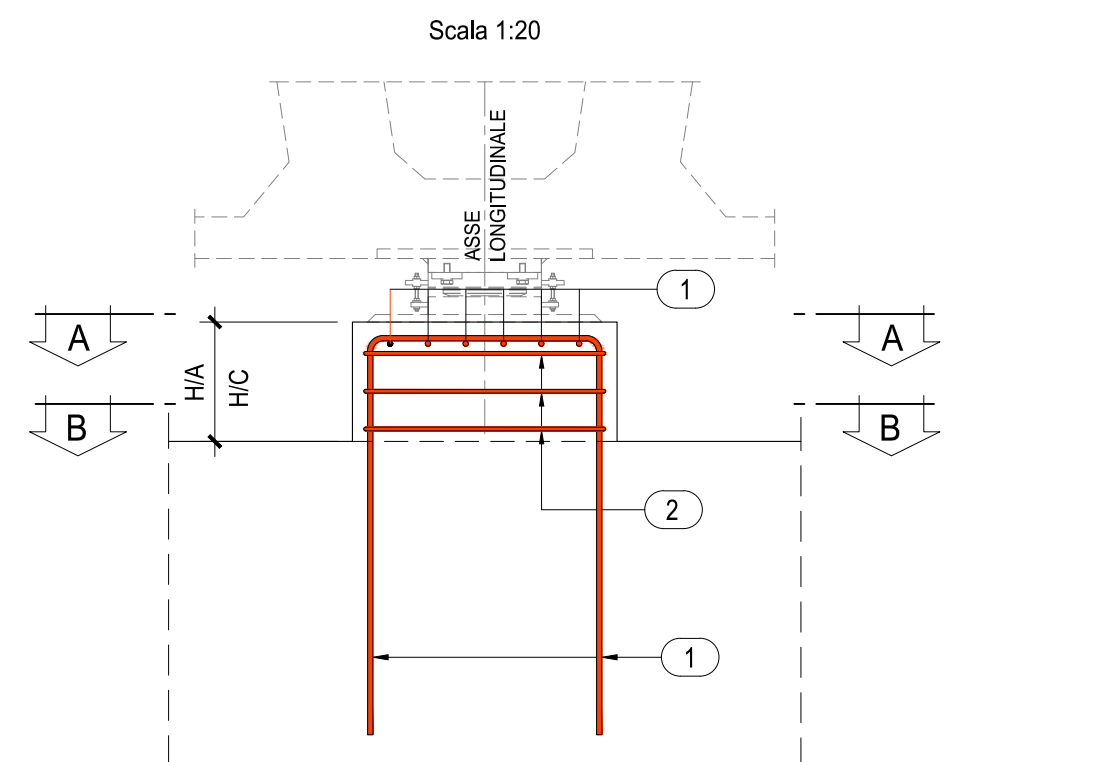

	HA (mm)	HC (mm)
APP. "P4N.2"	474	357

SEZIONE ORIZZONTALE A-A

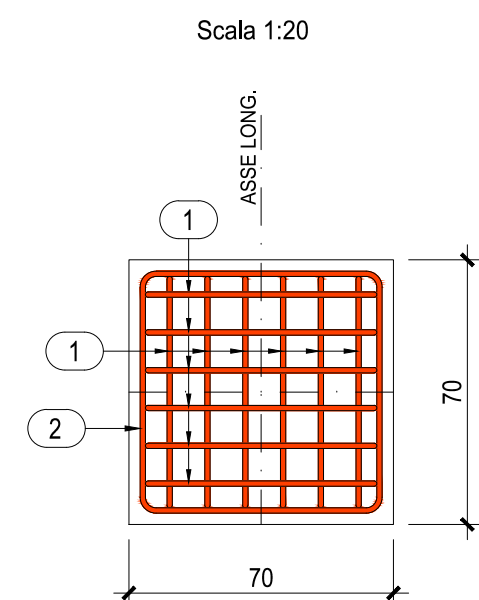

SEZIONE ORIZZONTALE B-B

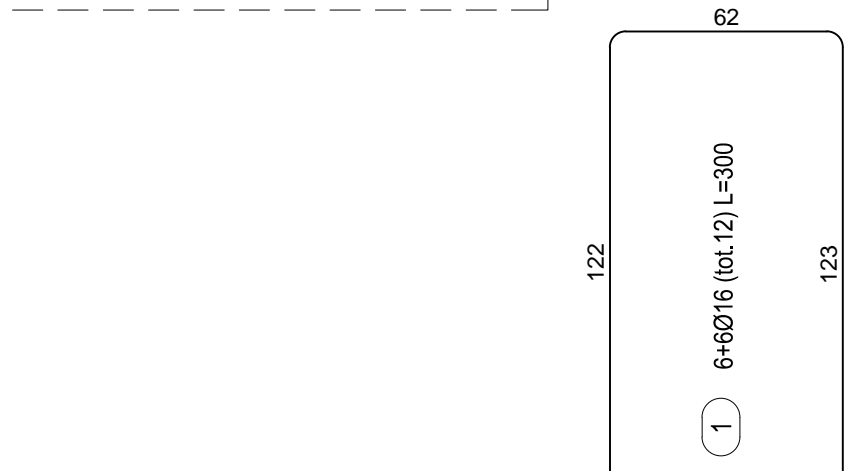
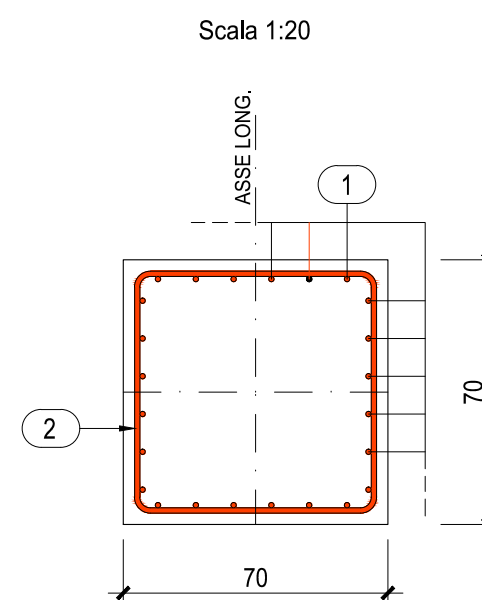

SEZIONE A-A

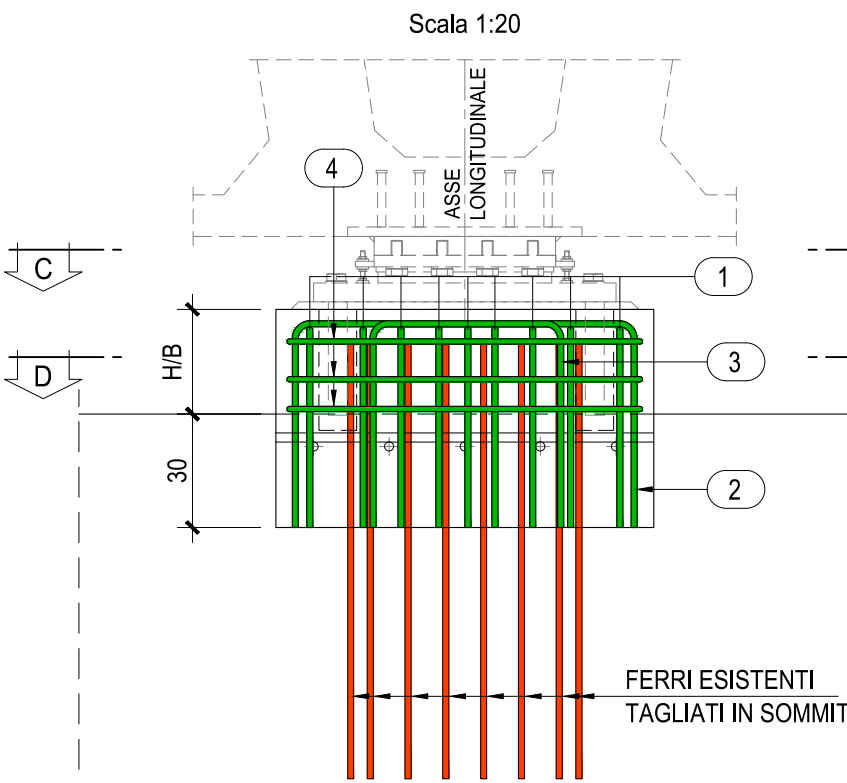

SEZIONE B-B

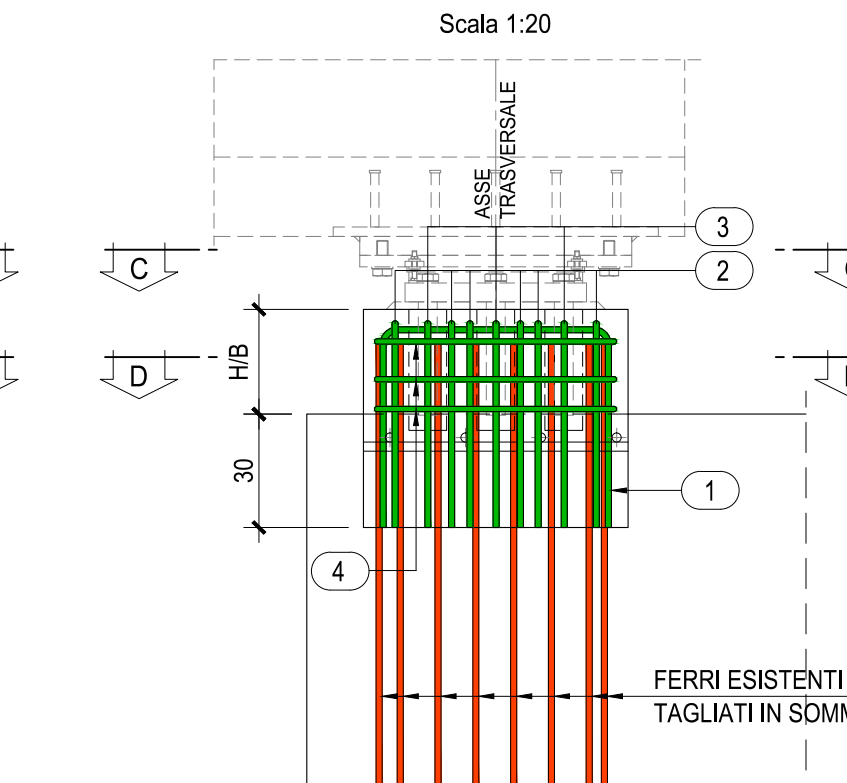

SEZIONE ORIZZONTALE C-C

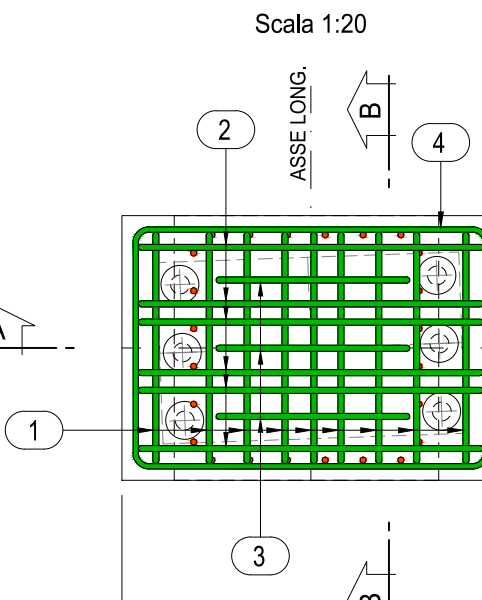

SEZIONE ORIZZONTALE D-D

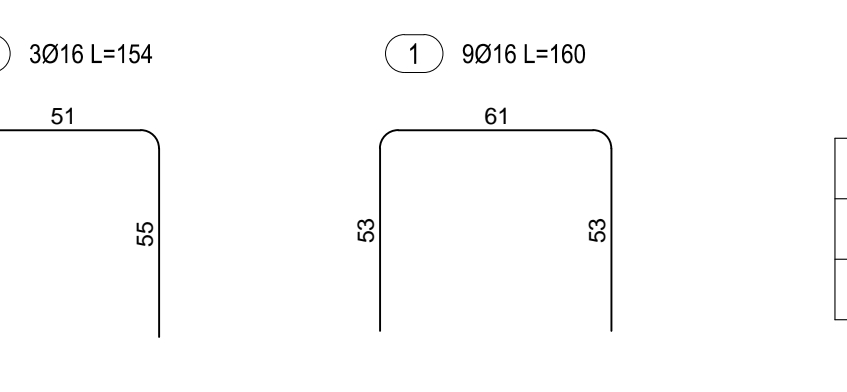
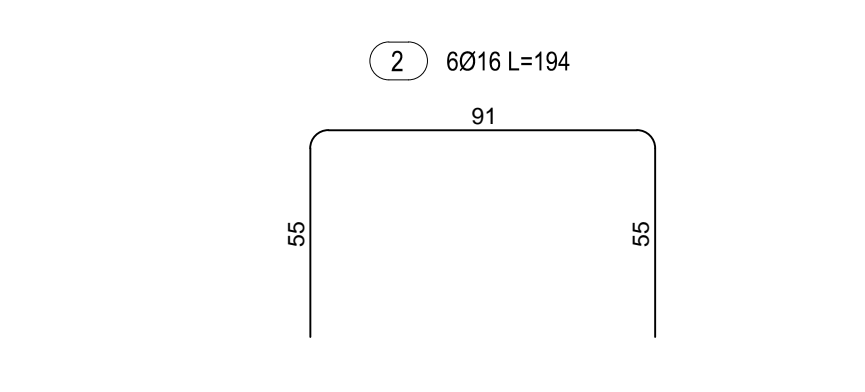
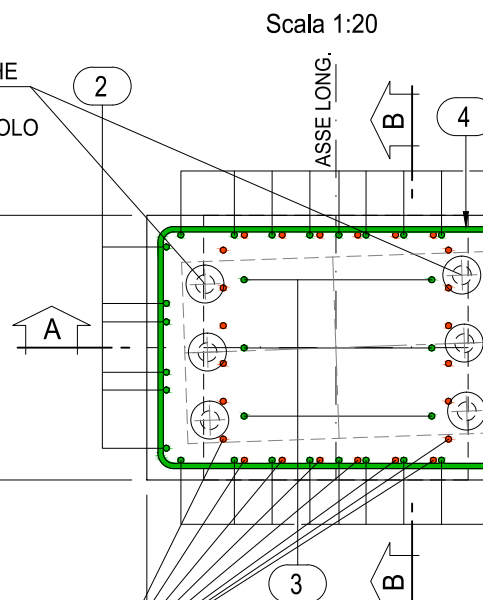

	HB (mm)
APP. "P5N.1"	271
APP. "P6N.1"	277
APP. "P7N.1"	273

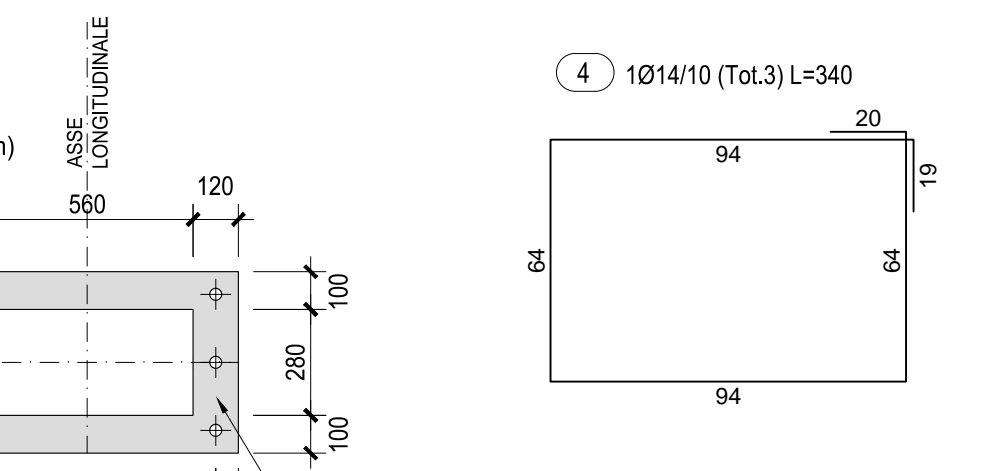

PILA "P4N.2"
ARMATURA BAGGIOLI "P4N.2/B"

SEZIONE A-A

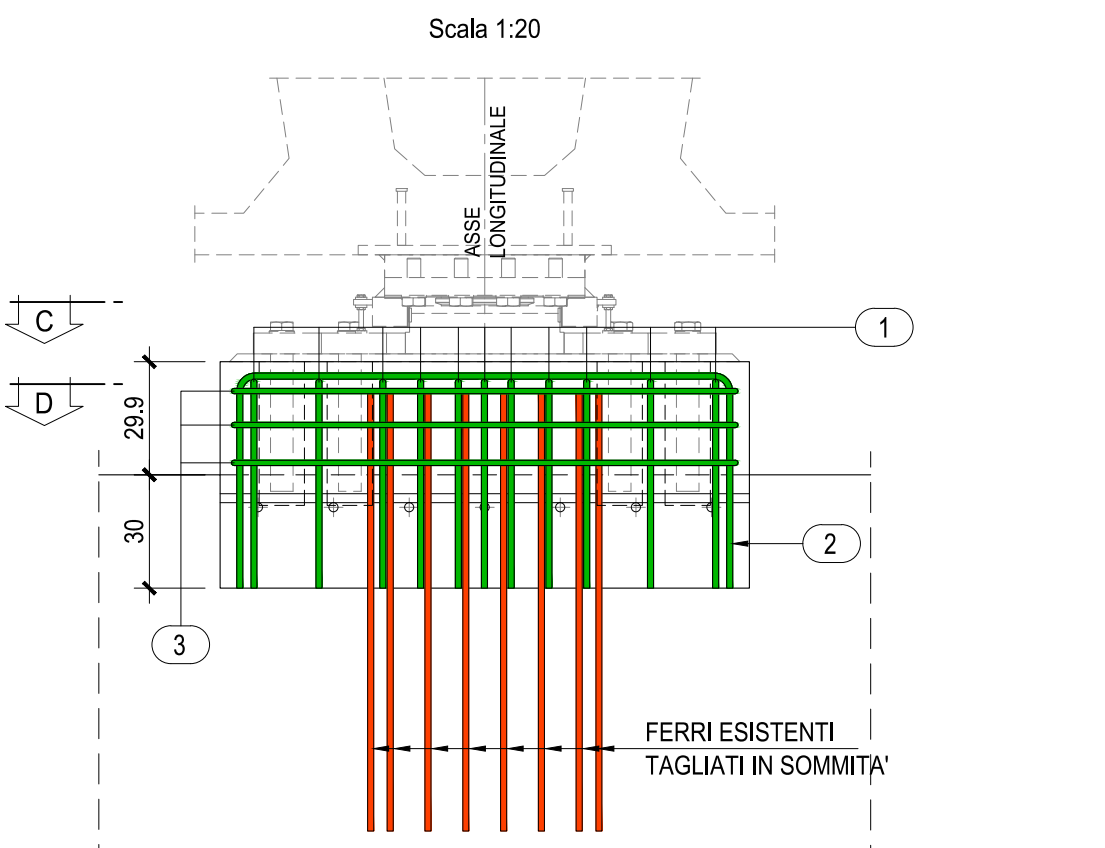

SEZIONE B-B

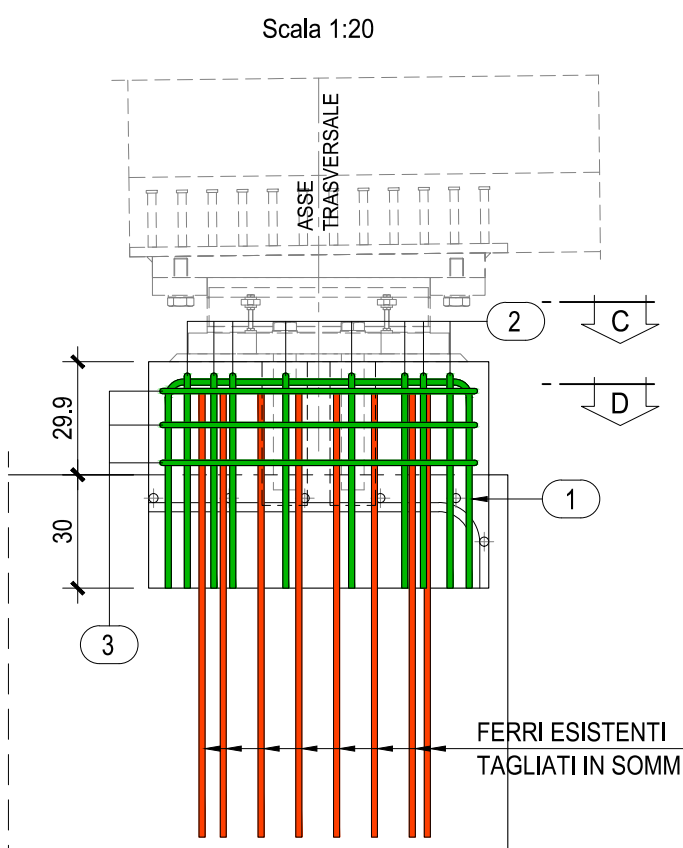

SEZIONE ORIZZONTALE C-C

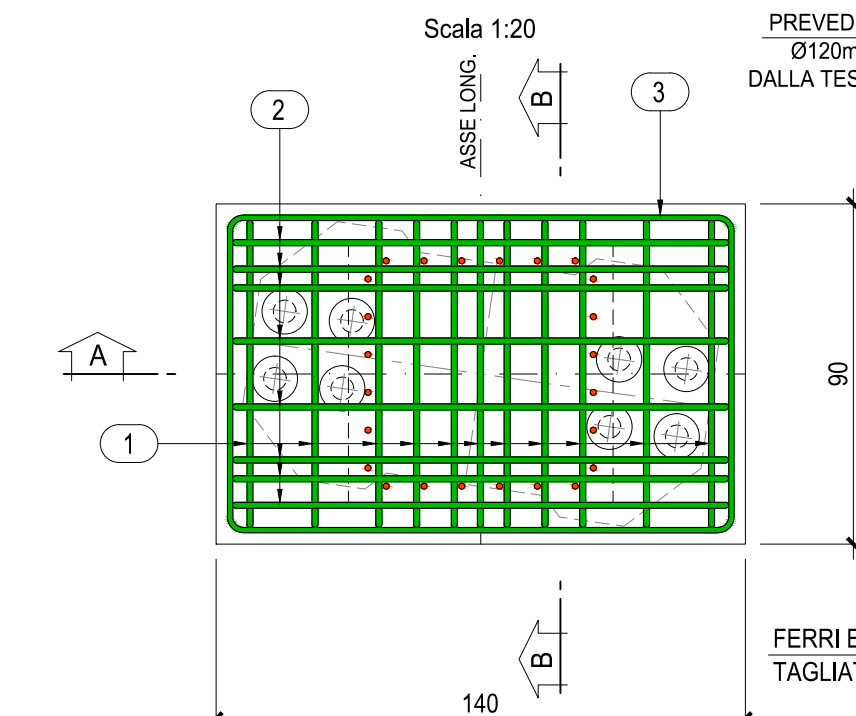

SEZIONE ORIZZONTALE D-D

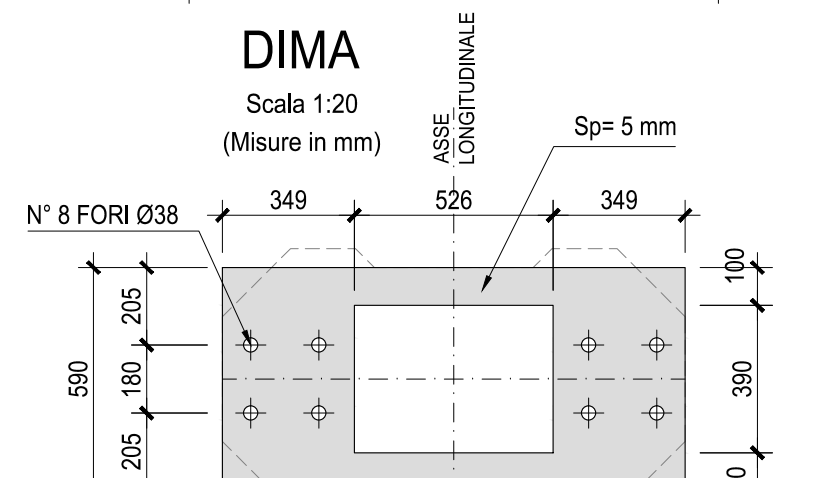
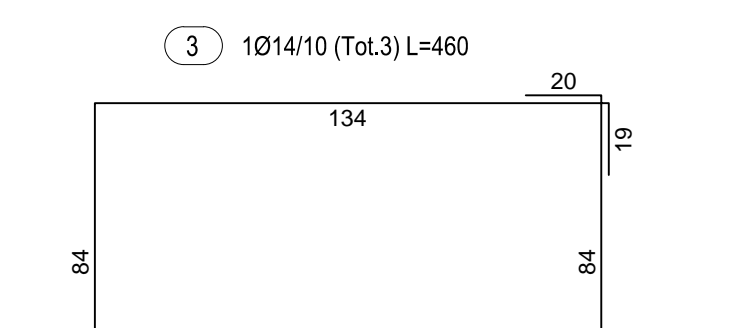
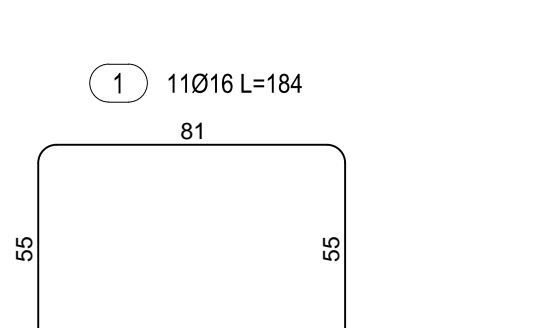
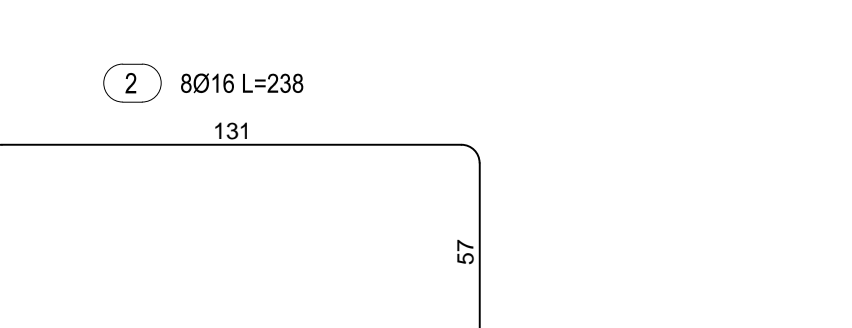
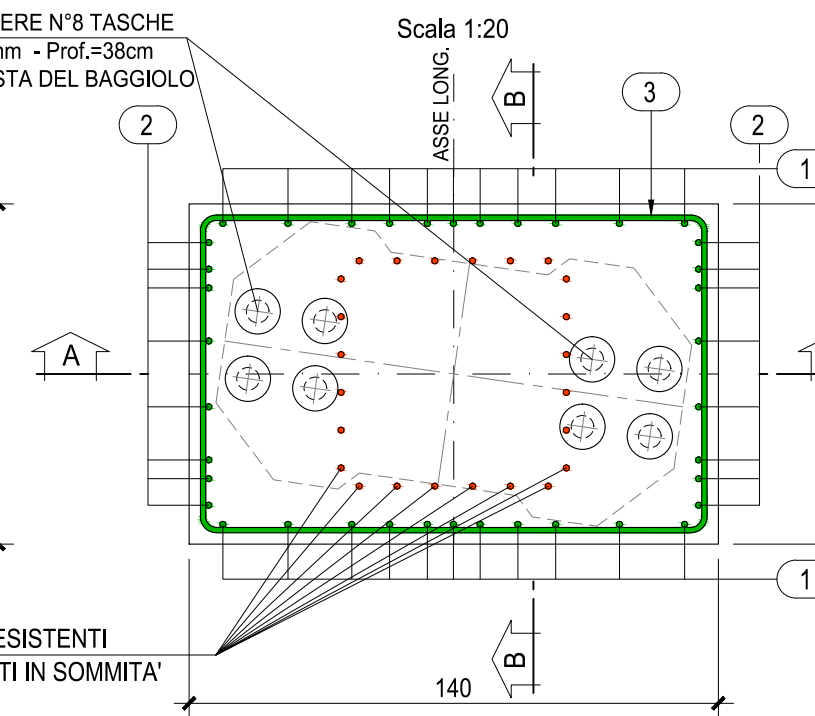

SEZIONE TRASVERSALE

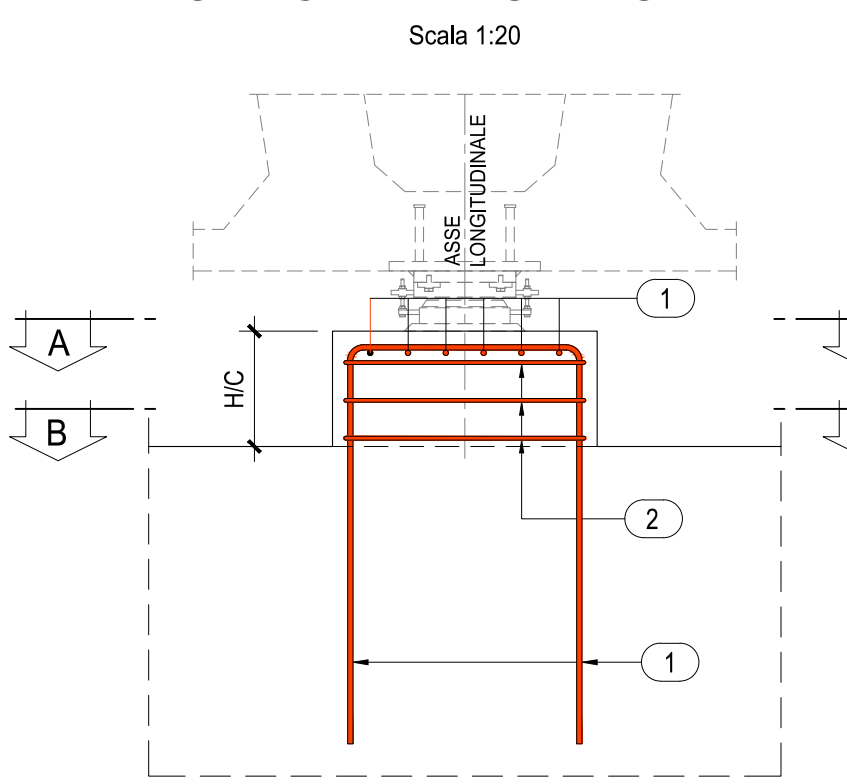

	HC (mm)
APP. "P5N.2"	304
APP. "P6N.2"	305
APP. "P7N.2"	305

SEZIONE ORIZZONTALE A-A

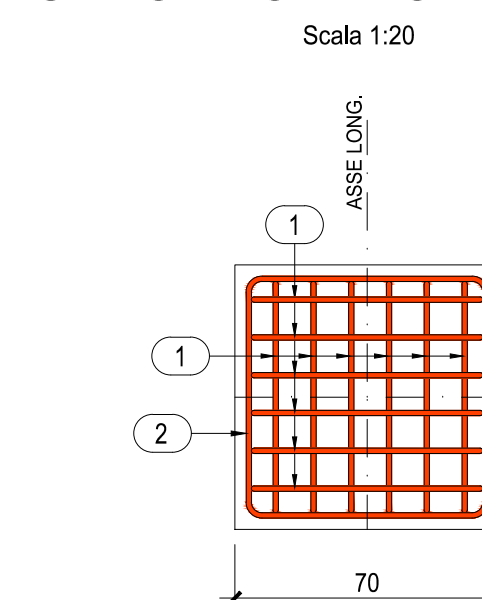

SEZIONE ORIZZONTALE B-B

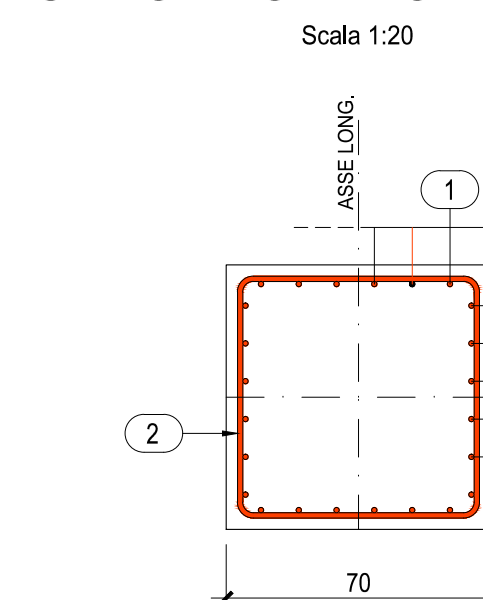

ANAS S.p.A.
Direzione Progettazione e Realizzazione Lavori

VARIANTE ALLA S.S.1 AURELIA (AURELIA BIS)
VIABILITA' DI ACCESSO ALL' HUB PORTUALE DI LA SPEZIA
INTERCONNESSIONE TRA I CASELLI DELLA A-12 E IL PORTO DI LA SPEZIA
3° LOTTO TRA FELETTINO E IL RACCORDO AUTOSTRADALE

PROGETTO ESECUTIVO DI STRALCIO E COMPLETAMENTO C - 3° TRATTO
PROGETTO ESECUTIVO **GE265**

CESI Direzione Area Energia
TECHINT Engineering & Construction
LEGGO Direzione Area Energia

VISTO IL RESPONSABILE DEL PROCEDIMENTO: Ing. Fabrizio CARONE
RESPONSABILE DELL'INTEGRAZIONE DELLE PRESTAZIONI SPECIALISTICHE: Ing. Alessandro RONDINO
PROGETTISTA SPECIALISTA: Ing. Paolo Alberto COLETTI
IL COORDINATORE DELLA SICUREZZA IN FASE DI PROGETTAZIONE: Dst. Domenico TRABOLTI

OPERE MAGGIORI
SVINCOLO DI MELARA
VIADOTTO RAMPA "N"
ARMATURA BAGGIOLI PILE: "SPN" - "P3N" - "P4N" - "P5N" - "P6N" - "P7N" - TAV. 1/2

CODICE PROGETTO	NO. FILE	REVISIONE	SCALA
DPGE0265	0000_V04V112STRCA02_B	B	1:20

REV.	DESCRIZIONE	DATA	REDATTO	VERIFICATO	APPROVATO
C					
B	REVISIONE A SEGUITO ISTRUTTORIA ANAS	Ottobre 2021	G. Naretto	A. Rodino	D. Morgera
A	EMMISSIONE	Marzo 2021	G. Naretto	A. Rodino	D. Morgera