

TRJHT27PDP - Vista frontale

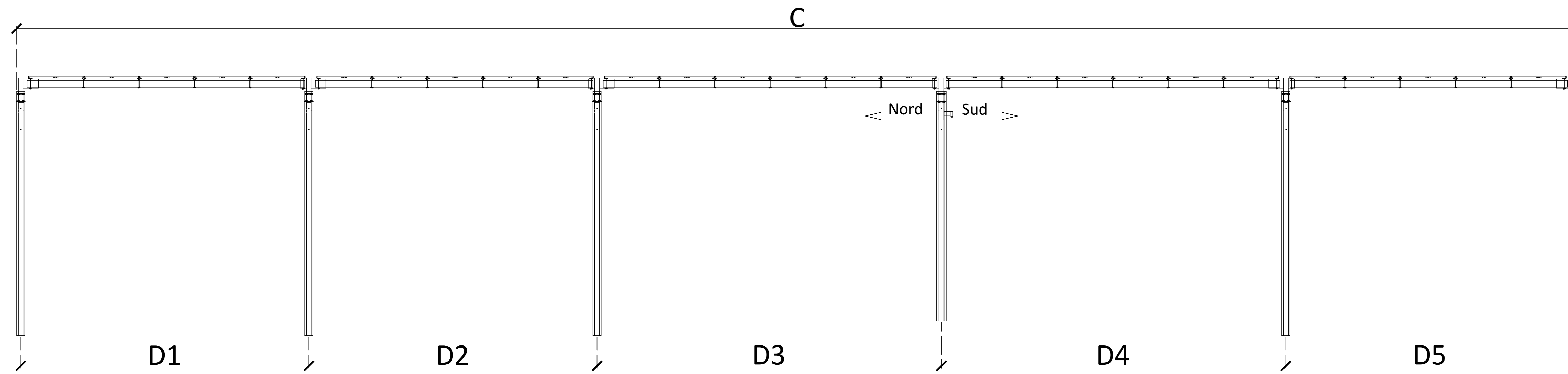

TRJHT27PDP - Vista superiore

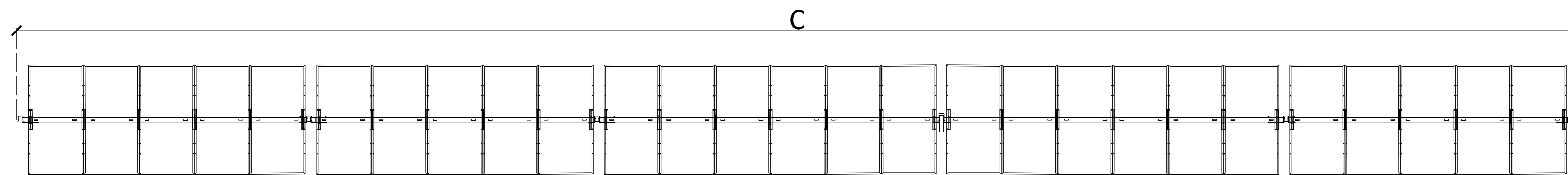

MODULO FOTOVOLTAICO  
JA SOLAR\_JAM 72D30\_545 Wp

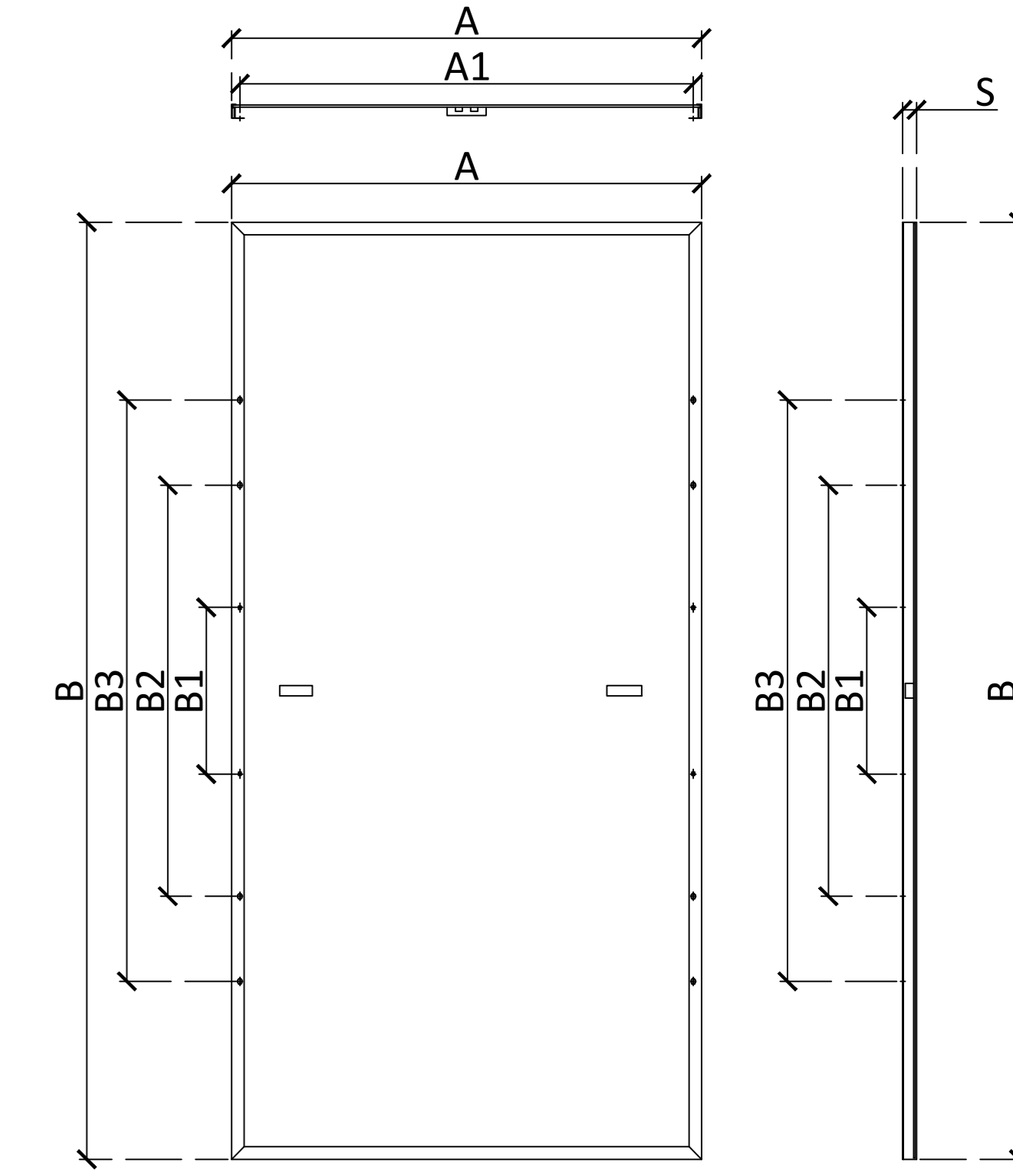

DIMENSIONI APPROSSIMATIVE [mm]

A	1134	E*	1800
A1	1098	H	3435
A2	-	H1	3635
B	2285	H2	3700
B1	400	H3	4571
B2	1300	Hm	2700
B3	1600	C1	-
S	35	D1	5970
C	32500	D2	5970
D3	7120	D4	7120
D5	5970	-	-
-	-	-	-

TRJHT27PDP  
VISTA LATERALE @ 0°

TRJHT27PDP  
VISTA LATERALE @ 55°

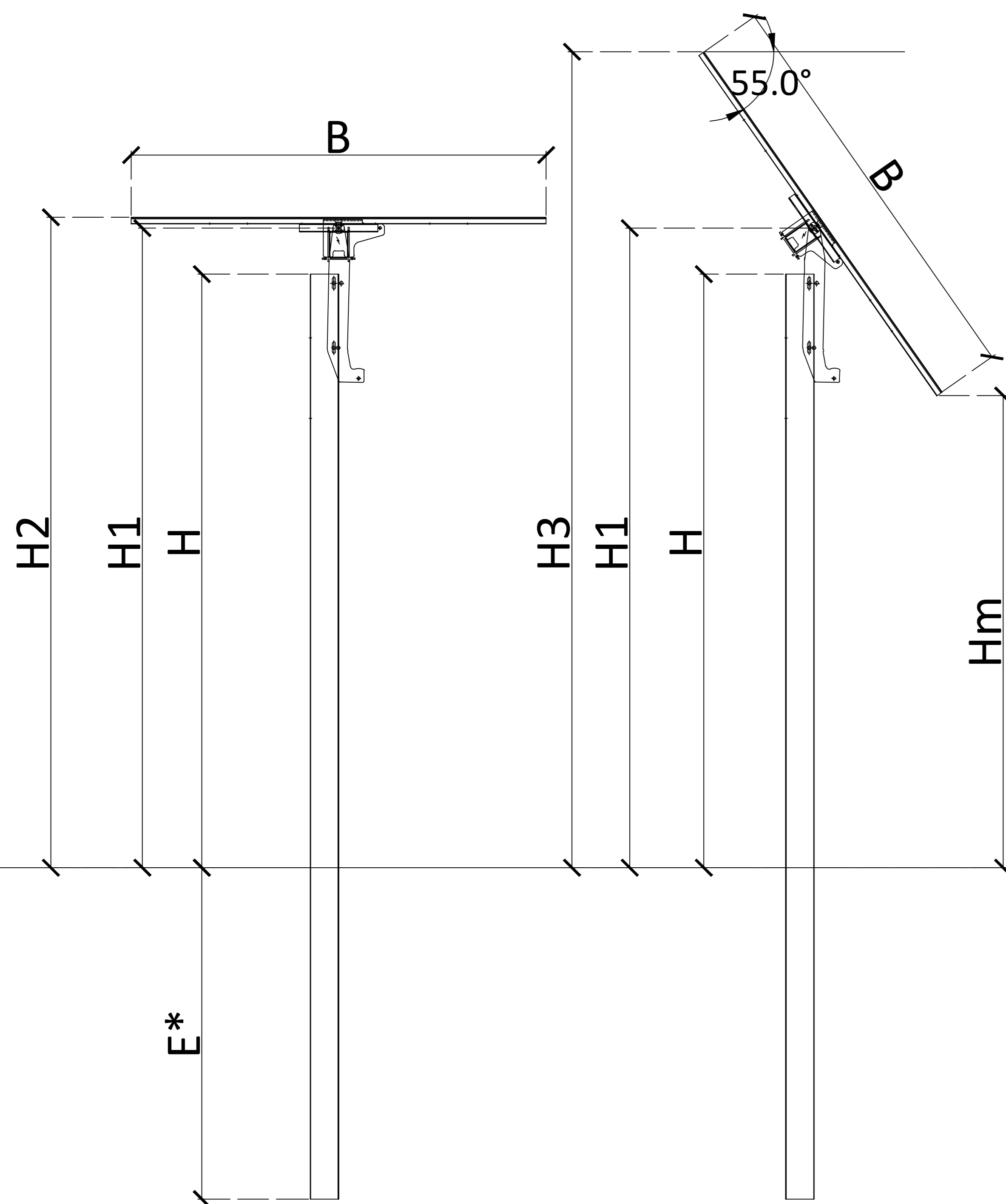

RICUPERO DELL'ERRORE DI TORSIONE DEL FONDAMENTO

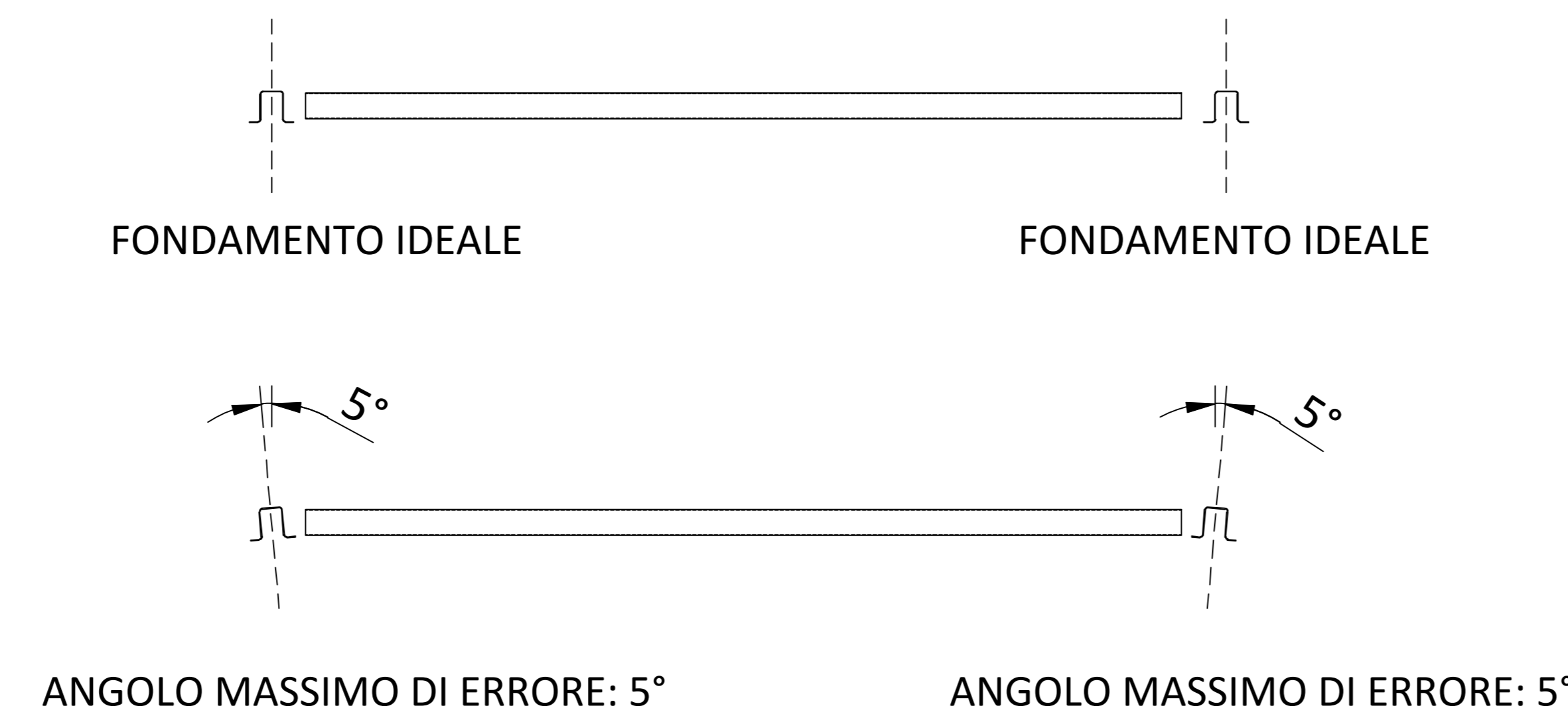

RICUPERO DELL'ERRORE DELL'ANGOLO DEL FONDAMENTO

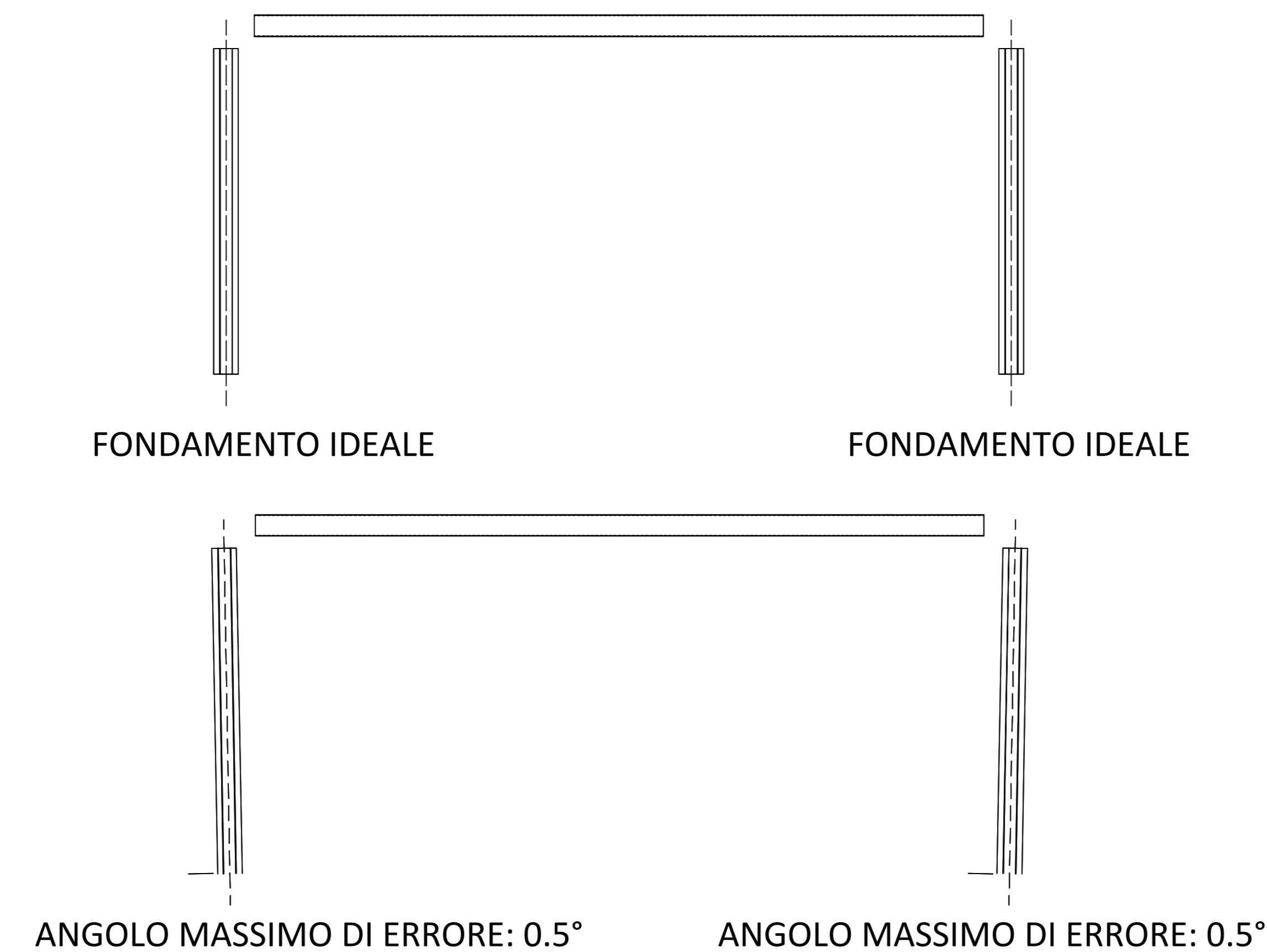

SPAZIATURA TAVOLE PV  
VALORE NOMINALE SOGGETTO A CAMBIO PER VALORI DI TOLLERANZE

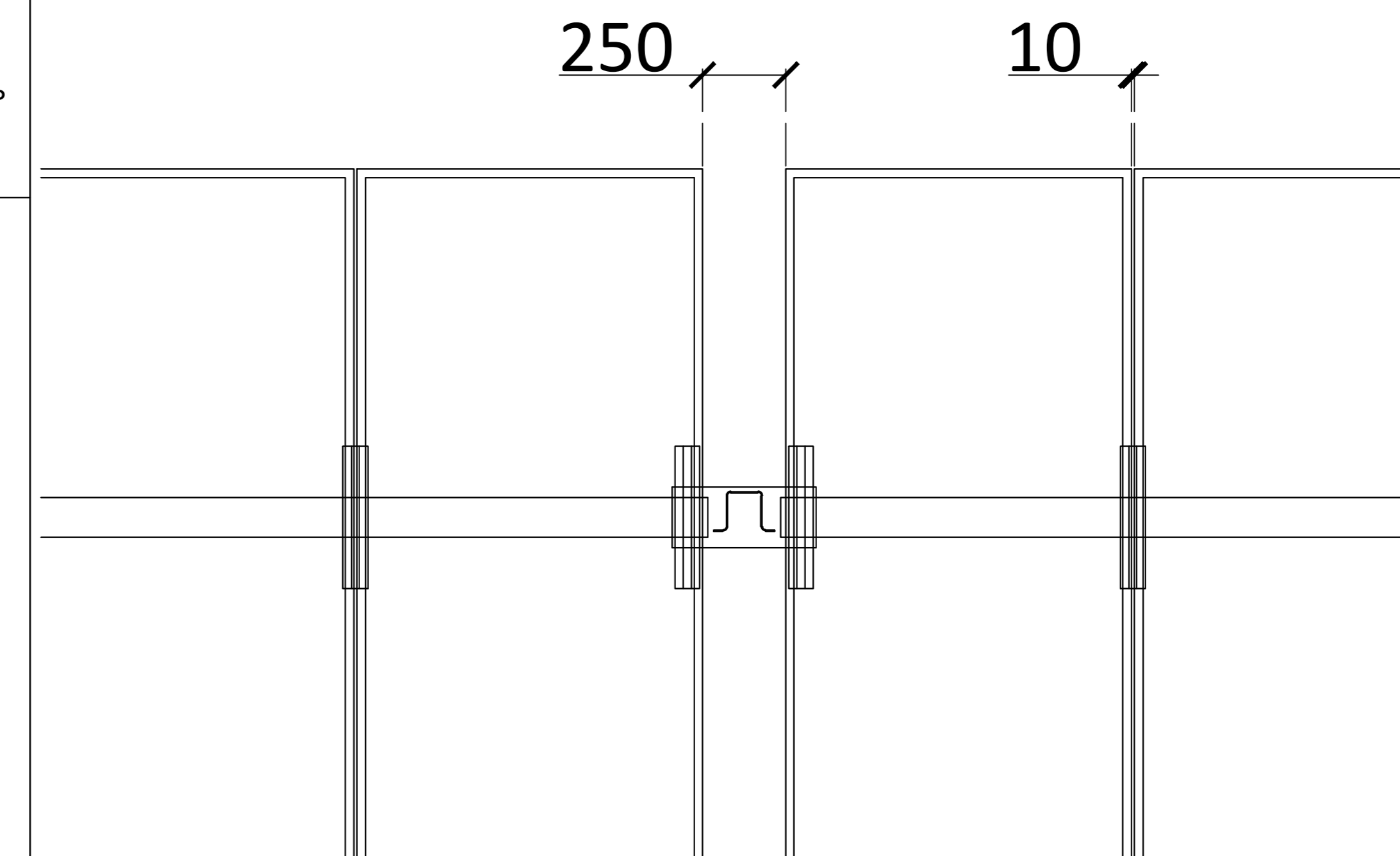

PROGETTO DEFINITIVO

DETTAGLI COSTRUTTIVI TRACKER

Tipo Elaborato	Codice Elaborato	Data	Scala CAD	Formato	Foglio / di	Scala
TAV.	2102_T.P.14	05/04/2023	VARIE	A0	1/1	VARIE

<b>PROPONENTE</b>	<b>SVILUPPO</b>
EF AGRI Società Agricola A R.L. Via del Brennero, 111 38121 - Trento (TN)	SET SVILUPPO s.r.l. Corso Trieste, 10 00198 - Roma (RM)

<b>PROGETTAZIONE</b>	
Ing. Giacomo Greco GIACOMO GRECO Ingegnere C.A.P. 01/04/1981 C.A.A. 01/04/1981	Ing. Marco Marsico MARCO MARSICO Ingegnere C.A.P. 01/04/1981 C.A.A. 01/04/1981

Rev.	Data	Descrizione	Redatto	Verificato	Approvato
00	05/04/2023	Prima Emissione	Ing. M. Marsico	Ing. G. Greco	Ing. M. Marsico