

NUOVA LINEA TORINO LIONE - NOUVELLE LIGNE LYON TURIN  
PARTE COMUNE ITALO-FRANCESE - PARTIE COMMUNE FRANCO-ITALIENNE

LOTTO COSTRUTTIVO 1 / LOT DE CONSTRUCTION 1  
CANTIERE OPERATIVO 02C / CHANTIER DE CONSTRUCTION 02C  
RILOCALIZZAZIONE DELL'AUTOPORTO DI SUSA  
DEPLACEMENT DE L'AUTOPORTO DE SUSE  
PROGETTO ESECUTIVO - ETUDES D'EXECUTION  
CUP C11J05000030001 - CIG 682325367F

PROGETTO STRADALE

Quaderno delle sezioni - Rampe di svincolo

Indice	Date / Data	Modifications / Modifiche	Etabli par / Concepito da	Vérifié par / Controllato da	Autorisé par / Autorizzato da
0	30/04/2017	Prima emissione Première diffusion	G. QUARANTA (MUSINET ENG.)	L. BARBERIS (MUSINET ENG.)	F. D'AMBRA (MUSINET ENG.)
B	30/04/2018	Recepimento istruttoria validazione RINA Check	R. BOERO (MUSINET ENG.)	L. BARBERIS (MUSINET ENG.)	C. GIOVANNETTI (MUSINET ENG.)
C	15/07/2020	Variatione geometria svincolo	G. QUARANTA (MUSINET ENG.)	L. BARBERIS (MUSINET ENG.)	L. BARBERIS (MUSINET ENG.)
D	15/09/2021	Variatione rampe svincolo	G. QUARANTA (MUSINET ENG.)	L. BARBERIS (MUSINET ENG.)	L. BARBERIS (MUSINET ENG.)

1	0	C	C	1	6	1	6	7	N	V	A	0	R	G
Lot. Cos. Lot. Con.	Cantiere operativo/ chantier de construction	Contratto/Contrat						Opera/Oeuvre			Tratto Tronçon	Parte Partie		

E	G	C	P	L	0	1	3	1	D
Fase Phase	Tipo documento Type de document	Oggetto Object			Numero documento Numéro de document		Indice Index		

SCALA / ÉCHELLE

1:200

IL PROGETTISTA/LE DESIGNER



Dott. Arch. Corrado GIOVANNETTI  
Albo di Torino  
N° 2736

L'APPALTATORE/L'ENTREPRENEUR

IL DIRETTORE DEI LAVORI/LE MAÎTRE D'ŒUVRE

# Uscita A32 Torino Autoporto – Rampa 1

## KEY PLAN

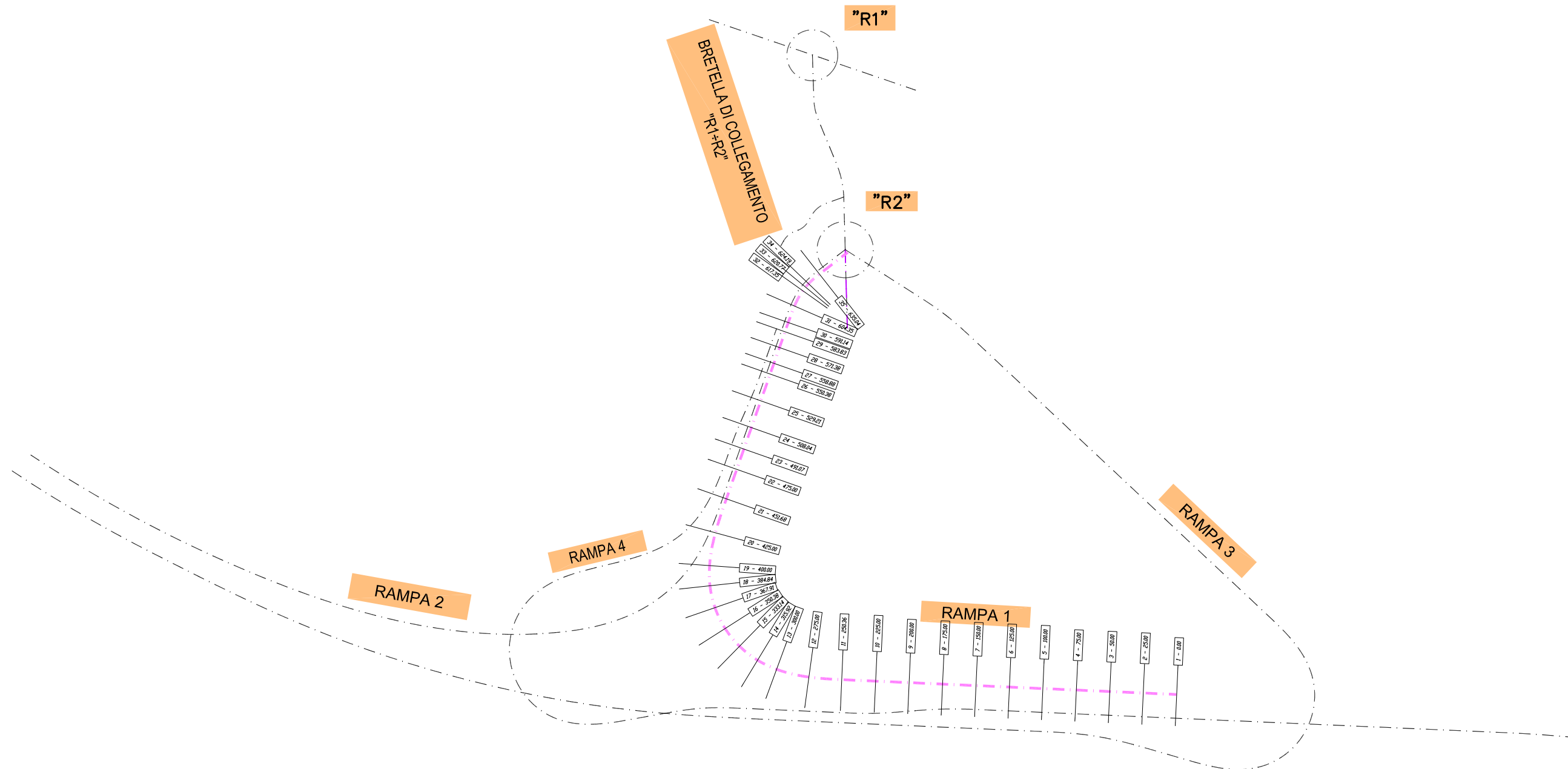

PROFILO TO-SV\_MM1

SEZIONE 1

PROGRESSIVA 0.00

STERRI E RIPORTI	2.87 mq.
S1 STABILIZZATO	0.90 mq.
DI CEMENTATO	0.82 mq.
E1 BASE	0.29 mq.
F1 VEGETALE	0.60 mq.
GI GEORIGLIA 28KN/m	4.68 ml.
CI IDROSEMINA	1.49 ml.
e1 USURA	3.69 ml.
f1 BINDER	3.19 ml.
g1	

390.00  
 200  
 200

PROGRESSIVE TERRENO					
PARZIALI TERRENO					
QUOTE TERRENO					
PROGRESSIVE PROGETTO					
PARZIALI PROGETTO					
QUOTE PROGETTO					

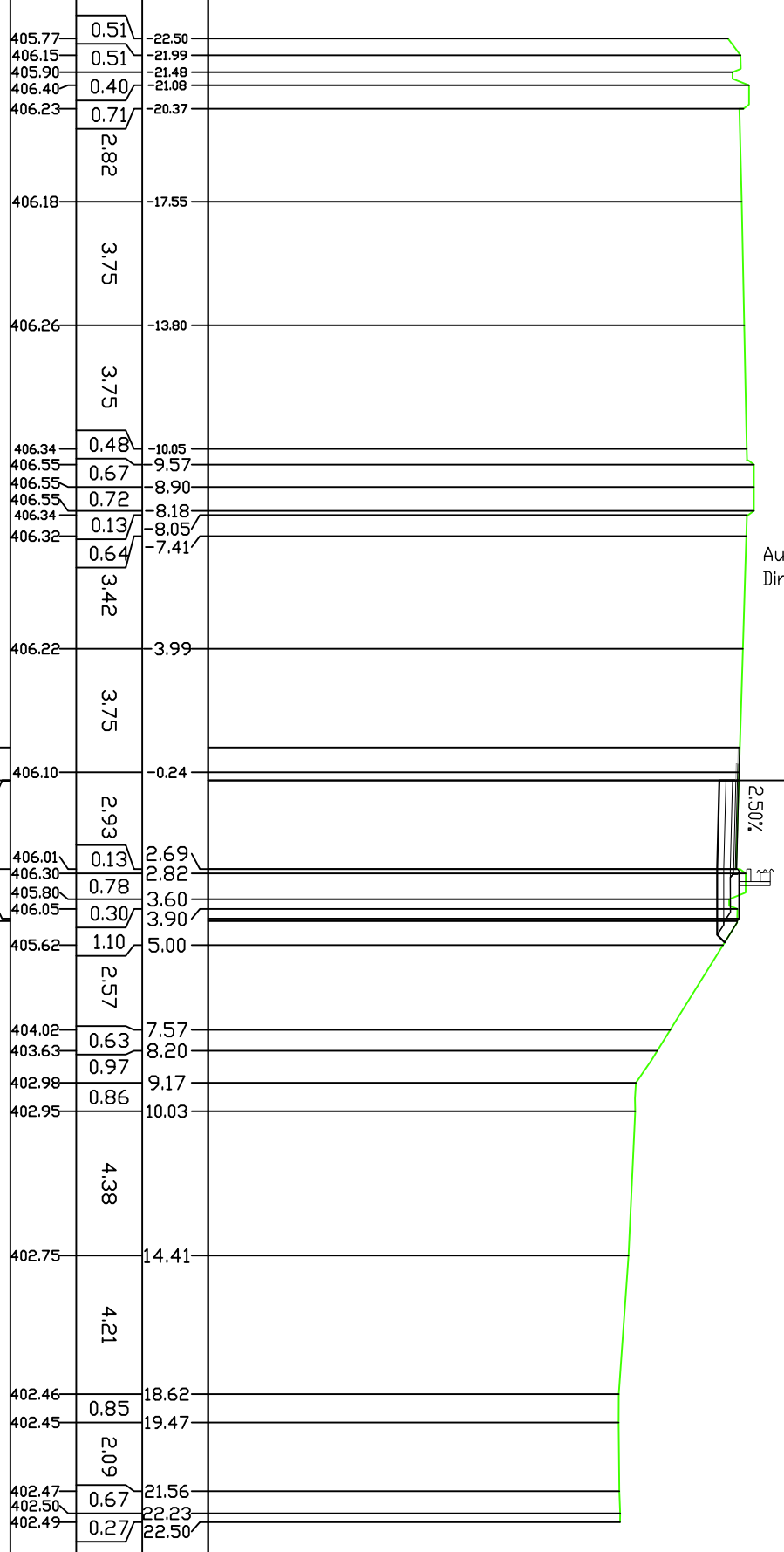

Autostrada A32 - Salita  
 Direzione BARDONECCHIA

PROFILO TO-SV\_MM1

SEZIONE 2

PROGRESSIVA 25.00

STERRI E RIPORTI	
S1	2,97 mq.
S2	0,01 mq.
Totale S:	2,98 mq.
R1	0,00 mq.
R2	1,10 mq.
Totale R:	1,10 mq.
SCOTTICI	0,63 mq.
A1	0,95 mq.
BONIFICA	0,95 mq.
B1	1,26 mq.
BONIFICA PROFONDA	1,26 mq.
C1	1,04 mq.
STABILIZZATO	1,04 mq.
D1	0,96 mq.
CEMENTATO	0,96 mq.
E1	0,35 mq.
BASE	0,35 mq.
F1	1,87 mq.
VEGETALE	1,87 mq.
G1	4,15 ml.
TNT	3,15 ml.
a1	5,31 ml.
GEORIGLIA 10KN/m	4,17 ml.
b1	7,16 ml.
GEORIGLIA 28KN/m	4,31 ml.
c1	4,31 ml.
GRADINATURA	3,81 ml.
d1	
IDROSEMINA	
e1	
USURA	
f1	
BINDER	
g1	

390.00  
 200  
 200

PROGRESSIVE TERRENO			
PARZIALI TERRENO			
QUOTE TERRENO			
PROGRESSIVE PROGETTO			
PARZIALI PROGETTO			
QUOTE PROGETTO			

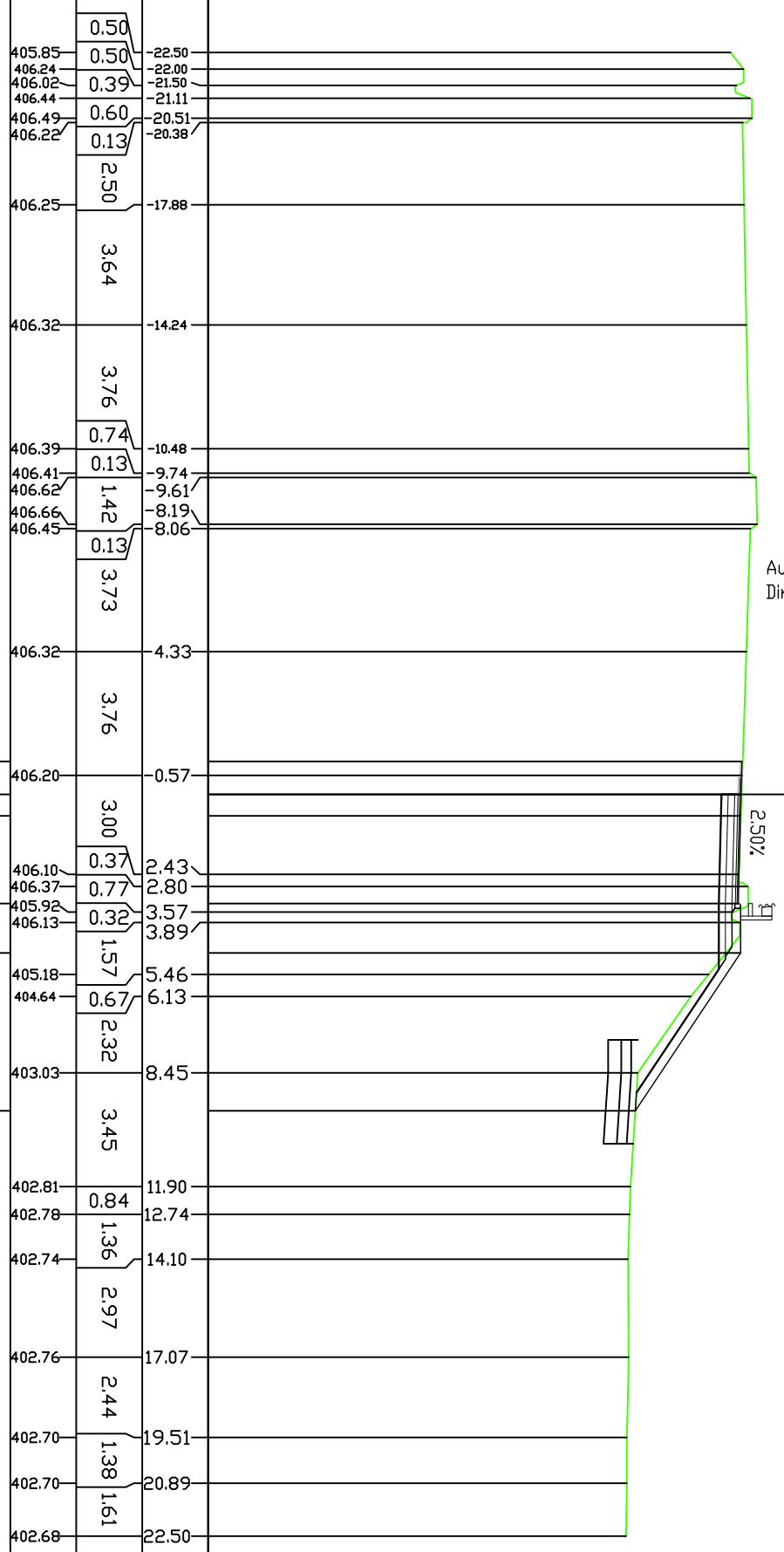

PROFILO TO-SV\_MM1

SEZIONE 3

PROGRESSIVA 50.00

STERRI E RIPORTI	
S1	2.88 mq.
S2	0.00 mq.
Totale S:	2.88 mq.
R1	0.00 mq.
R2	5.60 mq.
Totale R:	5.60 mq.
SCOTTICI	1.00 mq.
A1	1.00 mq.
BONIFICA	
B1	1.51 mq.
BONIFICA PROFONDA	
C1	2.01 mq.
STABILIZZATO	
D1	1.32 mq.
CEMENTATO	
E1	1.26 mq.
BASE	
F1	0.49 mq.
VEGETALE	
G1	1.97 mq.
TNT	
a1	6.02 ml.
GEORIGLIA 10KN/m	
b1	5.02 ml.
GEORIGLIA 28KN/m	
c1	6.76 ml.
GRADINATURA	
d1	4.17 ml.
IDROSEMINA	
e1	7.46 ml.
USURA	
f1	5.77 ml.
BINDER	
g1	5.27 ml.

390.00  
 200  
 200

PROGRESSIVE TERRENO			
PARZIALI TERRENO			
QUOTE TERRENO			
PROGRESSIVE PROGETTO			
PARZIALI PROGETTO			
QUOTE PROGETTO			

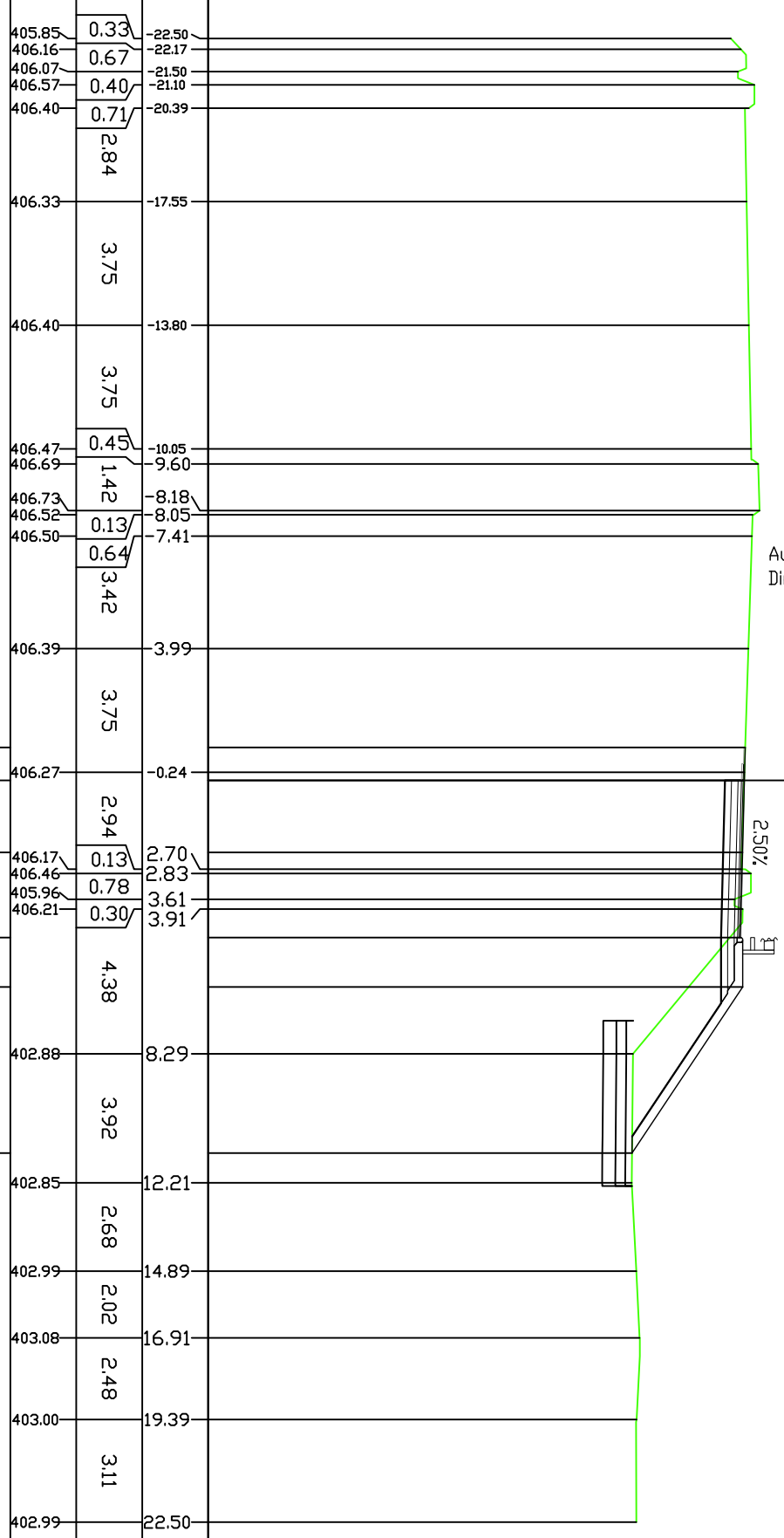

405.85	0.33	-22.50
406.16	0.67	-22.17
406.07	0.40	-21.50
406.57	0.40	-21.10
406.40	0.71	-20.39
	2.84	
406.33		-17.55
	3.75	
406.40		-13.80
	3.75	
406.47	0.45	-10.05
406.69	1.42	-9.60
406.73	0.13	-8.18
406.52	0.13	-8.05
406.50	0.64	-7.41
	3.42	
406.39		3.99
	3.75	
406.29	1.00	-1.00
406.27	2.19	0.00
406.21	2.58	2.19
406.15	1.50	4.77
406.22	5.04	6.27
402.88		8.29
	3.92	
402.86		11.31
	2.68	
402.99	2.02	14.89
403.08	2.48	16.91
403.00	3.11	19.39
402.99		22.50

PROFILO TO-SV\_MM1

SEZIONE 4

PROGRESSIVA 75.00

STERRI E RIPORTI	
S1	2,89 mq.
S2	0,00 mq.
Totale S:	2,89 mq.
R1	0,00 mq.
R2	8,46 mq.
Totale R:	8,46 mq.
SCOTTICI	
A1	1,17 mq.
BONIFICA	
B1	1,79 mq.
BONIFICA PROFONDA	
C1	2,37 mq.
STABILIZZATO	
D1	1,58 mq.
CEMENTATO	
E1	1,49 mq.
BASE	
F1	0,63 mq.
VEGETALE	
G1	1,92 mq.
TNT	
a1	6,94 ml.
GEORIGLIA 10KN/m	
b1	5,94 ml.
GEORIGLIA 28KN/m	
c1	8,02 ml.
GRADINATURA	
d1	4,32 ml.
IDROSEMINA	
e1	7,30 ml.
USURA	
f1	7,03 ml.
BINDER	
g1	6,53 ml.

390.00  
 200  
 200

PROGRESSIVE TERRENO			
PARZIALI TERRENO			
QUOTE TERRENO			
PROGRESSIVE PROGETTO			
PARZIALI PROGETTO			
QUOTE PROGETTO			

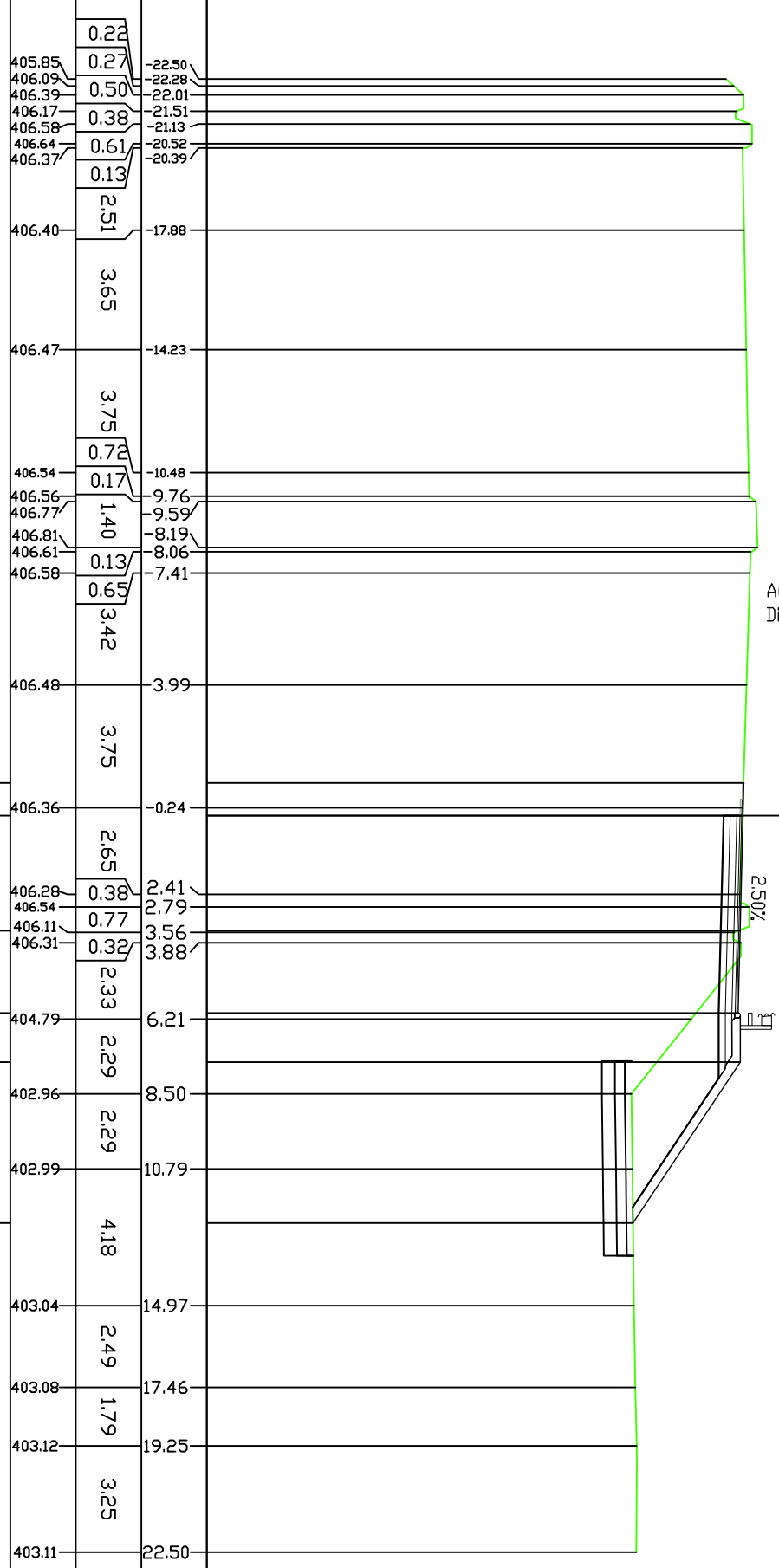

PROFILO TO-SV\_MM1

SEZIONE 5

PROGRESSIVA 100.00

STERRI E RIPORTI	
S1	2,93 mq.
S2	0,00 mq.
S3	0,00 mq.
Totale S:	
R1	2,93 mq.
SCOTTICO	8,35 mq.
A1	1,24 mq.
BNIFICA	1,88 mq.
B1	1,88 mq.
BNIFICA PROFONDA	2,49 mq.
C1	2,49 mq.
STABILIZZATO	1,62 mq.
D1	1,62 mq.
CEMENTATO	1,54 mq.
E1	1,54 mq.
BASE	0,65 mq.
F1	0,65 mq.
VEGETALE	1,88 mq.
G1	1,88 mq.
TNT	7,25 ml.
a1	7,25 ml.
GEOGRIGLIA 10KN/m	6,25 ml.
b1	6,25 ml.
GEOGRIGLIA 28KN/m	8,24 ml.
c1	8,24 ml.
GRADINATURA	3,97 ml.
d1	3,97 ml.
IDROSEMINA	7,12 ml.
e1	7,12 ml.
USURA	7,25 ml.
f1	7,25 ml.
BINDER	6,75 ml.
g1	6,75 ml.

390.00  
 200  
 200

PROGRESSIVE TERRENO			
PARZIALI TERRENO			
QUOTE TERRENO			
PROGRESSIVE PROGETTO			
PARZIALI PROGETTO			
QUOTE PROGETTO			

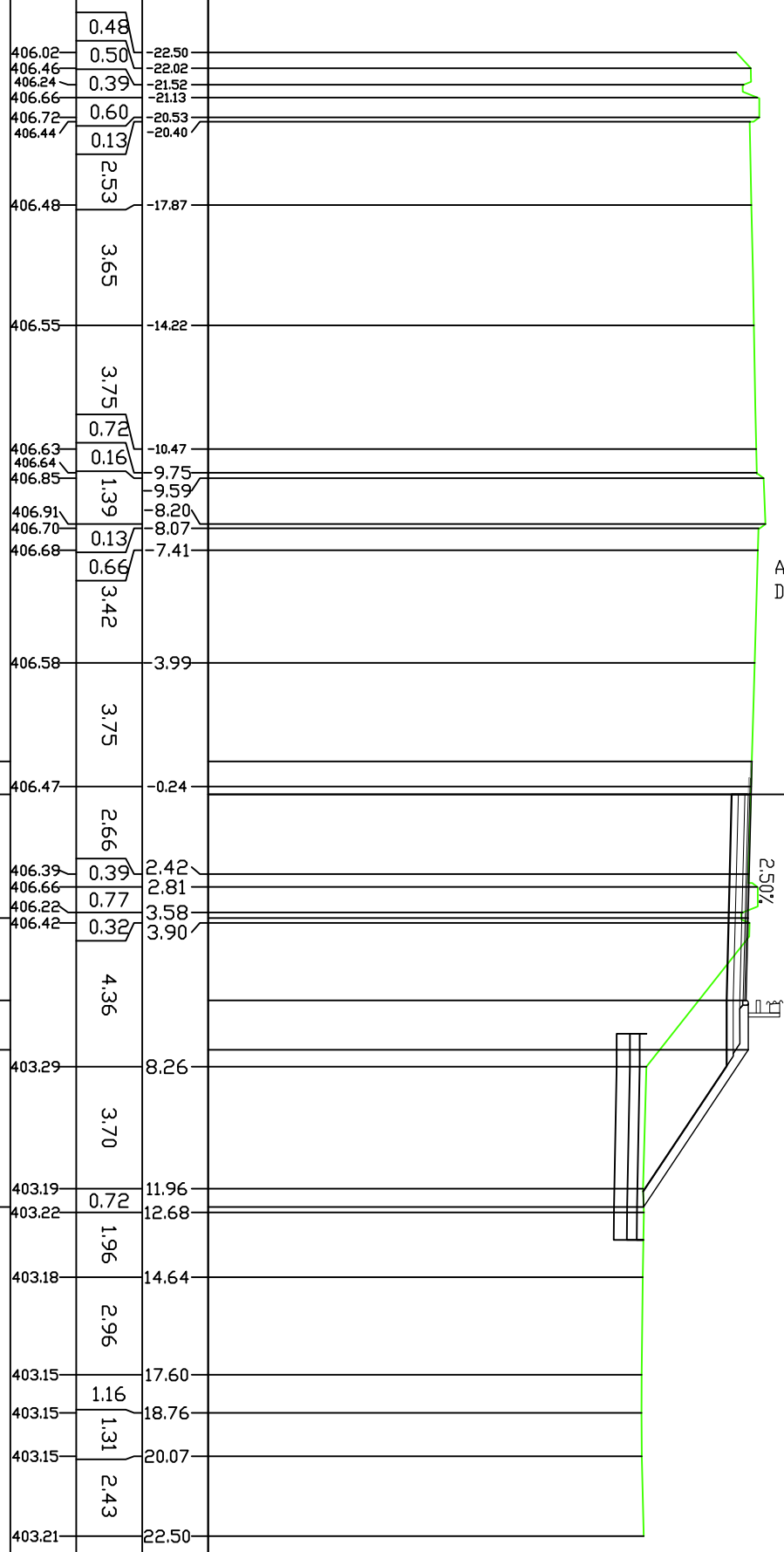

PROFILO TO-SV\_MM1

SEZIONE 6

PROGRESSIVA 125.00

STERRI E RIPORTI	
S1	2,89 mq.
R1	0,00 mq.
R2	0,00 mq.
R3	8,43 mq.
Totale R: 8,43 mq.	
SCULTO	
A1	1,27 mq.
BONIFICA	
B1	1,87 mq.
BONIFICA PROFONDA	
C1	2,53 mq.
STABILIZZATO	
D1	1,62 mq.
CEMENTATO	
E1	1,54 mq.
BASE	
F1	0,64 mq.
VEGETALE	
G1	1,86 mq.
TNT	
a1	7,29 ml.
GEOGRIGLIA 10KN/m	
b1	6,29 ml.
GEOGRIGLIA 28KN/m	
c1	8,24 ml.
GRADINATURA	
d1	3,93 ml.
IDROSEMINA	
e1	7,06 ml.
USURA	
f1	7,25 ml.
BINDER	
g1	6,75 ml.

390.00  
 200  
 200

PROGRESSIVE TERRENO				
PARZIALI TERRENO				
QUOTE TERRENO				
PROGRESSIVE PROGETTO				
PARZIALI PROGETTO				
QUOTE PROGETTO				

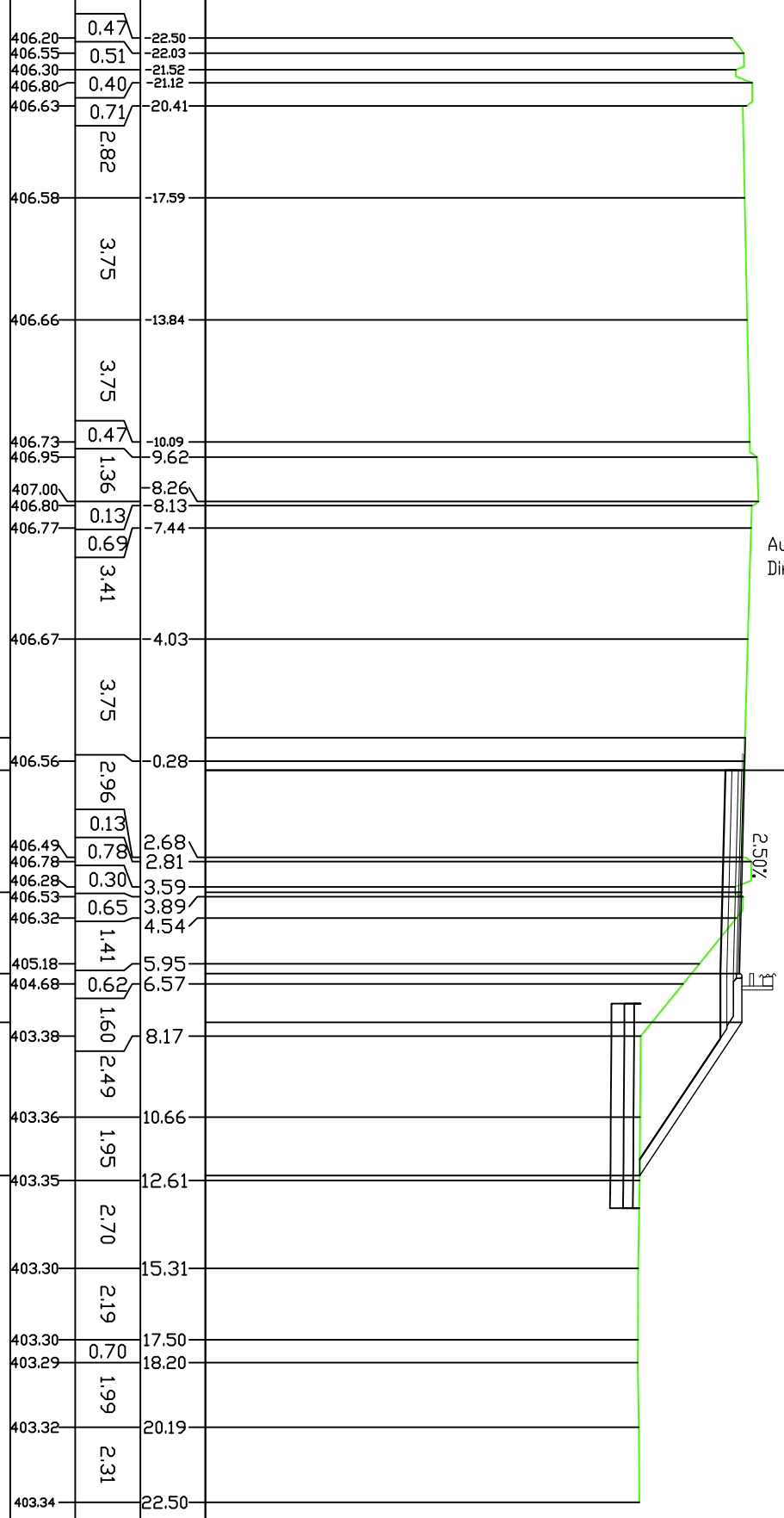

Autostrada A32 - Salita  
 Direzione BARDONECCHIA

2.50%



STERRI E RIPORTI	
S1	303 mq.
S2	0,00 mq.
S3	0,00 mq.
Totale S:	303 mq.
R1	8,55 mq.
SCOTTICO	
A1	1,22 mq.
BONIFICA	
B1	1,82 mq.
BONIFICA PROFONDA	
C1	2,45 mq.
STABILIZZATO	
D1	1,62 mq.
CEMENTATO	
E1	1,55 mq.
BASE	
F1	0,65 mq.
VEGETALE	
G1	1,86 mq.
TNT	
a1	7,08 ml.
GEOGRIGLIA 10KN/m	
b1	6,08 ml.
GEOGRIGLIA 28KN/m	
c1	8,24 ml.
GRADONATURA	
d1	4,12 ml.
IDROSEMINA	
e1	7,06 ml.
USURA	
f1	7,25 ml.
BINDER	
g1	6,75 ml.

390.00  
 200  
 200

PROGRESSIVE TERRENO				
PARZIALI TERRENO				
QUOTE TERRENO				
PROGRESSIVE PROGETTO				
PARZIALI PROGETTO				
QUOTE PROGETTO				

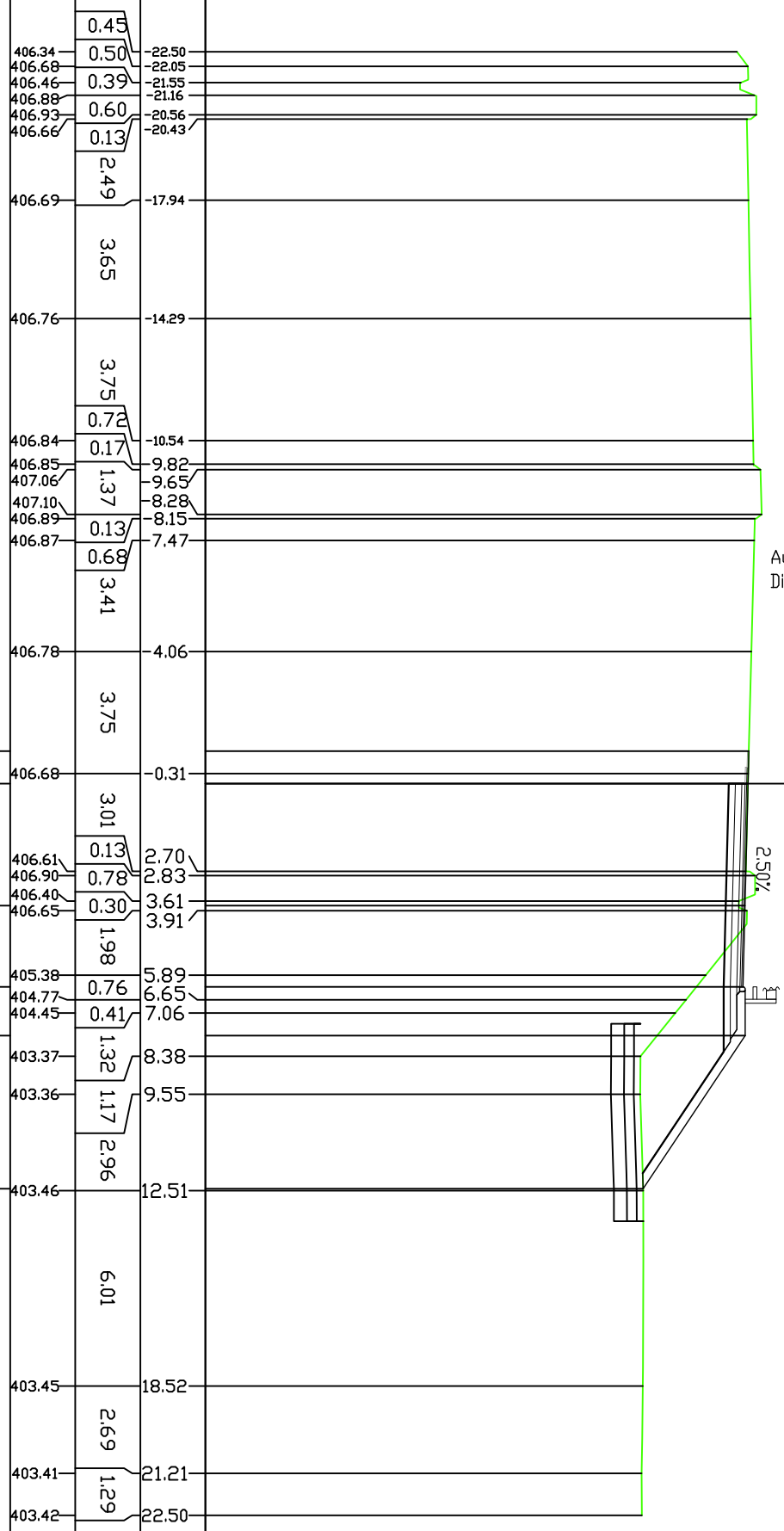

PROFILO TO-SV\_MM1

SEZIONE 8

PROGRESSIVA 175.00

STERRE E RIPARTI

S1	2,98 mq.
S2	0,01 mq.
Totale S:	2,99 mq.
R1	0,00 mq.
R2	8,66 mq.
Totale R:	8,66 mq.
SCOTTICD	8,66 mq.
A1	1,29 mq.
BONIFICA	
B1	1,93 mq.
BONIFICA PROFONDA	
C1	2,57 mq.
STABILIZZATO	
D1	1,61 mq.
CEMENTATO	
E1	1,54 mq.
BASE	
F1	0,66 mq.
VEGETALE	
G1	1,83 mq.
TNT	
a1	7,44 ml.
GEOGRIGLIA 10KN/m	
b1	6,44 ml.
GEOGRIGLIA 28KN/m	
c1	8,24 ml.
GRADONATURA	
d1	3,79 ml.
IDROSEMINA	
e1	6,99 ml.
USURA	
f1	7,25 ml.
BINDER	
g1	6,75 ml.

390.00  
  
 200  
 200

PROGRESSIVE TERRENO	PROGRESSIVE	PARZIALI TERRENO	PARZIALI PROGETTO	QUOTE TERRENO	QUOTE PROGETTO
406.56	22.50	0.75		0.19	
406.76	21.75	0.19		0.39	
406.54	21.56	0.39		0.60	
406.96	21.17	0.60		0.13	
407.01	20.57	0.13		2.50	
406.74	20.44	2.50		0.75	
406.78	17.94	0.75		3.32	
406.79	17.19	3.32		3.75	
406.86	13.87	3.75		0.47	
406.94	10.12	0.47		1.37	
407.16	9.65	1.37		0.13	
407.19	8.28	0.13		3.76	
406.98	8.15	3.76		3.76	
406.88	4.39	3.76		0.63	
406.78	0.63	0.63	1.00	3.06	
406.76	0.00	3.06	3.75	0.38	
406.69	2.43	0.38		0.77	
406.96	2.81	0.77		0.32	
406.52	3.58	0.32	2.50	4.06	
406.72	3.90	4.06	1.50	7.96	
406.66	3.75	7.96	4.65	4.52	
406.60	6.25	4.52		7.69	
406.67	7.75	7.69		0.64	
403.57	12.40	0.64		1.69	
403.57	12.48	1.69			
403.49	20.17				
403.48	20.81				
403.49	22.50				

Autostrada A32 - Salita  
 Direzione BARDOVECCHIA

2.50%

PROFILO TO-SV\_MM1

SEZIONE 9

PROGRESSIVA 200.00

STERRI E RIPORTI	
S1	2,93 mq.
R1	0,01 mq.
R2	0,00 mq.
R3	8,68 mq.
Totale R:	
SCULTO	8,69 mq.
A1	1,27 mq.
BONIFICA	
B1	1,94 mq.
BONIFICA PROFONDA	
C1	2,57 mq.
STABILIZZATO	
D1	1,62 mq.
CEMENTATO	
E1	1,55 mq.
BASE	
F1	0,64 mq.
VEGETALE	
G1	1,74 mq.
TNT	
a1	7,44 ml.
GEOGRIGLIA 10KN/m	
b1	6,44 ml.
GEOGRIGLIA 28KN/m	
c1	8,24 ml.
GRADINATURA	
d1	3,64 ml.
IDROSEMINA	
e1	6,65 ml.
USURA	
f1	7,25 ml.
BINDER	
g1	6,75 ml.

390.00  
 200  
 200

PROGRESSIVE TERRENO					
PARZIALI TERRENO					
QUOTE TERRENO					
PROGRESSIVE PROGETTO					
PARZIALI PROGETTO					
QUOTE PROGETTO					

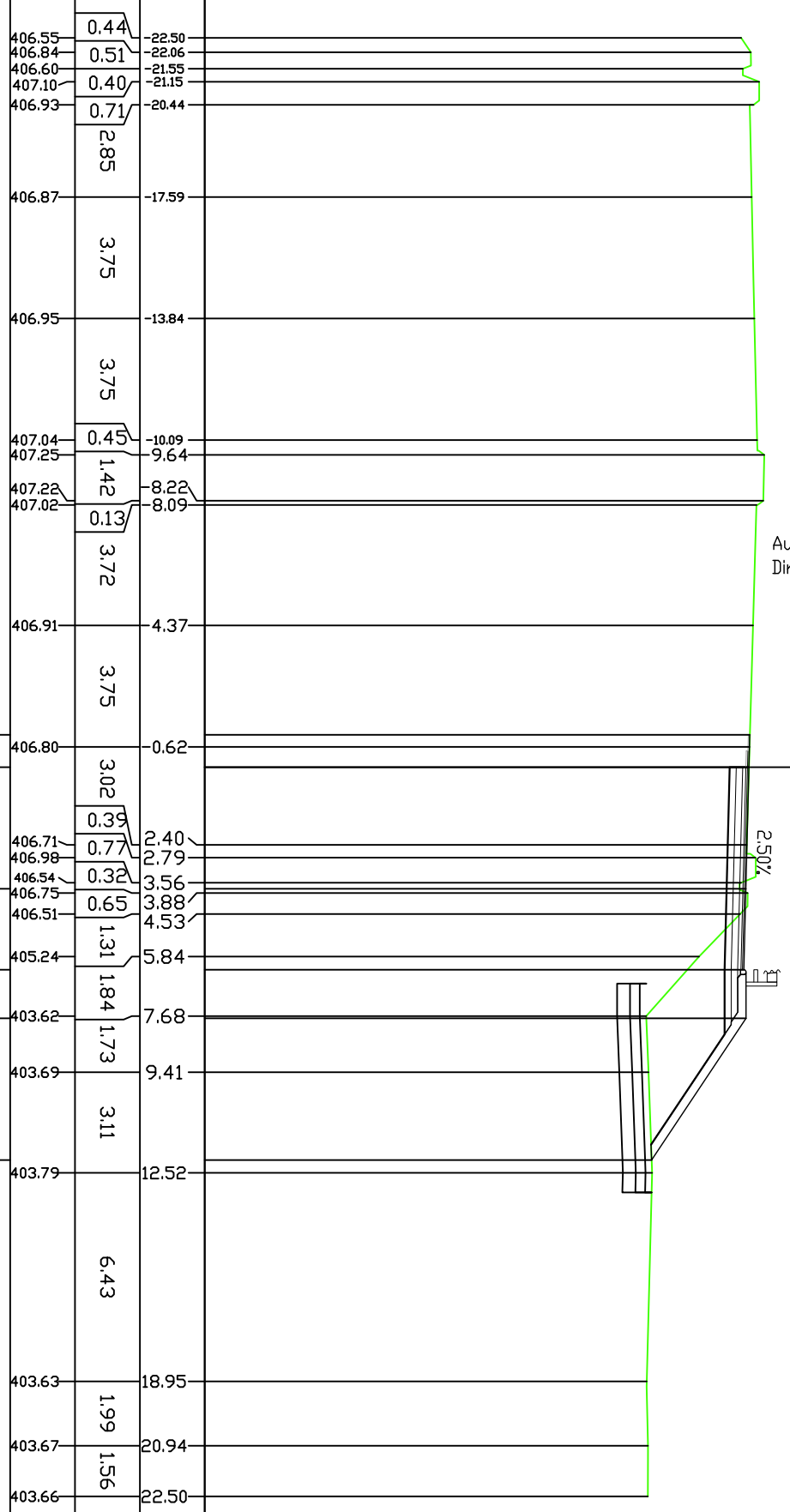

Autostrada A32 - Salita  
 Direzione BARDOVECCHIA

PROFILO TO-SV\_MM1

SEZIONE 10

PROGRESSIVA 225.00

STERRI E RIPORTI	
S1	309 mq.
S2	0,01 mq.
S3	0,00 mq.
Totale S:	310 mq.
R1	7,87 mq.
SCOTTICO	
A1	1,20 mq.
BONIFICA	
B1	1,78 mq.
BONIFICA PROFONDA	
C1	2,40 mq.
STABILIZZATO	
D1	1,62 mq.
CEMENTATO	
E1	1,54 mq.
BASE	
F1	0,65 mq.
VEGETALE	
G1	1,72 mq.
TNT	
a1	6,99 ml.
GEORIGLIA 10KN/m	
b1	5,98 ml.
GEORIGLIA 28KN/m	
c1	8,24 ml.
GRADINATURA	
d1	3,83 ml.
IDROSEMINA	
e1	6,59 ml.
USURA	
f1	7,25 ml.
BINDER	
g1	6,75 ml.

390.00  
200  
200

PROGRESSIVE TERRENO			
PARZIALI TERRENO			
QUOTE TERRENO			
PROGRESSIVE PROGETTO			
PARZIALI PROGETTO			
QUOTE PROGETTO			

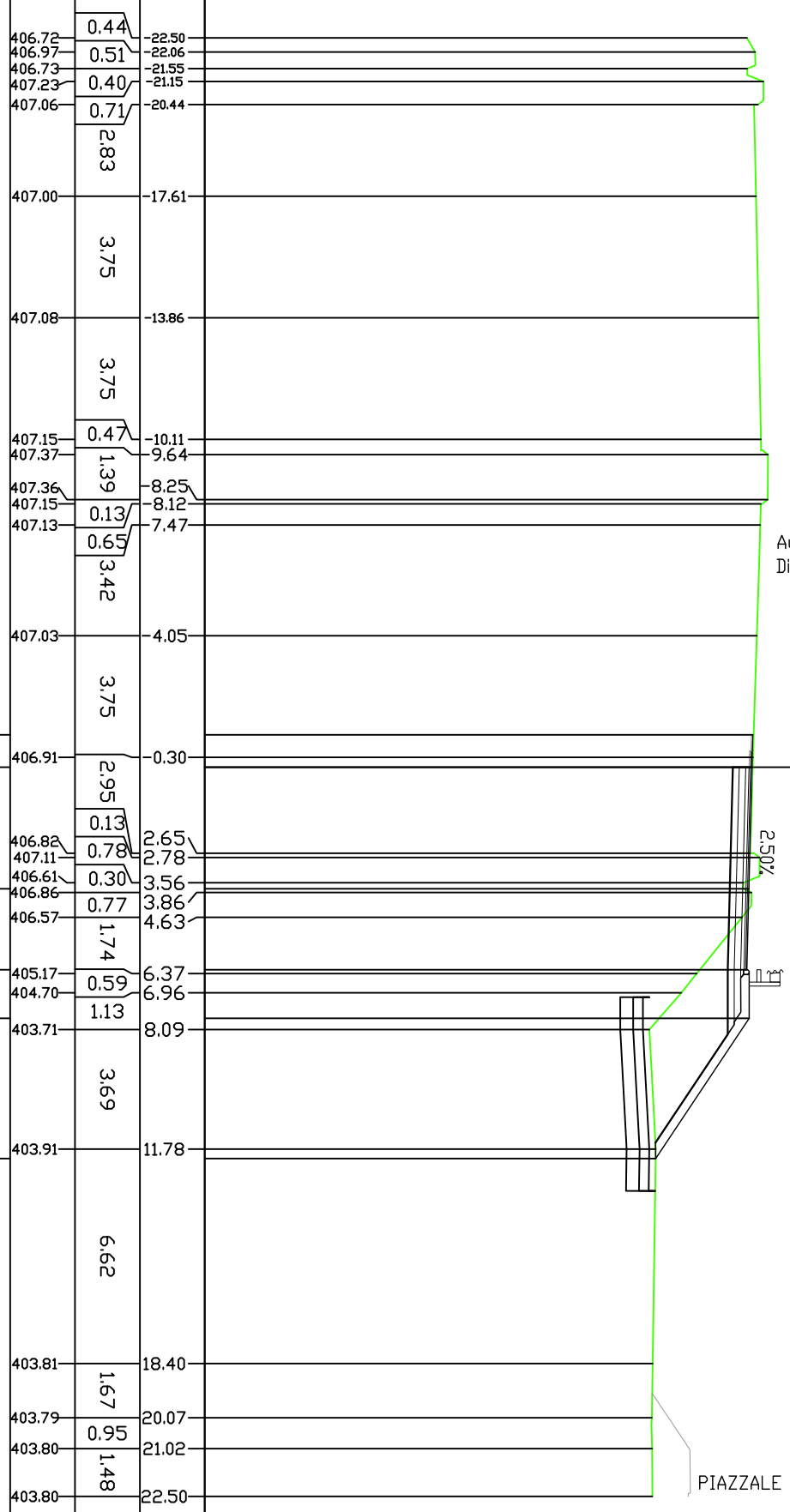

STERRE E RIPORTI	
S1	2,78 mq.
S2	0,16 mq.
Totale S:	2,94 mq.
R1	0,01 mq.
R2	9,00 mq.
Totale R:	9,01 mq.
SCOTTICI	
A1	1,32 mq.
BONIFICA	
B1	2,00 mq.
BONIFICA PROFONDA	
C1	2,64 mq.
STABILIZZATO	
D1	1,62 mq.
CEMENTATO	
E1	1,55 mq.
BASE	
F1	0,65 mq.
VEGETALE	
G1	1,82 mq.
TNT	
a1	7,62 ml.
GEORIGLIA 10KN/m	
b1	6,62 ml.
GEORIGLIA 28KN/m	
c1	8,26 ml.
GRADINATURA	
d1	3,67 ml.
IDROSEMINA	
e1	6,92 ml.
USURA	
f1	7,27 ml.
BINDER	
g1	6,77 ml.

390.00  
 ▲  
 PROGRESSIVE  
 TERRENO 200  
 200

PARZIALI TERRENO	406.80	0.41	22.50
	407.09	0.51	22.09
	406.86	0.39	21.58
	407.32	0.39	21.19
QUOTE TERRENO	407.18	0.72	20.47
		2.84	
	407.10	3.75	-17.63
	407.17	3.75	-13.88
	407.25	0.46	-10.13
	407.46	1.38	9.67
	407.43	0.13	8.29
	407.22	0.13	8.16
		4.09	
	407.10	3.75	4.07
	407.00	1.00	-1.00
	406.97	0.00	0.00
		2.99	
	406.89	0.13	2.67
	407.18	0.78	2.80
	406.68	0.30	3.58
	406.93	0.30	3.88
		2.31	
	406.81	0.55	6.19
	404.68	1.01	6.74
	406.88	1.04	7.75
	403.76	1.04	8.79
		8.22	
	403.82	12.37	
		5.36	
	403.89	17.01	
		0.13	
	403.94	22.37	
	403.94	22.50	

Autostrada A32 - Salita  
 Direzione BARDONECCHIA

2.50%

PIAZZALE in PROGETTO

PROFILO TO-SV\_MM1

SEZIONE 12

PROGRESSIVA 275.00

STERRI E RIPORTI	
S1	0.53 mq.
S2	2.16 mq.
Totale S:	2.69 mq.
R1	0.14 mq.
R2	7.89 mq.
Totale R:	8.03 mq.
SCOTTICI	
A1	1.39 mq.
BONIFICA	
B1	2.06 mq.
BONIFICA PROFONDA	
C1	2.77 mq.
STABILIZZATO	
D1	1.62 mq.
CEMENTATO	
E1	1.54 mq.
BASE	
F1	0.64 mq.
VEGETALE	
G1	1.63 mq.
TNT	
a1	7.90 ml.
GEOGRIGLIA 10KN/m	
b1	6.90 ml.
GEOGRIGLIA 28KN/m	
c1	8.22 ml.
GRADINATURA	
d1	3.22 ml.
IDROSEMINA	
e1	6.30 ml.
USURA	
f1	7.23 ml.
BINDER	
g1	6.73 ml.

390.00  
 200  
 200

PROGRESSIVE TERRENO				
PARZIALI TERRENO				
QUOTE TERRENO				
PROGRESSIVE PROGETTO				
PARZIALI PROGETTO				
QUOTE PROGETTO				

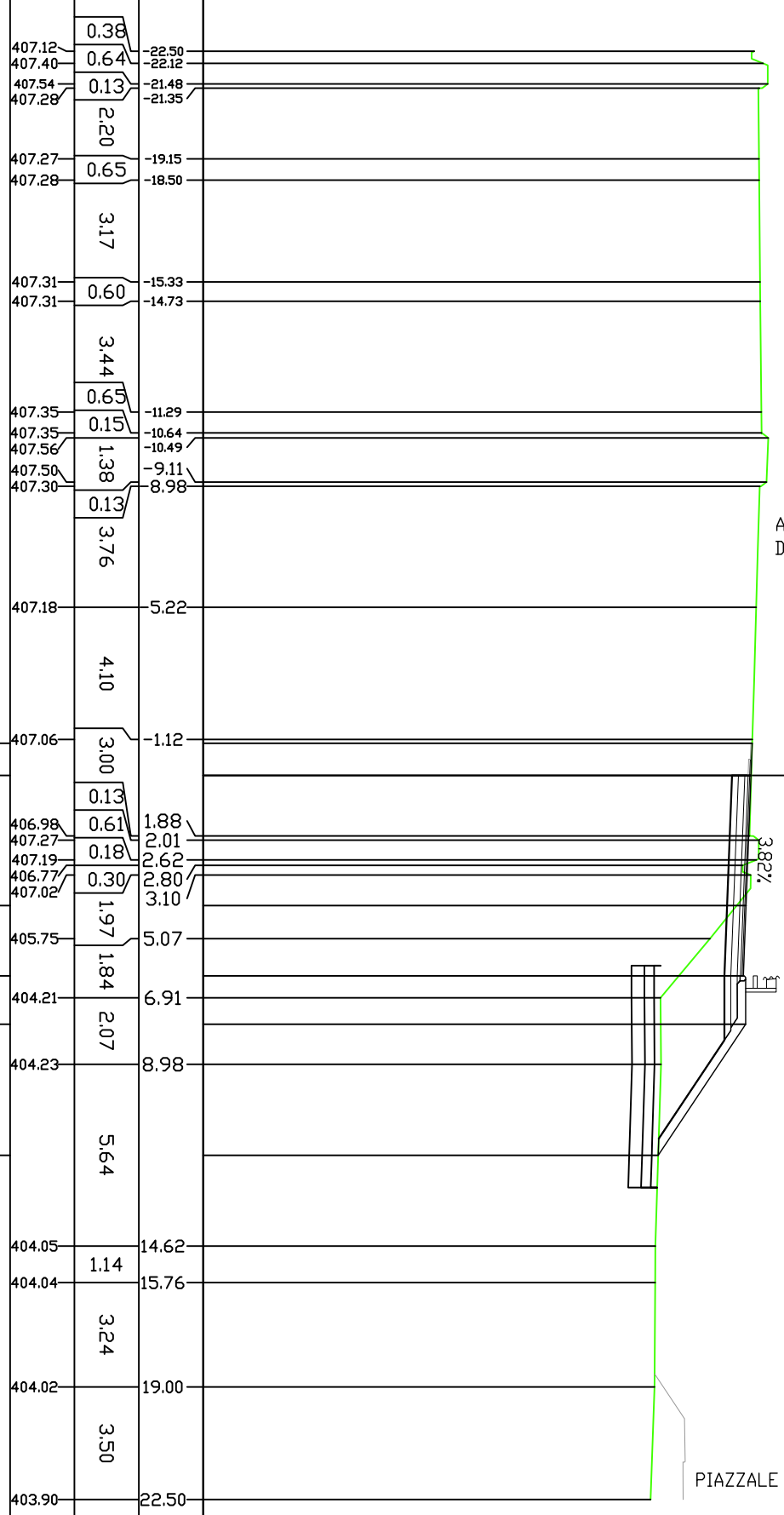

407.12	0.38	-22.50		
407.40	0.64	-22.12		
407.54	0.13	-21.48		
407.28	2.20	-21.35		
407.27	0.65	-19.15		
407.28	3.17	-18.50		
407.31	0.60	-15.33		
407.31	3.44	-14.73		
407.35	0.50	-11.29		
407.35	0.15	-10.64		
407.56	1.38	-10.49		
407.50	0.13	-9.11		
407.30	3.76	8.98		
407.18	4.10	5.22		
407.06	3.00	-1.12		
407.02	0.13			
406.98	0.61	1.88		
407.27	0.18	2.01		
407.19	0.30	2.62		
406.77	1.97	2.80		
407.02'	1.84	3.10		
405.75	1.97	5.07		
406.79	1.84	6.91		
406.86	2.07	8.98		
404.23	5.64			
404.05	1.14	14.62		
404.04	3.24	15.76		
404.02	3.50	19.00		
403.90		22.50		

PROFILO TO-SV\_MM1

SEZIONE 13

PROGRESSIVA 300.00

STERRI E RIPORTI	
S1	352 mq.
R1	224 mq.
R2	1098 mq.
Totale R	1322 mq.
SCOTTICD	
A1	1.70 mq.
B1	2.56 mq.
BONIFICA PROFONDA	
C1	3.42 mq.
STABILIZZATO	
D1	2.93 mq.
CEMENTATO	
E1	2.86 mq.
BASE	
F1	1.31 mq.
VEGETALE	
G1	1.61 mq.
TNT	
a1	9.54 ml.
GEORIGLIA 10KN/m	
b1	8.53 ml.
GEORIGLIA 28KN/m	
c1	14.81 ml.
GRADINATURA	
d1	5.46 ml.
IDROSEMINA	
e1	6.15 ml.
USURA	
f1	13.82 ml.
BINDER	
g1	13.32 ml.

390.00  
 200  
 200

PROGRESSIVE TERRENO				
PARZIALI TERRENO				
QUOTE TERRENO				
PROGRESSIVE PROGETTO				
PARZIALI PROGETTO				
QUOTE PROGETTO				

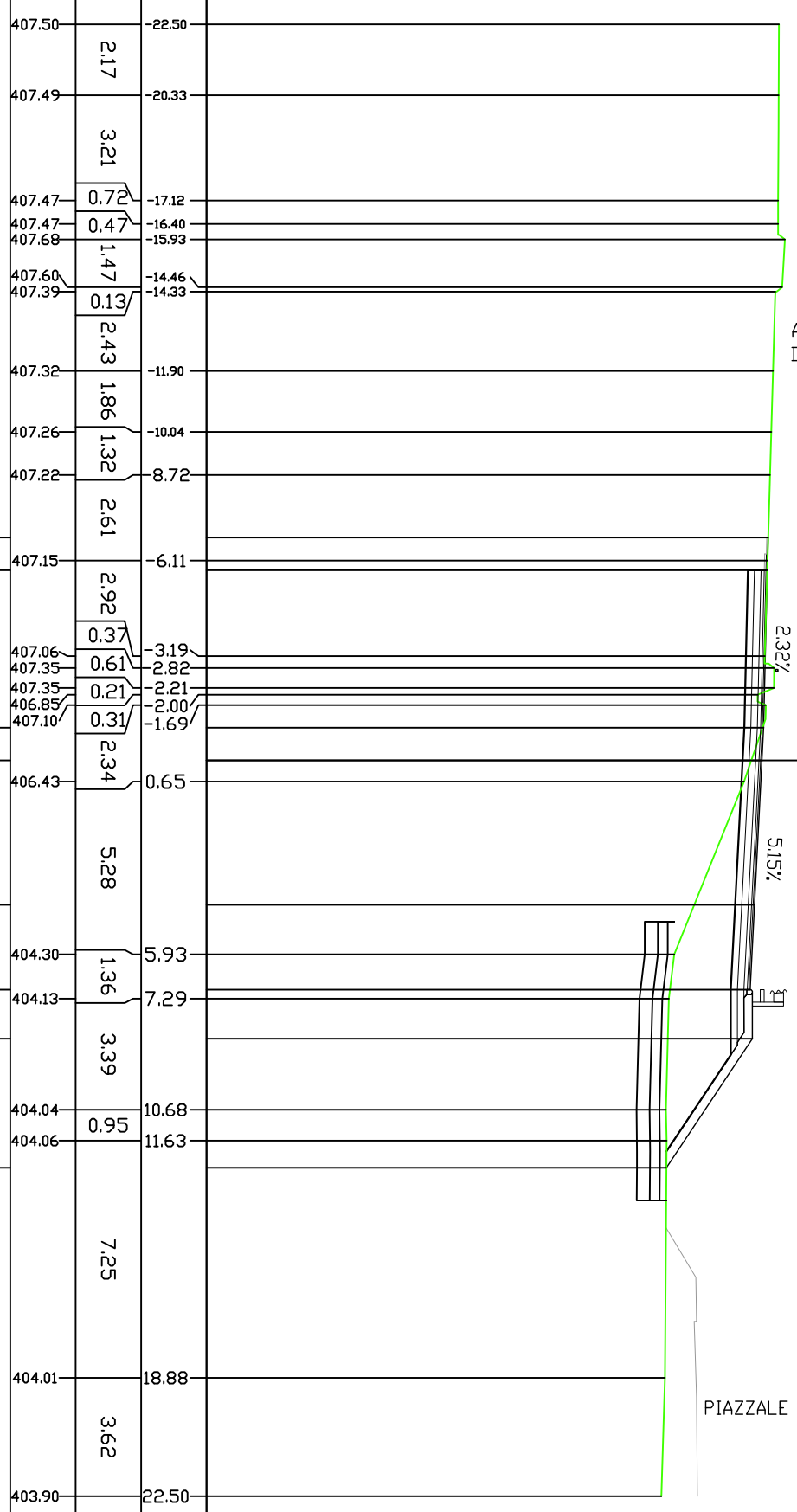

Autostrada A32 - Salita  
 Direzione BARDONECCHIA

PIAZZALE in PROGETTO

PROFILO TO-SV\_MM1

SEZIONE 14

PROGRESSIVA 315.92

STERRI E RIPORTI	
R1	22,58 mq.
SCOTTICO	3,11 mq.
A1	4,70 mq.
BONIFICA	2,37 mq.
B1	2,22 mq.
STABILIZZATO	0,86 mq.
DI	0,84 mq.
CEMENTATO	1,07 mq.
E1	1,91 mq.
BASE	16,96 ml.
F1	15,64 ml.
VEGETALE	3,31 ml.
G1	4,30 ml.
G2	7,61 ml.
Totale:	8,18 ml.
TNT	8,18 ml.
a1	
GEDRIGLIA 10KN/m	
b1	
IDROSEMINA	
e1	
e2	
Totale:	
USURA	
f1	
BINDER	
g1	

390.00  
 200  
 200

PROGRESSIVE TERRENO	407.44	407.40	407.32	407.21	407.19	407.13	407.11	407.35	407.40	407.08	407.14	406.38	406.01	407.07	407.00	406.94	404.33	404.36	404.27	406.67	406.51	406.58	404.97	404.14	404.09	404.09	
PARZIALI TERRENO	1,23	3,31	3,93	0,83	2,20	0,73	0,11	0,70	0,14	0,72	3,37	6,27	1,59	1,50	1,00	4,58	2,60	1,50	2,41	4,27	7,18	8,68	8,07	4,10	3,14		
QUOTE TERRENO																											
PROGRESSIVE PROGETTO																											
PARZIALI PROGETTO																											
QUOTE PROGETTO																											

Autostrada A32 - Salita  
 Direzione BARDONECCHIA

6,00%

PIAZZALE in PROGETTO



PROFILO TO-SV\_MM1

SEZIONE 15

PROGRESSIVA 333.14

STERRI E RIPORTI		26.49 mq.
R1	SCOTICD	3.51 mq.
A1	BONIFICA	5.25 mq.
B1	STABILIZZATO	2.27 mq.
D1	CEMENTATO	2.13 mq.
E1	BASE	0.81 mq.
F1	VEGETALE	1.61 mq.
G1		1.05 mq.
G2		2.66 mq.
TNT	Totale:	18.49 ml.
a1	GEDRIGLIA 10KN/m	17.49 ml.
b1	IDROSEMINA	6.13 ml.
e1		4.20 ml.
e2	Totale:	10.33 ml.
f1	USURA	7.72 ml.
g1	BINDER	7.72 ml.

390.00  
 ▼  
 PROGRESSIVE  
 TERRENO 200  
 200

PARZIALI TERRENO	406.77	0.40	-22.50	
	406.54	1.45	-22.10	
	405.71	2.21	-20.65	
	404.51	1.91	-18.44	
	404.64	3.60	-16.53	
	404.72	0.77	-12.93	
	404.63	1.64	-12.16	
	404.64	3.27	-10.52	
	404.43	3.09	7.25	
	404.34	3.47	4.16	
	404.35	2.53	0.69	
	404.23	5.88	1.84	
	406.62	2.12	4.60	
	406.50	1.50	6.72	
	406.57	2.33	8.22	
	405.01		10.55	
	404.31	3.82	12.67	
	404.35	4.92	17.59	
	404.34	3.95	21.54	
	404.34	0.96	22.50	
QUOTE PROGETTO	404.41	3.94	-6.44	
	407.03	1.50	-2.50	
	406.96	1.00	-1.00	
	406.90	4.60	0.00	
	406.62	2.12	4.60	
	406.50	1.50	6.72	
	406.57	2.33	8.22	
	405.01		10.55	

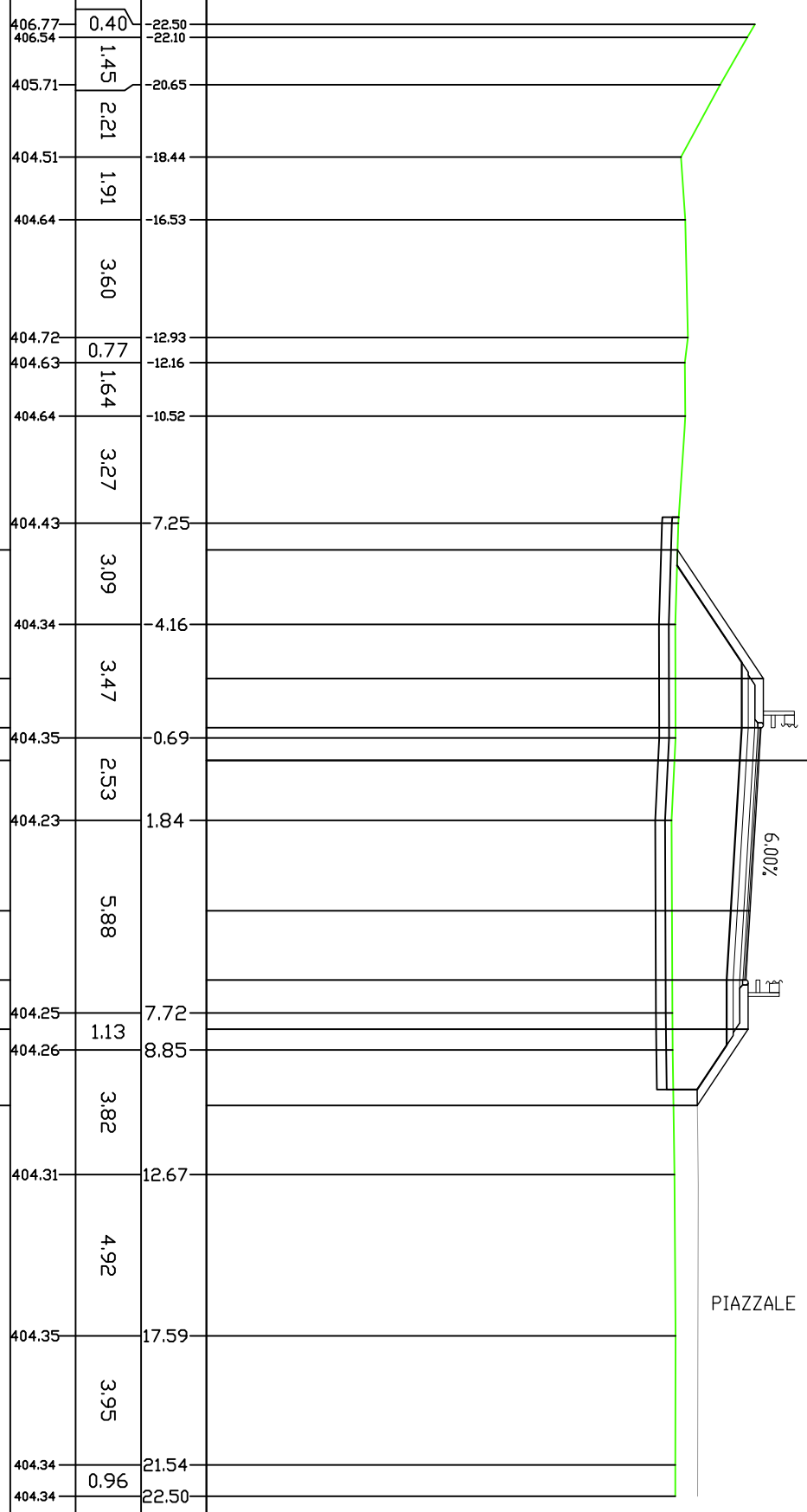

PIAZZALE in PROGETTO

PROFILO TO-SV\_MM1

SEZIONE 16

PROGRESSIVA 350.38

STERRI E RIPORTI	
R1	26.32 mq.
SCOTTICO	
A1	3.29 mq.
BONIFICA	
B1	4.90 mq.
STABILIZZATO	
D1	2.19 mq.
CEMENTATO	
E1	2.04 mq.
BASE	
F1	0.75 mq.
VEGETALE	
G1	1.05 mq.
G2	1.40 mq.
Totale:	2.45 mq.
TNT	
a1	17.61 ml.
GEDRIGLIA 10KN/m	
b1	16.38 ml.
IDROSEMINA	
e1	4.15 ml.
e2	5.42 ml.
Totale:	9.57 ml.
USURA	
f1	7.24 ml.
BINDER	
g1	7.24 ml.

390.00  
200  
200

PROGRESSIVE TERRENO	PARZIALI TERRENO	QUOTE TERRENO	PROGRESSIVE PROGETTO	PARZIALI PROGETTO	QUOTE PROGETTO
404.55	5.75		404.76	3.35	
404.60	5.89		406.99	1.50	
404.74	7.79		406.92	1.00	
404.76	5.85		406.86		4.60
404.77	1.93		406.58	1.64	1.50
404.65	4.38		406.49	1.50	2.28
404.51	3.24		406.56		
403.73	1.75		405.03		
403.27	1.71				
403.30	0.61				
403.33	4.05				
404.29	3.21				
404.35					

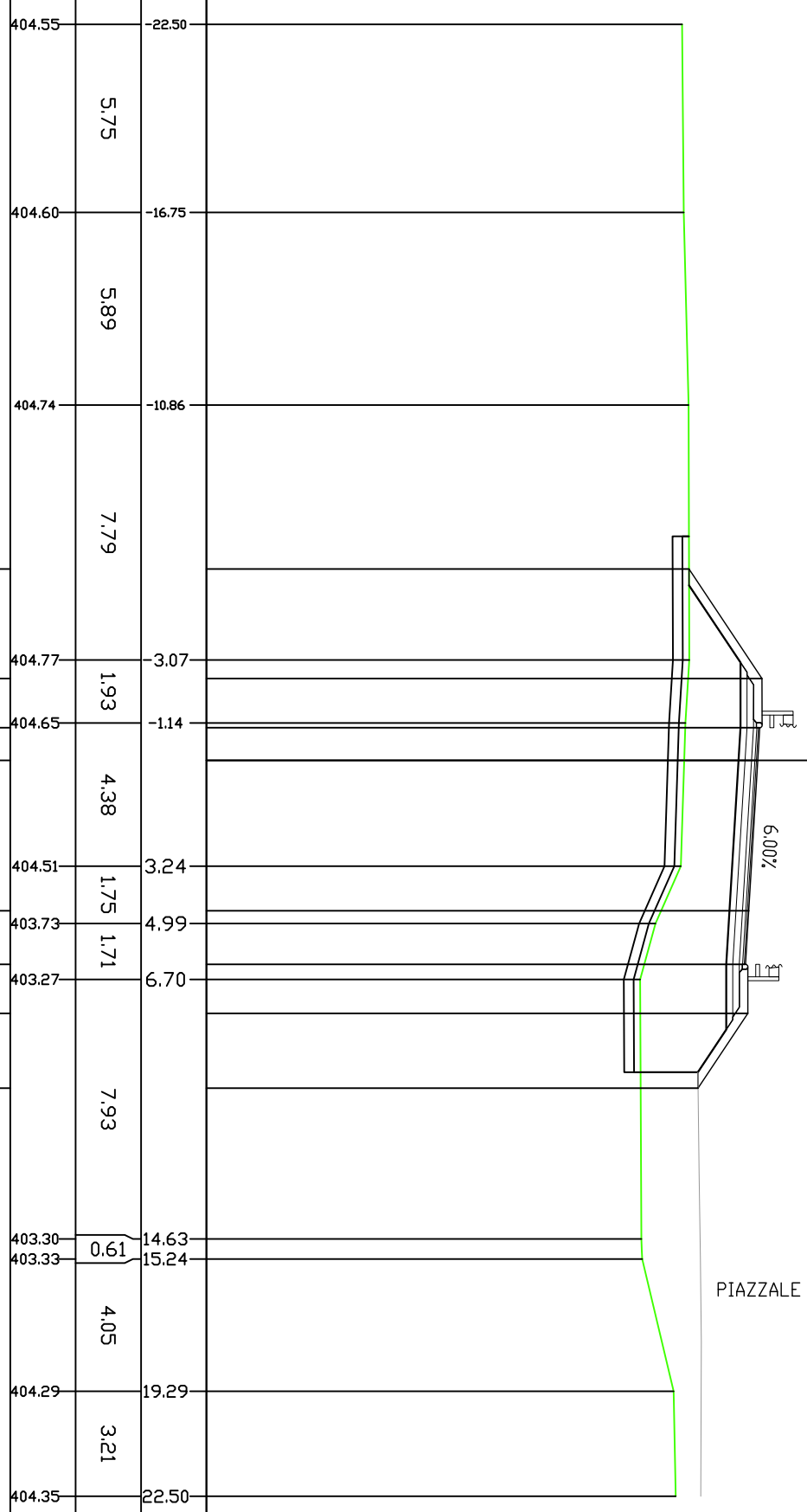

PIAZZALE in PROGETTO

PROFILO TO-SV\_MM1

SEZIONE 17

PROGRESSIVA 367.91

STERRI E RIPORTI	
R1	1813 mq.
SCOTICD	
A1	3.24 mq.
BONIFICA	
B1	4.91 mq.
STABILIZZATO	
D1	2.18 mq.
CEMENTATO	
E1	2.02 mq.
BASE	
F1	0.76 mq.
VEGETALE	
G1	1.40 mq.
G2	1.01 mq.
Totale:	2.41 mq.
TNT	
a1	17.33 ml.
GEDRIGLIA 10KN/m	
b1	16.32 ml.
IDROSEMINA	
e1	5.51 ml.
e2	4.02 ml.
Totale:	9.53 ml.
USURA	
f1	7.21 ml.
BINDER	
g1	7.21 ml.

390.00  
 ▼  
 PROGRESSIVE  
 TERRENO 200  
 200

PARZIALI TERRENO	2.23	5.36	7.43	7.19	2.72	2.93	5.52	6.12	1.78	1.42	2.30
QUOTE TERRENO											
PROGRESSIVE PROGETTO											
PARZIALI PROGETTO				3.42	1.50	1.00	4.60	1.61	1.50	2.18	
QUOTE PROGETTO											

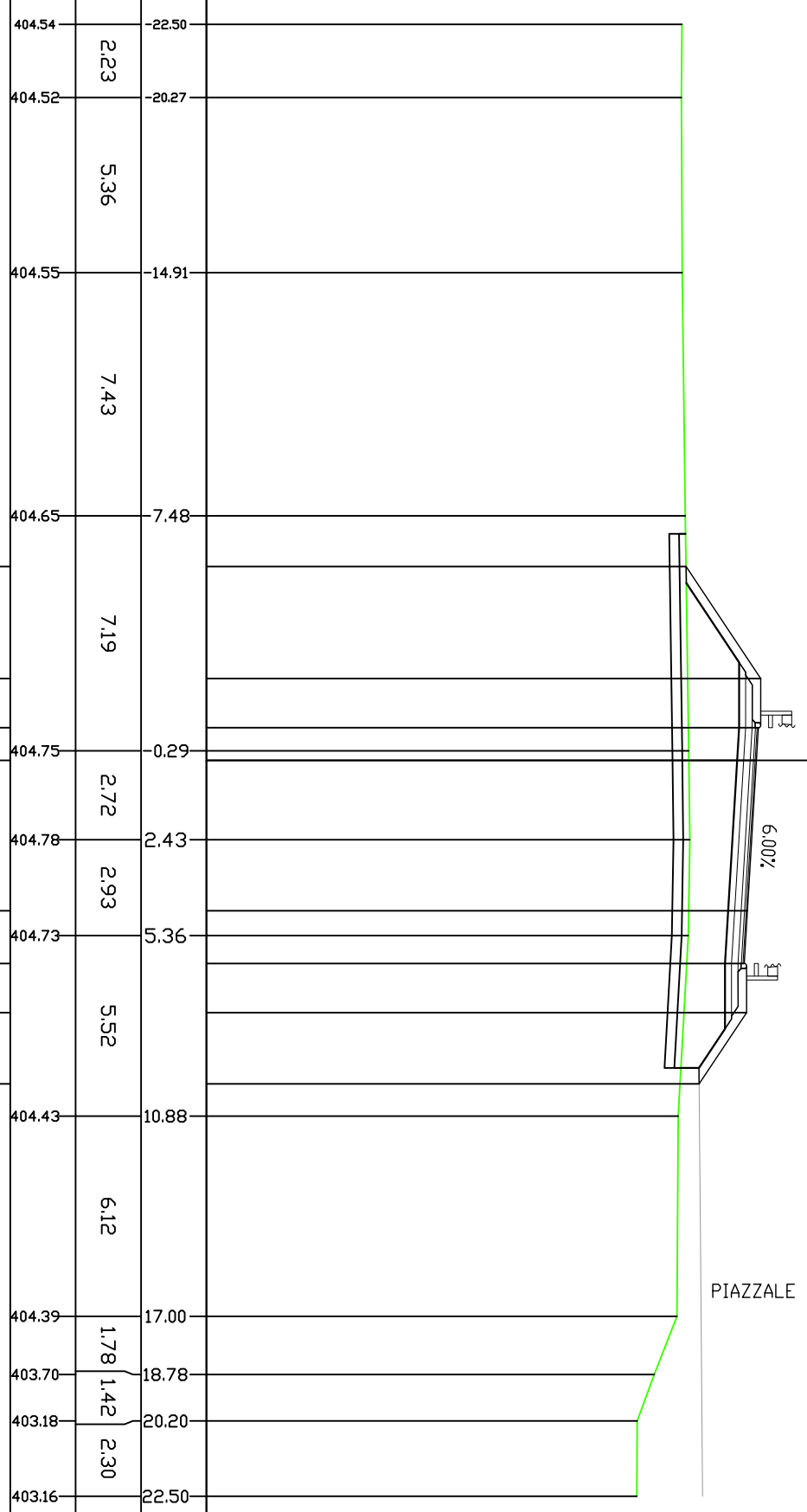

PIAZZALE in PROGETTO

PROFILO TO-SV\_MM1

SEZIONE 18

PROGRESSIVA 384.84

STERRI E RIPORTI	
R1	21.77 mq.
SCOTICD	
A1	3.25 mq.
BONIFICA	
B1	4.90 mq.
STABILIZZATO	
D1	2.16 mq.
CEMENTATO	
E1	2.02 mq.
BASE	
F1	0.74 mq.
VEGETALE	
G1	0.99 mq.
G2	1.47 mq.
Totale:	2.46 mq.
TNT	
a1	17.32 ml.
GEDRIGLIA 10KN/m	
b1	16.32 ml.
IDROSEMINA	
e1	5.78 ml.
e2	3.92 ml.
Totale:	9.70 ml.
USURA	
f1	7.08 ml.
BINDER	
g1	7.08 ml.

390.00  
 ▼  
 PROGRESSIVE  
 TERRENO 200  
 200

PARZIALI TERRENO	404.62	-22.50	11.73	404.54	-10.77	7.05	404.48	-6.14	404.45	3.72	8.79	404.37	5.07	5.87	404.40	10.94	11.21	404.33	22.15	0.35	404.33	22.50
QUOTE TERRENO																						
PROGRESSIVE PROGETTO																						
PARZIALI PROGETTO							3.64	1.50	1.00	4.58	1.50	1.50	2.09									
QUOTE PROGETTO																						

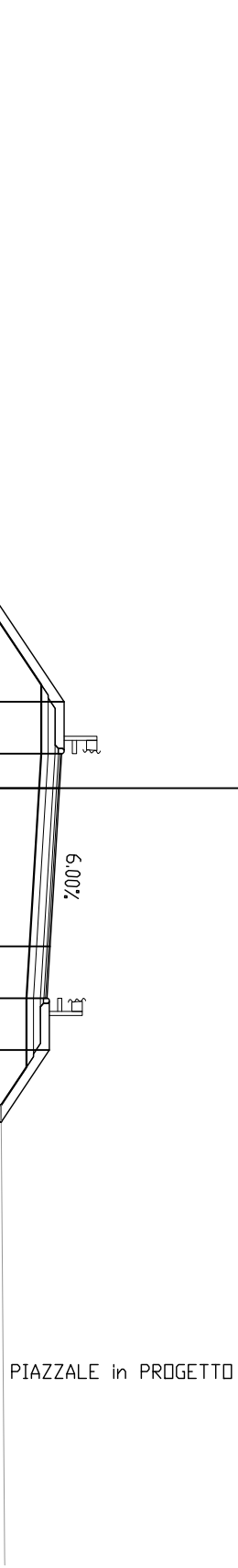



PROFILO TO-SV\_MM1

SEZIONE 20

PROGRESSIVA 425.00

STERRI E RIPORTI	16,58 mq.
R1	
SCOTTICO	2,12 mq.
A1	
BONIFICA	3,18 mq.
B1	
STABILIZZATO	1,91 mq.
D1	
CEMENTATO	1,85 mq.
E1	
BASE	0,71 mq.
F1	
VEGETALE	0,90 mq.
G1	
G2	0,22 mq.
Totale:	11,2 mq.
TNT	
a1	11,61 ml.
GEDRIGLIA 10KN/m	
b1	10,61 ml.
IDROSEMINA	
e1	0,94 ml.
e2	3,59 ml.
Totale:	4,53 ml.
USURA	
f1	6,74 ml.
BINDER	
g1	6,74 ml.

390.00  
 200  
 200

PROGRESSIVE TERRENO	404.54	-22.50		
PARZIALI TERRENO			8.91	
QUOTE TERRENO				
PROGRESSIVE PROGETTO	404.45	-13.59		
PARZIALI PROGETTO			12.22	
QUOTE PROGETTO				
PROGRESSIVE TERRENO	406.68	-2.04		
PARZIALI TERRENO	406.68	-2.04		
QUOTE TERRENO			1.04	
PROGRESSIVE PROGETTO	406.66	-1.00		
PARZIALI PROGETTO	406.66	-1.00		
QUOTE PROGETTO			1.00	
PROGRESSIVE TERRENO	406.62	0.00		
PARZIALI TERRENO			4.82	
QUOTE TERRENO				
PROGRESSIVE PROGETTO	406.46	3.45		
PARZIALI PROGETTO	406.46	3.45		
QUOTE PROGETTO			4.24	
PROGRESSIVE TERRENO	406.40	5.74		
PARZIALI TERRENO	406.40	5.74		
QUOTE TERRENO			1.50	
PROGRESSIVE PROGETTO	406.47	7.24		
PARZIALI PROGETTO	406.47	7.24		
QUOTE PROGETTO			1.50	
PROGRESSIVE TERRENO	405.25	9.06		
PARZIALI TERRENO			16.00	
QUOTE TERRENO				
PROGRESSIVE PROGETTO	404.44	19.45		
PARZIALI PROGETTO			3.05	
QUOTE PROGETTO				
PROGRESSIVE TERRENO	404.31	22.50		

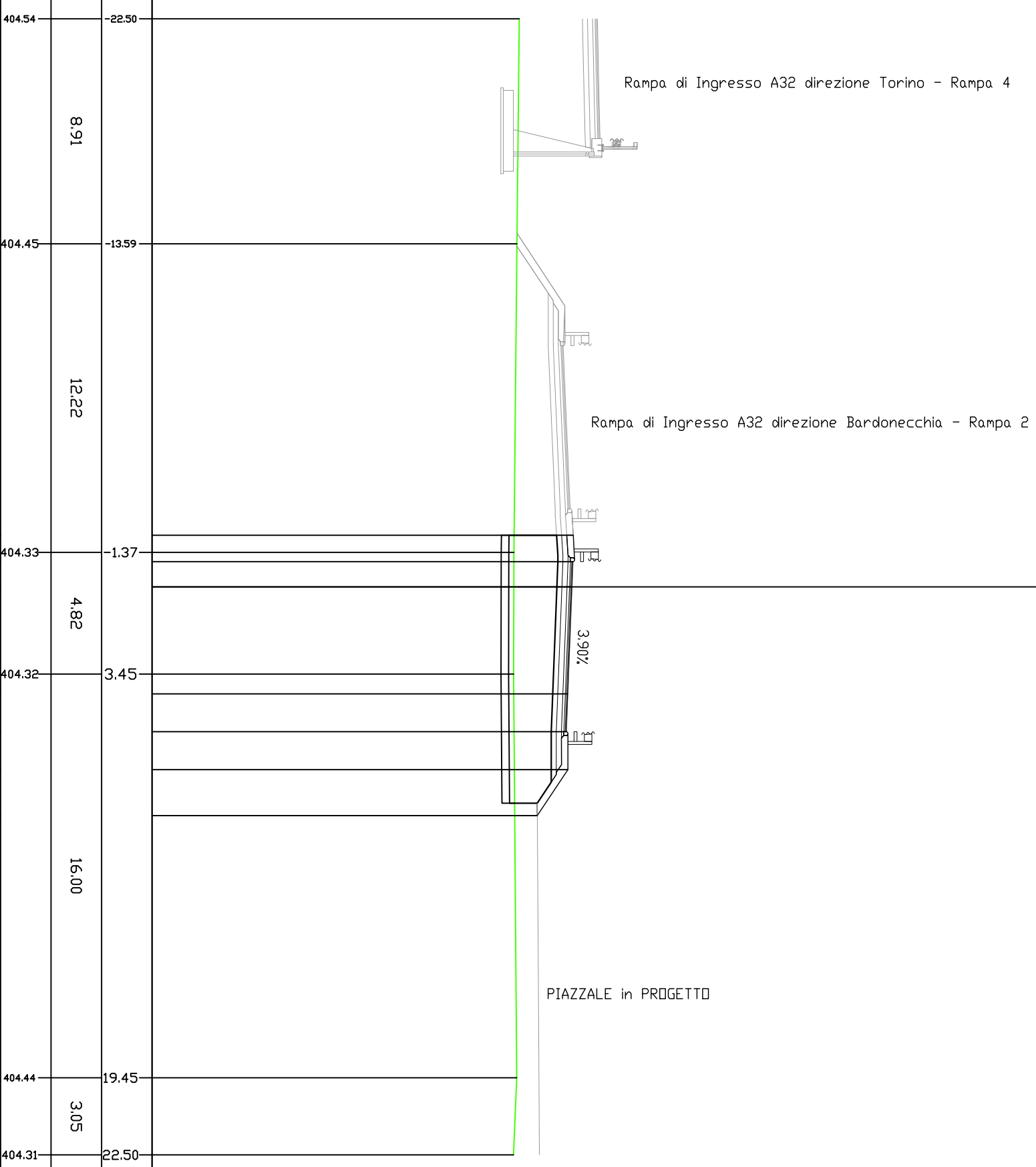

PROFILO TO-SV\_MM1

SEZIONE 21

PROGRESSIVA 451.68

STERRI E RIPORTI	
R1	1284 mq.
SCOTICD	188 mq.
A1	188 mq.
BONIFICA	2,83 mq.
B1	1,82 mq.
STABILIZZATO	1,75 mq.
DI	0,74 mq.
CEMENTATO	0,66 mq.
BASE	10,41 ml.
F1	9,41 ml.
VEGETALE	2,76 ml.
G1	7,27 ml.
TNT	7,27 ml.
a1	
GEDRIGLIA 10KN/m	
b1	
IDROSEMINA	
e1	
USURA	
f1	
BINDER	
g1	

390.00  
200  
200

PROGRESSIVE TERRENO	PARZIALI TERRENO	QUOTE TERRENO	PROGRESSIVE PROGETTO	PARZIALI PROGETTO	QUOTE PROGETTO
-22.50	2.82				
-19.68	3.61				
-16.07	16.38				
0.31	12.82				
0.00	5.49				
-1.75	3.88				
-1.75					
-1.00					
0.00					
4.02					
1.50					
1.50					
1.13					
8.15					

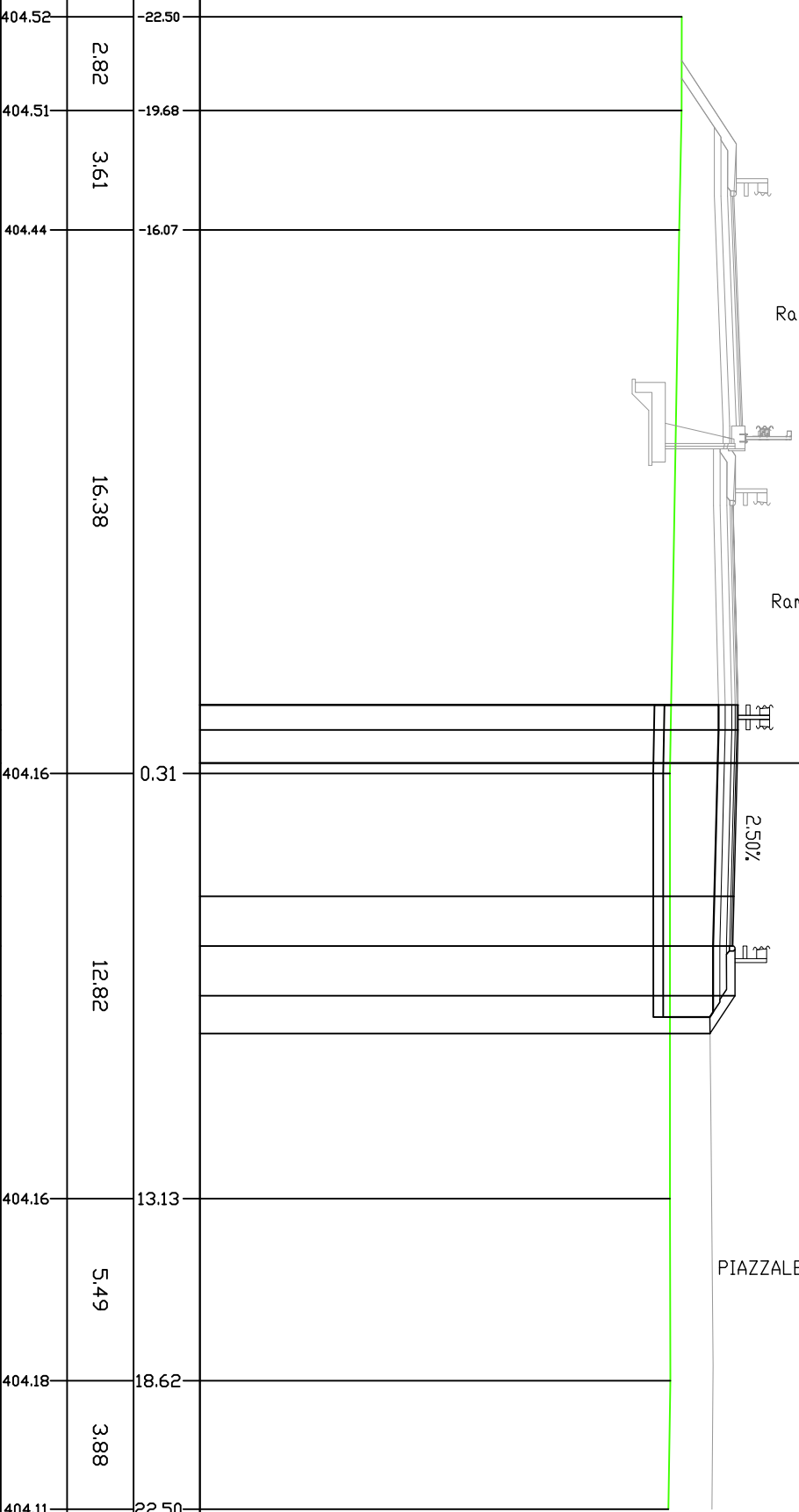

Rampa di Ingresso A32 direzione Torino - Rampa 4

Rampa di Ingresso A32 direzione Bardonecchia - Rampa 2

PIAZZALE in PROGETTO

PROFLO TO-SV\_MM1

SEZIONE 22

PROGRESSIVA 475.00

STERRI E RIPORTI	
R1	16,16 mq.
SCOTICD	
A1	3,15 mq.
BONIFICA	
B1	4,74 mq.
STABILIZZATO	
D1	3,11 mq.
CEMENTATO	
E1	3,05 mq.
BASE	
F1	1,37 mq.
VEGETALE	
G1	0,53 mq.
G2	0,10 mq.
Totale:	0,63 mq.
TNT	
a1	16,76 ml.
GEDRIGLIA 10KN/m	
b1	15,76 ml.
IDROSEMINA	
e1	0,42 ml.
e2	1,76 ml.
Totale:	2,18 ml.
USURA	
f1	13,25 ml.
BINDER	
g1	13,25 ml.

390.00  
 ▽  
 PROGRESSIVE  
 TERRENO 200  
 200

PARZIALI TERRENO		404.43	-22.50	3.30	10.22	404.58	-19.20
QUOTE TERRENO							
PROGRESSIVE PROGETTO							
PARZIALI PROGETTO							
QUOTE PROGETTO							

Rampa di Ingresso A32 direzione Torino - Rampa 4

Rampa di Ingresso A32 direzione Bardonecchia - Rampa 2

PIAZZALE in PROGETTO

405.63	7.75	404.29	8.98	9.78	0.80	404.01	0.80
405.66	6.75						
405.76	2.75						
405.78	1.75						
405.78	1.00						
405.76	0.00						
405.66	4.00						
405.62	5.50						
405.69	7.00						
405.49	7.30						



PROFLO TO-SV\_MM1

SEZIONE 23

PROGRESSIVA 491.07

STERRI E RIPORTI	
R1	2011 mq.
SCOTICD	
A1	5.34 mq.
BONIFICA	
B1	8.00 mq.
STABILIZZATO	
D1	4.90 mq.
CEMENTATO	
E1	4.74 mq.
BASE	
F1	2.10 mq.
VEGETALE	
G1	0.74 mq.
G2	0.52 mq.
Totale:	1.26 mq.
TNT	
a1	27.67 ml.
GEDRIGLIA 10KN/m	
b1	26.66 ml.
IDROSEMINA	
e1	3.13 ml.
e2	1.40 ml.
Totale:	4.53 ml.
USURA	
f1	20.74 ml.
BLINDER	
g1	20.74 ml.

390.00	200
▽	200
PROGRESSIVE TERRENO	
PARZIALI TERRENO	
QUOTE TERRENO	
PROGRESSIVE PROGETTO	
PARZIALI PROGETTO	
QUOTE PROGETTO	

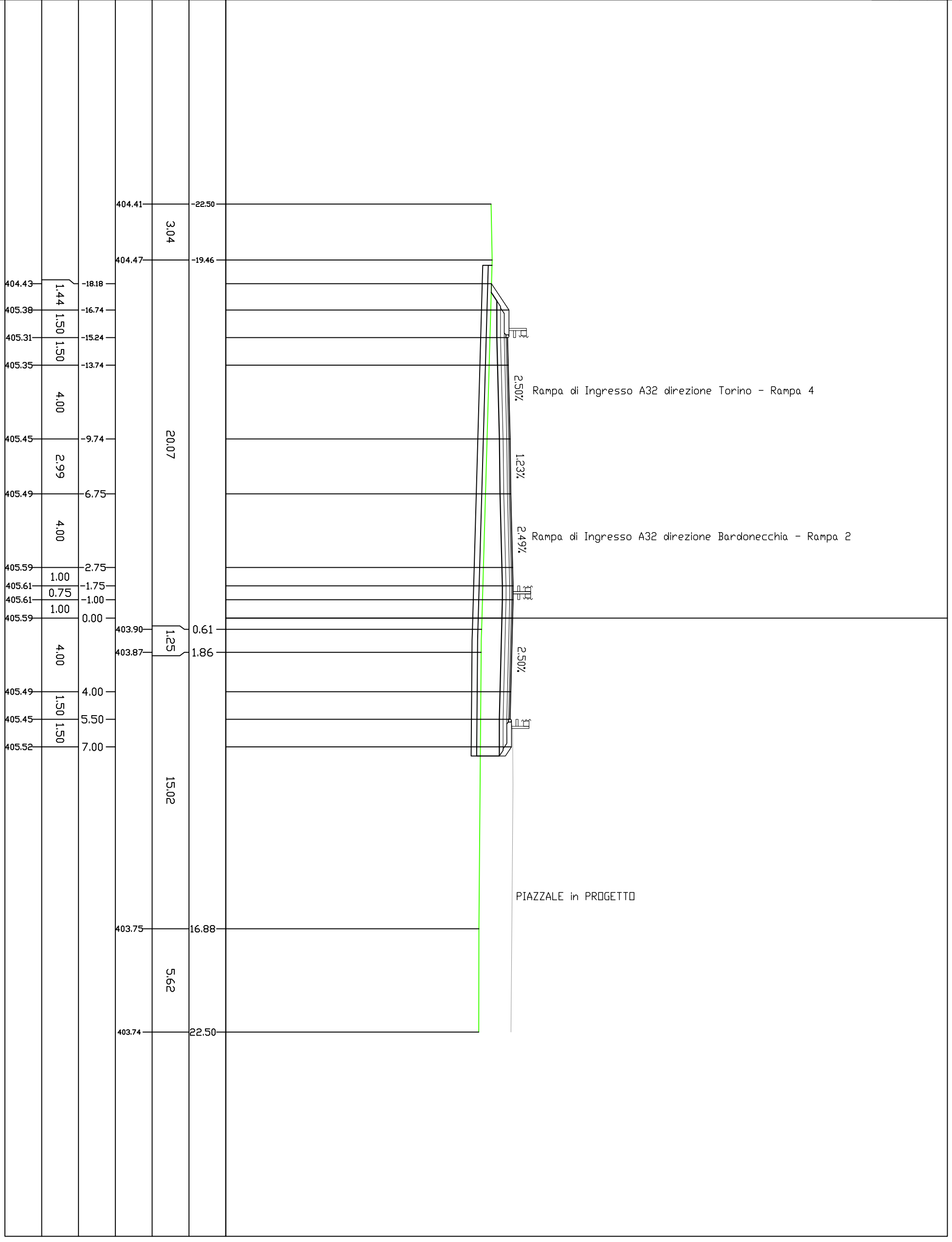

PROFILO TO-SV\_MM1

SEZIONE 24

PROGRESSIVA 508.04

STERRI E RIPORTI

R1	24.63 mq.
SCOTTICO	
A1	5.25 mq.
BONIFICA	
B1	7.89 mq.
STABILIZZATO	
D1	4.75 mq.
CEMENTATO	
E1	4.60 mq.
BASE	
F1	2.03 mq.
VEGETALE	
G1	0.85 mq.
G2	0.52 mq.
Totale:	1.37 mq.
TNT	
a1	27.29 ml.
GEDRIGLIA 10KN/m	
b1	26.28 ml.
IDROSEMINA	
e1	3.48 ml.
e2	1.40 ml.
Totale:	4.88 ml.
USURA	
f1	20.06 ml.
BINDER	
g1	20.06 ml.

390.00  
200  
200

PROGRESSIVE TERRENO	404.11	404.16	404.21	404.25	404.30	404.34	405.44	405.50	405.60	405.62	405.62	405.60	405.50	405.46	405.53	403.68	403.67	403.62	403.62	403.67
PARZIALI TERRENO	2.74	3.39	1.73	1.50	1.50	4.00	2.31	4.00	1.00	0.75	1.00	4.00	1.50	1.50						
QUOTE TERRENO																				
PROGRESSIVE PROGETTO																				
PARZIALI PROGETTO																				
QUOTE PROGETTO																				

2.50% Rampa di Ingresso A32 direzione Torino - Rampa 4

2.50% Rampa di Ingresso A32 direzione Bardonecchia - Rampa 2

2.50%

PIAZZALE in PROGETTO

PROFILO TO-SV\_MM1

SEZIONE 25

PROGRESSIVA 529.21

STERRI E RIPORTI		1558 mq.
R1	SCOTTICO	4,97 mq.
A1	BONIFICA	7,51 mq.
B1	STABILIZZATO	4,44 mq.
D1	CEMENTATO	4,28 mq.
E1	BASE	1,86 mq.
F1	VEGETALE	0,96 mq.
G1		0,54 mq.
G2		1,50 mq.
TNT	Totale:	26,02 ml.
a1	GEORIGLIA 10KN/m	24,92 ml.
b1	IDROSEMINA	3,72 ml.
e1		1,40 ml.
e2	Totale:	5,12 ml.
f1	USURA	18,53 ml.
g1	BINDER	18,53 ml.

390.00  
 200  
 200

PROGRESSIVE TERRENO	403.99	404.06	404.02	403.99	404.24	404.22	405.50	405.43	405.47	405.57	405.59	405.69	405.72	405.72	405.69	405.59	405.56	405.63	404.59	404.58	404.57	
PARZIALI TERRENO	0.78	3.08	1.32	0.64	3.95	1.93	1.50	1.50	4.00	0.78	4.00	1.00	0.75	1.00	4.00	4.00	1.50	1.50	6.82	4.07		
QUOTE TERRENO																						
PROGRESSIVE PROGETTO																						
PARZIALI PROGETTO																						
QUOTE PROGETTO																						

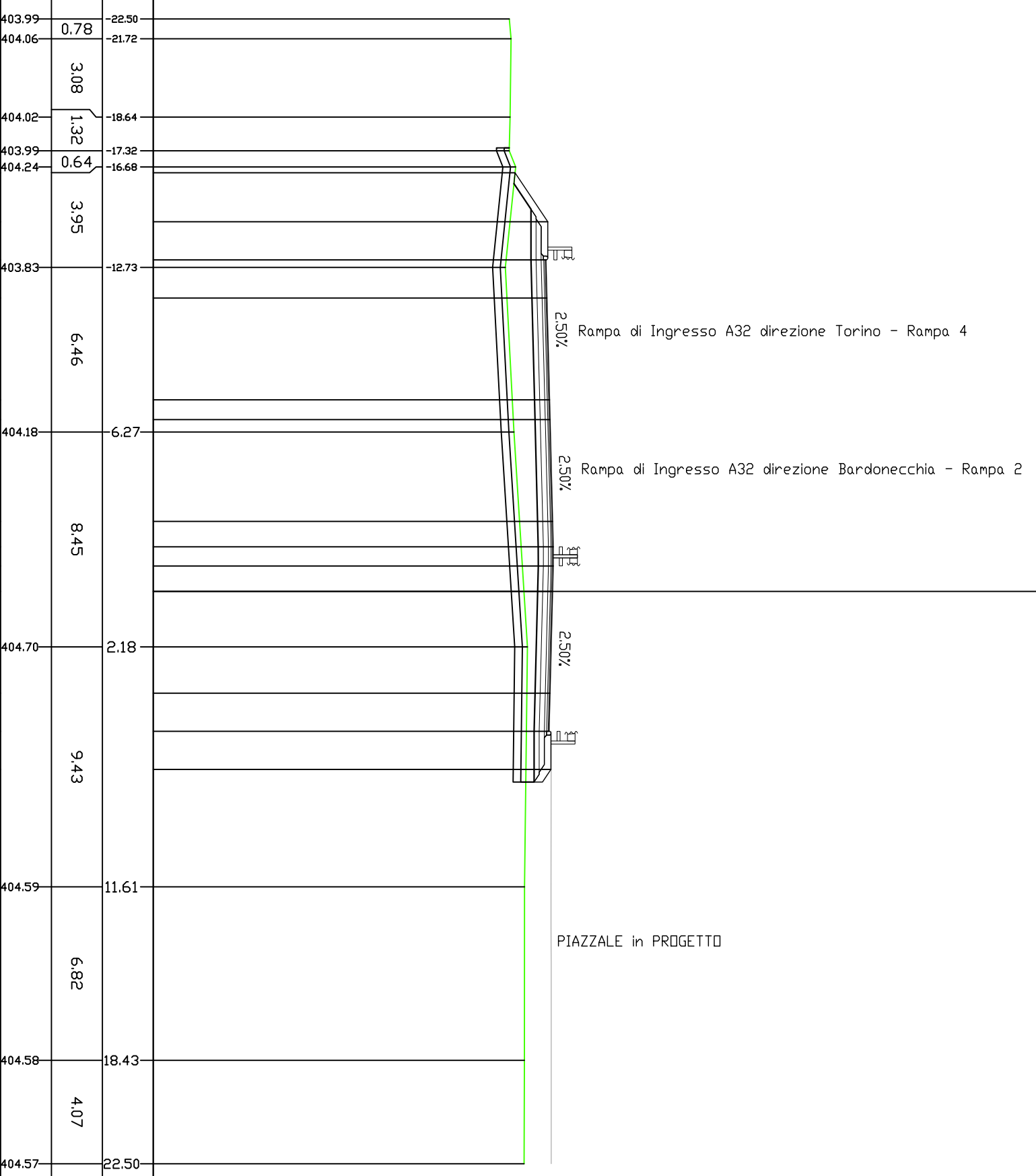

PROFILO TO-SV\_MM1  
 SEZIONE 26  
 PROGRESSIVA 550.38

STERRI E RIPORTI  
 R1 14.50 mq.  
 SCOTICD A1 4.97 mq.  
 BDNIFICA B1 7.48 mq.  
 STABILIZZATO DI 4.31 mq.  
 CEMENTATO E1 4.15 mq.  
 BASE F1 1.82 mq.  
 VEGETALE GI 1.14 mq.  
 G2 0.52 mq.  
 Totale: 1.66 mq.  
 TNT a1 25.94 ml.  
 GEORIGLIA 10KN/m b1 24.92 ml.  
 IDROSEMINA e1 4.55 ml.  
 Totale: 1.40 ml.  
 USURA f1 5.95 ml.  
 BINDER g1 17.81 ml.  
 17.81 ml.

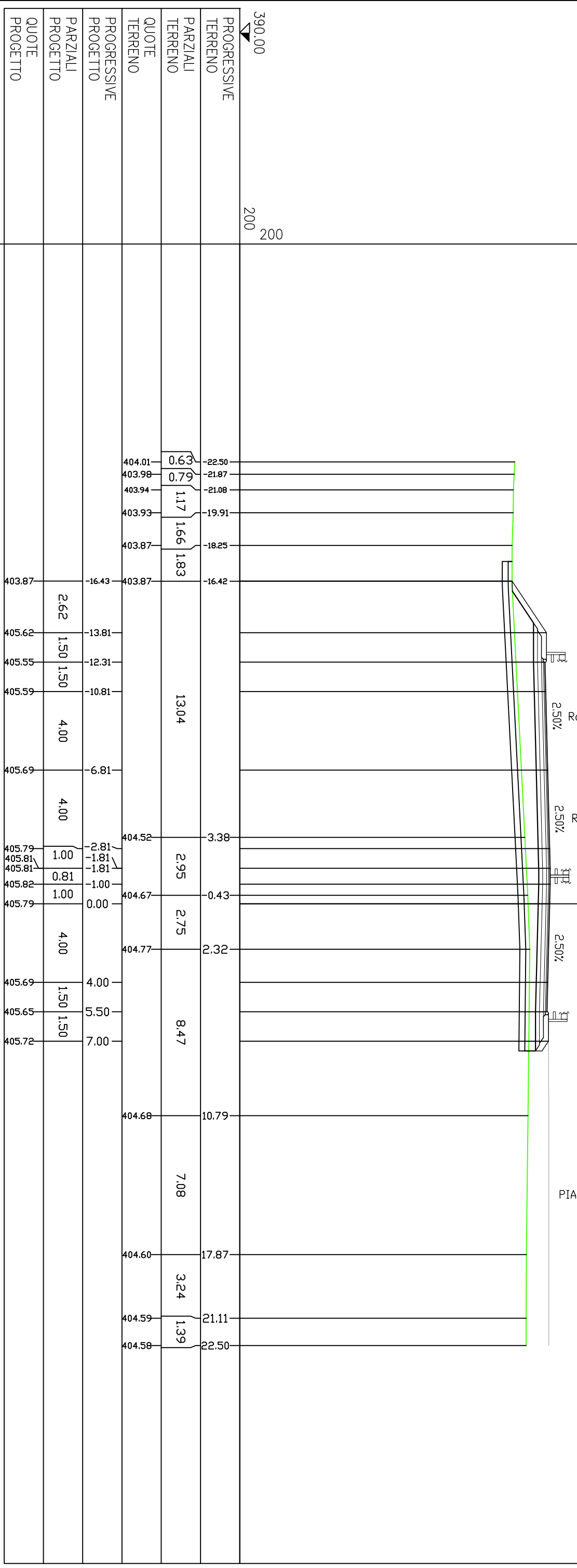

PROFILO TO-SV\_MM1

SEZIONE 27

PROGRESSIVA 558,88

STERRI E RIPORTI	17,59 mq.
R1	
SCOTTICO	4,96 mq.
A1	
BONIFICA	7,43 mq.
B1	
STABILIZZATO	4,29 mq.
D1	
CEMENTATO	4,17 mq.
E1	
BASE	1,78 mq.
F1	
VEGETALE	1,13 mq.
G1	
G2	0,52 mq.
Totale:	1,65 mq.
TNT	
a1	25,80 ml.
GEOGRIGLIA 10KN/m	
b1	24,77 ml.
IDROSEMINA	
e1	4,44 ml.
e2	1,40 ml.
Totale:	5,84 ml.
USURA	
f1	17,75 ml.
BINDER	
g1	17,75 ml.

390,00  
 ▼  
 PROGRESSIVE  
 TERRENO 200  
 200

PARZIALI TERRENO	0,90	2,84	0,91	1,57	1,72	0,86	2,53	1,50	1,50	4,00	4,00	1,00	0,75	1,00	4,00	4,00	1,50	1,50	8,70	5,26	6,49	
QUOTE TERRENO																						
PROGRESSIVE PROGETTO	403,98	404,02	403,92	403,92	403,98	403,82	405,66	405,59	405,63	405,73	405,83	405,86	405,86	405,83	404,72	405,73	405,69	405,76	404,64	404,58	404,56	
PROGRESSIVE TERRENO	-22,50	-21,60	-18,76	-17,85	-16,28	-14,56	-13,75	-12,25	-10,75	6,75	-2,75	-1,75	-1,00	0,00	2,05	4,00	5,50	7,00	10,75	16,01	22,50	

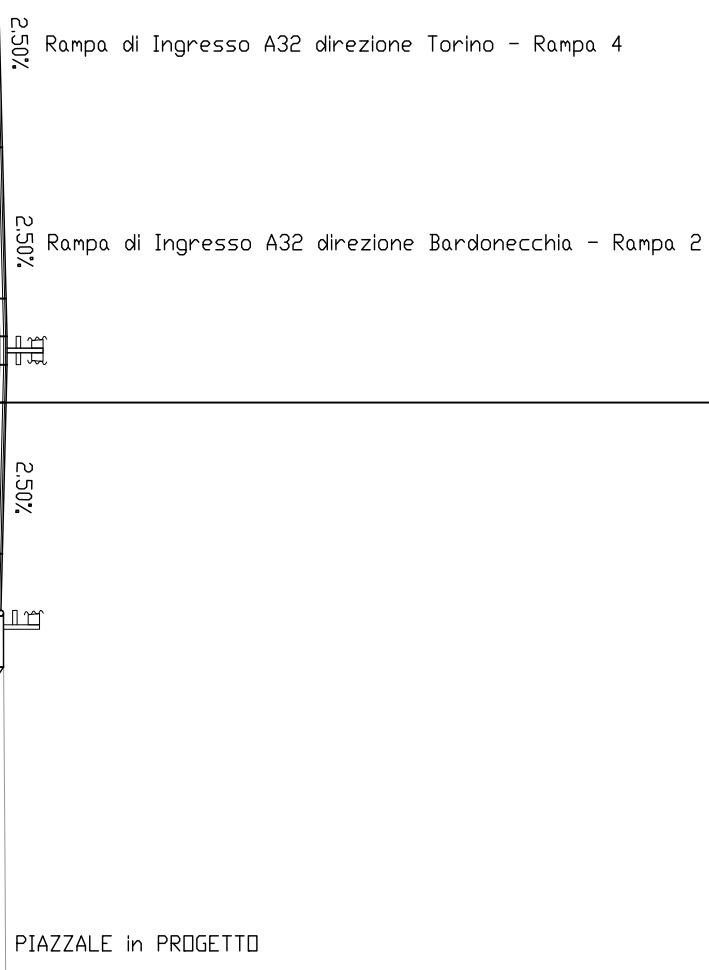

STERRI E RIPORTI	
R1	1545 mq.
SCOTICD	
A1	4.53 mq.
BONIFICA	
B1	6.81 mq.
STABILIZZATO	
D1	3.88 mq.
CEMENTATO	
E1	3.73 mq.
BASE	
F1	1.62 mq.
VEGETALE	
G1	1.09 mq.
G2	0.53 mq.
Totale:	1.62 mq.
TNT	
a1	23.68 ml.
GEORIGLIA 10KN/m	
b1	22.68 ml.
IDROSEMINA	
e1	4.33 ml.
e2	1.40 ml.
Totale:	5.73 ml.
USURA	
f1	15.75 ml.
BINDER	
g1	15.75 ml.

390.00  
 200  
 200

PROGRESSIVE TERRENO		403.98	404.00	404.06	404.14	405.77	405.70	405.74	405.79	405.79	405.89	405.91	405.91	405.89	404.57	404.62	404.61	405.79	405.75	405.82	404.61	404.57	
PARZIALI TERRENO		1.91	3.54	5.34											0.72	1.59	0.69						
QUOTE TERRENO																							
PROGRESSIVE PROGETTO																							
PARZIALI PROGETTO																							
QUOTE PROGETTO																							

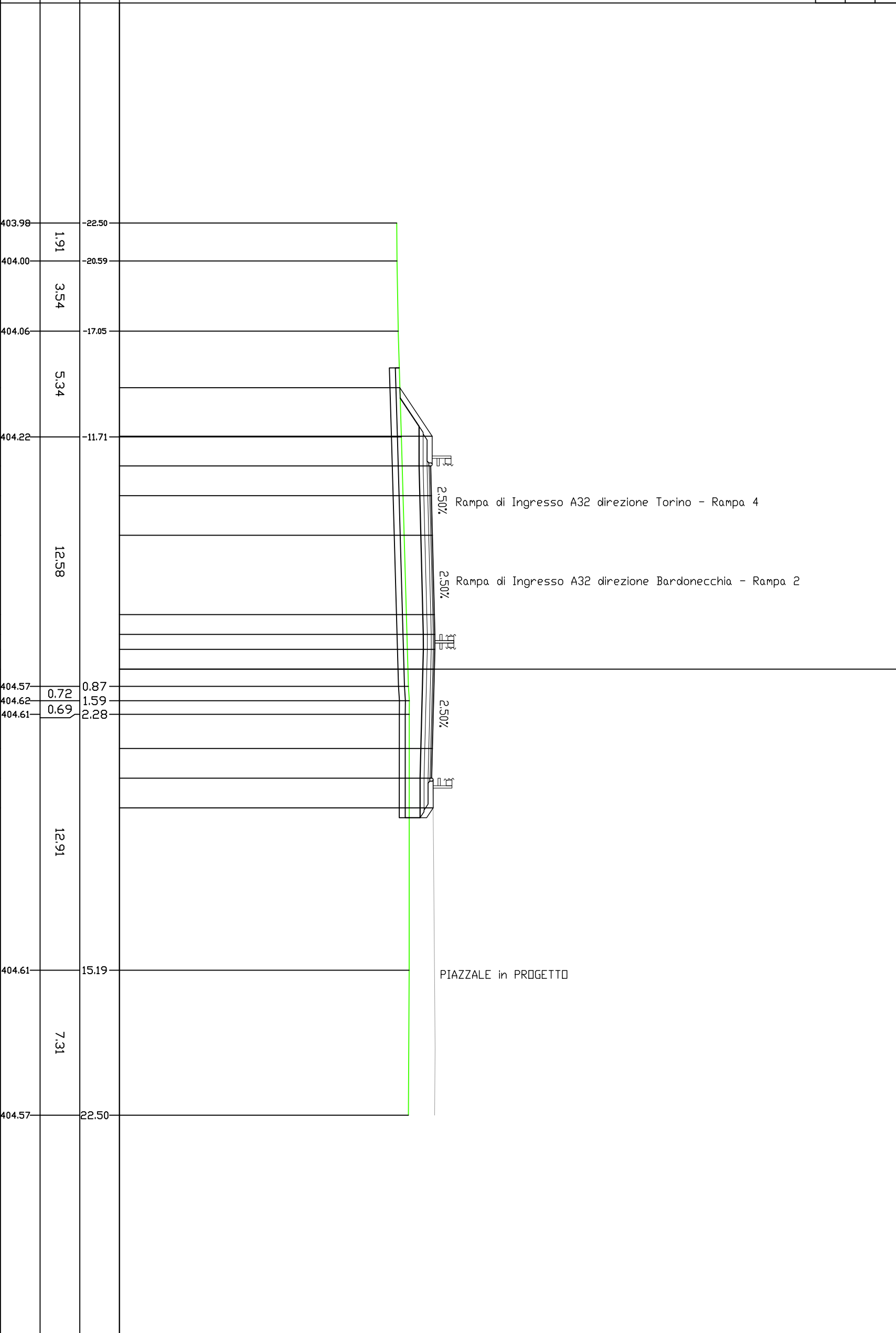

2.50% Rampa di Ingresso A32 direzione Torino - Rampa 4  
 2.50% Rampa di Ingresso A32 direzione Bardonecchia - Rampa 2

PIAZZALE in PROGETTO

PROFILO TO-SV\_MM1

SEZIONE 29

PROGRESSIVA 583.83

STERRI E RIPORTI	11.43 mq.
R1 SCOTICD	4.20 mq.
A1 BONIFICA	6.32 mq.
B1 STABILIZZATO	3.50 mq.
D1 CEMENTATO	3.32 mq.
E1 BASE	1.42 mq.
F1 VEGETALE	1.19 mq.
G1	0.52 mq.
G2	1.71 mq.
Totale:	22.06 ml.
TNT	21.02 ml.
a1 GEDRIGLIA 10KN/m	4.74 ml.
b1 IDROSEMINA	1.40 ml.
e1	6.14 ml.
e2	13.75 ml.
Totale:	13.75 ml.
USURA	13.75 ml.
f1 BINDER	13.75 ml.
g1	

390.00  
 200  
 200

PROGRESSIVE TERRENO	403.88	403.94	403.83	403.77	404.02	405.88	405.81	405.85	405.95	405.97	405.97	405.95	404.94	405.85	405.81	405.88	404.70	404.64	
PARZIALI TERRENO	2.51	1.08	2.75			12.82				1.00	0.75	1.00	0.64	3.54			10.62	8.34	
QUOTE TERRENO																			
PROGRESSIVE PROGETTO																			
PARZIALI PROGETTO																			
QUOTE PROGETTO																			

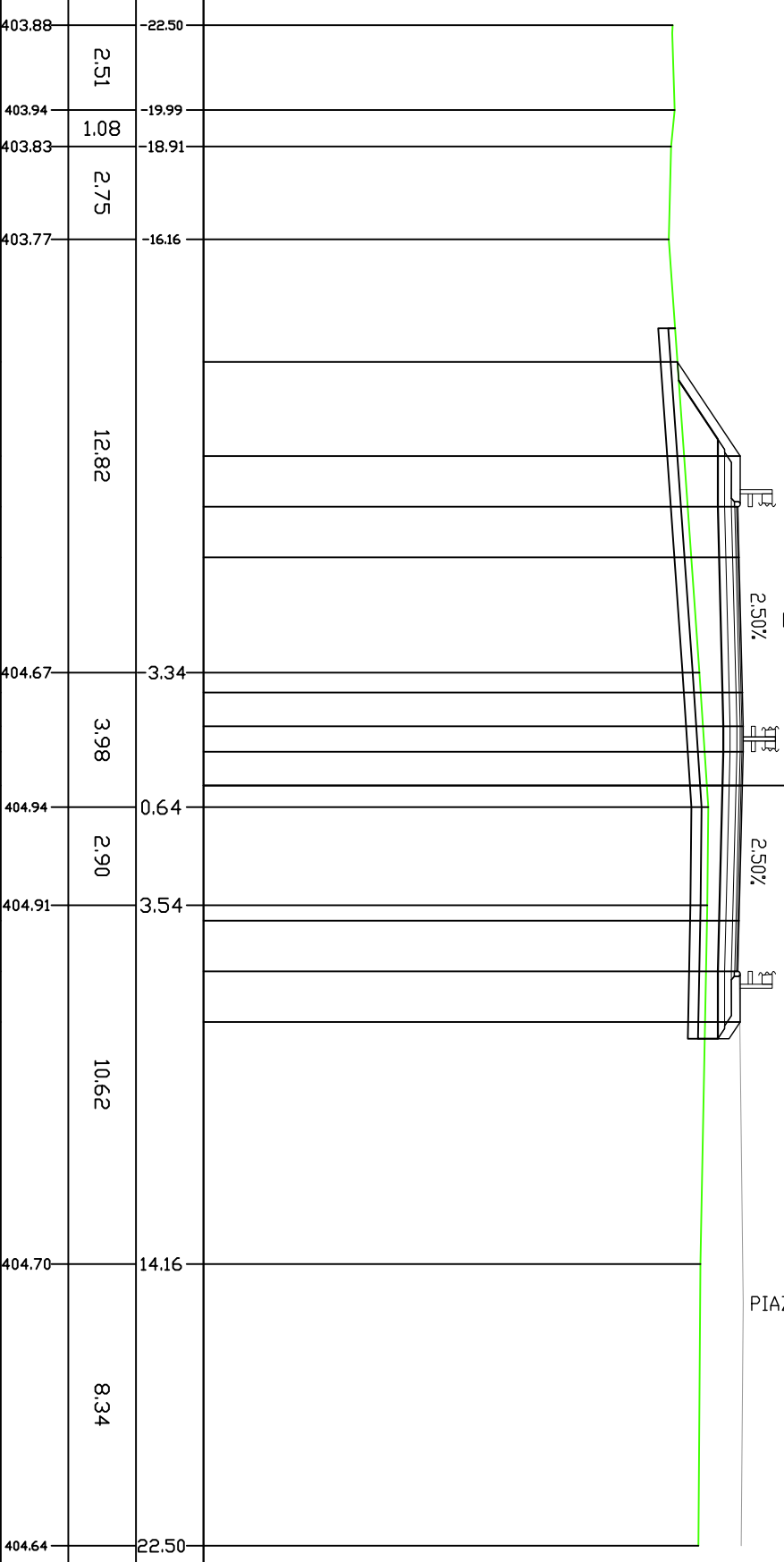

Rampa di Ingresso A32 direzione Bardonecchia - Rampa 2

PIAZZALE in PROGETTO

PROFILO TO-SV\_MM1

SEZIONE 30

PROGRESSIVA 591.14

STERRI E RIPORTI	1019 mq.
R1 SCOTICD	4.18 mq.
A1 BONIFICA	6.26 mq.
B1 STABILIZZATO	3.46 mq.
D1 CEMENTATO	3.37 mq.
E1 BASE	1.43 mq.
F1 VEGETALE	1.14 mq.
G1	0.53 mq.
G2	1.67 mq.
Totale:	21.92 ml.
TNT	20.89 ml.
a1 GEDRIGLIA 10KN/m	4.58 ml.
b1 IDROSEMINA	1.40 ml.
e1	5.98 ml.
e2	13.75 ml.
Totale:	13.75 ml.
USURA	13.75 ml.
f1 BINDER	13.75 ml.
g1	13.75 ml.

390.00  
 200  
 200

PROGRESSIVE TERRENO	403.95	403.86	404.15	405.91	405.84	405.88	405.98	406.00	406.00	405.98	405.88	405.84	405.91
PROGRESSIVE PROGETTO			404.14	405.91	405.84	405.88	405.98	406.00	406.00	405.98	405.88	405.84	405.91
PARZIALI TERRENO	4.12	5.83											
PARZIALI PROGETTO			12.36										
QUOTE TERRENO													
QUOTE PROGETTO			2.65	1.50	1.50	4.00	1.00	0.75	1.00	4.00	1.50	1.50	
PROGRESSIVE TERRENO	403.95	403.86	404.14	405.91	405.84	405.88	405.98	406.00	406.00	405.98	405.88	405.84	405.91
PROGRESSIVE PROGETTO			404.14	405.91	405.84	405.88	405.98	406.00	406.00	405.98	405.88	405.84	405.91
PARZIALI TERRENO	4.12	5.83											
PARZIALI PROGETTO			12.36										
QUOTE TERRENO													
QUOTE PROGETTO			2.65	1.50	1.50	4.00	1.00	0.75	1.00	4.00	1.50	1.50	

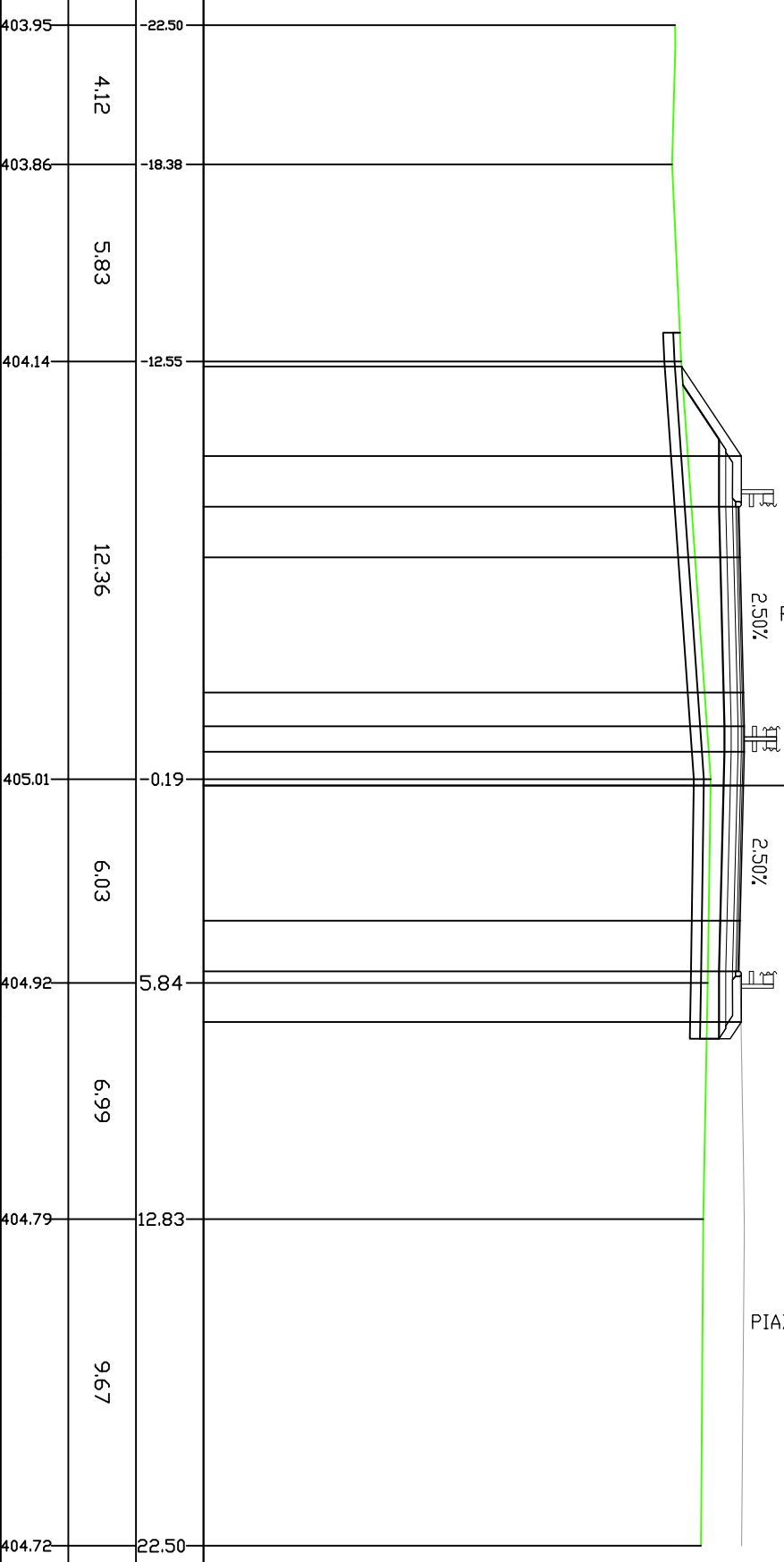

Rampa di Ingresso A32 direzione Bardonecchia - Rampa 2

PIAZZALE in PROGETTO



PROFILO TO-SV\_MM1

SEZIONE 31

PROGRESSIVA 604.35

STERRI E RIPORTI	
R1	1329 mq.
SCOTTICO	
A1	4.11 mq.
BDNIFICA	
B1	6.14 mq.
STABILIZZATO	
D1	3.49 mq.
CEMENTATO	
E1	3.32 mq.
BASE	
F1	1.42 mq.
VEGETALE	
G1	1.02 mq.
G2	0.53 mq.
Totale:	1.55 mq.
TNT	
a1	21.49 ml.
GEDRIGLIA 10KN/m	
b1	20.49 ml.
IDROSEMINA	
e1	4.10 ml.
e2	1.40 ml.
Totale:	5.50 ml.
USURA	
f1	13.76 ml.
BINDER	
g1	13.76 ml.

390.00  
 ▼  
 PROGRESSIVE  
 TERRENO 200  
 200

PROGRESSIVE	PARZIALI	QUOTE	PROGRESSIVE	PARZIALI	QUOTE
PROGETTO	PROGETTO	PROGETTO	TERRENO	PROGETTO	PROGETTO
404.47	2.25	-12.01	403.99	8.05	-22.50
405.97	1.50	9.76	404.41	12.76	-14.45
405.90	1.50	8.26			
405.94	4.00	6.76			
406.04	1.01	2.76			
406.06	0.75	-1.75	404.75	9.55	-1.69
406.06	1.00	-1.00			
406.04	4.00	0.00			
405.94	4.00	4.00			
405.90	1.50	5.50			
405.97	1.50	7.00	404.59	3.50	7.86
			404.46	10.75	11.36
			404.48	0.39	22.11
			404.48		22.50

Rampa di Ingresso A32 direzione Bardonecchia - Rampa 2  
 2.48%

2.50%

PIAZZALE in PROGETTO

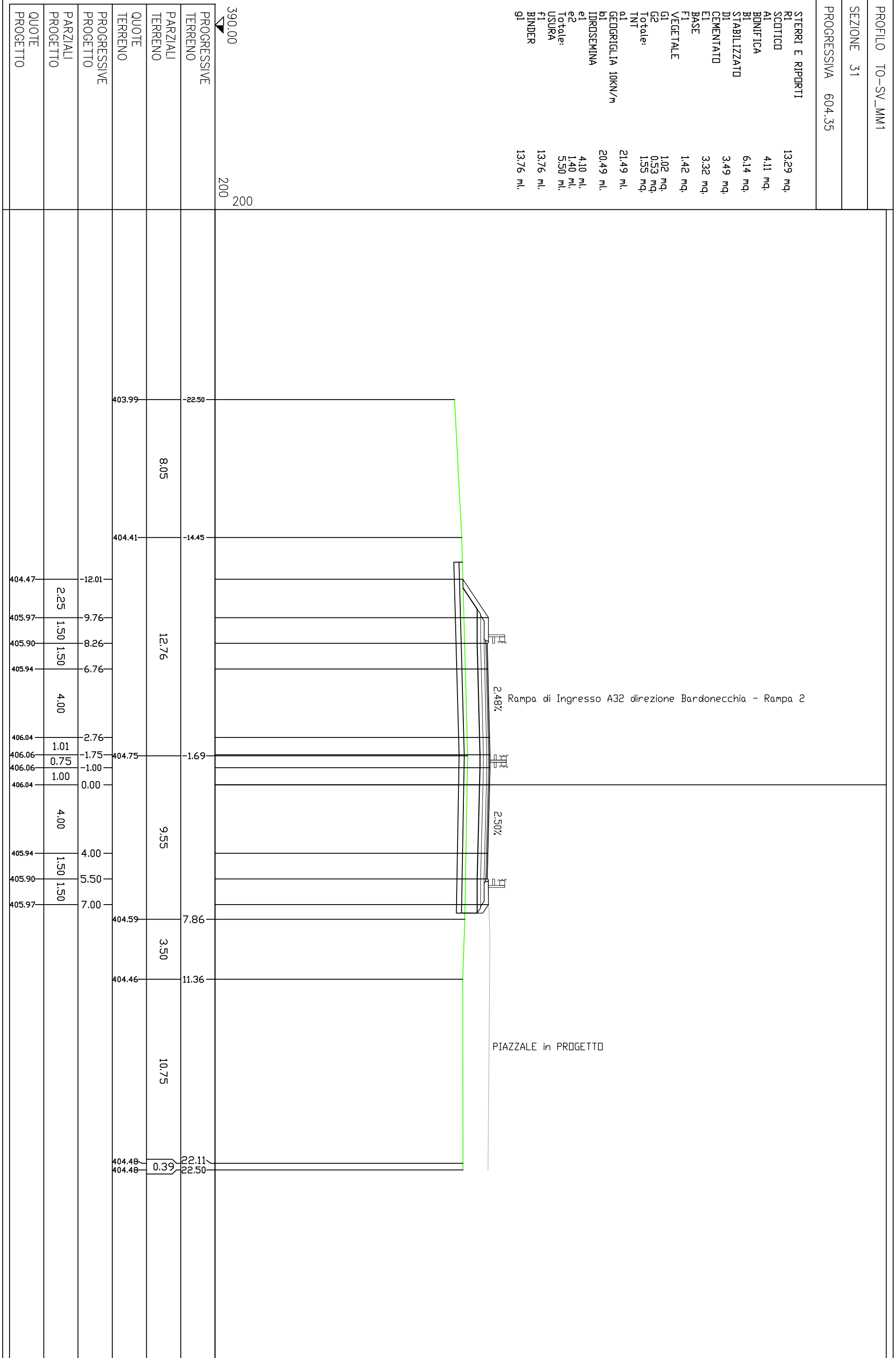

PROFILO TO-SV\_MM1

SEZIONE 32

PROGRESSIVA 617.35

STERRI E RIPORTI	
R1	17,50 mq.
SCOTTICO	
A1	4,20 mq.
BDNIFICA	
B1	6,28 mq.
STABILIZZATO	
D1	3,47 mq.
CEMENTATO	
E1	3,33 mq.
BASE	
F1	1,42 mq.
VEGETALE	
G1	1,17 mq.
G2	0,52 mq.
Totale:	1,69 mq.
TNT	
a1	21,95 ml.
GEDRIGLIA 10KN/m	
b1	20,94 ml.
IDROSEMINA	
e1	4,67 ml.
e2	1,57 ml.
Totale:	6,24 ml.
USURA	
f1	13,73 ml.
BINDER	
g1	13,73 ml.

390.00  
 ▼  
 PROGRESSIVE  
 TERRENO 200  
 200

PARZIALI TERRENO	6.97	403.97	-22.50
QUOTE TERRENO		404.10	-15.53
PROGRESSIVE PROGETTO		404.22	-12.45
PARZIALI PROGETTO	2.72	406.03	9.73
QUOTE PROGETTO	1.50	405.96	8.23
	1.50	405.98	6.73
	4.00	404.53	4.13
	0.98	406.04	2.73
	0.75	406.06	-1.75
	1.00	406.06	-1.00
		406.04	0.00
	4.00	405.99	4.00
	1.50	405.96	5.50
	1.50	406.03	7.00
	0.15	405.94	7.15
PARZIALI TERRENO	11.40	404.53	-4.13
QUOTE TERRENO		404.52	-0.40
PROGRESSIVE PROGETTO		404.44	10.74
PARZIALI PROGETTO	1.69	404.43	12.43
QUOTE PROGETTO	3.35	404.43	15.78
	6.72	404.45	22.50

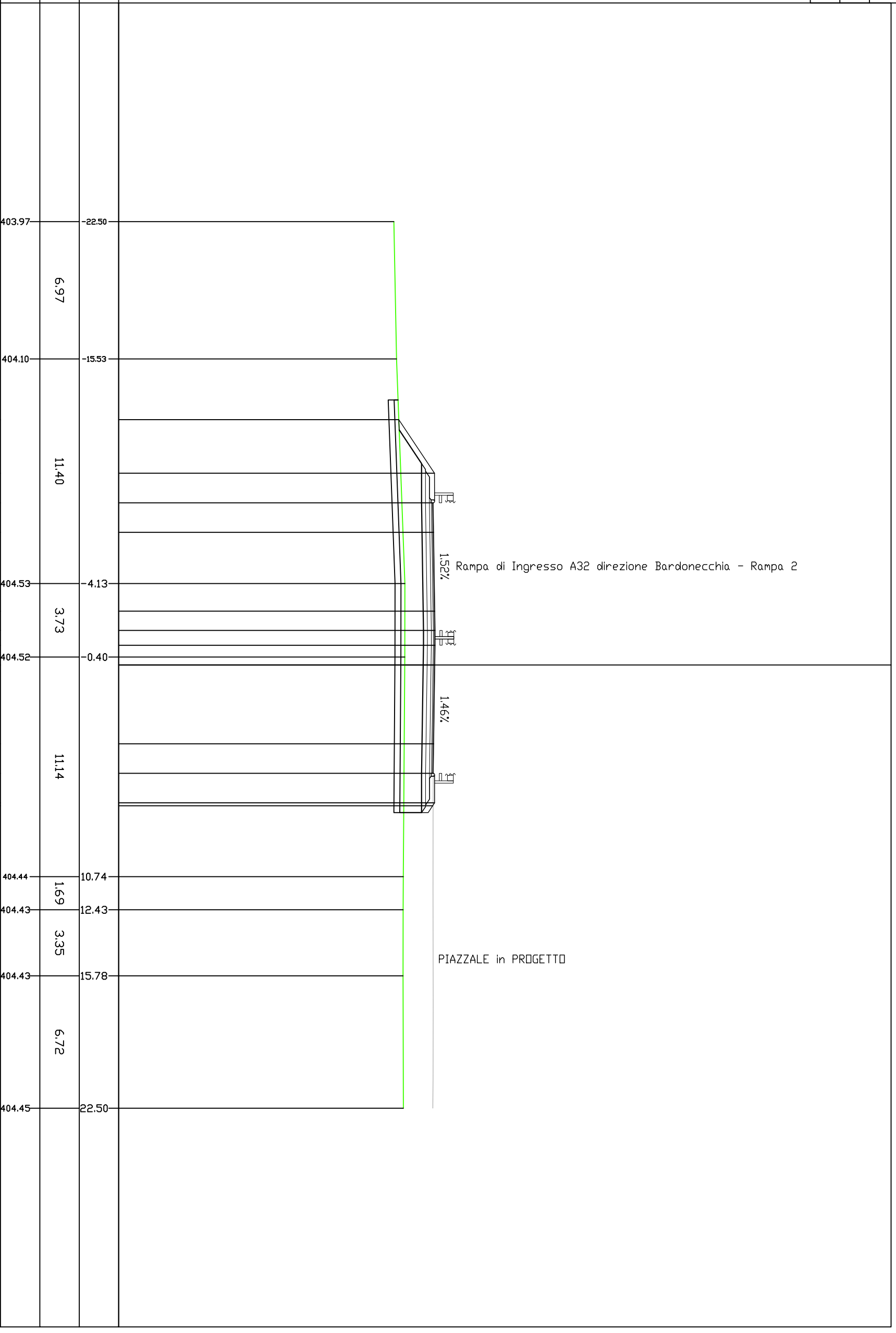

PROFILO TO-SV\_MM1

SEZIONE 33

PROGRESSIVA 620.77

STERRI E RIPORTI	17,61 mq.
R1 SCOTICD	4,16 mq.
A1 BONIFICA	6,25 mq.
B1 STABILIZZATO	3,47 mq.
D1 CEMENTATO	3,33 mq.
E1 BASE	1,39 mq.
F1 VEGETALE	1,17 mq.
G1	0,52 mq.
G2	1,69 mq.
Totale:	21,84 ml.
TNT	20,84 ml.
a1 GEDRIGLIA 10KN/m	4,60 ml.
b1 IDROSEMINA	1,54 ml.
e1	6,14 ml.
e2 Totale:	13,69 ml.
USURA	13,69 ml.
f1 BINDER	13,69 ml.
g1	13,69 ml.

390.00  
 200  
 200

PROGRESSIVE TERRENO	404.09	-22.50	10.70	404.27	-12.35	404.28	-11.80	6.46	404.51	5.34	6.06	404.51	0.72	8.74	404.45	9.46	4.41	404.42	13.87	7.07	404.42	20.94	1.56	404.42	22.50
QUOTE TERRENO																									
PROGRESSIVE PROGETTO																									
PARZIALI PROGETTO				2.66	1.50	1.50	4.00	0.97	0.72	1.00	4.00	1.50	1.50	0.12											
QUOTE PROGETTO																									

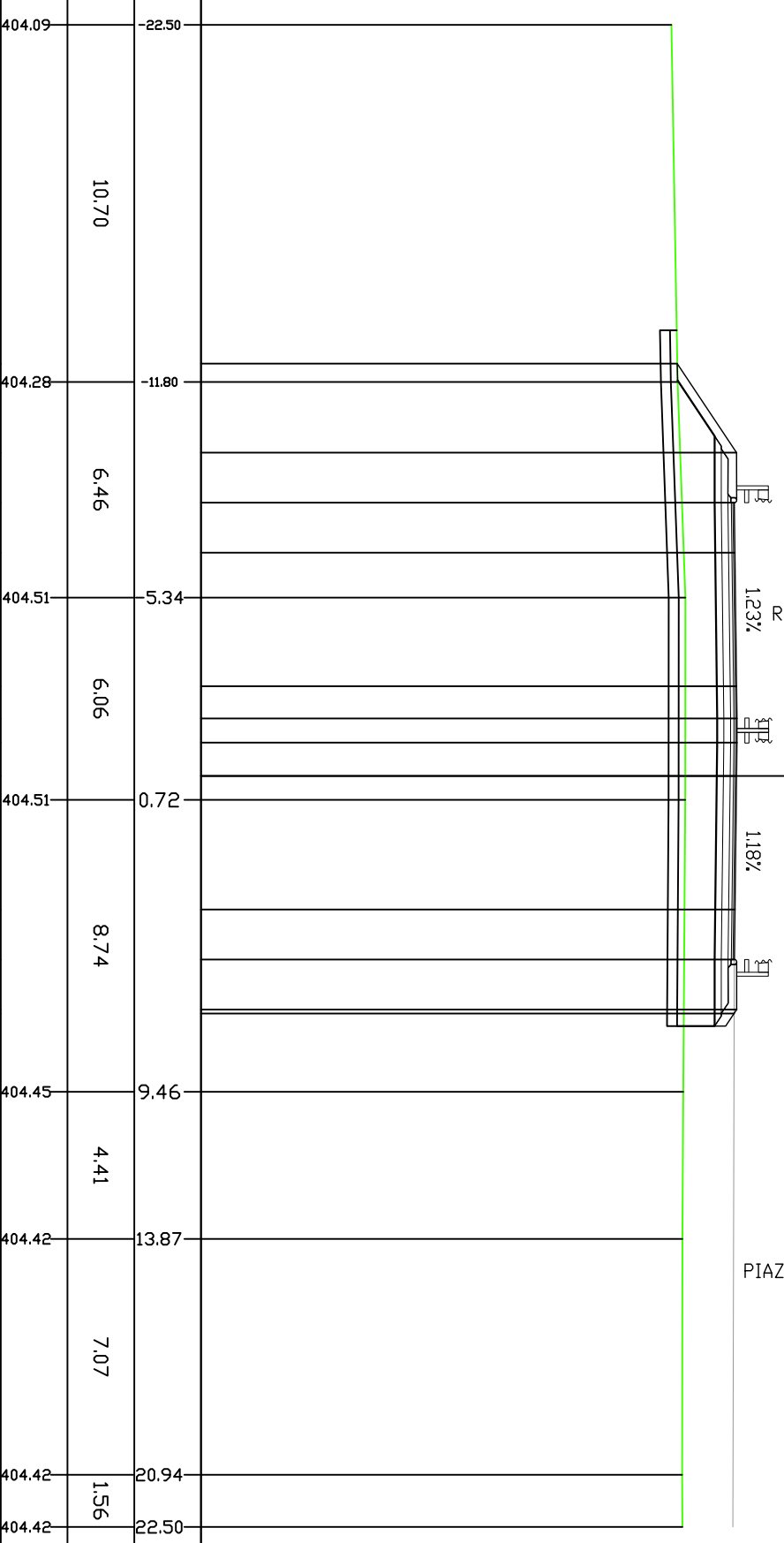

Rampa di Ingresso A32 direzione Bardonecchia - Rampa 2

PIAZZALE in PROGETTO

STERRI E RIPORTI	
R1	17,39 mq.
SCOTICD	
A1	4,13 mq.
A2	3,83 mq.
Totale:	7,96 mq.
BONIFICA	
B1	6,20 mq.
B2	5,75 mq.
B3	5,75 mq.
Totale:	17,70 mq.
STABILIZZATO	
D1	3,47 mq.
CEMENTATO	
E1	3,31 mq.
BASE	
F1	1,41 mq.
VEGETALE	
G1	1,10 mq.
G2	0,53 mq.
Totale:	1,63 mq.
TNT	
a1	21,66 ml.
a2	20,16 ml.
Totale:	41,82 ml.
GEDEGRIGLIA 10KN/m	
b1	20,66 ml.
b2	19,16 ml.
Totale:	39,82 ml.
IDROSEMINA	
e1	4,43 ml.
e2	1,56 ml.
Totale:	5,99 ml.
USURA	
f1	13,65 ml.
BINDER	
g1	13,65 ml.

390.00  
 200  
 200

PROGRESSIVE TERRENO	404.07	-22.50	10.15	404.38	-12.35	3.58	1.86	8.46	404.50	1.55	6.32	7.16	15.03	7.47	404.41	22.50
QUOTE TERRENO																
PROGRESSIVE PROGETTO	404.38	-12.17	3.58	404.44	8.77	1.86	6.91	8.46	404.50	1.55	6.32	7.16	15.03	7.47	404.41	22.50
PARZIALI PROGETTO	2.52	9.65	1.50	1.50	4.00	0.95	0.70	1.00	4.00	4.00	1.50	1.50	0.13			
QUOTE PROGETTO																

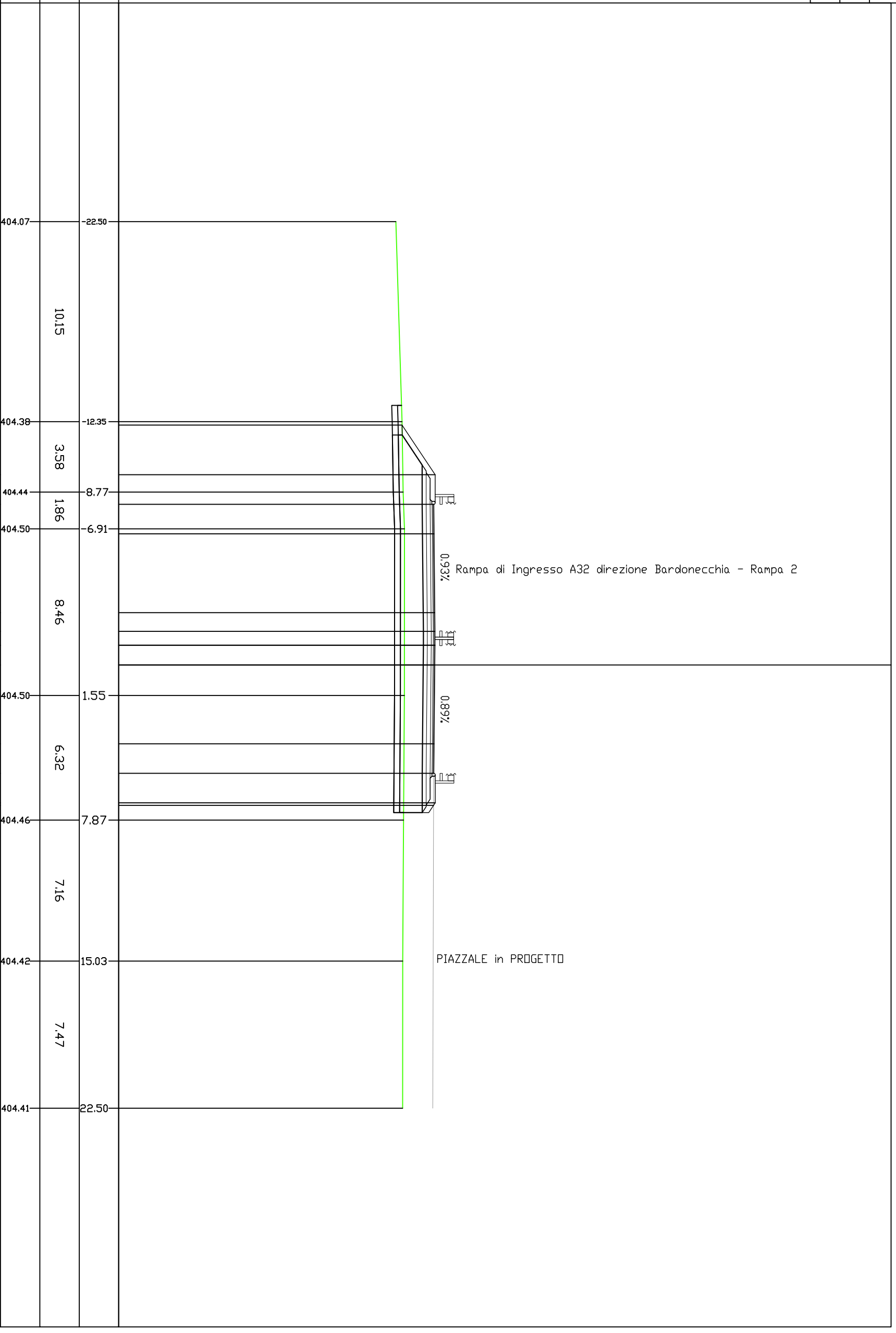

PROFILO TO-SV\_MM1

SEZIONE 35

PROGRESSIVA 635.04

STERRI E RIPARTI		
R1	25,05 mq.	
SCOTICD	5,52 mq.	
A1	8,28 mq.	
BONIFICA	4,86 mq.	
B1	4,70 mq.	
STABILIZZATO	0,61 mq.	
D1	1,19 mq.	
CEMENTATO	1,08 mq.	
E1	2,88 mq.	
VEGETALE	28,59 ml.	
G1	27,59 ml.	
G2	1,86 ml.	
G3	4,34 ml.	
Totale:	6,20 ml.	
TNT	7,65 ml.	
a1	8,24 ml.	
GEDRIGLIA 10KN/m	15,89 ml.	
b1		
IDROSEMINA		
e1		
Totale:		
USUKA		
f1		
f2		
Totale:		
BINDER		
g1		
g2		
Totale:		

390.00  
 ▽  
 PROGRESSIVE  
 TERRENO 200  
 200

PARZIALI TERRENO																				
	404.28																			
QUOTE TERRENO																				
PROGRESSIVE PROGETTO																				
PARZIALI PROGETTO																				
QUOTE PROGETTO																				

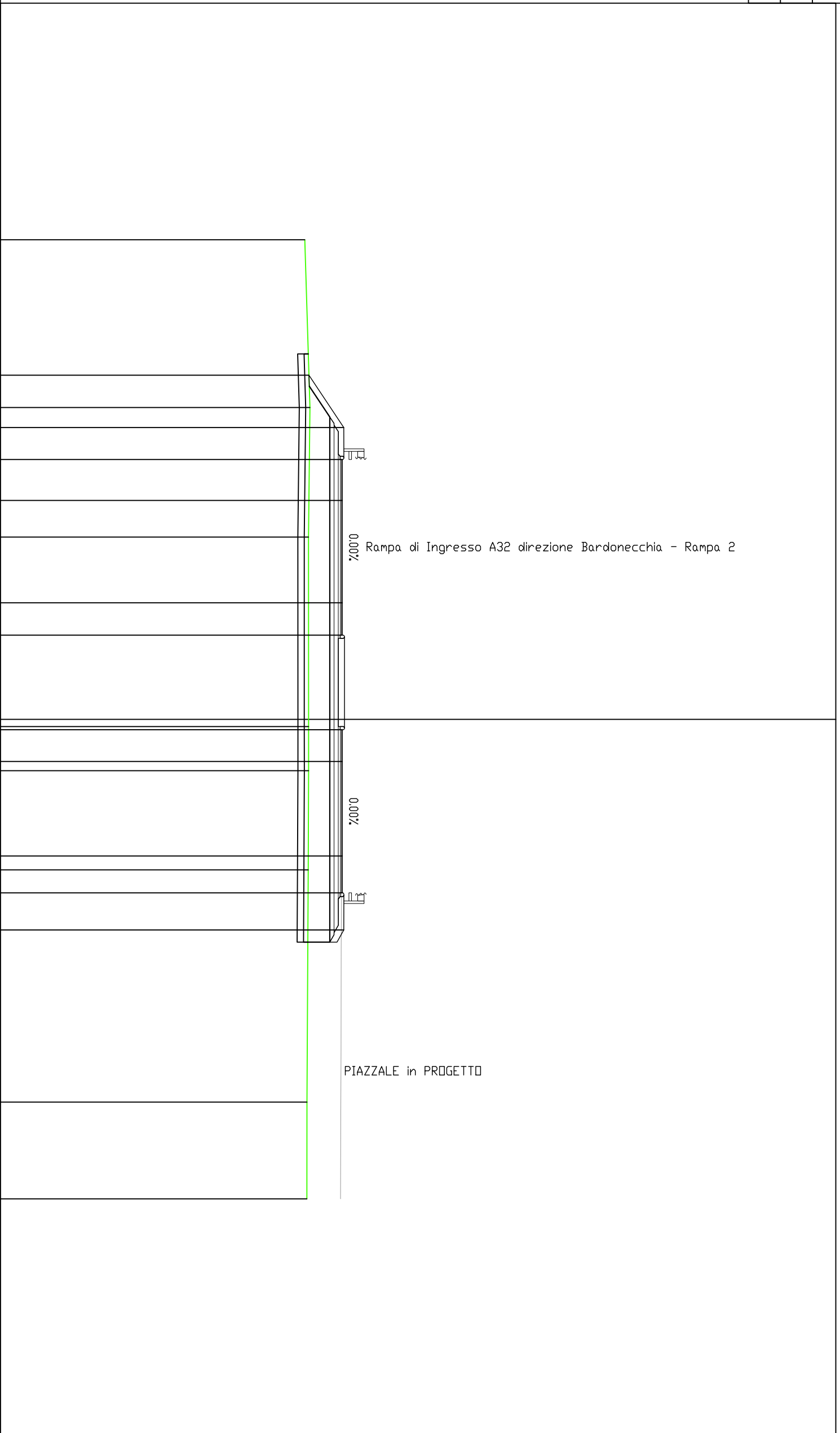

# Ingresso A32 direzione Bardonecchia – Rampa 2

## KEY PLAN

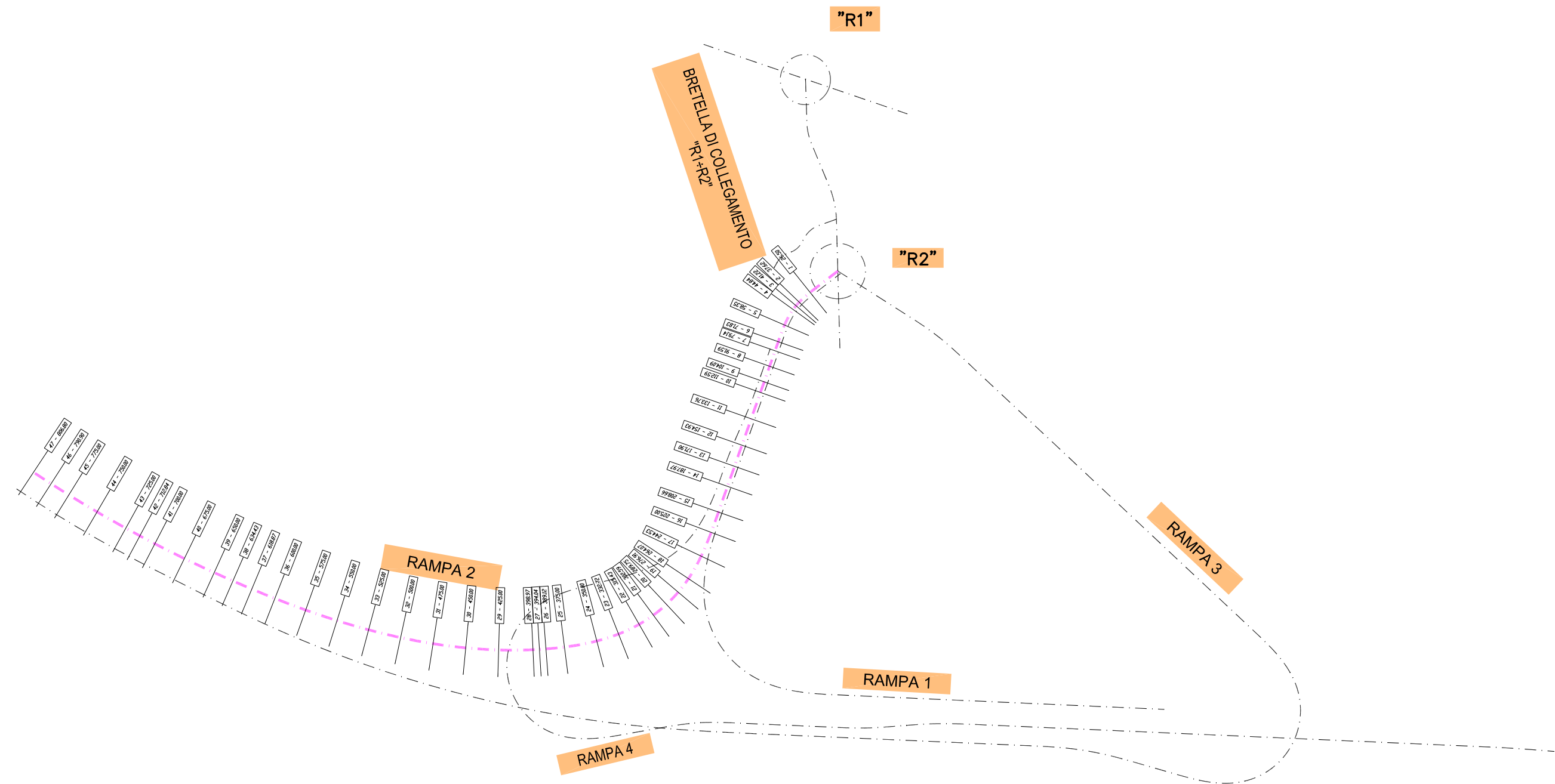

PROFILO SV-BA\_MM1

SEZIONE 1

PROGRESSIVA 26.50

390.00  
200  
200

PROGRESSIVE  
TERRENO

PARZIALI  
TERRENO

QUOTE  
TERRENO

PROGRESSIVE  
PROGETTO

PARZIALI  
PROGETTO

QUOTE  
PROGETTO

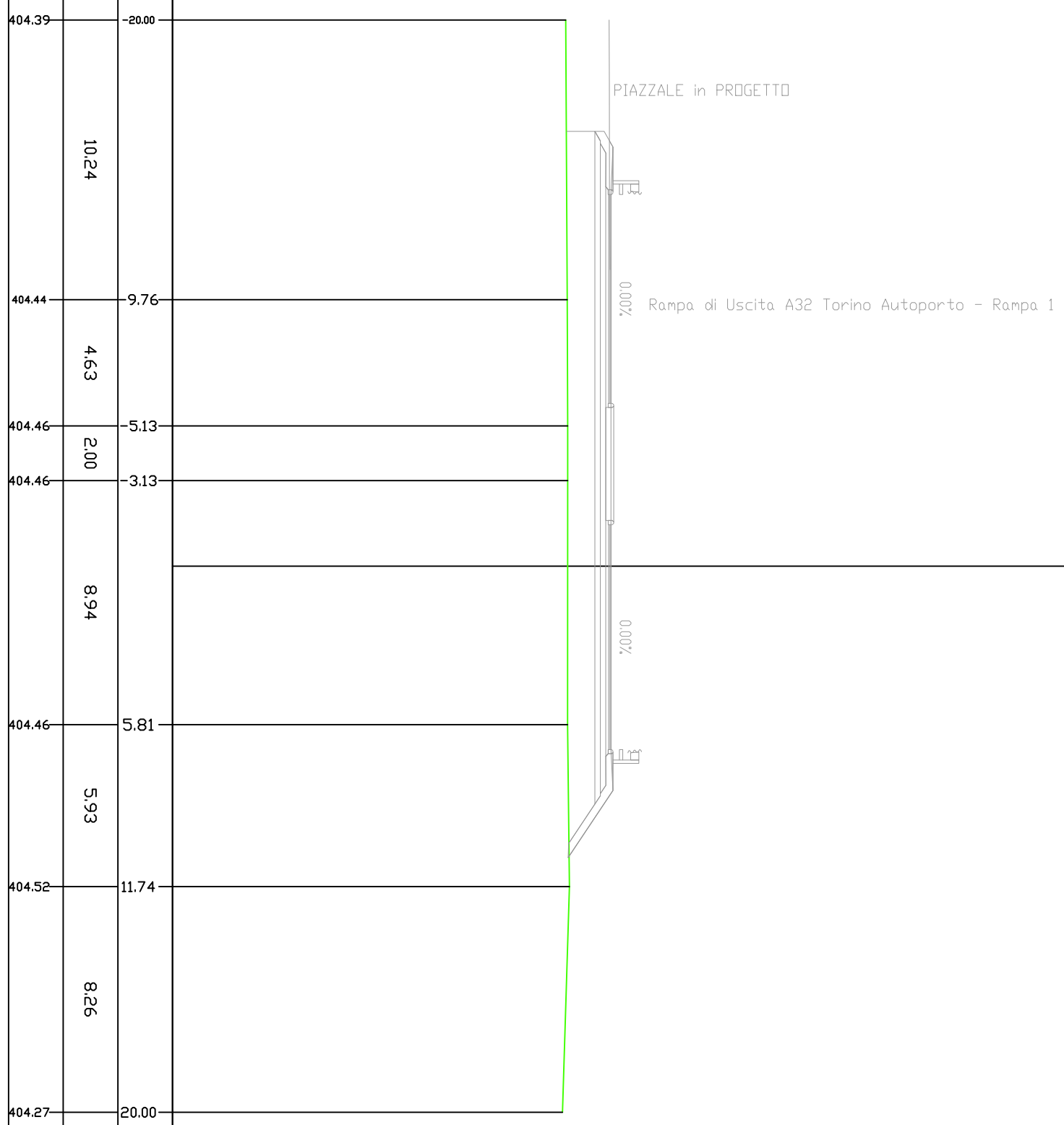

PROFILO SV-BA\_MM1

SEZIONE 2

PROGRESSIVA 37.62

390.00  
200  
200

PROGRESSIVE  
TERRENO

PARZIALI  
TERRENO

QUOTE  
TERRENO

PROGRESSIVE  
PROGETTO

PARZIALI  
PROGETTO

QUOTE  
PROGETTO

404.41	-20.00		
404.42	-17.64	2.36	
		7.07	
404.46	-10.57	6.37	
404.50	-4.20	8.46	
404.50	4.26	1.83	
404.44	6.09	3.44	
404.38	9.53	10.47	
404.06	20.00		

PIAZZALE in PROGETTO

Rampa di Uscita A32 Torino Autoporto - Rampa 1

0.89%

0.93%



PROFILO SV-BA\_MM1

SEZIONE 3

PROGRESSIVA 41.22

390.00  
200  
200

PROGRESSIVE  
TERRENO

PARZIALI  
TERRENO

QUOTE  
TERRENO

PROGRESSIVE  
PROGETTO

PARZIALI  
PROGETTO

QUOTE  
PROGETTO

PROGRESSIVE TERRENO	PARZIALI TERRENO	QUOTE TERRENO	PROGRESSIVE PROGETTO	PARZIALI PROGETTO	QUOTE PROGETTO
404.42		-20.00			
	3.54				
404.43		-16.46			
	4.23				
404.45		-12.23			
	8.83				
404.51		-3.40			
	6.07				
404.51		2.67			
	6.34				
404.28		9.01			
	10.99				
404.09		20.00			

PIAZZALE in PROGETTO

Rampa di Uscita A32 Torino Autoporto - Rampa 1

1.18%

1.23%

PROFILO SV-BA\_MM1

SEZIONE 4

PROGRESSIVA 44.84

390.00  
200  
200

PROGRESSIVE TERRENO	QUOTE TERRENO	PROGRESSIVE TERRENO
404.44	-20.00	
404.43	-18.09	1.91
404.44	-15.08	3.01
404.44	-13.52	1.56
		11.20
404.52	2.32	3.72
404.53	1.40	
		11.30
404.11	12.70	7.30
403.97	20.00	

PIAZZALE in PROGETTO

Rampa di Uscita A32 Torino Autoporto - Rampa 1

1.46%

1.52%

PROGRESSIVE TERRENO	QUOTE TERRENO	PROGRESSIVE TERRENO
404.44	-20.00	
404.43	-18.09	1.91
404.44	-15.08	3.01
404.44	-13.52	1.56
		11.20
404.52	2.32	3.72
404.53	1.40	
		11.30
404.11	12.70	7.30
403.97	20.00	

PROFILO SV-BA\_MM1

SEZIONE 5

PROGRESSIVA 58.35

390.00  
200  
200

PROGRESSIVE  
TERRENO

PARZIALI  
TERRENO

QUOTE  
TERRENO

PROGRESSIVE  
PROGETTO

PARZIALI  
PROGETTO

QUOTE  
PROGETTO

404.47	-20.00	5.88	404.47
404.46	-14.12	3.16	404.46
404.57	-10.96	9.89	404.57
404.74	-1.07	13.18	404.74
404.39	12.11	7.89	404.39
403.97	20.00		403.97

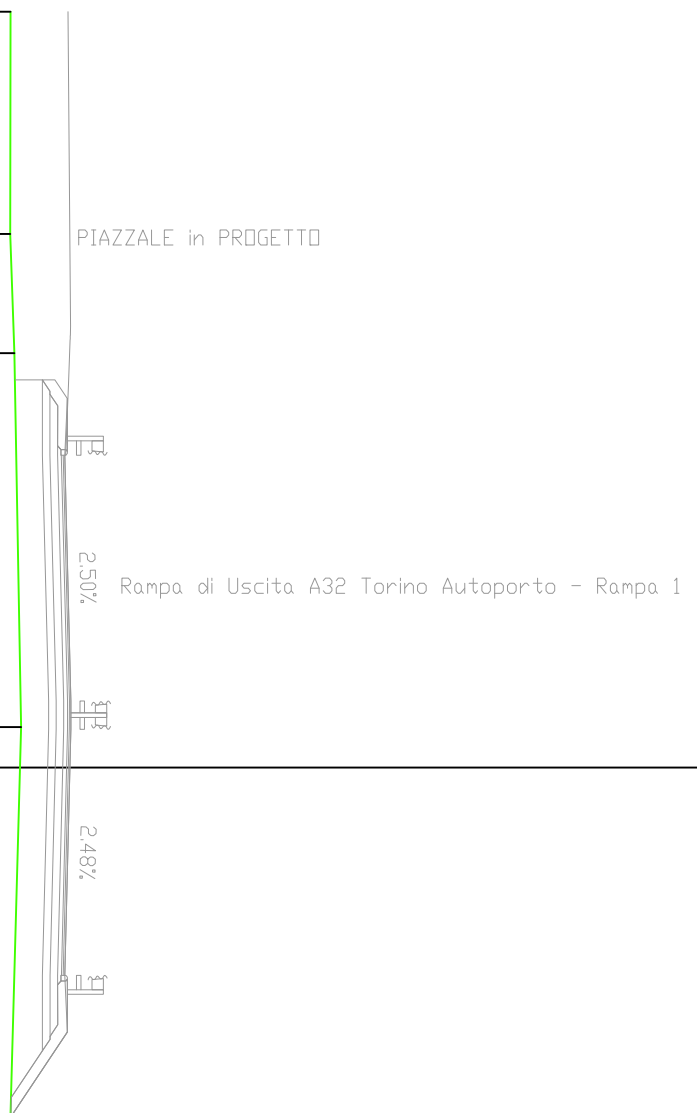

PROFILO SV-BA\_MM1

SEZIONE 6

PROGRESSIVA 71.83

390.00  
200  
200

PROGRESSIVE TERRENO	PROGRESSIVE PROGETTO	QUOTE TERRENO	QUOTE PROGETTO
404.76	-20.00	4.41	
404.79	-15.59	7.01	
404.92	8.58	6.02	
405.01	2.56	12.35	
404.14	9.79	5.85	
403.86	15.64	3.53	
403.96	19.17	0.83	
403.95	20.00		

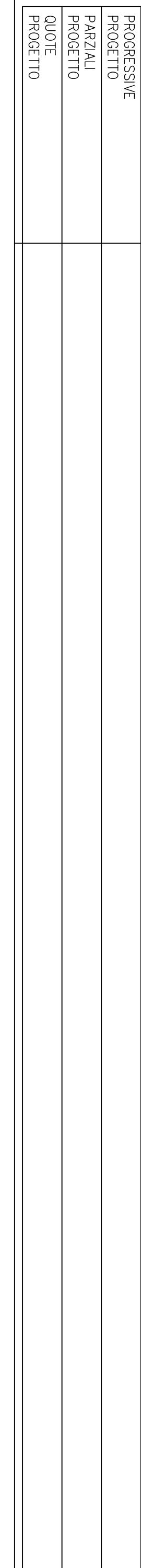

PROFILO SV-BA\_MM1

SEZIONE 7

PROGRESSIVA 79.14

390.00  
200  
200

PROGRESSIVE TERRENO	QUOTE TERRENO	PROGRESSIVE PROGETTO	QUOTE PROGETTO
404.68	-20.00	404.68	3.09
404.70	-16.91	404.70	10.62
404.91	6.29	404.91	2.90
404.94	3.39	404.94	3.98
404.67	0.59	404.67	12.82
403.77	13.41	403.77	2.75
403.83	16.16	403.83	1.08
403.94	17.24	403.94	2.28
403.87	19.52	403.87	0.40
403.90	20.00	403.90	

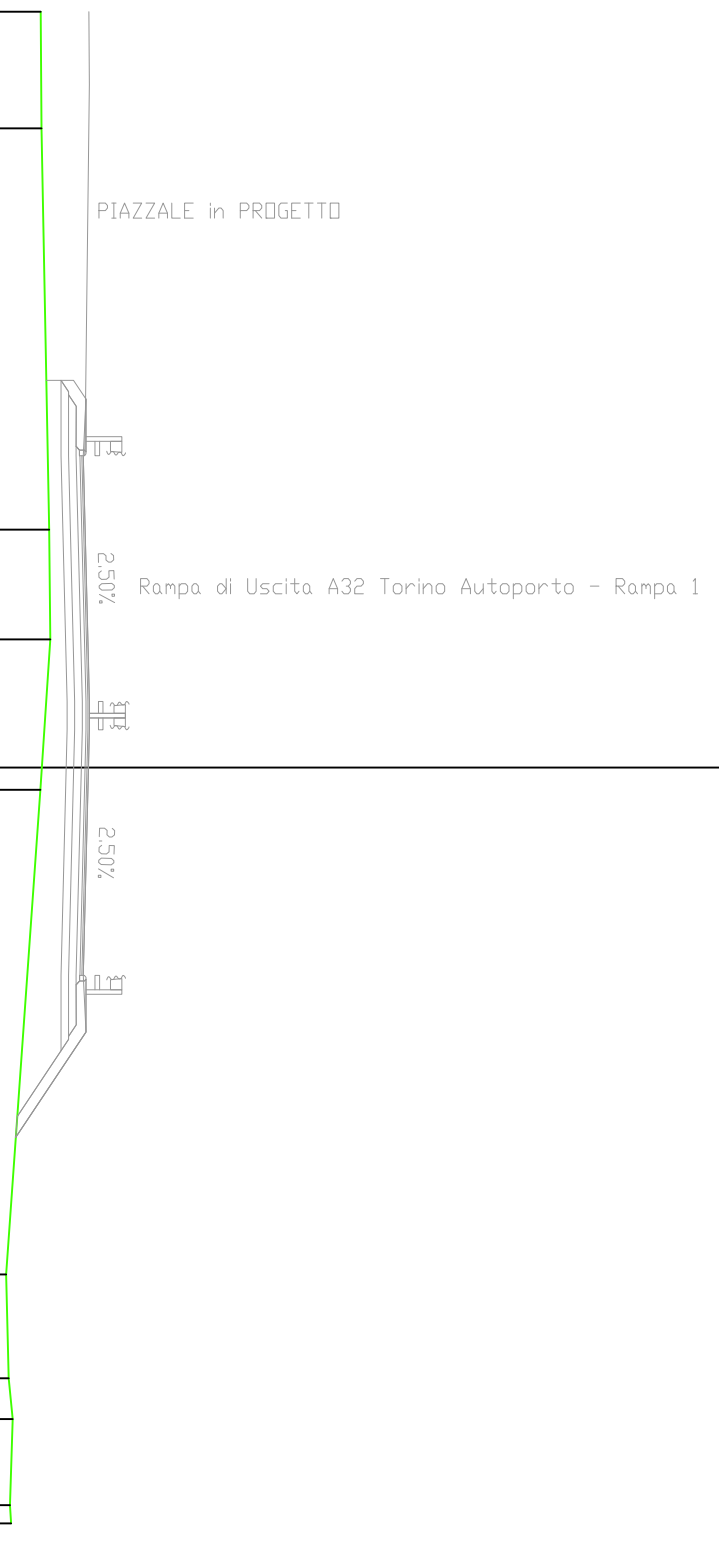

PROFILO SV-BA\_MM1

SEZIONE 8

PROGRESSIVA 91.59

390.00  
200  
200

PROGRESSIVE  
TERRENO

PARZIALI  
TERRENO

QUOTE  
TERRENO

PROGRESSIVE  
PROGETTO

PARZIALI  
PROGETTO

QUOTE  
PROGETTO

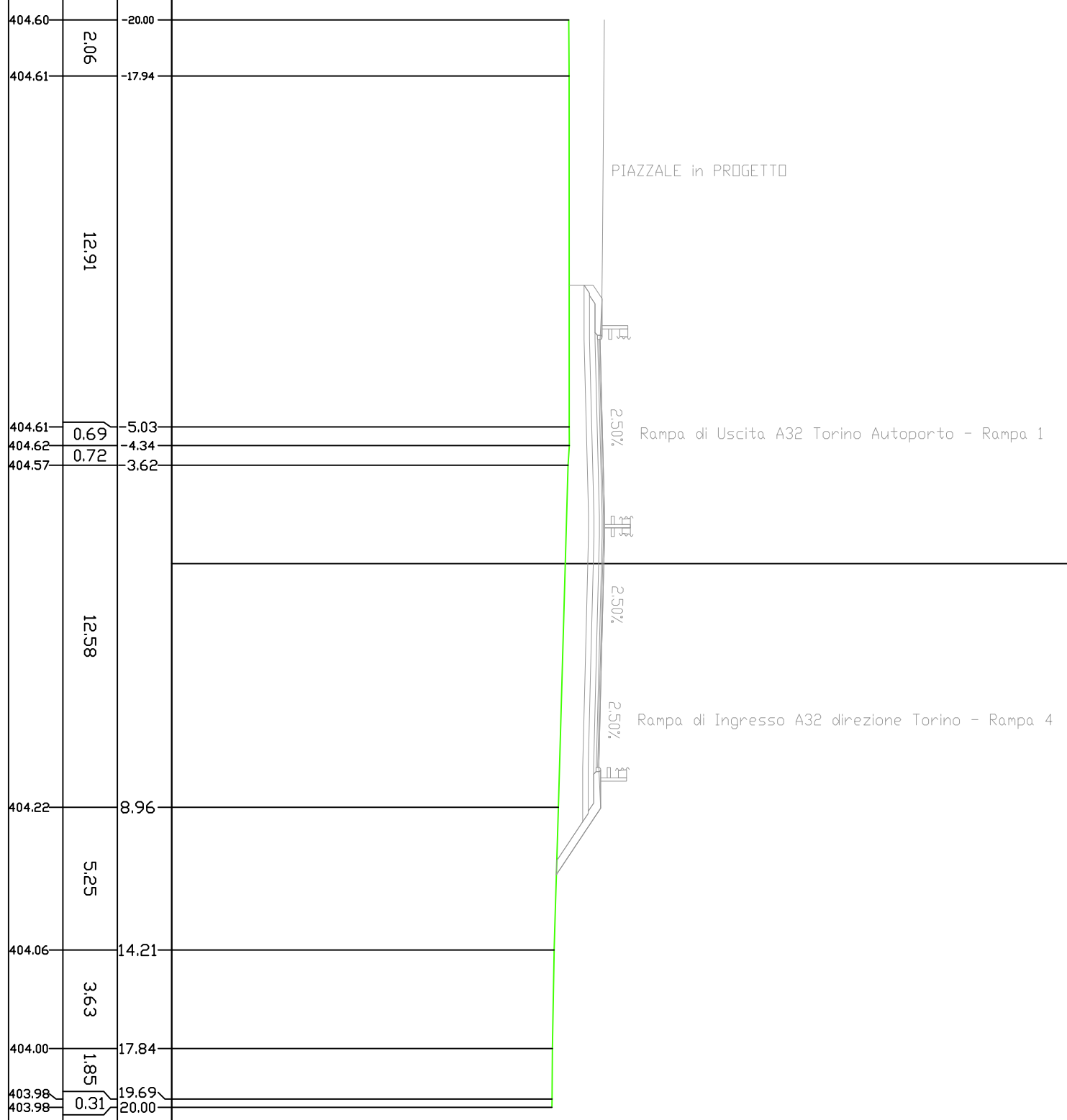

PROFILO SV-BA\_MM1

SEZIONE 9

PROGRESSIVA 104.09

390.00  
200  
200

PROGRESSIVE TERRENO	QUOTE TERRENO	PROGRESSIVE PROGETTO	QUOTE PROGETTO
404.57	1.24	404.58	5.26
404.64	8.70	404.72	15.75
403.84	0.86	403.82	1.72
403.98	1.57	403.92	0.91
404.02	2.84	403.97	1.02
403.97	1.02	403.99	0.13

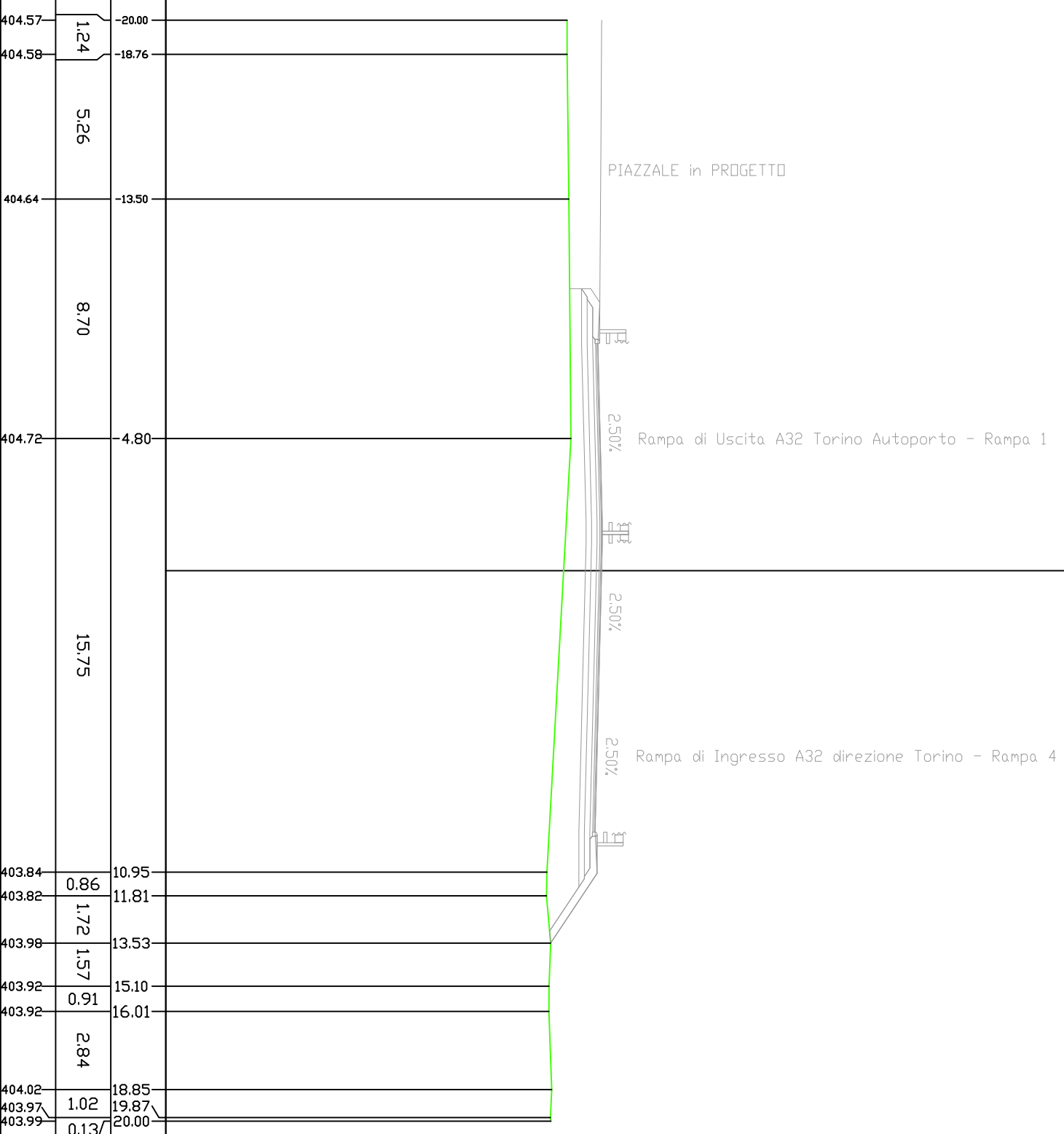

PROFILO SV-BA\_MM1

SEZIONE 10

PROGRESSIVA 112.59

390.00  
200  
200

PROGRESSIVE TERRENO	PROGRESSIVE PROGETTO	QUOTE TERRENO	QUOTE PROGETTO
404.60	-20.00	6.46	
404.68	-13.54	8.47	
404.77	-5.07	2.75	
404.67	2.32	2.95	
404.52	0.63	12.67	
403.88	13.30	2.20	
403.87	15.50	1.66	
403.93	17.16	1.04	
403.94	18.20	0.92	
403.98	19.12	0.88	
404.02	20.00		

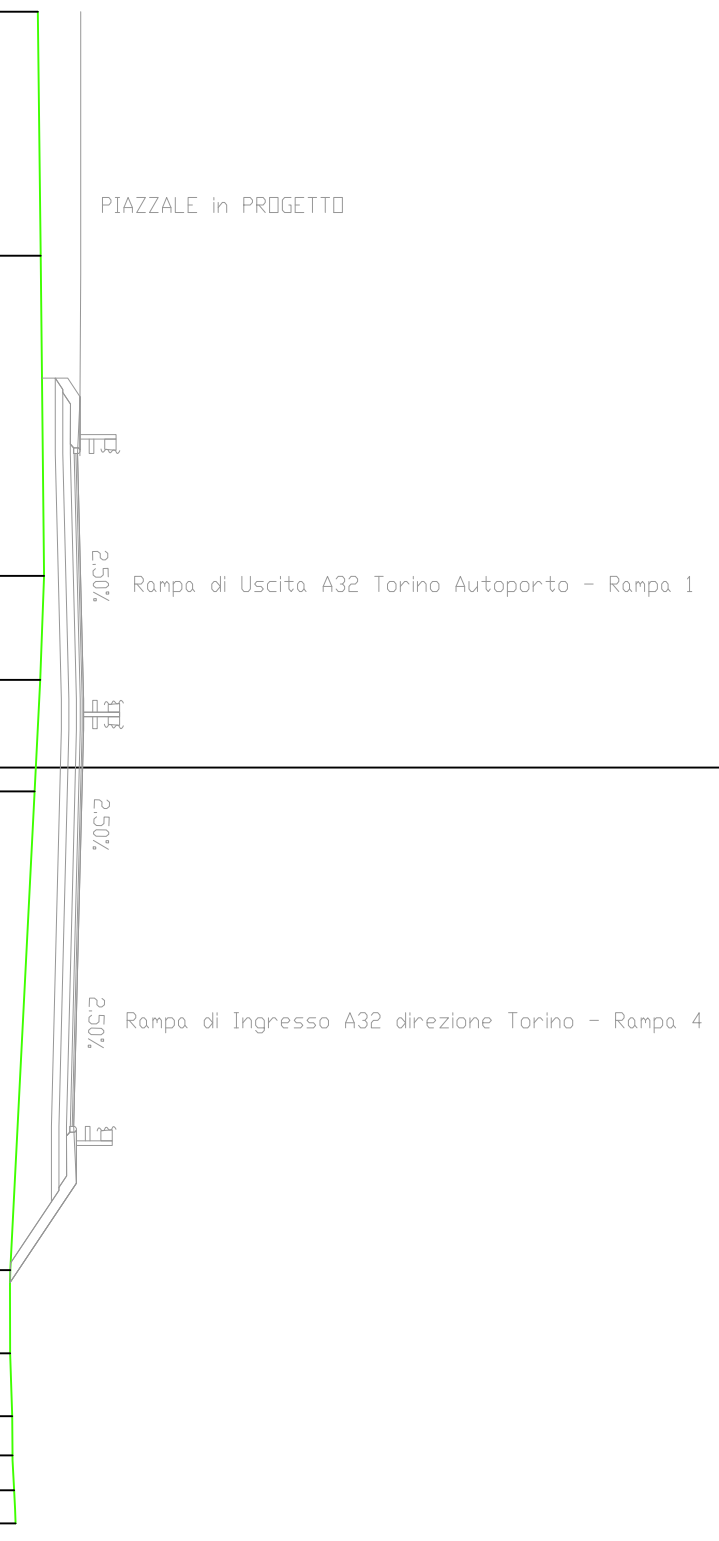



PROFILO SV-BA\_MM1

SEZIONE 11

PROGRESSIVA 133.76

390.00  
200  
200

PROGRESSIVE TERRENO	QUOTE TERRENO	PROGRESSIVE PROGETTO	QUOTE PROGETTO
404.58	-20.00		
404.59	-14.36		
404.70	4.93		
404.18	3.52		
403.83	9.98		
404.24	13.93		
403.99	14.57		
404.02	15.89		
404.06	18.97		
403.97	20.00		



PROFILO SV-BA\_MM1

SEZIONE 12

PROGRESSIVA 154.93

390.00  
200  
200

PROGRESSIVE  
TERRENO

PARZIALI  
TERRENO

QUOTE  
TERRENO

PROGRESSIVE  
PROGETTO

PARZIALI  
PROGETTO

QUOTE  
PROGETTO

403.62	-20.00	12.36	403.62
403.62	-7.64	3.43	403.67
403.67	-4.21	1.51	403.68
403.68	-2.70	16.32	404.25
404.25	-13.62	3.39	404.16
404.16	-17.01	2.99	404.11
404.11	-20.00		

PIAZZALE in PROGETTO

2.50% Rampa di Uscita A32 Torino Autoporto - Rampa 1

2.50% Rampa di Ingresso A32 direzione Torino - Rampa 4

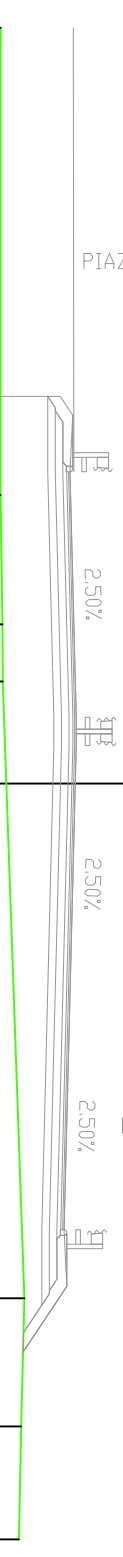

PROFILO SV-BA\_MM1

SEZIONE 13

PROGRESSIVA 171.90

390.00  
200  
200

PROGRESSIVE  
TERRENO

PARZIALI  
TERRENO

QUOTE  
TERRENO

PROGRESSIVE  
PROGETTO

PARZIALI  
PROGETTO

QUOTE  
PROGETTO

403.75  
403.87  
403.88  
404.47  
404.40

-20.00  
-4.61  
-3.95  
16.71  
20.00

15.39

20.66

3.29

PIAZZALE in PROGETTO

2.50% Rampa di Uscita A32 Torino Autoporto - Rampa 1

2.49%

1.23%

2.50% Rampa di Ingresso A32 direzione Torino - Rampa 4

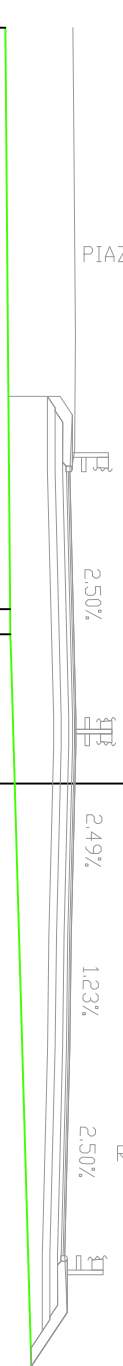

PROFILO SV-BA\_MM1

SEZIONE 14

PROGRESSIVA 187.97

390.00  
200  
200

PROGRESSIVE  
TERRENO

PARZIALI  
TERRENO

QUOTE  
TERRENO

PROGRESSIVE  
PROGETTO

PARZIALI  
PROGETTO

QUOTE  
PROGETTO

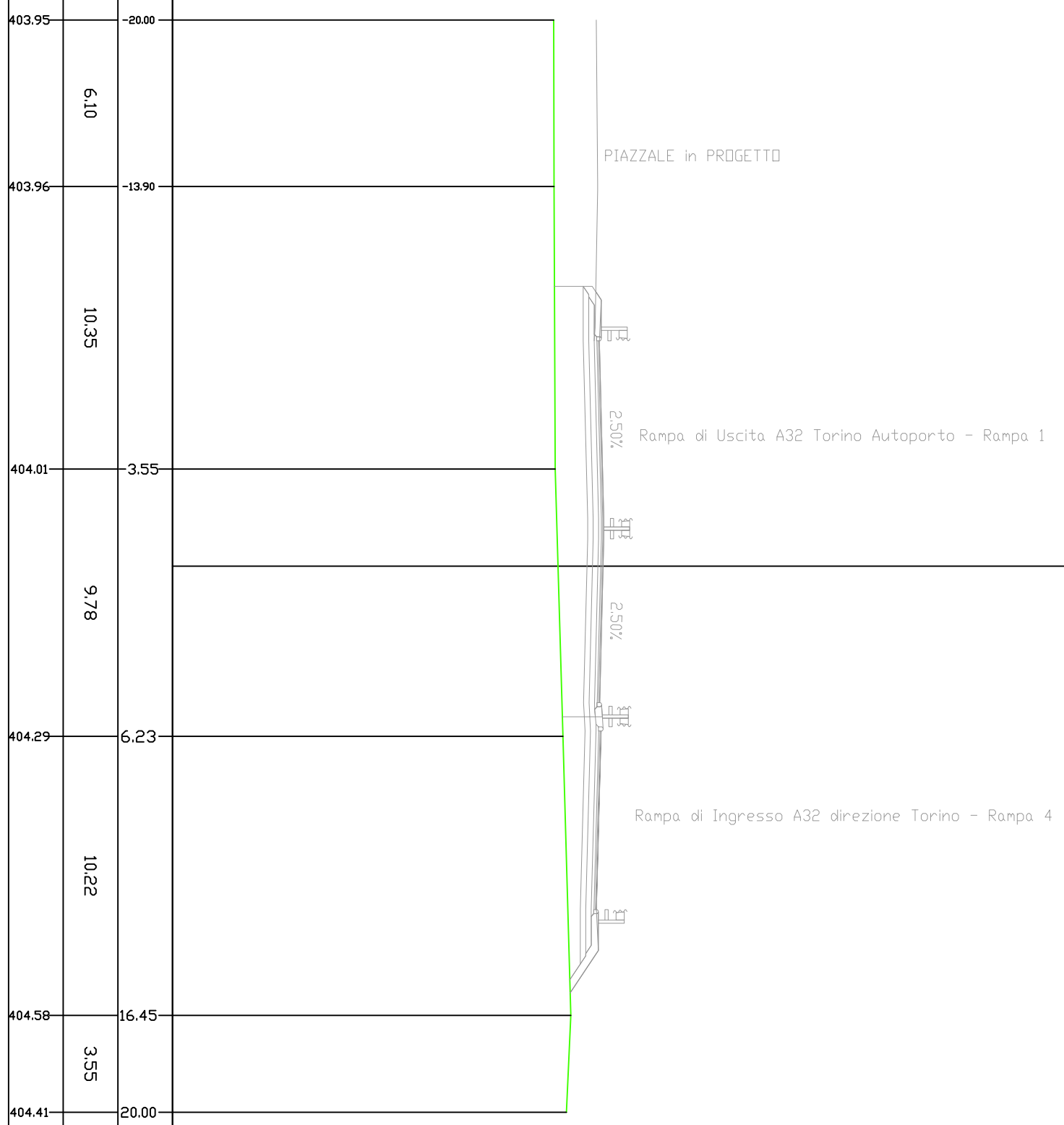

PROFLO SV-BA\_MM1

SEZIONE 15

PROGRESSIVA 208.66

STERRI E RIPORTI	
Ri	9,10 mq.
SCOTICD	
A1	1,48 mq.
BONIFICA	
B1	2,23 mq.
STABILIZZATO	
D1	1,49 mq.
CEMENTATO	
E1	1,49 mq.
BASE	
F1	0,62 mq.
VEGETALE	
G1	0,30 mq.
TNT	
G1	8,43 ml.
o1	
GEORIGLIA 10KN/m	7,43 ml.
b1	
IDROSEMINA	1,26 ml.
e1	
USURA	6,01 ml.
f1	
BINDER	6,01 ml.
g1	

390.00  
 200  
 200

PROGRESSIVE TERRENO				
PARZIALI TERRENO			16,51	
QUOTE TERRENO	404.15	-20.00		
PROGRESSIVE PROGETTO				
PARZIALI PROGETTO			15,85	
QUOTE PROGETTO	406.17	-1.00		
	406.14	0.00		1.00
				4.01
	406.04	4.01		1.00
	406.01	5.01		1.36
	406.08	6.37		
			4,54	
	404.43	12.36		
	404.51	16.90		0.60
	404.50	17.50		2.50
	404.49	20.00		

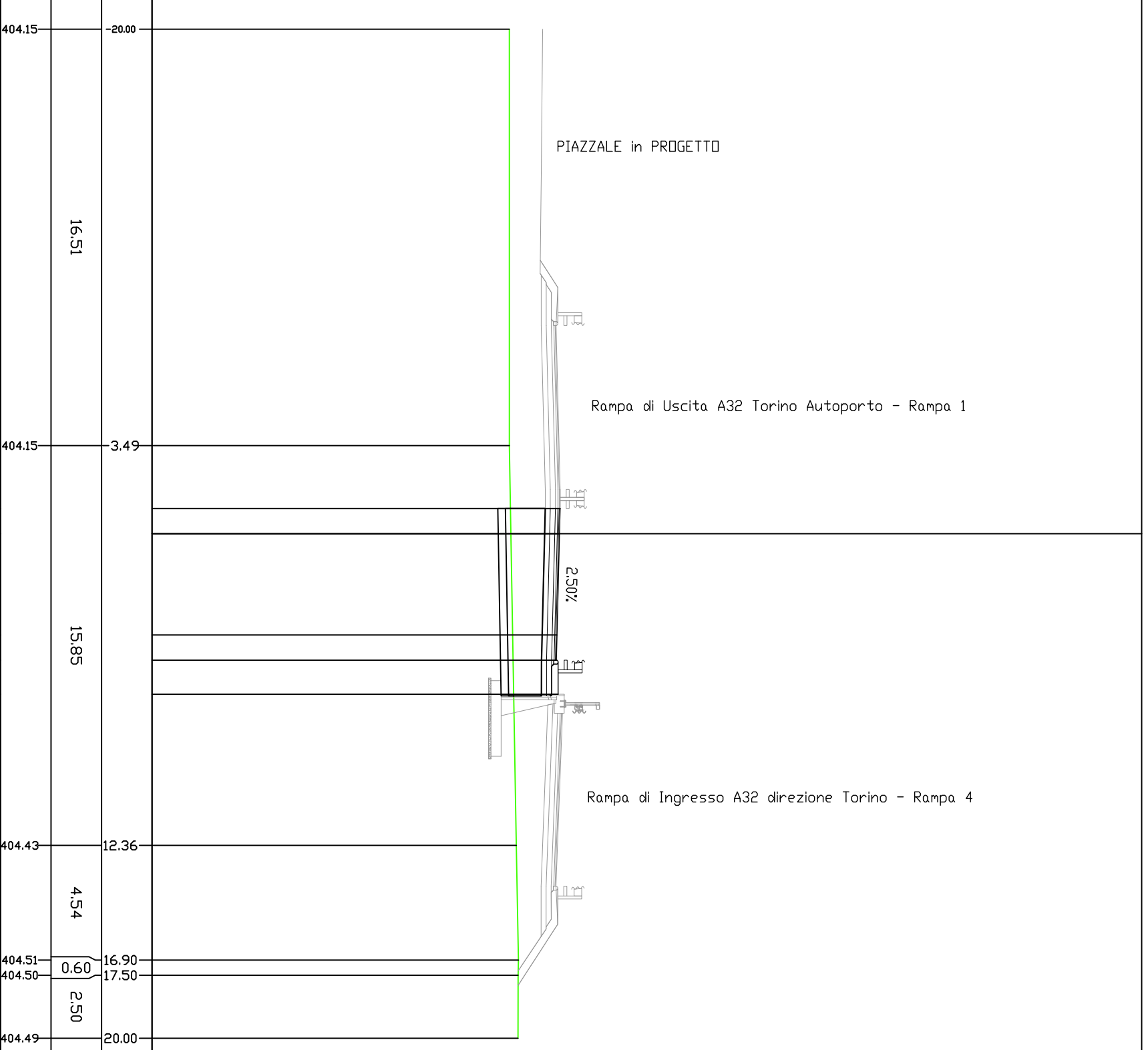

PROFILO SV-BA\_MM1

SEZIONE 16

PROGRESSIVA 225.00

STERRI E RIPORTI	
R1	1265 mq.
SCOTTICO	
A1	2.00 mq.
BONIFICA	
B1	2.99 mq.
STABILIZZATO	
D1	1.59 mq.
CEMENTATO	
E1	1.52 mq.
BASE	
F1	0.63 mq.
VEGETALE	
G1	1.17 mq.
TNT	
G1	10.97 ml.
GEORIGLIA 10KN/m	
b1	9.97 ml.
IDROSEMINA	
e1	4.31 ml.
USURA	
f1	6.12 ml.
BINDER	
g1	6.12 ml.

390.00  
200  
200

PROGRESSIVE TERRENO										
PARZIALI TERRENO			18.25							
QUOTE TERRENO										
PROGRESSIVE PROGETTO										
PARZIALI PROGETTO										
QUOTE PROGETTO										

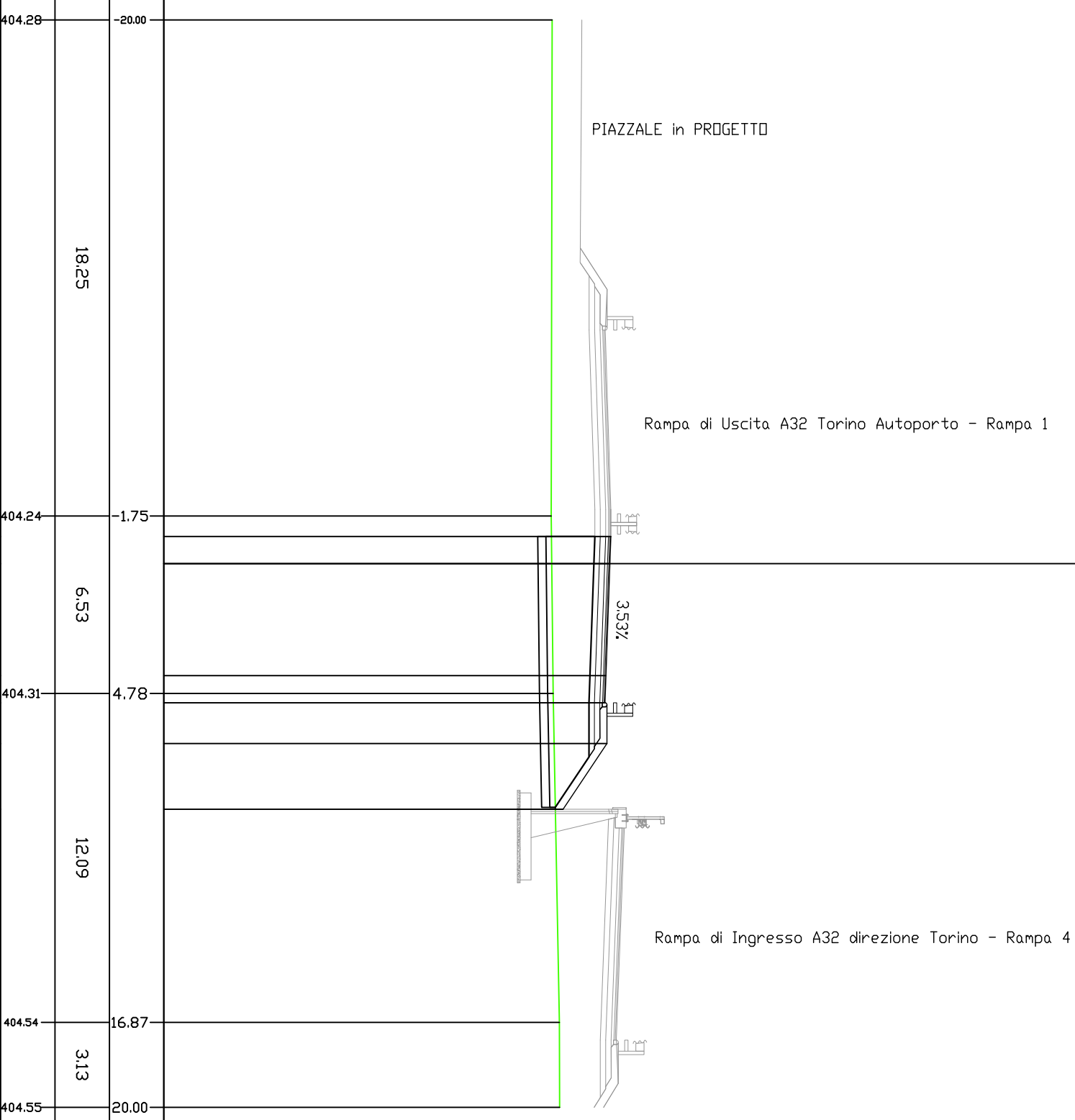

STERRE E RIPORTI

R1 SCOTICID	16,15 mq.
A1 BONIFICA	2,78 mq.
B1 STABILIZZATO	4,17 mq.
D1 CEMENTATO	2,00 mq.
E1 BASE	1,90 mq.
F1 VEGETALE	0,68 mq.
G1	0,37 mq.
G2	1,24 mq.
Totale:	1,61 mq.
TNT	14,90 ml.
a1 GEGGRIGLIA 10KN/m	13,90 ml.
b1 IDROSEMINA	1,44 ml.
e1	4,85 ml.
e2	6,29 ml.
Totale:	6,58 ml.
f1	6,58 ml.
BINDER	6,58 ml.
g1	6,58 ml.

390.00  
 200  
 200

PROGRESSIVE TERRENO										
PARZIALI TERRENO										
QUOTE TERRENO										
PROGRESSIVE PROGETTO										
PARZIALI PROGETTO										
QUOTE PROGETTO										

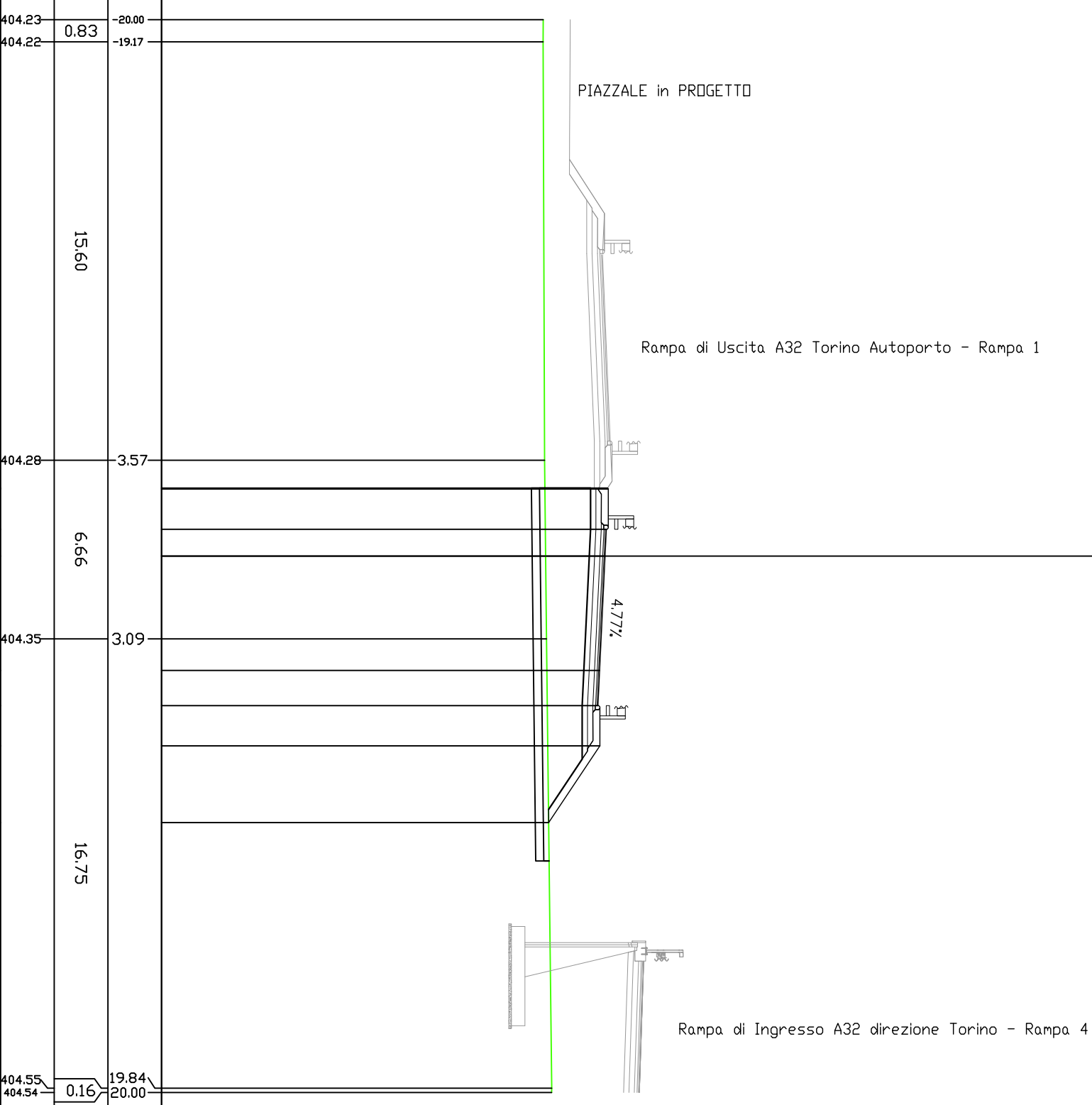

STERRI E RIPORTI		
R1		15,83 mq.
SCOTTICD		3,35 mq.
AI		5,03 mq.
BONIFICA		2,18 mq.
BI		2,02 mq.
STABILIZZATO		0,75 mq.
DI		1,34 mq.
CEMENTATO		1,06 mq.
EI		2,40 mq.
BASE		17,74 ml.
F1		16,74 ml.
VEGETALE		5,26 ml.
GI		4,21 ml.
GE		9,47 ml.
Totale:		7,19 ml.
TNT		7,19 ml.
GI		7,19 ml.
GEDGRIGLIA 10KN/m		
a1		
b1		
IDROSEMINA		
e1		
e2		
Totale:		
USURA		
F1		
BINDER		
g1		

390.00  
 200  
 200

Rampa di Uscita A32 Torino Autoporto - Rampa 1

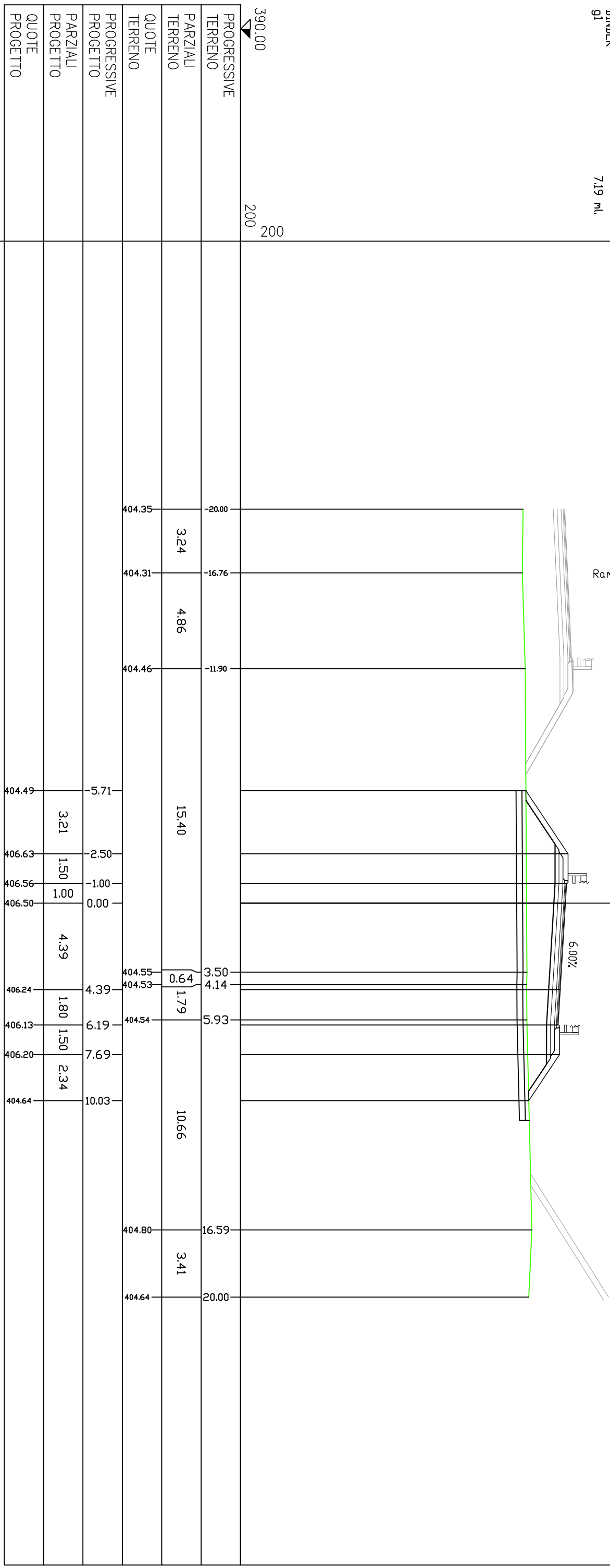

PROGRESSIVE TERRENO	
PARZIALI TERRENO	
QUOTE TERRENO	
PROGRESSIVE PROGETTO	
PARZIALI PROGETTO	
QUOTE PROGETTO	



PROFILO SV-BA\_MM1

SEZIONE 19

PROGRESSIVA 276.91

STERRI E RIPORTI

R1	15,10 mq.
SCOTICD	3,55 mq.
A1	5,34 mq.
BONIFICA	2,23 mq.
BI	2,12 mq.
STABILIZZATO	0,79 mq.
DI	1,31 mq.
CEMENTATO	0,98 mq.
E1	2,29 mq.
BASE	18,78 ml.
F1	17,78 ml.
VEGETALE	5,16 ml.
G1	3,95 ml.
GI	9,11 ml.
GG	7,53 ml.
Totale:	7,53 ml.
TNT	7,53 ml.
a1	18,78 ml.
GEDGRIGLIA 10KN/m	17,78 ml.
b1	5,16 ml.
IDROSEMINA	3,95 ml.
e1	9,11 ml.
e2	7,53 ml.
Totale:	7,53 ml.
USURA	7,53 ml.
f1	7,53 ml.
BINDER	7,53 ml.
g1	7,53 ml.

390.00  
 200  
 200

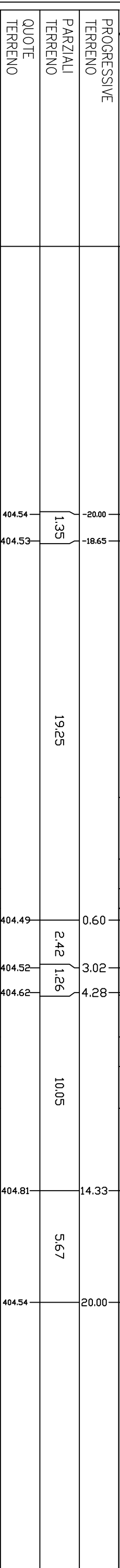

PROGRESSIVE TERRENO			
PARZIALI TERRENO	1,35	19,25	
QUOTE TERRENO	404.54 404.53		
PROGRESSIVE PROGETTO			
PARZIALI PROGETTO	3,13	4,41	2,12
QUOTE PROGETTO	404.51 404.59 404.52 404.46	404.49 404.52 404.62	404.07 404.14 404.73

PROFILO SV-BA\_MM1

SEZIONE 20

PROGRESSIVA 289.75

STERRI E RIPORTI

R	10.94 mq.
SCOTICD	
A1	3.49 mq.
BONIFICA	
B1	5.22 mq.
STABILIZZATO	
D1	2.24 mq.
CEMENTATO	
E1	2.12 mq.
BASE	
F1	0.79 mq.
VEGETALE	
G1	1.24 mq.
G2	0.93 mq.
Totale:	2.17 mq.
TNT	
a1	18.41 ml.
GEOGRIGLIA 10KN/m	
b1	17.41 ml.
IDROSEMINA	
e1	4.83 ml.
e2	3.84 ml.
Totale:	8.67 ml.
USURA	
f1	7.52 ml.
BINDER	
g1	7.52 ml.

390.00  
 200  
 200

PROGRESSIVE TERRENO															
PARZIALI TERRENO	1.12		13.59												
QUOTE TERRENO															
PROGRESSIVE PROGETTO															
PARZIALI PROGETTO															
QUOTE PROGETTO															

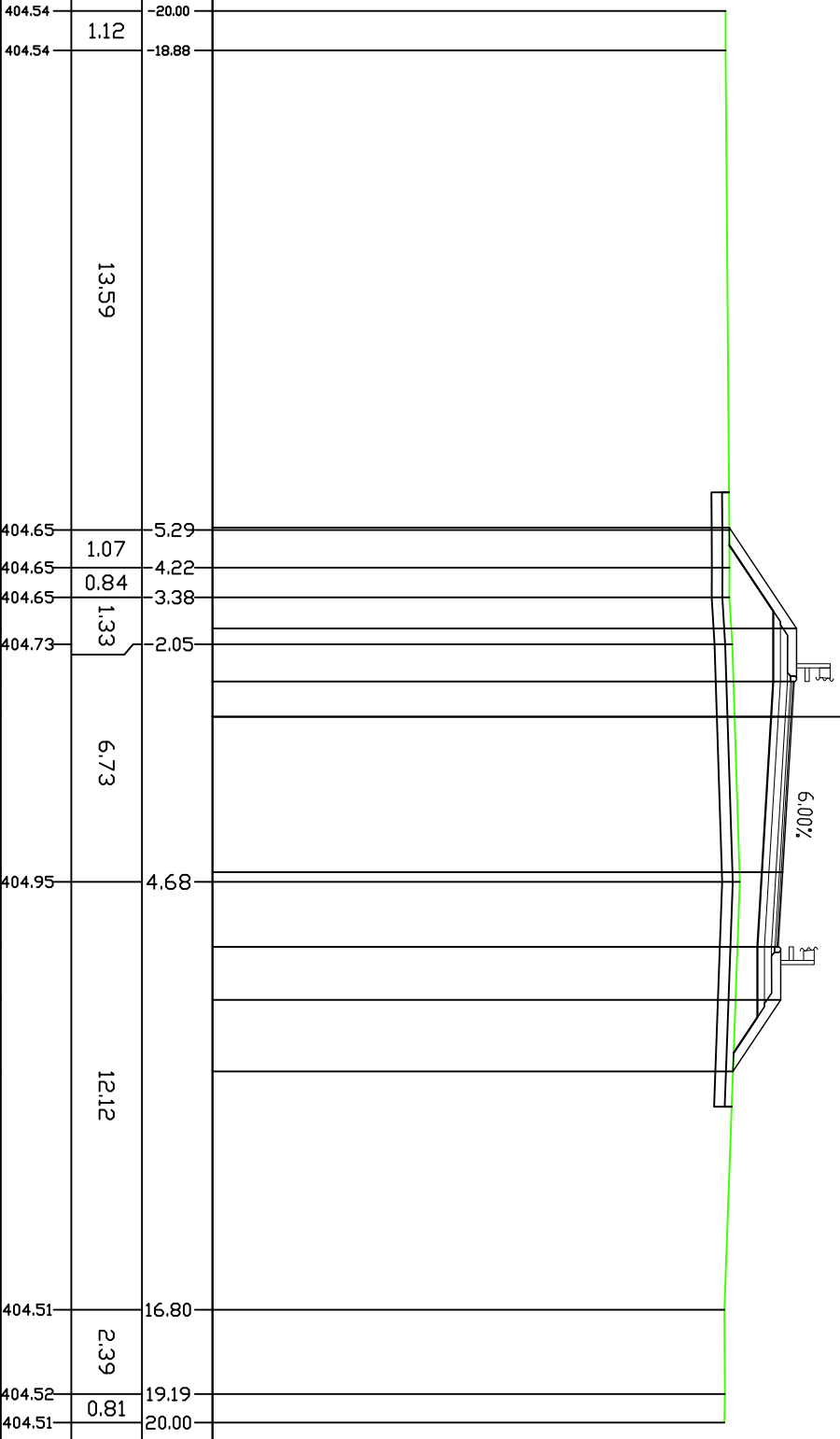



PROFILO SV-BA\_MM1

SEZIONE 22

PROGRESSIVA 315.43

STERRE E RIPORTI

R1 SCOTICO	1152 mq.
A1 BONIFICA	3.33 mq.
B1 STABILIZZATO	5.02 mq.
D1 CEMENTATO	2.14 mq.
E1 BASE	2.01 mq.
F1 VEGETALE	0.73 mq.
G1	1.13 mq.
G2	0.99 mq.
Totale:	2.12 mq.
TNT	17.72 ml.
a1 GEDGRIGLIA 10KN/m	16.72 ml.
b1 IDROSEMINA	4.44 ml.
e1	4.01 ml.
e2 Totale:	8.45 ml.
f1 USURA	7.01 ml.
f1 BINDER	7.01 ml.
g1	7.01 ml.

390.00  
 200  
 200

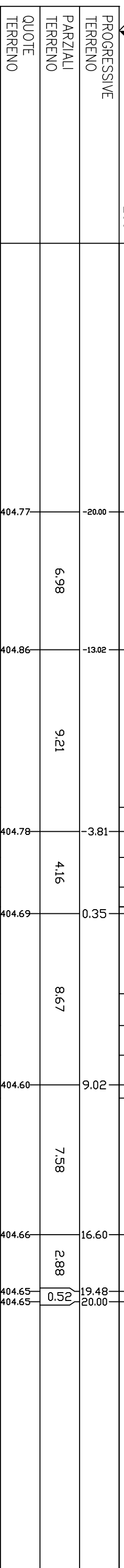

PROGRESSIVE TERRENO		6.98	9.21	4.16	8.67	7.58	2.88	0.50
PARZIALI TERRENO								
QUOTE TERRENO	404.77	404.86	404.79	404.78	404.69	406.08	405.98	406.05
PROGRESSIVE PROGETTO			5.03	-3.81	0.35	4.41	6.01	7.51
PARZIALI PROGETTO			2.53	1.50	1.00	4.41	1.60	1.50
QUOTE PROGETTO								
PROGRESSIVE TERRENO								
PROGRESSIVE PROGETTO								
PARZIALI TERRENO								
PARZIALI PROGETTO								
QUOTE TERRENO								
QUOTE PROGETTO								

PROFILO SV-BA\_MM1

SEZIONE 23

PROGRESSIVA 332.72

STERRE E RIPORTI

RI	1262 mq.
SCOTICD	3.37 mq.
AI	5.07 mq.
BONIFICA	2.12 mq.
BI	1.96 mq.
STABILIZZATO	0.74 mq.
DI	1.18 mq.
CEMENTATO	1.06 mq.
EI	2.24 mq.
BASE	17.88 ml.
F1	16.88 ml.
VEGETALE	4.61 ml.
GI	4.14 ml.
G2	8.75 ml.
Totale:	6.93 ml.
TNT	6.93 ml.
a1	6.93 ml.
GEOGRIGLIA 10KN/m	
b1	
IDROSEMINA	
e1	
e2	
Totale:	
USURA	
f1	
BINDER	
g1	

390.00  
PROGRESSIVE  
TERRENO  
200

PROGRESSIVE TERRENO	QUOTE TERRENO	PROGRESSIVE PARZIALI PROGETTO	QUOTE PARZIALI PROGETTO
404.68	4.14		
404.76	2.11		
404.81	10.67		
404.70	5.17	2.67	
404.48	2.50	1.50	
406.41	0.94	1.00	
406.36	0.00	4.30	
406.12	2.24	1.63	
406.04	4.30	1.50	
406.11	5.93	2.28	
404.59	7.43		
404.57	11.40		
404.56	13.64	2.77	
404.56	16.41	3.59	
404.56	20.00		

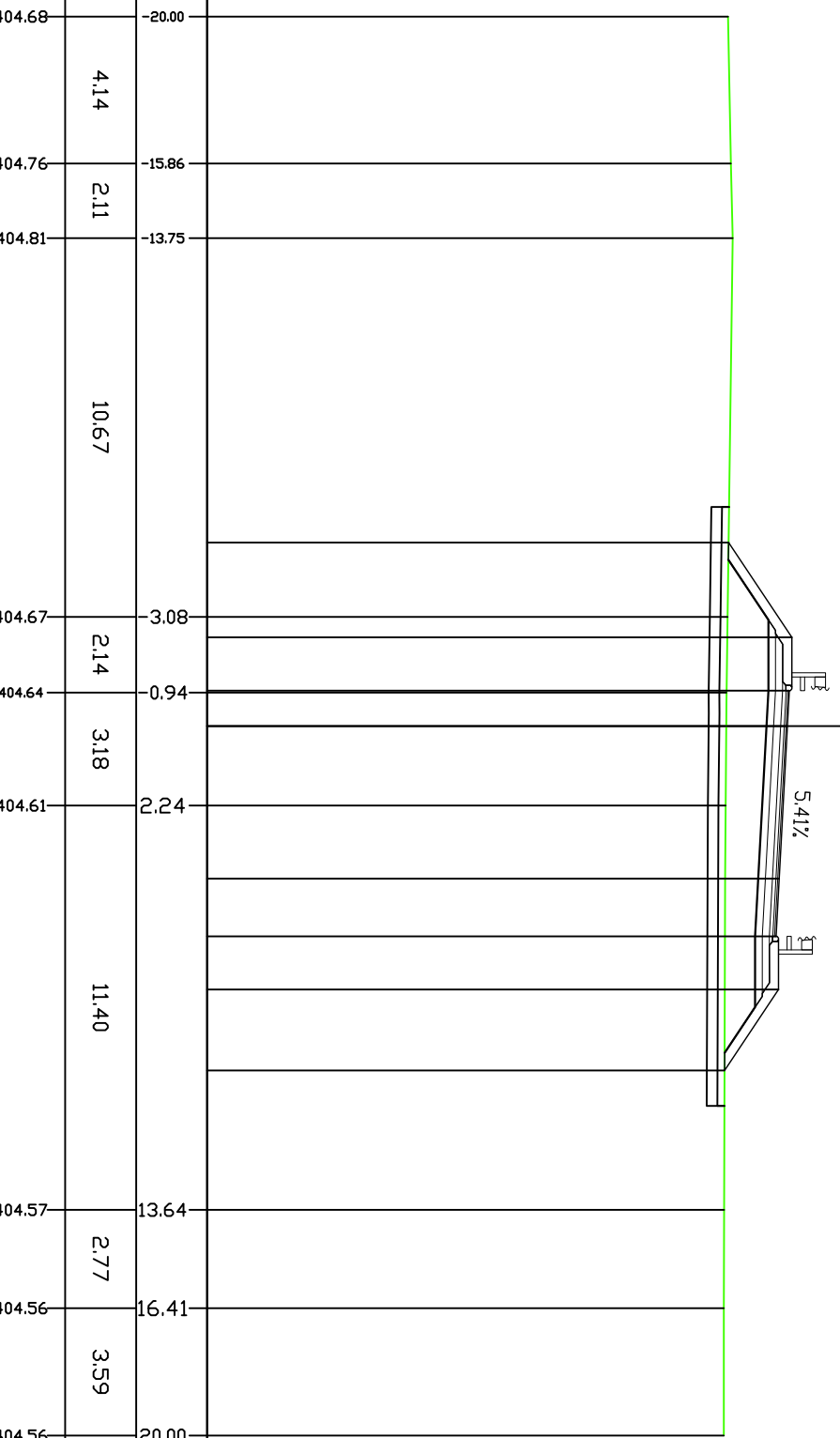

PROFILO SV-BA\_MM1

SEZIONE 24

PROGRESSIVA 350.00

STERRI E RIPORTI

R1	1165 mq.
SCOTICD	
A1	3.39 mq.
BONIFICA	
B1	5.09 mq.
STABILIZZATO	
D1	2.15 mq.
CEMENTATO	
E1	2.02 mq.
BASE	
F1	0.75 mq.
VEGETALE	
G1	1.18 mq.
G2	1.00 mq.
Totale:	2.18 mq.
TNT	
a1	17.97 ml.
GEDGRIGLIA 10KN/m	
b1	16.97 ml.
IDROSEMINA	
e1	4.64 ml.
e2	4.07 ml.
Totale:	8.71 ml.
USURA	
f1	7.05 ml.
BINDER	
g1	7.05 ml.

390.00  
 200  
 200

PROGRESSIVE TERRENO								
PARZIALI TERRENO	14.42							
QUOTE TERRENO								
PROGRESSIVE PROGETTO								
PARZIALI PROGETTO								
QUOTE PROGETTO								

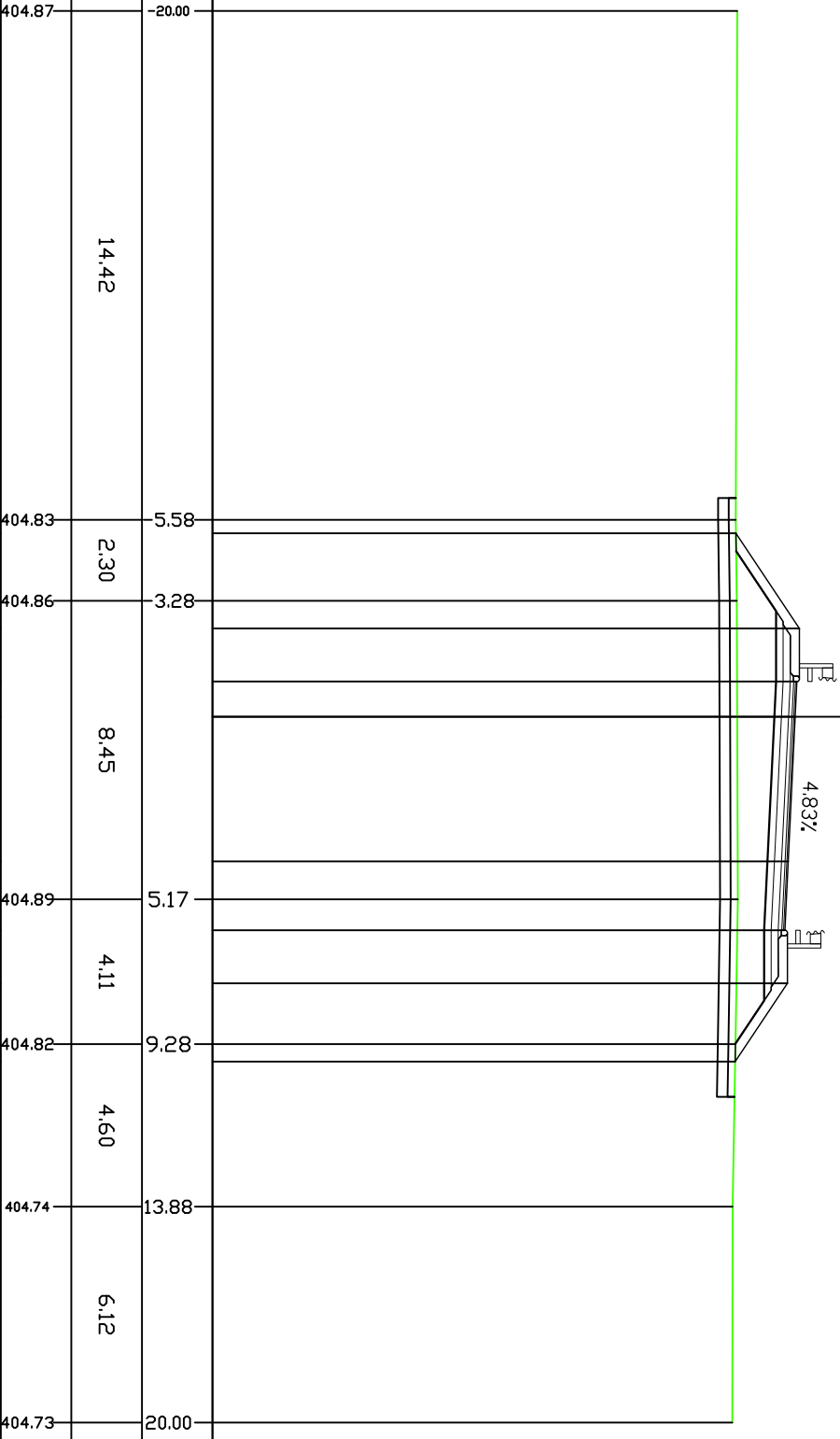

PROFILO SV-BA\_MM1

SEZIONE 25

PROGRESSIVA 375.00

STERRE E RIPORTI	
Ri	15.50 mq.
SCOTICD	
A1	3.58 mq.
BONIFICA	
B1	5.34 mq.
STABILIZZATO	
D1	2.18 mq.
CEMENTATO	
E1	2.05 mq.
BASE	
F1	0.76 mq.
VEGETALE	
G1	1.29 mq.
G2	1.11 mq.
Totale:	2.40 mq.
TNT	
a1	18.84 ml.
GEDGRIGLIA 10KN/m	
b1	17.84 ml.
IDROSEMINA	
e1	5.09 ml.
e2	4.45 ml.
Totale:	9.54 ml.
USURA	
f1	7.23 ml.
BINDER	
g1	7.23 ml.

390.00  
 200  
 200

PROGRESSIVE TERRENO			
PARZIALI TERRENO			
QUOTE TERRENO			
PROGRESSIVE PROGETTO			
PARZIALI PROGETTO			
QUOTE PROGETTO			

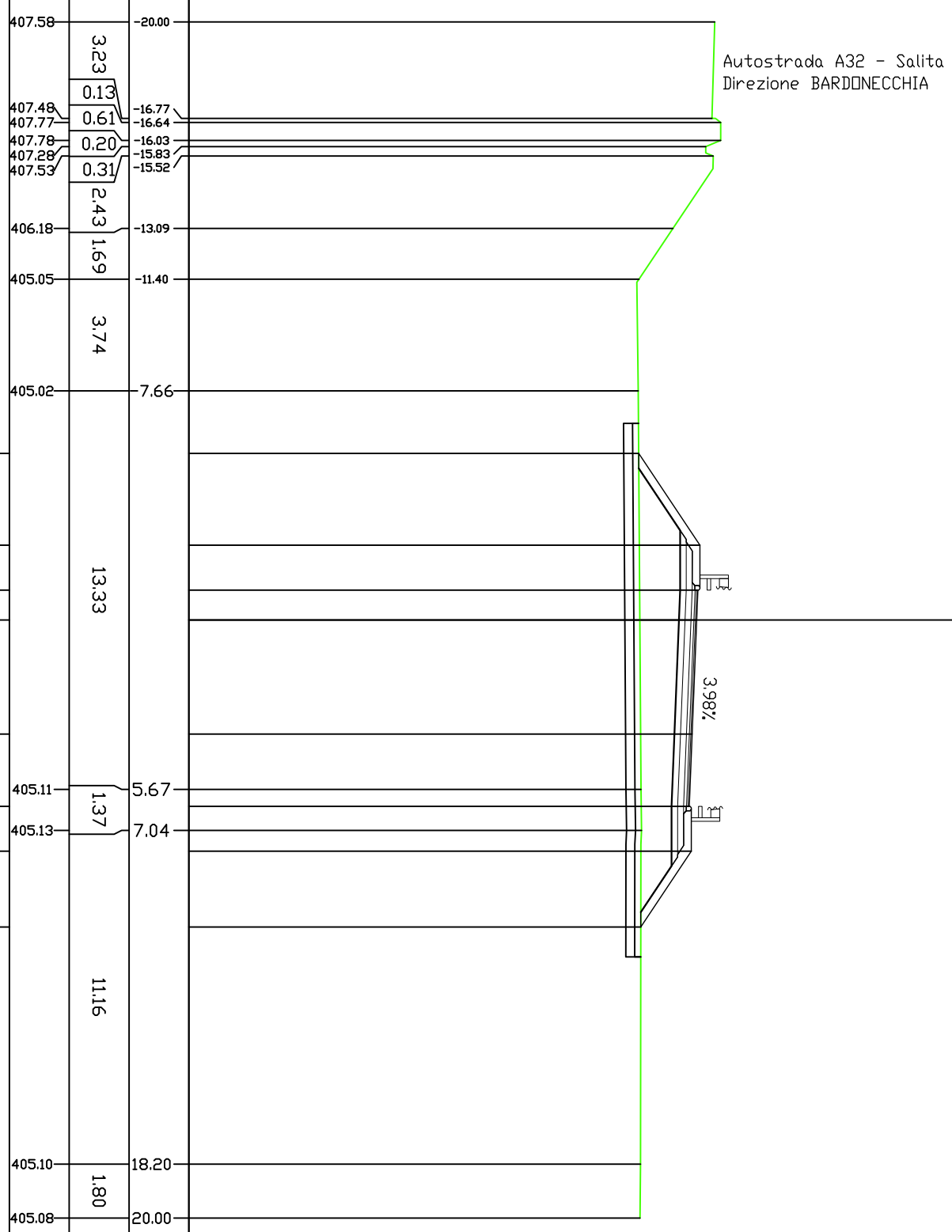

PROFILO SV-BA\_MM1

SEZIONE 26

PROGRESSIVA 389.12

STERRI E RIPORTI	
R1	17.73 mq.
SCOTICD	
A1	3.66 mq.
BONIFICA	
B1	5.49 mq.
STABILIZZATO	
D1	2.18 mq.
CEMENTATO	
E1	2.04 mq.
BASE	
F1	0.76 mq.
VEGETALE	
G1	1.42 mq.
G2	1.14 mq.
Totale:	2.56 mq.
TNT	
a1	19.29 ml.
GEDGRIGLIA 10KN/m	
b1	18.29 ml.
IDROSEMINA	
e1	5.52 ml.
e2	4.54 ml.
Totale:	10.06 ml.
USURA	
f1	7.25 ml.
BINDER	
g1	7.25 ml.

390.00  
 200  
 200

PROGRESSIVE TERRENO			
PARZIALI TERRENO			
QUOTE TERRENO			
PROGRESSIVE PROGETTO			
PARZIALI PROGETTO			
QUOTE PROGETTO			

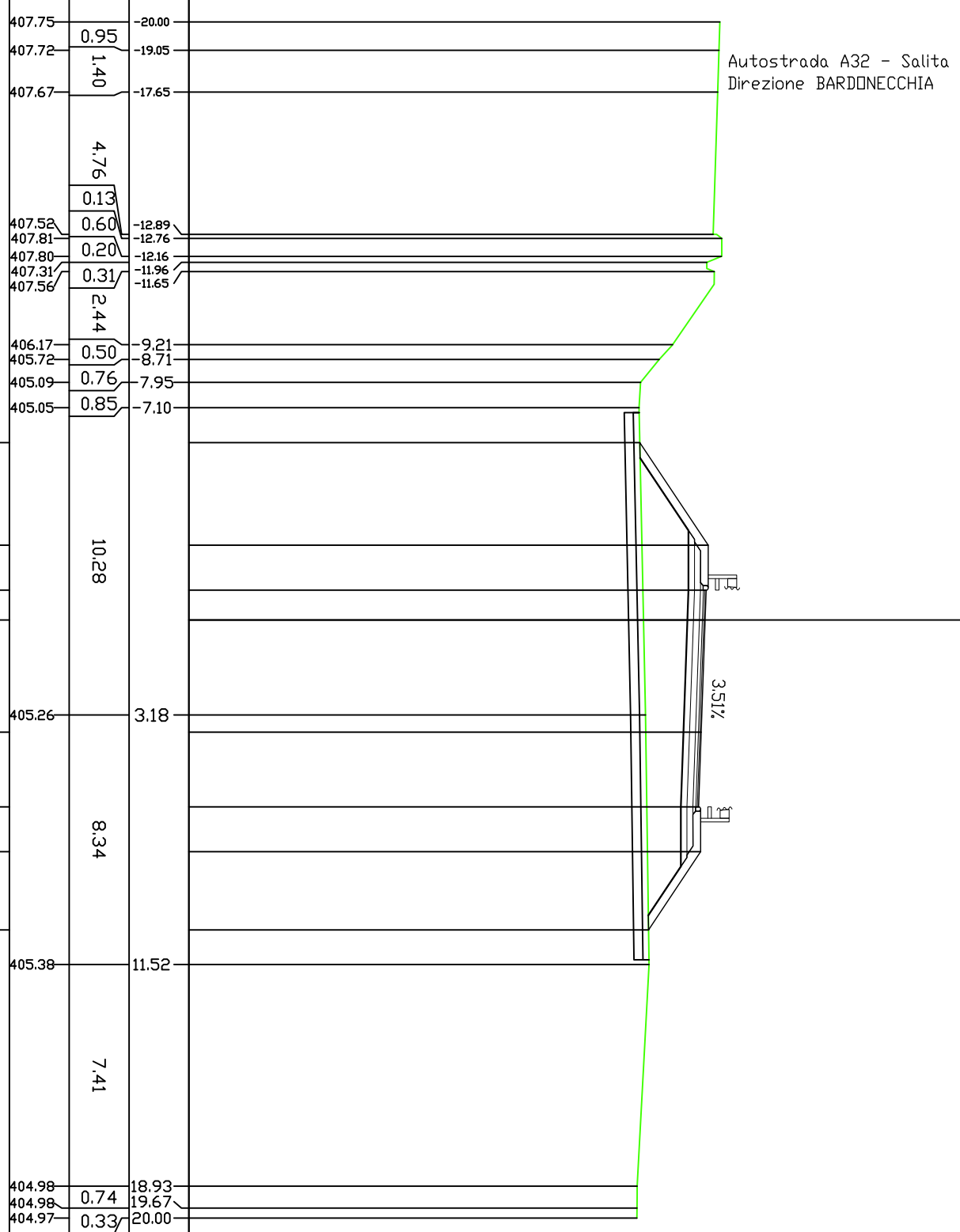



PROFILO SV-BA\_MM1

SEZIONE 27

PROGRESSIVA 394.04

STERRE E RIPORTI	
RI SCOTICO	19,79 mq.
AI BONIFICA	3,71 mq.
BI STABILIZZATO	5,56 mq.
DI CEMENTATO	2,20 mq.
EI BASE	2,03 mq.
F1 VEGETALE	0,76 mq.
GI	1,48 mq.
GG	1,19 mq.
Totale:	2,67 mq.
TNT	
a1	19,54 ml.
GEDGRIGLIA 10KN/m	
b1	18,54 ml.
IDROSEMINA	
e1	5,67 ml.
e2	4,69 ml.
Totale:	10,36 ml.
F1 USURA	7,25 ml.
F1 BINDER	7,25 ml.
g1	

390.00  
 200  
 200

PROGRESSIVE TERRENO	QUOTE TERRENO	PROGRESSIVE PROGETTO	QUOTE PROGETTO
407.80	1.39		
407.75	0.76		
407.73	3.30		
407.62	0.75		
407.60	1.99		
407.54	0.13		
407.83	0.78		
407.33	0.30		
407.58	1.30		
406.75	1.96		
405.15	2.14		
405.08	6.05	3.55	
405.03	5.20	1.50	
407.45	2.50	1.00	
407.38	-1.00	3.75	
407.34	0.00	2.50	
407.21	3.75	1.50	
407.12	6.25	2.74	
407.19	7.75		
405.32	8.69		
405.36	10.49		
405.41	12.73		
405.08	18.03		
405.04	20.00		

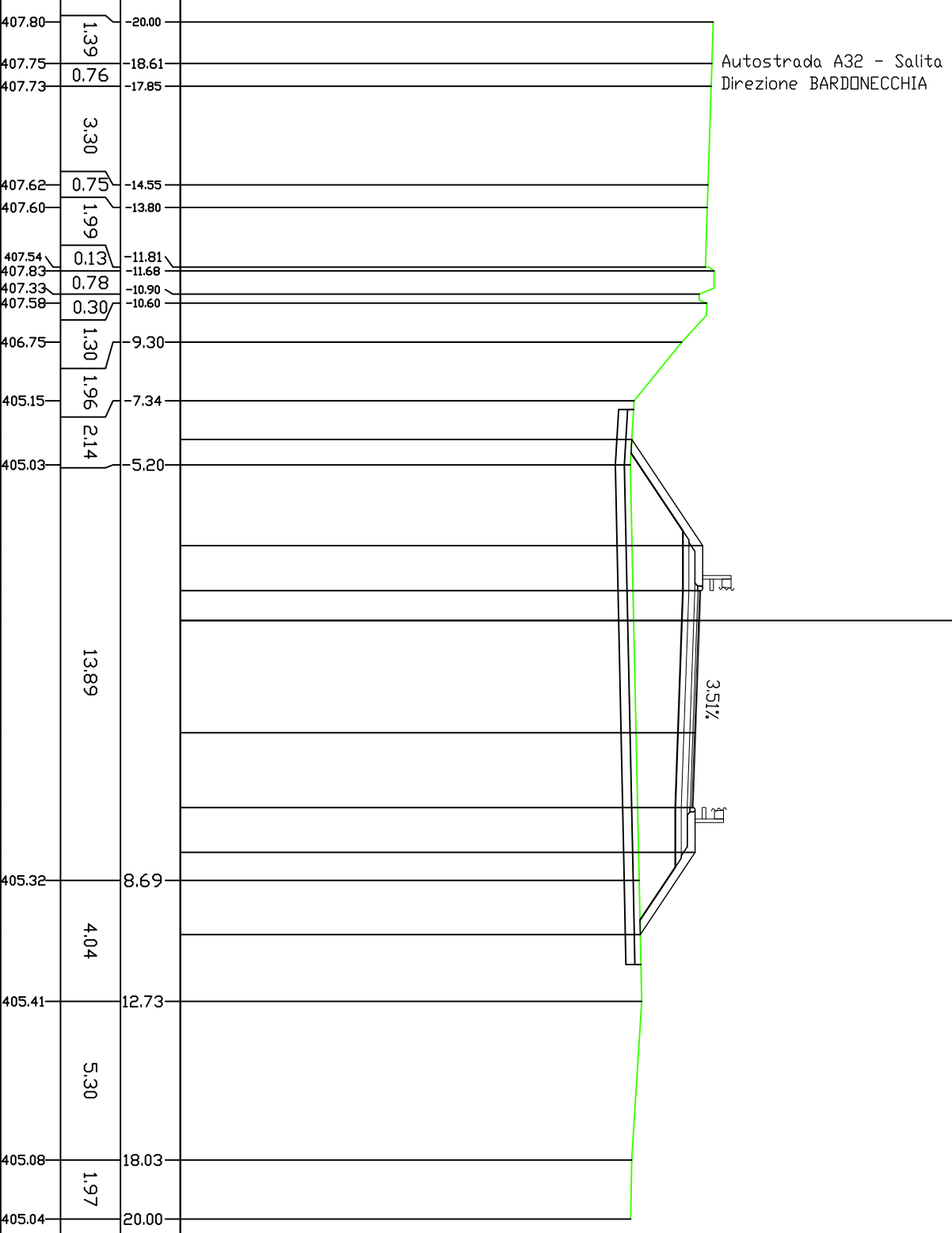

PROFILO SV-BA\_MM1

SEZIONE 28

PROGRESSIVA 398.97

STERRE E RIPORTI	
RI SCOTICO	21.59 mq.
AI BONIFICA	3.69 mq.
BI STABILIZZATO	5.55 mq.
DI CEMENTATO	2.19 mq.
EI BASE	2.04 mq.
F1 VEGETALE	0.76 mq.
G1	1.48 mq.
G2	1.27 mq.
Totale:	2.75 mq.
TNT	
a1	19.51 ml.
GEDGRIGLIA 10KN/m	
b1	18.50 ml.
IDROSEMINA	
e1	5.64 ml.
e2	4.93 ml.
Totale:	10.57 ml.
F1 USURA	7.25 ml.
BINDER	
g1	7.25 ml.

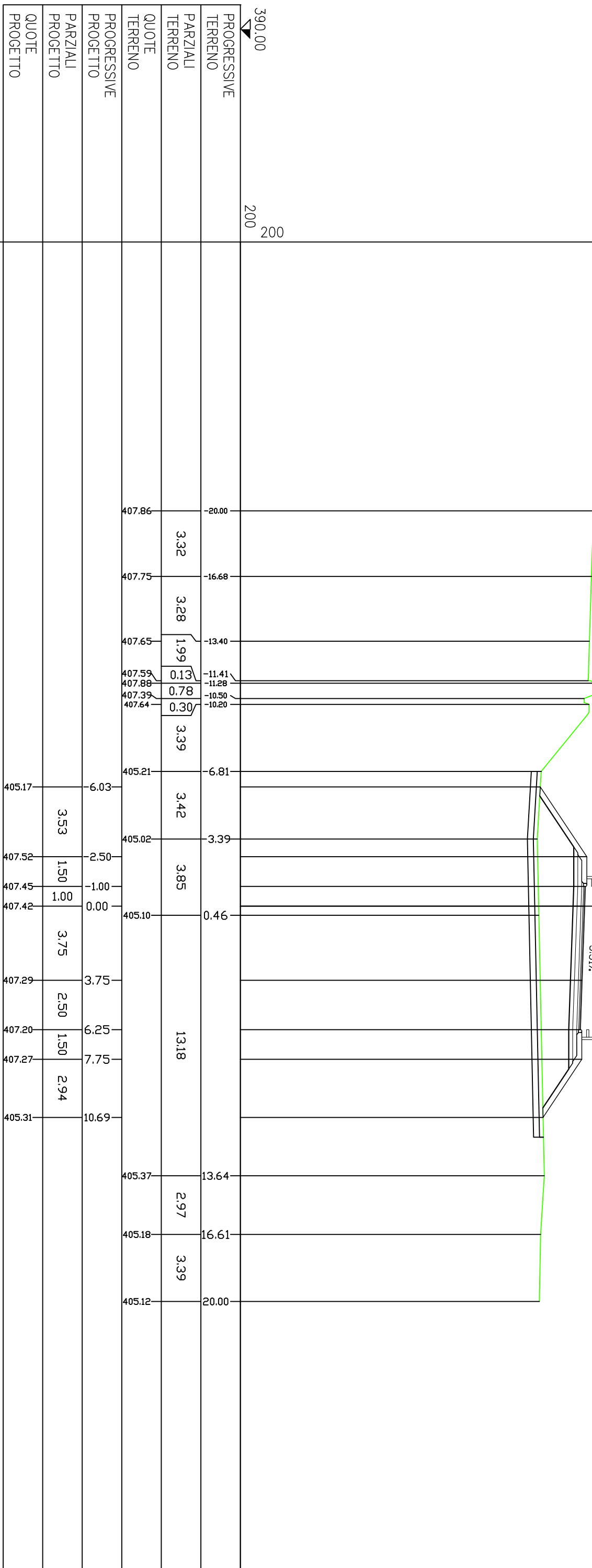

Autostrada A32 - Salita  
Direzione BARDONECCHIA

3.51%

390.00  
200  
200

QUOTE  
PARZIALI  
PROGETTO

PROFILO SV-BA\_MM1

SEZIONE 29

PROGRESSIVA 425.00

STERRE E RIPORTI

R1	3,71 mq.
R2	20,40 mq.
Totale R:	24,11 mq.
SCOTICD	
A1	3,36 mq.
BONIFICA	
B1	5,03 mq.
STABILIZZATO	
D1	2,18 mq.
CEMENTATO	
E1	2,03 mq.
BASE	
F1	0,76 mq.
VEGETALE	
G1	1,08 mq.
G2	1,36 mq.
Totale:	2,44 mq.
TNT	
a1	18,13 ml.
GEORIGLIA 10KN/m	
b1	16,77 ml.
IDROSEMINA	
e1	4,15 ml.
e2	5,28 ml.
Totale:	9,43 ml.
USURA	
f1	7,25 ml.
BINDER	
g1	7,25 ml.

390.00  
200  
200

PROGRESSIVE TERRENO			
PARZIALI TERRENO			
QUOTE TERRENO			
PROGRESSIVE PROGETTO			
PARZIALI PROGETTO			
QUOTE PROGETTO			

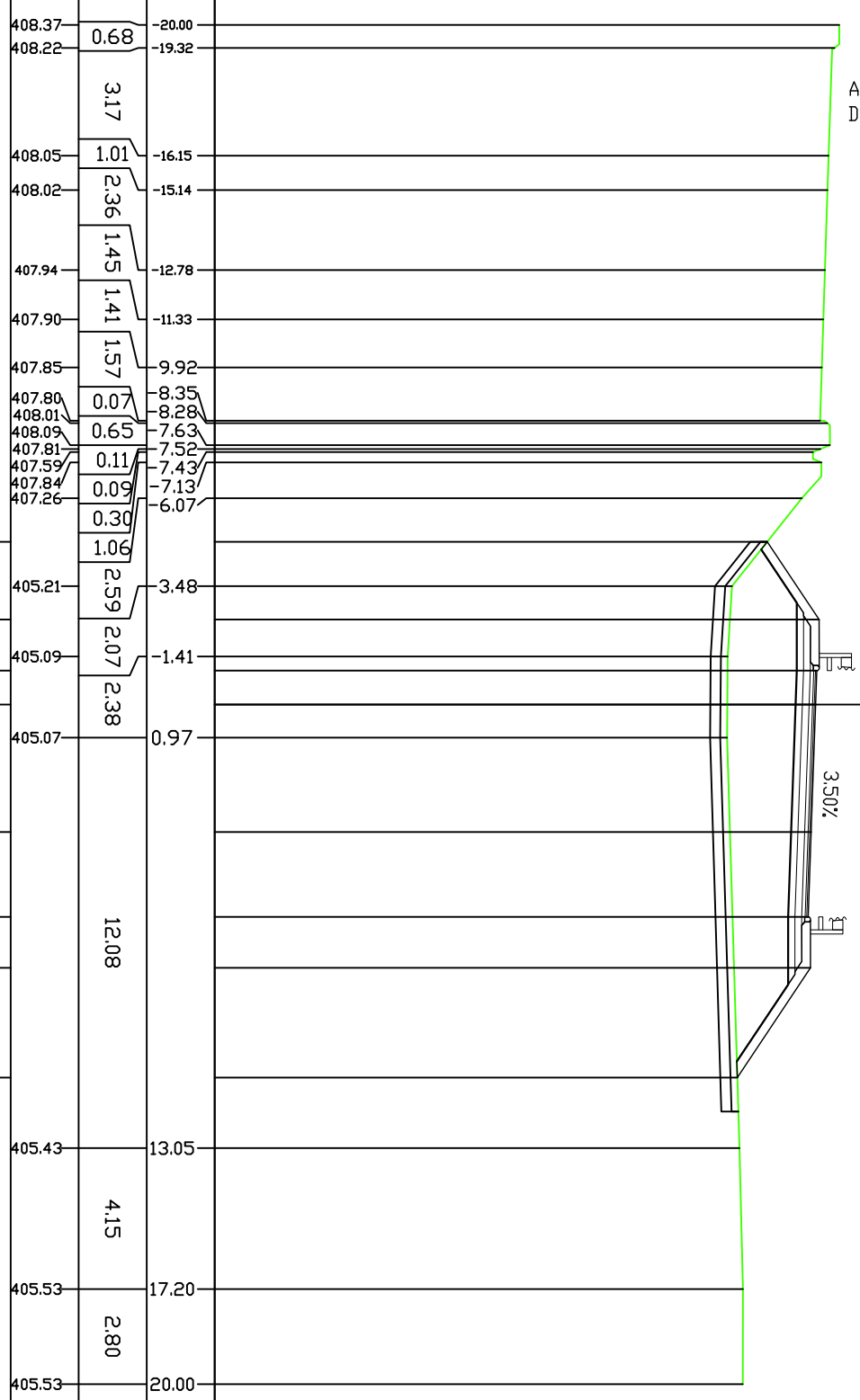

Autostrada A32 - Salita  
Direzione BARDONECCHIA

3.50%

PROFLO SV-BA\_MM1

SEZIONE 30

PROGRESSIVA 450.00

STERRE E RIPORTI

SI	0.59 mq.
R1	2.53 mq.
R2	16.83 mq.
Totale R:	19.36 mq.
SCOTICD	
A1	2.55 mq.
BONIFICA	
B1	3.80 mq.
BONIFICA PROFONDA	
C1	5.06 mq.
STABILIZZATO	
D1	2.18 mq.
CEMENTATO	
E1	2.04 mq.
BASE	
F1	0.76 mq.
VEGETALE	
G1	0.64 mq.
G2	1.51 mq.
Totale:	2.15 mq.
TNT	
a1	13.67 ml.
GEORIGLIA 10KN/m	
b1	12.67 ml.
GEORIGLIA 28KN/m	
c1	1.99 ml.
GRADONATURA	
d1	3.43 ml.
IDROSEMINA	
e1	1.77 ml.
e2	5.83 ml.
Totale:	7.60 ml.
USURA	
f1	7.25 ml.
BINDER	
g1	7.25 ml.

390.00  
200  
200

PROGRESSIVE TERRENO	QUOTE TERRENO	PROGRESSIVE TERRENO	QUOTE TERRENO	PROGRESSIVE TERRENO	QUOTE TERRENO	PROGRESSIVE TERRENO	QUOTE TERRENO
408.52	1.16	408.48	1.50	408.42	1.84	408.51	1.84
				408.30	0.13	408.22	2.22
				408.16	1.90	408.08	1.45
				408.02	2.08	407.95	0.60
				407.92	0.10	407.92	0.10
				408.17	0.60	408.21	0.60
				407.84	0.15	407.84	0.15
				407.96	0.69	407.96	0.69
				407.71	0.31	407.92	1.50
				407.85	1.00	407.82	0.00
				405.21	3.75	405.21	0.72
				407.68	3.75	405.21	0.83
				407.60	2.50	405.16	1.62
				407.67	1.50	405.16	5.07
				405.21	3.69	405.16	6.59
				405.21	11.44	405.21	11.66
				404.98	4.53	405.21	4.53
				405.46	3.81	404.98	16.19
						405.46	20.00

Autostrada A32 - Salita  
Direzione BARDDNECCHIA

3.50%

PROFILO SV-BA\_MM1

SEZIONE 31

PROGRESSIVA 475.00

STERRE E RIPORTI

SI	153 mq.
S2	158 mq.
Totale S:	311 mq.
R1	1,71 mq.
R2	11,99 mq.
Totale R:	13,70 mq.
SCOTTICI	
AI	220 mq.
BONIFICA	
BI	332 mq.
BONIFICA PROFONDA	
CI	440 mq.
STABILIZZATO	
DI	252 mq.
CEMENTATO	
EI	247 mq.
BASE	
FI	111 mq.
VEGETALE	
GI	154 mq.
TNT	
GI	1204 ml.
GI	1104 ml.
GI	1104 ml.
GI	1281 ml.
GRADONATURA	
GI	276 ml.
IDROSEMINA	
GI	599 ml.
USURA	
GI	1182 ml.
BINDER	
GI	1132 ml.

390.00  
200  
200

PROGRESSIVE TERRENO	PARZIALI TERRENO	QUOTE TERRENO	PROGRESSIVE PROGETTO	PARZIALI PROGETTO	QUOTE PROGETTO
408.74	1.77		408.15	1.00	
408.67	2.38		408.12	4.57	
408.58	1.40		408.03	3.75	
408.52	1.83		408.28	2.50	
408.61	0.13		408.31	1.50	
408.40	3.02		407.87	3.82	
408.29	1.09		408.05		
408.25	2.97		406.64		
408.15	0.80		406.23		
408.12	2.44		405.55		
408.03	0.60		405.57		
408.28	0.18		407.74		
408.31	0.69		407.81		
407.87	1.59		405.41		
408.05	0.45		405.34		
406.64	0.86		405.27		
406.23	0.71		405.17		
405.55	4.35		405.12		
405.57	6.08		405.08		
407.74	1.36		405.06		
407.81	1.78		405.00		
405.41	0.91				
405.34	1.29				

Autostrada A32 - Salita  
Direzione BARDONECCHIA

3.60%  
3.35%  
3.50%

STERZI E RIPORTI

SI	2.03 mq.
SE	1.09 mq.
Totale S:	3.12 mq.
R1	1.00 mq.
R2	9.95 mq.
Totale R:	10.95 mq.
SCOTICD	
AI	1.67 mq.
BONIFICA	
BI	2.53 mq.
BONIFICA PROFONDA	
CI	3.37 mq.
STABILIZZATO	
DI	2.14 mq.
CEMENTATO	
EI	2.05 mq.
BASE	
F1	0.90 mq.
VEGETALE	
G1	1.51 mq.
TNT	
GI	9.42 ml.
GI	8.42 ml.
GEDRIGLIA 10KN/m	
GI	8.42 ml.
GEDRIGLIA 28KN/m	
CI	10.81 ml.
GRADONATURA	
GI	3.21 ml.
IDROSEMINA	
GI	5.92 ml.
USURA	
F1	9.82 ml.
BINDER	
GI	9.32 ml.

390.00  
 ▲  
 200  
 200

PROGRESSIVE TERRENO																							
PARZIALI TERRENO																							
QUOTE TERRENO																							
PROGRESSIVE PROGETTO																							
PARZIALI PROGETTO																							
QUOTE PROGETTO																							

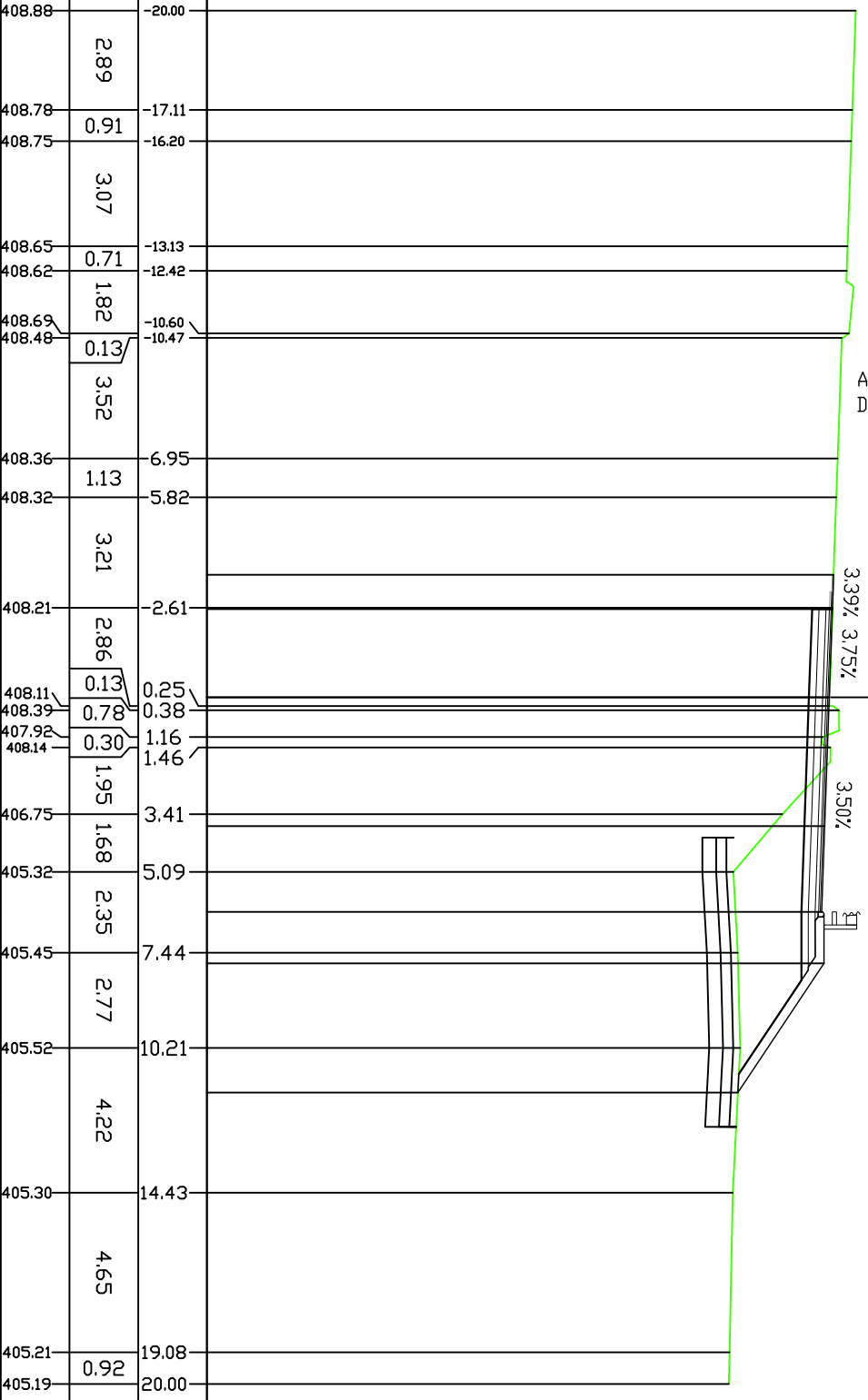

Autostrada A32 - Salita  
 Direzione BARDONECCHIA

PROFILO SV-BA\_MM1

SEZIONE 33

PROGRESSIVA 525.00

STERRE E RIPORTI

SI	285 mq.
S2	0,77 mq.
Totale S:	362 mq.
R1	0,19 mq.
R2	7,59 mq.
Totale R:	7,78 mq.
SCOTTICI	
AI	1,34 mq.
BONIFICA	
BI	2,02 mq.
BONIFICA PROFONDA	
CI	2,69 mq.
STABILIZZATO	
DI	1,86 mq.
CEMENTATO	
EI	1,81 mq.
BASE	
FI	0,77 mq.
VEGETALE	
GI	1,45 mq.
TNT	
GI	7,73 ml.
GI	7,73 ml.
GI	6,73 ml.
GI	6,73 ml.
GI	9,51 ml.
GRADINATURA	
GI	3,09 ml.
IDROSEMINA	
GI	5,68 ml.
USURA	
FI	8,52 ml.
BINDER	
GI	8,02 ml.

390.00  
200  
200

PROGRESSIVE  
TERRENO

PARZIALI  
TERRENO

QUOTE  
TERRENO

PROGRESSIVE  
PROGETTO

PARZIALI  
PROGETTO

QUOTE  
PROGETTO

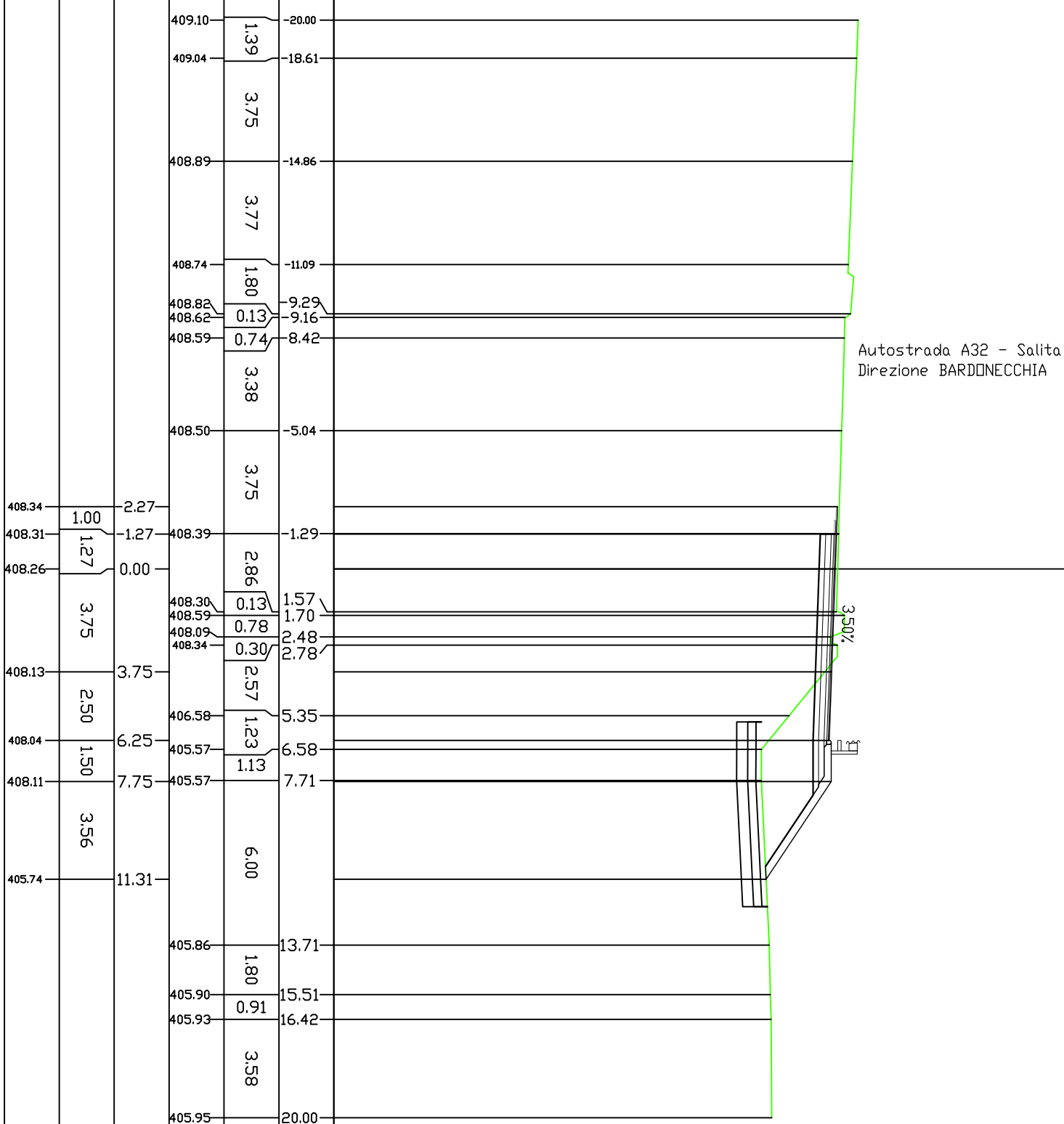

Autostrada A32 - Salita  
Direzione BARDONECCHIA

408.34	2.27
408.31	-1.27
408.26	0.00
408.30	0.13
408.29	0.78
408.09	0.30
408.34	0.30
408.13	3.75
406.58	5.35
408.04	6.25
405.57	1.23
408.11	7.75
405.57	1.13
405.74	11.31
405.86	13.71
405.90	15.51
405.93	16.42
405.95	20.00

408.34	1.00
408.31	1.27
408.26	3.75
408.30	0.13
408.29	0.78
408.09	0.30
408.34	0.30
408.13	2.57
406.58	1.23
405.57	1.13
405.74	6.00
405.86	1.80
405.90	0.91
405.93	3.58

PROFILO SV-BA\_MM1

SEZIONE 34

PROGRESSIVA 550.00

STERZI E RIPORTI

SI	3.40 mq.
S2	0.20 mq.
Totale S:	3.60 mq.
R1	0.01 mq.
R2	7.83 mq.
Totale R:	7.84 mq.
SCOTICD	
A1	1.32 mq.
BONIFICA	
B1	1.99 mq.
BONIFICA PROFONDA	
C1	2.64 mq.
STABILIZZATO	
D1	1.72 mq.
CEMENTATO	
E1	1.64 mq.
BASE	
F1	0.70 mq.
VEGETALE	
G1	1.67 mq.
TNT	
o1	7.63 ml.
GEORIGLIA 10KN/m	
b1	6.63 ml.
GEORIGLIA 28KN/m	
c1	8.74 ml.
GRADONATURA	
o1	3.26 ml.
IDROSEMINA	
e1	6.41 ml.
USURA	
f1	7.75 ml.
BINDER	
g1	7.25 ml.

390.00  
200  
200

PROGRESSIVE TERRENO	PROGRESSIVA	QUOTE TERRENO	PROGRESSIVE TERRENO	PROGRESSIVA	QUOTE TERRENO	PROGRESSIVE TERRENO	PROGRESSIVA	QUOTE TERRENO
409.28	-20.00	1.93	409.20	-18.07	3.92	409.04	-14.15	3.69
408.89	-10.46	1.94	408.95	-8.52	0.13	408.74	-8.39	4.12
408.64	4.27	2.96	408.56	-1.31	0.78	408.54	0.53	2.79
408.50	-1.50	1.00	408.47	-0.50	0.50	408.45	0.00	3.75
408.32	3.75	3.75	408.47	2.26	0.16	408.76	2.42	0.78
408.23	6.25	2.50	408.27	3.20	0.30	408.51	3.50	2.05
408.30	7.75	1.50	407.14	5.55	1.38	405.89	6.93	0.36
405.52	11.92	4.17	405.49	7.29	0.72	405.51	8.01	4.79
405.53	12.80	7.20	405.53	12.80		405.83	20.00	

Autostrada A32 - Salita  
Direzione BARDOVECCHIA

3.50%

1%



PROFILO SV-BA\_MM1

SEZIONE 35

PROGRESSIVA 575.00

STERZI E RIPORTI

SI	3,21 mq.
S2	0,02 mq.
Totale S:	3,23 mq.
R1	0,04 mq.
R2	8,34 mq.
Totale R:	8,38 mq.
SCOTTICD	
A1	1,28 mq.
BONIFICA	
B1	1,93 mq.
BONIFICA PROFONDA	
C1	2,55 mq.
STABILIZZATO	
D1	1,63 mq.
CEMENTATO	
E1	1,58 mq.
BASE	
F1	0,66 mq.
VEGETALE	
G1	1,74 mq.
TNT	
a1	7,42 ml.
GEGRIGLIA 10KN/m	
b1	6,40 ml.
GEGRIGLIA 28KN/m	
c1	8,38 ml.
GRADONATURA	
d1	3,54 ml.
IDROSEMINA	
e1	6,59 ml.
USURA	
f1	7,39 ml.
BINDER	
g1	6,89 ml.

390.00  
200  
200

PROGRESSIVE  
TERRENO

PARZIALI  
TERRENO

QUOTE  
TERRENO

PROGRESSIVE  
PROGETTO

PARZIALI  
PROGETTO

QUOTE  
PROGETTO

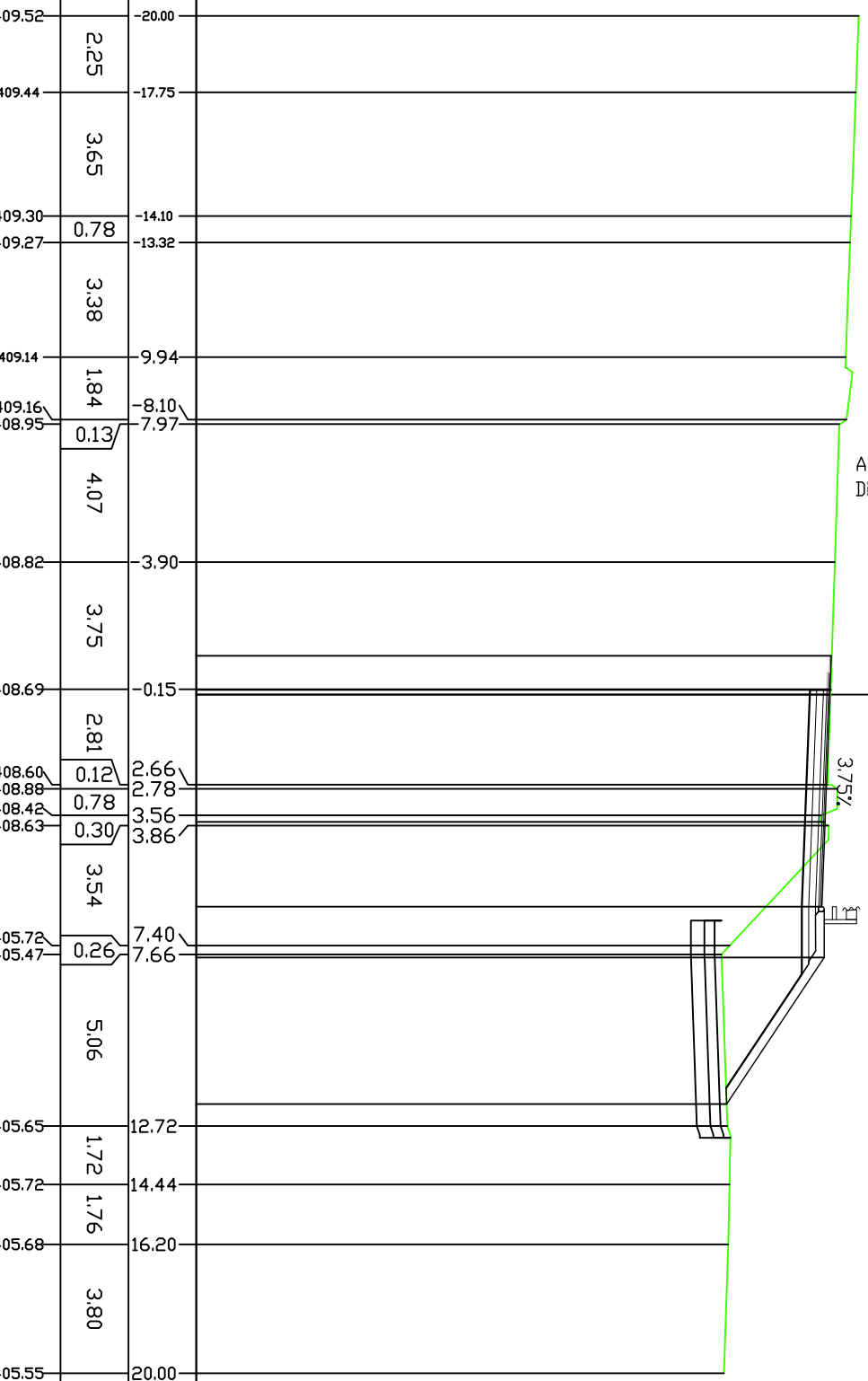

Autostrada A32 - Salita  
Direzione BARDONECCHIA

PROFILO SV-BA\_MM1

SEZIONE 36

PROGRESSIVA 600.00

STERZI E RIPORTI

SI	3.36 mq.
S2	0.04 mq.
Totale S:	3.40 mq.
R1	0.00 mq.
R2	6.70 mq.
Totale R:	6.70 mq.
SCOTICD	
AI	1.26 mq.
BONIFICA	
BI	1.91 mq.
BONIFICA PROFONDA	
CI	2.56 mq.
STABILIZZATO	
DI	1.63 mq.
CEMENTATO	
EI	1.56 mq.
BASE	
FI	0.64 mq.
VEGETALE	
GI	1.67 mq.
TNT	
GI	7.39 ml.
GI	6.38 ml.
GEDRIGLIA 10KN/m	
GI	6.38 ml.
GEDRIGLIA 28KN/m	
GI	8.24 ml.
GRADONATURA	
GI	3.07 ml.
IDROSEMINA	
GI	6.52 ml.
USURA	
GI	7.25 ml.
BINDER	
GI	6.75 ml.

390.00  
 200  
 200

PROGRESSIVE TERRENO	409.77	-20.00	
PARZIALI TERRENO	409.68	-17.32	2.68
QUOTE TERRENO	409.66	-16.69	0.63
PROGRESSIVE TERRENO	409.55	-13.57	3.12
PARZIALI TERRENO	409.53	-12.92	0.65
QUOTE TERRENO	409.42	-9.81	3.11
PROGRESSIVE TERRENO	409.43	-7.99	1.82
PARZIALI TERRENO	409.22	-7.86	0.13
QUOTE TERRENO	409.19	-7.15	0.71
PROGRESSIVE TERRENO	409.07	-3.76	3.39
PARZIALI TERRENO	408.98	-1.00	3.75
QUOTE TERRENO	408.93	0.00	2.84
PROGRESSIVE TERRENO	408.84	2.83	0.13
PARZIALI TERRENO	409.13	2.96	0.60
QUOTE TERRENO	409.08	3.56	0.18
PROGRESSIVE TERRENO	408.74	3.75	0.30
PARZIALI TERRENO	408.88	4.04	0.81
QUOTE TERRENO	408.52	4.85	0.81
PROGRESSIVE TERRENO	408.61	6.38	1.53
PARZIALI TERRENO	408.68	7.63	1.25
QUOTE TERRENO	405.99	8.90	1.27
PROGRESSIVE TERRENO	405.84	12.42	3.52
PARZIALI TERRENO	405.82	12.42	0.61
QUOTE TERRENO	405.94	13.03	1.22
PROGRESSIVE TERRENO	405.98	14.25	1.75
PARZIALI TERRENO	405.93	16.00	1.75
QUOTE TERRENO	405.84	18.57	2.57
PROGRESSIVE TERRENO	405.86	20.00	1.43

Autostrada A32 - Salita  
 Direzione BARDONECCHIA

5.00%

PROFILO SV-BA\_MM1

SEZIONE 37

PROGRESSIVA 618.87

STERRE E RIPORTI

SI	3.35 mq.
SE	0.00 mq.
Totale S:	3.35 mq.
R1	0.00 mq.
R2	5.69 mq.
Totale R:	5.69 mq.
SCOTICD	
A1	1.03 mq.
BONIFICA	
B1	1.55 mq.
BONIFICA PROFONDA	
C1	2.08 mq.
STABILIZZATO	
D1	1.61 mq.
CEMENTATO	
E1	1.54 mq.
BASE	
F1	0.64 mq.
VEGETALE	
G1	1.44 mq.
TNT	
a1	6.21 ml.
GEORIGLIA 10KN/m	
b1	5.18 ml.
GEORIGLIA 28KN/m	
c1	8.24 ml.
GRADINATURA	
d1	3.34 ml.
IDROSEMINA	
e1	5.55 ml.
USURA	
f1	7.25 ml.
BINDER	
g1	6.75 ml.

390.00  
200  
200

PROGRESSIVE TERRENO	QUOTE TERRENO	PROGRESSIVE TERRENO	QUOTE TERRENO	PROGRESSIVE TERRENO	QUOTE TERRENO
410.00	2.67	409.90	3.75	409.76	3.77
409.63	1.81	409.63	9.81	409.63	1.81
409.65	0.13	409.44	0.13	409.41	0.76
409.41	0.76	409.41	7.11	409.29	3.34
409.29	3.34	409.29	3.77	409.19	3.75
409.19	3.75	409.19	-1.00	409.14	1.00
409.14	1.00	409.14	0.00	409.15	0.02
409.15	0.02	409.04	2.85	409.04	0.13
409.04	2.85	409.33	0.13	409.33	0.13
409.33	0.13	409.27	0.13	409.27	0.13
409.27	0.13	409.08	0.13	409.08	0.13
409.08	0.13	409.08	4.04	408.83	3.74
408.83	3.74	408.83	3.97	408.83	3.97
408.83	3.97	408.83	6.25	408.90	7.75
408.90	7.75	406.18	8.01	406.18	8.01
406.18	8.01	406.63	11.44	406.63	11.44
406.63	11.44	406.71	12.87	406.71	12.87
406.71	12.87	406.65	15.56	406.65	15.56
406.65	15.56	406.59	18.53	406.59	18.53
406.59	18.53	406.54	20.00	406.54	20.00
406.54	20.00				

Autostrada A32 - Salita  
Direzione BARDOVECCHIA

5.00%

PROFILO SV-BA\_MM1

SEZIONE 38

PROGRESSIVA 634.43

STERRE E RIPORTI

S1	3,29 mq.
S2	0,00 mq.
S3	0,00 mq.
Totale S:	3,29 mq.
R1	5,98 mq.
SCOTICD	
A1	1,10 mq.
BONIFICA	
B1	1,65 mq.
BONIFICA PROFONDA	
C1	2,21 mq.
STABILIZZATO	
D1	1,62 mq.
CEMENTATO	
E1	1,55 mq.
BASE	
F1	0,65 mq.
VEGETALE	
G1	1,60 mq.
TNT	
g1	6,51 ml.
GEORIGLIA 10KN/m	
b1	5,51 ml.
GEORIGLIA 28KN/m	
c1	8,24 ml.
GRADINATURA	
d1	3,46 ml.
IDROSEMINA	
e1	6,18 ml.
USURA	
f1	7,25 ml.
BINDER	
g1	6,75 ml.

390.00  
 200  
 200

PROGRESSIVE TERRENO	QUOTE TERRENO	PROGRESSIVE PROGETTO	QUOTE PROGETTO
410.19	2,29		
410.10	3,65		
409.96	3,79		
409.81	0,72		
409.79	0,17		
410.00	1,41		
409.83	7,97		
409.62	0,13		
	3,97		
409.46	3,87		
	3,75		
409.37	-1,00		
409.32	0,00		
	2,86		
409.21	0,20		
409.49	0,81		
409.01	0,78		
409.24	0,31		
	2,41		
409.01	6,25		
409.08	7,75		
	1,78		
406.36	2,74		
	2,74		
406.39	10,96		
406.43	11,73		
	4,06		
406.57	15,02		
	3,38		
406.49	18,40		
406.49	20,00		
	1,60		

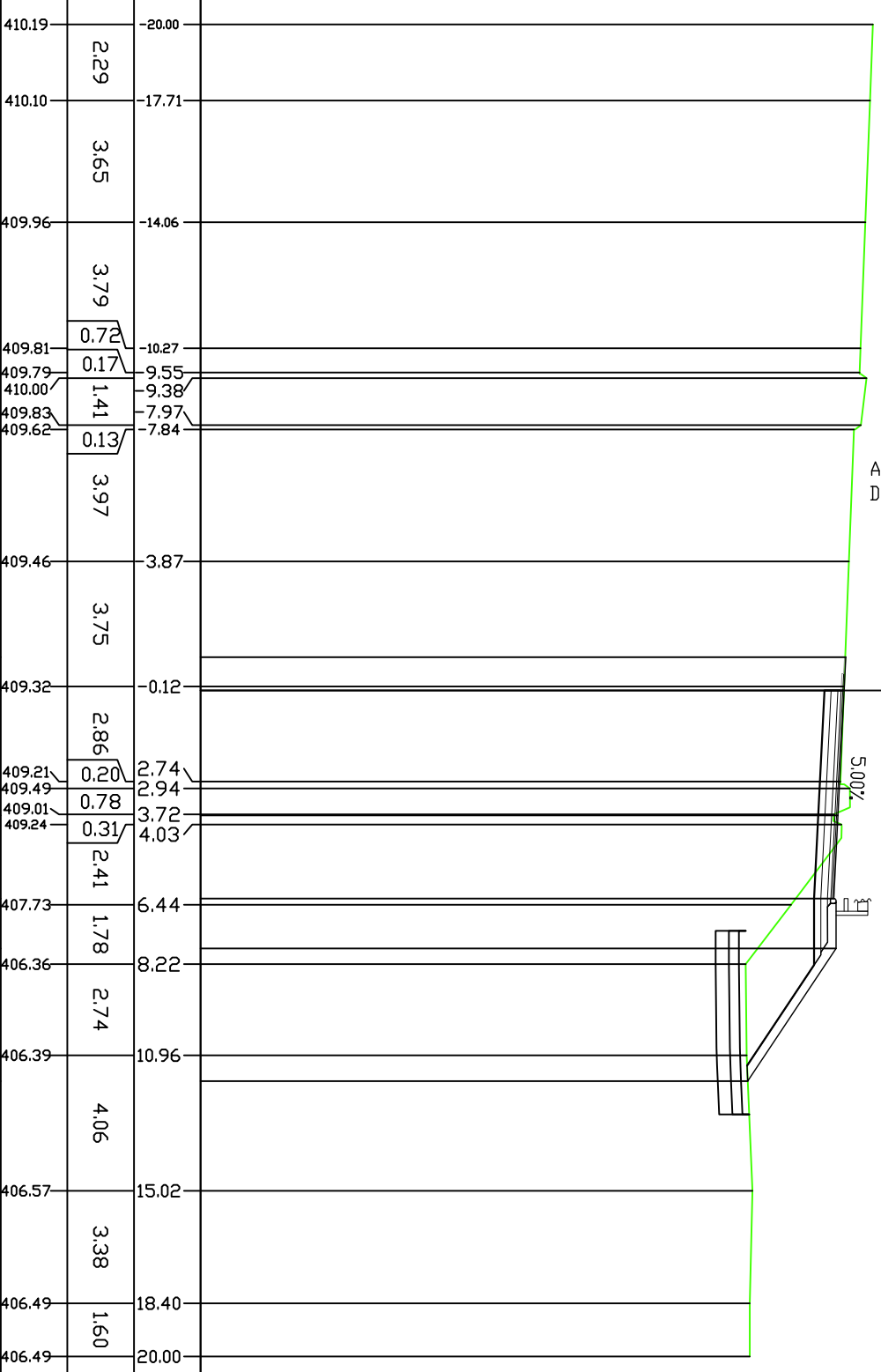

Autostrada A32 - Salita  
 Direzione BARDONECCHIA

5.00%

STERRE E RIPORTI	
SI	3,31 mq.
S2	0,00 mq.
Totale S:	3,31 mq.
R1	0,00 mq.
R2	7,20 mq.
Totale R:	7,20 mq.
SCOTTICI	
A1	1,14 mq.
BONIFICA	
B1	1,73 mq.
BONIFICA PROFONDA	
C1	2,30 mq.
STABILIZZATO	
D1	1,62 mq.
CEMENTATO	
E1	1,54 mq.
BASE	
F1	0,66 mq.
VEGETALE	
G1	1,80 mq.
TNT	
a1	6,75 ml.
GEORIGLIA 10KN/m	
b1	5,75 ml.
GEORIGLIA 28KN/m	
c1	8,24 ml.
GRADINATURA	
d1	3,90 ml.
IDROSEMINA	
e1	6,79 ml.
USURA	
f1	7,25 ml.
BINDER	
g1	6,75 ml.

390.00  
200  
200

PROGRESSIVE TERRENO	QUOTE TERRENO	PROGRESSIVE TERRENO	QUOTE TERRENO
410.37	1.88	410.37	-20.00
410.30	0.83	410.30	-18.12
410.27	2.71	410.27	-17.29
410.17	1.04	410.17	-14.58
410.13	2.74	410.13	-13.54
410.02	1.02	410.02	-10.80
409.99	1.84	409.99	9.78
410.01	0.13	410.01	-7.94
409.81	1.00	409.81	-7.81
409.76	3.08	409.76	-6.81
409.65	0.68	409.65	3.73
409.62	3.07	409.62	3.05
409.56	1.00	409.56	-1.00
409.51	3.75	409.51	0.00
409.40	0.91	409.40	2.81
409.32	2.50	409.32	3.75
409.20	1.50	409.20	6.25
409.27	4.48	409.27	7.75
406.28		406.28	12.23
		406.28	12.67
		406.33	16.39
		406.38	19.35
		406.37	20.00
		406.37	20.00

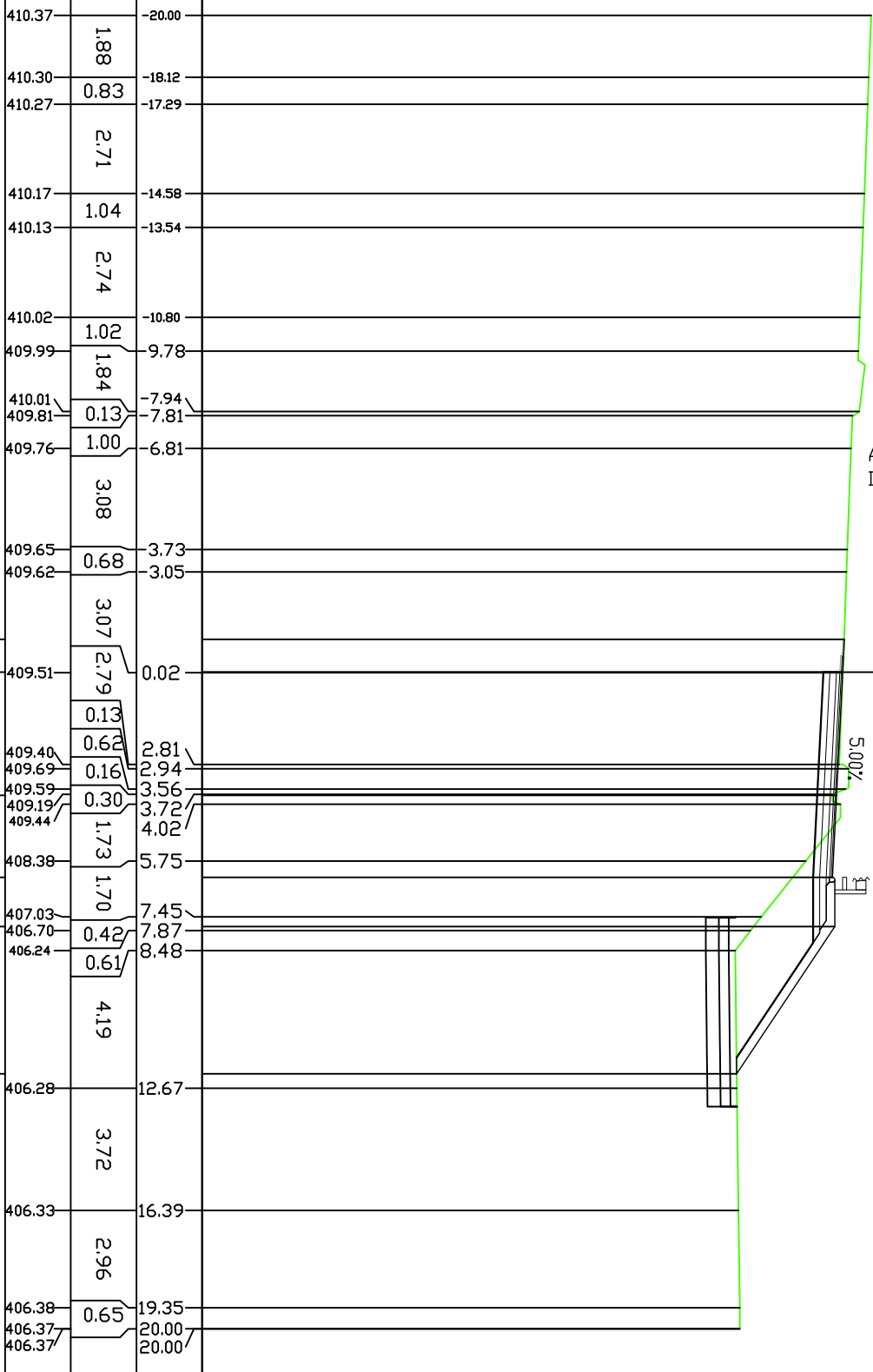

Autostrada A32 - Salita  
Direzione BARDONECCHIA

STERRE E RIPORTI	
SI	3,38 mq.
R1	0,00 mq.
R2	0,00 mq.
R3	8,94 mq.
Totale R:	8,94 mq.
SCOTICD	
A1	1,23 mq.
BONIFICA	
B1	1,84 mq.
BONIFICA PROFONDA	
C1	2,46 mq.
STABILIZZATO	
D1	1,62 mq.
CEMENTATO	
E1	1,54 mq.
BASE	
F1	0,64 mq.
VEGETALE	
G1	1,99 mq.
TNT	
g1	7,15 ml.
GEOGRIGLIA 10KN/m	
b1	6,15 ml.
GEOGRIGLIA 28KN/m	
c1	8,24 ml.
GRADINATURA	
d1	4,39 ml.
IDROSEMINA	
e1	7,59 ml.
USURA	
f1	7,25 ml.
BINDER	
g1	6,75 ml.

390.00  
 200  
 200

PROGRESSIVE TERRENO			
PARZIALI TERRENO			
QUOTE TERRENO			
PROGRESSIVE PROGETTO			
PARZIALI PROGETTO			
QUOTE PROGETTO			

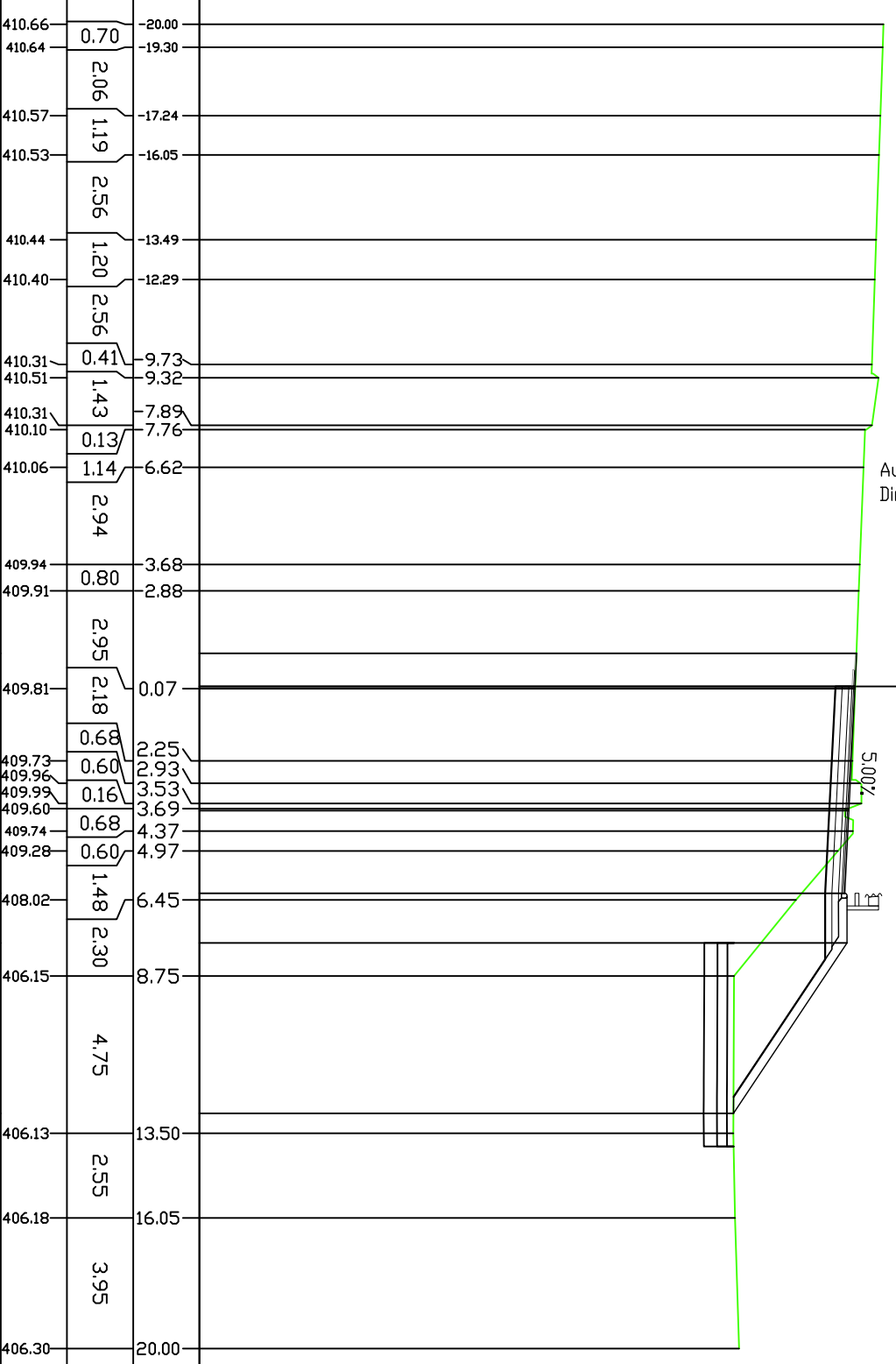

Autostrada A32 - Salita  
 Direzione BARDONECCHIA

PROFILO SV-BA\_MM1

SEZIONE 41

PROGRESSIVA 700.00

STERRE E RIPORTI

SI	3,29 mq.
S2	0,00 mq.
S3	0,00 mq.
Totale S:	3,29 mq.
RI	9,47 mq.
SCOTICD	
A1	1,17 mq.
BONIFICA	
B1	1,70 mq.
BONIFICA PROFONDA	
C1	2,30 mq.
STABILIZZATO	
D1	1,62 mq.
CEMENTATO	
E1	1,55 mq.
BASE	
F1	0,63 mq.
VEGETALE	
G1	2,16 mq.
TNT	
g1	6,74 ml.
GEOGRIGLIA 10KN/m	
b1	5,74 ml.
GEOGRIGLIA 28KN/m	
c1	8,24 ml.
GRADINATURA	
d1	5,24 ml.
IDROSEMINA	
e1	8,19 ml.
USURA	
f1	7,25 ml.
BINDER	
g1	6,75 ml.

390.00  
 200  
 200

PROGRESSIVE TERRENO			
PARZIALI TERRENO			
QUOTE TERRENO			
PROGRESSIVE PROGETTO			
PARZIALI PROGETTO			
QUOTE PROGETTO			

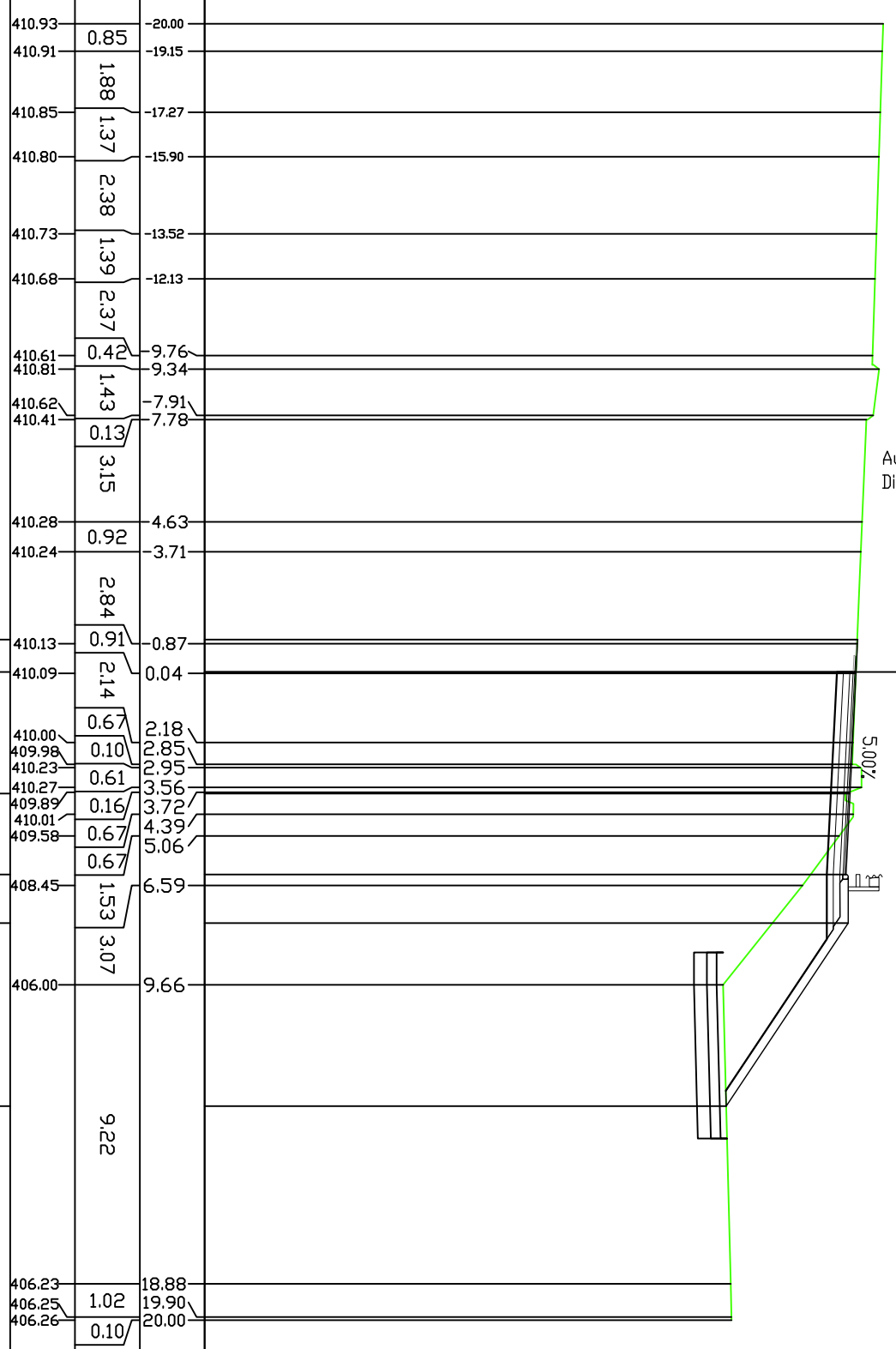

PROFILO SV-BA\_MM1

SEZIONE 42

PROGRESSIVA 712.84

STERZI E RIPORTI

SI	3.38 mq.
S2	0.01 mq.
Totale S:	3.39 mq.
R1	0.00 mq.
R2	9.78 mq.
Totale R:	9.78 mq.
SCOTICD	
A1	1.14 mq.
BONIFICA	
B1	1.70 mq.
BONIFICA PROFONDA	
C1	2.27 mq.
STABILIZZATO	
D1	1.61 mq.
CEMENTATO	
E1	1.54 mq.
BASE	
F1	0.64 mq.
VEGETALE	
G1	2.21 mq.
TNT	
GI	6.68 ml.
al	5.68 ml.
GEOGRIGLIA 10KN/m	
b1	8.24 ml.
GEOGRIGLIA 28KN/m	
c1	5.53 ml.
GRADONATURA	
d1	8.44 ml.
IDROSEMINA	
e1	7.25 ml.
USURA	
f1	6.75 ml.
BINDER	
g1	

390.00  
200  
200

PROGRESSIVE TERRENO

PARZIALI TERRENO

QUOTE TERRENO

PROGRESSIVE PROGETTO

PARZIALI PROGETTO

QUOTE PROGETTO

PROGETTO

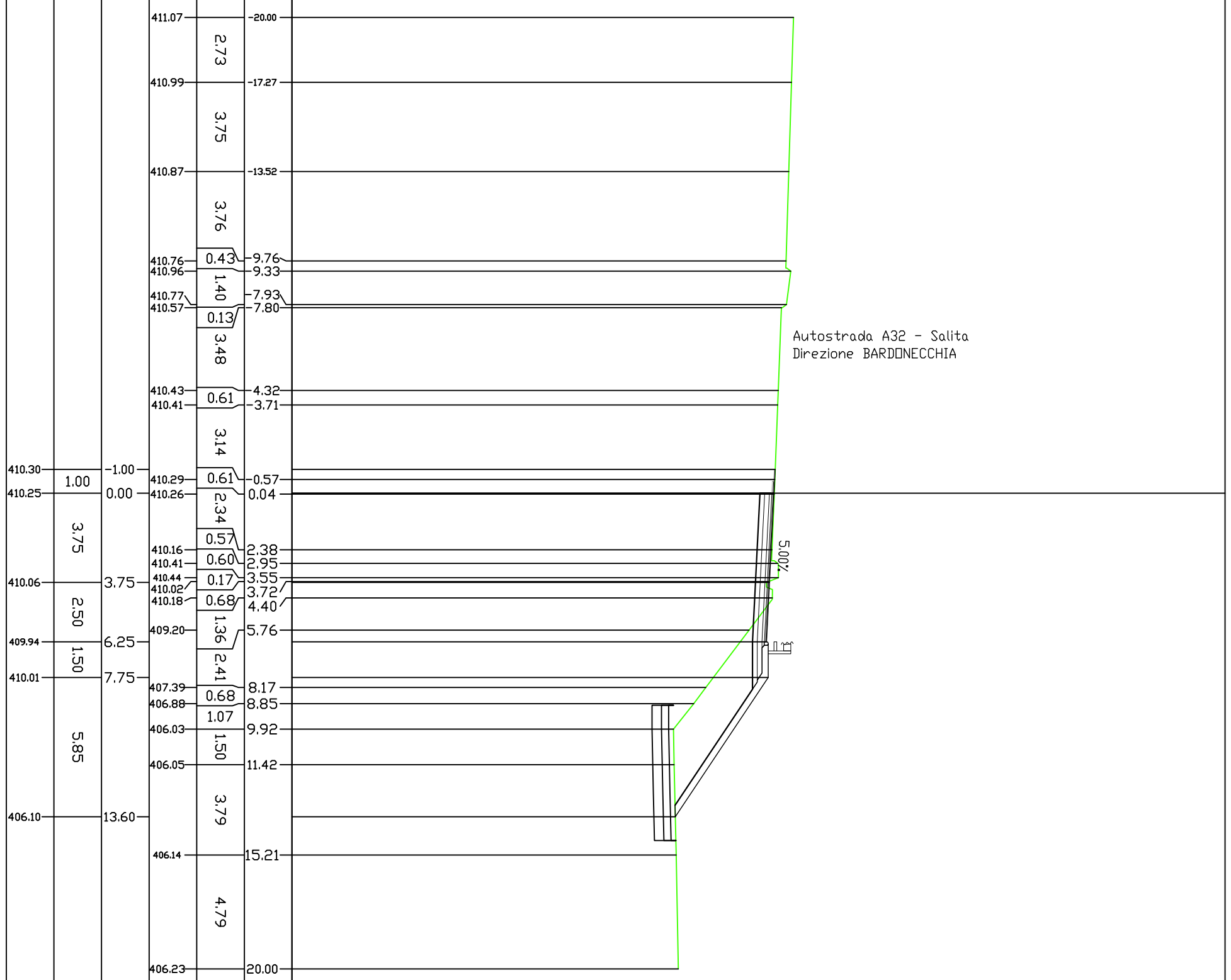

Autostrada A32 - Salita  
Direzione BARDONECCHIA

5.00%



PROFILO SV-BA\_MM1

SEZIONE 43

PROGRESSIVA 725.00

STERZI E RIPORTI

SI	3,23 mq.
S2	0,04 mq.
Totale S:	3,27 mq.
R1	0,00 mq.
R2	10,96 mq.
Totale R:	10,96 mq.
SCOTICD	
A1	1,19 mq.
BONIFICA	
B1	1,83 mq.
BONIFICA PROFONDA	
C1	2,39 mq.
STABILIZZATO	
D1	1,62 mq.
CEMENTATO	
E1	1,55 mq.
BASE	
F1	0,65 mq.
VEGETALE	
G1	2,28 mq.
TNT	
a1	7,04 ml.
GEORIGLIA 10KN/m	
b1	6,04 ml.
GEORIGLIA 28KN/m	
c1	8,24 ml.
GRADINATURA	
d1	5,56 ml.
IDROSEMINA	
e1	8,63 ml.
USURA	
f1	7,25 ml.
BINDER	
g1	6,75 ml.

390.00  
200  
200

PROGRESSIVE TERRENO	QUOTE TERRENO	PROGRESSIVE TERRENO	QUOTE TERRENO	PROGRESSIVE TERRENO	QUOTE TERRENO
411.22	6.0	411.19	1.82	411.12	1.51
				411.07	2.24
				410.99	1.54
				410.93	2.22
				410.86	1.85
		410.90	0.13	410.69	1.43
				410.64	2.64
				410.53	1.12
		410.48	2.63		
410.44	1.00	410.39	0.00	410.38	0.09
				410.35	1.93
				410.28	0.13
		410.21	3.75	410.15	0.64
				410.07	0.14
				410.32	0.30
		409.84	0.95		
					4.73
		410.08	6.25		
		410.15	7.75		
				406.06	9.73
		406.14	13.77		
				406.21	17.92
				406.23	18.94
				406.25	20.00

Autostrada A32 - Salita  
Direzione BARDONECCHIA

5.00%

STERRE E RIPORTI

SI	2,95 mq.
R1	0,07 mq.
R2	0,01 mq.
R3	13,39 mq.
Totale R:	13,47 mq.
SCOTICD	
A1	1,49 mq.
BONIFICA	
B1	2,27 mq.
BONIFICA PROFONDA	
C1	3,03 mq.
STABILIZZATO	
D1	1,53 mq.
CEMENTATO	
E1	1,44 mq.
BASE	
F1	0,60 mq.
VEGETALE	
G1	2,40 mq.
TNT	
g1	8,54 ml.
GEORIGLIA 10KN/m	
b1	7,53 ml.
GEORIGLIA 28KN/m	
c1	7,78 ml.
GRADINATURA	
d1	4,55 ml.
IDROSEMINA	
e1	8,96 ml.
USURA	
f1	6,79 ml.
BINDER	
g1	6,29 ml.

390.00  
 ▲  
 PROGRESSIVE  
 TERRENO 200  
 200

Autostrada A32 - Salita  
 Direzione BARDONECCHIA

5,00%

PARZIALI TERRENO	411.51	1,26	-20,00	
	411.47	1,48	-18,74	
	411.42	1,94	-17,26	
	411.36	1,81	-15,32	
	411.29	2,01	-13,51	
	411.23	1,78	-11,50	
	411.17	0,41	-9,72	
	411.37	1,41	-9,31	
	411.19	0,13	-7,90	
	410.98	1,59	7,77	
	410.91	2,48	6,18	
	410.81	2,52	3,70	
	410.70	1,23	-1,18	
	410.69	1,87	0,05	
	410.57	0,91	1,92	
	410.53	0,09	2,83	
	410.76	0,62	2,92	
	410.82	0,14	3,54	
	410.48	0,9	3,68	
	410.56	0,9	4,34	
	407.64	2,52	6,86	
	406.44	1,19	8,05	
	406.29	1,92	9,97	
	406.27	2,46	12,43	
	406.28	7,57	20,00	
QUOTE PROGETTO		1,00		
		3,25		
		2,54		
		1,50		
		6,29		
		13,58		

PROFILO SV-BA\_MM1

SEZIONE 45

PROGRESSIVA 775.00

STERRE E RIPORTI

SI	3.00 mq.
S2	0.05 mq.
Totale S:	3.05 mq.
R1	3.16 mq.
SCOTICD	
A1	0.79 mq.
BONIFICA	
B1	1.20 mq.
BONIFICA PROFONDA	
C1	1.59 mq.
STABILIZZATO	
D1	1.19 mq.
CEMENTATO	
E1	1.12 mq.
BASE	
F1	0.42 mq.
VEGETALE	
G1	2.31 mq.
TNT	
a1	4.99 ml.
GEDGRIGLIA 10KN/m	
b1	3.99 ml.
GEDGRIGLIA 28KN/m	
c1	6.11 ml.
GRADONATURA	
d1	5.57 ml.
IDROSEMINA	
e1	8.79 ml.
USURA	
f1	5.11 ml.
BINDER	
g1	4.61 ml.

390.00  
 200  
 200

PROGRESSIVE TERRENO				
PARZIALI TERRENO				
QUOTE TERRENO				
PROGRESSIVE PROGETTO				
PARZIALI PROGETTO				
QUOTE PROGETTO				

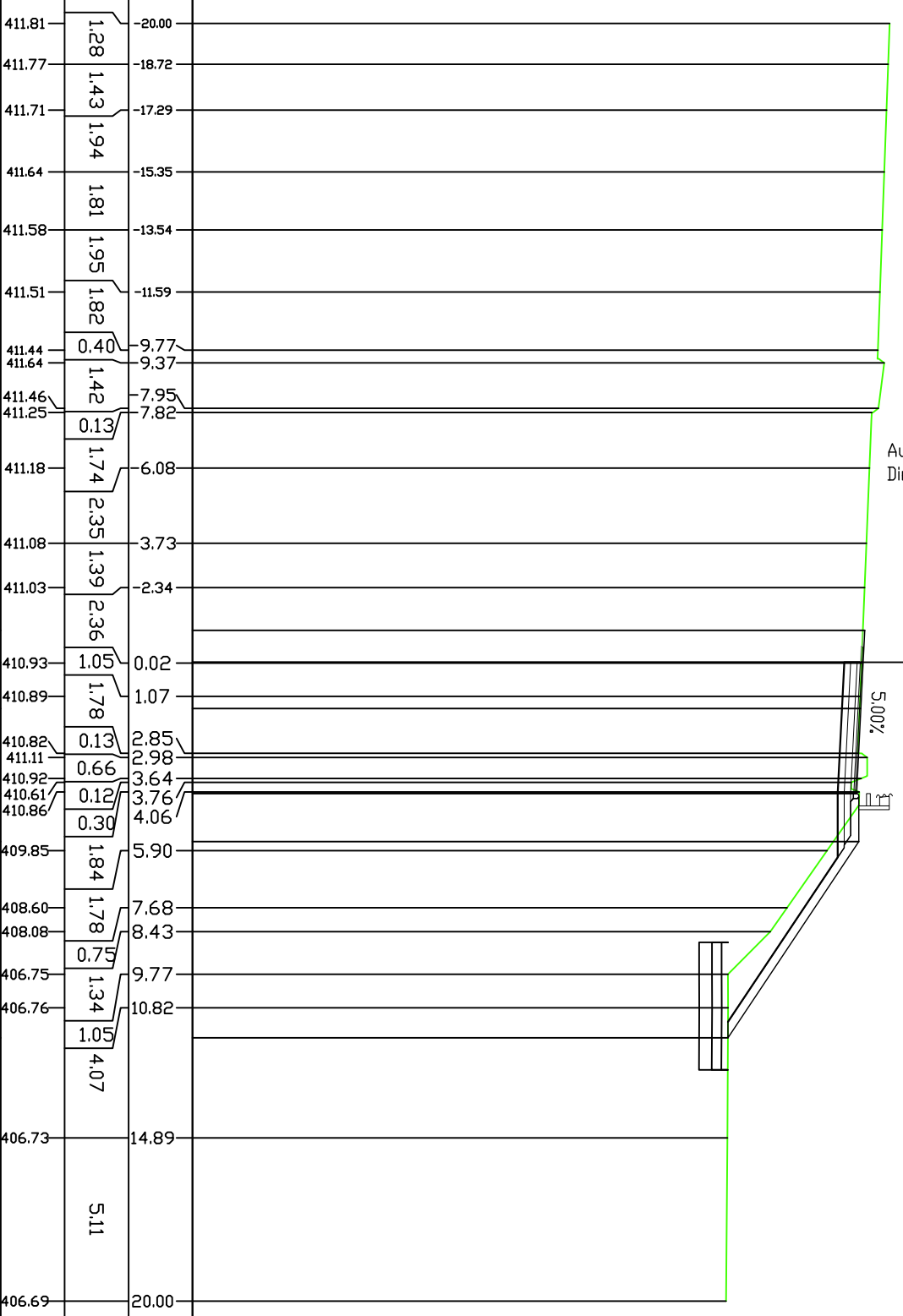

411.81	-20.00	1.28	
411.77	-18.72	1.43	
411.71	-17.29	1.94	
411.64	-15.35	1.81	
411.58	-13.54	1.95	
411.51	-11.59	1.82	
411.44	-9.77	0.40	
411.64	9.37	1.42	
411.46	-7.95	0.13	
411.25	7.82	1.74	
411.18	6.08	2.35	
411.08	3.73	1.39	
411.03	-2.34	2.36	
411.03	-1.00	1.00	
410.98	0.00	1.45	
410.91	1.45	2.66	
410.82	2.85	0.13	
411.11	2.98	0.66	
410.92	3.64	0.12	
410.61	3.76	0.30	
410.86	4.06	1.84	
410.85	5.90	1.78	
408.60	7.68	0.75	
408.08	8.43	1.34	
406.75	9.77	1.05	
406.76	10.82	4.07	
406.75	11.76	5.11	
406.73	14.89		
406.69	20.00		



PROFILO SV-BA\_MM1

SEZIONE 47

PROGRESSIVA 806.80

STERRI E RIPORTI	3.17 mq.
SI STABILIZZATO	0.92 mq.
DI CEMENTATO	0.85 mq.
EI BASE	0.29 mq.
F1 VEGETALE	0.62 mq.
GI GEORIGLIA 28KN/m	4.76 ml.
CI IDROSEMINA	1.55 ml.
eI USURA	3.77 ml.
fI BINDER	3.27 ml.
gI	

PROGRESSIVE TERRENO	390.00	200	200
PARZIALI TERRENO			
QUOTE TERRENO			
PROGRESSIVE PROGETTO			
PARZIALI PROGETTO			
QUOTE PROGETTO			

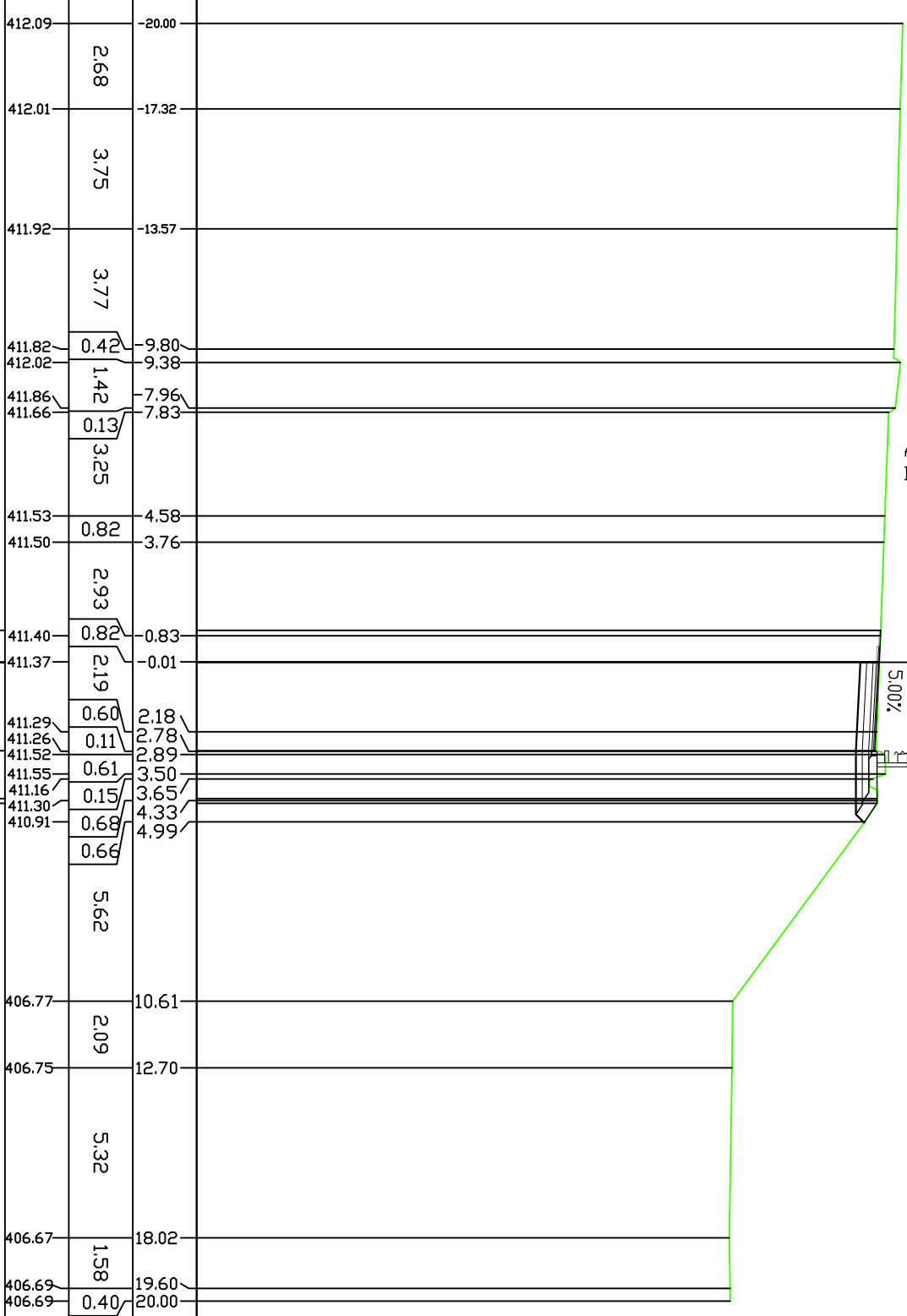

Autostrada A32 - Salita  
Direzione BARDOVECCHIA

5.00%

# Uscita A32 Bardonecchia Autoporto – Rampa 3

## KEY PLAN

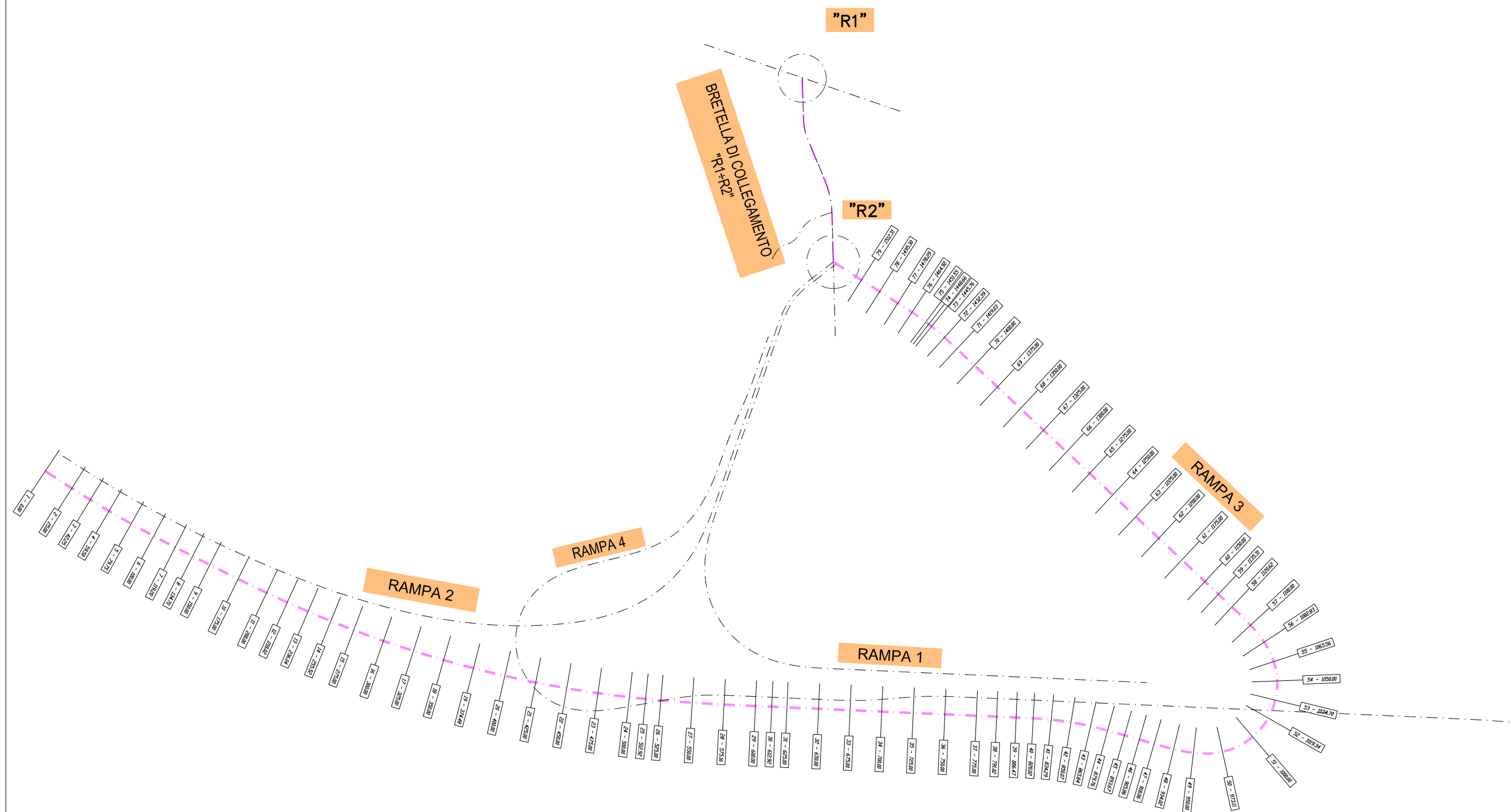

STERRI E RIPORTI	2.73 mq.
S1 STABILIZZATO	0.90 mq.
D1 CEMENTATO	0.82 mq.
E1 BASE	0.28 mq.
F1 VEGETALE	0.57 mq.
G1 GEODRIGLIA 28KN/m	4.63 ml.
C1 IDROSEMINA	2.23 ml.
e1 USURA	3.64 ml.
f1 BINDER	3.14 ml.
g1	

390.00  
 ▼  
 200  
 200

PROGRESSIVE TERRENO			
PARZIALI TERRENO			
QUOTE TERRENO			
PROGRESSIVE PROGETTO			
PARZIALI PROGETTO			
QUOTE PROGETTO			

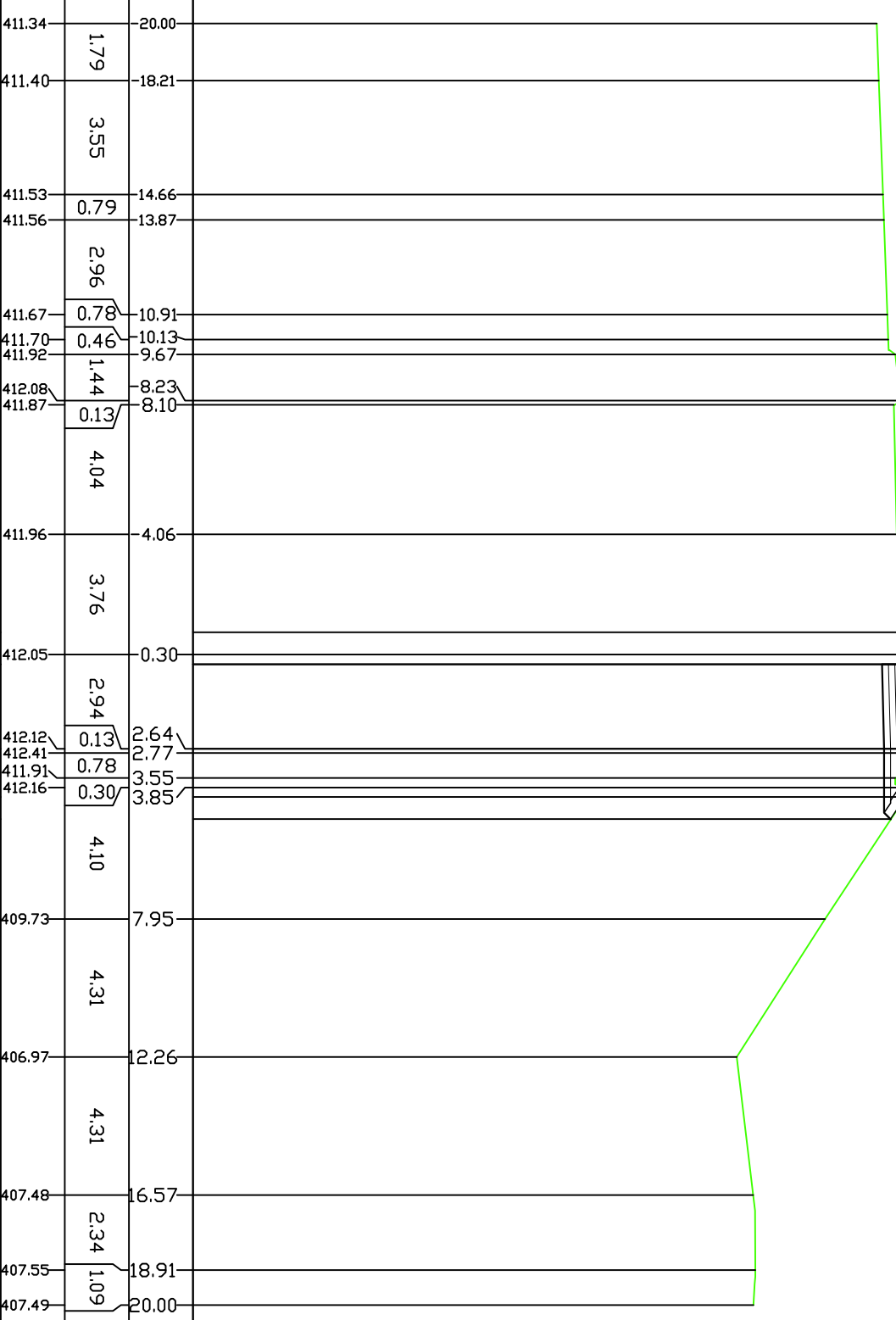

Autostrada A32 - Discesa  
 Direzione TORINO

2.50%

412.07	1.00	1.00
412.09	0.00	0.00
412.09	2.64	2.64
412.16	1.50	2.64
412.23	0.69	4.14
411.77		4.83

411.34	20.00	
411.40	18.21	
411.53	14.66	
411.56	13.87	
411.67	10.91	
411.70	10.13	
411.92	9.67	
412.08	8.23	
411.87	8.10	
411.96	4.06	
412.05	0.30	
412.12	2.64	
412.41	2.77	
411.91	3.55	
412.16	3.85	
409.73	7.95	
406.97	12.26	
407.48	16.57	
407.55	18.91	
407.49	20.00	

STERRI E RIPORTI	
S1	3.15 mq.
S2	0.86 mq.
Totale S:	
STABILIZZATO	4.01 mq.
D1	1.02 mq.
CEMENTATO	
E1	0.95 mq.
BASE	
F1	0.35 mq.
VEGETALE	
G1	2.08 mq.
GEORIGLIA 28KN/m	
C1	5.26 ml.
GRADONATURA	
D1	5.82 ml.
IDROSEMINA	
e1	7.98 ml.
USURA	
f1	4.27 ml.
BINDER	
g1	3.77 ml.

390.00  
 200  
 200

PROGRESSIVE TERRENO			
PARZIALI TERRENO			
QUOTE TERRENO			
PROGRESSIVE PROGETTO			
PARZIALI PROGETTO			
QUOTE PROGETTO			

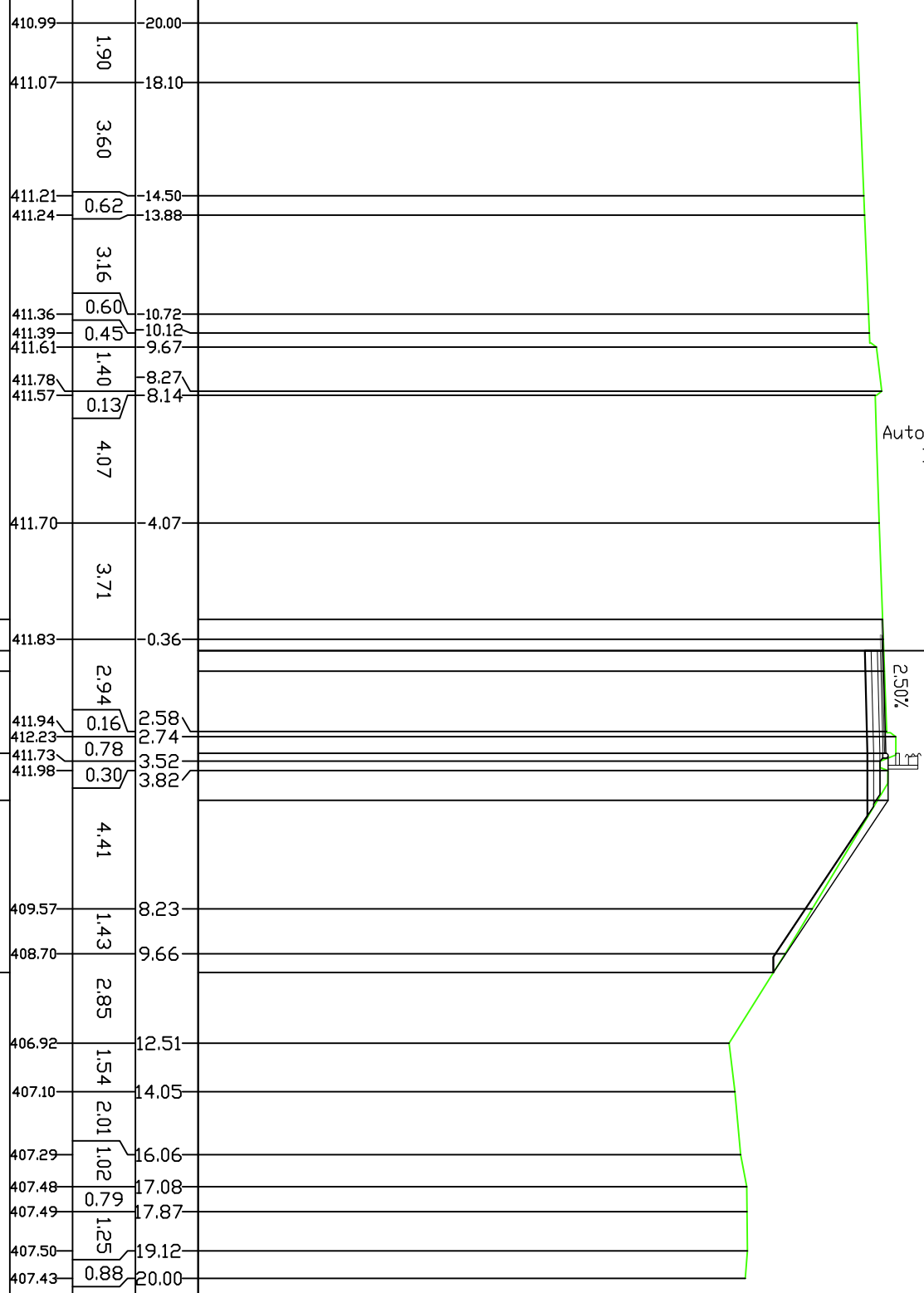

410.99	20.00	1.90	
411.07	18.10	3.60	
411.21	14.50	0.62	
411.24	13.88	3.16	
411.36	10.72	0.60	
411.39	10.12	0.45	
411.61	9.67	1.40	
411.78	8.27	0.13	
411.57	8.14	4.07	
411.70	4.07	3.71	
411.81	1.00	1.00	
411.83	0.00	0.65	
411.85	0.65	2.62	
411.91	3.27	1.50	
411.98	4.77	5.48	
409.57	8.23	1.43	
408.70	9.66	2.85	
406.92	12.51	1.54	
407.10	14.05	2.01	
407.29	16.06	1.02	
407.48	17.08	0.76	
407.49	17.87	1.25	
407.50	19.12	0.88	
407.43	20.00		



STERRI E RIPORTI	
S1	3,11 mq.
S2	0,01 mq.
Totale S:	3,12 mq.
R1	3,64 mq.
SCOTICO	
A1	0,60 mq.
BONIFICA	
B1	0,90 mq.
BONIFICA PROFONDA	
C1	1,18 mq.
STABILIZZATO	
D1	1,23 mq.
CEMENTATO	
E1	1,14 mq.
BASE	
F1	0,45 mq.
VEGETALE	
G1	2,67 mq.
TNT	
a1	4,00 ml.
GEDRIGLIA 10KN/m	
b1	2,99 ml.
GEDRIGLIA 28KN/m	
c1	6,27 ml.
GRADONATURA	
d1	7,89 ml.
IPROSEMINA	
e1	9,96 ml.
USURA	
f1	5,28 ml.
BINDER	
g1	4,78 ml.

390.00  
 200  
 200

PROGRESSIVE TERRENO			
PARZIALI TERRENO			
QUOTE TERRENO			
PROGRESSIVE PROGETTO			
PARZIALI PROGETTO			
QUOTE PROGETTO			

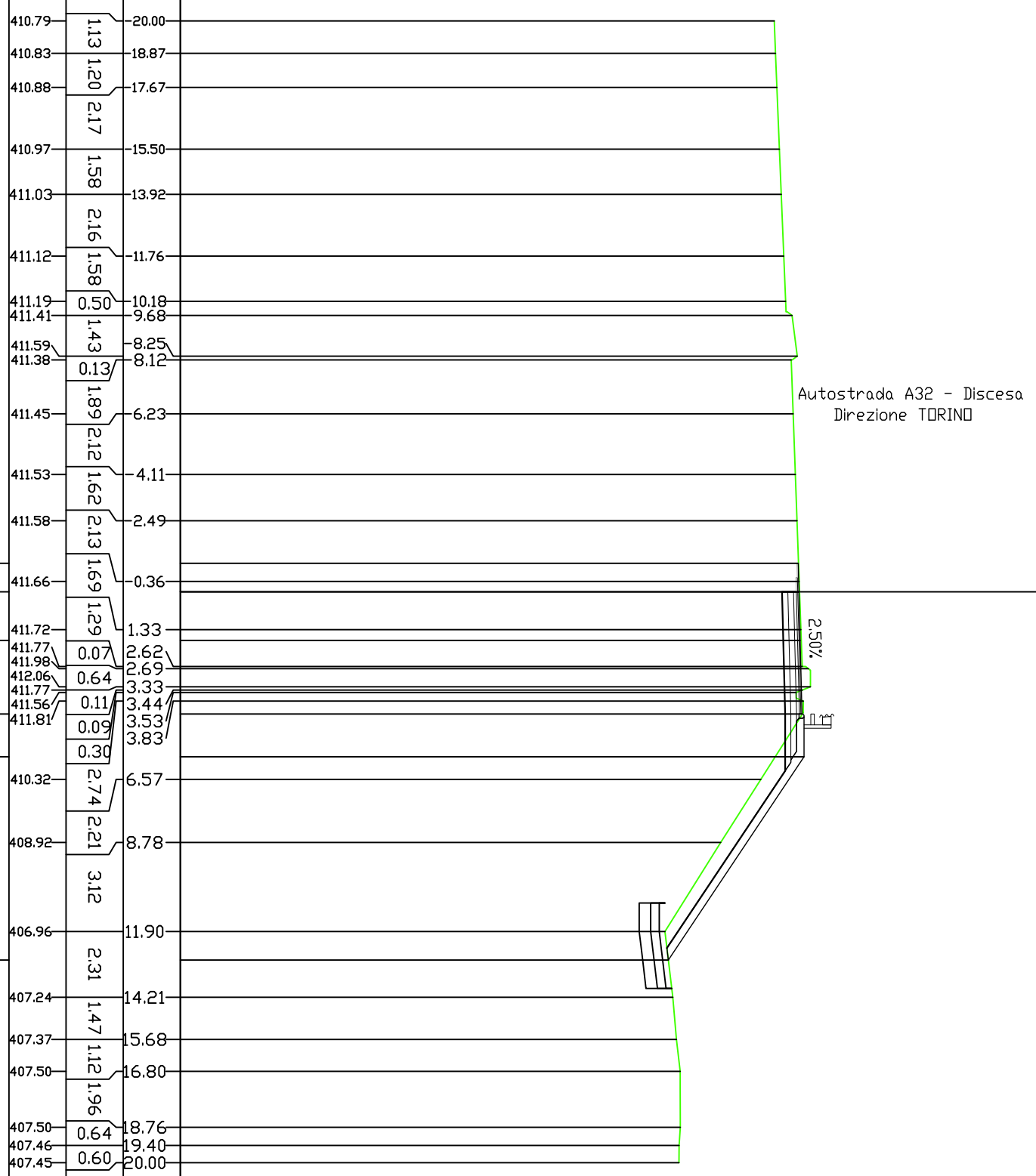

STERRI E RIPORTI	
S1	2,98 mq.
R1	0,00 mq.
R2	0,01 mq.
R3	11,85 mq.
Totale R:	
SCOTTICU	11,86 mq.
A1	0,93 mq.
BONIFICA	
B1	1,40 mq.
BONIFICA PROFONDA	
C1	1,88 mq.
STABILIZZATO	
D1	1,44 mq.
CEMENTATO	
E1	1,36 mq.
BASE	
F1	0,55 mq.
VEGETALE	
G1	2,67 mq.
TNT	
a1	5,76 ml.
GEOGRIGLIA 10KN/m	
b1	4,67 ml.
GEOGRIGLIA 28KN/m	
c1	7,31 ml.
GRADONATURA	
d1	7,84 ml.
IDROSEMINA	
e1	10,05 ml.
USURA	
f1	6,32 ml.
BINDER	
g1	5,82 ml.

390.00  
 200  
 200

PROGRESSIVE TERRENO	PROGRESSIVE	QUOTE TERRENO	PARZIALI TERRENO	QUOTE PROGETTO	PARZIALI PROGETTO
410.60	20.00		2.33		
410.70	17.67		1.47		
410.76	16.20		2.29		
410.85	13.91		3.71		
411.00	10.20		0.49		
411.23	9.71		1.43		
411.41	8.28		0.13		
411.20	8.15		0.13		
411.22	7.35		0.80		
			3.24		
411.33	4.11		3.75		
411.45	1.00		1.00		
411.47	0.00		2.78		
411.54	2.78		2.54		
411.61	5.32		1.50		
411.68	6.82		7.19		
406.59	10.93		0.39		
406.31	11.32		1.20		
406.56	12.52		1.85		
406.96	14.37		0.90		
407.17	15.27		1.26		
407.39	16.53		2.08		
407.40	18.61		0.60		
407.31	19.29		0.71		
407.31	20.00				

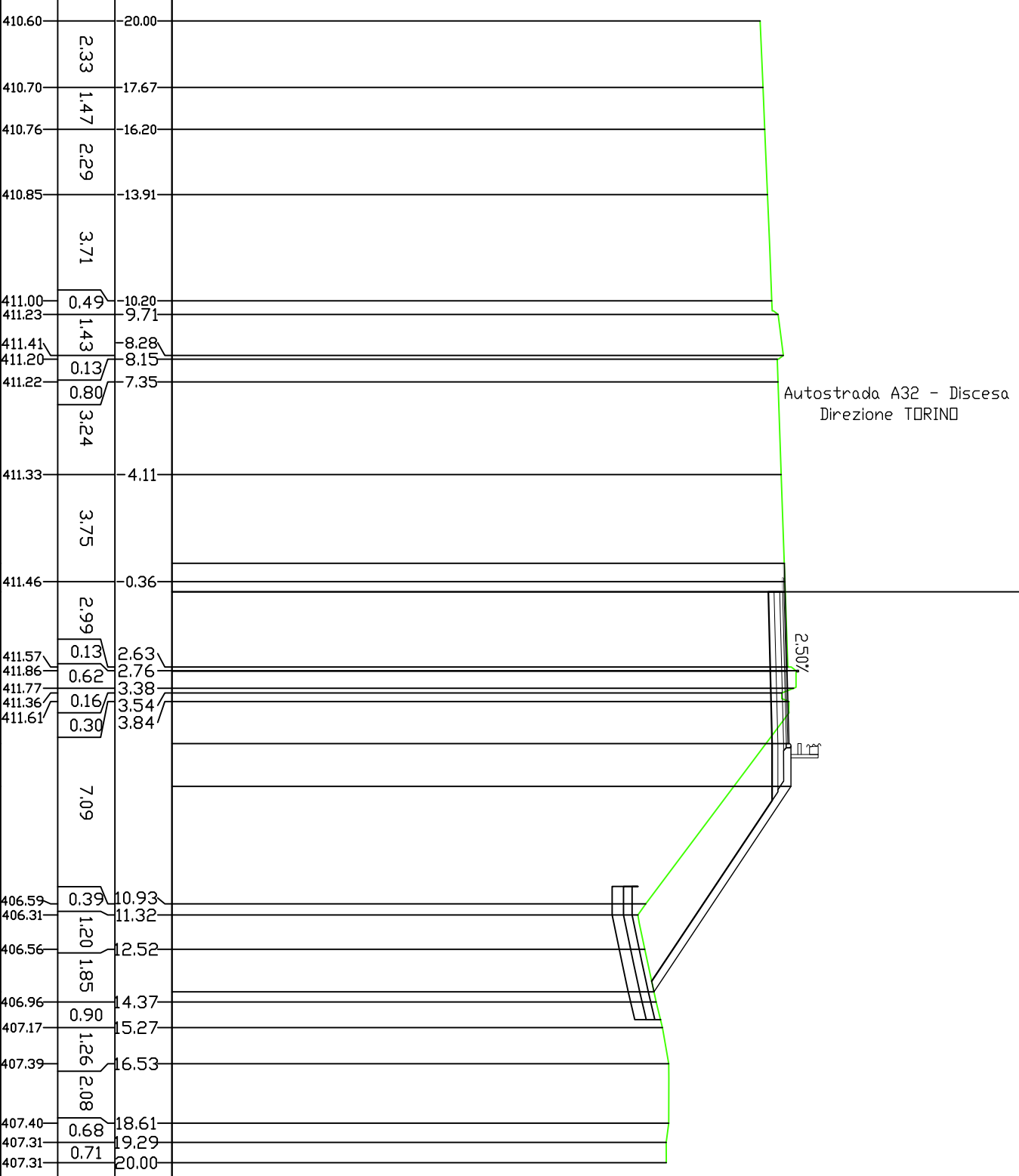

Autostrada A32 - Discesa  
 Direzione TORINO

STERRI E RIPORTI	
S1	2,85 mq.
S2	0,00 mq.
S3	0,00 mq.
Totale S:	2,85 mq.
R1	1324 mq.
SCOTICU	1,06 mq.
A1	1,06 mq.
BONIFICA	1,58 mq.
B1	1,58 mq.
BONIFICA PROFONDA	2,10 mq.
C1	2,10 mq.
STABILIZZATO	1,60 mq.
D1	1,60 mq.
CEMENTATO	1,53 mq.
E1	1,53 mq.
BASE	0,63 mq.
F1	0,63 mq.
VEGETALE	2,48 mq.
G1	2,48 mq.
TNT	6,33 ml.
a1	6,33 ml.
GEOGRIGLIA 10KN/m	5,27 ml.
b1	5,27 ml.
GEOGRIGLIA 28KN/m	8,14 ml.
c1	8,14 ml.
GRADONATURA	7,26 ml.
d1	7,26 ml.
IDROSEMINA	9,30 ml.
e1	9,30 ml.
USURA	7,14 ml.
f1	7,14 ml.
BINDER	6,64 ml.
g1	6,64 ml.

390.00  
 200  
 200

PROGRESSIVE TERRENO			410.37	20.00					
PARZIALI TERRENO			410.46	17.75		2,25	3,74		
QUOTE TERRENO			410.61	14.01		3,75			
PROGRESSIVE PROGETTO			410.77	10.26	0.47				
PARZIALI PROGETTO			411.00	9.79	1.39				
QUOTE PROGETTO			411.15	8.40	0.13	3.63			
PROGRESSIVE TERRENO			410.94	8.27					
PARZIALI TERRENO			411.07	4.64			3,77		
QUOTE TERRENO			411.23	0.87					
PROGRESSIVE PROGETTO			411.25	0.00					
PARZIALI PROGETTO			411.31	2.27	0.46				
QUOTE PROGETTO			411.34	3.50	0.77	3.64			
PROGRESSIVE TERRENO			411.36	4.19	0.69				
PARZIALI TERRENO			411.41	6.24	2.05				
QUOTE TERRENO			411.48	7.64			2,50		
PROGRESSIVE PROGETTO			406.56	10.95					
PARZIALI PROGETTO			407.10	14.23					
QUOTE PROGETTO			407.34	16.28					
			407.37	17.76					
			407.37	18.54					
			407.35	20.00					
			407.10	14.21					
							6,57		

Autostrada A32 - Discesa  
 Direzione TORINO

2.50%

3.00

PROFILO BA-SV\_MM4quint

SEZIONE 6

PROGRESSIVA 100.00

STERRI E RIPORTI	2,79 mq.
S1	0,00 mq.
R1	0,00 mq.
R2	12,38 mq.
R3	12,38 mq.
Totale R:	108 mq.
SCOTTICI	1,62 mq.
A1	1,62 mq.
BONIFICA	2,16 mq.
B1	2,16 mq.
BONIFICA PROFONDA	1,62 mq.
C1	1,62 mq.
STABILIZZATO	1,54 mq.
D1	0,64 mq.
CEMENTATO	2,40 mq.
E1	6,42 ml.
BASE	5,41 ml.
F1	8,24 ml.
VEGETALE	6,76 ml.
G1	8,95 ml.
TNT	7,25 ml.
a1	6,75 ml.
GEDRIGLIA 10KN/m	
b1	
GEDRIGLIA 28KN/m	
c1	
GRADONATURA	
d1	
DROSEMINA	
e1	
USURA	
f1	
BINDER	
g1	

390.00  
200  
200

PROGRESSIVE TERRENO		410.18	20.00
PARZIALI TERRENO		410.27	17.67
QUOTE TERRENO		410.42	13.92
PROGRESSIVE PROGETTO		410.56	10.18
PARZIALI PROGETTO		410.78	9.70
QUOTE PROGETTO		410.96	8.30
PROGRESSIVE TERRENO		410.75	8.17
PARZIALI TERRENO		410.77	7.46
QUOTE TERRENO		410.88	4.11
PROGRESSIVE PROGETTO		411.00	1.00
PARZIALI PROGETTO		411.03	0.00
QUOTE PROGETTO		411.08	0.13
PROGRESSIVE TERRENO		411.37	2.60
PARZIALI TERRENO		411.32	2.73
QUOTE TERRENO		410.87	3.34
PROGRESSIVE PROGETTO		411.12	3.51
PARZIALI PROGETTO		411.19	3.81
QUOTE PROGETTO		410.87	4.58
PROGRESSIVE TERRENO		406.74	10.61
PARZIALI TERRENO		407.07	14.11
QUOTE TERRENO		407.18	15.40
PROGRESSIVE PROGETTO		407.28	17.70
PARZIALI PROGETTO		407.23	18.86
QUOTE PROGETTO		407.24	20.00

Autostrada A32 - Discesa  
Direzione TORINO

2.50%

2.50%

STERRI E RIPORTI	
S1	2,82 mq.
S2	0,00 mq.
S3	0,00 mq.
Totale S:	2,82 mq.
R1	11,67 mq.
SCOTICU	
A1	1,06 mq.
BONIFICA	
B1	1,57 mq.
BONIFICA PROFONDA	
C1	2,10 mq.
STABILIZZATO	
D1	1,61 mq.
CEMENTATO	
E1	1,56 mq.
BASE	
F1	0,64 mq.
VEGETALE	
G1	2,30 mq.
TNT	
a1	6,27 ml.
GEDRIGLIA 10KN/m	
b1	5,25 ml.
GEDRIGLIA 28KN/m	
c1	8,24 ml.
GRADONATURA	
d1	6,63 ml.
DROSEMINA	
e1	8,67 ml.
USURA	
f1	7,25 ml.
BINDER	
g1	6,75 ml.

390.00  
 200  
 200

PROGRESSIVE TERRENO	409.94	410.03	410.06	410.18	410.21	410.33	410.56	410.74	410.53	410.58	410.66	410.70	410.79	410.82	410.81	410.88	411.17	411.01	410.67	410.92	410.20	410.97	411.04	406.67	406.80	406.97	407.10	407.21	407.20	407.21	407.12	407.12			
QUOTE TERRENO	20.00	17.67	16.98	13.92	13.23	10.18	9.73	8.27	8.14	6.76	4.11	2.98	1.00	0.00	0.54	2.60	2.73	3.37	3.51	3.81	5.25	6.25	7.75	10.55	12.27	13.29	14.96	15.73	16.87	17.59	18.43	20.00			
PARZIALI TERRENO	2.33	0.69	3.06	0.69	3.05	0.45	1.46	0.13	1.38	2.65	1.13	2.62	0.90	2.06	0.13	0.13	0.64	0.14	0.30	1.44	5.30	1.72	1.02	1.67	0.77	1.14	0.72	0.84	1.57						
PROGRESSIVE PROGETTO													1.00	3.75								2.50	1.50		6.05										
PARZIALI PROGETTO													1.00	3.75								2.50	1.50		6.05										
QUOTE PROGETTO													1.00	3.75								2.50	1.50		6.05										

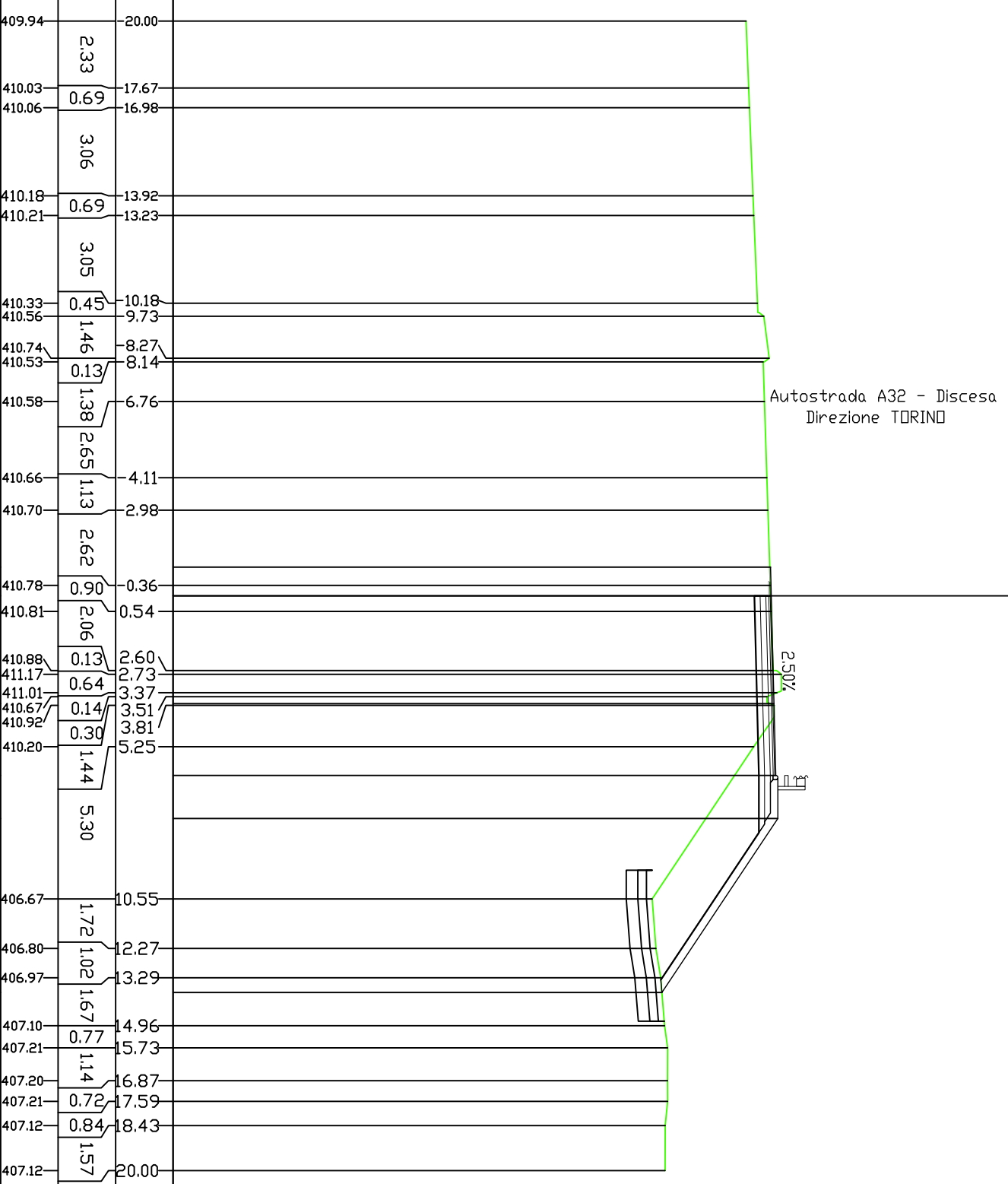

STERRI E RIPORTI	
S1	2,84 mq.
R1	0,00 mq.
R2	11,08 mq.
Totale R:	11,08 mq.
SCOTICCI	
A1	1,03 mq.
BONIFICA	
B1	1,54 mq.
BONIFICA PROFONDA	
C1	2,05 mq.
STABILIZZATO	
D1	1,61 mq.
CEMENTATO	
E1	1,55 mq.
BASE	
F1	0,66 mq.
VEGETALE	
G1	2,33 mq.
TNT	
a1	6,13 ml.
GEDRIGLIA 10KN/m	
b1	5,13 ml.
GEDRIGLIA 28KN/m	
c1	8,24 ml.
GRADONATURA	
d1	6,69 ml.
IDROSEMINA	
e1	8,68 ml.
USURA	
f1	7,25 ml.
BINDER	
g1	6,75 ml.

390.00  
 200  
 200

PROGRESSIVE TERRENO	QUOTE TERRENO	PROGRESSIVE TERRENO	QUOTE TERRENO	PROGRESSIVE TERRENO	QUOTE TERRENO
409.77	2.00	409.85	3.65	409.99	3.71
410.13	0.62	410.15	0.16	410.36	1.43
410.15	0.16	410.36	1.43	410.56	0.13
410.36	1.43	410.56	0.13	410.62	3.26
410.56	0.13	410.62	3.26	410.46	0.79
410.62	3.26	410.46	0.79	410.49	0.81
410.65	0.50	410.52	3.44	410.62	2.94
410.65	0.18	410.62	0.68	410.65	0.68
410.72	2.49	410.72	0.13	410.72	0.13
411.01	2.62	411.01	0.62	411.01	0.62
410.90	3.24	410.90	0.16	410.90	0.16
410.51	3.40	410.51	0.30	410.51	0.30
410.76	3.70	410.76	0.30	410.76	0.30
409.98	5.30	409.98	1.60	409.98	1.60
410.80	6.25	410.80	2.29	410.80	2.29
410.87	7.75	410.87	3.08	410.87	3.08
406.63	10.67	406.63	1.69	406.63	1.69
406.73	12.36	406.73	2.35	406.73	2.35
406.84	13.81	406.84	0.91	406.84	0.91
406.90	14.71	406.90	0.92	406.90	0.92
407.06	15.62	407.06	0.98	407.06	0.98
407.05	16.54	407.05	1.49	407.05	1.49
407.06	17.52	407.06	0.99	407.06	0.99
406.89	19.01	406.89		406.89	
406.90	20.00	406.90		406.90	

Autostrada A32 - Discesa  
 Direzione TORINO

2.50%



STERRI E RIPORTI	
R1	0.00 mq.
R2	9.92 mq.
Totale R	9.92 mq.
SCOTICD	
A1	0.97 mq.
BONIFICA	
B1	1.45 mq.
BONIFICA PROFONDA	
C1	1.93 mq.
STABILIZZATO	
D1	1.71 mq.
CEMENTATO	
E1	1.62 mq.
BASE	
F1	0.69 mq.
VEGETALE	
G1	2.23 mq.
TNT	
a1	5.82 ml.
GEDRIGLIA 10KN/m	
b1	4.82 ml.
GEDRIGLIA 28KN/m	
c1	8.67 ml.
GRADONATURA	
d1	6.85 ml.
IDROSEMINA	
e1	8.46 ml.
USURA	
f1	7.68 ml.
BINDER	
g1	7.18 ml.

390.00  
 200  
 200

PROGRESSIVE TERRENO	QUOTE TERRENO	PROGRESSIVE TERRENO	QUOTE TERRENO	PROGRESSIVE TERRENO	QUOTE TERRENO	PROGRESSIVE TERRENO	QUOTE TERRENO
409.59	1.76	409.66	3.82	409.81	3.68	409.96	0.58
410.19	1.42	410.38	1.42	410.57	3.75	410.76	1.91
410.84	0.13	411.03	0.13	411.22	0.16	411.41	0.16
411.57	0.85	411.76	0.85	411.95	0.30	412.14	0.30
412.48	3.21	412.67	3.21	412.86	3.21	413.05	3.21
413.36	0.63	413.55	0.63	413.74	0.63	413.93	0.63
414.23	3.12	414.42	3.12	414.61	3.12	414.80	3.12
415.12	1.00	415.31	1.00	415.50	1.00	415.69	1.00
415.96	0.43	416.15	0.43	416.34	0.43	416.53	0.43
416.72	3.00	416.91	3.00	417.10	3.00	417.29	3.00
417.58	0.13	417.77	0.13	417.96	0.13	418.15	0.13
418.34	0.62	418.53	0.62	418.72	0.62	418.91	0.62
419.10	2.95	419.29	2.95	419.48	2.95	419.67	2.95
419.86	3.11	420.05	3.11	420.24	3.11	420.43	3.11
420.62	4.13	420.81	4.13	421.00	4.13	421.19	4.13
421.57	6.25	421.76	6.25	421.95	6.25	422.14	6.25
422.52	7.75	422.71	7.75	422.90	7.75	423.09	7.75
423.46	1.35	423.65	1.35	423.84	1.35	424.03	1.35
424.38	1.91	424.57	1.91	424.76	1.91	424.95	1.91
425.47	1.91	425.66	1.91	425.85	1.91	426.04	1.91
426.53	2.32	426.72	2.32	426.91	2.32	427.10	2.32
427.42	2.23	427.61	2.23	427.80	2.23	427.99	2.23
428.28	1.18	428.47	1.18	428.66	1.18	428.85	1.18
429.03	0.63	429.22	0.63	429.41	0.63	429.60	0.63
429.96	0.63	430.15	0.63	430.34	0.63	430.53	0.63
430.88	0.63	431.07	0.63	431.26	0.63	431.45	0.63
431.80	0.63	432.00	0.63	432.20	0.63	432.40	0.63

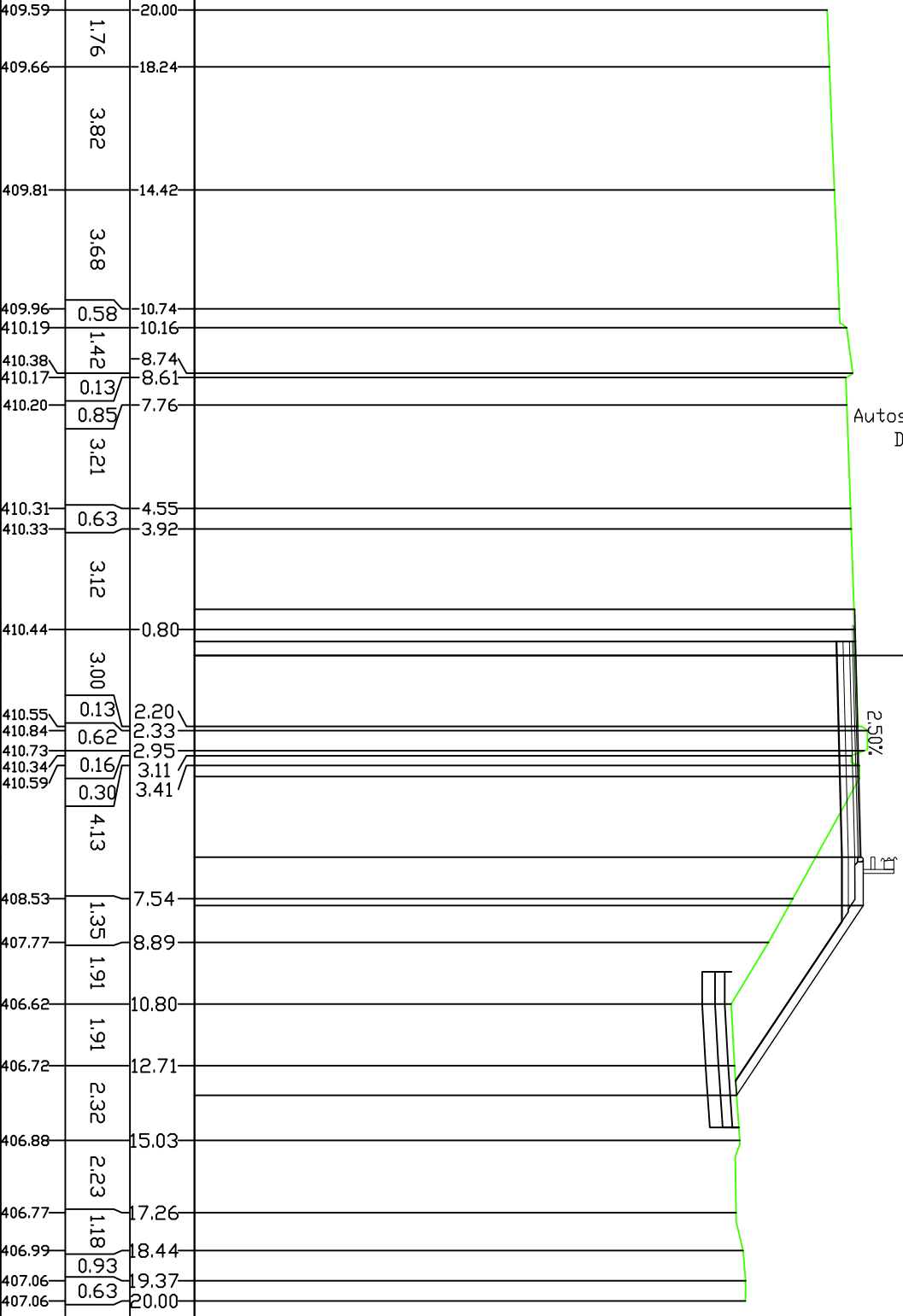

Autostrada A32 - Discesa  
 Direzione TORINO

2.50%

PROFILO BA-SV\_MM4quint

SEZIONE 10

PROGRESSIVA 175.00

STERRI E RIPORTI	
S1	2,60 mq.
S2	0,39 mq.
Totale S1	2,99 mq.
R1	0,06 mq.
R2	2,83 mq.
Totale R1	2,89 mq.
STABILIZZATO	
D1	1,61 mq.
CEMENTATO	
E1	1,55 mq.
BASE	
F1	0,76 mq.
GEORIGLIA 28KN/m	
C1	7,53 ml.
GRADINATURA	
d1	7,39 ml.
USURA	
f1	8,53 ml.
BINDER	
g1	8,03 ml.

390.00  
 200  
 200

PROGRESSIVE TERRENO			
PARZIALI TERRENO			
QUOTE TERRENO			
PROGRESSIVE PROGETTO			
PARZIALI PROGETTO			
QUOTE PROGETTO			

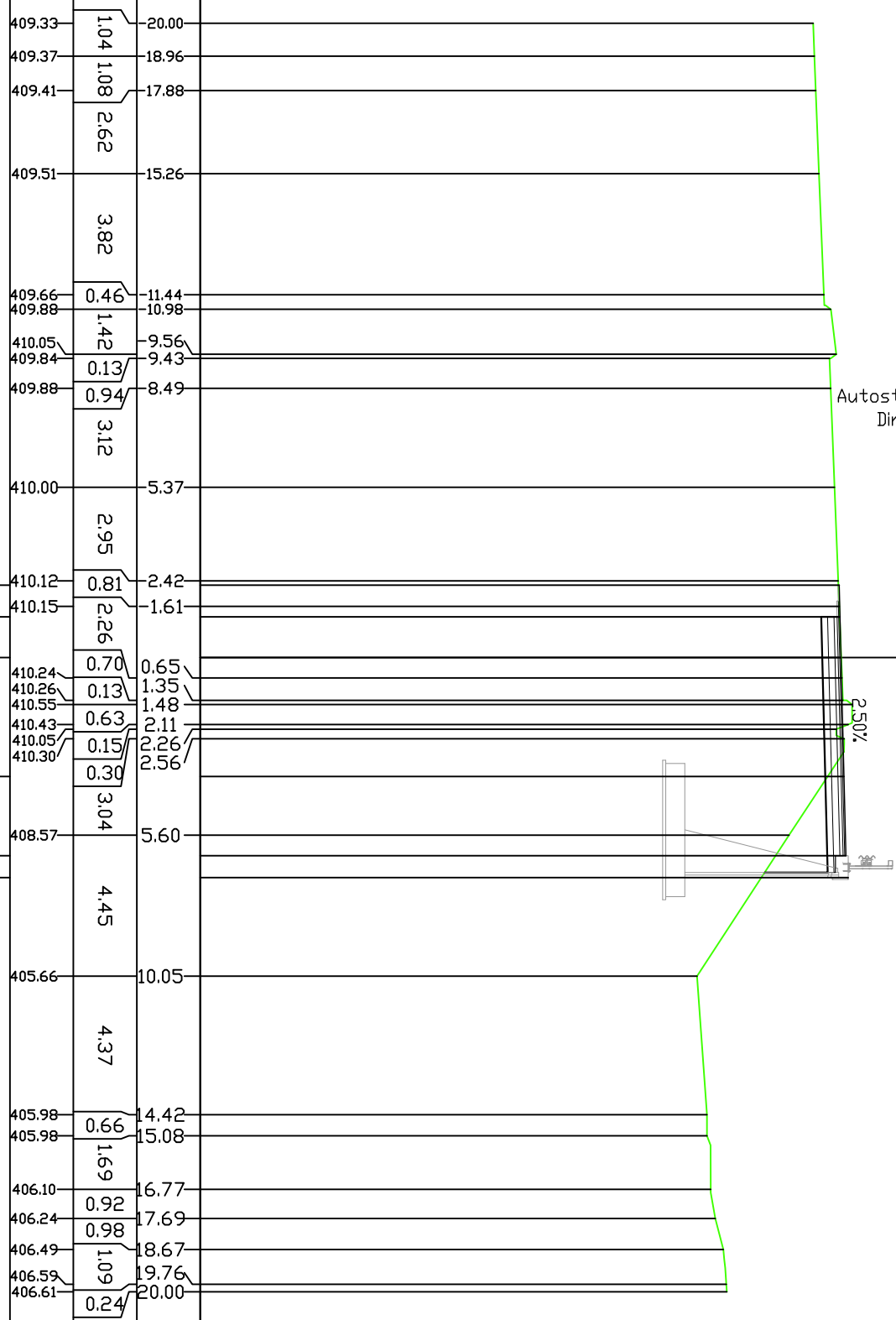

409.33	1.04	20.00
409.37	1.08	18.96
409.41	2.62	17.88
409.51	3.82	15.26
409.66	0.49	11.44
409.88	1.42	10.98
410.05	0.13	9.56
409.84	0.94	9.43
409.88	3.12	8.49
410.00	2.95	5.37
410.15	1.00	2.42
410.17	1.28	1.61
410.20	0.00	0.65
410.24	0.13	1.35
410.26	0.63	1.48
410.55	0.15	2.11
410.43	0.30	2.26
410.05	3.04	2.56
410.30	4.45	5.60
410.36	6.25	
410.43	6.94	
405.66	4.37	10.05
405.98	0.66	14.42
405.98	1.69	15.08
406.10	0.92	16.77
406.24	0.98	17.69
406.49	1.09	18.67
406.59	0.24	19.76
406.61		20.00



STERRI E RIPORTI	
S1	2,79 mq.
S2	0,24 mq.
Totale S1	3,03 mq.
R1	0,39 mq.
R2	4,72 mq.
Totale R1	5,11 mq.
STABILIZZATO	1,84 mq.
D1	1,84 mq.
CEMENTATO	1,74 mq.
E1	1,74 mq.
BASE	0,86 mq.
F1	0,86 mq.
GEDRIGLIA 28KN/m	8,67 ml.
cl	8,67 ml.
GRADONATURA	7,91 ml.
dl	7,91 ml.
USURA	9,67 ml.
f1	9,67 ml.
BINDER	9,17 ml.
g1	9,17 ml.

390.00  
 ▼  
 200  
 200

PROGRESSIVE TERRENO			
PARZIALI TERRENO			
QUOTE TERRENO			
PROGRESSIVE PROGETTO			
PARZIALI PROGETTO			
QUOTE PROGETTO			

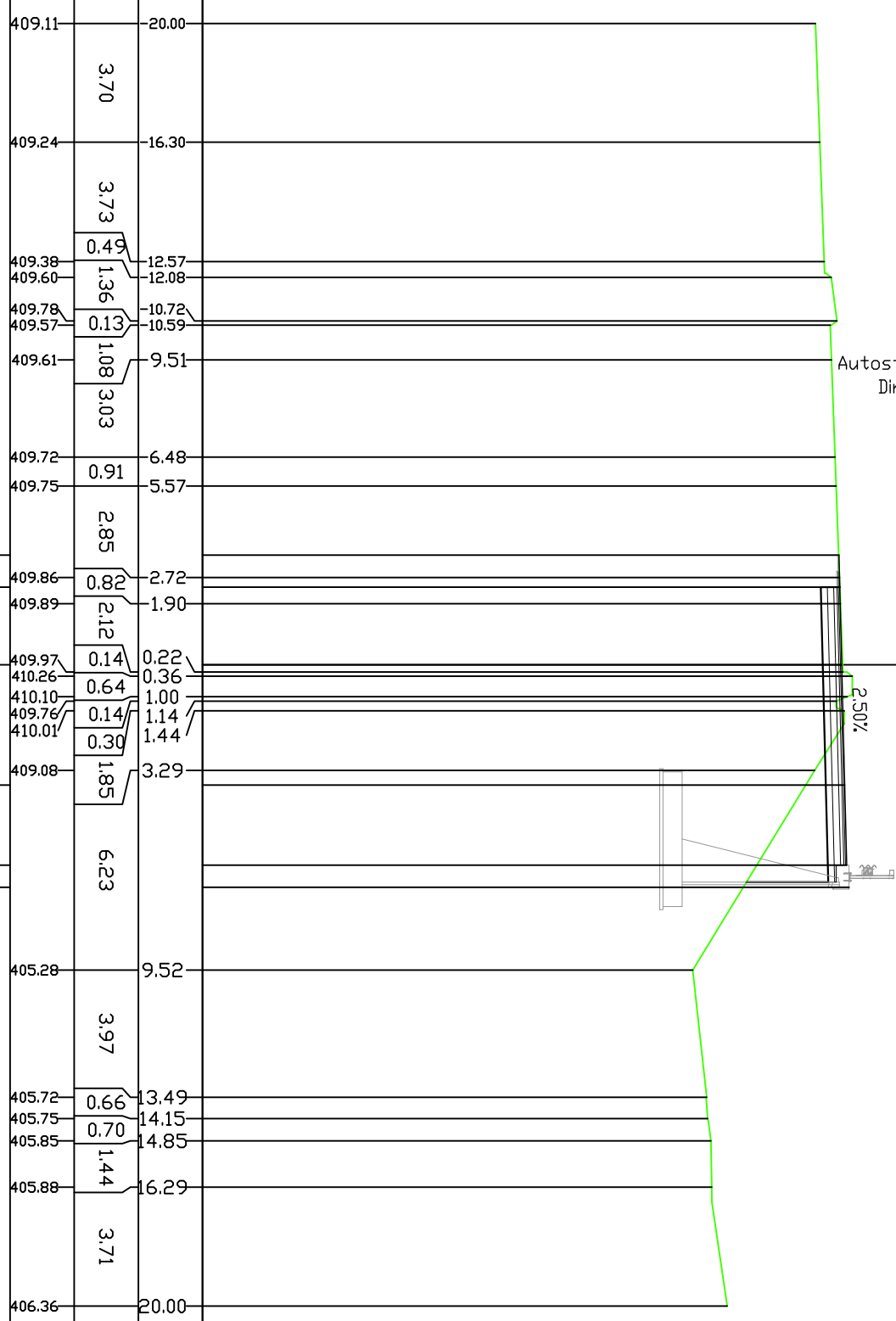

Autostrada A32 - Discesa  
 Direzione TORINO

2.50%

STERRI E RIPORTI	
S1	2,83 mq.
S2	0,32 mq.
Totale S1	3,15 mq.
R1	0,23 mq.
R2	7,36 mq.
Totale R1	7,59 mq.
STABILIZZATO	
D1	2,03 mq.
CEMENTATO	
E1	1,96 mq.
BASE	
F1	0,96 mq.
GEORIGLIA 28KN/m	
C1	9,59 ml.
GRADINATURA	
d1	7,40 ml.
USURA	
f1	10,59 ml.
BINDER	
g1	10,09 ml.

390.00  
 200  
 200

PROGRESSIVE TERRENO			
PARZIALI TERRENO			
QUOTE TERRENO			
PROGRESSIVE PROGETTO			
PARZIALI PROGETTO			
QUOTE PROGETTO			

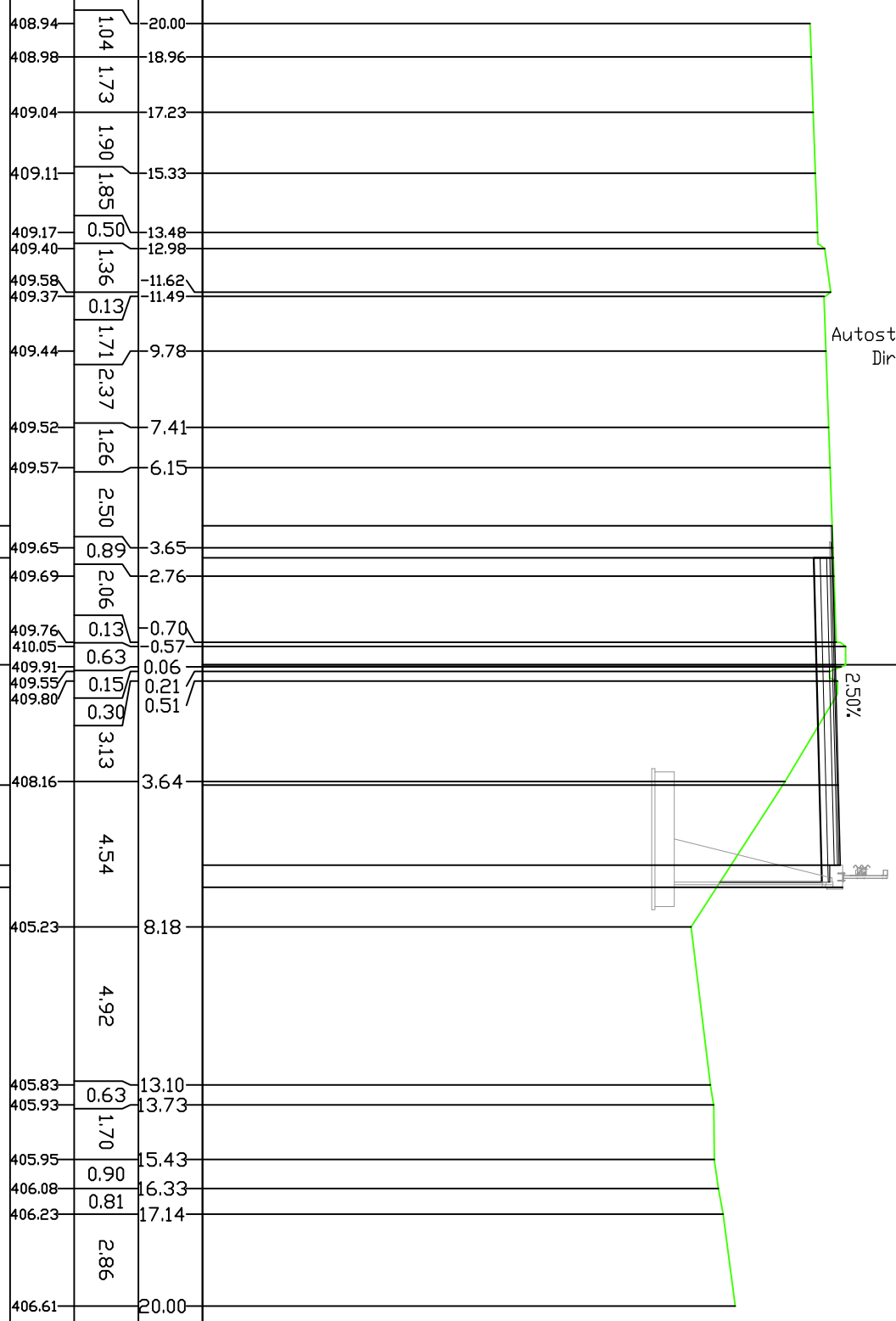

PROFILO BA-SV\_MM4quint

SEZIONE 13

PROGRESSIVA 236.04

STERRI E RIPORTI	
S1	3.03 mq.
S2	0.32 mq.
Totale S1	3.35 mq.
R1	0.36 mq.
R2	11.87 mq.
Totale R1	12.23 mq.
SCOTTICI	
A1	0.25 mq.
BDNIFICA	
B1	0.38 mq.
BDNIFICA PROFONDA	
C1	0.51 mq.
STABILIZZATO	
D1	2.20 mq.
CEMENTATO	
E1	2.15 mq.
BASE	
F1	1.04 mq.
TNT	
a1	2.27 ml.
GEDRIGLIA 10KN/m	
b1	1.27 ml.
GEDRIGLIA 28KN/m	
c1	10.48 ml.
GRADONATURA	
d1	6.96 ml.
USURA	
f1	11.48 ml.
BINDER	
g1	10.98 ml.

390.00  
 200  
 200

PROGRESSIVE TERRENO	PROGRESSIVE PROGETTO	QUOTE TERRENO	QUOTE PROGETTO	PARZIALI TERRENO	PARZIALI PROGETTO
408.79		20.00		1.87	
408.85		18.13		3.74	
408.98		14.39		0.48	
409.20		13.91		1.37	
409.40		12.54		0.13	
409.19		12.41		4.10	
409.34		8.31		3.75	
409.40	5.27				1.01
409.42	4.26				4.26
409.48	4.56			2.46	
409.57	2.10			0.58	
409.85	1.52			0.60	
409.88	0.92			0.17	
409.46	-0.75			0.69	
409.62	0.07			1.76	
408.43	1.69			4.94	
409.62	3.76			2.45	
409.69	6.21			0.69	
409.76	6.90			1.95	
405.28	8.58			3.61	
405.86	12.19			0.99	
405.93	13.18			1.13	
405.98	14.31			3.59	
406.54	17.90			1.03	
406.75	18.93			1.07	
406.75	20.00				

Autostrada A32 - Discesa  
 Direzione TORINO

2.50%

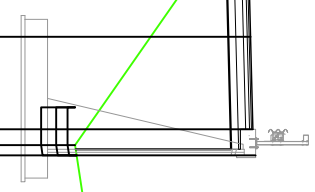

PROFILO BA-SV\_MM4quint

SEZIONE 14

PROGRESSIVA 255.52

STERRI E RIPORTI	
S1	3.15 mq.
S2	0.38 mq.
Totale S1	3.53 mq.
R1	0.33 mq.
R2	13.98 mq.
Totale R	14.31 mq.
SCOTICID	
A1	0.46 mq.
BDNIFICA	
B1	0.71 mq.
BDNIFICA PROFONDA	
C1	0.94 mq.
STABILIZZATO	
D1	2.30 mq.
CEMENTATO	
E1	2.23 mq.
BASE	
F1	1.10 mq.
TNT	
a1	3.36 ml.
GEDRIGLIA 10KN/m	
b1	2.35 ml.
GEDRIGLIA 28KN/m	
C1	10.95 ml.
GRADONATURA	
d1	6.29 ml.
USURA	
f1	11.95 ml.
BINDER	
g1	11.45 ml.

390.00  
 200  
 200

PROGRESSIVE TERRENO	QUOTE TERRENO	PROGRESSIVE TERRENO	QUOTE TERRENO
408.66	20.00	408.66	0.60
408.68	19.40	408.68	3.62
408.80	15.78	408.80	0.72
408.82	15.06	408.82	0.17
409.03	14.89	409.03	1.39
409.18	13.50	409.18	0.13
408.97	13.37	408.97	3.20
409.10	10.17	409.10	0.88
409.14	9.29	409.14	2.74
409.25	6.55	409.25	1.02
409.29	5.53	409.29	0.85
409.33	4.68	409.33	2.12
409.41	2.56	409.41	0.14
409.70	2.42	409.70	0.14
409.55	1.78	409.55	0.64
409.20	1.64	409.20	0.14
409.45	1.34	409.45	0.30
409.34	0.00	409.34	5.53
409.44	4.19	409.44	0.87
405.65	5.06	405.65	6.17
405.03		405.03	0.91
405.82	11.23	405.82	0.84
405.86	12.14	405.86	2.76
405.87	12.98	405.87	1.31
406.53	15.74	406.53	1.01
406.59	17.05	406.59	1.18
406.76	18.06	406.76	0.76
406.78	19.24	406.78	
406.78	20.00	406.78	

Autostrada A32 - Discesa  
 Direzione TORINO

2.50%

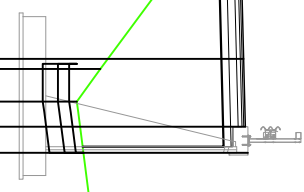

STERRI E RIPORTI	
S1	2,97 mq.
R1	0,35 mq.
R2	14,58 mq.
Totale R	14,93 mq.
SCOTICCI	
A1	0,76 mq.
BONIFICA	
B1	1,14 mq.
BONIFICA PROFONDA	
C1	1,53 mq.
STABILIZZATO	
D1	2,44 mq.
CEMENTATO	
E1	2,32 mq.
BASE	
F1	1,16 mq.
TNT	
a1	4,82 ml.
GEDGRIGLIA 10KN/m	
b1	3,82 ml.
GEDGRIGLIA 28KN/m	
c1	11,65 ml.
GRADONATURA	
d1	5,27 ml.
USURA	
f1	12,65 ml.
BINDER	
g1	12,15 ml.

390.00  
 200  
 200

PROGRESSIVE TERRENO			
PARZIALI TERRENO			
QUOTE TERRENO			
PROGRESSIVE PROGETTO			
PARZIALI PROGETTO			
QUOTE PROGETTO			

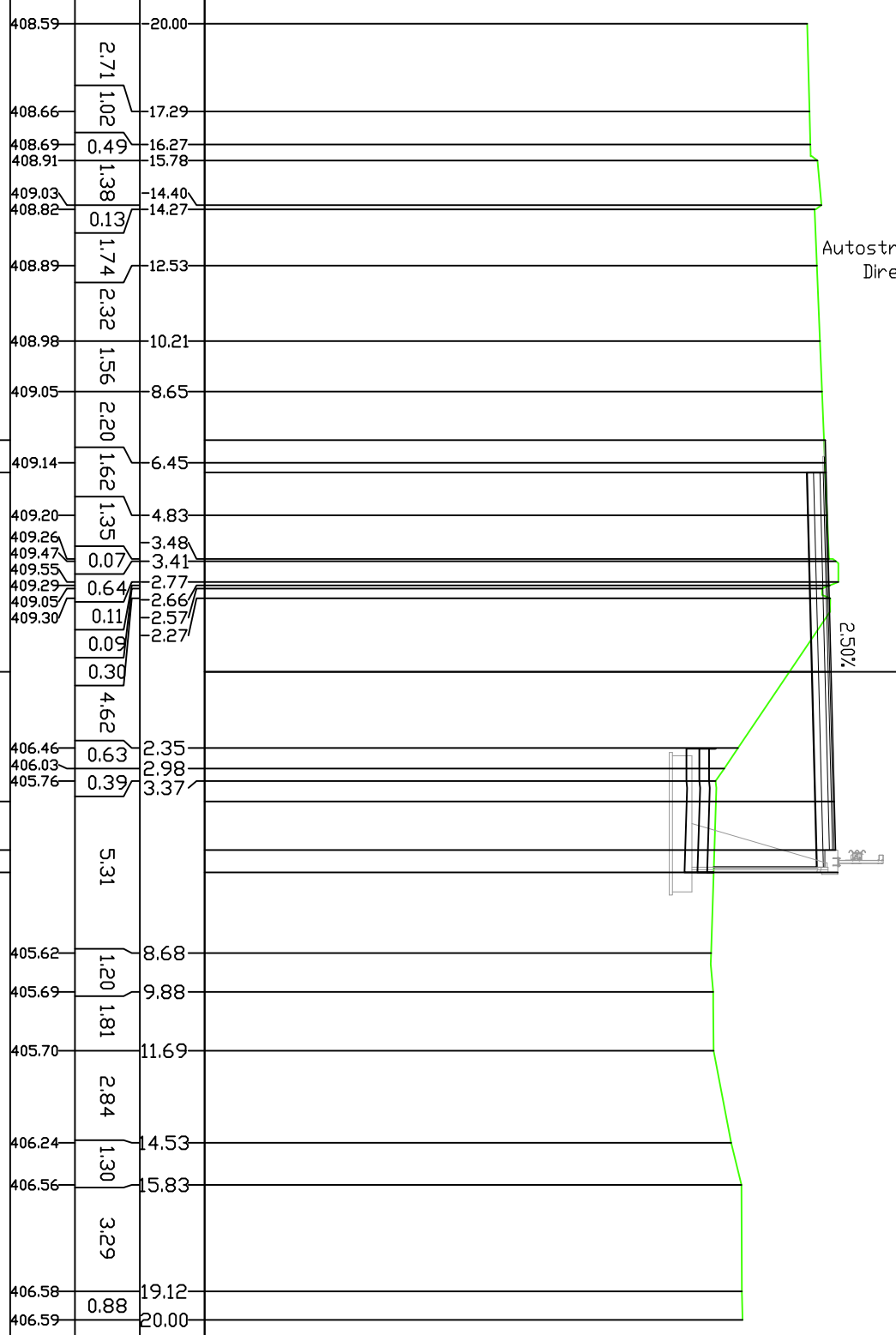

Autostrada A32 - Discesa  
 Direzione TORINO

2.50%

PROFILO BA-SV\_MM4quint

SEZIONE 16

PROGRESSIVA 300.00

STERRI E RIPORTI	0.14 mq.
S1	22.60 mq.
R1	
BONIFICA	2.56 mq.
B1	
STABILIZZATO	1.78 mq.
D1	
CEMENTATO	1.63 mq.
E1	
BASE	0.67 mq.
F1	
VEGETALE	0.60 mq.
G1	
TNT	
a1	10.87 ml.
GEDRIGLIA 10KN/m	
b1	8.55 ml.
GRADONATURA	
d1	6.71 ml.
IDROSEMINA	
e1	2.02 ml.
USURA	
f1	6.50 ml.
BINDER	
g1	6.50 ml.

390.00  
 ▼  
 PROGRESSIVE  
 TERRENO 200  
 200

PARZIALI TERRENO	408.49	1.29	20.00
	408.52	1.33	18.71
	408.56	0.50	17.38
	408.79	1.35	16.88
	408.90	1.35	15.53
	408.69	0.12	15.40
	408.78	2.36	13.04
	408.85	1.74	11.30
	408.92	1.90	9.40
	409.00	1.85	7.55
	409.06	1.41	6.14
	409.12	0.13	4.59
	409.41	0.08	4.46
	409.18	0.08	3.78
	408.91	0.11	3.67
	409.16	0.03	3.37
	409.15	0.51	3.01
	409.50	1.50	2.50
	409.43	1.50	1.00
	409.45	1.00	0.00
	406.91	1.45	0.19
	404.90	2.73	2.92
	409.55	4.00	4.00
	409.59	1.50	5.50
	409.66	0.69	6.19
	405.76	1.18	7.68
	405.78	1.50	8.86
	405.76	1.50	10.36
	406.13	0.80	12.81
	406.28	0.80	13.61
	406.61	2.63	16.24
	406.67	3.76	20.00

Autostrada A32 - Discesa  
 Direzione TORINO

2.50%

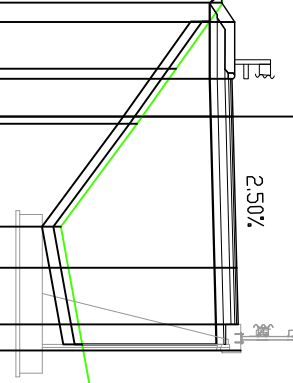

STERRI E RIPORTI	
R1	0,63 mq.
R2	28,33 mq.
Totale R	28,96 mq.
BONIFICA	
B1	2,86 mq.
STABILIZZATO	
D1	1,78 mq.
CEMENTATO	
E1	1,59 mq.
BASE	
F1	0,67 mq.
VEGETALE	
G1	0,75 mq.
TNT	
a1	11,73 ml.
b1	9,54 ml.
IPROSEMINA	2,90 ml.
e1	2,90 ml.
USURA	6,50 ml.
f1	6,50 ml.
BINDER	
g1	6,50 ml.

390.00  
 200  
 200

PROGRESSIVE TERRENO			
PARZIALI TERRENO			
QUOTE TERRENO			
PROGRESSIVE PROGETTO			
PARZIALI PROGETTO			
QUOTE PROGETTO			

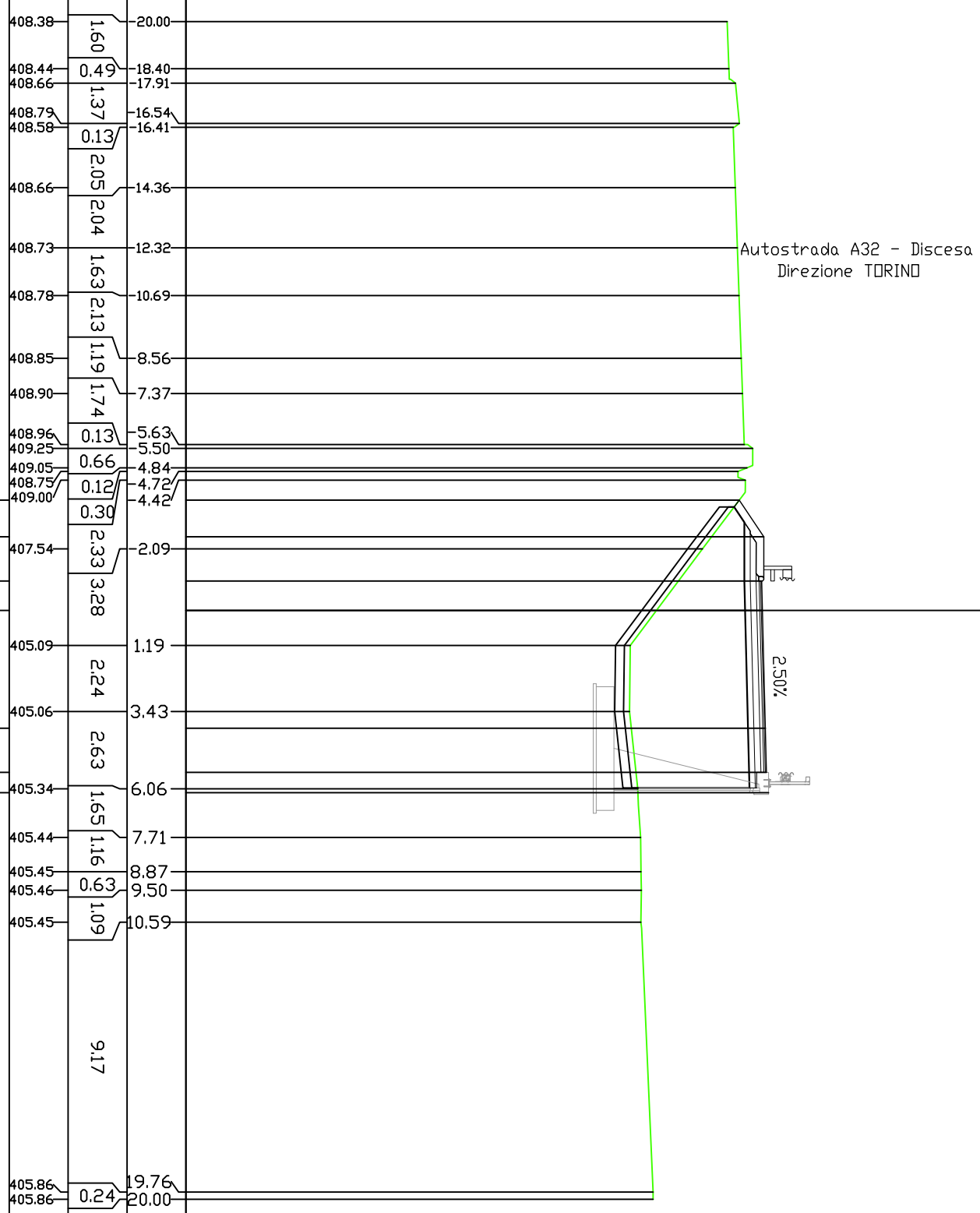

Autostrada A32 - Discesa  
 Direzione TORINO

2.50%

PROFILO BA-SV\_MM4quint

SEZIONE 18

PROGRESSIVA 350.00

STERRI E RIPORTI	
R1	33.51 mq.
BONIFICA	
B1	3.05 mq.
STABILIZZATO	
D1	1.78 mq.
CEMENTATO	
E1	1.62 mq.
BASE	
F1	0.67 mq.
VEGETALE	
G1	0.95 mq.
TNT	
a1	12.33 ml.
GEDRIGLIA 10KN/m	
b1	10.15 ml.
IDROSEMINA	
e1	3.64 ml.
USURA	
f1	6.50 ml.
BINDER	
g1	6.50 ml.

390.00  
 200  
 200

PROGRESSIVE TERRENO	QUOTE TERRENO	PROGRESSIVE TERRENO	QUOTE TERRENO
408.35	0.66	20.00	
408.37	0.50	19.34	
408.60	1.38	18.84	
408.70	0.13	17.46	
408.49	1.70	17.33	
408.56	2.37	15.63	
408.65	1.30	13.26	
408.70	2.45	11.96	
408.80	0.95	9.51	
408.83	1.98	8.56	
408.91	0.13	6.58	
409.20	0.64	6.45	
409.05	0.14	5.81	
408.70	0.30	5.67	
408.95	4.90	5.37	
408.51	4.36		
409.75	2.50		
409.68	1.00		
409.70	0.00		
404.93	1.22	1.96	
409.80	4.00		
409.84	1.50		
409.91	0.69		
405.53	1.00	6.90	
405.62	0.80	7.90	
405.63	0.95	8.70	
405.65	6.55	9.65	
405.50	16.20		
405.66	3.80	20.00	

Autostrada A32 - Discesa  
 Direzione TORINO

2.50%

1.86	1.50	1.00	4.00
------	------	------	------



STERRI E RIPORTI	35,93 mq.
R1 BONIFICA	3,21 mq.
B1 STABILIZZATO	1,76 mq.
D1 CEMENTATO	1,64 mq.
E1 BASE	0,66 mq.
F1 VEGETALE	1,13 mq.
G1 TNT	12,82 ml.
a1 GEDRIGLIA 10KN/m	10,72 ml.
b1 IDROSEMINA	4,32 ml.
e1 USURA	6,50 ml.
f1 BINDER	6,50 ml.
g1	

390.00  
 ▼  
 PROGRESSIVE TERRENO 200  
 200

PROGRESSIVE TERRENO	200
PARZIALI TERRENO	
QUOTE TERRENO	
PROGRESSIVE PROGETTO	
PARZIALI PROGETTO	
QUOTE PROGETTO	

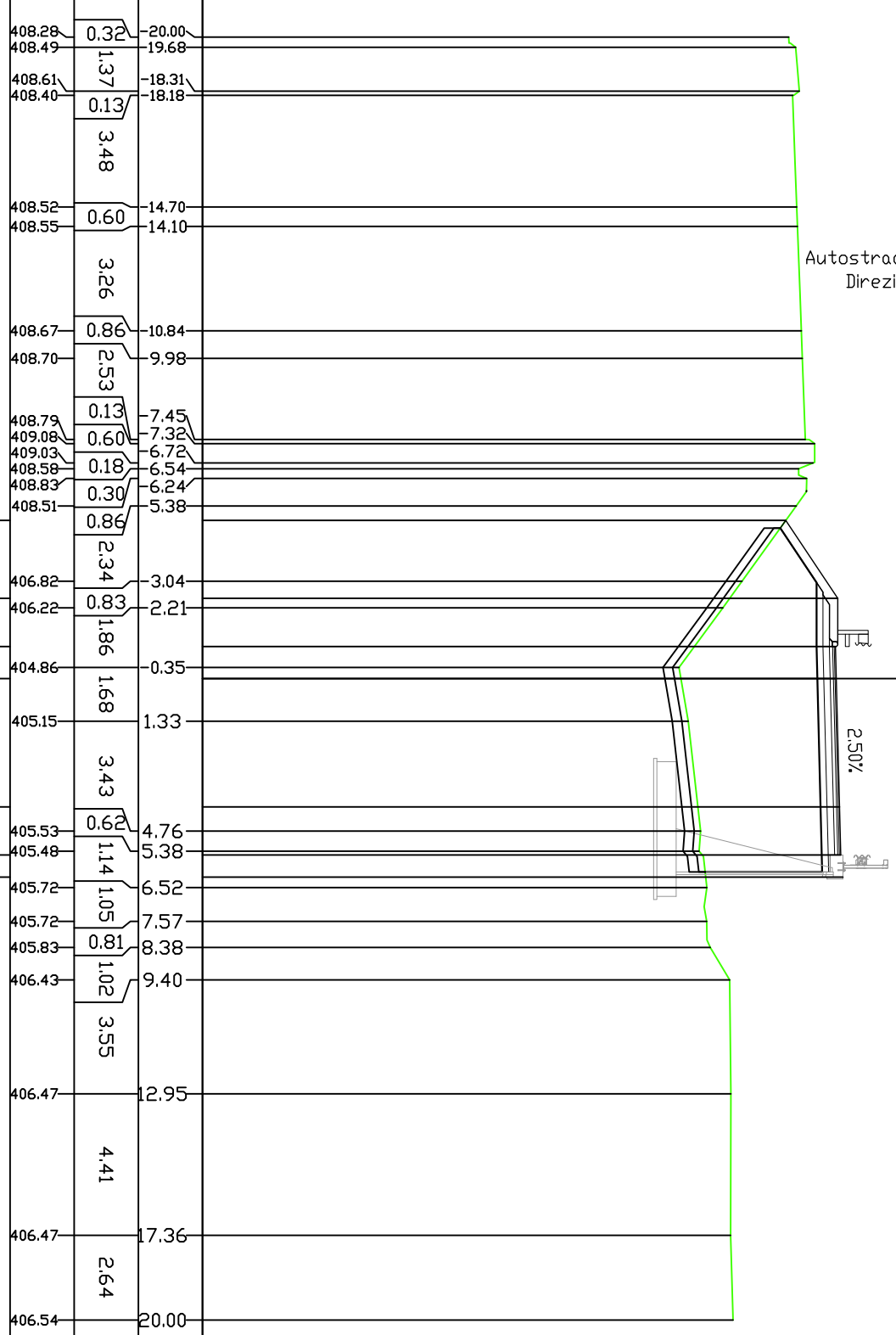

PROFILO BA-SV\_MM4quint

SEZIONE 20

PROGRESSIVA 400.00

STERRI E RIPORTI	
R1	36.11 mq.
BONIFICA	
B1	3.34 mq.
STABILIZZATO	
D1	1.78 mq.
CEMENTATO	
E1	1.64 mq.
BASE	
F1	0.66 mq.
VEGETALE	
G1	1.27 mq.
TNT	
a1	12.85 ml.
GEDRIGLIA 10KN/m	
b1	11.10 ml.
IDROSEMINA	
e1	4.78 ml.
USURA	
f1	6.50 ml.
BINDER	
g1	6.50 ml.

390.00  
 200  
 200

PROGRESSIVE TERRENO	QUOTE TERRENO	PROGRESSIVE TERRENO	QUOTE TERRENO
408.49	0.69	19.78	
408.49	0.13	19.10	
408.29		18.97	
	3.44		
408.41	0.65	15.53	
408.43		14.88	
408.45	0.61	14.27	
	3.14		
408.57	2.84	11.13	
	0.14		
408.67	0.60	8.29	
408.96	0.18	8.15	
408.89		7.55	
408.46	0.30	7.37	
408.71		7.07	
408.11	1.28	5.79	
407.78	5.32		
	2.35	3.44	
406.48	0.10	2.78	
406.04		1.61	
405.20	1.17		
409.58	1.00		
409.61	0.00		
	3.00		
405.31		1.39	
	2.10		
405.36	0.10	3.49	
405.37		4.14	
409.71	4.00		
	0.15		
409.75		5.67	
409.82	0.69	6.19	
	1.53		
405.44		7.09	
	1.42		
405.56		8.98	
406.45			
	4.87		
406.55		13.85	
	2.45		
406.57		16.30	
	3.70		
406.66		20.00	

Autostrada A32 - Discesa  
 Direzione TORINO

2.50%

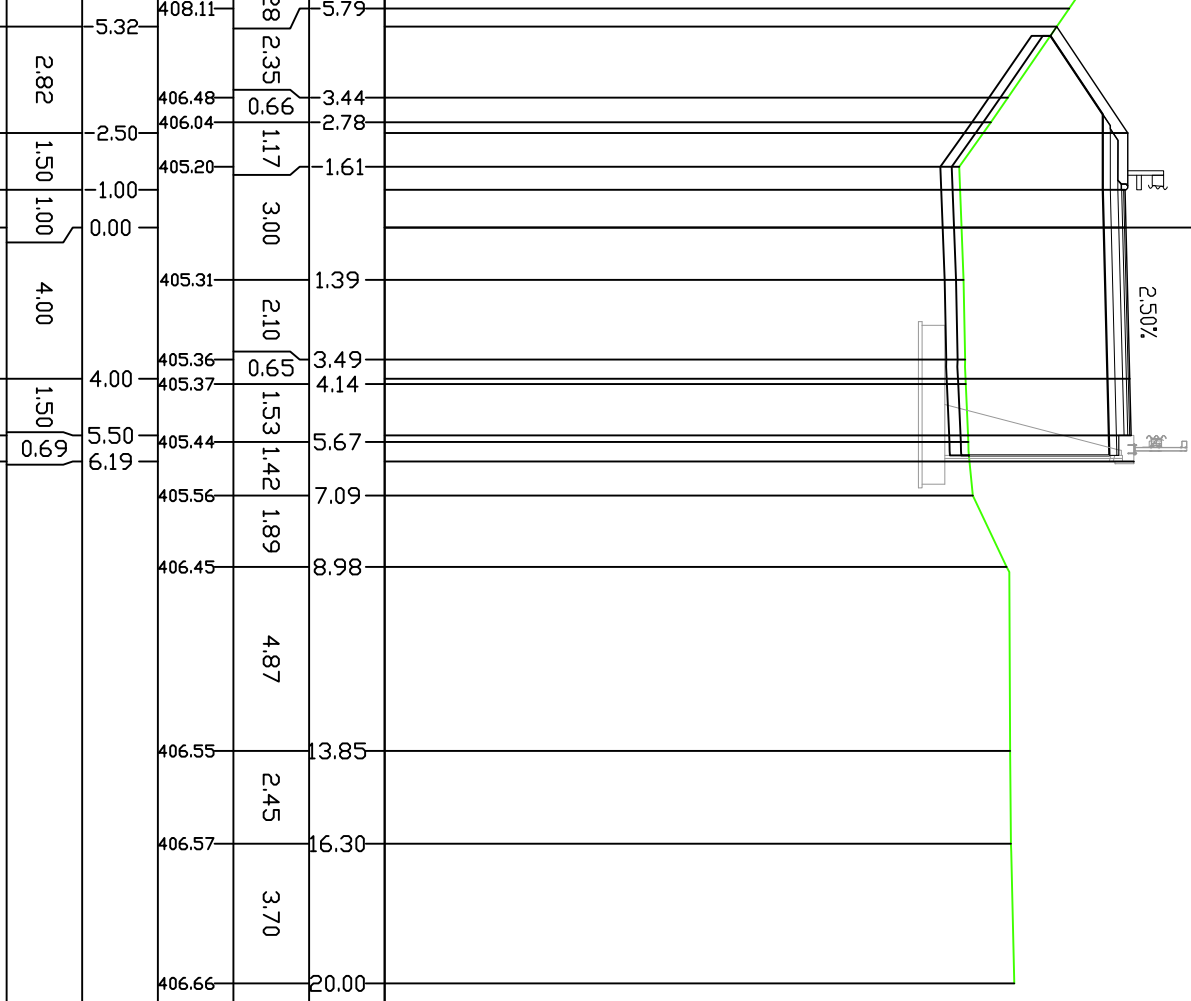

STERRI E RIPORTI	45,39 mq.
R1 BONIFICA	4,92 mq.
B1 STABILIZZATO	2,04 mq.
D1 CEMENTATO	1,88 mq.
E1 BASE	0,68 mq.
F1 VEGETALE	1,38 mq.
G1	1,76 mq.
G2	3,14 mq.
TNT Totale:	18,45 ml.
a1 GEDRIGLIA 10KN/m	16,38 ml.
b1 IDROSEMINA	5,22 ml.
e1	6,70 ml.
e2 Totale:	11,92 ml.
f1 USURA	6,50 ml.
g1 BINDER	6,50 ml.

390.00  
 ▼  
 PROGRESSIVE TERRENO 200  
 200

PROGRESSIVE TERRENO	200
PARZIALI TERRENO	3,87
QUOTE TERRENO	3,87
PROGRESSIVE PROGETTO	3,98
PARZIALI PROGETTO	2,73
QUOTE PROGETTO	2,33
PROGRESSIVE TERRENO	5,47
PARZIALI TERRENO	2,83
QUOTE TERRENO	2,83
PROGRESSIVE PROGETTO	4,00
PARZIALI PROGETTO	1,50
QUOTE PROGETTO	4,41
PROGRESSIVE TERRENO	11,82
PARZIALI TERRENO	2,01
QUOTE TERRENO	2,01
PROGRESSIVE PROGETTO	11,41
PARZIALI PROGETTO	1,50
QUOTE PROGETTO	4,41

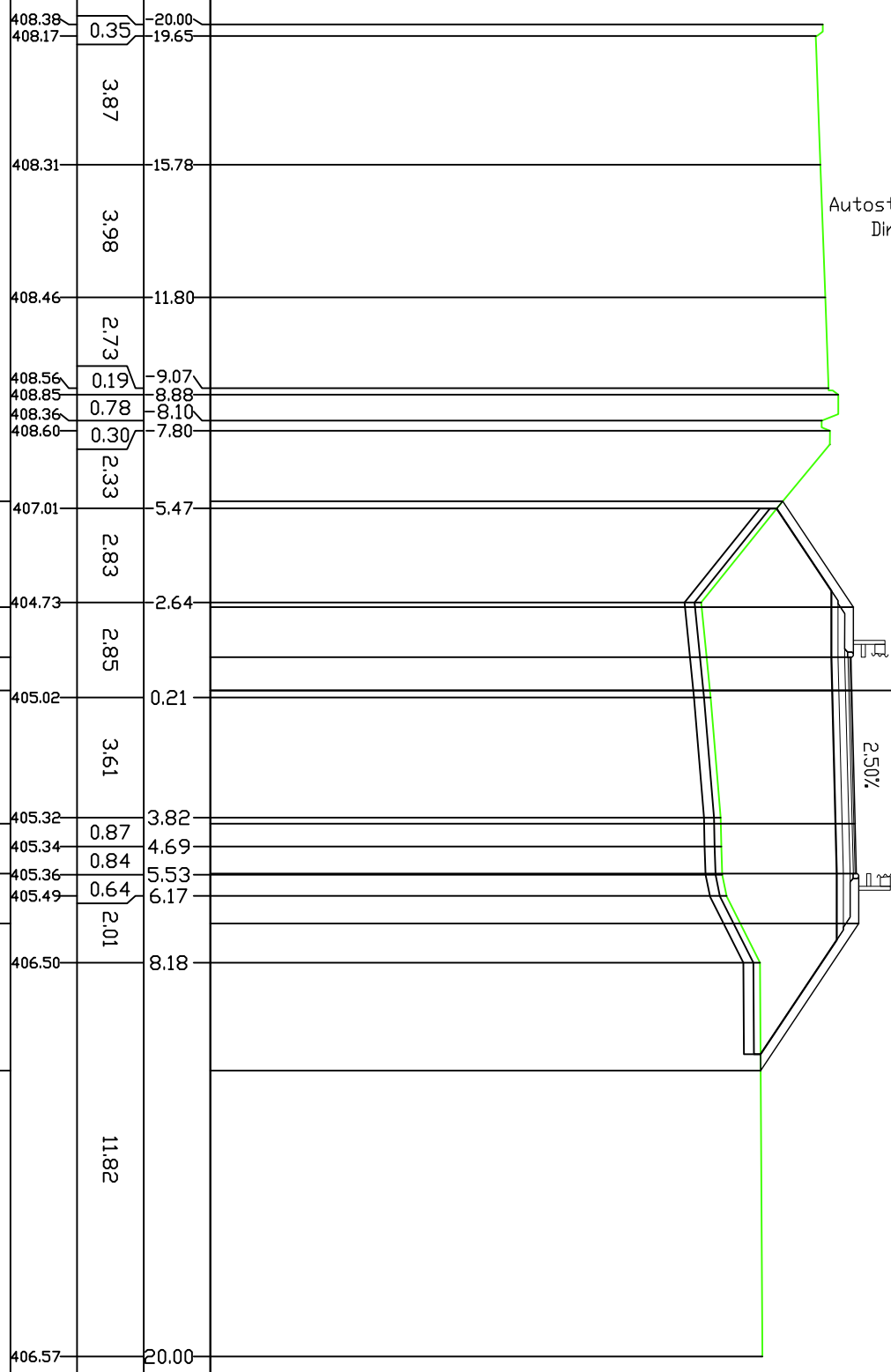

Autostrada A32 - Discesa  
 Direzione TORINO

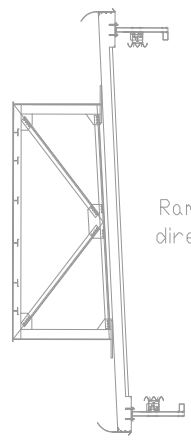

Rampa di Ingresso A32  
 direzione Torino - Rampa 4

STERRI E RIPORTI	
R1 BONIFICA	39,04 mq.
B1 STABILIZZATO	4,66 mq.
D1 CEMENTATO	2,03 mq.
E1 BASE	1,89 mq.
F1 VEGETALE	0,68 mq.
G1	1,38 mq.
G2	1,46 mq.
Totale:	2,84 mq.
TNT	17,58 ml.
a1 GEDRIGLIA 10KN/m	15,49 ml.
b1 IDROSEMINA	5,22 ml.
e1	5,64 ml.
e2 Totale:	10,86 ml.
f1 USUKA	6,50 ml.
g1 BINDER	6,50 ml.

390.00  
 200  
 200

PROGRESSIVE TERRENO	408.08	20.00	
PARZIALI TERRENO	408.21	16.36	3.64
QUOTE TERRENO	408.34	12.66	3.70
PROGRESSIVE PROGETTO	408.44	9.81	2.85
PARZIALI PROGETTO	408.73	9.50	0.31
QUOTE PROGETTO	408.28	8.73	0.77
PROGRESSIVE TERRENO	408.49	8.42	0.31
PARZIALI TERRENO	406.62	5.68	5.44
QUOTE TERRENO	408.73	2.98	3.18
PROGRESSIVE PROGETTO	408.66	1.00	1.50
PARZIALI PROGETTO	408.69	0.00	1.00
QUOTE PROGETTO	405.11	3.09	4.00
PROGRESSIVE TERRENO	408.79	4.00	1.50
PARZIALI TERRENO	408.83	5.50	1.50
QUOTE TERRENO	408.90	7.00	1.50
PROGRESSIVE PROGETTO	406.55	10.53	3.53
PARZIALI PROGETTO	406.54	9.56	1.73
QUOTE PROGETTO	406.57	14.71	5.15
PROGRESSIVE TERRENO	406.55	18.74	4.03
PARZIALI TERRENO	406.55	20.00	1.26

Autostrada A32 - Discesa  
 Direzione TORINO

2.50%

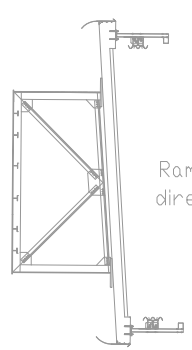

Rampa di Ingresso A32  
 direzione Torino - Rampa 4

STERRI E RIPORTI	
R1	3118 mq.
BONIFICA	
B1	4.51 mq.
STABILIZZATO	
D1	2.03 mq.
CEMENTATO	
E1	1.88 mq.
BASE	
F1	0.69 mq.
VEGETALE	
G1	1.25 mq.
G2	1.40 mq.
Totale:	2.65 mq.
TNT	
a1	16.50 ml.
GEDRIGLIA 10KN/m	
b1	14.96 ml.
IPROSEMINA	
e1	4.79 ml.
e2	5.29 ml.
Totale:	10.08 ml.
USURA	
f1	6.50 ml.
BINDER	
g1	6.50 ml.

390.00  
 200  
 200

PROGRESSIVE TERRENO			
PARZIALI TERRENO			
QUOTE TERRENO			
PROGRESSIVE PROGETTO			
PARZIALI PROGETTO			
QUOTE PROGETTO			

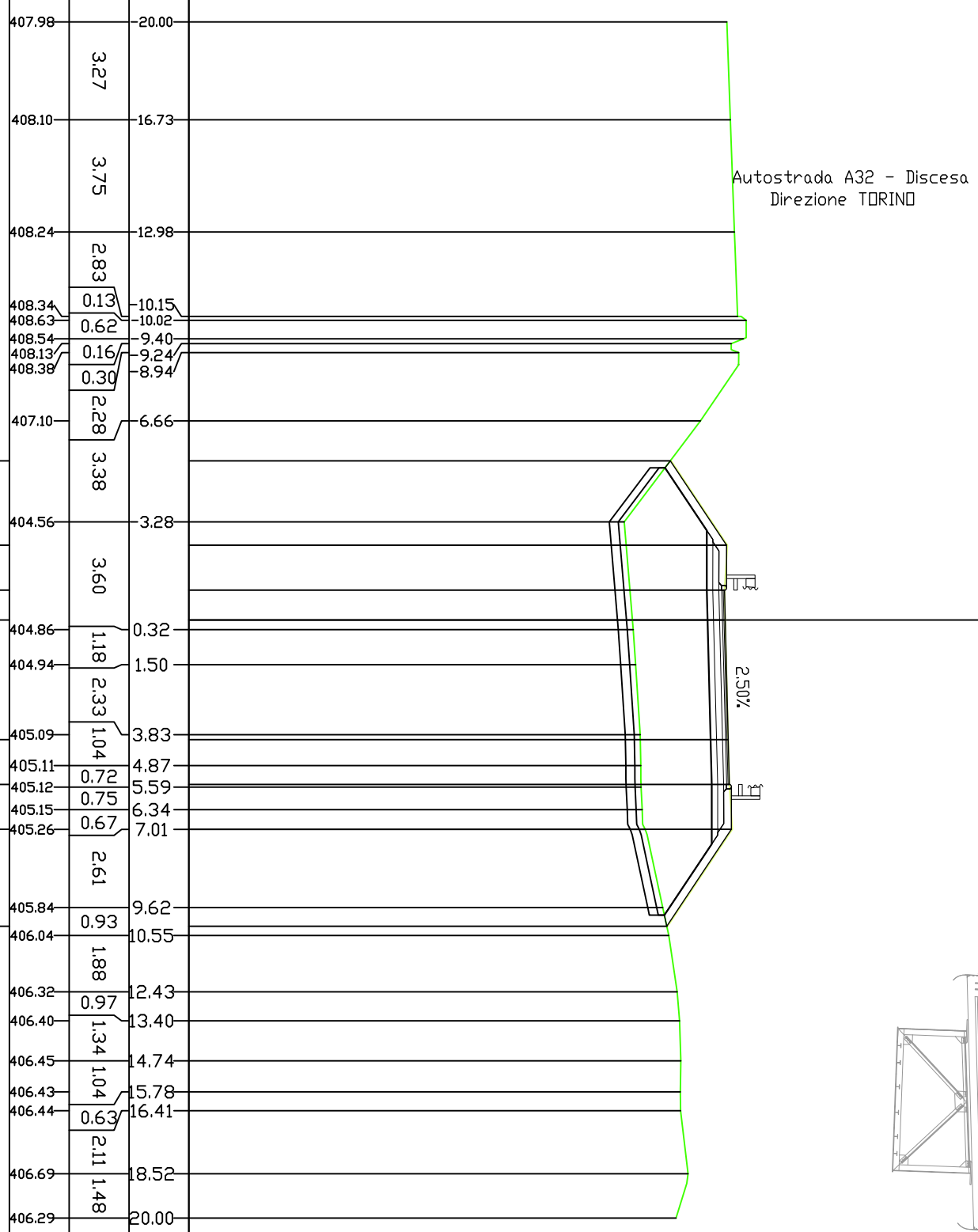

Autostrada A32 - Discesa  
 Direzione TORINO

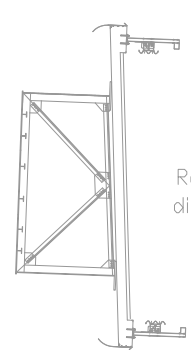

Rampa di Ingresso A32  
 direzione Torino - Rampa 4

PROFILO BA-SV\_MM4quint

SEZIONE 24

PROGRESSIVA 500.00

STERRI E RIPORTI	14.78 mq.
R1 STABILIZZATO	1.50 mq.
DI CEMENTATO	1.50 mq.
E1 BASE	0.75 mq.
F1 USURA	7.50 ml.
F1 BINDER	7.50 ml.
g1	

390.00  
200  
200

PROGRESSIVE TERRENO	PARZIALI TERRENO	QUOTE TERRENO	PROGRESSIVE PROGETTO	PARZIALI PROGETTO	QUOTE PROGETTO
407.91	2.81	20.00			
408.02	1.03	17.19			
408.05	2.72	16.16			
408.16	0.81	13.44			
408.19	2.04	12.63			
408.26	0.13	10.59			
408.55	0.64	10.46			
408.40	0.14	9.82			
408.05	0.14	9.68			
408.30	0.30	9.38			
407.17	1.89	7.49			
	3.62				
404.56		3.87			
407.11	0.50	1.50			
407.11	1.00	1.00			
407.13		0.00			
	4.00				
407.23		4.00			
407.27	1.50	5.50			
407.27	0.50	6.00			
405.05	1.43	6.22			
405.11		7.65			
	5.23				
405.36	1.41	12.88			
405.42	1.70	14.29			
405.47	2.08	15.99			
405.45	1.17	18.07			
405.47	0.76	19.24			
405.46		20.00			

Autostrada A32 - Discesa  
Direzione TORINO

Rampa di Ingresso A32  
direzione Torino - Rampa 4

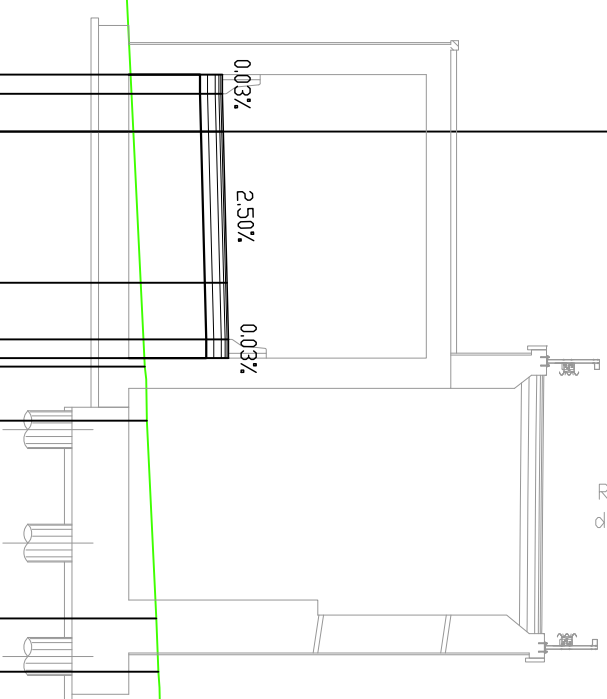

PROFILO BA-SV\_MM4quint

SEZIONE 25

PROGRESSIVA 512.92

STERRI E RIPORTI	11.71 mq.
R1 STABILIZZATO	1.50 mq.
DI CEMENTATO	1.51 mq.
E1 BASE	0.74 mq.
F1 USURA	7.50 ml.
F1 BINDER	7.50 ml.
g1	

390.00  
 ▼  
 PROGRESSIVE  
 TERRENO 200  
 200

QUOTE TERRENO	407.87	20.00
PARZIALI TERRENO	407.93	18.37
QUOTE TERRENO	407.96	17.39
PARZIALI TERRENO	408.07	14.57
QUOTE TERRENO	408.11	13.64
PARZIALI TERRENO	408.19	11.48
QUOTE TERRENO	408.22	10.80
PARZIALI TERRENO	408.47	10.70
QUOTE TERRENO	408.51	10.09
PARZIALI TERRENO	408.13	9.94
QUOTE TERRENO	408.26	9.26
PARZIALI TERRENO	406.62	6.98
QUOTE TERRENO	405.88	6.01
PARZIALI TERRENO	405.52	5.55
QUOTE TERRENO	404.58	4.40
PARZIALI TERRENO	406.70	1.50
QUOTE TERRENO	406.70	1.00
PARZIALI TERRENO	406.72	0.00
QUOTE TERRENO	406.82	4.00
PARZIALI TERRENO	406.86	1.50
QUOTE TERRENO	406.86	0.50
PARZIALI TERRENO	405.43	11.38
QUOTE TERRENO	405.45	12.53
PARZIALI TERRENO	405.48	13.15
QUOTE TERRENO	405.47	14.39
PARZIALI TERRENO	405.46	15.38
QUOTE TERRENO	404.47	16.69
PARZIALI TERRENO	403.93	20.00

Autostrada A32 - Discesa  
Direzione TORINO

Rampa di Ingresso A32  
direzione Torino - Rampa 4

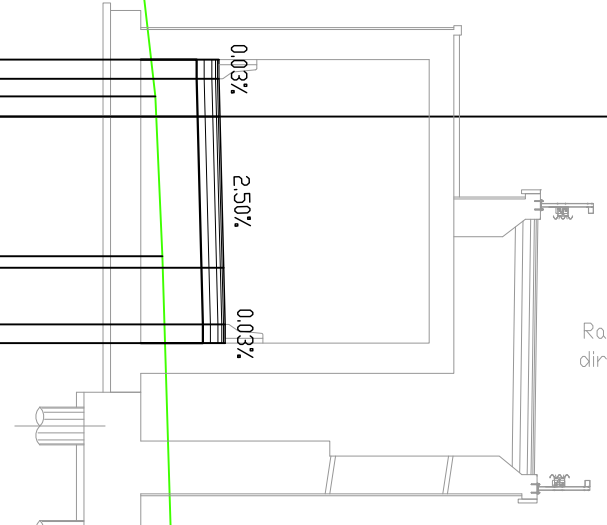

PROFILO BA-SV\_MM4quint

SEZIONE 26

PROGRESSIVA 525.00

STERRI E RIPORTI	9,08 mq.
R1 STABILIZZATO	1,49 mq.
D1 CEMENTATO	1,52 mq.
E1 BASE	0,74 mq.
F1 USURA	7,50 ml.
F1 BINDER	7,50 ml.
g1	

390.00  
 ▼  
 PROGRESSIVE  
 TERRENO 200  
 200

PROGRESSIVE TERRENO	20.00
PARZIALI TERRENO	2.44
QUOTE TERRENO	2.28
PROGRESSIVE PROGETTO	1.47
PARZIALI PROGETTO	1.12
QUOTE PROGETTO	1.71
PROGRESSIVE TERRENO	10.98
PARZIALI TERRENO	0.13
QUOTE TERRENO	0.96
PROGRESSIVE PROGETTO	10.07
PARZIALI PROGETTO	0.12
QUOTE PROGETTO	0.30
PROGRESSIVE TERRENO	8.83
PARZIALI TERRENO	0.64
QUOTE TERRENO	3.97
PROGRESSIVE PROGETTO	4.86
PARZIALI PROGETTO	2.22
QUOTE PROGETTO	2.64
PROGRESSIVE TERRENO	1.50
PARZIALI TERRENO	0.50
QUOTE TERRENO	1.00
PROGRESSIVE PROGETTO	0.00
PARZIALI PROGETTO	4.00
QUOTE PROGETTO	4.00
PROGRESSIVE TERRENO	5.50
PARZIALI TERRENO	1.50
QUOTE TERRENO	0.50
PROGRESSIVE PROGETTO	6.00
PARZIALI PROGETTO	1.43
QUOTE PROGETTO	0.65
PROGRESSIVE TERRENO	11.75
PARZIALI TERRENO	0.83
QUOTE TERRENO	12.58
PROGRESSIVE PROGETTO	7.42
PARZIALI PROGETTO	
QUOTE PROGETTO	
PROGRESSIVE TERRENO	20.00

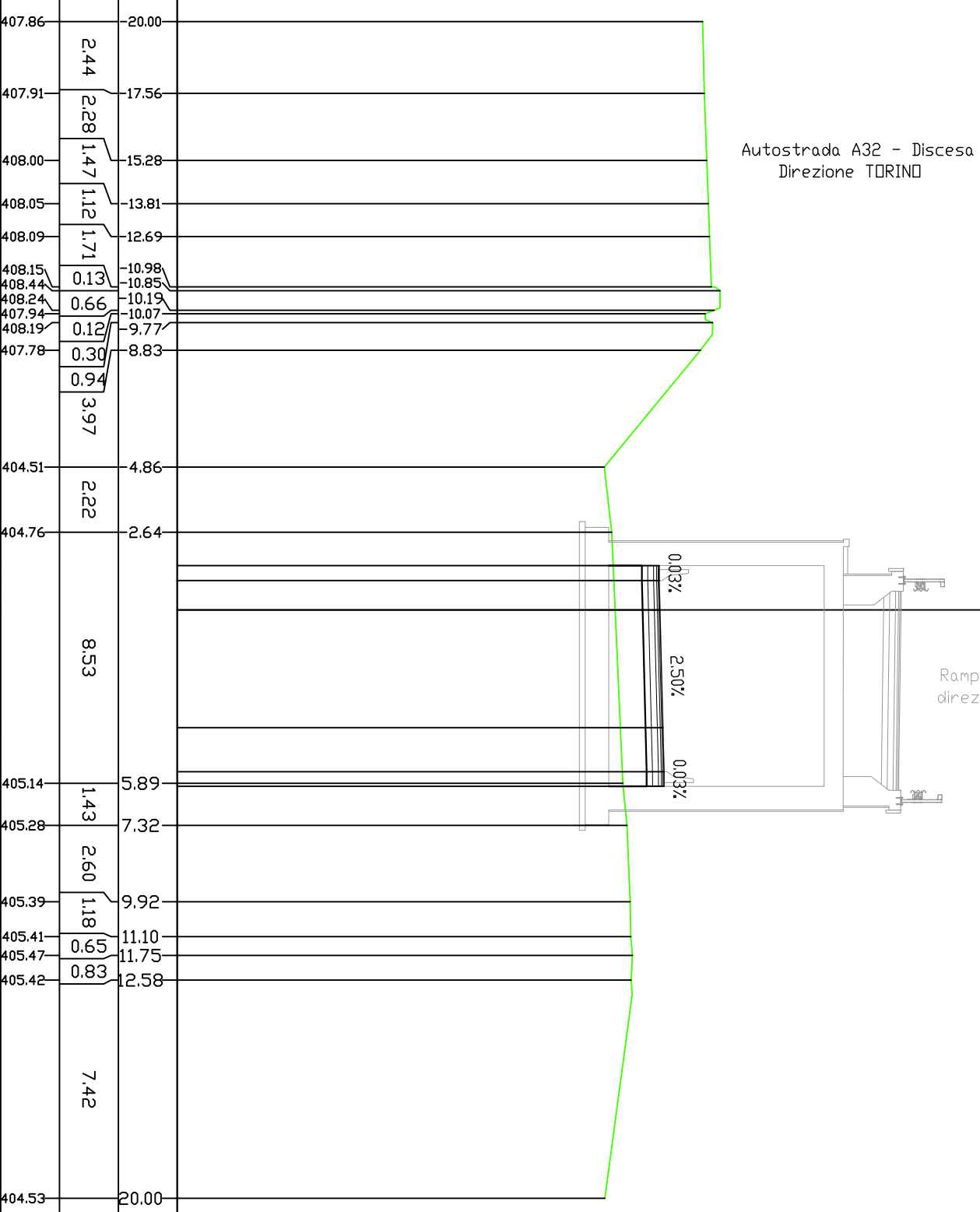



PROFILO BA-SV\_MM4quint

SEZIONE 27

PROGRESSIVA 550.00

STERRI E RIPORTI	6,08 mq.
R1 STABILIZZATO	1,50 mq.
D1 CEMENTATO	1,50 mq.
E1 BASE	0,75 mq.
F1 USURA	7,50 ml.
f1 BINDER	7,50 ml.
g1	

390.00  
 ▼  
 PROGRESSIVE  
 TERRENO 200  
 200

PROGRESSIVE TERRENO	200
PARZIALI TERRENO	
QUOTE TERRENO	
PROGRESSIVE PROGETTO	
PARZIALI PROGETTO	
QUOTE PROGETTO	

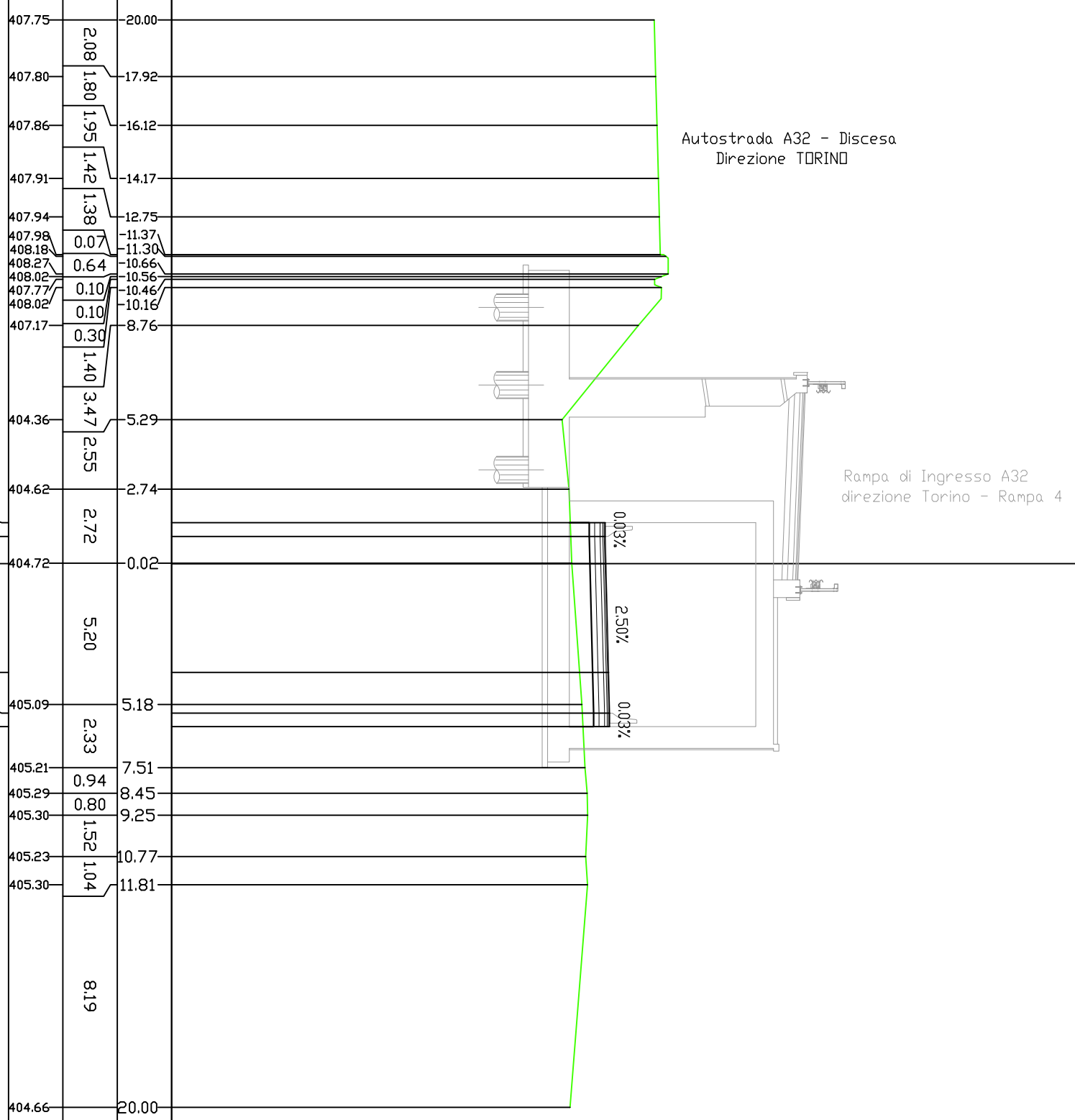

PROFILO BA-SV\_MM4quint

SEZIONE 28

PROGRESSIVA 575.16

STERRI E RIPORTI	4.18 mq.
R1	
SCOTICID	1.44 mq.
A1	
BONIFICA	2.14 mq.
B1	
STABILIZZATO	1.44 mq.
D1	
CEMENTATO	1.40 mq.
E1	
BASE	0.70 mq.
F1	
TNT	8.20 ml.
a1	
GEDRIGLIA 10KN/m	7.17 ml.
b1	
USURA	7.00 ml.
f1	
BINDER	7.00 ml.
g1	

390.00  
 200  
 200

PROGRESSIVE TERRENO	407.62	407.65	407.68	407.71	407.73	407.76	407.96	408.05	407.80	407.55	407.80	405.26	404.14	404.27	405.85	405.85	405.86	404.44	404.61	405.91	405.93	406.00	404.99	405.01	405.04	405.08	405.14	405.00	404.24	403.38
PARZIALI TERRENO	1.76	1.88	1.87	1.39	1.41	0.07	0.64	0.10	0.10	0.10	0.30	3.92	1.67	2.25	2.20	0.50	1.00	0.60	0.24	5.39	0.80	0.65	0.84	1.65	1.50	1.57	1.15	6.86		
QUOTE TERRENO	20.00	18.24	16.36	14.49	13.10	-11.69	-11.62	-10.98	-10.88	-10.78	-10.48	6.56	4.89	2.64	0.44	0.00	0.00	0.44	0.24	5.63	6.43	7.27	8.92	10.42	11.99	13.14	20.00			
PROGRESSIVE PROGETTO																														
PARZIALI PROGETTO																														
QUOTE PROGETTO																														

Autostrada A32 - Discesa  
 Direzione TORINO

Rampa di Ingresso A32  
 direzione Torino - Rampa 4

0.03%

1.28%

PROFILO BA-SV\_MM4quint

SEZIONE 29

PROGRESSIVA 600.00

STERRI E RIPORTI	
R1	6,46 mq.
SCOTICD	1,43 mq.
A1	2,15 mq.
BONIFICA	1,43 mq.
B1	1,40 mq.
STABILIZZATO	0,70 mq.
DI	8,17 ml.
CEMENTATO	7,15 ml.
E1	7,01 ml.
BASE	7,01 ml.
F1	7,01 ml.
TNT	7,01 ml.
a1	7,01 ml.
GEDRIGLIA 10KN/m	7,01 ml.
b1	7,01 ml.
USURA	7,01 ml.
f1	7,01 ml.
BINDER	7,01 ml.
g1	7,01 ml.

390.00  
 200  
 200

PROGRESSIVE TERRENO	407.49	407.50	407.50	407.52	407.53	407.54	407.83	407.61	407.33	407.58	406.57	405.66	405.18	403.82	406.07	406.07	406.06	406.01	405.99	406.06	404.83	404.86	404.90	404.95	404.94	404.94	403.87	403.43
PARZIALI TERRENO	1,67	1,67	2,08	1,26	1,55	0,13	0,57	0,11	0,11	0,30	1,59	1,08	0,55	1,82	4,98	0,51	1,00	4,00	1,50	0,65	4,44	0,85	0,91	1,29	1,16	0,80	2,56	7,41
QUOTE TERRENO	20,00	18,33	16,66	14,58	13,32	-11,77	-11,64	10,97	-10,86	-10,56	8,97	7,89	7,34	5,52	-1,51	-1,00	0,00	4,00	5,50	6,15	4,84	5,69	6,60	7,89	9,05	10,03	12,59	20,00
PROGRESSIVE PROGETTO																												
PARZIALI PROGETTO																												
QUOTE PROGETTO																												

Autostrada A32 - Discesa  
 Direzione TORINO

Rampa di Ingresso A32  
 direzione Torino - Rampa 4

0,03%

1,21%

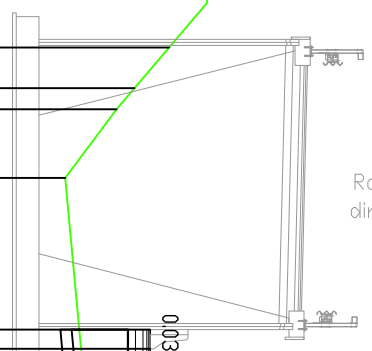

STERRI E RIPORTI	
R1	7.70 mq.
SCOTICD	1.41 mq.
A1	1.41 mq.
BONIFICA	2.15 mq.
B1	2.15 mq.
STABILIZZATO	1.41 mq.
D1	1.41 mq.
CEMENTATO	1.41 mq.
E1	1.41 mq.
BASE	0.70 mq.
F1	0.70 mq.
TNT	8.14 ml.
a1	8.14 ml.
GEDRIGLIA 10KN/m	7.12 ml.
b1	7.12 ml.
USURA	7.01 ml.
f1	7.01 ml.
BINDER	7.01 ml.
g1	7.01 ml.

390.00  
 ▼  
 200  
 200

PROGRESSIVE TERRENO		407.42	20.00	
PARZIALI TERRENO		407.41	18.42	1.58
QUOTE TERRENO		407.40	14.66	3.76
PROGRESSIVE PROGETTO		407.40	11.81	2.85
PARZIALI PROGETTO		407.40	11.62	0.19
QUOTE PROGETTO		407.69	10.85	0.77
		407.20	10.54	0.31
		407.44	5.34	5.20
		403.85	2.31	3.03
		404.13	0.00	6.37
		406.28	4.00	0.51
		406.28	5.50	1.00
		406.25	6.15	4.00
		406.15	6.74	1.50
		406.11	8.90	0.65
		406.19	10.81	
		404.84	13.16	
		404.84	20.00	6.84
		404.55		
		403.62		

Autostrada A32 - Discesa  
 Direzione TORINO

Rampa di Ingresso A32  
 direzione Torino - Rampa 4

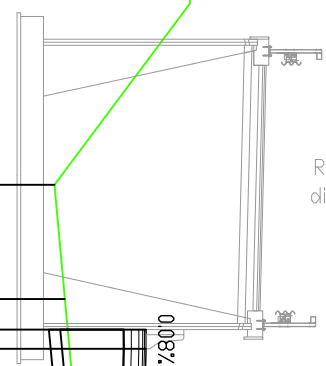

PROFILO BA-SV\_MM4quint

SEZIONE 31

PROGRESSIVA 625.00

STERRI E RIPORTI	
R1	8,56 mq.
SCOTICD	1,43 mq.
A1	2,13 mq.
BONIFICA	
B1	1,44 mq.
STABILIZZATO	
D1	1,44 mq.
CEMENTATO	
E1	1,41 mq.
BASE	
F1	0,69 mq.
TNT	
a1	8,16 ml.
GEDRIGLIA 10KN/m	
b1	7,13 ml.
USURA	
f1	7,01 ml.
BINDER	
g1	7,01 ml.

390.00  
 200  
 200

PROGRESSIVE TERRENO			
PARZIALI TERRENO			
QUOTE TERRENO			
PROGRESSIVE PROGETTO			
PARZIALI PROGETTO			
QUOTE PROGETTO			

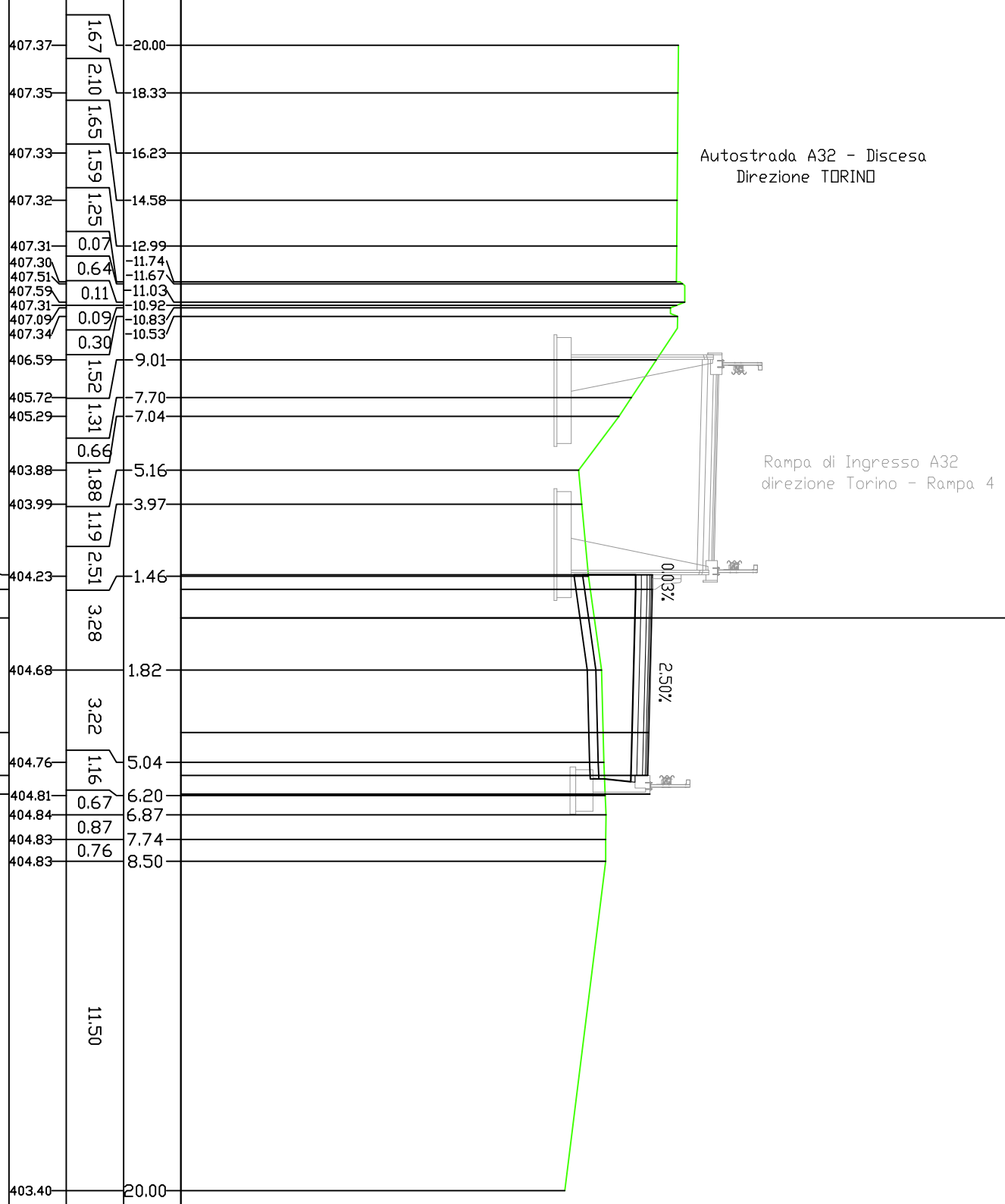

PROFILO BA-SV\_MM4quint

SEZIONE 32

PROGRESSIVA 650.00

STERRI E RIPORTI	12.41 mq.
R1	1.53 mq.
SCOTICD	2.25 mq.
A1	1.50 mq.
BONIFICA	1.42 mq.
B1	0.71 mq.
STABILIZZATO	8.55 ml.
D1	7.53 ml.
CEMENTATO	7.00 ml.
E1	7.00 ml.
BASE	7.00 ml.
F1	7.00 ml.
TNT	7.00 ml.
a1	
GEDRIGLIA 10KN/m	
b1	
USURA	
f1	
BINDER	
g1	

390.00  
 200  
 200

PROGRESSIVE TERRENO	407.24	1.68	20.00
PARZIALI TERRENO	407.21	1.66	18.32
QUOTE TERRENO	407.19	2.09	16.66
PROGRESSIVE PROGETTO	407.15	1.26	14.57
PARZIALI PROGETTO	407.14	1.58	13.31
QUOTE PROGETTO	407.11	0.13	-11.73
	407.40	0.67	11.60
	407.18	0.11	10.93
	406.90	0.11	-10.82
	407.15	0.30	-10.52
	406.59	1.21	9.31
	405.94	0.64	8.37
	405.53	0.50	7.78
	403.88	2.62	5.16
	404.06	2.79	2.37
	406.84	0.50	-1.50
	406.84	1.00	-1.00
	406.81	1.00	0.00
	404.47	1.39	0.61
	404.52	2.92	2.00
	406.71	1.50	4.00
	406.67	0.78	4.92
	404.71	0.99	5.70
	406.74	0.69	6.69
	404.75	2.46	6.69
	405.94	2.08	9.15
	405.83	3.65	11.23
	403.26	5.12	14.88
	402.67		20.00

Autostrada A32 - Discesa  
 Direzione TORINO

Rampa di Ingresso A32  
 direzione Torino - Rampa 4

2.50%

0.03%

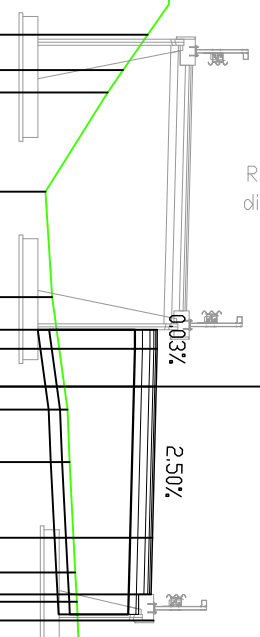

PROFILO BA-SV\_MM4quint

SEZIONE 33

PROGRESSIVA 675.00

STERRI E RIPORTI	
R1	1460 mq.
SCOTICD	152 mq.
A1	228 mq.
BONIFICA	
B1	153 mq.
STABILIZZATO	
D1	147 mq.
CEMENTATO	
E1	066 mq.
BASE	
F1	011 mq.
VEGETALE	
G1	863 ml.
TNT	
a1	762 ml.
GEDRIGLIA 10KN/m	
b1	049 ml.
IDROSEMINA	
e1	650 ml.
USURA	
f1	650 ml.
BINDER	
g1	

390.00  
 ▼  
 PROGRESSIVE  
 TERRENO 200  
 200

PARZIALI TERRENO	407.14	1.70	20.00
	407.11	2.09	18.30
	407.07	1.66	16.21
	407.04	1.58	14.55
	407.00	1.24	12.97
	406.98	0.7	-11.73
	407.19	0.54	-11.66
	407.27	0.4	-11.02
	406.99	0.11	10.91
	406.77	0.09	-10.82
	407.02	0.5	-10.52
	406.59	0.30	9.38
	405.99	1.14	8.34
	405.64	1.14	7.72
	404.08	1.04	5.24
	404.08	2.48	5.24
	404.36	4.36	0.88
	407.25	0.59	-1.59
	407.11	1.00	-1.00
	407.09	1.00	0.00
	404.58	3.56	2.68
	404.64	1.81	4.49
	404.62	0.72	5.21
	406.95	0.96	6.17
	407.02	0.69	6.19
	404.72	1.56	7.73
	404.13	1.93	9.66
	402.54	10.34	20.00
QUOTE PROGETTO			
PARZIALI PROGETTO			
PROGRESSIVE PROGETTO			
QUOTE PROGETTO			

Autostrada A32 - Discesa  
Direzione TORINO

Rampa di Ingresso A32  
direzione Torino - Rampa 4

2.50%

PROFILO BA-SV\_MM4quint

SEZIONE 34

PROGRESSIVA 700.00

STERRI E RIPORTI	
R1	16,82 mq.
SCOTICD	1,73 mq.
A1	2,57 mq.
BONIFICA	1,72 mq.
B1	1,61 mq.
STABILIZZATO	0,66 mq.
DI	0,47 mq.
CEMENTATO	9,64 ml.
EI	8,62 ml.
BASE	2,06 ml.
F1	6,50 ml.
VEGETALE	6,50 ml.
G1	
TNT	
GEDRIGLIA 10KN/m	
al	
bl	
IDROSEMINA	
e1	
USURA	
f1	
BINDER	
g1	

390.00  
 200  
 200

PROGRESSIVE TERRENO	PARZIALI TERRENO	QUOTE TERRENO	PROGRESSIVE PROGETTO	PARZIALI PROGETTO	QUOTE PROGETTO
407.03	168	20.00			
407.00	166	18.32			
406.96	209	16.66			
406.91	126	14.57			
406.89	158	13.31			
406.85	0.13	-11.73			
407.14	0.67	11.60			
406.92	0.67	10.93			
406.64	0.11	-10.82			
406.89	0.30	-10.52			
405.75	2.47	8.05			
404.12	2.95	5.10			
404.25	1.74	3.36			
404.31	1.29	2.07			
407.18	5.36	1.00			
407.15	4.00	0.00			
404.73	0.90	3.29			
404.70	1.71	4.19			
407.05	12.25	4.00			
407.01	1.71	5.50			
407.08	0.69	6.19			
402.70	1.85	18.15			
402.35		20.00			

Autostrada A32 - Discesa  
 Direzione TORINO

Rampa di Ingresso A32  
 direzione Torino - Rampa 4

2.50%

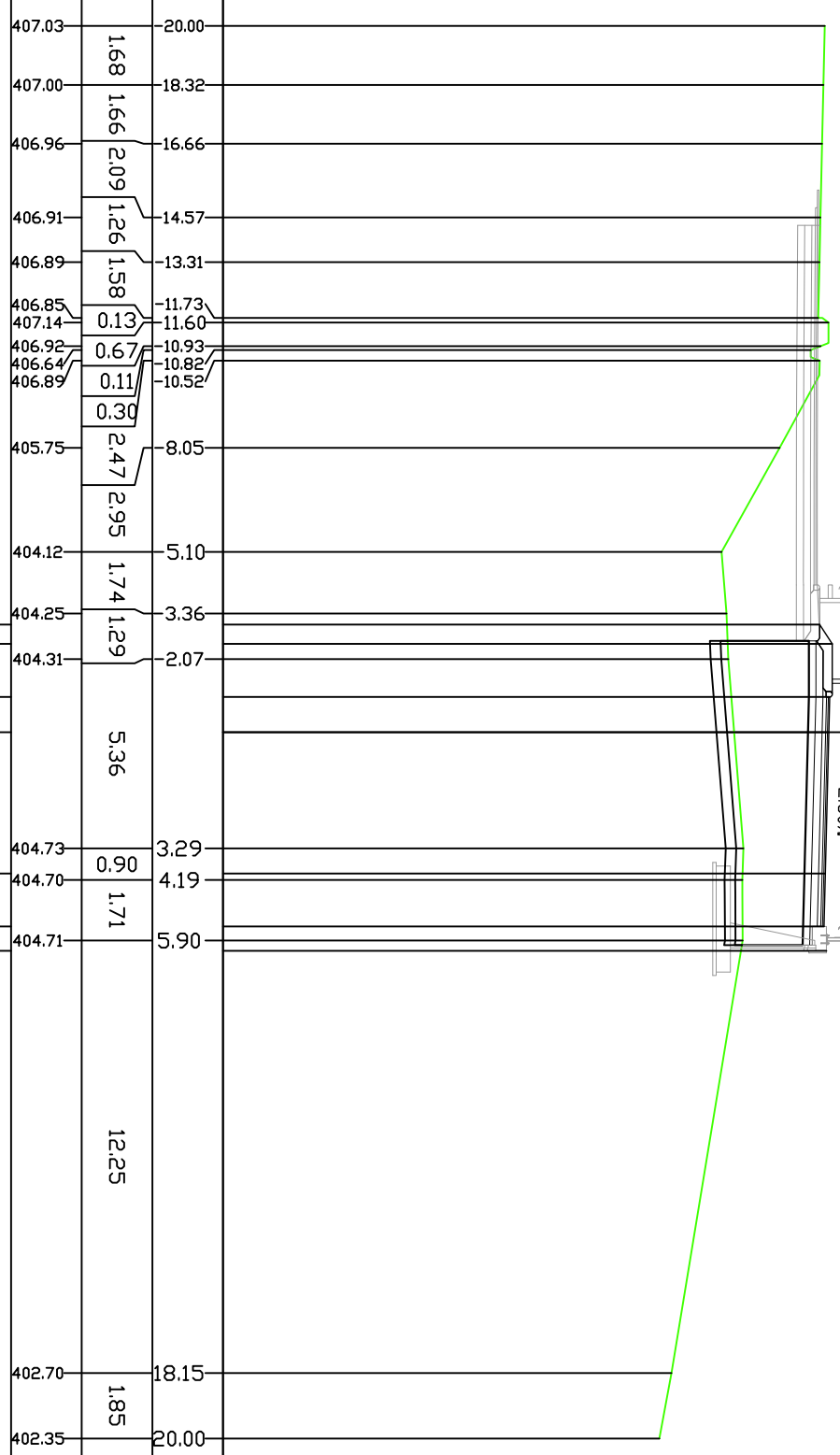



PROFILO BA-SV\_MM4quint

SEZIONE 35

PROGRESSIVA 725.00

STERRI E RIPORTI	1811 mq.
R1	
SCOTICD	1.60 mq.
A1	
BONIFICA	2.39 mq.
B1	
STABILIZZATO	1.77 mq.
D1	
CEMENTATO	1.65 mq.
E1	
BASE	0.67 mq.
F1	
VEGETALE	1.01 mq.
G1	
TNT	8.97 ml.
a1	
GEDRIGLIA 10KN/m	7.96 ml.
b1	
IDROSEMINA	3.69 ml.
e1	
USURA	6.50 ml.
f1	
BINDER	6.50 ml.
g1	

390.00  
 200  
 200

PROGRESSIVE TERRENO	406.92	406.88	406.84	406.80	406.78	406.75	407.04	406.81	406.54	406.79	405.48	405.88	407.14	407.07	407.04	406.94	406.91	406.98	401.96	
PARZIALI TERRENO	1.70	2.09	1.66	1.26	1.57	0.13	0.67	0.11	0.30	3.34	2.80	1.55	2.92	3.71	0.89	1.79	0.78	0.64	12.09	
QUOTE TERRENO	20.00	18.30	16.21	14.55	13.29	-11.72	-11.59	-10.92	-10.81	-10.51	7.17	4.37	2.82	0.10	3.81	4.70	6.49	7.27	7.91	20.00
PROGRESSIVE PROGETTO												4.39	2.50	1.00	0.00	4.00	5.50	6.19		
PARZIALI PROGETTO												1.89	1.50	1.00	4.00	1.50	0.69			
QUOTE PROGETTO																				

Autostrada A32 - Discesa  
 Direzione TORINO

Rampa di Ingresso A32  
 direzione Torino - Rampa 4

2.50%

PROFILO BA-SV\_MM4quint

SEZIONE 36

PROGRESSIVA 750.00

STERRI E RIPORTI	1983 mq.
R1 SCOTICD	1.71 mq.
A1 BONIFICA	2.57 mq.
B1 STABILIZZATO	1.78 mq.
D1 CEMENTATO	1.62 mq.
E1 BASE	0.68 mq.
F1 VEGETALE	1.14 mq.
G1 TNT	9.69 ml.
a1 GEDRIGLIA 10KN/m	8.56 ml.
b1 IDROSEMINA	4.27 ml.
e1 USURA	6.50 ml.
f1 BINDER	6.50 ml.
g1	6.50 ml.

390.00  
 200  
 200

PROGRESSIVE TERRENO			
PARZIALI TERRENO			
QUOTE TERRENO			
PROGRESSIVE PROGETTO			
PARZIALI PROGETTO			
QUOTE PROGETTO			

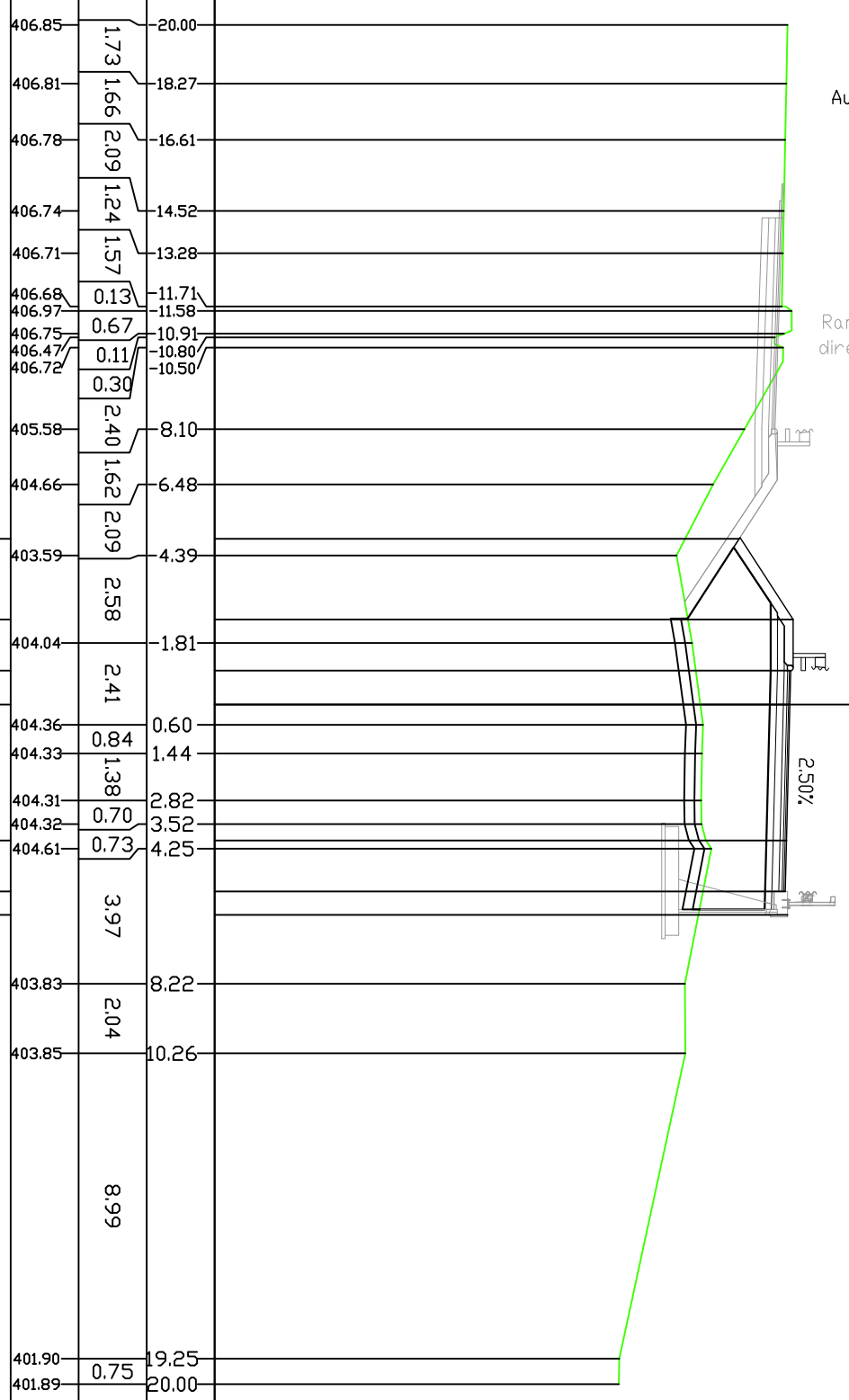

Autostrada A32 - Discesa  
 Direzione TORINO

Rampa di Ingresso A32  
 direzione Torino - Rampa 4

2.50%

PROFILO BA-SV\_MM4quint

SEZIONE 37

PROGRESSIVA 775.00

STERRI E RIPORTI	1967 mq.
R1 SCOTICO	163 mq.
A1 BONIFICA	242 mq.
B1 STABILIZZATO	178 mq.
D1 CEMENTATO	166 mq.
E1 BASE	066 mq.
F1 VEGETALE	109 mq.
G1 TNT	932 ml.
a1 GEDRIGLIA 10KN/m	809 ml.
b1 IDROSEMINA	414 ml.
e1 USURA	650 ml.
f1 BINDER	650 ml.
g1	650 ml.

390.00  
 200  
 200

PROGRESSIVE TERRENO	406.73	406.69	406.66	406.61	406.58	406.55	406.77	406.84	406.56	406.34	406.59	406.17	403.13	403.29	406.89	406.82	406.79	403.83	403.83	403.83	404.63	406.69	406.66	406.73	404.74	403.90	403.92	401.73	401.77	401.78		
PARZIALI TERRENO	1.72	1.65	2.10	1.58	1.23	0.08	0.64	0.11	0.09	0.33	0.6	4.05	1.98	2.31	1.45	1.02	0	1.77	3.73	5.75	9.48	3.19	1.48	3.24	2.19	0.4						
QUOTE TERRENO	20.00	18.28	16.63	14.53	12.95	-11.72	-11.64	11.00	10.89	-10.80	-10.50	9.53	5.48	3.50	1.19	0.26	1.28	1.96	3.73	5.50	6.19	9.48	12.67	14.15	17.39	19.58	20.00					
PROGRESSIVE PROGETTO													4.78	2.50	1.00	0.00			4.00	1.50	0.69											
PARZIALI PROGETTO													2.28	1.50	1.00				4.00	1.50	0.69											
QUOTE PROGETTO													4.78	2.50	1.00	0.00			4.00	1.50	0.69											

Autostrada A32 - Discesa  
 Direzione TORINO

Rampa di Ingresso A32  
 direzione Torino - Rampa 4

2.50%

PROFILO BA-SV\_MM4quint

SEZIONE 38

PROGRESSIVA 791.02

STERRI E RIPORTI	
R1	2167 mq.
SCOTICD	165 mq.
A1	241 mq.
BONIFICA	178 mq.
STABILIZZATO	165 mq.
CEMENTATO	066 mq.
BASE	106 mq.
VEGETALE	927 ml.
G1	810 ml.
TNT	410 ml.
GEDRIGLIA 10KN/m	650 ml.
IPROSEMINA	650 ml.
USURA	650 ml.
BINDER	650 ml.

390.00  
 200  
 200

PROGRESSIVE TERRENO			
PARZIALI TERRENO			
QUOTE TERRENO			
PROGRESSIVE PROGETTO			
PARZIALI PROGETTO			
QUOTE PROGETTO			

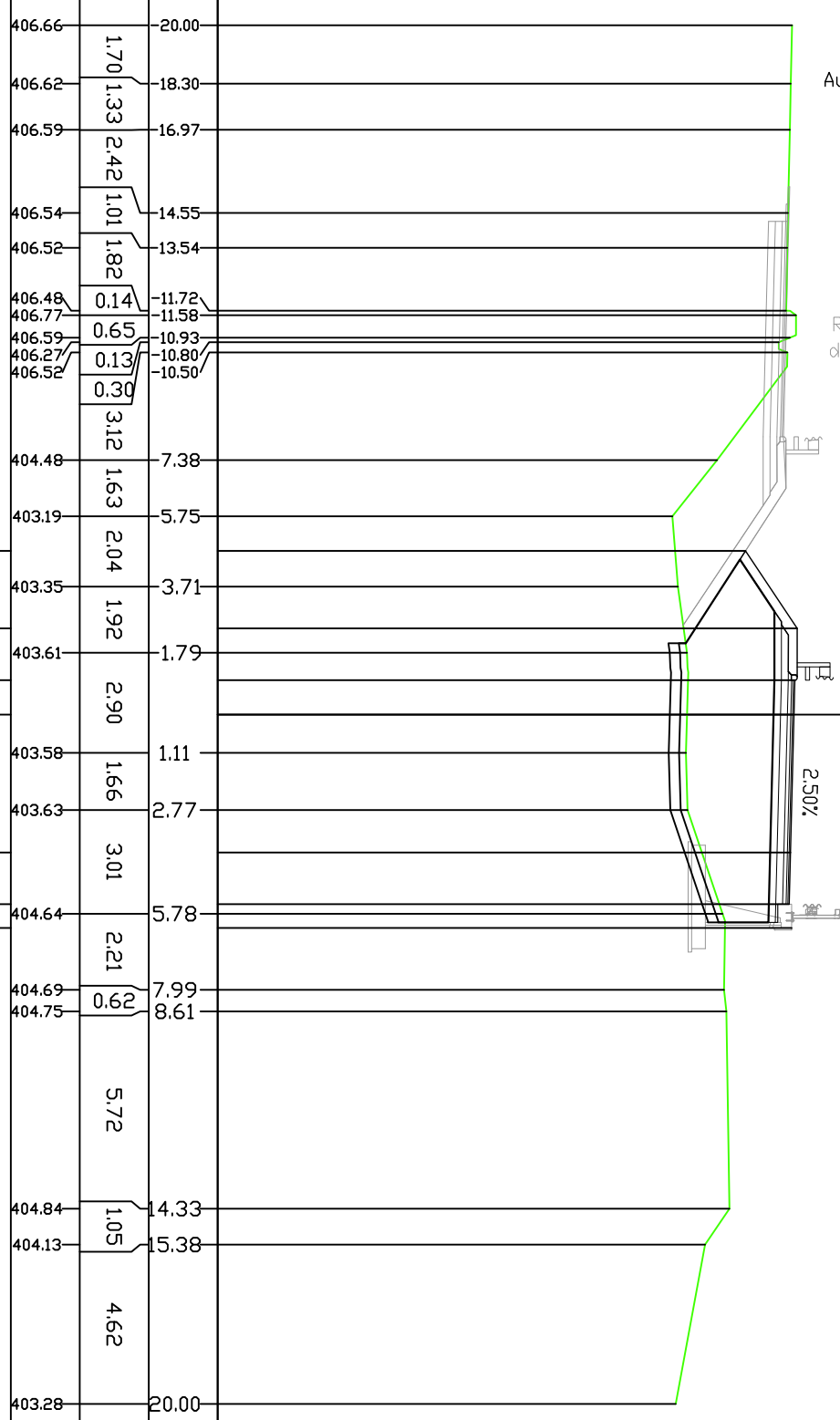

Autostrada A32 - Discesa  
 Direzione TORINO

Rampa di Ingresso A32  
 direzione Torino - Rampa 4

2.50%

PROFILO BA-SV\_MM4quint

SEZIONE 39

PROGRESSIVA 806.47

STERRI E RIPORTI	23.87 mq.
R1	
SCOTICID	1.59 mq.
A1	
BONIFICA	2.36 mq.
B1	
STABILIZZATO	1.78 mq.
D1	
CEMENTATO	1.65 mq.
E1	
BASE	0.66 mq.
F1	
VEGETALE	1.08 mq.
G1	
TNT	8.96 ml.
a1	
GEDRIGLIA 10KN/m	7.92 ml.
b1	
IDROSEMINA	4.08 ml.
e1	
USURA	6.50 ml.
f1	
BINDER	6.50 ml.
g1	

390.00  
 200  
 200

PROGRESSIVE TERRENO			
PARZIALI TERRENO			
QUOTE TERRENO			
PROGRESSIVE PROGETTO			
PARZIALI PROGETTO			
QUOTE PROGETTO			

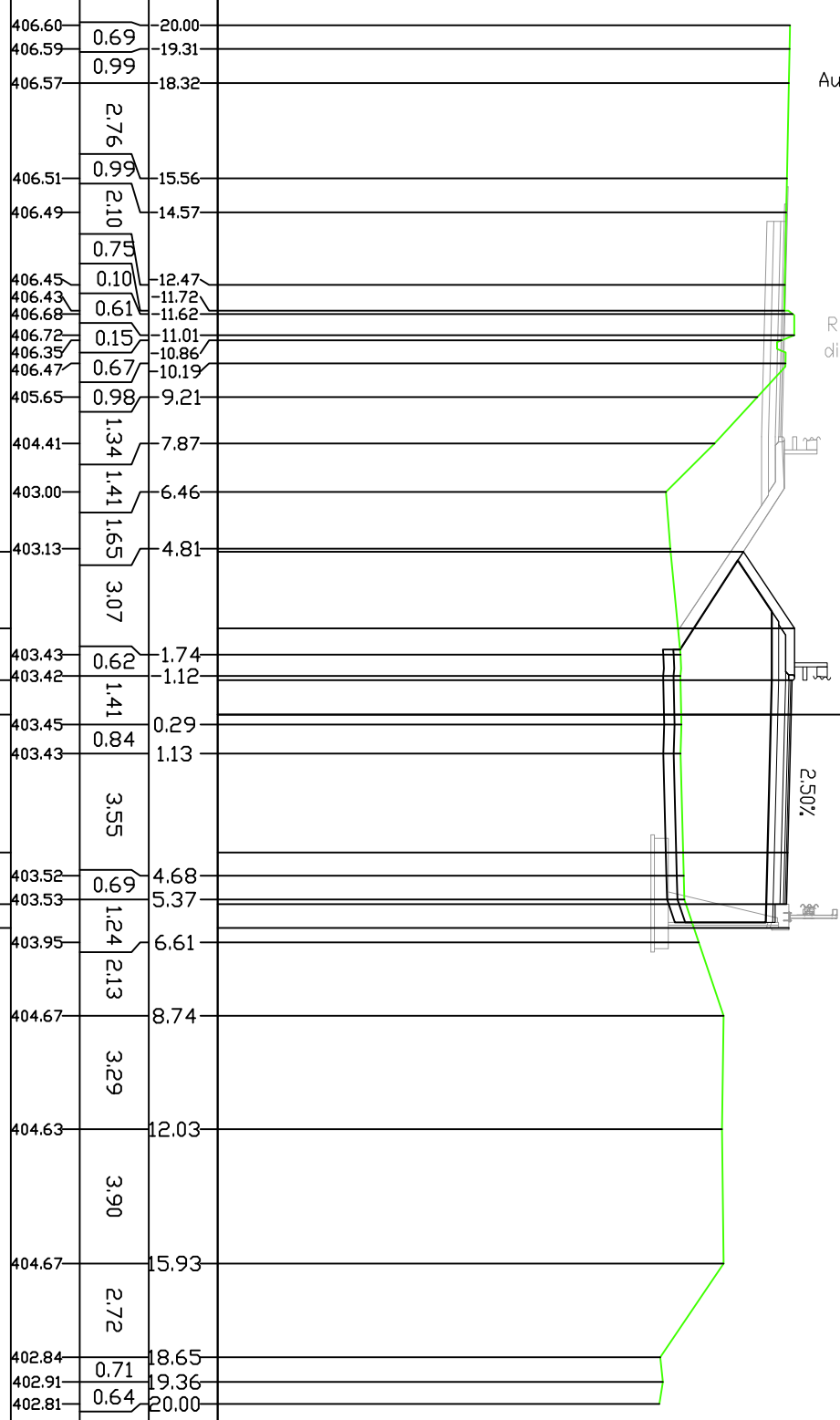

Autostrada A32 - Discesa  
 Direzione TORINO

Rampa di Ingresso A32  
 direzione Torino - Rampa 4

2.50%

STERRI E RIPORTI	
R1	24,73 mq.
SCOTTICI	
A1	1,54 mq.
A2	1,54 mq.
A3	1,54 mq.
Totale:	
BDNFICA	4,62 mq.
BONIFICA	
B1	2,30 mq.
B2	2,30 mq.
B3	2,30 mq.
B4	2,30 mq.
B5	2,30 mq.
B6	2,30 mq.
B7	2,30 mq.
B8	2,30 mq.
B9	2,30 mq.
Totale:	
STABILIZZATO	20,70 mq.
CEMENTATO	
D1	1,77 mq.
E1	
E1	1,63 mq.
BASE	
F1	0,67 mq.
VEGETALE	
G1	1,08 mq.
TNT	
a1	8,68 ml.
a2	8,68 ml.
a3	8,68 ml.
Totale:	
GEDRIGLIA 10KN/m	26,04 ml.
b1	
b1	7,68 ml.
b2	7,68 ml.
b3	7,68 ml.
Totale:	
IDROSEMINA	23,04 ml.
e1	
e1	4,09 ml.
USURA	
f1	6,50 ml.
BINDER	
g1	6,50 ml.

390.00  
 200  
 200

PROGRESSIVE TERRENO	406.55	406.52	406.48	406.44	406.41	406.39	406.60	406.68	406.42	406.18	406.43	404.39	403.59	402.81	405.18	406.67	406.60	406.57	406.44	406.39	406.46	404.17	403.95				
PARZIALI TERRENO	1,62	1,92	1,83	1,48	1,37	0,07	0,07	0,64	0,11	0,09	0,09	0,30	2,35	0,77	0,73	5,60	2,19	2,19	5,32	0,69	1,23	3,34	1,38	7,35	0,31		
QUOTE TERRENO	20,00	18,38	16,46	14,63	13,15	11,78	11,71	11,07	10,96	10,87	10,57	8,22	7,45	6,72	4,74	2,50	1,12	0,00	4,00	5,50	6,19	6,39	7,62	10,96	12,34	19,69	20,00
PROGRESSIVE PROGETTO																											
PARZIALI PROGETTO																											
QUOTE PROGETTO																											

Autostrada A32 - Discesa  
 Direzione TORINO

Rampa di Ingresso A32  
 direzione Torino - Rampa 4

3,27%

PROFILO BA-SV\_MM4quint

SEZIONE 41

PROGRESSIVA 834.29

STERRI E RIPORTI	
R1	26,12 mq.
SCOTICD	1,60 mq.
A1	2,37 mq.
BONIFICA	1,78 mq.
STABILIZZATO	1,62 mq.
CEMENTATO	0,67 mq.
BASE	1,15 mq.
VEGETALE	8,92 ml.
F1	7,91 ml.
TNT	4,35 ml.
a1	6,50 ml.
GEDRIGLIA 10KN/m	6,50 ml.
b1	
IDROSEMINA	
e1	
USURA	
f1	
BINDER	
g1	

390.00  
 ▼  
 PROGRESSIVE  
 TERRENO 200  
 200

PARZIALI TERRENO	406.49	1,15	20,00
	406.47	1,84	18,85
	406.43	1,92	17,01
	406.40	1,29	15,09
	406.38	1,55	13,80
	406.35	0,13	12,25
	406.64	0,57	12,12
	406.42	0,57	11,45
	406.14	0,11	11,34
	406.39	0,30	11,04
	405.34	0,30	9,68
	404.23	1,36	8,67
	402.56	1,01	7,10
	404.97	4,28	4,95
	406.61	1,24	2,82
	403.01	1,77	1,58
	406.54	1,50	1,00
	406.50	1,00	0,00
	403.06	1,62	1,81
	406.33	3,73	4,00
	406.27	0,69	5,50
	406.34	0,69	6,19
	403.34	5,54	5,54
	403.38	9,75	9,75
	404.08	2,04	11,79
	404.60	0,77	12,56
	402.70	7,44	20,00
QUOTE TERRENO			
PROGRESSIVE PROGETTO			
PARZIALI PROGETTO			
QUOTE PROGETTO			

Autostrada A32 - Discesa  
 Direzione TORINO

Rampa di Ingresso A32  
 direzione Torino - Rampa 4

4,08%

PROFILO BA-SV\_MM4quint

SEZIONE 42

PROGRESSIVA 850.07

STERRI E RIPORTI	
R1	29,78 mq.
SCOTICID	1,87 mq.
A1	2,81 mq.
BONIFICA	1,78 mq.
STABILIZZATO	1,61 mq.
CEMENTATO	0,67 mq.
BASE	1,39 mq.
VEGETALE	10,37 ml.
G1	9,37 ml.
TNT	5,25 ml.
a1	6,50 ml.
GEDRIGLIA 10KN/m	6,50 ml.
b1	
IDROSEMINA	
e1	
USURA	
f1	
BINDER	
g1	

390.00  
 ▼  
 PROGRESSIVE  
 TERRENO 200  
 200

PROGRESSIVE	QUOTE	PARZIALI	QUOTE
TERRENO	TERRENO	PROGETTO	PROGETTO
406.41	20.00	3.45	
406.35	16.55	2.85	
406.30	13.70	0.13	
406.59	13.57	0.6	
406.46	12.93	0.15	
406.09	12.78	0.15	
406.34	12.48	0.30	
405.88	11.65	0.83	
402.59	8.43	3.22	
402.66	6.11	2.32	
404.48	5.70	3.01	3.20
402.98	3.10	1.02	1.50
402.89	2.08	1.31	1.00
406.55	1.00		4.00
406.50	0.00		1.50
406.34	4.00	8.35	0.69
406.28	5.50		
406.35	6.19		
403.15	7.58	1.57	
403.28	9.15	2.08	
403.31	11.23	0.9	
403.52	11.86	1.54	
404.57	13.40		
402.88	20.00	6.60	

Autostrada A32 - Discesa  
 Direzione TORINO

Rampa di Ingresso A32  
 direzione Torino - Rampa 4

4.08%

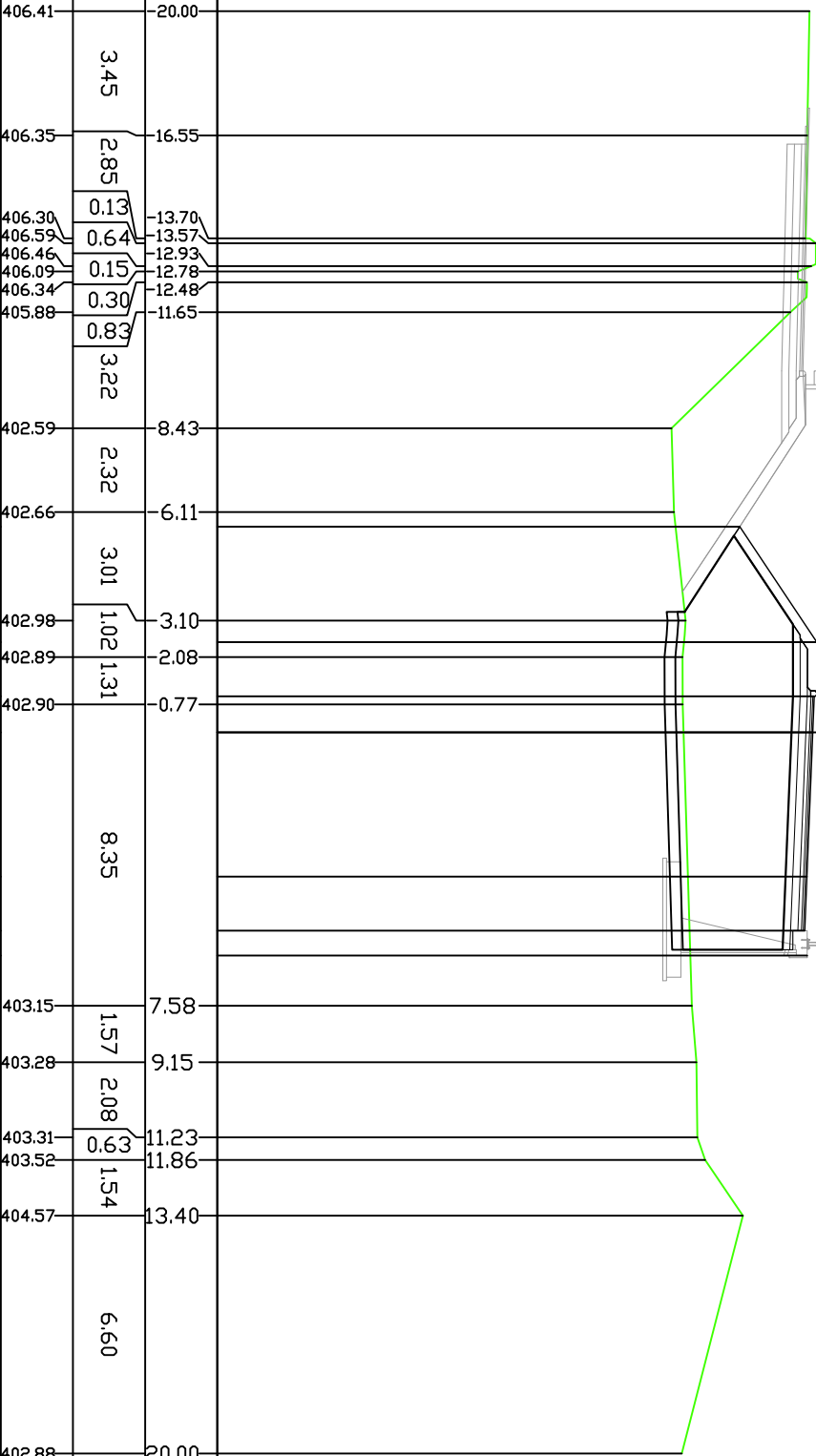



PROFILO BA-SV\_MM4quint

SEZIONE 43

PROGRESSIVA 865.84

STERRI E RIPORTI	
R1	35,36 mq.
SCOTICD	2,38 mq.
A1	3,56 mq.
BONIFICA	
B1	
STABILIZZATO	
D1	1,77 mq.
CEMENTATO	1,62 mq.
E1	
BASE	0,67 mq.
F1	
VEGETALE	
G1	1,86 mq.
TNT	
a1	12,92 ml.
GEDRIGLIA 10KN/m	
b1	11,91 ml.
IDROSEMINA	
e1	6,96 ml.
USURA	
f1	6,50 ml.
BINDER	
g1	6,50 ml.

390.00  
200  
200

PROGRESSIVE TERRENO			
PARZIALI TERRENO			
QUOTE TERRENO			
PROGRESSIVE PROGETTO			
PARZIALI PROGETTO			
QUOTE PROGETTO			

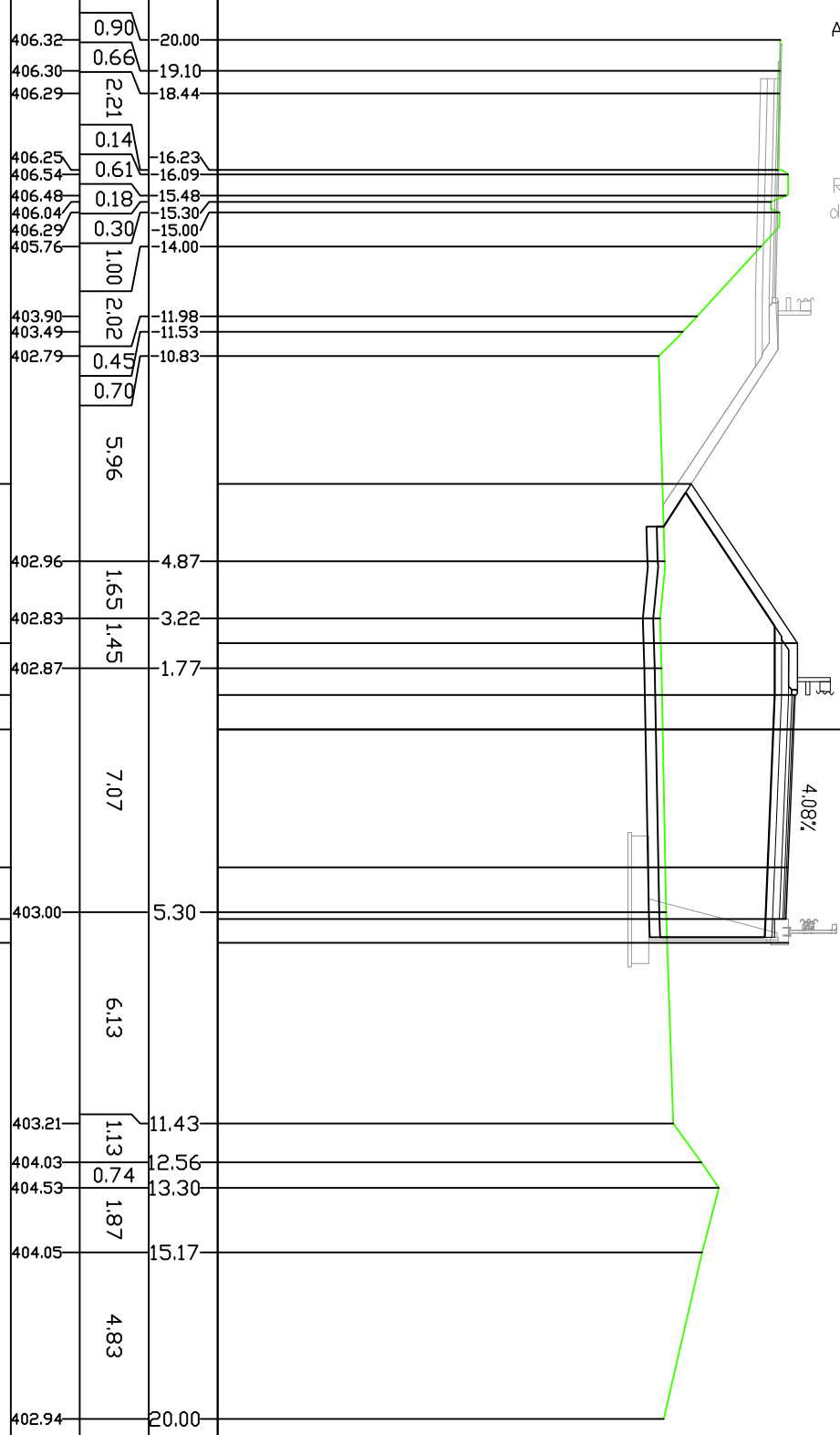

Autostrada A32 - Discesa  
Direzione TORINO

Rampa di Ingresso A32  
direzione Torino - Rampa 4

PROFILO BA-SV\_MM4quint

SEZIONE 44

PROGRESSIVA 879.76

STERRI E RIPORTI	
R1	40.57 mq.
SCOTICD	2.91 mq.
A1	4.35 mq.
BONIFICA	1.76 mq.
B1	1.66 mq.
STABILIZZATO	0.67 mq.
D1	2.44 mq.
CEMENTATO	15.53 ml.
E1	14.52 ml.
BASE	9.28 ml.
F1	6.50 ml.
VEGETALE	6.50 ml.
G1	
TNT	
a1	
GEDRIGLIA 10KN/m	
b1	
IDROSEMINA	
e1	
USURA	
f1	
BINDER	
g1	

390.00  
 200  
 200

PROGRESSIVE TERRENO	PARZIALI TERRENO	QUOTE TERRENO	PROGRESSIVE PROGETTO	PARZIALI PROGETTO	QUOTE PROGETTO
406.22	0.73	20.00	402.77	9.06	
406.20	0.13	19.27	402.96	6.91	6.56
406.49	0.62	19.14	403.02	6.24	
406.44	0.18	18.52	403.00	4.94	
406.00	0.31	18.34	402.99	2.61	1.50
406.25	0.31	18.03	407.14	2.50	1.00
405.89	0.88	17.15	407.07	1.00	4.00
403.93	2.58	14.57	407.04	0.00	1.50
402.51	1.64	12.93	406.91	4.00	0.69
402.56	1.34	11.59	406.86	5.50	
402.77	4.68	9.06	406.93	6.19	
402.96	0.67	6.91	403.01	7.53	
403.02	1.30	6.24	403.12	3.11	
403.00	2.33	4.94	403.81	0.65	
402.99	2.61	2.61	404.50	1.05	
407.14	2.50	2.50	404.50	1.08	
407.07	1.00	1.00	403.24	17.93	
407.04	0.00	0.00	402.77	20.00	
406.91	4.00	4.00			
406.86	5.50	5.50			
406.93	6.19	6.19			

Rampa di Ingresso A32  
 direzione Torino - Rampa 4

3.29%

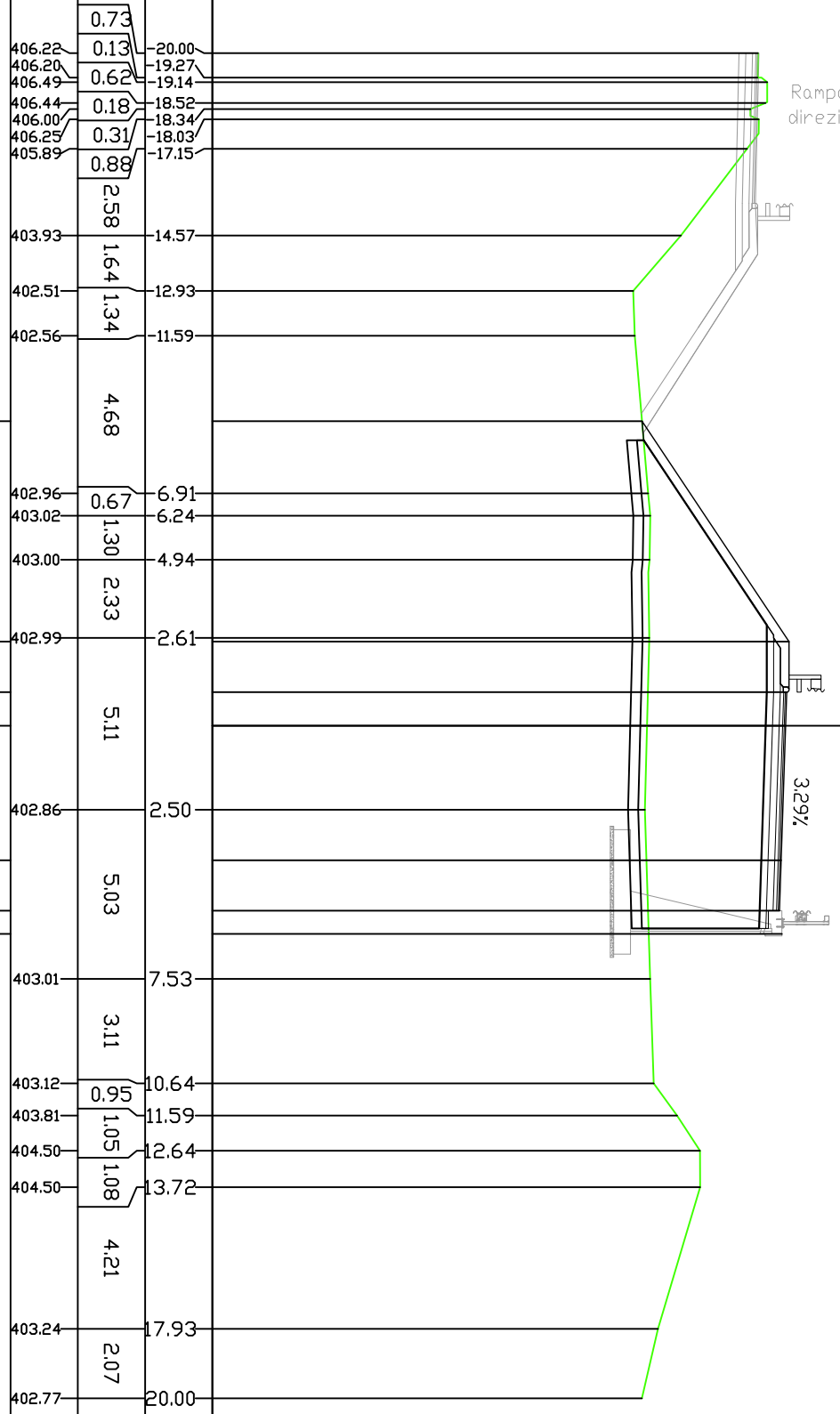

PROFILO BA-SV\_MM4quint

SEZIONE 45

PROGRESSIVA 893.67

USURA  
f1 6.50 ml.  
BINDER 6.50 ml.  
g1

390.00  
200  
200

PROGRESSIVE TERRENO	PARZIALI TERRENO	QUOTE TERRENO	PROGRESSIVE PROGETTO	PARZIALI PROGETTO	QUOTE PROGETTO
405.48	1.47	20.00	407.55	1.00	1.00
404.41	2.56	18.53	407.52	4.00	0.00
402.51	3.59	15.97	407.42	1.50	4.00
402.95	0.96	12.38	407.39		5.50
403.03	2.02	11.42			
403.00	1.39	9.40			
403.00	0.64	8.01			
402.98	4.17	7.37			
402.87	3.29	3.20			
402.72	6.48	0.09			
402.92	2.30	6.57			
402.94	0.70	8.87			
403.03	0.60	9.57			
403.32	1.74	9.96			
404.46	2.92	11.70			
404.47	5.38	14.62			
402.86		20.00			

Rampa di Ingresso A32  
direzione Torino - Rampa 4

2.50%

PROFILO BA-SV\_MM4quint

SEZIONE 46

PROGRESSIVA 905.86

USURA  
f1 6:50 ml.  
BLINDER  
g1 6:50 ml.

390.00  
200  
200

PROGRESSIVE TERRENO	QUOTE TERRENO	PROGRESSIVE PROGETTO	QUOTE PROGETTO
403.20	1.16	403.20	
402.32	2.22	402.32	
402.75	2.94	402.75	
402.95	0.70	402.95	
403.01	0.93	403.01	
403.03	1.15	403.03	
403.02	5.25	403.02	
402.68	2.80	402.68	
402.55	1.58	402.55	
402.60	1.27	402.60	
408.10	1.00	408.10	1.00
408.07		408.07	0.00
407.97	4.00	407.97	4.00
407.93	1.50	407.93	5.50
402.66	2.33	402.66	
402.94	1.29	402.94	
403.94	0.74	403.94	
404.43	4.57	404.43	
404.44	2.06	404.44	
403.82	2.57	403.82	
402.69		402.69	

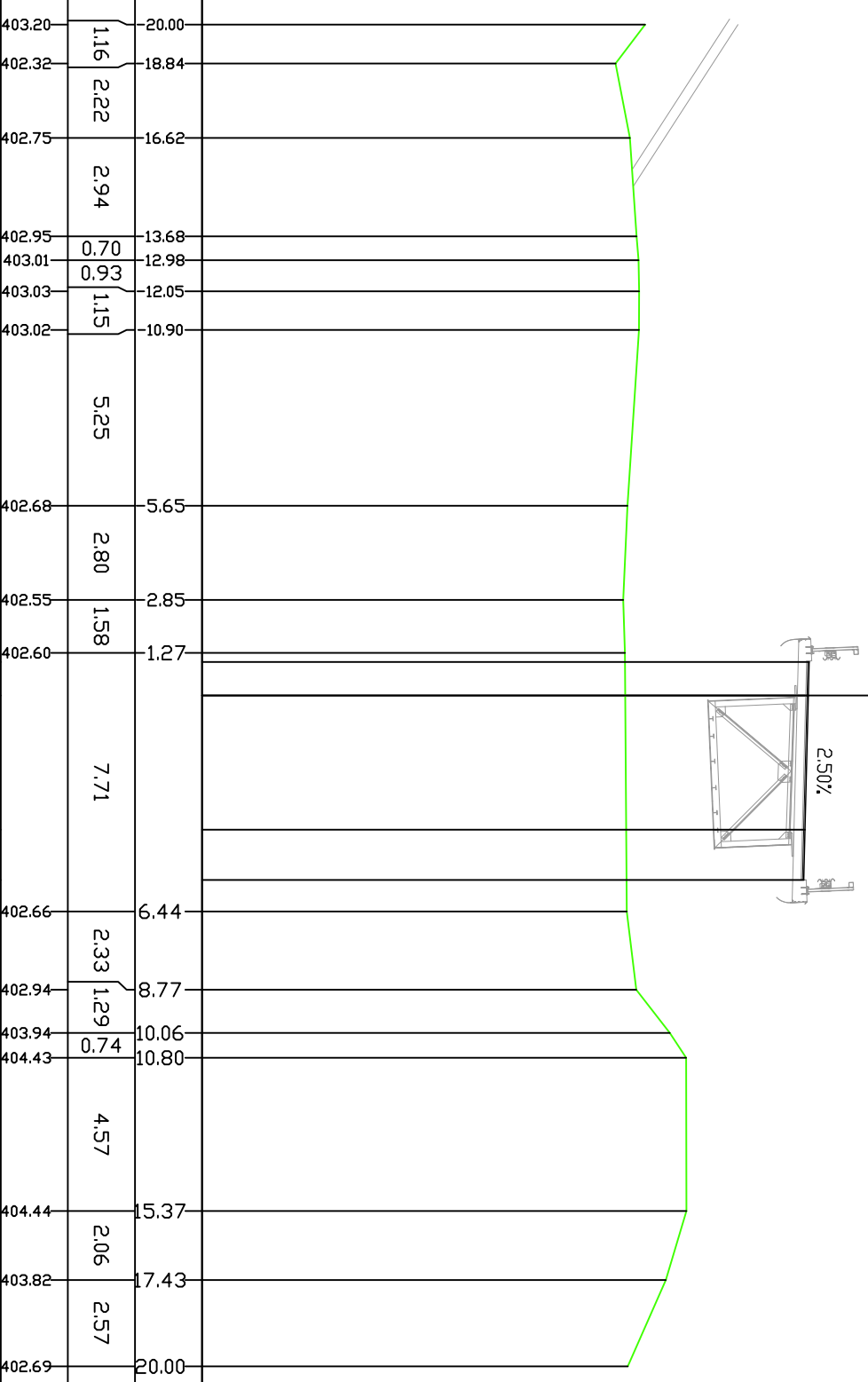

PROFILO BA-SV\_MM4quint

SEZIONE 47

PROGRESSIVA 918.06

USURA  
f1 6,53 ml.  
BINDER  
g1 6,53 ml.

390.00  
200  
200

PROGRESSIVE TERRENO	QUOTE TERRENO	PROGRESSIVE PROGETTO	PARZIALI PROGETTO	QUOTE PROGETTO
402.25	20.00			
402.74	16.75			
402.85	15.19			
402.95	12.01			
402.71	8.17			
408.76	1.03			
408.73	0.03			
402.36	1.80			
408.63	4.00			
408.59	5.50			
402.86	7.97			
403.86	9.26			
404.37	10.19			
403.51	13.68			
403.00	18.22			
402.20	20.00			

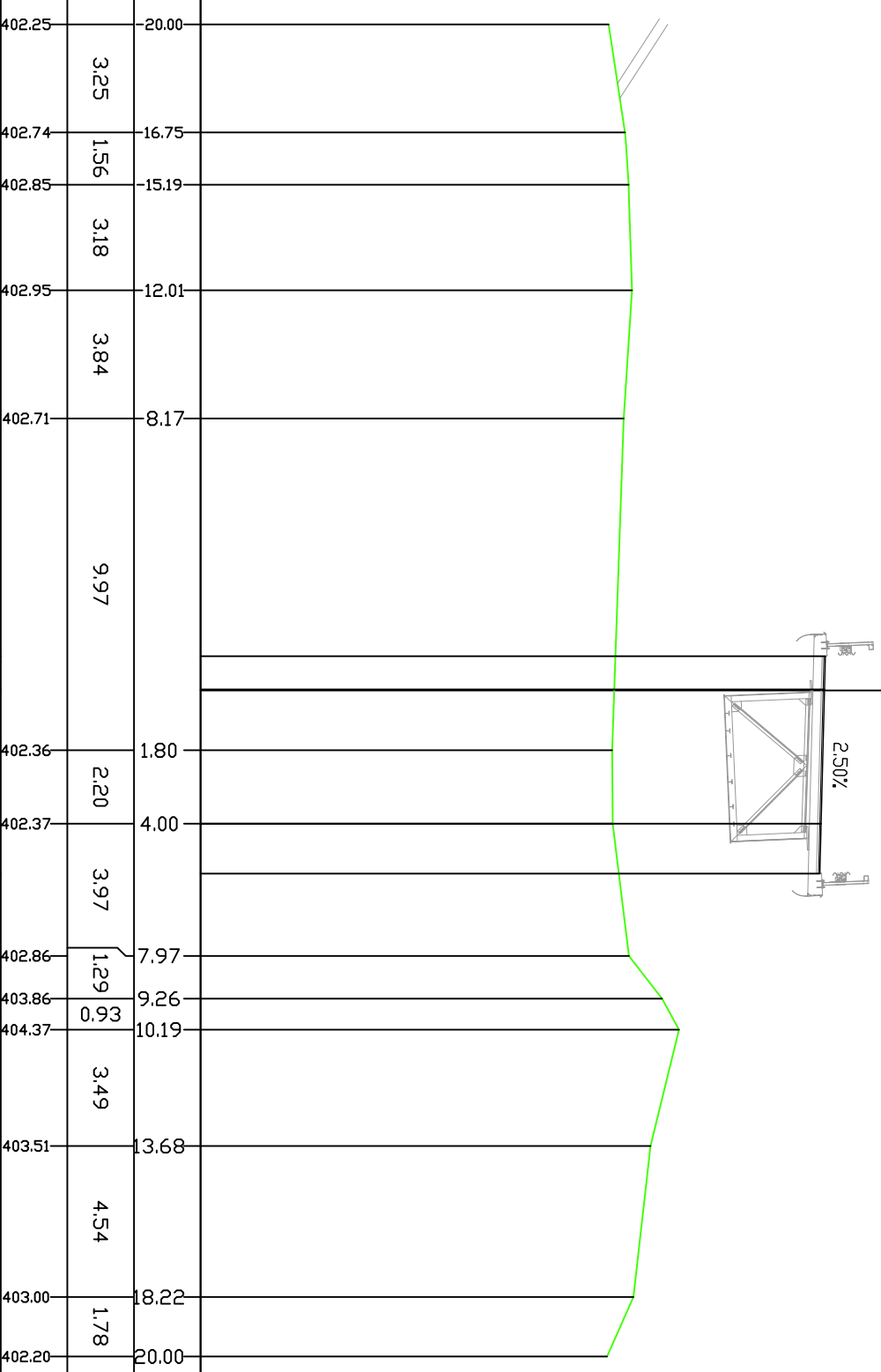

PROFILO BA-SV\_MM4quint

SEZIONE 48

PROGRESSIVA 934.02

USURA  
f1 6,73 ml.  
BINDER 6,73 ml.  
g1

390.00  
200  
200

PROGRESSIVE TERRENO	PARZIALI TERRENO	QUOTE TERRENO	PROGRESSIVE PROGETTO	PARZIALI PROGETTO	QUOTE PROGETTO
402.22	20.00		402.22		
402.34	18.74	1.26	402.34		
402.48	16.93	1.81	402.48		
402.51	15.97	0.96	402.51		
		10.17			
402.52	5.80		402.52		
		8.11			
409.69		1.23	409.69	1.00	
409.69		0.23	409.69		4.23
402.71	2.31		402.71		
409.69		4.95	409.69		1.50
409.69		5.50	409.69		
402.77	7.26		402.77		
403.75	9.89	2.63	403.75		
404.18	10.68	0.79	404.18		
		2.78			
403.50	13.46		403.50		
		2.71			
403.35	16.17		403.35		
		3.83			
402.54	20.00		402.54		

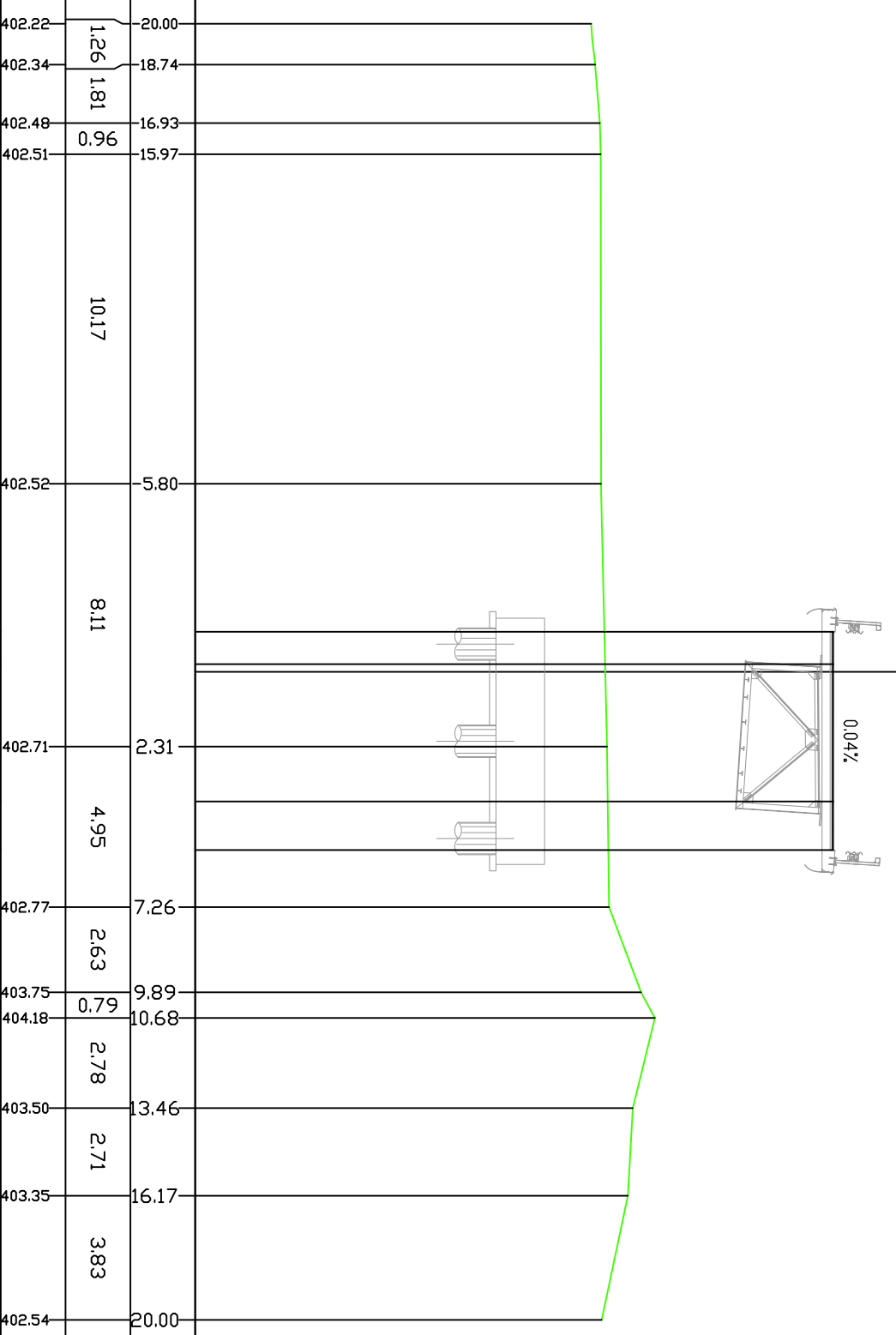

PROFILO BA-SV\_MM4quint

SEZIONE 49

PROGRESSIVA 950.00

USURA 7.17 ml.  
f1 BINDER 7.17 ml.  
g1

390.00  
200  
200

PROGRESSIVE TERRENO	QUOTE TERRENO	PROGRESSIVE TERRENO	QUOTE TERRENO
402.32	20.00	410.62	1.67
402.37	19.34	410.65	0.47
402.44	17.86	410.76	4.47
402.49	16.23	410.79	1.50
	7.83		
402.64	8.40		
	7.35		
402.66	1.05		
	4.54		
402.63	3.49		
	4.54		
402.68	8.03		
403.15	9.29		
	2.33		
404.22	11.62		
	5.04		
402.97	16.66		
402.97	18.50		
403.01	19.72		
402.93	20.00		

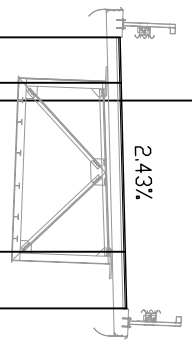

PROFILO BA-SV\_MM4quint

SEZIONE 50

PROGRESSIVA 973.11

USURA  
f1 7.98 ml.  
BLINDER  
g1 7.98 ml.

390.00  
200  
200

PROGRESSIVE TERRENO	PARZIALI TERRENO	QUOTE TERRENO	PROGRESSIVE PROGETTO	PARZIALI PROGETTO	QUOTE PROGETTO
402.39	20.00				
402.48	17.58	2.42			
402.59	16.25	1.33			
402.62	15.61	0.64			
		7.12			
402.76	8.49				
402.79	6.04	2.45			
411.92	2.48				
412.03	0.78	12.31		1.70	
				4.78	
412.31	4.00			1.50	
412.40	5.50				
402.35	6.27	2.00			
402.30	8.27				
		7.64			
402.62	15.91				
403.58	18.25	2.34			
404.15	19.61	1.36			
404.07	20.00	0.39			

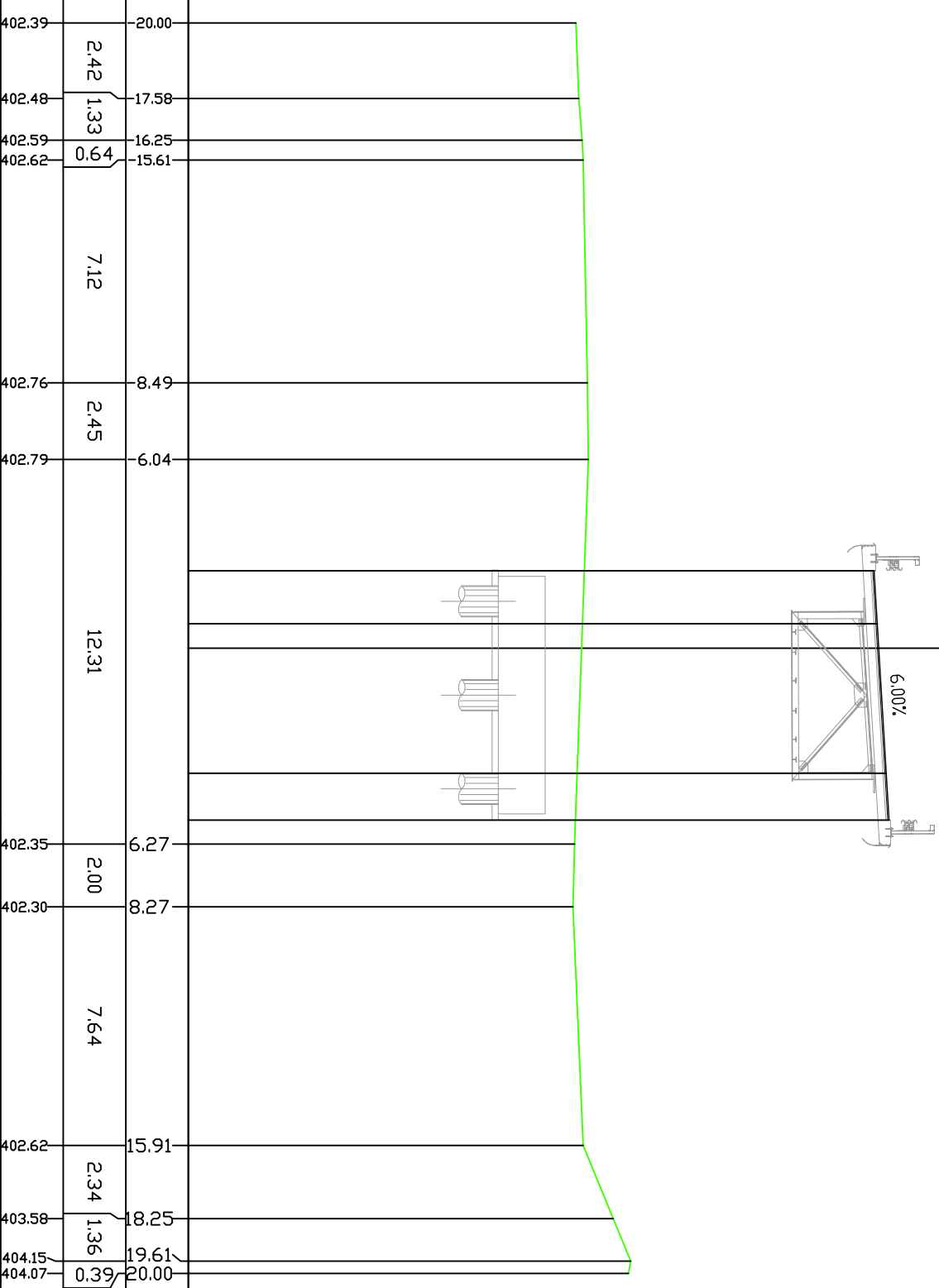



PROFILO BA-SV\_MM4quint

SEZIONE 51

PROGRESSIVA 1000.00

USURA 7.47 ml.  
f1 BINDER 7.47 ml.  
g1

390.00  
200  
200

PROGRESSIVE TERRENO	QUOTE TERRENO	PROGRESSIVE PARZIALI PROGETTO	QUOTE PARZIALI PROGETTO
402.41	20.00		
402.33	12.14		
402.43	9.25		
402.45	8.24		
402.32	6.30		
402.46	3.61		
413.24	1.97		
413.31	0.81		
402.66	0.03		
413.60	4.00		
413.69	5.50		
402.69	7.51		
402.56	13.57		
402.50	17.94		
402.50	20.00		

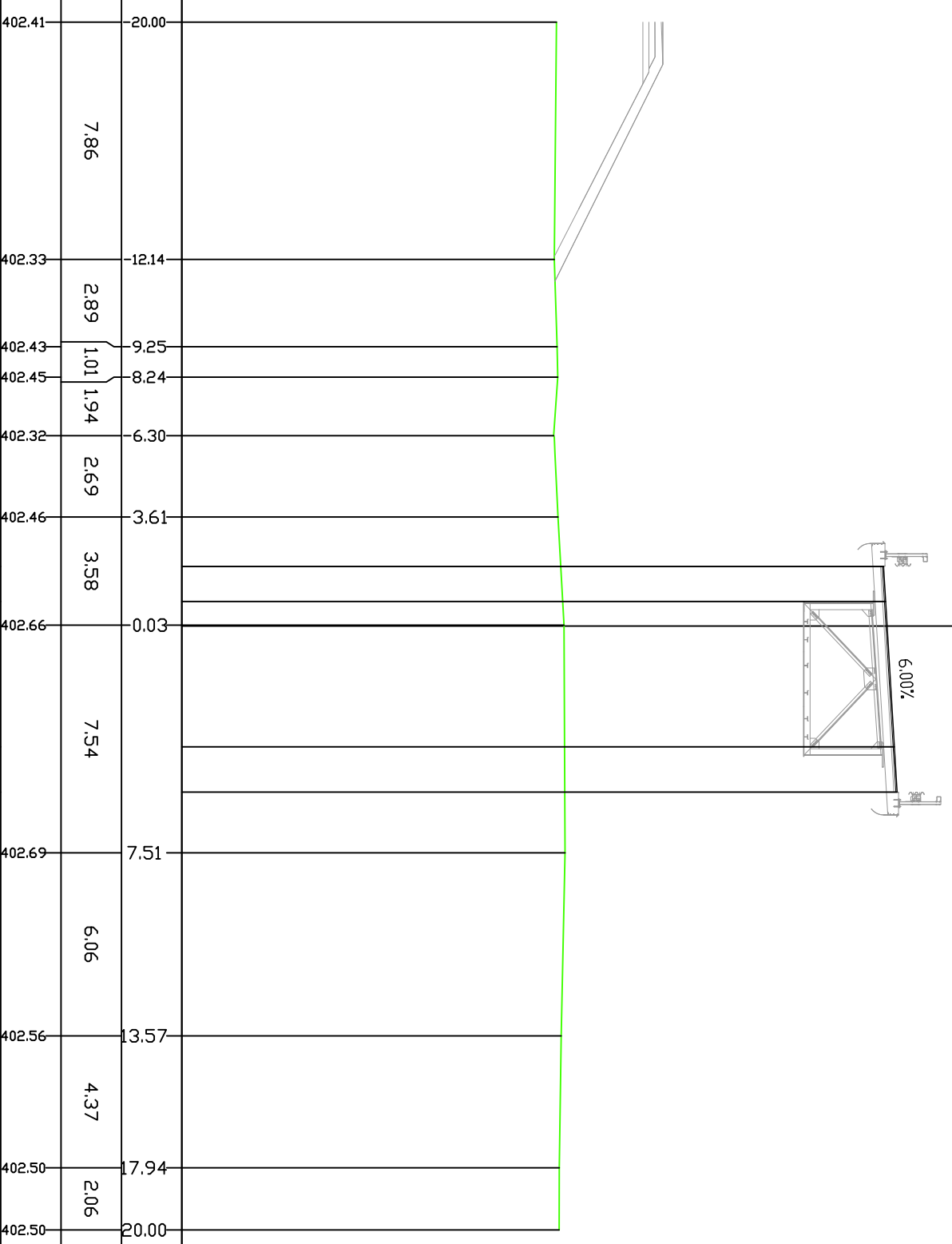

PROFILO BA-SV\_MM4quint

SEZIONE 52

PROGRESSIVA 1019.34

USURA  
f1  
BLINDER  
g1  
7.51 ml.  
7.51 ml.

390.00  
200  
200

PROGRESSIVE TERRENO	PARZIALI TERRENO	QUOTE TERRENO	PROGRESSIVE PROGETTO	PARZIALI PROGETTO	QUOTE PROGETTO
406.01	2.47	20.00			
405.97	3.04	17.53			
405.92	0.74	14.49			
405.91	4.88	13.75			
405.82	2.43	8.87			
405.78	3.20	6.44			
405.72	0.74	3.24			
405.71	1.68	2.52			
405.68	0.16	-0.84			
405.90	0.67	0.68			
405.97	0.74	0.01			
405.97	0.73	0.73			
405.47	0.44	1.17			
405.72	0.67	1.84			
405.71	0.85	2.69			
413.86	1.20	2.01			
413.94	4.81	0.81			
414.22	1.50	4.00			
414.31		5.50			
404.09	0.60	4.89			
404.80	1.50	5.54			
404.19	1.41	6.95			
403.82	0.85	7.80			
	6.45				
401.97	2.15	14.25			
401.92	3.60	16.40			
401.73		20.00			

Autostrada A32 - Discesa  
Direzione TORINO

Rampa di Ingresso A32  
direzione Torino - Rampa 4

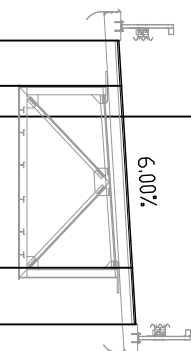

PROFILO BA-SV\_MM4quint

SEZIONE 53

PROGRESSIVA 1034.70

USURA 7.55 ml.  
f1 BINDER 7.55 ml.  
g1

390.00  
200  
200

PROGRESSIVE TERRENO	PARZIALI TERRENO	QUOTE TERRENO	PROGRESSIVE PROGETTO	PARZIALI PROGETTO	QUOTE PROGETTO
406.02	1.85	20.00	414.18	1.24	2.05
406.02	3.40	18.15	414.25	4.81	0.81
406.04	1.70	14.75	414.54	1.50	4.00
406.04	4.72	13.05	414.63		5.50
406.06	1.80	8.33			
406.07	0.67	6.53			
406.28		5.86			
	6.93				
406.29	0.90	1.07			
406.12	1.44	1.73			
406.07	3.27	3.17			
406.05	0.77	6.44			
406.04	3.26	7.21			
406.02	1.84	10.47			
406.00	2.19	12.31			
405.99	2.91	14.50			
405.96	1.13	17.41			
405.95	1.46	18.54			
405.94		20.00			

Autostrada A32 - Salita  
Direzione BARDONECCHIA

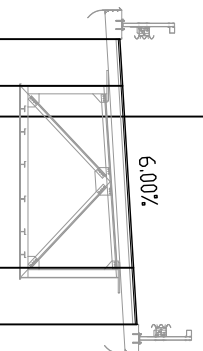

Autostrada A32 - Discesa  
Direzione TORINO

PROFILO BA-SV\_MM4quint

SEZIONE 54

PROGRESSIVA 1050.00

USURA 7.56 ml.  
F1 BINDER 7.56 ml.  
G1

390.00  
200  
200

PROGRESSIVE TERRENO	PARZIALI TERRENO	QUOTE TERRENO	PROGRESSIVE PROGETTO	PARZIALI PROGETTO	QUOTE PROGETTO
405.73	1.28	20.00			
405.72	1.04	18.72			
405.72	3.98	17.68			
405.70	0.71	13.70			
405.70	4.31	12.99			
405.67	4.98	8.68			
405.63	1.41	3.70			
405.62	0.65	2.29			
405.80	1.03	1.64			
405.90	1.57	0.61			
405.89	0.81	0.96			
405.88	1.60	1.80			
405.89	0.37	3.40			
405.68	0.48	3.77			
405.39	0.48	4.25			
405.40	0.85	5.10			
405.60	0.34	5.44			
405.65	0.90	6.34			
405.65	0.93	7.27			
405.27	4.30	11.57			
404.93	3.80	15.37			
404.54	3.38	18.75			
404.41	1.25	20.00			
414.34	1.25	2.06			
414.42	4.81	0.81			
414.71	1.50	4.00			
414.80		5.50			

Autostrada A32 - Salita  
Direzione BARDONECCHIA

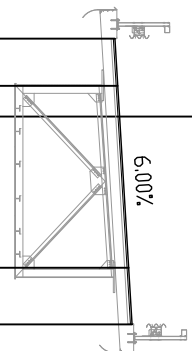

PROFILO BA-SV\_MM4quint

SEZIONE 55

PROGRESSIVA 1065.56

USURA  
f1 7.34 ml.  
BINDER  
g1 7.34 ml.

390.00  
200  
200

PROGRESSIVE TERRENO	PARZIALI TERRENO	QUOTE TERRENO	PROGRESSIVE PROGETTO	PARZIALI PROGETTO	QUOTE PROGETTO
402.61	3.10		414.36	1.06	1.84
402.29	2.82		414.42		0.78
402.12	4.53			4.78	
401.98	2.57			1.50	
402.04	1.99		414.71		4.00
401.95	2.21		414.80		5.50
401.92	4.41				
402.07	1.47				
402.16	5.33				
402.48	6.57				
402.58	5.00				
402.53					

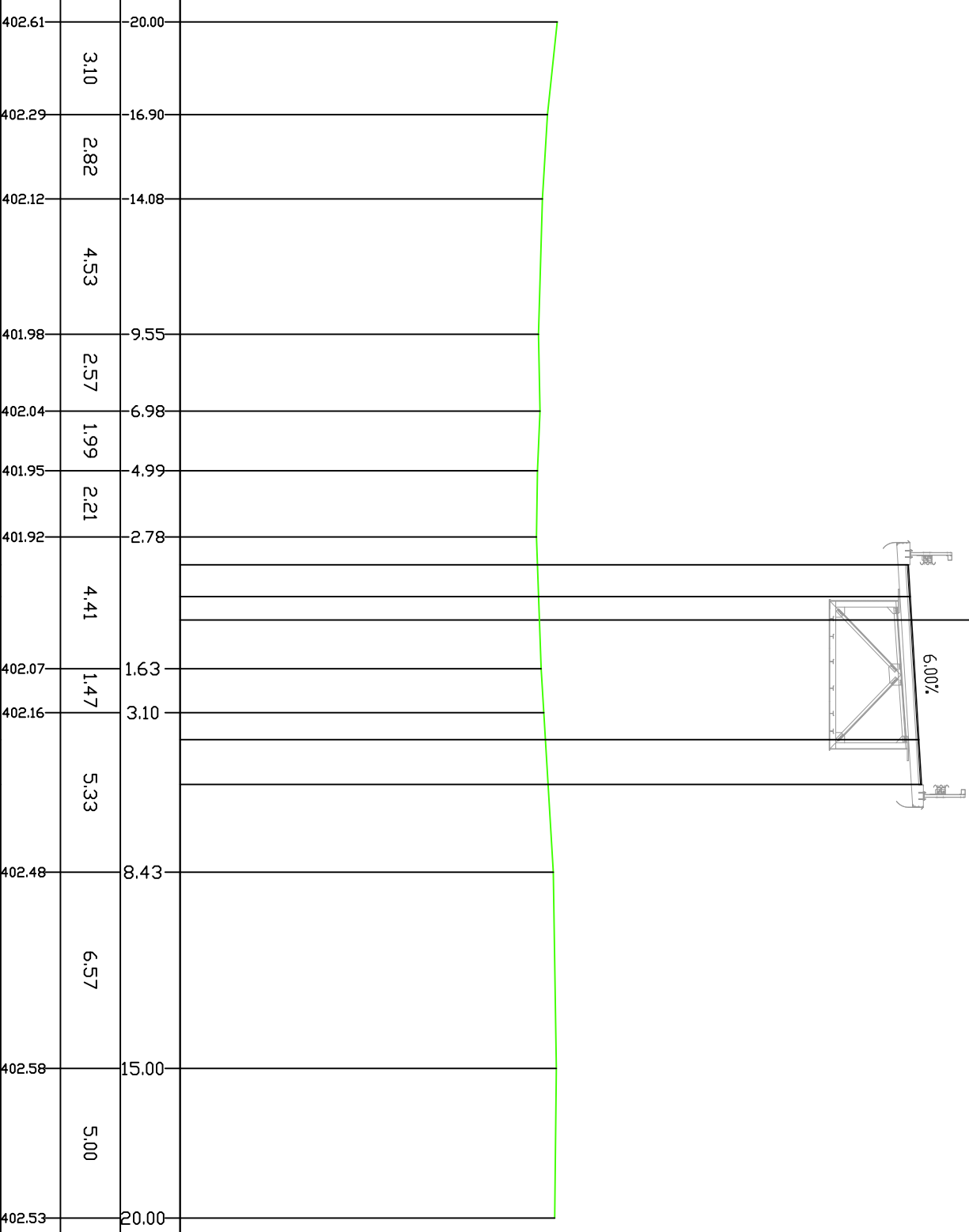

PROFILO BA-SV\_MM4quint

SEZIONE 56

PROGRESSIVA 1082.83

USURA 7.06 ml.  
f1 BINDER 7.06 ml.  
g1

390.00  
200  
200

PROGRESSIVE TERRENO
PARZIALI TERRENO
QUOTE TERRENO
PROGRESSIVE PROGETTO
PARZIALI PROGETTO
QUOTE PROGETTO

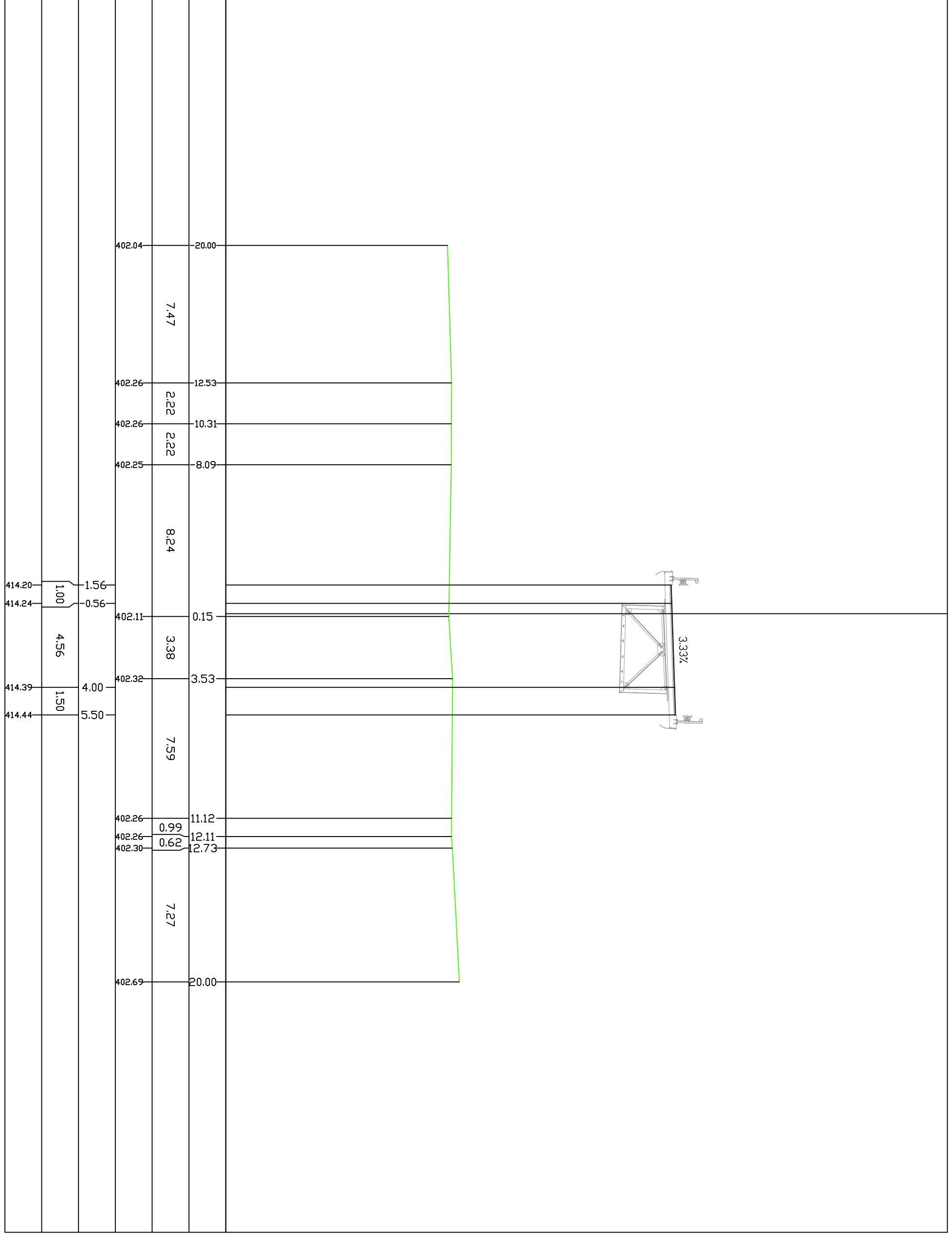

PROFILO BA-SV\_MM4quint

SEZIONE 57

PROGRESSIVA 1100.00

USURA  
f1 6,80 ml.  
BINDER 6,80 ml.  
g1

390.00  
200  
200

PROGRESSIVE TERRENO	PARZIALI TERRENO	QUOTE TERRENO	PROGRESSIVE PROGETTO	PARZIALI PROGETTO	QUOTE PROGETTO
402.35	8.10	20.00	402.35		
402.36	5.79	11.90	402.36		
402.35	4.78	6.11	402.35		
402.30	1.33	1.33	402.30	1.30	1.30
402.30	3.68	2.35	402.30	0.30	1.00
402.30	7.99	4.00	402.30	4.30	4.30
402.24	10.34	5.50	402.24	1.50	1.50
402.51	16.33	2.15	402.51		
402.64	18.48	1.35	402.64		
402.06	19.83	0.17	402.06		
401.96	20.00		401.96		

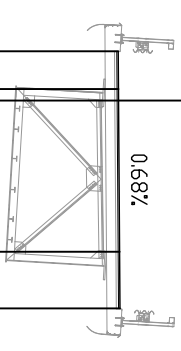

PROFILO BA-SV\_MM4quint

SEZIONE 58

PROGRESSIVA 1120.62

USURA  
f1 6,53 ml.  
BINDER  
g1 6,53 ml.

390.00  
200  
200

PROGRESSIVE TERRENO	PARZIALI TERRENO	QUOTE TERRENO	PROGRESSIVE PROGETTO	PARZIALI PROGETTO	QUOTE PROGETTO
402.39	20.00	6.71	402.34	13.29	2.59
402.34	13.29	2.59	402.34	10.70	
413.16	1.03	1.00	413.14	0.03	4.03
413.04	4.00	1.50	413.00	5.50	
402.72	8.20	2.86	402.76	11.06	1.86
402.70	12.92	5.24	402.35	18.16	0.77
402.35	18.16	0.77	402.00	18.93	1.07
402.00	18.93	1.07	401.77	20.00	

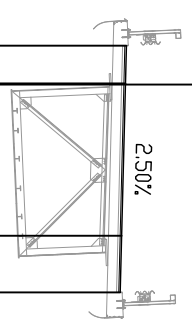



PROFILO BA-SV\_MM4quint

SEZIONE 59

PROGRESSIVA 1135.31

USURA  
f1  
BLINDER  
g1  
6:50 ml.  
6:50 ml.

390.00  
200  
200

PROGRESSIVE TERRENO	PARZIALI TERRENO	QUOTE TERRENO	PROGRESSIVE PROGETTO	PARZIALI PROGETTO	QUOTE PROGETTO
402.49	20.00		412.48	1.00	
402.43	17.38	2.62	412.46	1.00	1.00
		11.33		4.00	4.00
402.39	6.05	3.48	412.36	1.50	5.50
402.40	2.57	1.85	412.32		
402.43	0.72				
		7.68			
402.63	6.96				
		6.80			
402.53	13.76	5.07			
		18.83			
402.45	18.83	1.17			
402.01	20.00				

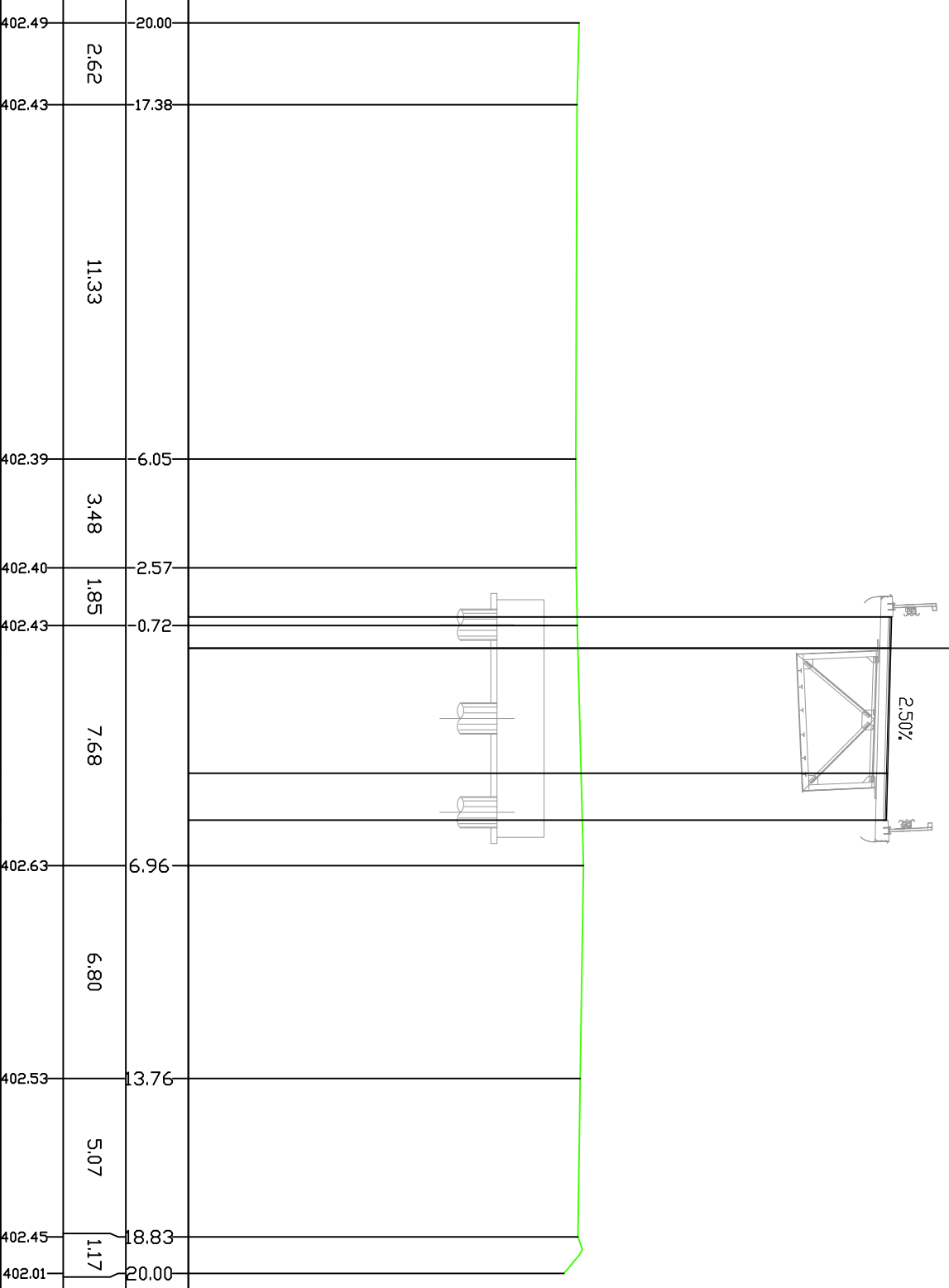

PROFILO BA-SV\_MM4quint

SEZIONE 60

PROGRESSIVA 1150.00

USURA f1 6:50 ml.  
BLINDER g1 6:50 ml.

PROGRESSIVE TERRENO	390.00	200	200
PARZIALI TERRENO			
QUOTE TERRENO			
PROGRESSIVE PROGETTO			
PARZIALI PROGETTO			
QUOTE PROGETTO			

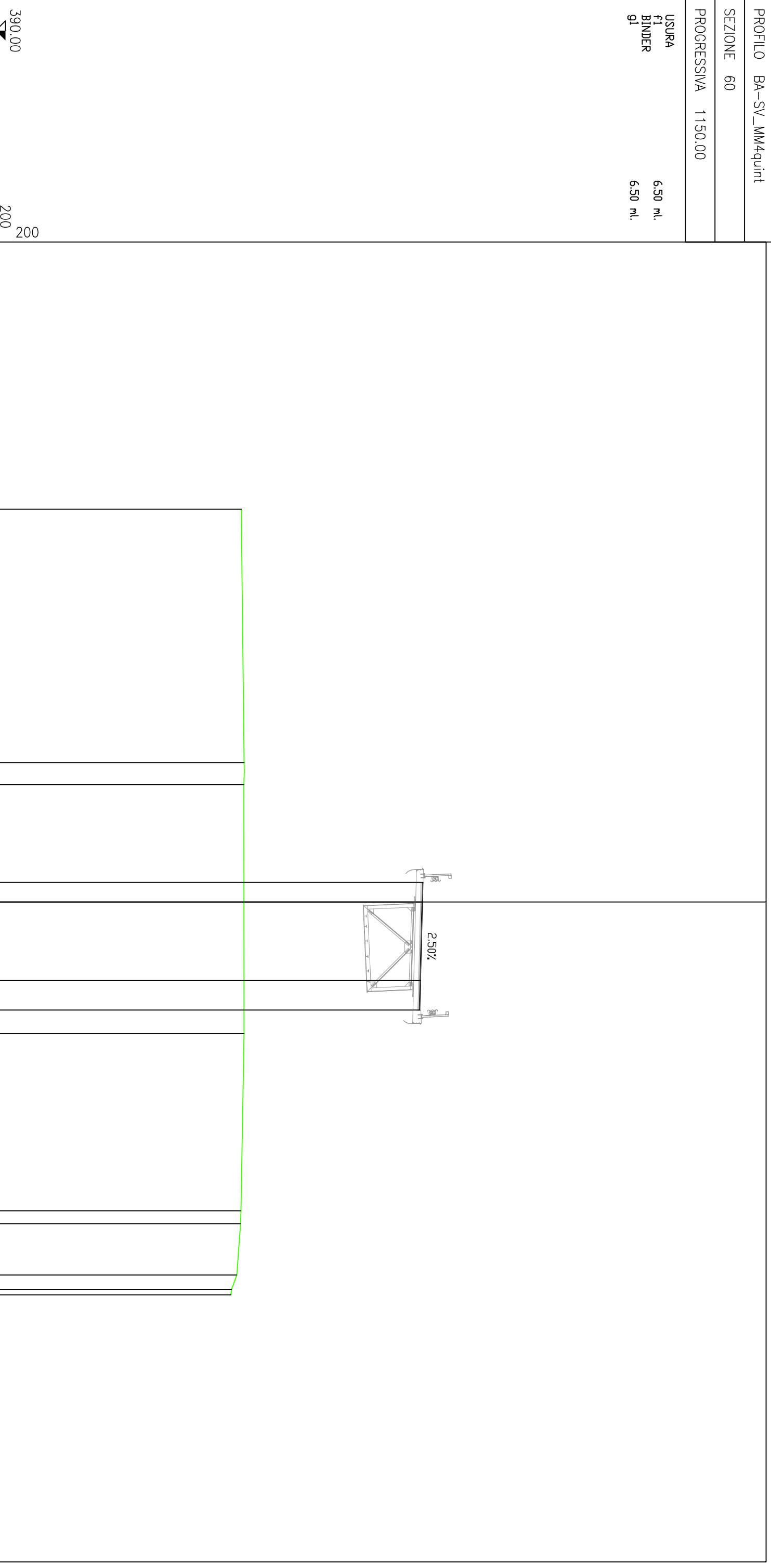

PROFILO BA-SV\_MM4quint

SEZIONE 61

PROGRESSIVA 1175.00

STERRI E RIPORTI	37.39 mq.
R1 STABILIZZATO	1.27 mq.
D1 CEMENTATO	1.27 mq.
E1 BASE	0.65 mq.
F1 USURA	6.50 ml.
f1 BINDER	6.50 ml.
g1	

390.00  
 ▼  
 PROGRESSIVE  
 TERRENO

200  
 200

PARZIALI TERRENO	2.85	8.02	5.71	10.89	4.23	3.61	1.82	0.68	0.91	1.03						
QUOTE TERRENO	20.00	17.15	9.13	3.42	7.47	8.07	12.30	15.91	17.73	18.41	18.97	20.00				
PROGRESSIVE PROGETTO	403.08	402.99	402.74	402.88	410.49	410.46	410.36	410.32	402.70	402.69	402.68	402.67	402.56	402.51	402.24	401.81
PARZIALI PROGETTO	1.00	4.00	1.50	0.60	0.60	0.50	0.50	0.50	0.50	0.50	0.50	0.50	0.50	0.50	0.50	0.50
QUOTE PROGETTO	1.00	4.00	1.50	1.00	1.00	1.00	1.00	1.00	1.00	1.00	1.00	1.00	1.00	1.00	1.00	1.00

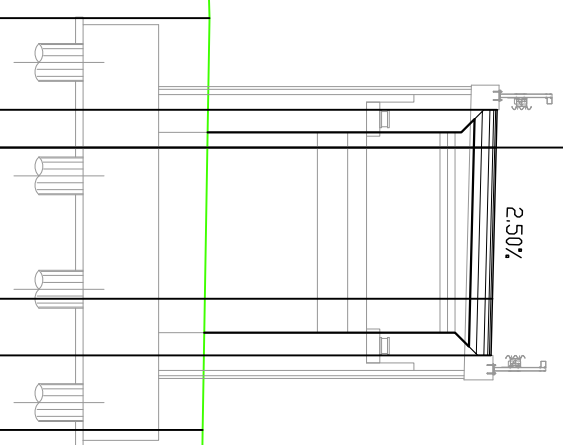

PROFILO BA-SV\_MM4quint

SEZIONE 62

PROGRESSIVA 1200.00

STERRI E RIPORTI	43.50 mq.
R1	
SCOTICID	1.53 mq.
A1	
BONIFICA	2.32 mq.
B1	
STABILIZZATO	1.54 mq.
D1	
CEMENTATO	1.39 mq.
E1	
BASE	0.67 mq.
F1	
TNT	8.71 ml.
a1	
GEDRIGLIA 10KN/m	7.71 ml.
b1	
USURA	6.65 ml.
f1	
BINDER	6.65 ml.
g1	

390.00  
 200  
 200

PROGRESSIVE TERRENO			
PARZIALI TERRENO			
QUOTE TERRENO			
PROGRESSIVE PROGETTO			
PARZIALI PROGETTO			
QUOTE PROGETTO			

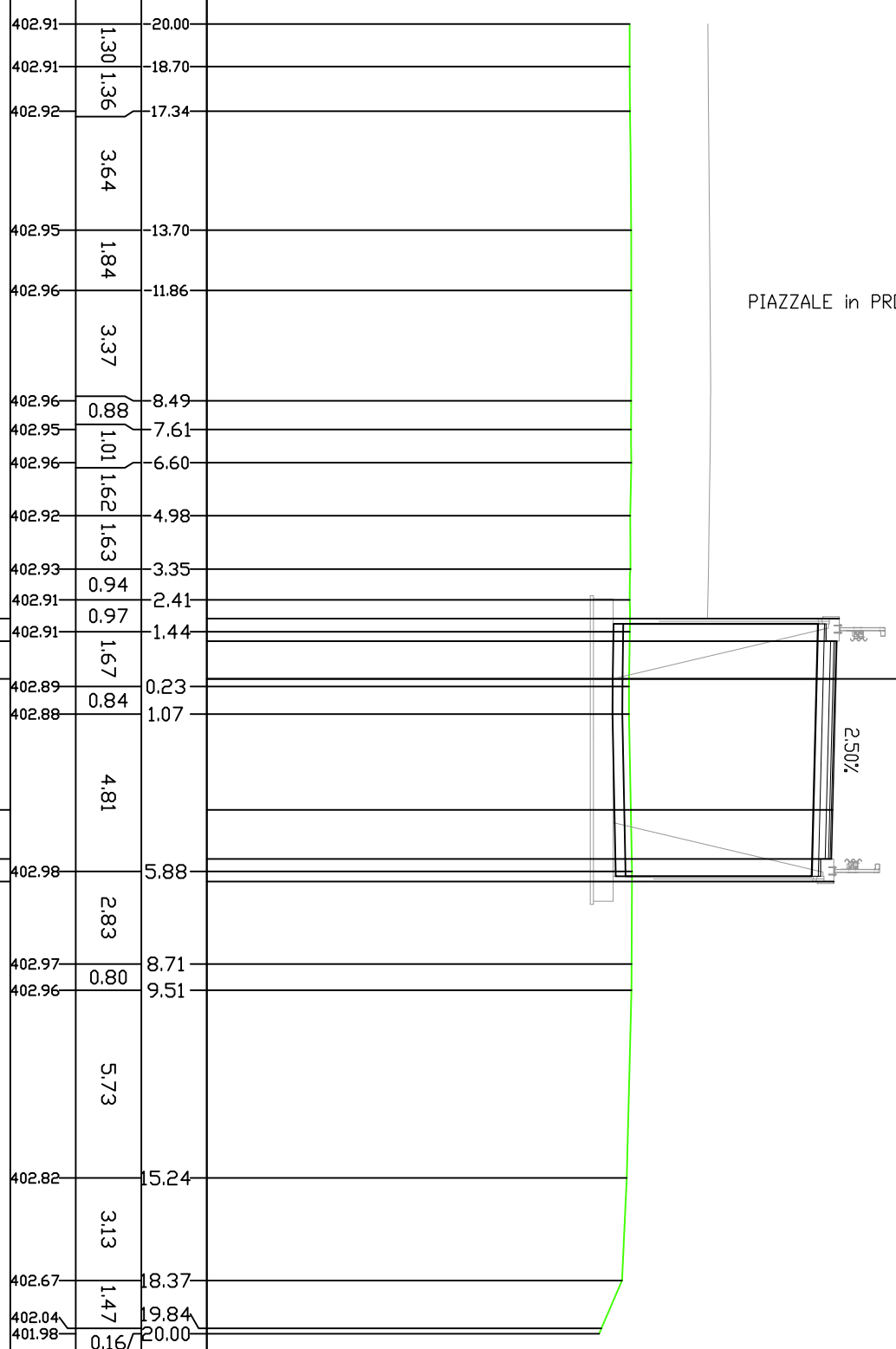

PROFILO BA-SV\_MM4quint

SEZIONE 63

PROGRESSIVA 1225.00

STERRI E RIPORTI	
R1	35,45 mq.
SCOTICD	1,63 mq.
A1	2,40 mq.
BONIFICA	1,61 mq.
B1	1,46 mq.
STABILIZZATO	0,70 mq.
DI	9,06 ml.
CEMENTATO	8,06 ml.
E1	7,00 ml.
BASE	7,00 ml.
F1	7,00 ml.
TNT	7,00 ml.
a1	
GEDRIGLIA 10KN/m	
b1	
USURA	
f1	
BINDER	
g1	

390.00  
 200  
 200

PROGRESSIVE TERRENO	QUOTE TERRENO	PROGRESSIVE PROGETTO	PARZIALI PROGETTO	QUOTE PROGETTO
402.98	20.00			
402.92	17.69		2.31	
402.88	14.21		3.48	
402.94	11.90		2.31	
402.87	7.35		4.55	
402.90	3.29		4.06	
408.06	2.19	402.90	4.41	0.69
407.99	1.50	402.91	3.32	1.50
407.95	0.00	402.92	3.05	4.00
407.85	4.00	402.91	6.09	1.50
407.81	5.50	402.88	4.40	0.69
407.88	6.19	402.84	2.02	
		402.16		

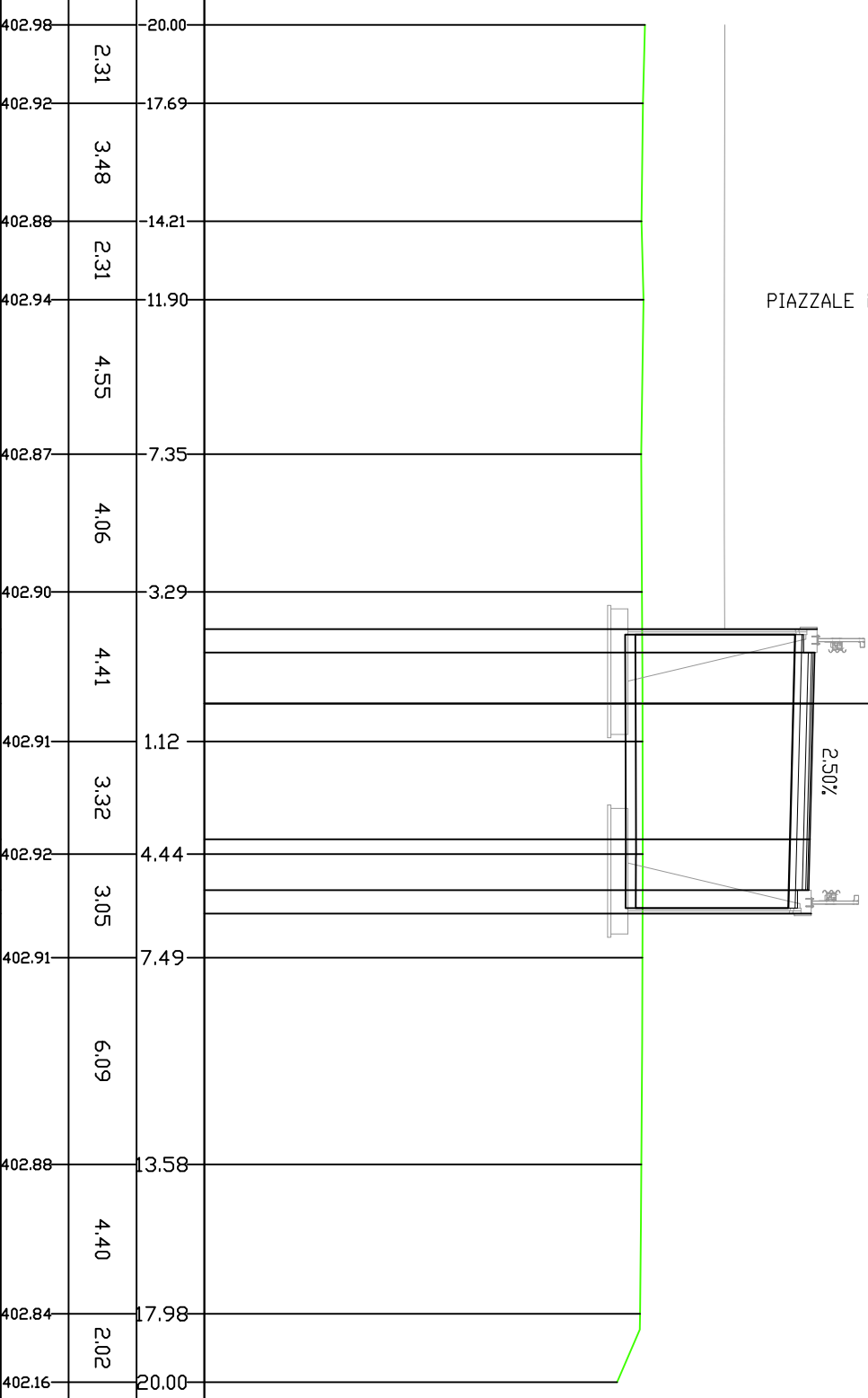

PIAZZALE in PROGETTO

2.50%

2.50m

PROFILO BA-SV\_MM4quint

SEZIONE 64

PROGRESSIVA 1250.00

STERRI E RIPORTI	
R1	24,45 mq.
SCOTICD	1,60 mq.
A1	2,42 mq.
BONIFICA	1,62 mq.
B1	1,51 mq.
STABILIZZATO	0,70 mq.
DI	9,06 ml.
CEMENTATO	8,06 ml.
E1	7,00 ml.
BASE	7,00 ml.
F1	7,00 ml.
TNT	7,00 ml.
a1	
GEDRIGLIA 10KN/m	
b1	
USURA	
f1	
BINDER	
g1	

390.00  
 ▲  
 200  
 200

PROGRESSIVE TERRENO	PARZIALI TERRENO	QUOTE TERRENO	PROGRESSIVE PROGETTO	PARZIALI PROGETTO	QUOTE PROGETTO
403.05	5.28		403.05		
402.99	0.62		402.99		
402.99			402.99		
	15.35				
406.83		2.19	406.83		0.69
406.76		1.50	406.76		1.50
406.72		0.00	406.72		4.00
403.04	2.06		403.04		
403.07	1.84		403.07		1.50
403.05	0.69		403.05		0.69
403.05			403.05		
	7.18				
403.07		2.98	403.07		
403.11	3.79		403.11		
403.12	1.31		403.12		
403.12	1.92		403.12		
402.32		20.00	402.32		

PIAZZALE in PROGETTO

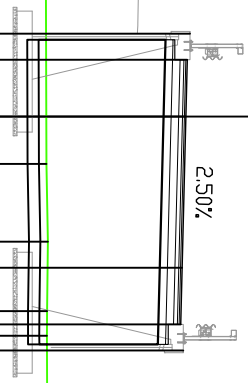

PROFILO BA-SV\_MM4quint

SEZIONE 65

PROGRESSIVA 1275.00

STERRI E RIPORTI	17.19 mq.
R1	1.60 mq.
SCOTICD	2.43 mq.
A1	1.62 mq.
BONIFICA	1.46 mq.
B1	0.70 mq.
STABILIZZATO	9.07 ml.
D1	8.06 ml.
CEMENTATO	7.00 ml.
E1	7.00 ml.
BASE	7.00 ml.
F1	7.00 ml.
TNT	7.00 ml.
a1	
GEDRIGLIA 10KN/m	
b1	
USURA	
f1	
BINDER	
g1	

390.00  
 200  
 200

PROGRESSIVE TERRENO	402.60	402.37	402.30	402.31	403.01	403.20	403.19	403.18	403.18	403.23	402.60
PARZIALI TERRENO	2.50	4.81	2.67	9.55	3.21	0.74	1.81	6.95	12.14	1.34	
QUOTE TERRENO											
PROGRESSIVE PROGETTO											
PARZIALI PROGETTO											
QUOTE PROGETTO											

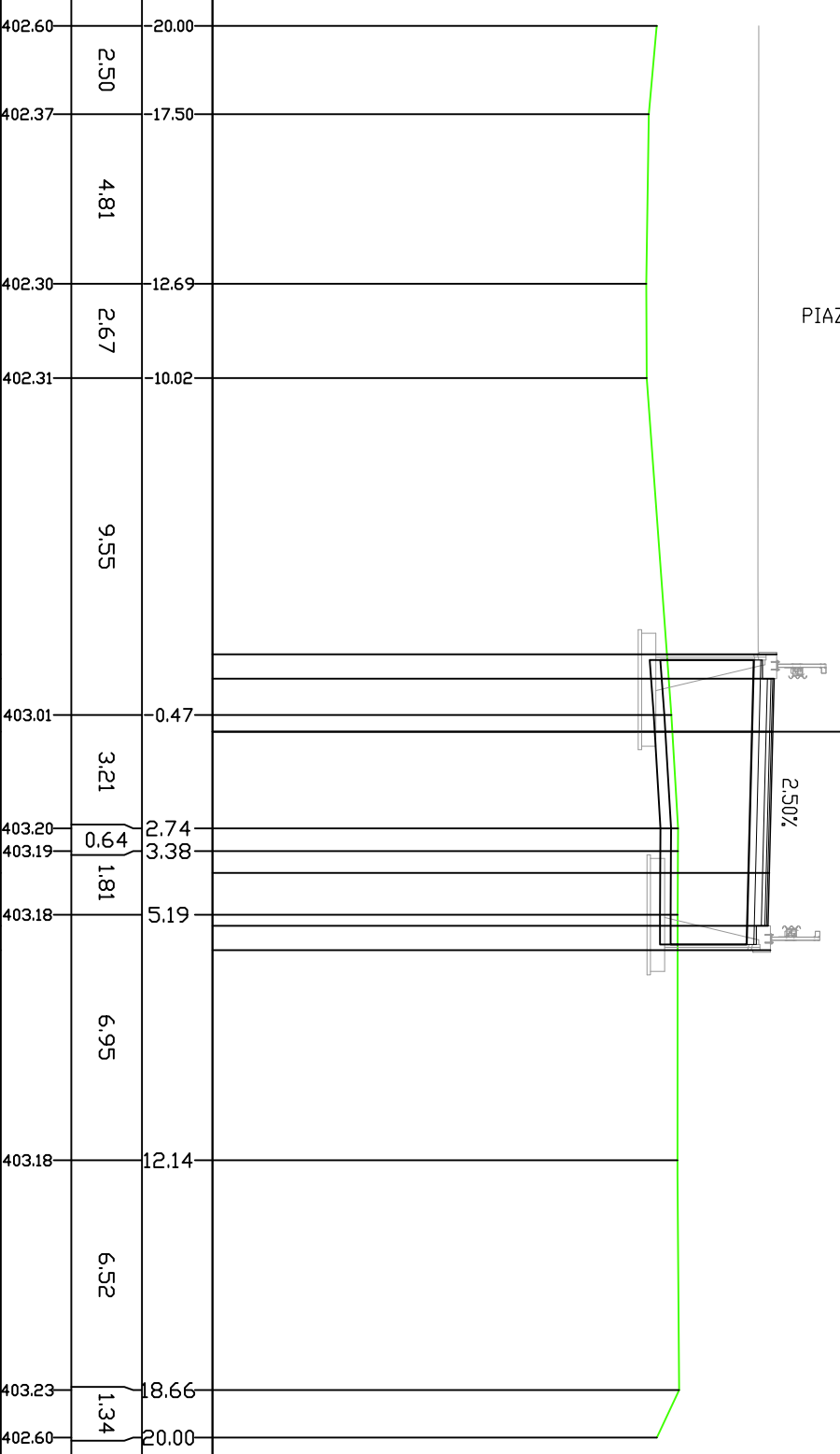

PROFILO BA-SV\_MM4quint

SEZIONE 66

PROGRESSIVA 1300.00

STERRI E RIPRINTI	
R1	1343 mq.
SCOTICD	1.60 mq.
A1	243 mq.
BONIFICA	
B1	161 mq.
STABILIZZATO	
D1	1.47 mq.
CEMENTATO	
E1	0.70 mq.
BASE	
F1	1.00 ml.
TNT	9.06 ml.
a1	1006 ml.
a2	0.00 ml.
Totale:	
GEDRIGLIA 10KN/m	8.06 ml.
b1	8.06 ml.
b2	8.06 ml.
Totale:	
USURA	7.00 ml.
f1	7.00 ml.
BINDER	
g1	7.00 ml.

390.00  
 200  
 200

PROGRESSIVE TERRENO	402.52	402.54	402.58	405.63	405.56	405.52	405.42	405.38	405.45	403.27	403.25	403.19	402.88	402.75
PROGRESSIVE PROGETTO	20.00	16.01	11.11	0.20	3.26	5.84	6.61	9.01	16.62	19.09	19.74	20.00		
PARZIALI TERRENO	3.99	4.90	11.31	3.06	2.58	0.77	2.40	7.61	2.47	0.91	0.26			
QUOTE TERRENO														
PROGRESSIVE PROGETTO														
PARZIALI PROGETTO														
QUOTE PROGETTO														

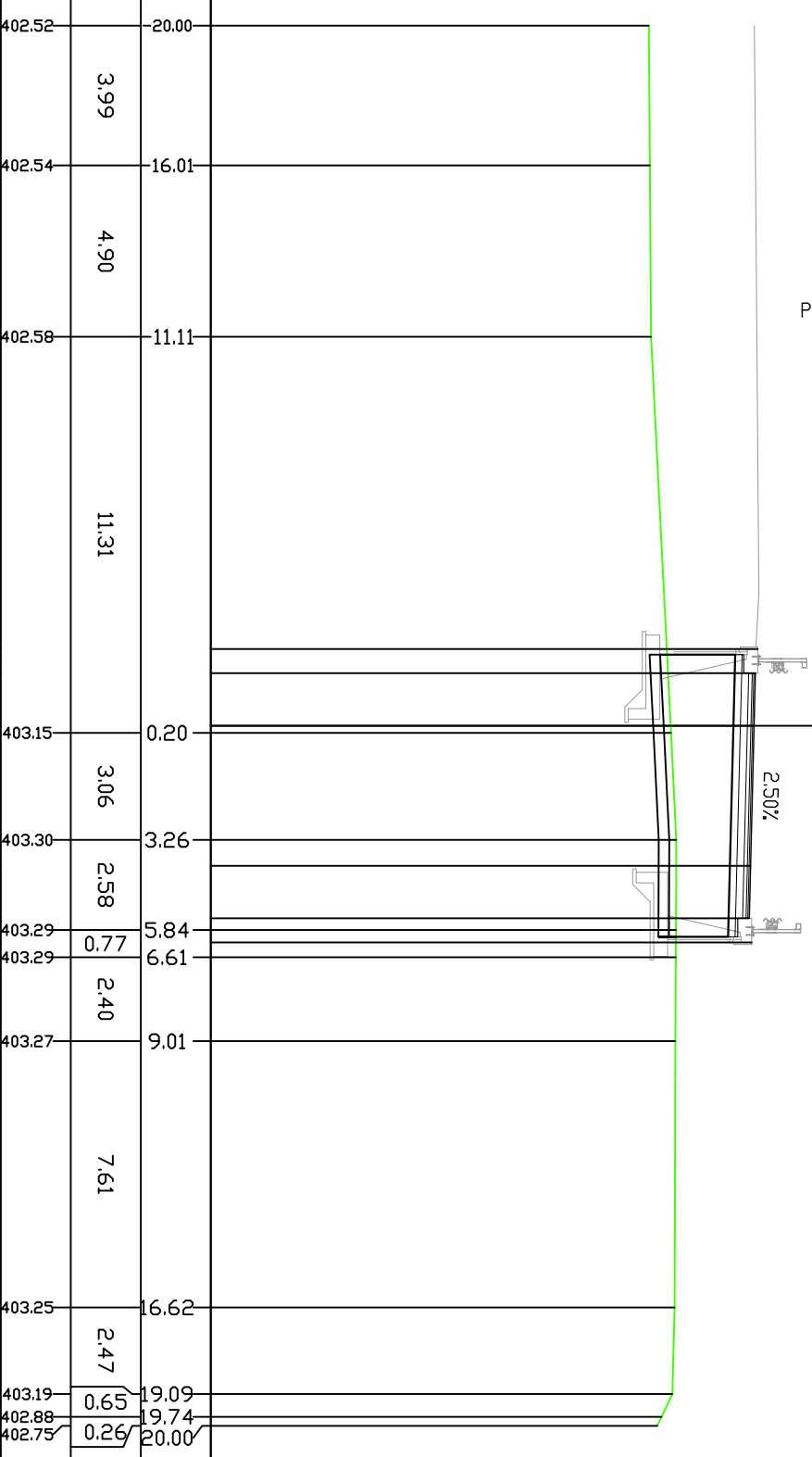

PIAZZALE in PROGETTO

2.50%



PROFILO BA-SV\_MM4quint

SEZIONE 67

PROGRESSIVA 1325.00

STERRI E RIPORTI	16,09 mq.
R1	
SCOTICID	1,90 mq.
A1	
BONIFICA	2,86 mq.
B1	
STABILIZZATO	1,88 mq.
D1	
CEMENTATO	1,71 mq.
E1	
BASE	0,71 mq.
F1	
VEGETALE	0,54 mq.
G1	
TNT	
a1	10,54 ml.
GEDRIGLIA 10KN/m	
b1	9,52 ml.
IDROSEMINA	
e1	1,99 ml.
USURA	
f1	7,00 ml.
BINDER	
g1	7,00 ml.

390.00  
 200  
 200

PROGRESSIVE TERRENO	403.28	403.12	402.91	402.82	402.89	405.66	405.59	405.55	405.45	405.41	405.48	403.44	403.45	403.44	403.41	403.41	403.29	402.98	
PARZIALI TERRENO	1.98	3.62	7.23	2.61	9.06	1.50	1.50	4.00	1.50	0.69		1.95	0.94	3.85	1.48	6.62	0.66		
QUOTE TERRENO	20.00	18.02	14.40	7.17	4.56	3.00	1.50	0.00	4.00	5.50	6.19	4.50	6.45	7.39	11.24	12.72	19.34	20.00	
PROGRESSIVE PROGETTO																			
PARZIALI PROGETTO																			
QUOTE PROGETTO																			

PIAZZALE in PROGETTO

2.50%

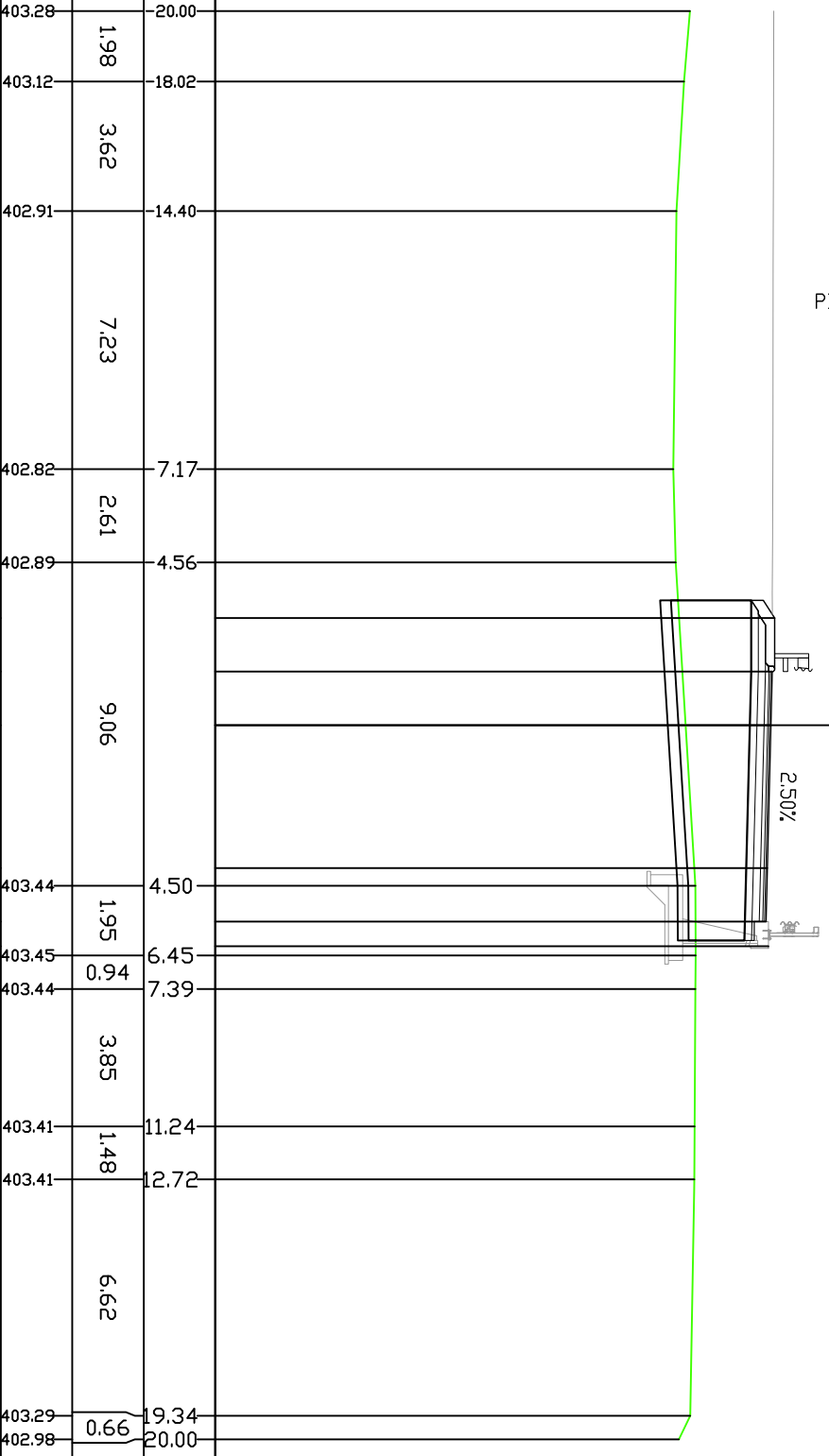

PROFILO BA-SV\_MM4quint

SEZIONE 68

PROGRESSIVA 1350.00

STERRI E RIPORTI	14.75 mq.
R1 SCOTICD	1.91 mq.
A1 BONIFICA	2.85 mq.
B1 STABILIZZATO	1.87 mq.
D1 CEMENTATO	1.77 mq.
E1 BASE	0.72 mq.
F1 VEGETALE	0.53 mq.
G1 TNT	10.52 ml.
a1 GEDRIGLIA 10KN/m	9.52 ml.
b1 IDROSEMINA	1.99 ml.
e1 USURA	7.00 ml.
f1 BINDER	7.00 ml.
g1	7.00 ml.

390.00  
 ▼  
 200  
 200

PROGRESSIVE TERRENO	403.47	20.00	
PARZIALI TERRENO	403.34	15.41	4.59
QUOTE TERRENO	403.23	8.89	6.52
PROGRESSIVE PROGETTO	403.20	7.17	1.72
PARZIALI PROGETTO	403.22	6.32	0.85
QUOTE PROGETTO	405.72	3.00	3.48
	405.65	1.50	9.50
	405.62	0.00	4.00
	405.52	4.00	1.50
	405.48	5.50	0.69
	405.55	6.19	
	403.59	6.66	2.62
	403.64	9.28	2.69
	403.62	11.97	4.83
	403.59	16.80	1.80
	403.57	18.60	0.96
	403.55	19.56	
	403.34	20.00	0.44

PIAZZALE in PROGETTO

2.50%

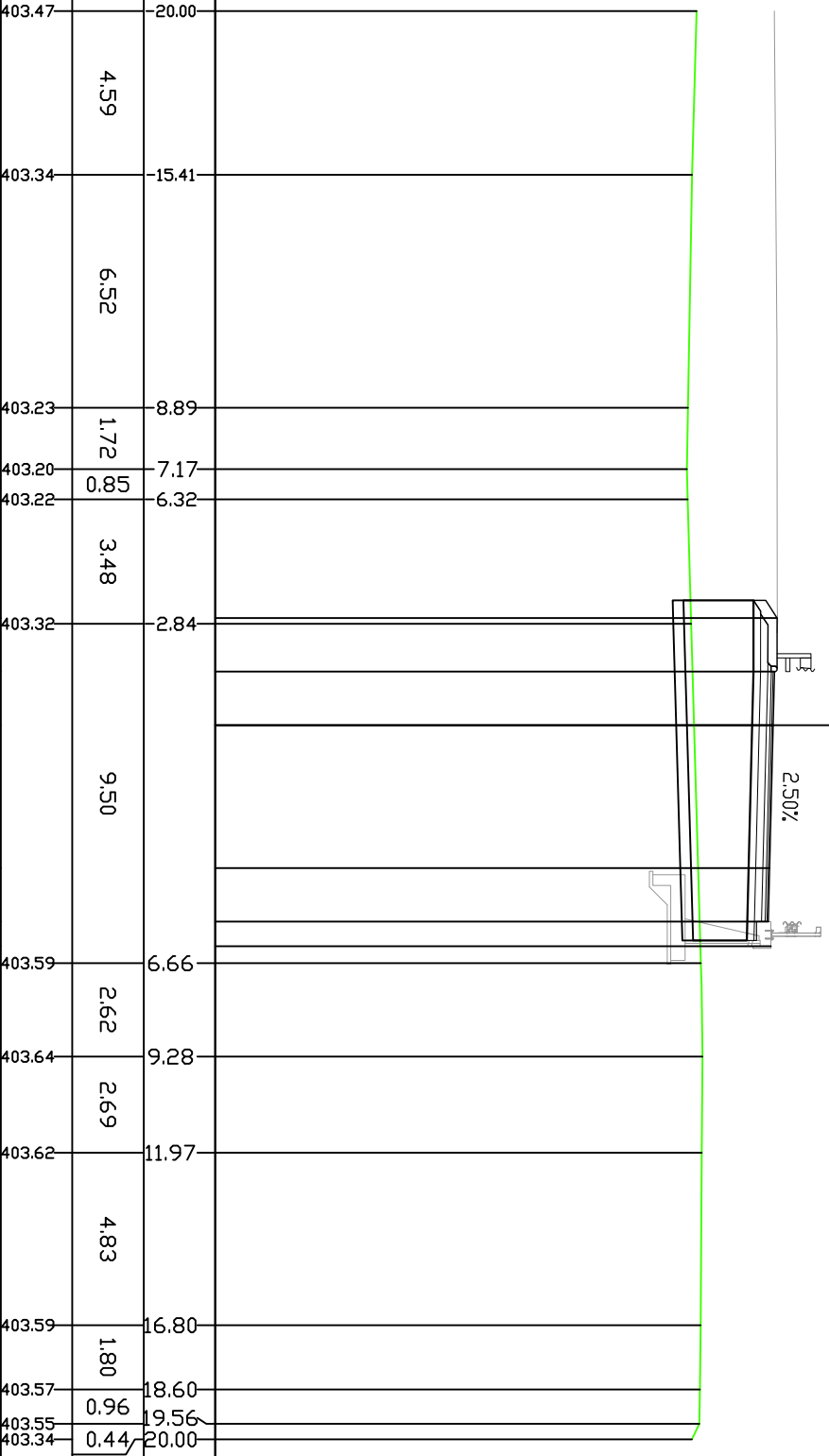

PROFILO BA-SV\_MM4quint

SEZIONE 69

PROGRESSIVA 1375.00

STERRI E RIPORTI	
R1	1359 mq.
SCOTICD	1.90 mq.
A1	2.85 mq.
BONIFICA	1.88 mq.
B1	1.71 mq.
STABILIZZATO	0.72 mq.
D1	0.53 mq.
CEMENTATO	10.52 ml.
E1	9.52 ml.
BASE	1.99 ml.
F1	7.00 ml.
VEGETALE	7.00 ml.
G1	7.00 ml.
TNT	
a1	
GEDRIGLIA 10KN/m	
b1	
IDROSEMINA	
e1	
USURA	
f1	
BINDER	
g1	

390.00  
 200  
 200

PROGRESSIVE TERRENO	403.39	20.00	
PARZIALI TERRENO	403.39	7.75	
QUOTE TERRENO	403.39	2.49	
PROGRESSIVE PROGETTO	403.39	9.76	
PARZIALI PROGETTO	403.38	0.92	
QUOTE PROGETTO	403.38	1.74	
PROGRESSIVE TERRENO	403.44	7.10	
PARZIALI TERRENO	405.79	3.00	
QUOTE TERRENO	405.72	1.50	
PROGRESSIVE PROGETTO	405.68	0.00	
PARZIALI PROGETTO	405.68	4.00	
QUOTE PROGETTO	405.58	4.00	
PROGRESSIVE TERRENO	405.54	5.50	
PARZIALI TERRENO	405.61	0.69	
QUOTE TERRENO	403.69	3.52	
PROGRESSIVE PROGETTO	403.69	3.16	
PARZIALI PROGETTO	403.69	1.27	
QUOTE PROGETTO	403.69	7.95	
PROGRESSIVE TERRENO	403.72	17.27	
PARZIALI TERRENO	403.69	2.20	
QUOTE TERRENO	403.44	0.53	
PROGRESSIVE PROGETTO	403.44	19.47	
PARZIALI PROGETTO	403.44	20.00	
QUOTE PROGETTO			

PIAZZALE in PROGETTO

2.50%

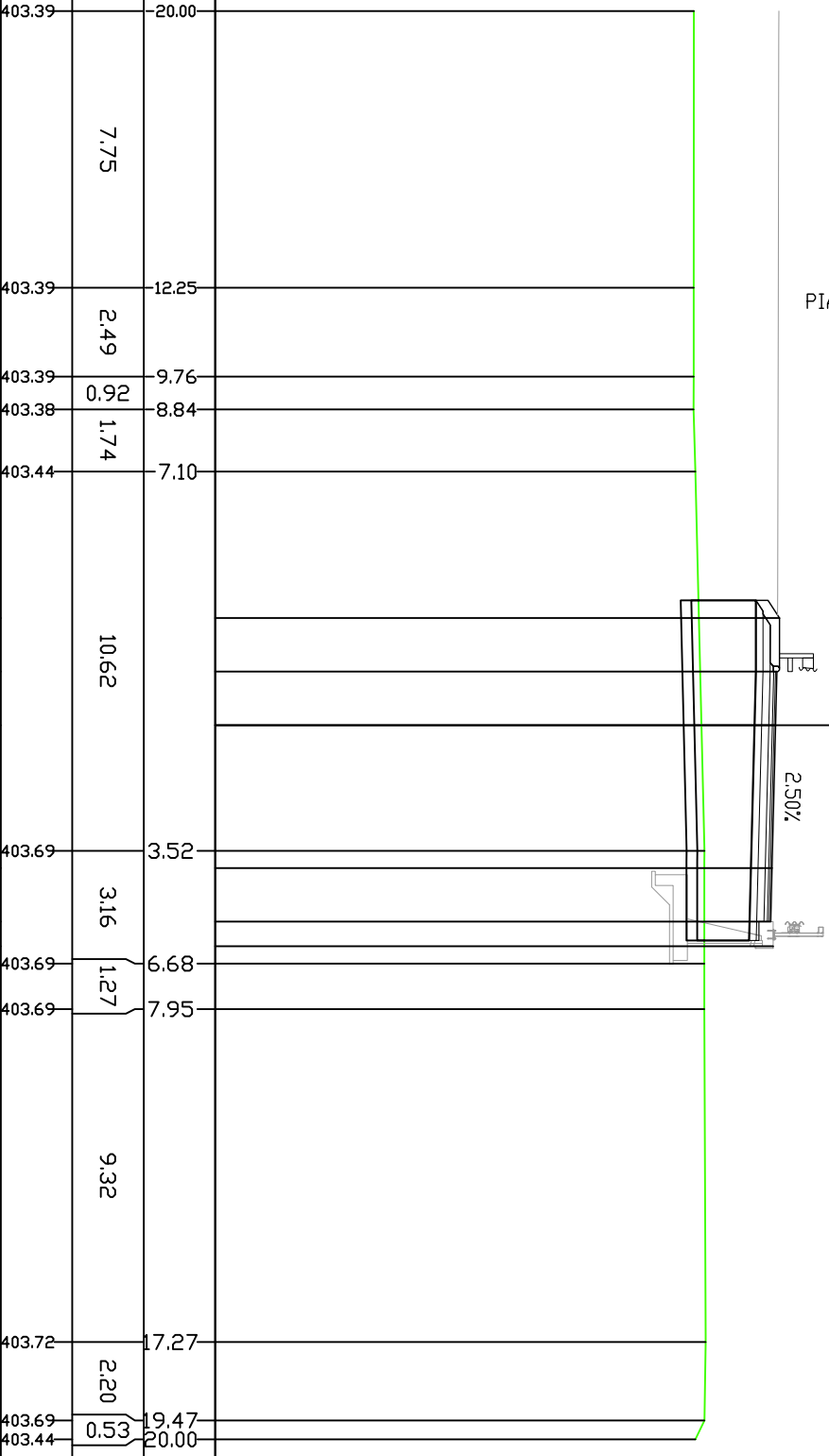

PROFILO BA-SV\_MM4quint

SEZIONE 70

PROGRESSIVA 1400.00

STERRI E RIPORTI	12.57 mq.
R1 SCOTICD	1.89 mq.
A1 BONIFICA	2.86 mq.
B1 STABILIZZATO	1.89 mq.
D1 CEMENTATO	1.72 mq.
E1 BASE	0.71 mq.
F1 VEGETALE	0.53 mq.
G1 TNT	10.52 ml.
a1 GEDRIGLIA 10KN/m	9.52 ml.
b1 IDROSEMINA	1.98 ml.
e1 USURA	7.00 ml.
f1 BINDER	7.00 ml.
g1	7.00 ml.

390.00  
 200  
 200

PROGRESSIVE TERRENO	403.69	20.00	403.61	14.42	403.64	6.74	405.85	3.00	405.78	1.50	405.75	0.00	403.84	1.10	403.84	2.35	403.81	4.16	405.65	4.00	403.81	5.57	405.61	5.50	405.68	6.19
PARZIALI TERRENO	5.58		7.68		7.84		1.25	1.81	1.41	6.84		12.41		2.82		4.77		20.00		20.00						
QUOTE TERRENO																										
PROGRESSIVE PROGETTO																										
PARZIALI PROGETTO																										
QUOTE PROGETTO																										

PIAZZALE in PROGETTO

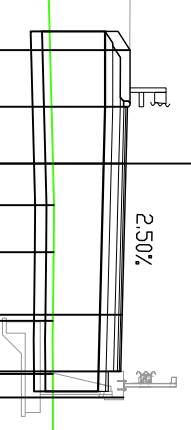

PROFILO BA-SV\_MM4quint

SEZIONE 71

PROGRESSIVA 1419.03

STERRI E RIPORTI	12.37 mq.
R1 SCOTICD	1.90 mq.
A1 BONIFICA	2.87 mq.
B1 STABILIZZATO	1.88 mq.
D1 CEMENTATO	1.71 mq.
E1 BASE	0.72 mq.
F1 VEGETALE	0.55 mq.
G1 TNT	10.55 ml.
a1 GEDRIGLIA 10KN/m	9.55 ml.
b1 IDROSEMINA	1.99 ml.
e1 USURA	7.02 ml.
f1 BINDER	7.02 ml.
g1	7.02 ml.

390.00  
 200  
 200

PROGRESSIVE TERRENO	404.16	404.17	404.02	405.91	405.84	405.80	405.70	405.66	405.73	403.90	403.91	403.89	403.89	403.88	403.80	403.75
PARZIALI TERRENO	2.09	9.26	7.70	3.02	1.50	1.50	4.02	1.50	0.69	0.90	1.74	2.15	4.02	2.64	3.22	
QUOTE TERRENO																
PROGRESSIVE PROGETTO																
PARZIALI PROGETTO																
QUOTE PROGETTO																

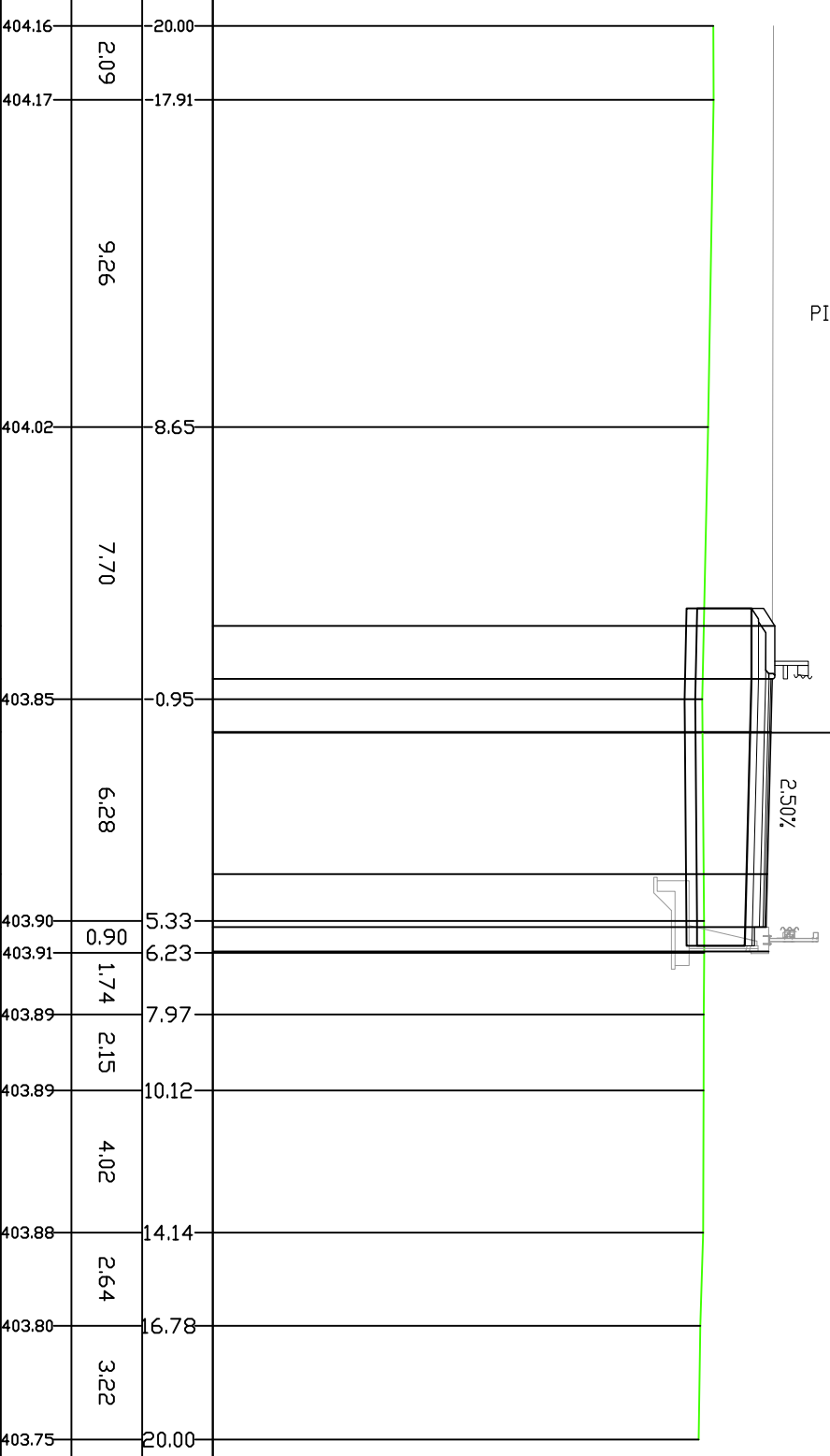

PIAZZALE in PROGETTO

2.50%

PROFILO BA-SV\_MM4quint

SEZIONE 72

PROGRESSIVA 1432.39

STERRI E RIPORTI	9,89 mq.
R1	
SCOTICD	1,95 mq.
A1	
BONIFICA	2,89 mq.
B1	
STABILIZZATO	1,91 mq.
D1	
CEMENTATO	1,74 mq.
E1	
BASE	0,73 mq.
F1	
VEGETALE	0,55 mq.
G1	
TNT	10,69 ml.
a1	
GEDRIGLIA 10KN/m	9,68 ml.
b1	
IDROSEMINA	1,99 ml.
e1	
USURA	7,15 ml.
f1	
BINDER	7,15 ml.
g1	

390.00  
 ▼  
 PROGRESSIVE  
 TERRENO 200  
 200

PARZIALI TERRENO	1.73	5.06	3.04	6.49	2.16	3.07	5.65	2.69	2.87	3.64	2.90	0.70				
QUOTE TERRENO	404.39	404.39	404.27	404.36	404.34	404.29	404.19	405.73	405.69	405.76	403.91	403.91	403.95	403.95	403.86	403.84
PROGRESSIVE PROGETTO	20.00	18.27	13.21	10.17	3.68	1.52	1.55	4.00	5.50	6.19	7.20	9.89	12.76	16.40	19.30	20.00
PARZIALI PROGETTO								1.50	1.50	4.15	1.50	0.69				
QUOTE PROGETTO																

PIAZZALE in PROGETTO

2.50%

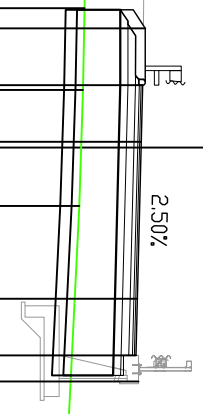

PROFILO BA-SV\_MM4quint

SEZIONE 73

PROGRESSIVA 1445.76

- STERRI E RIPORTI
- R1 9,80 mq.
- SCOTICD
- A1 1,95 mq.
- BONIFICA
- B1 2,93 mq.
- STABILIZZATO
- D1 1,93 mq.
- CEMENTATO
- E1 1,76 mq.
- BASE
- F1 0,75 mq.
- VEGETALE
- G1 0,52 mq.
- TNT
- a1 10,78 ml.
- GEDRIGLIA 10KN/m
- b1 9,77 ml.
- IDROSEMINA
- e1 1,99 ml.
- USURA
- f1 7,25 ml.
- BINDER
- g1 7,25 ml.

390.00  
 ▼  
 PROGRESSIVE  
 TERRENO 200  
 200

PROGRESSIVE TERRENO	404.37	20.00	404.38	17.69	404.45	6.48	404.44	3.50	405.98	3.25	405.91	1.75	405.87	0.25	404.16	2.80	405.76	4.00	405.72	5.50	405.79	6.19	403.94	8.45	403.92	11.03	403.93	12.60	403.91	13.87	403.94	20.00	
PARZIALI TERRENO	2.31	11.21	2.98	6.30	5.65	2.58	1.57	1.27	6.13																								
QUOTE TERRENO																																	
PROGRESSIVE PROGETTO																																	
PARZIALI PROGETTO																																	
QUOTE PROGETTO																																	

PIAZZALE in PROGETTO

2.50%

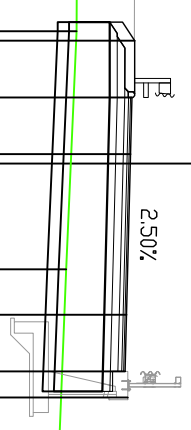

PROFILO BA-SV\_MM4quint

SEZIONE 74

PROGRESSIVA 1448.66

STERRI E RIPORTI	9,64 mq.
R1 SCOTICD	1,96 mq.
A1 BONIFICA	2,93 mq.
B1 STABILIZZATO	1,93 mq.
D1 CEMENTATO	1,77 mq.
E1 BASE	0,74 mq.
F1 VEGETALE	0,52 mq.
G1 TNT	10,79 ml.
a1 GEDRIGLIA 10KN/m	9,78 ml.
b1 IDROSEMINA	1,99 ml.
e1 USURA	7,25 ml.
f1 BINDER	7,25 ml.
g1	7,25 ml.

390.00  
 200  
 200

PROGRESSIVE TERRENO		20.00	19.11	16.31	4.52	3.87	2.56	11.02	8.46	9.61	11.04	14.29	16.94	20.00
PARZIALI TERRENO		0.89	2.80		0.65	1.31			1.15	1.43	3.25	2.65	3.06	
QUOTE TERRENO														
PROGRESSIVE PROGETTO														
PARZIALI PROGETTO														
QUOTE PROGETTO														

PIAZZALE in PROGETTO

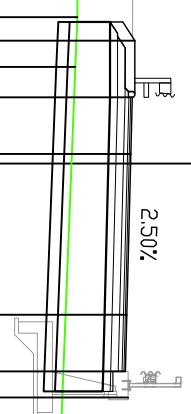



PROFILO BA-SV\_MM4quint

SEZIONE 75

PROGRESSIVA 1451.55

STERRI E RIPORTI	
R1	9,46 mq.
SCOTICID	1,95 mq.
A1	2,94 mq.
BONIFICA	
B1	1,92 mq.
STABILIZZATO	
D1	1,78 mq.
CEMENTATO	
E1	0,75 mq.
BASE	
F1	0,54 mq.
VEGETALE	
G1	
TNT	
a1	10,77 ml.
GEDRIGLIA 10KN/m	
b1	9,77 ml.
IDROSEMINA	
e1	1,99 ml.
USURA	
f1	7,25 ml.
BINDER	
g1	7,25 ml.

390.00  
 ▲  
 200  
 200

PROGRESSIVE TERRENO			
PARZIALI TERRENO			
QUOTE TERRENO			
PROGRESSIVE PROGETTO			
PARZIALI PROGETTO			
QUOTE PROGETTO			

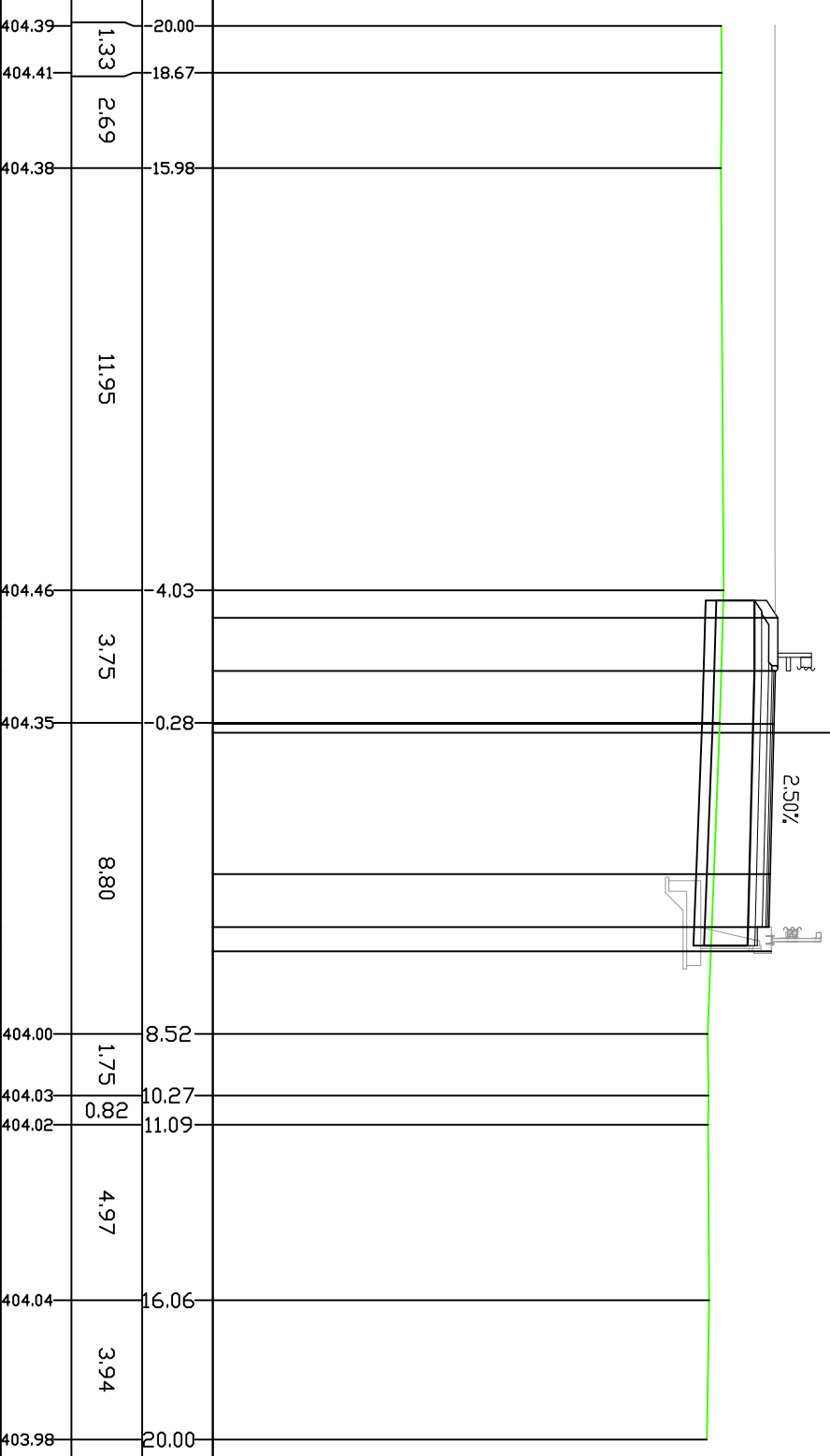

404.39	20.00		
404.41	18.67	1.33	
404.38	15.98	2.69	
		11.95	
404.46	4.03		
405.99	3.25	3.75	
405.92	1.75		
405.88	0.25	404.35	
		8.80	
405.78	4.00		
405.74	5.50	0.69	
405.81	6.19		
404.00	8.52	1.75	
404.03	10.27	0.82	
404.02	11.09	4.97	
404.04	16.06		
403.98	20.00	3.94	

PROFILO BA-SV\_MM4quint

SEZIONE 76

PROGRESSIVA 1464.92

STERRI E RIPORTI R1	9,83 mq.
SCOTICID A1	1,94 mq.
BONIFICA B1	2,91 mq.
STABILIZZATO D1	1,91 mq.
CEMENTATO E1	1,79 mq.
BASE F1	0,74 mq.
VEGETALE G1	0,53 mq.
TNT	
a1	10,68 ml.
GEDRIGLIA 10KN/m	
b1	9,68 ml.
IDROSEMINA e1	1,99 ml.
USURA f1	7,15 ml.
BINDER g1	7,15 ml.

390.00  
▼  
PROGRESSIVE  
TERRENO 200  
200

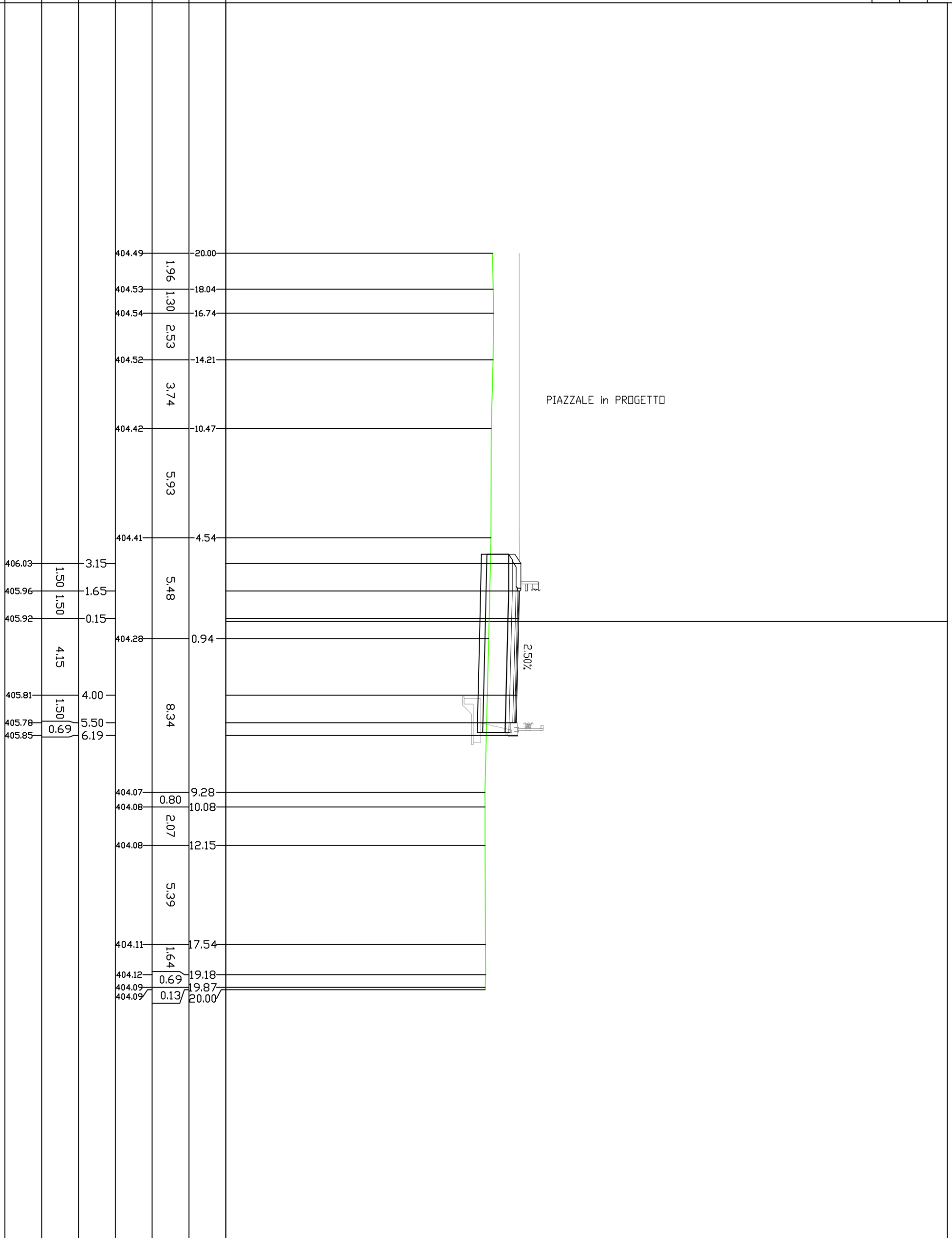

QUOTE  
PARZIALI  
PROGETTO

PROGRESSIVE  
PROGETTO

PARZIALI  
PROGETTO

QUOTE  
PROGETTO

STERRI E RIPORTI	
R1	10.74 mq.
SCOTICD	1.91 mq.
A1	2.87 mq.
BONIFICA	1.88 mq.
B1	1.76 mq.
STABILIZZATO	0.71 mq.
D1	0.54 mq.
CEMENTATO	10.55 ml.
E1	9.55 ml.
BASE	1.99 ml.
F1	7.02 ml.
VEGETALE	7.02 ml.
G1	7.02 ml.
TNT	
a1	
GEDRIGLIA 10KN/m	
b1	
IDROSEMINA	
e1	
USURA	
f1	
BINDER	
g1	

390.00  
 ▼  
 PROGRESSIVE  
 TERRENO 200  
 200

PROGRESSIVE	QUOTE	PARZIALI	QUOTE	PARZIALI
TERRENO	TERRENO	TERRENO	TERRENO	TERRENO
PROGETTO	PROGETTO	PROGETTO	PROGETTO	PROGETTO
404.49	20.00	1.08	1.70	9.61
404.49	18.92			
404.48	17.22			
404.45	7.61	1.29		9.72
404.44	6.32			
406.06	3.02	1.50	1.50	4.02
405.99	1.52			
405.95	0.02			
404.12	3.40	1.50	0.69	7.23
405.85	4.00			
405.82	5.50			
405.89	6.19			
404.13	10.63	1.20	1.61	6.02
404.12	11.83			
404.08	13.44			
404.15	19.46	0.54		
404.15	20.00			

PIAZZALE in PROGETTO

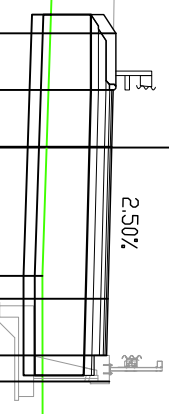

PROFILO BA-SV\_MM4quint

SEZIONE 78

PROGRESSIVA 1495.30

STERRI E RIPORTI		1386 mq.
R1	SCOTICID	2.83 mq.
A1	BONIFICA	4.27 mq.
B1	STABILIZZATO	2.12 mq.
D1	CEMENTATO	1.99 mq.
E1	BASE	0.74 mq.
F1	VEGETALE	0.54 mq.
G1		1.19 mq.
G2		1.73 mq.
Totale:		15.19 ml.
TNT		14.19 ml.
a1	GEORIGLIA 10KN/m	1.99 ml.
b1	IDROSEMINA	4.64 ml.
e1		6.63 ml.
e2	Totale:	7.00 ml.
USURA		7.00 ml.
f1	BINDER	7.00 ml.
g1		

390.00  
 200  
 200

PROGRESSIVE TERRENO	404.39	404.41	404.49	404.17	404.16	404.19	406.09	406.02	406.00	404.23	405.94	404.23	406.01	404.21	404.18	404.15	404.15
PARZIALI TERRENO	1.23	3.50	6.53	2.34	3.14	3.26	1.50	1.50	4.00	2.84	1.50	1.50	2.70	6.08	2.63	4.86	
QUOTE TERRENO	20.00	18.77	15.27	8.74	6.40	3.26	3.00	1.50	0.00	3.59	5.50	6.43	9.70	12.51	15.14	20.00	
PROGRESSIVE PROGETTO																	
PARZIALI PROGETTO																	
QUOTE PROGETTO																	

PIAZZALE in PROGETTO

113%

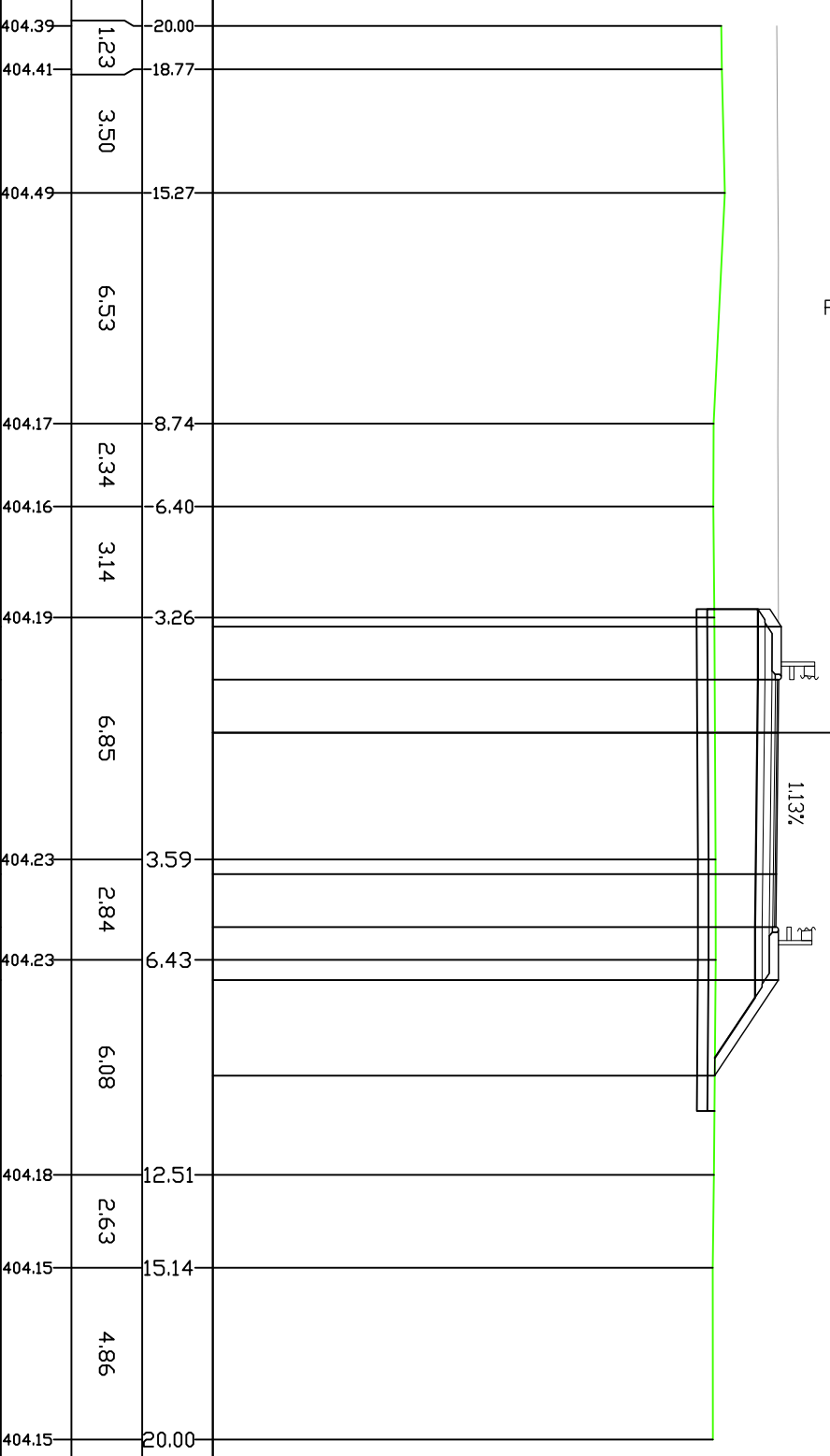

STERRI E RIPORTI	
R1	21.41 mq.
SCOTTICD	
A1	3.98 mq.
BONIFICA	
B1	5.98 mq.
STABILIZZATO	
D1	3.26 mq.
CEMENTATO	
E1	3.11 mq.
BASE	
F1	1.29 mq.
VEGETALE	
G1	0.53 mq.
G2	1.22 mq.
Totale:	1.75 mq.
TNT	
a1	20.93 ml.
GEDRIGLIA 10KN/m	
b1	19.93 ml.
IDROSEMINA	
e1	1.99 ml.
e2	4.83 ml.
Totale:	6.82 ml.
USURA	
f1	12.59 ml.
BINDER	
g1	12.59 ml.

390.00  
 ▼  
 PROGRESSIVE  
 TERRENO 200  
 200

PARZIALI TERRENO	7.98	1.12	2.07	3.65	5.18	8.34	3.16	8.50	3.78	0.93	1.27	2.36					
QUOTE TERRENO	404.30	404.29	404.28	404.26	404.25	406.11	406.04	406.04	404.23	406.05	406.05	406.12	404.21	404.21	404.20	404.19	404.41
PROGRESSIVE PROGETTO	20.00	12.02	10.90	8.83	5.18	4.61	3.11	0.87	3.16	7.60	9.48	10.98	11.66	15.44	16.37	17.64	20.00
PARZIALI PROGETTO						1.50	2.24		8.47	1.88	1.50	2.85					
QUOTE PROGETTO						406.11	406.04	406.04	404.23	406.05	406.05	406.12	404.21	404.21	404.20	404.19	404.41

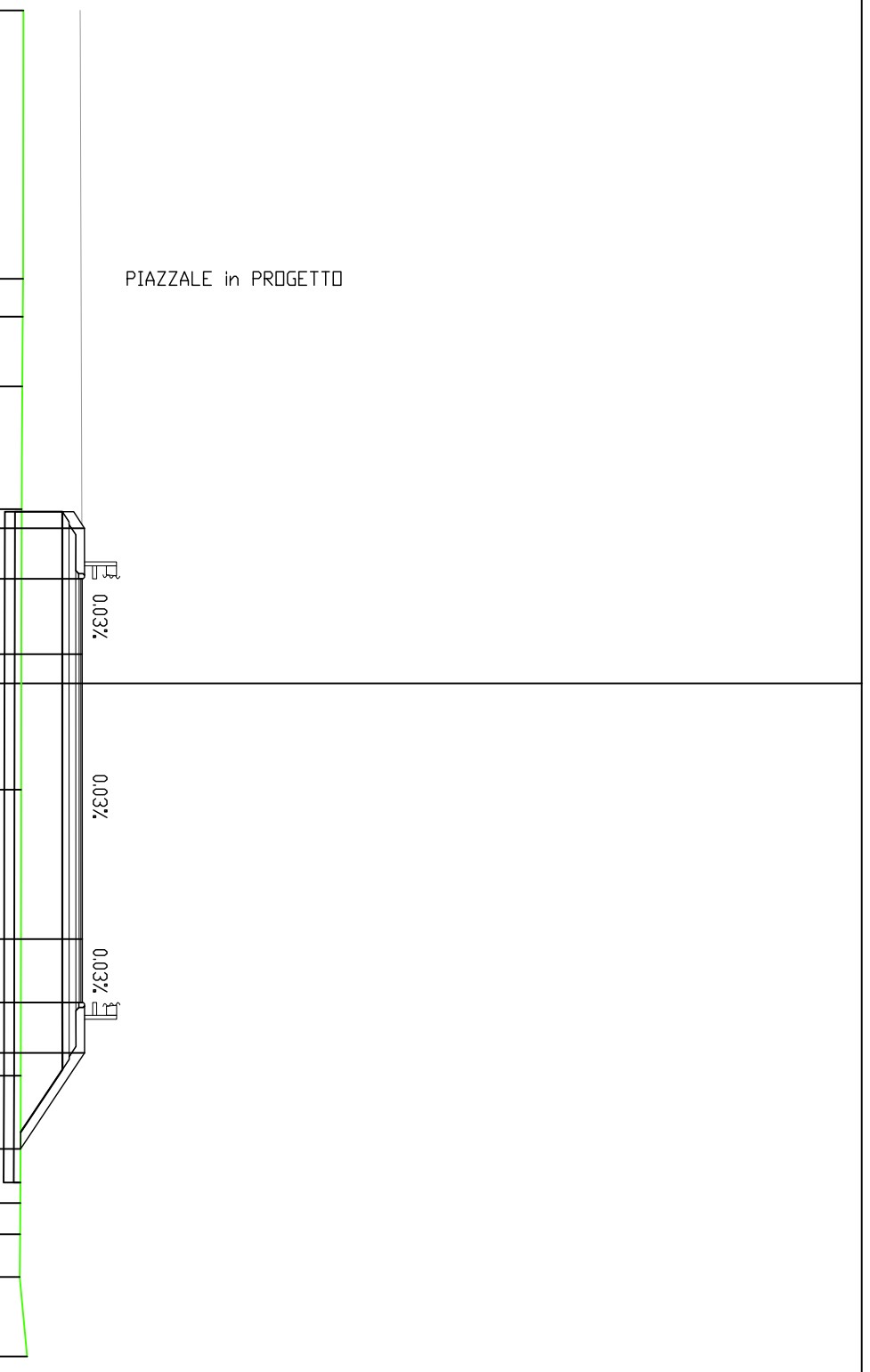

PIAZZALE in PROGETTO

0.03%

0.03%

0.03%

# Ingresso A32 direzione Torino – Rampa 4

## KEY PLAN

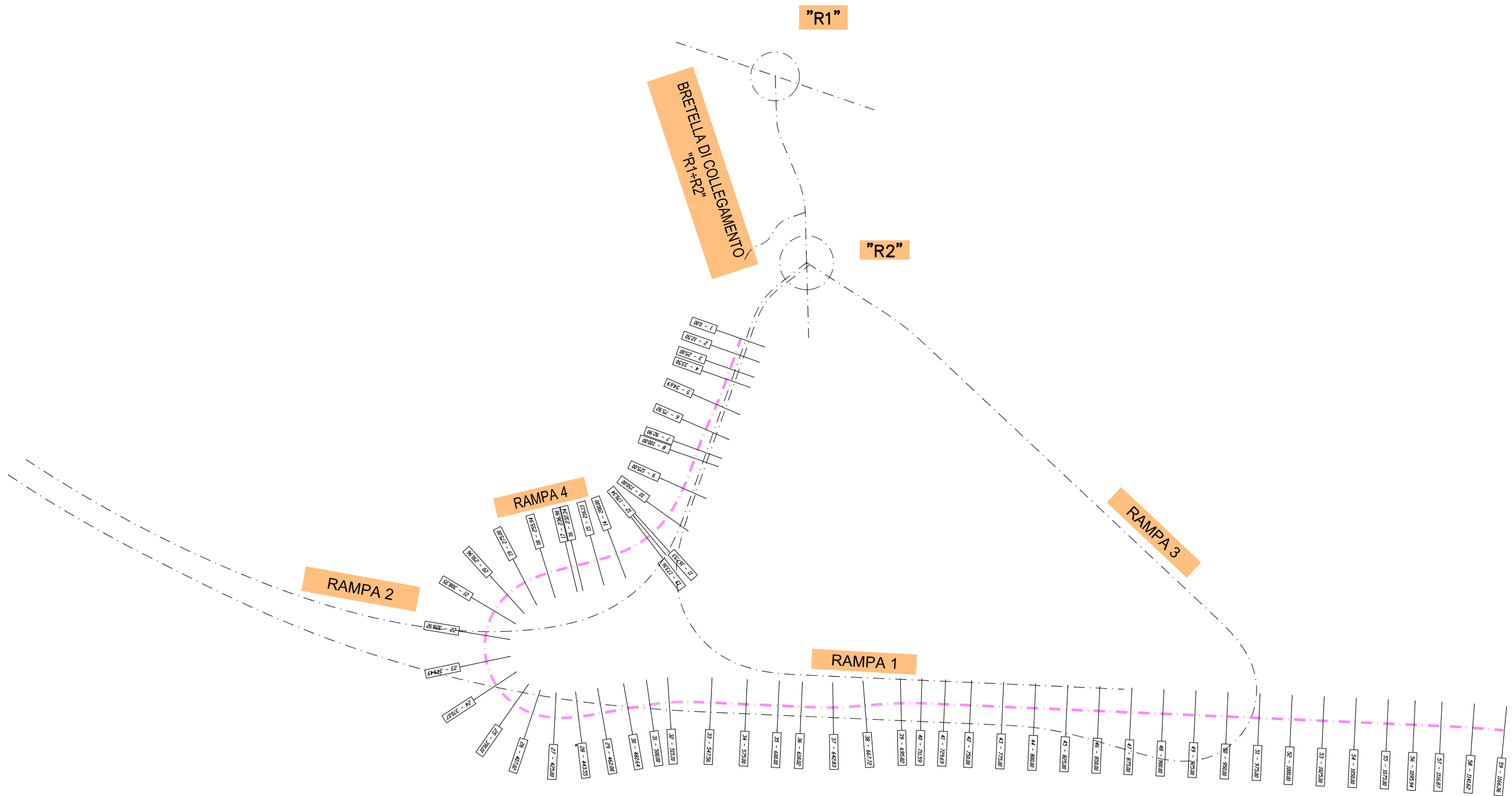

PROFILO SV-T0\_MM3

SEZIONE 1

PROGRESSIVA 0.00

390.00  
200  
200

PROGRESSIVE  
TERRENO

PARZIALI  
TERRENO

QUOTE  
TERRENO

PROGRESSIVE  
PROGETTO

PARZIALI  
PROGETTO

QUOTE  
PROGETTO

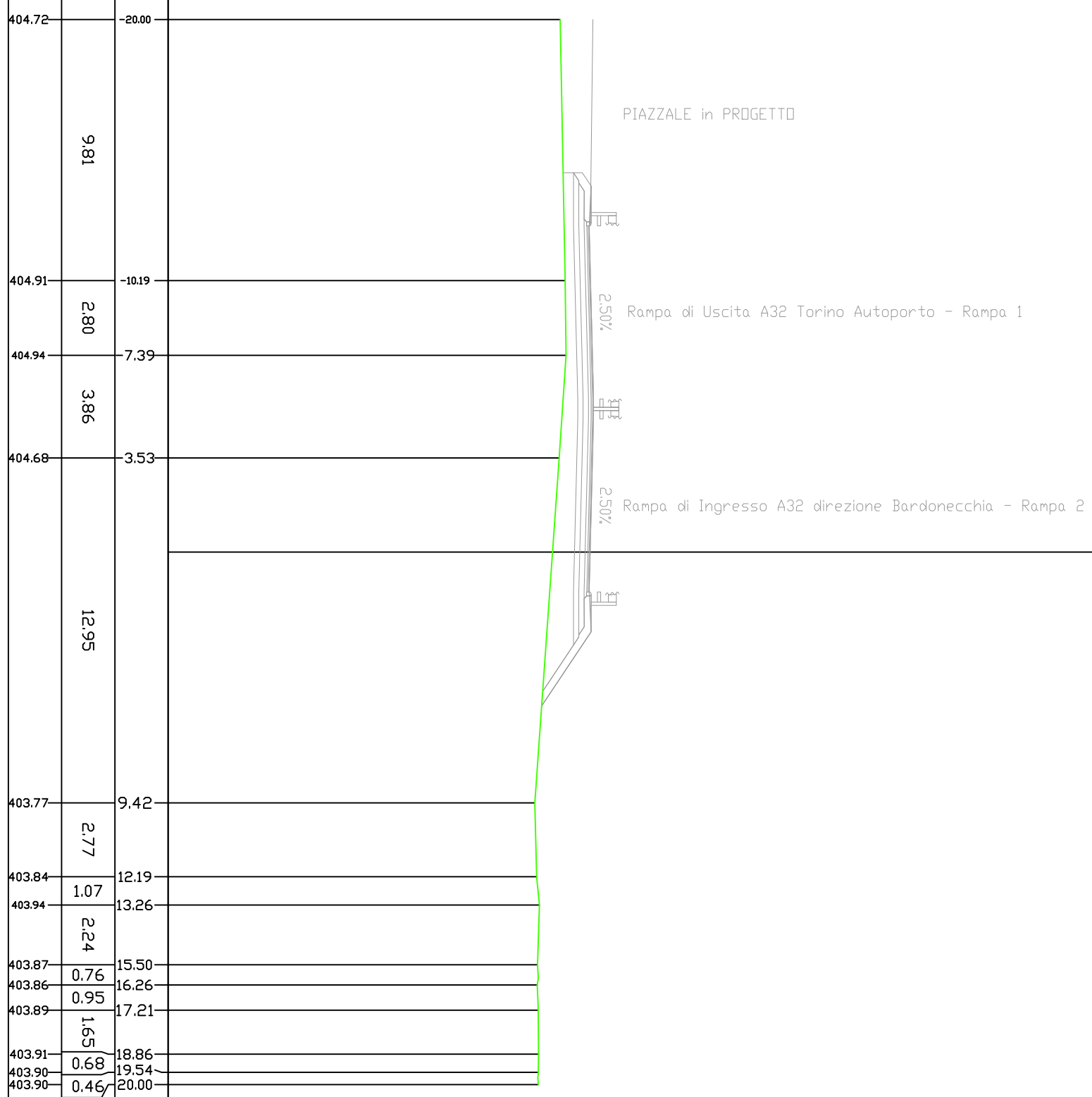

PROFILO SV-T0\_MM3

SEZIONE 2

PROGRESSIVA 12.50

390.00  
200  
200

PROGRESSIVE  
TERRENO

PARZIALI  
TERRENO

QUOTE  
TERRENO

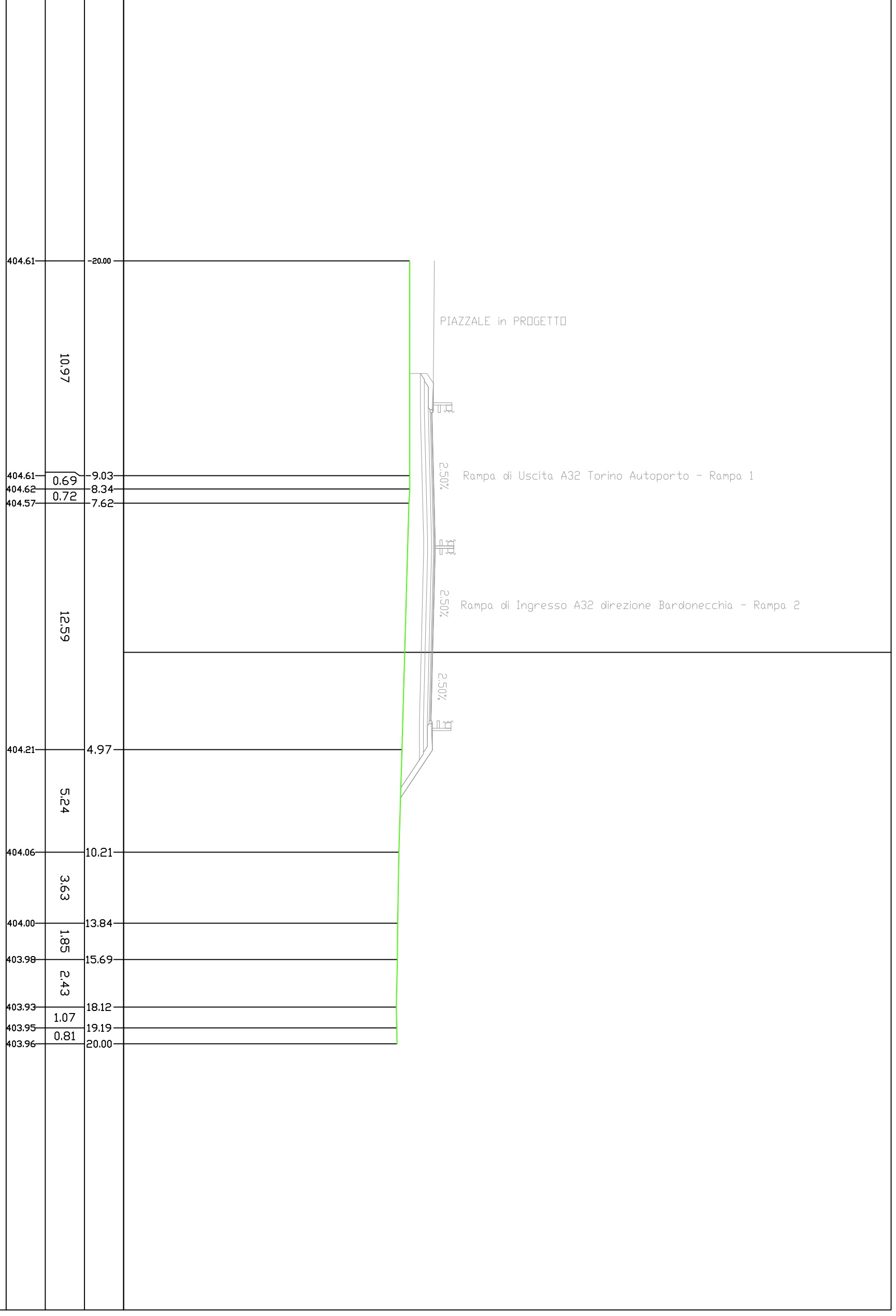

PROGRESSIVE  
PROGETTO

PARZIALI  
PROGETTO

QUOTE  
PROGETTO



PROFILO SV-T0\_MM3

SEZIONE 3

PROGRESSIVA 25.00

390.00  
200  
200

PROGRESSIVE TERRENO	QUOTE TERRENO	PROGRESSIVE PROGETTO	QUOTE PROGETTO
404.61	-20.00	404.61	2.50
404.64	-17.50	404.64	8.70
404.72	-8.80	404.72	15.75
403.84	6.95	403.84	0.86
403.82	7.81	403.82	1.72
403.98	9.53	403.98	1.57
403.92	11.10	403.92	0.61
403.92	12.01	403.92	2.84
404.02	14.85	404.02	1.02
403.97	15.87	403.97	0.70
404.06	16.57	404.06	1.56
404.10	18.13	404.10	1.07
404.08	19.20	404.08	0.80
404.09	20.00	404.09	

PIAZZALE in PROGETTO

2.50% Rampa di Uscita A32 Torino Autoporto - Rampa 1

2.50% Rampa di Ingresso A32 direzione Bardonecchia - Rampa 2

2.50%

PROFILO SV-T0\_MM3

SEZIONE 4

PROGRESSIVA 33.50

390.00  
200  
200

PROGRESSIVE  
TERRENO

PARZIALI  
TERRENO

QUOTE  
TERRENO

PROGRESSIVE  
PROGETTO

PARZIALI  
PROGETTO

QUOTE  
PROGETTO

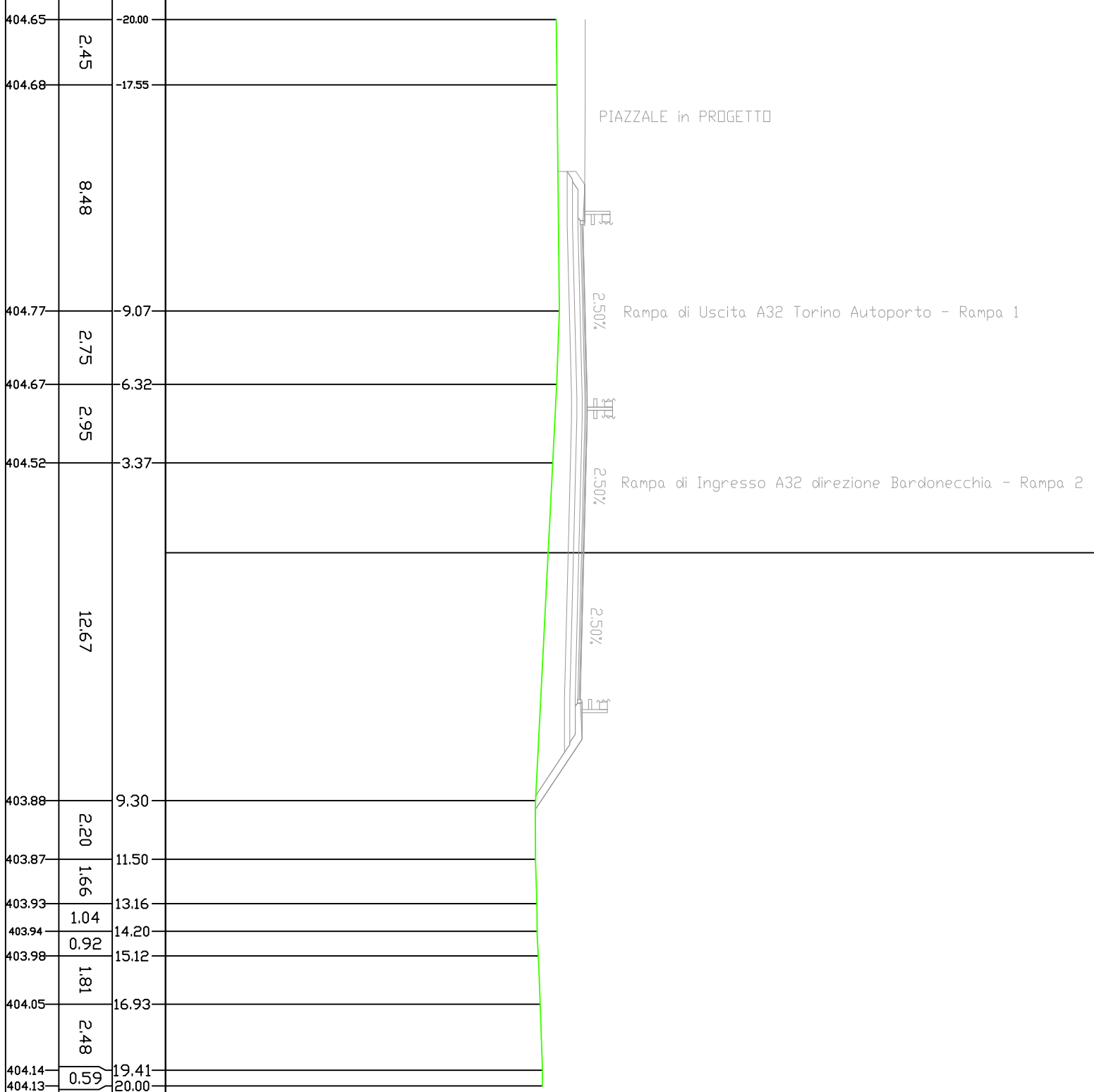

PROFILO SV-T0\_MM3

SEZIONE 5

PROGRESSIVA 54.69

390.00  
200  
200

PROGRESSIVE TERRENO	QUOTE TERRENO	PROGRESSIVE TERRENO	QUOTE TERRENO
404.61		-20.00	
404.61	2.57	-17.43	
	7.73		
404.71		-9.70	
	8.32		
404.18		-1.38	
	6.61		
403.83		5.23	
	3.53		
404.18	0.54	8.76	
403.96	1.09	9.30	
403.98		10.39	
	3.53		
404.02		13.92	
	1.55		
403.92		15.47	
	2.86		
403.87	0.54	18.33	
403.88	0.54	19.02	
403.96	0.54	19.69	
404.00	0.31	20.00	

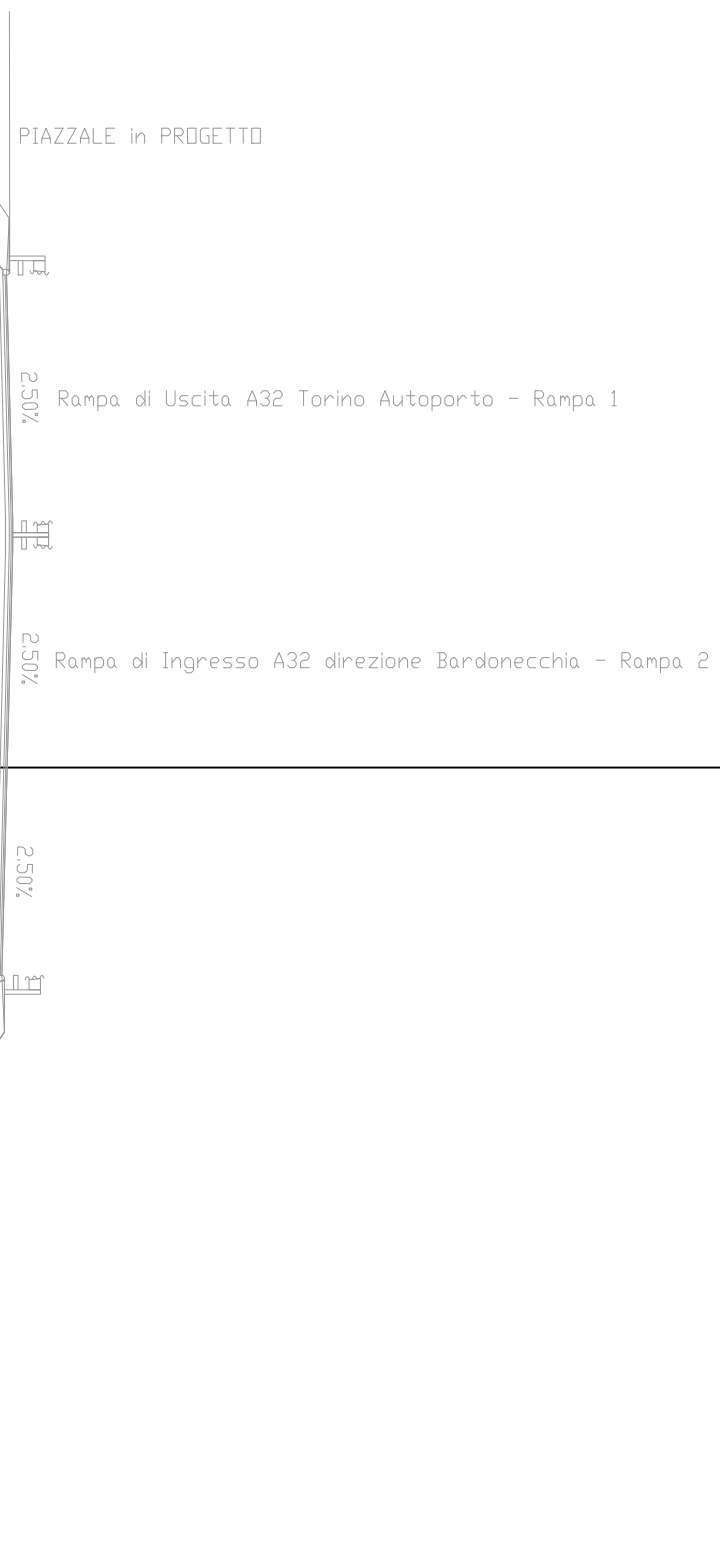

PROFILO SV-T0\_MM3

SEZIONE 6

PROGRESSIVA 75.92

390.00  
200  
200

PROGRESSIVE TERRENO	QUOTE TERRENO
403.63	8.92
403.62 403.64	0.82
404.24	17.31
404.14	3.67
404.06	3.31
404.07	1.25
405.44	4.72

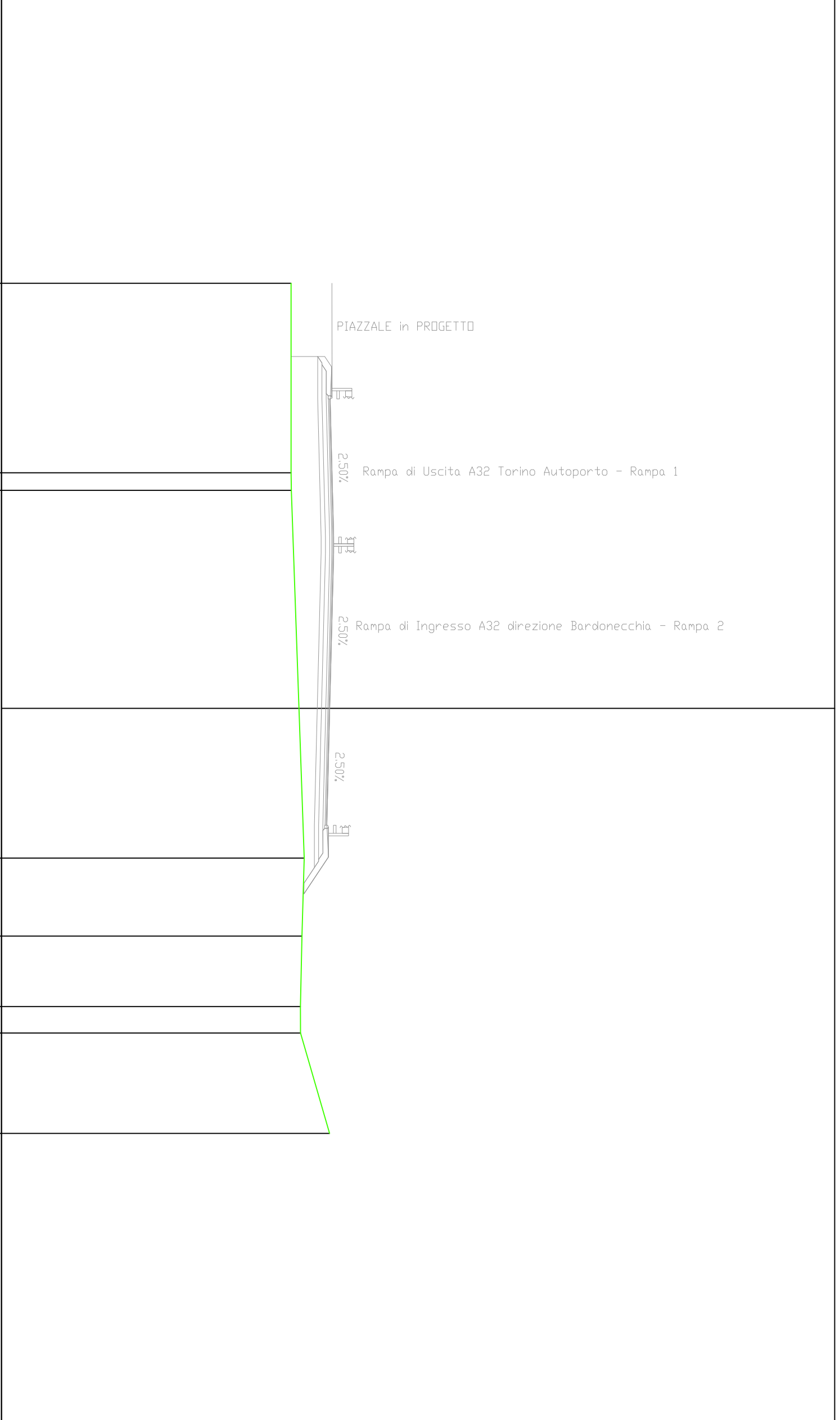

PROGRESSIVE TERRENO  
QUOTE TERRENO  
PARZIALI PROGETTO  
PARZIALI PROGETTO  
QUOTE PROGETTO

PROFILO SV-T0\_MM3

SEZIONE 7

PROGRESSIVA 92.90

390.00  
200  
200

PROGRESSIVE  
TERRENO

PARZIALI  
TERRENO

QUOTE  
TERRENO

PROGRESSIVE  
PROGETTO

PARZIALI  
PROGETTO

QUOTE  
PROGETTO

403.81	-20.00		
403.88	-11.34	8.66	
403.89	-10.56	0.78	
		20.29	
404.47	9.73	7.51	
404.32	17.24	1.84	
404.17	19.08	0.92	
404.15	20.00		

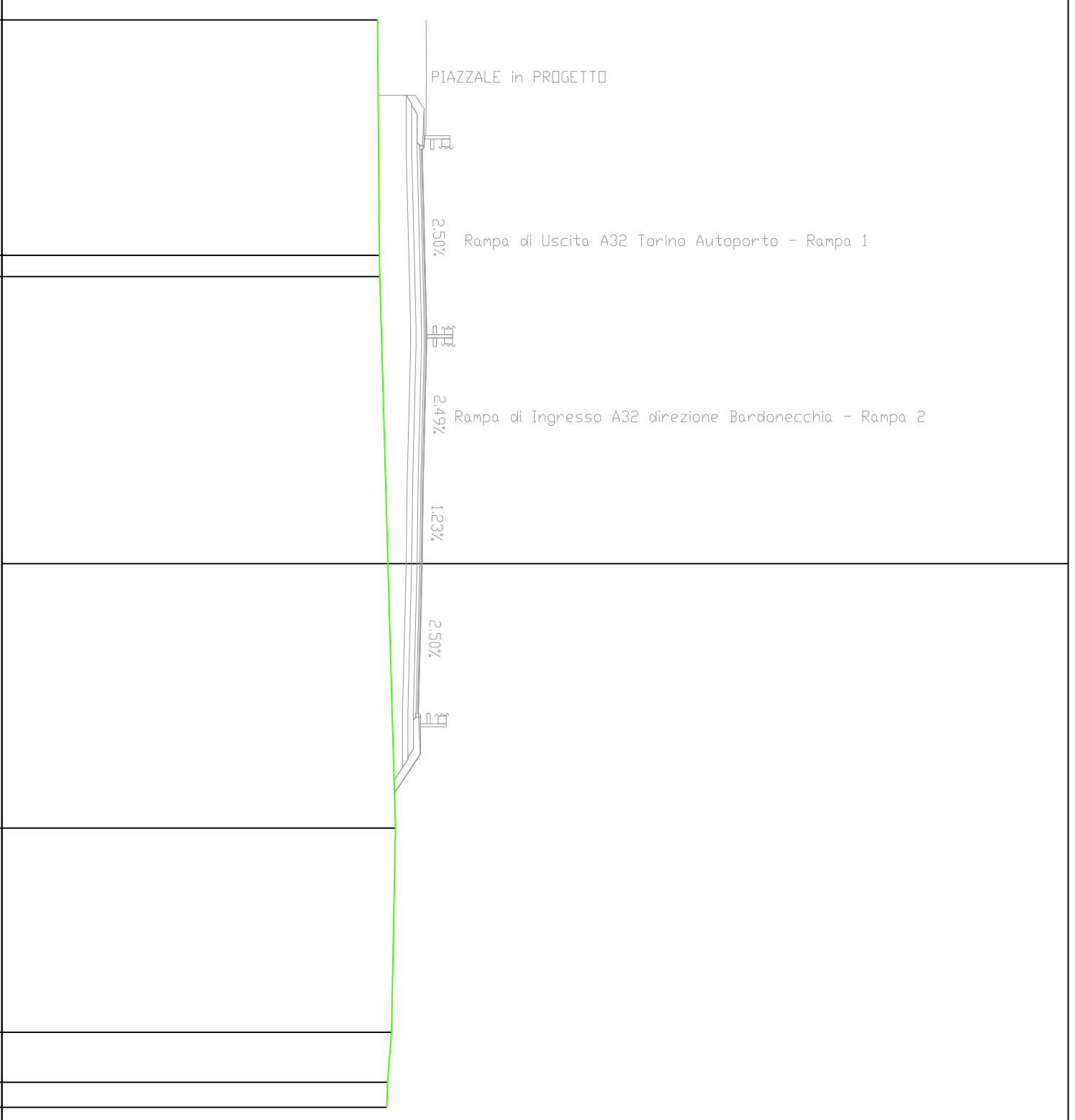

STERRE E RIPORTI	4.72 mq.
Ri	
SCOTTICO	2.20 mq.
Ai	
BONIFICA	3.32 mq.
Bi	
STABILIZZATO	1.78 mq.
Di	
CEMENTATO	1.72 mq.
Ei	
BASE	0.68 mq.
F1	
VEGETALE	0.08 mq.
Gi	
G2	0.75 mq.
Totale:	0.83 mq.
TNT	
o1	12.05 ml.
GEDGRIGLIA 10KN/m	
k1	11.05 ml.
IDROSEMINA	
e1	0.40 ml.
e2	3.12 ml.
Totale:	3.52 ml.
USURA	6.54 ml.
f1	6.54 ml.
BINDER	
g1	6.54 ml.

390.00  
 ▽  
 PROGRESSIVE  
 TERRENO 200  
 200

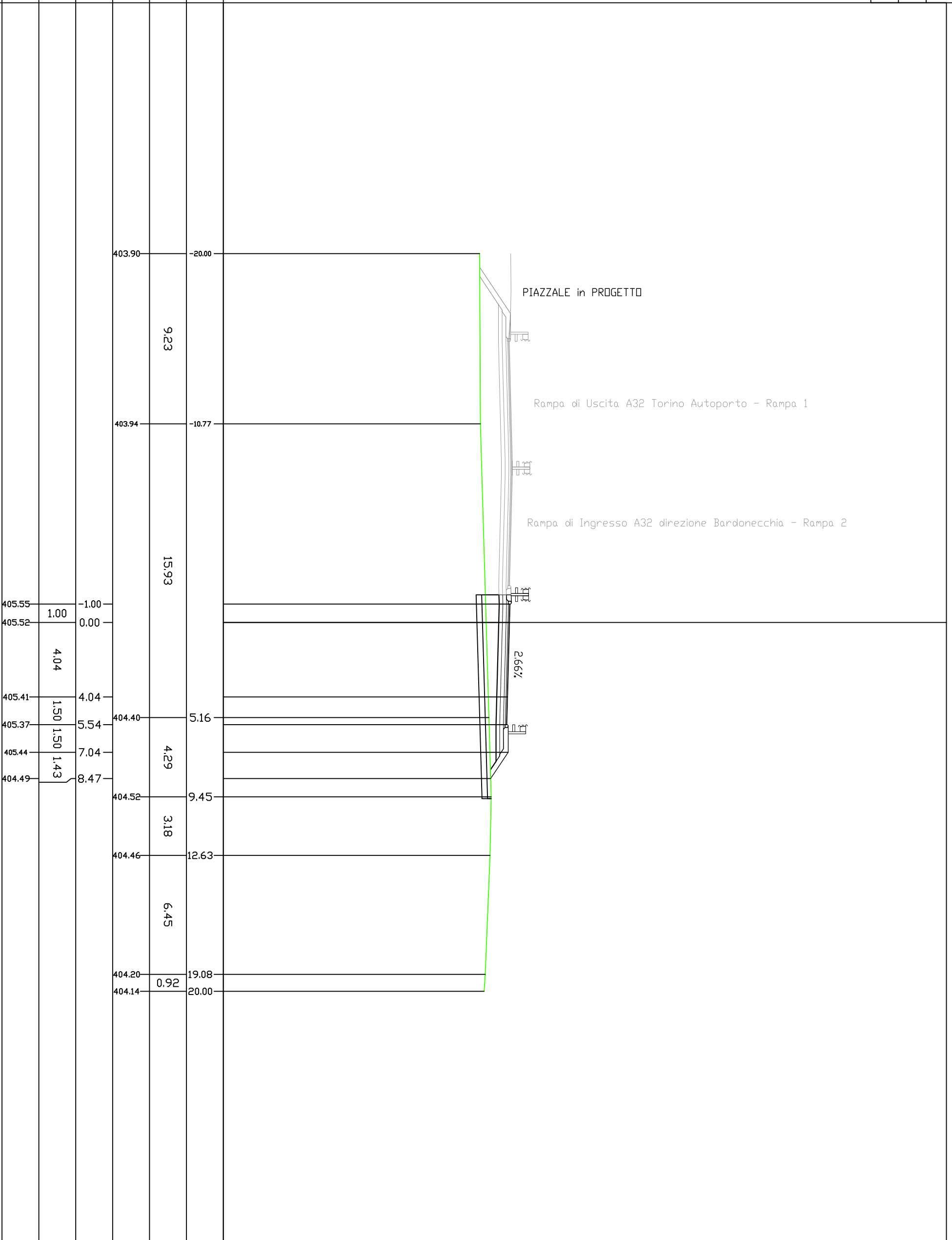

QUOTE  
 PARZIALI  
 PROGETTO

QUOTE  
 PARZIALI  
 PROGETTO

QUOTE  
 PARZIALI  
 PROGETTO

QUOTE  
 PARZIALI  
 PROGETTO

QUOTE  
 PARZIALI  
 PROGETTO

QUOTE  
 PARZIALI  
 PROGETTO

QUOTE  
 PARZIALI  
 PROGETTO

QUOTE  
 PARZIALI  
 PROGETTO

QUOTE  
 PARZIALI  
 PROGETTO

QUOTE  
 PARZIALI  
 PROGETTO

QUOTE  
 PARZIALI  
 PROGETTO

QUOTE  
 PARZIALI  
 PROGETTO

QUOTE  
 PARZIALI  
 PROGETTO

QUOTE  
 PARZIALI  
 PROGETTO

QUOTE  
 PARZIALI  
 PROGETTO

QUOTE  
 PARZIALI  
 PROGETTO

QUOTE  
 PARZIALI  
 PROGETTO

QUOTE  
 PARZIALI  
 PROGETTO

QUOTE  
 PARZIALI  
 PROGETTO

QUOTE  
 PARZIALI  
 PROGETTO

QUOTE  
 PARZIALI  
 PROGETTO

QUOTE  
 PARZIALI  
 PROGETTO

QUOTE  
 PARZIALI  
 PROGETTO

QUOTE  
 PARZIALI  
 PROGETTO

QUOTE  
 PARZIALI  
 PROGETTO

QUOTE  
 PARZIALI  
 PROGETTO

QUOTE  
 PARZIALI  
 PROGETTO

STERRI E RIPORTI	8,24 mq.
Ri	
SCOTTICO	2,34 mq.
AI	
BONIFICA	3,52 mq.
BI	
STABILIZZATO	1,83 mq.
DI	
CEMENTATO	1,67 mq.
EI	
BASE	0,70 mq.
F1	
VEGETALE	0,92 mq.
GI	
TNT	
a1	12,72 ml.
GEORIGLIA 10KN/m	
b1	11,72 ml.
IDRESEMINA	
e1	3,71 ml.
USURA	
f1	6,77 ml.
BINDER	
g1	6,77 ml.

390.00  
 200  
 200

PROGRESSIVE TERRENO	404.13	-20.00	
PARZIALI TERRENO	404.13	-15.08	4,92
QUOTE TERRENO	404.13	-11.34	3,74
PROGRESSIVE PROGETTO	404.13		13,95
PARZIALI PROGETTO	406.17	-1.69	0,69
QUOTE PROGETTO	406.10	-1.00	1,00
	406.06	0,00	4,27
	404.50	2,61	6,37
	405.90	4,27	5,77
	405.84	5,77	7,27
	405.91	7,27	9,19
	404.63	8,98	3,15
	404.58	12,13	5,21
	404.41	17,34	1,58
	404.41	18,92	1,08
	404.42	20,00	

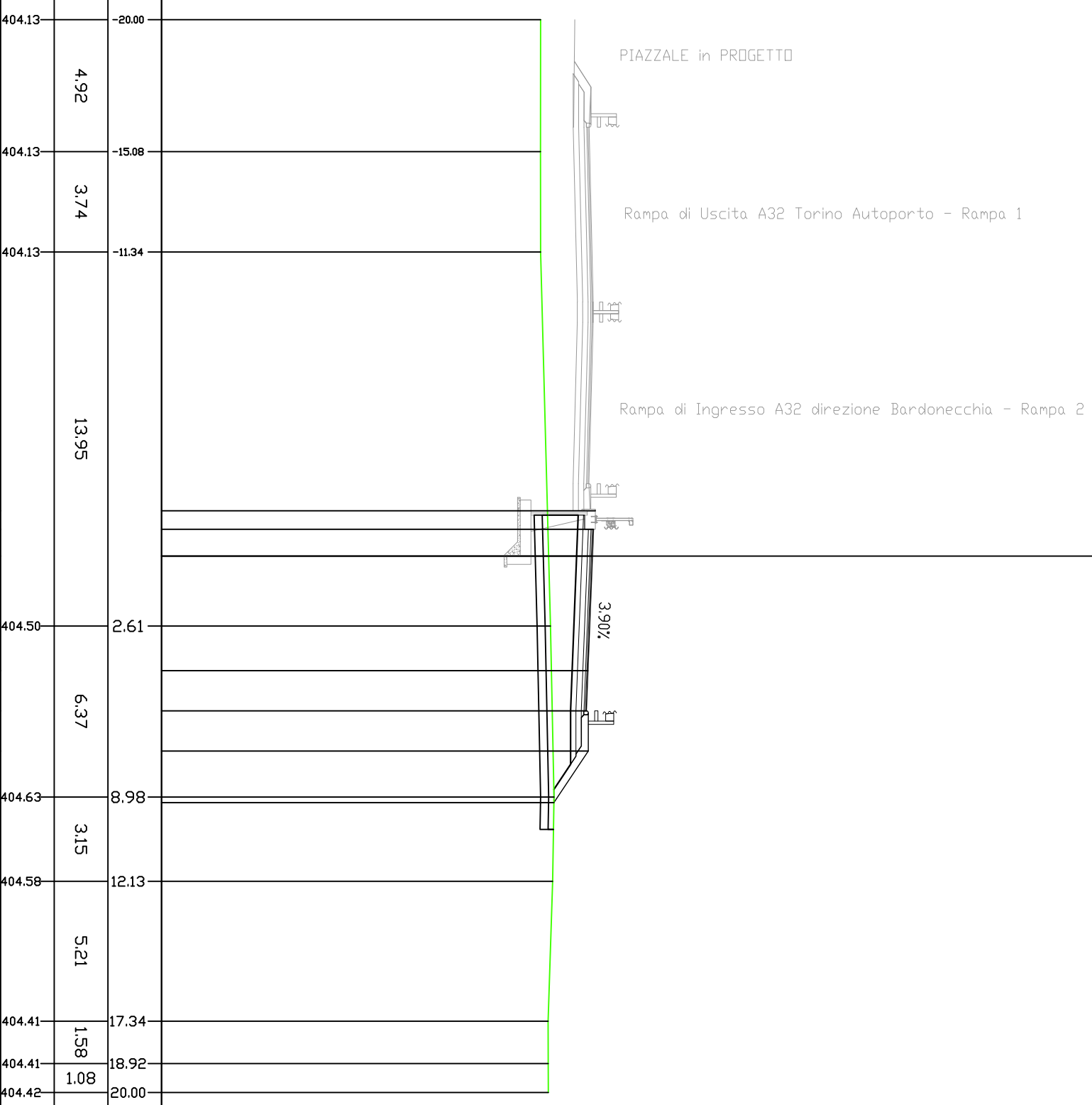

PROFILO SV-T0\_MM3

SEZIONE 10

PROGRESSIVA 150.00

STERRE E RIPORTI	16,12 mq.
Ri	
SCOTTICO	1,75 mq.
AI	
BONIFICA	2,63 mq.
BI	
STABILIZZATO	1,75 mq.
DI	
CEMENTATO	1,60 mq.
EI	
BASE	0,77 mq.
F1	
TNT	9,75 ml.
a1	
GEORIGLIA 10KN/m	8,75 ml.
b1	
USURA	7,69 ml.
f1	
BINDER	7,69 ml.
g1	

390.00  
 ▲  
 PROGRESSIVE  
 TERRENO 200  
 200

PROGRESSIVE TERRENO												
PARZIALI TERRENO		4.10	1.65		13.31		6.27	3.20	3.03	3.41	3.62	1.41
QUOTE TERRENO												
PROGRESSIVE PROGETTO												
PARZIALI PROGETTO												
QUOTE PROGETTO												

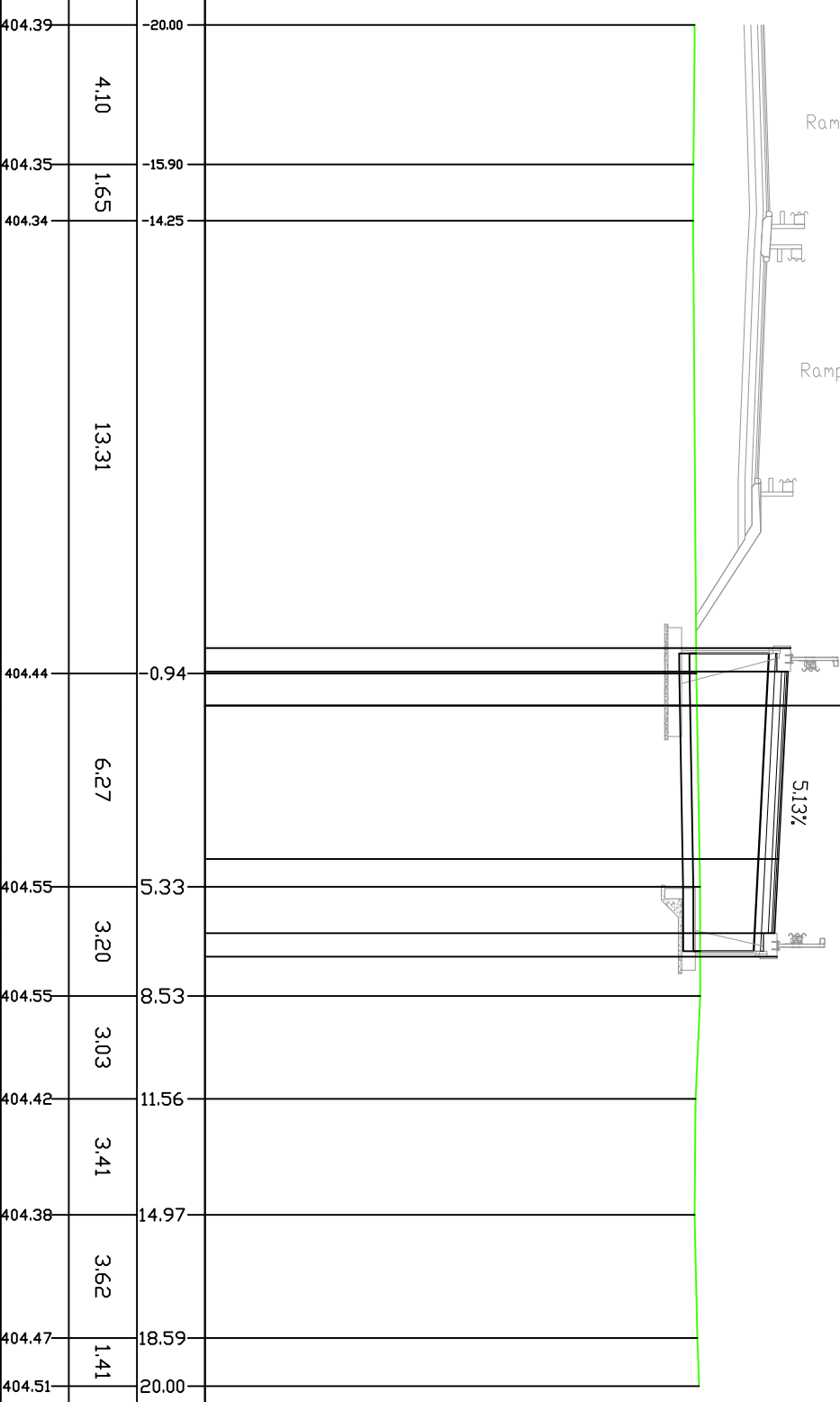

407.20	0.69	-1.69	404.44	0.94
407.13	1.00	-1.00		
407.08		0.00		
406.85	4.51	4.51		
406.74	2.18	6.69		
406.81	0.69	7.38		







PROFILO SV-T0\_MM3

SEZIONE 13

PROGRESSIVA 173.16

STERRI E RIPORTI	
Ri	27.10 mq.
SCOTTICD	
AI	1.71 mq.
BONIFICA	
BI	2.55 mq.
STABILIZZATO	
DI	1.71 mq.
CEMENTATO	
EI	1.56 mq.
BASE	
F1	0.74 mq.
TNT	
a1	9.51 ml.
GEORIGLIA 10KN/m	
b1	8.51 ml.
USURA	
f1	7.45 ml.
BINDER	
g1	7.45 ml.

Rampa di Ingresso A32 direzione Bardonecchia - Rampa 2

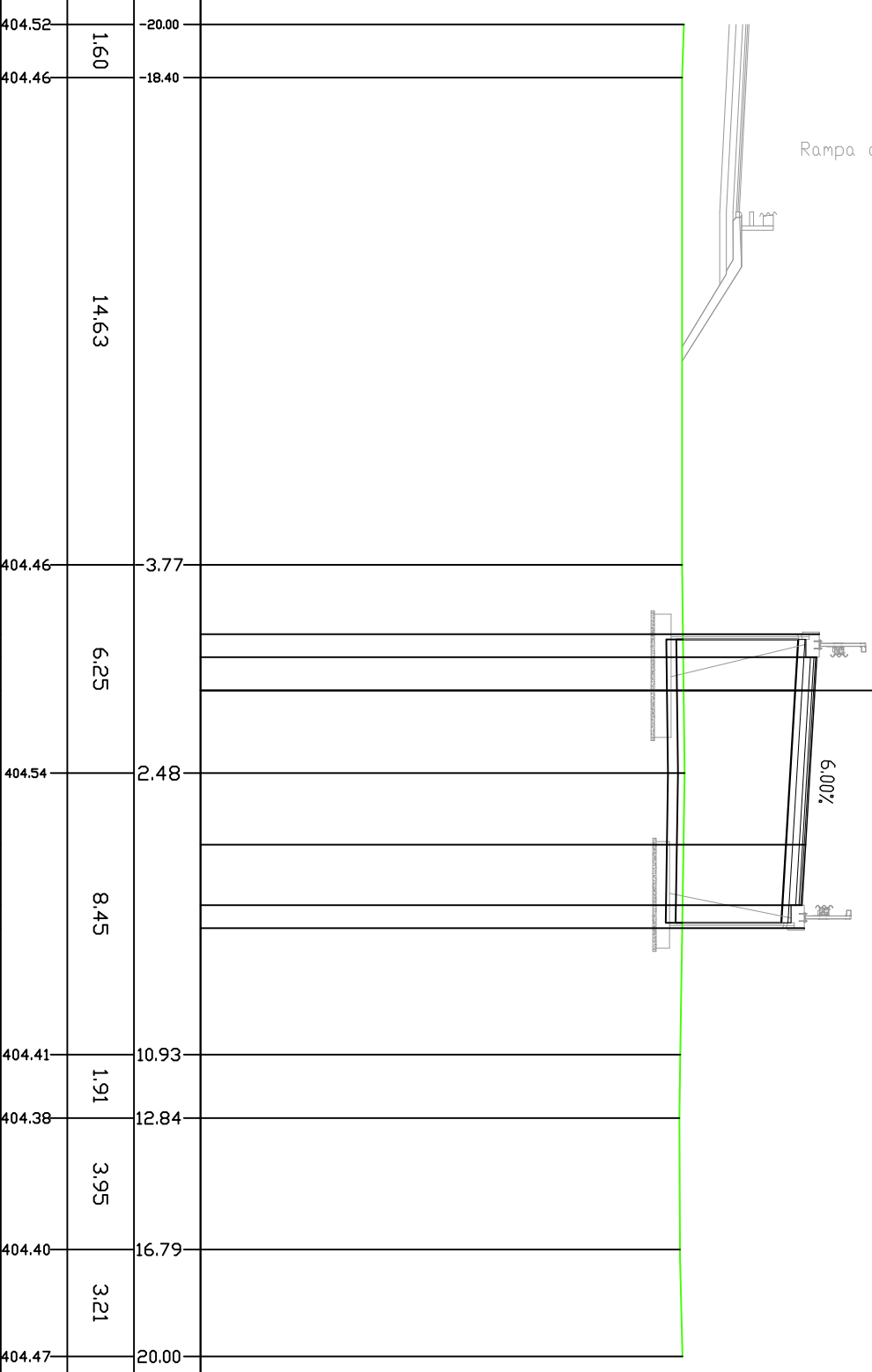

390.00  
 ▼  
 PROGRESSIVE  
 TERRENO 200  
 200

PARZIALI TERRENO	1.60	14.63	6.25	8.45	1.91	3.95	3.21
QUOTE TERRENO	404.52	404.46	404.46	404.54	408.17	408.06	408.13
PROGRESSIVE PROGETTO	-20.00	-18.40	3.77	2.48	4.63	6.45	7.14
PARZIALI PROGETTO					4.63	0.69	
QUOTE PROGETTO					0.69	1.00	

PROFILO SV-T0\_MM3

SEZIONE 14

PROGRESSIVA 200.00

STERRI E RIPORTI	29,78 mq.
Ri	
STABILIZZATO	1,32 mq.
DI	
CEMENTATO	1,38 mq.
E1	
BASE	0,68 mq.
F1	
USURA	6,88 ml.
f1	
BINDER	6,88 ml.
g1	

PROGRESSIVE TERRENO	390.00	200	200
PARZIALI TERRENO	404.61	3.53	
QUOTE TERRENO	404.51	3.72	
PROGRESSIVE PROGETTO	404.53	4.28	
PARZIALI PROGETTO	404.44	6.10	
QUOTE PROGETTO	404.38	4.37	
PROGRESSIVE TERRENO	410.37	1.00	
PARZIALI TERRENO	410.33	4.38	
QUOTE TERRENO	410.13	1.50	
PROGRESSIVE PROGETTO	410.07	5.88	
PARZIALI PROGETTO			
QUOTE PROGETTO			

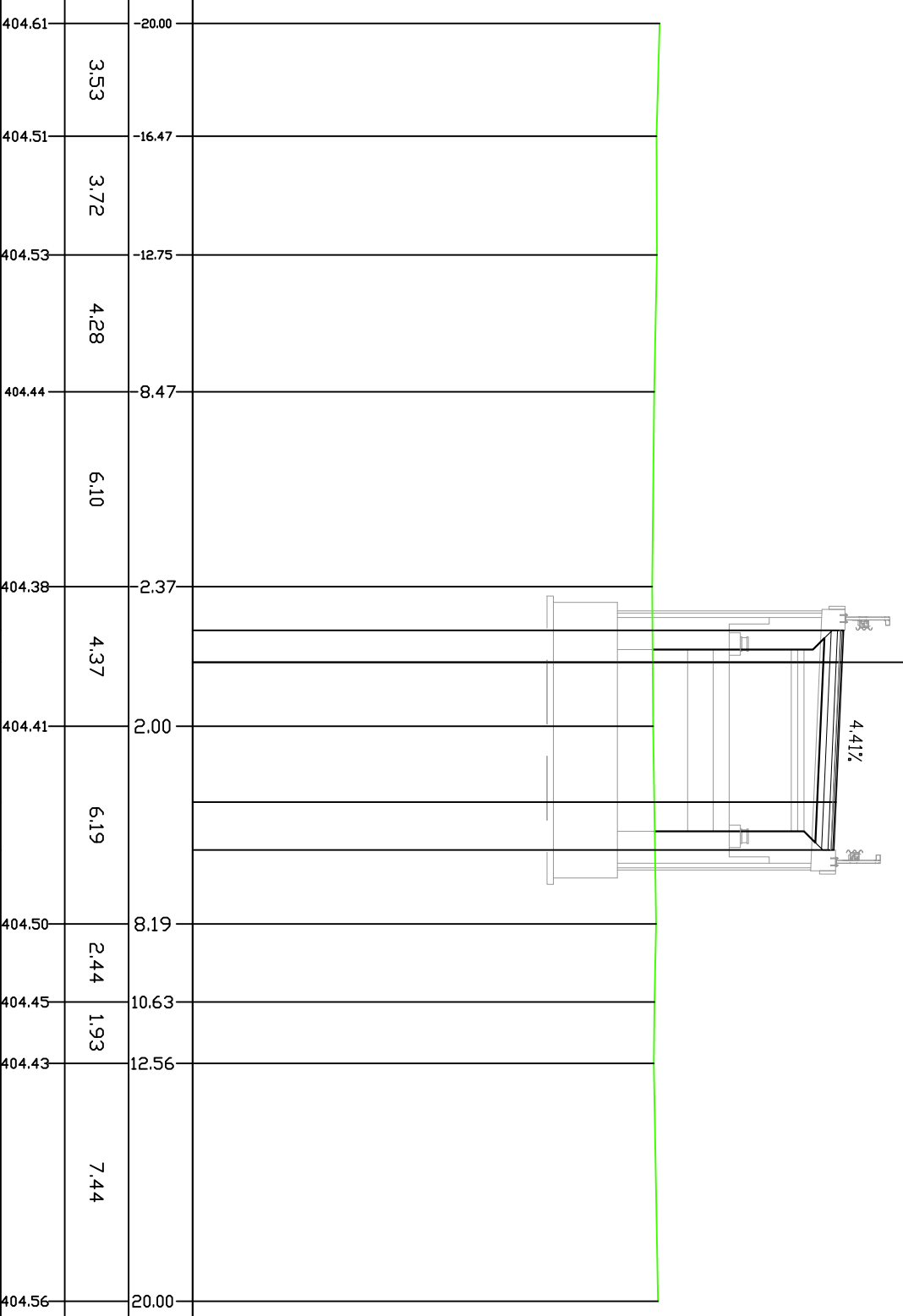

PROFILO SV-T0\_MM3

SEZIONE 15

PROGRESSIVA 216.13

USURA f1 669 ml.  
BINDER g1 669 ml.

390.00  
200  
200

PROGRESSIVE TERRENO									
PARZIALI TERRENO	167	2.29	9.69	11.07	2.12	3.00	0.60	9.56	
QUOTE TERRENO	404.66	404.66	404.67	404.60	404.48	404.51	404.58 404.57	404.68	
PROGRESSIVE PROGETTO									
PARZIALI PROGETTO									
QUOTE PROGETTO									

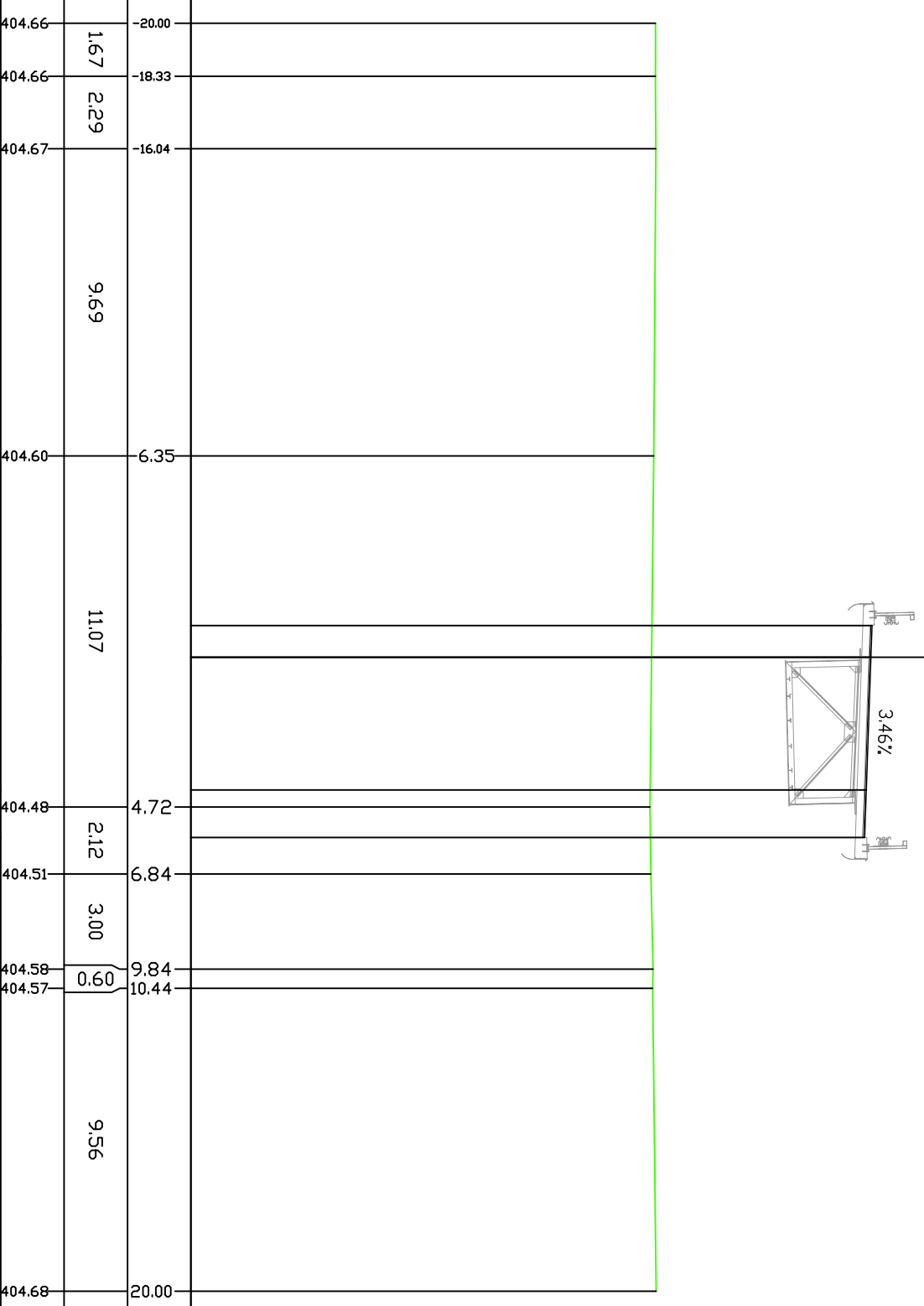





PROFILO SV-T0\_MM3

SEZIONE 18

PROGRESSIVA 255.94

USURA f1 6.78 ml.  
BINDER g1 6.78 ml.

390.00  
200  
200

PROGRESSIVE  
TERRENO  
PARZIALI  
TERRENO  
QUOTE  
TERRENO  
PROGRESSIVE  
PROGETTO  
PARZIALI  
PROGETTO  
QUOTE  
PROGETTO

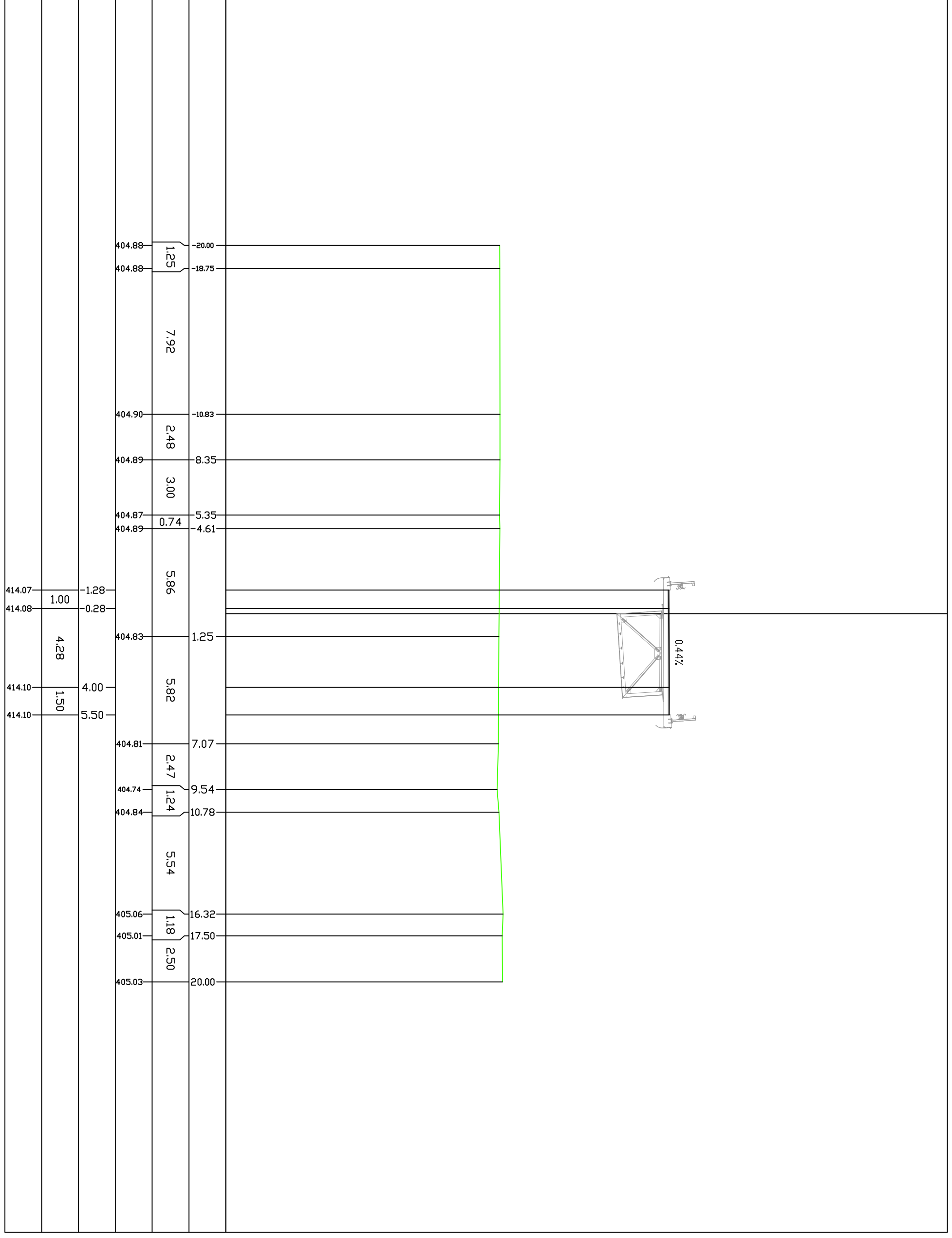



PROFILO SV-T0\_MM3

SEZIONE 19

PROGRESSIVA 275.00

USURA f1 7.57 ml.  
BINDER g1 7.57 ml.

390.00  
200  
200

PROGRESSIVE TERRENO									
PARZIALI TERRENO									
QUOTE TERRENO									
PROGRESSIVE PROGETTO									
PARZIALI PROGETTO									
QUOTE PROGETTO									

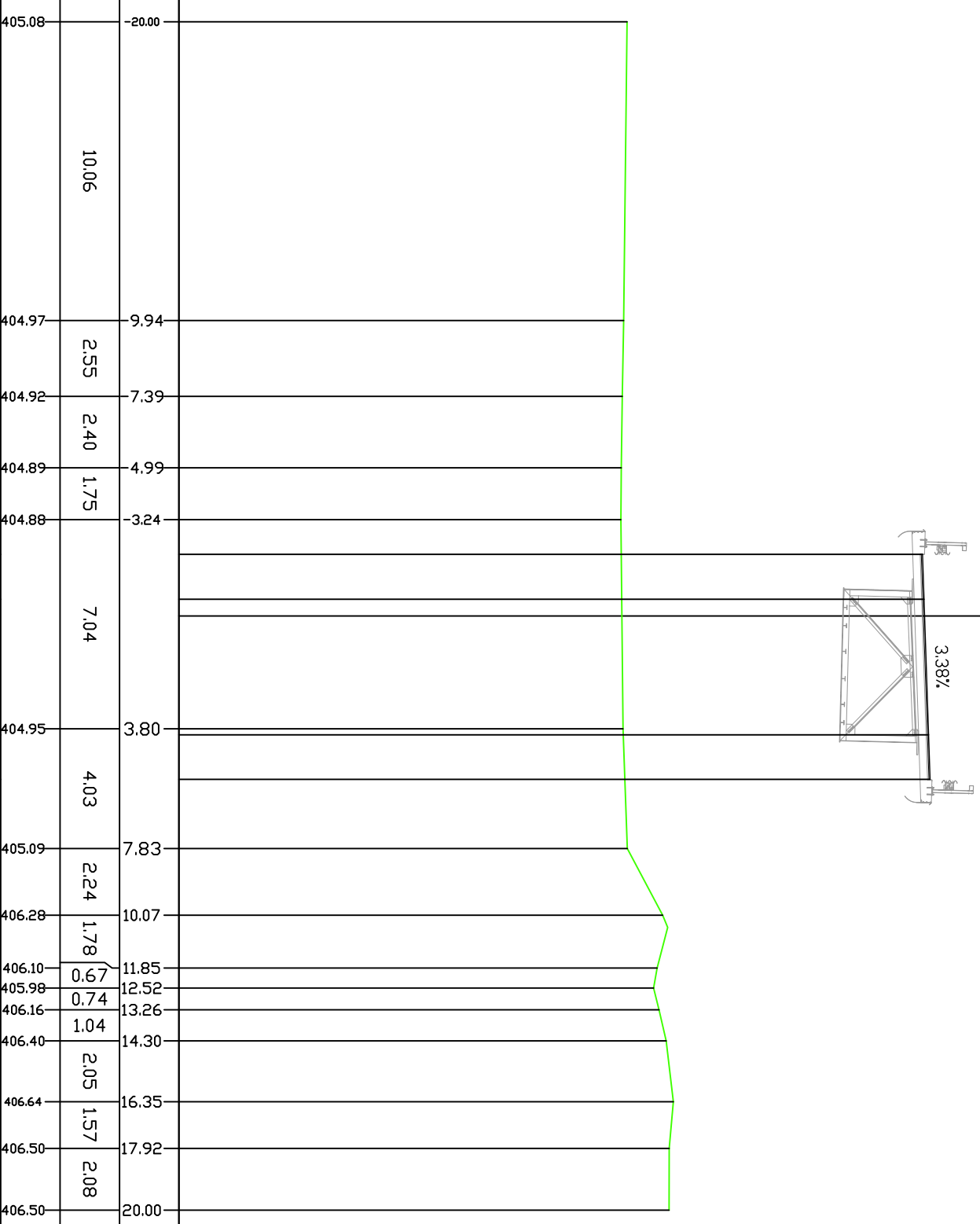

PROFILO SV-T0\_MM3

SEZIONE 20

PROGRESSIVA 291.96

USURA f1 8.03 ml.  
BINDER g1 8.03 ml.

390.00  
200  
200

PROGRESSIVE TERRENO
PARZIALI TERRENO
QUOTE TERRENO
PROGRESSIVE PROGETTO
PARZIALI PROGETTO
QUOTE PROGETTO

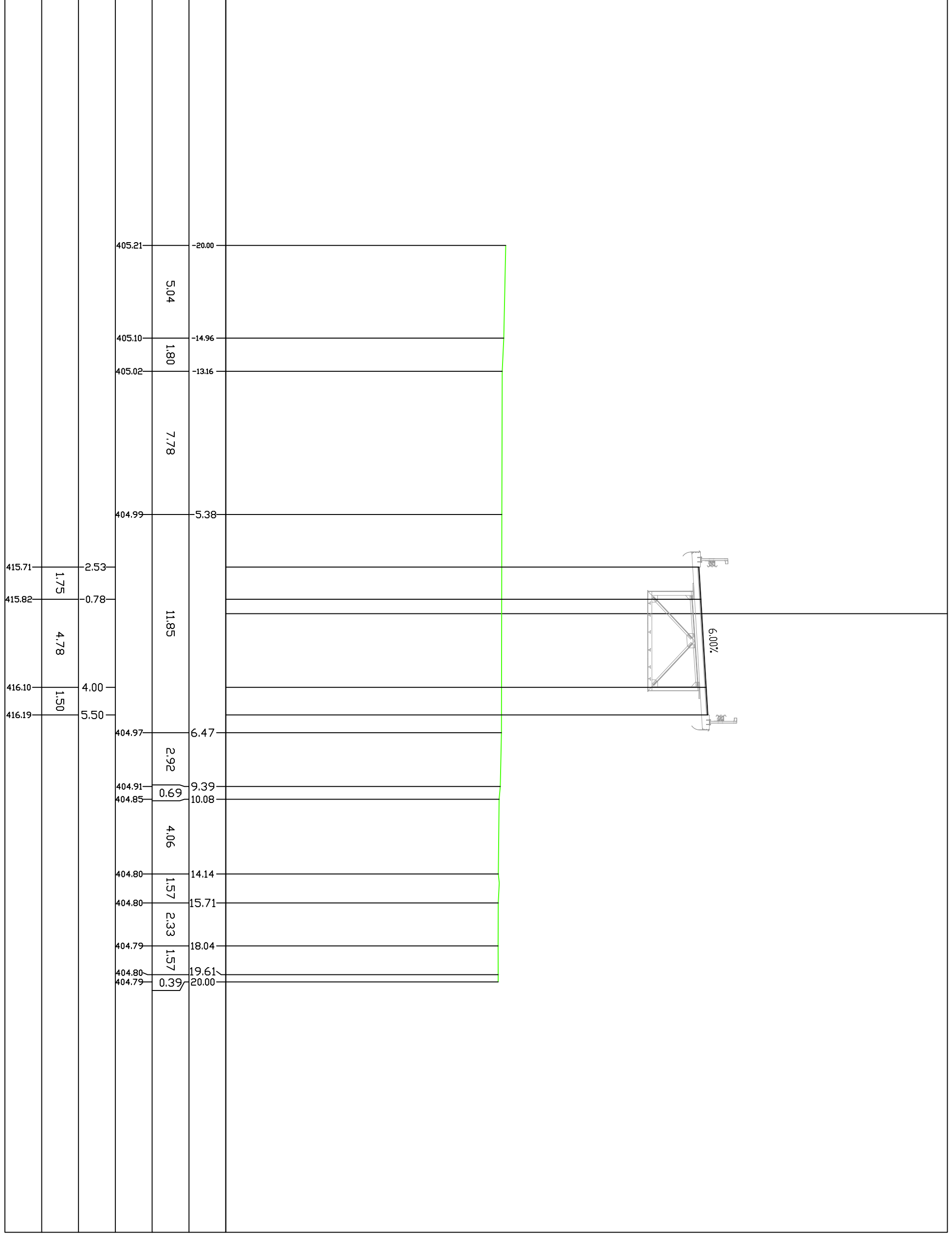

PROFILO SV-T0\_MM3

SEZIONE 21

PROGRESSIVA 308.35

USURA f1 7.67 ml.  
BINDER g1 7.67 ml.

390.00  
200  
200

Rampa di Ingresso A32 direzione Bardonecchia - Rampa 2

PROGRESSIVE TERRENO					
PARZIALI TERRENO	1.27	10.71	1.71	3.82	18.27
QUOTE TERRENO					
PROGRESSIVE PROGETTO					
PARZIALI PROGETTO					
QUOTE PROGETTO					

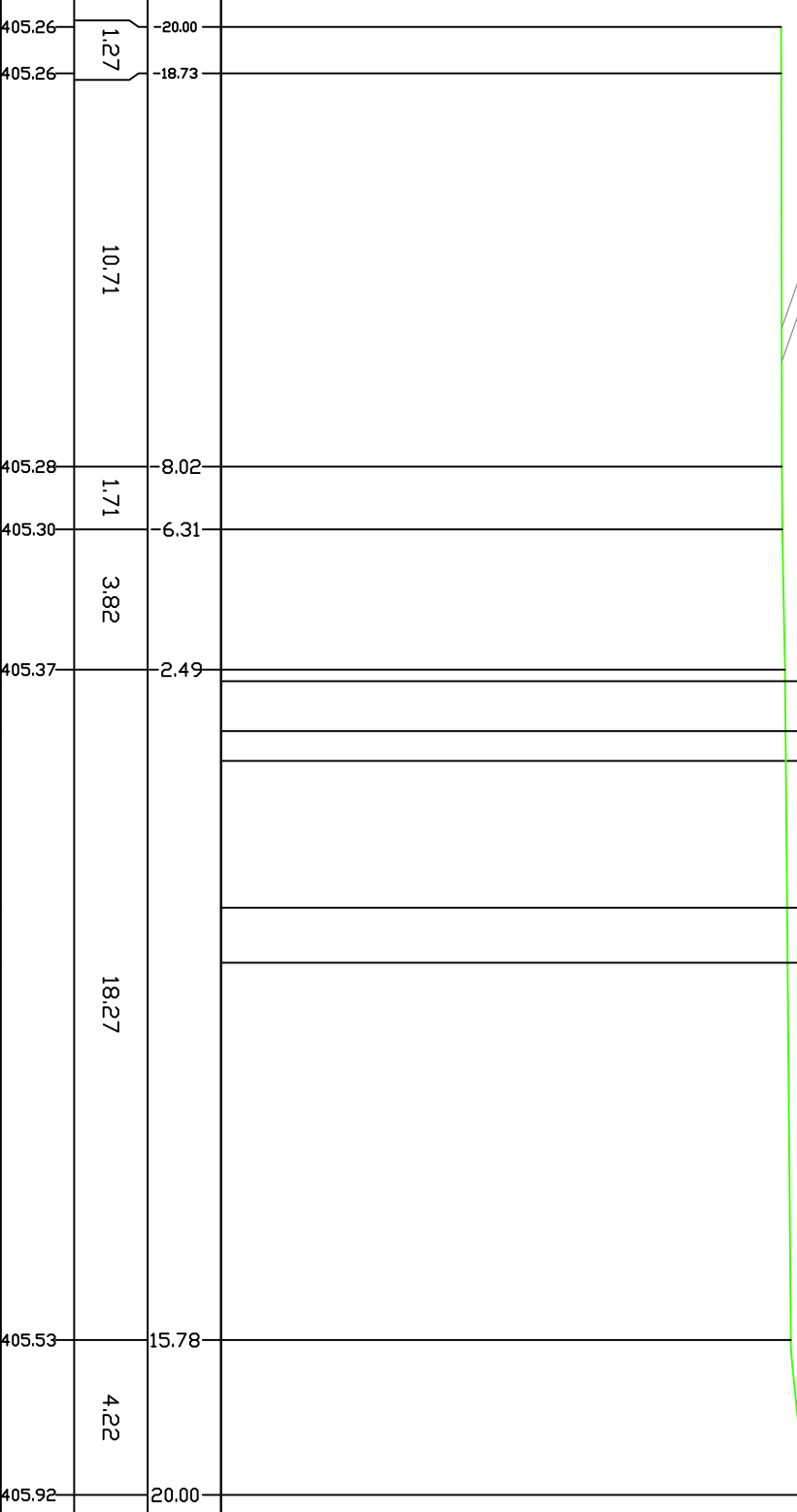

416.31	-2.17	405.37	2.49
416.39	-0.81		
416.68	4.00		
416.77	5.50		

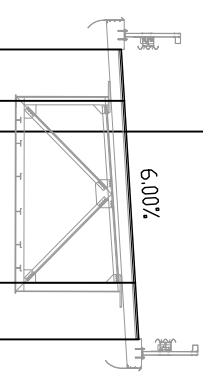

PROFILO SV-T0\_MM3

SEZIONE 22

PROGRESSIVA 328.92

USURA f1 7.54 ml.  
BINDER g1 7.54 ml.

390.00  
200  
200

PROGRESSIVE TERRENO
PARZIALI TERRENO
QUOTE TERRENO
PROGRESSIVE PROGETTO
PARZIALI PROGETTO
QUOTE PROGETTO

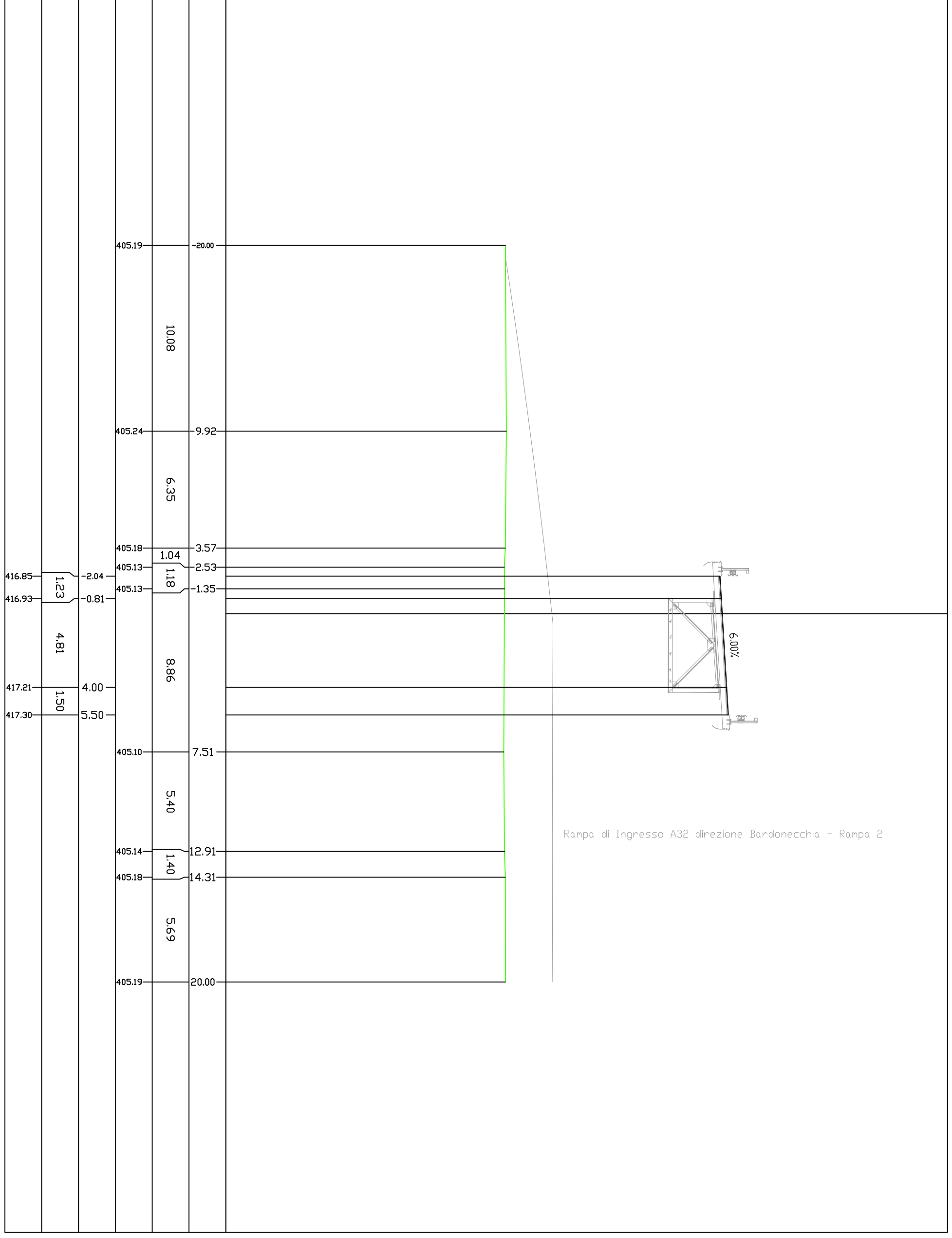

PROFILO SV-T0\_MM3

SEZIONE 23

PROGRESSIVA 349.49

USURA f1 7.57 ml.  
BINDER g1 7.57 ml.

390.00  
▼  
PROGRESSIVE TERRENO 200  
200

PARZIALI TERRENO  
QUOTE TERRENO  
PROGRESSIVE PROGETTO  
PARZIALI PROGETTO  
QUOTE PROGETTO

Autostrada A32 - Salita  
Direzione BARDONECCHIA

Autostrada A32 - Discesa  
Direzione TORINO

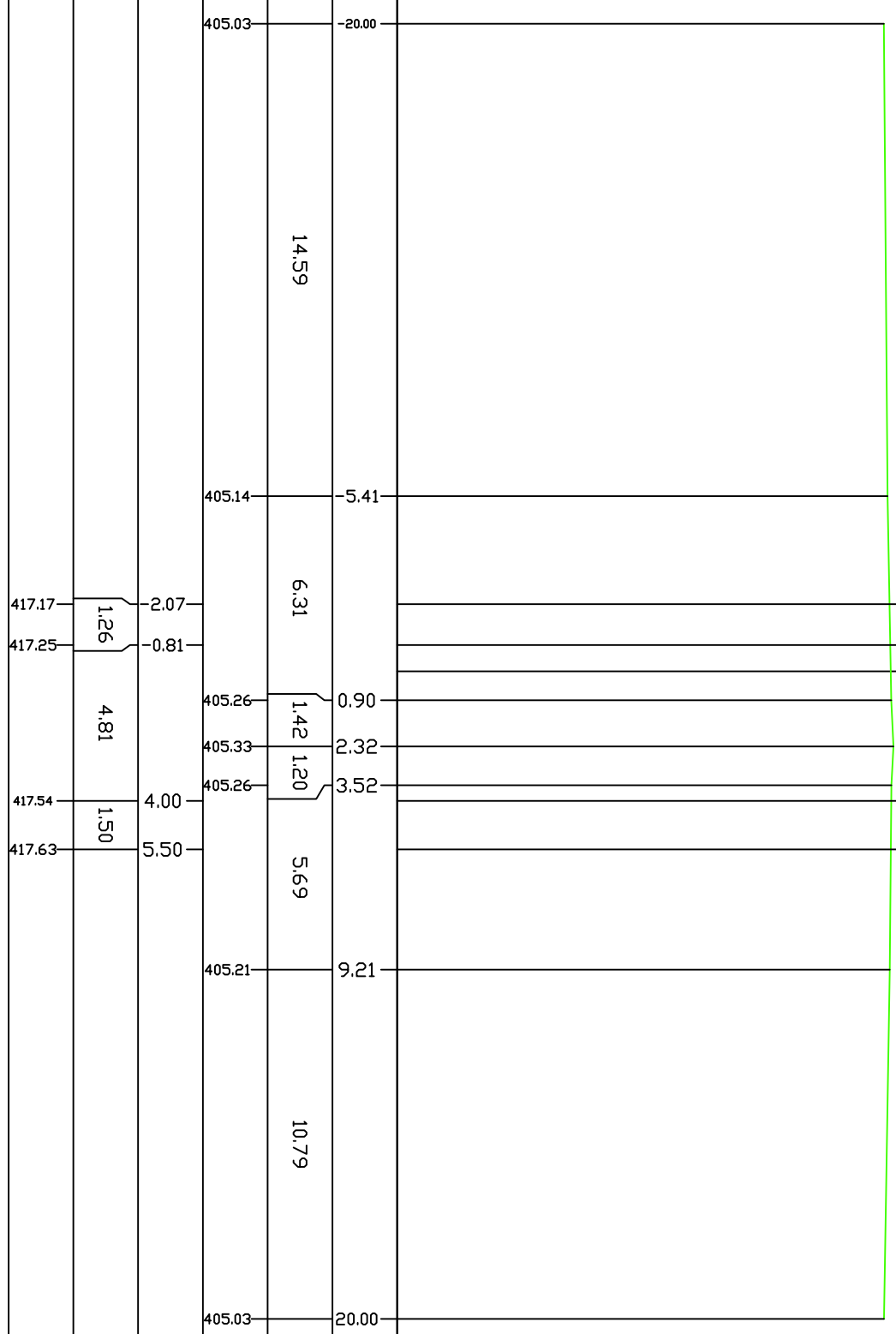
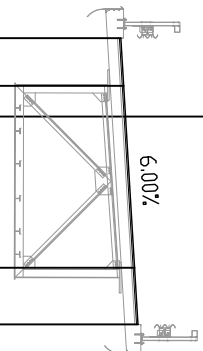

PROFILO SV-T0\_MM3

SEZIONE 24

PROGRESSIVA 370.07

USURA f1 7.61 ml.  
BINDER g1 7.61 ml.

390.00  
200  
200

PROGRESSIVE TERRENO
PARZIALI TERRENO
QUOTE TERRENO
PROGRESSIVE PROGETTO
PARZIALI PROGETTO
QUOTE PROGETTO

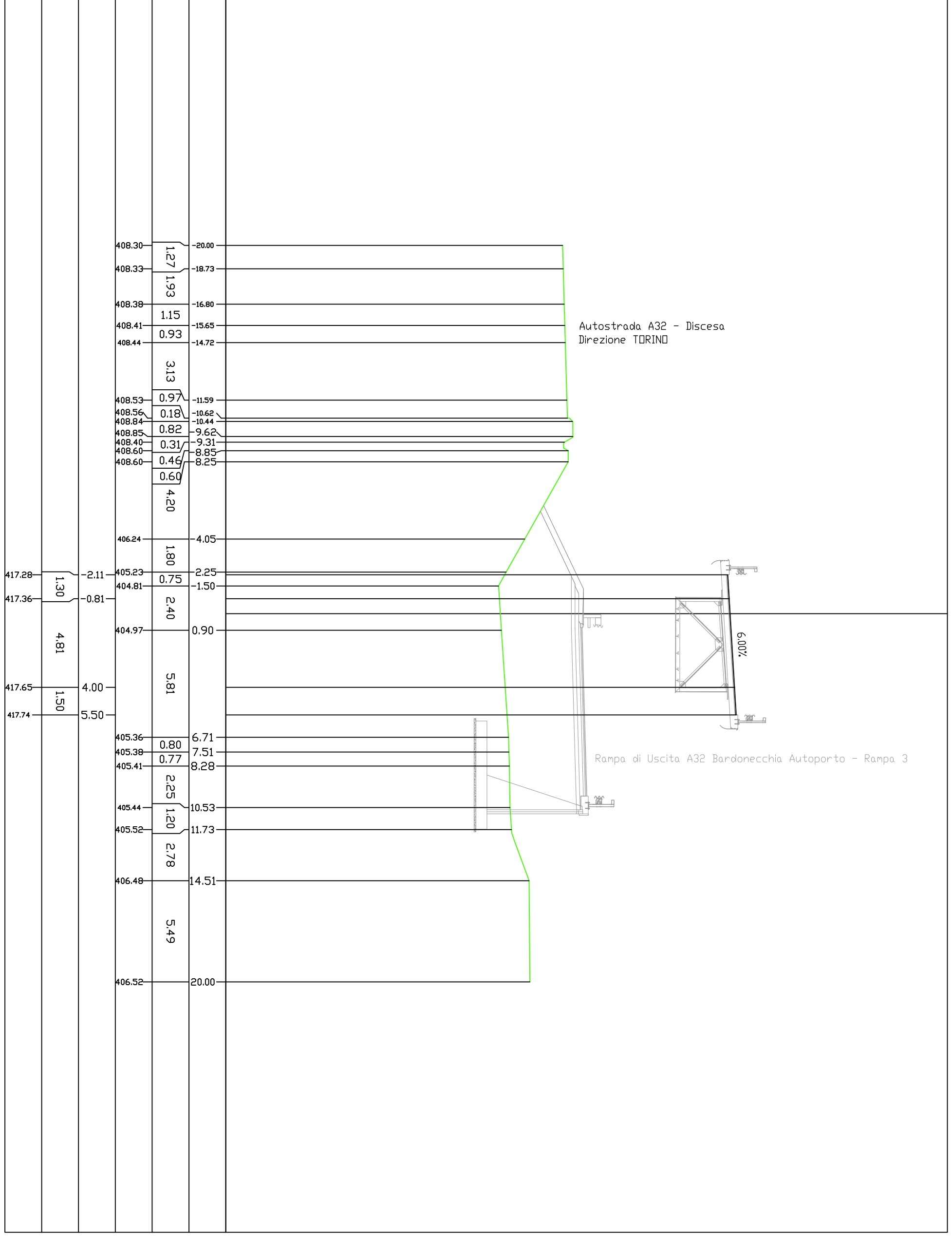

PROFILO SV-T0\_MM3

SEZIONE 25

PROGRESSIVA 391.01

USURA f1 7.63 ml.  
BINDER g1 7.63 ml.

Rampa di Uscita A32 Bardonecchia Autoporto - Rampa 3

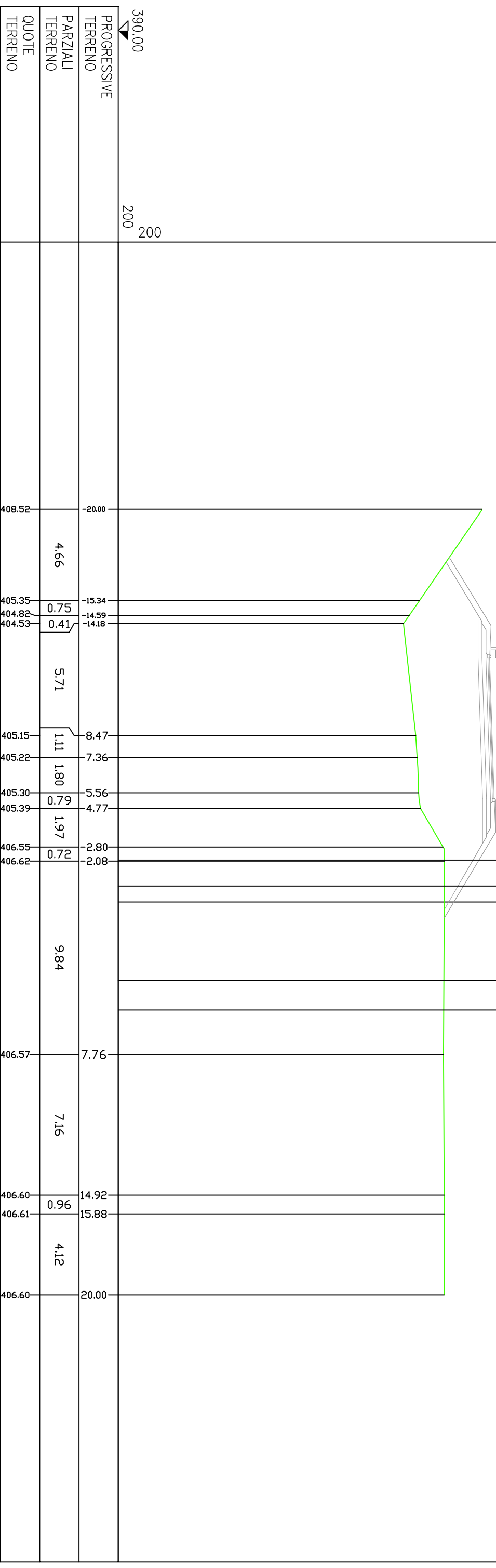

PROGRESSIVE TERRENO	390.00	200	200
PARZIALI TERRENO	408.52	-20.00	
QUOTE TERRENO			
PROGRESSIVE PROGETTO			
PARZIALI PROGETTO			
QUOTE PROGETTO			

PROFILO SV-T0\_MM3

SEZIONE 26

PROGRESSIVA 407.02

USURA f1 7.40 ml.  
BINDER g1 7.40 ml.

390.00  
200  
200

PROGRESSIVE TERRENO
PARZIALI TERRENO
QUOTE TERRENO
PROGRESSIVE PROGETTO
PARZIALI PROGETTO
QUOTE PROGETTO

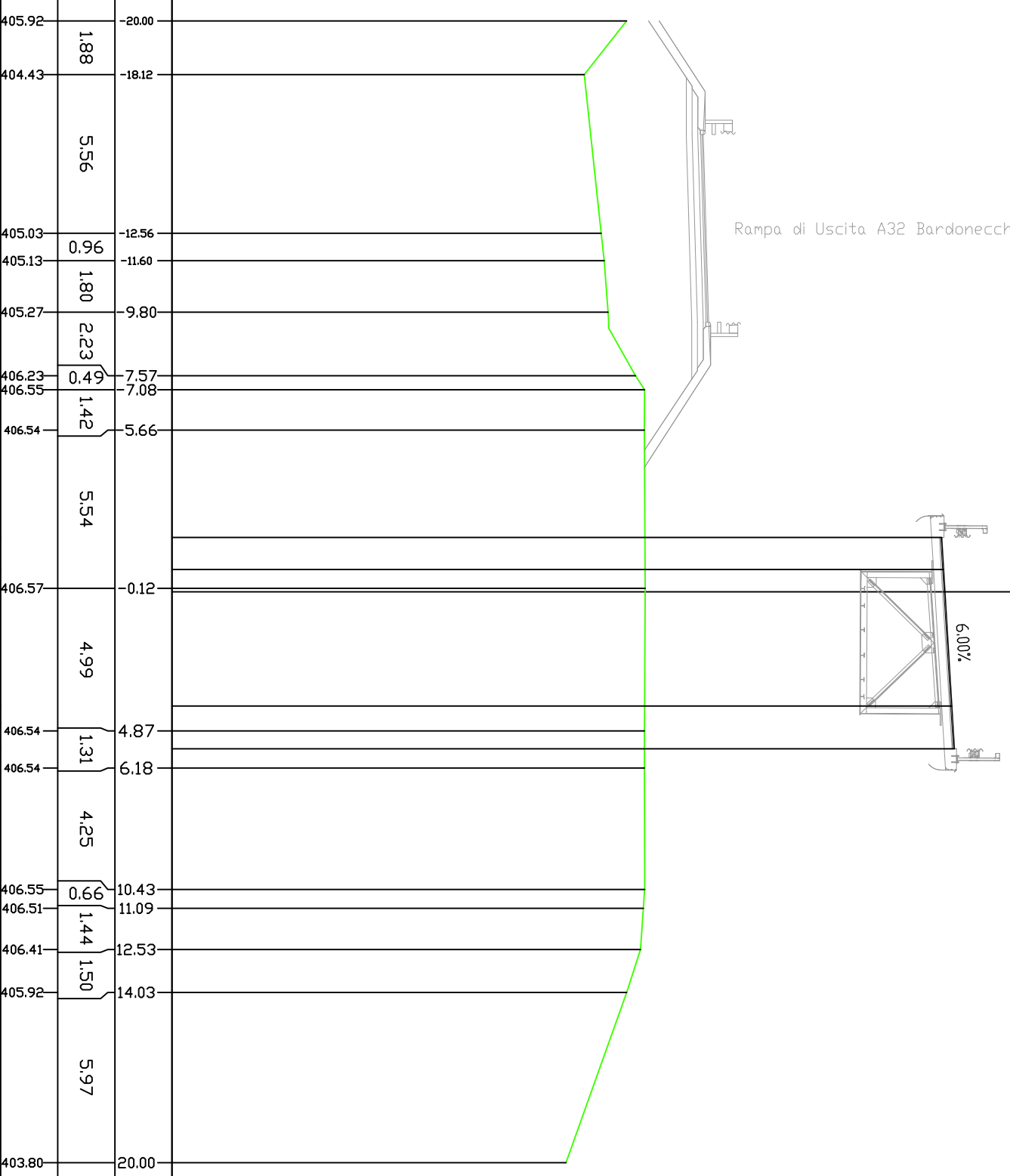

405.92	-20.00		
404.43	-18.12	1.88	
		5.56	
405.03	-12.56	0.96	
405.13	-11.60	1.80	
405.27	9.80	2.23	
406.23	7.57	0.49	
406.55	7.08	1.42	
406.54	5.66		
		5.54	
416.95	-1.90		1.12
417.02	-0.78		
		4.99	4.78
417.31	4.00		
417.40	5.50		1.50
		4.25	
406.55	10.43	0.66	
406.51	11.09	1.44	
406.41	12.53	1.50	
405.92	14.03		5.97
403.80	20.00		



PROFILO SV-T0\_MM3

SEZIONE 27

PROGRESSIVA 425.00

USURA f1 7.05 ml.  
BINDER g1 7.05 ml.

390.00  
200  
200

PROGRESSIVE TERRENO
PARZIALI TERRENO
QUOTE TERRENO
PROGRESSIVE PROGETTO
PARZIALI PROGETTO
QUOTE PROGETTO

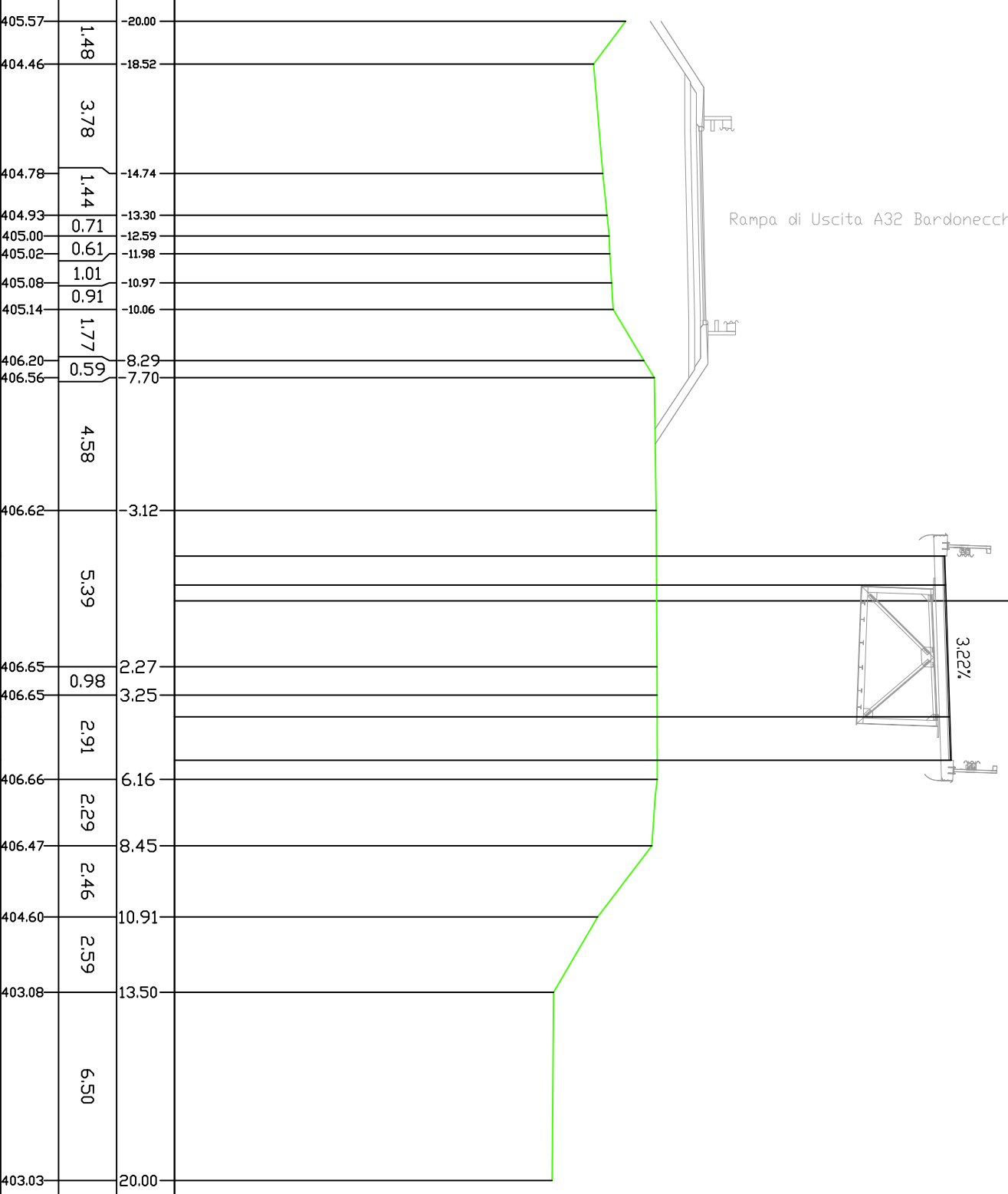

PROFILO SV-T0\_MM3

SEZIONE 28

PROGRESSIVA 443.55

STERRE E RIPORTI	53,72 mq.
RiSTABILIZZATO	1,31 mq.
DI CEMENTATO	1,35 mq.
E1 BASE	0,67 mq.
F1 USURA	6,77 ml.
BINDER	6,77 ml.
g1	

390.00  
 200  
 200

PROGRESSIVE TERRENO			
PARZIALI TERRENO			
QUOTE TERRENO			
PROGRESSIVE PROGETTO			
PARZIALI PROGETTO			
QUOTE PROGETTO			

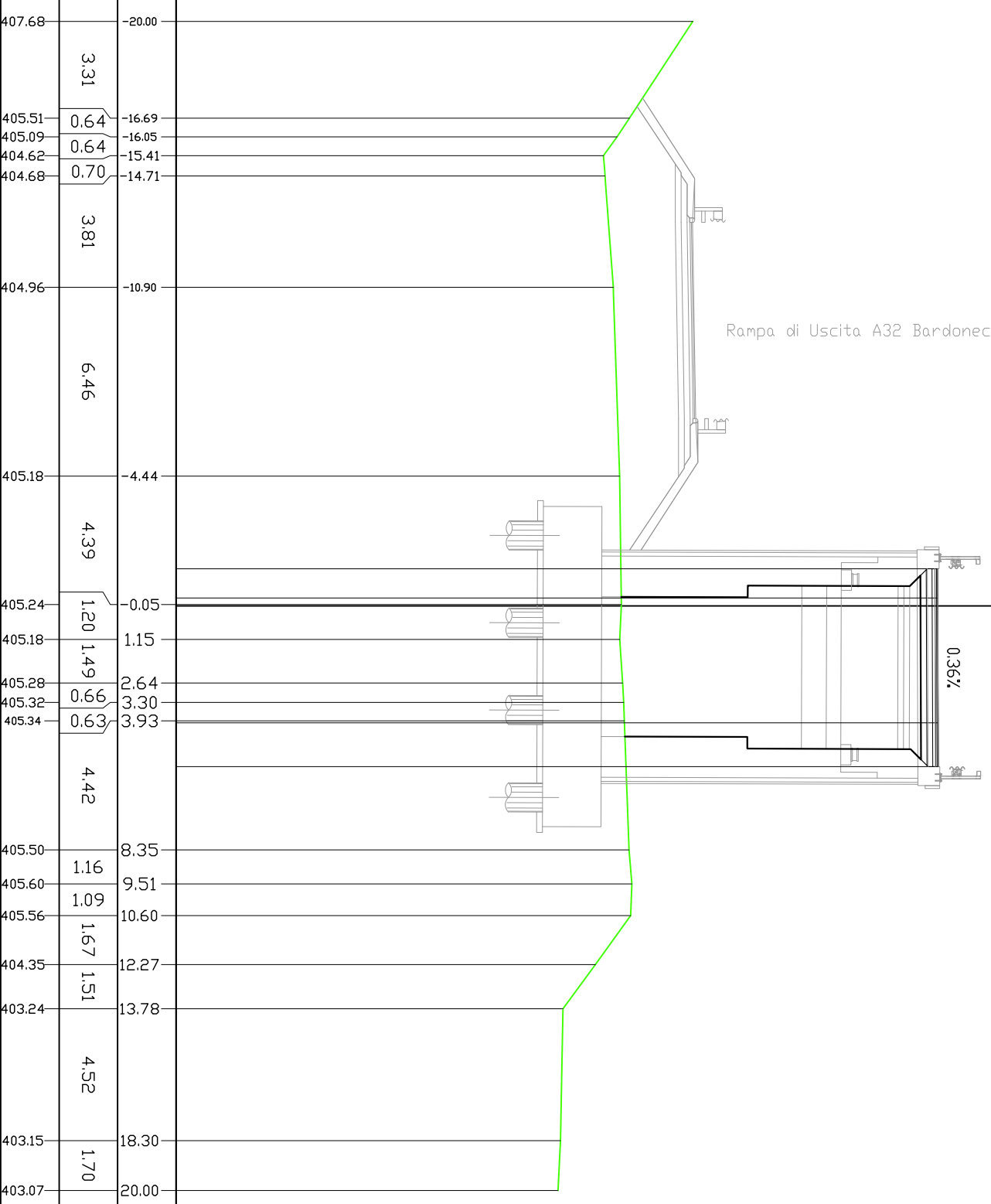

407.68	-20.00	3.31	
405.51	-16.69	0.64	
405.09	-16.05	0.64	
404.62	-15.41	0.70	
404.68	-14.71		3.81
404.96	-10.90		6.46
405.18	-4.44		4.39
416.06	-1.27		1.00
416.06	-0.27	1.20	4.27
405.24	-0.05	1.49	
405.18	1.15	0.63	
405.28	2.64	0.63	
405.32	3.30	0.63	
416.08	3.93		1.50
405.34	3.93		
416.08	5.50	4.42	
405.50	8.35	1.16	
405.60	9.51	1.09	
405.56	10.60	1.67	
404.35	12.27	1.51	
403.24	13.78	4.52	
403.15	18.30	1.70	
403.07	20.00		

PROFILO SV-T0\_MM3

SEZIONE 29

PROGRESSIVA 462.08

STERRI E RIPORTI	45,96 mq.
RI	
STABILIZZATO	1,29 mq.
DI	
CEMENTATO	1,27 mq.
E1	
BASE	0,65 mq.
F1	
USURA	6,53 ml.
f1	
BINDER	6,53 ml.
g1	

390.00  
 200  
 200

PROGRESSIVE TERRENO			
PARZIALI TERRENO			
QUOTE TERRENO			
PROGRESSIVE PROGETTO			
PARZIALI PROGETTO			
QUOTE PROGETTO			

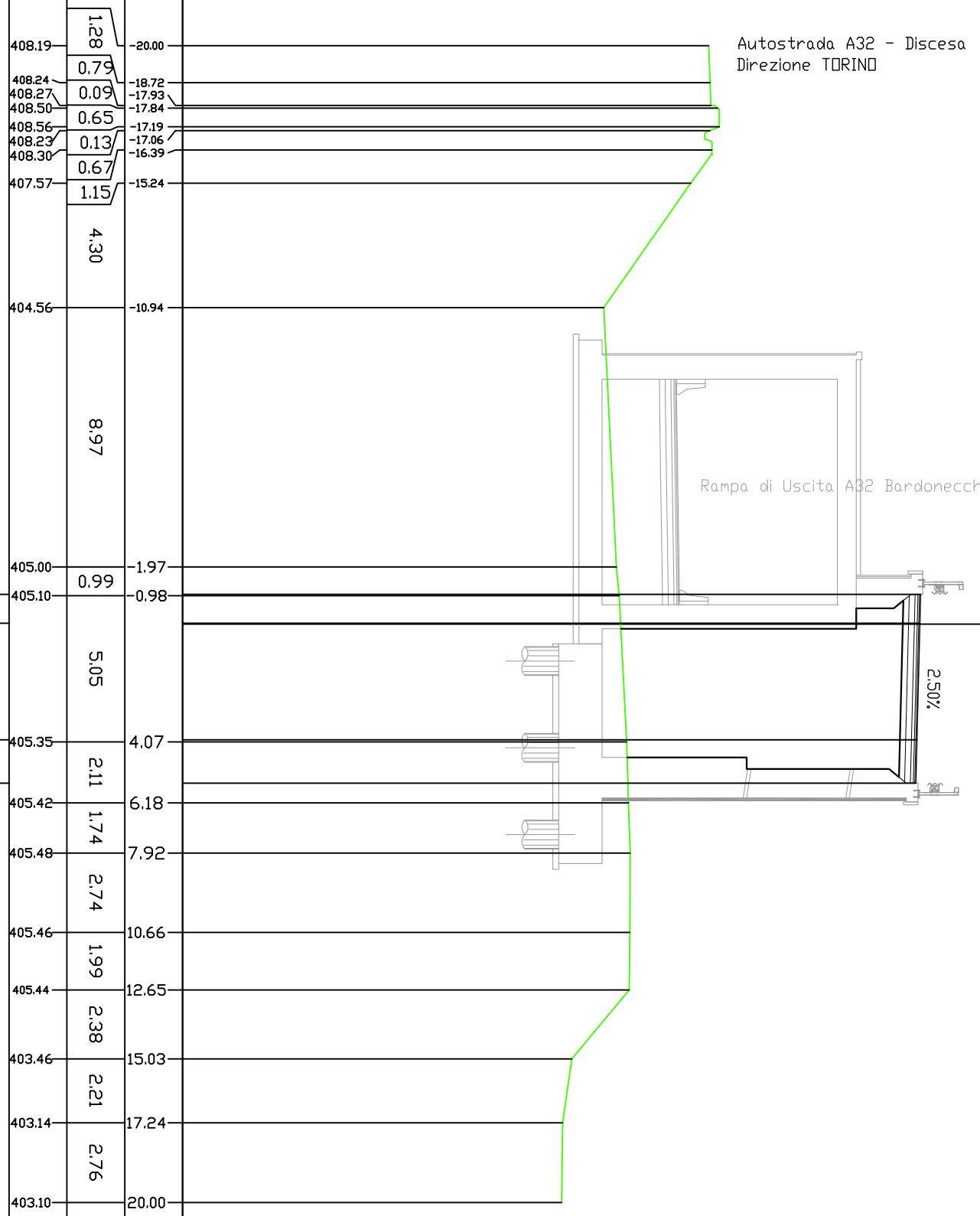

Autostrada A32 - Discesa  
 Direzione TORINO

Rampa di Uscita A32 Bardonecchia Autoporto - Rampa 3

2.50%

PROFILO SV-T0\_MM3

SEZIONE 30

PROGRESSIVA 482.64

STERRI E RIPORTI	7.60 mq.
RI	
STABILIZZATO	1.29 mq.
DI	
CEMENTATO	1.26 mq.
E1	
BASE	0.65 mq.
F1	
USURA	6.52 ml.
F1	
BINDER	6.52 ml.
g1	

390.00  
 ▼  
 PROGRESSIVE  
 TERRENO 200  
 200

PARZIALI  
 TERRENO  
 QUOTE  
 TERRENO  
 PROGRESSIVE  
 PROGETTO  
 PARZIALI  
 PROGETTO  
 QUOTE  
 PROGETTO

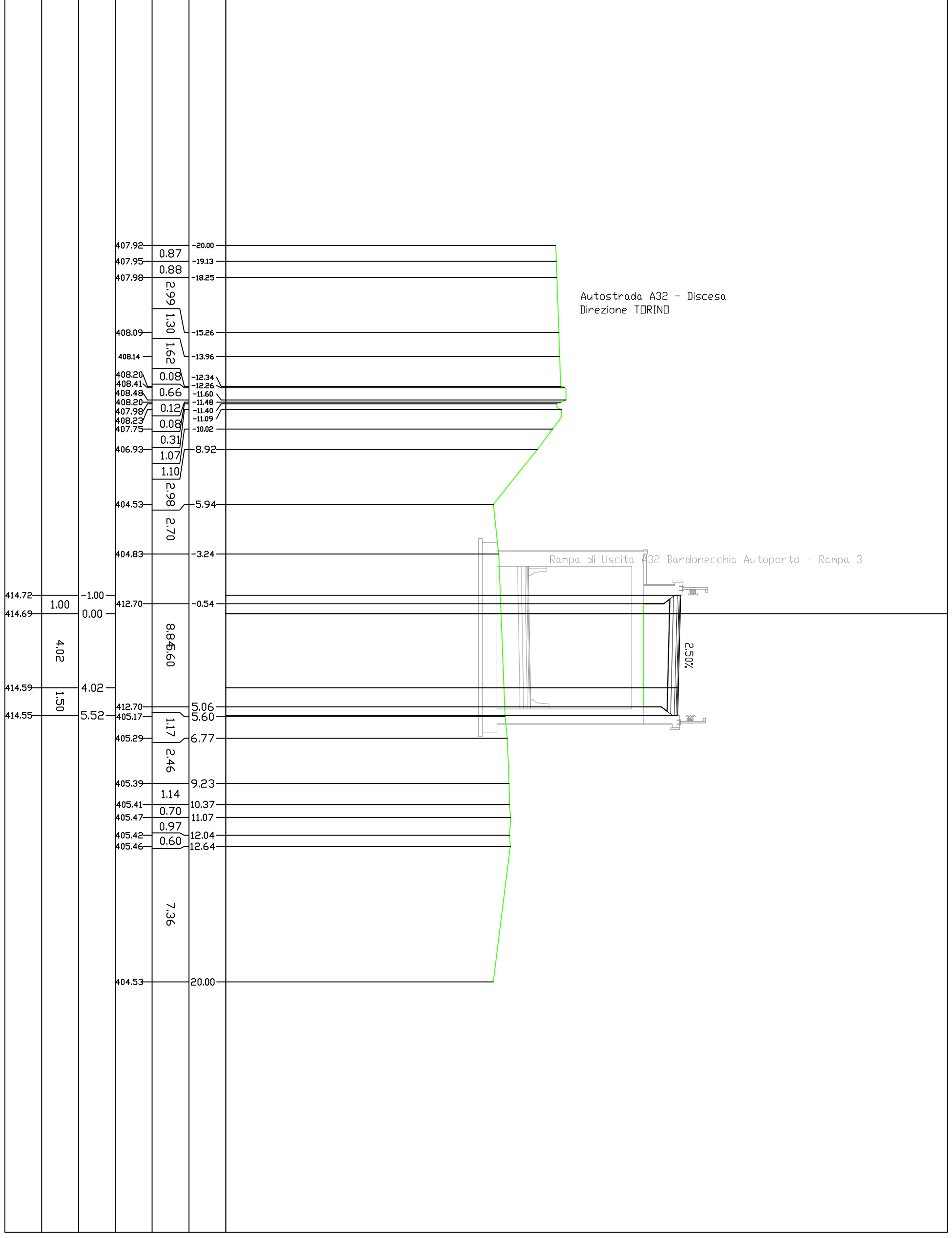

PROFILO SV-T0\_MM3

SEZIONE 31

PROGRESSIVA 500.00

STERRI E RIPORTI	1551 mq.
RI	
STABILIZZATO	1,28 mq.
DI	
CEMENTATO	1,34 mq.
E1	
BASE	0,67 mq.
F1	
USURA	6,71 ml.
f1	
BINDER	6,71 ml.
g1	

390.00  
 ▼  
 PROGRESSIVE  
 TERRENO 200  
 200

PROGRESSIVE TERRENO					
PARZIALI TERRENO					
QUOTE TERRENO					
PROGRESSIVE PROGETTO					
PARZIALI PROGETTO					
QUOTE PROGETTO					

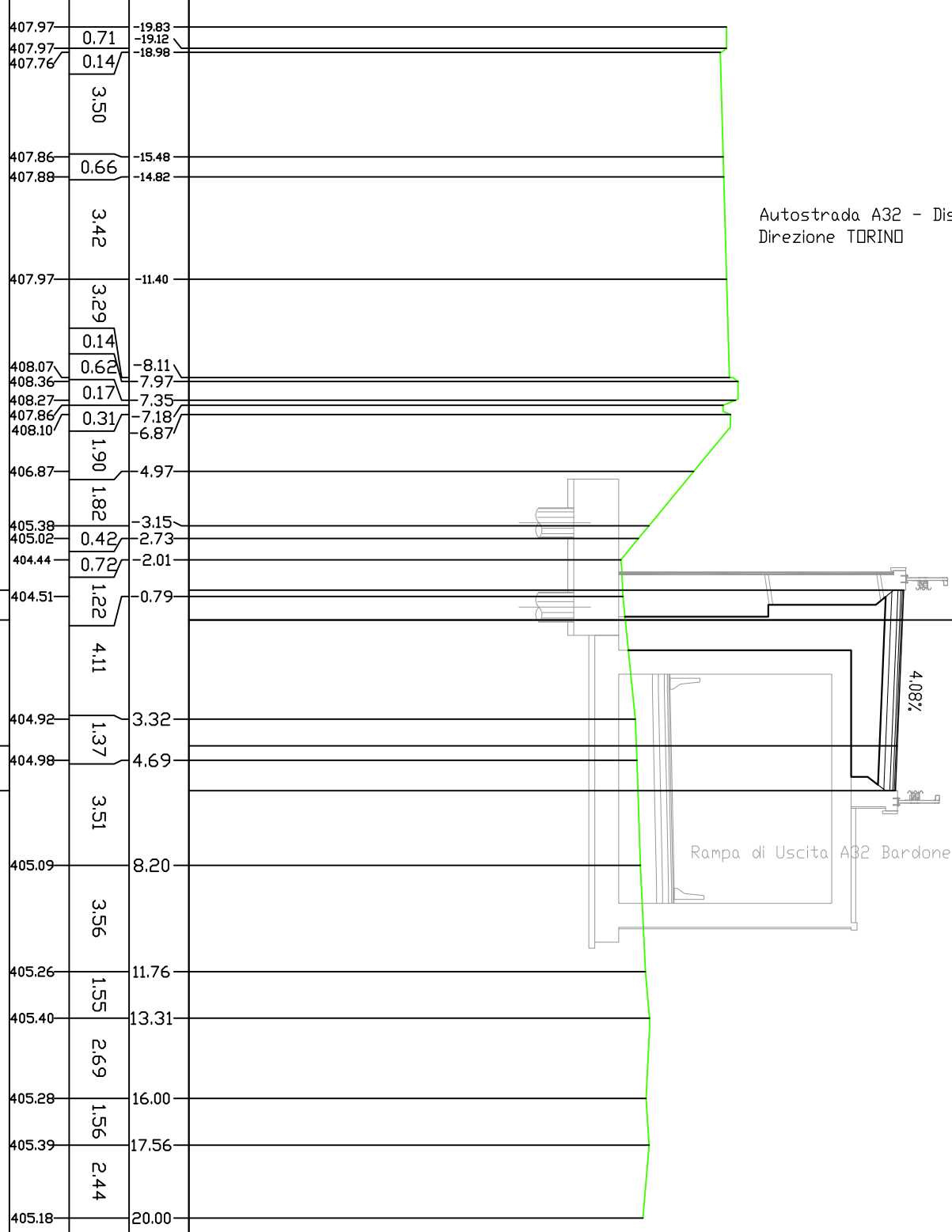

PROFILO SV-T0\_MM3

SEZIONE 32

PROGRESSIVA 515.10

STERRI E RIPORTI	31,48 mq.
RI	
STABILIZZATO	1,34 mq.
DI	
CEMENTATO	1,35 mq.
E1	
BASE	0,68 mq.
F1	
USURA	6,80 ml.
f1	
BINDER	6,80 ml.
g1	

390.00  
200  
200

PROGRESSIVE TERRENO	QUOTE TERRENO	PROGRESSIVE TERRENO	QUOTE TERRENO
407.48	1,75	407.77	3,73
407.53 407.75	0,4	407.86 407.87	0,68
407.89 407.69	1,40	407.92 407.94 408.19	0,97 0,10 0,6
		408.23 407.87 407.97	0,6 0,14 0,67
		407.20	1,10
		413.05	1,00
		413.00	0,00
		404.33	1,34
		404.46	1,34
		404.51	1,34
		412.77	4,30
		412.69	1,50
			8,58
		405.11	1,10
		405.16	1,66
		405.22 405.18	0,70
			4,63
		404.87	20,00

Autostrada A32 - Discesa  
Direzione TORINO

Rampa di Uscita A32 Bardonecchia Autoporto - Rampa 3

5,39%

PROFILO SV-T0\_MM3

SEZIONE 33

PROGRESSIVA 547.56

STERRI E RIPORTI	41.75 mq.
Ri	
SCOTTICO	1.45 mq.
AI	
BONIFICA	2.21 mq.
BI	
STABILIZZATO	1.46 mq.
DI	
CEMENTATO	1.34 mq.
EI	
BASE	0.65 mq.
F1	
TNT	9.38 ml.
a1	
GEODRIGLIA 10KN/m	7.33 ml.
bi	
USURA	6.52 ml.
f1	
BINDER	6.52 ml.
g1	

390.00  
 ▼  
 PROGRESSIVE  
 TERRENO 200  
 200

PROGRESSIVE			
TERRENO			
PARZIALI			
TERRENO			
QUOTE			
TERRENO			
PROGRESSIVE			
PROGETTO			
PARZIALI			
PROGETTO			
QUOTE			
PROGETTO			

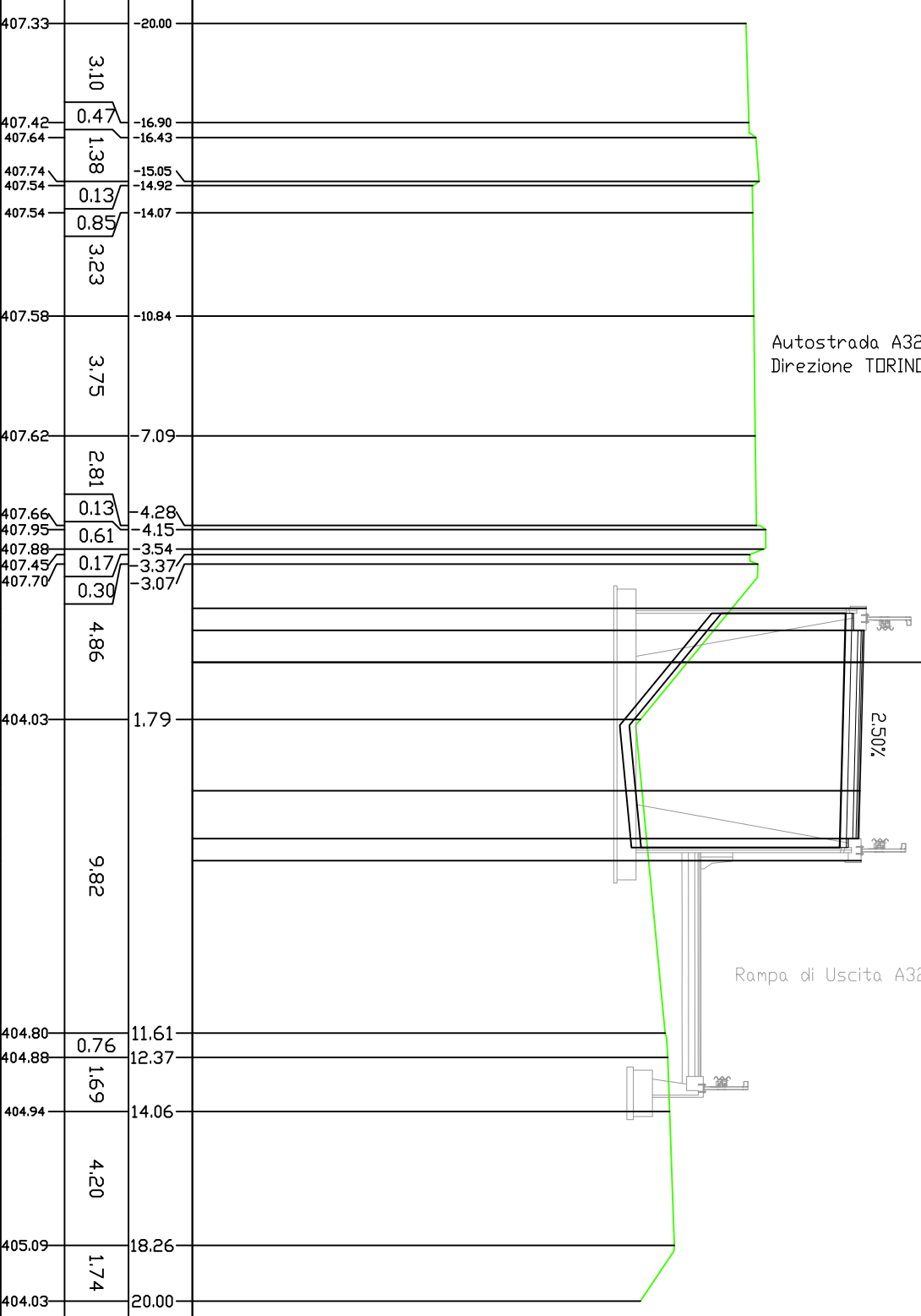

407.33	-20.00		
407.42	-16.90	0.47	3.10
407.64	-16.43	1.38	
407.74	-15.05	0.13	
407.54	-14.92	0.85	3.23
407.54	-14.07		
407.58	-10.84		3.75
407.62	-7.09	2.81	
407.66	-4.28	0.13	
407.95	-4.15	0.61	
407.88	-3.54	0.17	
407.45	-3.37	0.30	
407.70	-3.07		4.86
411.10	-1.69	0.69	
411.03	-1.00	1.00	
411.00	0.00		4.02
404.03	1.79		
410.90	4.02		
410.86	5.52	1.50	
410.93	6.21	0.69	9.82
404.80	11.61	0.76	
404.88	12.37	1.69	
404.94	14.06		4.20
405.09	18.26	1.74	
404.03	20.00		

PROFILO SV-T0\_MM3

SEZIONE 34

PROGRESSIVA 575.00

STERRI E RIPORTI	29.63 mq.
Ri	
SCOTTICO	1.46 mq.
AI	
BONIFICA	2.20 mq.
BI	
STABILIZZATO	1.46 mq.
DI	
CEMENTATO	1.30 mq.
EI	
BASE	0.65 mq.
F1	
TNT	
a1	9.24 ml.
GEORIGLIA 10KN/m	
bi	7.31 ml.
USURA	
f1	6.50 ml.
BINDER	
g1	6.50 ml.

390.00  
 ▼  
 PROGRESSIVE  
 TERRENO 200  
 200

PARZIALI TERRENO	407.25	1.89	-20.00
	407.30	1.22	-18.11
	407.34	0.47	-16.89
	407.56	1.38	-16.42
	407.64	0.13	-15.04
	407.43	2.77	-14.91
	407.41	1.31	-12.14
	407.40	2.45	-10.83
	407.40	1.30	8.38
	407.39	1.85	7.08
	407.39	0.90	5.23
	407.39	0.09	-4.25
	407.62	0.60	-4.16
	407.68	0.13	-3.54
	407.35	0.13	-3.41
	407.42	0.66	-2.75
	407.13	0.50	-2.19
409.44	0.69	-1.69	
409.36	1.00	-1.00	
409.34		0.00	
	4.00		
409.24	1.50	4.00	
409.20	0.69	5.50	
409.27		6.19	
	5.86		
404.66	0.81	10.82	
404.77	0.80	11.63	
404.79	1.83	12.43	
404.86	1.98	14.26	
404.84	1.76	16.24	
404.84	2.00	18.00	
404.59		20.00	

Autostrada A32 - Discesa  
Direzione TORINO

2.50%

Rampa di Uscita A32 Bardonecchia Autoporto - Rampa 3

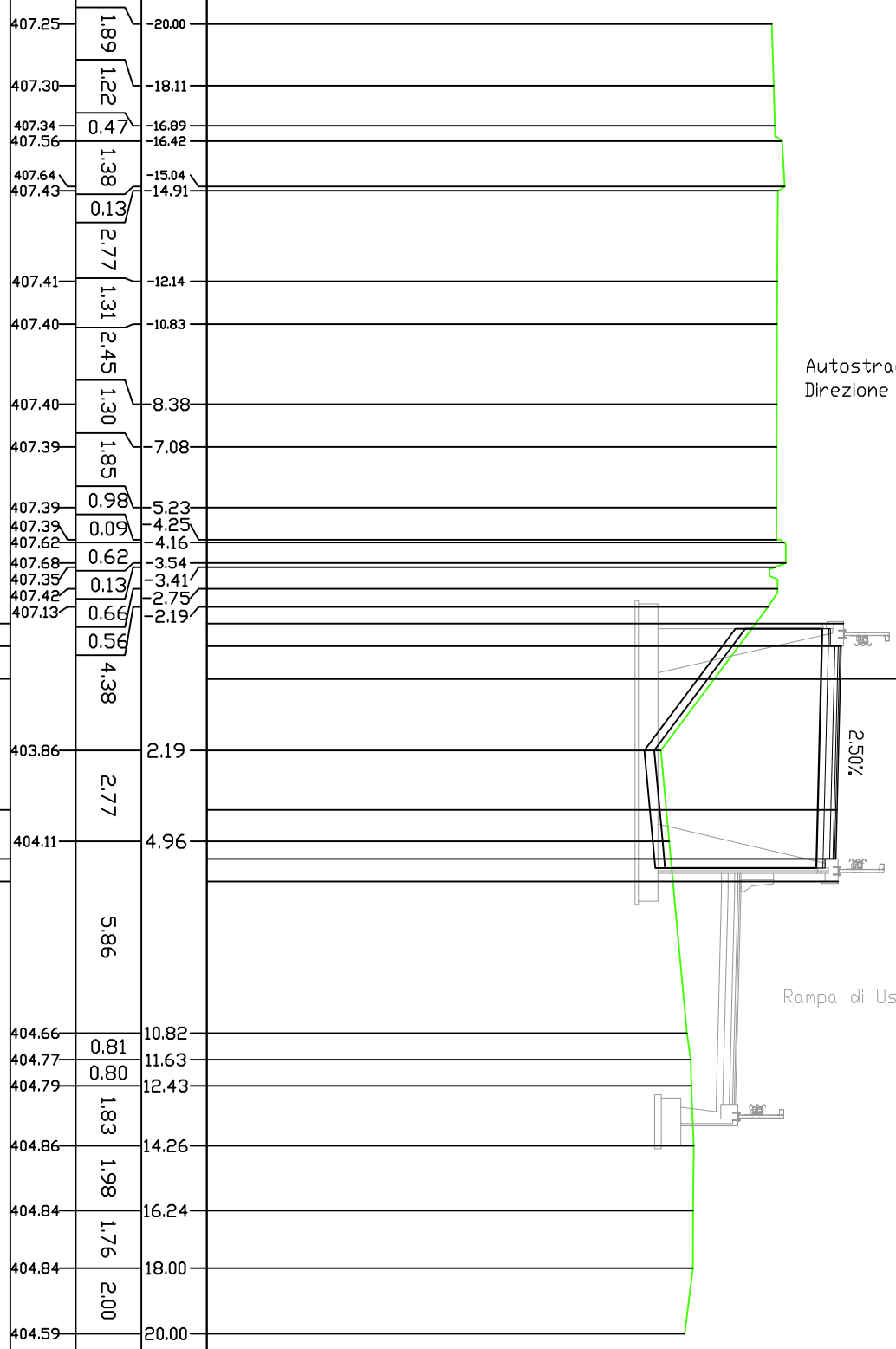



PROFILO SV-TO\_MM3

SEZIONE 35

PROGRESSIVA 600.00

STERRI E RIPORTI	21.48 mq.
Ri	
SCOTTICO	1.48 mq.
AI	
BONIFICA	2.21 mq.
BI	
STABILIZZATO	1.47 mq.
DI	
CEMENTATO	1.33 mq.
EI	
BASE	0.65 mq.
F1	
TNT	
a1	9.22 ml.
GEODRIGLIA 10KN/m	
bi	7.37 ml.
USURA	
f1	6.50 ml.
BINDER	
g1	6.50 ml.

390.00  
 ▼  
 PROGRESSIVE  
 TERRENO 200  
 200

PARZIALI TERRENO	407.18	-20.00	3.11	
	407.27	-16.89	0.46	
	407.49	-16.43	1.38	
	407.53	-15.05	0.13	
	407.32	-14.92	1.65	
	407.30	-13.27	2.44	
	407.26	-10.83	1.32	
	407.25	-9.51	2.43	
	407.22	-7.08	1.01	
	407.21	-6.07	1.83	
	407.19	-4.24	0.13	
	407.48	-4.11	0.66	
	407.30	-3.45	0.12	
	406.98	-3.33	0.30	
	407.23	-3.03	2.57	
408.23	-1.69	0.69		
408.16	-1.00	1.00		
408.14	0.00		4.00	
408.04	4.00		1.50	
408.00	5.50	0.69		
408.07	6.19			
	404.48	7.79	4.76	
	404.72	12.55	1.81	
	404.79	14.36	0.74	
	405.25	15.30	0.80	
	405.20	16.10	1.40	
	404.22	17.50	2.50	
	403.93	20.00		

Autostrada A32 - Discesa  
 Direzione TORINO

Rampa di Uscita A32 Bardonecchia Autoporto - Rampa 3

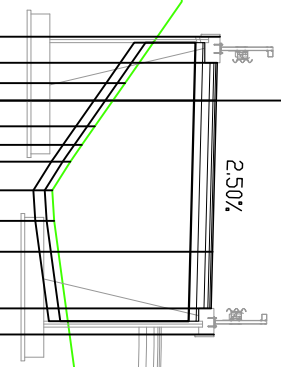

PROFILO SV-T0\_MM3

SEZIONE 36

PROGRESSIVA 618.02

STERRE E RIPORTI	16.55 mq.
Ri	
SCOTTICO	1.47 mq.
AI	
BONIFICA	2.23 mq.
BI	
STABILIZZATO	1.48 mq.
DI	
CEMENTATO	1.33 mq.
EI	
BASE	0.65 mq.
F1	
TNT	9.10 ml.
a1	
GEORIGLIA 10KN/m	7.39 ml.
bi	
USURA	6.52 ml.
f1	
BINDER	6.52 ml.
g1	

390.00  
 ▼  
 PROGRESSIVE  
 TERRENO 200  
 200

PARZIALI TERRENO	407.12	-20.00	3.13
	407.21	-16.87	0.47
	407.43	-16.40	1.38
	407.47	-15.02	0.13
	407.26	-14.89	4.08
QUOTE TERRENO	407.18	-10.81	3.75
PROGRESSIVE PROGETTO	407.10	-7.06	2.84
PARZIALI PROGETTO	407.06	-4.22	0.13
	407.35	-4.09	0.78
	406.85	-3.31	0.30
	407.10	-3.01	1.36
QUOTE PROGETTO	407.61	-1.71	0.69
	407.54	-1.02	1.00
	407.51	-0.02	3.97
	403.94	2.32	4.22
	407.41	4.00	1.50
	407.37	5.50	0.69
	407.44	6.19	1.80
	404.21	6.54	2.16
	404.46	8.34	1.82
	404.54	10.50	1.13
	404.64	12.32	0.69
	404.70	13.45	1.57
	404.73	14.07	1.41
	405.48	15.64	2.32
	405.43	17.05	0.63
	403.76	19.37	
	403.68	20.00	

Autostrada A32 - Discesa  
Direzione TORINO

2.50%

Rampa di Uscita A32 Bardonecchia Autoporto - Rampa 3

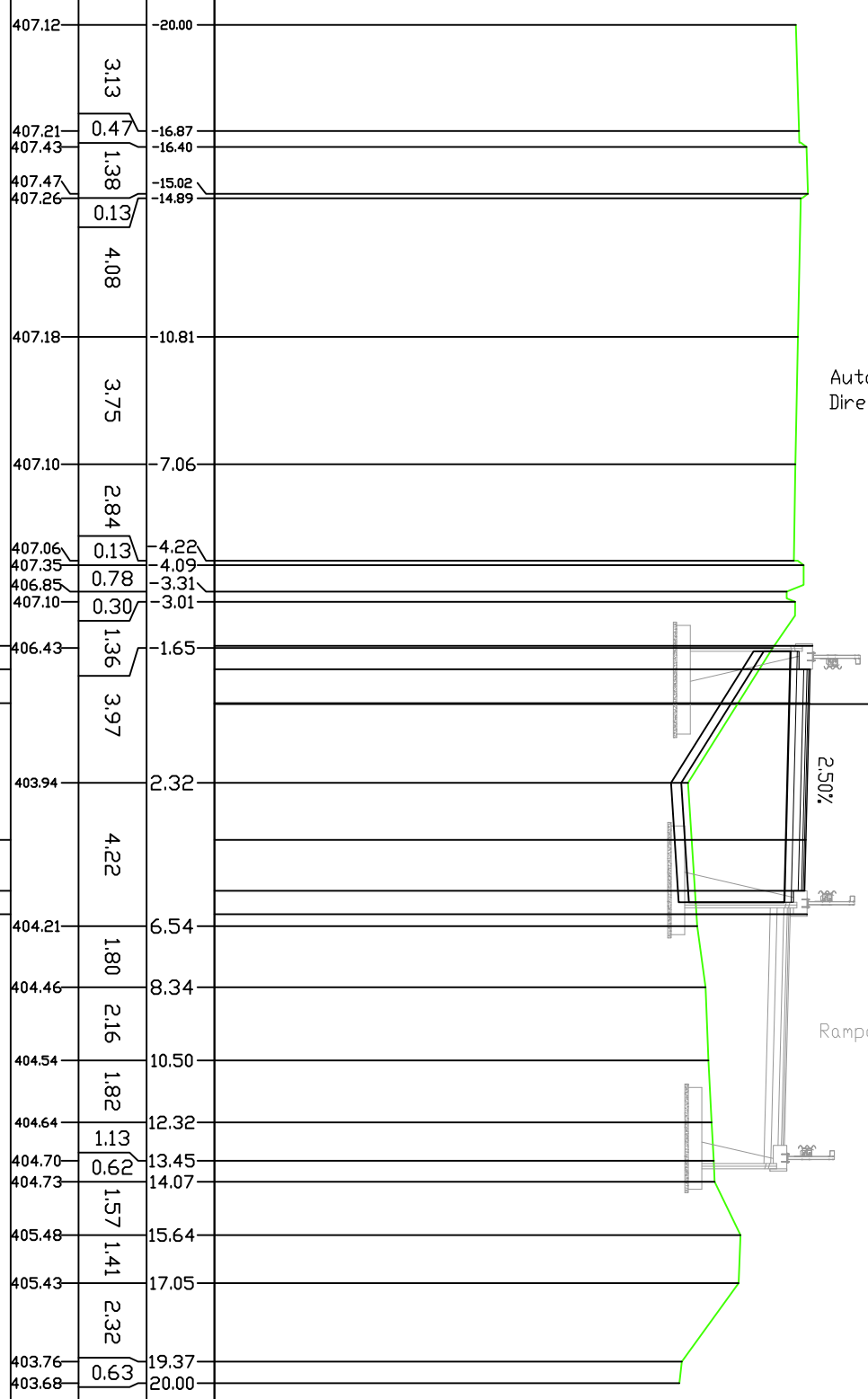

STERRI E RIPORTI	
SI	0,73 mq.
SS	0,31 mq.
Totale S:	1,04 mq.
R1	2,17 mq.
R2	10,43 mq.
Totale R:	12,60 mq.
SCOTTICD	12,60 mq.
AI	0,90 mq.
BONIFICA	
BI	1,35 mq.
BONIFICA PROFONDA	
CI	1,80 mq.
STABILIZZATO	
DI	1,86 mq.
CEMENTATO	
EI	1,81 mq.
BASE	
F1	0,70 mq.
VEGETALE	
GI	0,52 mq.
G2	0,15 mq.
Totale:	0,67 mq.
TNT	
a1	5,50 ml.
GEODRIGLIA 10KN/m	
b1	4,50 ml.
GEODRIGLIA 28KN/m	
c1	8,70 ml.
GRADINATURA	
d1	4,37 ml.
IDROSEMINA	
e1	1,98 ml.
e2	0,66 ml.
Totale:	2,64 ml.
USURA	
f1	6,71 ml.
BINDER	
g1	6,71 ml.

390.00  
 200  
 200

PROGRESSIVE TERRENO			
PARZIALI TERRENO			
QUOTE TERRENO			
PROGRESSIVE PROGETTO			
PARZIALI PROGETTO			
QUOTE PROGETTO			

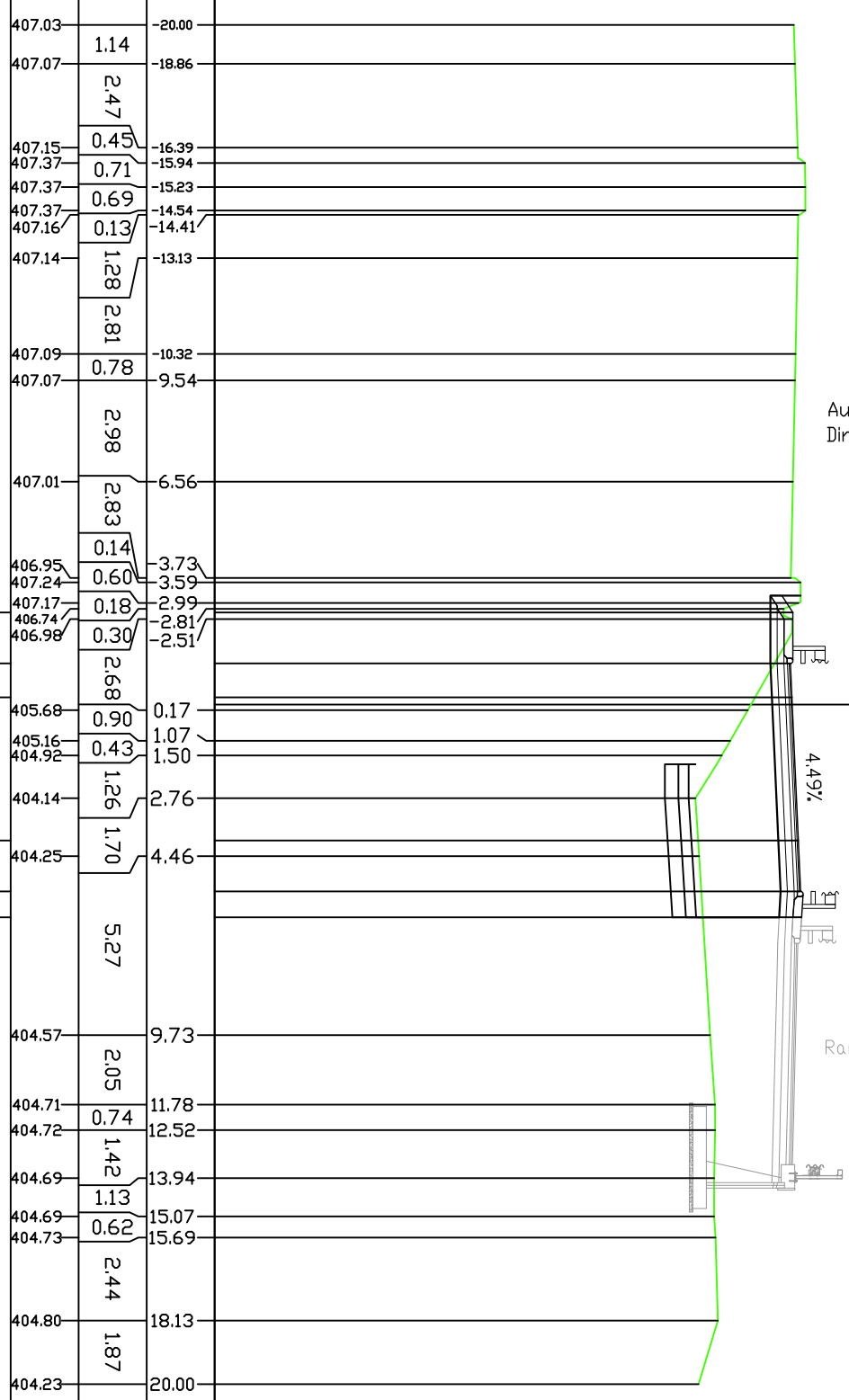

Autostrada A32 - Discesa  
 Direzione TORINO

Rampa di Uscita A32 Bardonecchia Autoporto - Rampa 3

STERRI E RIPORTI	
SI	163 mq.
SS	139 mq.
Totale S:	302 mq.
R1	391 mq.
R2	4,44 mq.
Totale R:	835 mq.
SCOTTID	835 mq.
A1	0,59 mq.
BONIFICA	0,89 mq.
B1	0,89 mq.
BONIFICA PROFONDA	1,18 mq.
C1	1,18 mq.
STABILIZZATO	2,22 mq.
D1	2,22 mq.
CEMENTATO	2,16 mq.
E1	2,16 mq.
BASE	0,94 mq.
F1	0,94 mq.
VEGETALE	0,52 mq.
G1	0,52 mq.
TNT	3,99 ml.
a1	3,99 ml.
GEDGRIGLIA 10KN/m	2,96 ml.
b1	2,96 ml.
GEDGRIGLIA 28KN/m	11,25 ml.
c1	11,25 ml.
GRADINATURA	4,52 ml.
d1	4,52 ml.
IDROSEMINA	1,65 ml.
e1	1,65 ml.
USURA	10,26 ml.
f1	10,26 ml.
BINDER	9,76 ml.
g1	9,76 ml.

390.00  
 200  
 200

PROGRESSIVE TERRENO			
PARZIALI TERRENO			
QUOTE TERRENO			
PROGRESSIVE PROGETTO			
PARZIALI PROGETTO			
QUOTE PROGETTO			

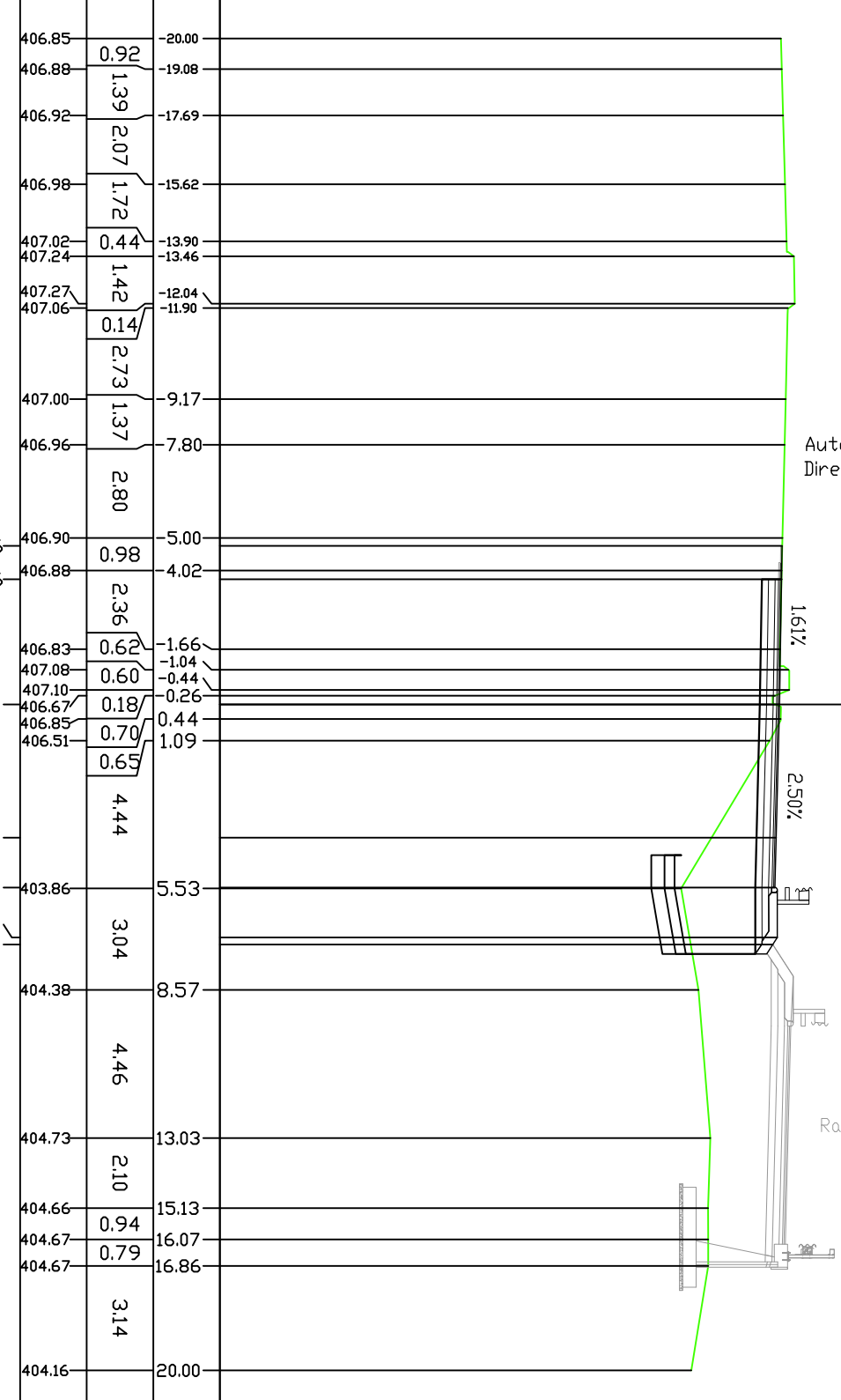

Autostrada A32 - Discesa  
 Direzione TORINO

Rampa di Uscita A32 Bardonecchia Autoporto - Rampa 3

PROFILO SV-T0\_MM3

SEZIONE 39

PROGRESSIVA 695.82

STERRI E RIPORTI	
SI	151 mq.
S2	212 mq.
Totale S:	363 mq.
R1	000 mq.
R2	348 mq.
Totale R:	348 mq.
SCOTICD	348 mq.
A1	0.70 mq.
BONIFICA	
B1	104 mq.
BONIFICA PROFONDA	
C1	139 mq.
STABILIZZATO	
D1	167 mq.
CEMENTATO	
E1	161 mq.
BASE	
F1	066 mq.
VEGETALE	
G1	148 mq.
TNT	
a1	452 ml.
GEODRIGLIA 10KN/m	
b1	348 ml.
GEODRIGLIA 28KN/m	
c1	853 ml.
GRADINATURA	
d1	447 ml.
IDROSEMINA	
e1	569 ml.
USURA	
f1	753 ml.
BINDER	
g1	703 ml.

390.00  
 ▲  
 PROGRESSIVE  
 TERRENO 200

PARZIALI TERRENO	QUOTE TERRENO
166	0.70
306	0.90
285	0.48
0	1.37
0	0.13
271	1.39
139	2.19
219	1.57
157	0.76
1	0.76
100	3.91
391	1.86
186	1.50
150	3.57
357	10.84

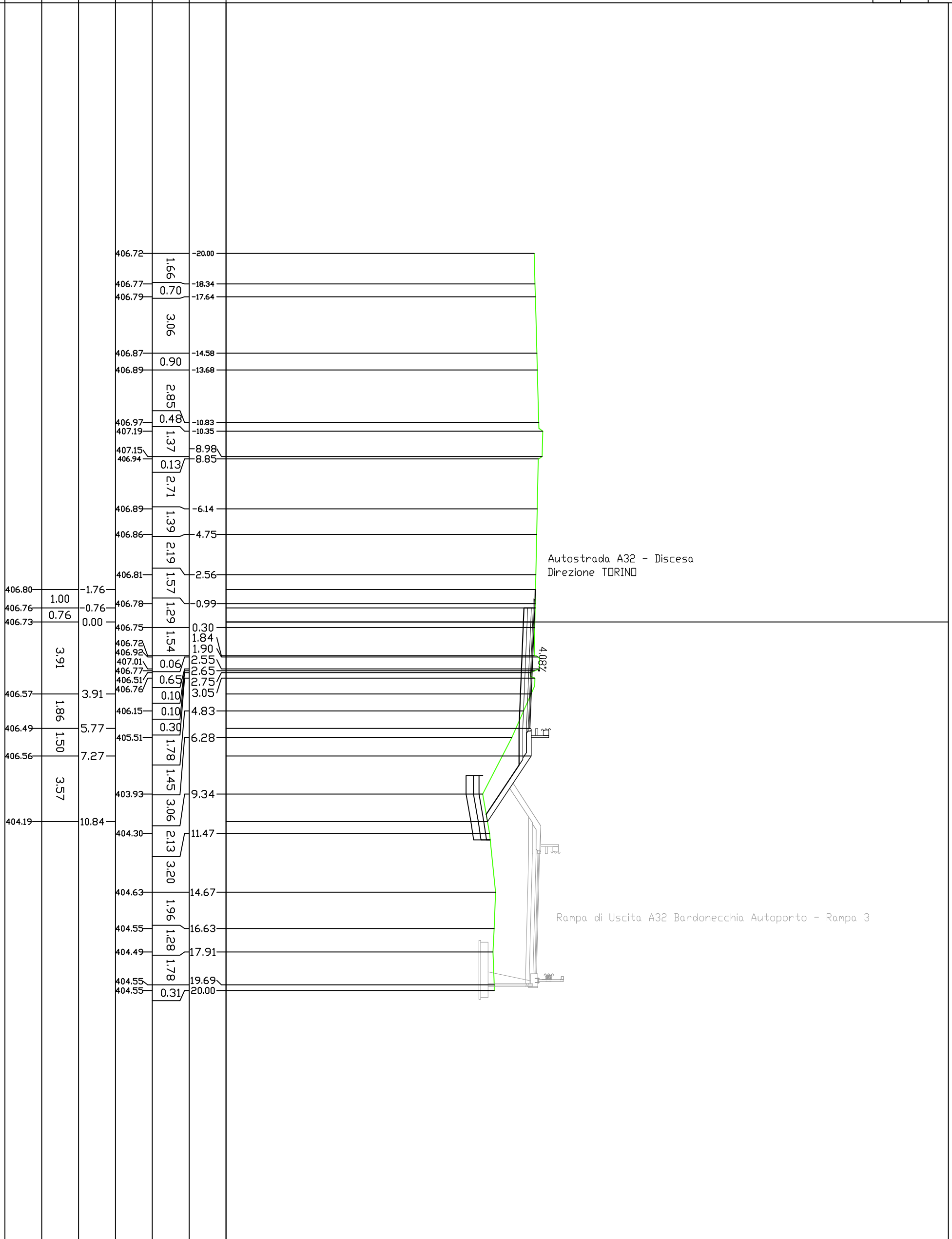

STERRI E RIPORTI	
SI	349 mq.
SS	0,03 mq.
S3	0,01 mq.
Totale S:	
RI	3,53 mq.
SCOTICD	4,91 mq.
A1	0,76 mq.
BONIFICA	
BI	1,14 mq.
BONIFICA PROFONDA	
C1	1,51 mq.
STABILIZZATO	
D1	1,61 mq.
CEMENTATO	
E1	1,53 mq.
BASE	
F1	0,64 mq.
VEGETALE	
G1	1,61 mq.
TNT	
a1	4,82 ml.
GEDGRIGLIA 10KN/m	
b1	3,78 ml.
GEDGRIGLIA 28KN/m	
c1	8,20 ml.
GRADINATURA	
d1	4,88 ml.
IDROSEMINA	
e1	6,22 ml.
USURA	
f1	7,20 ml.
BINDER	
g1	6,70 ml.

390.00  
 200  
 200

PROGRESSIVE TERRENO			
PARZIALI TERRENO			
QUOTE TERRENO			
PROGRESSIVE PROGETTO			
PARZIALI PROGETTO			
QUOTE PROGETTO			

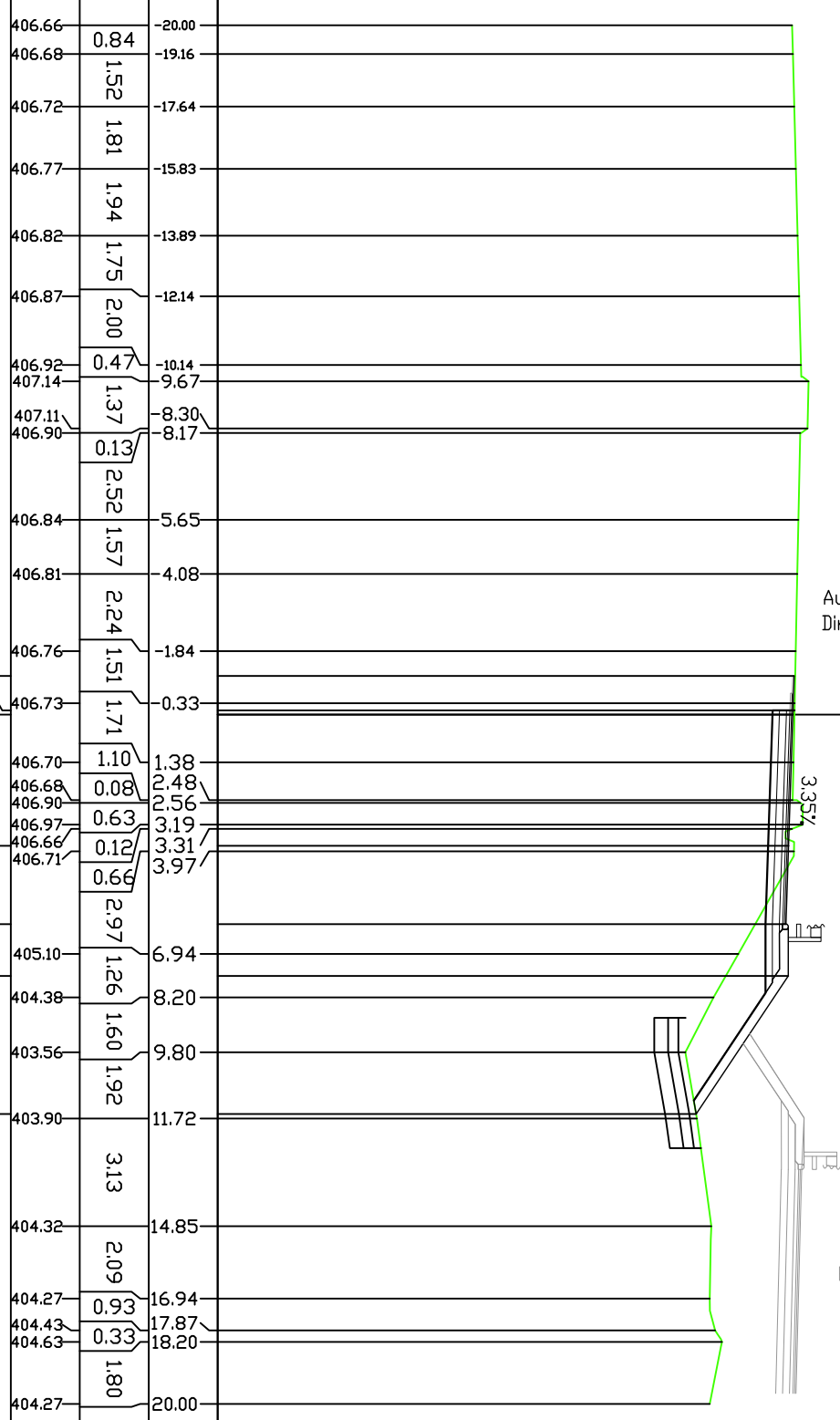

Autostrada A32 - Discesa  
 Direzione TORINO

Rampa di Uscita A32 Bardonecchia Autoporto - Rampa 3

STERRI E RIPORTI	
S1	310 mq.
S2	0,00 mq.
Totale S:	310 mq.
R1	0,05 mq.
R2	8,51 mq.
Totale R:	8,56 mq.
SCOTICD	8,56 mq.
A1	1,02 mq.
BONIFICA	1,56 mq.
B1	1,56 mq.
BONIFICA PROFONDA	2,07 mq.
C1	2,07 mq.
STABILIZZATO	1,62 mq.
D1	1,62 mq.
CEMENTATO	1,55 mq.
E1	1,55 mq.
BASE	0,65 mq.
F1	0,65 mq.
VEGETALE	1,76 mq.
G1	1,76 mq.
TNT	6,24 ml.
a1	6,24 ml.
GEDGRIGLIA 10KN/m	5,17 ml.
b1	5,17 ml.
GEDGRIGLIA 28KN/m	8,24 ml.
c1	8,24 ml.
GRADINATURA	4,70 ml.
d1	4,70 ml.
IDROSEMINA	6,66 ml.
e1	6,66 ml.
USURA	7,25 ml.
f1	7,25 ml.
BINDER	6,75 ml.
g1	6,75 ml.

390.00  
 200  
 200

PROGRESSIVE TERRENO			
PARZIALI TERRENO			
QUOTE TERRENO			
PROGRESSIVE PROGETTO			
PARZIALI PROGETTO			
QUOTE PROGETTO			

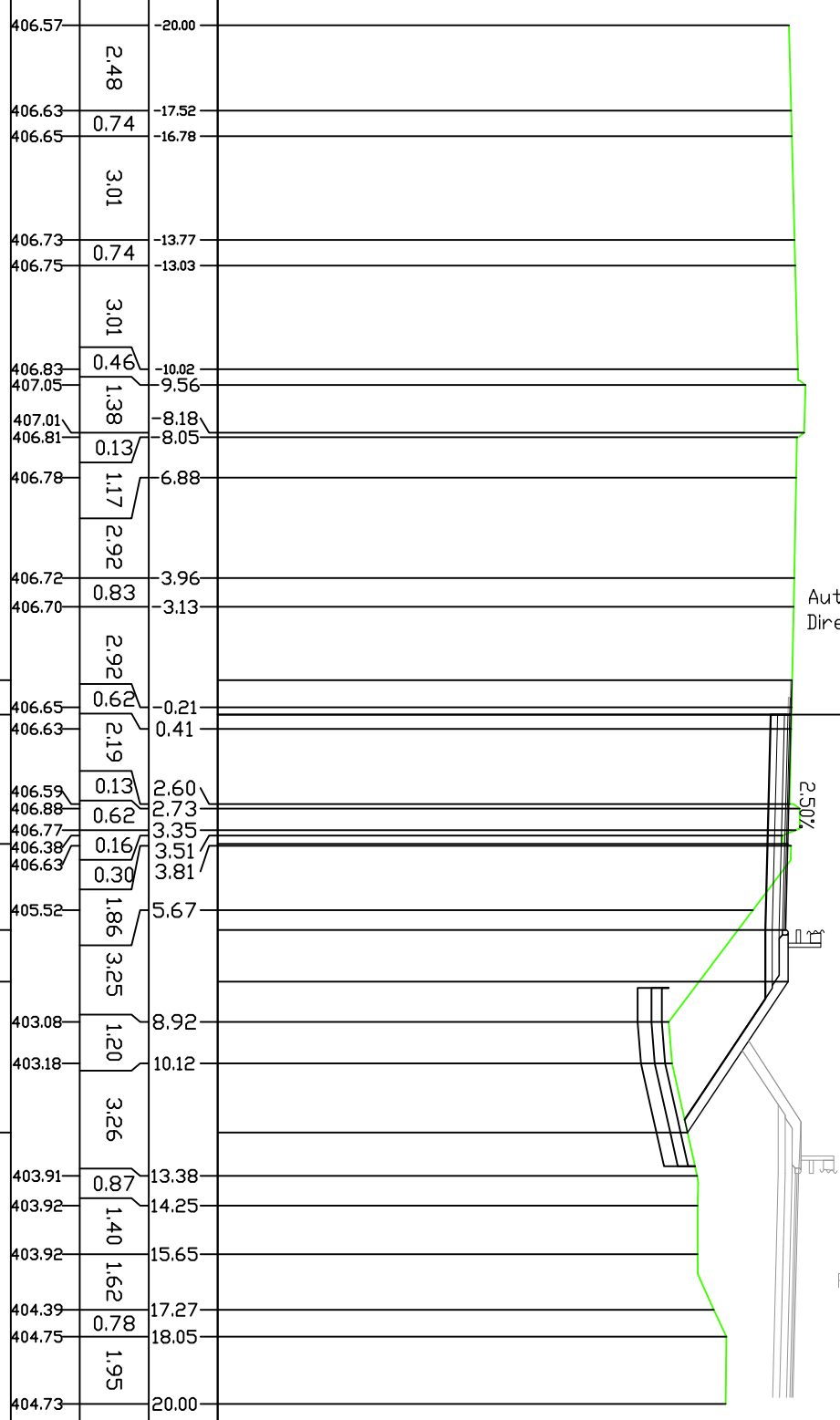

Autostrada A32 - Discesa Direzione TORINO

Rampa di Uscita A32 Bardonecchia Autoporto - Rampa 3

2.50%

STERRI E RIPORTI	
SI	2,87 mq.
SS	0,03 mq.
Totale S:	2,90 mq.
R1	0,00 mq.
R2	8,09 mq.
Totale R:	8,09 mq.
SCOTICD	8,09 mq.
A1	1,11 mq.
BONIFICA	1,67 mq.
B1	1,67 mq.
BONIFICA PROFONDA	2,24 mq.
C1	2,24 mq.
STABILIZZATO	1,62 mq.
D1	1,62 mq.
CEMENTATO	1,55 mq.
E1	1,55 mq.
BASE	0,64 mq.
F1	0,64 mq.
VEGETALE	1,75 mq.
G1	1,75 mq.
TNT	6,61 ml.
a1	6,61 ml.
GEDRIGLIA 10KN/m	5,59 ml.
b1	5,59 ml.
GEDRIGLIA 28KN/m	8,24 ml.
c1	8,24 ml.
GRADINATURA	4,34 ml.
d1	4,34 ml.
IDROSEMINA	6,72 ml.
e1	6,72 ml.
USURA	7,25 ml.
f1	7,25 ml.
BINDER	6,75 ml.
g1	6,75 ml.

390.00  
 200  
 200

PROGRESSIVE TERRENO			
PARZIALI TERRENO			
QUOTE TERRENO			
PROGRESSIVE PROGETTO			
PARZIALI PROGETTO			
QUOTE PROGETTO			

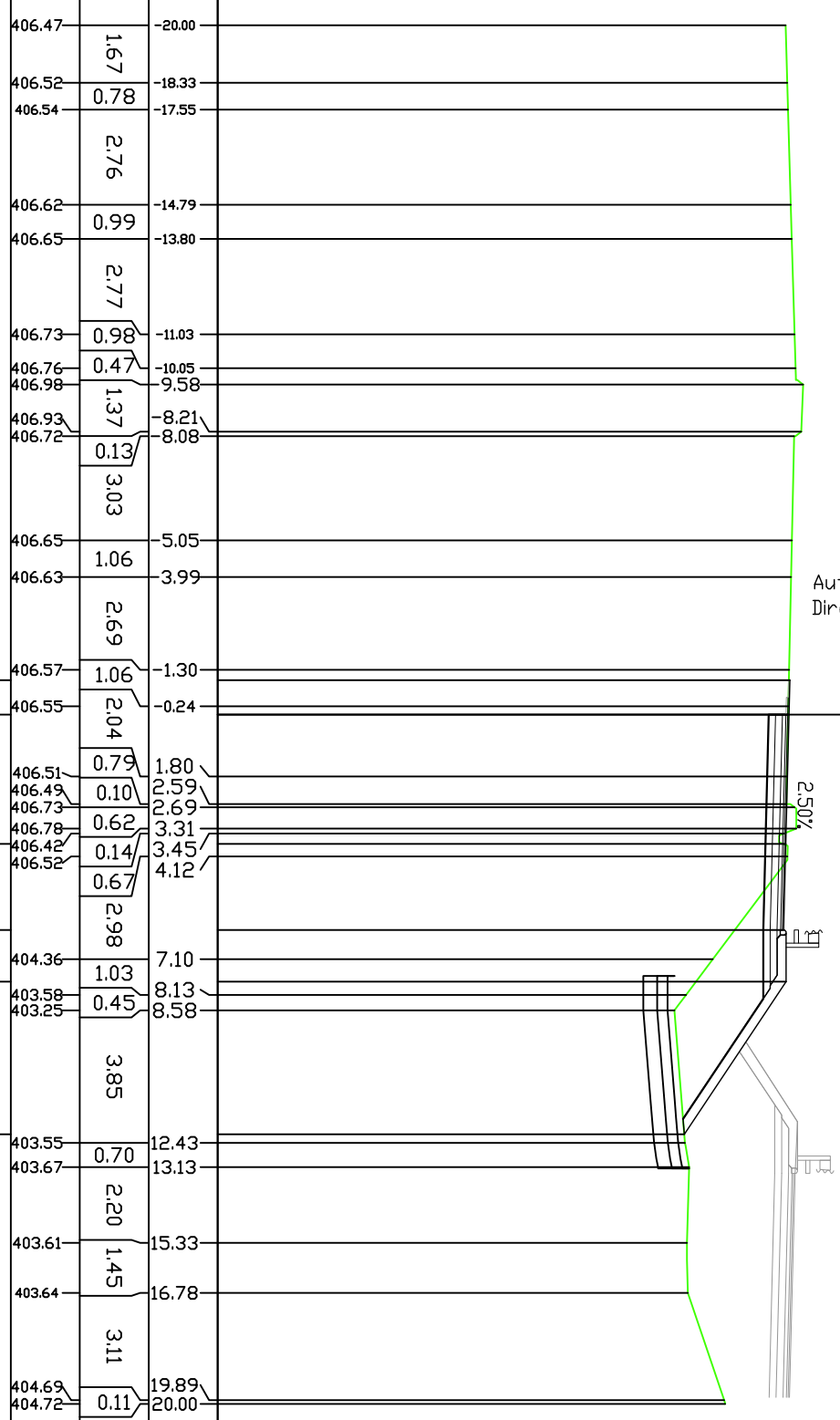

Autostrada A32 - Discesa  
 Direzione TORINO

Rampa di Uscita A32 Bardonecchia Autoporto - Rampa 3



PROFILO SV-TO\_MM3

SEZIONE 43

PROGRESSIVA 775.00

STERRI E RIPORTI	
SI	2,76 mq.
S2	0,00 mq.
Totale S:	2,76 mq.
R1	0,04 mq.
R2	10,85 mq.
Totale R:	10,89 mq.
SCOTTICD	
A1	1,35 mq.
BONIFICA	
B1	2,03 mq.
BONIFICA PROFONDA	
C1	2,70 mq.
STABILIZZATO	
D1	1,62 mq.
CEMENTATO	
E1	1,55 mq.
BASE	
F1	0,64 mq.
VEGETALE	
G1	1,83 mq.
TNT	
a1	7,76 ml.
GEORIGLIA 10KN/m	
b1	6,75 ml.
GEORIGLIA 28KN/m	
c1	8,24 ml.
GRADINATURA	
d1	4,07 ml.
IDROSEMINA	
e1	7,06 ml.
USURA	
f1	7,25 ml.
BINDER	
g1	6,75 ml.

390.00  
 200  
 200

PROGRESSIVE TERRENO			
PARZIALI TERRENO			
QUOTE TERRENO			
PROGRESSIVE PROGETTO			
PARZIALI PROGETTO			
QUOTE PROGETTO			

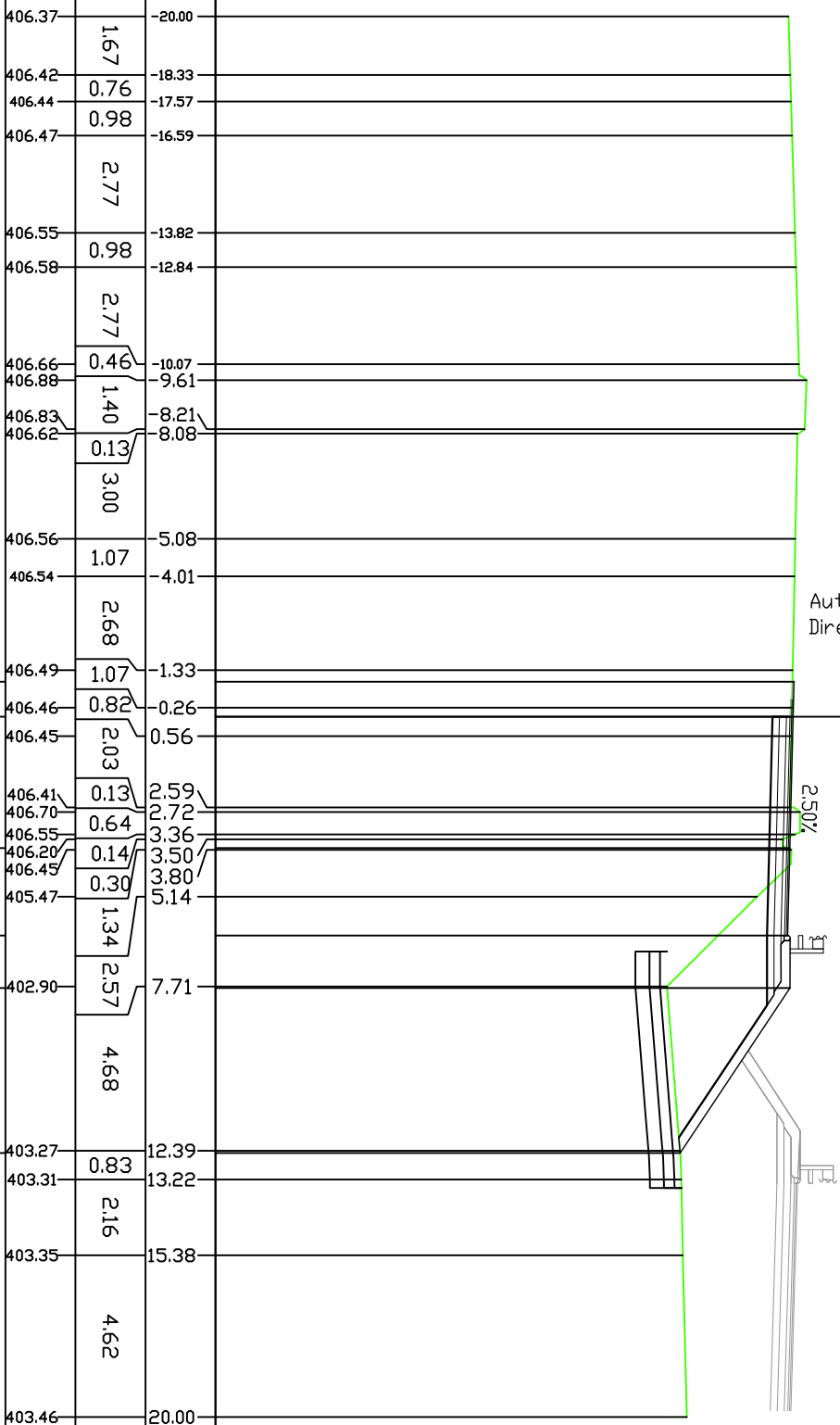

STERRI E RIPORTI	
S1	2,79 mq.
R1	0,00 mq.
R2	0,00 mq.
R3	12,90 mq.
Totale R:	
SCOTICD	12,90 mq.
A1	1,41 mq.
BONIFICA	
B1	2,14 mq.
BONIFICA PROFONDA	
C1	2,84 mq.
STABILIZZATO	
D1	1,62 mq.
CEMENTATO	
E1	1,53 mq.
BASE	
F1	0,64 mq.
VEGETALE	
G1	2,00 mq.
TNT	
a1	8,14 ml.
GEODRIGLIA 10KN/m	
b1	7,13 ml.
GEODRIGLIA 28KN/m	
c1	8,24 ml.
GRADINATURA	
d1	4,38 ml.
IDROSEMINA	
e1	7,58 ml.
USURA	
f1	7,25 ml.
BINDER	
g1	6,75 ml.

390.00  
 200  
 200

PROGRESSIVE TERRENO			
PARZIALI TERRENO			
QUOTE TERRENO			
PROGRESSIVE PROGETTO			
PARZIALI PROGETTO			
QUOTE PROGETTO			

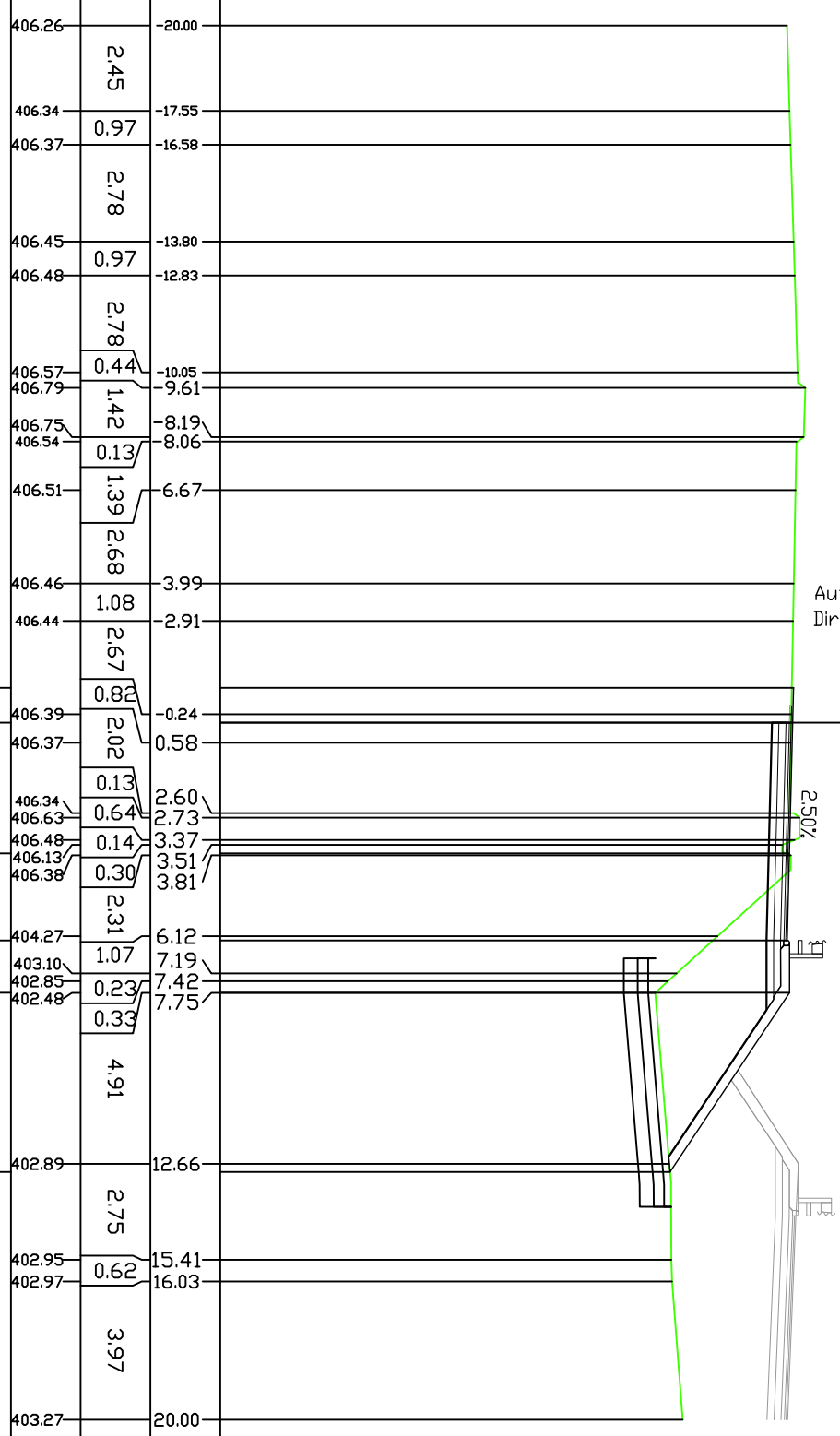

Autostrada A32 - Discesa  
 Direzione TORINO

Rampa di Uscita A32 Bardonecchia Autoporto - Rampa 3

STERRI E RIPORTI	
SI	2,81 mq.
SE	0,00 mq.
Totale S:	2,81 mq.
R1	0,01 mq.
R2	10,90 mq.
Totale R:	10,91 mq.
SCOTTICD	
A1	1,37 mq.
BONIFICA	
B1	2,07 mq.
BONIFICA PROFONDA	
C1	2,75 mq.
STABILIZZATO	
D1	1,62 mq.
CEMENTATO	
E1	1,54 mq.
BASE	
F1	0,66 mq.
VEGETALE	
G1	1,96 mq.
TNT	
a1	7,89 ml.
GEDGRIGLIA 10KN/m	
b1	6,89 ml.
GEDGRIGLIA 28KN/m	
c1	8,24 ml.
GRADINATURA	
d1	4,15 ml.
IDROSEMINA	
e1	7,46 ml.
USURA	
f1	7,25 ml.
BINDER	
g1	6,75 ml.

390.00  
 200  
 200

PROGRESSIVE TERRENO			
PARZIALI TERRENO			
QUOTE TERRENO			
PROGRESSIVE PROGETTO			
PARZIALI PROGETTO			
QUOTE PROGETTO			

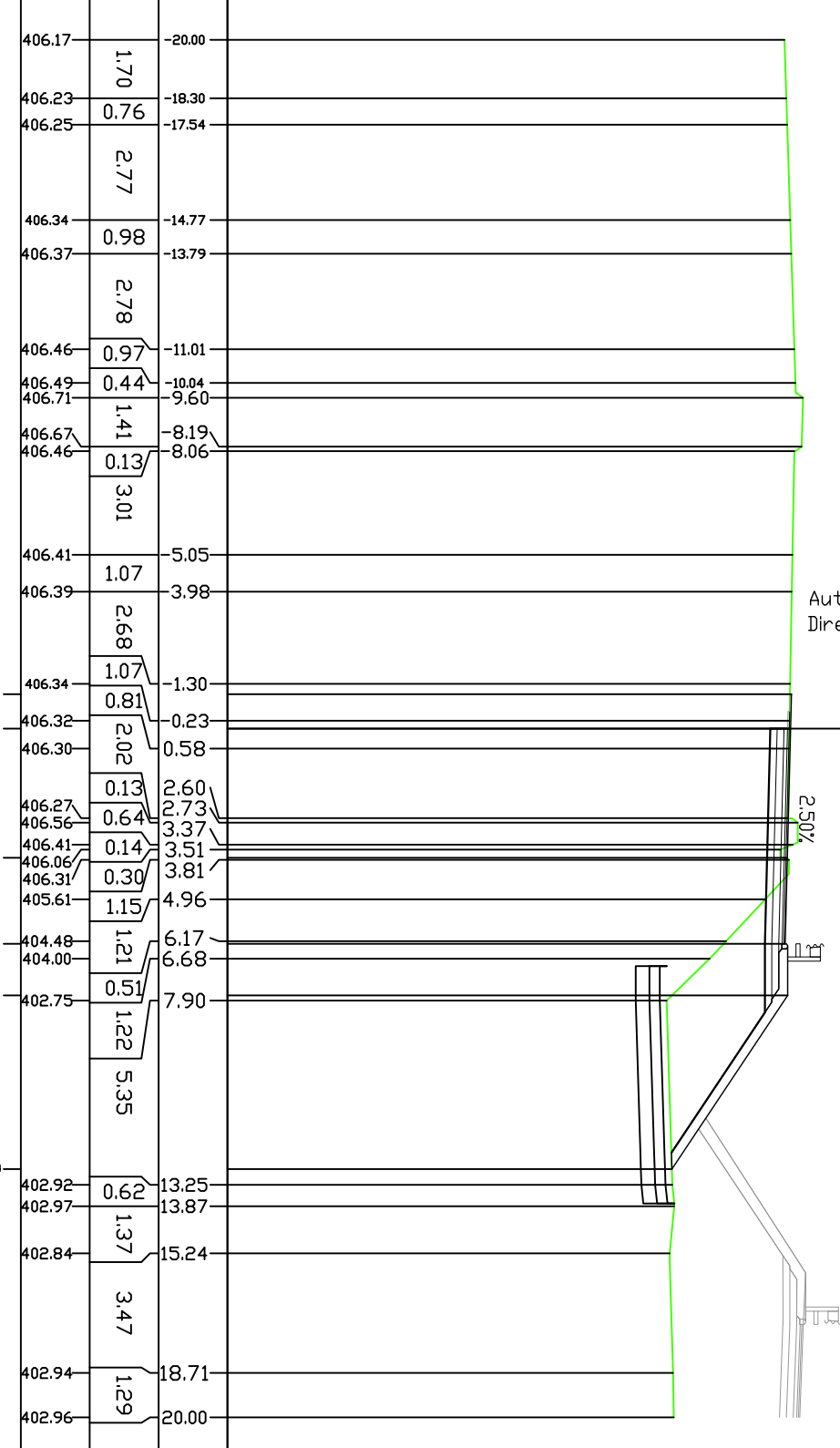

STERRI E RIPORTI	
S1	2,78 mq.
S2	0,00 mq.
S3	0,00 mq.
Totale S:	
R1	2,78 mq.
R2	9,94 mq.
R3	1,15 mq.
BONIFICA	
B1	1,71 mq.
BONIFICA PROFONDA	
C1	2,27 mq.
STABILIZZATO	
D1	1,62 mq.
CEMENTATO	
E1	1,54 mq.
BASE	
F1	0,65 mq.
VEGETALE	
G1	1,96 mq.
TNT	
a1	6,72 ml.
GEORIGLIA 10KN/m	
b1	5,70 ml.
GEORIGLIA 28KN/m	
c1	8,24 ml.
GRADINATURA	
d1	5,07 ml.
IDROSEMINA	
e1	7,44 ml.
USURA	
f1	7,25 ml.
BINDER	
g1	6,75 ml.

390.00  
 200  
 200

PROGRESSIVE TERRENO			
PARZIALI TERRENO			
QUOTE TERRENO			
PROGRESSIVE PROGETTO			
PARZIALI PROGETTO			
QUOTE PROGETTO			

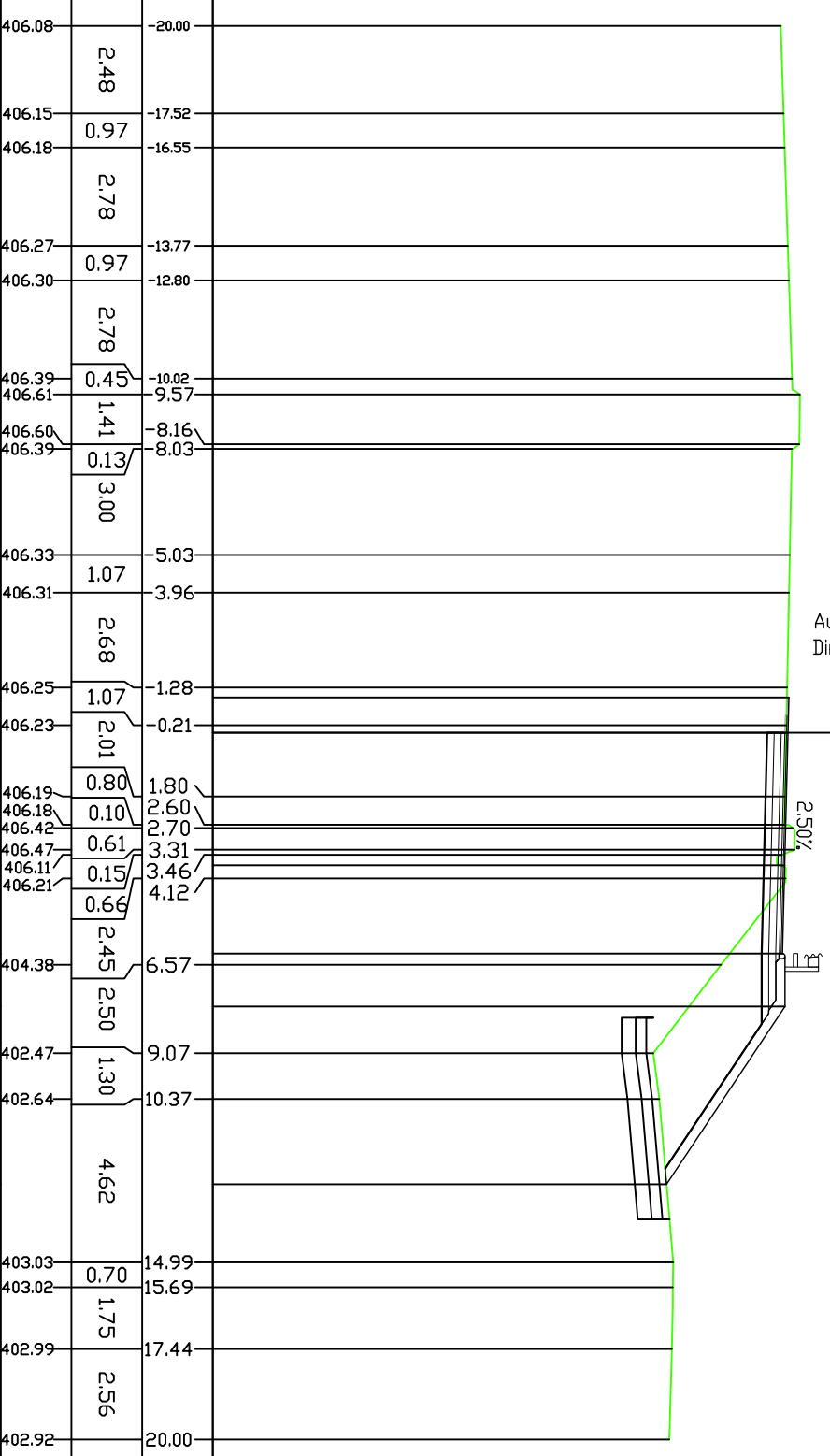

Autostrada A32 - Discesa  
 Direzione TORINO

STERRI E RIPORTI	
SI	2,66 mq.
R1	0,00 mq.
R2	0,00 mq.
R3	10,65 mq.
Totale R:	
SCOTICD	10,65 mq.
A1	1,09 mq.
BONIFICA	
B1	1,64 mq.
BONIFICA PROFONDA	
C1	2,19 mq.
STABILIZZATO	
D1	1,62 mq.
CEMENTATO	
E1	1,55 mq.
BASE	
F1	0,63 mq.
VEGETALE	
G1	1,92 mq.
TNT	
a1	6,53 ml.
GEODRIGLIA 10KN/m	
b1	5,46 ml.
GEODRIGLIA 28KN/m	
c1	8,24 ml.
GRADINATURA	
d1	5,37 ml.
IDROSEMINA	
e1	7,33 ml.
USURA	
f1	7,25 ml.
BINDER	
g1	6,75 ml.

390.00  
 ▲  
 PROGRESSIVE  
 TERRENO  
 200  
 200

PARZIALI TERRENO	406.03	-20.00	1.72
	406.08	-18.28	0.76
	406.10	-17.52	2.77
	406.19	-14.75	0.98
	406.22	-13.77	2.77
	406.30	-11.00	0.98
	406.33	-10.02	0.43
	406.55	9.59	0.73
	406.55	8.86	0.66
	406.55	8.20	0.13
	406.34	-8.07	3.05
	406.27	5.02	1.06
	406.25	3.96	2.69
	406.18	-1.27	1.06
	406.15	-0.21	2.03
	406.10	1.82	0.79
	406.08	2.61	0.09
	406.33	2.70	0.62
	406.37	3.32	0.14
	406.01	3.46	0.67
	406.12	4.13	0.74
	405.59	4.87	4.35
	406.05	6.25	4.35
	406.12	7.75	4.35
	402.17	9.22	3.95
	402.83	12.68	1.34
	402.92	13.17	1.78
	403.04	14.51	3.71
	403.07	16.29	
	402.83	20.00	
QUOTE TERRENO			
PROGRESSIVE PROGETTO			
PARZIALI PROGETTO			
QUOTE PROGETTO			

Autostrada A32 - Discesa  
 Direzione TORINO

2.50%

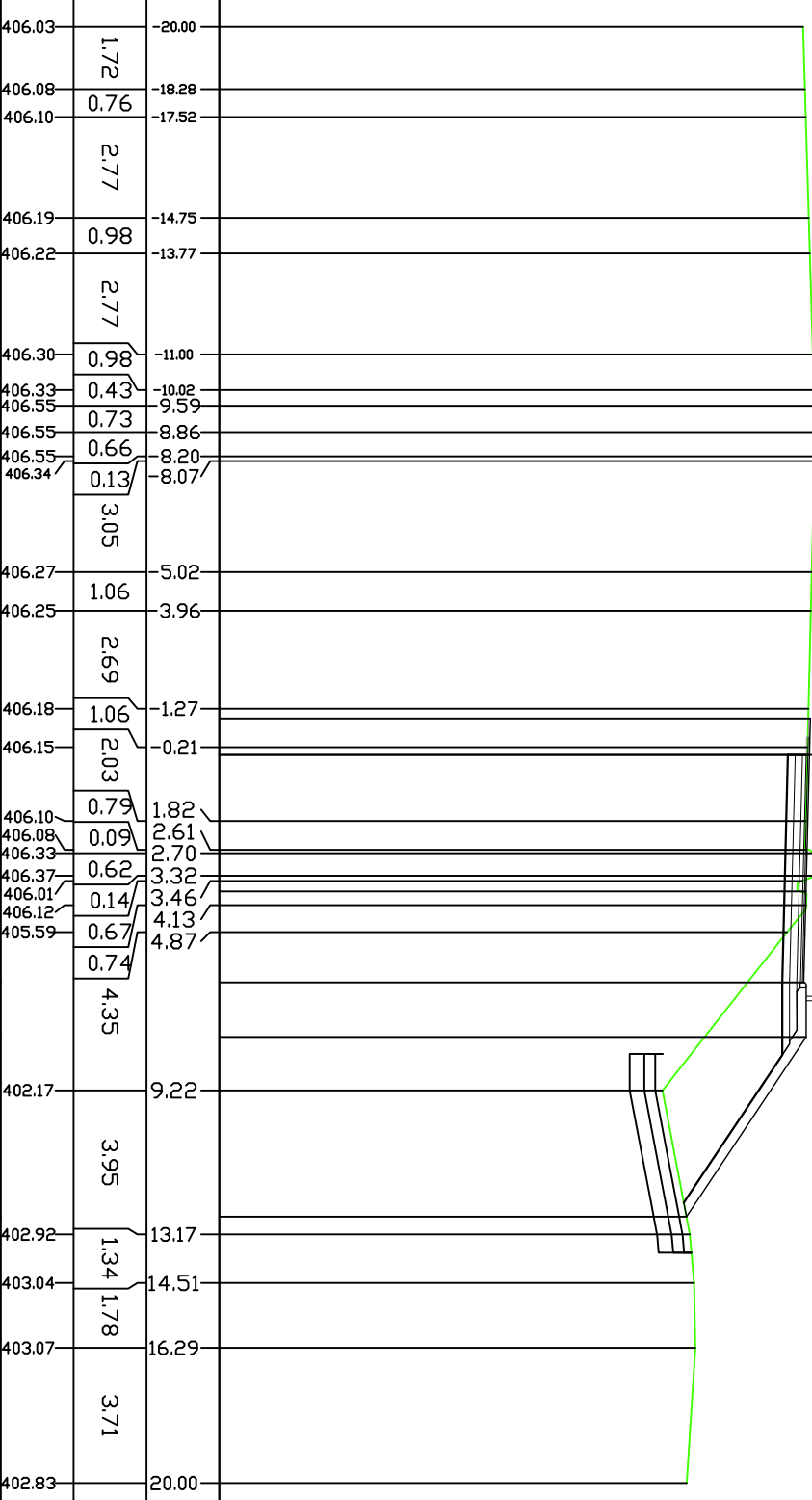

STERRI E RIPORTI	
SI	2,86 mq.
SE	0,00 mq.
Totale S:	
R1	2,86 mq.
R2	1,57 mq.
Totale R:	
SCOTICD	10,65 mq.
AI	12,22 mq.
BI	1,24 mq.
BONIFICA PROFONDA	
BI	1,87 mq.
CI	2,48 mq.
STABILIZZATO	
DI	1,62 mq.
CEMENTATO	
EI	1,54 mq.
BASE	
F1	0,63 mq.
VEGETALE	
G1	2,23 mq.
TNT	
a1	7,22 ml.
GEORIGLIA 10KN/m	
b1	6,22 ml.
GEORIGLIA 28KN/m	
c1	8,24 ml.
GRADINATURA	
d1	5,61 ml.
IDROSEMINA	
e1	8,48 ml.
USURA	
f1	7,25 ml.
BINDER	
g1	6,75 ml.

390.00  
 200  
 200

PROGRESSIVE TERRENO			
PARZIALI TERRENO			
QUOTE TERRENO			
PROGRESSIVE PROGETTO			
PARZIALI PROGETTO			
QUOTE PROGETTO			

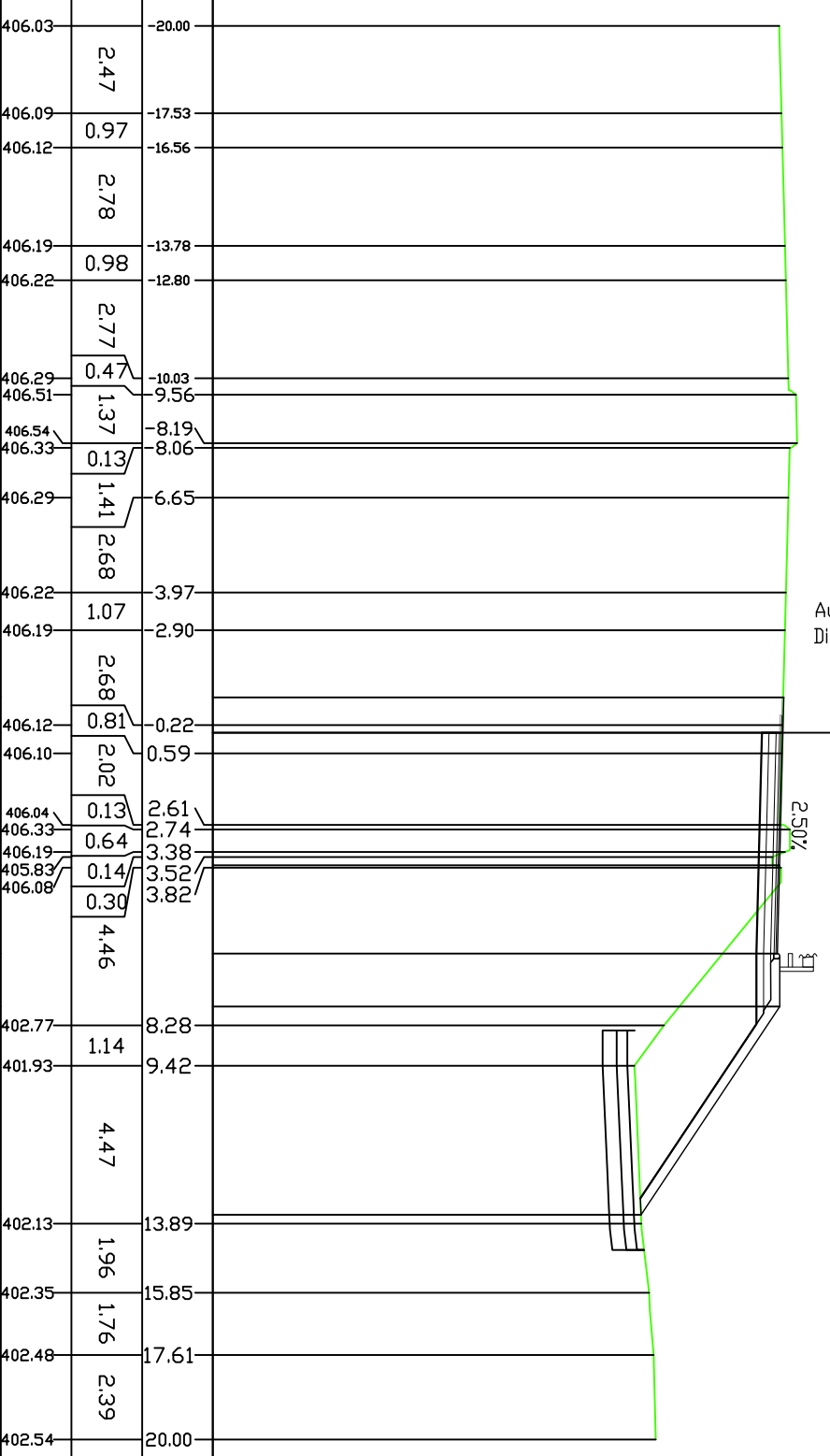

406.03	-20.00	2.47	
406.09	-17.53	0.97	
406.12	-16.56	2.78	
406.19	-13.78	0.98	
406.22	-12.80	2.77	
406.29	-10.03	0.47	
406.51	-9.56	1.37	
406.54	-8.19	0.13	
406.33	-8.06	1.41	
406.29	-6.65	2.68	
406.22	-3.97	1.07	
406.19	-2.90	2.68	
406.16	-1.00	0.81	1.00
406.13	0.00	2.02	3.75
406.10	0.59	0.13	
406.04	2.61	0.64	
406.33	2.74	0.14	
406.19	3.38	0.30	3.75
405.83	3.52	4.46	2.50
406.08	3.82		1.50
405.98	6.25		5.89
406.05	7.75		
402.77	8.28	1.14	
401.93	9.42	4.47	
402.12	13.64	1.96	
402.13	13.89	1.76	
402.35	15.85	2.39	
402.48	17.61		
402.54	20.00		

STERRI E RIPORTI	
SI	307 mq.
SS	0,97 mq.
Totale S:	4,04 mq.
R1	0,45 mq.
R2	3,25 mq.
Totale R:	3,70 mq.
SCOTTICD	0,71 mq.
AI	0,71 mq.
BONIFICA	1,07 mq.
BONIFICA PROFONDA	1,43 mq.
C1	1,43 mq.
STABILIZZATO	1,61 mq.
D1	1,61 mq.
CEMENTATO	1,54 mq.
E1	1,54 mq.
BASE	0,64 mq.
F1	0,64 mq.
VEGETALE	2,13 mq.
G1	2,13 mq.
TNT	4,56 ml.
a1	4,56 ml.
GEDRIGLIA 10KN/m	3,56 ml.
b1	3,56 ml.
GEDRIGLIA 28KN/m	8,24 ml.
c1	8,24 ml.
GRADINATURA	5,61 ml.
d1	5,61 ml.
IDROSEMINA	8,02 ml.
e1	8,02 ml.
USURA	7,25 ml.
f1	7,25 ml.
BINDER	6,75 ml.
g1	6,75 ml.

390.00  
 200  
 200

PROGRESSIVE TERRENO				
PARZIALI TERRENO				
QUOTE TERRENO				
PROGRESSIVE PROGETTO				
PARZIALI PROGETTO				
QUOTE PROGETTO				

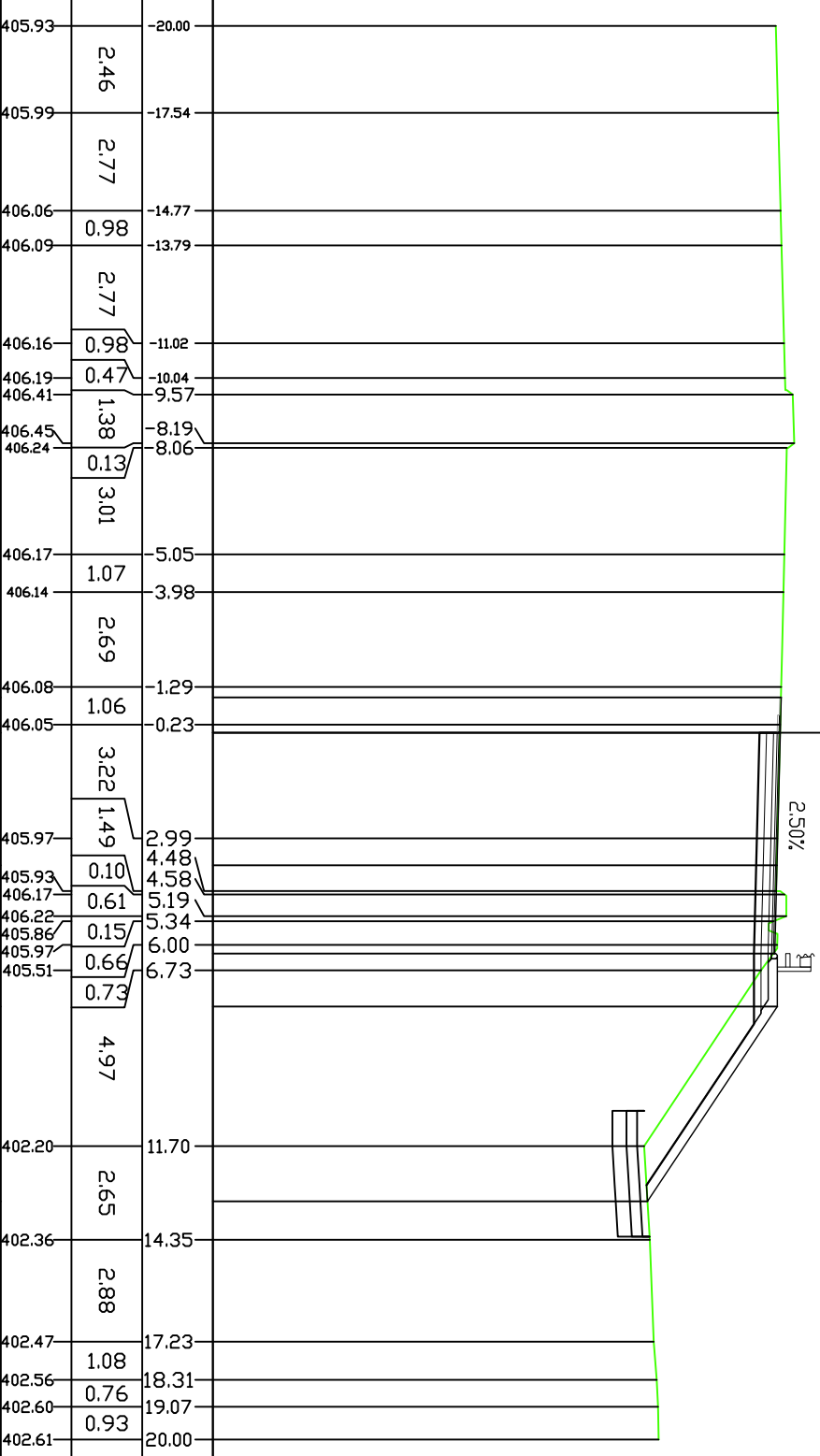

Autostrada A32 - Discesa  
 Direzione TORINO

PROFILO SV-T0\_MM3

SEZIONE 50

PROGRESSIVA 950.00

STERRI E RIPORTI	
S1	4.01 mq.
S2	0.35 mq.
S3	0.09 mq.
Totale S:	4.45 mq.
R1	0.10 mq.
SCOTICD	
A1	0.51 mq.
BONIFICA	
B1	0.75 mq.
BONIFICA PROFONDA	
C1	0.99 mq.
STABILIZZATO	
D1	1.61 mq.
CEMENTATO	
E1	1.54 mq.
BASE	
F1	0.66 mq.
VEGETALE	
G1	2.05 mq.
TNT	
a1	3.50 ml.
GEDGRIGLIA 10KN/m	
b1	2.50 ml.
GEDGRIGLIA 28KN/m	
c1	8.24 ml.
GRADINATURA	
d1	5.19 ml.
IDROSEMINA	
e1	7.74 ml.
USURA	
f1	7.25 ml.
BINDER	
g1	6.75 ml.

390.00  
 ▲  
 PROGRESSIVE  
 TERRENO 200

PARZIALI TERRENO	405.79	-20.00	2.47	
	405.87	-17.53	0.97	
	405.89	-16.56	2.78	
	405.98	-13.78	0.98	
	406.01	-12.80	2.77	
	406.09	-10.03	0.46	
	406.31	-9.57	1.39	
	406.36	-8.18	0.13	
	406.15	-8.05	3.01	
	406.07	-5.04	1.07	
	406.04	3.97	2.69	
	405.96	-1.28	1.06	
405.98	-1.00		1.00	
405.95	0.00		3.75	
	405.88	1.46	4.22	
	405.86	3.75	0.14	
	405.75	5.68	0.63	
	406.04	5.88	0.15	
	405.90	6.45	0.30	
	405.54	6.60	0.86	
	405.79	6.90	4.76	
	405.50	7.76	1.92	
	402.33	12.52	0.78	
	402.42	14.44	1.57	
	402.44	15.22	2.07	
	402.33	16.79	1.14	
	402.50	18.86		
	402.60	20.00		
QUOTE PROGETTO	402.35	13.02	5.27	

Autostrada A32 - Discesa  
 Direzione TORINO

2.50%



STERRI E RIPORTI	
S1	3.17 mq.
S2	1.06 mq.
Totale S:	4.23 mq.
R1	0.09 mq.
R2	1.44 mq.
Totale R:	1.53 mq.
SCOTTICD	1.53 mq.
A1	0.54 mq.
BONIFICA	0.80 mq.
B1	0.80 mq.
BONIFICA PROFONDA	1.09 mq.
C1	1.62 mq.
STABILIZZATO	1.62 mq.
D1	1.55 mq.
CEMENTATO	1.55 mq.
E1	0.63 mq.
BASE	0.63 mq.
F1	2.12 mq.
VEGETALE	2.12 mq.
G1	3.70 ml.
TNT	3.70 ml.
a1	2.70 ml.
GEDRIGLIA 10KN/m	2.70 ml.
b1	8.24 ml.
GEDRIGLIA 28KN/m	8.24 ml.
c1	5.76 ml.
GRADINATURA	5.76 ml.
d1	8.07 ml.
IDROSEMINA	8.07 ml.
e1	7.25 ml.
USURA	7.25 ml.
f1	6.75 ml.
BINDER	6.75 ml.
g1	6.75 ml.

390.00  
 200  
 200

PROGRESSIVE TERRENO				
PARZIALI TERRENO				
QUOTE TERRENO				
PROGRESSIVE PROGETTO				
PARZIALI PROGETTO				
QUOTE PROGETTO				

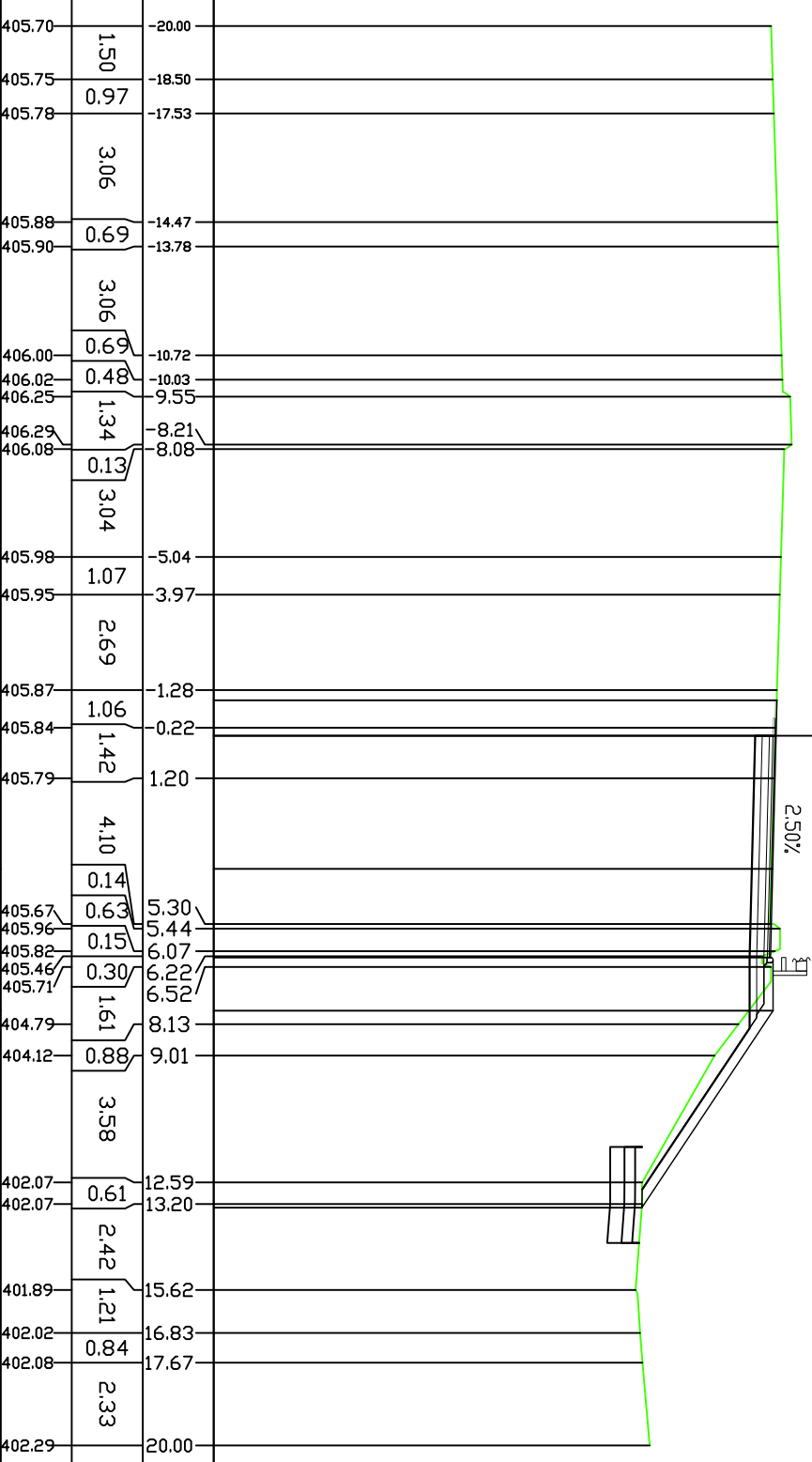

Rampa di Uscita A32 Bardonecchia Autoporto - Rampa 3

Autostrada A32 - Discesa Direzione TORINO

2.50%

PROFILO SV-TO\_MM3

SEZIONE 52

PROGRESSIVA 1000.00

STERRE E RIPORTI

SI	3,31 mq.
R1	0,00 mq.
R2	1,19 mq.
R3	5,42 mq.
Totale R:	6,61 mq.
SCOTTICD	
A1	0,75 mq.
BONIFICA	
B1	1,09 mq.
BONIFICA PROFONDA	
C1	1,49 mq.
STABILIZZATO	
D1	1,62 mq.
CEMENTATO	
E1	1,54 mq.
BASE	
F1	0,63 mq.
VEGETALE	
G1	2,40 mq.
TNT	
TNT	
a1	4,69 ml.
GEORIGLIA 10KN/m	
b1	3,67 ml.
GEORIGLIA 28KN/m	
c1	8,24 ml.
GRADINATURA	
d1	7,63 ml.
IDROSEMINA	
e1	9,00 ml.
USURA	
f1	7,25 ml.
BINDER	
g1	6,75 ml.

390.00  
 200  
 200

PROGRESSIVE TERRENO		405.68	-20.00
PARZIALI TERRENO	2.44	405.76	-17.56
QUOTE TERRENO	3.75	405.88	-13.81
PROGRESSIVE PROGETTO		405.97	-10.06
PARZIALI PROGETTO	0.50	406.17	-9.56
QUOTE PROGETTO	1.31	406.22	-8.25
	0.13	406.01	-8.12
	0.71	405.99	-7.41
	3.41	405.89	-4.00
	3.75	405.77	-1.00
	1.00	405.74	0.00
	3.75	405.71	2.37
	0.42	405.98	2.79
	0.77	405.55	3.56
	0.70	405.74	4.26
	1.39	404.99	5.65
	2.31	405.59	7.96
	1.64	403.72	9.60
	0.79	402.96	10.39
	2.00	402.60	12.39
	1.76	401.45	14.15
	2.29	401.66	16.44
	0.79	401.69	17.23
	2.77	401.75	20.00

Autostrada A32 - Discesa  
 Direzione TORINO

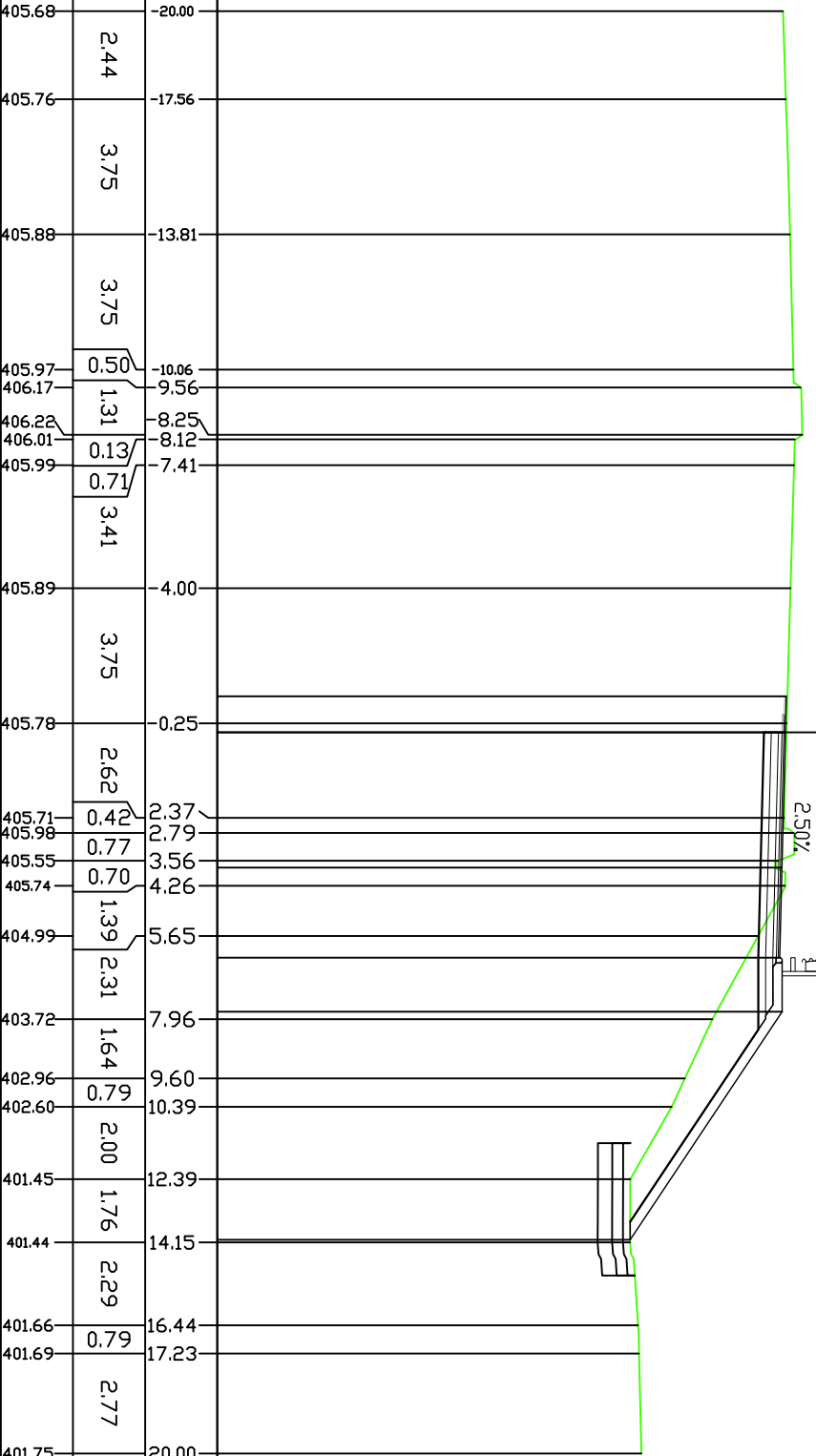

PROFILO SV-T0\_MM3

SEZIONE 53

PROGRESSIVA 1025.00

USURA f1 7.25 ml.  
BINDER g1 7.25 ml.

390.00  
200  
200

PROGRESSIVE TERRENO
PARZIALI TERRENO
QUOTE TERRENO
PROGRESSIVE PROGETTO
PARZIALI PROGETTO
QUOTE PROGETTO

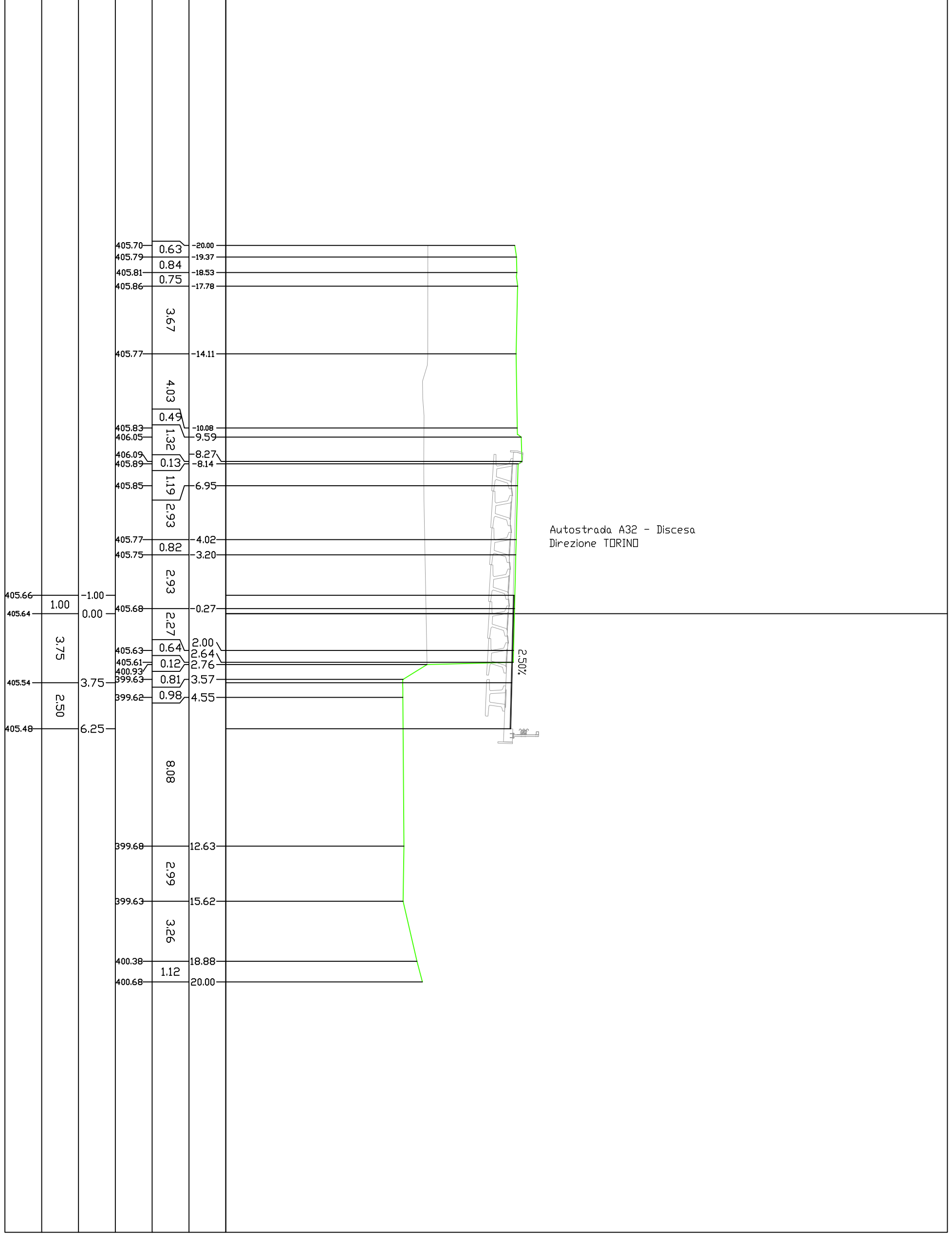

Autostrada A32 - Discesa  
Direzione TORINO

2.50%



PROFILO SV-T0\_MM3

SEZIONE 55

PROGRESSIVA 1075.00

STERRI E RIPORTI

SI	2,97 mq.
S2	0,00 mq.
Totale S:	2,97 mq.
R1	0,00 mq.
R2	9,61 mq.
Totale R:	9,61 mq.
SCOTICD	0,86 mq.
A1	0,86 mq.
BONIFICA	
B1	1,31 mq.
BONIFICA PROFONDA	
C1	1,74 mq.
STABILIZZATO	
D1	1,62 mq.
CEMENTATO	
E1	1,55 mq.
BASE	
F1	0,65 mq.
VEGETALE	
G1	2,75 mq.
TNT	
a1	5,34 ml.
GEDRIGLIA 10KN/m	
b1	4,34 ml.
GEDRIGLIA 28KN/m	
c1	8,24 ml.
GRADINATURA	
d1	8,54 ml.
IDROSEMINA	
e1	10,33 ml.
USURA	
f1	7,25 ml.
BINDER	
g1	6,75 ml.

390.00  
 200  
 200

PROGRESSIVE TERRENO	
PARZIALI TERRENO	
QUOTE TERRENO	
PROGRESSIVE PROGETTO	
PARZIALI PROGETTO	
QUOTE PROGETTO	

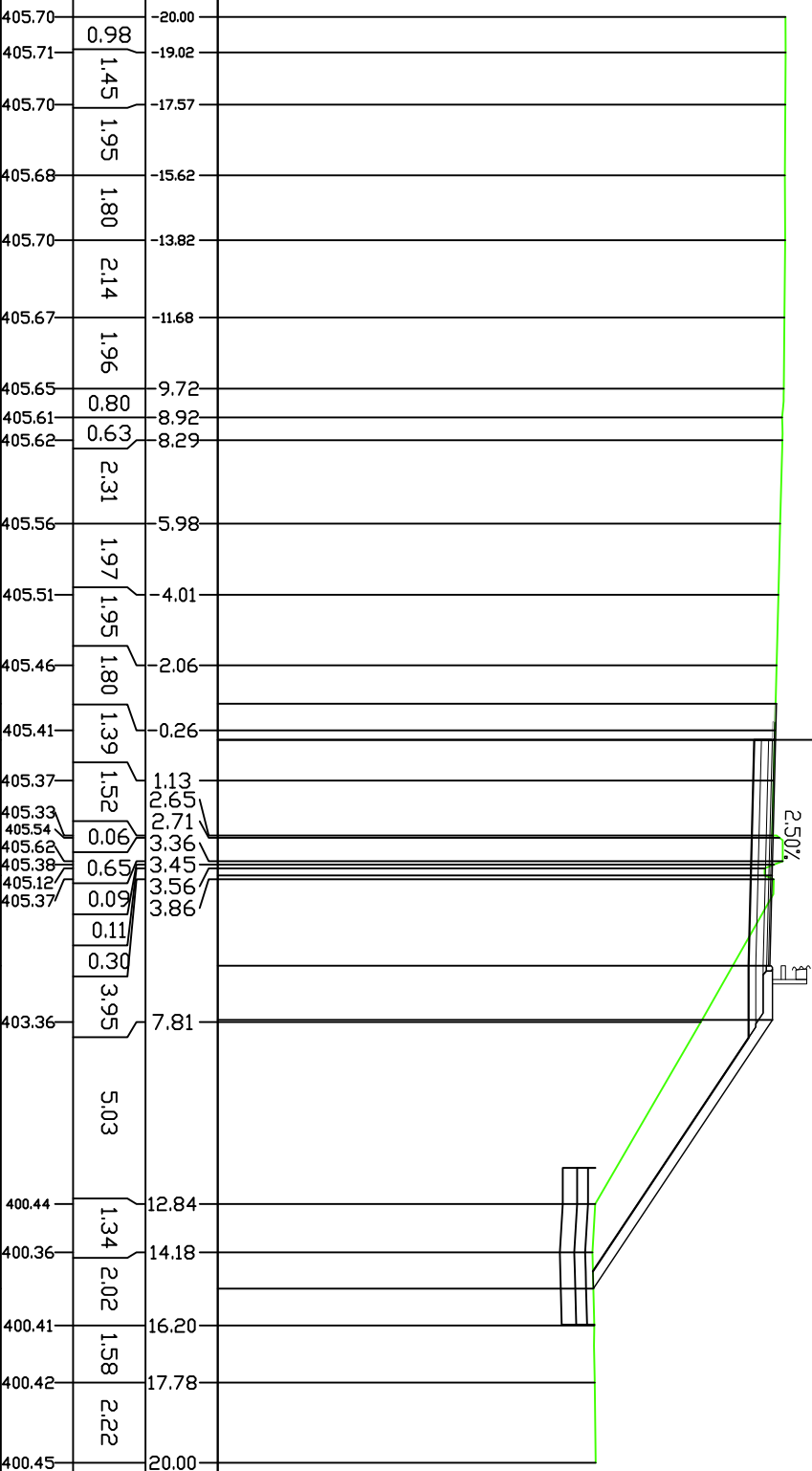

Autostrada A32 - Discesa  
 Direzione TORINO

405.70	8.00	-20.00
405.71	1.45	-19.02
405.70	1.95	-17.57
405.68	1.80	-15.62
405.70	2.14	-13.82
405.67	1.96	-11.68
405.65	0.80	9.72
405.61	0.63	8.92
405.62	2.31	8.29
405.56	1.97	5.98
405.51	1.95	-4.01
405.46	1.80	2.06
405.45	1.00	-1.00
405.43	3.75	0.00
405.37	1.52	1.13
405.33	0.00	2.65
405.54	0.00	2.71
405.62	0.00	3.36
405.38	0.00	3.45
405.12	0.00	3.59
405.37	0.11	3.86
405.27	6.25	0.30
405.34	7.75	3.95
400.44	5.03	7.81
400.36	1.34	12.84
400.39	15.18	14.18
400.41	2.02	16.20
400.42	1.58	17.78
400.45	2.22	20.00

PROFILO SV-TO\_MM3

SEZIONE 56

PROGRESSIVA 1095.94

STERRI E RIPORTI

S1 2.87 mq.  
 R1 0.00 mq.  
 R2 0.00 mq.  
 R3 9.78 mq.  
 Totale R: 9.78 mq.  
 SCOTICD 0.82 mq.  
 A1 0.82 mq.  
 BONIFICA 1.26 mq.  
 BONIFICA PROFONDA 1.67 mq.  
 C1 1.67 mq.  
 STABILIZZATO 1.62 mq.  
 D1 1.55 mq.  
 CEMENTATO 0.63 mq.  
 E1 0.63 mq.  
 BASE 2.79 mq.  
 F1 5.17 mq.  
 VEGETALE 4.17 ml.  
 G1 8.21 ml.  
 TNT 8.80 ml.  
 a1 10.40 ml.  
 GEGRIGLIA 10KN/m 7.22 ml.  
 b1 6.72 ml.  
 GEGRIGLIA 28KN/m  
 c1  
 GRADINATURA 8.80 ml.  
 d1  
 IDROSEMINA 10.40 ml.  
 e1  
 USURA 7.22 ml.  
 f1  
 BINDER 6.72 ml.  
 g1

390.00  
 200  
 200

PROGRESSIVE TERRENO	PARZIALI TERRENO	QUOTE TERRENO	PROGRESSIVE PROGETTO	PARZIALI PROGETTO	QUOTE PROGETTO
405.81	1.78		405.81		
405.76	0.64		405.76		
405.74	2.89		405.74		
405.68	0.86		405.68		
405.66	0.94		405.66		
405.64	3.16		405.64		
405.61	0.80		405.61		
405.57	0.79		405.57		
405.55	0.95		405.55		
405.52	3.17		405.52		
405.44	2.89		405.44		
405.37	0.86		405.37	1.00	
405.34	2.26		405.34	3.72	
405.25	0.67		405.25	2.50	
405.23	0.10		405.23	1.50	
405.48	0.61		405.48	7.49	
405.52	0.16		405.52		
405.13	0.67		405.13		
405.26	0.83		405.26		
404.83	8.00		404.83		
405.18			405.18		
405.25			405.25		
400.23	2.63		400.23		
400.26	0.69		400.26		
400.27	1.52		400.27		
400.25	2.17		400.25		
400.32			400.32		
400.44			400.44		

Autostrada A32 - Discesa  
Direzione TORINO

2.50%

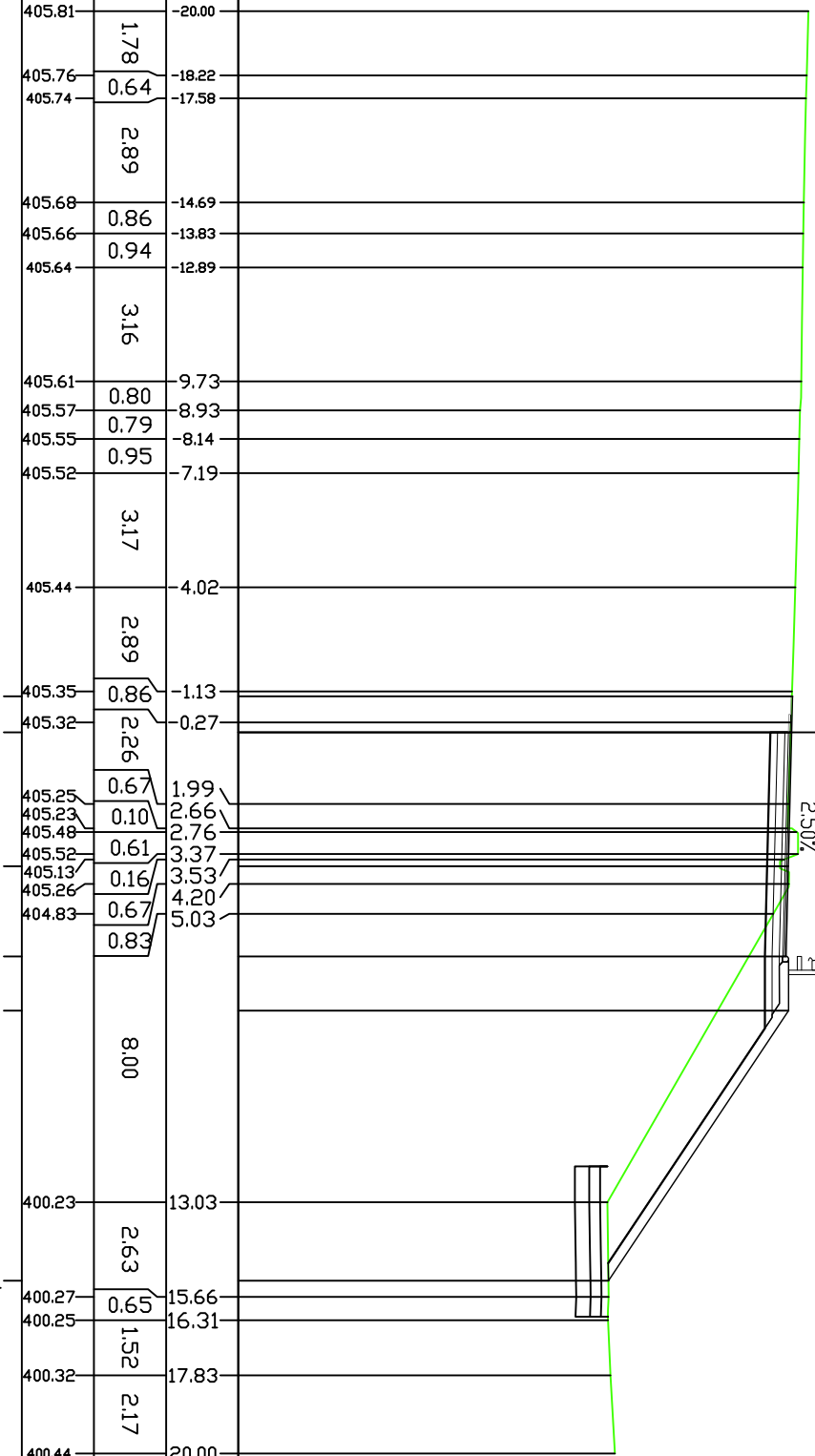

STERRI E RIPORTI	
S1	2,95 mq.
S2	0,06 mq.
S3	0,00 mq.
Totale S:	
R1	3,01 mq.
SCOTICD	7,09 mq.
A1	0,73 mq.
BONIFICA	
B1	1,12 mq.
BONIFICA PROFONDA	
C1	1,47 mq.
STABILIZZATO	
D1	1,43 mq.
CEMENTATO	
E1	1,36 mq.
BASE	
F1	0,56 mq.
VEGETALE	
G1	2,89 mq.
TNT	
a1	4,72 ml.
GEDGRIGLIA 10KN/m	
b1	3,69 ml.
GEDGRIGLIA 28KN/m	
c1	7,32 ml.
GRADINATURA	
d1	8,94 ml.
IDROSEMINA	
e1	10,88 ml.
USURA	
f1	6,32 ml.
BINDER	
g1	5,82 ml.

390.00  
 ▲  
 PROGRESSIVE  
 TERRENO 200  
 200

PARZIALI TERRENO	405.96	-20.00	0.73
	405.94	-19.27	1.75
	405.88	-17.52	1.41
	405.83	-16.11	2.34
	405.75	-13.77	1.44
	405.70	-12.33	2.31
	405.63	-10.02	1.82
	405.73	-8.20	0.13
	405.52	-8.07	2.03
	405.45	-6.04	2.08
	405.39	3.96	1.87
	405.33	2.09	1.88
	405.30	-1.00	1.31
QUOTE TERRENO	405.28	0.00	1.59
	405.23	1.10	0.13
	405.18	2.69	0.67
	405.47	2.82	0.11
	405.24	3.49	0.30
	404.97	3.60	2.73
	405.22	3.90	2.15
	405.15	5.32	4.23
	405.22	6.82	1.44
	403.88	6.63	0.98
	402.64	8.78	1.74
	399.80	13.01	2.79
	399.99	14.45	0.04
	400.09	15.43	
	400.22	17.17	
	400.38	19.96	
	400.38	20.00	
PROGRESSIVE PROGETTO			14.71
PARZIALI PROGETTO			7.89
QUOTE PROGETTO			1.00
			2.77
			2.55
			1.50

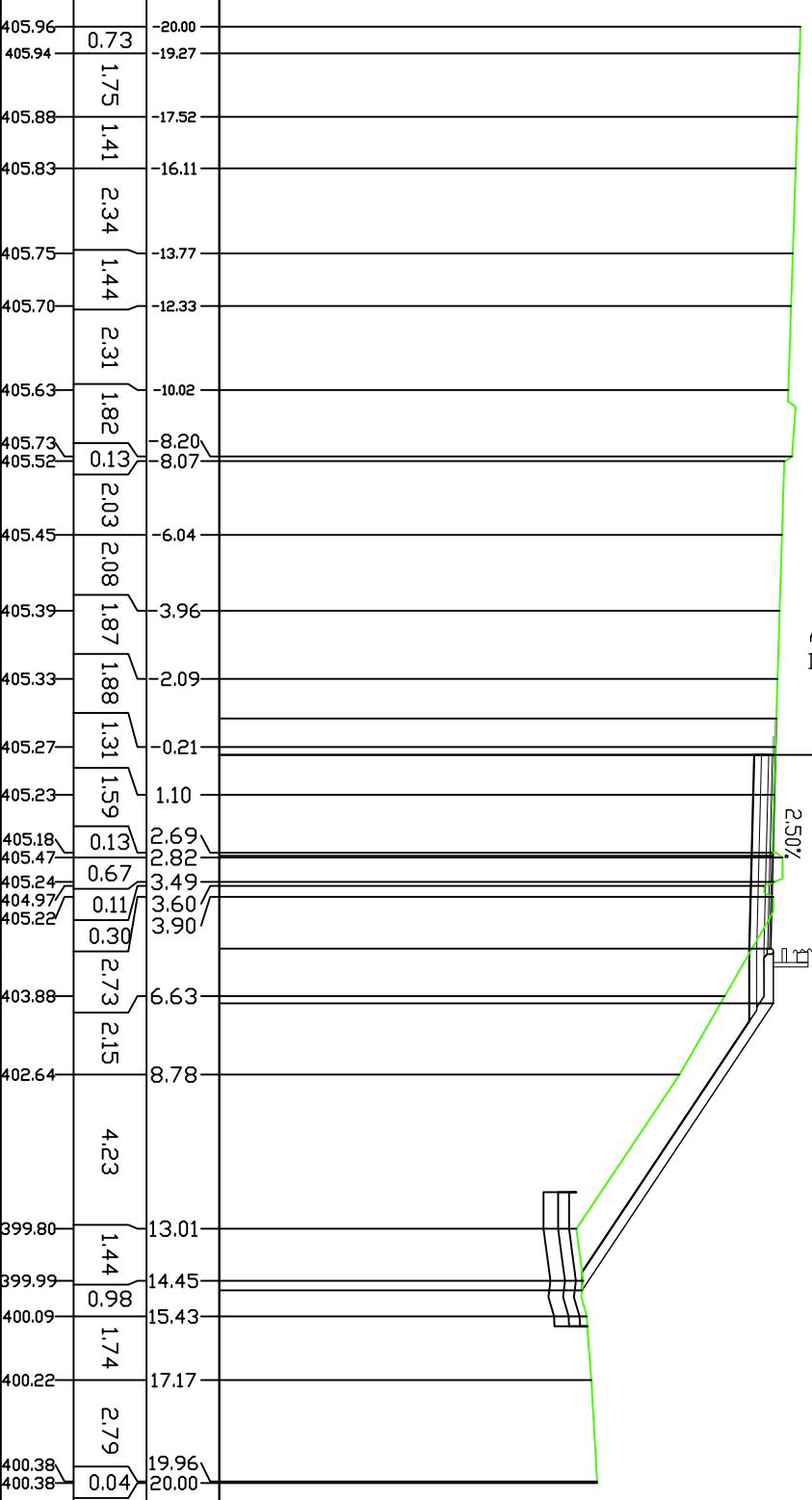

Autostrada A32 - Discesa  
 Direzione TORINO

PROFILO SV-T0\_MM3

SEZIONE 58

PROGRESSIVA 1141.62

USURA 4.56 ml.  
f1 BINDER 4.56 ml.  
g1

390.00  
200  
200

PROGRESSIVE TERRENO	
PARZIALI TERRENO	
QUOTE TERRENO	
PROGRESSIVE PROGETTO	
PARZIALI PROGETTO	
QUOTE PROGETTO	

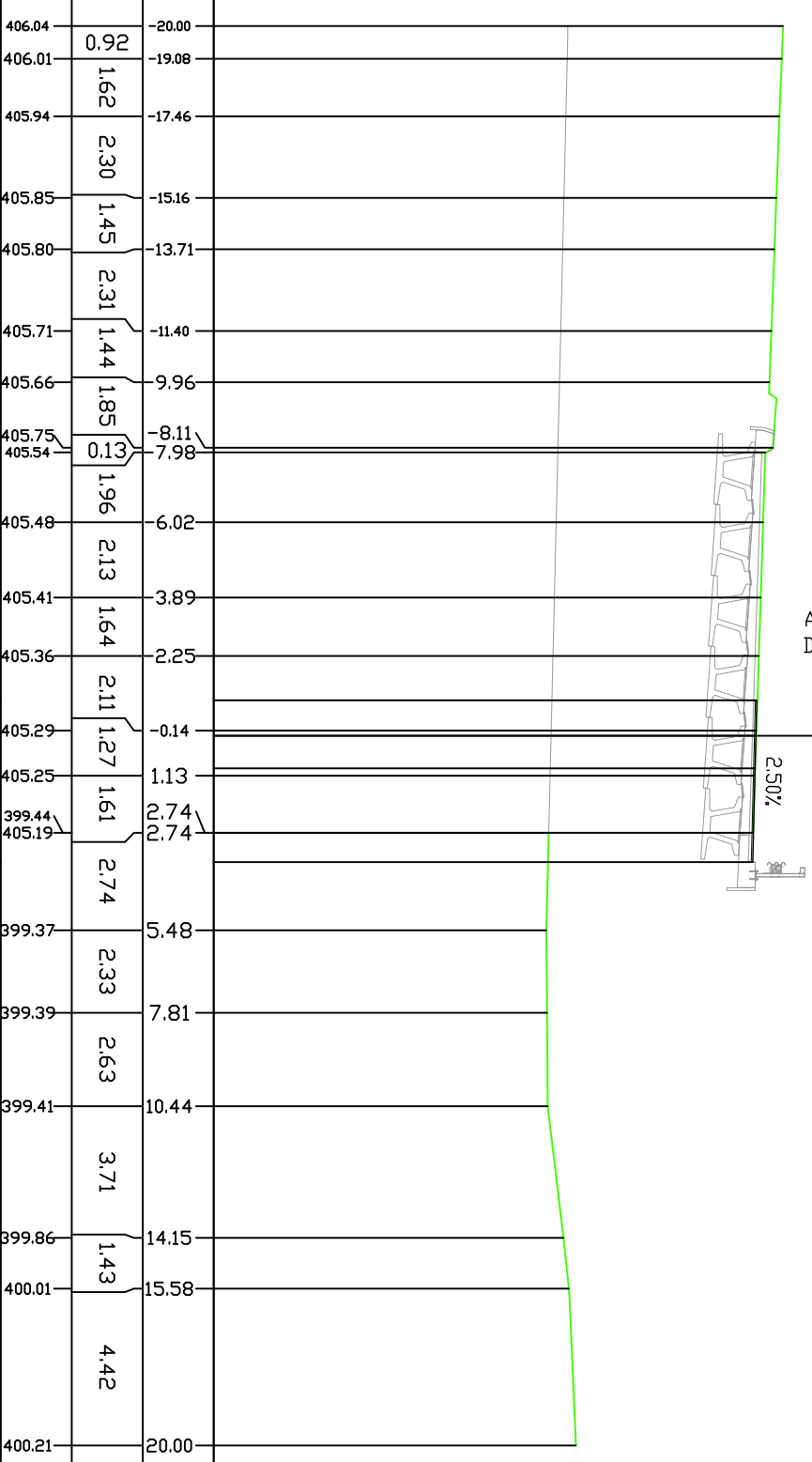

Autostrada A32 - Discesa  
Direzione TORINO

2.50%



PROFILO SV-T0\_MM3

SEZIONE 59

PROGRESSIVA 1166.36

USURA f1 369 ml.  
BINDER g1 369 ml.

390.00  
200  
200

PROGRESSIVE  
TERRENO  
PARZIALI  
TERRENO  
QUOTE  
TERRENO  
PROGRESSIVE  
PROGETTO  
PARZIALI  
PROGETTO  
QUOTE  
PROGETTO

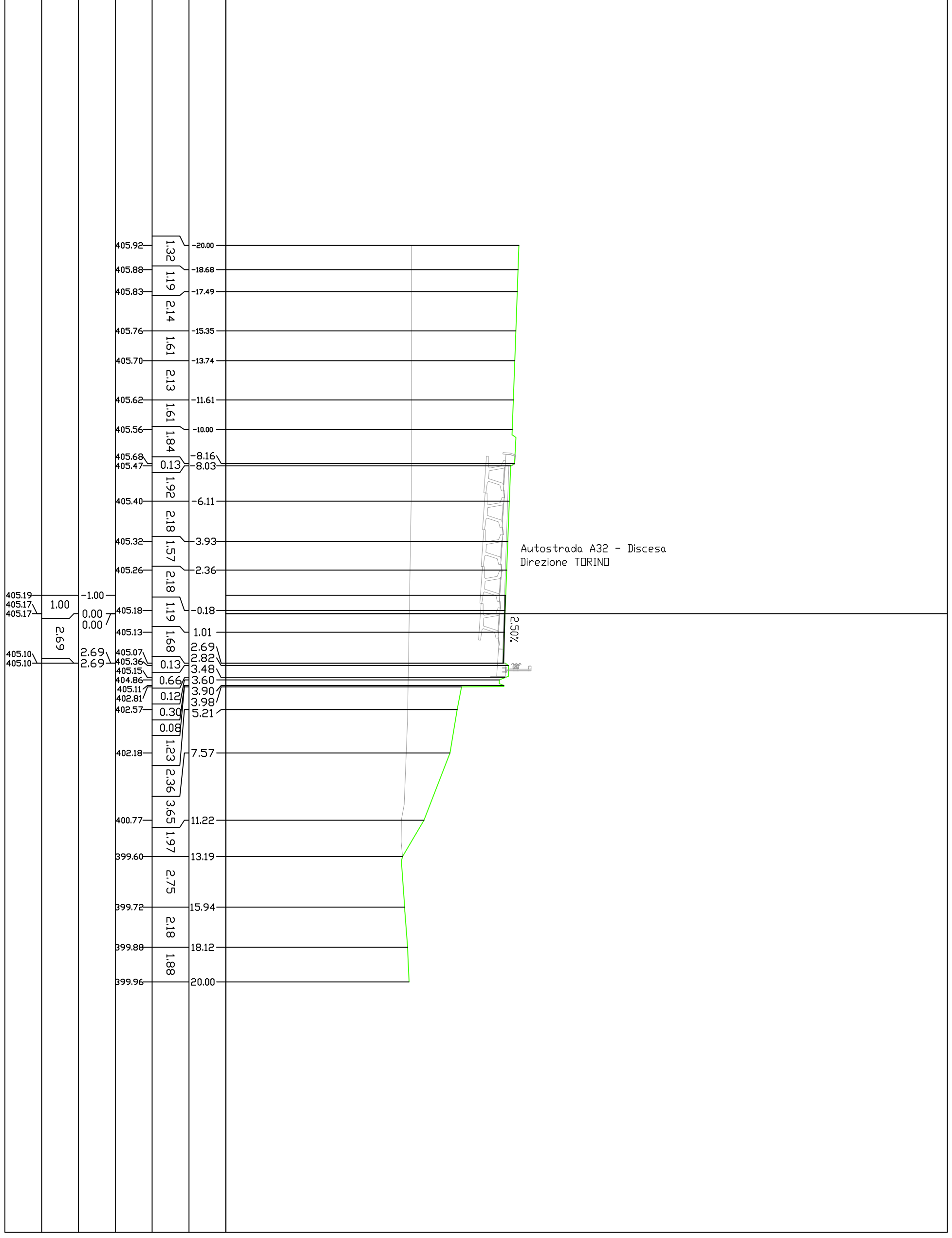

# Adeguamento S.S.25

## KEY PLAN

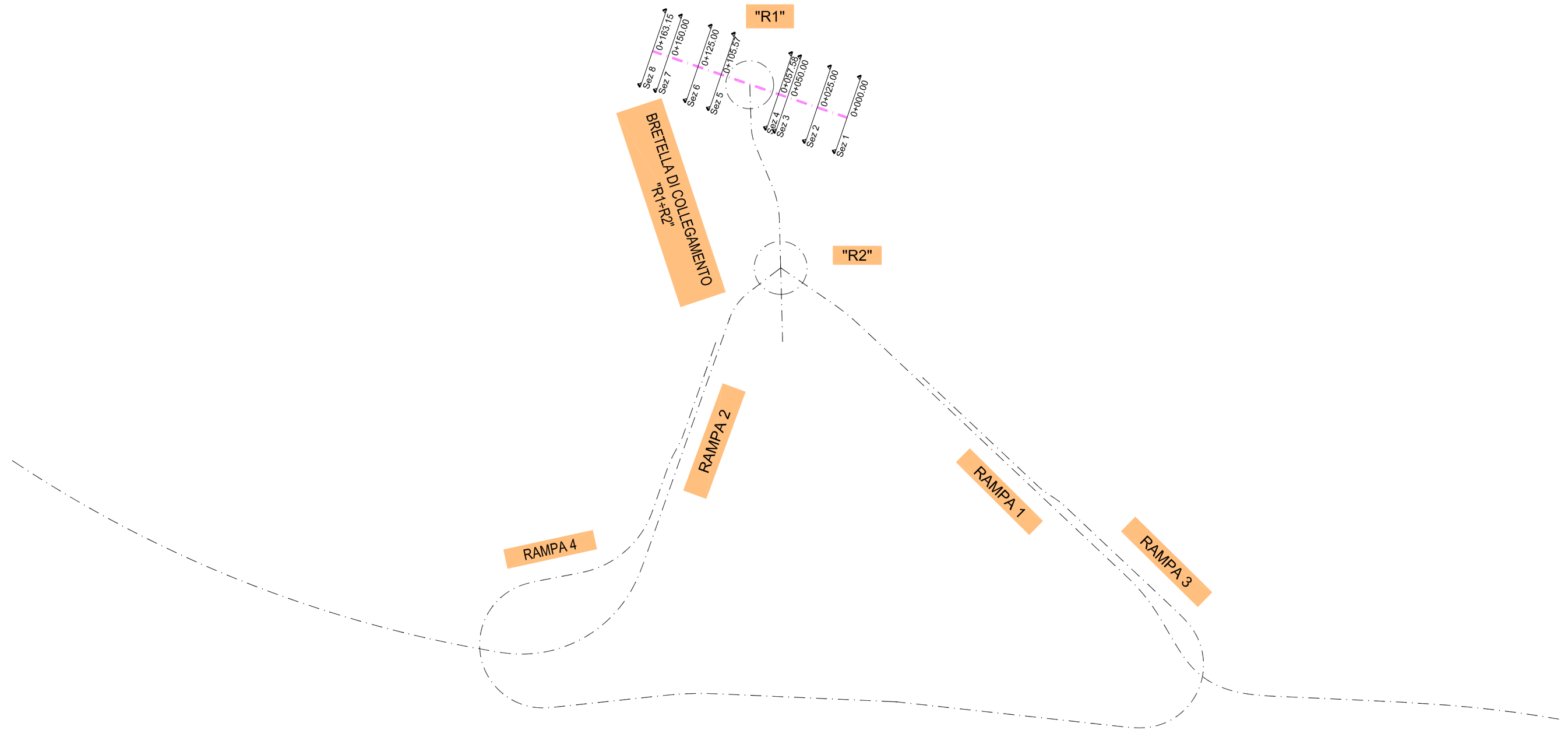

SS25\_Asse  
 Sez. 1  
 Progr. 0+000.00  
 Scala 1:200  
 Q.Rif. 390.00m

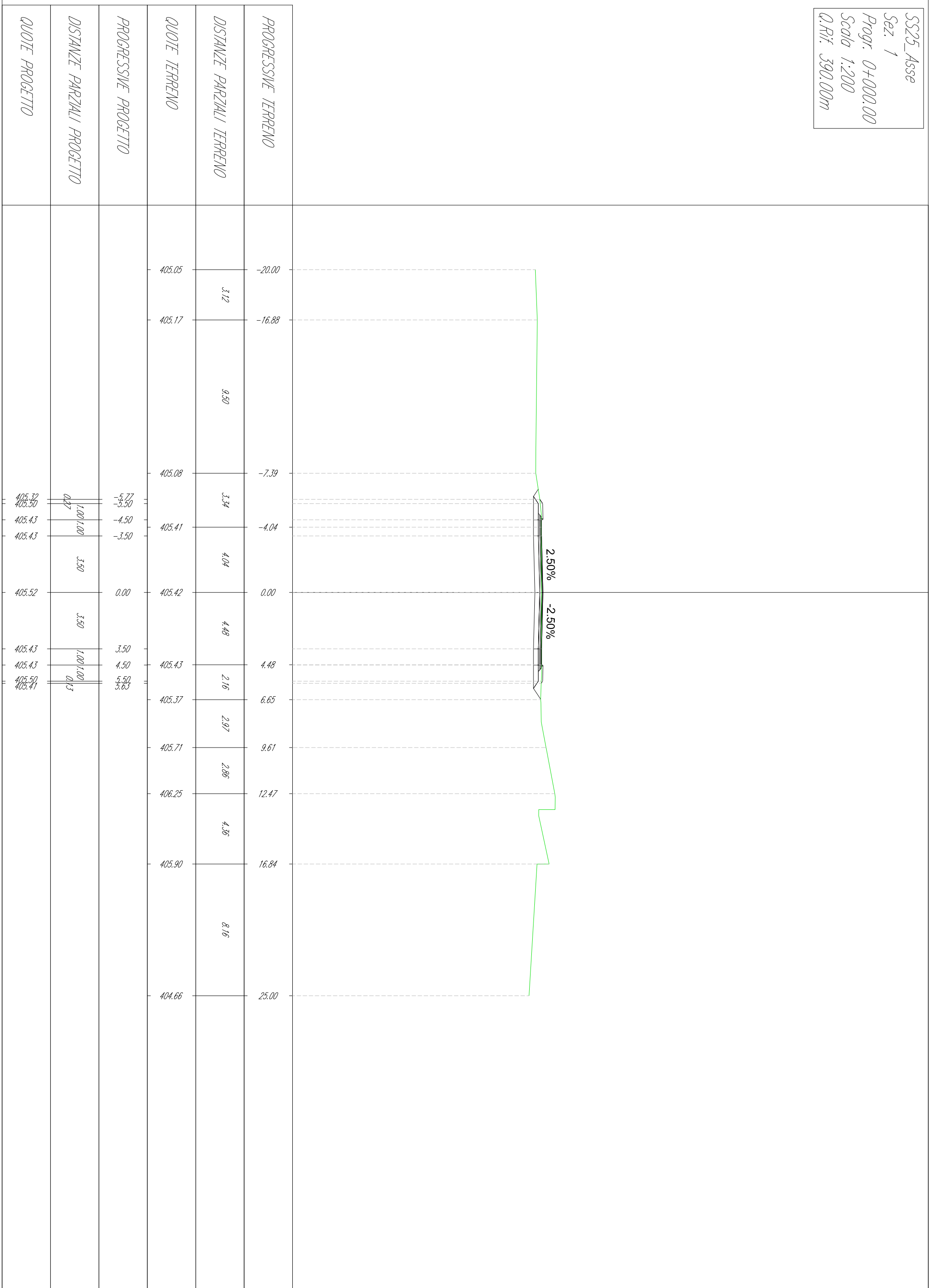

SS25\_Asse  
 Sez. 2  
 Progr. 0+025.00  
 Scala 1:200  
 Q.Rif. 390.00m

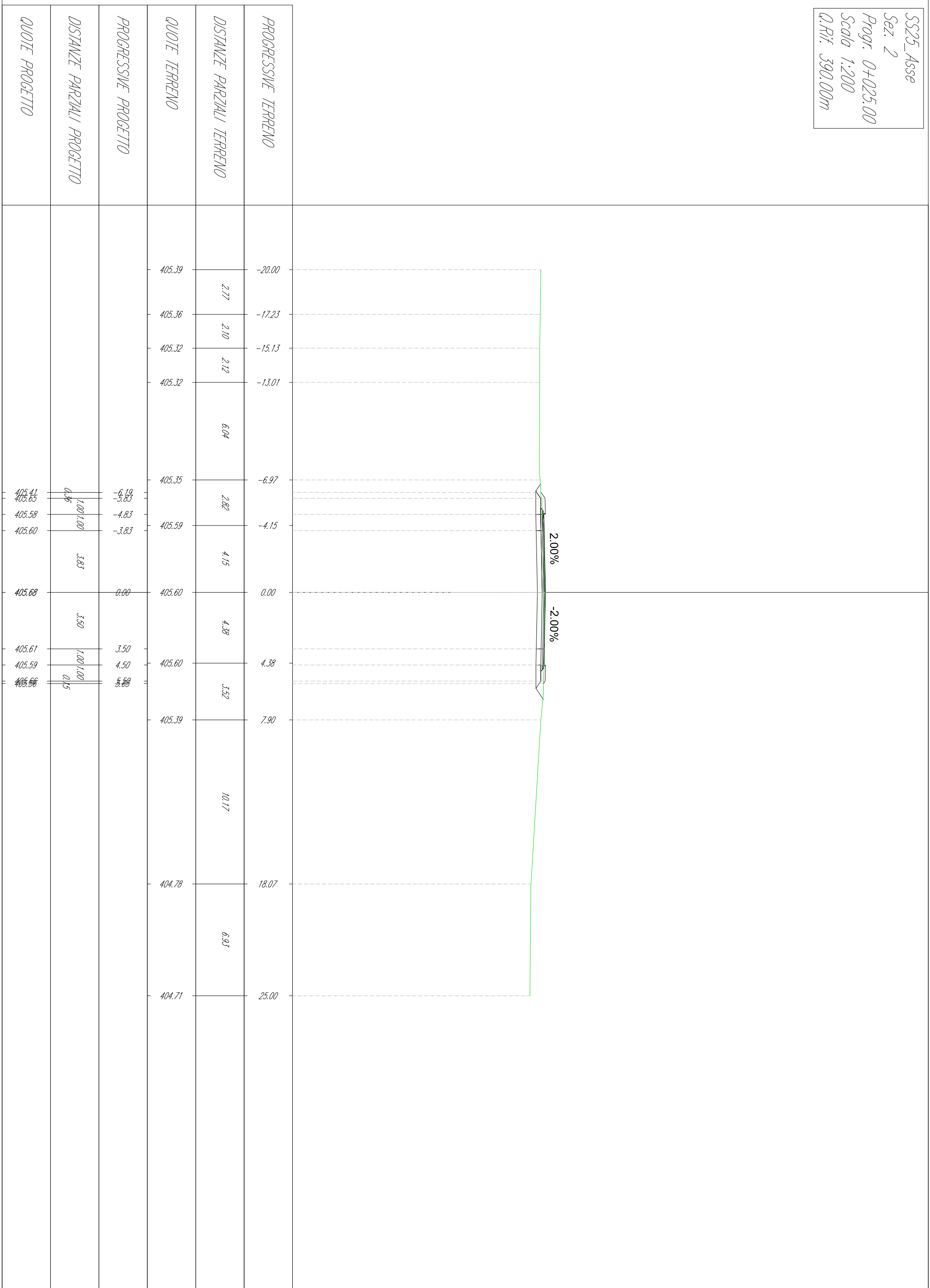

SS25\_Asse  
 Sez. 3  
 Progr. 0+050.00  
 Scala 1:200  
 Q.Rif. 390.00m

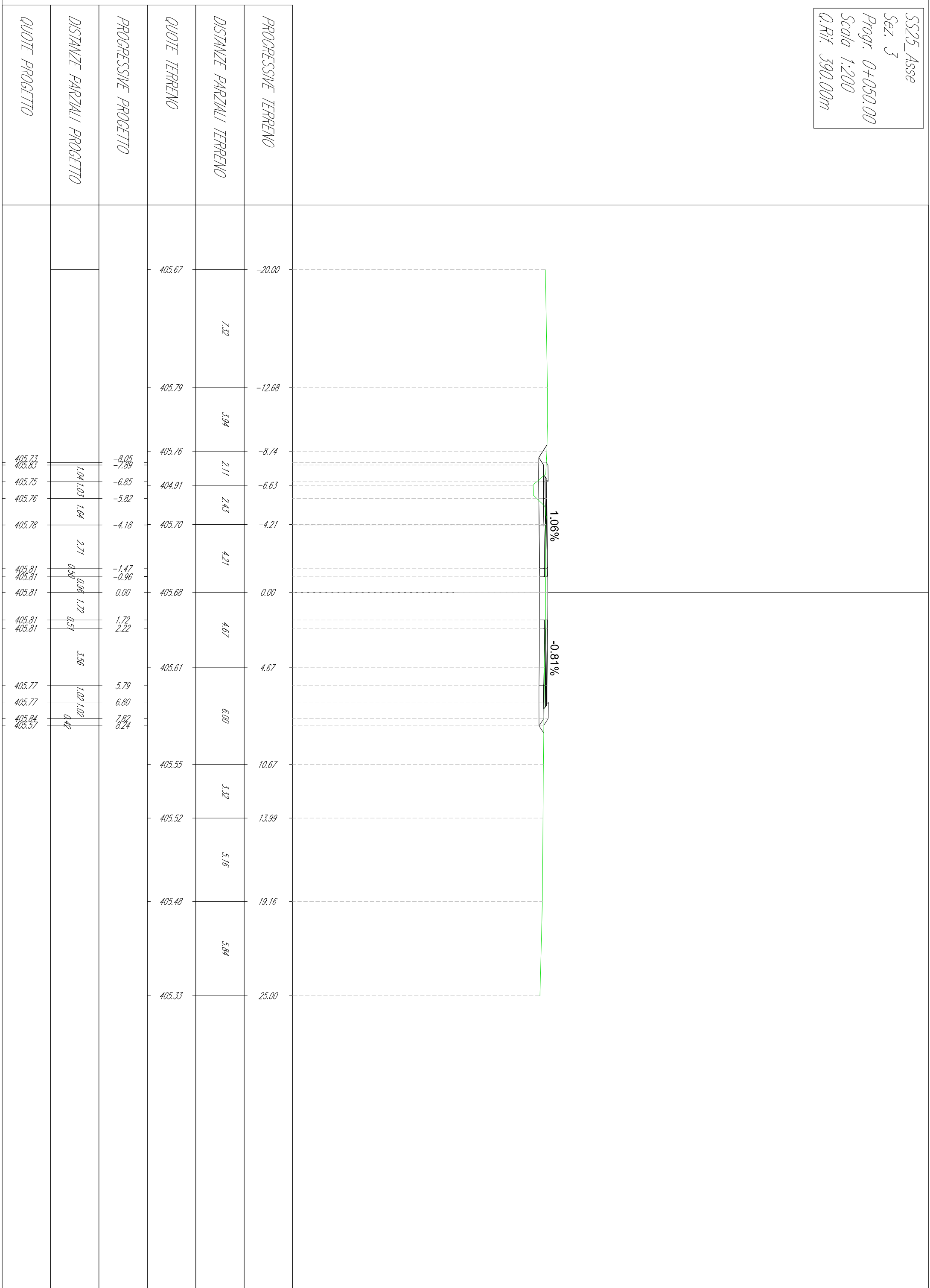

SS25\_Asse  
 Sez. 4  
 Progr. 0+057.58  
 Scala 1:200  
 Q.Rif. 390.00m

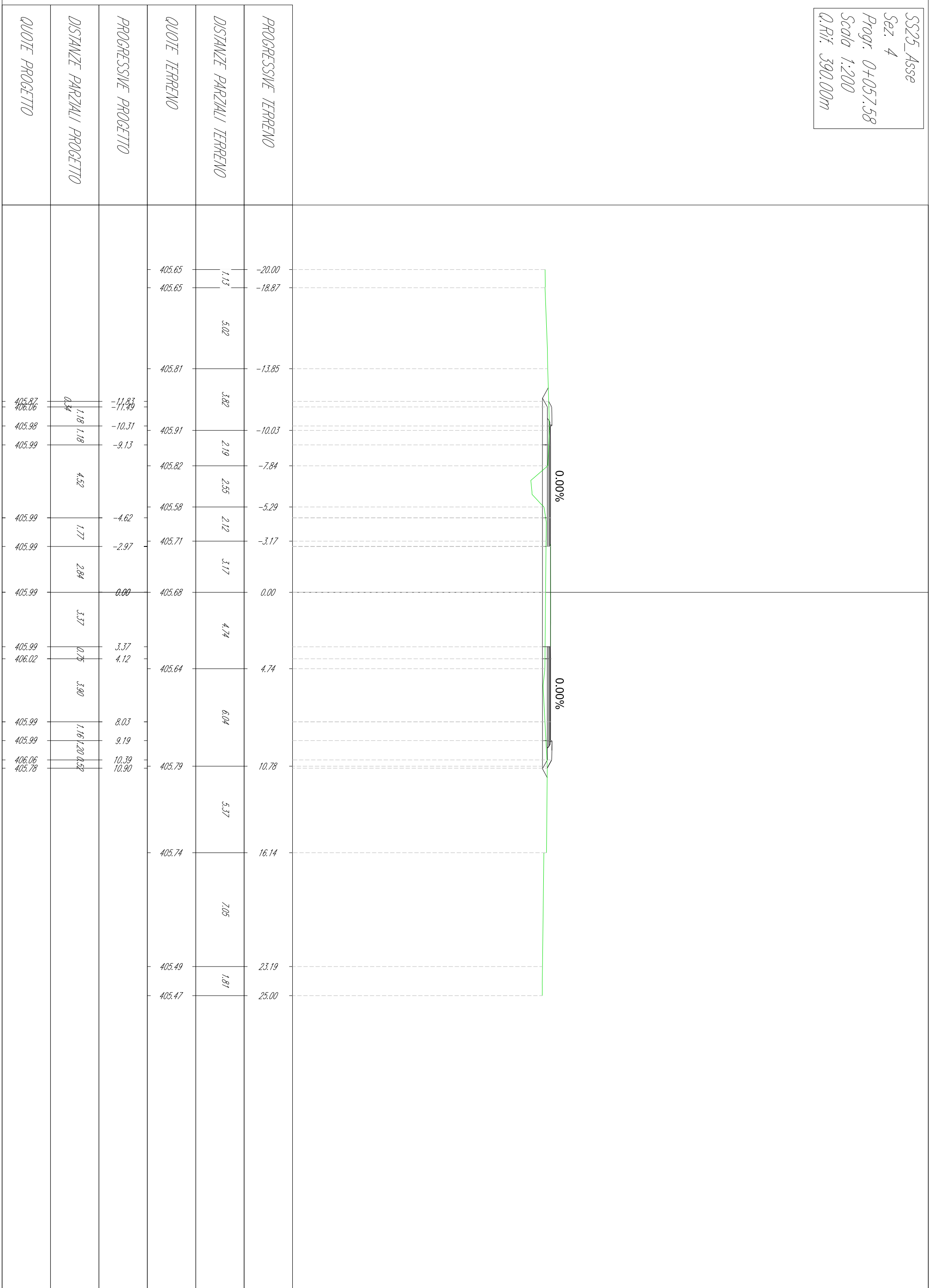

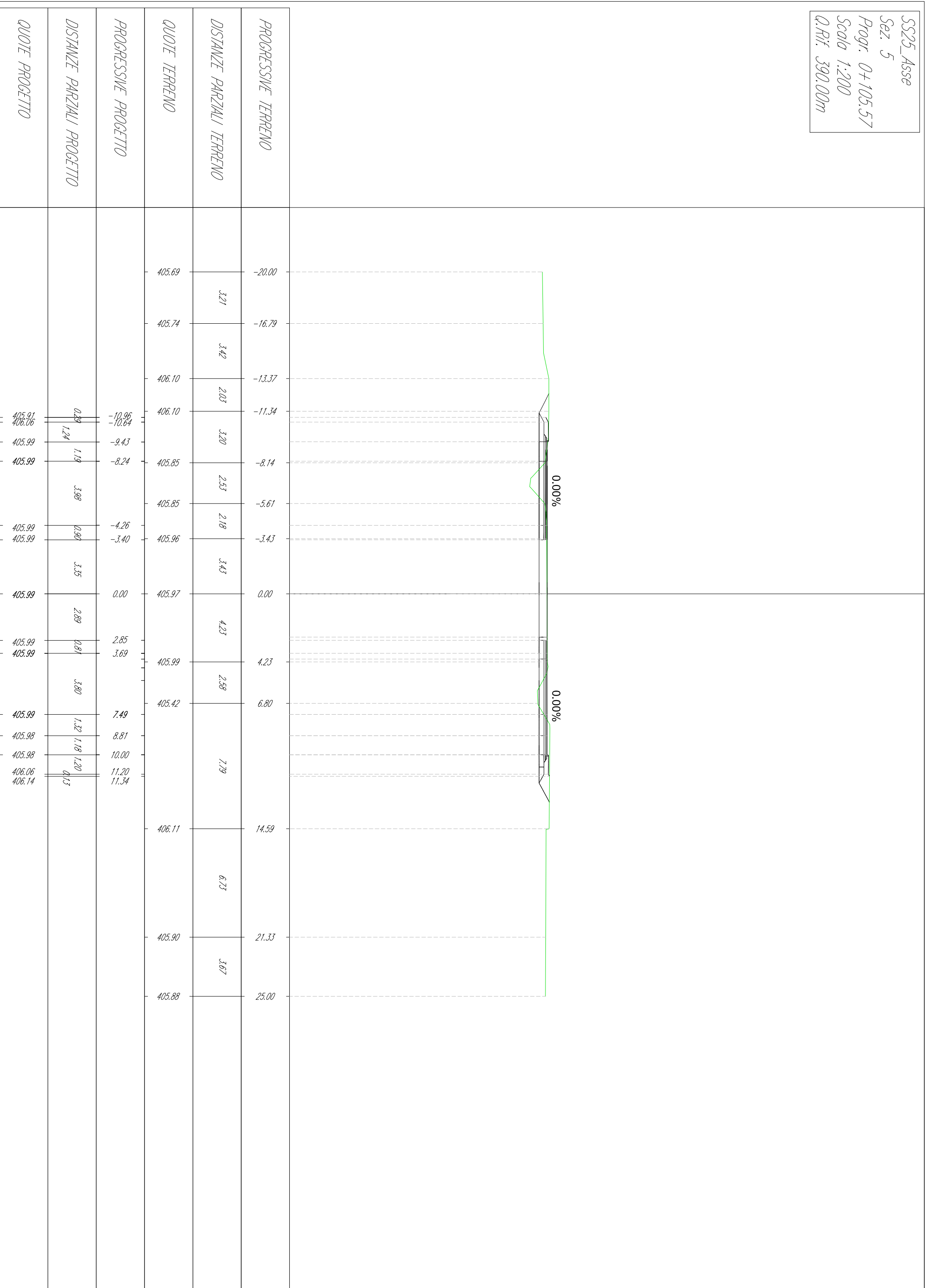

SS25\_Asse  
 Sez. 6  
 Progr. 0+125.00  
 Scala 1:200  
 Q.Rif. 390.00m

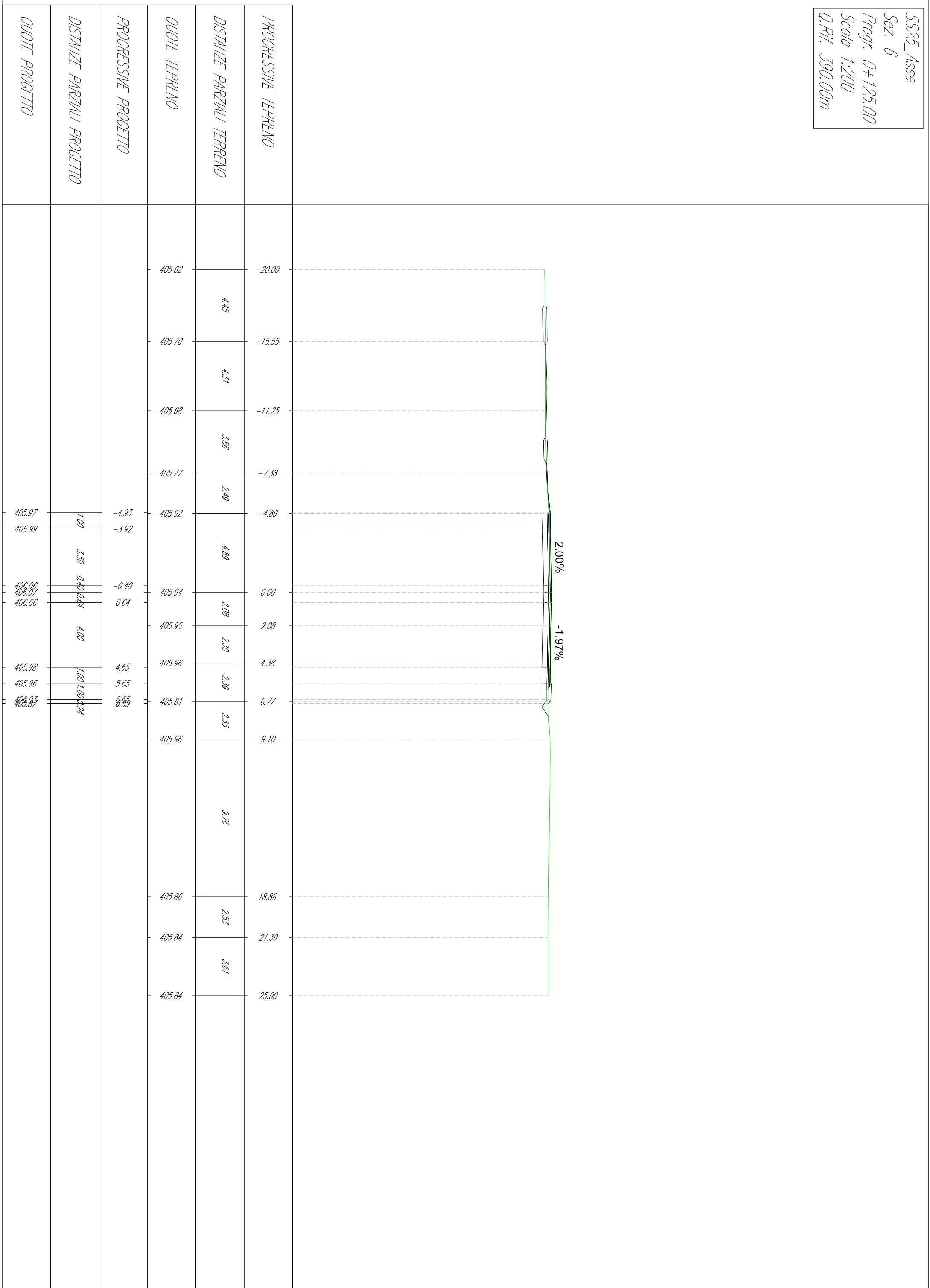



SS25\_Asse  
 Sez. 7  
 Progr. 0+150.00  
 Scala 1:200  
 Q.Rif. 390.00m

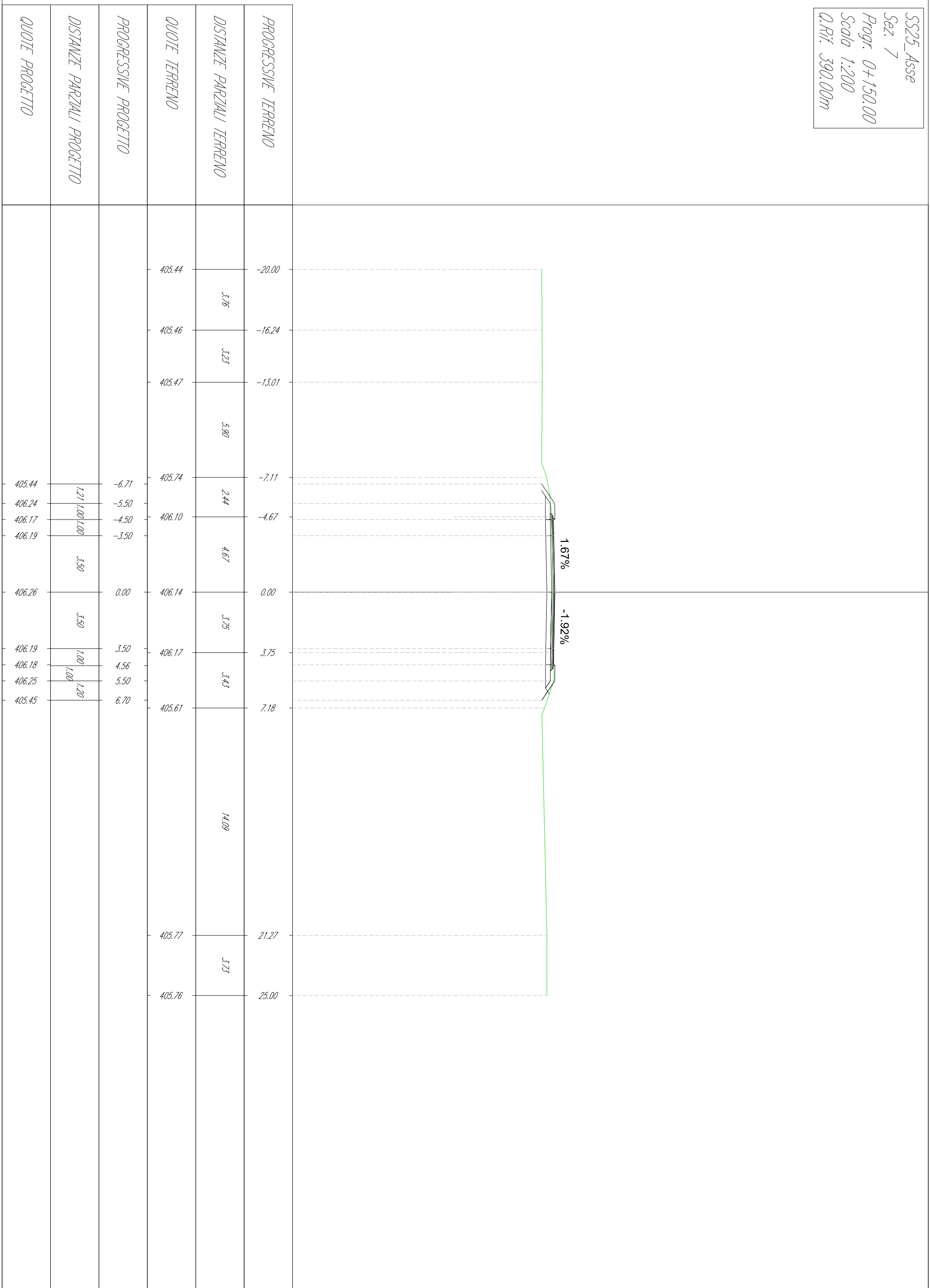

SS25\_Asse  
 Sez. 8  
 Progr. 0+163.12  
 Scala 1:200  
 Q.Rif. 390.00m

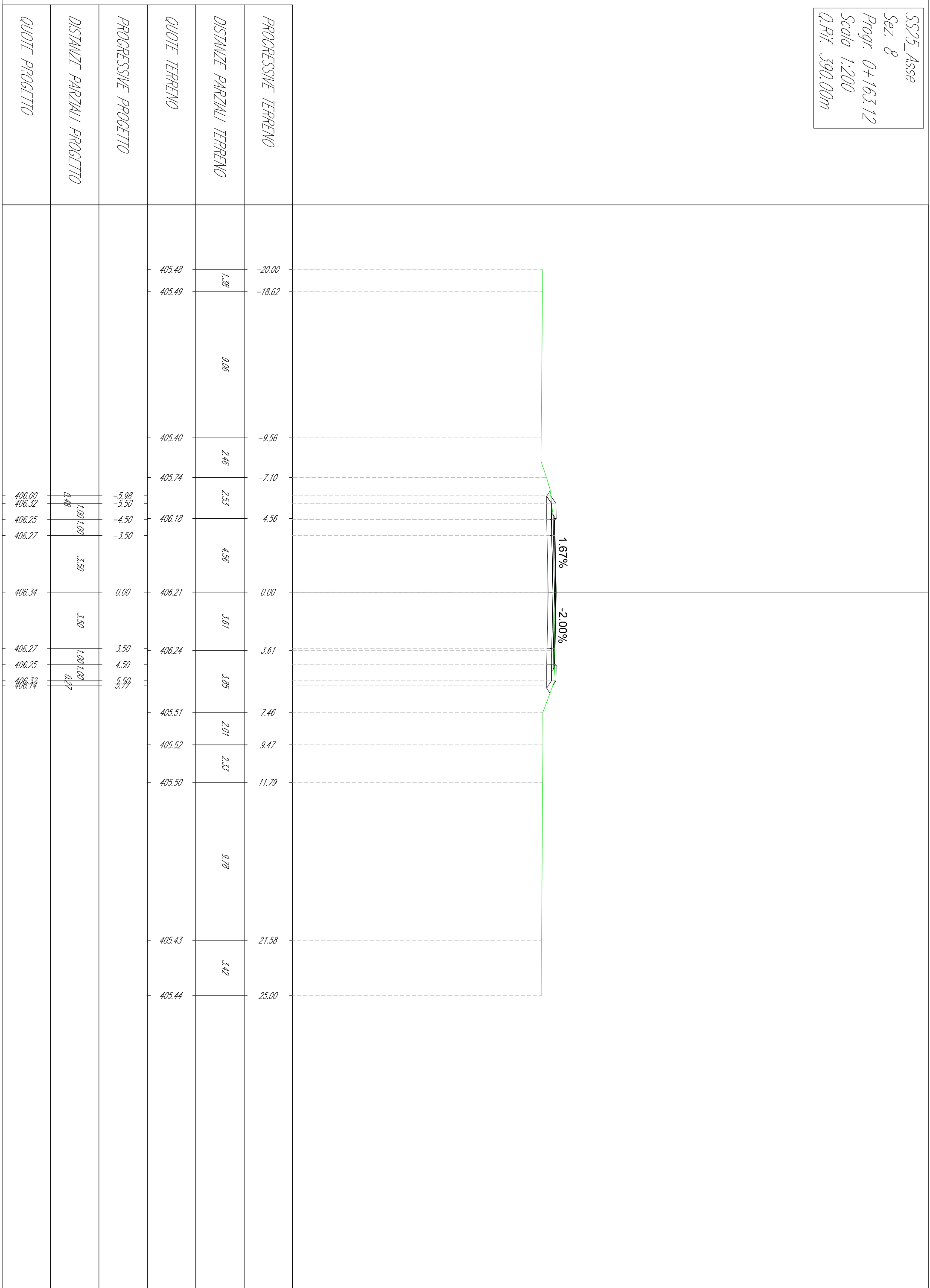

# Rotatoria su S.S.25 - "R1"

## KEY PLAN

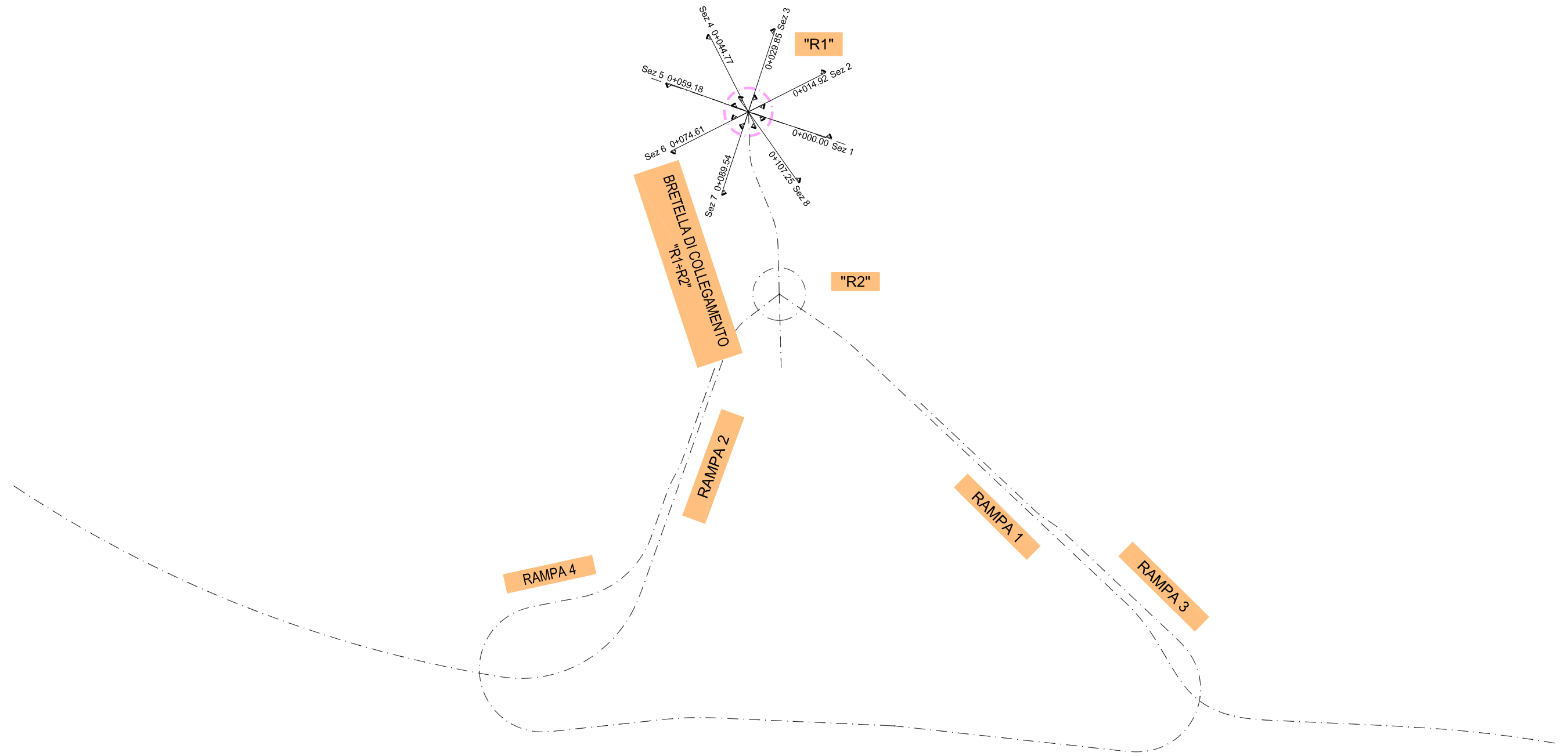

R1\_Asse  
 Sez. 1  
 Progr. 0+000.00  
 Scala 1:200  
 Q.Rif. 390.00m

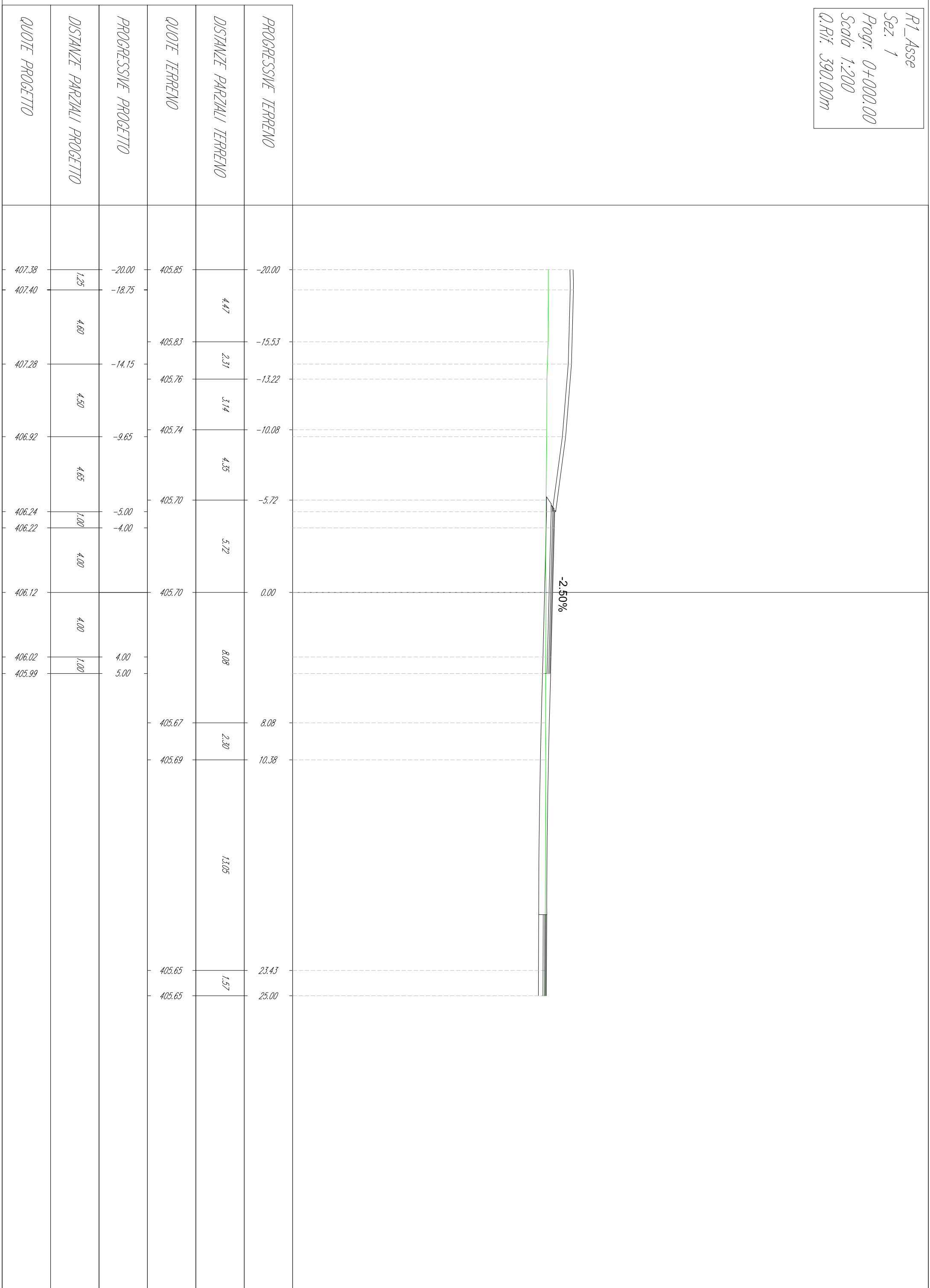

R1\_Asse  
 Sez. 2  
 Progr. 0+014.92  
 Scala 1:200  
 Q.Rif. 390.00m

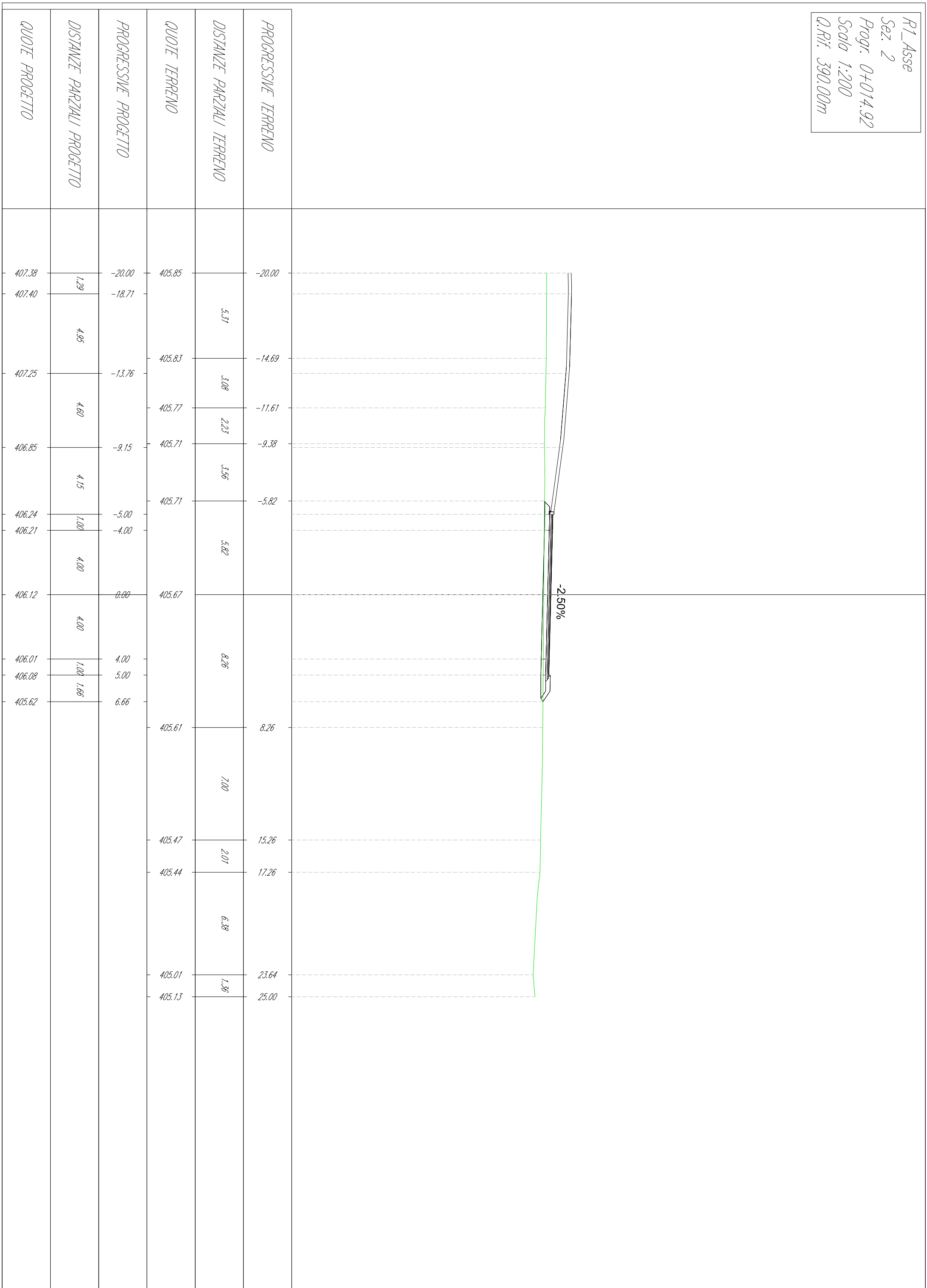

R1\_Asse  
 Sez. 3  
 Progr. 0+029.85  
 Scala 1:200  
 Q.Rif. 390.00m

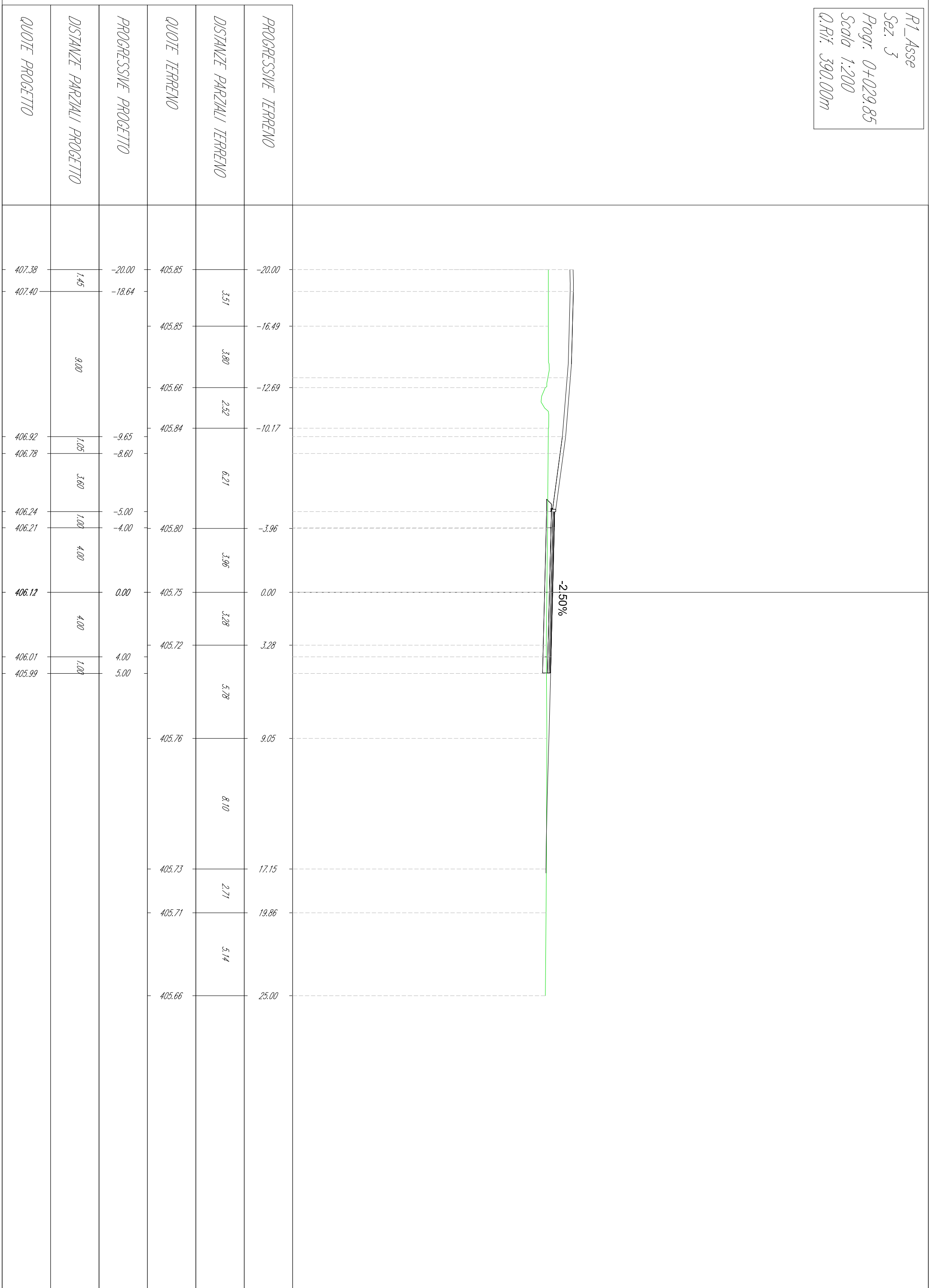

R1\_Asse  
 Sez. 4  
 Progr. 0+044.77  
 Scala 1:200  
 Q.Rif. 390.00m

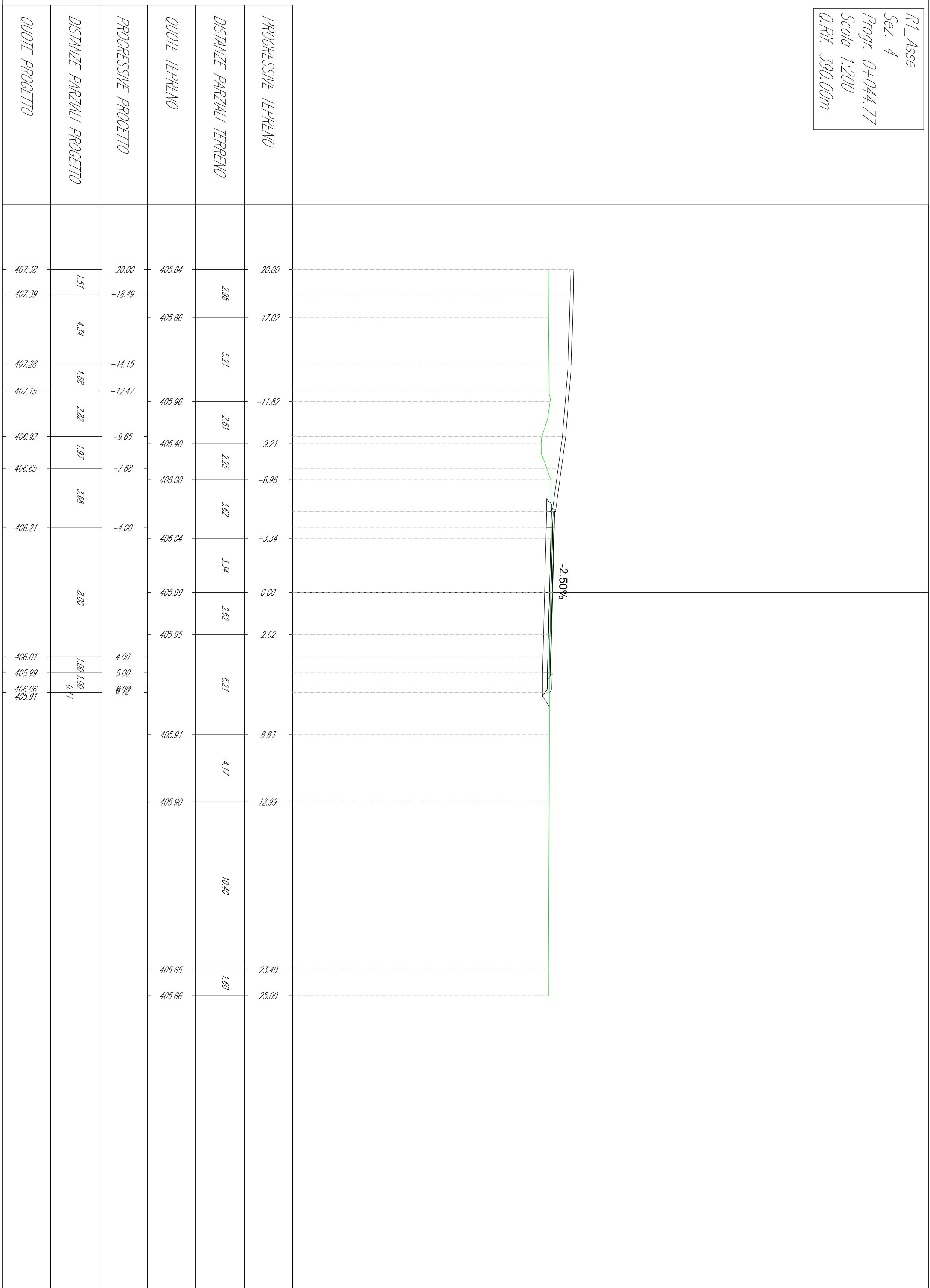

PROGRESSIVE TERRENO	DISTANZE PARZIALI TERRENO	QUOTE TERRENO	PROGRESSIVE PROGETTO	DISTANZE PARZIALI PROGETTO	QUOTE PROGETTO
405.84	2.98	405.84	-20.00	1.51	407.38
405.86	5.21	405.86	-18.49	4.34	407.39
405.96	2.61	405.96	-14.15	1.68	407.28
405.40	2.25	405.96	-12.47	2.82	407.15
406.00	3.62	405.40	-9.65	1.97	406.92
406.04	3.34	406.00	-7.68	3.68	406.65
405.99	2.62	406.04	-4.00	8.00	406.21
405.95	6.21	405.99	4.00	1.00	406.01
405.91	4.17	405.95	5.00	1.00	405.99
405.90	10.40	406.06	6.92	0.11	406.06
405.85	1.60	405.91	8.83		405.91
405.86		405.90	12.99		
		405.85	23.40		
		405.86	25.00		

R1\_Asse  
 Sez. 5  
 Progr. 0+059.18  
 Scala 1:200  
 Q.Rif. 390.00m

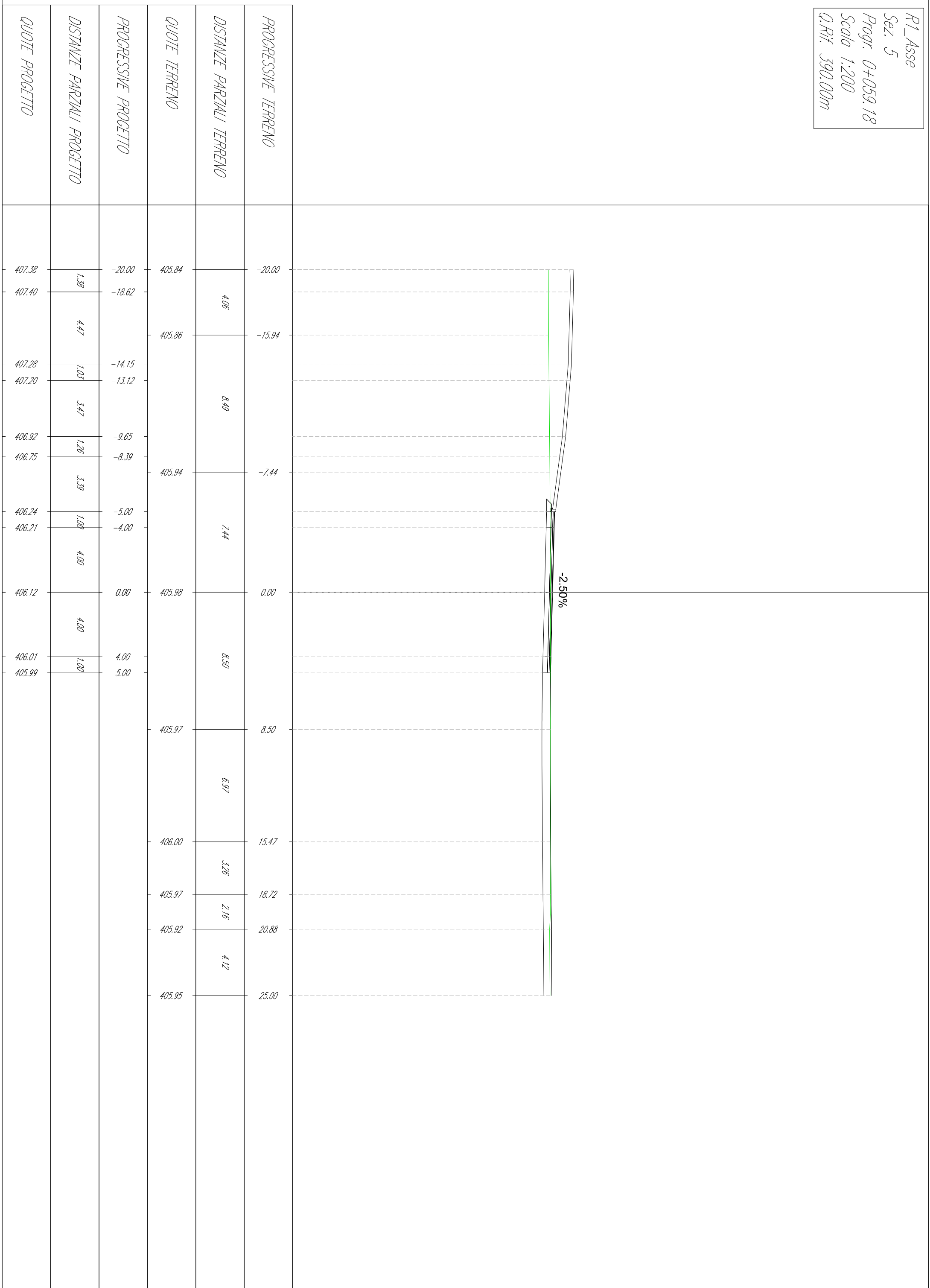



R1\_Asse  
 Sez. 6  
 Progr. 0+074.61  
 Scala 1:200  
 Q.Rif. 390.00m

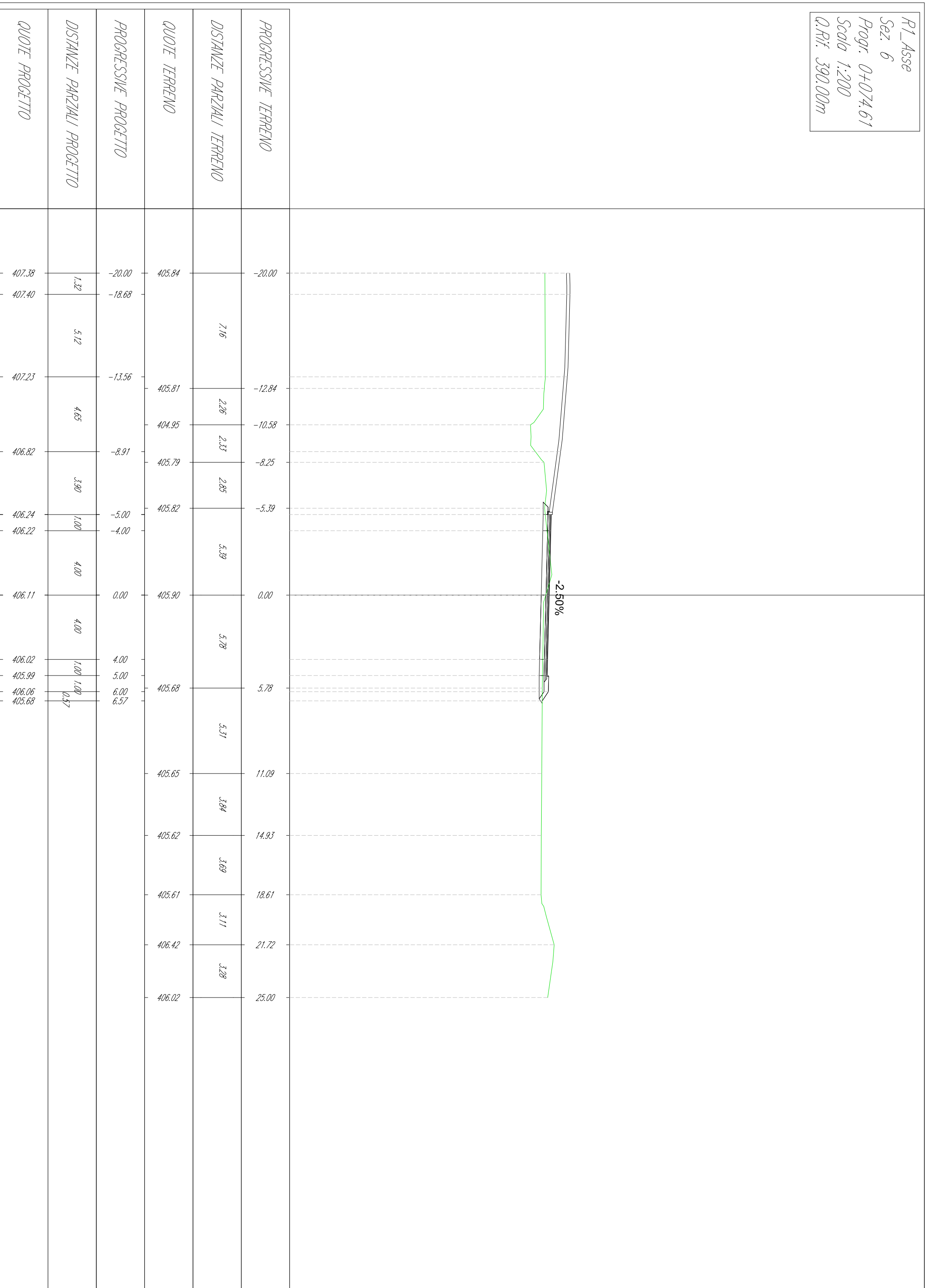

R1\_Asse  
 Sez. 7  
 Progr. 0+089.54  
 Scala 1:200  
 Q.Rif. 390.00m

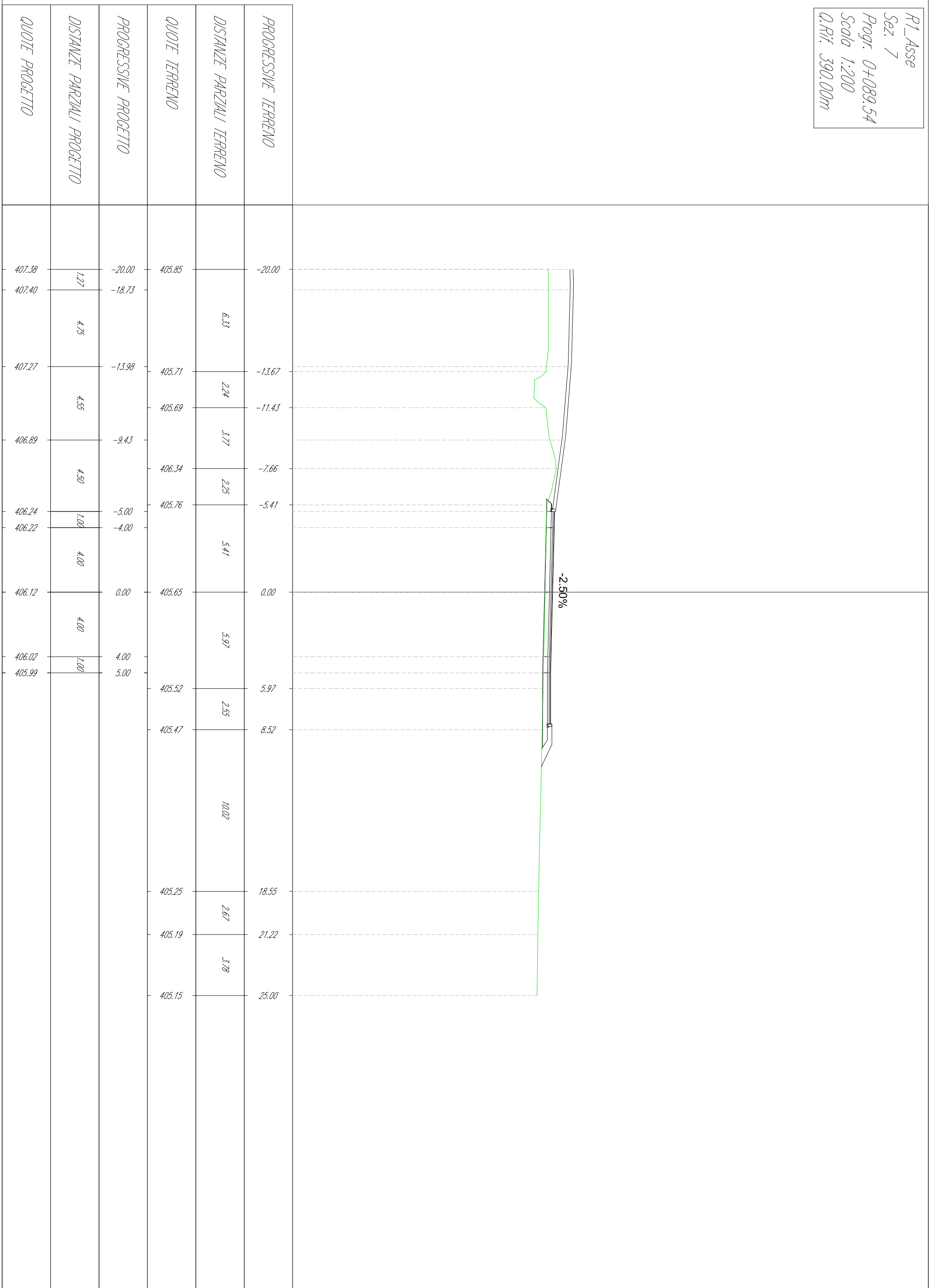

R1\_Asse  
 Sez. 8  
 Progr. 0+096.21  
 Scala 1:200  
 Q.Rif. 390.00m

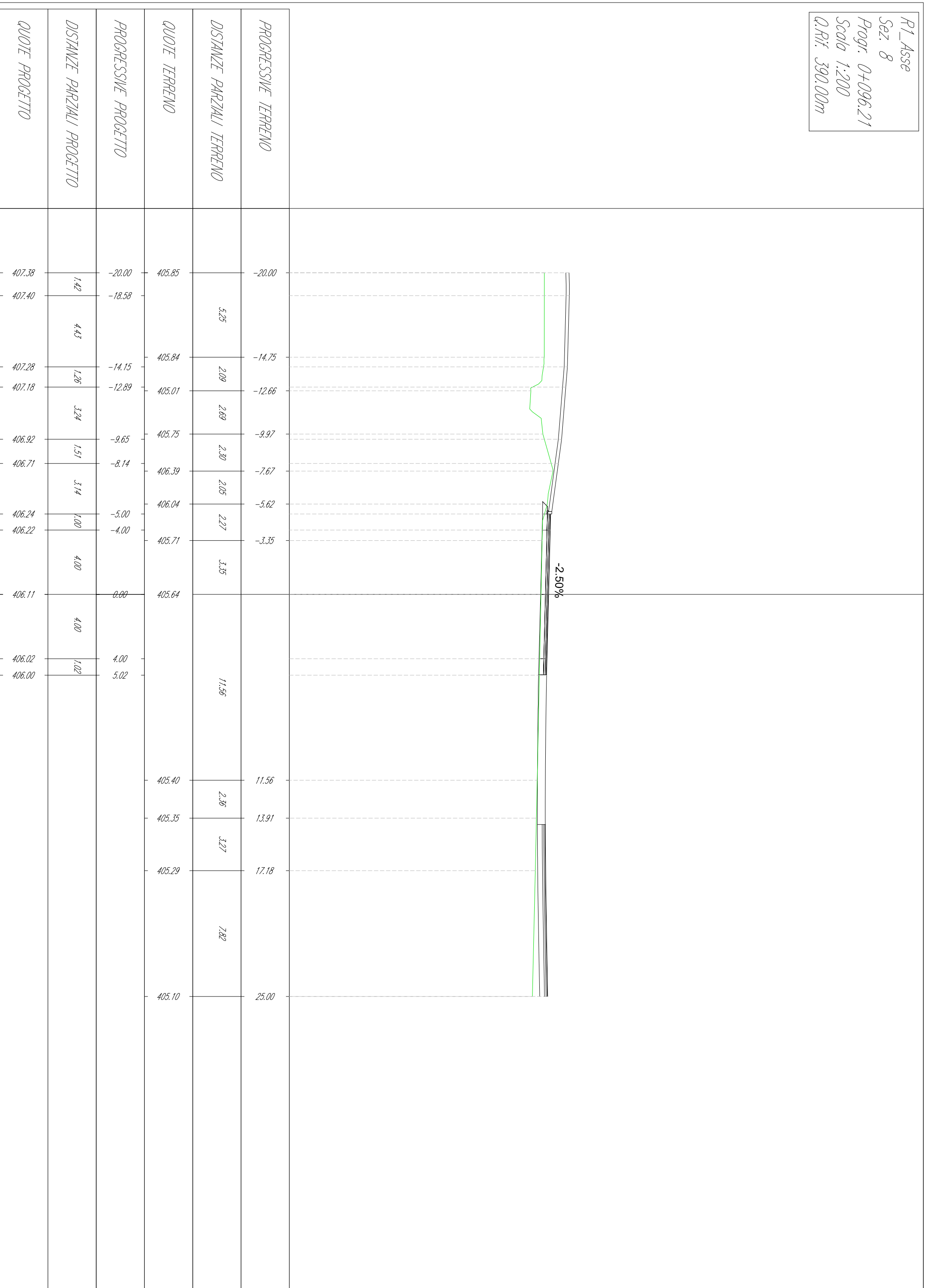

R1\_Asse  
 Sez. 9  
 Progr. 0+107.25  
 Scala 1:200  
 Q.Rif. 390.00m

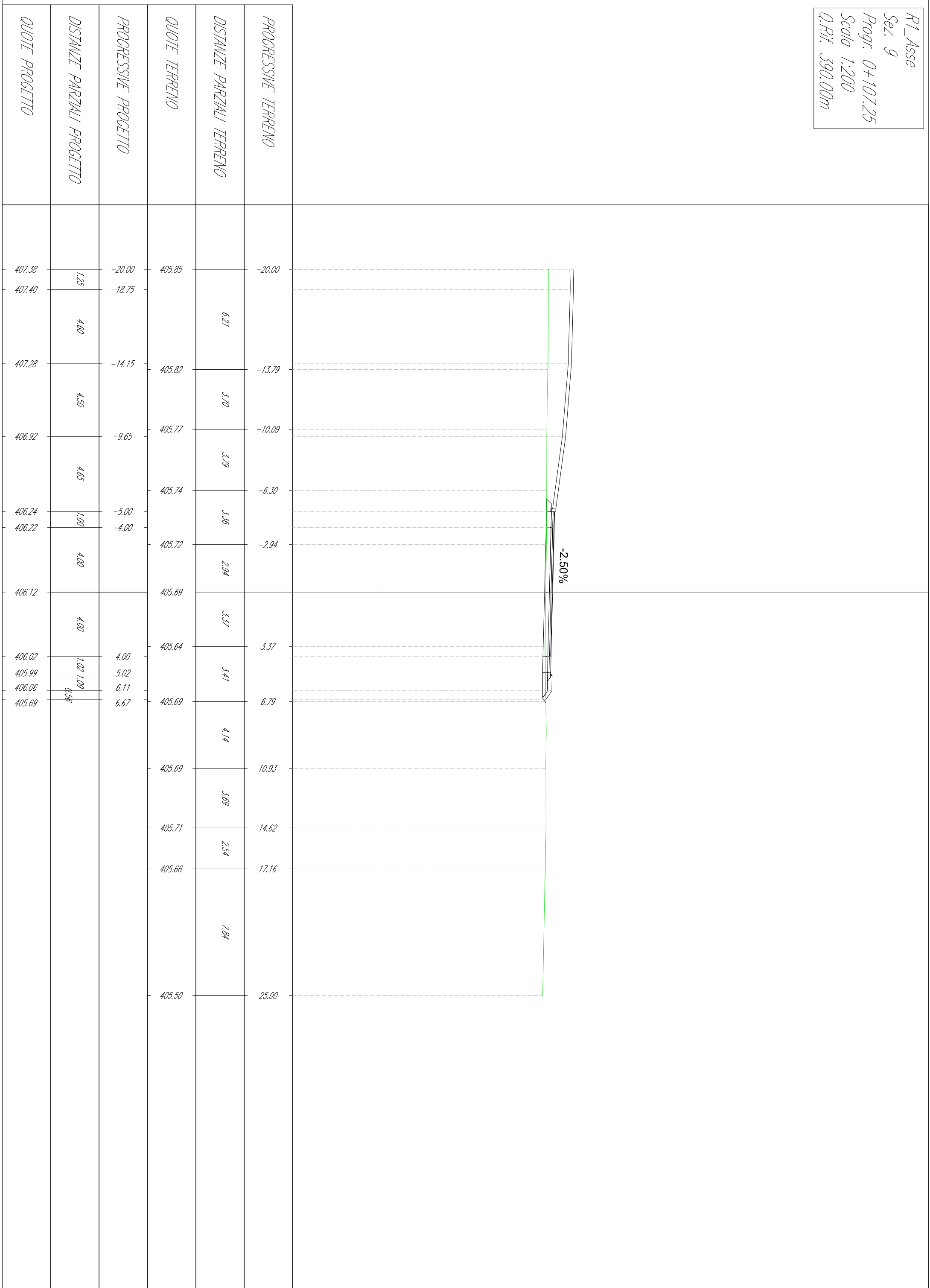

# Bretella di collegamento "R1÷R2"

## KEY PLAN

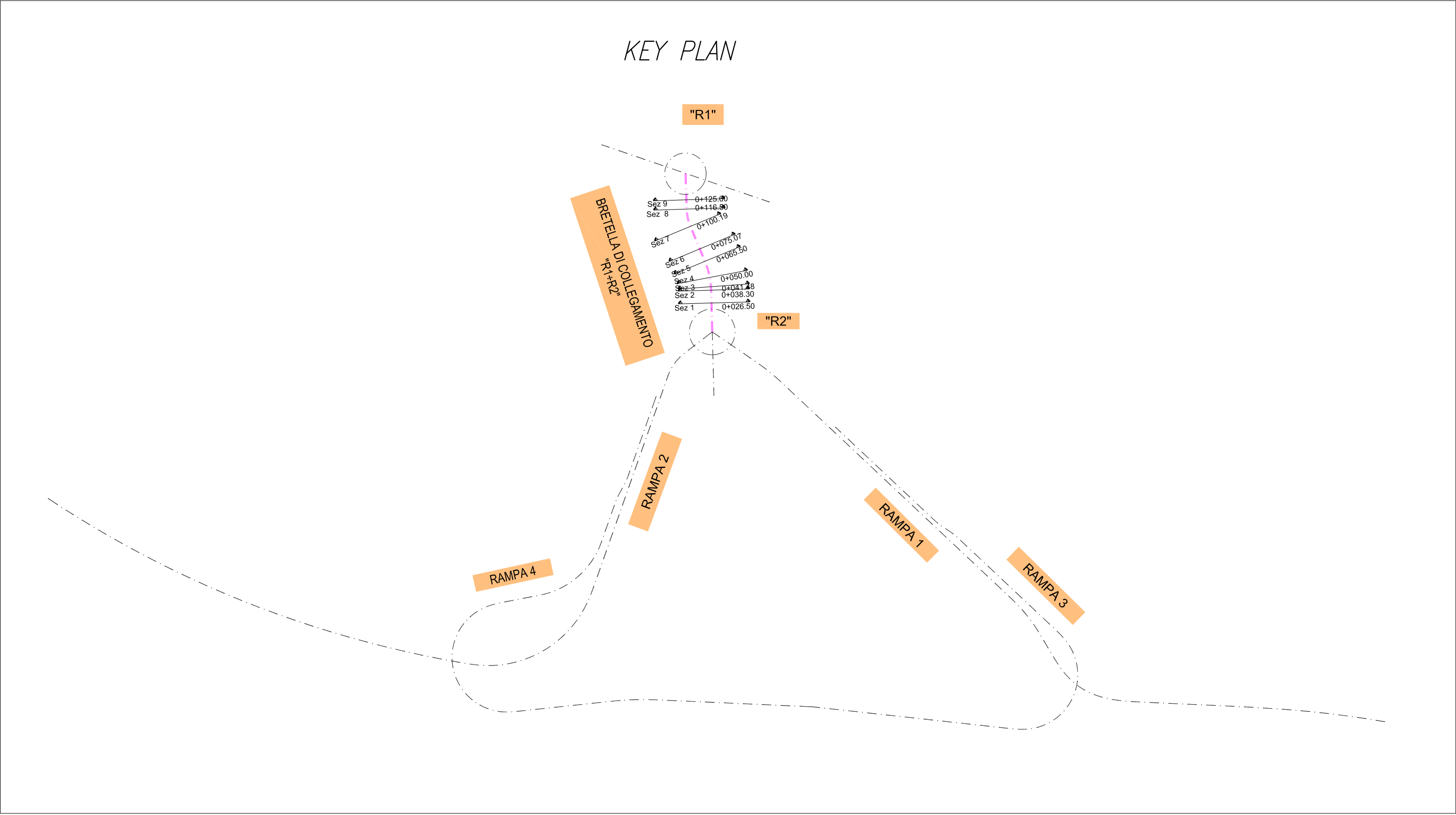

Collegamento-R1R2\_Asse  
 Sez. 1  
 Progr. 0+026.50  
 Scala 1:200  
 Q.Rif. 390.00m

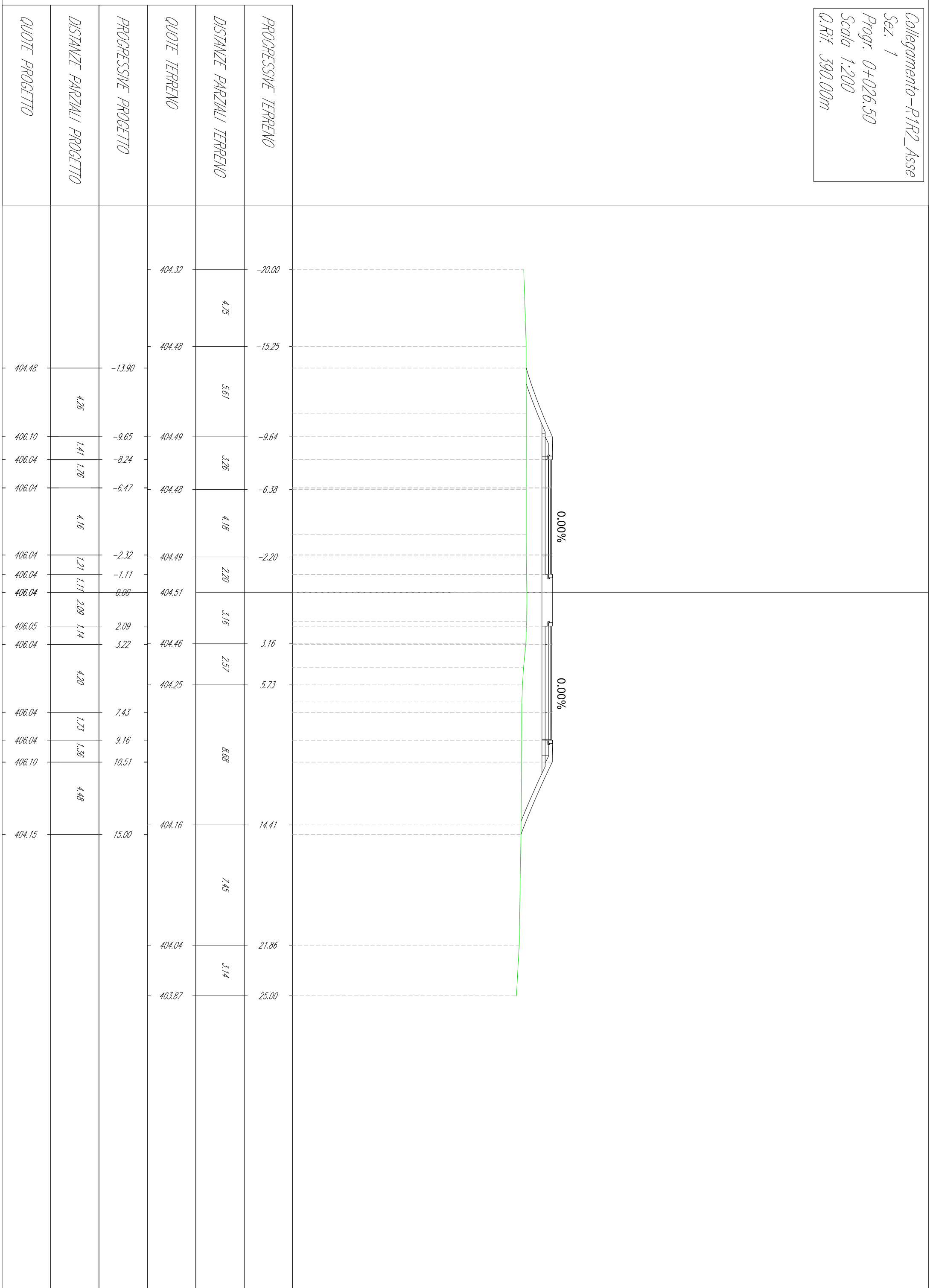

Collegamento-R1R2\_Asse  
 Sez. 2  
 Progr. 0+038.30  
 Scala 1:200  
 Q.Rif. 385.00m

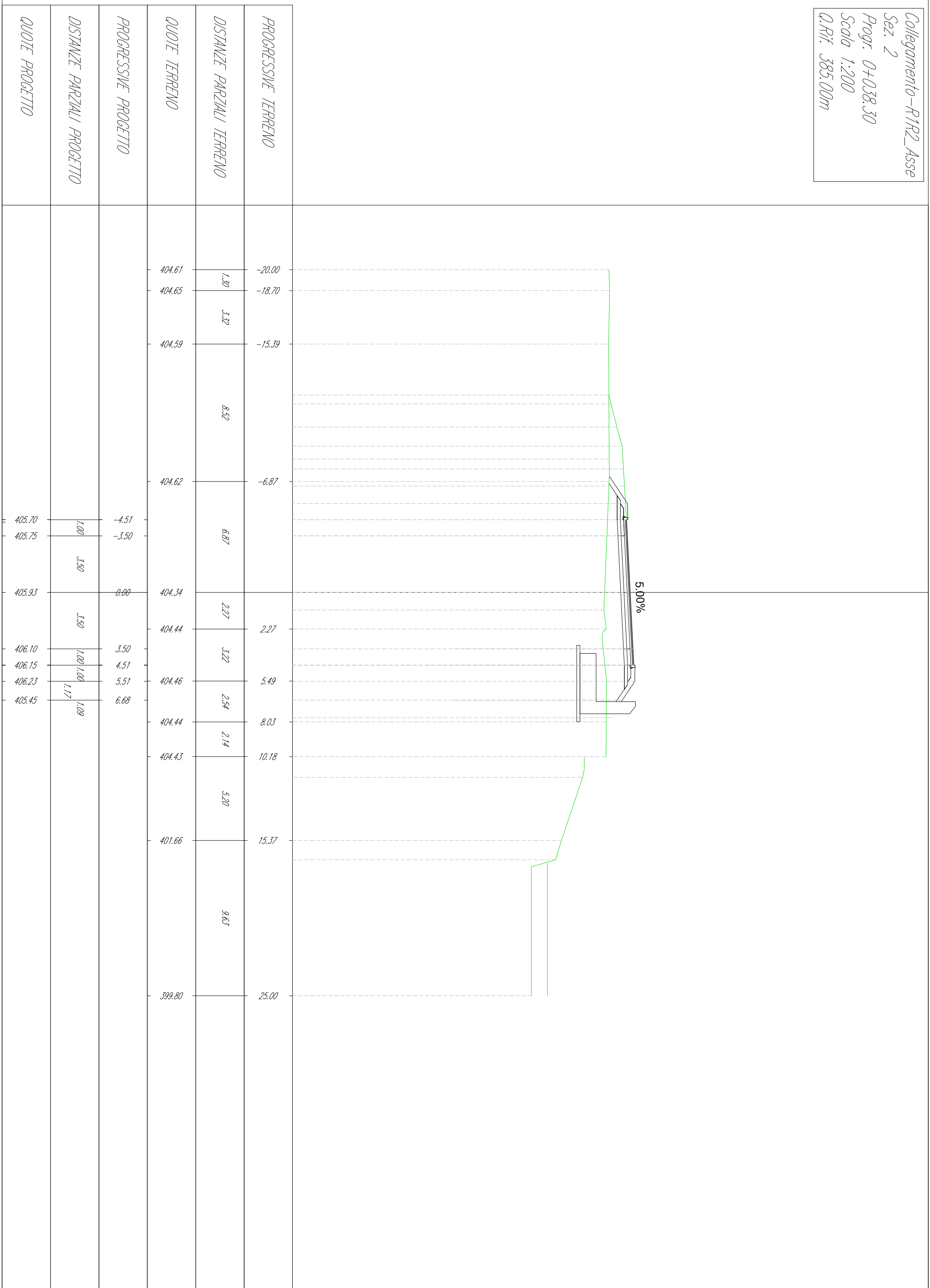

Collegamento-R1R2-Asse  
 Sez. 3  
 Progr. 0+041.48  
 Scala 1:200  
 Q.Rif. 385.00m

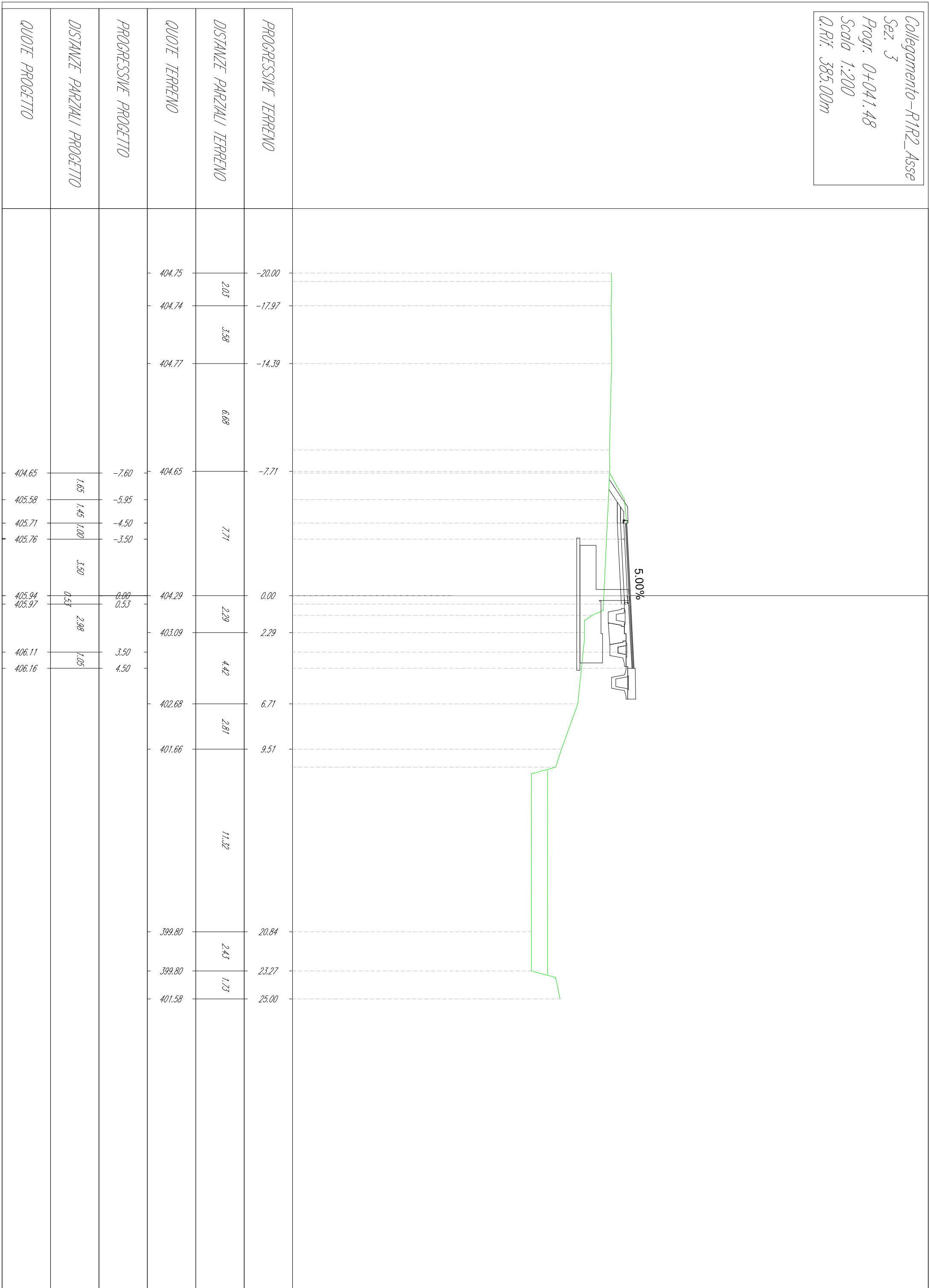



Collegamento-R1R2\_Asse  
 Sez. 4  
 Progr. 0+050.00  
 Scala 1:200  
 Q.Rif. 385.00m

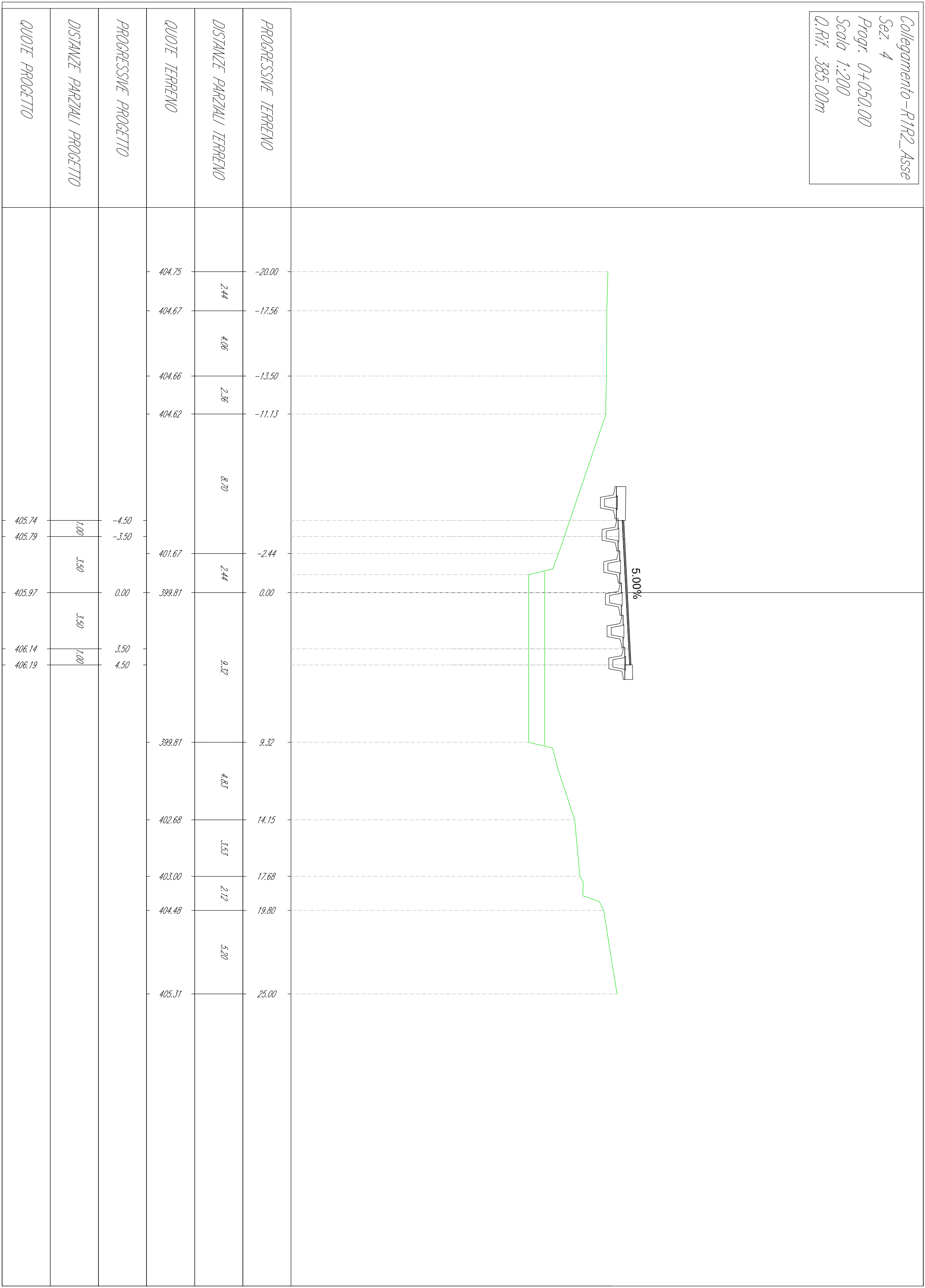

Collegamento-R1R2\_Asse  
 Sez. 5  
 Progr. 0+065.50  
 Scala 1:200  
 Q.Rif. 385.00m

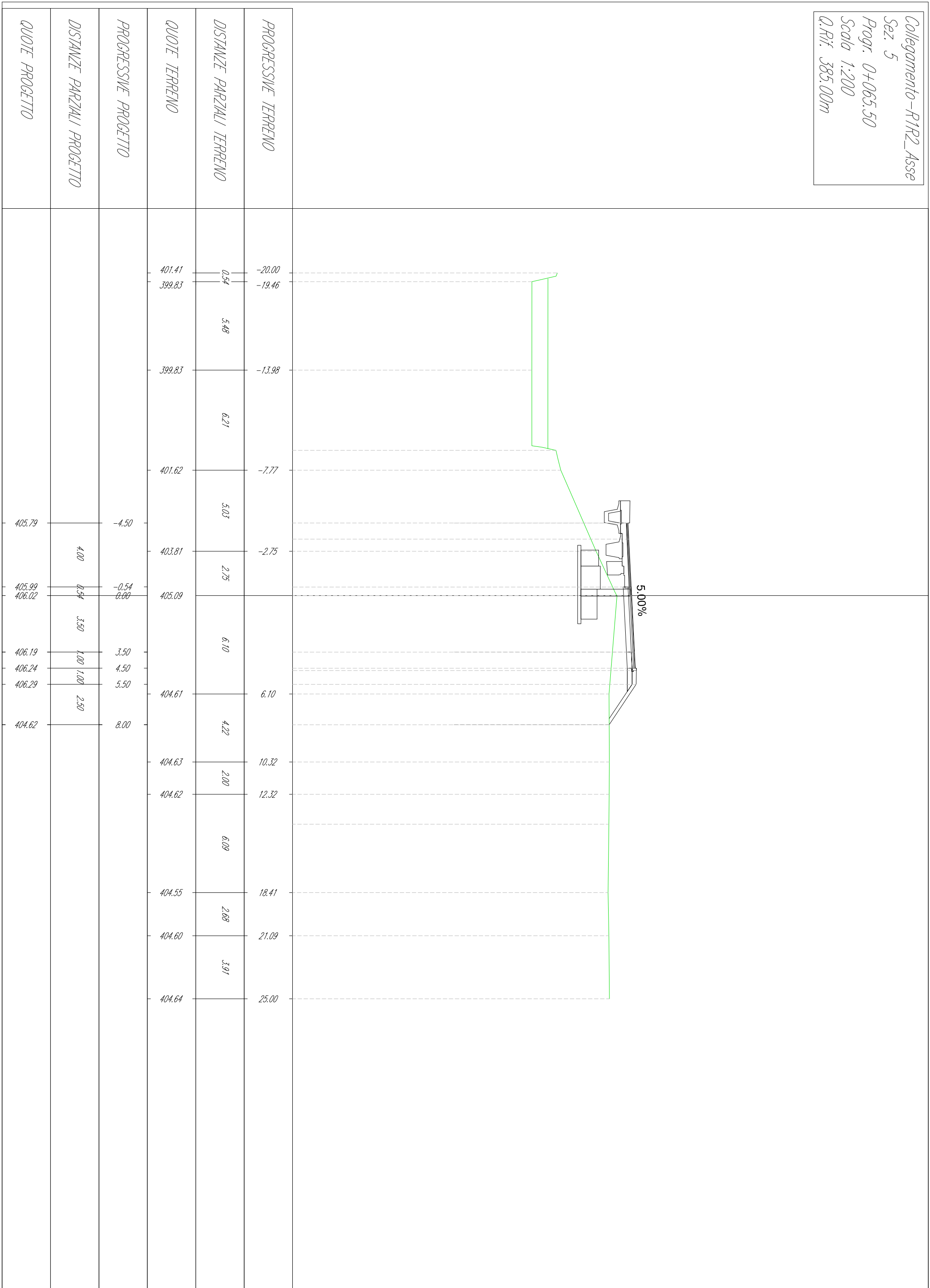

Collegamento-R1R2-Asse  
 Sez. 6  
 Progr. 0+075.07  
 Scala 1:200  
 Q.Rif. 385.00m

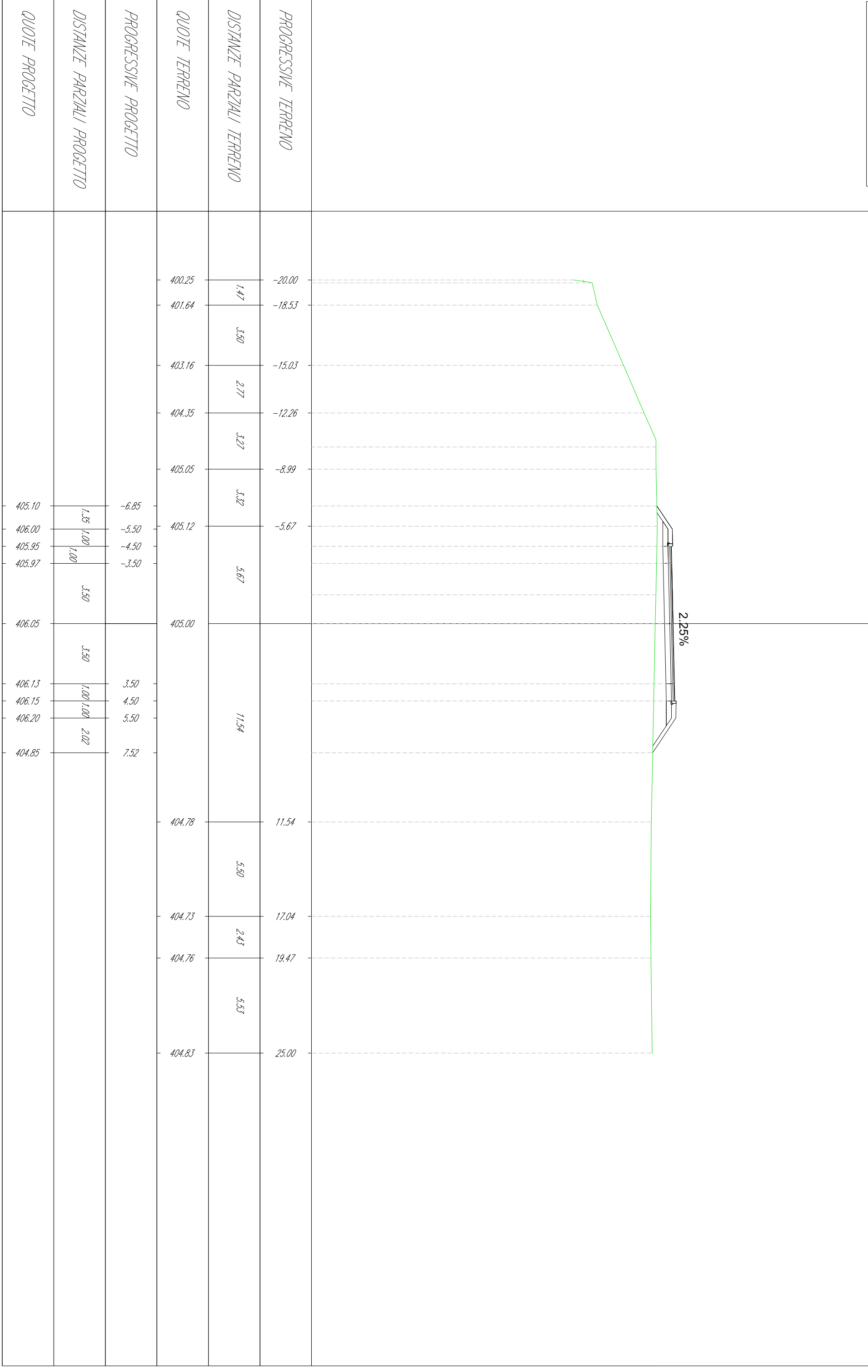

Collegamento-R1R2-Asse  
 Sez. 7  
 Progr. 0+100.19  
 Scala 1:200  
 Q.Rif. 390.00m

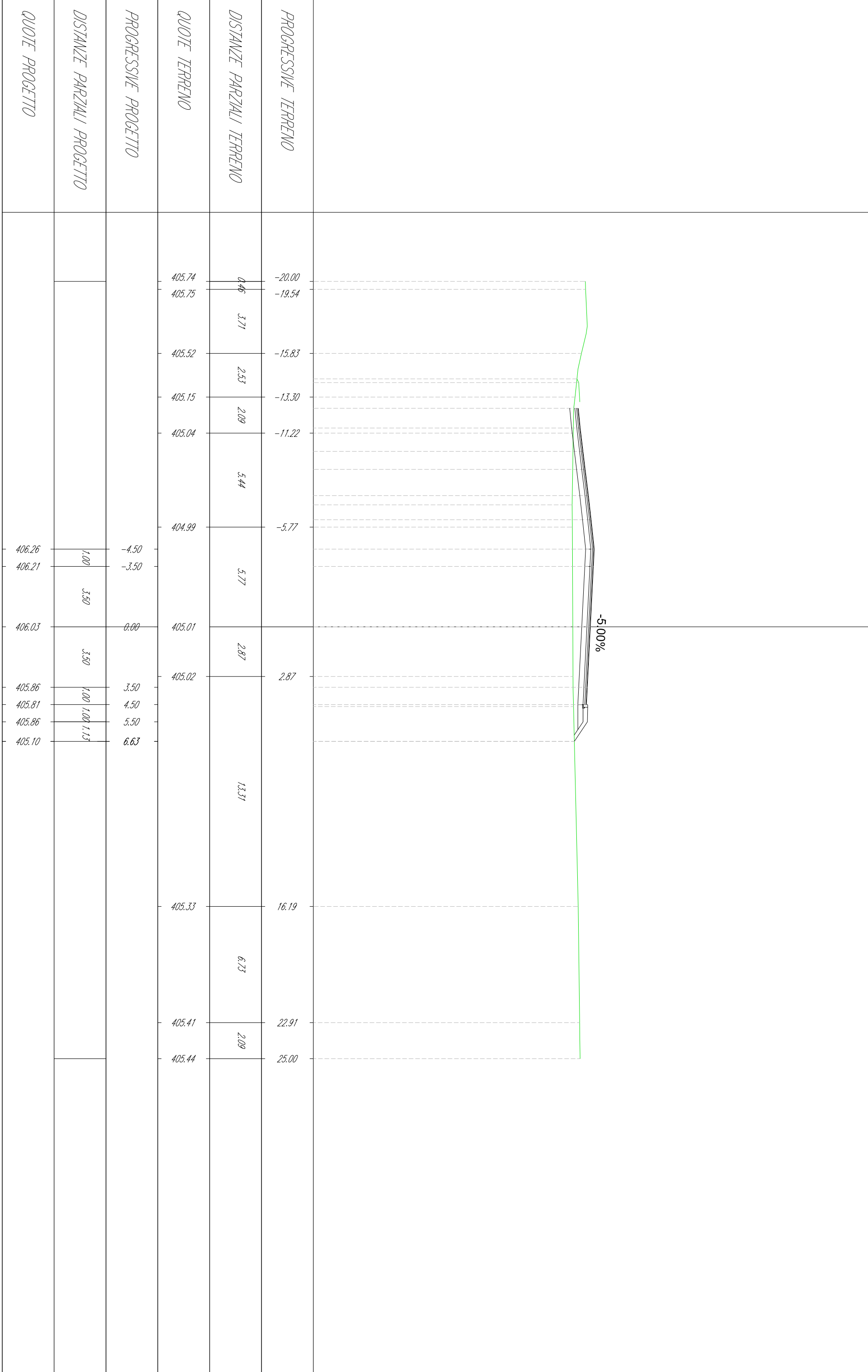

Collegamento-R1R2-Asse  
 Sez. 8  
 Progr. 0+116.50  
 Scala 1:200  
 Q.Rif. 390.00m

PROGRESSIVE TERRENO	DISTANZE PARZIALI TERRENO	QUOTE TERRENO	PROGRESSIVE PROGETTO	DISTANZE PARZIALI PROGETTO	QUOTE PROGETTO
-20.00	6.02	405.30	-9.01	1.47	405.33
-13.98	3.59	405.30	-7.54	1.02	406.29
-10.38	10.38	405.32	-6.52	1.02	406.23
			-5.50	4.16	406.19
			-1.34	0.90	405.98
			-0.84	1.13	405.96
		405.36	0.29	1.02	405.90
	2.48	405.37	0.81	3.55	405.87
2.48			4.36	1.02	405.70
			5.38	1.02	405.65
			6.40	0.43	405.71
			6.83		405.45
	12.37				
14.86	2.18	405.54			
17.04	2.89	405.59			
19.93	5.07	405.60			
25.00		405.58			

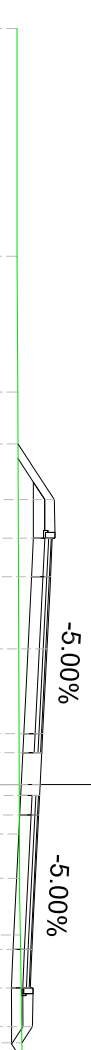



# Rotatoria di ingresso – "R2"

## KEY PLAN

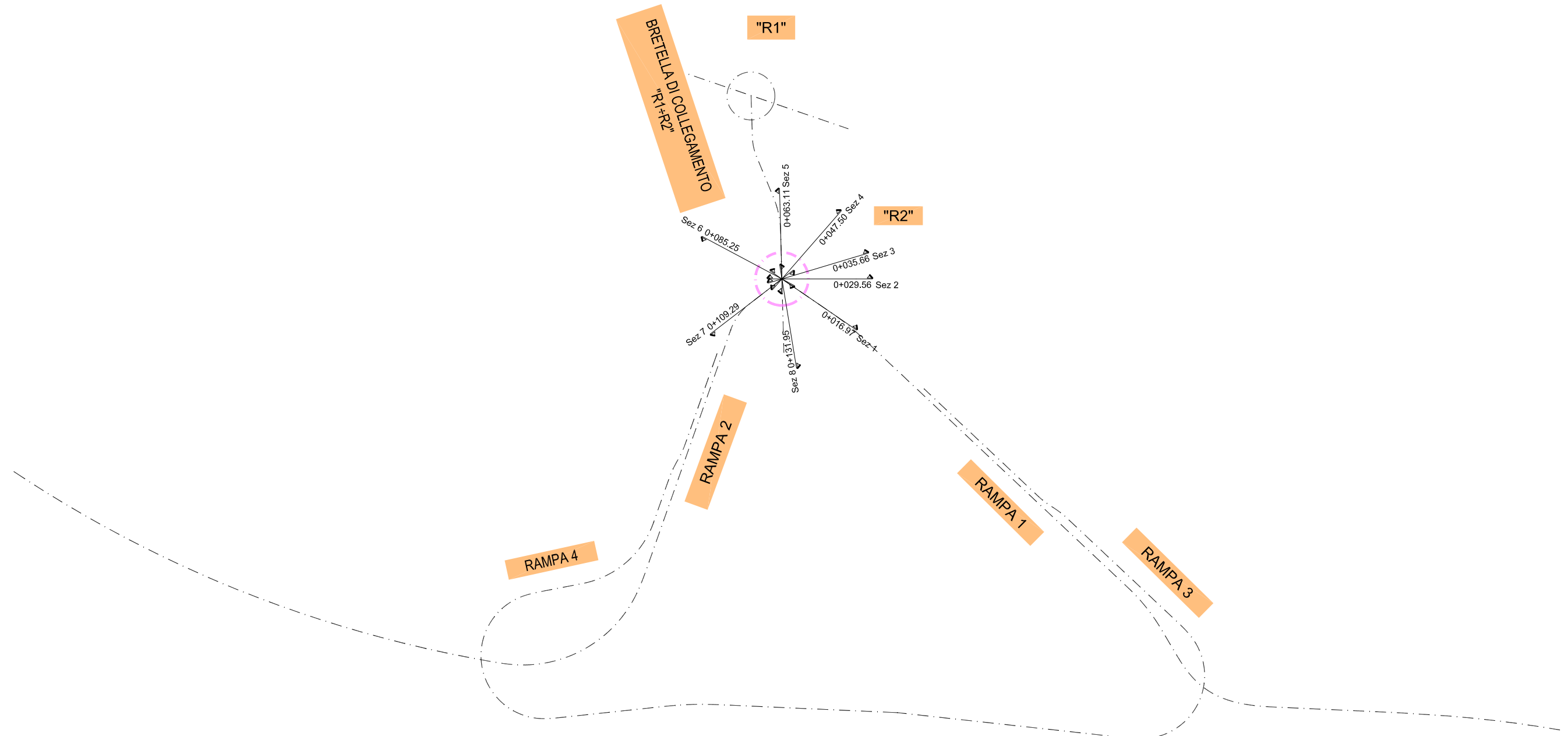

R2\_Asse  
 Sez. 1  
 Progr. 0+016.97  
 Scala 1:200  
 Q.Rif. 390.00m

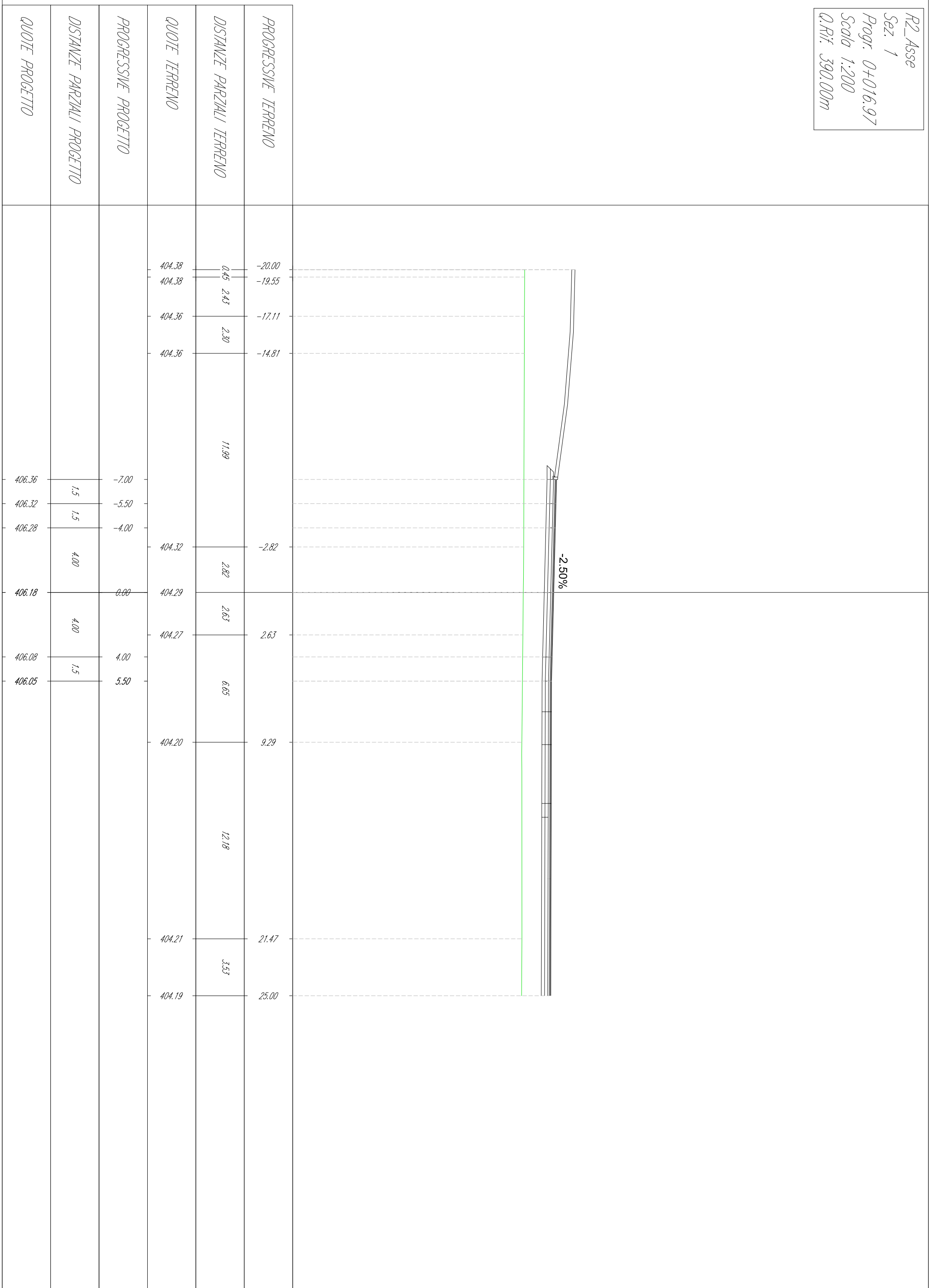



R2\_Asse  
 Sez. 2  
 Progr. 0+029.56  
 Scala 1:200  
 Q.Rif. 390.00m

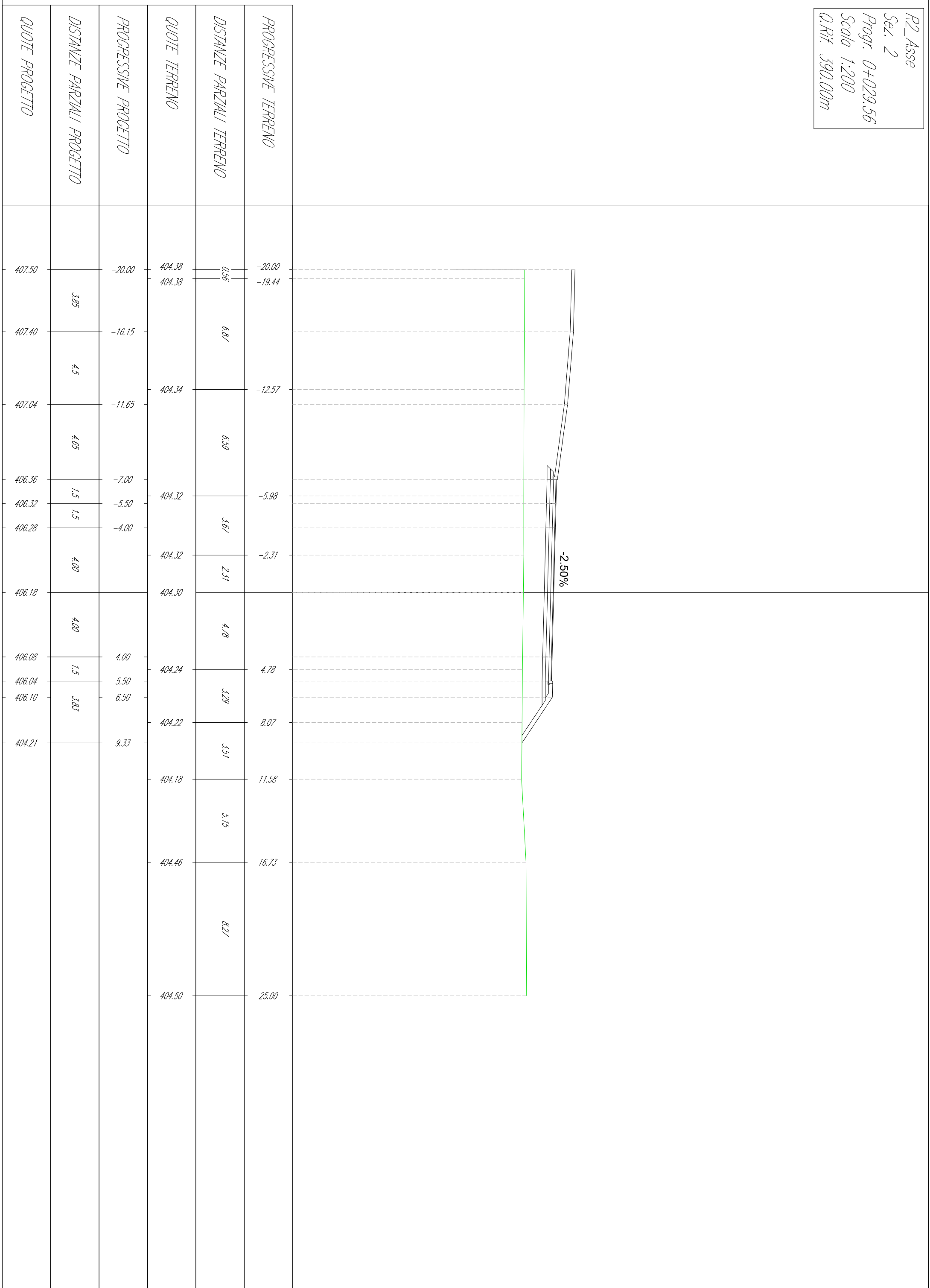

R2\_Asse  
 Sez. 3  
 Progr. 0+035.66  
 Scala 1:200  
 Q.Rif. 390.00m

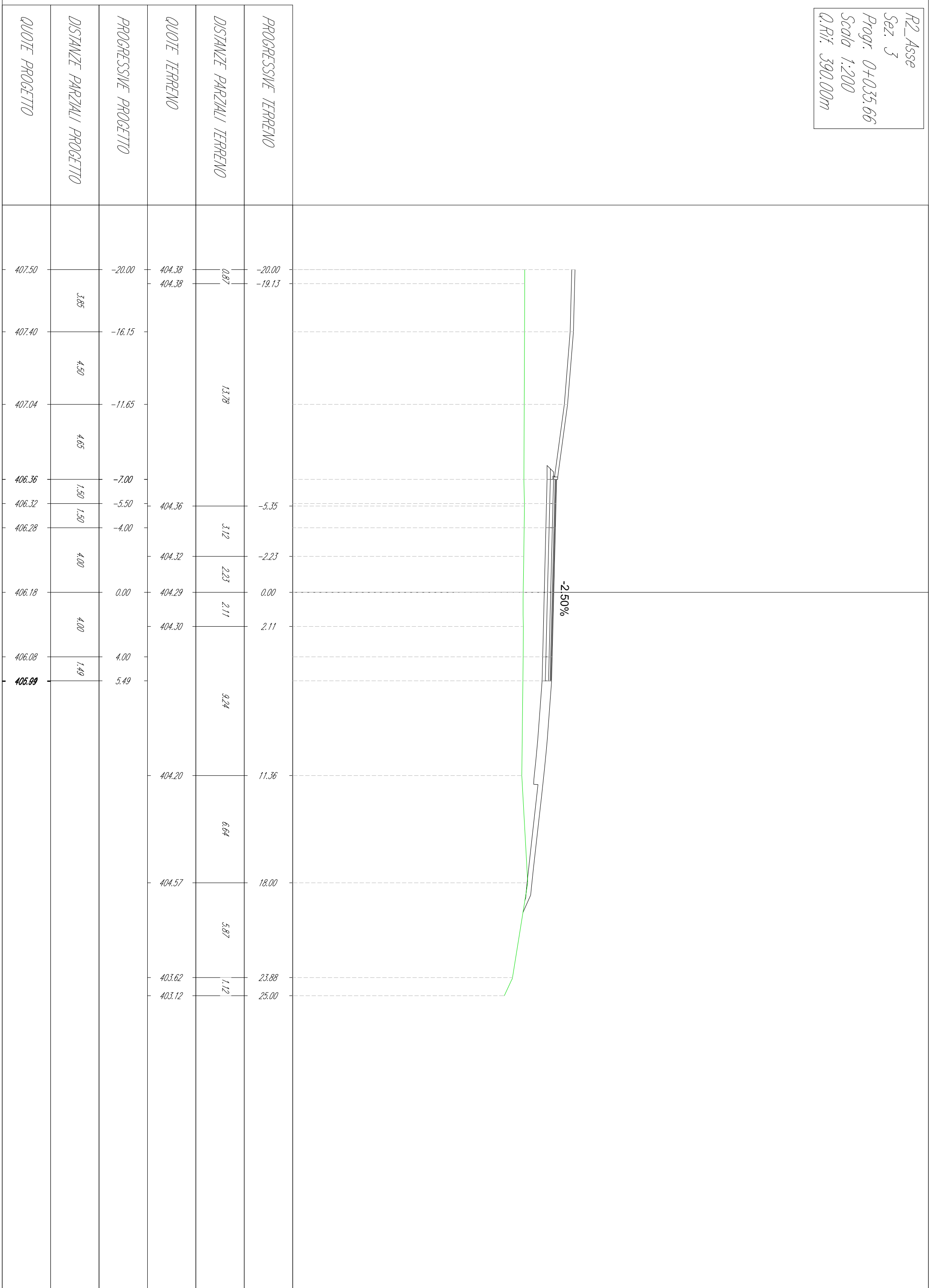

R2\_Asse  
 Sez. 4  
 Progr. 0+047.50  
 Scala 1:200  
 Q.Rif. 385.00m

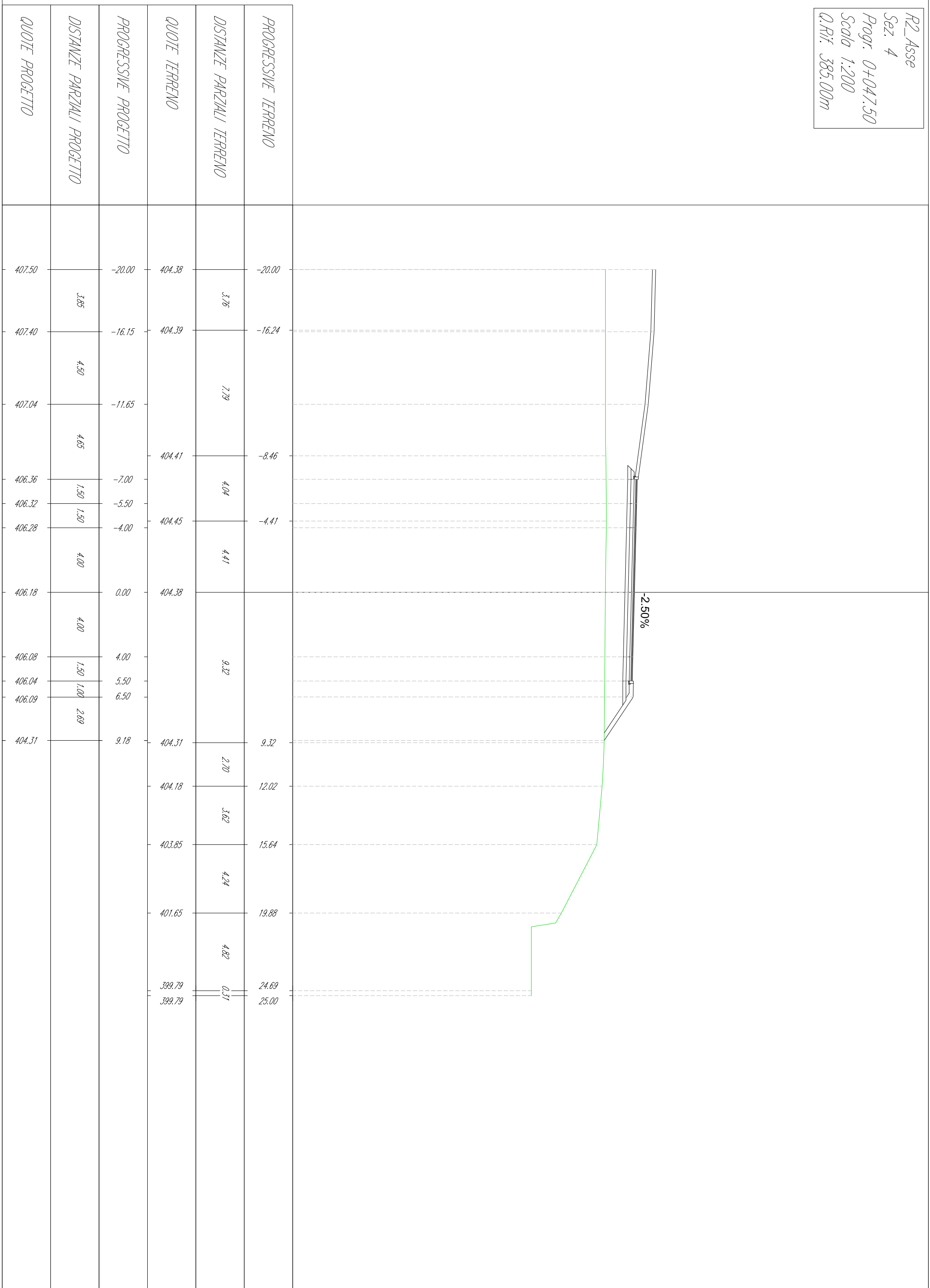

R2\_Asse  
 Sez. 5  
 Progr. 0+063.11  
 Scala 1:200  
 Q.Rif. 390.00m

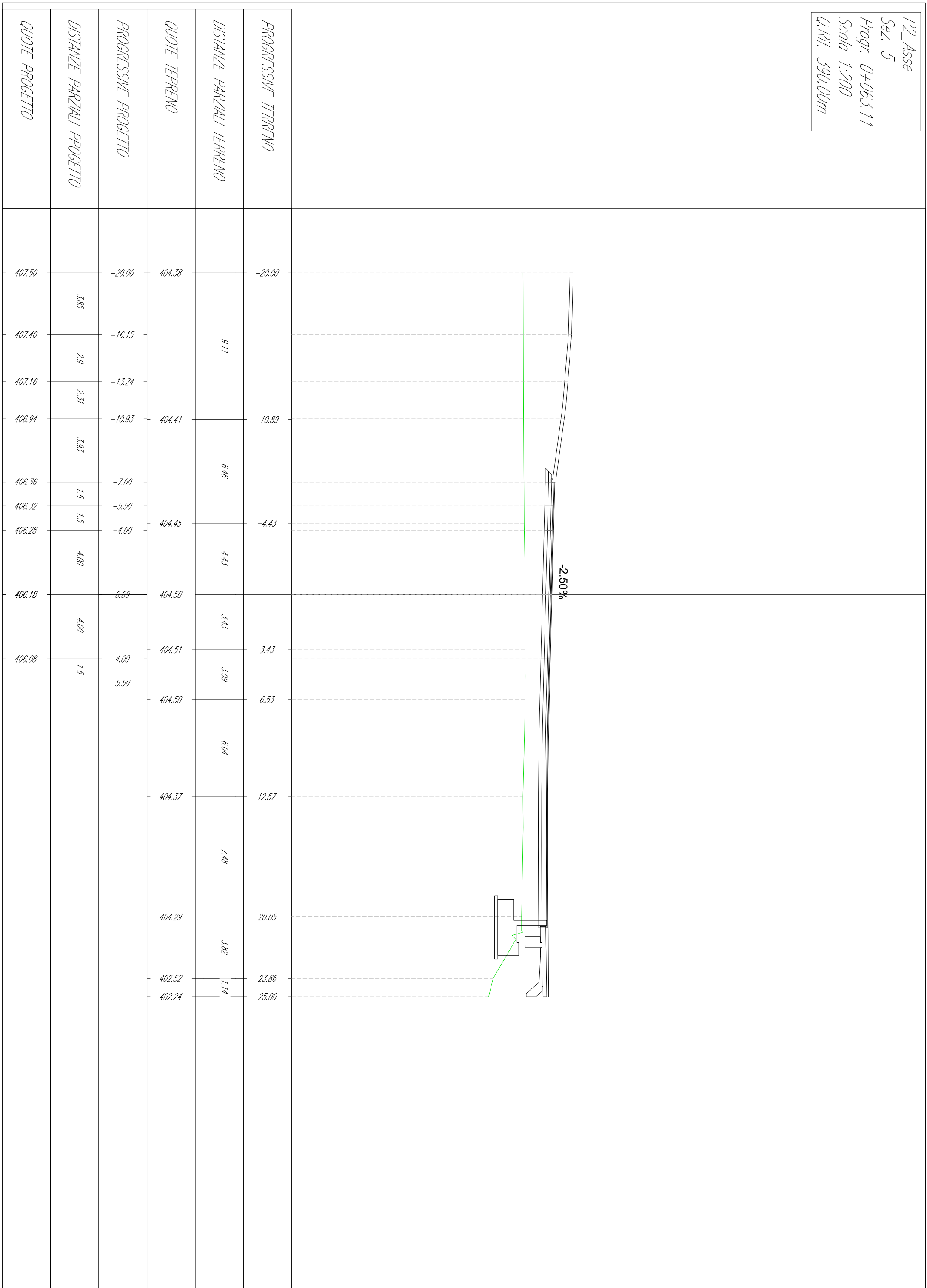

R2\_Asse  
 Sez. 6  
 Progr. 0+085.25  
 Scala 1:200  
 Q.Rif. 390.00m

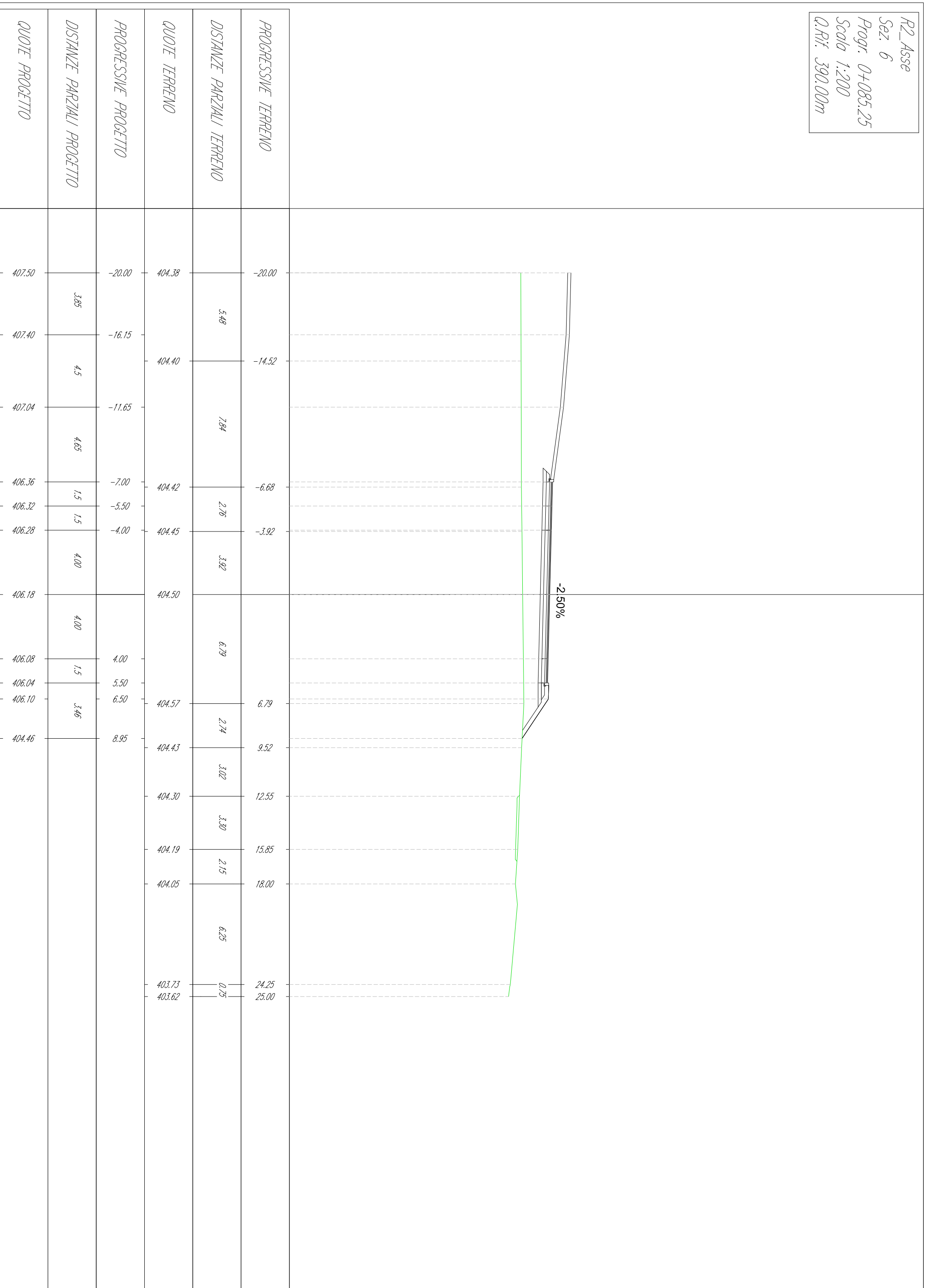

R2\_Asse  
 Sez. 7  
 Progr. 0+109.29  
 Scala 1:200  
 Q.Rif. 390.00m

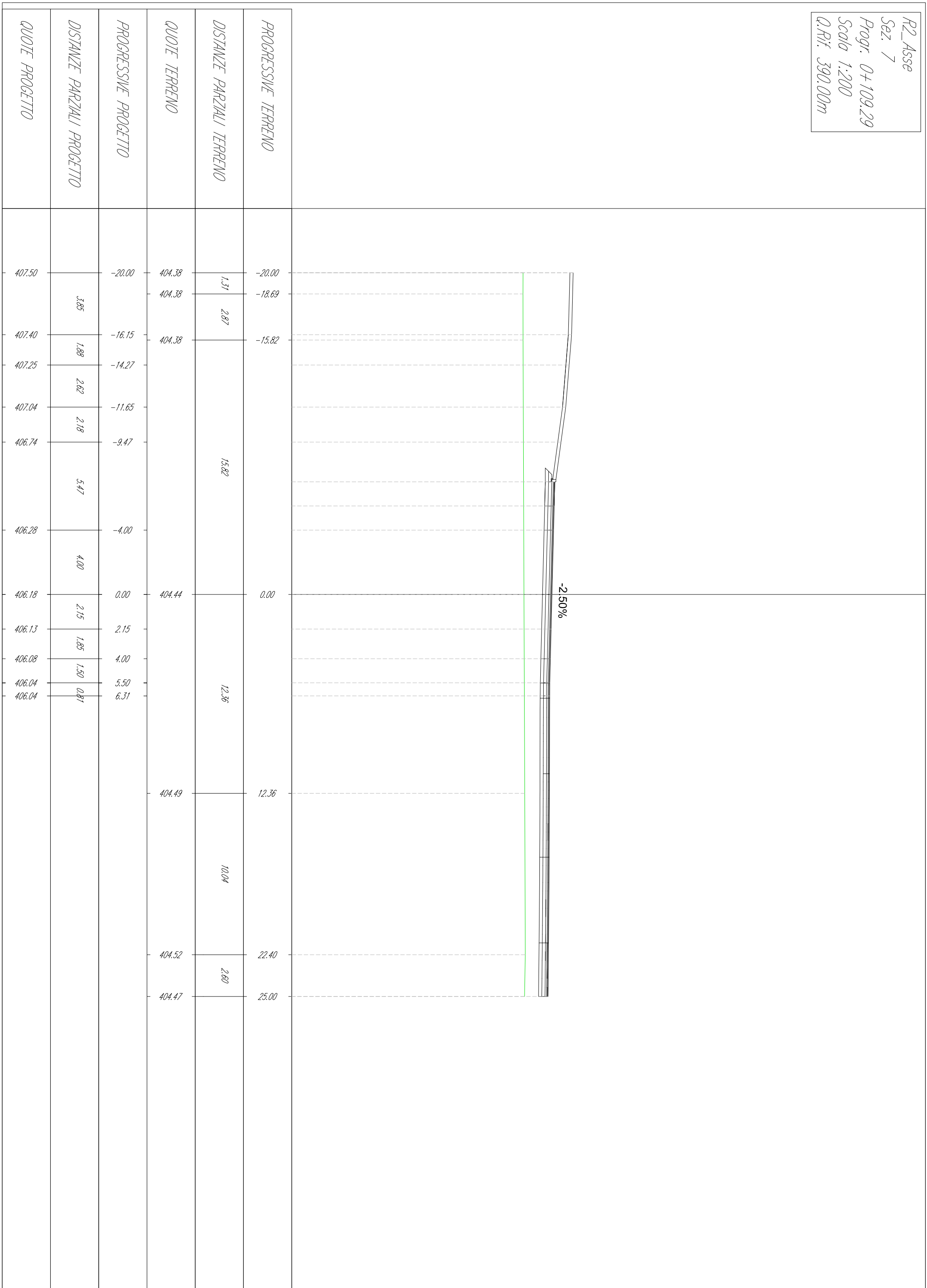

R2\_Asse  
 Sez. 8  
 Progr. 0+131.95  
 Scala 1:200  
 Q.Rif. 390.00m

