

LEGENDA

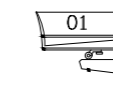

Telecamera con custodia da esterno



Illuminatore ad infrarossi

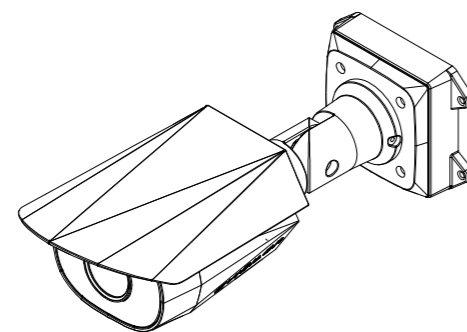
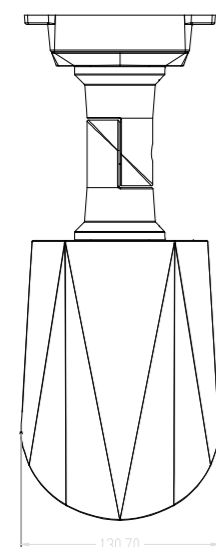
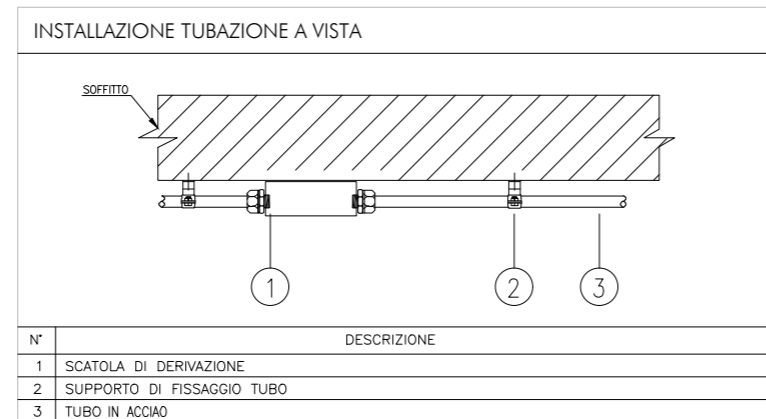

GRADO DI PROTEZIONE: IP66
DIMENSIONI ESPRESSE IN MM

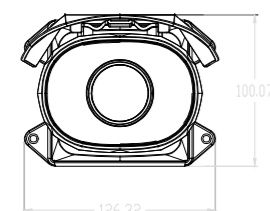

INSTALLAZIONE DI TELECAMERA DA ESTERNO

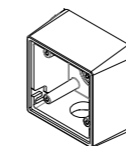
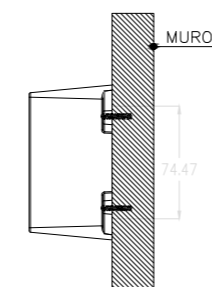
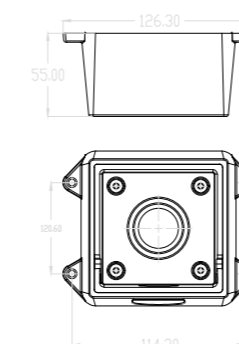
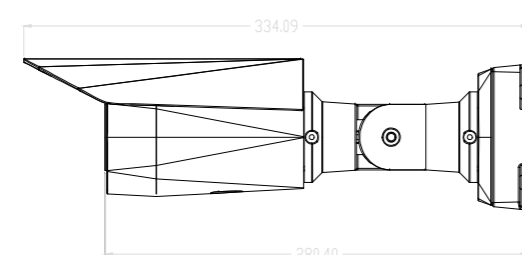

SUPPORTO PER AGGANCIO A PARETE

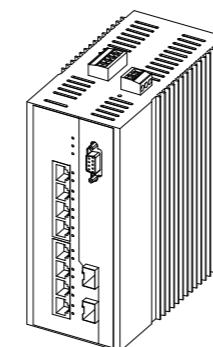
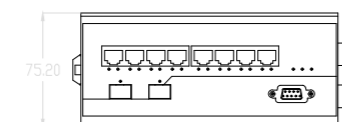
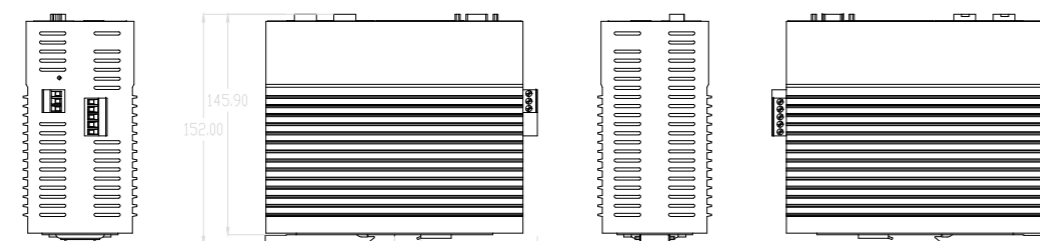

SWITCH 8 porte PoE + 2 SPF

COMMITTENTE:



DIREZIONE LAVORI:



APPALTATORE:



PROGETTAZIONE:



PROGETTO ESECUTIVO

LINEA BARI-LECCE - RIASSETTO NODO DI BARI

TRATTA A SUD DI BARI

VARIANTE DI TRACCIATO TRA BARI C.LE E BARI TORRE A MARE

SL01 - SOTTOVIA DELLA VIABILITA' DI ACCESSO ALLA STAZIONE EXECUTIVE

IMPIANTO TVCC

PARTICOLARI DI INSTALLAZIONE SOTTOVIA

APPALTATORE	PROGETTAZIONE	SCALA:
D'Agostino Angelo Antonio Costruzioni Generali s.r.l.	DIRETTORE DELLA PROGETTAZIONE Ing. MARCO RASIMELLI	FUORI SCALA

COMMESSA LOTTO FASE ENTE TIPO DOC. OPERA/DISCIPLINA Progr. REV.

IA3S 01 V ZZ BX AN0302 003 A

Revis.	Descrizione	Redatto	Data	Verificato	Data	Approvato	Data	Autorizzato Data
A	Revisione IA3S-RV-000000299	D. Salzillo	28/12/2021	P. Fusco	30/12/2021	M. Rasimelli	03/01/2022	

File: IA3S01VZZBXAN0302003A.DWG

n. Elab.: