



COD. SAMBU.CZ.IT.SIA.09.PRCIV.00.

**ENERGIA LEVANTE S.R.L.**



FILE TIPO R

## PROCEDURA DI VALUTAZIONE IMPATTO AMBIENTALE

### PROGETTO DEFINITIVO

**IMPIANTO EOLICO "SAMBUCELLO" DI POTENZA 50 MW DA REALIZZARE NEL TERRITORIO DEI COMUNI DI MARCELLINARA, MAIDA E CARAFFA DI CATANZARO IN PROVNCIA DI CATANZARO**



Titolo Elaborato:

**LAYOUT PARCO EOLICO: SEZIONI DI PROGETTO ASSE 4**

Formato

Scala

**A3**

**1:200**

Codice Elaborato:

Identificativo	Provincia	Nazione	Procedura	Settore	Tipo Elaborato	Revisione	Numero Progressivo
<b>SAMBU.</b>	<b>CZ.</b>	<b>IT.</b>	<b>SIA.</b>	<b>09.</b>	<b>PRCIV.</b>	<b>00.</b>	<b>50</b>

Committente:

**ENERGIA LEVANTE S.R.L.**



Via L. Gaurico n°9/11 - Regus Eur - 4° piano - 00143 Roma (Italia)  
P.IVA 10240591007 - REA RM1219825 - Tel. (+39) 0654832107  
E\_Mail: sserenewables.com - PEC: energialevantesrl@legalmail.it

Progettazione:



via Don Minzoni 95 87036 Rende (CS)  
Pec: e.cosrl@legalmail.it

Codice Progetto

N° Revisione

Data revisione

Redazione Interna

Redazione Esterna

CZ\_22\_03/AU-VIA

00

luglio 2023

E.co Srl

No

PROFILO Asse4

SEZIONE 1

PROGRESSIVA 0.00

A STERRO m<sup>2</sup> 5.39

70

200  
200

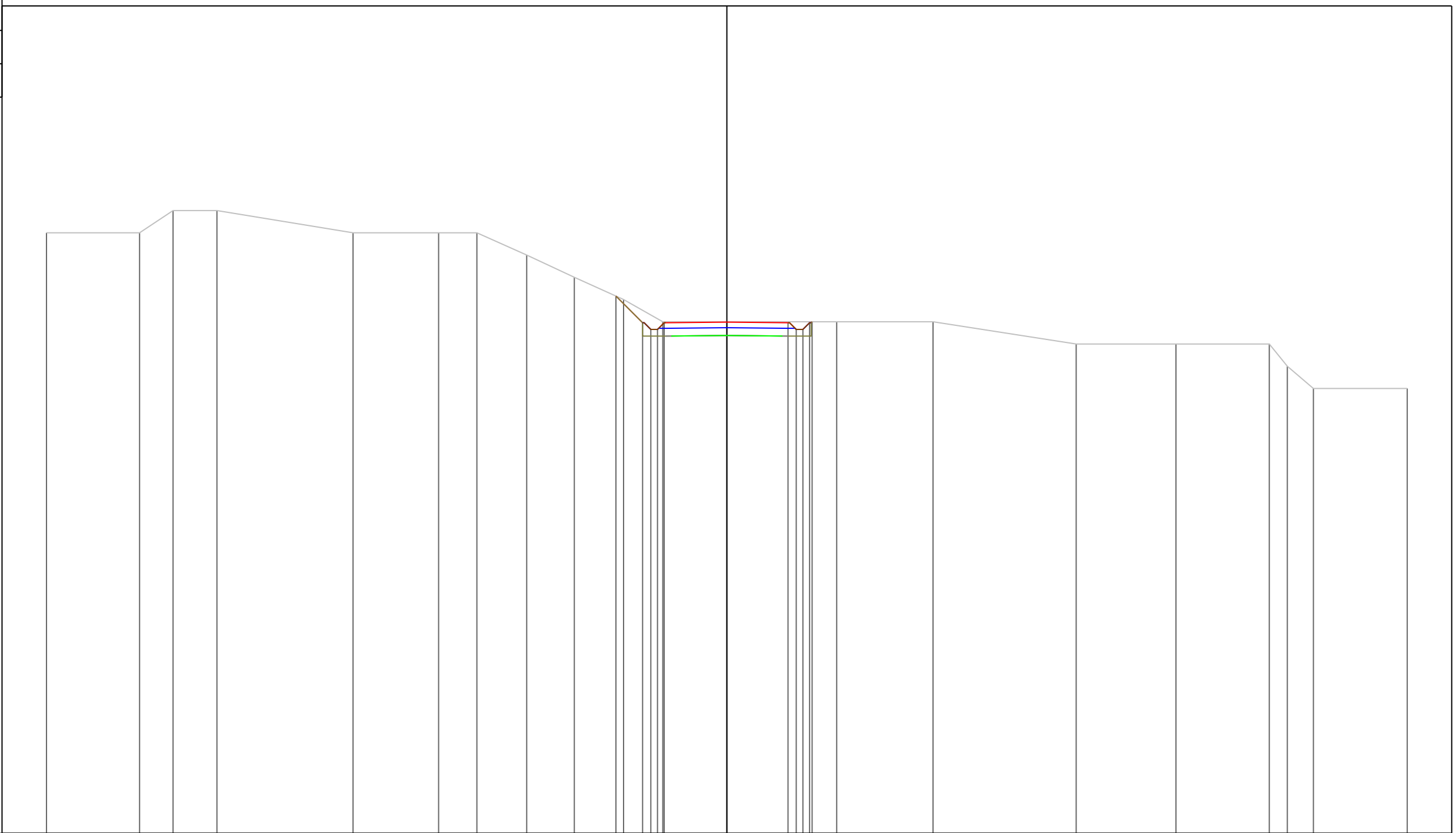

PROGRESSIVE TERRENO	-30.60	-26.41	-24.91	-22.93		-16.81		-12.96	-11.24	-9.00	-6.86	-4.65	-2.88		4.94	9.27		15.71	20.20		24.40	25.21	26.38	30.60
PARZIALI TERRENO		4.19	1.50	1.98	6.12	3.85	1.72	2.24	2.14	2.21	1.77	7.82	4.33	6.44	4.49	4.20	0.81	1.17	4.22					
QUOTE TERRENO	97.00	97.00	98.00	98.00	97.00	97.00	97.00	96.00	95.00	94.00	93.00	93.00	93.00	93.00	93.00	92.00	92.00	92.00	92.00	92.00	92.00	91.00	90.00	90.00
PROGRESSIVE PROGETTO												-4.99	-3.79	-3.42	-3.12	-2.82	0.00	2.75	3.12	3.42	3.72	3.83		
PARZIALI PROGETTO												1.20	0.37	0.30	0.30	2.82	2.75	0.37	0.30	0.30	0.30	0.11		
QUOTE PROGETTO										94.16	92.96	92.66	92.66	92.96	92.98	92.96	92.66	92.66	92.96	93.00				

PROFILO Asse4

SEZIONE 2

PROGRESSIVA 10.00

A STERRO m<sup>2</sup> 4.56  
 B RIPORTO m<sup>2</sup> 0.59

70

200  
 200

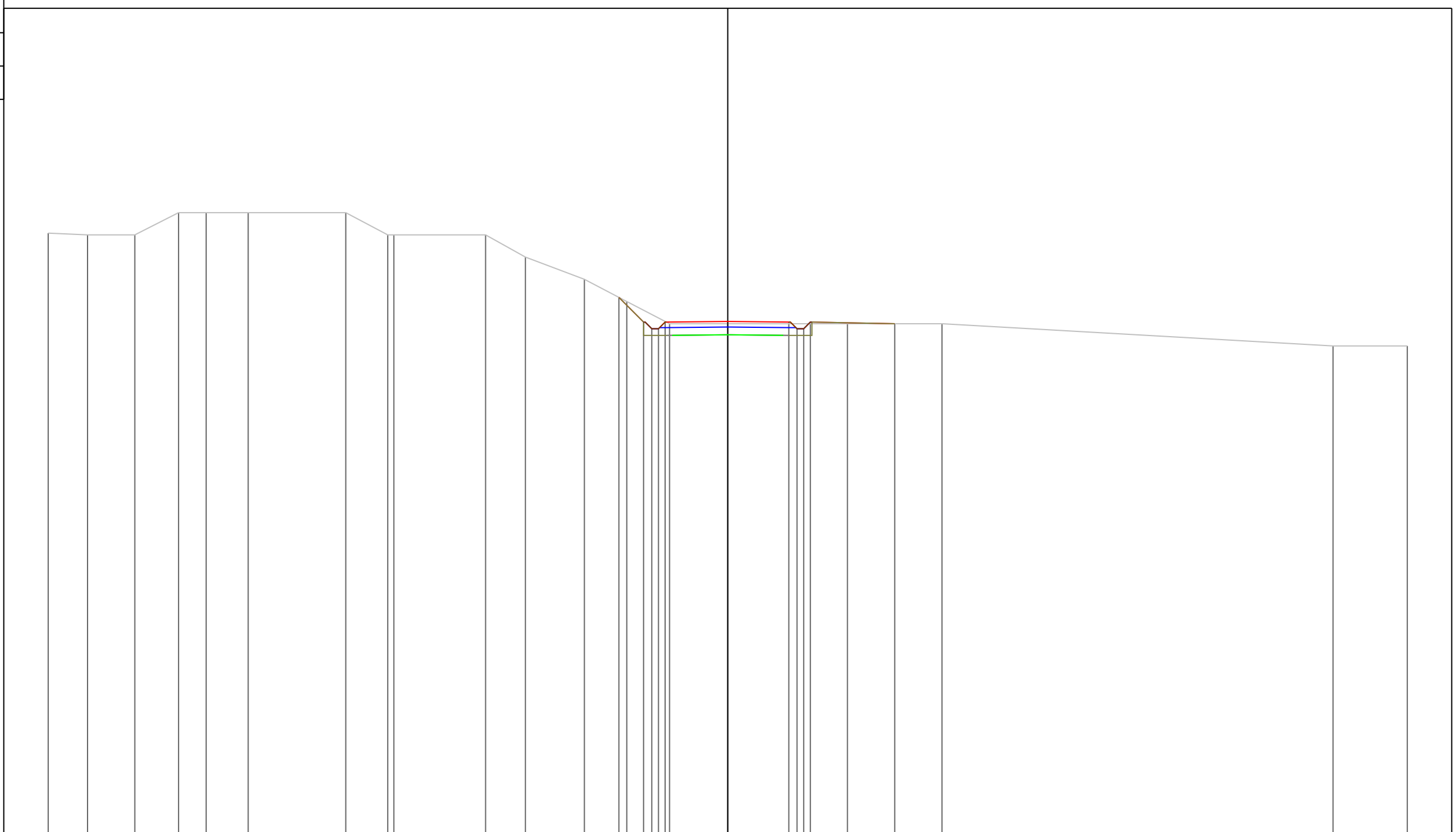

PROGRESSIVE TERRENO	-30.60	-28.83	-26.70	-24.73	-23.49	-21.59		-17.20	-15.31	-15.03		-10.90	-9.11	-6.46	-4.55	-2.62		5.39	9.65		27.26	30.60	
PARZIALI TERRENO		1.77	2.13	1.97	1.24	1.90	4.39	1.89	0.28	4.13	1.79	2.65	1.91	1.93	8.01	4.26		17.61			3.34		
QUOTE TERRENO	97.08	97.00	97.00	98.00	98.00	98.00	98.00	97.00	97.00	97.00	96.00	95.00	94.00	93.00	93.00	93.00	93.00	93.00	93.00	92.00	92.00		
PROGRESSIVE PROGETTO															-4.90	-3.79	-3.42	-3.12	-2.82	0.00			
PARZIALI PROGETTO															1.11	0.37	0.30	0.30	2.82	2.75	0.37	0.30	0.30
QUOTE PROGETTO															94.19	93.07	92.77	92.77	93.07	93.10	93.07	92.77	93.07

PROFILO Asse4  
 SEZIONE 3  
 PROGRESSIVA 20.00  
 A STERRO m<sup>2</sup> 2.87  
 B RIPORTO m<sup>2</sup> 1.97

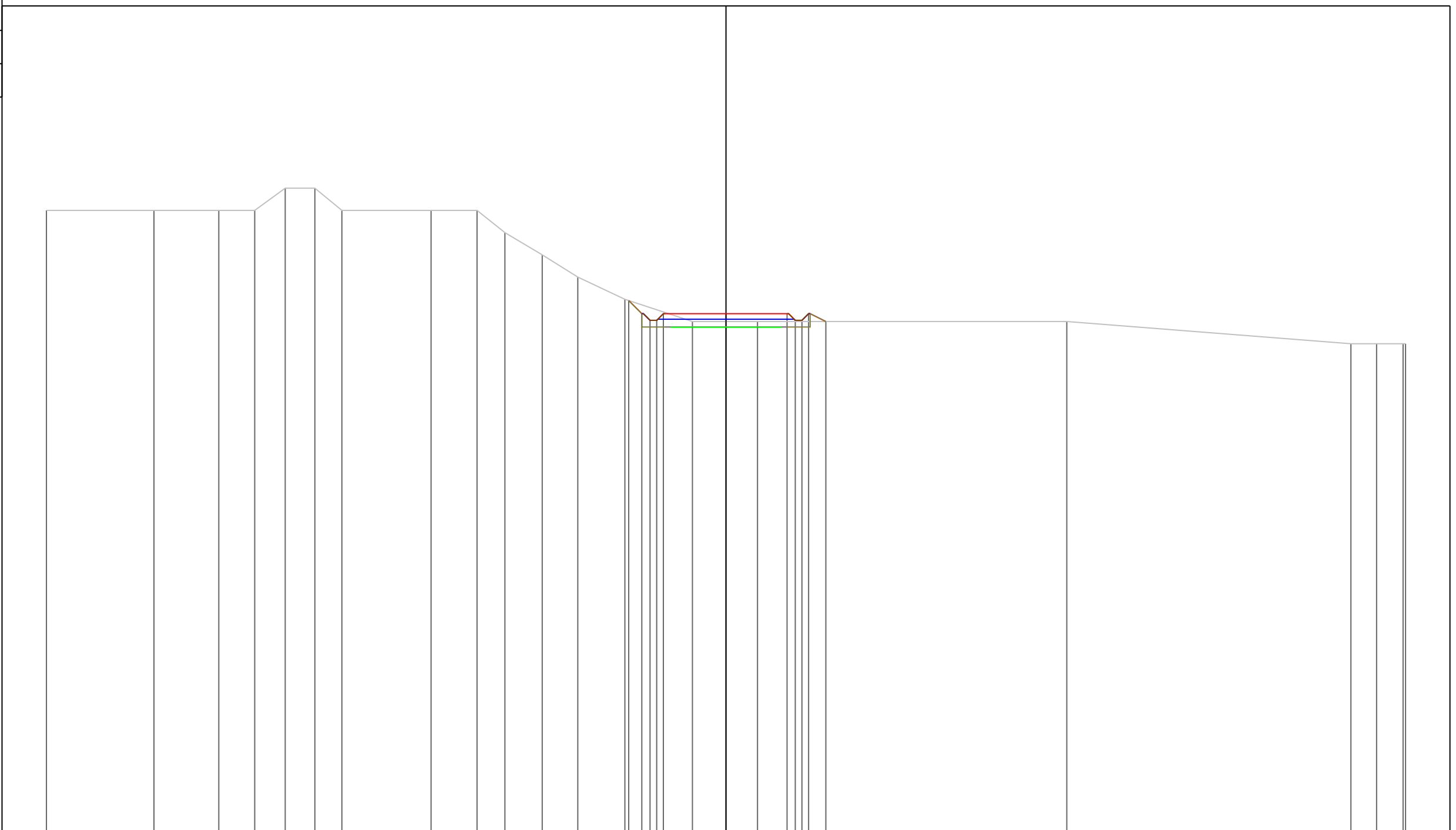

PROGRESSIVE TERRENO	-30.60	-25.76	-22.84	-21.22	-19.85	-18.51	-17.30		-13.28	-11.21	-9.96	-8.27	-6.67	-4.55	-1.51	1.42		15.35		28.14	29.30	30.49	30.60		
PARZIALI TERRENO		4.84	2.92	1.62	1.37	1.34	1.21	4.02	2.07	1.25	1.69	1.60	2.12	3.04	2.93	13.93		12.79		1.16	1.19	0.11			
QUOTE TERRENO	98.00	98.00	98.00	98.00	99.00	99.00	98.00		98.00	98.00	97.00	96.00	95.00	94.00	93.00	93.00		93.00		92.00	92.00	92.00	92.00		
PROGRESSIVE PROGETTO														4.38	3.79	3.42	3.12	2.82	0.00		2.75	3.12	3.42	3.72	4.50
PARZIALI PROGETTO														0.59	0.37	0.30	0.30	2.82	2.75		0.37	0.30	0.30	0.78	
QUOTE PROGETTO														93.94	93.35	93.05	93.05	93.35	93.35	93.35	93.35	93.05	93.35	93.00	

PROFILO Asse4

SEZIONE 4

PROGRESSIVA 30.00

A STERRO m<sup>2</sup> 4.57  
 B RIPORTO m<sup>2</sup> 0.44

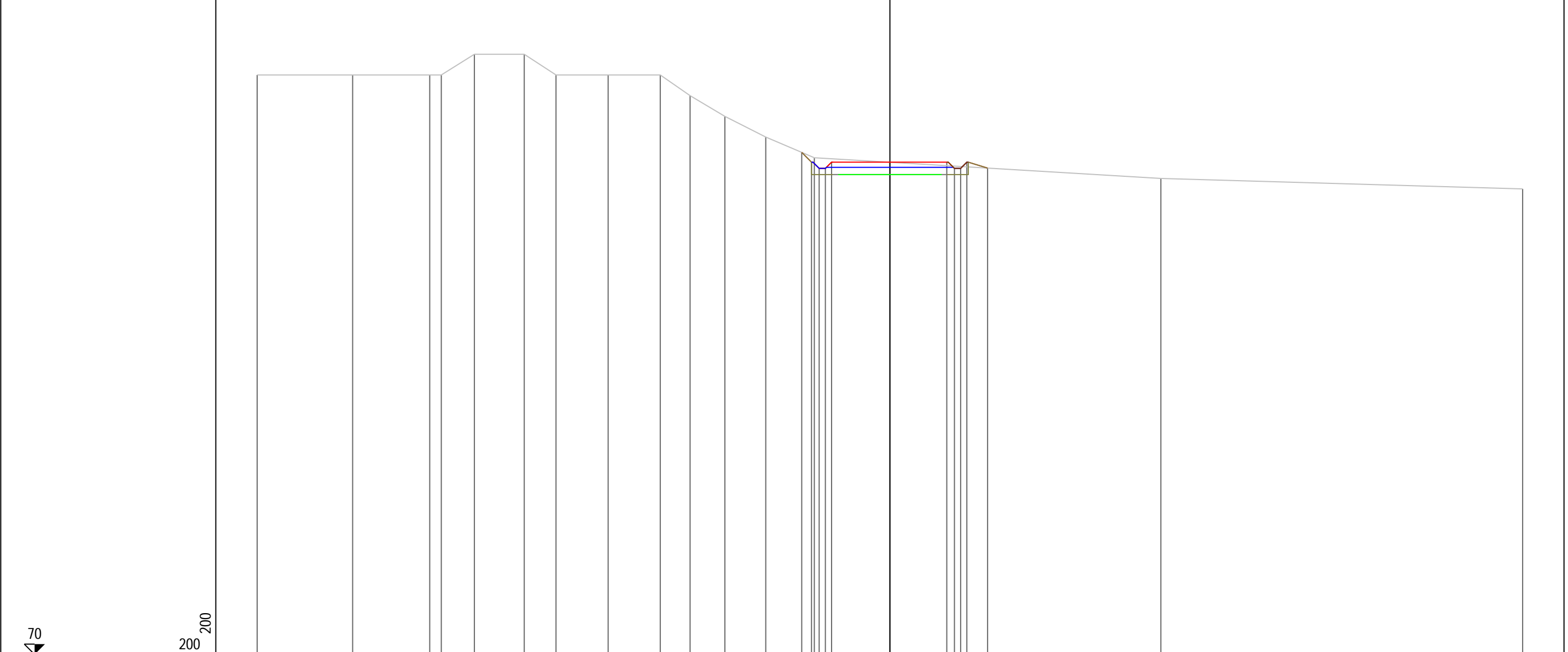

PROGRESSIVE TERRENO	-30.60	-25.98	-22.25	-21.69	-20.09	-17.68	-16.15	-13.63	-11.11	-9.66	-7.98	-6.00	-3.65			13.10			30.60				
PARZIALI TERRENO		4.62		3.73	0.56	1.60	2.41	1.53	2.52	2.52	1.45	1.68	1.98	2.35		16.75			17.50				
QUOTE TERRENO	98.00	98.00	98.00	98.00	99.00	99.00	98.00	98.00	98.00	97.00	96.00	95.00	94.00			93.00			92.49				
PROGRESSIVE PROGETTO													94.26	93.79	93.49	93.49	93.79	93.79	93.79	93.50			
PARZIALI PROGETTO													0.47	0.37	0.30	0.30	0.30	2.82	2.75	0.37	0.30	0.30	1.00
QUOTE PROGETTO													94.26	93.79	93.49	93.49	93.79	93.79	93.79	93.50			

PROFILO Asse4

SEZIONE 5

PROGRESSIVA 40.00

A STERRO m<sup>2</sup> 2.31  
 B RIPORTO m<sup>2</sup> 3.15

70

200  
 200

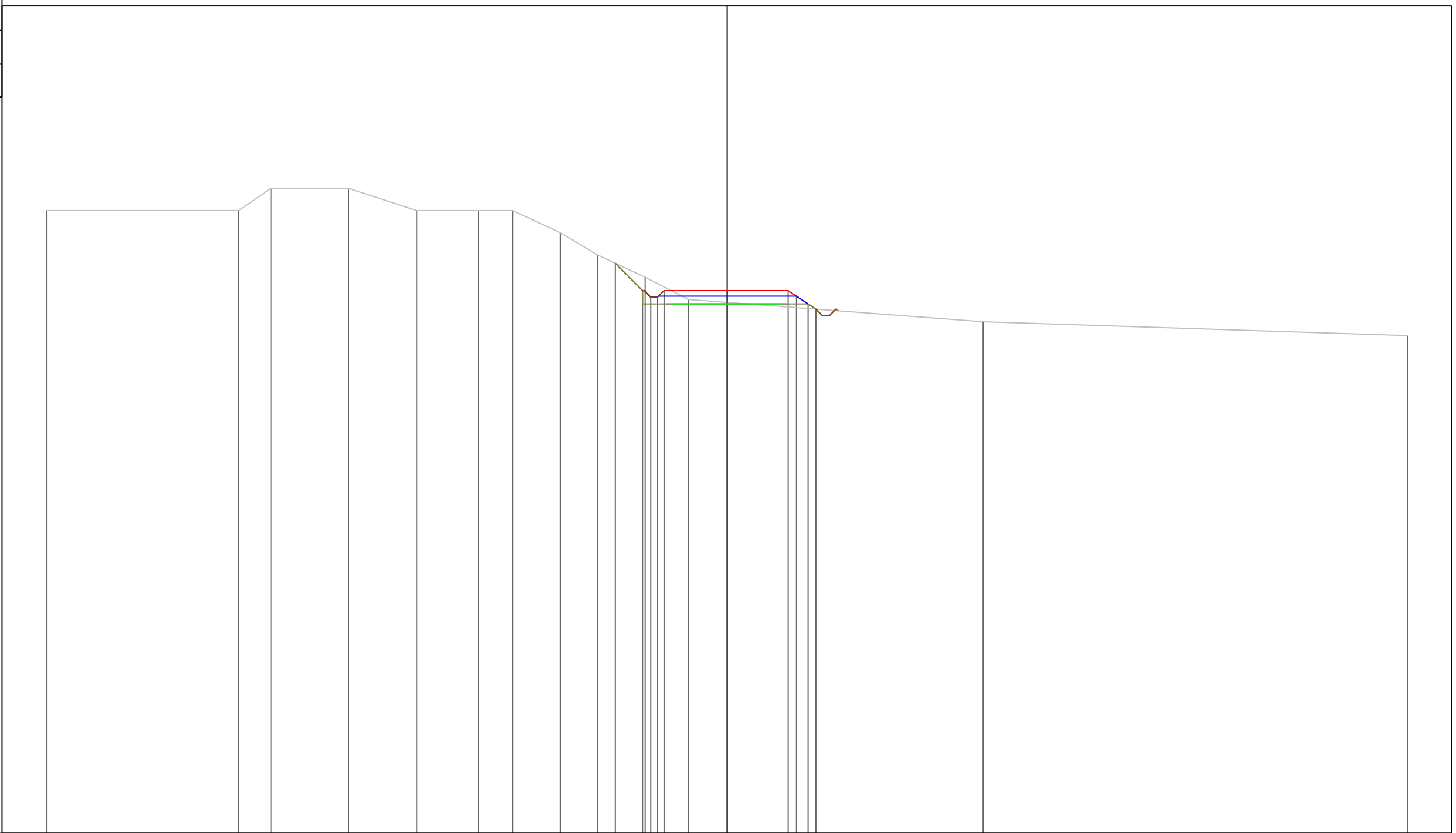

PROGRESSIVE TERRENO	-30.60	-21.95	-20.50	-17.02	-13.95	-11.16	-9.64	-7.48	-5.81	-3.68	-1.72			11.53		30.60				
PARZIALI TERRENO		8.65	1.45	3.48	3.07	2.79	1.52	2.16	1.67	2.13	1.96		13.25		19.07					
QUOTE TERRENO	98.00	98.00	99.00	99.00	98.00	98.00	98.00	97.00	96.00	95.00	94.00			93.00		92.38				
PROGRESSIVE PROGETTO										-5.02	-3.79	-3.42	-3.12	-2.82	0.00		2.75	3.13	3.65	4.01
PARZIALI PROGETTO										1.23	0.37	0.30	0.30	2.82		2.75	0.38	0.52	0.36	
QUOTE PROGETTO										95.63	94.40	94.10	94.10	94.40	94.40	94.40	94.40	94.15	93.80	93.57

PROFILO Asse4

SEZIONE 6

PROGRESSIVA 50.00

A STERRO m<sup>2</sup> 4.71  
 B RIPORTO m<sup>2</sup> 5.53

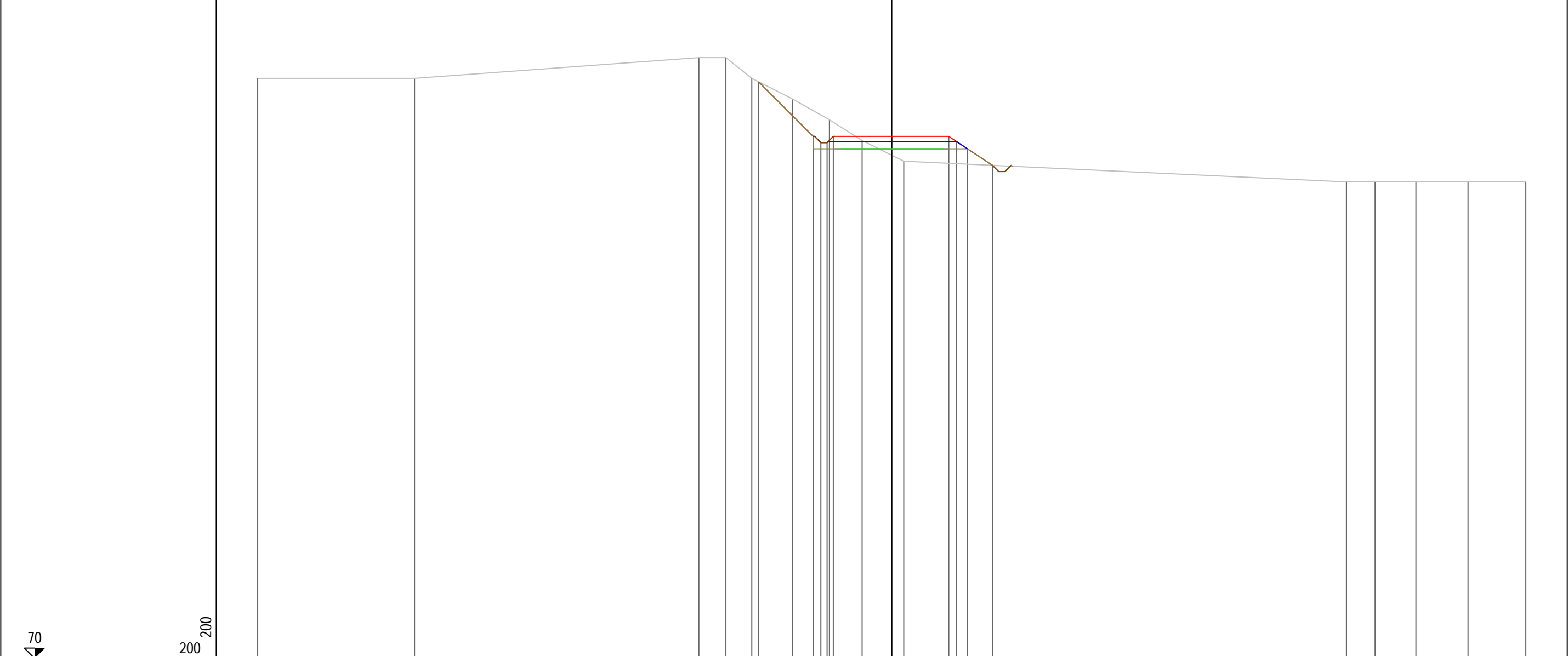

PROGRESSIVE TERRENO	-30.60	-23.03	-9.31	-8.00	-6.75	-4.78	-3.01	-1.43	0.58	21.94	23.33	25.30	27.81	30.60
PARZIALI TERRENO	7.57	13.72	1.31	1.25	1.97	1.77	1.58	2.01	21.36	1.39	1.97	2.51	2.79	
QUOTE TERRENO	98.00	98.00	99.00	99.00	98.00	97.00	96.00	95.00	94.00	93.00	93.00	93.00	93.00	93.00
PROGRESSIVE PROGETTO					-6.43	-3.79	-3.42	-3.12	-2.82	0.00	2.75	3.13	3.65	4.86
PARZIALI PROGETTO					2.64	0.37	0.30	0.30	2.82	2.75	0.38	0.52	1.21	
QUOTE PROGETTO					97.83	95.20	94.90	94.90	95.20	95.20	95.20	94.95	94.60	93.80

PROFILO Asse4

SEZIONE 7

PROGRESSIVA 60.00

A STERRO m<sup>2</sup> 13.13  
 B RIPORTO m<sup>2</sup> 2.76

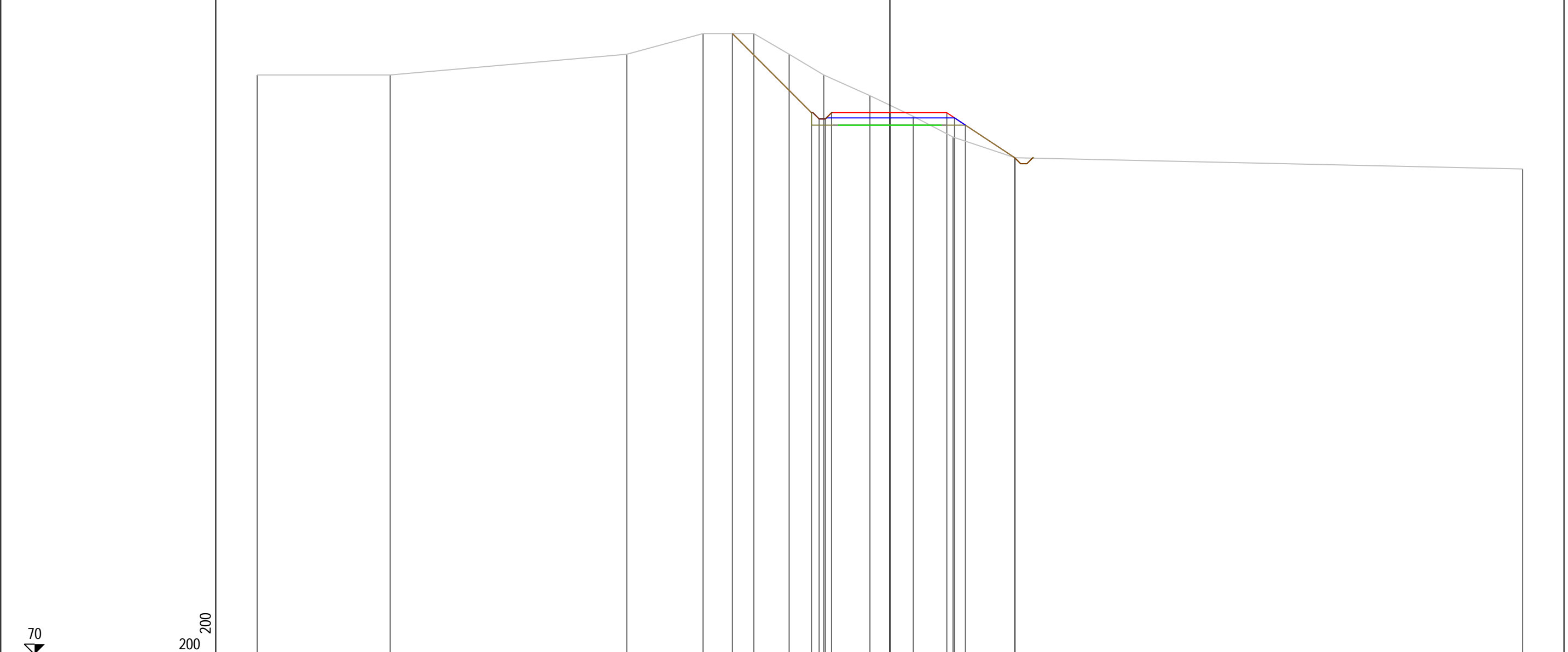

PROGRESSIVE TERRENO	-30.60	-24.17	-12.73	-9.04	-6.58	-4.87	-3.20	-0.97	1.13	3.05	6.06	30.60											
PARZIALI TERRENO		6.43		11.44		3.69		2.46	1.71	1.67	2.23	2.10	1.92	3.01		24.54							
QUOTE TERRENO	98.00		98.00		99.00		100.00		100.00	99.00		98.00		97.00		96.00		95.00		94.00		93.46	
PROGRESSIVE PROGETTO					-7.62		-3.79		-3.42		-3.12		-2.82		0.00		2.75		3.13		3.65		6.02
PARZIALI PROGETTO						3.83		0.37		0.30		0.30		2.82		2.75		0.38		0.52		2.37	
QUOTE PROGETTO					100.00		96.18		95.88		95.88		96.18		96.18		96.18		95.93		95.58		94.01



PROFILO Asse4

SEZIONE 8

PROGRESSIVA 70.00

A STERRO m<sup>2</sup> 13.91  
 B RIPORTO m<sup>2</sup> 0.94

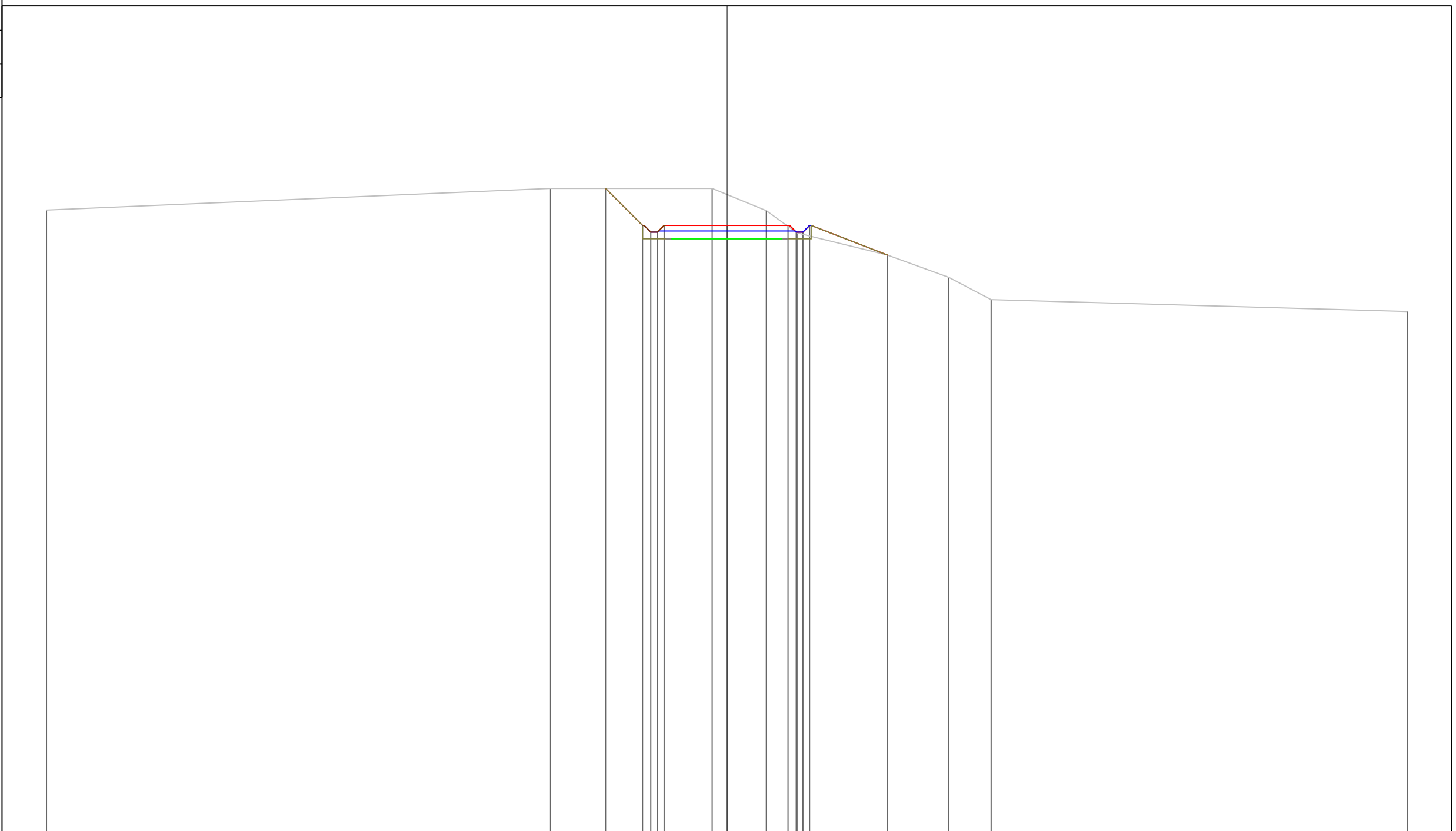

PROGRESSIVE TERRENO	-30.60			-7.93				-0.66	1.78	3.16	7.23	9.99	11.89			30.60
PARZIALI TERRENO		22.67			7.27		2.44		1.38	4.07	2.76	1.90		18.71		
QUOTE TERRENO	98.03			99.00			99.00	98.00	97.00		96.00	95.00	94.00			93.47
PROGRESSIVE PROGETTO					-5.46	-3.79	-3.42	-3.12	-2.82	0.00	2.75	3.12	3.42	3.72	7.23	
PARZIALI PROGETTO					1.67	0.37	0.30	0.30	2.82		2.75	0.37	0.30	0.30	3.51	
QUOTE PROGETTO					99.00	97.34	97.04	97.04	97.34	97.34	97.34	97.04	97.04	97.34	96.00	

PROFILO Asse4

SEZIONE 9

PROGRESSIVA 80.00

A STERRO m<sup>2</sup> 15.99

70

200  
200

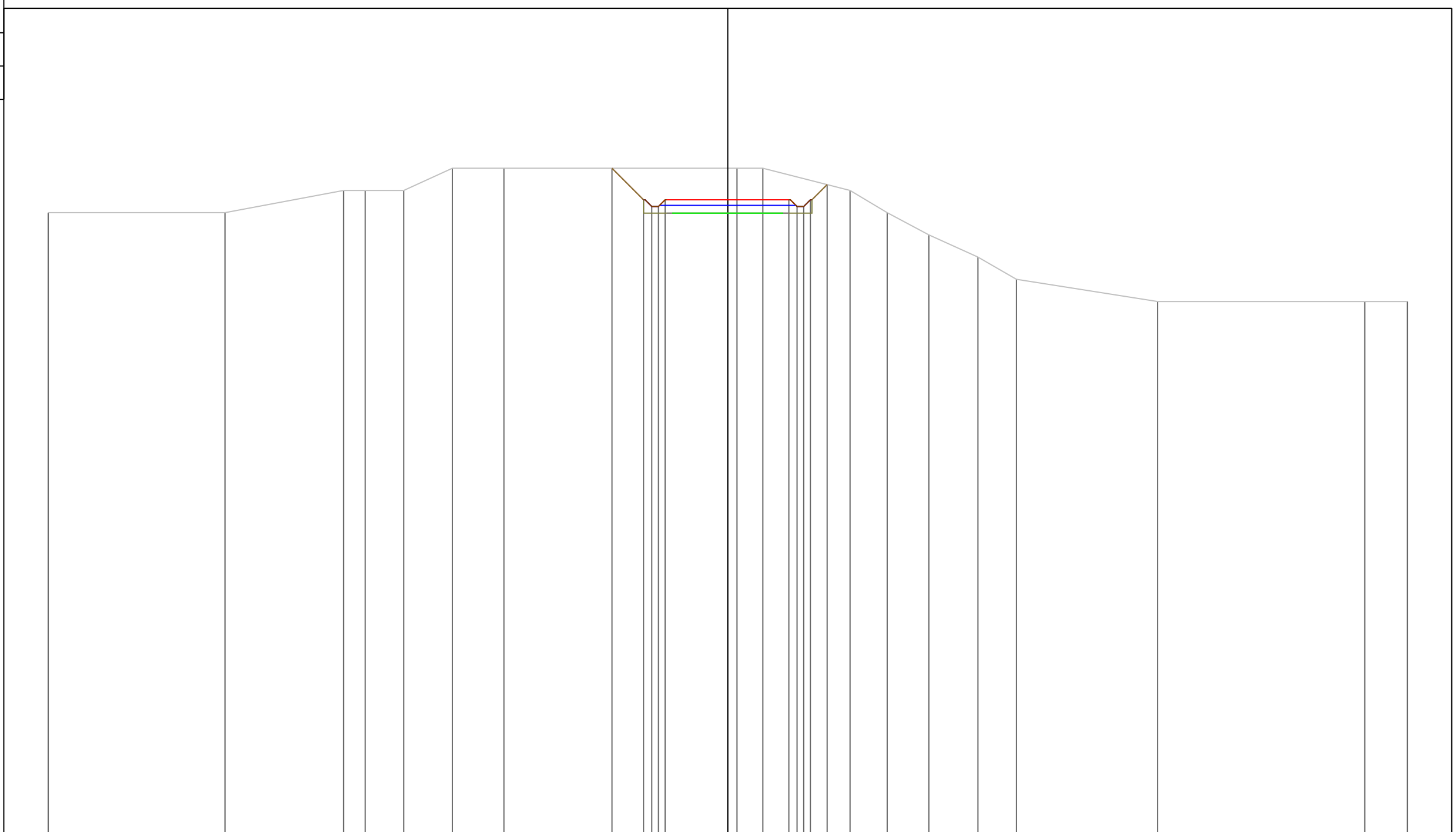

PROGRESSIVE TERRENO

-30.60	-22.64	-17.30	-16.32	-14.59	-12.40	-10.08	0.42	1.58	5.51	7.18	9.06	11.27	13.00	19.36	28.69	30.60
--------	--------	--------	--------	--------	--------	--------	------	------	------	------	------	-------	-------	-------	-------	-------

PARZIALI TERRENO

7.96	5.34	0.98	1.73	2.19	2.32	10.50	1.16	3.93	1.67	1.88	2.21	1.73	6.36	9.33	1.91
------	------	------	------	------	------	-------	------	------	------	------	------	------	------	------	------

QUOTE TERRENO

98.00	98.00	99.00	99.00	99.00	100.00	100.00	100.00	100.00	99.00	98.00	97.00	96.00	95.00	94.00	94.00	94.00
-------	-------	-------	-------	-------	--------	--------	--------	--------	-------	-------	-------	-------	-------	-------	-------	-------

PROGRESSIVE PROGETTO

							-5.21	-3.79	-3.42	-3.12	-2.82	0.00	2.75	3.12	3.42	3.72	4.48
--	--	--	--	--	--	--	-------	-------	-------	-------	-------	------	------	------	------	------	------

PARZIALI PROGETTO

							1.42	0.37	0.30	0.30	2.82	2.75	0.37	0.30	0.30	0.76
--	--	--	--	--	--	--	------	------	------	------	------	------	------	------	------	------

QUOTE PROGETTO

							100.00	98.58	98.28	98.28	98.58	98.58	98.58	98.28	98.28	98.58	99.26
--	--	--	--	--	--	--	--------	-------	-------	-------	-------	-------	-------	-------	-------	-------	-------

PROFILO Asse4

SEZIONE 10

PROGRESSIVA 90.00

A STERRO m<sup>2</sup> 5.94

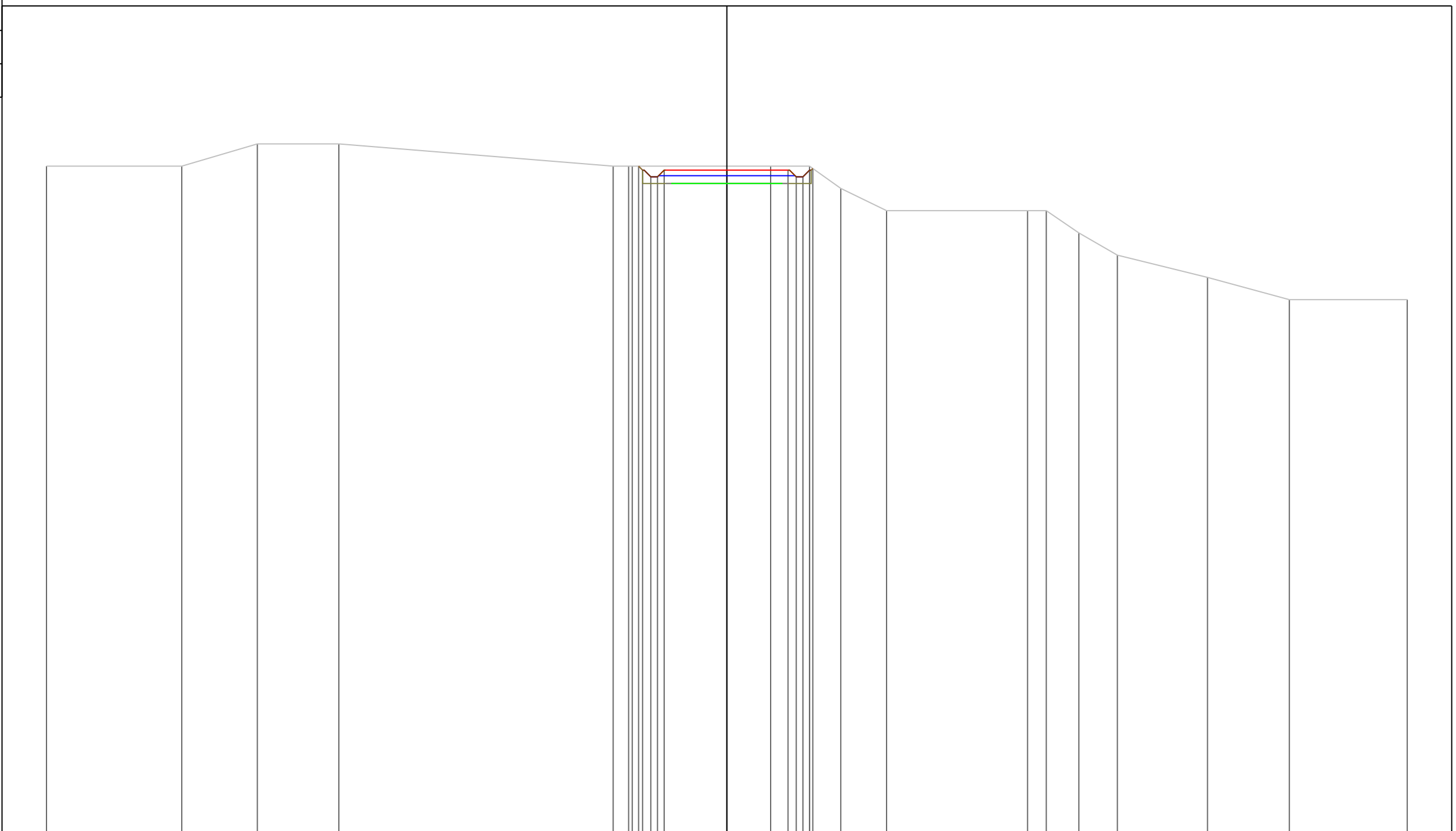

PROGRESSIVE TERRENO	-30.60	-24.52	-21.12	-17.45	-5.11	-4.42	-4.26	1.97	3.72	5.12	7.18	13.52	14.37	15.83	17.56	21.62	25.30	30.60
PARZIALI TERRENO	6.08	3.40	3.67	12.34	0.69	0.16	6.23	1.75	1.40	2.06	6.34	0.85	1.46	1.73	4.06	3.68	5.30	
QUOTE TERRENO	100.00	100.00	101.00	101.00	100.00	100.00	100.00	100.00	100.00	99.00	98.00	98.00	98.00	97.00	96.00	95.00	94.00	94.00
PROGRESSIVE PROGETTO																		
PARZIALI PROGETTO					0.18	0.37	0.30	0.30	2.82	2.75	0.37	0.30	0.30	0.30	0.14			
QUOTE PROGETTO					100.00	99.82	99.52	99.52	99.82	99.82	99.82	99.52	99.52	99.82	99.90			





















PROFILO Asse4

SEZIONE 20

PROGRESSIVA 190.00

A STERRO m<sup>2</sup> 8.19  
B RIPORTO m<sup>2</sup> 1.09

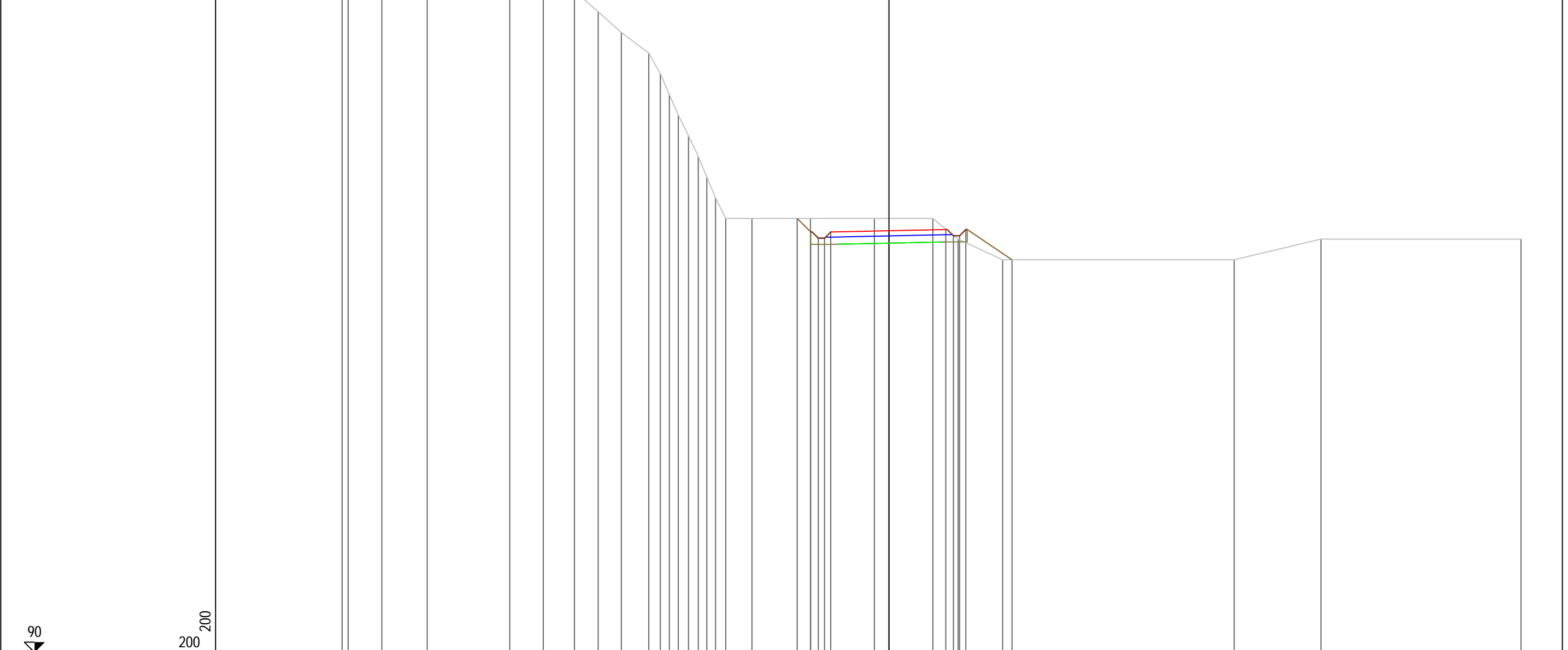

PROGRESSIVE TERRENO	127.20	127.00	126.00	125.00	124.00	123.00	122.00	121.00	120.00	119.00	118.00	117.00	116.00	115.00	114.00	113.00	112.00	111.00	111.00	111.00	111.00	111.00	110.00	109.00	109.00	110.00	110.00
PARZIALI TERRENO	0.29	1.63	2.19	4.00	1.62	1.51	1.15	1.12	1.33	0.56	0.44	0.43	0.49	0.48	0.41	0.43	0.49	1.27	2.83	3.09	2.84	1.22	2.15	11.21	4.21	9.68	
QUOTE TERRENO	127.20	127.00	126.00	125.00	124.00	123.00	122.00	121.00	120.00	119.00	118.00	117.00	116.00	115.00	114.00	113.00	112.00	111.00	111.00	111.00	111.00	111.00	110.00	109.00	109.00	110.00	110.00
PROGRESSIVE PROGETTO																			111.00	110.35	110.05	110.35	110.46	110.16	110.46	109.00	109.00
PARZIALI PROGETTO																			0.65	0.37	0.30	0.30	0.37	0.30	0.30	2.24	
QUOTE PROGETTO																			111.00	110.35	110.05	110.35	110.46	110.16	110.46	109.00	109.00

PROFILO Asse4

SEZIONE 21

PROGRESSIVA 200.00

A STERRO m<sup>2</sup> 8.85

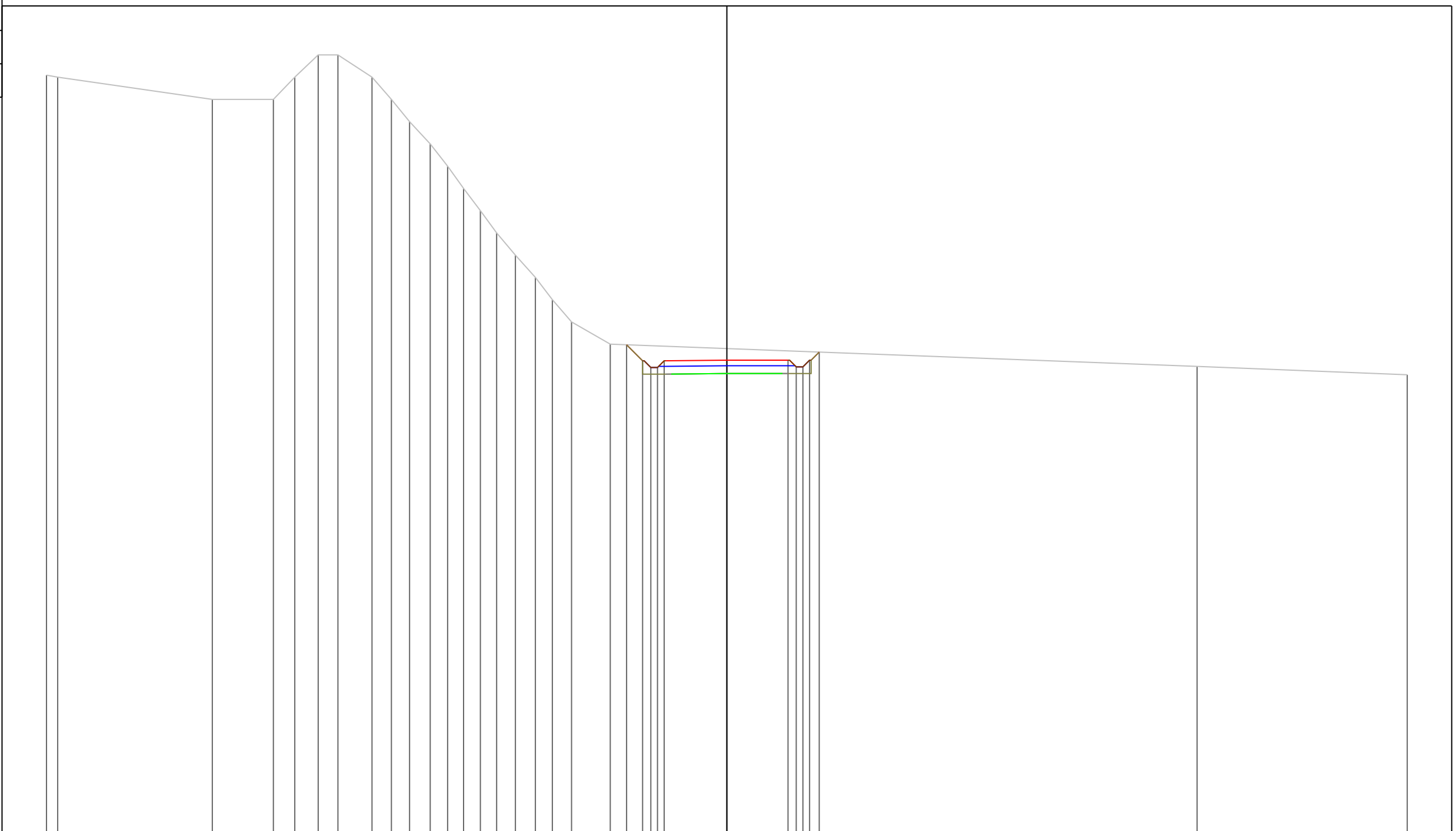

90

200  
200

PROGRESSIVE TERRENO	124.09	124.00	123.00	123.00	124.00	125.00	125.00	124.00	123.00	122.00	121.00	120.00	119.00	118.00	117.00	116.00	115.00	114.00	113.00	112.00	111.00	110.62
PARZIALI TERRENO	0.50	6.96	2.74	0.97	1.05	0.89	1.53	0.87	0.82	0.93	0.78	0.72	0.75	0.74	0.84	0.90	0.76	0.86	1.75	26.39	9.45	
QUOTE TERRENO	124.09	124.00	123.00	123.00	124.00	125.00	125.00	124.00	123.00	122.00	121.00	120.00	119.00	118.00	117.00	116.00	115.00	114.00	113.00	112.00	111.00	110.62
PROGRESSIVE PROGETTO																						
PARZIALI PROGETTO																						
QUOTE PROGETTO																						

0.72  
 111.97  
 0.37  
 111.25  
 0.30  
 110.95  
 0.30  
 110.95  
 0.30  
 111.25  
 2.82  
 0.00  
 111.28  
 2.75  
 111.28  
 0.37  
 110.98  
 0.30  
 110.98  
 0.30  
 111.28  
 0.30  
 111.64  
 0.43  
 4.15

PROFILO Asse4

SEZIONE 22

PROGRESSIVA 210.00

A STERRO m<sup>2</sup> 8.60

90

200  
200

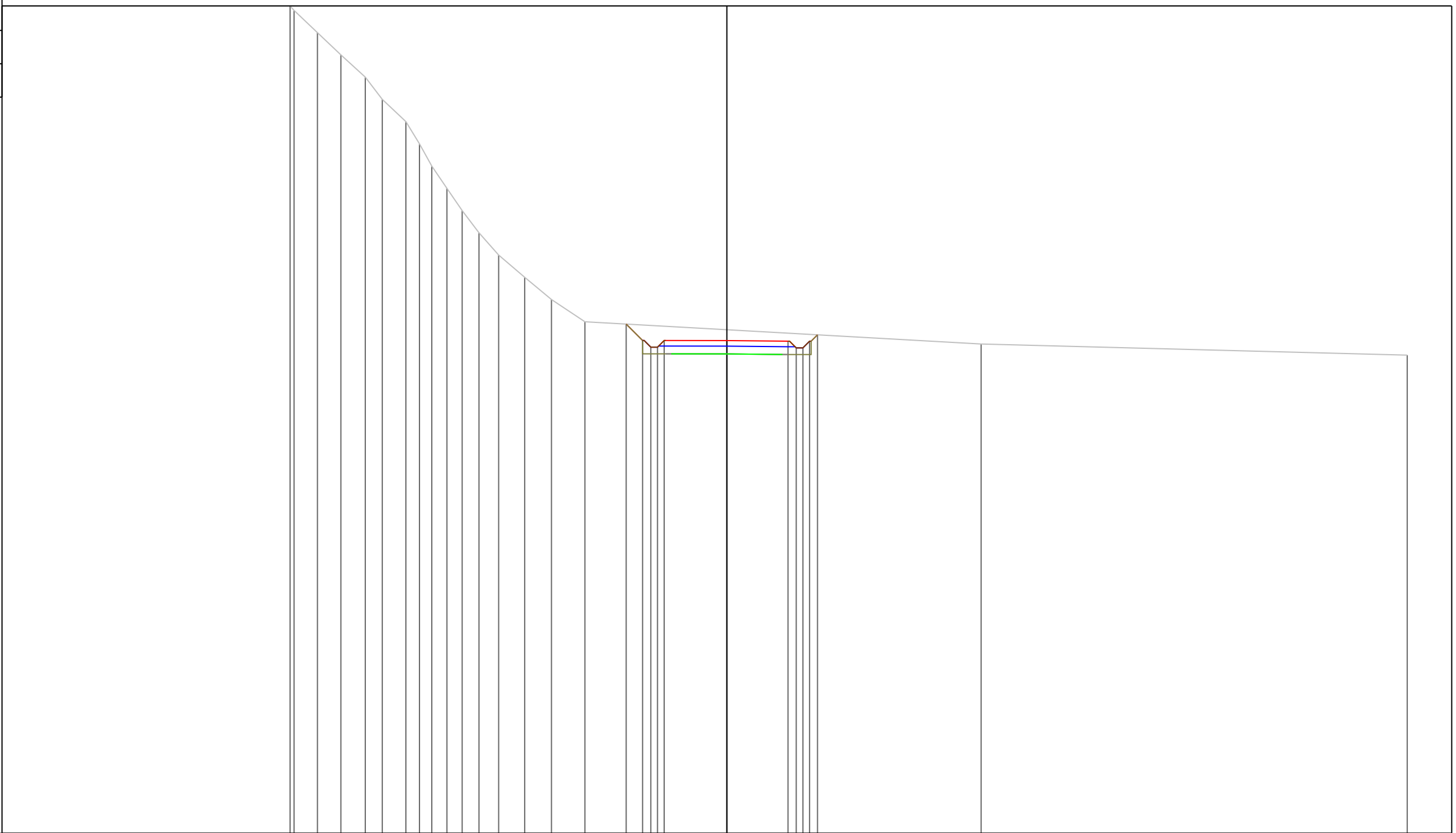

PROGRESSIVE TERRENO	127.20 127.00 126.00 125.00 124.00 123.00 122.00 121.00 120.00 119.00 118.00 117.00 116.00 115.00 114.00 113.00	-19.64 -19.47 -18.41 -17.36 -16.26 -15.50 -14.44 -13.82 -13.27 -12.59 -11.91 -11.15 -10.26 -9.09 -7.89 -6.38	112.00	111.43	30.60	111.50
PARZIALI TERRENO	0.17 1.06 1.05 1.10 0.76 1.06 0.62 0.55 0.68 0.68 0.76 0.89 1.17 1.20 1.51		17.81	19.17		
PROGRESSIVE PROGETTO	112.90 112.16 111.86 111.86 112.16	-4.53 -3.79 -3.42 -3.12 -2.82	0.00	2.75 3.12 3.42 3.72 4.08		
PARZIALI PROGETTO	0.74 0.37 0.30 0.30 2.82		2.75	0.37 0.30 0.30 0.36		
QUOTE PROGETTO			112.15	112.13 111.83 112.13 112.41		

PROFILO Asse4

SEZIONE 23

PROGRESSIVA 220.00

A STERRO m<sup>2</sup> 6.10  
B RIPORTO m<sup>2</sup> 0.05

90

200  
200

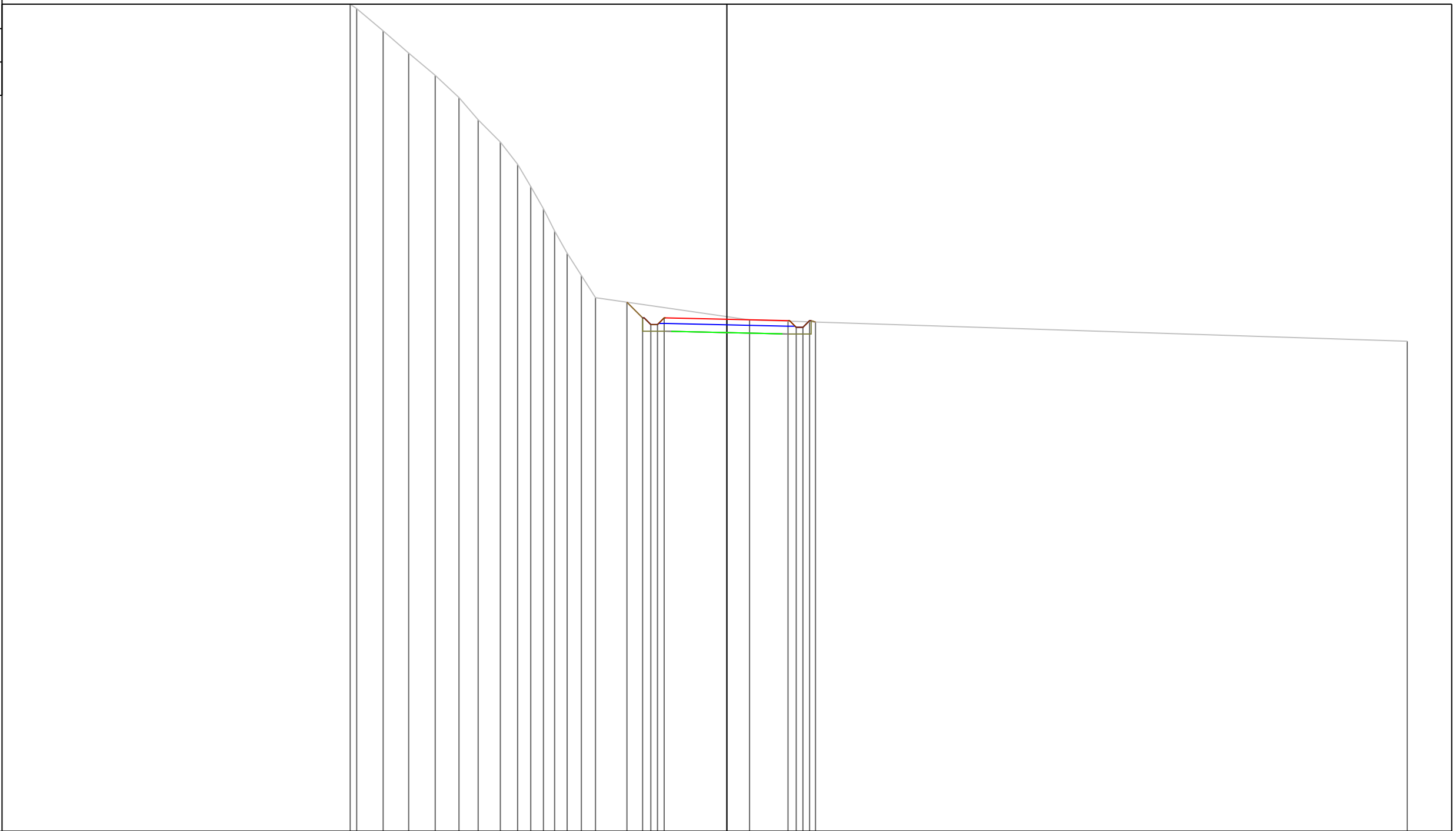

PROGRESSIVE TERRENO

-16.94	-16.65	-15.46	-14.31	-13.12	-12.05	-11.19	-10.19	-9.41	-8.82	-8.25	-7.75	-7.18	-6.54	-5.91	1.02	30.60
--------	--------	--------	--------	--------	--------	--------	--------	-------	-------	-------	-------	-------	-------	-------	------	-------

PARZIALI TERRENO

0.29	1.19	1.15	1.19	1.07	0.86	1.00	0.78	0.59	0.57	0.50	0.57	0.64	0.63	6.93	29.58
------	------	------	------	------	------	------	------	------	------	------	------	------	------	------	-------

QUOTE TERRENO

127.20	127.00	126.00	125.00	124.00	123.00	122.00	121.00	120.00	119.00	118.00	117.00	116.00	115.00	114.00	113.00	112.04
--------	--------	--------	--------	--------	--------	--------	--------	--------	--------	--------	--------	--------	--------	--------	--------	--------

PROGRESSIVE PROGETTO

-4.49	-3.79	-3.42	-3.12	-2.82	0.00	2.75	3.12	3.42	3.72	3.99
-------	-------	-------	-------	-------	------	------	------	------	------	------

PARZIALI PROGETTO

0.70	0.37	0.30	0.30	0.30	2.82	2.75	0.37	0.30	0.30	0.27
------	------	------	------	------	------	------	------	------	------	------

QUOTE PROGETTO

113.80	113.09	112.79	112.79	113.09	113.03	112.97	112.67	112.67	112.97	112.90
--------	--------	--------	--------	--------	--------	--------	--------	--------	--------	--------



PROFILO Asse4

SEZIONE 24

PROGRESSIVA 230.00

A STERRO m<sup>2</sup> 5.26

95

200  
200

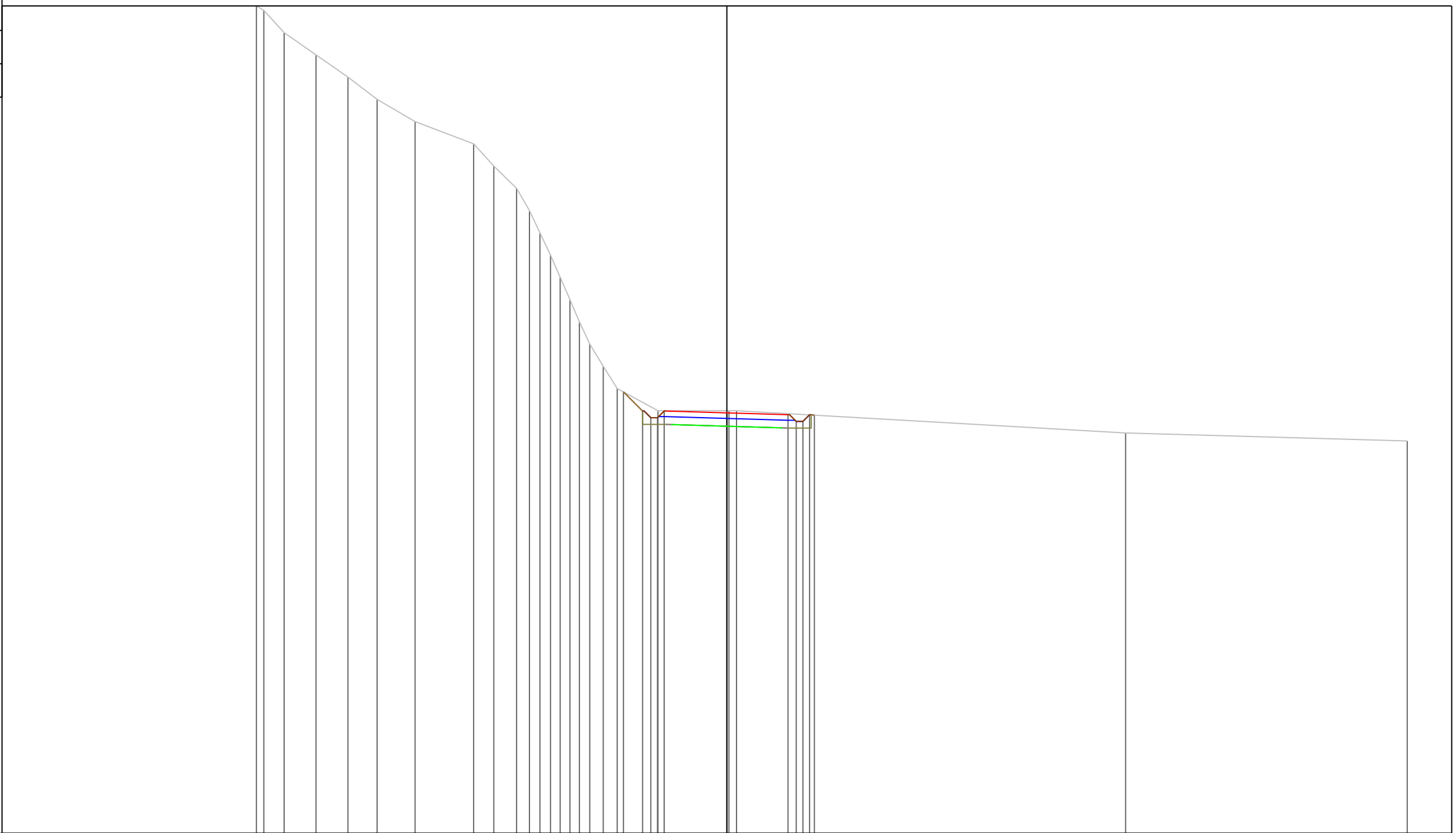

PROGRESSIVE  
TERRENO

21.16  
20.82  
19.91  
18.48  
17.04  
15.73  
14.02  
11.39  
10.48  
9.46  
8.88  
8.41  
7.93  
7.50  
7.06  
6.63  
6.17  
5.56  
4.93  
3.10  
0.09  
0.43  
17.93  
30.60

PARZIALI  
TERRENO

0.34  
0.91  
1.43  
1.44  
1.31  
1.71  
2.63  
0.91  
1.02  
0.58  
0.47  
0.48  
0.43  
0.44  
0.43  
0.46  
0.61  
0.63  
1.83  
3.19  
0.34  
17.50  
12.67

QUOTE  
TERRENO

132.20  
132.00  
131.00  
130.00  
129.00  
128.00  
127.00  
126.00  
125.00  
124.00  
123.00  
122.00  
121.00  
120.00  
119.00  
118.00  
117.00  
116.00  
115.00  
114.00  
114.00  
113.00  
112.64

PROGRESSIVE  
PROGETTO

4.65  
3.79  
3.42  
3.12  
2.82  
0.00  
2.75  
3.12  
3.42  
3.72  
3.94

PARZIALI  
PROGETTO

0.86  
0.37  
0.30  
0.30  
2.82  
2.75  
0.37  
0.30  
0.30  
0.22

QUOTE  
PROGETTO

114.85  
113.99  
113.69  
113.69  
113.99  
113.90  
113.82  
113.52  
113.82  
113.80



PROFILO Asse4

SEZIONE 26

PROGRESSIVA 250.00

A STERRO m<sup>2</sup> 2.34  
B RIPORTO m<sup>2</sup> 2.20

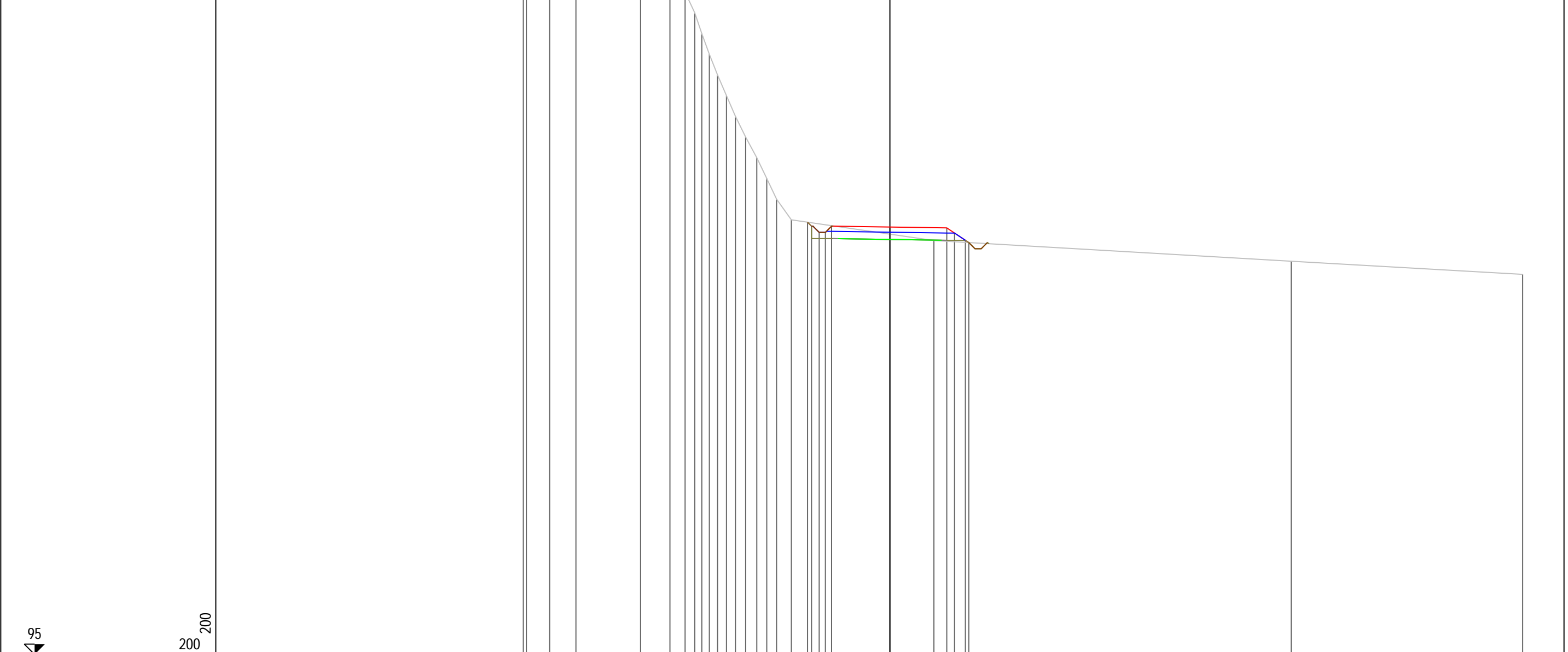

PROGRESSIVE TERRENO	132.20	132.00	131.00	130.00	129.00	128.00	127.00	126.00	125.00	124.00	123.00	122.00	121.00	120.00	119.00	118.00	117.00	116.00	115.00	114.00	113.37		
PARZIALI TERRENO	0.15	1.13	1.27	3.12	1.42	0.74	0.46	0.34	0.37	0.39	0.44	0.43	0.49	0.54	0.48	0.48	0.71	6.90	2.13	17.28	11.19	30.60	
QUOTE TERRENO	132.20	132.00	131.00	130.00	129.00	128.00	127.00	126.00	125.00	124.00	123.00	122.00	121.00	120.00	119.00	118.00	117.00	116.00	115.00	114.00	113.37		
PROGRESSIVE PROGETTO																			115.65	115.61	115.36	115.01	114.90
PARZIALI PROGETTO																			0.00	2.75	2.82	2.75	0.16
QUOTE PROGETTO	115.89	115.69	115.39	115.69	115.89	115.69	115.39	115.69	115.39	115.69	115.39	115.69	115.39	115.69	115.39	115.69	115.39	115.69	115.65	115.61	115.36	115.01	114.90



PROFILO Asse4

SEZIONE 28

PROGRESSIVA 270.00

A STERRO m<sup>2</sup> 2.30  
B RIPORTO m<sup>2</sup> 4.53

95

200  
200

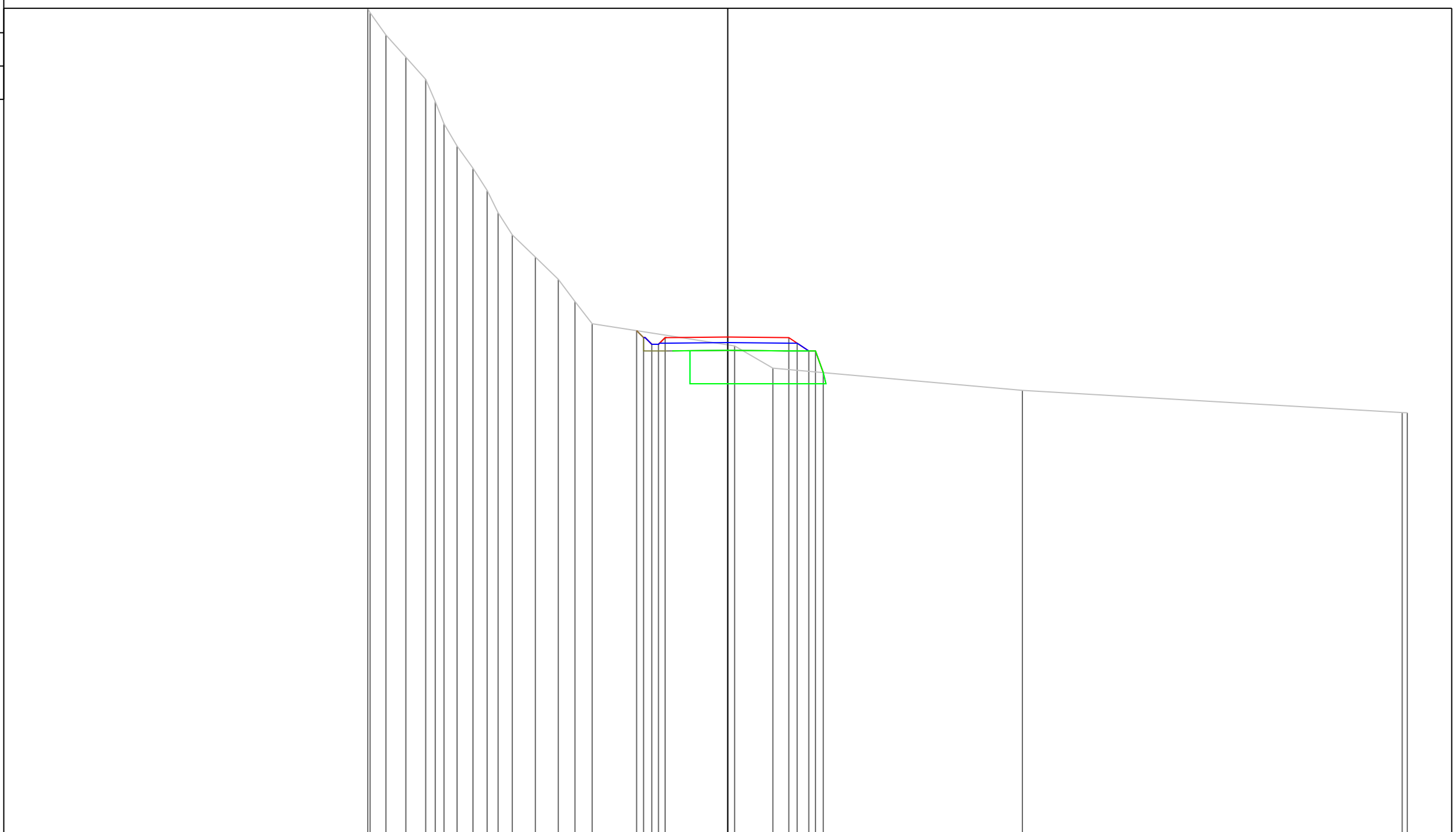

PROGRESSIVE TERRENO

0.10 -16.21 -16.11 -15.39 -14.50 -13.60 -13.17 -12.78 -12.19 -11.47 -10.83 -10.34 -9.70 -8.66 -7.63 -6.88 -6.11 0.31 2.03 11.24 13.27 30.37 30.60

PARZIALI TERRENO

0.72 0.89 0.90 0.43 0.39 0.59 0.72 0.64 0.49 0.64 1.04 1.03 0.75 0.77 6.42 1.72 17.10 0.23

QUOTE TERRENO

132.20 132.00 131.00 130.00 129.00 128.00 127.00 126.00 125.00 124.00 123.00 122.00 121.00 120.00 119.00 118.00 117.00 116.00 115.00 114.00 113.99

PROGRESSIVE PROGETTO

4.10 -3.79 -3.42 -3.12 -2.82 0.00 2.75 3.13 3.65 3.95 4.30

PARZIALI PROGETTO

0.31 0.37 0.30 0.30 2.82 2.75 0.38 0.52 0.30 0.35

QUOTE PROGETTO

117.69 117.37 117.07 117.07 117.37 117.40 117.37 117.12 116.77 116.77 115.80

PROFILO Asse4

SEZIONE 29

PROGRESSIVA 280.00

A STERRO m<sup>2</sup> 2.75  
B RIPORTO m<sup>2</sup> 4.81

96

200 200

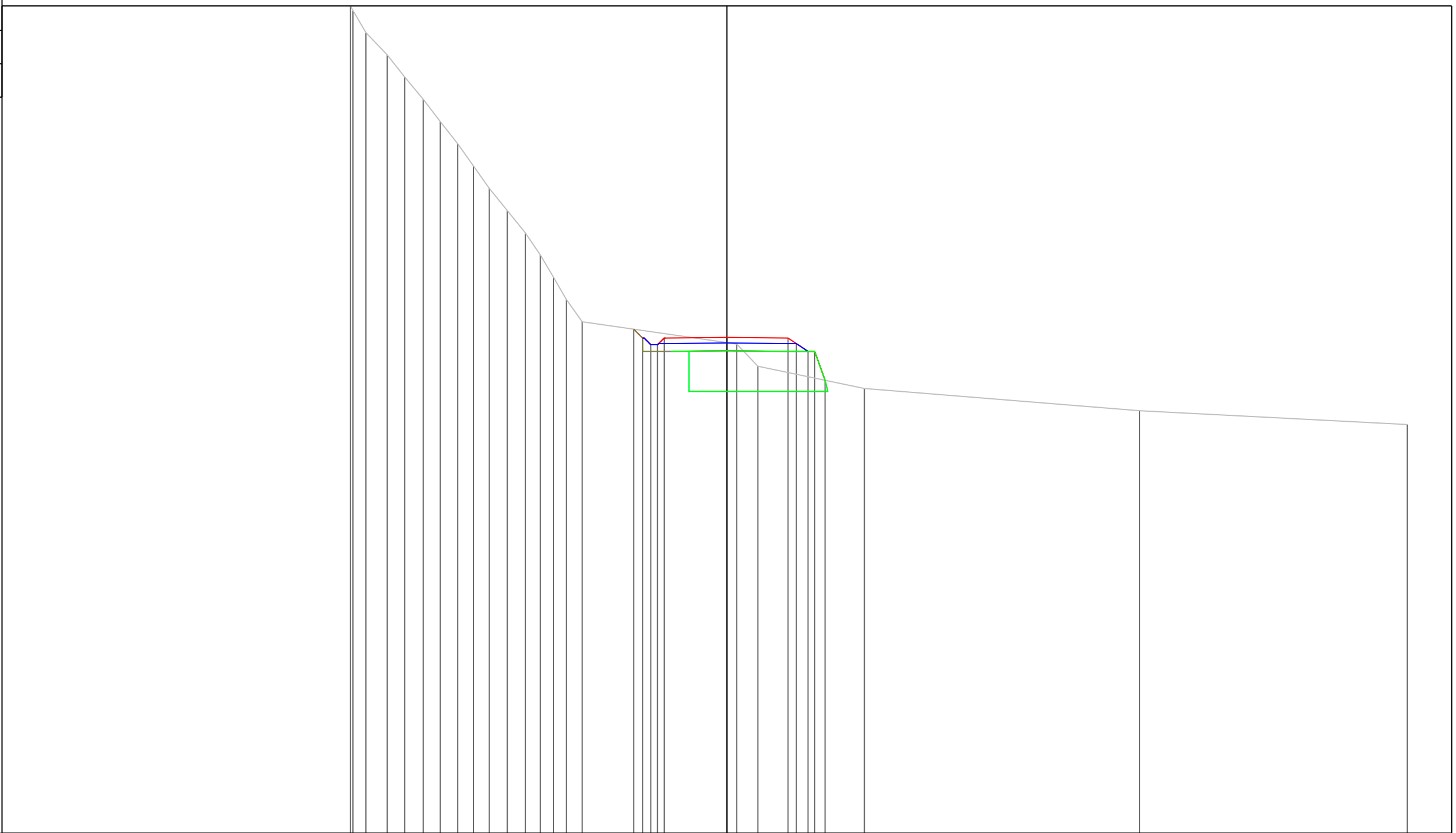

PROGRESSIVE TERRENO

PARZIALI TERRENO

QUOTE TERRENO

PROGRESSIVE PROGETTO

PARZIALI PROGETTO

QUOTE PROGETTO

PROGRESSIVE TERRENO	133.20	133.00	132.00	131.00	130.00	129.00	128.00	127.00	126.00	125.00	124.00	123.00	122.00	121.00	120.00	119.00	118.00	117.00	116.00	115.00	114.38
PARZIALI TERRENO	0.11	0.59	0.95	0.79	0.84	0.76	0.79	0.71	0.70	0.81	0.81	0.68	0.59	0.58	0.71	6.95	0.96	4.78	12.38	12.04	30.60
QUOTE TERRENO	133.20	133.00	132.00	131.00	130.00	129.00	128.00	127.00	126.00	125.00	124.00	123.00	122.00	121.00	120.00	119.00	118.00	117.00	116.00	115.00	114.38
PROGRESSIVE PROGETTO	118.67	118.27	117.97	117.67	117.27	116.87	116.47	116.07	115.67	115.27	114.87	114.47	114.07	113.67	113.27	112.87	112.47	112.07	111.67	111.27	110.87
PARZIALI PROGETTO	0.40	0.37	0.30	0.30	0.30	0.30	2.82	2.75	0.37	0.53	0.30	0.47	0.37	0.53	0.30	0.47	0.00	2.75	0.37	0.53	0.30
QUOTE PROGETTO	118.67	118.27	117.97	117.67	117.27	116.87	116.47	116.07	115.67	115.27	114.87	114.47	114.07	113.67	113.27	112.87	112.47	112.07	111.67	111.27	110.87

PROFILO Asse4

SEZIONE 30

PROGRESSIVA 290.00

A STERRO m<sup>2</sup> 2.43  
B RIPORTO m<sup>2</sup> 7.02

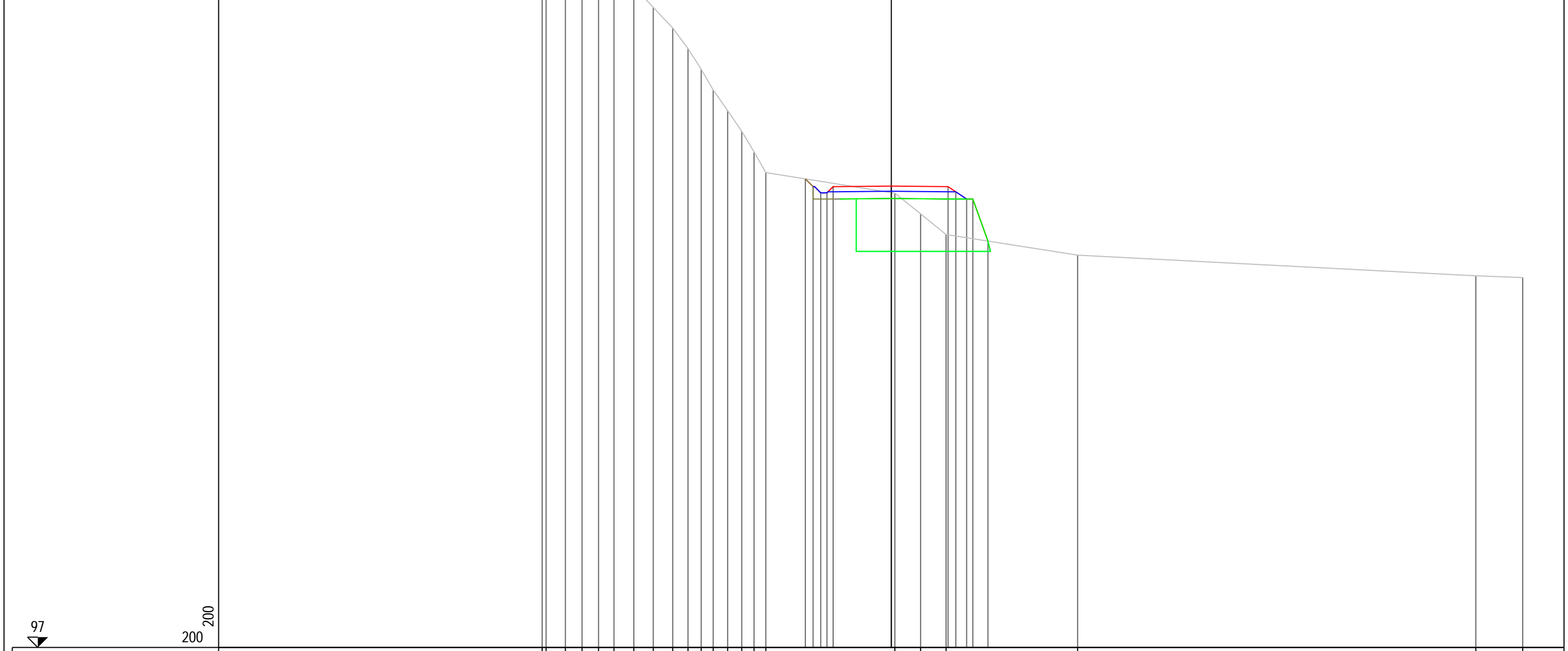

PROGRESSIVE TERRENO		134.20	134.00	133.00	132.00	131.00	130.00	129.00	128.00	127.00	126.00	125.00	124.00	123.00	122.00	121.00	120.00							116.00				115.00	114.91		
PARZIALI TERRENO		0.19	0.93	0.81	0.80	0.75	0.96	0.94	0.95	0.74	0.64	0.58	0.70	0.68	0.60	0.57	6.25	1.25	1.23	6.38	19.30	2.27									
QUOTE TERRENO		134.20	134.00	133.00	132.00	131.00	130.00	129.00	128.00	127.00	126.00	125.00	124.00	123.00	122.00	121.00	120.00							116.00				115.00	114.91		
PROGRESSIVE PROGETTO																								0.00							
PARZIALI PROGETTO																								0.38							
QUOTE PROGETTO																								119.69							

PROFILO Asse4

SEZIONE 31

PROGRESSIVA 300.00

A STERRO m<sup>2</sup> 4.37  
B RIPORTO m<sup>2</sup> 6.30

99

200  
200

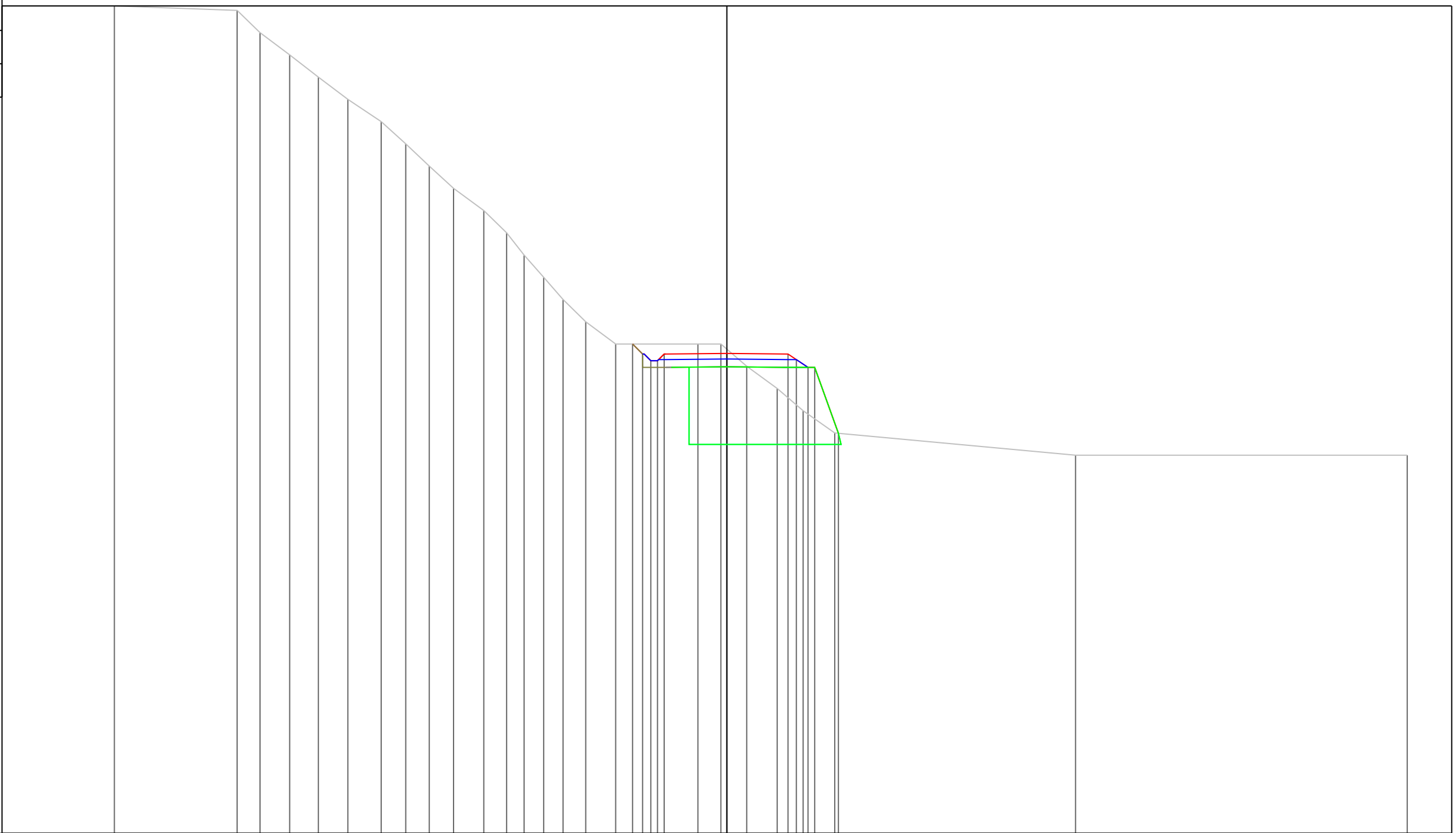

PROGRESSIVE TERRENO	-27.55	-22.03	-21.00	-19.66	-18.37	-17.05	-15.55	-14.44	-13.39	-12.29	-10.93	-9.91	-9.12	-8.24	-7.37	-6.35	-5.00	-1.30	-0.27	0.89	2.26	3.43	4.85	15.68	30.60			
PARZIALI TERRENO	5.52	1.03	1.34	1.29	1.32	1.50	1.11	1.05	1.10	1.36	1.02	0.79	0.88	0.87	1.02	1.35	3.70	1.03	1.16	1.37	1.17	1.42	10.83	14.92				
QUOTE TERRENO	136.20	136.00	135.00	134.00	133.00	132.00	131.00	130.00	129.00	128.00	127.00	126.00	125.00	124.00	123.00	122.00	121.00	121.00	121.00	120.00	119.00	118.00	117.00	116.00	116.00			
PROGRESSIVE PROGETTO																		121.00	120.58	120.58	120.55	120.30	119.95	116.98				
PARZIALI PROGETTO																		0.45	0.37	0.30	0.30	0.30	2.82	2.75	0.38	0.52	0.30	1.07
QUOTE PROGETTO																		121.00	120.55	120.25	120.25	120.55	120.55	119.95	116.98			



PROFILO Asse4

SEZIONE 32

PROGRESSIVA 310.00

A STERRO m<sup>2</sup> 4.92  
B RIPORTO m<sup>2</sup> 4.51

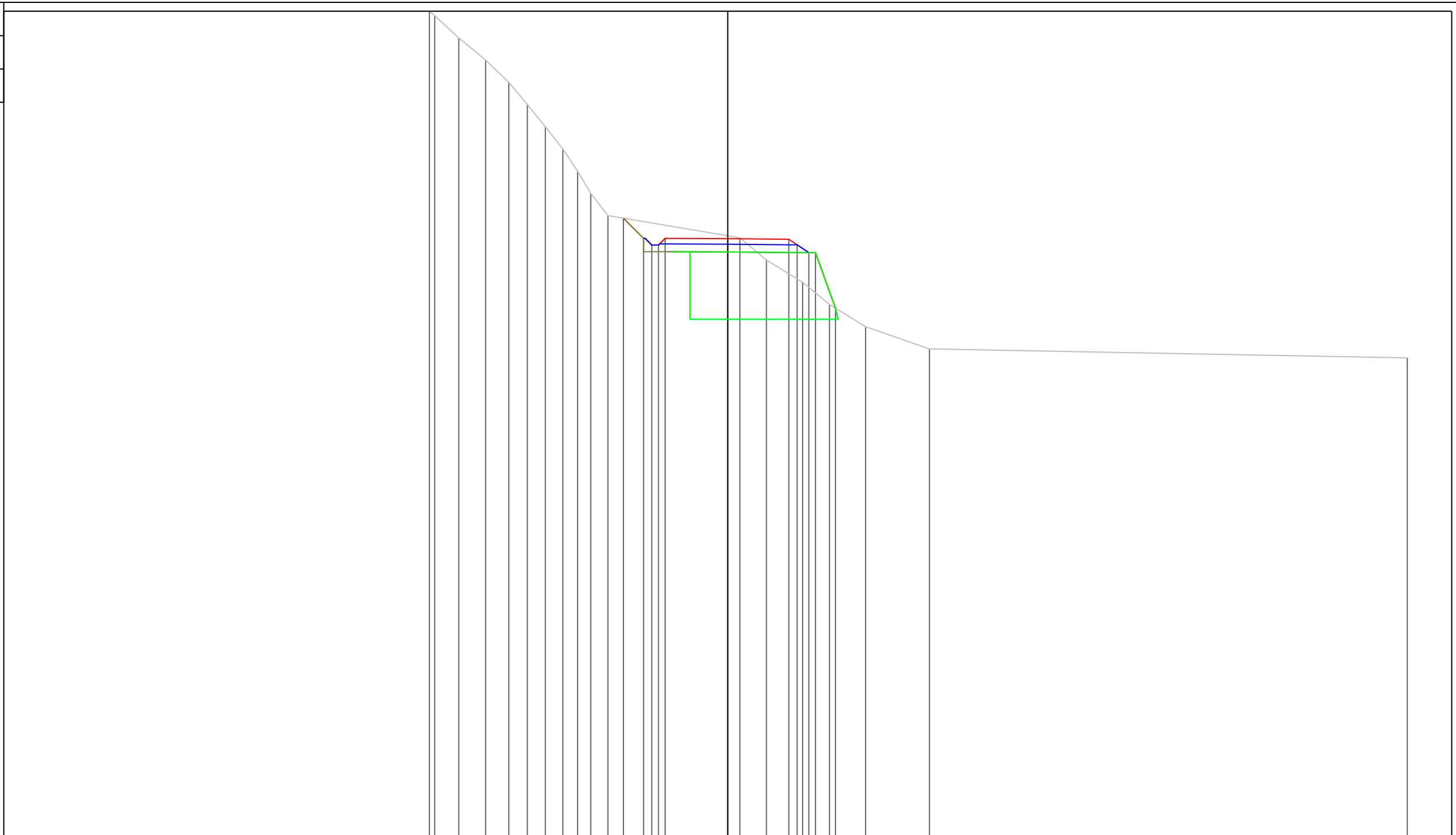

PROGRESSIVE TERRENO	
PARZIALI TERRENO	
QUOTE TERRENO	
PROGRESSIVE PROGETTO	
PARZIALI PROGETTO	
QUOTE PROGETTO	

132.20	133.44	132.20	131.00	130.00	129.00	128.00	127.00	126.00	125.00	124.00	123.00	5.95	0.55	1.74	3.37	4.58	6.21	9.08	30.60					
0.24	1.09	1.21	1.04	0.84	0.81	0.78	0.67	0.59	0.77			5.95	1.19	1.63	1.21	1.63	2.87	21.52						
132.20	132.00	131.00	130.00	129.00	128.00	127.00	126.00	125.00	124.00	123.00			122.00	121.00	120.00	119.00	118.00	117.00	116.60					
													0.00	2.75	3.12	3.65	3.95	4.85						
												0.91	0.37	0.30	0.30	2.82	2.75	0.37	0.53	0.30	0.90			
122.88	121.97	121.67	121.67	121.97	121.96					121.96										121.93	121.68	121.33	121.33	118.83

PROFILO Asse4  
 SEZIONE 33  
 PROGRESSIVA 320.00  
 A STERRO m<sup>2</sup> 5.69  
 B RIPORTO m<sup>2</sup> 4.16

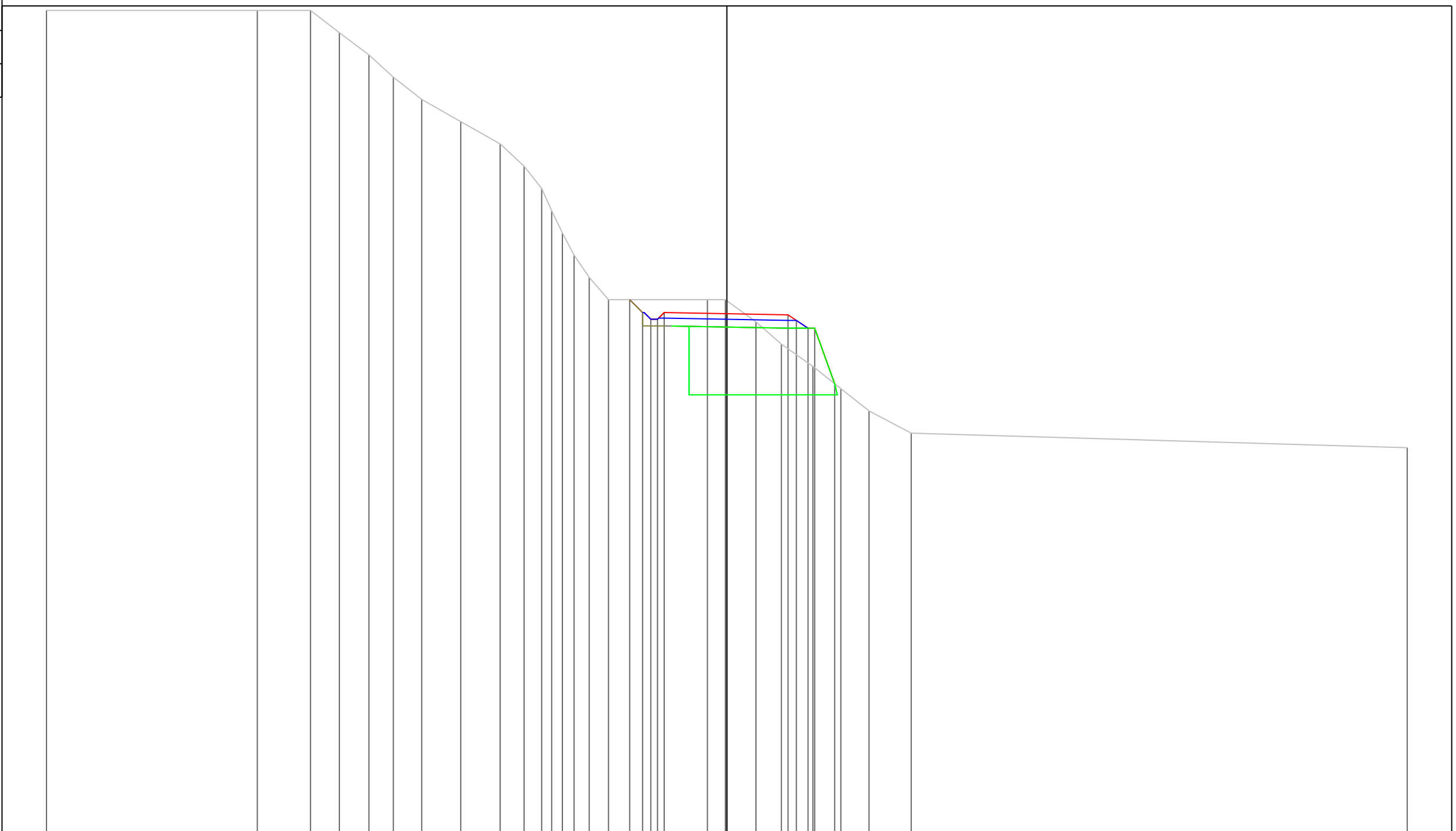

PROGRESSIVE TERRENO	-30.60	-21.12	-18.73	-17.43	-16.10	-15.00	-13.72	-11.97	-10.20	-9.12	-8.33	-7.88	-7.40	-6.87	-6.19	-5.32	-0.88	-0.07	1.31	2.45	3.87	5.13	6.39	8.29	30.60
PARZIALI TERRENO	9.48	2.39	1.30	1.33	1.10	1.28	1.75	1.77	1.08	0.79	0.45	0.48	0.53	0.68	0.87	4.44	0.81	1.38	1.14	1.42	1.26	1.26	1.90	22.31	
QUOTE TERRENO	137.00	137.00	137.00	136.00	135.00	134.00	133.00	132.00	131.00	130.00	129.00	128.00	127.00	126.00	125.00	124.00	124.00	123.00	122.00	121.00	120.00	119.00	118.00	117.35	
PROGRESSIVE PROGETTO																	0.00	0.00	2.75	3.13	3.65	3.95	4.85		
PARZIALI PROGETTO																	2.82	2.75	0.38	0.52	0.30	0.30	0.90		
QUOTE PROGETTO																	124.00	123.37	123.32	123.07	122.72	122.72	120.22		

PROFILO Asse4

SEZIONE 34

PROGRESSIVA 330.00

A STERRO m<sup>2</sup> 5.21  
B RIPORTO m<sup>2</sup> 5.33

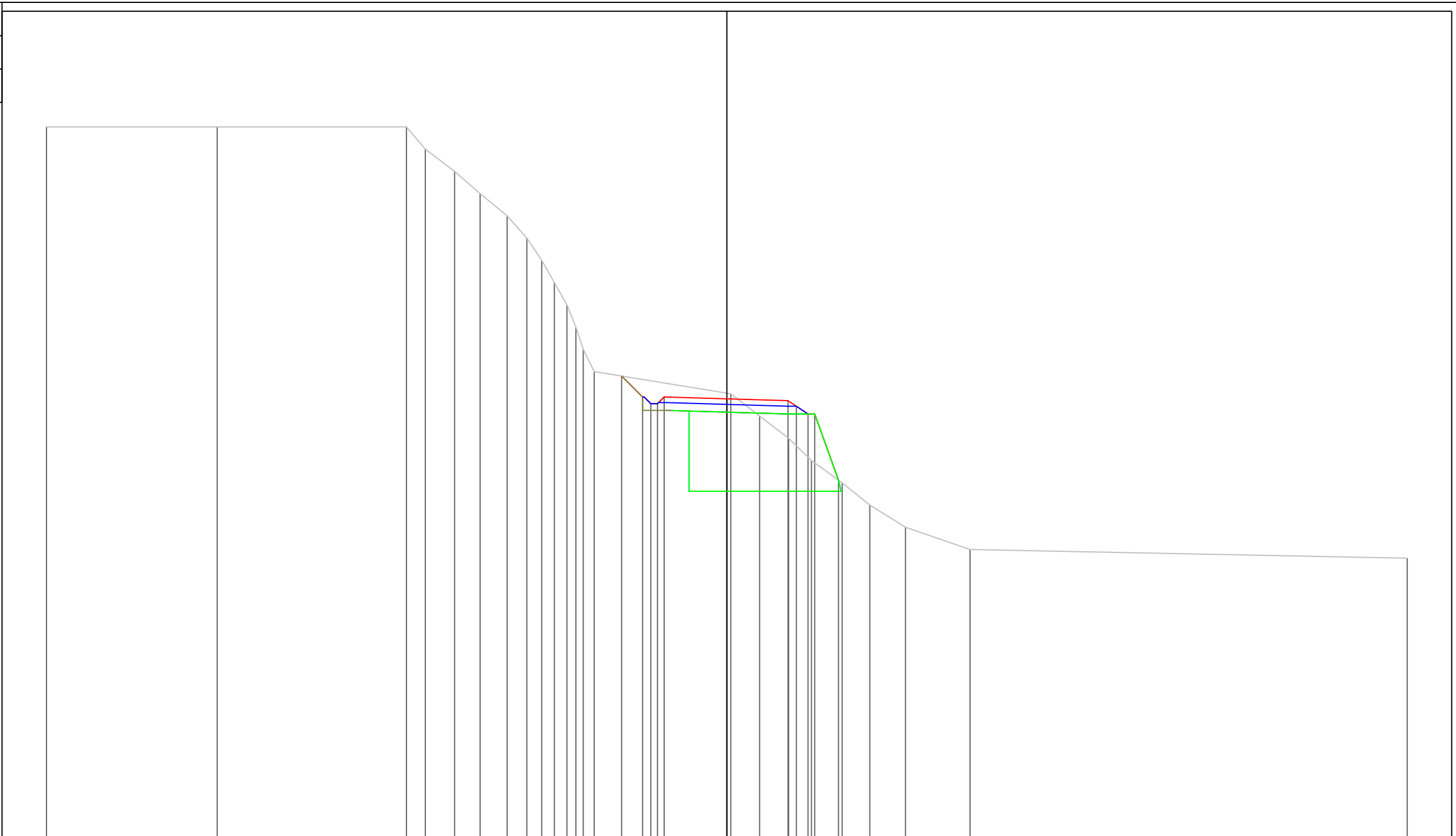

105

200 200

PROGRESSIVE TERRENO	-30.60	-22.92	-14.41	-13.56	-12.25	-11.10	-9.88	-9.00	-8.33	-7.76	-7.19	-6.79	-6.46	-5.97	0.18	1.47	2.78	3.80	5.19	6.43	8.03	10.94	30.60		
PARZIALI TERRENO		7.68	8.51	0.85	1.31	1.15	1.22	0.88	0.67	0.57	0.57	0.40	0.33	0.49	6.15	1.29	1.31	1.02	1.39	1.24	1.60	2.91	19.66		
QUOTE TERRENO	137.00	137.00	137.00	136.00	135.00	134.00	133.00	132.00	131.00	130.00	129.00	128.00	127.00	126.00	125.00	124.00	123.00	122.00	121.00	120.00	119.00	118.00	117.61		
PROGRESSIVE PROGETTO															0.00	2.75	3.13	3.65	3.95	5.02					
PARZIALI PROGETTO															0.94	0.37	0.30	0.30	0.30	2.82	2.75	0.38	0.52	0.30	1.07
QUOTE PROGETTO															125.80	124.86	124.56	124.56	124.86	124.77	124.69	124.44	124.09	121.12	

PROFILO Asse4

SEZIONE 35

PROGRESSIVA 340.00

A STERRO m<sup>2</sup> 5.57  
B RIPORTO m<sup>2</sup> 6.44

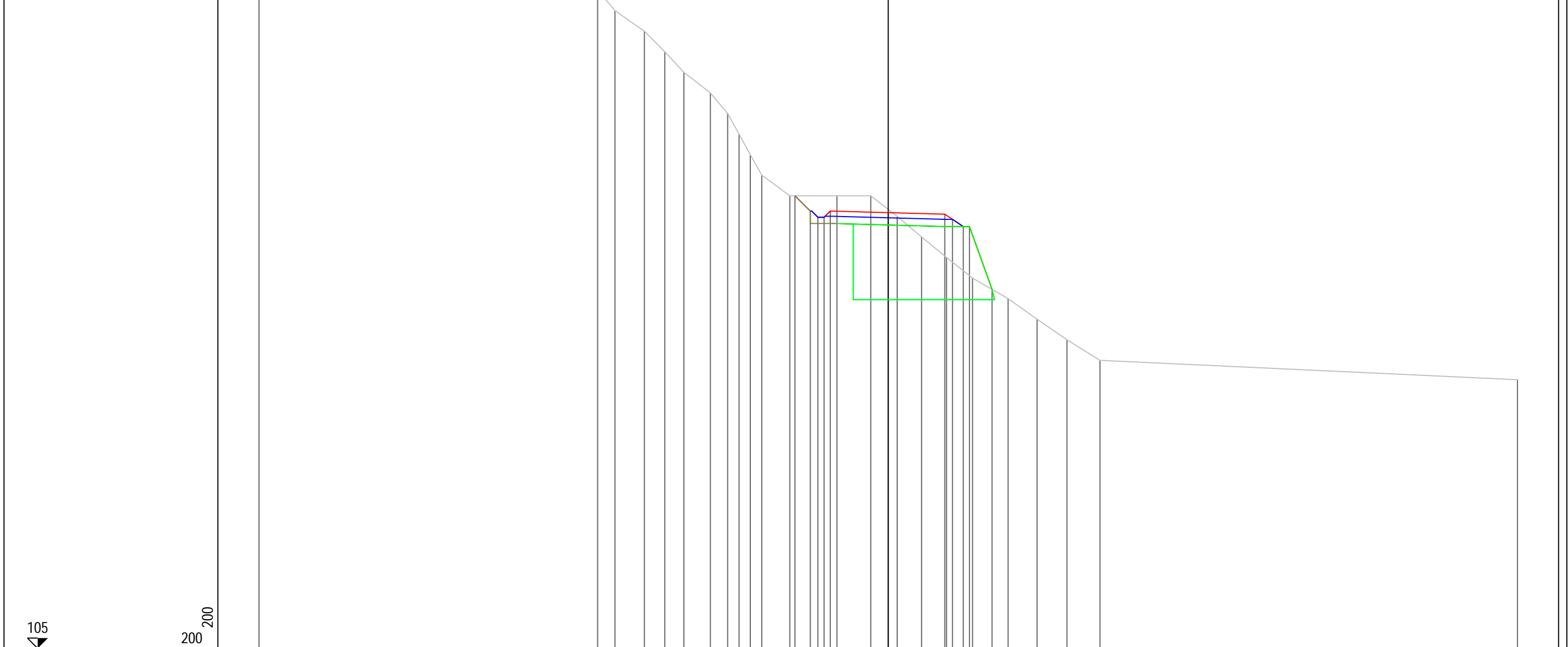

PROGRESSIVE TERRENO	-30.60						-14.13	-13.29	-11.86	-10.87	-9.94	-8.65	-7.81	-7.25	-6.71	-6.15	-4.79	-2.49	-0.85	0.43	1.62	2.84	4.10	5.83	7.24	8.69	10.30	30.60
PARZIALI TERRENO		16.47	0.84	1.43	0.99	0.93	1.29	0.84	0.56	0.54	0.56	1.36	2.30	1.64	1.28	1.19	1.22	1.26	1.73	1.41	1.45	1.61				20.30		
QUOTE TERRENO	137.33		137.00	136.00	135.00	134.00	133.00	132.00	131.00	130.00	129.00	128.00	127.00	127.00	127.00	126.00	125.00	124.00	123.00	122.00	121.00	120.00	119.00				118.06	
PROGRESSIVE PROGETTO													-4.54	-3.79	-3.42	-3.12	-2.82	0.00				2.75	3.13	3.65	5.05			
PARZIALI PROGETTO													0.75	0.37	0.30	0.30	2.82		2.75			0.38	0.52	0.30	1.10			
QUOTE PROGETTO													127.00	126.25	125.95	126.25		126.18				126.10	125.85	125.50	122.45			

PROFILO Asse4  
 SEZIONE 36  
 PROGRESSIVA 350.00  
 A STERRO m<sup>2</sup> 11.75  
 B RIPORTO m<sup>2</sup> 2.42

105  
 200  
 200

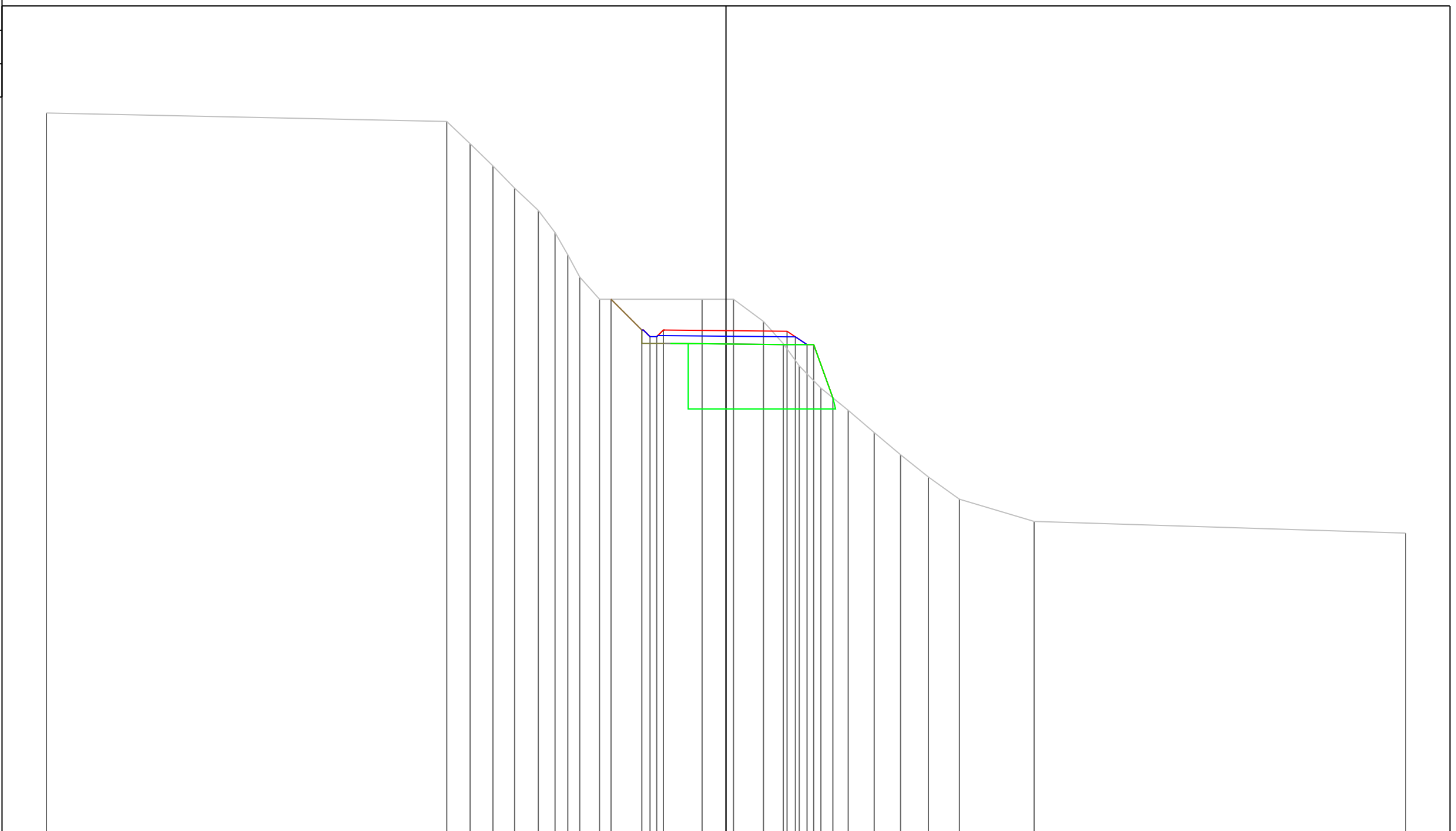

PROGRESSIVE TERRENO	-30.60		-12.57	-11.52	-10.49	-9.52	-8.45	-7.70	-7.12	-6.59	-5.70		-1.08	0.34	1.69	2.58	3.30	4.27	5.50	6.67	7.86	9.11	10.51	13.87	30.60
PARZIALI TERRENO		18.03	1.05	1.03	0.97	1.07	0.75	0.58	0.53	0.89	4.62	1.42	1.35	0.89	0.72	0.97	1.23	1.17	1.19	1.25	1.40	3.36	16.73		
QUOTE TERRENO	137.38		137.00	136.00	135.00	134.00	133.00	132.00	131.00	130.00	129.00		129.00	129.00	128.00	127.00	126.00	125.00	124.00	123.00	122.00	121.00	120.00	119.00	118.47
PROGRESSIVE PROGETTO											-5.18	-3.79	-3.42	-3.12	-2.82	0.00	2.75	3.13	3.65	3.95	4.81				
PARZIALI PROGETTO											1.39	0.37	0.30	0.30	2.82	2.75	0.38	0.52	0.30	0.86					
QUOTE PROGETTO											129.00	127.61	127.31	127.31	127.61	127.59	127.56	127.31	126.96	126.96	124.56				

PROFILO Asse4

SEZIONE 37

PROGRESSIVA 360.00

A STERRO m<sup>2</sup> 8.63  
B RIPORTO m<sup>2</sup> 5.28

105

200  
200

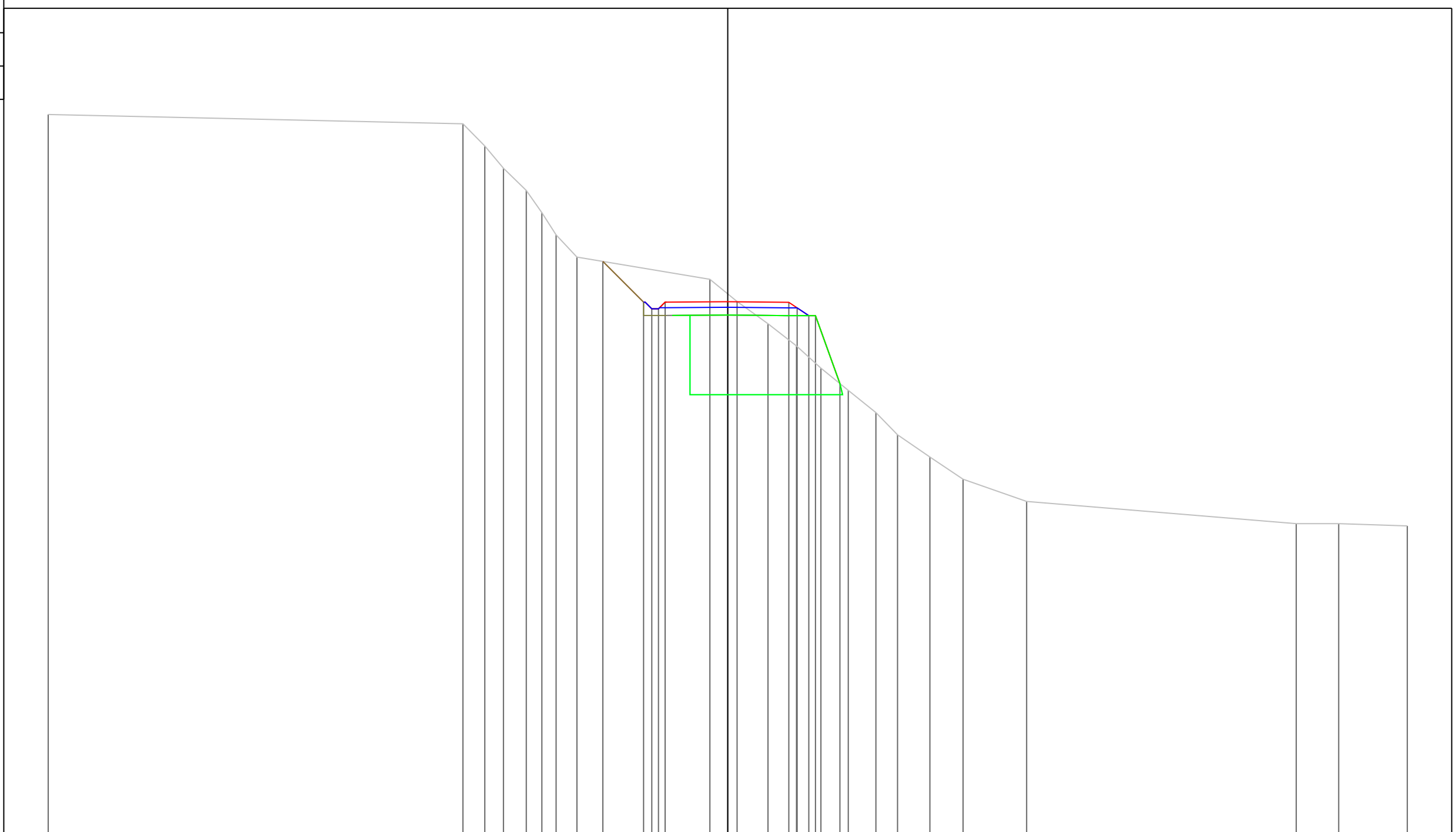

PROGRESSIVE TERRENO	-30.60					-11.93	-10.94	-10.10	-9.07	-8.37	-7.73	-6.79			-0.80	0.42	1.81	3.10	4.20	5.43	6.67	7.65	9.10	10.60	13.46				25.60	27.51	30.60
PARZIALI TERRENO		18.67				0.99	0.84	1.03	0.70	0.64		0.94			5.99	1.22	1.39	1.29	1.10	1.23	1.24	0.98	1.45	1.50	2.86				12.14	1.91	3.09
QUOTE TERRENO	137.42					137.00	136.00	135.00	134.00	133.00	132.00	131.00			130.00	129.00	128.00	127.00	126.00	125.00	124.00	123.00	122.00	121.00	120.00				119.00	119.00	118.90
PROGRESSIVE PROGETTO															-5.62	0.00				2.75	3.12	3.65	3.95	5.05							
PARZIALI PROGETTO															1.83	2.82				2.75	0.37	0.53	0.30	0.30	1.10						
QUOTE PROGETTO															130.80	128.99				128.96	128.71	128.36	128.36	125.31							

PROFILO Asse4

SEZIONE 38

PROGRESSIVA 370.00

A STERRO m<sup>2</sup> 6.09  
 B RIPORTO m<sup>2</sup> 6.41

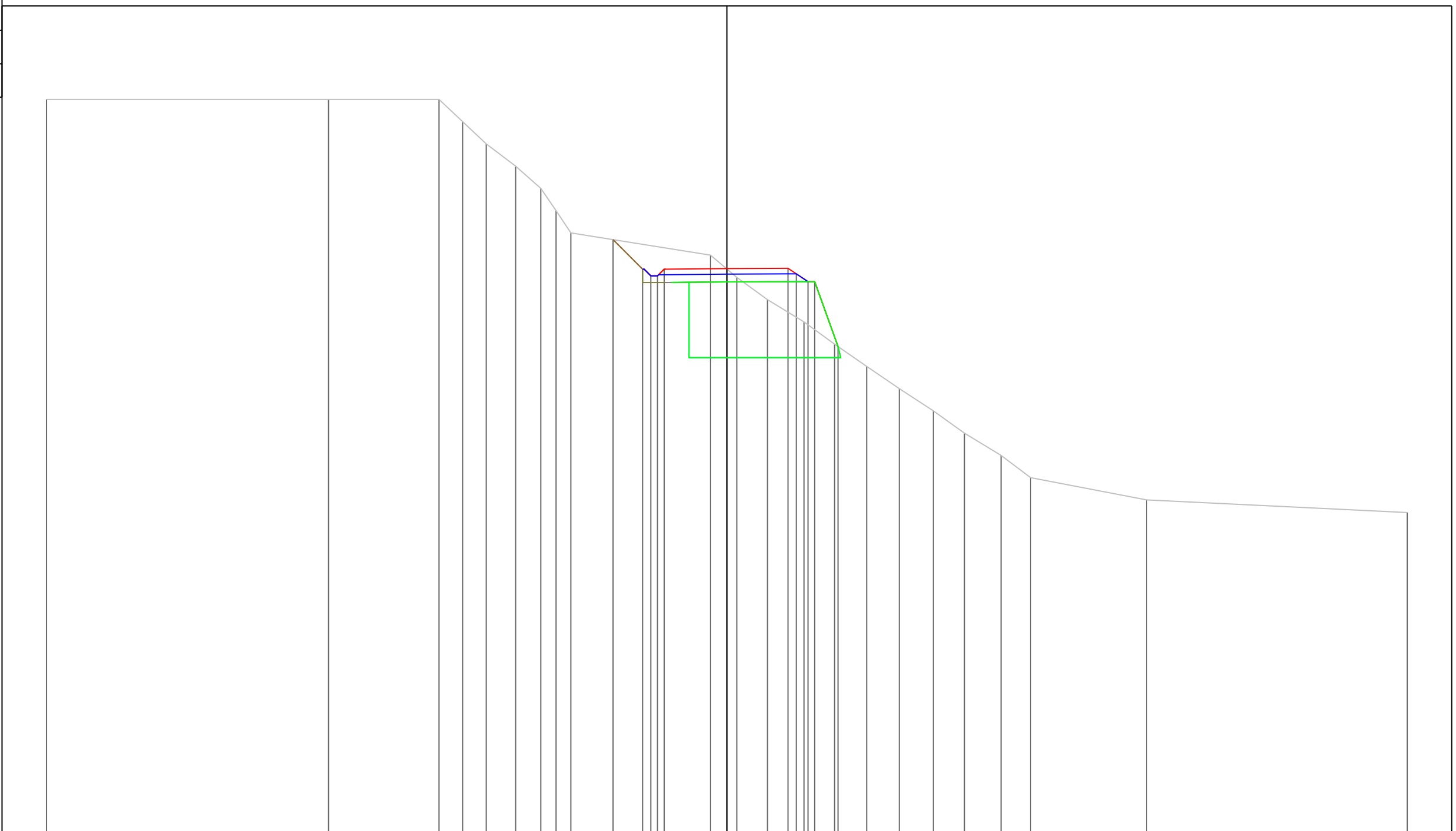

PROGRESSIVE TERRENO	-30.60	-17.92	-12.95	-11.88	-10.82	-9.50	-8.37	-7.68	-7.02	-0.73	0.45	1.83	3.47	4.84	6.29	7.76	9.29	10.68	12.33	13.66	18.88	30.60
PARZIALI TERRENO	12.68	4.97	1.07	1.06	1.32	1.13	0.69	0.66	6.29	1.18	1.38	1.64	1.37	1.45	1.47	1.53	1.39	1.65	1.33	5.22	11.72	
QUOTE TERRENO	138.00	138.00	138.00	137.00	136.00	135.00	134.00	133.00	132.00	131.00	130.00	129.00	128.00	127.00	126.00	125.00	124.00	123.00	122.00	121.00	120.00	119.43
PROGRESSIVE PROGETTO										0.00	2.75	3.12	3.65	5.00								
PARZIALI PROGETTO										2.82	2.75	0.37	0.53	0.30	1.05							
QUOTE PROGETTO										131.70	130.37	130.07	130.07	130.37	130.40	130.41	130.16	129.81	129.81	126.89		





PROFILO Asse4

SEZIONE 40

PROGRESSIVA 390.00

A STERRO m<sup>2</sup> 11.10

105

200  
200

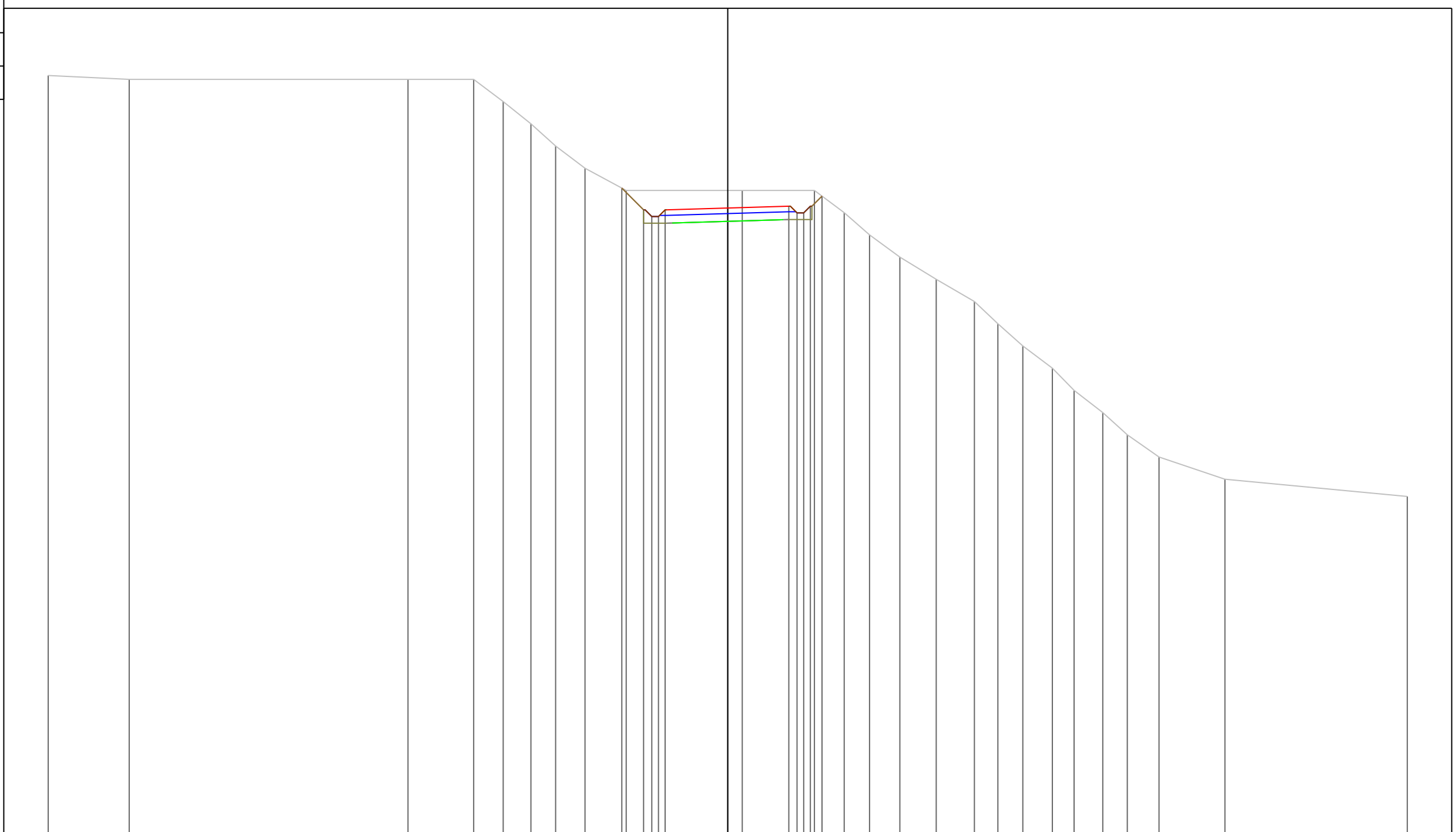

PROGRESSIVE TERRENO	-30.60	-26.95		-14.40	-11.44	-10.11	-8.86	-7.75	-6.43	-4.57		0.65	3.90	5.24	6.39	7.75	9.39	11.11	12.16	13.29	14.62	15.60	16.89	17.99	19.42	22.39		30.60
PARZIALI TERRENO	3.65	12.55	2.96	1.33	1.25	1.11	1.32	1.86	5.22	3.25	1.34	1.15	1.36	1.64	1.72	1.05	1.13	1.33	0.98	1.29	1.10	1.43	2.97	8.21				
QUOTE TERRENO	139.17	139.00	139.00	139.00	138.00	137.00	136.00	135.00	134.00	134.00	134.00	134.00	134.00	133.00	132.00	131.00	130.00	129.00	128.00	127.00	126.00	125.00	124.00	123.00	122.00	121.00	120.22	
PROGRESSIVE PROGETTO										-4.77	-3.79	-3.42	-3.12	-2.82	0.00	2.75	3.12	3.42	3.72	4.24								
PARZIALI PROGETTO										0.98	0.37	0.30	0.30	2.82	2.75	0.37	0.30	0.30	0.30	0.52								
QUOTE PROGETTO										134.11	133.13	132.83	132.83	133.13	133.21	133.29	132.99	132.99	133.29	133.75								





PROFILO Asse4

SEZIONE 43

PROGRESSIVA 420.00

A STERRO m<sup>2</sup> 5.68  
B RIPORTO m<sup>2</sup> 0.48

110

200  
200

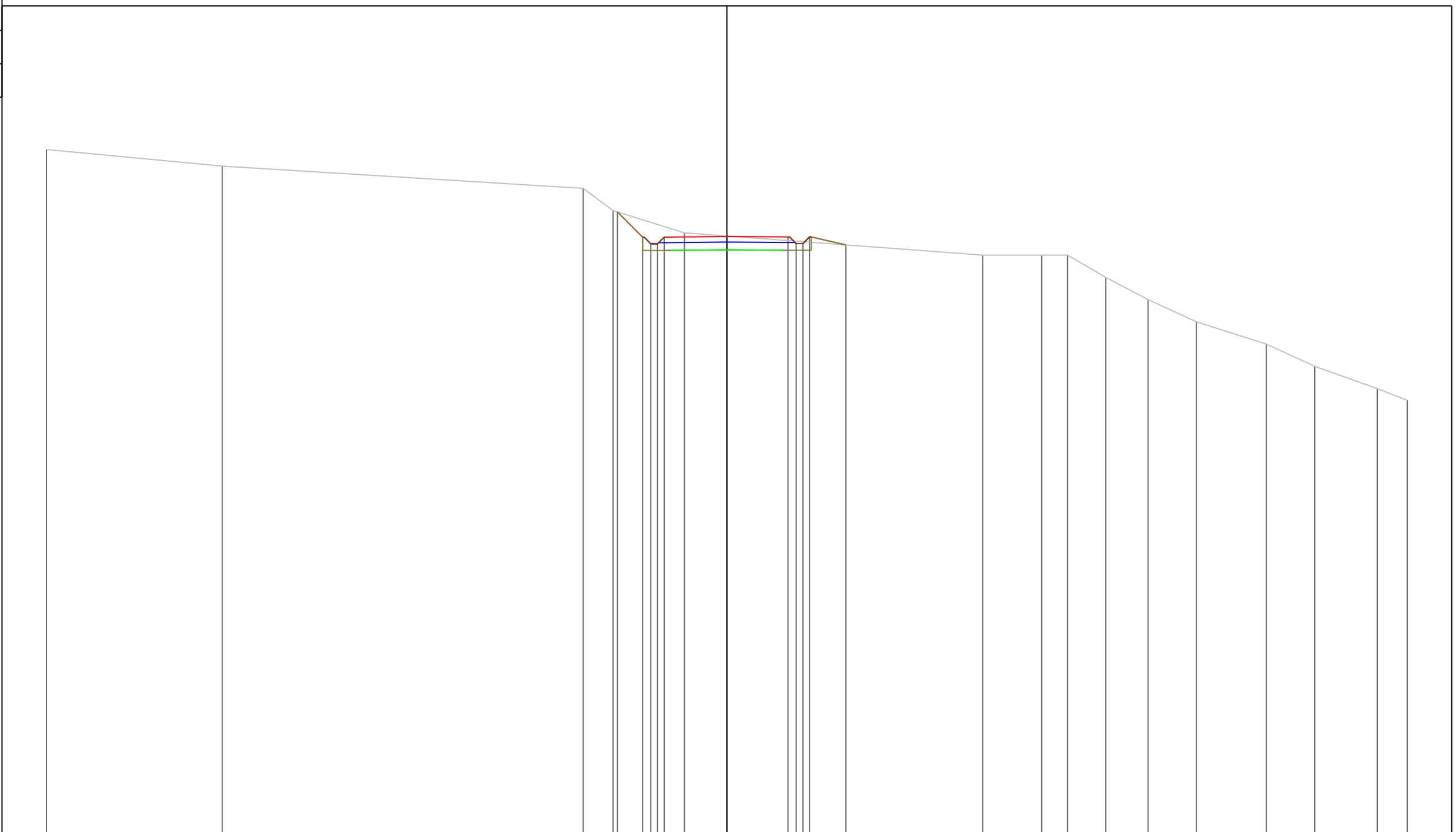

PROGRESSIVE TERRENO	-30.60	-22.70	-6.46	-5.12	-1.91	11.51	14.16	15.32	17.04	18.94	21.12	24.26	26.44	29.25	30.60
PARZIALI TERRENO	7.90	16.24	1.34	3.21	13.42	2.65	1.16	1.72	1.90	2.18	3.14	2.18	2.81	1.35	
QUOTE TERRENO	140.75	140.00	139.00	138.00	137.00	136.00	136.00	136.00	135.00	134.00	133.00	132.00	131.00	130.00	129.47
PROGRESSIVE PROGETTO				-4.92	-3.79	-3.42	-3.12	-2.82	0.00	2.75	3.12	3.42	3.72	5.35	
PARZIALI PROGETTO			1.13	0.37	0.30	0.30	2.82	2.75	0.37	0.30	0.30	1.63			
QUOTE PROGETTO			137.94	136.81	136.51	136.51	136.81	136.84	136.82	136.52	136.52	136.82	136.46		

PROFILO Asse4

SEZIONE 44

PROGRESSIVA 430.00

A STERRO m<sup>2</sup> 8.13

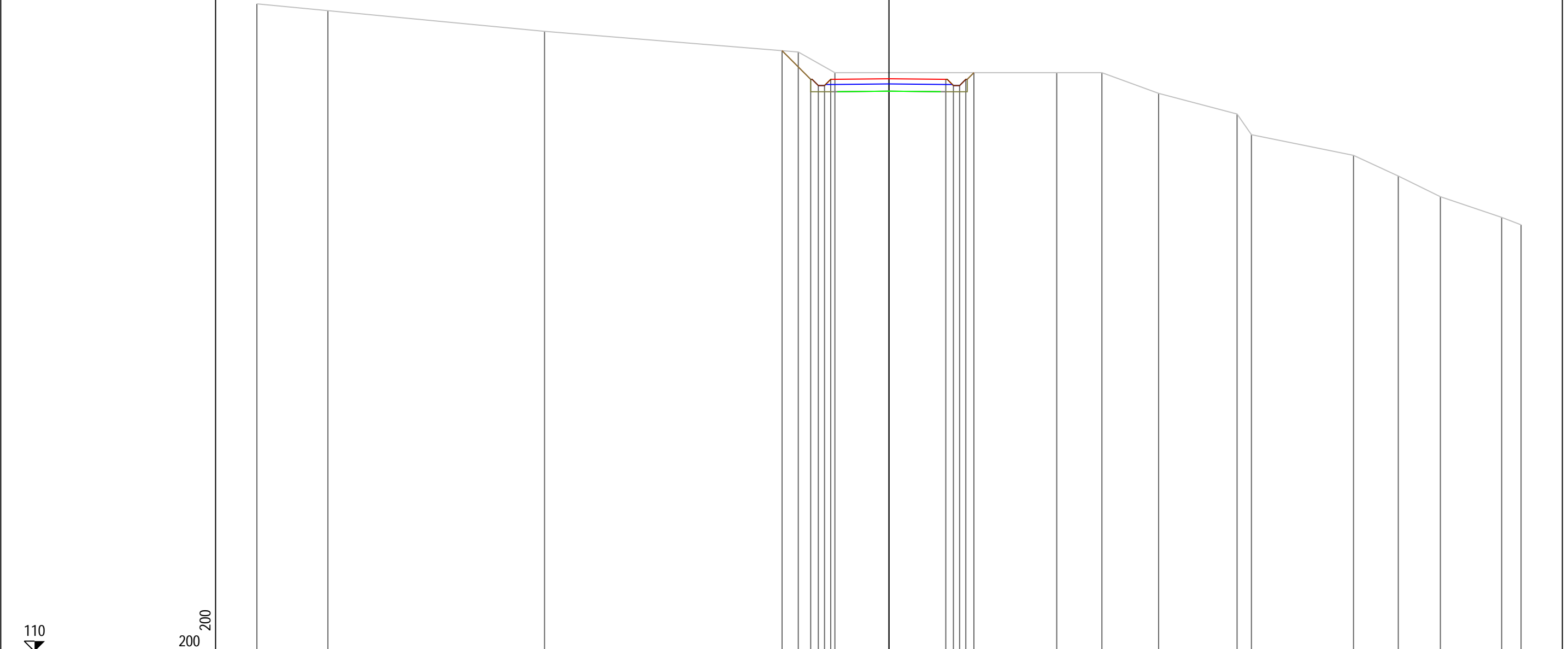

PROGRESSIVE TERRENO	-30.60	-27.16		-16.68		-4.39	-2.62		8.12	10.31	13.05		16.85	17.55		22.49	24.66	26.69	29.66	30.60
PARZIALI TERRENO		3.44	10.48		12.29	1.77		10.74	2.19	2.74	3.80		0.70	4.94	2.17	2.03	2.97	0.94		
QUOTE TERRENO	141.33	141.00		140.00		139.00	138.00		138.00	138.00	137.00		136.00	135.00		134.00	133.00	132.00	131.00	130.64
PROGRESSIVE PROGETTO						-5.18	-3.79	-3.42	-3.12	-2.82	0.00		2.75	3.12	3.42	3.72	4.11			
PARZIALI PROGETTO						1.39	0.37	0.30	0.30	2.82	2.75		0.37	0.30	0.30	0.30	0.39			
QUOTE PROGETTO						139.06	137.68	137.38	137.38	137.68	137.71		137.68	137.38	137.38	137.68	138.00			

PROFILO Asse4

SEZIONE 45

PROGRESSIVA 440.00

A STERRO m<sup>2</sup> 10.21

115

200  
200

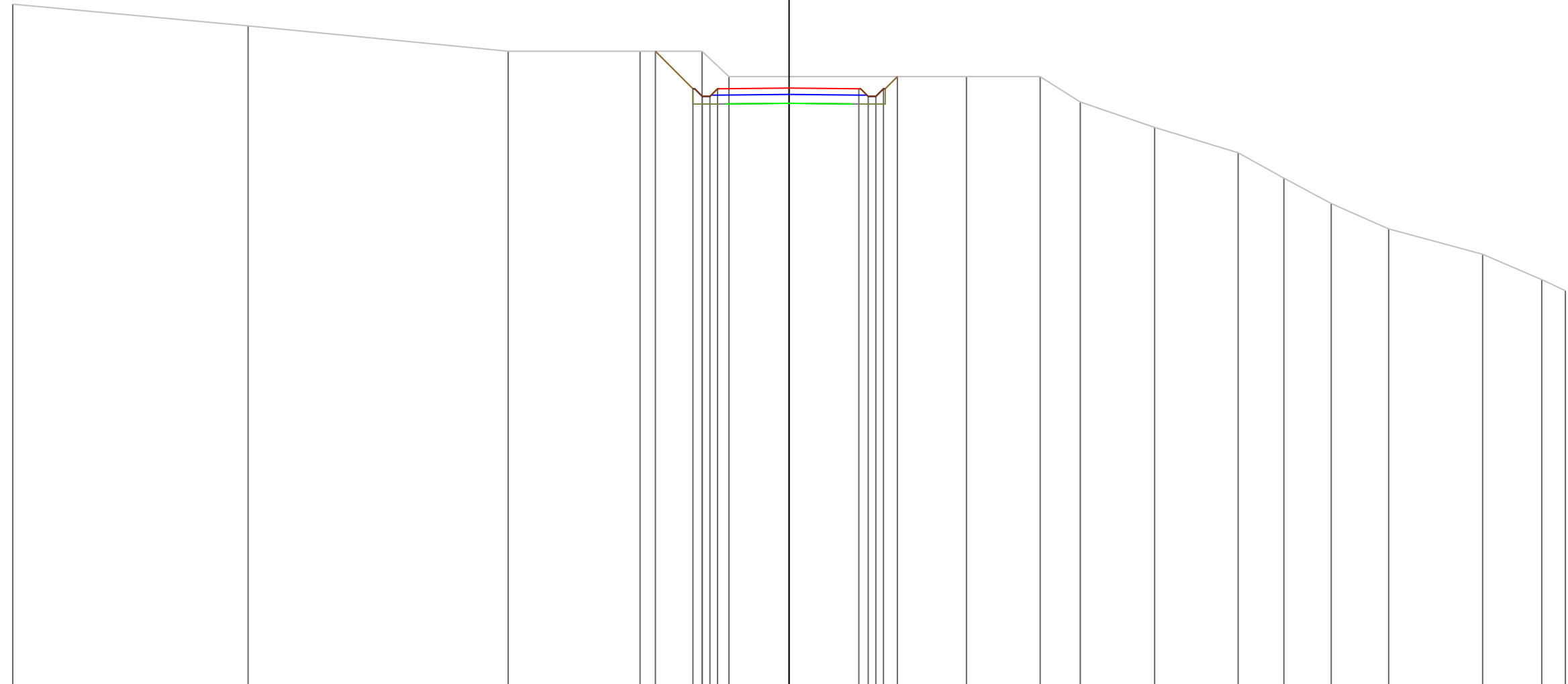

PROGRESSIVE TERRENO	-30.60	-21.32	-11.07	-5.87	-3.43	-2.37	6.99	9.90	11.48	14.41	17.70	19.50	21.37	23.63	27.34	29.67	30.60
PARZIALI TERRENO	9.28	10.25	5.20	2.44	1.06	9.36	2.91	1.58	2.93	3.29	1.80	1.87	2.26	3.71	2.33	0.93	
QUOTE TERRENO	141.85	141.00	140.00	140.00	140.00	139.00	139.00	139.00	138.00	137.00	136.00	135.00	134.00	133.00	132.00	131.00	130.57
PROGRESSIVE PROGETTO				-5.27	-3.79	-3.42	-3.12	-2.82	0.00	2.75	3.12	3.42	3.72	4.27			
PARZIALI PROGETTO				1.48	0.37	0.30	0.30	2.82	2.75	0.37	0.30	0.30	0.30	0.55			
QUOTE PROGETTO				140.00	138.52	138.22	138.22	138.52	138.55	138.52	138.22	138.22	138.52	139.00			

PROFILO Asse4

SEZIONE 46

PROGRESSIVA 450.00

A STERRO m<sup>2</sup> 8.13

115

200  
200

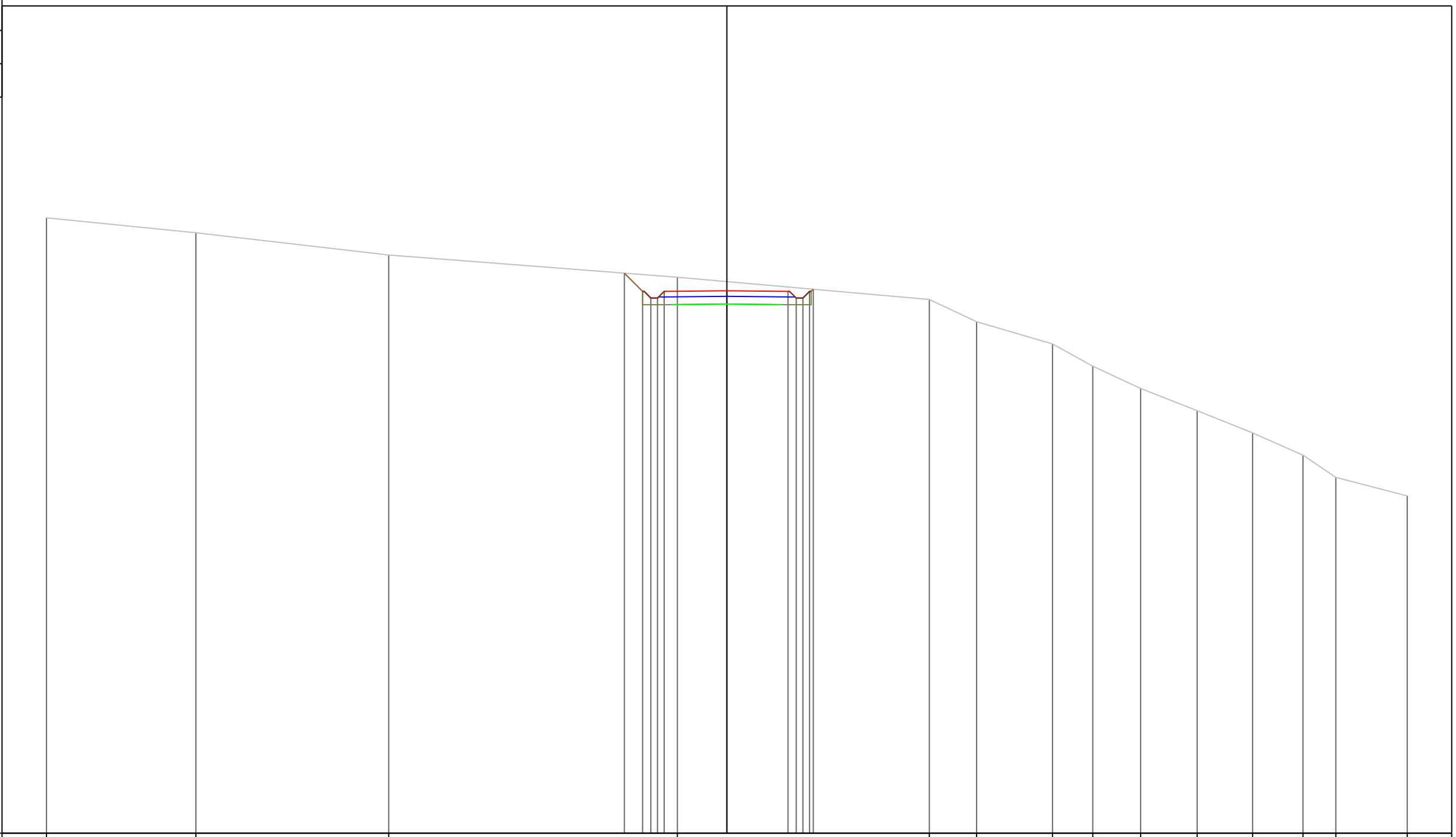

PROGRESSIVE TERRENO	-30.60	-23.88	-15.21	-2.23	9.10	11.23	14.65	16.46	18.61	21.15	23.65	25.91	27.39	30.60
PARZIALI TERRENO	6.72	8.67	12.98	11.33	2.13	3.42	1.81	2.15	2.54	2.50	2.26	1.48	3.21	
QUOTE TERRENO	142.67	142.00	141.00	140.00	139.00	138.00	137.00	136.00	135.00	134.00	133.00	132.00	131.00	130.17
PROGRESSIVE PROGETTO														
PARZIALI PROGETTO														
QUOTE PROGETTO														

0.82  
 140.18  
 139.36  
 0.37  
 139.36  
 0.30  
 139.06  
 0.30  
 139.06  
 0.30  
 139.36  
 2.82  
 139.39  
 2.75  
 139.36  
 0.37  
 139.06  
 0.30  
 139.06  
 0.30  
 139.36  
 0.17  
 2.75  
 2.75  
 3.12  
 3.42  
 3.72  
 3.89





PROFILO Asse4

SEZIONE 48

PROGRESSIVA 470.00

A STERRO m<sup>2</sup> 3.12  
 B RIPORTO m<sup>2</sup> 1.50

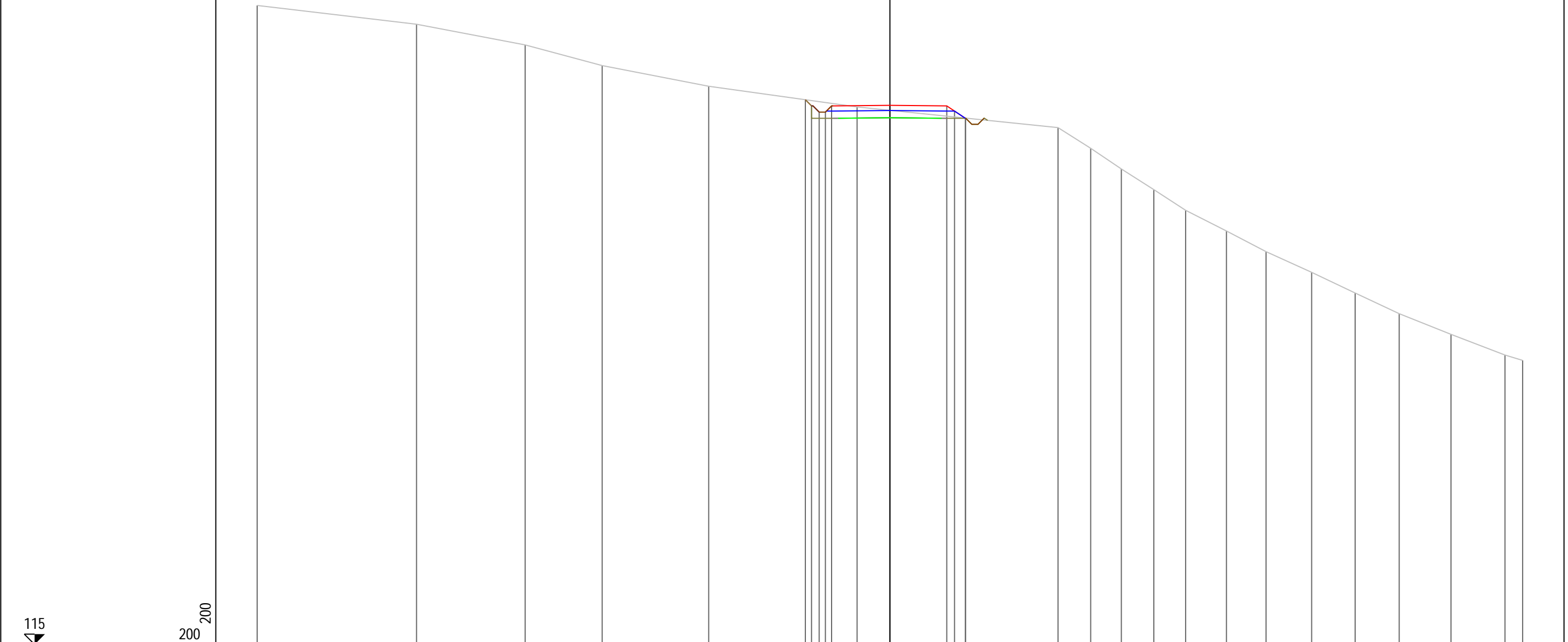

PROGRESSIVE TERRENO	-30.60	-22.89	-17.64	-13.91	-8.76	-1.59		8.13	9.71	11.19	12.76	14.30	16.28	18.19	20.40	22.50	24.63	27.14	29.74	30.60
PARZIALI TERRENO		7.71	5.25	3.73	5.15	7.17		9.72	1.58	1.48	1.57	1.54	1.98	1.91	2.21	2.10	2.13	2.51	2.60	0.86
QUOTE TERRENO	145.91	145.00	144.00	143.00	142.00	141.00		140.00	139.00	138.00	137.00	136.00	135.00	134.00	133.00	132.00	131.00	130.00	129.00	128.74
PROGRESSIVE PROGETTO																				
PARZIALI PROGETTO																				
QUOTE PROGETTO																				

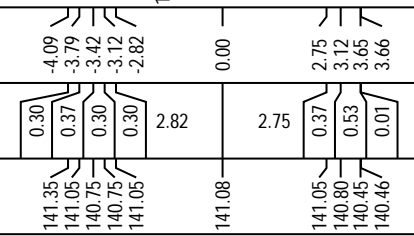

PROFILO Asse4

SEZIONE 49

PROGRESSIVA 480.00

A STERRO m<sup>2</sup> 5.41

115

200  
200

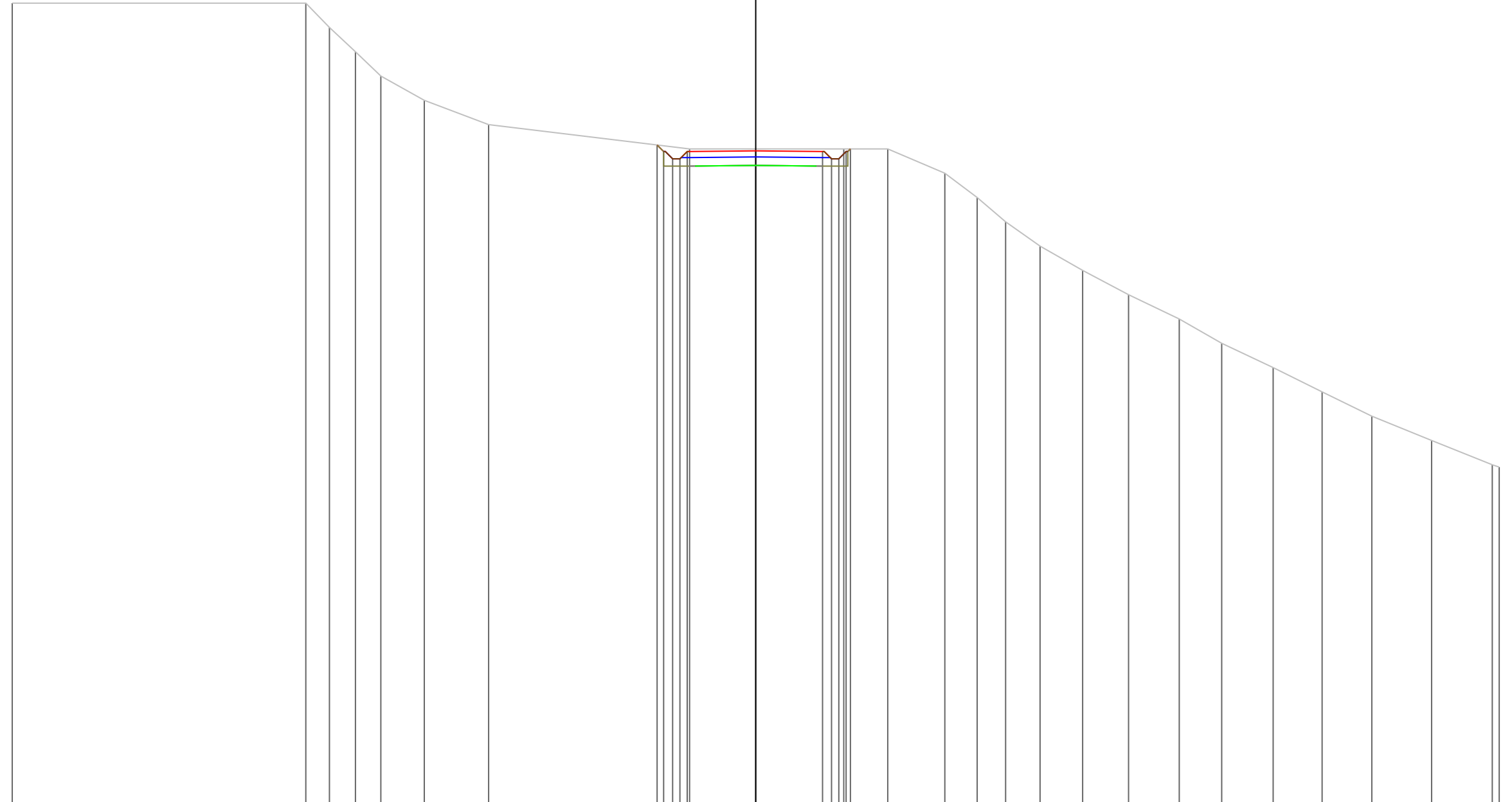

PROGRESSIVE TERRENO	-30.60	-18.52	-17.54	-16.47	-15.43	-13.64	-10.99	-2.72	3.62	5.43	7.78	9.11	10.28	11.70	13.46	15.34	17.43	19.18	21.30	23.31	25.36	27.82	30.31	30.60
PARZIALI TERRENO	12.08	0.98	1.07	1.04	1.79	2.65	8.27	6.34	1.81	2.35	1.33	1.17	1.42	1.76	1.88	2.09	1.75	2.12	2.01	2.05	2.46	2.49	0.29	
QUOTE TERRENO	148.00	148.00	147.00	146.00	145.00	144.00	143.00	142.00	142.00	142.00	141.00	140.00	139.00	138.00	137.00	136.00	135.00	134.00	133.00	132.00	131.00	130.00	129.00	128.90
PROGRESSIVE PROGETTO								-4.06	-3.79	-3.42	-3.12	-2.82	0.00	2.75	3.12	3.42	3.72	3.90						
PARZIALI PROGETTO								0.27	0.37	0.30	0.30	2.82	2.75	0.37	0.30	0.30	0.30	0.18						
QUOTE PROGETTO								142.16	141.89	141.59	141.59	141.89	141.92	141.89	141.59	141.59	141.89	142.00						

PROFILO Asse4

SEZIONE 50

PROGRESSIVA 490.00

A STERRO m<sup>2</sup> 6.93

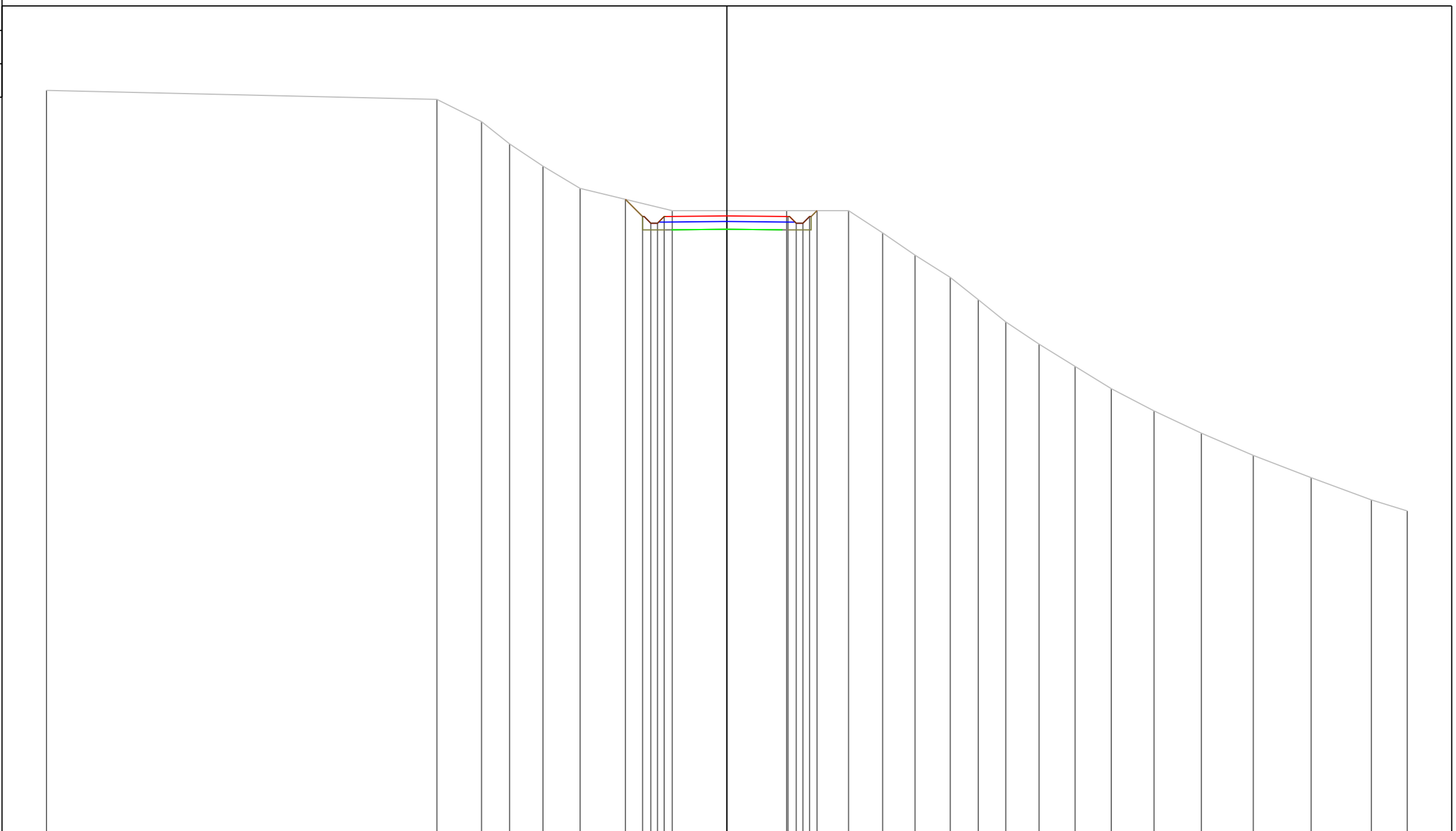

115

200  
200

PROGRESSIVE TERRENO	-30.60	-13.04	-11.03	-9.77	-8.27	-6.60	-2.46	2.69	5.47	7.01	8.46	10.05	11.31	12.54	14.04	15.66	17.29	19.21	21.34	23.68	26.28	28.99	30.60
PARZIALI TERRENO		17.56	2.01	1.26	1.50	1.67	4.14	5.15	2.78	1.54	1.45	1.59	1.26	1.23	1.50	1.62	1.63	1.92	2.13	2.34	2.60	2.71	1.61
QUOTE TERRENO	148.40	148.00	147.00	146.00	145.00	144.00	143.00	143.00	143.00	142.00	141.00	140.00	139.00	138.00	137.00	136.00	135.00	134.00	133.00	132.00	131.00	130.00	129.50
PROGRESSIVE PROGETTO							-4.56	-3.79	-3.42	-3.12	-2.82	0.00	2.75	3.12	3.42	3.72	4.05						
PARZIALI PROGETTO							0.77	0.37	0.30	0.30	2.82	2.75	0.37	0.30	0.30	0.30	0.33						
QUOTE PROGETTO							143.51	142.74	142.44	142.44	142.74	142.76	142.74	142.44	142.44	142.74	143.00						

PROFILO Asse4

SEZIONE 51

PROGRESSIVA 500.00

A STERRO m<sup>2</sup> 10.12

120

200  
200

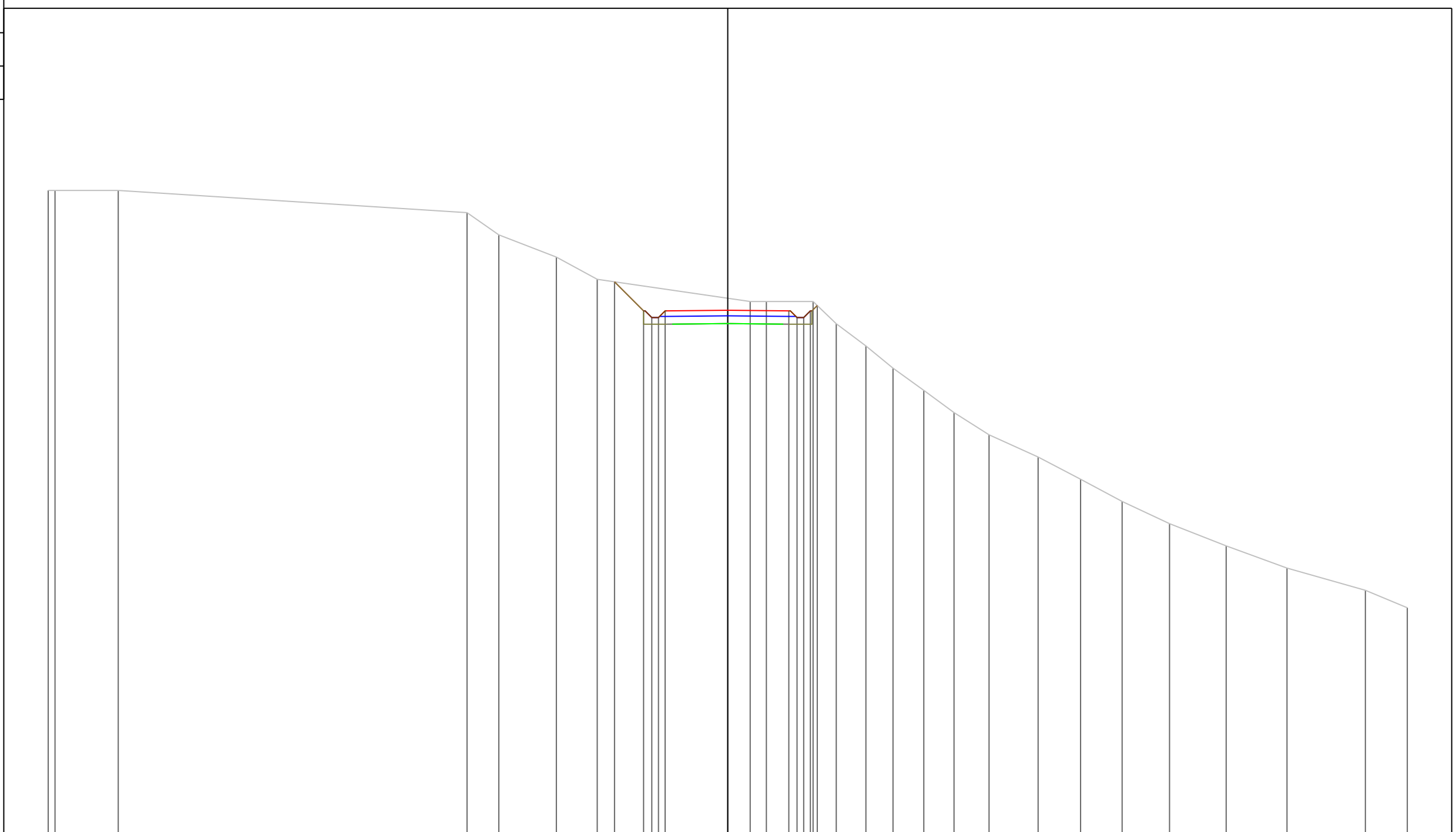

PROGRESSIVE TERRENO	-30.60	-30.29	-27.45	-11.74	-10.31	-7.72	-5.88	1.01	1.74	3.84	4.89	6.22	7.44	8.83	10.19	11.77	13.98	15.89	17.76	19.89	22.44	25.18	28.71	30.60
PARZIALI TERRENO	0.31	2.84	15.71	1.43	2.59	1.84	6.89	0.73	2.10	1.05	1.33	1.22	1.39	1.36	1.58	2.21	1.91	1.87	2.13	2.55	2.74	3.53	1.89	
QUOTE TERRENO	149.00	149.00	149.00	148.00	147.00	146.00	145.00	144.00	144.00	144.00	143.00	142.00	141.00	140.00	139.00	138.00	137.00	136.00	135.00	134.00	133.00	132.00	131.00	130.21
PROGRESSIVE PROGETTO							-5.10	0.00	2.75	3.12	3.72	4.03												
PARZIALI PROGETTO							1.31	0.37	0.30	0.30	2.82	2.75	0.37	0.30	0.30	0.30	0.31							
QUOTE PROGETTO							144.89	143.58	143.28	143.28	143.58	143.61	143.58	143.28	143.28	143.58	143.82							

PROFILO Asse4
SEZIONE 52
PROGRESSIVA 510.00
A STERRO m <sup>2</sup> 19.06

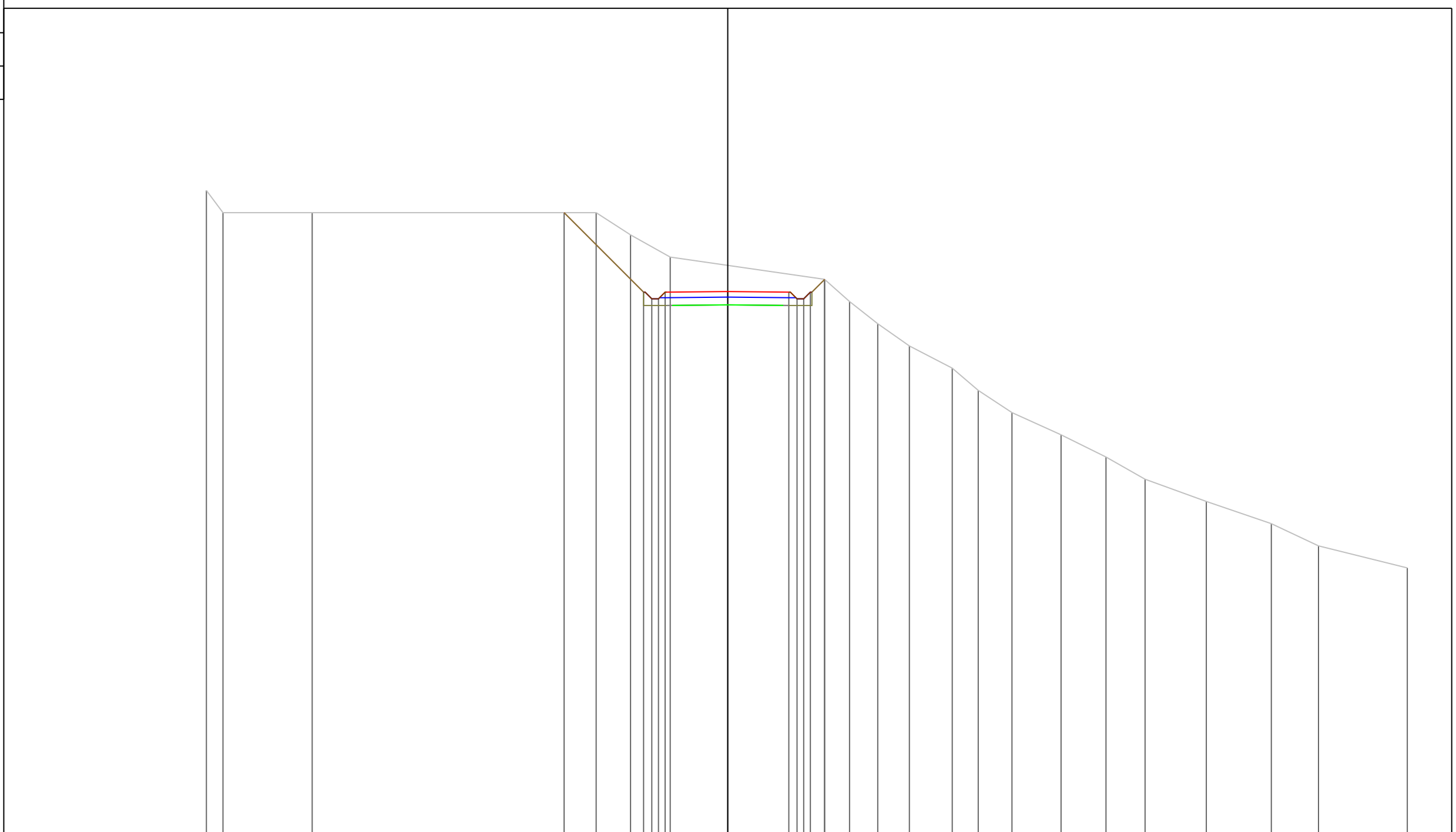

PROGRESSIVE TERRENO	-23.48	-22.73	-18.71	-5.93	-4.38	-2.59		4.36	5.48	6.75	8.18	10.11	11.28	12.80	15.01	17.03	18.79	21.55	24.48	26.60	30.60	
PARZIALI TERRENO	0.75	4.02		12.78	1.55	1.79		6.95	1.12	1.27	1.43	1.93	1.17	1.52	2.21	2.02	1.76	2.76	2.93	2.12	4.00	
QUOTE TERRENO	149.00	148.00	148.00	148.00	147.00	146.00		145.00	144.00	143.00	142.00	141.00	140.00	139.00	138.00	137.00	136.00	135.00	134.00	133.00	132.01	
PROGRESSIVE PROGETTO				-7.37	-3.79	-3.42	-2.82	0.00	2.75	3.12	3.42	3.72	4.36									
PARZIALI PROGETTO				3.58	0.37	0.30	0.30	2.82	2.75	0.37	0.30	0.30	0.64									
QUOTE PROGETTO				148.00	144.42	144.12	144.12	144.42	144.45	144.42	144.12	144.12	144.42	144.99								





PROFILO Asse4

SEZIONE 55

PROGRESSIVA 540.00

A STERRO m<sup>2</sup> 17.33

130

200  
200

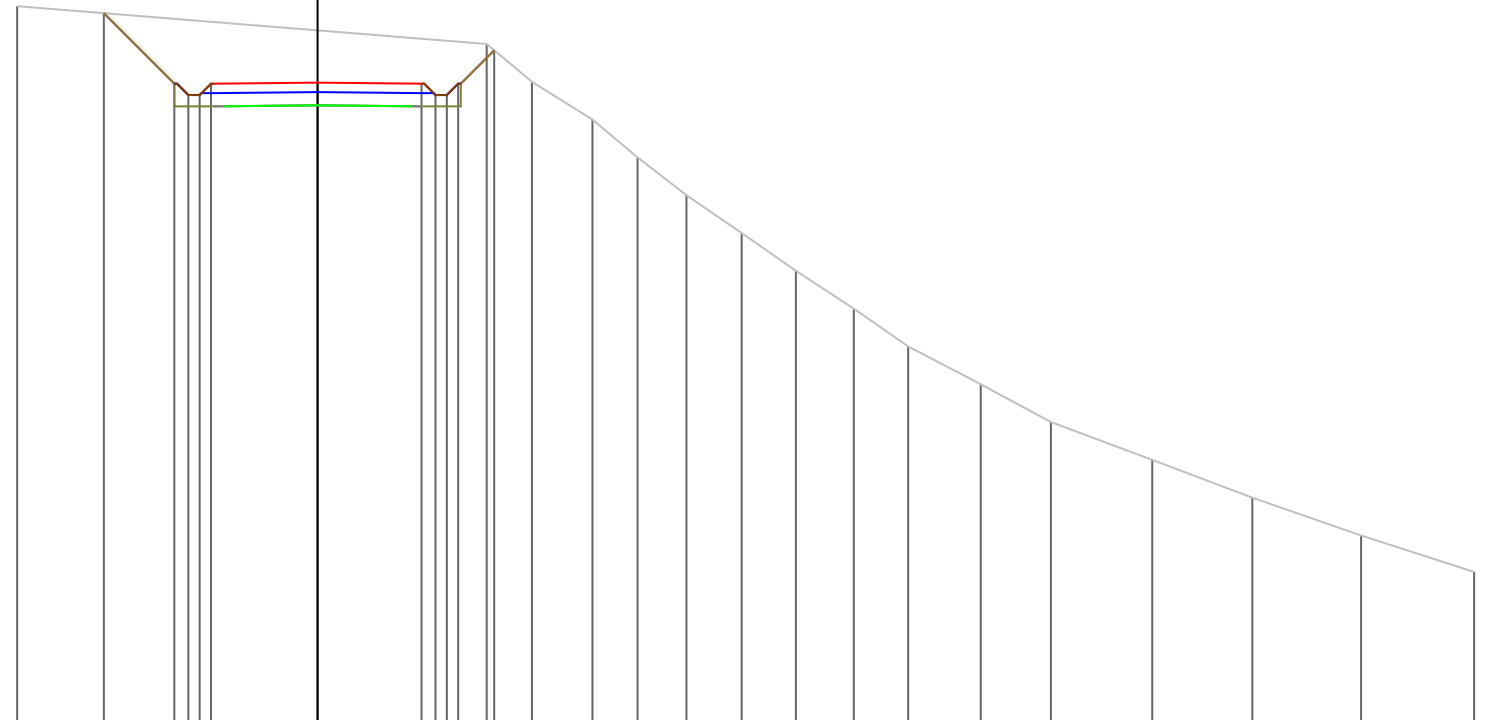

PROGRESSIVE TERRENO

-7.95 4.47 5.67 7.27 8.47 9.76 11.22 12.66 14.19 15.63 17.55 19.40 22.08 24.73 27.61 30.60

PARZIALI TERRENO

12.42 1.20 1.60 1.20 1.29 1.46 1.44 1.53 1.44 1.92 1.85 2.68 2.65 2.88 2.99

QUOTE TERRENO

149.00 148.00 147.00 146.00 145.00 144.00 143.00 142.00 141.00 140.00 139.00 138.00 137.00 136.00 135.00 134.04

PROGRESSIVE PROGETTO

-5.66 -3.79 -3.42 -3.12 -2.82 0.00 2.75 3.12 3.42 3.72 4.67

PARZIALI PROGETTO

1.87 0.37 0.30 0.30 2.82 2.75 0.37 0.30 0.30 0.95

QUOTE PROGETTO

148.82 146.95 146.65 146.65 146.95 146.98 146.95 146.65 146.65 146.95 147.83



PROFILO Asse4

SEZIONE 56

PROGRESSIVA 550.00

A STERRO m<sup>2</sup> 10.35

130

200  
200

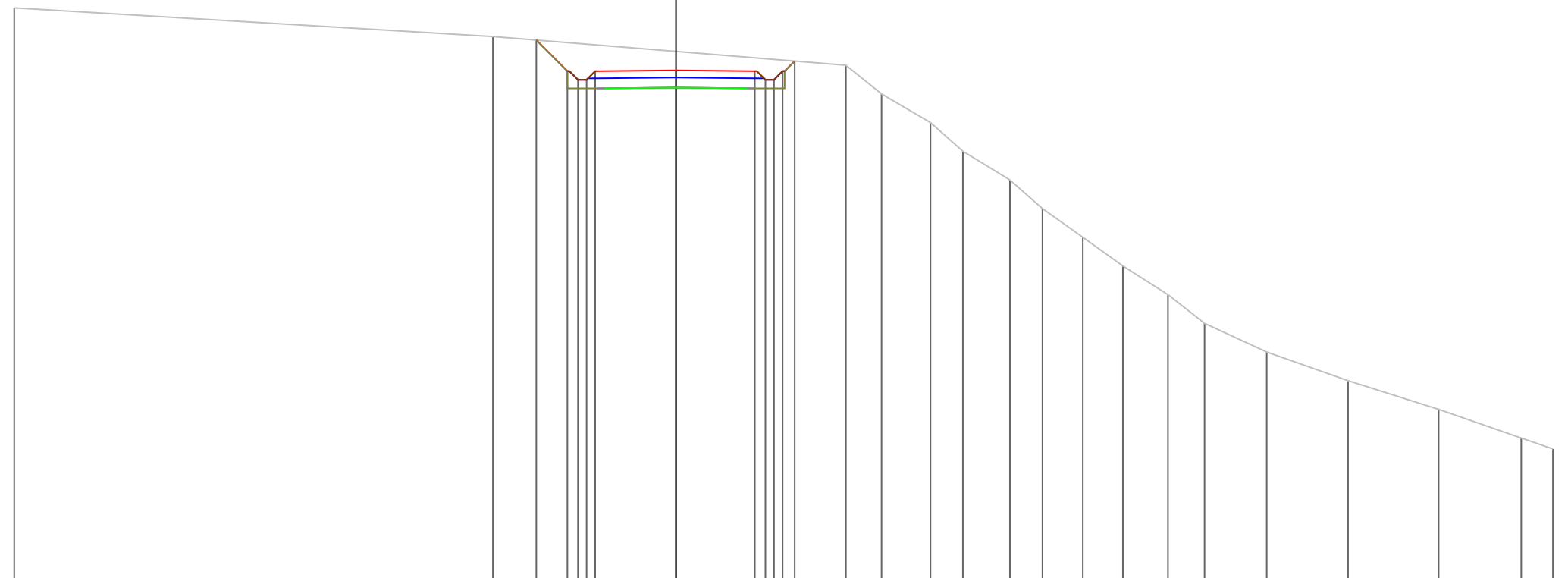

PROGRESSIVE TERRENO

-23.09

-6.39

5.93

7.17

8.88

10.01

11.65

12.79

14.20

15.59

17.17

18.44

20.61

23.45

26.61

29.50

30.60

PARZIALI TERRENO

16.70

12.32

1.24

1.71

1.13

1.64

1.14

1.41

1.39

1.58

1.27

2.17

2.84

3.16

2.89

1.10

QUOTE TERRENO

150.00

149.00

148.00

147.00

146.00

145.00

144.00

143.00

142.00

141.00

140.00

139.00

138.00

137.00

136.00

135.00

134.62

PROGRESSIVE PROGETTO

1.08

0.37

0.30

0.30

2.82

0.00

2.75

0.37

0.30

0.30

0.30

3.72

4.14

PARZIALI PROGETTO

1.08

0.37

0.30

0.30

2.82

2.75

0.37

0.30

0.30

0.30

3.72

4.14

QUOTE PROGETTO

148.88

147.79

147.49

147.49

147.79

147.82

147.79

147.49

147.49

147.79

148.15

PROFILO Asse4

SEZIONE 57

PROGRESSIVA 560.00

A STERRO m<sup>2</sup> 8.93

130

200  
200

PROGRESSIVE TERRENO	-20.96					4.59	5.82	7.90	9.97	11.40	13.27	14.72	15.96	17.52	19.27	21.57	24.34	26.97	30.06	30.60
PARZIALI TERRENO		25.55				1.23	2.08	2.07	1.43	1.87	1.45	1.24	1.56	1.75	2.30	2.77	2.63	3.09	0.54	0.60
QUOTE TERRENO	150.00					149.00	148.00	147.00	146.00	145.00	144.00	143.00	142.00	141.00	140.00	139.00	138.00	137.00	136.00	135.84
PROGRESSIVE PROGETTO						-4.51	-3.79	-3.42	-3.12	-2.82	0.00	2.75	3.12	3.42	3.72	4.17				
PARZIALI PROGETTO						0.72	0.37	0.30	0.30	2.82	2.75	0.37	0.30	0.30	0.30	0.45				
QUOTE PROGETTO						149.36	148.64	148.34	148.34	148.64	148.66	148.64	148.34	148.34	148.64	149.02				

PROFILO Asse4  
 SEZIONE 58  
 PROGRESSIVA 570.00  
 A STERRO m² 2.49  
 B RIPORTO m² 2.23

130  
 200 200

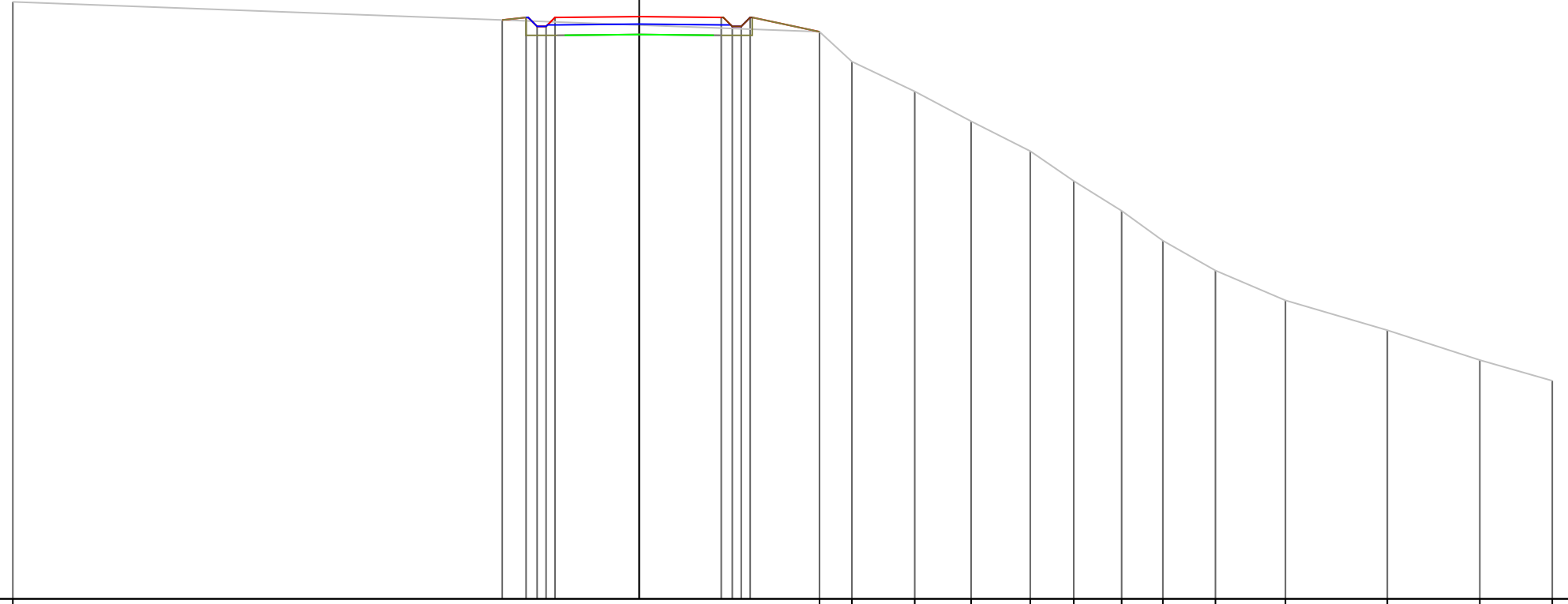

PROGRESSIVE TERRENO	-20.99				6.04	7.13	9.23	11.12	13.11	14.56	16.17	17.55	19.31	21.66	25.07	28.17	30.60
PARZIALI TERRENO		27.03			1.09	2.10	1.89	1.99	1.45	1.61	1.38	1.76	2.35	3.41	3.10	2.43	
QUOTE TERRENO	150.00				149.00	148.00	147.00	146.00	145.00	144.00	143.00	142.00	141.00	140.00	139.00	138.00	137.31
PROGRESSIVE PROGETTO																	
PARZIALI PROGETTO																	
QUOTE PROGETTO																	

-4.59  
 -3.79  
 -3.42  
 -3.12  
 -2.82  
 0.00  
 2.75  
 3.12  
 3.42  
 3.72  
 6.04  
 0.80  
 0.37  
 0.30  
 0.30  
 2.82  
 2.75  
 0.37  
 0.30  
 0.30  
 2.32  
 149.39  
 149.48  
 149.18  
 149.18  
 149.48  
 149.51  
 149.48  
 149.18  
 149.18  
 149.48  
 149.00



PROFILO Asse4

SEZIONE 60

PROGRESSIVA 590.00

A STERRO m<sup>2</sup> 8.03

130

200  
200

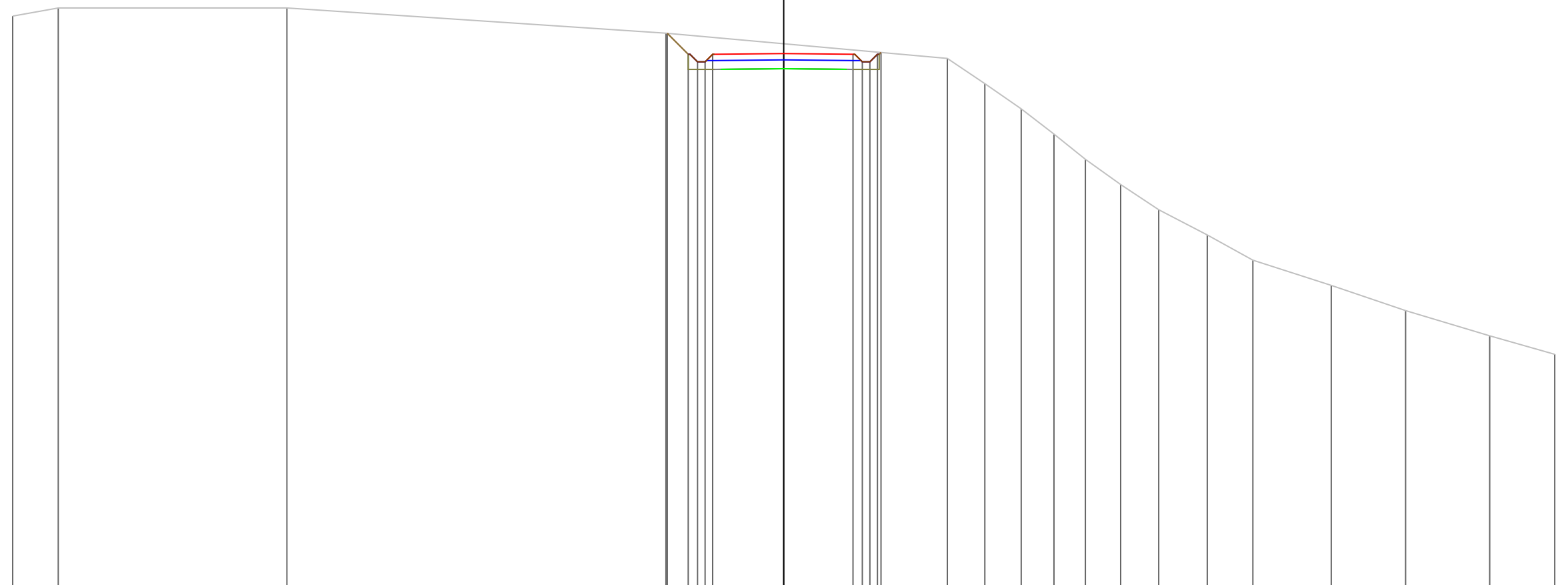

PROGRESSIVE TERRENO	-30.60	-28.79	-19.72	-4.67	6.49	7.98	9.43	10.73	11.97	13.37	14.88	16.81	18.62	21.73	24.68	28.02	30.60
PARZIALI TERRENO	1.81	9.07	15.05	11.16	1.49	1.45	1.30	1.24	1.40	1.51	1.93	1.81	3.11	2.95	3.34	2.58	
QUOTE TERRENO	152.68	153.00	153.00	152.00	151.00	150.00	149.00	148.00	147.00	146.00	145.00	144.00	143.00	142.00	141.00	140.00	139.27
PROGRESSIVE PROGETTO				-4.62	0.00	2.75	3.12	3.42	3.72	3.86							
PARZIALI PROGETTO				0.83	0.37	0.30	0.30	2.82	2.75	0.37	0.30	0.30	0.30	0.14			
QUOTE PROGETTO				152.00	151.16	150.86	150.86	151.16	151.19	151.16	150.86	150.86	151.16	151.24			





PROFILO Asse4

SEZIONE 63

PROGRESSIVA 620.00

A STERRO m<sup>2</sup> 7.14

130

200  
200

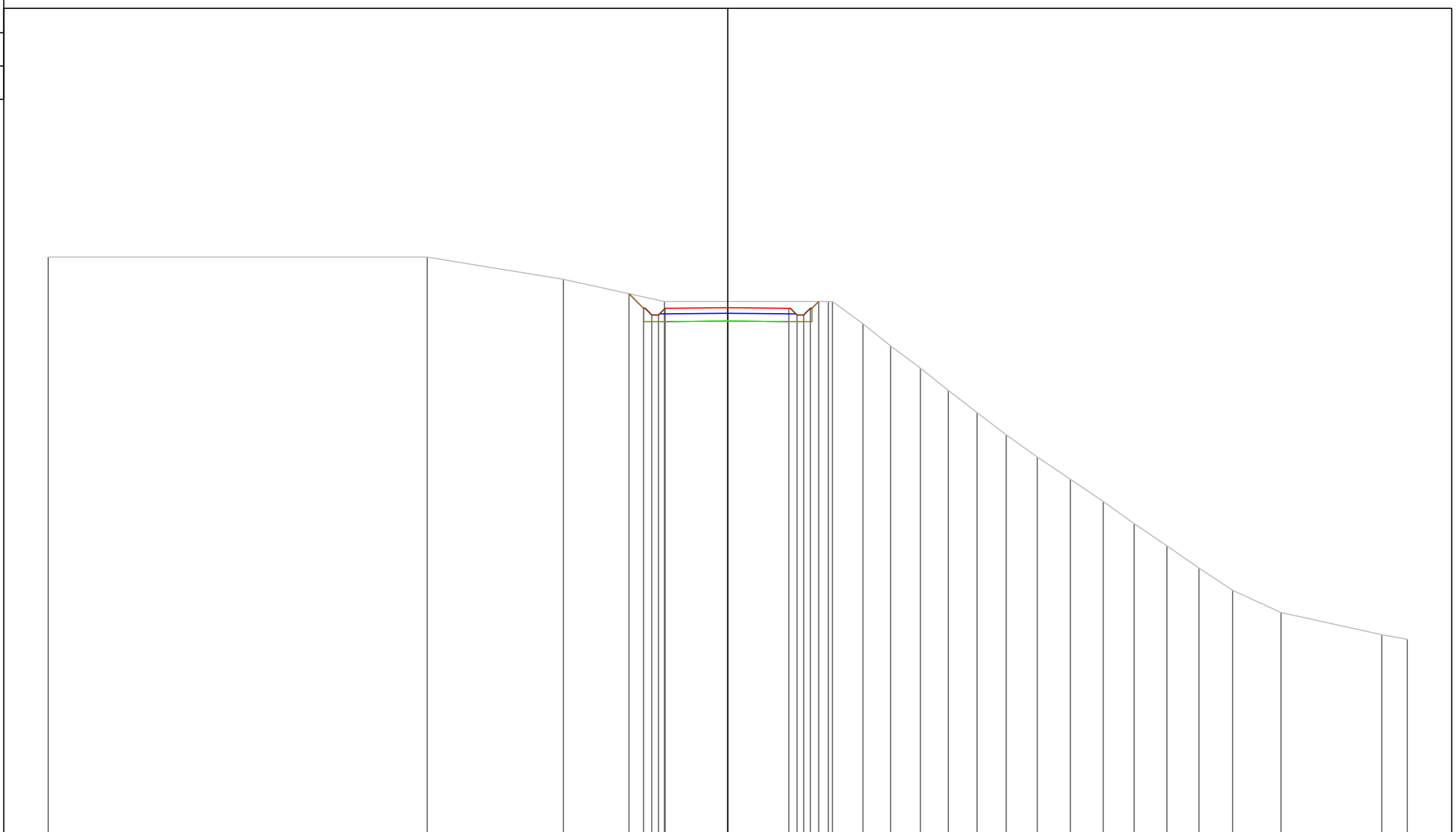

PROGRESSIVE TERRENO	-30.60	-13.53	-7.40	-2.85	4.53	4.71	6.09	7.33	8.68	9.93	11.23	12.54	13.94	15.43	16.91	18.30	19.78	21.22	22.73	24.91	29.45	30.60
PARZIALI TERRENO		17.07	6.13	4.55	7.38	0.18	1.38	1.24	1.35	1.25	1.30	1.31	1.40	1.49	1.48	1.39	1.48	1.44	1.51	2.18	4.54	1.15
QUOTE TERRENO	156.00	156.00	155.00	154.00	154.00	154.00	153.00	152.00	151.00	150.00	149.00	148.00	147.00	146.00	145.00	144.00	143.00	142.00	141.00	140.00	139.00	138.79
PROGRESSIVE PROGETTO																						
PARZIALI PROGETTO																						
QUOTE PROGETTO																						

0.66  
 154.35  
 0.37  
 153.69  
 0.30  
 153.39  
 0.30  
 153.39  
 0.30  
 153.69  
 2.82  
 153.72  
 2.75  
 153.69  
 0.37  
 153.39  
 0.30  
 153.39  
 0.30  
 153.69  
 3.72  
 154.00  
 4.10



PROFILO Asse4

SEZIONE 64

PROGRESSIVA 630.00

A STERRO m<sup>2</sup> 6.78  
B RIPORTO m<sup>2</sup> 0.38

140

200  
200

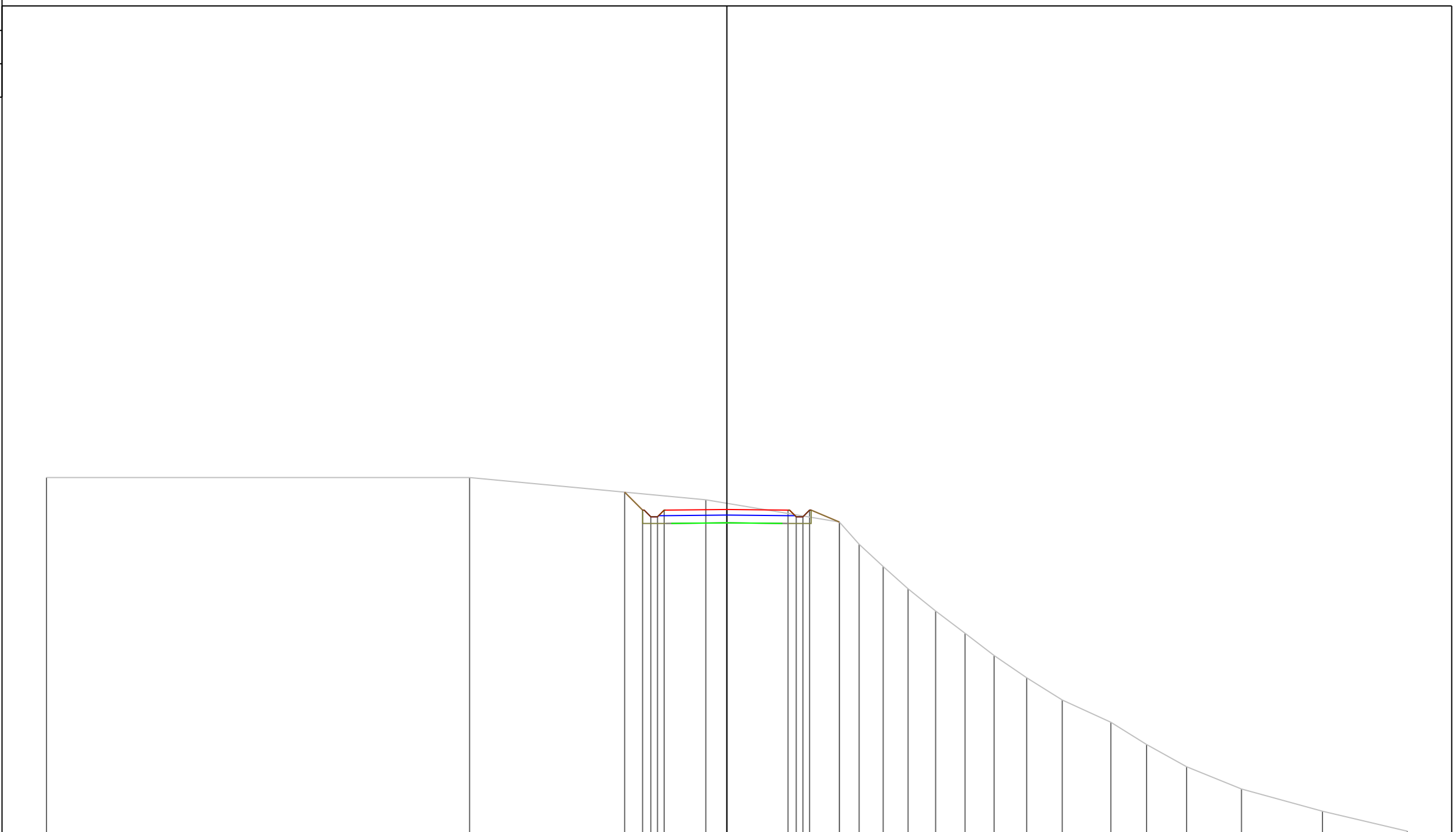

PROGRESSIVE TERRENO	-30.60	-11.57	-0.95	5.06	5.95	7.03	8.15	9.39	10.71	12.02	13.48	15.08	17.27	18.88	20.68	23.15	26.79	30.60
PARZIALI TERRENO		19.03	10.62	6.01	0.89	1.08	1.12	1.24	1.32	1.31	1.46	1.60	2.19	1.61	1.80	2.47	3.64	3.81
QUOTE TERRENO	156.00	156.00	155.00	154.00	153.00	152.00	151.00	150.00	149.00	148.00	147.00	146.00	145.00	144.00	143.00	142.00	141.00	140.10
PROGRESSIVE PROGETTO																		
PARZIALI PROGETTO																		
QUOTE PROGETTO																		

0.81  
155.34  
154.54  
154.24  
154.24  
154.54

-4.60  
-3.79  
-3.42  
-3.12  
-2.82

0.00  
154.56

2.75  
0.37  
154.54  
154.24  
154.54

2.75  
0.30  
0.30  
0.30

5.06  
154.00

1.34  
1.34

PROFILO Asse4

SEZIONE 65

PROGRESSIVA 640.00

A STERRO m<sup>2</sup> 3.30  
 B RIPORTO m<sup>2</sup> 1.41

140  
 200 200

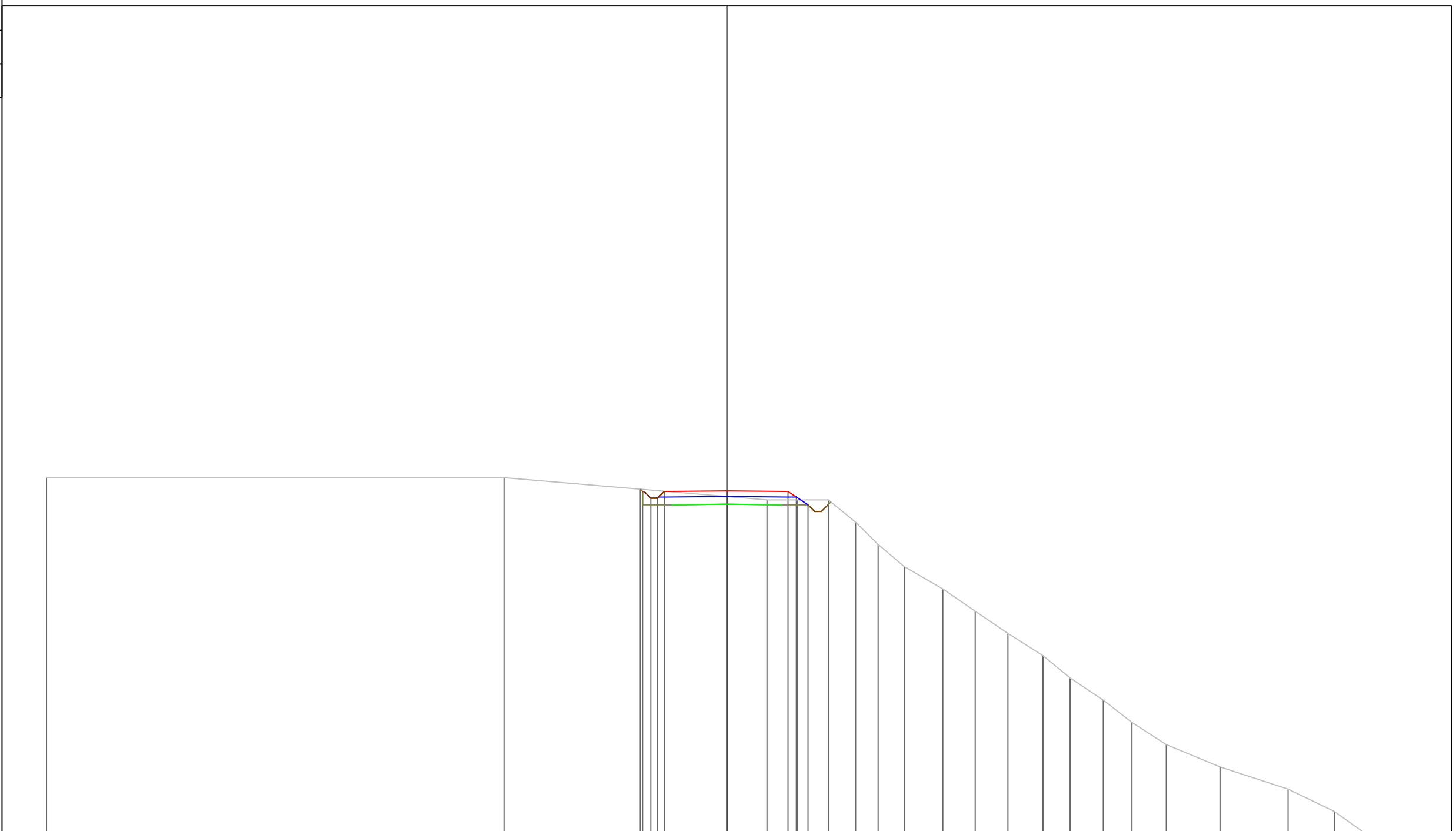

PROGRESSIVE TERRENO	-30.60	-10.02	1.80	3.16	4.57	5.79	6.80	7.98	9.71	11.17	12.64	14.22	15.44	16.93	18.22	19.76	22.18	25.24	27.32	28.72
PARZIALI TERRENO	20.58	11.82	1.36	1.41	1.22	1.01	1.18	1.73	1.46	1.47	1.58	1.22	1.49	1.29	1.54	2.42	3.06	2.08	1.40	
QUOTE TERRENO	156.00	156.00	155.00	155.00	155.00	154.00	153.00	152.00	151.00	150.00	149.00	148.00	147.00	146.00	145.00	144.00	143.00	142.00	141.00	140.00
PROGRESSIVE PROGETTO																				
PARZIALI PROGETTO																				
QUOTE PROGETTO																				

0.10  
 0.37  
 0.30  
 0.30  
 2.82  
 2.75  
 0.38  
 0.52  
 155.48  
 155.38  
 155.08  
 155.08  
 155.38  
 155.41  
 155.38  
 155.13  
 154.78

-3.89  
 -3.79  
 -3.42  
 -3.12  
 -2.82



PROFILO Asse4

SEZIONE 67

PROGRESSIVA 660.00

A STERRO m<sup>2</sup> 0.36  
 B RIPORTO m<sup>2</sup> 5.43

140

200  
 200

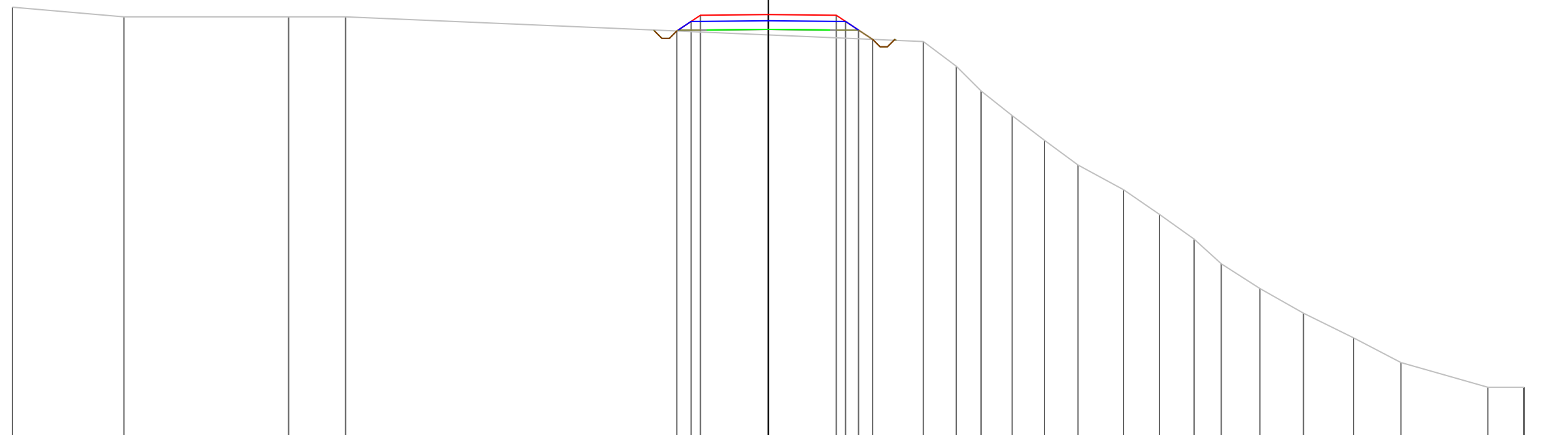

PROGRESSIVE TERRENO	-30.60	-26.09	-19.42	-17.11		6.27	7.61	8.61	9.87	11.18	12.54	14.38	15.83	17.23	18.33	19.90	21.66	23.69	25.61	29.13	30.57	30.60
PARZIALI TERRENO		4.51	6.67	2.31	23.38	1.34	1.00	1.26	1.31	1.36	1.84	1.45	1.40	1.10	1.57	1.76	2.03	1.92	3.52	1.44	0.03	
QUOTE TERRENO	157.39	157.00	157.00	157.00		156.00	155.00	154.00	153.00	152.00	151.00	150.00	149.00	148.00	147.00	146.00	145.00	144.00	143.00	142.00	142.00	142.00
PROGRESSIVE PROGETTO																						
PARZIALI PROGETTO																						
QUOTE PROGETTO						156.43	156.81	157.06	157.09	157.06	156.81	156.46	156.09									

-3.71  
 -3.13  
 -2.75  
 0.58  
 0.38  
 157.06

0.00  
 2.75  
 2.75  
 0.38  
 3.13  
 3.65  
 4.22  
 157.06  
 156.81  
 156.46  
 156.09

PROFILO Asse4

SEZIONE 68

PROGRESSIVA 670.00

A STERRO m<sup>2</sup> 0.40  
B RIPORTO m<sup>2</sup> 6.11

140

200  
200

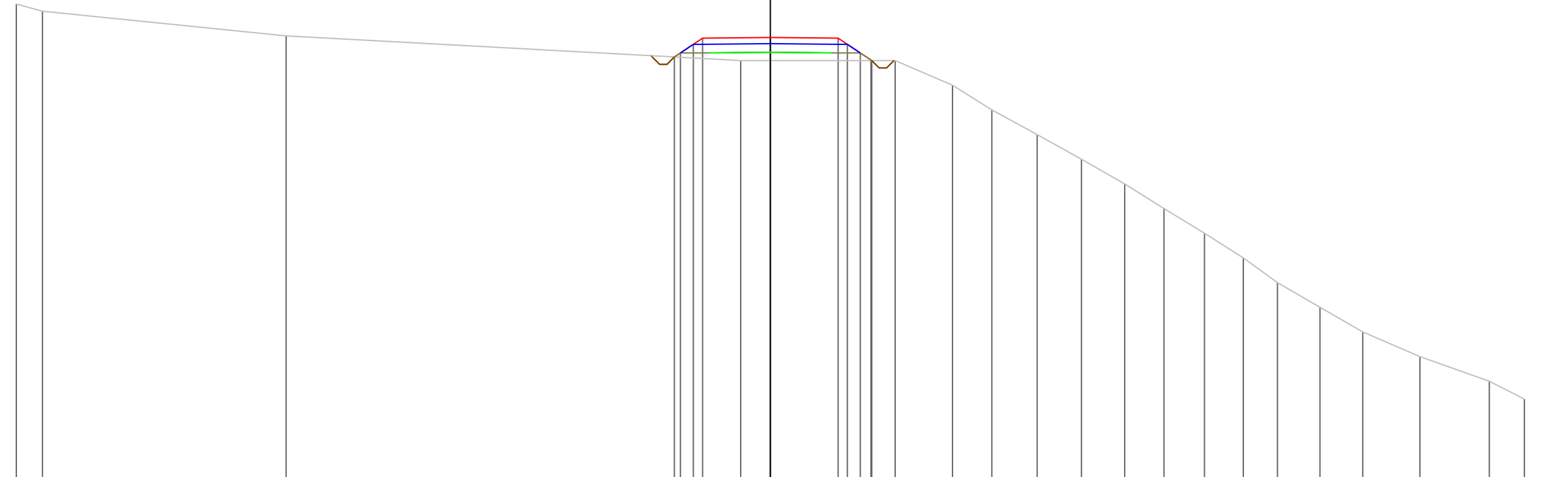

PROGRESSIVE TERRENO	-30.60	-29.54	-19.65	-1.20	4.08	5.06	7.39	8.99	10.83	12.62	14.38	15.97	17.62	19.19	20.58	22.30	24.04	26.36	29.18	30.60
PARZIALI TERRENO	1.06	9.89	18.45	5.28	0.98	2.33	1.60	1.84	1.79	1.76	1.59	1.65	1.57	1.39	1.72	1.74	2.32	2.82	1.42	
QUOTE TERRENO	159.29	159.00	158.00	157.00	157.00	157.00	156.00	155.00	154.00	153.00	152.00	151.00	150.00	149.00	148.00	147.00	146.00	145.00	144.00	143.28
PROGRESSIVE PROGETTO																				
PARZIALI PROGETTO																				
QUOTE PROGETTO																				

-3.90  
 -3.65  
 -3.13  
 -2.75  
 0.00  
 2.75  
 2.75  
 0.37  
 0.53  
 0.47  
 157.15  
 157.31  
 157.66  
 157.91  
 157.94  
 157.91  
 157.66  
 157.31  
 157.00

PROFILO Asse4

SEZIONE 69

PROGRESSIVA 680.00

A STERRO m<sup>2</sup> 0.34  
B RIPORTO m<sup>2</sup> 13.63

143

200  
200

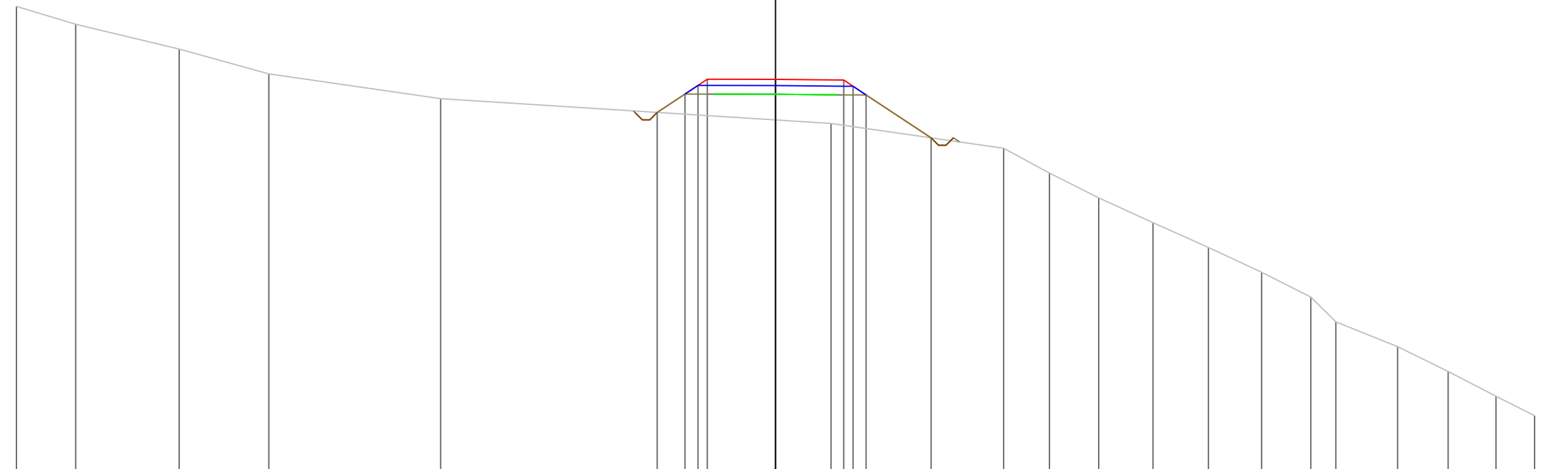

PROGRESSIVE TERRENO	-30.60	-28.21	-24.04	-20.43		-13.50		2.24		9.20	11.04	13.03	15.22	17.45	19.60	21.58	22.59	25.08	27.11	29.04	30.60
PARZIALI TERRENO		2.39	4.17	3.61	6.93		15.74		6.96	1.84	1.99	2.19	2.23	2.15	1.98	1.01	2.49	2.03	1.93	1.56	
QUOTE TERRENO	161.72	161.00	160.00	159.00		158.00		157.00		156.00	155.00	154.00	153.00	152.00	151.00	150.00	149.00	148.00	147.00	146.00	145.22
PROGRESSIVE PROGETTO																					
PARZIALI PROGETTO																					
QUOTE PROGETTO																					

157.45 -4.77  
 158.18 -3.65  
 158.53 -3.12  
 158.78 -2.75  
 158.78 0.00  
 158.75 2.75  
 158.50 3.13  
 158.15 3.65  
 156.42 6.27

1.12  
 0.53  
 0.37  
 2.75  
 2.75  
 0.38  
 0.52  
 2.62

PROFILO Asse4

SEZIONE 70

PROGRESSIVA 690.00

A STERRO m<sup>2</sup> 0.26  
B RIPOSTO m<sup>2</sup> 15.87

146

200  
200

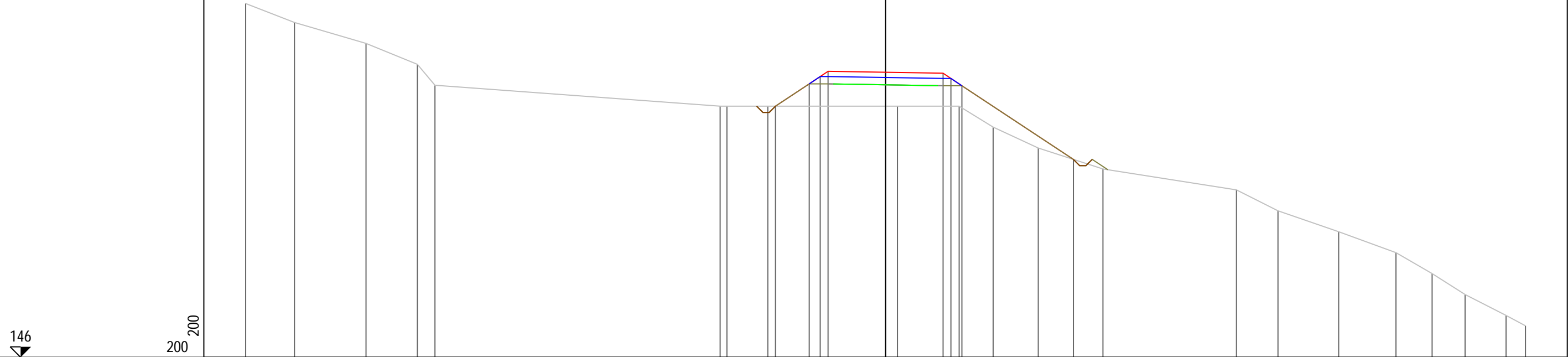

PROGRESSIVE TERRENO

-30.60	-28.27	-24.85	-22.39	-21.55		-7.91	-7.59	-5.63		0.57	3.52	5.14	7.30		10.39		16.78	18.77	21.67	24.41	26.14	27.71	29.67	30.60
--------	--------	--------	--------	--------	--	-------	-------	-------	--	------	------	------	------	--	-------	--	-------	-------	-------	-------	-------	-------	-------	-------

PARZIALI TERRENO

2.33	3.42	2.46	0.84		13.64	0.32	1.96		6.20	2.95	1.62	2.16	3.09		6.39	1.99	2.90	2.74	1.73	1.57	1.96	0.93		
------	------	------	------	--	-------	------	------	--	------	------	------	------	------	--	------	------	------	------	------	------	------	------	--	--

QUOTE TERRENO

162.91	162.00	161.00	160.00	159.00		158.00	158.00	158.00		158.00	158.00	157.00	156.00		155.00		154.00	153.00	152.00	151.00	150.00	149.00	148.00	147.51
--------	--------	--------	--------	--------	--	--------	--------	--------	--	--------	--------	--------	--------	--	--------	--	--------	--------	--------	--------	--------	--------	--------	--------

PROGRESSIVE PROGETTO

								-5.27		0.00					8.98										
--	--	--	--	--	--	--	--	-------	--	------	--	--	--	--	------	--	--	--	--	--	--	--	--	--	--

PARZIALI PROGETTO

								1.62	0.53	0.37	2.75		2.75	0.38	0.52	5.33									
--	--	--	--	--	--	--	--	------	------	------	------	--	------	------	------	------	--	--	--	--	--	--	--	--	--

QUOTE PROGETTO

								158.00	159.07	159.42	159.67		159.62	159.58	159.33	158.98		155.46							
--	--	--	--	--	--	--	--	--------	--------	--------	--------	--	--------	--------	--------	--------	--	--------	--	--	--	--	--	--	--

PROFILO Asse4

SEZIONE 71

PROGRESSIVA 700.00

A STERRO m<sup>2</sup> 0.36  
 B RIPORTO m<sup>2</sup> 11.30

148

200  
 200

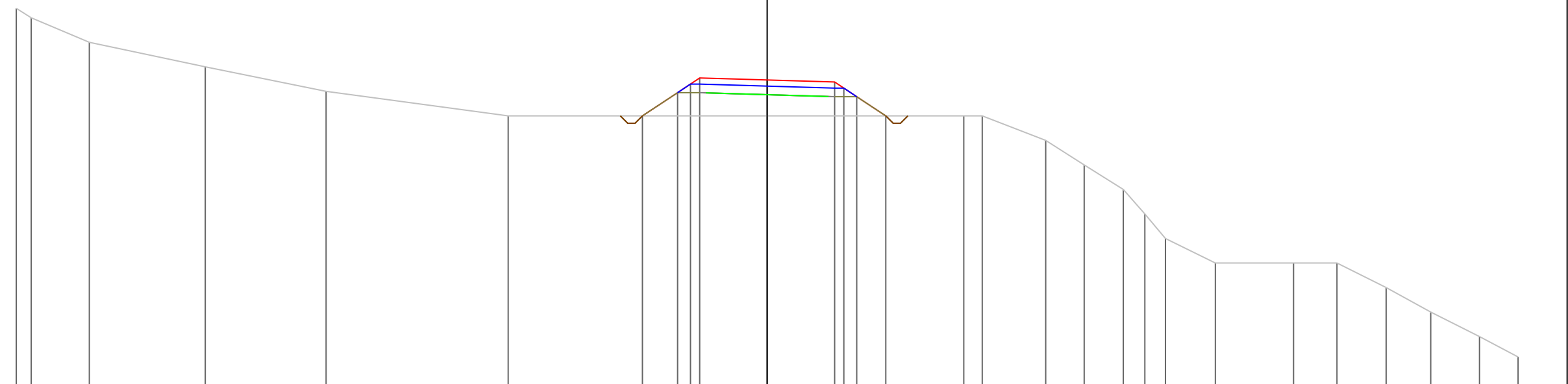

PROGRESSIVE TERRENO	-30.60	-29.99	-27.62	-22.90	-17.97	-10.55					8.01	8.76	11.35	12.92	14.51	15.39	16.23	18.26	21.45	23.22	25.22	27.04	29.03	30.60
PARZIALI TERRENO	0.61	2.37	4.72	4.93	7.42			18.56			0.75	2.59	1.57	1.59	0.88	0.84	2.03	3.19	1.77	2.00	1.82	1.99	1.57	
QUOTE TERRENO	163.39	163.00	162.00	161.00	160.00	159.00					159.00	159.00	158.00	157.00	156.00	155.00	154.00	153.00	153.00	153.00	152.00	151.00	150.00	149.17
PROGRESSIVE PROGETTO									-5.08															
PARZIALI PROGETTO									1.43	0.52	0.38	2.75	2.75	0.38	0.52	1.18								
QUOTE PROGETTO									159.00	159.95	160.30	160.55	160.46	160.38	160.13	159.78	159.00							



PROFILO Asse4

SEZIONE 72

PROGRESSIVA 710.00

A STERRO m² 0.47  
B RIPORTO m² 20.51

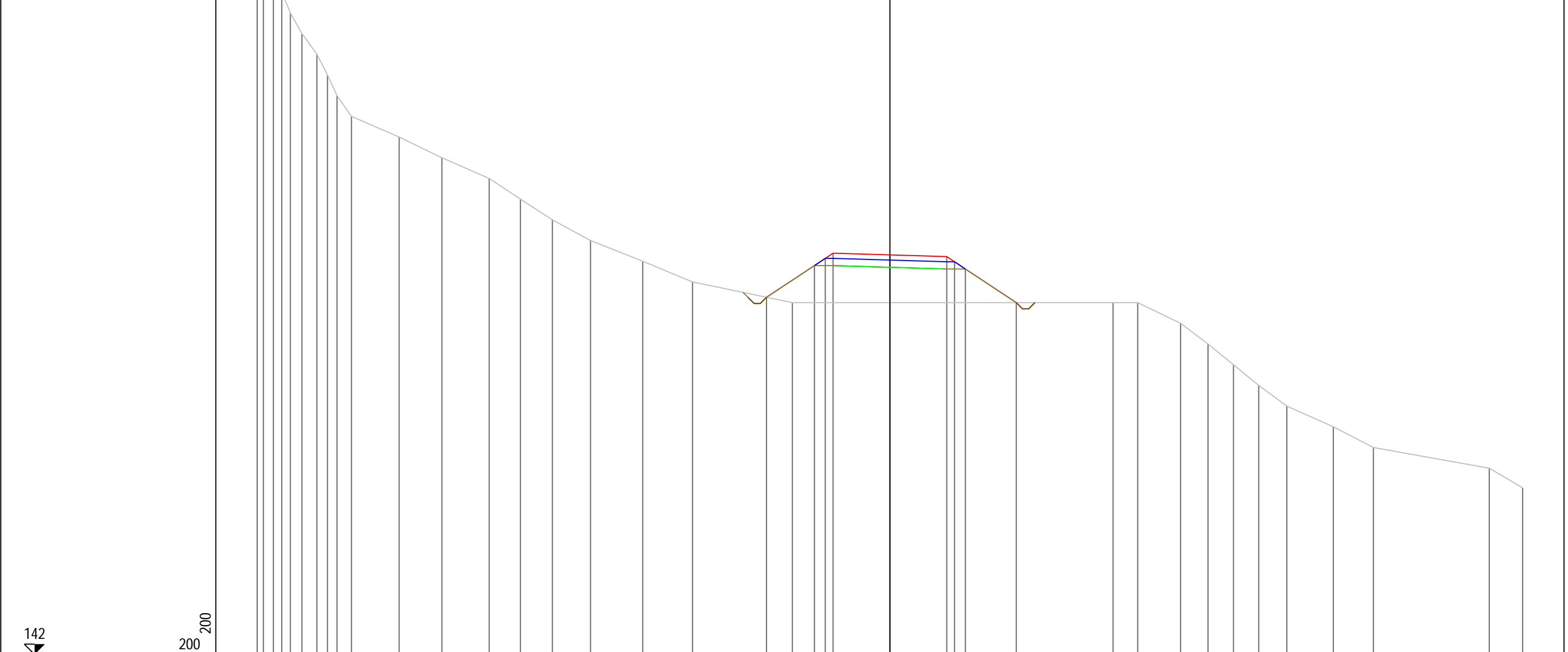

142

200

PROGRESSIVE TERRENO	176.40	176.00	175.00	174.00	173.00	172.00	171.00	170.00	169.00	168.00	167.00	166.00	165.00	164.00	163.00	162.00	161.00	160.00	159.00	159.00	158.00	157.00	156.00	155.00	154.00	153.00	152.00	151.00	150.05	
PARZIALI TERRENO	0.30	0.48	0.41	0.41	0.56	0.73	0.51	0.46	0.70	2.31	2.06	2.29	1.51	1.55	1.84	2.53	2.40	4.83	15.51	1.19	2.08	1.32	1.23	1.23	1.36	2.24	1.94	5.61	1.61	
QUOTE TERRENO	176.40	176.00	175.00	174.00	173.00	172.00	171.00	170.00	169.00	168.00	167.00	166.00	165.00	164.00	163.00	162.00	161.00	160.00	159.00	159.00	158.00	157.00	156.00	155.00	154.00	153.00	152.00	151.00	150.05	
PROGRESSIVE PROGETTO																			-5.97	0.00	2.75	3.13	3.65	6.11						
PARZIALI PROGETTO																			2.32	0.52	0.38	2.75	0.38	0.52	2.46					
QUOTE PROGETTO																			159.26	160.79	161.14	161.39	161.31	161.22	160.97	160.62	159.00			

PROFILO Asse4  
 SEZIONE 73  
 PROGRESSIVA 720.00  
 A STERRO m<sup>2</sup> 0.64  
 B RIPORTO m<sup>2</sup> 16.06

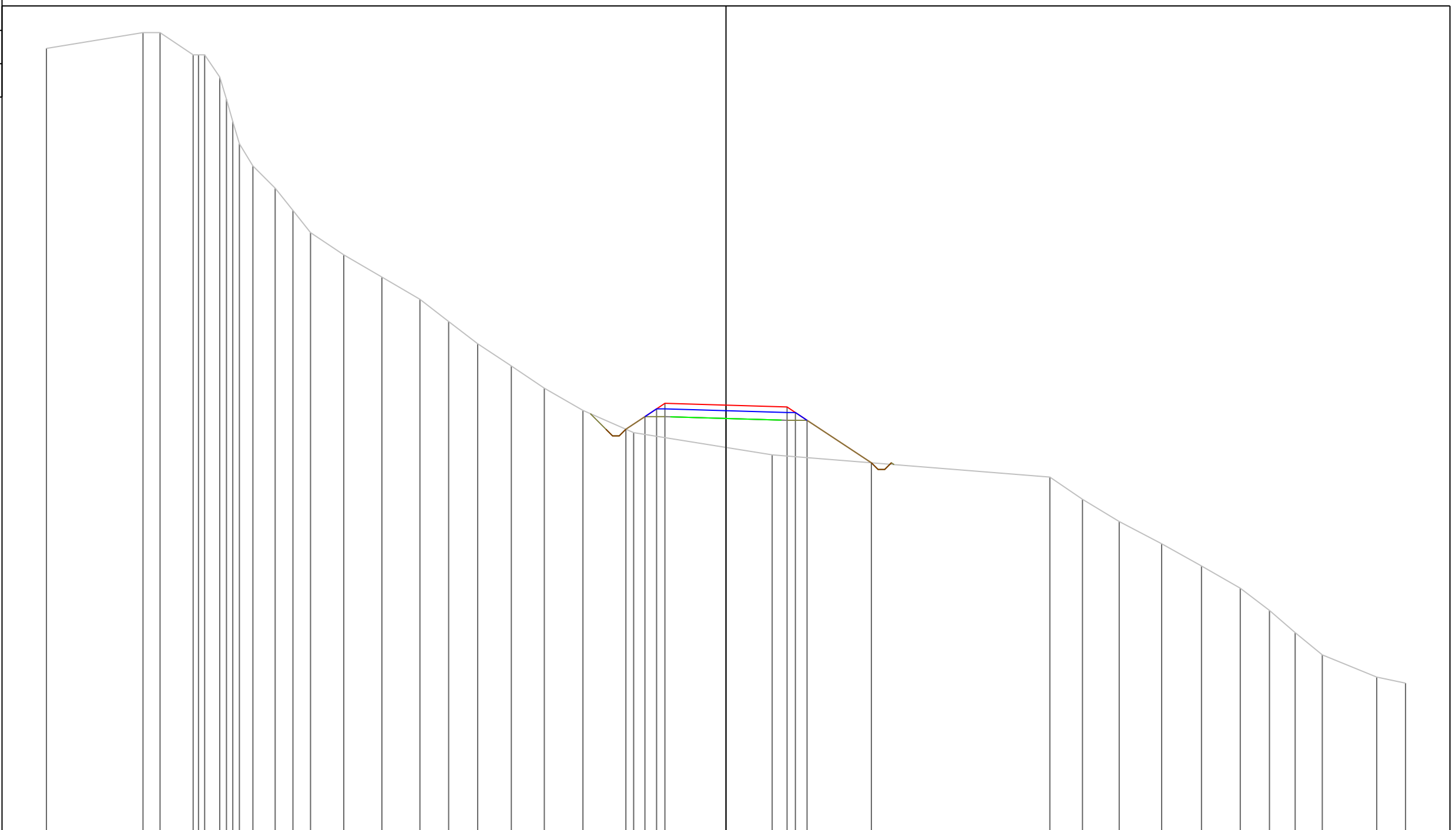

143  
 200 200

PROGRESSIVE TERRENO	-30.60	-26.25	-25.48	-23.99	-23.75	-23.48	-22.80	-22.49	-21.91	-21.30	-20.30	-19.50	-18.71	-17.21	-15.49	-13.78	-12.49	-11.18	-9.67	-8.18	-6.44	-4.16	2.08	14.58	16.05	17.71	19.62	21.41	23.16	24.47	25.63	26.85	29.30	30.60	
PARZIALI TERRENO	4.35	0.77	1.49	0.24	0.27	0.68	0.31	0.28	0.30	0.61	1.00	0.80	0.79	1.50	1.72	1.71	1.29	1.31	1.51	1.49	1.74	2.28	6.24	12.50	1.47	1.66	1.91	1.79	1.75	1.31	1.16	1.22	2.45	1.30	
QUOTE TERRENO	178.29	179.00	179.00	178.00	178.00	178.00	177.00	176.00	175.00	174.00	173.00	172.00	171.00	170.00	169.00	168.00	167.00	166.00	165.00	164.00	163.00	162.00	161.00	160.00	159.00	158.00	157.00	156.00	155.00	154.00	153.00	152.00	151.00	150.00	149.73
PROGRESSIVE PROGETTO																						-4.51	-3.65	-3.13	-2.75	0.00	2.75	3.13	3.65	6.55					
PARZIALI PROGETTO																						0.86	0.52	0.38	2.75	2.75	0.38	0.52	2.90						
QUOTE PROGETTO																						161.15	161.72	162.07	162.32	162.24	162.15	161.90	161.55	159.64					







PROFILO Asse4

SEZIONE 77

PROGRESSIVA 760.00

A STERRO m² 12.74  
B RIPORTO m² 23.28



PROGRESSIVE TERRENO	-30.60	-29.09	-26.28	-17.53	-15.11	-12.61	-11.31	-9.95	-8.97	-8.18	-7.22	-6.44	-5.25	-3.70	-2.64	-2.09	-1.47	-0.12	2.85	4.07	5.24	6.32	7.47	9.08	15.53	17.51	18.52	20.25	22.40	24.32	26.44	28.22	30.15	30.60	
PARZIALI TERRENO	1.51	2.81	8.75	2.42	2.50	1.30	1.36	0.98	0.79	0.96	0.78	1.19	1.55	1.06	0.55	0.62	1.35	2.97	1.22	1.17	1.08	1.15	1.61	6.45	1.98	1.01	1.73	2.15	1.92	2.12	1.78	1.93	0.45		
QUOTE TERRENO	181.35	182.00	182.00	181.00	180.00	179.00	178.00	177.00	176.00	175.00	174.00	173.00	172.00	171.00	170.00	169.00	168.00	167.00	166.00	165.00	164.00	163.00	162.00	161.00	160.00	159.00	158.00	157.00	156.00	155.00	154.00	153.00	152.00	151.76	
PROGRESSIVE PROGETTO				-13.86									-4.09	-3.79	-3.79	-3.72	-3.42	-3.12	-2.82	0.00														13.98	
PARZIALI PROGETTO									9.77					0.30	0.37	0.30	0.30	2.82		2.75	0.38	0.52		10.33											
QUOTE PROGETTO				179.50									170.68	167.68	170.68	167.68	167.38	167.68	167.68	167.69					167.66	167.41	167.06	160.24							

PROFILO Asse4

SEZIONE 78

PROGRESSIVA 770.00

A STERRO m<sup>2</sup> 14.98  
 B RIPORTO m<sup>2</sup> 38.04

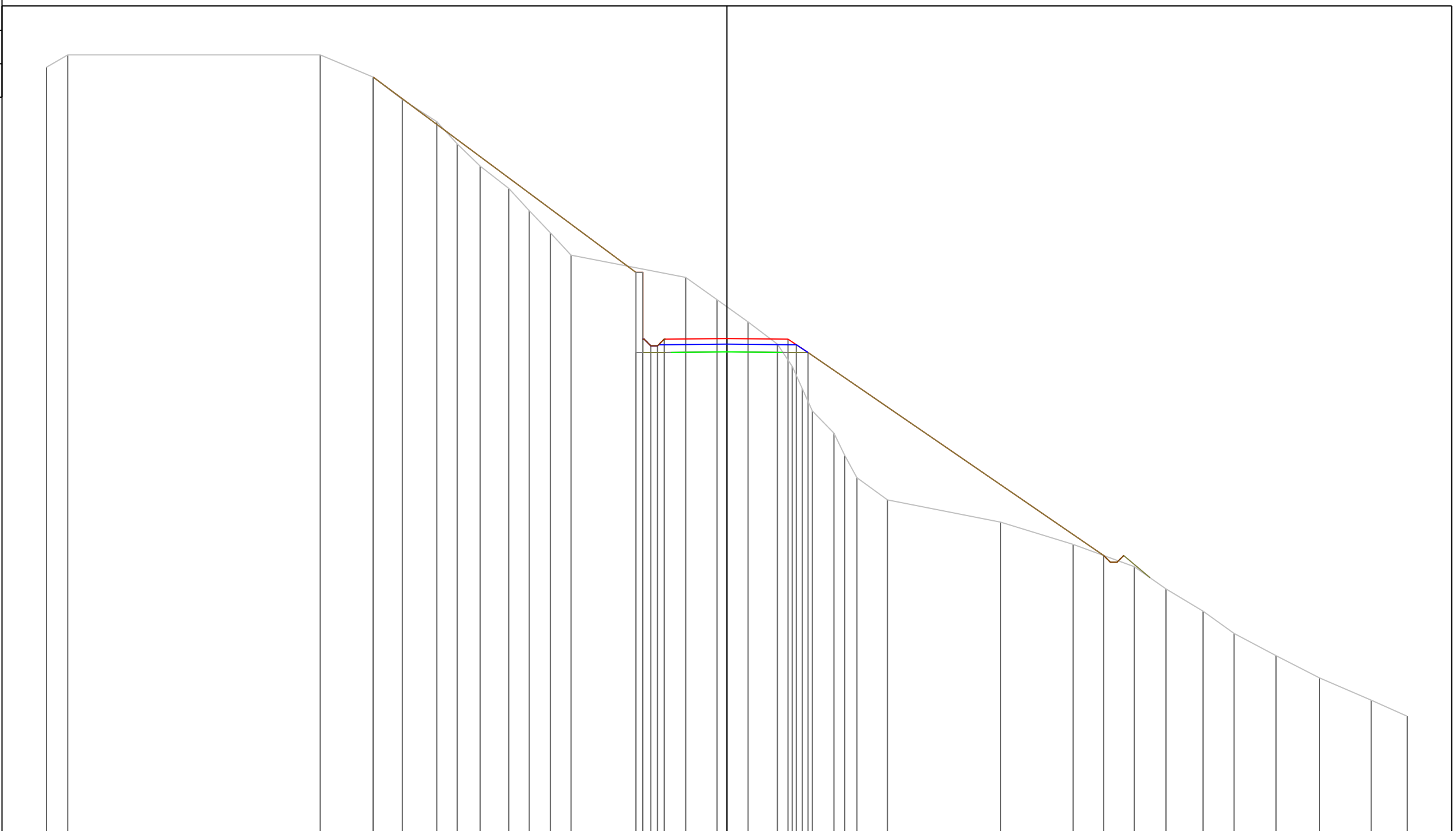

147

200  
200

PROGRESSIVE TERRENO	-30.60	-29.64	-18.29	-15.90	-14.60	-13.05	-12.13	-11.09	-9.81	-8.89	-7.93	-7.01	-1.85	-0.44	0.95	2.27	2.94	3.39	3.84	4.82	5.30	5.85	7.22	12.31	15.57	18.32	19.75	21.42	22.81	24.70	26.65	28.98	30.60
PARZIALI TERRENO	0.96	11.35	2.39	1.30	1.55	0.92	1.04	1.28	0.92	0.96	0.92	5.16	1.41	1.39	1.32	0.67	0.45	0.45	0.98	0.48	0.55	1.37	5.09	3.26	2.75	1.43	1.67	1.39	1.89	1.95	2.33	1.62	
QUOTE TERRENO	181.45	182.00	182.00	181.00	180.00	179.00	178.00	177.00	176.00	175.00	174.00	173.00	172.00	171.00	170.00	169.00	168.00	167.00	166.00	165.00	164.00	163.00	162.00	161.00	160.00	159.00	158.00	157.00	156.00	155.00	154.00	153.00	152.28
PROGRESSIVE PROGETTO			-15.90										-4.09	-3.79	-3.79	-3.42	-3.12	-2.82	0.00							16.95							
PARZIALI PROGETTO									11.81				0.30	0.37	0.30	0.30	2.82	2.75	0.38	0.52						13.30							
QUOTE PROGETTO			181.00										172.22	172.22	169.22	168.92	168.92	169.22	169.25							169.50							



















PROFILO Asse4  
 SEZIONE 87  
 PROGRESSIVA 860.00  
 A STERRO m<sup>2</sup> 8.26

153  
 200 200

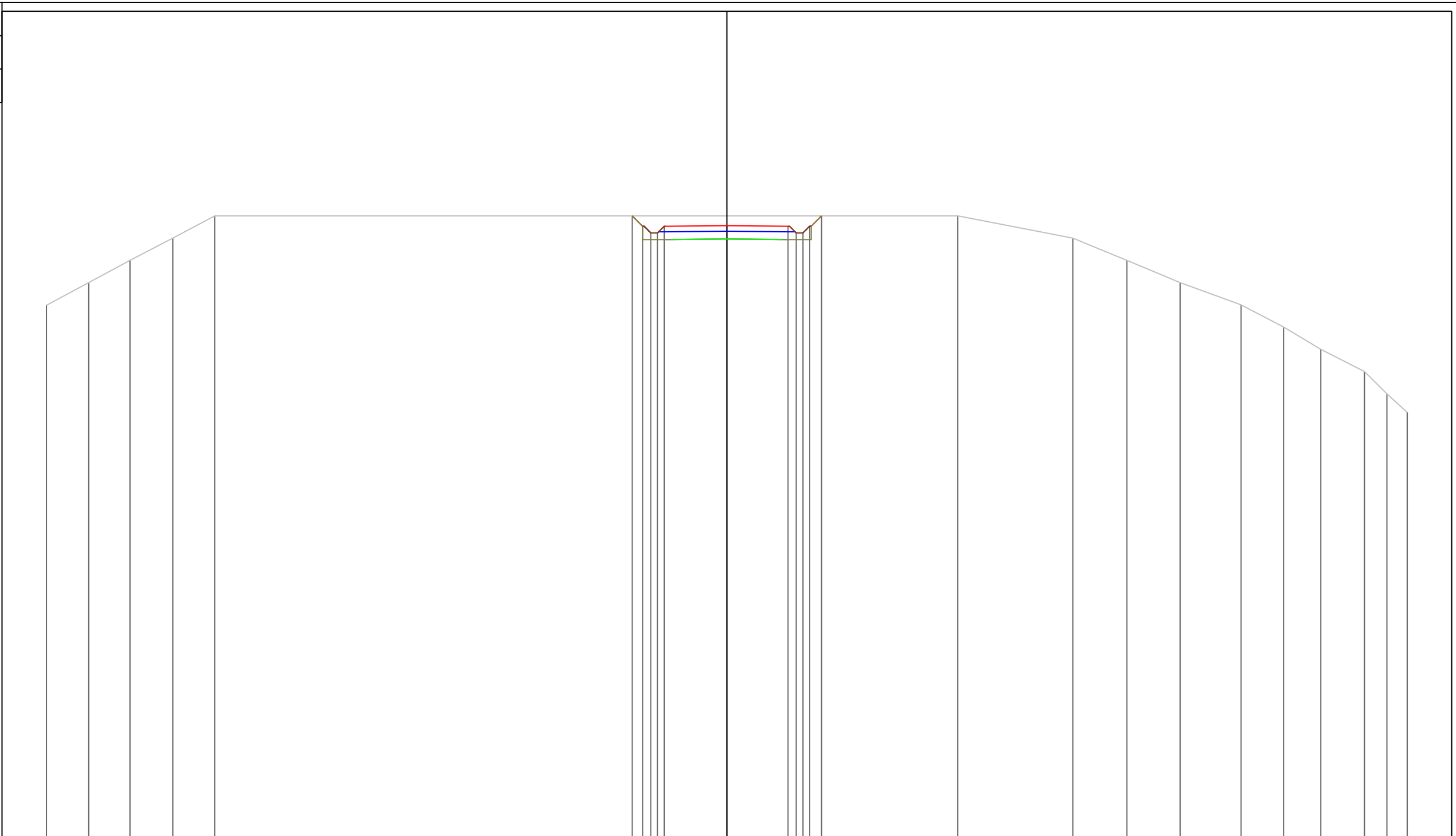

PROGRESSIVE TERRENO	-30.60	-28.70	-26.84	-24.92	-23.03					10.39	15.56	17.99	20.39	23.13	25.04	26.71	28.68	29.69	30.60
PARZIALI TERRENO	1.90	1.86	1.92	1.89	33.42					5.17	2.43	2.40	2.74	1.91	1.67	1.97	1.01	0.91	
QUOTE TERRENO	176.98	178.00	179.00	180.00	181.00					181.00	180.00	179.00	178.00	177.00	176.00	175.00	174.00	173.00	172.16
PROGRESSIVE PROGETTO																			
PARZIALI PROGETTO																			
QUOTE PROGETTO																			

4.26  
 3.79  
 3.42  
 3.12  
 2.82  
 0.00  
 2.75  
 2.75  
 0.37  
 0.30  
 0.30  
 0.30  
 0.30  
 0.54

181.00  
 180.53  
 180.23  
 180.23  
 180.53  
 180.56  
 180.53  
 180.23  
 180.23  
 180.53  
 181.00



PROFILO Asse4

SEZIONE 88

PROGRESSIVA 870.00

A STERRO m<sup>2</sup> 4.46  
 B RIPORTO m<sup>2</sup> 0.08

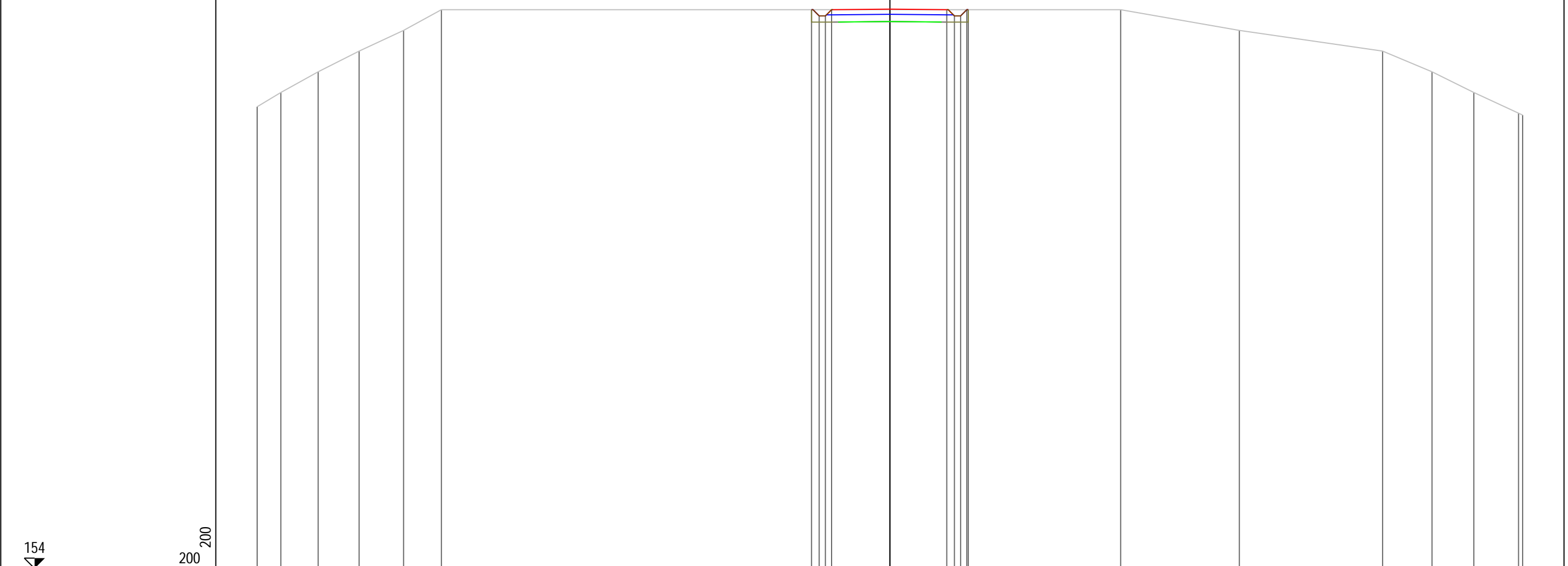

PROGRESSIVE TERRENO	-30.60	-29.45	-27.65	-25.67	-23.52	-21.69			11.16	16.90	23.83	26.22	28.24	30.40	30.60	
PARZIALI TERRENO	1.15	1.80	1.98	2.15	1.83		32.85		5.74	6.93	2.39	2.02	2.16	0.20		
QUOTE TERRENO	176.31	177.00	178.00	179.00	180.00	181.00			181.00	180.00	179.00	178.00	177.00	176.00	175.91	
PROGRESSIVE PROGETTO																
PARZIALI PROGETTO								0.37	0.30	0.30	2.82	2.75	0.37	0.30	0.30	0.07
QUOTE PROGETTO								181.00	180.70	180.70	181.00	181.03	181.00	180.70	181.00	181.00

PROFILO Asse4

SEZIONE 89

PROGRESSIVA 880.00

A STERRO m<sup>2</sup> 2.28  
 B RIPORTO m<sup>2</sup> 2.16

154

200  
 200

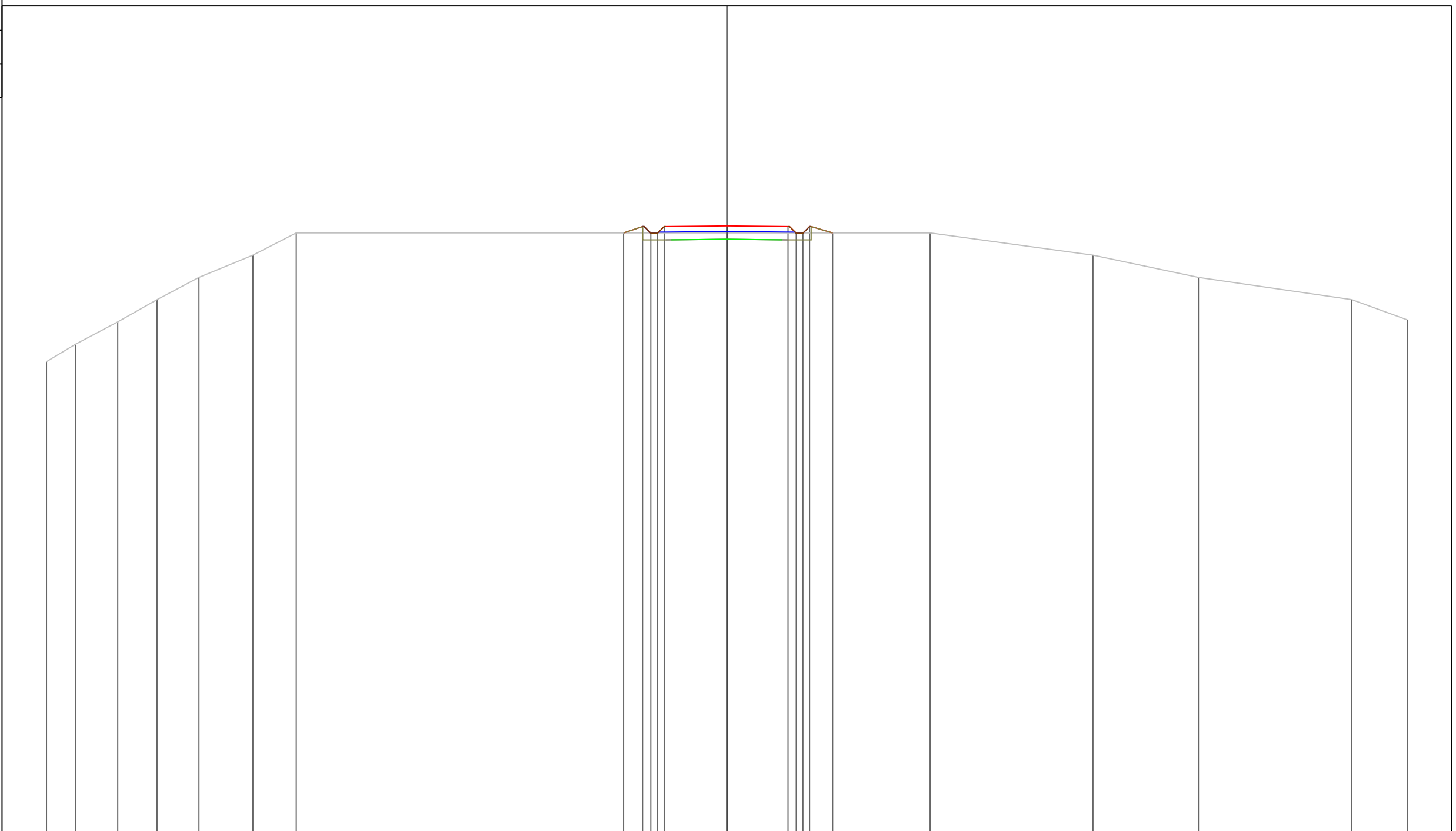

PROGRESSIVE TERRENO	-30.60	-29.29	-27.40	-25.63	-23.74	-21.32	-19.37			9.14	16.47	21.21	28.11	30.60			
PARZIALI TERRENO	1.31	1.89	1.77	1.89	2.42	1.95		28.51		7.33	4.74	6.90	2.49				
QUOTE TERRENO	175.21	176.00	177.00	178.00	179.00	180.00	181.00			181.00	180.00	179.00	178.00	177.09			
PROGRESSIVE PROGETTO									-4.64								
PARZIALI PROGETTO								0.85	0.37	0.30	0.30	2.82	2.75	0.37	0.30	0.30	1.04
QUOTE PROGETTO								181.00	181.29	180.99	180.99	181.29	181.31	181.29	180.99	181.29	181.00

PROFILO Asse4

SEZIONE 90

PROGRESSIVA 890.00

A STERRO m<sup>2</sup> 1.28  
 B RIPORTO m<sup>2</sup> 3.14

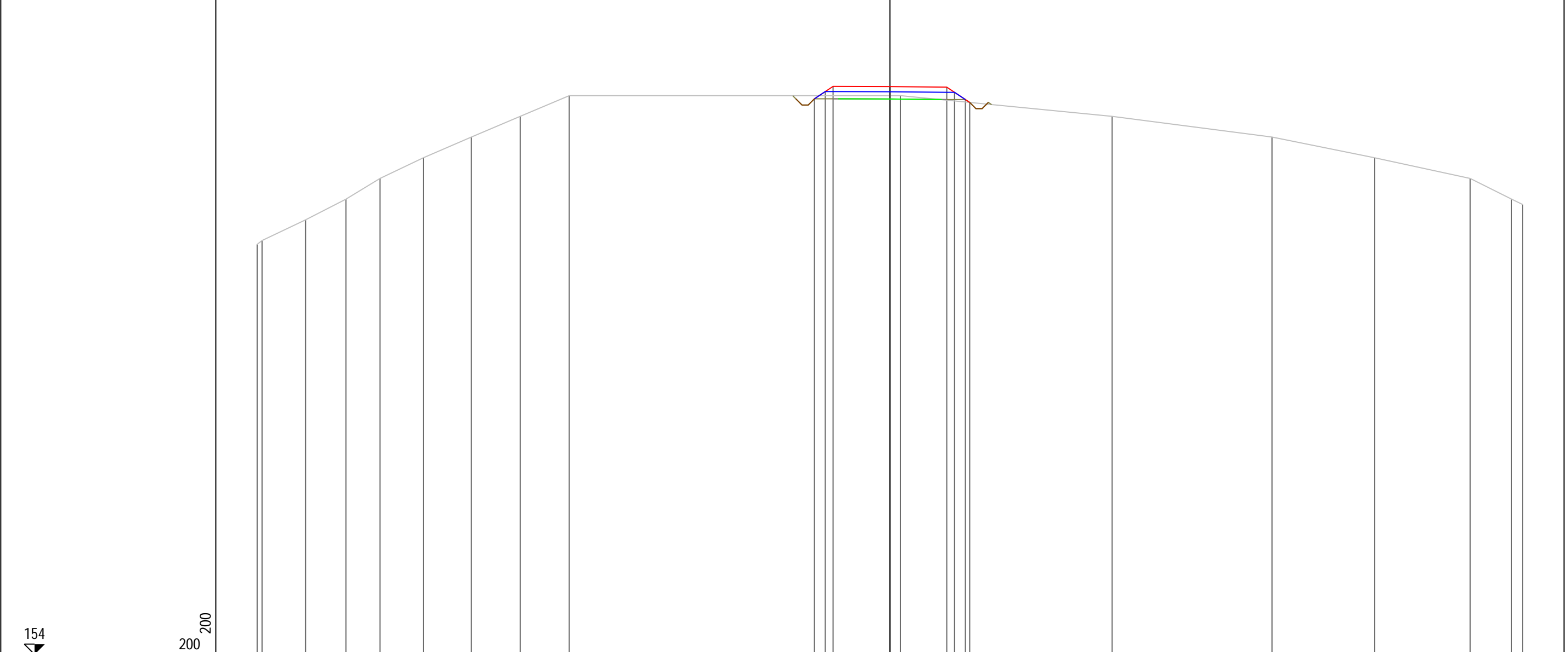

PROGRESSIVE TERRENO	-30.60	-30.36	-28.26	-26.30	-24.66	-22.56	-20.24	-17.88	-15.51	0.51	10.74	18.48	23.43	28.06	30.06	30.60	
PARZIALI TERRENO	0.24	2.10	1.96	1.64	2.10	2.32	2.36	2.37	16.02	10.23	7.74	4.95	4.63	2.00	0.54	0.60	
QUOTE TERRENO	173.82	174.00	175.00	176.00	177.00	178.00	179.00	180.00	181.00	181.00	180.00	179.00	178.00	177.00	176.00	175.74	
PROGRESSIVE PROGETTO										3.65	0.00	2.75	3.13	3.65	3.86		
PARZIALI PROGETTO										0.52	0.38	2.75	0.38	0.52	0.21		
QUOTE PROGETTO										180.85	181.20	181.45	181.44	181.41	181.16	180.81	180.67



PROFILO Asse4  
 SEZIONE 92  
 PROGRESSIVA 910.00  
 A STERRO m² 0.31  
 B RIPORTO m² 25.55

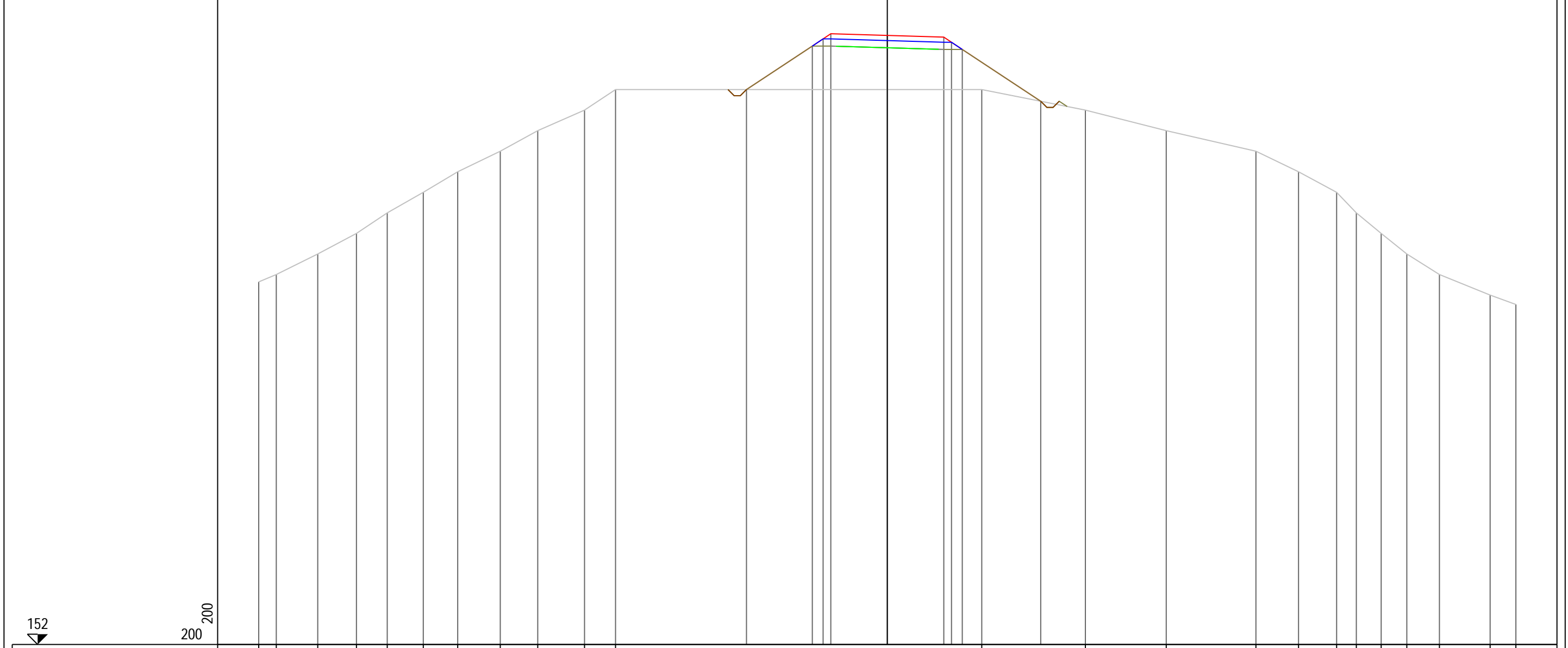

152  
 200 200

PROGRESSIVE TERRENO	-30.60	-29.75	-27.73	-25.84	-24.34	-22.59	-20.91	-18.84	-17.02	-14.74	-13.23	4.60	9.64	13.58	17.94	20.02	21.87	22.83	24.04	25.29	26.88	29.35	30.60	
PARZIALI TERRENO	0.85	2.02	1.89	1.50	1.75	1.68	2.07	1.82	2.28	1.51	17.83	5.04	3.94	4.36	2.08	1.85	0.96	1.21	1.25	1.59	2.47	1.25		
QUOTE TERRENO	169.64	170.00	171.00	172.00	173.00	174.00	175.00	176.00	177.00	178.00	179.00	179.00	178.00	177.00	176.00	175.00	174.00	173.00	172.00	171.00	170.00	169.00	168.54	
PROGRESSIVE PROGETTO												-6.86												
PARZIALI PROGETTO												3.21												
QUOTE PROGETTO												181.12	181.47	181.72	181.63	181.55	181.30	180.95						



PROFILO Asse4

SEZIONE 94

PROGRESSIVA 930.00

A STERRO m<sup>2</sup> 0.25  
 B RIPORTO m<sup>2</sup> 32.65

152

200  
 200

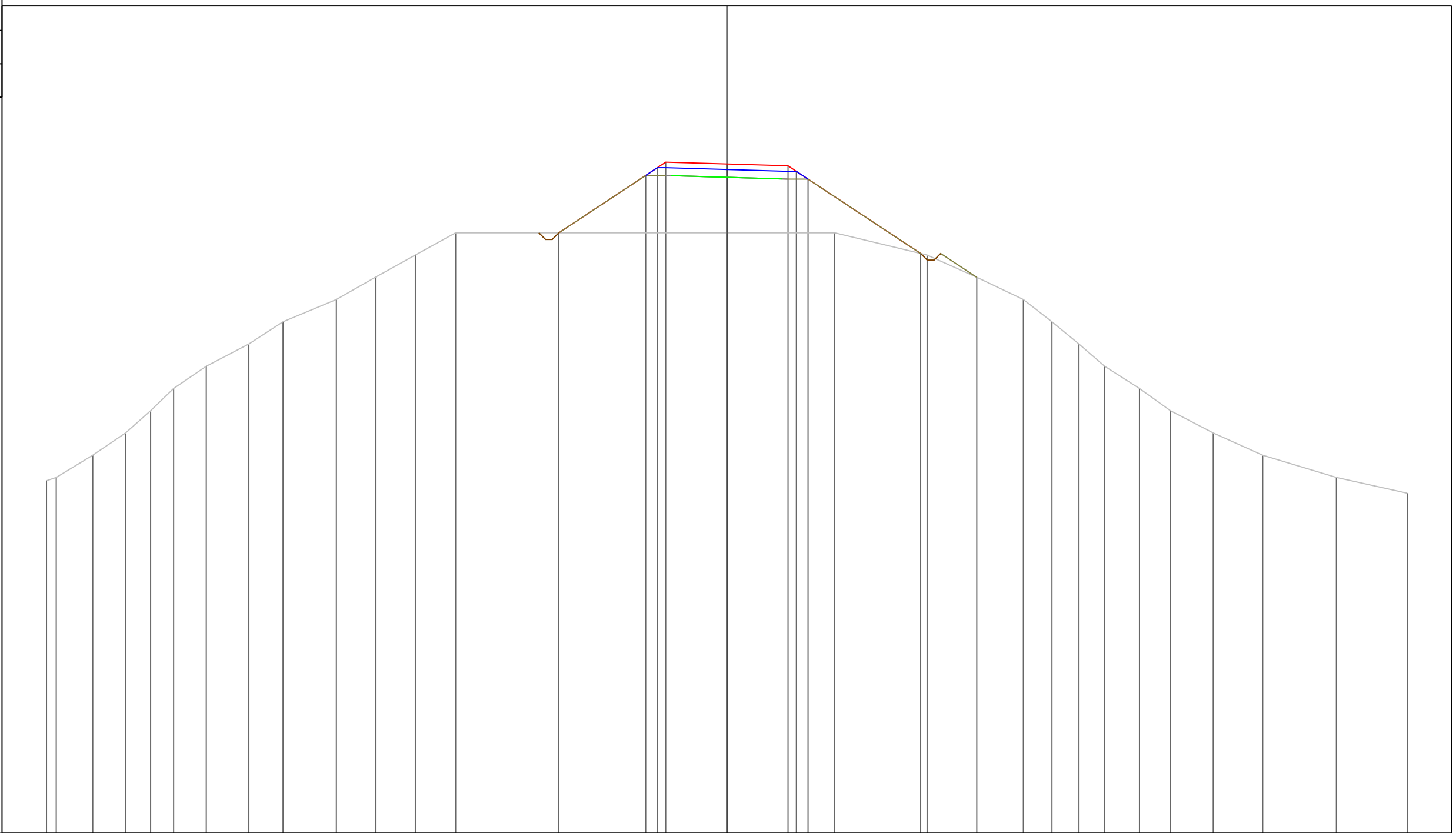

PROGRESSIVE TERRENO	-30.60	-30.16	-28.52	-27.04	-25.92	-24.88	-23.41	-21.50	-19.96	-17.56	-15.81	-14.01	-12.20			4.85	9.01	11.24	13.34	14.62	15.84	16.99	18.56	19.95	21.87	24.10	27.41	30.60	
PARZIALI TERRENO	0.44	1.64	1.48	1.12	1.04	1.47	1.91	1.54	2.40	1.75	1.80	1.81		17.05		4.16	2.23	2.10	1.28	1.22	1.15	1.57	1.39	1.92	2.23	3.31	3.19		
QUOTE TERRENO	167.85	168.00	169.00	170.00	171.00	172.00	173.00	174.00	175.00	176.00	177.00	178.00	179.00			179.00	178.00	177.00	176.00	175.00	174.00	173.00	172.00	171.00	170.00	169.00	168.00	167.29	
PROGRESSIVE PROGETTO														-7.56															
PARZIALI PROGETTO														3.91		0.52	0.38	2.75		2.75	0.38	0.52							5.07
QUOTE PROGETTO														179.00		181.58	181.93	182.10		182.10	182.01	181.76	181.41						178.07







PROFILO Asse4

SEZIONE 97

PROGRESSIVA 960.00

A STERRO m<sup>2</sup> 0.33  
 B RIPORTO m<sup>2</sup> 20.74

157

200  
 200

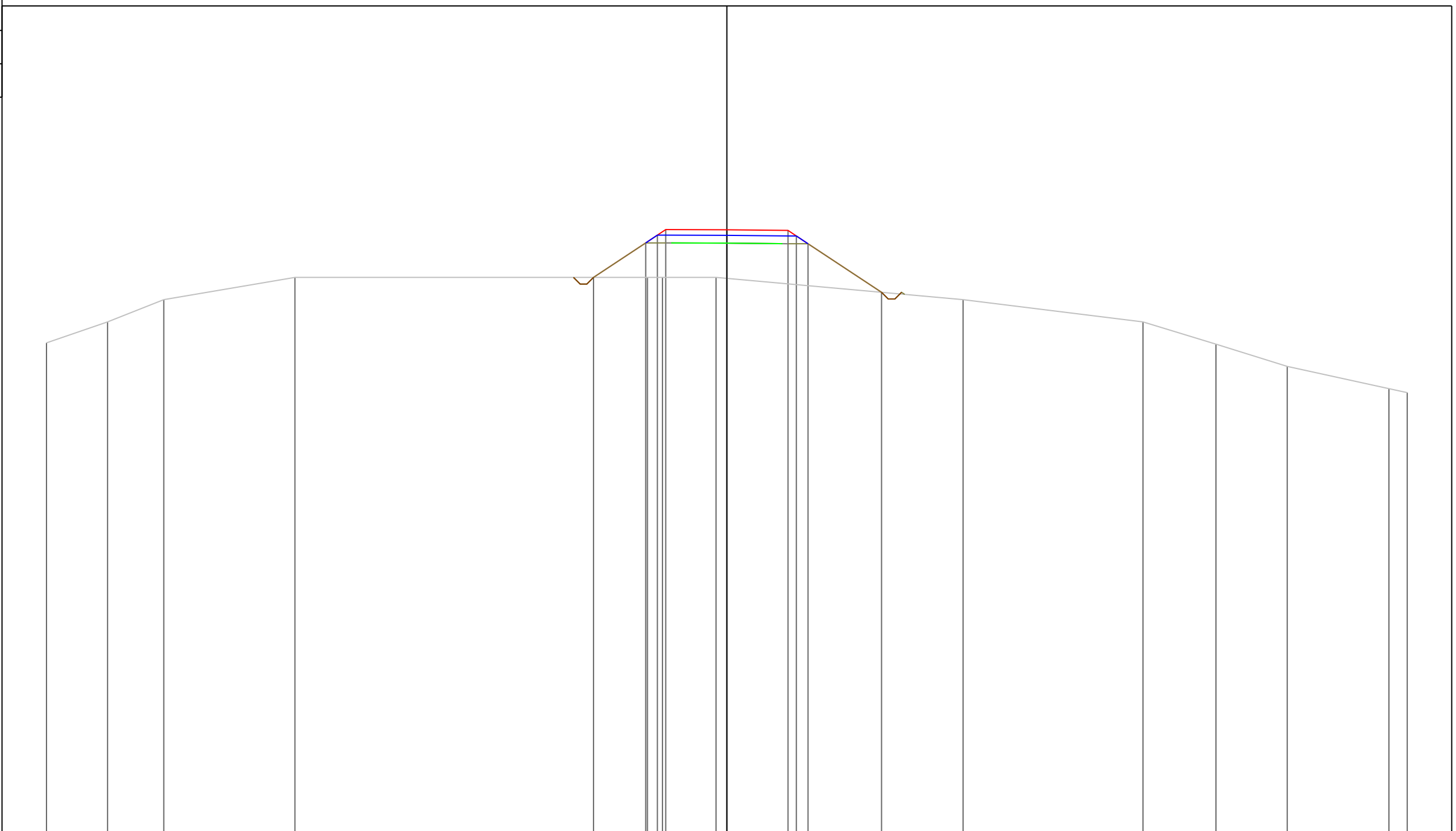

PROGRESSIVE TERRENO	-30.60	-27.85	-25.32	-19.43	-3.57	-2.90	-0.49	10.62	18.71	22.00	25.20	29.78	30.60
PARZIALI TERRENO	2.75	2.53	5.89	15.86	0.67	2.41	11.11	8.09	3.29	3.20	4.58	0.82	
QUOTE TERRENO	179.06	180.00	181.00	182.00	182.00	182.00	182.00	181.00	180.00	179.00	178.00	177.00	176.82
PROGRESSIVE PROGETTO					-6.00	-3.65	-3.13	0.00	2.75	3.12	3.65	6.96	
PARZIALI PROGETTO					2.35	0.52	0.38	2.75	2.75	0.37	0.53	3.31	
QUOTE PROGETTO					182.00	183.55	183.90	184.15	184.14	184.11	183.86	183.51	181.33

PROFILO Asse4

SEZIONE 98

PROGRESSIVA 970.00

A STERRO m<sup>2</sup> 0.36  
 B RIPORTO m<sup>2</sup> 14.34

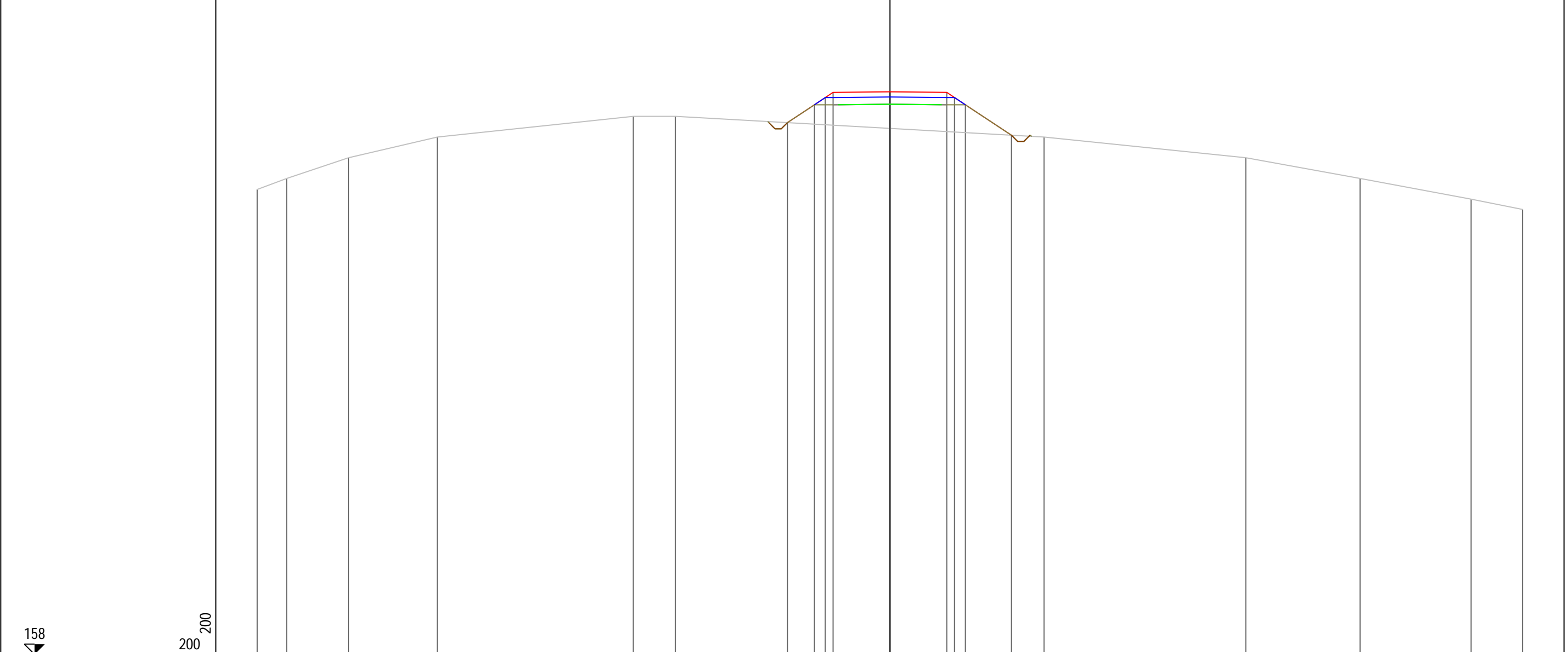

PROGRESSIVE TERRENO	-30.60	-29.17	-26.18	-21.88		-12.41	-10.37			7.46		17.22	22.74	28.10	30.60	
PARZIALI TERRENO	1.43	2.99	4.30		9.47	2.04		17.83		9.76		5.52	5.36	2.50		
QUOTE TERRENO	180.47	181.00	182.00	183.00		184.00	184.00			183.00		182.00	181.00	180.00	179.50	
PROGRESSIVE PROGETTO								-4.96	-3.65	-3.13	-2.75	0.00	2.75	3.12	3.65	5.88
PARZIALI PROGETTO								1.31	0.52	0.38	2.75	2.75	0.37	0.53	2.23	
QUOTE PROGETTO								183.70	184.56	184.91	185.16	185.19	185.16	184.91	184.56	183.09

PROFILO Asse4

SEZIONE 99

PROGRESSIVA 980.00

A STERRO m<sup>2</sup> 0.34  
B RIPORTO m<sup>2</sup> 12.51

160  
200  
200

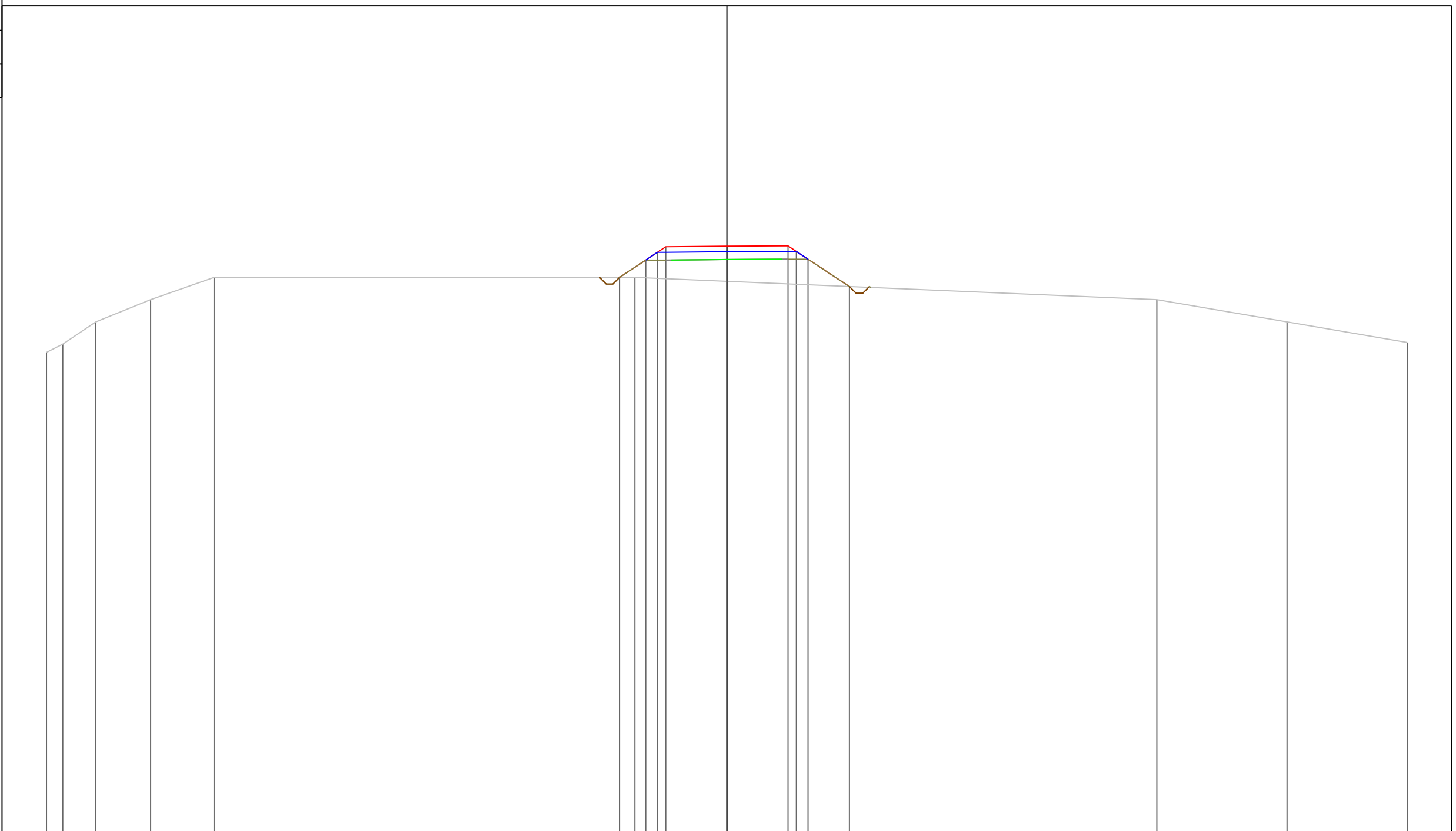

PROGRESSIVE TERRENO	-30.60	-29.87	-28.38	-25.92	-23.06	-4.14	19.34	25.19	30.60					
PARZIALI TERRENO	0.73	1.49	2.46	2.86	18.92	23.48	5.85	5.41						
QUOTE TERRENO	181.63	182.00	183.00	184.00	185.00	185.00	184.00	183.00	182.08					
PROGRESSIVE PROGETTO						-4.83	0.00	2.75	3.12	3.65	5.51			
PARZIALI PROGETTO						1.18	0.52	0.38	2.75	0.37	0.53	1.86		
QUOTE PROGETTO						185.00	185.78	186.13	186.38	186.40	186.42	186.17	185.82	184.59



PROFILO Asse4

SEZIONE 101

PROGRESSIVA 1000.00

A STERRO m<sup>2</sup> 2.73  
B RIPORTO m<sup>2</sup> 1.75

165

200  
200

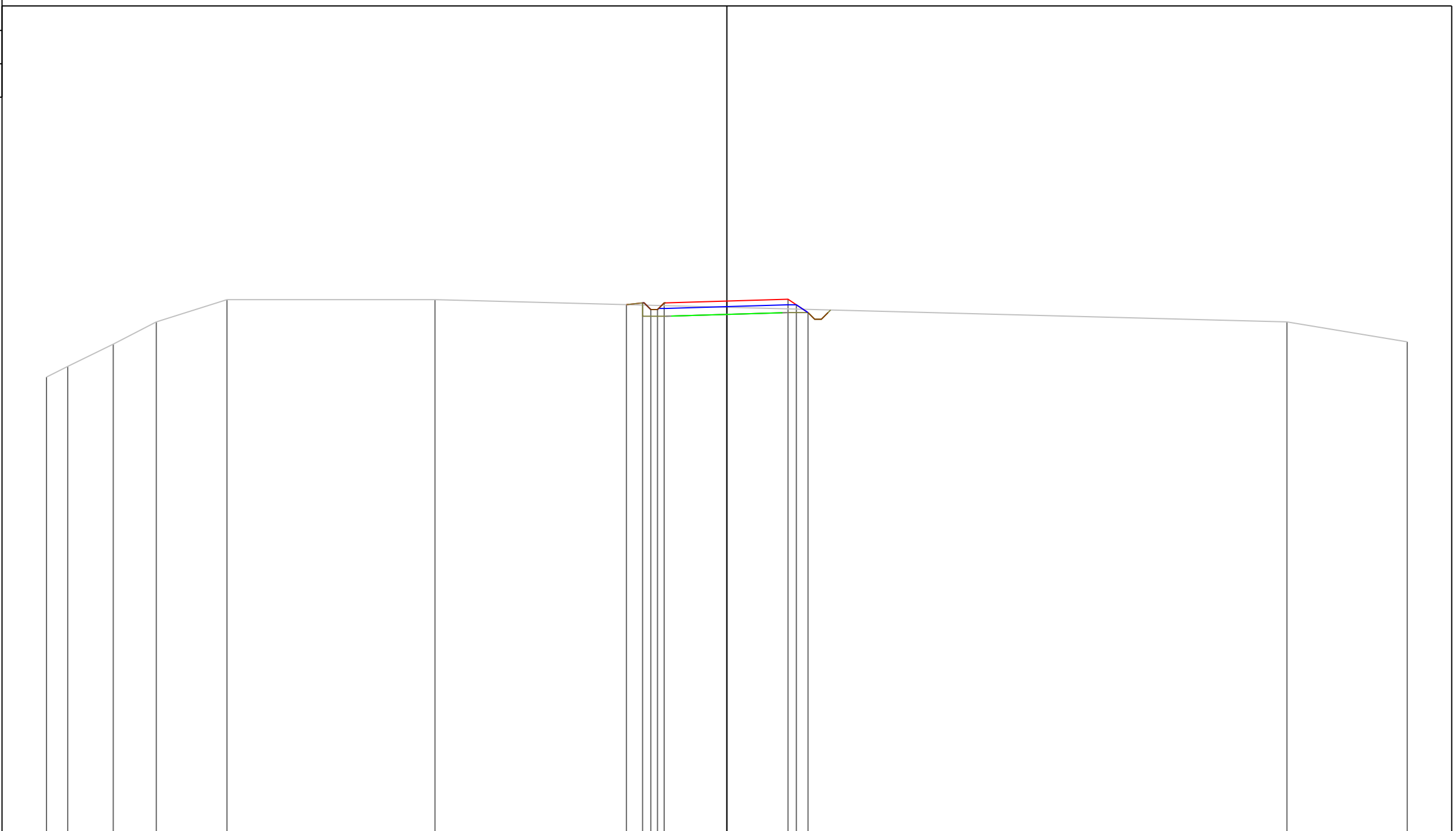

PROGRESSIVE TERRENO	-30.60	-29.64	-27.60	-25.66	-22.48	-13.13					25.19	30.60								
PARZIALI TERRENO	0.96	2.04	1.94	3.18		9.35					38.32	5.41								
QUOTE TERRENO	185.52	186.00	187.00	188.00	189.00	189.00					188.00	187.10								
PROGRESSIVE PROGETTO																				
PARZIALI PROGETTO							0.73	4.52	0.37	3.79	0.30	3.42	0.30	3.12	2.82	0.00	2.75	0.38	3.13	3.65
QUOTE PROGETTO							188.78	188.85	188.85	188.55	188.55	188.85	188.94	189.02	188.77	188.42				

PROFILO Asse4	
SEZIONE 102	
PROGRESSIVA 1010.00	
A STERRO	m <sup>2</sup> 3.62
B RIPORTO	m <sup>2</sup> 0.81



PROGRESSIVE TERRENO	-30.60	-30.04	-28.08	-26.01	-23.48						27.79	30.60
PARZIALI TERRENO	0.56	1.96	2.07	2.53				51.27				2.81
QUOTE TERRENO	186.69 187.00		188.00	189.00	190.00						190.00	189.28
PROGRESSIVE PROGETTO												
PARZIALI PROGETTO												
QUOTE PROGETTO												

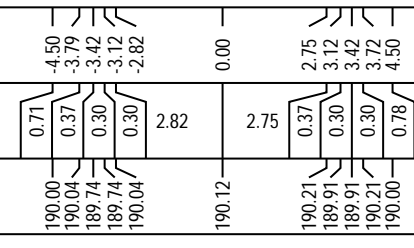

PROFILO Asse4

SEZIONE 103

PROGRESSIVA 1020.00

A STERRO m<sup>2</sup> 11.91

167

200  
200

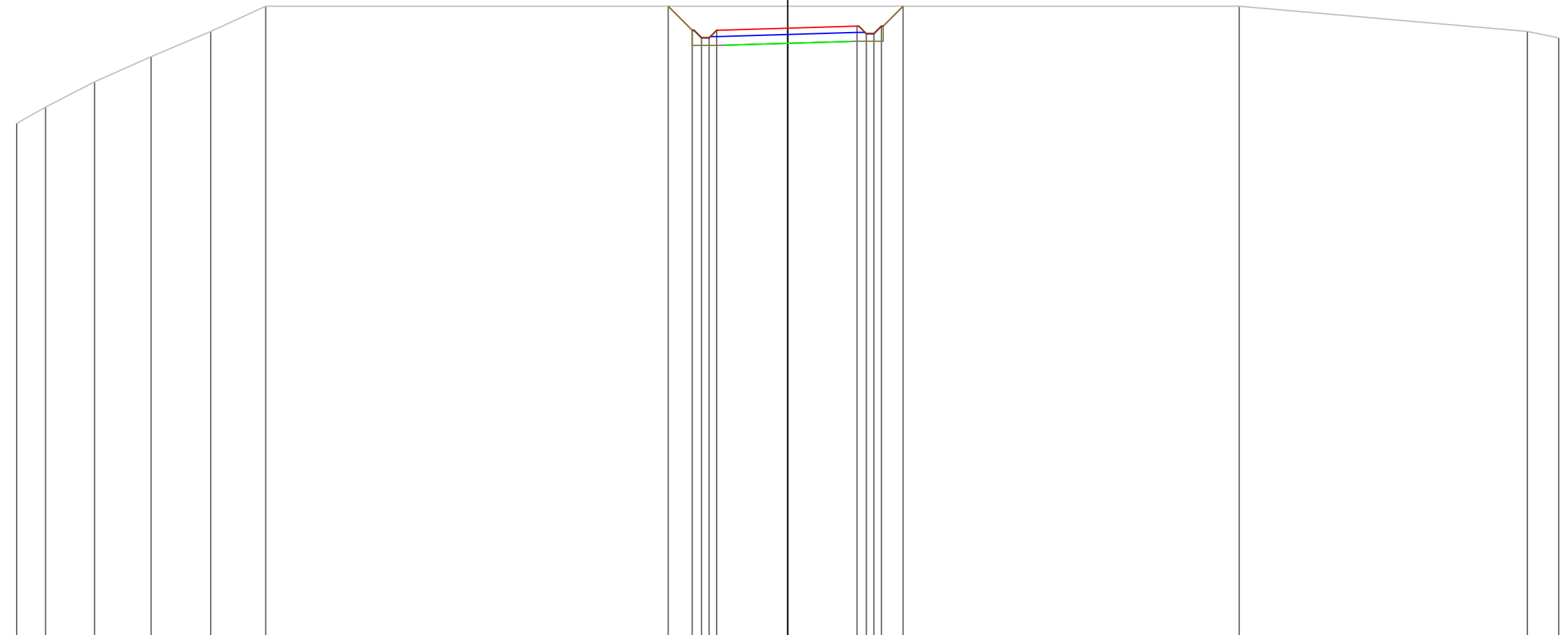

PROGRESSIVE TERRENO	-30.60	-29.45	-27.51	-25.27	-22.90	-20.72				17.92		29.36	30.60					
PARZIALI TERRENO	1.15	1.94	2.24	2.37	2.18		38.64				11.44	1.24						
QUOTE TERRENO	187.35	188.00	189.00	190.00	191.00	192.00				192.00		191.00	190.74					
PROGRESSIVE PROGETTO								-4.74	-3.79	-3.42	-3.12	-2.82	0.00	2.75	3.12	3.42	3.72	4.58
PARZIALI PROGETTO								0.95	0.37	0.30	0.30	2.82	2.75	0.37	0.30	0.30	0.86	
QUOTE PROGETTO								192.00	191.05	190.75	190.75	191.05	191.13	191.21	190.91	190.91	191.21	192.00



PROFILO Asse4

SEZIONE 104

PROGRESSIVA 1030.00

A STERRO m<sup>2</sup> 13.57

167

200  
200

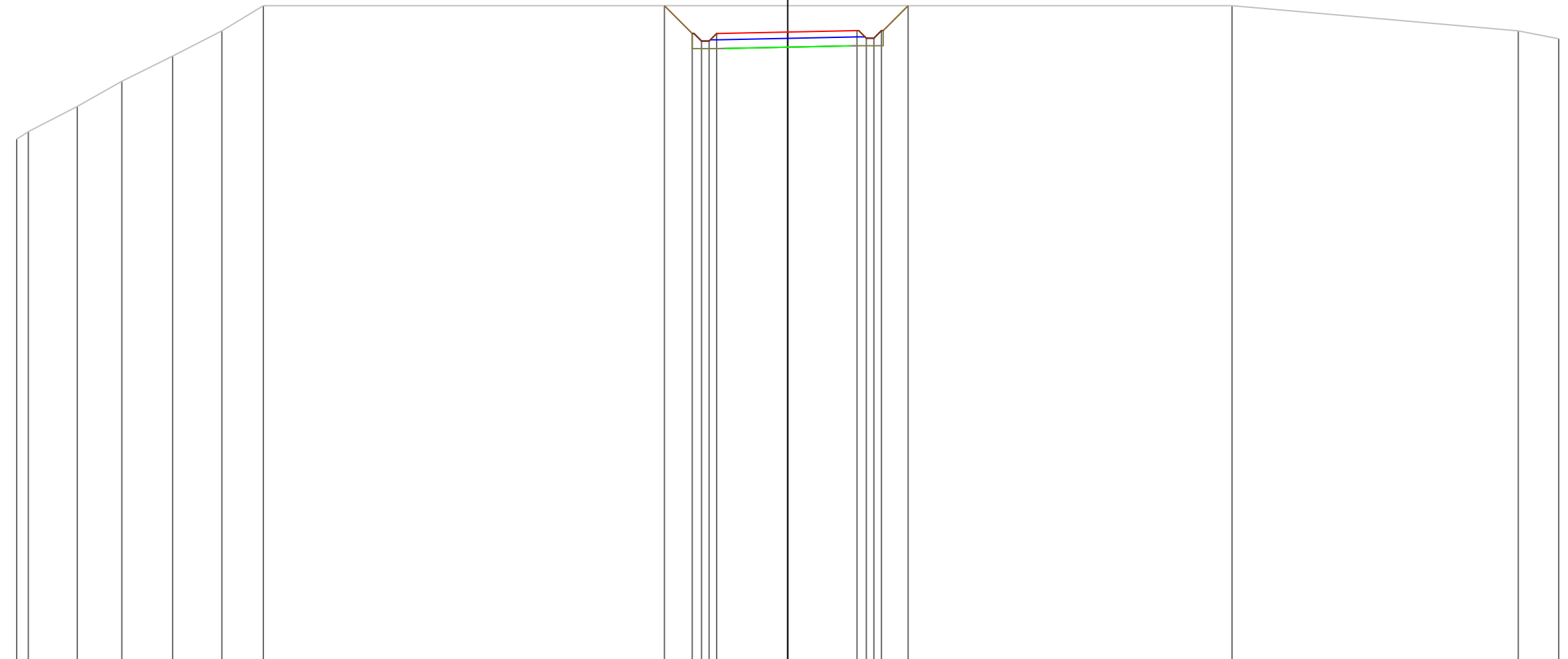

PROGRESSIVE TERRENO	-30.60	-30.14	-28.20	-26.43	-24.41	-22.46	-20.81				17.63		28.99	30.60				
PARZIALI TERRENO	0.46	1.94	1.77	2.02	1.95	1.65		38.44			11.36		1.61					
QUOTE TERRENO	187.70	188.00	189.00	190.00	191.00	192.00	193.00				193.00		192.00	191.69				
PROGRESSIVE PROGETTO								-4.89	-3.79	-3.42	-3.12	-2.82	0.00	2.75	3.12	3.42	3.72	4.78
PARZIALI PROGETTO								1.10	0.37	0.30	0.30	2.82	2.75	0.37	0.30	0.30	1.06	
QUOTE PROGETTO								193.00	191.90	191.60	191.60	191.90	191.95	192.01	191.71	192.01	193.00	

PROFILO Asse4

SEZIONE 105

PROGRESSIVA 1040.00

A STERRO m<sup>2</sup> 17.20

167

200  
200

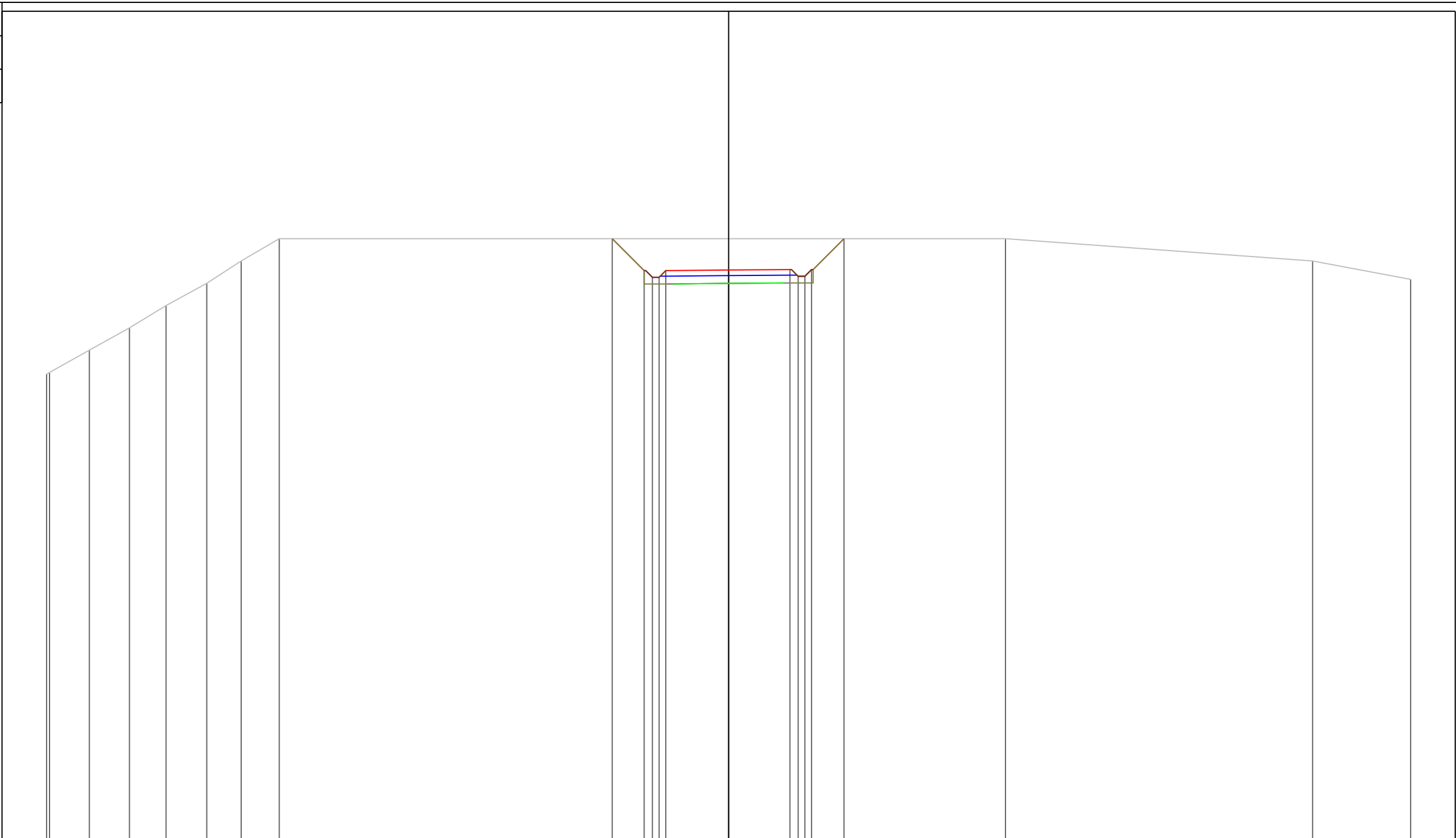

PROGRESSIVE TERRENO	187.92	188.00	189.00	190.00	191.00	192.00	193.00	194.00			194.00	193.00	192.18							
PARZIALI TERRENO	0.13	1.79	1.80	1.64	1.83	1.54	1.71		32.58			13.78	4.40							
QUOTE TERRENO																				
PROGRESSIVE PROGETTO										-5.22	-3.79	-3.42	-3.12	-2.82	0.00	2.75	3.12	3.42	3.72	5.18
PARZIALI PROGETTO										1.43	0.37	0.30	0.30	2.82	2.75	0.37	0.30	0.30	1.46	
QUOTE PROGETTO										194.00	192.57	192.27	192.27	192.57	192.60	192.61	192.31	192.31	192.61	194.00

PROFILO Asse4

SEZIONE 106

PROGRESSIVA 1050.00

A STERRO m<sup>2</sup> 12.76

167

200  
200

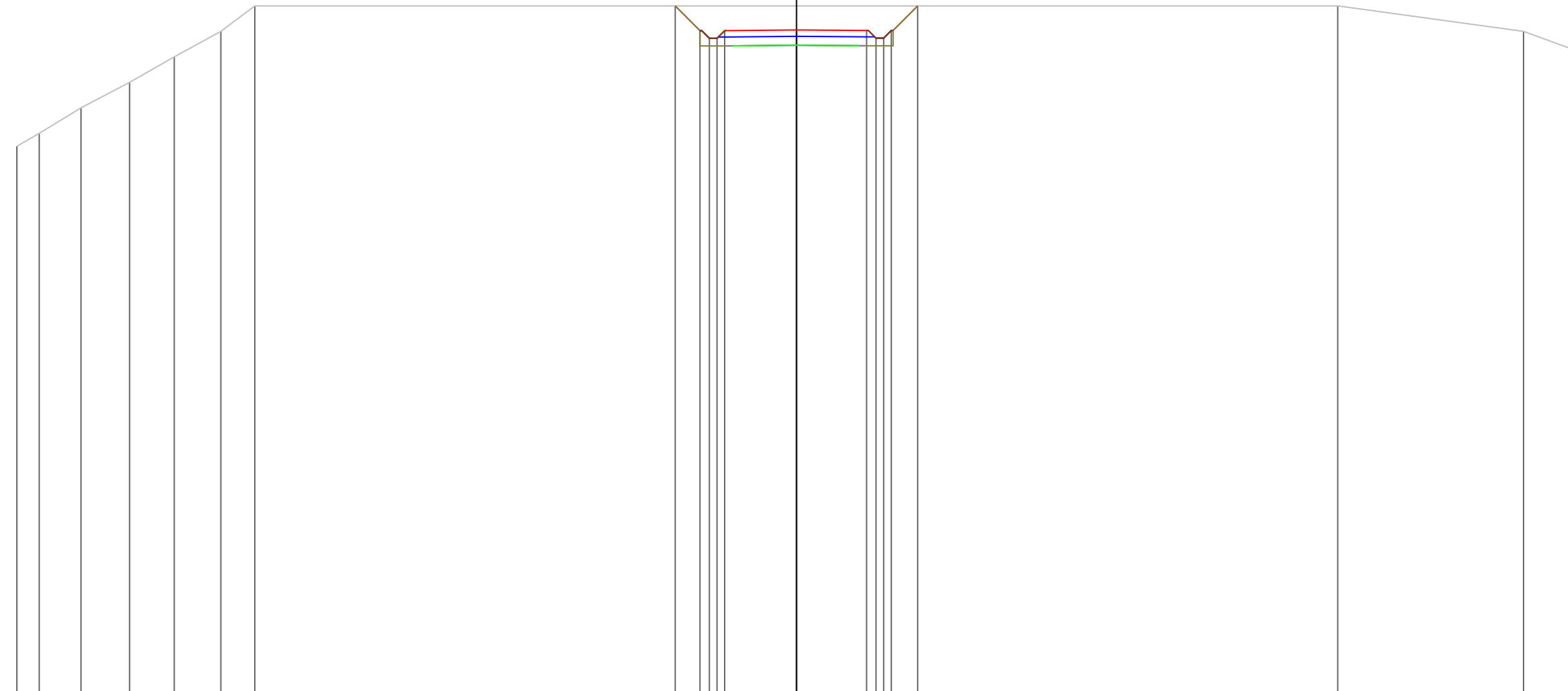

PROGRESSIVE TERRENO	-30.60	-29.72	-28.08	-26.18	-24.42	-22.59	-21.26				21.24	28.53	30.60					
PARZIALI TERRENO	0.88	1.64	1.90	1.76	1.83	1.33		42.50			7.29	2.07						
QUOTE TERRENO	188.49	189.00	190.00	191.00	192.00	193.00	194.00				194.00	193.00	192.25					
PROGRESSIVE PROGETTO								-4.76	-3.79	-3.42	-3.12	-2.82	0.00	2.75	3.12	3.42	3.72	4.76
PARZIALI PROGETTO								0.97	0.37	0.30	0.30	2.82	2.75	0.37	0.30	0.30	1.04	
QUOTE PROGETTO								194.00	193.03	192.73	192.73	193.03	193.06	193.03	192.73	192.73	193.03	194.00

PROFILO Asse4  
 SEZIONE 107  
 PROGRESSIVA 1060.00  
 A STERRO m<sup>2</sup> 10.20

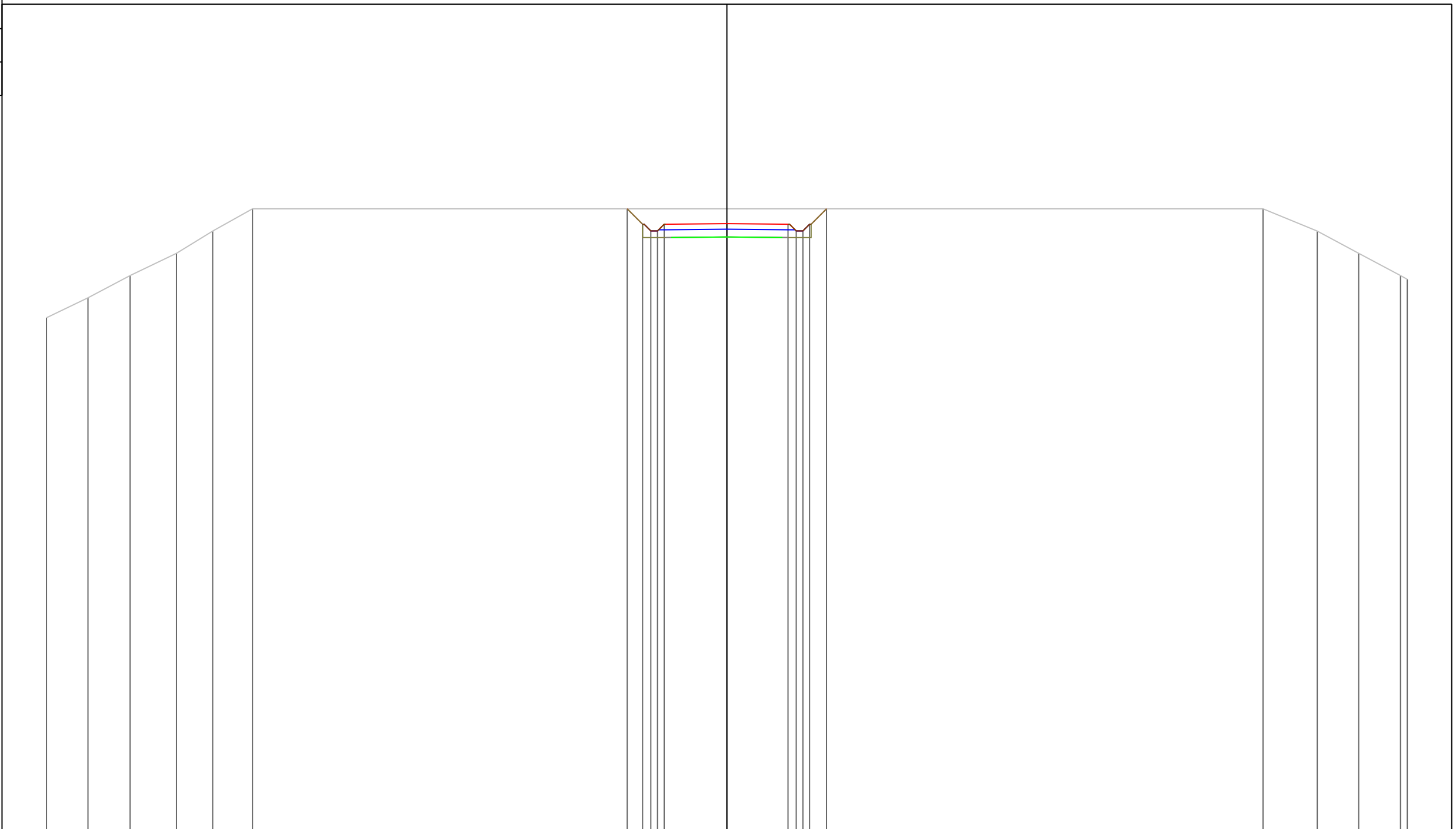

166

200 200

PROGRESSIVE TERRENO	-30.60	-28.73	-26.84	-24.75	-23.13	-21.34					24.11	26.55	28.42	30.30	30.60			
PARZIALI TERRENO	1.87	1.89	2.09	1.62	1.79		45.45				2.44	1.87	1.88	0.30				
QUOTE TERRENO	189.10	190.00	191.00	192.00	193.00	194.00					194.00	193.00	192.00	191.00	190.83			
PROGRESSIVE PROGETTO																		
PARZIALI PROGETTO							0.69	0.37	0.30	0.30	2.82		2.75	0.37	0.30	0.30	0.30	0.76
QUOTE PROGETTO							194.00	193.31	193.01	193.01	193.31	193.33		193.31	193.01	193.01	193.31	194.00







PROFILO Asse4

SEZIONE 111

PROGRESSIVA 1100.00

A STERRO m<sup>2</sup> 9.39

164

200  
200

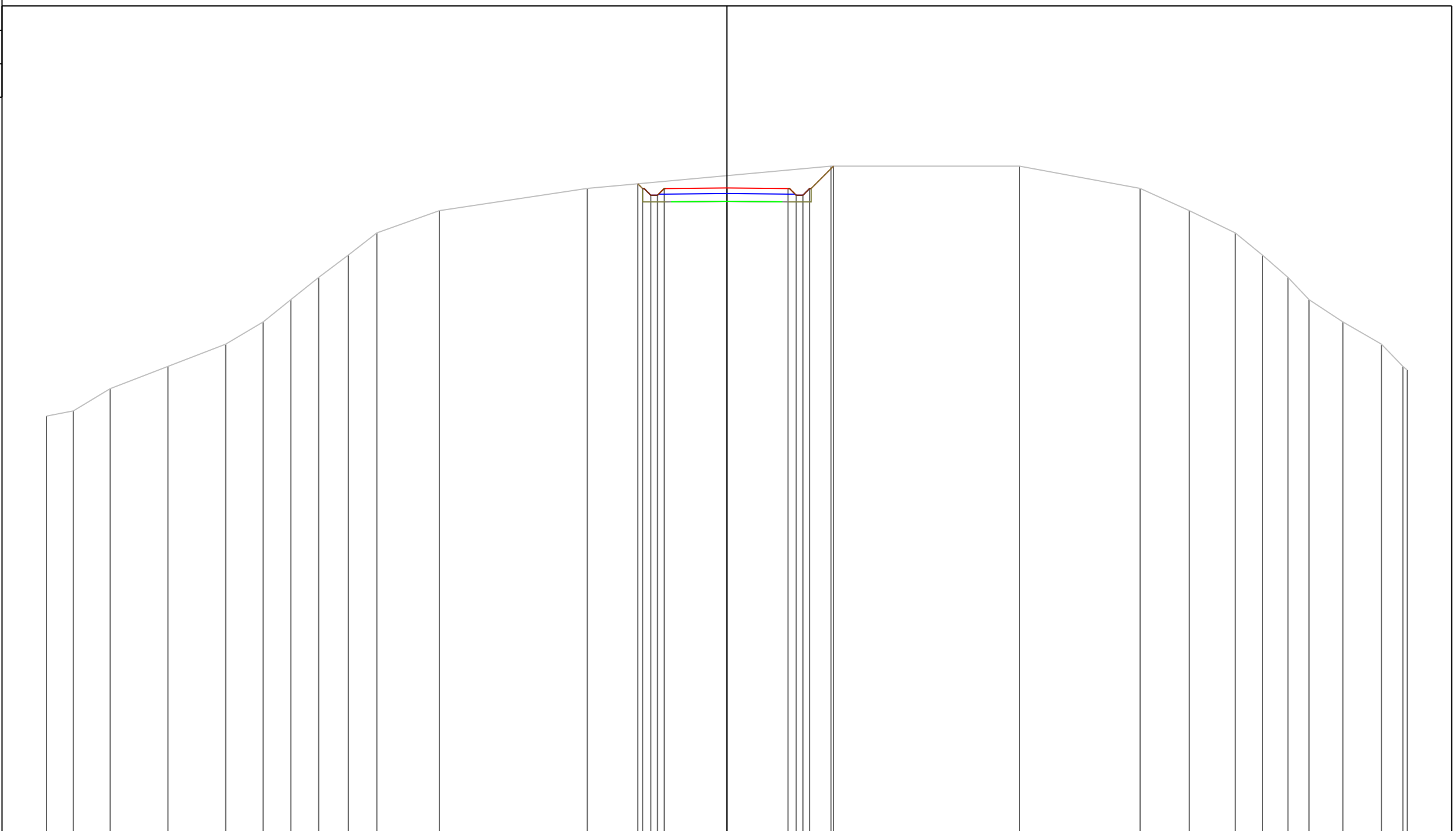

PROGRESSIVE TERRENO

-30.60	-29.39	-27.73	-25.14	-22.54	-20.85	-19.61	-18.36	-17.03	-15.74	-12.93	-6.28	4.68	13.16	18.59	20.80	22.87	24.09	25.24	26.18	27.70	29.44	30.40	30.60
--------	--------	--------	--------	--------	--------	--------	--------	--------	--------	--------	-------	------	-------	-------	-------	-------	-------	-------	-------	-------	-------	-------	-------

PARZIALI TERRENO

1.21	1.66	2.59	2.60	1.69	1.24	1.25	1.33	1.29	2.81	6.65	10.96	8.48	5.43	2.21	2.07	1.22	1.15	0.94	1.52	1.74	0.96	0.20
------	------	------	------	------	------	------	------	------	------	------	-------	------	------	------	------	------	------	------	------	------	------	------

QUOTE TERRENO

182.77	183.00	184.00	185.00	186.00	187.00	188.00	189.00	190.00	191.00	192.00	193.00	194.00	194.00	193.00	192.00	191.00	190.00	189.00	188.00	187.00	186.00	185.00	184.83
--------	--------	--------	--------	--------	--------	--------	--------	--------	--------	--------	--------	--------	--------	--------	--------	--------	--------	--------	--------	--------	--------	--------	--------

PROGRESSIVE PROGETTO

--	--	--	--	--	--	--	--	--	--	--	--	--	--	--	--	--	--	--	--	--	--	--	--

PARZIALI PROGETTO

--	--	--	--	--	--	--	--	--	--	--	--	--	--	--	--	--	--	--	--	--	--	--	--

QUOTE PROGETTO

--	--	--	--	--	--	--	--	--	--	--	--	--	--	--	--	--	--	--	--	--	--	--	--

0.21	0.37	0.30	0.30	2.82	2.75	0.37	0.30	0.30	1.08
193.21	192.99	192.69	192.69	192.99	193.02	192.99	192.69	192.69	194.00
-4.00	-3.79	-3.42	-3.12	-2.82	0.00	2.75	3.12	3.42	3.72



PROFILO Asse4

SEZIONE 112

PROGRESSIVA 1110.00

A STERRO m<sup>2</sup> 5.78

163

200  
200

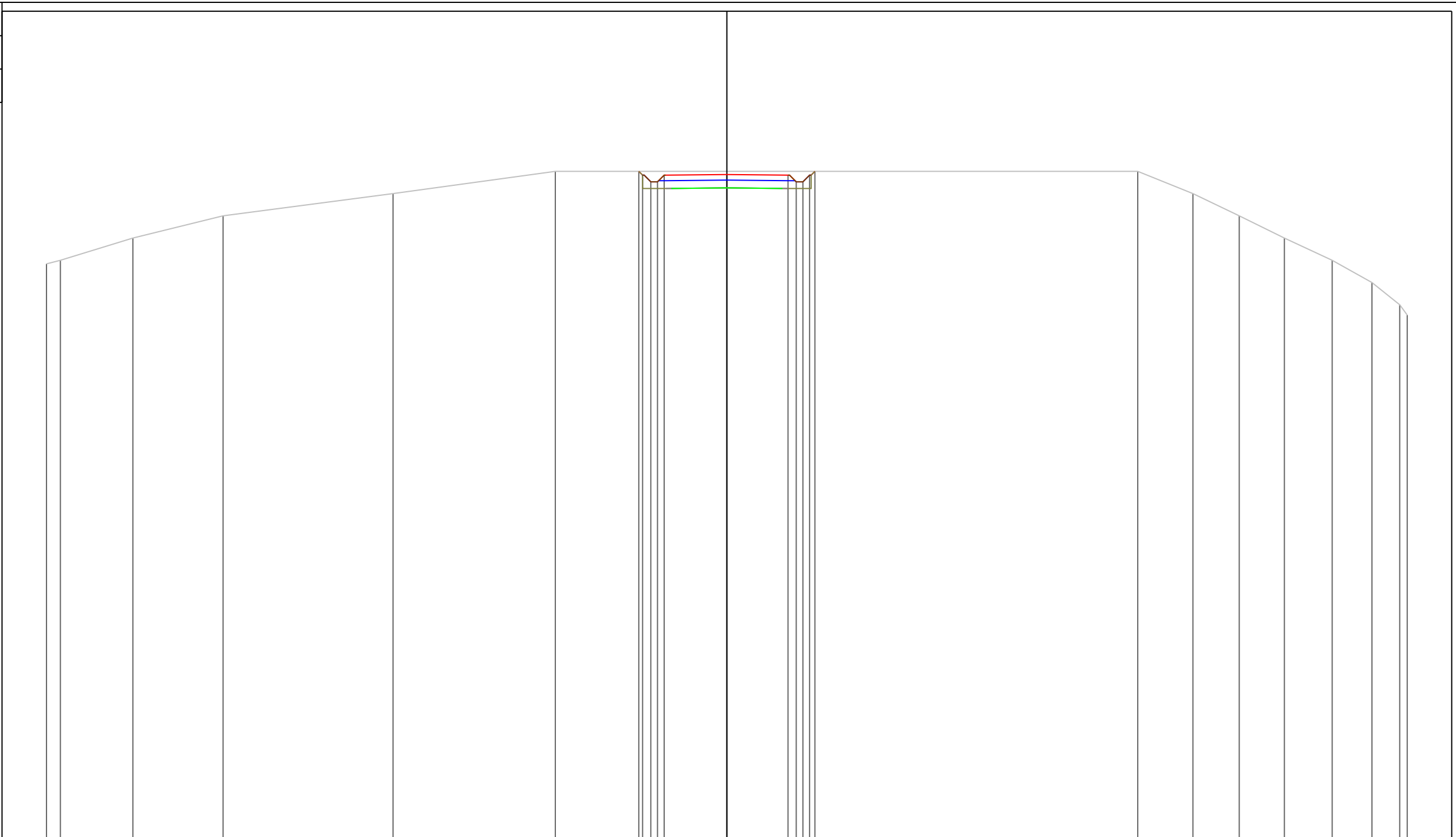

PROGRESSIVE TERRENO	-30.60	-29.98	-26.72	-22.66	-15.01	-7.72	18.48	20.96	23.04	25.07	27.22	29.01	30.26	30.60
PARZIALI TERRENO	0.62	3.26	4.06	7.65	7.29	26.20	2.48	2.08	2.03	2.15	1.79	1.25	0.34	
QUOTE TERRENO	188.84	189.00	190.00	191.00	192.00	193.00	193.00	192.00	191.00	190.00	189.00	188.00	187.00	186.54
PROGRESSIVE PROGETTO														
PARZIALI PROGETTO														
QUOTE PROGETTO														

0.17  
 0.37  
 0.30  
 0.30  
 2.82  
 2.75  
 0.37  
 0.30  
 0.30  
 0.24  
 193.00  
 192.83  
 192.53  
 192.53  
 192.83  
 192.86  
 192.83  
 192.53  
 192.83  
 193.00

-3.96  
 -3.79  
 -3.42  
 -3.12  
 -2.82  
 0.00  
 2.75  
 3.12  
 3.42  
 3.72  
 3.96

PROFILO Asse4

SEZIONE 113

PROGRESSIVA 1120.00

A STERRO m<sup>2</sup> 7.83

164

200  
200

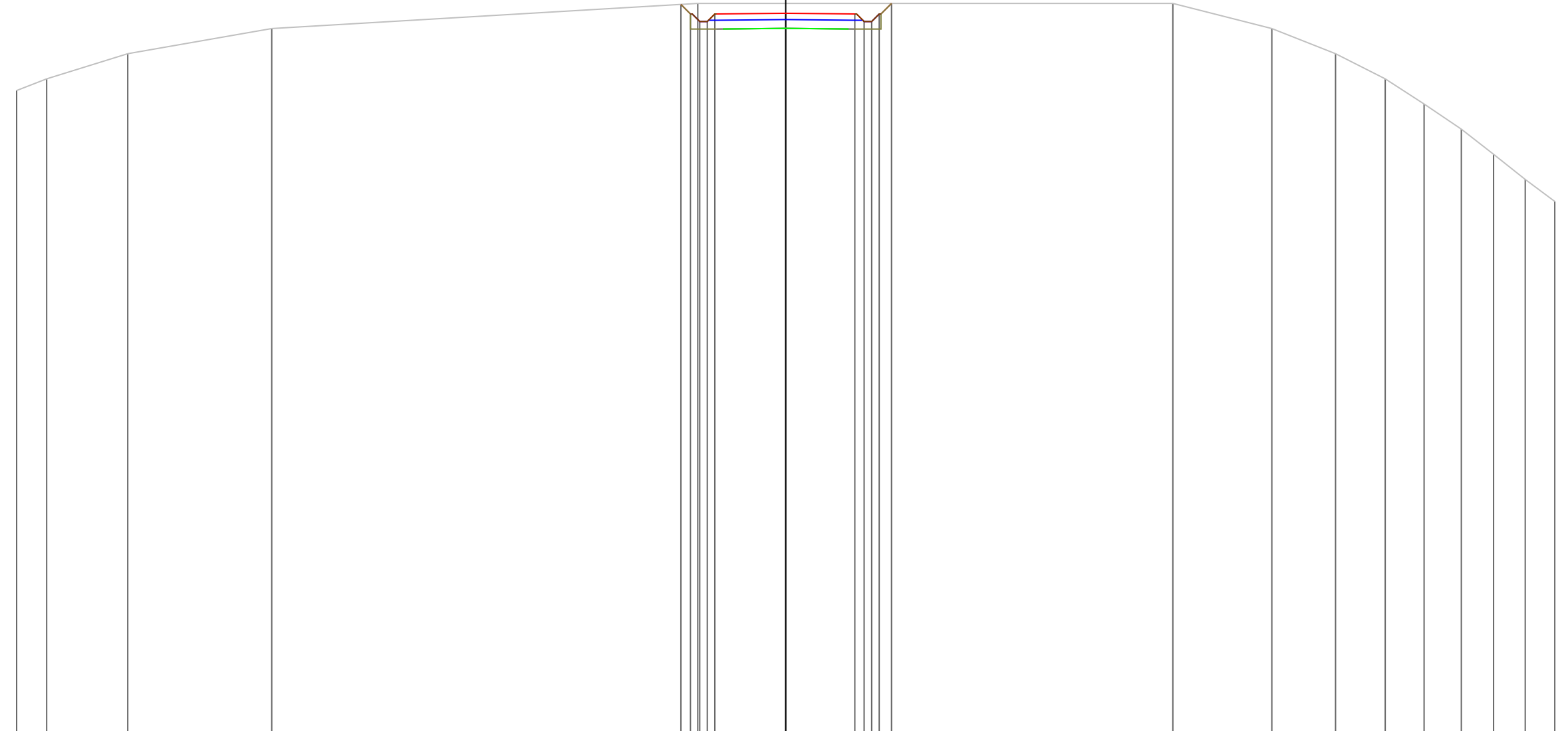

PROGRESSIVE TERRENO	-30.60	-29.41	-26.18	-20.45	-3.50	15.40	19.34	21.88	23.85	25.40	26.88	28.17	29.42	30.60
PARZIALI TERRENO	1.19	3.23	5.73	16.95	18.90	3.94	2.54	1.97	1.55	1.48	1.29	1.25	1.18	
QUOTE TERRENO	189.54	190.00	191.00	192.00	193.00	193.00	192.00	191.00	190.00	189.00	188.00	187.00	186.00	185.13
PROGRESSIVE PROGETTO					-4.17	0.00	2.75	3.12	3.42	3.72	4.21			
PARZIALI PROGETTO					0.38	2.82	2.75	0.37	0.30	0.30	0.49			
QUOTE PROGETTO					192.96	192.61	192.58	192.28	192.28	192.58	193.00			

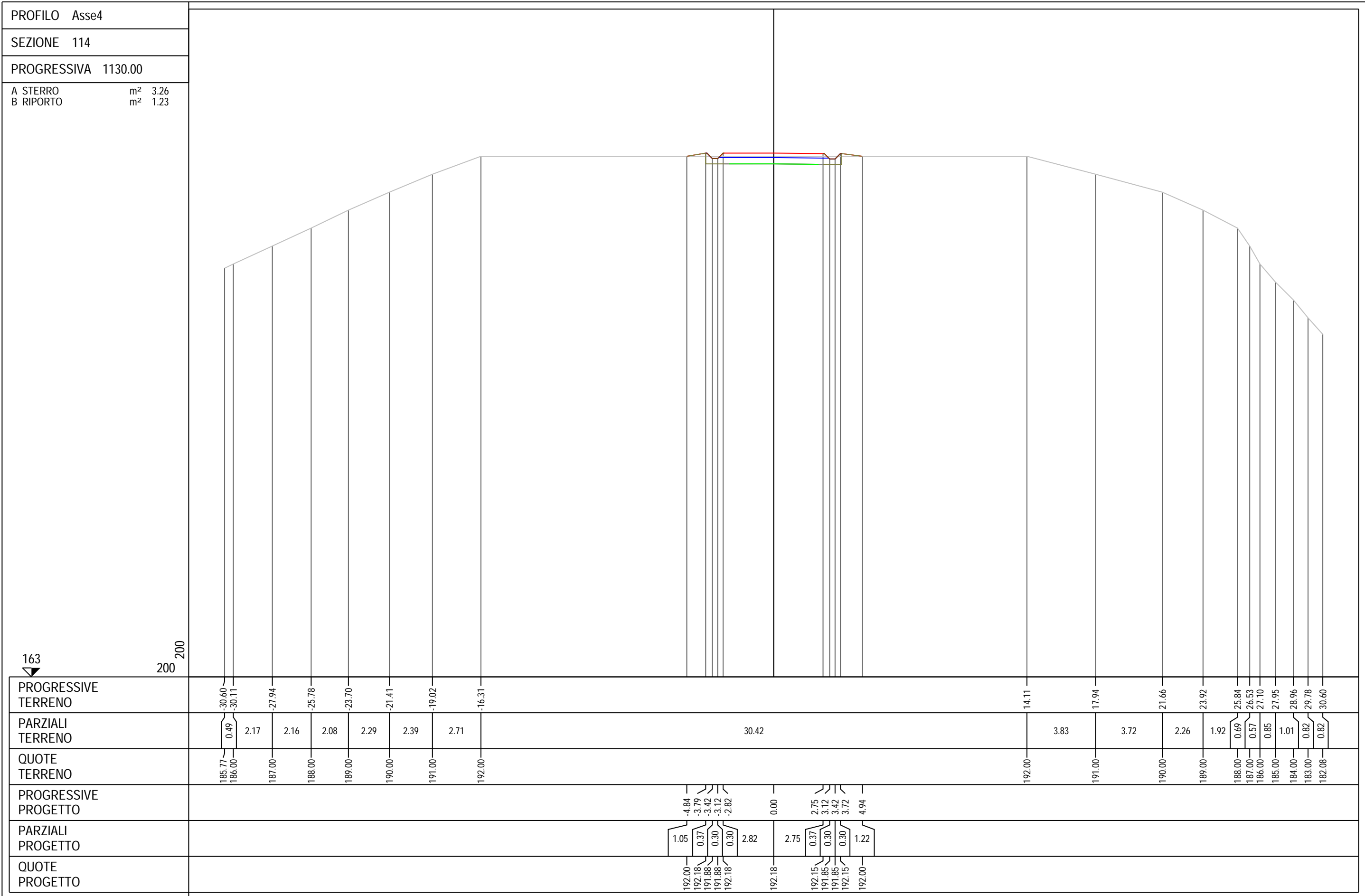







PROFILO Asse4

SEZIONE 118

PROGRESSIVA 1170.00

A STERRO m<sup>2</sup> 0.19  
B RIPORTO m<sup>2</sup> 29.39

160  
200  
200

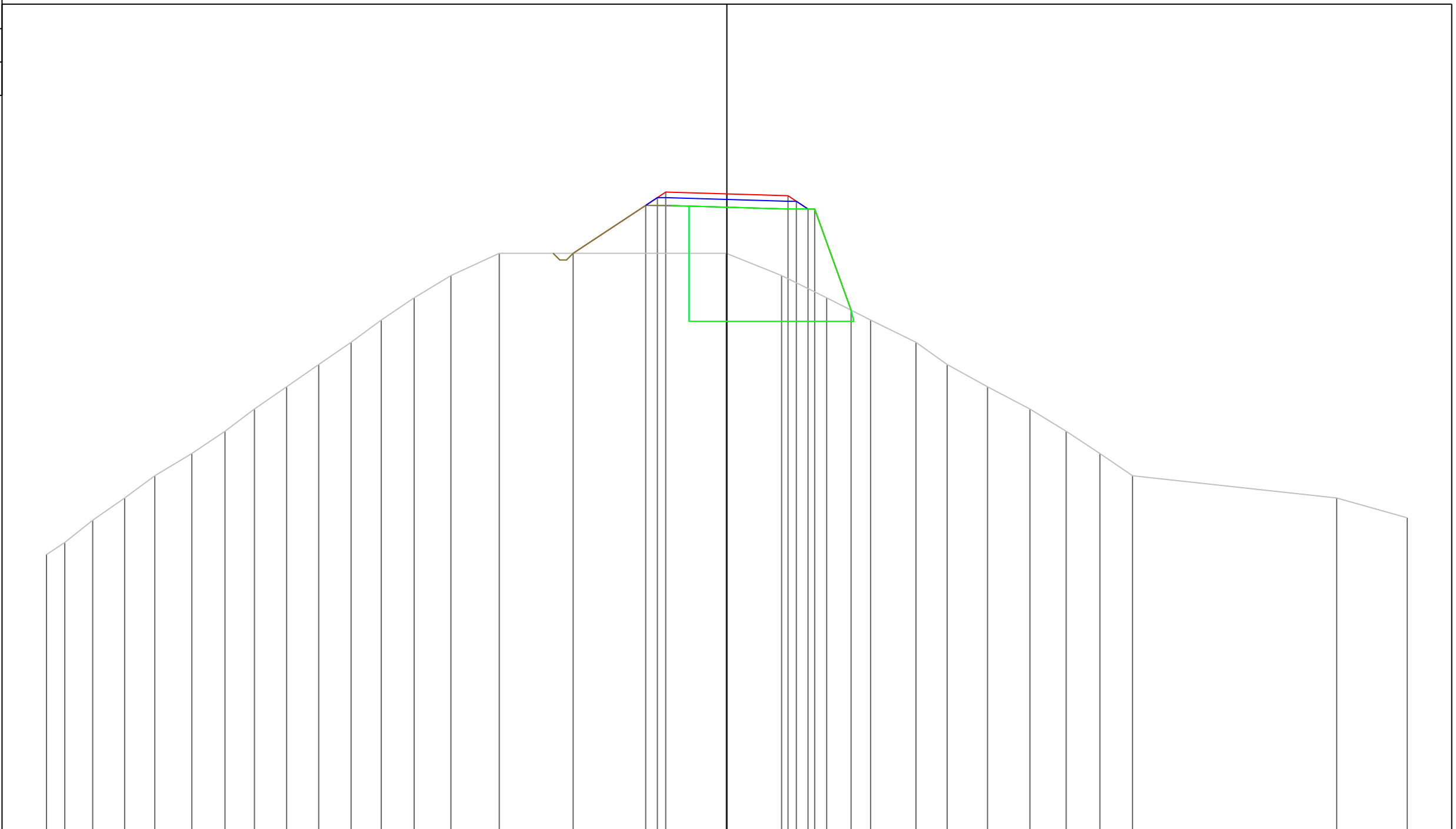

PROGRESSIVE TERRENO	-30.60	-29.78	-28.52	-27.08	-25.73	-24.06	-22.57	-21.25	-19.80	-18.36	-16.90	-15.54	-14.06	-12.41	-10.24			-0.03	2.46	4.49	6.46	8.51	9.91	11.72	13.63	15.26	16.78	18.25			27.43	30.60
PARZIALI TERRENO	0.82	1.26	1.44	1.35	1.67	1.49	1.32	1.45	1.44	1.46	1.36	1.48	1.65	2.17	10.21			2.49	2.03	1.97	2.05	1.40	1.81	1.91	1.63	1.52	1.47			9.18	3.17	
QUOTE TERRENO	172.46	173.00	174.00	175.00	176.00	177.00	178.00	179.00	180.00	181.00	182.00	183.00	184.00	185.00	186.00			186.00	185.00	184.00	183.00	182.00	181.00	180.00	179.00	178.00	177.00	176.00			175.00	174.11
PROGRESSIVE PROGETTO																-6.91		0.00	2.75	3.13	3.65	3.95	5.59									
PARZIALI PROGETTO																3.26		0.52	0.38	2.75	2.75	0.38	0.52	0.30	1.64							
QUOTE PROGETTO																186.00		188.15	188.50	188.75	188.67	188.59	188.34	187.99	183.44							





PROFILO Asse4

SEZIONE 120

PROGRESSIVA 1190.00

A STERRO m<sup>2</sup> 0.23  
 B RIPORTO m<sup>2</sup> 37.24

161

200  
 200

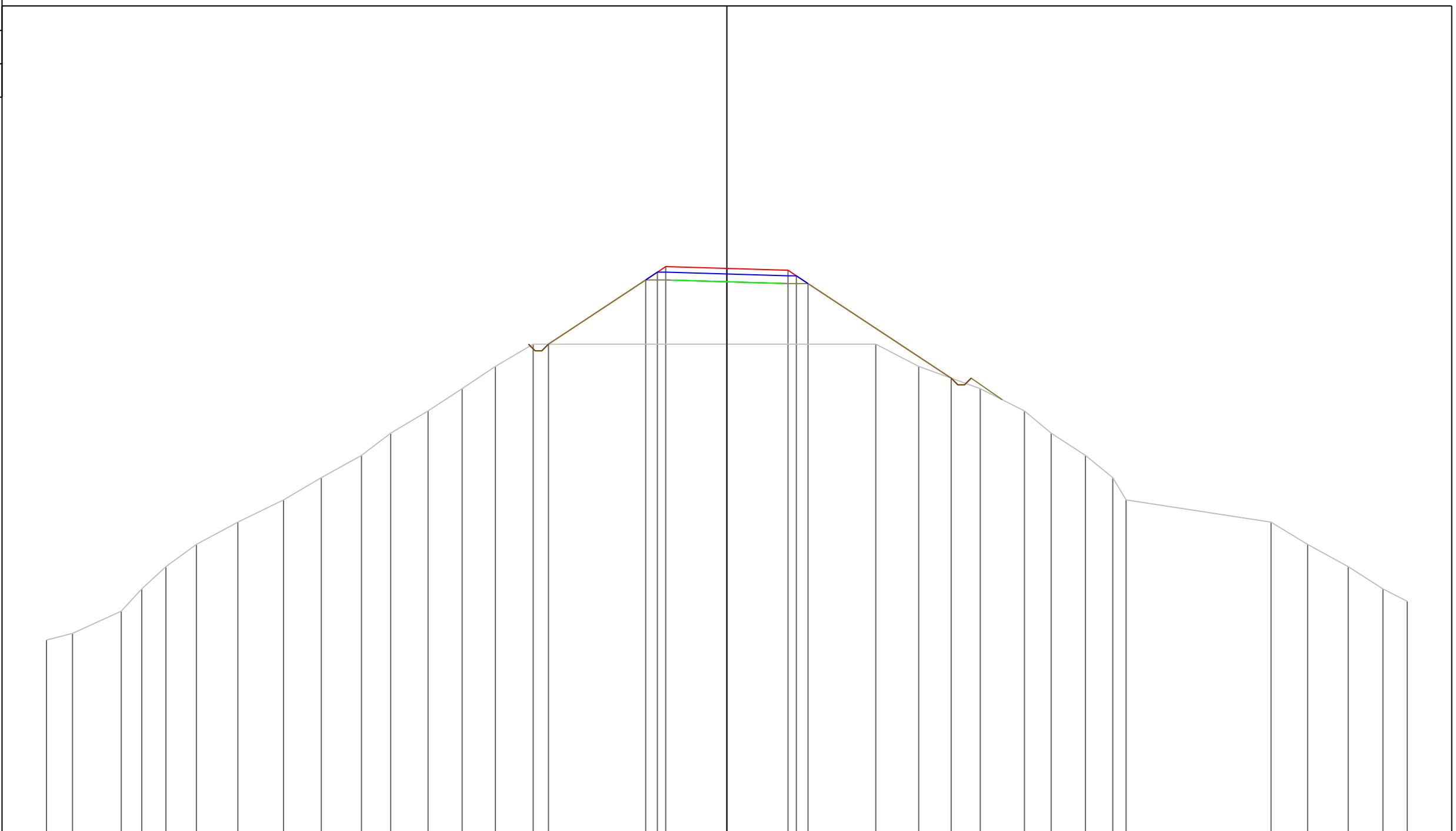

PROGRESSIVE TERRENO	-30.60	-29.43	-27.24	-26.32	-25.23	-23.86	-21.99	-19.94	-18.24	-16.43	-15.12	-13.44	-11.91	-10.41	-8.71		6.70	8.63	11.40	13.38	14.59	16.13	17.36	17.96		24.47	26.12	27.94	29.51	30.60	
PARZIALI TERRENO	1.17	2.19	0.92	1.09	1.37	1.87	2.05	1.70	1.81	1.31	1.68	1.53	1.50	1.70	15.41		1.93	2.77	1.98	1.21	1.54	1.23	0.60	6.51	1.65	1.82	1.57	1.09			
QUOTE TERRENO	169.70	170.00	171.00	172.00	173.00	174.00	175.00	176.00	177.00	178.00	179.00	180.00	181.00	182.00	183.00		183.00	182.00	181.00	180.00	179.00	178.00	177.00	176.00	175.00	174.00	173.00	172.00	171.44		
PROGRESSIVE PROGETTO															-8.02																
PARZIALI PROGETTO															4.37		0.53	0.37	2.75	2.75	0.37	0.53	6.44								
QUOTE PROGETTO															183.00		185.89	186.24	186.49	186.40	186.32	186.07	185.72	181.47							



PROFILO Asse4  
 SEZIONE 122  
 PROGRESSIVA 1210.00  
 A STERRO m<sup>2</sup> 0.33  
 B RIPORTO m<sup>2</sup> 71.08

164  
 200 200

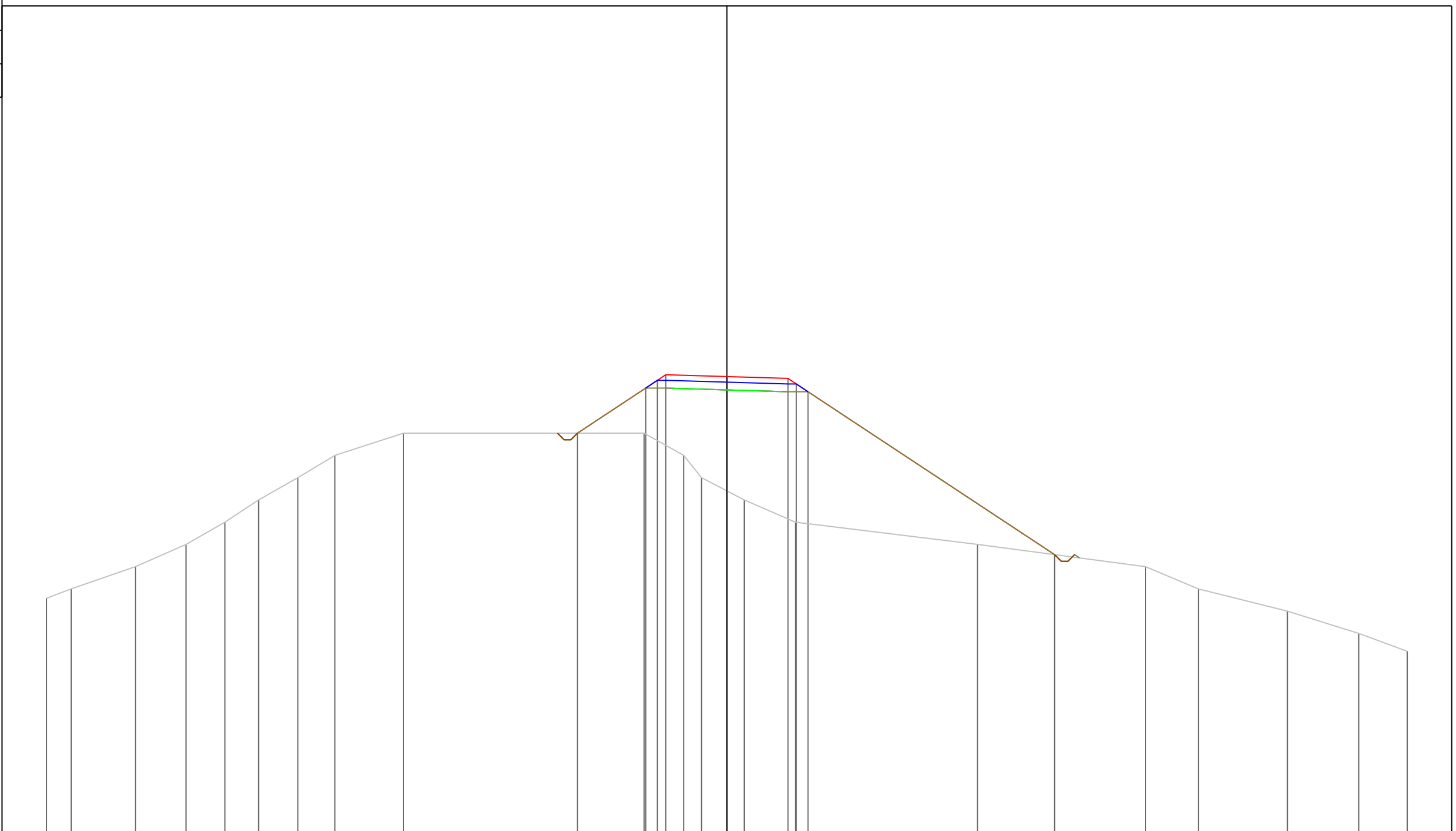

PROGRESSIVE TERRENO	-30.60	-29.49	-26.60	-24.32	-22.57	-21.06	-19.29	-17.63	-14.54	-3.72	-1.94	-1.14	0.78	3.08	11.27	18.83	21.21	25.21	28.42	30.60
PARZIALI TERRENO	1.11	2.89	2.28	1.75	1.51	1.77	1.66	3.09	10.82	1.78	0.80	1.92	2.30	8.19	7.56	2.38	4.00	3.21	2.18	
QUOTE TERRENO	174.58	175.00	176.00	177.00	178.00	179.00	180.00	181.00	182.00	182.00	181.00	180.00	179.00	178.00	177.00	176.00	175.00	174.00	173.00	172.20
PROGRESSIVE PROGETTO										-6.72	-3.65	-3.12	-2.75	0.00	2.75	3.12	3.65	14.74		
PARZIALI PROGETTO									3.07	0.53	0.37	2.75	2.75	0.37	0.53	11.09				
QUOTE PROGETTO									182.00	184.02	184.37	184.62	184.54	184.46	184.21	183.86	176.54			

PROFILO Asse4  
 SEZIONE 123  
 PROGRESSIVA 1220.00  
 A STERRO m<sup>2</sup> 1.92  
 B RIPORTO m<sup>2</sup> 78.25

165  
 200 200

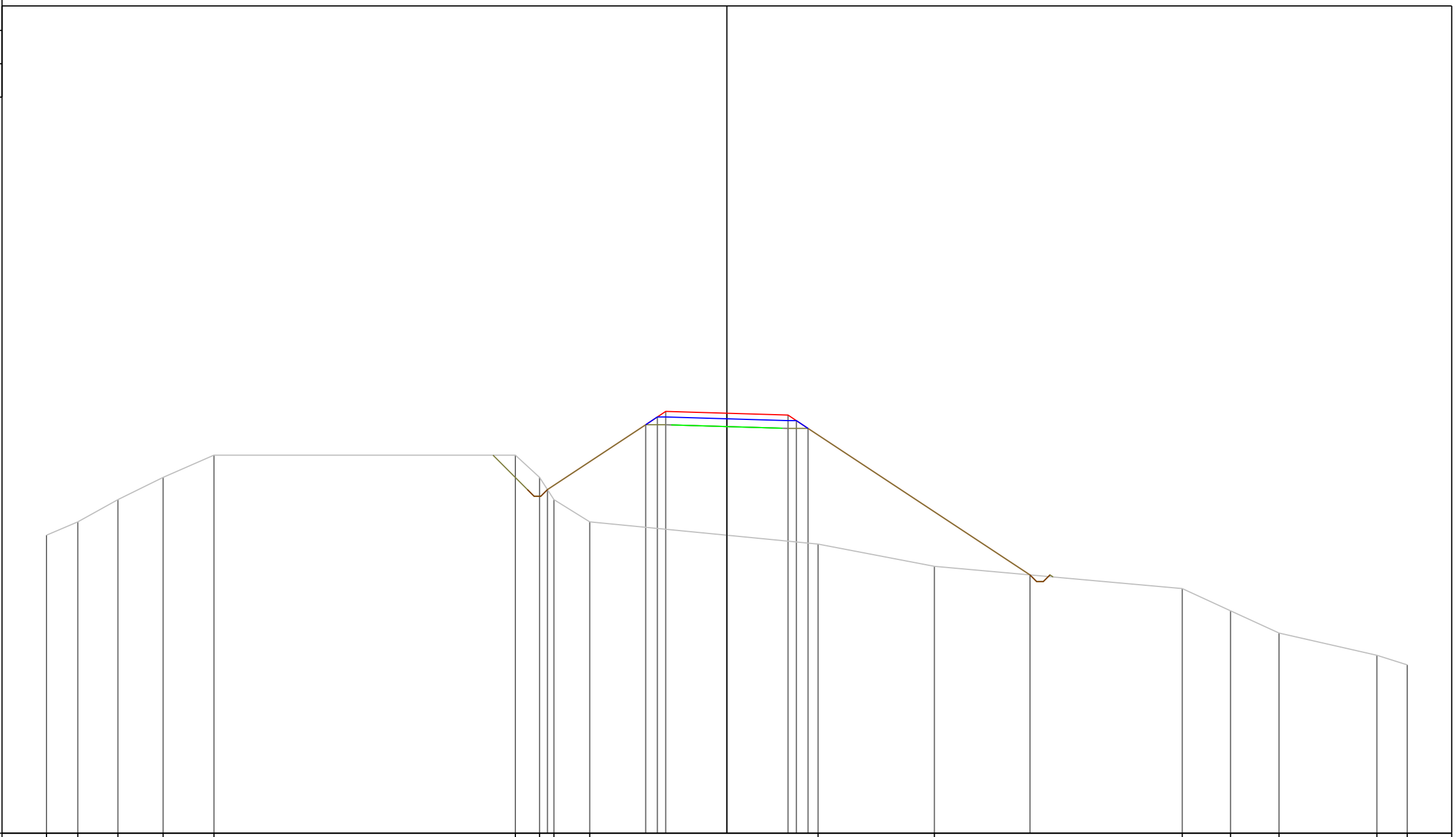

PROGRESSIVE TERRENO	-30.60	-29.19	-27.39	-25.35	-23.07		-9.51	-8.42	-7.78	-6.17		4.10	9.33		20.48	22.65	24.83	29.23	30.60
PARZIALI TERRENO	1.41	1.80	2.04	2.28		13.56	1.09	0.64	1.61		10.27	5.23		11.15	2.17	2.18	4.40	1.37	
QUOTE TERRENO	178.40	179.00	180.00	181.00	182.00		182.00	181.00	180.00	179.00		178.00	177.00		176.00	175.00	174.00	173.00	172.57
PROGRESSIVE PROGETTO							-8.07					0.00							13.63
PARZIALI PROGETTO							4.42	0.52	0.38	2.75		2.75	0.38	0.52	9.98				
QUOTE PROGETTO							180.45	183.37	183.72	183.97	183.88	183.80	183.55	183.20		176.61			

PROFILO Asse4

SEZIONE 124

PROGRESSIVA 1230.00

A STERRO m<sup>2</sup> 0.29  
 B RIPORTO m<sup>2</sup> 35.58

165  
 200  
 200

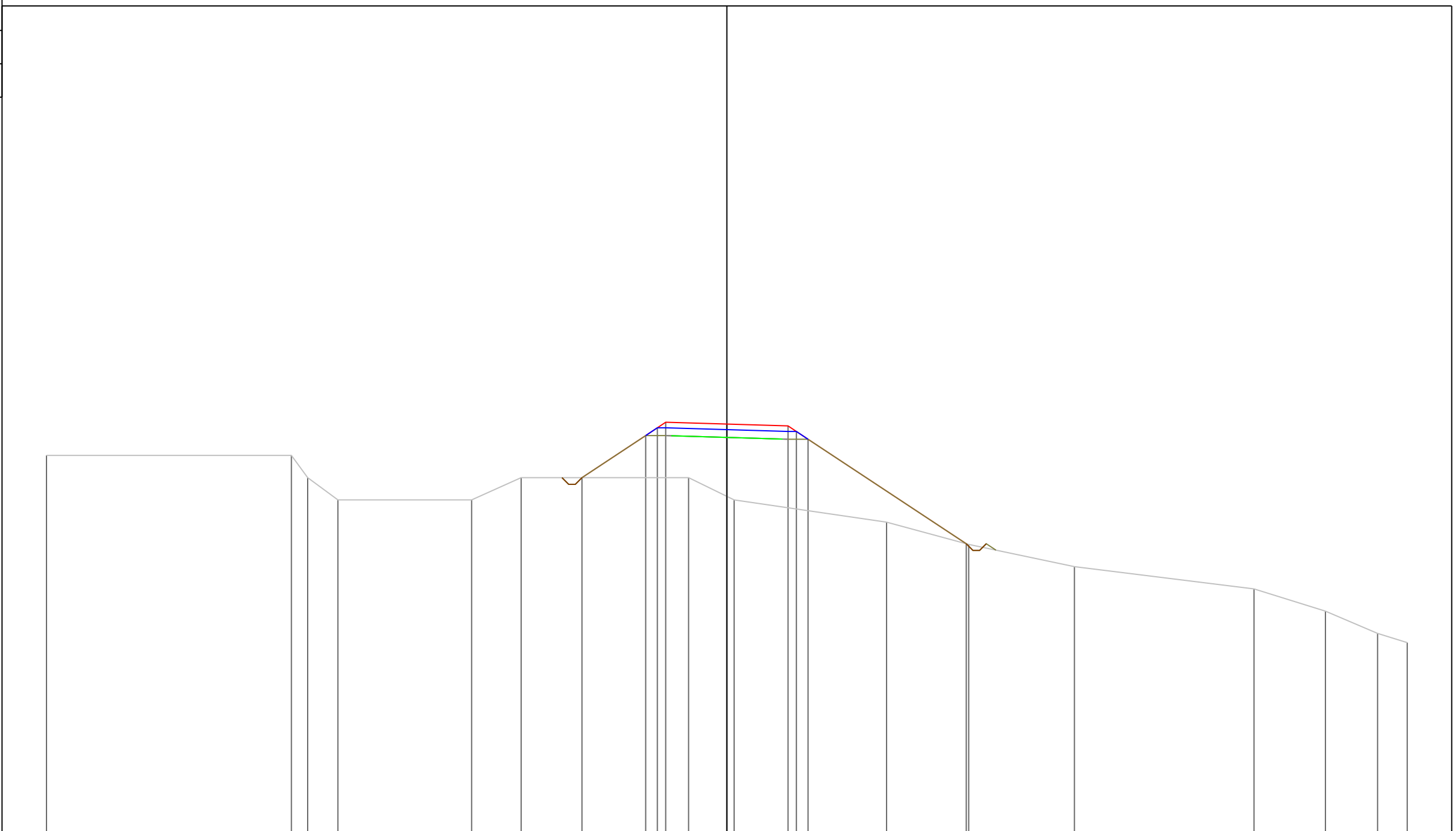

PROGRESSIVE TERRENO	-30.60	-19.58	-18.85	-17.49	-11.48	-9.25	-1.72	0.33	7.18	10.88	15.63	23.71	26.92	29.27	30.60	
PARZIALI TERRENO	11.02	0.73	1.36	6.01	2.23	7.53	2.05	6.85	3.70	4.75	8.08	3.21	2.35	1.33		
QUOTE TERRENO	182.00	182.00	181.00	180.00	180.00	181.00	181.00	181.00	180.00	179.00	178.00	177.00	176.00	175.00	174.00	173.59
PROGRESSIVE PROGETTO							-6.52		0.00		10.77					
PARZIALI PROGETTO							2.87	0.52	0.38	2.75	0.38	0.52	7.12			
QUOTE PROGETTO							181.00	182.89	183.24	183.49	183.41	183.33	183.08	182.73	178.03	

PROFILO Asse4

SEZIONE 125

PROGRESSIVA 1240.00

A STERRO m<sup>2</sup> 12.07

166

200  
200

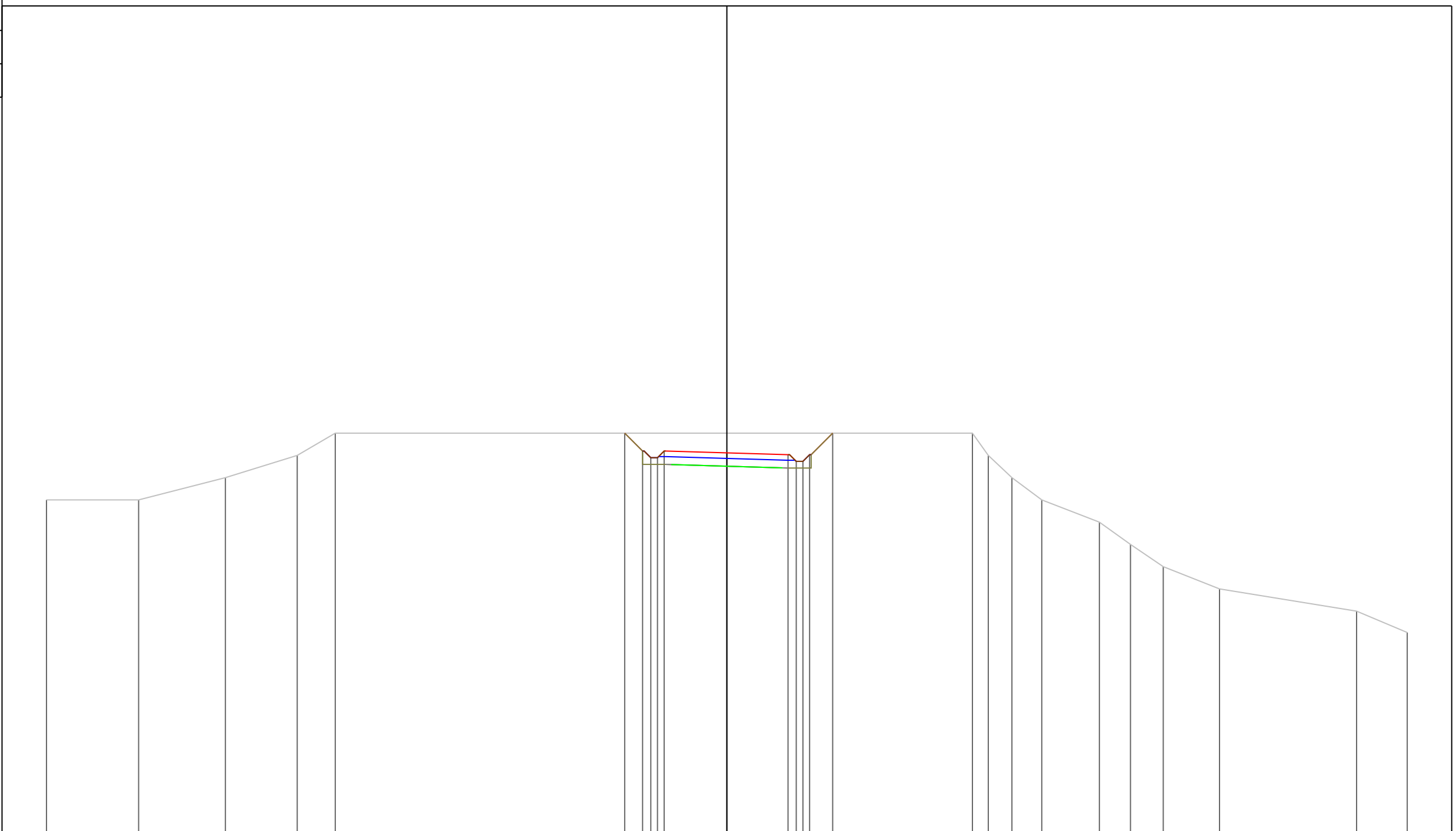

PROGRESSIVE TERRENO	-30.60	-26.46	-22.55	-19.32	-17.61							11.04	11.76	12.82	14.16	16.75	18.15	19.63	22.16		28.32	30.60	
PARZIALI TERRENO		4.14	3.91	3.23	1.71		28.65					0.72	1.06	1.34	2.59	1.40	1.48	2.53		6.16		2.28	
QUOTE TERRENO	181.00	181.00	182.00	183.00	184.00							184.00	183.00	182.00	181.00	180.00	179.00	178.00	177.00		176.00	175.04	
PROGRESSIVE PROGETTO																							
PARZIALI PROGETTO																							
QUOTE PROGETTO																							

0.80  
 184.00  
 0.37  
 183.20  
 0.30  
 182.90  
 0.30  
 182.90  
 0.30  
 183.20  
 2.82  
 0.00  
 183.11  
 2.75  
 0.37  
 183.03  
 0.30  
 182.73  
 0.30  
 182.73  
 0.30  
 183.03  
 1.04  
 184.00

PROFILO Asse4

SEZIONE 126

PROGRESSIVA 1250.00

A STERRO m<sup>2</sup> 50.13

168

200  
200

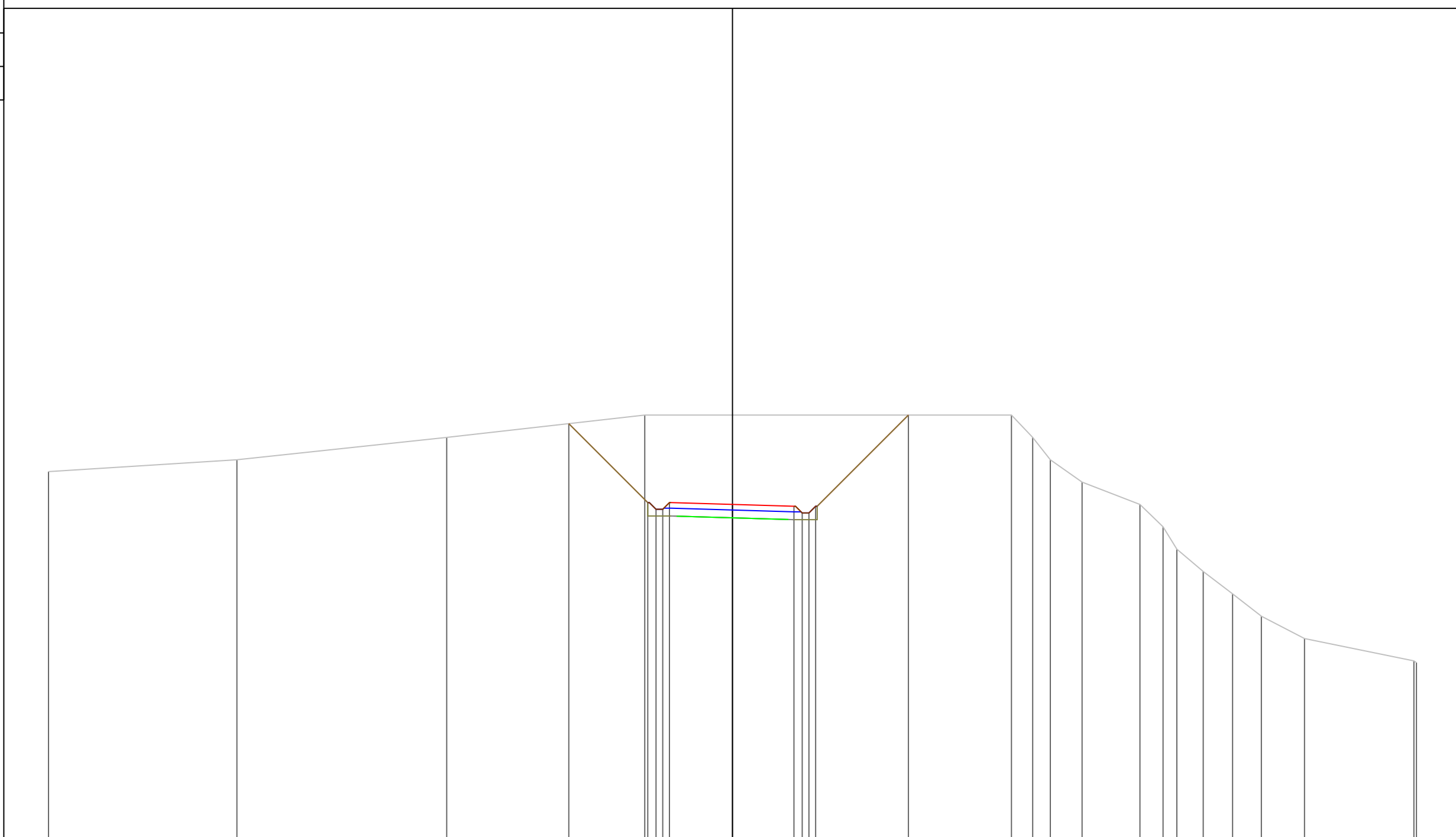

PROGRESSIVE TERRENO	-30.60	-22.17	-12.78	-3.92						12.48	13.43	14.22	15.64	18.23	19.26	19.88	21.06	22.37	23.66	25.59	30.49	30.60	
PARZIALI TERRENO		8.43		9.39		8.86			16.40	0.95	0.79	1.42	2.59	1.03	0.62	1.18	1.31	1.29	1.93		4.90	0.11	
QUOTE TERRENO	184.47	185.00	186.00	187.00						187.00	186.00	185.00	184.00	183.00	182.00	181.00	180.00	179.00	178.00	177.00	176.00	175.92	
PROGRESSIVE PROGETTO						-7.32	-3.79	-3.42	-3.12	-2.82	0.00	2.75	3.12	3.42	3.72								
PARZIALI PROGETTO							3.53	0.37	0.30	0.30	2.82	2.75	0.37	0.30	0.30	4.15							
QUOTE PROGETTO						186.62	183.08	182.78	182.78	183.08	183.00	182.92	182.62	182.62	182.92								





PROFILO Asse4

SEZIONE 128

PROGRESSIVA 1270.00

A STERRO m<sup>2</sup> 122.96

170

200  
200

PROGRESSIVE TERRENO	-30.60	-29.48	-23.57	-18.91	-13.54	-8.63	-3.10	9.46	13.01	14.25	15.34	16.56	17.72	18.46	19.26	20.31	21.36	22.34	23.55	25.01	27.04	30.60
PARZIALI TERRENO	1.12	5.91	4.66	5.37	4.91	5.53	12.56	3.55	1.24	1.09	1.22	1.16	0.74	0.80	1.05	1.05	0.98	1.21	1.46	2.03	3.56	
QUOTE TERRENO	185.81	186.00	187.00	188.00	189.00	190.00	191.00	191.00	190.00	189.00	188.00	187.00	186.00	185.00	184.00	183.00	182.00	181.00	180.00	179.00	178.00	177.22
PROGRESSIVE PROGETTO						-10.41	-3.79	-3.42	0.00	2.75	3.12	3.42	3.72			11.30						
PARZIALI PROGETTO					6.62	0.37	0.30	0.30	2.82	2.75	0.37	0.30	0.30	7.58								
QUOTE PROGETTO					189.64	183.01	182.71	182.71	183.01	183.00	182.97	182.67	182.67	182.97		190.48						







PROFILO Asse4

SEZIONE 132

PROGRESSIVA 1310.00

A STERRO m<sup>2</sup> 73.50

172

200  
200

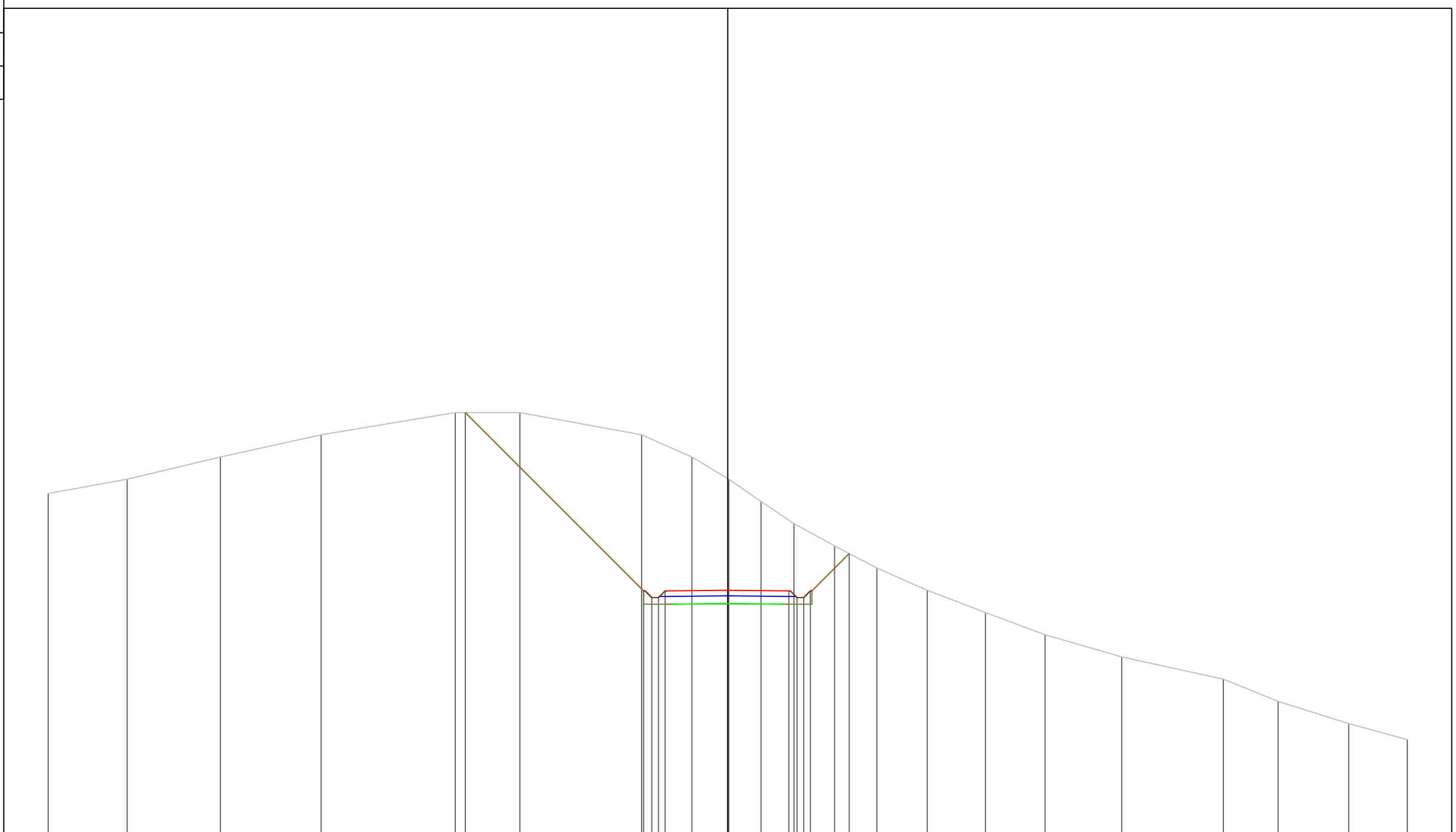

PROGRESSIVE TERRENO	-30.60	-27.04	-22.85	-18.31	-12.27	-9.36	-3.88	-1.61	0.05	1.50	2.98	4.81	6.72	8.98	11.61	14.29	17.74	22.32	24.78	27.96	30.60	
PARZIALI TERRENO		3.56	4.19	4.54	6.04	2.91	5.48	2.27	1.66	1.45	1.48	1.83	1.91	2.26	2.63	2.68	3.45	4.58	2.46	3.18	2.64	
QUOTE TERRENO	187.36	188.00	189.00	190.00	191.00	191.00	190.00	189.00	188.00	187.00	186.00	185.00	184.00	183.00	182.00	181.00	180.00	179.00	178.00	177.00	176.28	
PROGRESSIVE PROGETTO					-11.82		-3.79	-3.42	-3.12	-2.82	0.00	2.75	3.12	3.42	3.72	5.47						
PARZIALI PROGETTO					8.03		0.37	0.30	0.30	2.82	2.75	0.37	0.30	0.30	1.75							
QUOTE PROGETTO					191.00		182.97	182.67	182.67	182.97	183.00	182.97	182.67	182.67	182.97	184.65						

PROFILO Asse4

SEZIONE 133

PROGRESSIVA 1320.00

A STERRO m<sup>2</sup> 31.47  
B RIPORTO m<sup>2</sup> 0.29

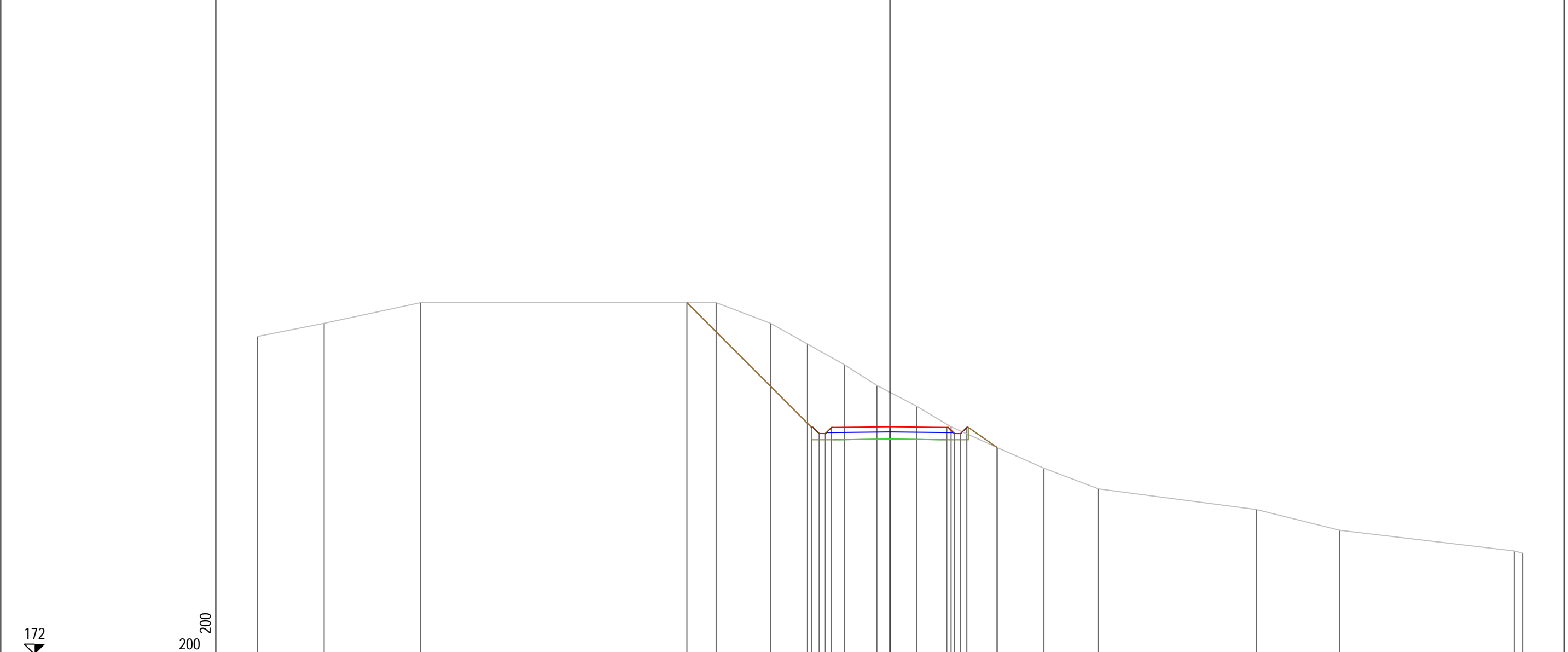

PROGRESSIVE TERRENO	-30.60	-27.36	-22.70	-8.40	-5.77	-3.99	-2.20	-0.63	1.28	2.96	5.18	7.45	10.09	17.73	21.76	30.20	30.60
PARZIALI TERRENO	3.24	4.66	14.30	2.63	1.78	1.79	1.57	1.91	1.68	2.22	2.27	2.64	7.64	4.03	8.44	0.40	
QUOTE TERRENO	187.36	188.00	189.00	189.00	188.00	187.00	186.00	185.00	184.00	183.00	182.00	181.00	180.00	179.00	178.00	177.00	176.89
PROGRESSIVE PROGETTO				-9.82		-3.79	-3.42	-3.12	-2.82	0.00	2.75	3.12	3.42	3.72	5.18		
PARZIALI PROGETTO				6.03		0.37	0.30	0.30	2.82	2.75	0.37	0.30	0.30	1.46			
QUOTE PROGETTO				189.00		182.97	182.67	182.67	182.97	183.00	182.97	182.67	182.67	182.97	182.00		

PROFILO Asse4

SEZIONE 134

PROGRESSIVA 1330.00

A STERRO m<sup>2</sup> 17.84  
 B RIPORTO m<sup>2</sup> 0.28

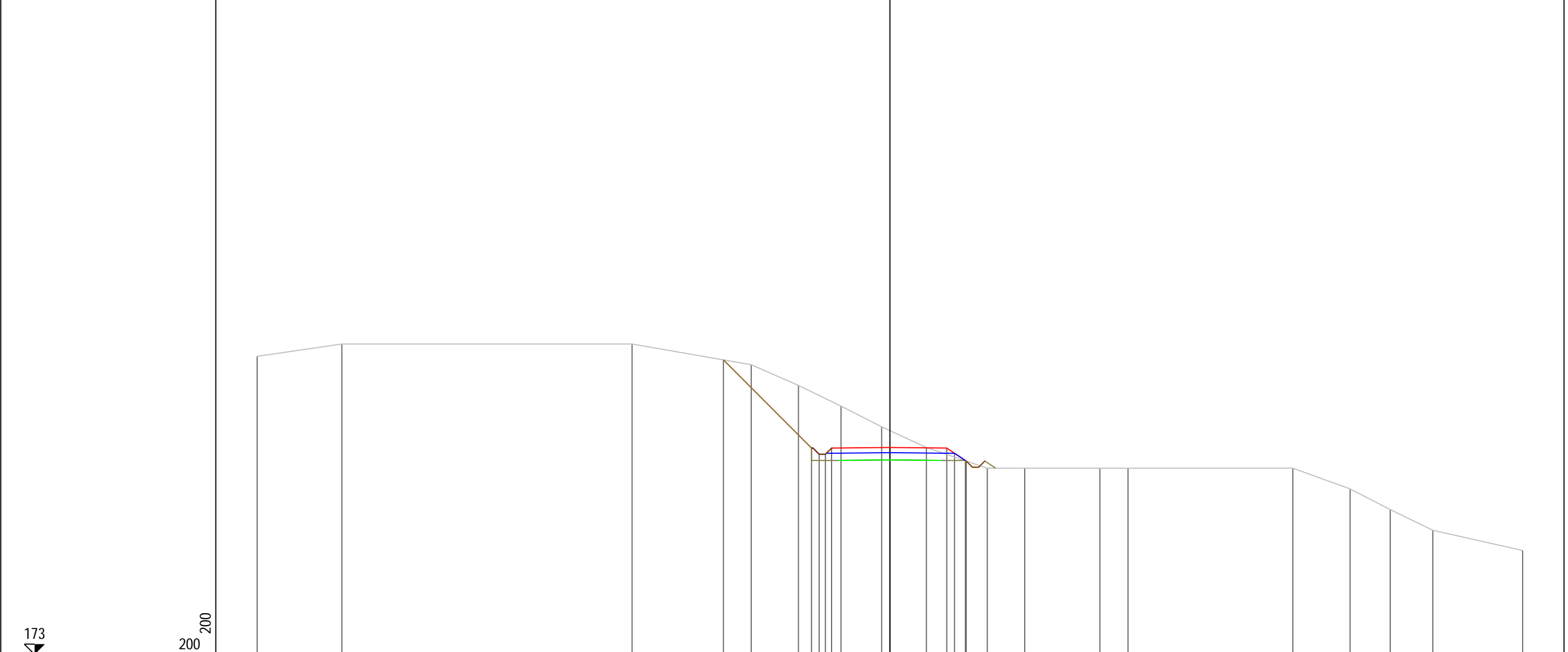

PROGRESSIVE TERRENO	-30.60	-26.50		-12.47		-6.71	-4.42	-2.36	-0.40	1.77	4.71	6.52	10.15	11.51		19.49	22.25	24.20	26.26	30.60
PARZIALI TERRENO		4.10		14.03		5.76	2.29	2.06	1.96	2.17	2.94	1.81	3.63	1.36		7.98	2.76	1.95	2.06	4.34
QUOTE TERRENO	187.41	188.00		188.00		187.00	186.00	185.00	184.00	183.00	182.00	182.00	182.00	182.00		182.00	181.00	180.00	179.00	178.02
PROGRESSIVE PROGETTO						-8.05	-3.79	-3.42	-3.12	-2.82	0.00	2.75	3.12	3.65	3.69					
PARZIALI PROGETTO						4.26	0.37	0.30	0.30	2.82	2.75	0.37	0.53	0.04						
QUOTE PROGETTO						187.23	182.97	182.67	182.97	183.00	182.97	182.72	182.37	182.35						

PROFILO Asse4

SEZIONE 135

PROGRESSIVA 1340.00

A STERRO m<sup>2</sup> 24.16

173

200  
200

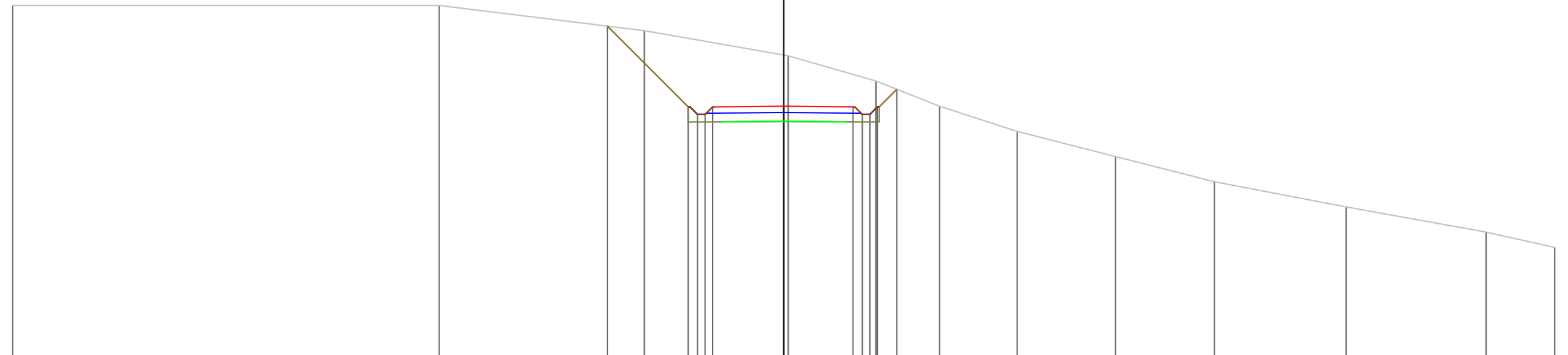

PROGRESSIVE TERRENO

-30.60		-13.67		-5.53		0.18		3.66		6.18		9.26		13.17		17.09		22.32		27.88		30.60
--------	--	--------	--	-------	--	------	--	------	--	------	--	------	--	-------	--	-------	--	-------	--	-------	--	-------

PARZIALI TERRENO

	16.93		8.14		5.71		3.48		2.52		3.08		3.91		3.92		5.23		5.56		2.72	
--	-------	--	------	--	------	--	------	--	------	--	------	--	------	--	------	--	------	--	------	--	------	--

QUOTE TERRENO

187.00		187.00		186.00		185.00		184.00		183.00		182.00		181.00		180.00		179.00		178.00		177.39
--------	--	--------	--	--------	--	--------	--	--------	--	--------	--	--------	--	--------	--	--------	--	--------	--	--------	--	--------

PROGRESSIVE PROGETTO

				-7.00		0.00		2.75		2.75		3.12		3.42		3.72		4.49				
--	--	--	--	-------	--	------	--	------	--	------	--	------	--	------	--	------	--	------	--	--	--	--

PARZIALI PROGETTO

				3.21		2.82		2.75		0.37		0.30		0.30		0.30		0.77				
--	--	--	--	------	--	------	--	------	--	------	--	------	--	------	--	------	--	------	--	--	--	--

QUOTE PROGETTO

				186.18		183.00		182.97		182.67		182.67		182.67		182.97		183.67				
--	--	--	--	--------	--	--------	--	--------	--	--------	--	--------	--	--------	--	--------	--	--------	--	--	--	--



PROFILO Asse4

SEZIONE 136

PROGRESSIVA 1350.00

A STERRO m<sup>2</sup> 15.99  
B RIPORTO m<sup>2</sup> 1.25

175  
200  
200

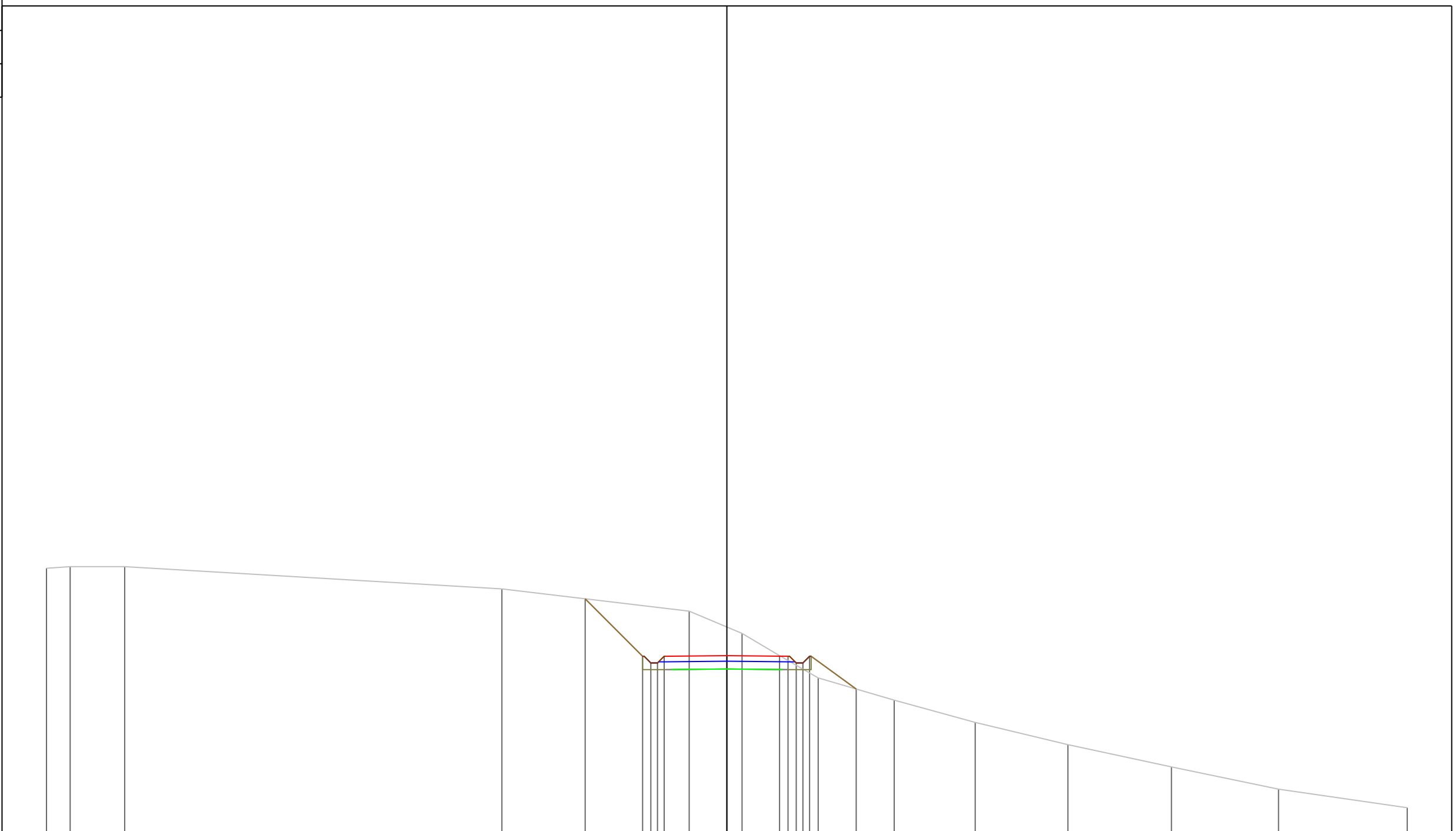

PROGRESSIVE TERRENO	-30.60	-29.54	-27.08	-10.12	-1.69	0.68	2.37	4.11	7.53	11.17	15.34	20.00	24.81	30.60	
PARZIALI TERRENO	1.06	2.46	16.96	8.43	2.37	1.69	1.74	3.42	3.64	4.17	4.66	4.81	5.79		
QUOTE TERRENO	186.93	187.00	187.00	186.00	185.00	184.00	183.00	182.00	181.00	180.00	179.00	178.00	177.00	176.17	
PROGRESSIVE PROGETTO					-6.37	-3.79	-3.42	-3.12	-2.82	0.00	2.75	3.12	3.42	3.72	5.82
PARZIALI PROGETTO					2.58	0.37	0.30	0.30	2.82	2.75	0.37	0.30	0.30	2.10	
QUOTE PROGETTO					185.56	182.97	182.67	182.67	182.97	183.00	182.97	182.67	182.67	182.97	181.50



PROFILO Asse4

SEZIONE 138

PROGRESSIVA 1370.00

A STERRO m<sup>2</sup> 16.53

163

200  
200

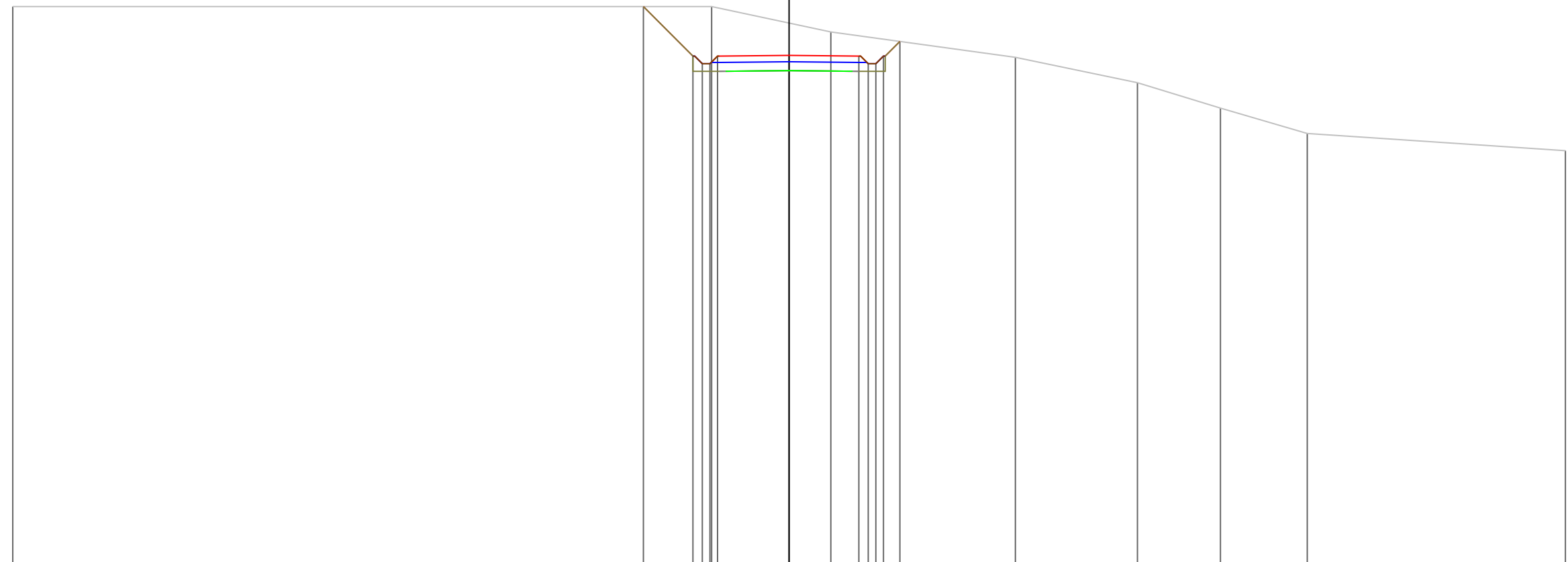

PROGRESSIVE TERRENO	-30.60			-3.05	1.65		8.92	13.73	17.00	20.43	30.60		
PARZIALI TERRENO		27.55		4.70	7.27	4.81	3.27	3.43	10.17				
QUOTE TERRENO	185.00		185.00	184.00	183.00	182.00	181.00	180.00	179.32				
PROGRESSIVE PROGETTO			-5.74	-3.79	-3.42	-3.12	-2.82	0.00	2.75	3.12	3.42	3.72	4.37
PARZIALI PROGETTO		1.95	0.37	0.30	0.30	2.82	2.75	0.37	0.30	0.30	0.30	0.65	
QUOTE PROGETTO		185.00	183.05	182.75	183.05	183.08	183.05	182.75	183.05	183.63			

PROFILO Asse4

SEZIONE 139

PROGRESSIVA 1380.00

A STERRO m<sup>2</sup> 20.08

162

200  
200

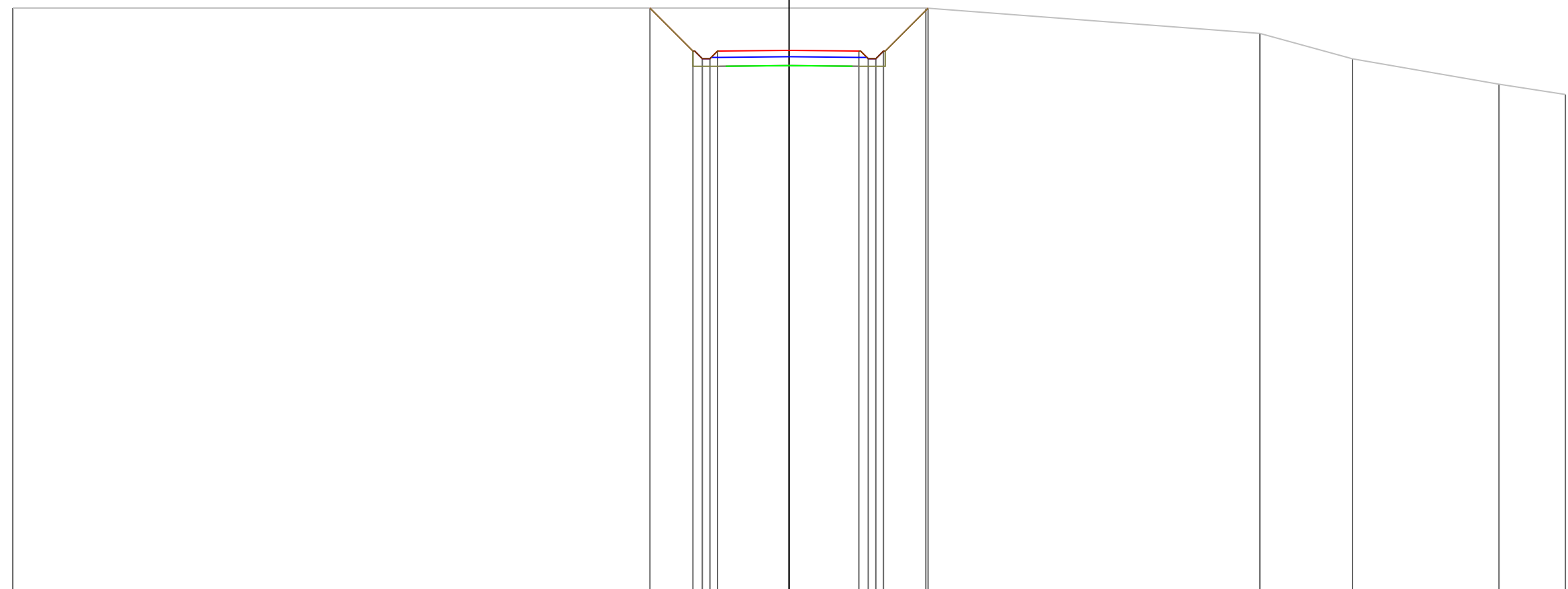

PROGRESSIVE TERRENO	-30.60			5.39		18.56	22.21	27.98	30.60
PARZIALI TERRENO		35.99			13.17	3.65	5.77	2.62	
QUOTE TERRENO	185.00			185.00		184.00	183.00	182.00	181.59
PROGRESSIVE PROGETTO			-5.48 -3.79 -3.42 -3.12 -2.82	0.00		2.75 3.12 3.42 3.72			
PARZIALI PROGETTO		1.69	0.37 0.30 0.30	2.82	2.75	0.37 0.30 0.30	1.76		
QUOTE PROGETTO		185.00	183.31 183.01 183.31	183.33		183.31 183.01 183.31	184.99		

PROFILO Asse4

SEZIONE 140

PROGRESSIVA 1390.00

A STERRO m<sup>2</sup> 25.81

161

200  
200

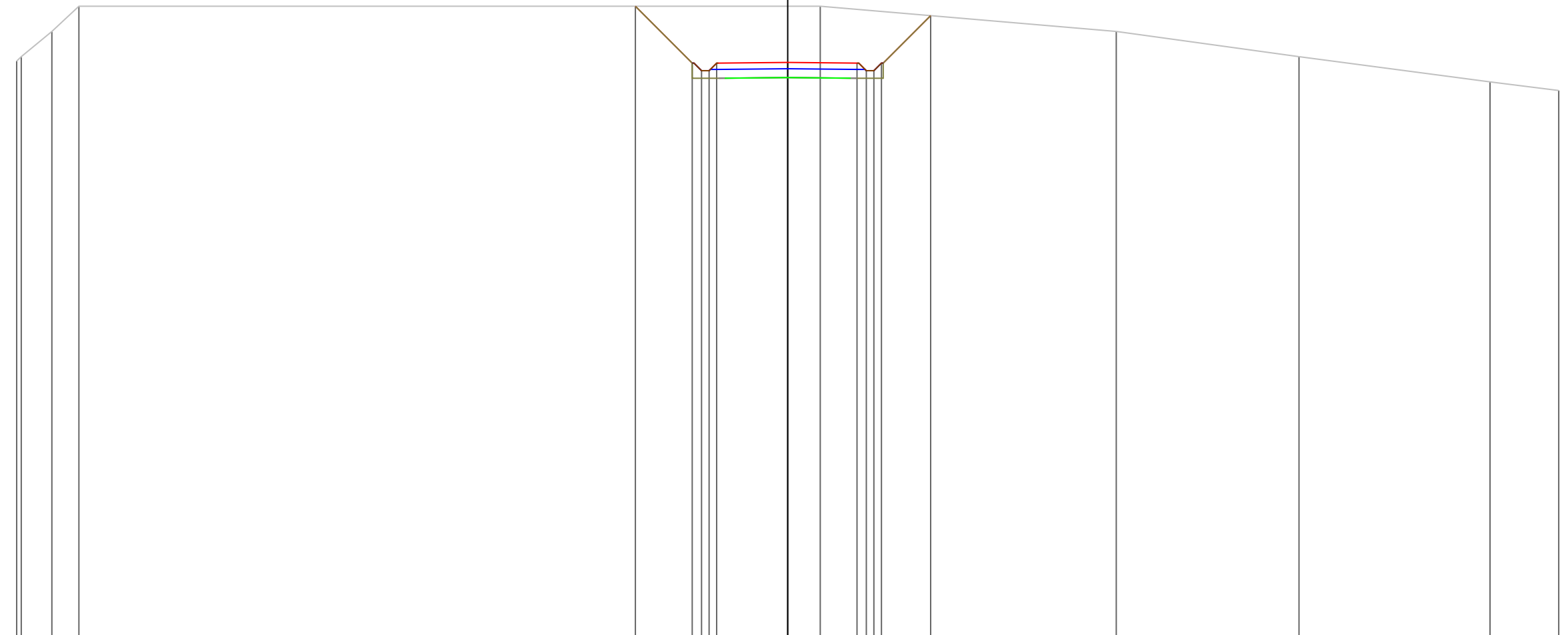

PROGRESSIVE TERRENO	183.82	184.00	185.00	186.00			186.00		185.00	184.00	183.00	182.66				
PARZIALI TERRENO	0.18	1.22	1.07		29.42			11.75	7.25	7.58	2.73					
QUOTE TERRENO	-30.60	-30.42	-29.20	-28.13			1.29		13.04	20.29	27.87	30.60				
PROGRESSIVE PROGETTO						-6.05		0.00		2.75	3.12	3.72				
PARZIALI PROGETTO						2.26	0.37	0.30	0.30	2.82	2.75	0.37	0.30	0.30	1.95	
QUOTE PROGETTO						186.00	183.74	183.44	183.44	183.74	183.77	183.74	183.44	183.44	183.74	185.63

PROFILO Asse4

SEZIONE 141

PROGRESSIVA 1400.00

A STERRO m<sup>2</sup> 29.28

160

200  
200

PROGRESSIVE TERRENO	176.81	177.00	178.00	179.00	180.00	181.00	182.00	183.00	184.00	185.00	186.00	187.00	187.00	186.00	185.00	184.00	183.00	182.00	181.00	180.67		
PARZIALI TERRENO	0.62	0.50	0.39	0.36	0.45	0.71	1.76	0.96	0.84	1.15	11.78	10.44	12.16	4.90	3.44	2.61	2.56	2.99	2.58			
QUOTE TERRENO	-30.60	-29.98	-29.48	-29.09	-28.73	-28.28	-27.57	-25.81	-24.85	-24.01	-22.86	-11.08	-0.64	11.52	16.42	19.86	22.47	25.03	28.02	30.60		
PROGRESSIVE PROGETTO												-6.40	-3.79	-3.42	-3.12	-2.82	0.00	2.75	3.12	3.42	3.72	5.86
PARZIALI PROGETTO												2.61	0.37	0.30	0.30	2.82	2.75	0.37	0.30	0.30	2.14	
QUOTE PROGETTO												187.00	184.39	184.09	184.09	184.39	184.39	184.39	184.09	184.39	186.47	

PROFILO Asse4

SEZIONE 142

PROGRESSIVA 1410.00

A STERRO m<sup>2</sup> 32.40

160

200  
200

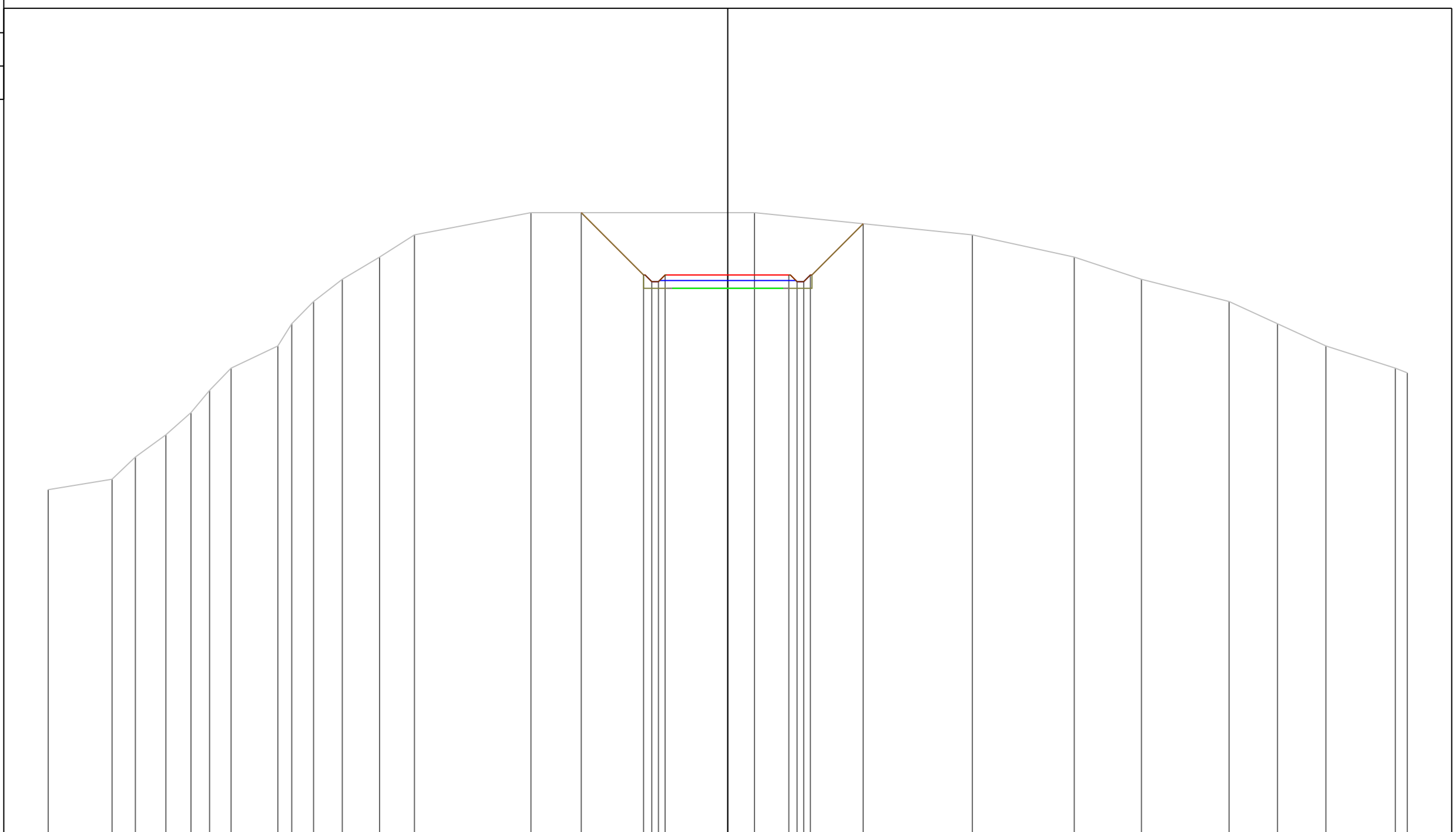

PROGRESSIVE TERRENO	-30.60	-27.72	-26.67	-25.30	-24.17	-23.33	-22.36	-20.26	-19.63	-18.65	-17.36	-15.68	-14.11	-8.86	1.20	11.01	15.60	18.63	22.57	24.76	26.93	30.06	30.60	
PARZIALI TERRENO	2.88	1.05	1.37	1.13	0.84	0.97	2.10	0.63	0.98	1.29	1.68	1.57	5.25	10.06	9.81	4.59	3.03	3.94	2.19	2.17	3.13	0.54		
QUOTE TERRENO	175.53	176.00	177.00	178.00	179.00	180.00	181.00	182.00	183.00	184.00	185.00	186.00	187.00	188.00	188.00	187.00	186.00	185.00	184.00	183.00	182.00	181.00	180.79	
PROGRESSIVE PROGETTO														-6.60	0.00	2.75	3.12	3.42	3.72	6.10				
PARZIALI PROGETTO														2.81	0.37	0.30	0.30	0.30	2.82	2.75	0.37	0.30	0.30	2.38
QUOTE PROGETTO														188.00	185.19	184.89	184.89	185.19	185.19	187.50				

PROFILO Asse4

SEZIONE 143

PROGRESSIVA 1420.00

A STERRO m<sup>2</sup> 32.97

160

200  
200

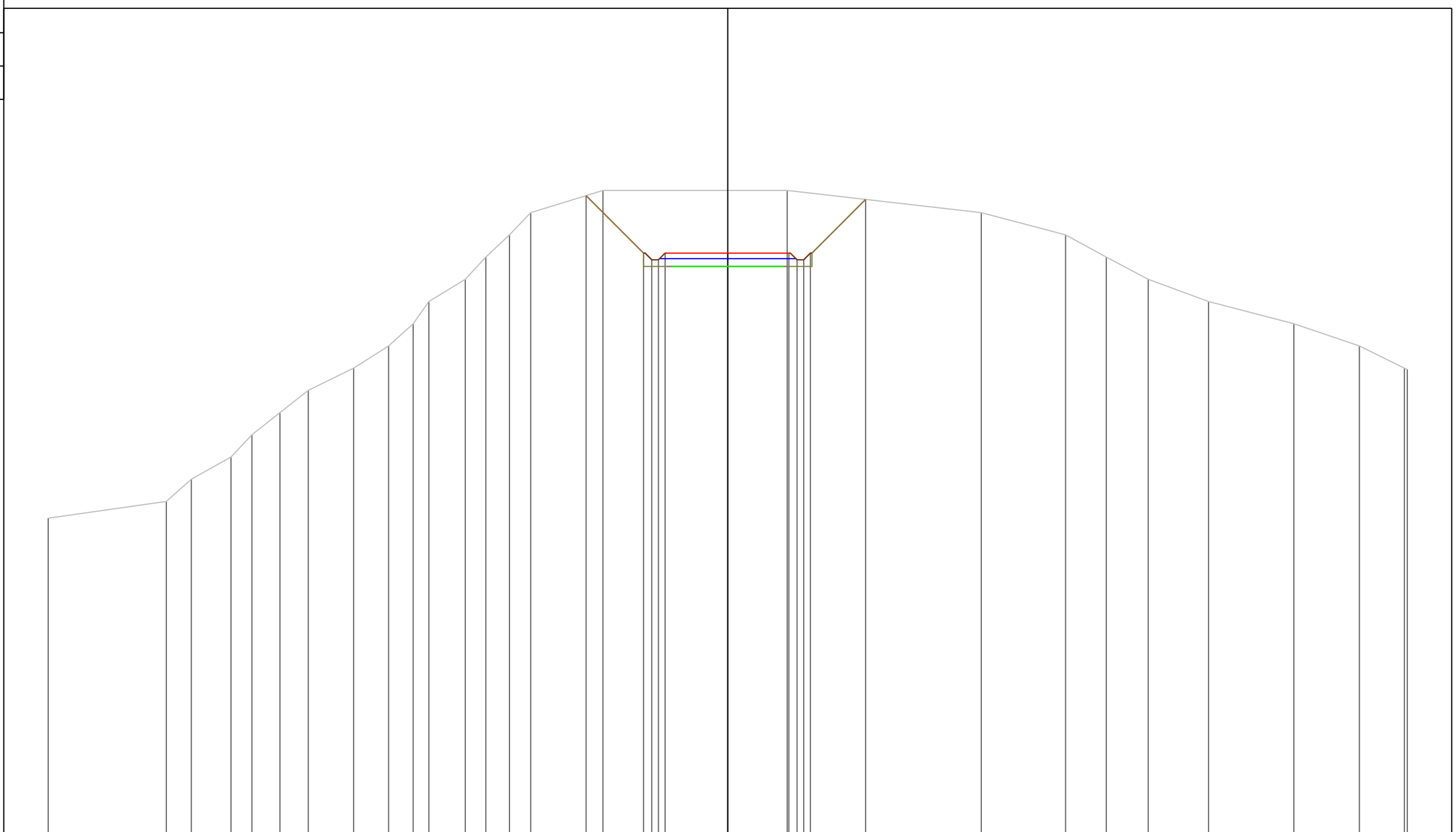

PROGRESSIVE TERRENO	-30.60	-25.28	-24.16	-22.37	-21.43	-20.16	-18.89	-16.85	-15.27	-14.16	-13.46	-11.82	-10.89	-9.83	-8.87	-5.62	2.68	11.42	15.21	17.04	18.93	21.65	25.49	28.44	30.47	30.60	
PARZIALI TERRENO	5.32	1.12	1.79	0.94	1.27	1.27	2.04	1.58	1.11	0.70	1.64	0.93	1.06	0.96	3.25	8.30	8.74	3.79	1.83	1.89	2.72	3.84	2.95	2.03	0.13		
QUOTE TERRENO	174.25	175.00	176.00	177.00	178.00	179.00	180.00	181.00	182.00	183.00	184.00	185.00	186.00	187.00	188.00	189.00	189.00	188.00	187.00	186.00	185.00	184.00	183.00	182.00	181.00	180.94	
PROGRESSIVE PROGETTO																-6.38	-3.79	-3.42	0.00	2.75	3.12	3.42	3.72	6.21			
PARZIALI PROGETTO																2.59	0.37	0.30	0.30	2.82	2.75	0.37	0.30	0.30	2.49		
QUOTE PROGETTO																188.77	186.18	185.88	186.18	186.18	186.18	185.88	185.88	186.18	188.60		



PROFILO Asse4

SEZIONE 144

PROGRESSIVA 1430.00

A STERRO m<sup>2</sup> 29.36

160

200  
200

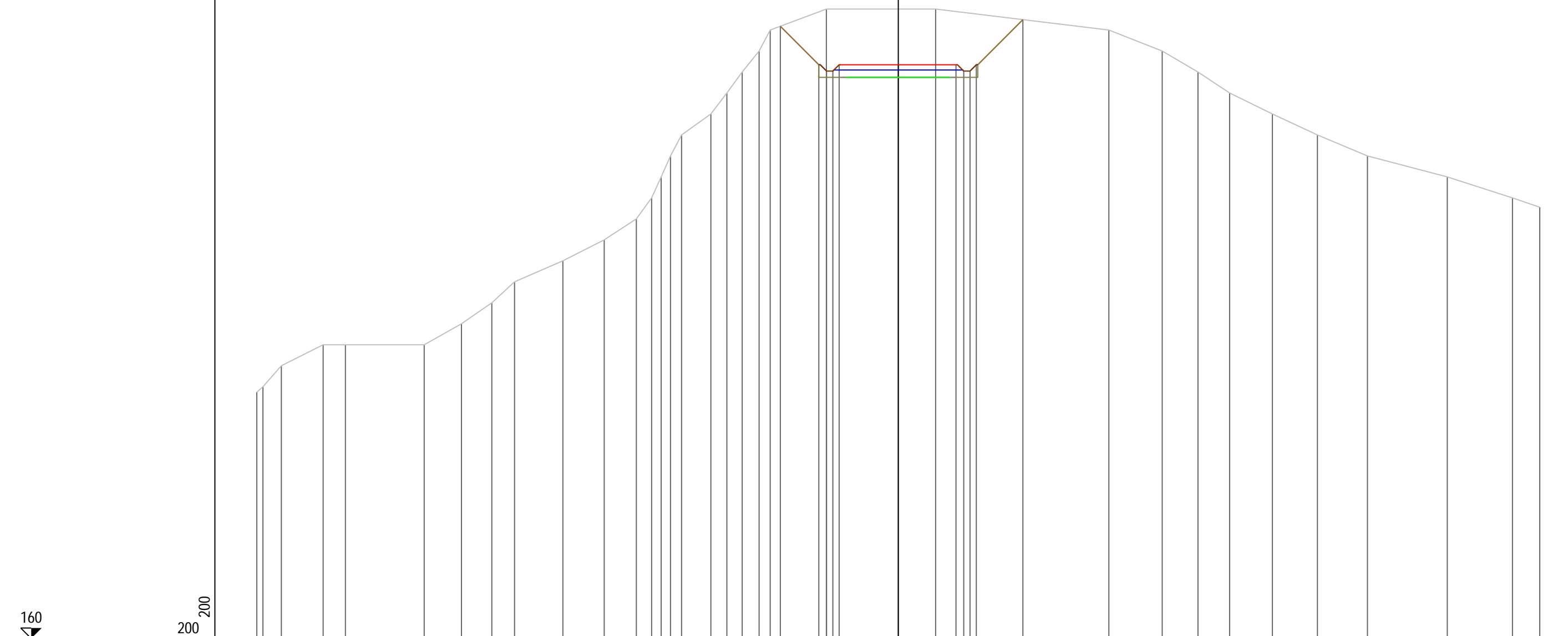

PROGRESSIVE TERRENO	-30.60	-30.31	-29.43	-27.44	-26.37		-22.62	-20.84	-19.39	-18.31	-16.00	-14.03	-12.50	-11.77	-11.31	-10.87	-10.34	-8.94	-8.18	-7.45	-6.64	-6.11	-3.43		1.78			10.04	12.59	14.29	15.80	17.85	19.99	22.38	26.19	29.30	30.60
PARZIALI TERRENO	0.29	0.88	1.99	1.07	3.75	1.78	1.45	1.08	2.31	1.97	1.53	0.73	0.46	0.44	0.53	1.40	0.76	0.73	0.81	0.53	2.68	5.21	8.26	2.55	1.70	1.51	2.05	2.14	2.39	3.81	3.11	1.30					
QUOTE TERRENO	171.74	172.00	173.00	174.00	174.00	174.00	175.00	176.00	177.00	178.00	179.00	180.00	181.00	182.00	183.00	184.00	185.00	186.00	187.00	188.00	189.00	190.00	190.00	189.00	188.00	187.00	186.00	185.00	184.00	183.00	182.00	181.00	180.55				
PROGRESSIVE PROGETTO																					-5.63	-3.79	-3.42	-3.12	-2.82	0.00	2.75	3.12	3.42	3.72	5.94						
PARZIALI PROGETTO																					1.84	0.37	0.30	0.30	2.82	2.75	0.37	0.30	0.30	2.22							
QUOTE PROGETTO																					189.18	187.34	187.04	187.04	187.34	187.34	187.34	187.04	187.34	189.50							





PROFILO Asse4

SEZIONE 147

PROGRESSIVA 1460.00

A STERRO m<sup>2</sup> 10.05  
B RIPORTO m<sup>2</sup> 2.45

169

200  
200

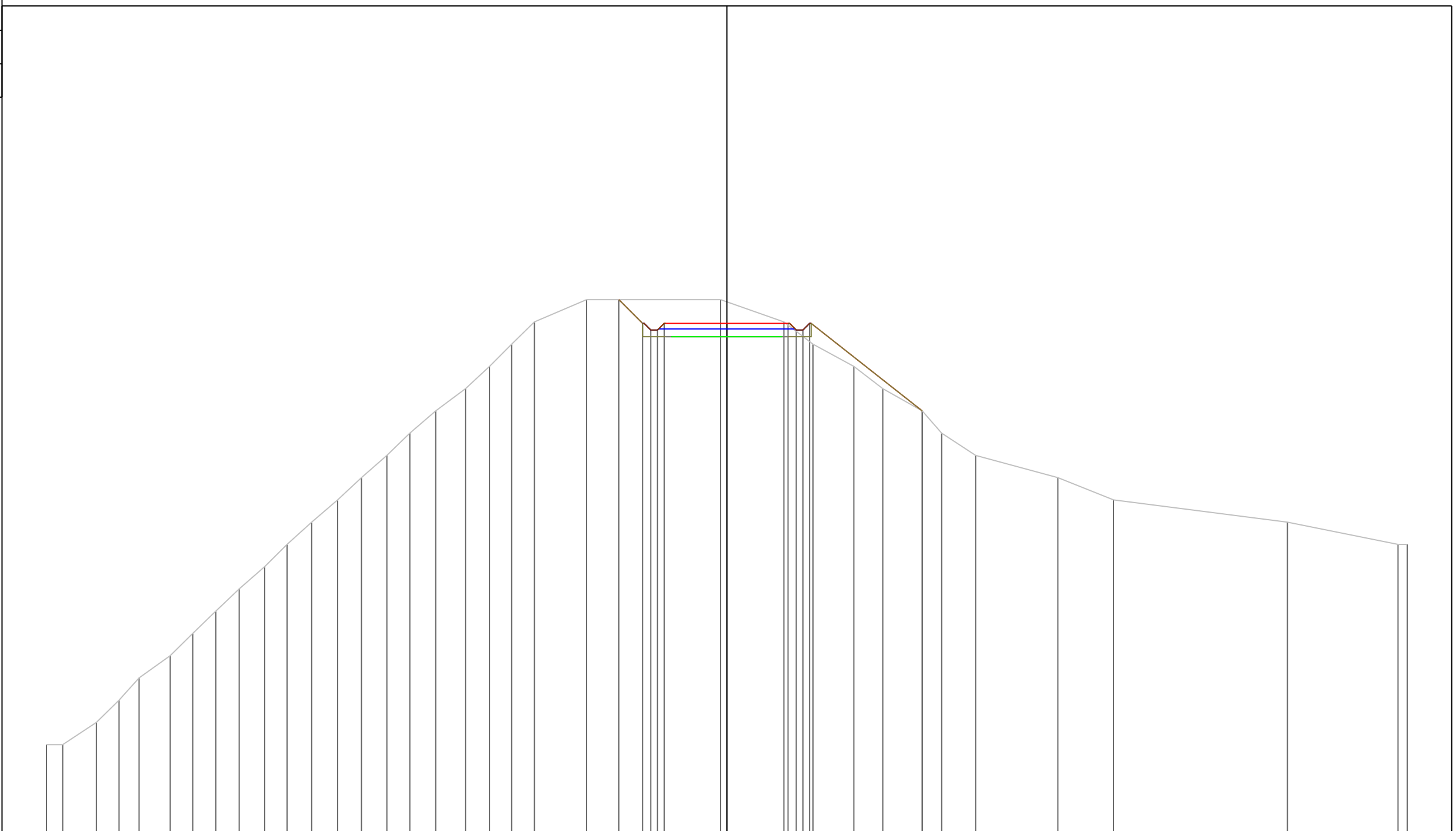

PROGRESSIVE TERRENO	-30.60	-29.87	-28.36	-27.34	-26.44	-25.04	-24.02	-22.99	-21.93	-20.79	-19.78	-18.67	-17.51	-16.43	-15.29	-14.26	-13.09	-11.75	-10.67	-9.68	-8.66	-6.31	-0.28	2.56	3.87	5.71	7.01	8.79	9.66	11.19	14.89	17.39	25.21	30.19	30.60		
PARZIALI TERRENO	0.73	1.51	1.02	0.90	1.40	1.02	1.03	1.06	1.14	1.01	1.11	1.16	1.08	1.14	1.03	1.17	1.34	1.08	0.99	1.02	2.35	6.03	2.84	1.31	1.84	1.30	1.78	0.87	1.53	3.70	2.50	7.82	4.98	0.41			
QUOTE TERRENO	173.00	173.00	174.00	175.00	176.00	177.00	178.00	179.00	180.00	181.00	182.00	183.00	184.00	185.00	186.00	187.00	188.00	189.00	190.00	191.00	192.00	193.00	193.00	192.00	191.00	190.00	189.00	188.00	187.00	186.00	185.00	184.00	183.00	182.00	182.00		
PROGRESSIVE PROGETTO																								-4.86	-3.79	-3.42	-3.12	-2.82	0.00	2.75	3.12	3.42	3.72	8.79			
PARZIALI PROGETTO																								1.07	0.37	0.30	0.30	2.82	2.75	0.37	0.30	0.30	5.07				
QUOTE PROGETTO																								193.00	191.93	191.63	191.63	191.93	191.93	191.93	188.00						

PROFILO Asse4

SEZIONE 148

PROGRESSIVA 1470.00

A STERRO m<sup>2</sup> 1.73  
 B RIPORTO m<sup>2</sup> 15.48

172

200  
 200

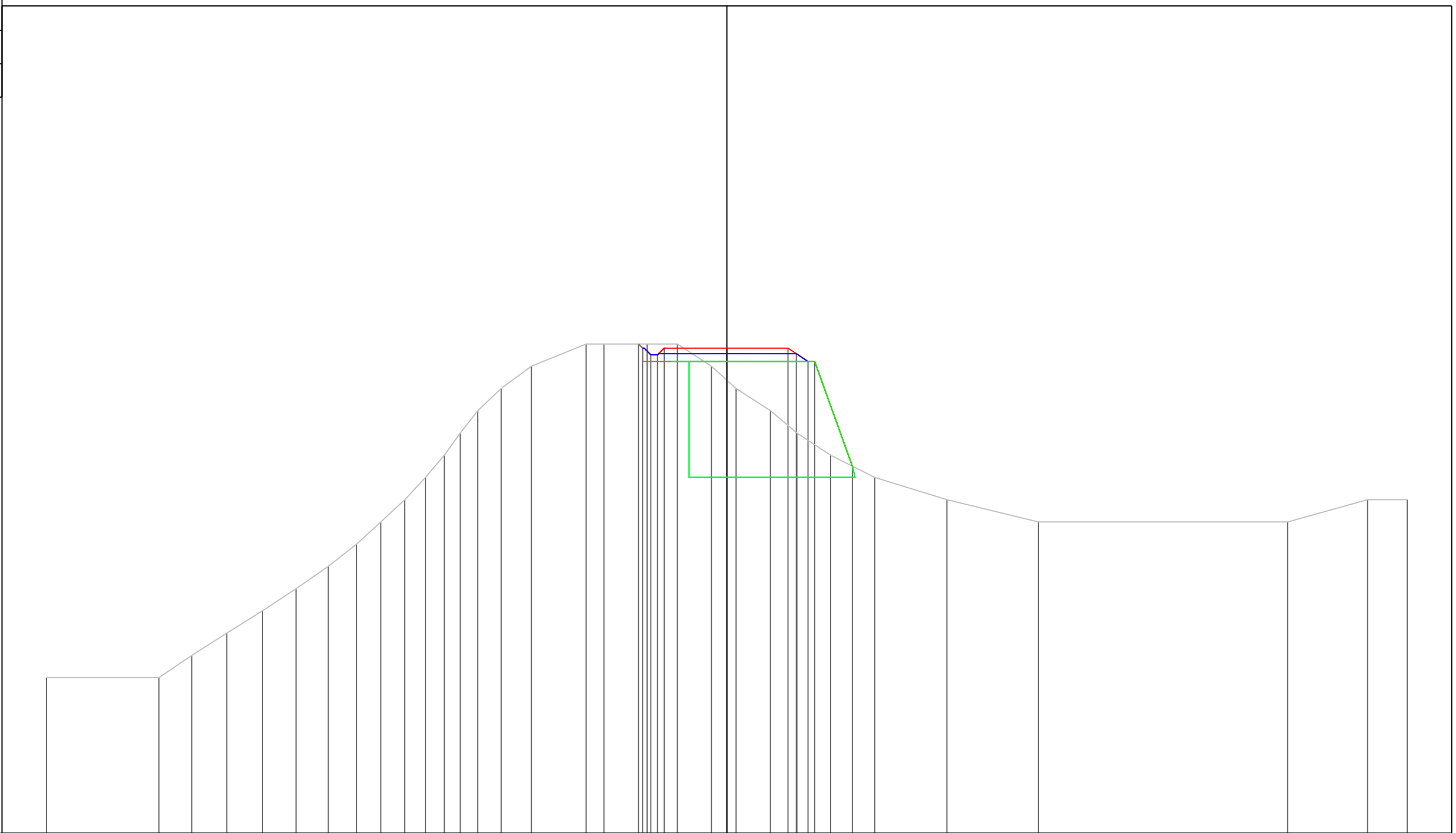

PROGRESSIVE TERRENO	-30.60	-25.54	-24.06	-22.49	-20.89	-19.37	-17.93	-16.65	-15.56	-14.49	-13.56	-12.71	-11.99	-11.20	-10.15	-8.79	-6.33	-5.53	-3.59	-2.23	-0.70	0.42	1.96	3.15	4.67	6.65	9.90	14.01	25.22	28.82	30.60
PARZIALI TERRENO		5.06	1.48	1.57	1.60	1.52	1.44	1.28	1.09	1.07	0.93	0.85	0.72	0.79	1.05	1.36	2.46	0.80	1.94	1.36	1.53	1.12	1.54	1.19	1.52	1.98	3.25	4.11	11.21	3.60	1.78
QUOTE TERRENO	179.00	179.00	180.00	181.00	182.00	183.00	184.00	185.00	186.00	187.00	188.00	189.00	190.00	191.00	192.00	193.00	194.00	194.00	194.00	194.00	193.00	192.00	191.00	190.00	189.00	188.00	187.00	186.00	186.00	187.00	187.00
PROGRESSIVE PROGETTO																			3.98	3.79	3.42	3.12	2.82	0.00	2.75	3.12	3.65	3.95	5.64		
PARZIALI PROGETTO																			0.19	0.37	0.30	0.30	2.82	2.75	0.37	0.53	0.30	1.69			
QUOTE PROGETTO																			194.00	193.81	193.51	193.51	193.81	193.81	193.81	193.56	193.21	193.21	188.51		





PROFILO Asse4

SEZIONE 151

PROGRESSIVA 1500.00

A STERRO m<sup>2</sup> 5.79  
 B RIPORTO m<sup>2</sup> 2.67

183

200  
 200

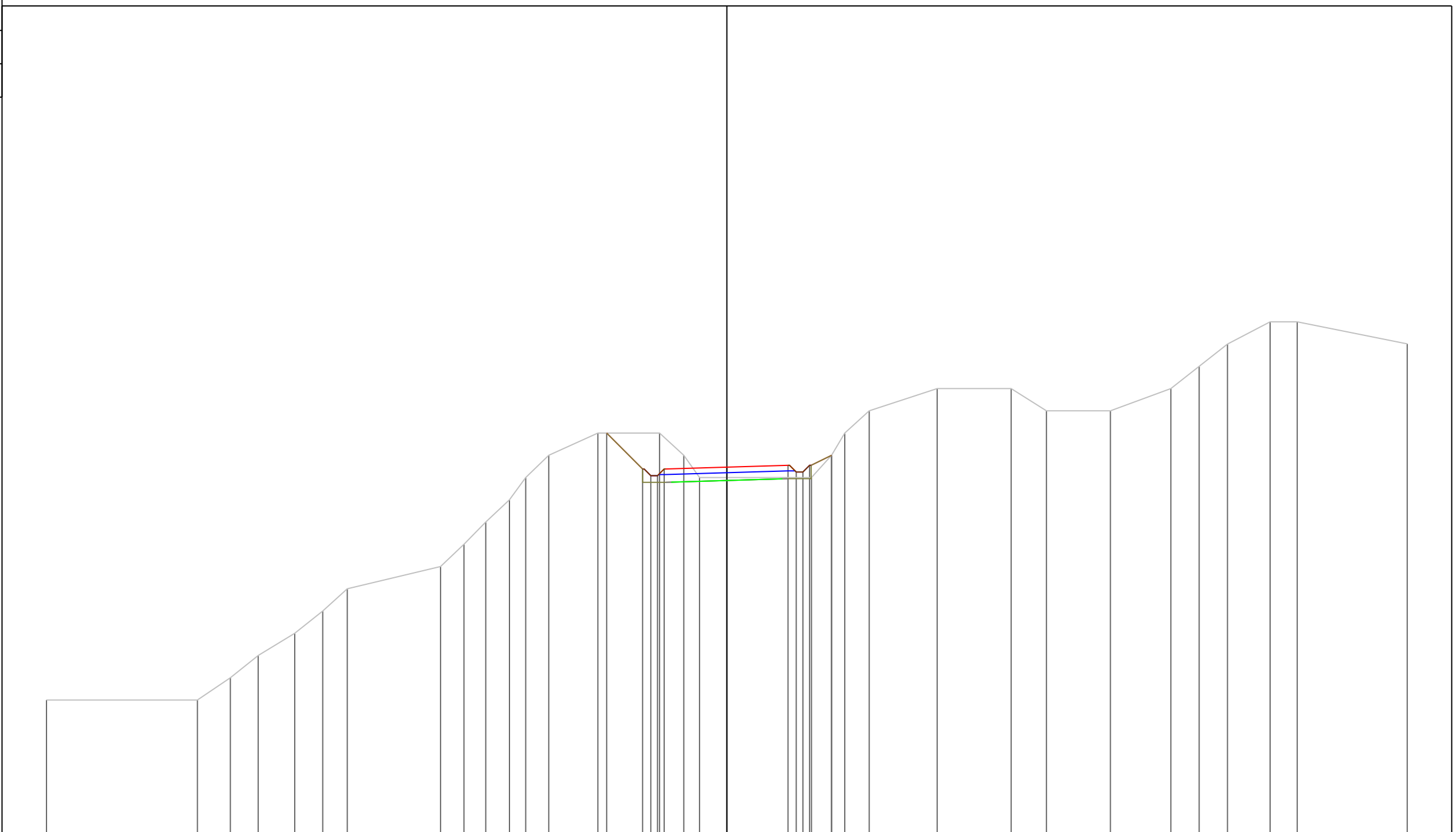

PROGRESSIVE TERRENO	-30.60	-23.81	-22.33	-21.08	-19.43	-18.18	-17.07	-12.88	-11.82	-10.84	-9.78	-9.05	-8.01	-5.80	-3.03	-1.94	-1.23	3.81	4.71	5.30	6.40	9.46	12.79	14.37	17.25	19.97	21.24	22.52	24.43	25.65	30.60
PARZIALI TERRENO	6.79	1.48	1.25	1.65	1.25	1.11	4.19	1.06	0.98	1.06	0.73	1.04	2.21	2.77	1.09	0.71	5.04	0.90	0.59	1.10	3.06	3.33	1.58	2.88	2.72	1.27	1.28	1.91	1.22	4.95	
QUOTE TERRENO	189.00	189.00	190.00	191.00	192.00	193.00	194.00	195.00	196.00	197.00	198.00	199.00	200.00	201.00	201.00	200.00	199.00	199.00	200.00	201.00	202.00	203.00	203.00	202.00	202.00	203.00	204.00	205.00	206.00	206.00	205.01
PROGRESSIVE PROGETTO														-5.41	-3.79	-3.42	-3.12	-2.82	0.00	2.75	3.12	3.42	3.72	4.71							
PARZIALI PROGETTO														1.62	0.37	0.30	0.30	2.82	2.75	0.37	0.30	0.30	0.30	0.99							
QUOTE PROGETTO														201.00	199.38	199.08	199.08	199.38	199.47	199.55	199.25	199.25	199.55	200.00							



PROFILO Asse4  
 SEZIONE 152  
 PROGRESSIVA 1510.00  
 A STERRO m<sup>2</sup> 10.20

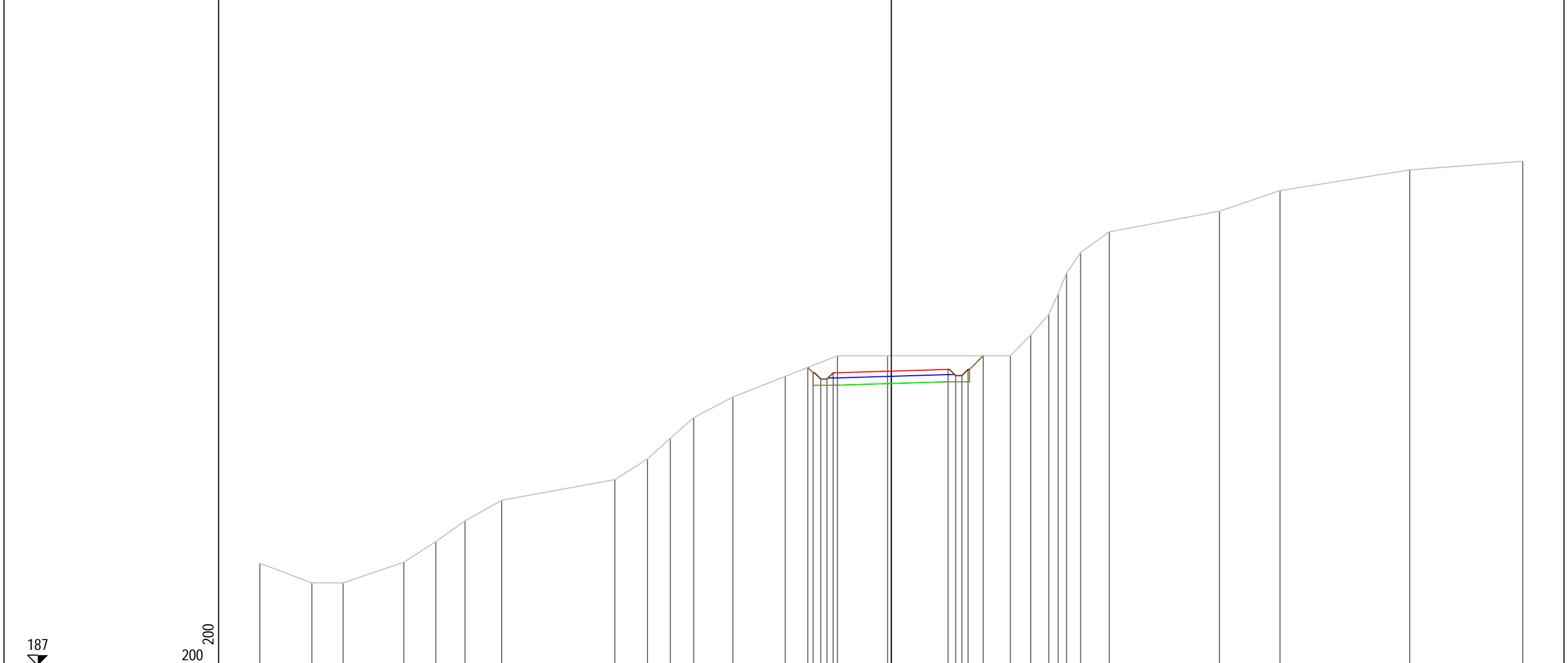

PROGRESSIVE TERRENO	-30.60	-28.08	-26.57	-23.62	-22.07	-20.66	-18.88		-13.40	-11.82	-10.71	-9.58	-7.68	-5.14	-2.61	-0.18		5.77	6.76	7.63	8.09	8.49	9.17	10.56		15.90	18.84		25.12		30.60	
PARZIALI TERRENO		2.52	1.51	2.95	1.55	1.41	1.78		5.48	1.58	1.11	1.13	1.90	2.54	2.53	2.43		5.95	0.99	0.87	0.46	0.40	0.68	1.39		5.34	2.94		6.28		5.48	
QUOTE TERRENO	191.95	191.00	191.00	192.00	193.00	194.00	195.00		196.00	197.00	198.00	199.00	200.00	201.00	202.00	202.00		202.00	203.00	204.00	205.00	206.00	207.00	208.00		209.00	210.00		211.00		211.42	
PROGRESSIVE PROGETTO																0.00																
PARZIALI PROGETTO																0.26	0.37	0.30	0.30	2.82	2.75				0.37	0.30	0.30	0.73				
QUOTE PROGETTO																201.43	201.17	200.87	200.87	201.17	201.25				201.34	201.04	201.04	201.34	202.00			

PROFILO Asse4

SEZIONE 153

PROGRESSIVA 1520.00

A STERRO m² 15.15  
B RIPORTO m² 1.84

189

200

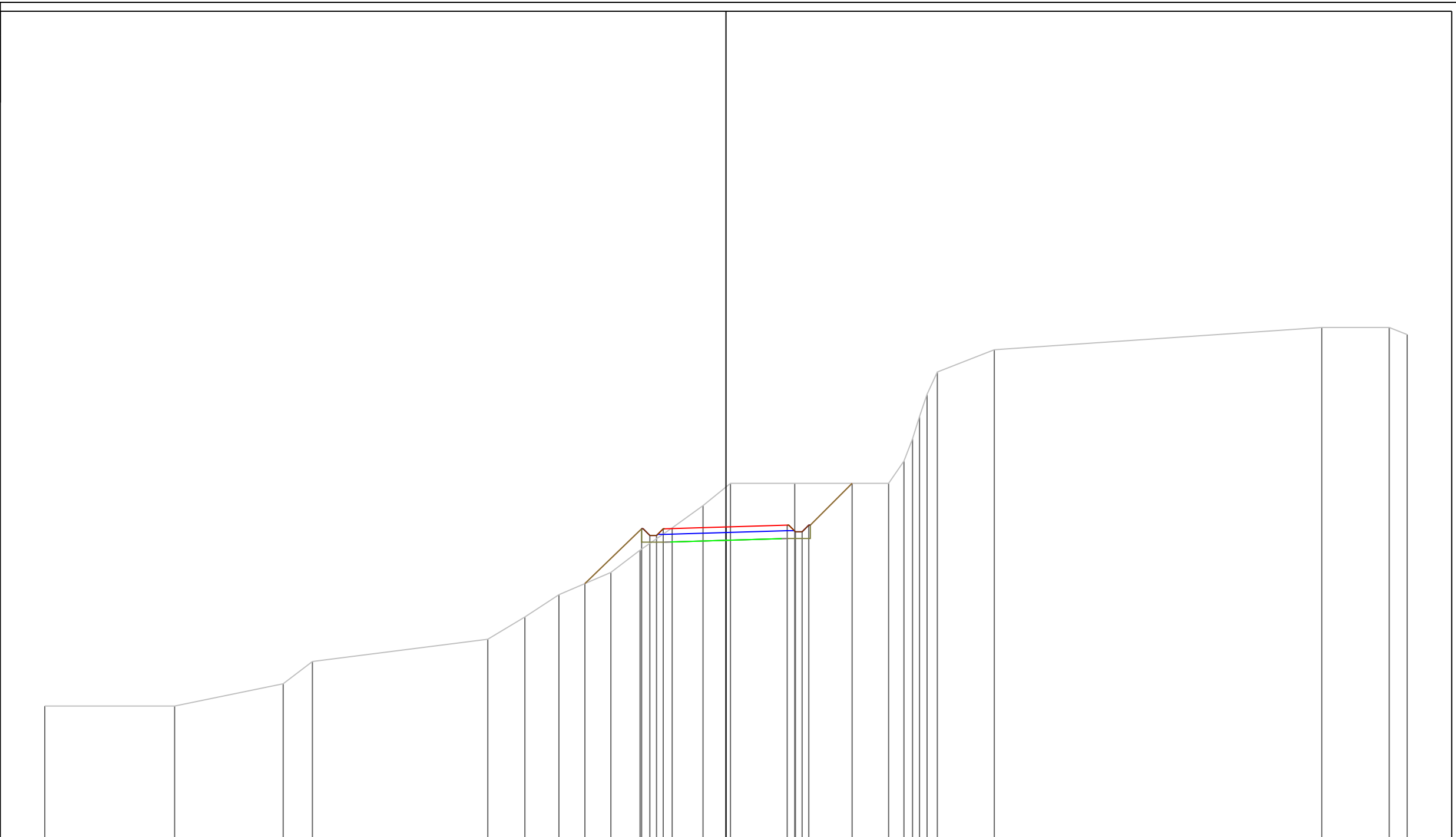

PROGRESSIVE TERRENO	-30.60	-24.77	-19.89	-18.58	-10.70	-9.03	-7.50	-5.17	-3.86	-2.42	-1.03	0.20	3.09	7.31	7.99	8.38	8.69	9.03	9.49	12.05	26.76	29.79	30.60
PARZIALI TERRENO	5.83	4.88	1.31	7.88	1.67	1.53	2.33	1.31	1.44	1.39	1.23	2.89	4.22	0.68	0.39	0.31	0.34	0.46	2.56	14.71	3.03	0.81	
QUOTE TERRENO	195.00	195.00	196.00	197.00	198.00	199.00	200.00	201.00	202.00	203.00	204.00	205.00	205.00	205.00	206.00	207.00	208.00	209.00	210.00	211.00	212.00	212.00	211.68
PROGRESSIVE PROGETTO								-6.34	-3.79	-3.42	-3.12	-2.82	0.00	2.75	3.12	3.42	3.72	5.67					
PARZIALI PROGETTO								2.55	0.37	0.30	0.30	2.82	2.75	0.37	0.30	0.30	1.95						
QUOTE PROGETTO								200.50	202.96	202.66	202.96	203.04	203.12	202.82	202.82	203.12	205.00						

PROFILO Asse4

SEZIONE 154

PROGRESSIVA 1530.00

A STERRO m<sup>2</sup> 47.41

182

200  
200

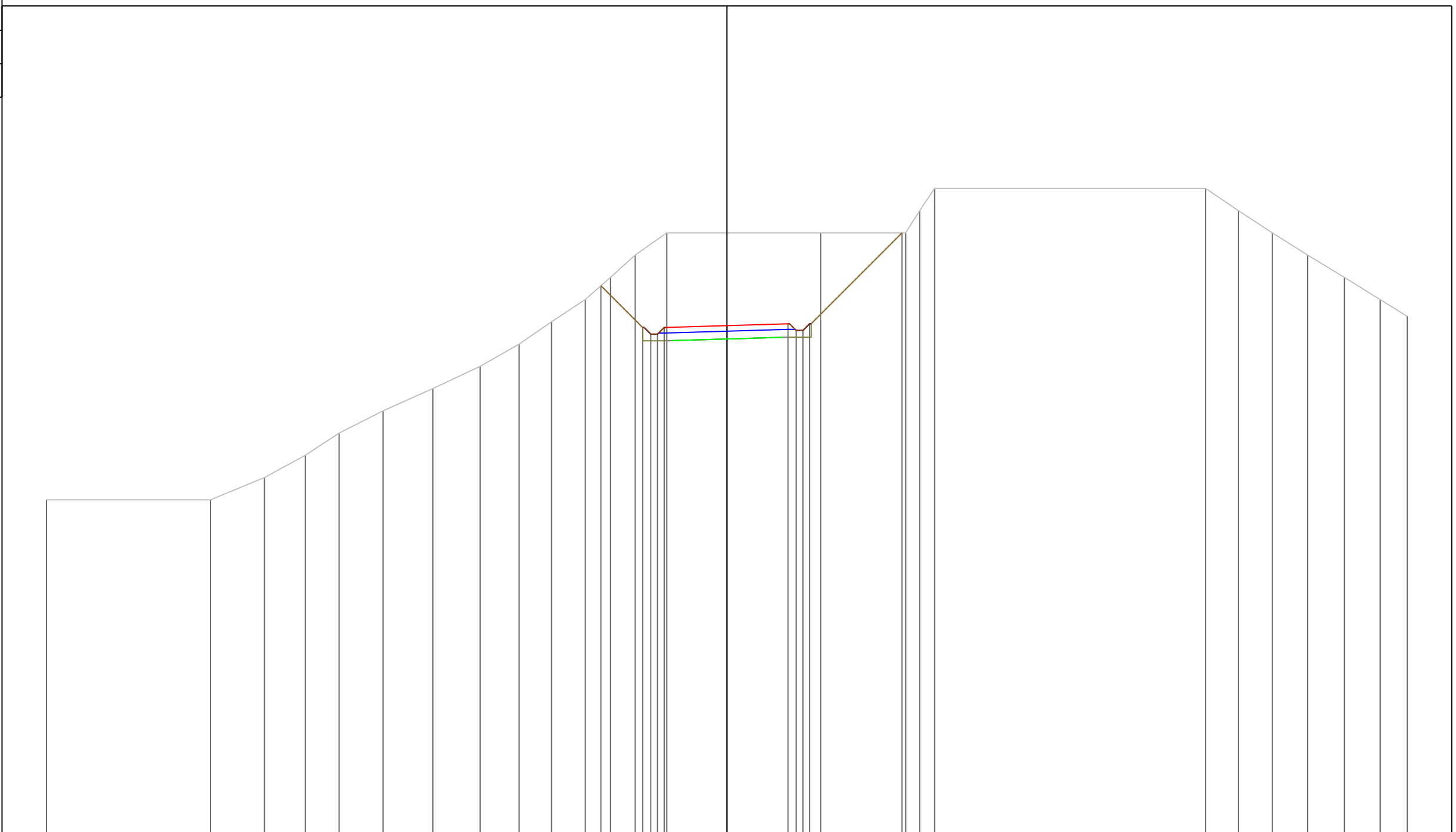

PROGRESSIVE TERRENO	-30.60	-23.22	-20.80	-18.96	-17.44	-15.46	-13.22	-11.10	-9.34	-7.89	-6.37	-5.23	-4.13	-2.70	4.22	8.04	8.67	9.34	21.53	23.01	24.53	26.12	27.77	29.38	30.60
PARZIALI TERRENO	7.38	2.42	1.84	1.52	1.98	2.24	2.12	1.76	1.45	1.52	1.14	1.10	1.43	6.92	3.82	0.63	0.67	12.19	1.48	1.52	1.59	1.65	1.61	1.22	
QUOTE TERRENO	197.00	197.00	198.00	199.00	200.00	201.00	202.00	203.00	204.00	205.00	206.00	207.00	208.00	209.00	209.00	209.00	210.00	211.00	211.00	210.00	209.00	208.00	207.00	206.00	205.25
PROGRESSIVE PROGETTO											-5.66	-3.79	-3.42	-3.12	-2.82	0.00	2.75	3.12	3.42	3.72	7.88				
PARZIALI PROGETTO											1.87	0.37	0.30	0.30	0.30	2.82	2.75	0.37	0.30	0.30	4.16				
QUOTE PROGETTO											206.62	204.75	204.45	204.45	204.75	204.83	204.91	204.61	204.61	204.91	209.00				

PROFILO Asse4

SEZIONE 155

PROGRESSIVA 1540.00

A STERRO m<sup>2</sup> 48.89

179

200  
200

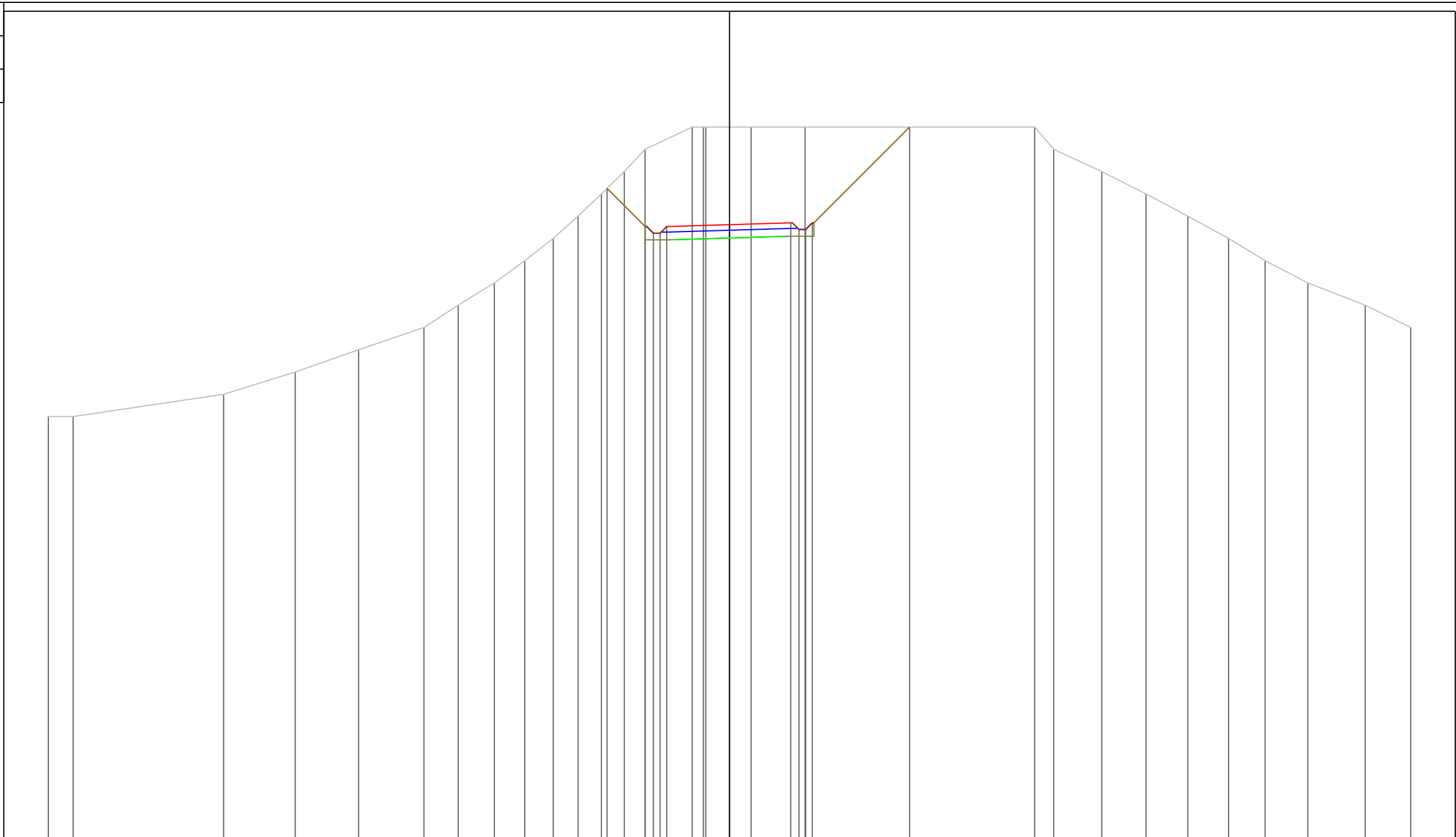

PROGRESSIVE TERRENO	-30.60	-29.48	-22.73	-19.51	-16.66	-13.73	-12.19	-10.56	-9.20	-7.92	-6.80	-5.75	-4.73	-3.79	-1.68	-1.17	-1.07	0.97	3.39	13.71	14.56	16.72	18.71	20.59	22.42	24.06	25.98	28.55	30.60
PARZIALI TERRENO	1.12	6.75	3.22	2.85	2.93	1.54	1.63	1.36	1.28	1.12	1.05	1.02	0.94	2.11	0.51	0.10	2.04	2.42	10.32	0.85	2.16	1.99	1.88	1.83	1.64	1.92	2.57	2.05	
QUOTE TERRENO	198.00	198.00	199.00	200.00	201.00	202.00	203.00	204.00	205.00	206.00	207.00	208.00	209.00	210.00	211.00	211.00	211.00	211.00	211.00	211.00	210.00	209.00	208.00	207.00	206.00	205.00	204.00	203.00	202.00
PROGRESSIVE PROGETTO												-5.50	-3.79	-3.42	-3.12	-2.82	0.00		2.75	3.12	3.42	3.72	8.09						
PARZIALI PROGETTO												1.71	0.37	0.30	0.30	2.82		2.75	0.37	0.30	0.30	4.37							
QUOTE PROGETTO												208.25	206.53	206.23	206.53	206.62		206.62	206.70	206.40	206.40	206.70	211.00						







PROFILO Asse4

SEZIONE 159

PROGRESSIVA 1580.00

A STERRO m<sup>2</sup> 15.45

191

200  
200

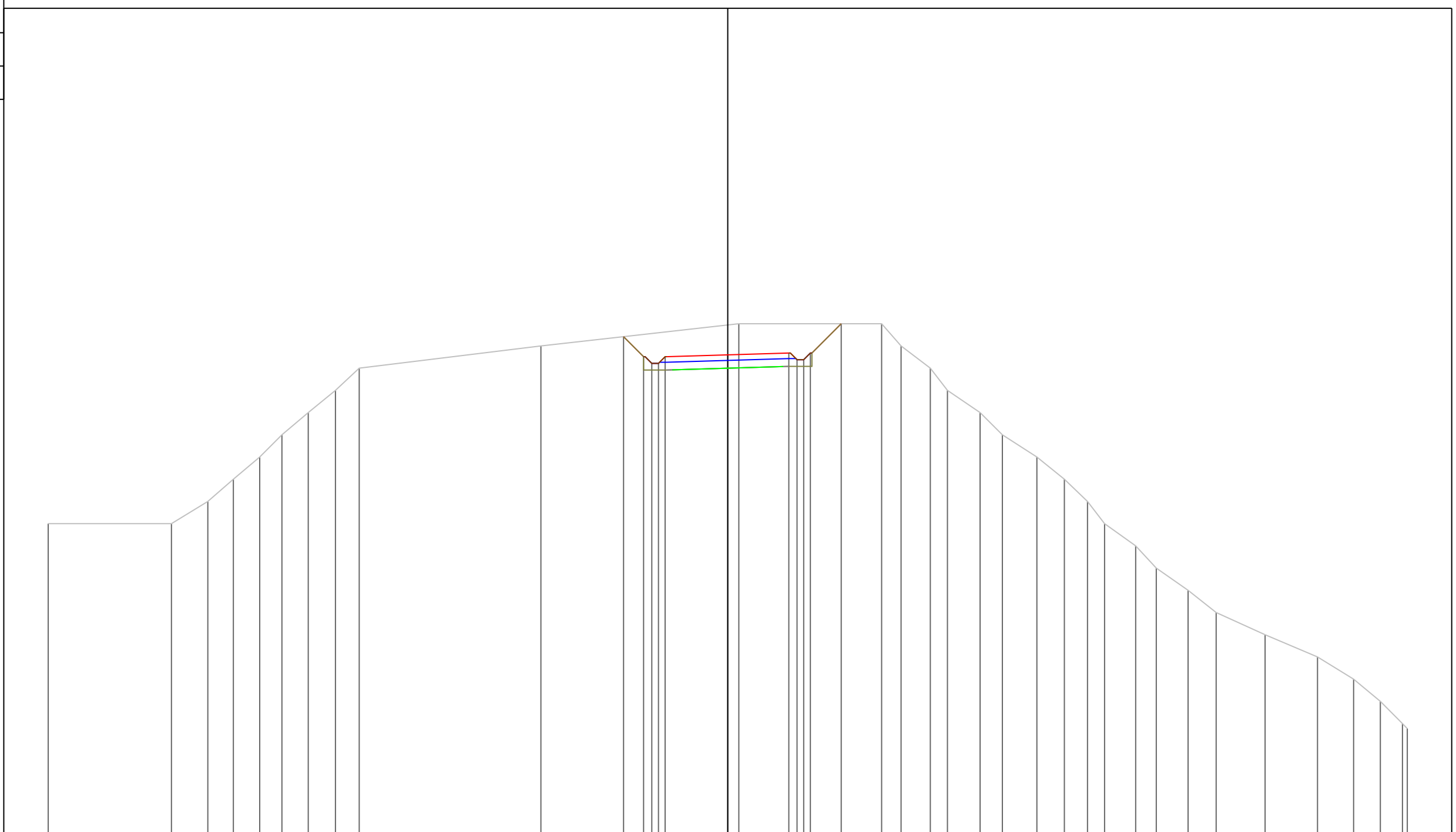

PROGRESSIVE TERRENO

-30.60	-25.05	-23.41	-22.26	-21.08	-20.08	-18.89	-17.67	-16.59	-8.41	0.50	6.93	7.80	9.12	9.89	11.36	12.37	13.92	15.16	16.20	16.97	18.37	19.30	20.73	21.99	24.20	26.56	28.18	29.39	30.38	30.60
--------	--------	--------	--------	--------	--------	--------	--------	--------	-------	------	------	------	------	------	-------	-------	-------	-------	-------	-------	-------	-------	-------	-------	-------	-------	-------	-------	-------	-------

PARZIALI TERRENO

5.55	1.64	1.15	1.18	1.00	1.19	1.22	1.08	8.18	8.91	6.43	0.87	1.32	0.77	1.47	1.01	1.55	1.24	1.04	0.77	1.40	0.93	1.43	1.26	2.21	2.36	1.62	1.21	0.99	0.38	0.22
------	------	------	------	------	------	------	------	------	------	------	------	------	------	------	------	------	------	------	------	------	------	------	------	------	------	------	------	------	------	------

QUOTE TERRENO

205.00	205.00	206.00	207.00	208.00	209.00	210.00	211.00	212.00	213.00	214.00	214.00	213.00	212.00	211.00	210.00	209.00	208.00	207.00	206.00	205.00	204.00	203.00	202.00	201.00	200.00	199.00	198.00	197.00	196.00	195.77
--------	--------	--------	--------	--------	--------	--------	--------	--------	--------	--------	--------	--------	--------	--------	--------	--------	--------	--------	--------	--------	--------	--------	--------	--------	--------	--------	--------	--------	--------	--------

PROGRESSIVE PROGETTO

										0.00																				
--	--	--	--	--	--	--	--	--	--	------	--	--	--	--	--	--	--	--	--	--	--	--	--	--	--	--	--	--	--	--

PARZIALI PROGETTO

--	--	--	--	--	--	--	--	--	--	--	--	--	--	--	--	--	--	--	--	--	--	--	--	--	--	--	--	--	--	--

QUOTE PROGETTO

--	--	--	--	--	--	--	--	--	--	--	--	--	--	--	--	--	--	--	--	--	--	--	--	--	--	--	--	--	--	--

213.42  
212.52  
212.22  
212.22  
212.52

0.90  
0.37  
0.30  
0.30  
0.30

212.60

212.68  
212.38  
212.38  
212.68

214.00







PROFILO Asse4

SEZIONE 162

PROGRESSIVA 1610.00

A STERRO m<sup>2</sup> 3.08  
B RIPORTO m<sup>2</sup> 1.36

193

200  
200

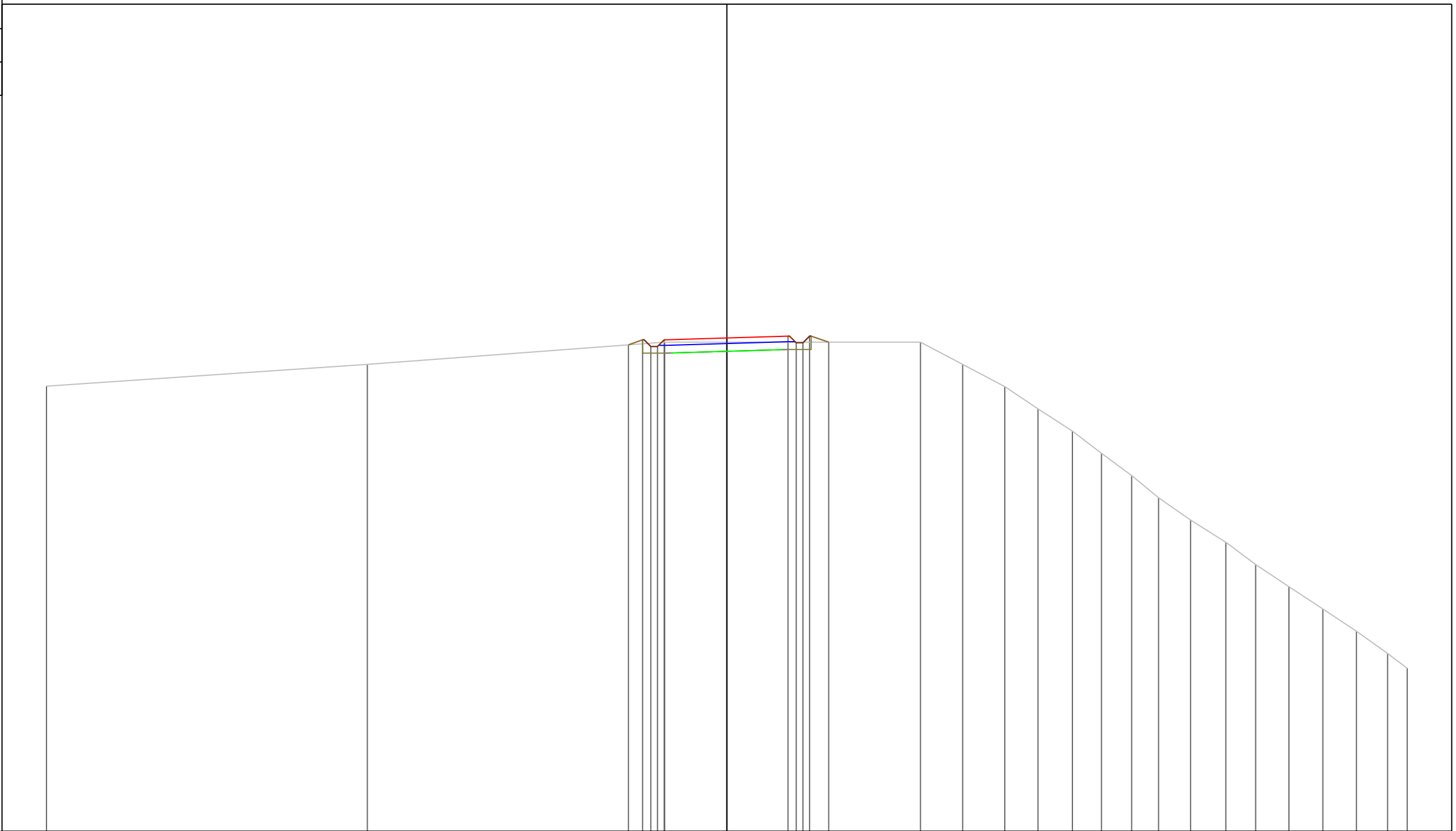

PROGRESSIVE TERRENO	-30.60	-16.17	-2.80	8.71	10.61	12.50	13.99	15.54	16.85	18.21	19.42	20.86	22.44	23.78	25.28	26.80	28.31	29.72	30.60
PARZIALI TERRENO	14.43	13.37	11.51	1.90	1.89	1.49	1.55	1.31	1.36	1.21	1.44	1.58	1.34	1.50	1.52	1.51	1.41	0.88	
QUOTE TERRENO	213.02	214.00	215.00	215.00	214.00	213.00	212.00	211.00	210.00	209.00	208.00	207.00	206.00	205.00	204.00	203.00	202.00	201.00	200.33
PROGRESSIVE PROGETTO																			
PARZIALI PROGETTO																			
QUOTE PROGETTO																			

214.88 0.64  
 215.10 4.43  
 214.80 0.37  
 214.80 3.79  
 215.10 0.30  
 214.80 3.42  
 215.10 0.30  
 215.10 2.82  
 215.19 0.00  
 215.27 2.75  
 214.97 0.37  
 214.97 3.12  
 215.27 0.30  
 215.27 3.42  
 215.00 0.30  
 215.00 3.72  
 215.00 4.58

PROFILO Asse4

SEZIONE 163

PROGRESSIVA 1620.00

A STERRO m<sup>2</sup> 0.38  
 B RIPORTO m<sup>2</sup> 4.50

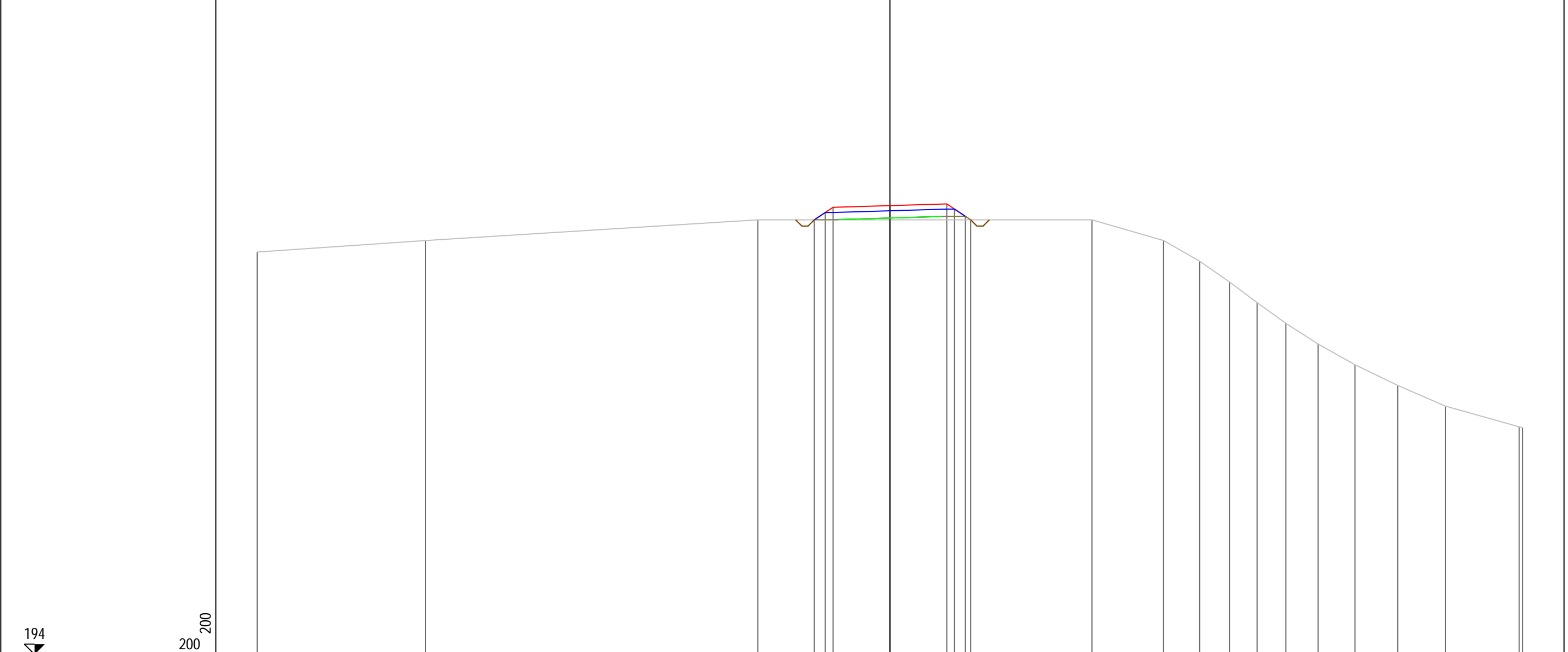

PROGRESSIVE TERRENO	-30.60	-22.45	-6.38	9.77	13.23	14.98	16.42	17.76	19.15	20.71	22.49	24.56	26.87	30.43	30.60
PARZIALI TERRENO	8.15	16.07	16.15	3.46	1.75	1.44	1.34	1.39	1.56	1.78	2.07	2.31	3.56	0.17	
QUOTE TERRENO	213.44	214.00	215.00	215.00	214.00	213.00	212.00	211.00	210.00	209.00	208.00	207.00	206.00	205.00	204.96
PROGRESSIVE PROGETTO															
PARZIALI PROGETTO															
QUOTE PROGETTO															

215.00 -3.66  
 215.35 -3.12  
 215.60 -2.75  
 0.54  
 0.37  
 2.75  
 215.69  
 2.75  
 215.77 0.38  
 215.52 3.13  
 215.17 0.52  
 215.00 3.65  
 3.91  
 0.26



PROFILO Asse4

SEZIONE 165

PROGRESSIVA 1640.00

A STERRO m<sup>2</sup> 1.41  
 B RIPORTO m<sup>2</sup> 3.01

196  
 200 200

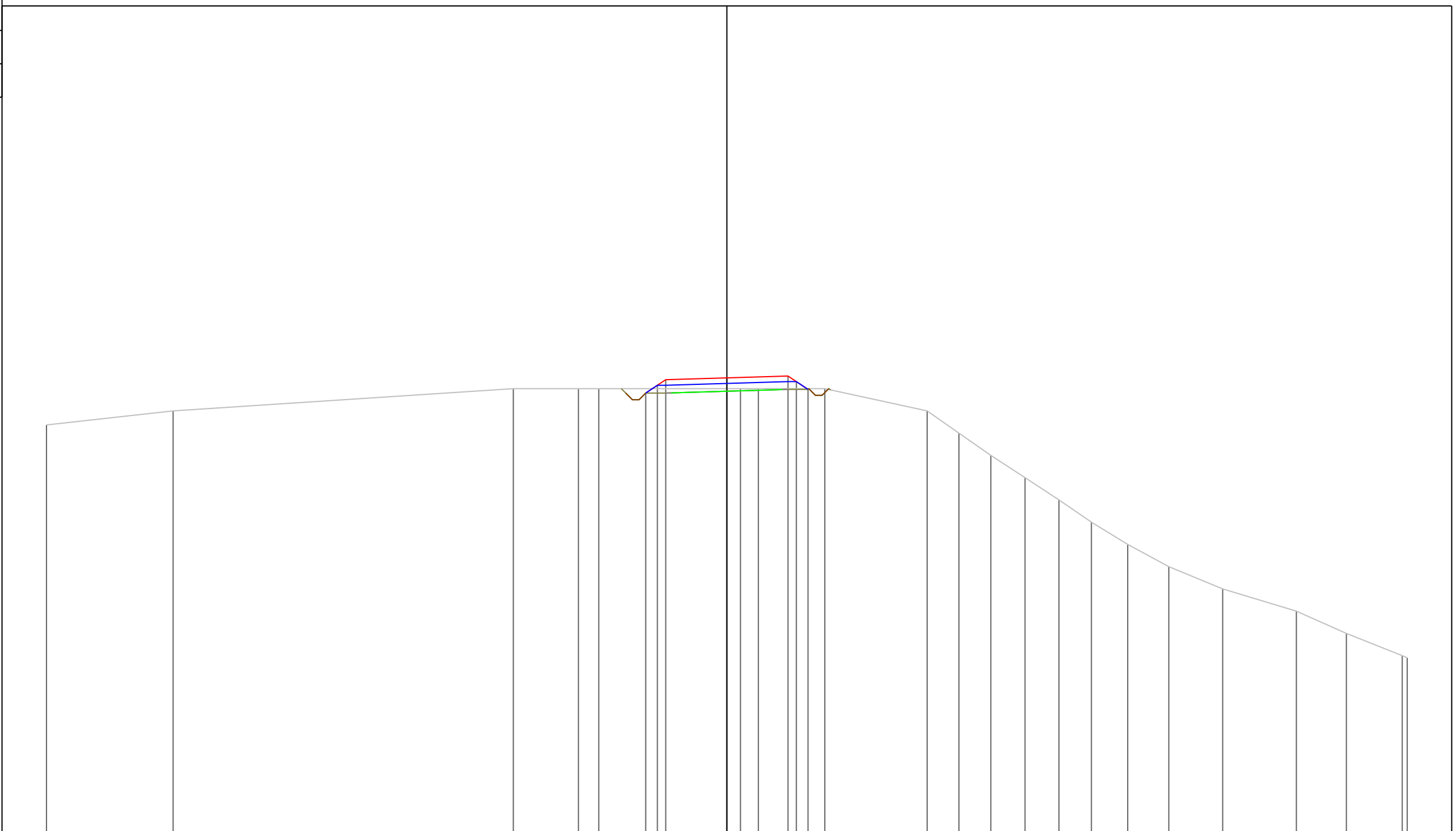

PROGRESSIVE TERRENO	-30.60	-24.90	-9.60	-6.67	-5.76	0.61	1.42	4.41	9.01	10.44	11.87	13.41	14.94	16.40	18.03	19.88	22.30	25.61	27.86	30.37	30.60
PARZIALI TERRENO	5.70	15.30	2.93	0.91	6.37	0.81	2.99	4.60	1.43	1.43	1.54	1.53	1.46	1.63	1.85	2.42	3.31	2.25	2.51	0.23	
QUOTE TERRENO	214.37	215.00	216.00	216.00	216.00	216.00	216.00	216.00	215.00	214.00	213.00	212.00	211.00	210.00	209.00	208.00	207.00	206.00	205.00	204.00	203.90
PROGRESSIVE PROGETTO																					
PARZIALI PROGETTO																					
QUOTE PROGETTO																					

215.80  
 216.15  
 216.40

3.65  
 -3.12  
 -2.75

0.53  
 0.37

2.75

216.48

2.75

216.57  
 216.32  
 215.97

2.75  
 3.12  
 3.65

PROFILO Asse4

SEZIONE 166

PROGRESSIVA 1650.00

A STERRO	m <sup>2</sup>	0.38
B RIPORTO	m <sup>2</sup>	6.04

192

200  
200

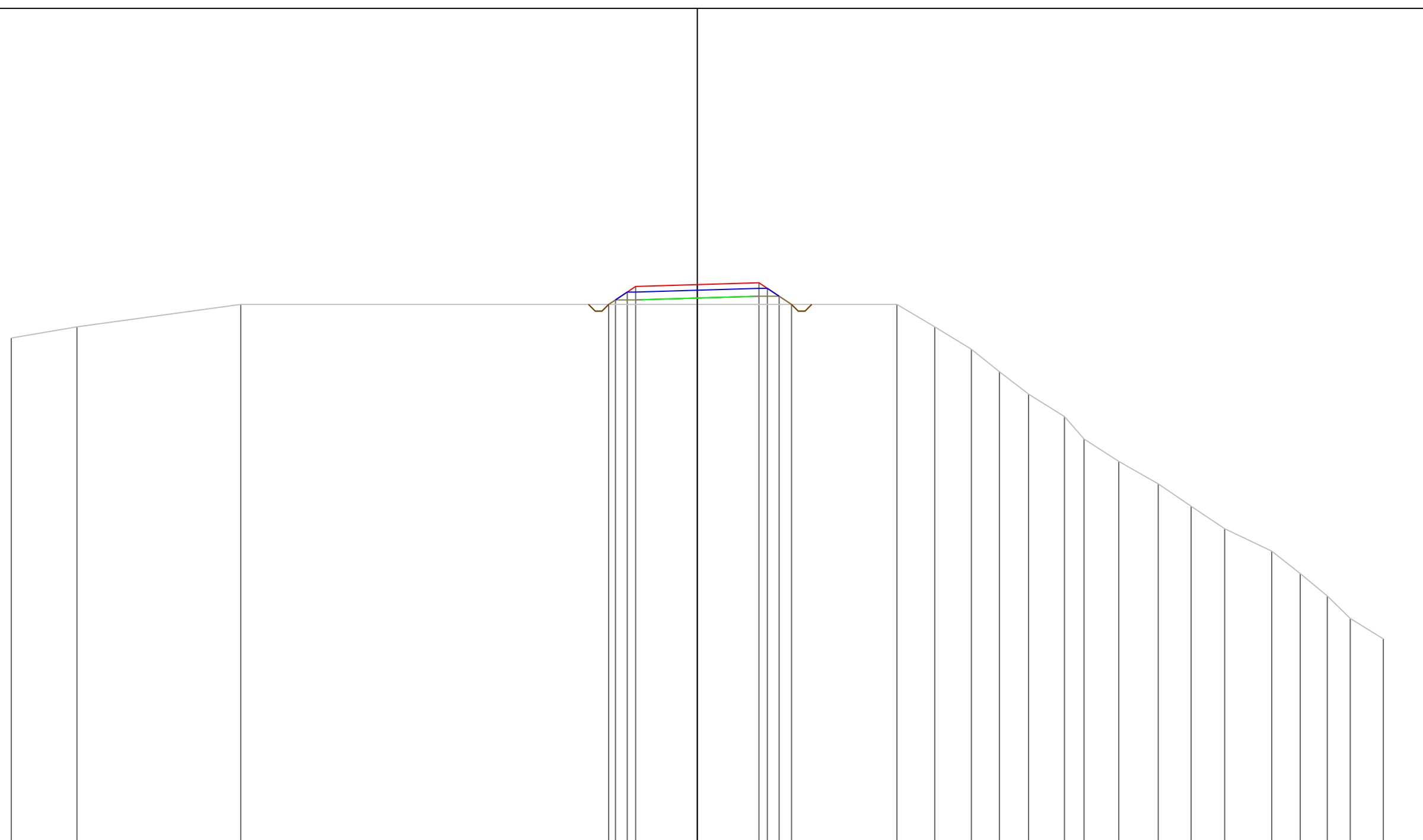

PROGRESSIVE TERRENO	-30.60	-27.67	-20.36		8.90	10.59	12.23	13.48	14.78	16.38	17.25	18.80	20.56	22.03	23.52	25.62	26.89	28.10	29.12	30.60
PARZIALI TERRENO	2.93	7.31	29.26		1.69	1.64	1.25	1.30	1.60	0.87	1.55	1.76	1.47	1.49	2.10	1.27	1.21	1.02	1.48	
QUOTE TERRENO	214.50	215.00	216.00		216.00	215.00	214.00	213.00	212.00	211.00	210.00	209.00	208.00	207.00	206.00	205.00	204.00	203.00	202.00	201.08
PROGRESSIVE PROGETTO																				
PARZIALI PROGETTO																				
QUOTE PROGETTO					216.00	216.20	216.55	216.80	216.88	216.97	216.72	216.37	216.00							

PROFILO Asse4

SEZIONE 167

PROGRESSIVA 1660.00

A STERRO m<sup>2</sup> 3.39

B RIPORTO m<sup>2</sup> 1.67

198

200

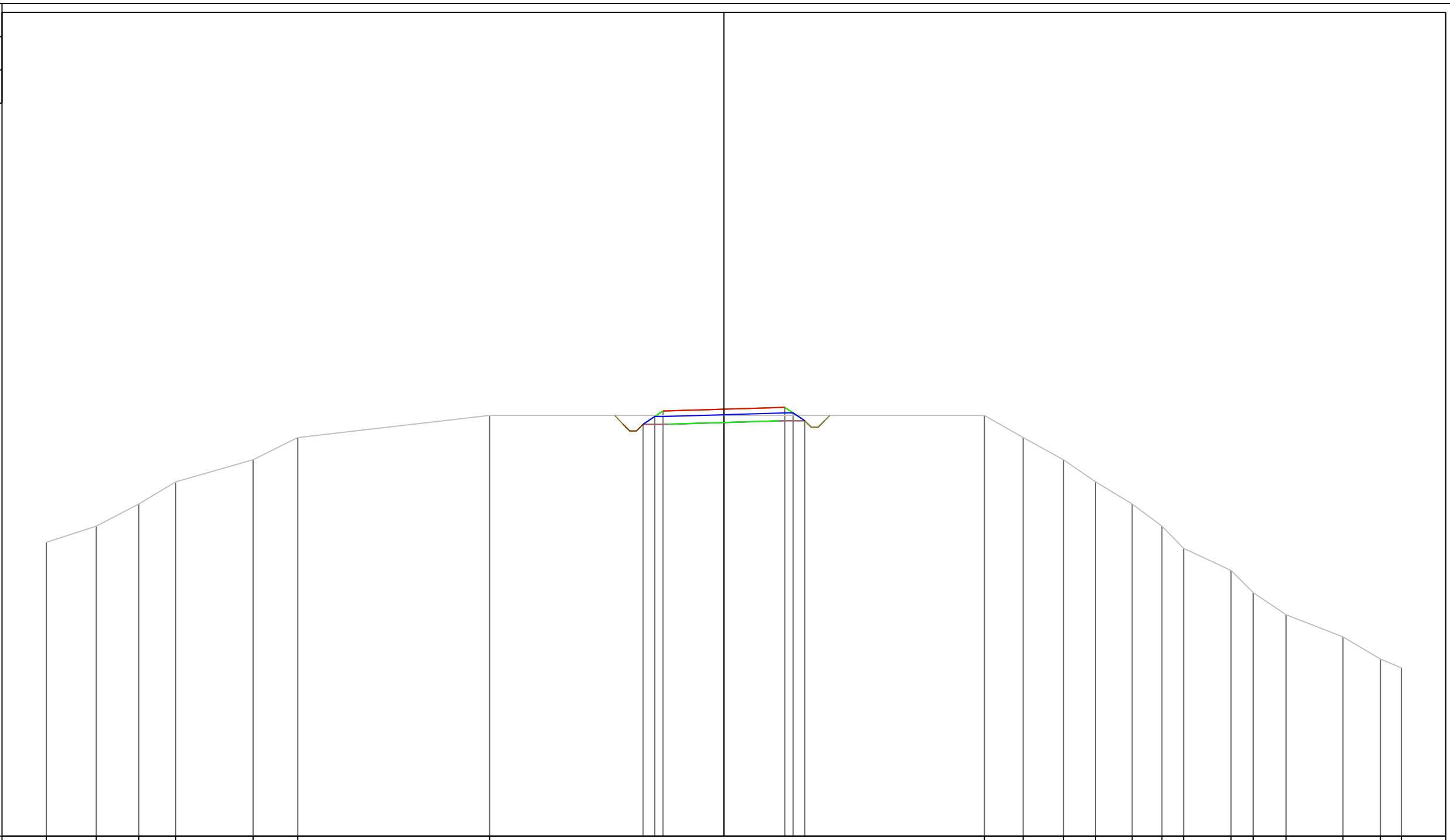

PROGRESSIVE TERRENO	-30.60	-28.34	-26.42	-24.75	-21.26	-19.24	-10.58											11.76	13.52	15.34	16.79	18.44	19.78	20.76	22.91	23.90	25.39	27.96	29.65	30.60
PARZIALI TERRENO		2.26	1.92	1.67	3.49	2.02	8.66		22.34									1.76	1.82	1.45	1.65	1.34	0.98	2.15	0.99	1.49	2.57	1.69	0.95	
QUOTE TERRENO	211.27	212.00	213.00	214.00	215.00	216.00	217.00											217.00	216.00	215.00	214.00	213.00	212.00	211.00	210.00	209.00	208.00	207.00	206.00	205.60
PROGRESSIVE PROGETTO																														
PARZIALI PROGETTO																														
QUOTE PROGETTO																														

216.60  
216.95  
217.20

3.65  
3.12  
2.75

0.53  
0.37

2.75

217.28

217.36  
217.11  
216.76

2.75  
3.12  
3.65





PROFILO Asse4  
SEZIONE 169  
PROGRESSIVA 1680.00

A STERRO m<sup>2</sup> 0.79  
B RIPORTO m<sup>2</sup> 4.37

198  
200

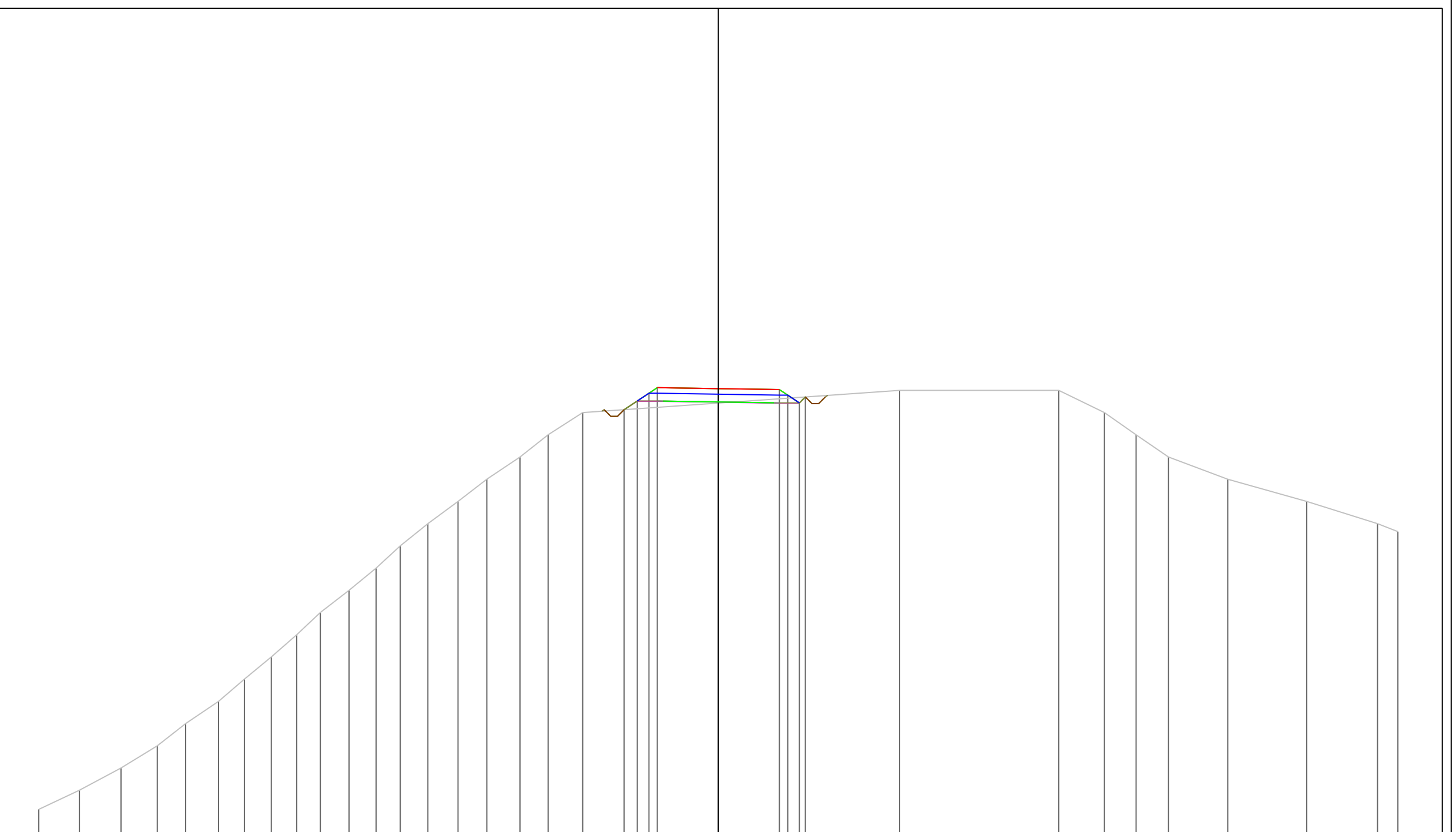

PROGRESSIVE TERRENO	-30.60	-28.77	-26.90	-25.26	-23.99	-22.51	-21.34	-20.13	-18.98	-17.92	-16.63	-15.41	-14.32	-13.08	-11.72	-10.43	-8.93	-7.67	-6.11			8.16		15.33	17.38	18.81	20.27	22.94	26.50	29.68	30.60	
PARZIALI TERRENO		1.83	1.87	1.64	1.27	1.48	1.17	1.21	1.15	1.06	1.29	1.22	1.09	1.24	1.36	1.29	1.50	1.26	1.56		14.27		7.17		2.05	1.43	1.46	2.67	3.56	3.18	0.92	
QUOTE TERRENO	199.14	200.00	201.00	202.00	203.00	204.00	205.00	206.00	207.00	208.00	209.00	210.00	211.00	212.00	213.00	214.00	215.00	216.00	217.00			218.00		218.00	217.00	216.00	215.00	214.00	213.00	212.00	211.64	
PROGRESSIVE PROGETTO																					-4.24	0.00			2.75	3.12	3.65	3.92				
PARZIALI PROGETTO																					0.59		2.75		0.37	0.53	0.37	2.75				
QUOTE PROGETTO																					217.13	218.08		218.04	217.79	217.44	217.70					

PROFILO Asse4

SEZIONE 170

PROGRESSIVA 1690.00

A STERRO m<sup>2</sup> 1.06  
 B RIPORTO m<sup>2</sup> 4.96

197

200 200

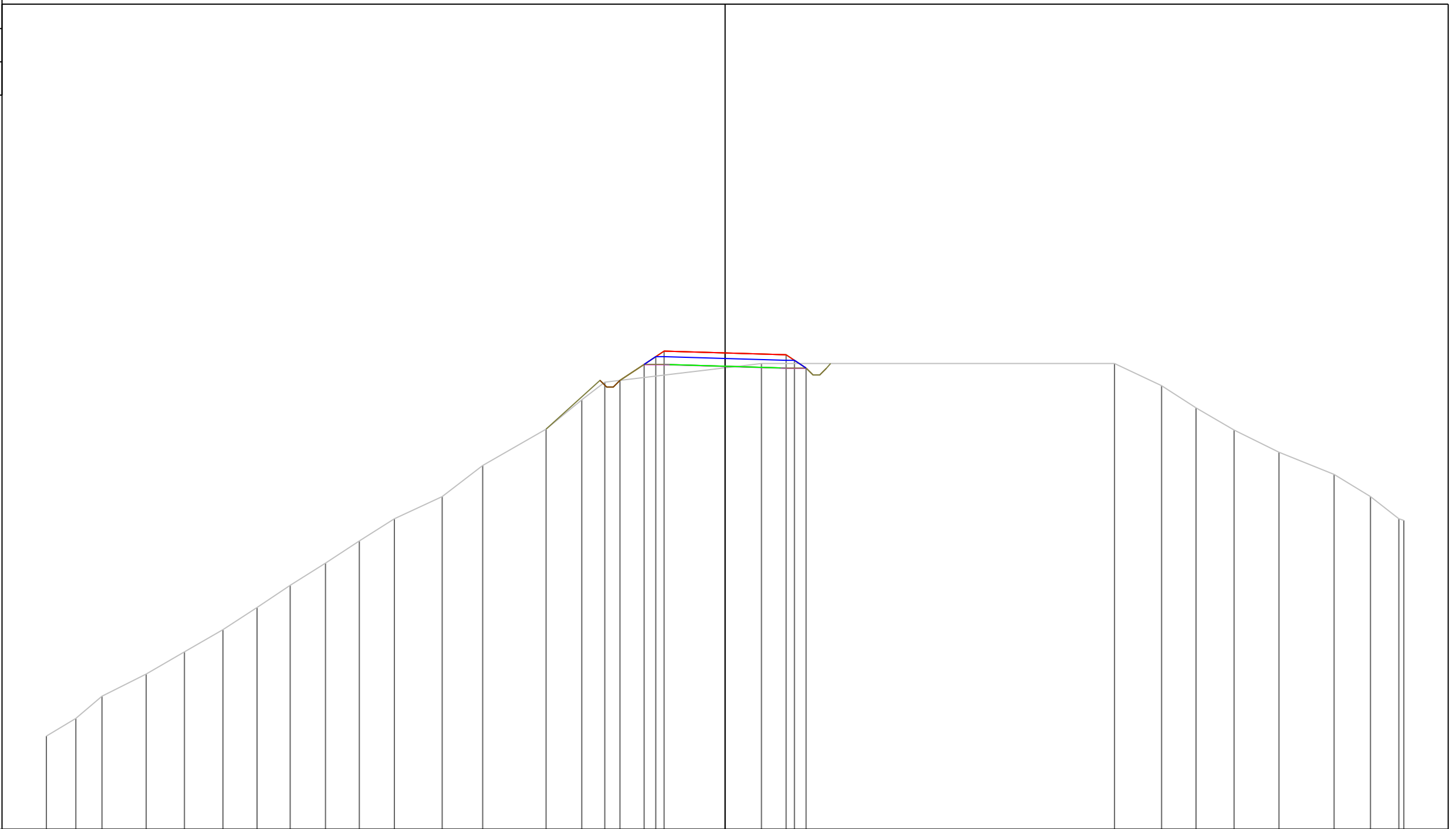

PROGRESSIVE TERRENO	-30.60	-29.27	-28.09	-26.10	-24.38	-22.64	-21.10	-19.61	-18.02	-16.49	-14.91	-12.76	-10.93	-8.07	-6.46	-5.42	1.64	17.56	19.68	21.23	22.95	24.97	27.46	29.10	30.38	30.60
PARZIALI TERRENO	1.33	1.18	1.99	1.72	1.74	1.54	1.49	1.59	1.53	1.58	2.15	1.83	2.86	1.61	1.04	7.06	15.92	2.12	1.55	1.72	2.02	2.49	1.64	1.28	0.22	
QUOTE TERRENO	201.20	202.00	203.00	204.00	205.00	206.00	207.00	208.00	209.00	210.00	211.00	212.00	213.40	215.04	216.36	217.16	218.00	218.00	217.00	216.00	215.00	214.00	213.00	212.00	211.00	210.93
PROGRESSIVE PROGETTO																-4.74	0.00	2.75	3.13	3.65						
PARZIALI PROGETTO																1.09	2.75	0.38	0.52	2.75						
QUOTE PROGETTO																217.24	218.48	218.39	218.14	217.79						





PROFILO Asse4

SEZIONE 173

PROGRESSIVA 1720.00

A STERRO m<sup>2</sup> 5.95  
 B RIPORTO m<sup>2</sup> 0.05

197

200  
 200

PROGRESSIVE TERRENO	-30.60	-29.07	-27.66	-25.70	-24.29	-23.11	-21.21	-19.79	-18.31	-17.18	-16.06	-14.57		3.13	4.51	5.79	7.00	8.50	9.86	11.70	13.70	15.59	17.30	19.03		29.05	30.59	30.60
PARZIALI TERRENO	1.53	1.41	1.96	1.41	1.18	1.90	1.42	1.48	1.13	1.12	1.49	17.70		1.38	1.28	1.21	1.50	1.36	1.84	2.00	1.89	1.71	1.73	10.02		1.54	0.01	
QUOTE TERRENO	208.14	209.00	210.00	211.00	212.00	213.00	214.00	215.00	216.00	217.00	218.00	219.00		219.00	218.00	217.00	216.00	215.00	214.00	213.00	212.00	211.00	210.00	209.00		208.00	207.00	206.99
PROGRESSIVE PROGETTO														-3.96	-3.79	-3.42	-3.12	-2.82	0.00	2.75	3.12	3.42	3.72	3.96				
PARZIALI PROGETTO													0.17	0.37	0.30	0.30	2.82	2.75	0.37	0.30	0.30	0.30	0.24					
QUOTE PROGETTO													219.00	218.83	218.53	218.83	218.79	218.76	218.46	218.46	218.76	218.40						









PROFILO Asse4

SEZIONE 177

PROGRESSIVA 1760.00

A STERRO m<sup>2</sup> 31.21

199

200  
200

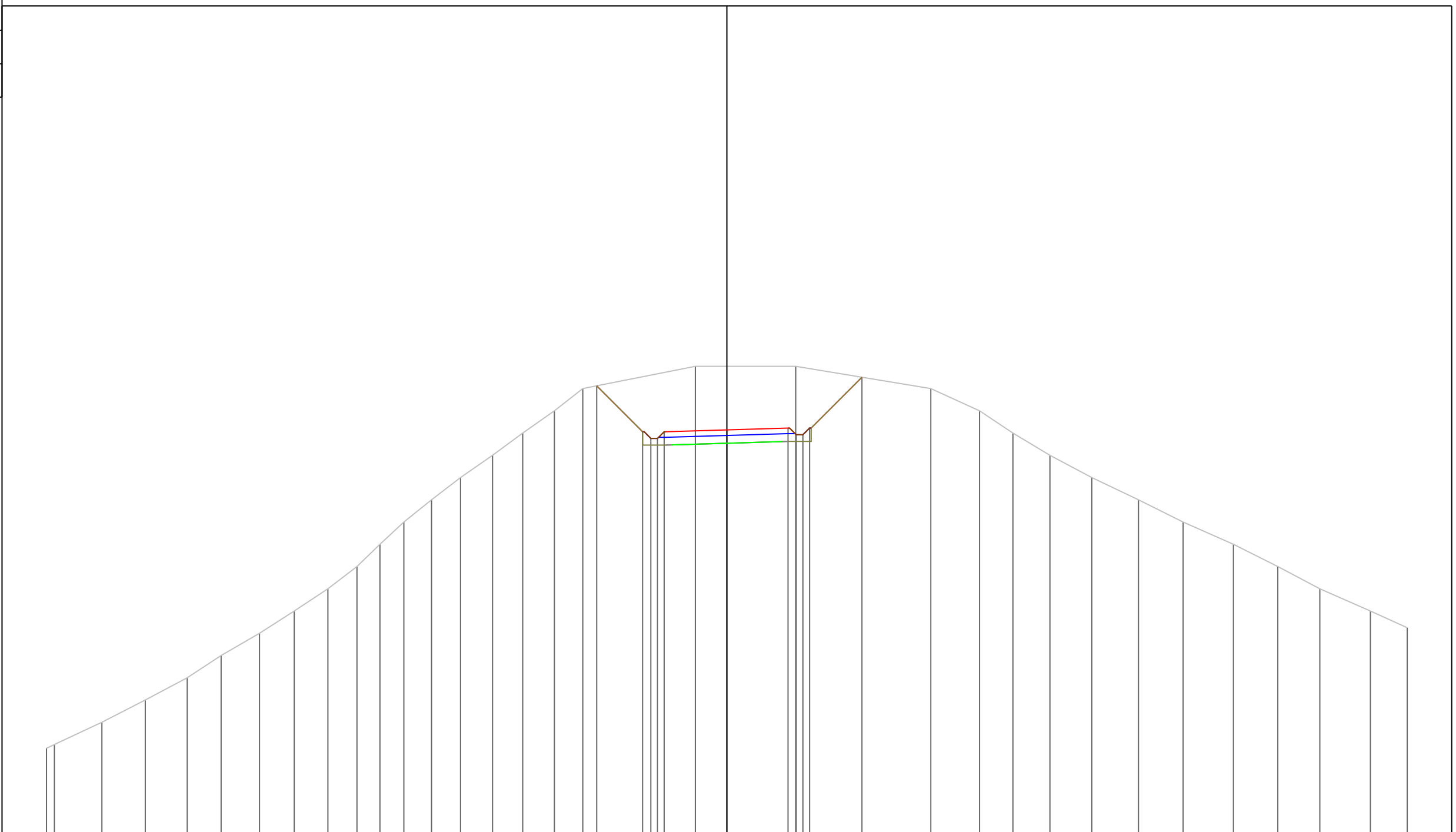

PROGRESSIVE TERRENO	-30.60	-30.24	-28.11	-26.16	-24.27	-22.75	-21.02	-19.46	-17.94	-16.64	-15.60	-14.53	-13.28	-11.98	-10.54	-9.18	-7.76	-6.48	-1.42	3.10	9.17	11.36	12.87	14.53	16.41	18.51	20.52	22.78	24.78	26.67	28.94	30.60
PARZIALI TERRENO	0.36	2.13	1.95	1.89	1.52	1.73	1.56	1.52	1.30	1.04	1.07	1.25	1.30	1.44	1.36	1.42	1.28	5.06	4.52	6.07	2.19	1.51	1.66	1.88	2.10	2.01	2.26	2.00	1.89	2.27	1.66	
QUOTE TERRENO	202.83	203.00	204.00	205.00	206.00	207.00	208.00	209.00	210.00	211.00	212.00	213.00	214.00	215.00	216.00	217.00	218.00	219.00	220.00	220.00	219.00	218.00	217.00	216.00	215.00	214.00	213.00	212.00	211.00	210.00	209.00	208.25
PROGRESSIVE PROGETTO																		-5.85	-3.79	-3.42	-3.12	-2.82	0.00	2.75	3.12	3.42	3.72	6.08				
PARZIALI PROGETTO																		2.06	0.37	0.30	0.30	2.82	2.75	0.37	0.30	0.30	2.36					
QUOTE PROGETTO																		219.12	217.06	216.76	217.06	217.14	217.22	216.92	217.22	219.51						







PROFILO Asse4

SEZIONE 181

PROGRESSIVA 1800.00

A STERRO m<sup>2</sup> 47.15

189

200  
200

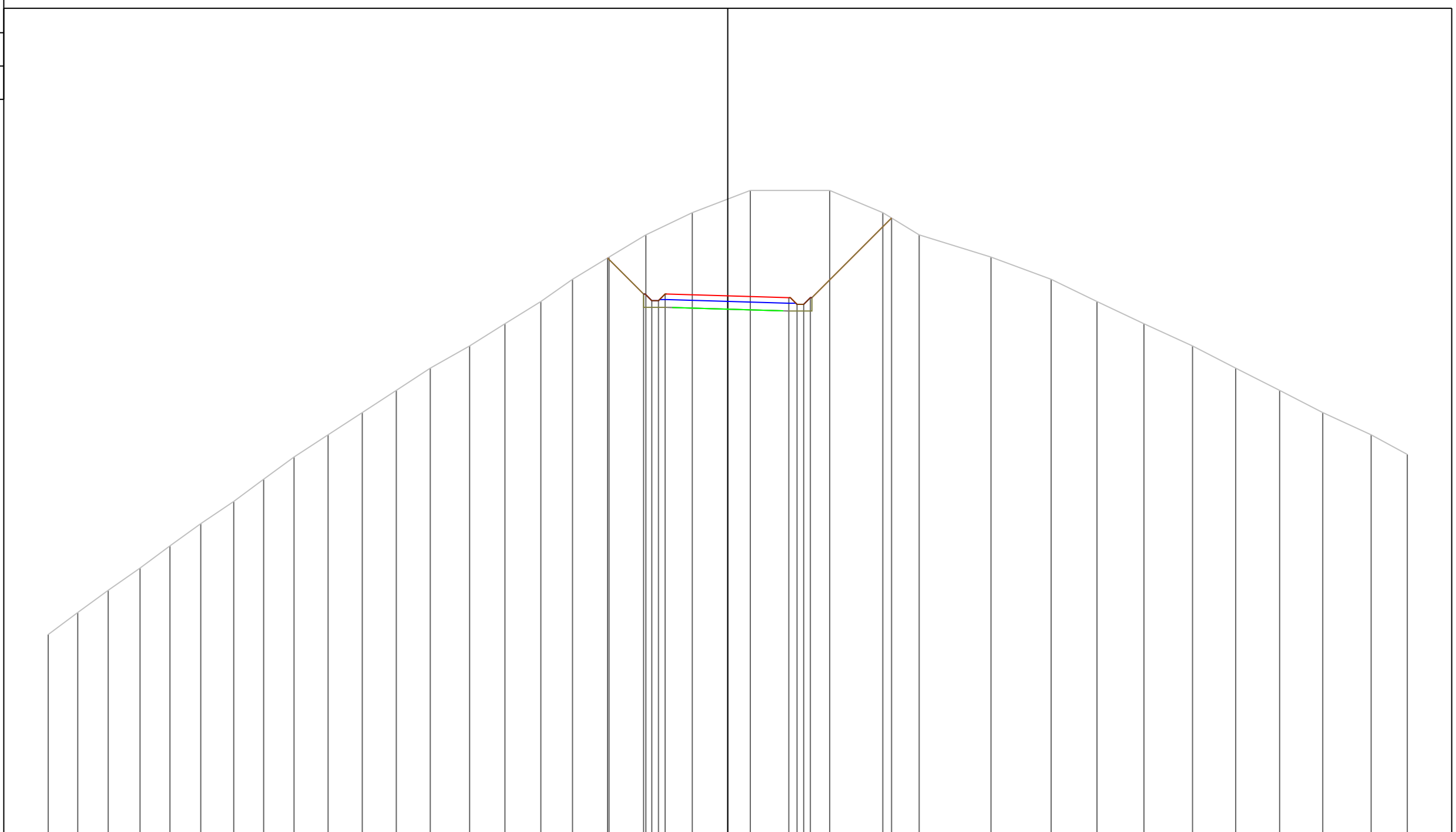

PROGRESSIVE TERRENO	-30.60	-29.27	-27.90	-26.46	-25.12	-23.73	-22.24	-20.90	-19.53	-18.00	-16.46	-14.92	-13.40	-11.62	-10.03	-8.42	-6.99	-5.34	-3.69	-1.60	1.02	4.59	6.98	8.62	11.85	14.56	16.63	18.74	20.93	22.87	24.85	26.79	28.97	30.60
PARZIALI TERRENO	1.33	1.37	1.44	1.34	1.39	1.49	1.34	1.37	1.53	1.54	1.54	1.52	1.78	1.59	1.61	1.43	1.65	1.65	2.09	2.62	3.57	2.39	1.64	3.23	2.71	2.07	2.11	2.19	1.94	1.98	1.94	2.18	1.63	
QUOTE TERRENO	198.01	199.00	200.00	201.00	202.00	203.00	204.00	205.00	206.00	207.00	208.00	209.00	210.00	211.00	212.00	213.00	214.00	215.00	216.00	217.00	218.00	218.00	217.00	216.00	215.00	214.00	213.00	212.00	211.00	210.00	209.00	208.00	207.00	206.12
PROGRESSIVE PROGETTO																		-5.41	-3.79	-3.42	-3.12	-2.82	0.00	2.75	3.12	3.42	3.72	7.38						
PARZIALI PROGETTO																		1.62	0.37	0.30	0.30	2.82	2.75	0.37	0.30	0.30	3.66							
QUOTE PROGETTO																		214.96	213.34	213.04	213.04	213.34	213.25	213.17	212.87	213.17	216.76							

















PROFILO Asse4

SEZIONE 189

PROGRESSIVA 1880.00

A STERRO m<sup>2</sup> 11.13  
 B RIPORTO m<sup>2</sup> 2.95

180  
 200 200

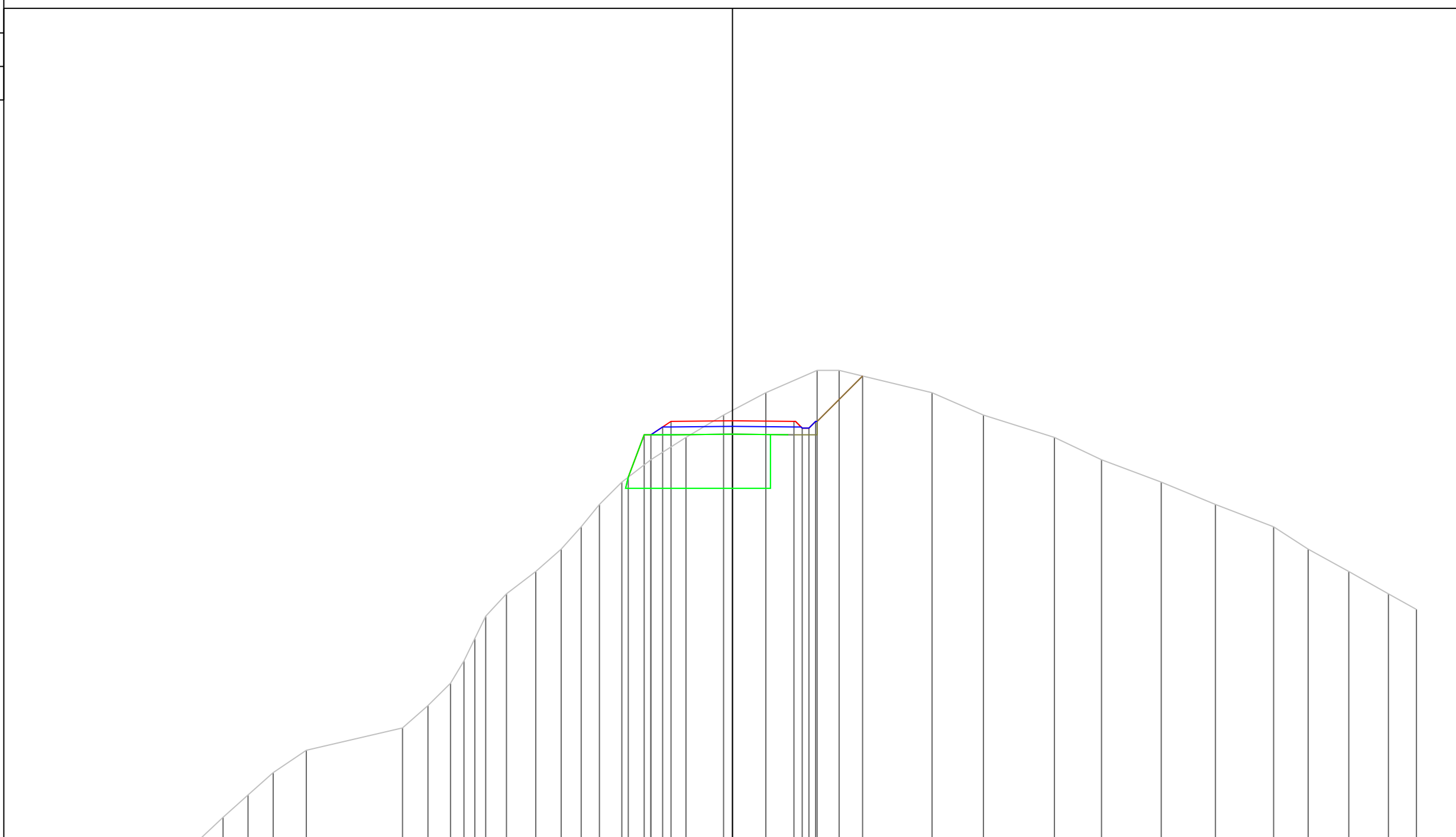

PROGRESSIVE TERRENO	-23.85	-22.79	-21.67	-20.55	-19.07	-14.76	-13.62	-12.61	-12.01	-11.53	-11.04	-10.11	-8.80	-7.66	-6.77	-5.95	-4.95	-3.65	-2.08	-0.40	1.49	3.79	4.77	8.93	11.23	14.40	16.51	19.18	21.61	24.21	25.76	27.57	29.35	30.60
PARZIALI TERRENO	1.06	1.12	1.12	1.48	4.31	1.14	1.01	0.60	0.48	0.49	0.93	1.31	1.14	0.89	0.82	1.00	1.30	1.57	1.68	1.89	2.30	0.98	4.16	2.30	3.17	2.11	2.67	2.43	2.60	1.55	1.81	1.78	1.25	
QUOTE TERRENO	180.00	181.00	182.00	183.00	184.00	185.00	186.00	187.00	188.00	189.00	190.00	191.00	192.00	193.00	194.00	195.00	196.00	197.00	198.00	199.00	200.00	201.00	201.00	200.00	199.00	198.00	197.00	196.00	195.00	194.00	193.00	192.00	191.00	190.30
PROGRESSIVE PROGETTO																	-4.66	-3.95	-3.65	-3.12	-2.75	0.00	2.75	3.12	3.42	3.72	5.82							
PARZIALI PROGETTO																	0.71	0.30	0.53	0.37	2.75	2.75	0.37	0.30	0.30	2.10								
QUOTE PROGETTO																	196.22	196.12	198.12	198.47	198.72	198.74	198.72	198.42	198.42	198.72	200.75							









PROFILO Asse4

SEZIONE 193

PROGRESSIVA 1920.00

A STERRO m<sup>2</sup> 0.31  
B RIPORTO m<sup>2</sup> 67.60

168

200  
200

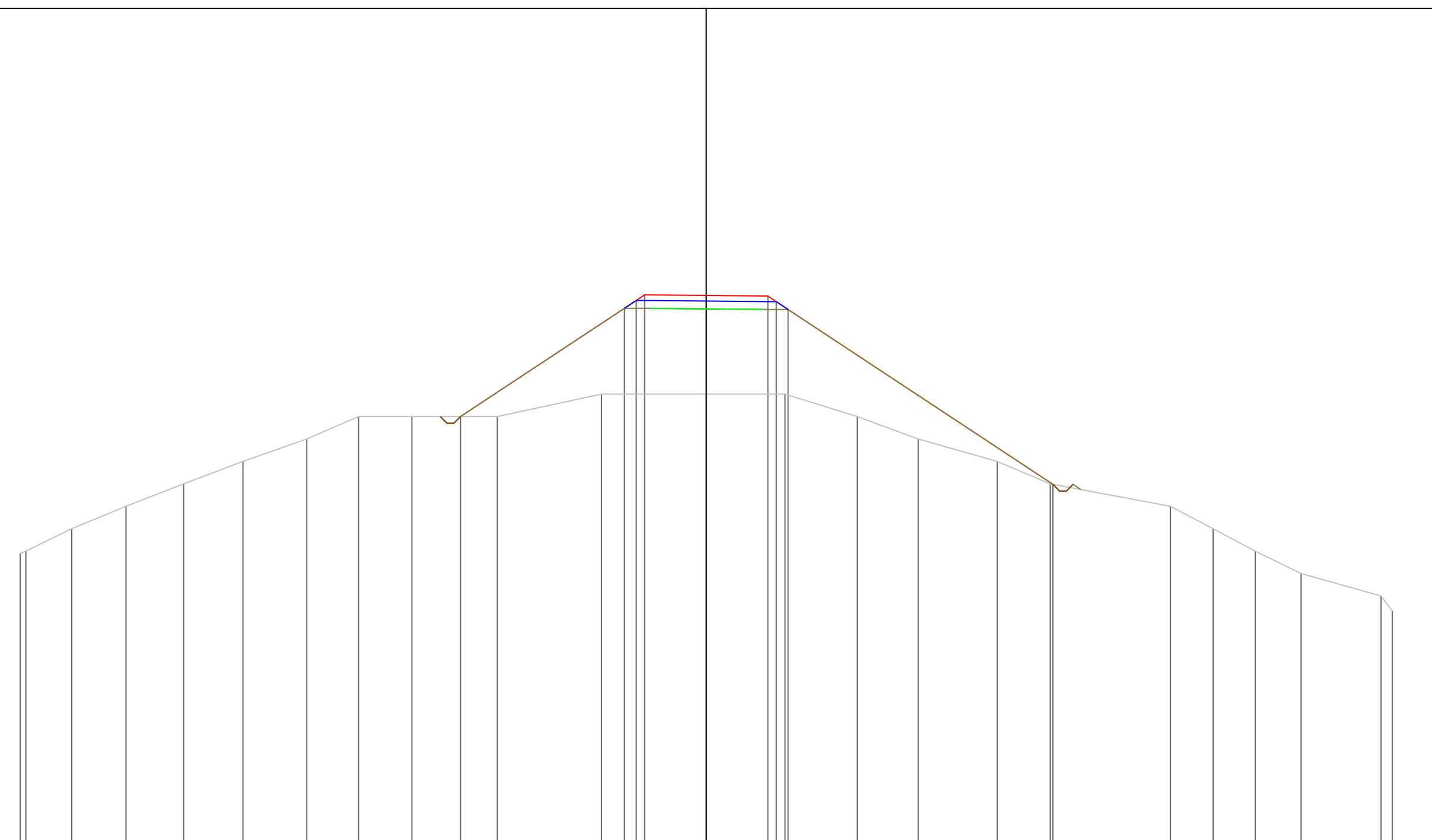

PROGRESSIVE TERRENO	-30.60	-30.35	-28.30	-25.88	-23.31	-20.66	-17.82	-15.51	-13.13	-9.32	-4.67	3.51	6.73	9.45	12.98	15.34	20.70	22.61	24.49	26.53	30.10	30.60	
PARZIALI TERRENO	0.25	2.05	2.42	2.57	2.65	2.84	2.31	2.38	3.81	4.65	8.18	3.22	2.72	3.53	2.36	5.36	1.91	1.88	2.04	3.57	0.50		
QUOTE TERRENO	180.89	181.00	182.00	183.00	184.00	185.00	186.00	187.00	187.00	187.00	188.00	188.00	187.00	186.00	185.00	184.00	183.00	182.00	181.00	180.00	179.00	178.33	
PROGRESSIVE PROGETTO										-10.96						15.46							
PARZIALI PROGETTO										7.31						11.81							
QUOTE PROGETTO										187.00						183.98							

PROFILO Asse4

SEZIONE 194

PROGRESSIVA 1930.00

A STERRO m<sup>2</sup> 0.31  
 B RIPORTO m<sup>2</sup> 63.02

165

200  
 200

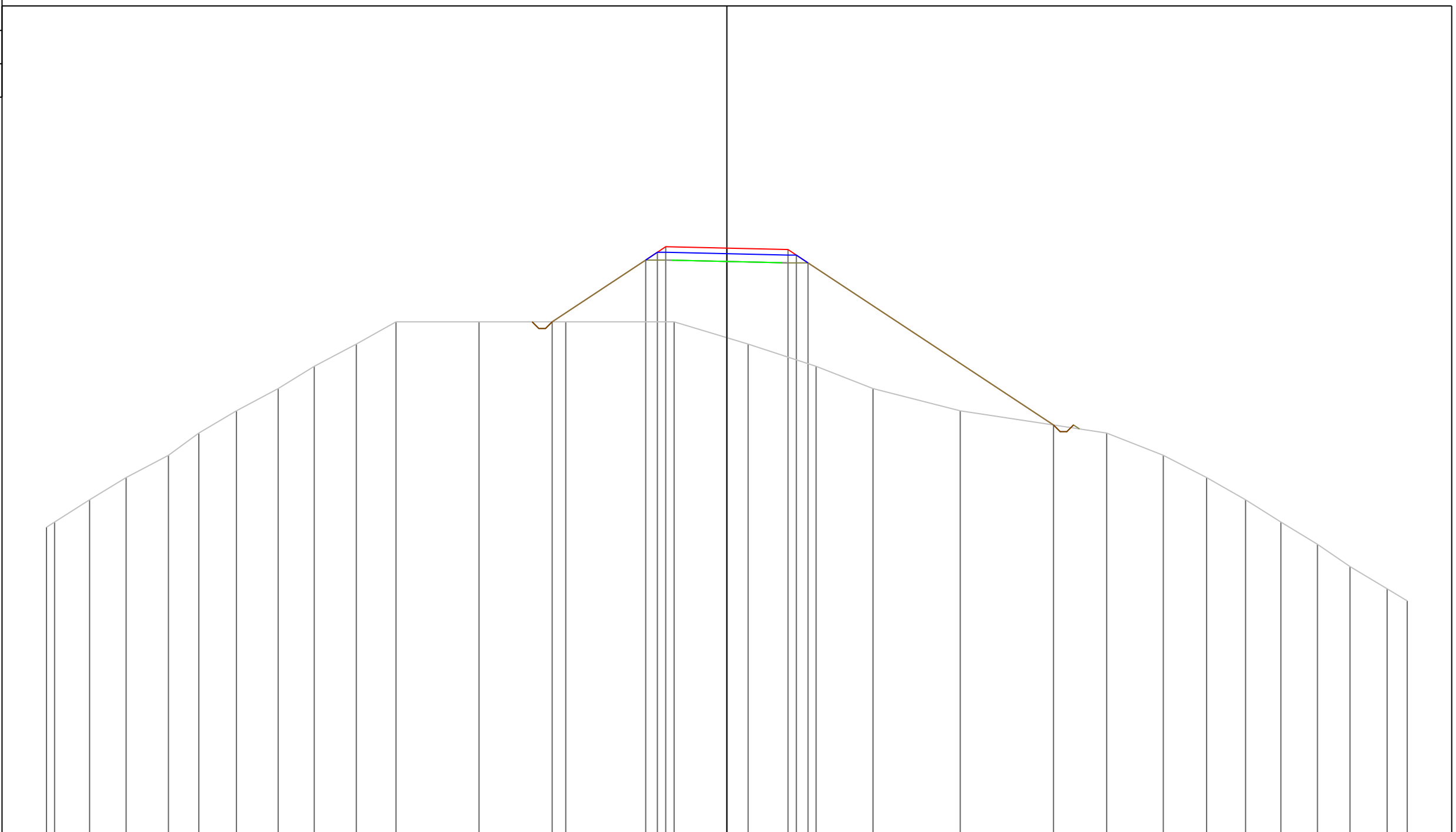

PROGRESSIVE TERRENO	-30.60	-30.24	-28.66	-27.02	-25.11	-23.75	-22.06	-20.18	-18.56	-16.67	-14.88	-11.15	-7.25	-2.37	0.96	4.01	6.57	10.50	17.08	19.63	21.58	23.33	24.92	26.56	28.02	29.70	30.60
PARZIALI TERRENO	0.36	1.58	1.64	1.91	1.36	1.69	1.88	1.62	1.89	1.79	3.73	3.90	4.88	3.33	3.05	2.56	3.93	6.58	2.55	1.95	1.75	1.59	1.64	1.46	1.68	0.90	
QUOTE TERRENO	178.77	179.00	180.00	181.00	182.00	183.00	184.00	185.00	186.00	187.00	188.00	188.00	188.00	188.00	187.00	186.00	185.00	184.00	183.00	182.00	181.00	180.00	179.00	178.00	177.00	176.00	175.46
PROGRESSIVE PROGETTO													-7.86		0.00					14.69							
PARZIALI PROGETTO													4.21	0.53	0.37	2.75	2.75	0.38	0.52	11.04							
QUOTE PROGETTO													188.00	190.78	191.13	191.38	191.31	191.25	191.00	190.65	183.36						

PROFILO Asse4

SEZIONE 195

PROGRESSIVA 1940.00

A STERRO m<sup>2</sup> 0.20  
B RIPORTO m<sup>2</sup> 54.55

162  
200 200

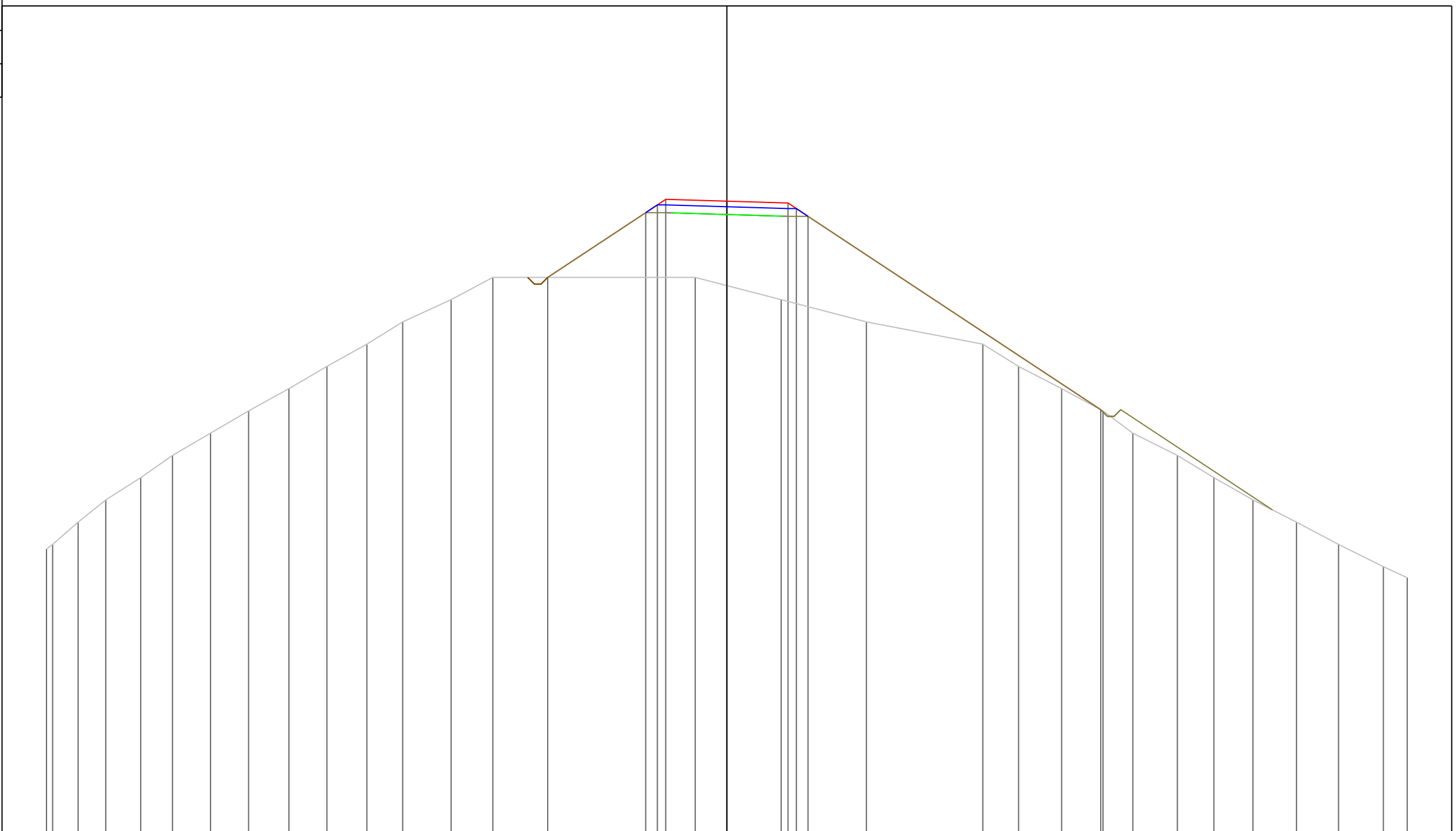

PROGRESSIVE TERRENO	174.79	175.00	176.00	177.00	178.00	179.00	180.00	181.00	182.00	183.00	184.00	185.00	186.00	187.00	187.00	186.00	185.00	184.00	183.00	182.00	181.00	180.00	179.00	178.00	177.00	176.00	175.00	174.00	173.50
PARZIALI TERRENO	0.28	1.14	1.25	1.57	1.43	1.71	1.71	1.81	1.71	1.80	1.61	2.18	1.87	9.11	3.86	3.83	5.24	1.61	1.94	1.86	1.34	2.00	1.65	1.75	1.96	1.89	2.02	1.07	
QUOTE TERRENO	174.79	175.00	176.00	177.00	178.00	179.00	180.00	181.00	182.00	183.00	184.00	185.00	186.00	187.00	187.00	186.00	185.00	184.00	183.00	182.00	181.00	180.00	179.00	178.00	177.00	176.00	175.00	174.00	173.50
PROGRESSIVE PROGETTO														-8.06							16.82								
PARZIALI PROGETTO														4.41	0.52	0.38	2.75	2.75	0.38	0.52	13.17								
QUOTE PROGETTO														187.00	189.91	190.26	190.51	190.43	190.34	190.09	189.74	181.05							

PROFILO Asse4

SEZIONE 196

PROGRESSIVA 1950.00

A STERRO m<sup>2</sup> 0.21  
B RIPORTO m<sup>2</sup> 38.59

160

200  
200

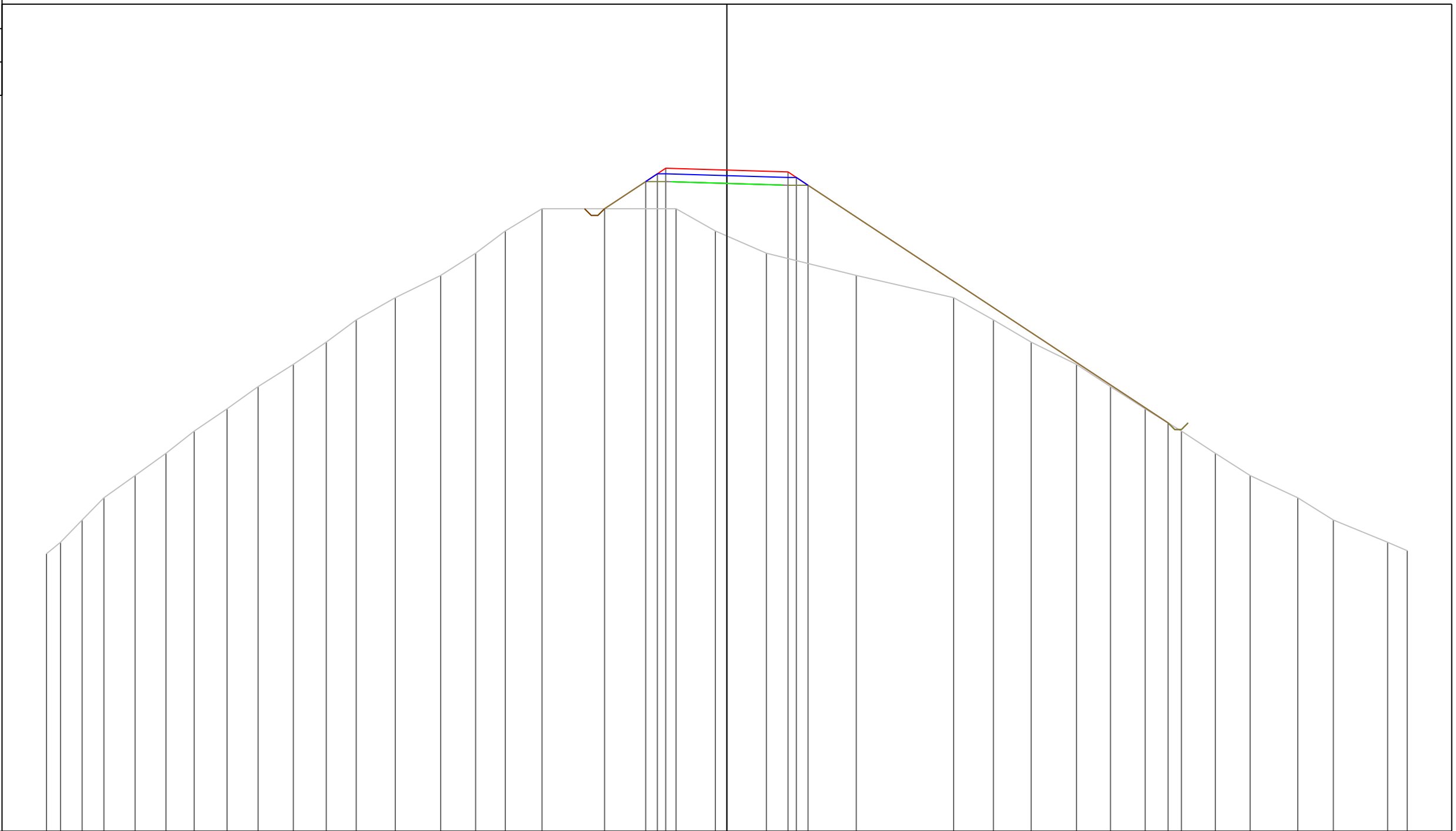

PROGRESSIVE TERRENO	-30.60	-29.97	-29.00	-28.02	-26.61	-25.23	-23.96	-22.48	-21.08	-19.50	-18.02	-16.67	-14.91	-12.87	-11.30	-9.97	-8.31	-2.28	-0.52	1.78	5.82	10.20	11.99	13.69	15.72	17.25	18.81	20.44	21.97	23.54	25.68	27.28	29.72	30.60	
PARZIALI TERRENO	0.63	0.97	0.98	1.41	1.38	1.27	1.48	1.40	1.58	1.48	1.35	1.76	2.04	1.57	1.33	1.66	6.03	1.76	2.30	4.04	4.38	1.79	1.70	2.03	1.53	1.56	1.63	1.53	1.57	2.14	1.60	2.44	0.88		
QUOTE TERRENO	172.48	173.00	174.00	175.00	176.00	177.00	178.00	179.00	180.00	181.00	182.00	183.00	184.00	185.00	186.00	187.00	188.00	188.00	187.00	186.00	185.00	184.00	183.00	182.00	181.00	180.00	179.00	178.00	177.00	176.00	175.00	174.00	173.00	172.62	
PROGRESSIVE PROGETTO														-5.50	-3.65	-3.13	-2.75	0.00	2.75	3.13	3.65							19.84							
PARZIALI PROGETTO														1.85	0.52	0.38	2.75	2.75	0.38	0.52	16.19														
QUOTE PROGETTO														188.00	189.22	189.57	189.82	189.74	189.66	189.41	189.06							178.37							

PROFILO Asse4

SEZIONE 197

PROGRESSIVA 1960.00

A STERRO m<sup>2</sup> 0.24  
B RIPOSTO m<sup>2</sup> 41.85

160  
200 200

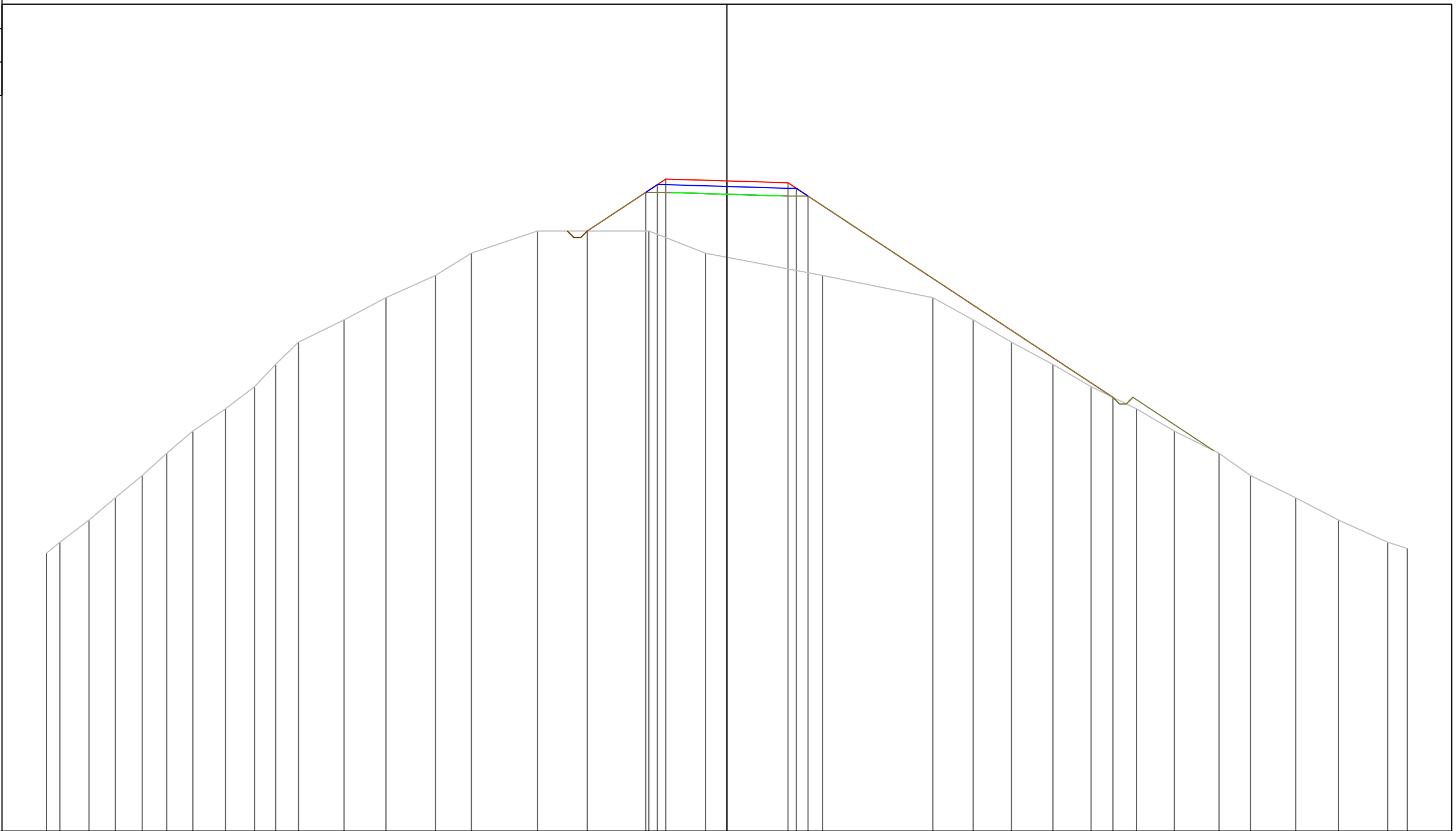

PROGRESSIVE TERRENO	-30.60	-30.00	-28.69	-27.51	-26.30	-25.19	-24.02	-22.55	-21.24	-20.29	-19.27	-17.22	-15.33	-13.11	-11.49	-8.51	-3.51	-0.96	4.30	9.26	11.08	12.80	14.66	16.38	18.42	20.12	22.14	23.55	25.58	27.50	29.72	30.60
PARZIALI TERRENO	0.60	1.31	1.18	1.21	1.11	1.17	1.47	1.31	0.95	1.02	2.05	1.89	2.22	1.62	2.98	5.00	2.55	5.26	4.96	1.82	1.72	1.86	1.72	2.04	1.70	2.02	1.41	2.03	1.92	2.22	0.88	
QUOTE TERRENO	172.51	173.00	174.00	175.00	176.00	177.00	178.00	179.00	180.00	181.00	182.00	183.00	184.00	185.00	186.00	187.00	187.00	186.00	185.00	184.00	183.00	182.00	181.00	180.00	179.00	178.00	177.00	176.00	175.00	174.00	173.00	172.72
PROGRESSIVE PROGETTO																-6.28	-3.65	-3.13	-2.75	0.00	2.75	3.13	3.65			17.36						
PARZIALI PROGETTO																2.63	0.52	0.38	2.75	2.75	0.38	0.52	13.71									
QUOTE PROGETTO																187.00	188.73	189.08	189.33	189.25	189.17	188.92	188.57			179.52						

PROFILO Asse4

SEZIONE 198

PROGRESSIVA 1970.00

A STERRO m<sup>2</sup> 0.31  
B RIPORTO m<sup>2</sup> 45.73

162

200  
200

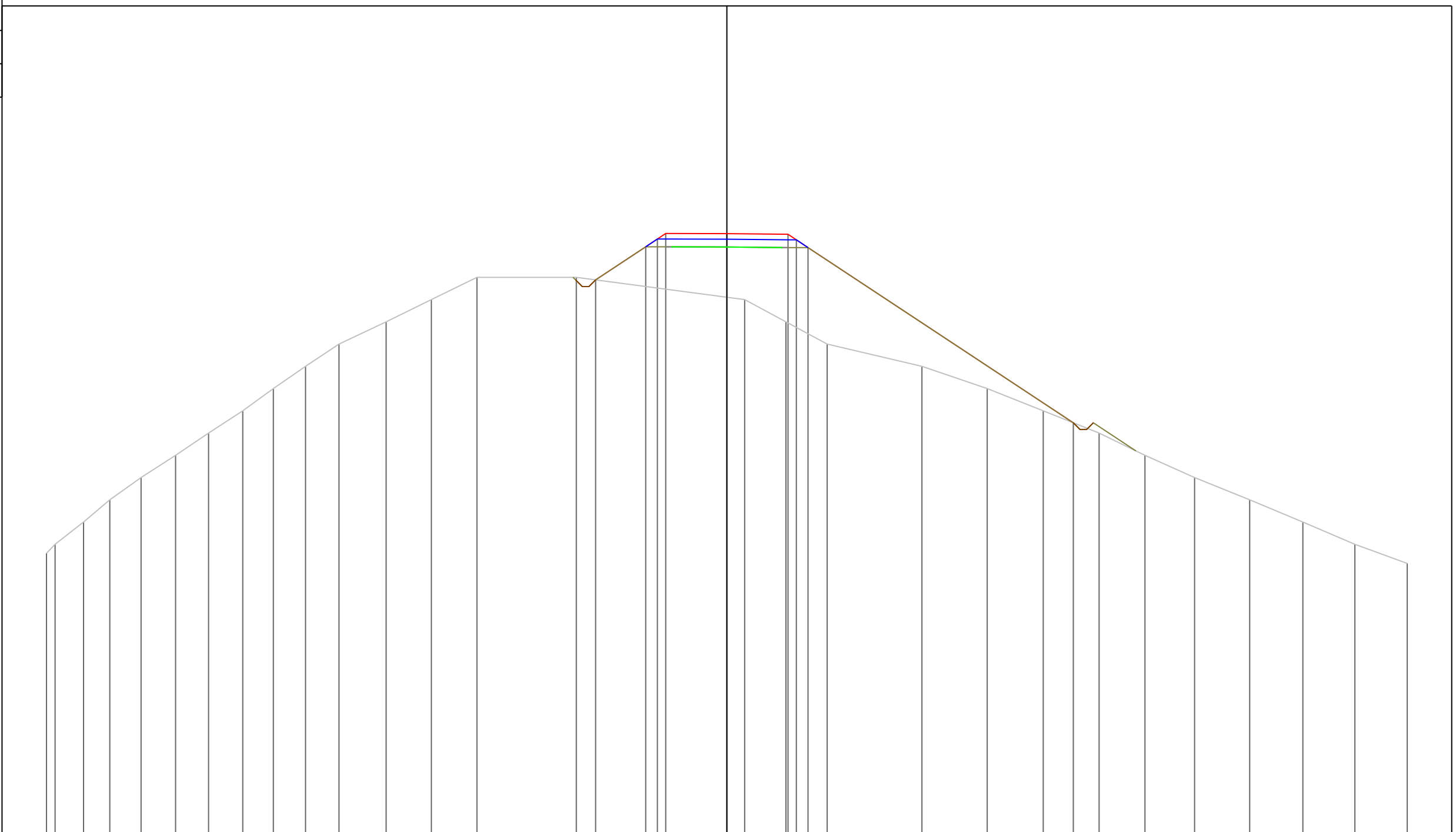

PROGRESSIVE TERRENO	-30.60	-30.21	-28.93	-27.75	-26.35	-24.79	-23.31	-21.77	-20.40	-18.95	-17.44	-15.32	-13.29	-11.24	-6.77	0.80	2.66	4.51	8.77	11.71	14.23	16.74	18.80	21.04	23.51	25.91	28.25	30.60
PARZIALI TERRENO	0.39	1.28	1.18	1.40	1.56	1.48	1.54	1.37	1.45	1.51	2.12	2.03	2.05	4.47	7.57	1.86	1.85	4.26	2.94	2.52	2.51	2.06	2.24	2.47	2.40	2.34	2.35	
QUOTE TERRENO	174.60	175.00	176.00	177.00	178.00	179.00	180.00	181.00	182.00	183.00	184.00	185.00	186.00	187.00	187.00	186.00	185.00	184.00	183.00	182.00	181.00	180.00	179.00	178.00	177.00	176.00	175.00	174.14
PROGRESSIVE PROGETTO															-5.90	0.00	2.75	3.12	3.65			15.58						
PARZIALI PROGETTO															2.25	0.53	0.37	2.75	2.75	0.37	0.53	11.93						
QUOTE PROGETTO															186.89	188.37	188.72	188.97	188.96	188.94	188.69	188.34	180.46					

PROFILO Asse4

SEZIONE 199

PROGRESSIVA 1980.00

A STERRO m<sup>2</sup> 0.18  
B RIPORTO m<sup>2</sup> 22.50

164

200  
200

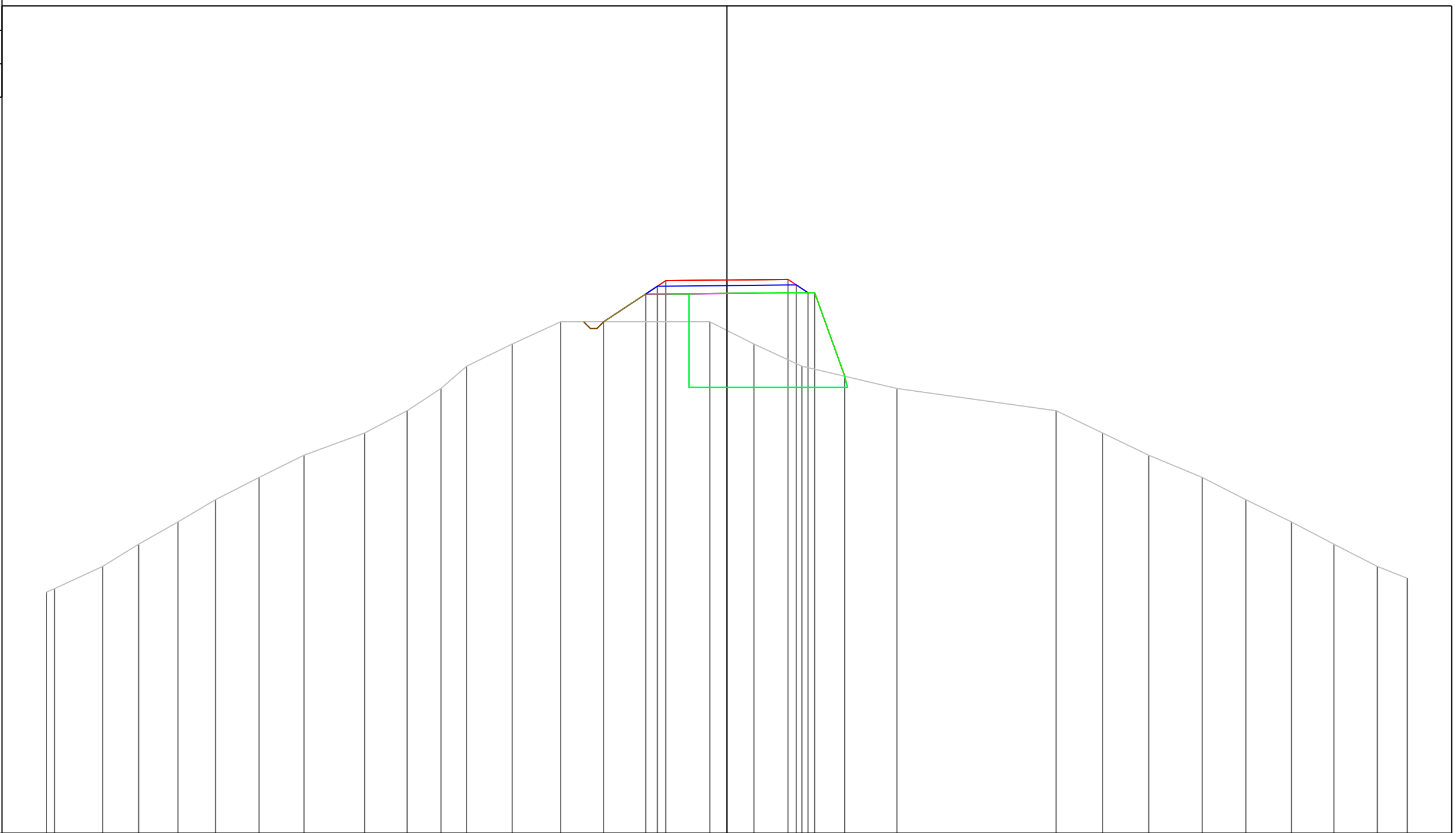

PROGRESSIVE TERRENO	-30.60	-30.24	-28.08	-26.45	-24.69	-23.00	-21.04	-19.02	-16.29	-14.38	-12.86	-11.71	-9.65	-7.47	-0.77	1.22	3.38	7.65	14.81	16.90	18.97	21.38	23.34	25.39	27.30	29.25	30.60
PARZIALI TERRENO	0.36	2.16	1.63	1.76	1.69	1.96	2.02	2.73	1.91	1.52	1.15	2.06	2.18	6.70	1.99	2.16	4.27	7.16	2.09	2.07	2.41	1.96	2.05	1.91	1.95	1.35	
QUOTE TERRENO	174.84	175.00	176.00	177.00	178.00	179.00	180.00	181.00	182.00	183.00	184.00	185.00	186.00	187.00	187.00	186.00	185.00	184.00	183.00	182.00	181.00	180.00	179.00	178.00	177.00	176.00	175.47
PROGRESSIVE PROGETTO														-5.54	0.00	2.75	3.13	3.65	5.30								
PARZIALI PROGETTO														1.89	0.53	0.37	2.75	2.75	0.38	0.52	0.30	1.35					
QUOTE PROGETTO														187.00	188.25	188.60	188.85	188.88	188.91	188.66	188.31	188.31	184.55				





PROFILO Asse4

SEZIONE 201

PROGRESSIVA 2000.00

A STERRO m<sup>2</sup> 2.28  
B RIPORTO m<sup>2</sup> 4.75

167

200  
200

PROGRESSIVE TERRENO	-30.60	-30.42	-28.75	-27.52	-25.92	-24.44	-21.61	-20.31	-19.55	-18.87	-18.16	-17.12	-15.45	-14.60	-14.00	-13.30	-10.68	-9.57	-8.19	-7.05	-5.45	-4.16	-2.64	0.40	5.32	8.67	10.88	24.94	30.60			
PARZIALI TERRENO	0.18	1.67	1.23	1.60	1.48	2.83	1.30	0.76	0.68	0.71	1.04	1.67	0.85	0.60	0.70	2.62	1.11	1.38	1.14	1.60	1.29	1.52	3.04	4.92	3.35	2.21	14.06	5.66				
QUOTE TERRENO	166.93	167.00	168.00	169.00	170.00	171.00	172.00	173.00	174.00	175.00	176.00	177.00	178.00	179.00	180.00	181.00	182.00	183.00	184.00	185.00	186.00	187.00	188.00	189.00	190.00	191.00	192.00	192.00	192.00	191.14		
PROGRESSIVE PROGETTO																						-4.71	-3.95	-3.65	-3.13	-2.75	0.00	2.75	3.12	3.42	3.72	4.20
PARZIALI PROGETTO																						0.76	0.30	0.52	0.38	2.75	2.75	0.37	0.30	0.30	0.30	0.48
QUOTE PROGETTO																						186.57	188.60	188.60	188.95	189.20	189.28	189.36	189.06	189.06	189.36	189.77

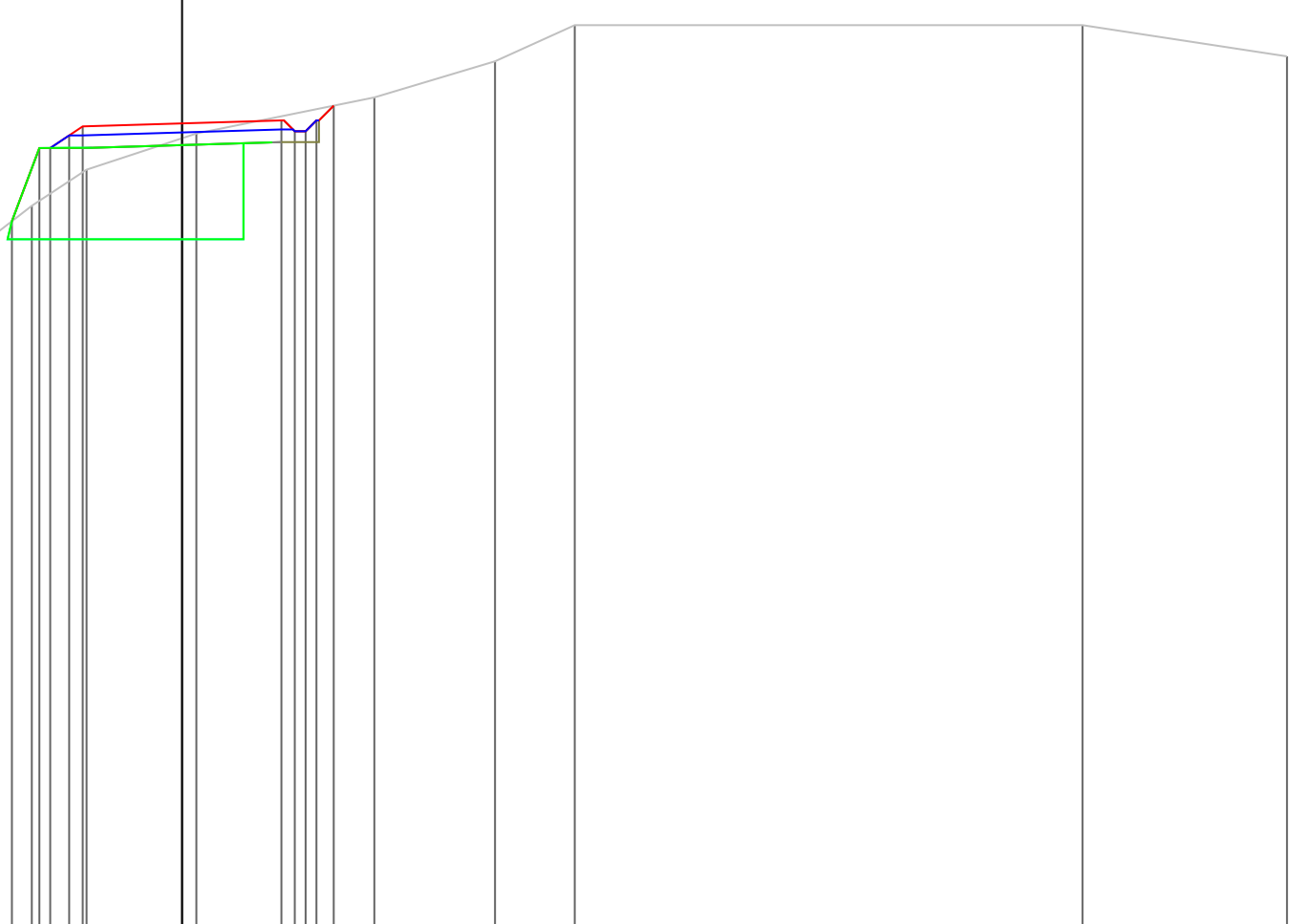



PROFILO Asse4

SEZIONE 203

PROGRESSIVA 2020.00

A STERRO m<sup>2</sup> 8.55  
B RIPORTO m<sup>2</sup> 10.15

177

200  
200

PROGRESSIVE  
TERRENO

-16.73 -14.79 -13.58 -12.43 -11.36 -9.85 -8.87 -7.75 -6.14 -4.70 -3.47 -2.25 -1.26 -0.49 0.34 2.73 6.97 8.13 9.29 10.47 11.41 12.38 13.43 14.44 15.64 17.02 18.02 18.73 19.89 21.21 22.54 24.58 25.90 27.21 29.88 30.60

PARZIALI  
TERRENO

1.94 1.21 1.15 1.07 1.51 0.98 1.12 1.61 1.44 1.23 1.22 0.99 0.77 0.83 2.39 4.24 1.16 1.16 1.18 0.94 0.97 1.05 1.01 1.20 1.38 1.00 0.71 1.16 1.32 1.33 2.04 1.32 1.31 2.67 0.72

QUOTE  
TERRENO

177.00 178.00 179.00 180.00 181.00 182.00 183.00 184.00 185.00 186.00 187.00 188.00 189.00 190.00 191.00 192.00 193.00 194.00 195.00 196.00 197.00 198.00 199.00 200.00 201.00 202.00 203.00 204.00 205.00 206.00 207.00 208.00 209.00 210.00 211.00 211.28

PROGRESSIVE  
PROGETTO

-5.61 -3.95 -3.65 -3.13 -2.75 0.00 2.75 3.12 3.42 3.72 6.02

PARZIALI  
PROGETTO

1.66 0.30 0.52 0.38 2.75 2.75 0.37 0.30 0.30 2.30

QUOTE  
PROGETTO

185.37 189.78 189.78 190.13 190.38 190.46 190.55 190.25 190.55 192.78

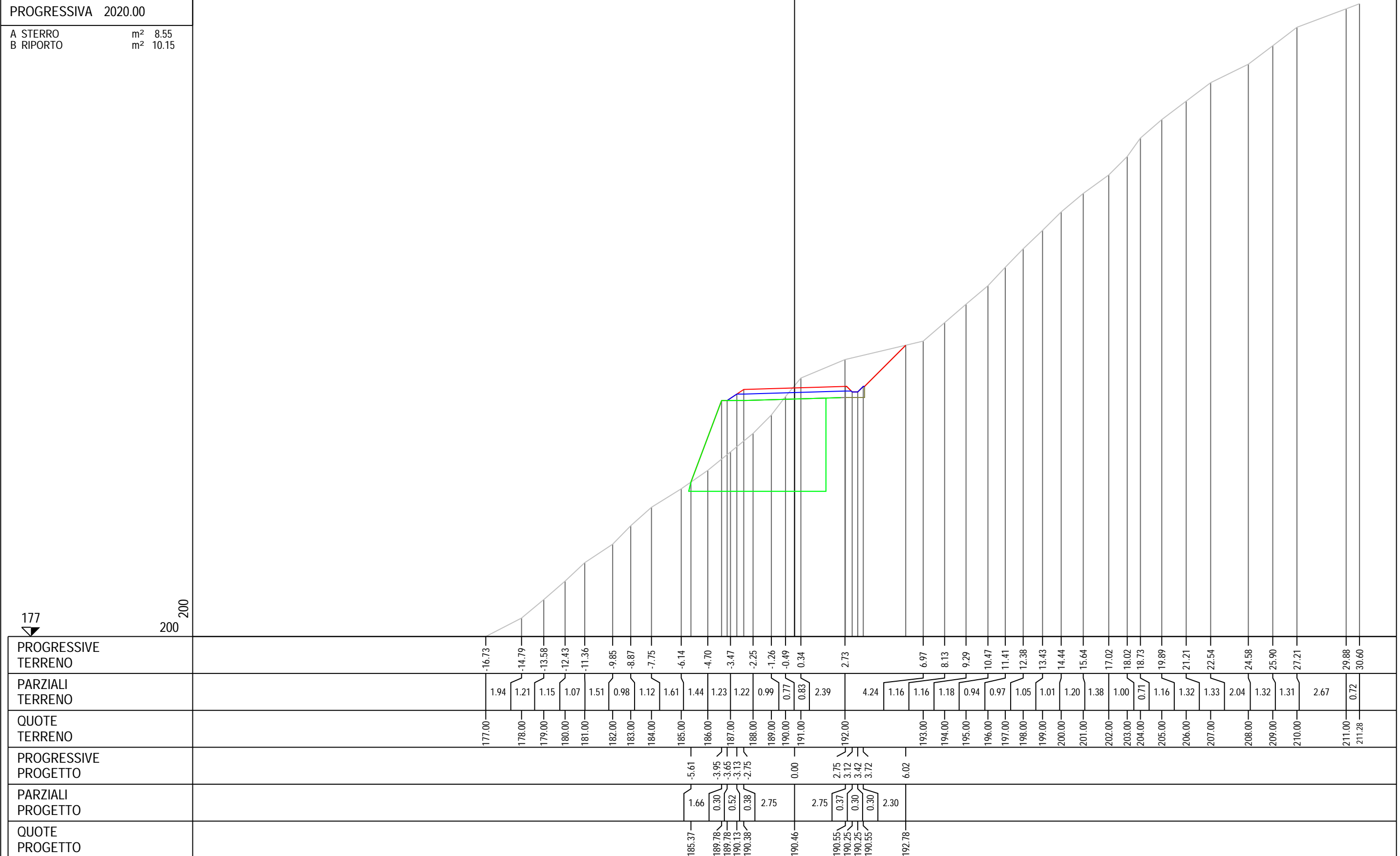



PROFILO Asse4

SEZIONE 205

PROGRESSIVA 2040.00

A STERRO m<sup>2</sup> 17.54  
B RIPORTO m<sup>2</sup> 3.89

180

200 200

PROGRESSIVE  
TERRENO

-16.78 -15.32 -13.83 -12.31 -11.10 -9.60 -8.16 -6.77 -5.38 -4.21 -3.34 -2.24 -1.05 0.04 1.47 5.62 7.10 8.19 9.74 10.94 11.95 13.25 14.56 15.74 17.39 18.63 19.96 21.26 22.51 23.62 24.72 25.38 26.01 26.73 27.61 28.79 30.30 30.60

PARZIALI  
TERRENO

1.46 1.49 1.52 1.21 1.50 1.44 1.39 1.39 1.17 0.87 1.10 1.19 1.09 1.43 4.15 1.48 1.09 1.55 1.20 1.01 1.30 1.31 1.18 1.65 1.24 1.33 1.30 1.25 1.11 1.10 0.66 0.63 0.72 0.88 1.18 1.51 0.30

QUOTE  
TERRENO

180.00 181.00 182.00 183.00 184.00 185.00 186.00 187.00 188.00 189.00 190.00 191.00 192.00 193.00 194.00 195.00 196.00 197.00 198.00 199.00 200.00 201.00 202.00 203.00 204.00 205.00 206.00 207.00 208.00 209.00 210.00 211.00 212.00 213.00 214.00 215.00 216.00 216.27

PROGRESSIVE  
PROGETTO

-5.06 -3.95 -3.65 -3.13 -2.75 0.00 2.75 2.75 3.12 3.42 3.72 10.11

PARZIALI  
PROGETTO

1.11 0.30 0.52 0.38 2.75 2.75 0.37 0.30 0.30 6.39 0.30

QUOTE  
PROGETTO

188.27 191.23 191.23 191.58 191.83 191.91 191.99 191.69 191.99 198.31

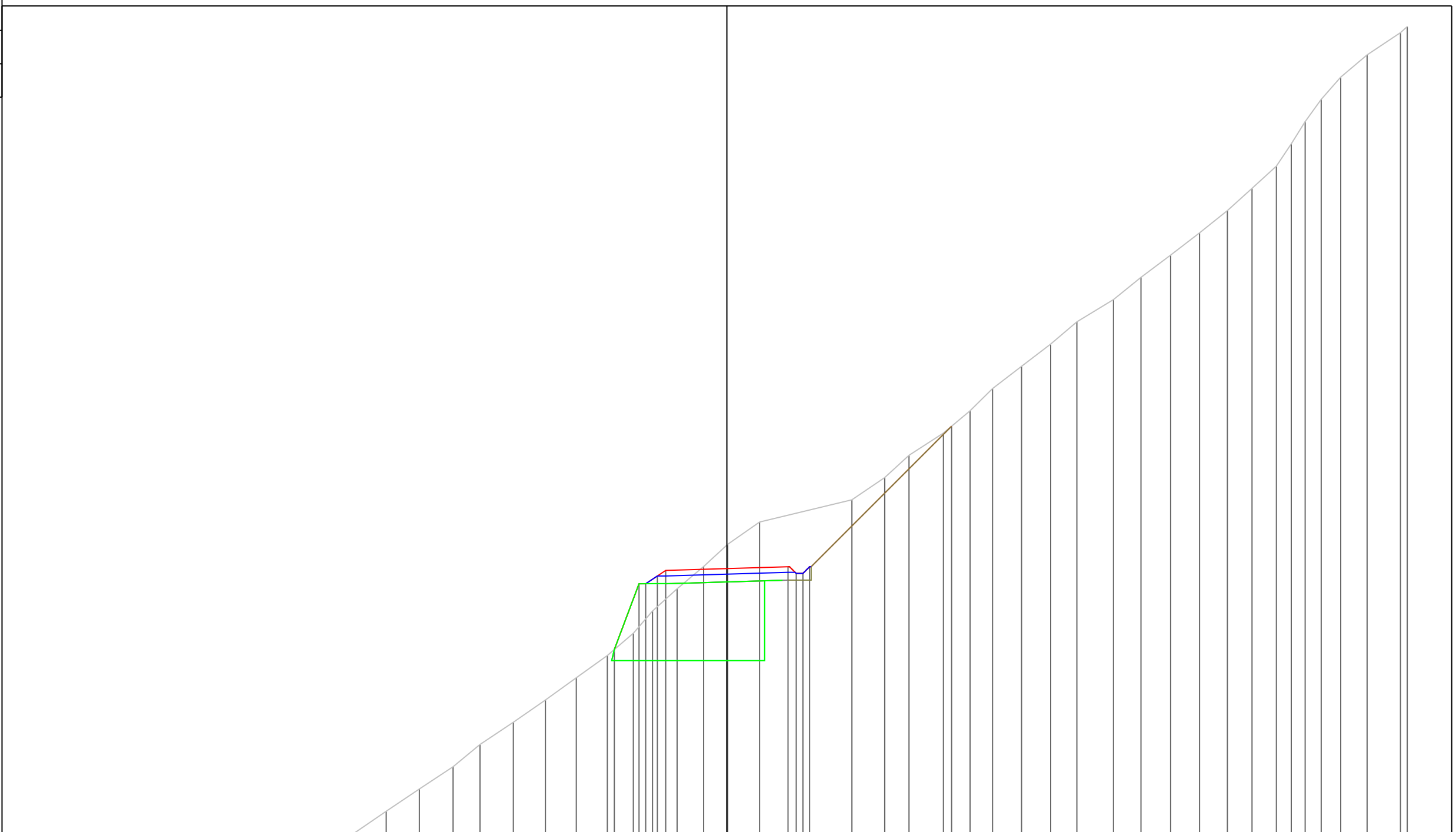











PROFILO Asse4

SEZIONE 210

PROGRESSIVA 2090.00

A STERRO m² 1.84  
B RIPORTO m² 13.09

175

200  
200

PROGRESSIVE  
TERRENO

-23.58 -22.48 -21.70 -20.98 -20.05 -18.92 -18.08 -17.19 -15.66 -14.45 -12.59 -11.34 -9.76 -8.50 -7.22 -5.81 -4.64 -3.49 -2.31 -0.91 0.63 4.55 5.85 6.91 8.21 9.47 10.77 11.73 12.34 13.06 13.63 14.19 15.10 15.86 16.75 17.69 18.34 19.06 19.34

PARZIALI  
TERRENO

1.10 0.78 0.72 0.93 1.13 0.84 0.89 1.53 1.21 1.86 1.25 1.58 1.26 1.28 1.41 1.17 1.15 1.18 1.40 1.54 3.92 1.30 1.06 1.30 1.26 1.30 0.96 0.61 0.72 0.57 0.56 0.91 0.76 0.89 0.94 0.65 0.72 0.28

QUOTE  
TERRENO

175.00 176.00 177.00 178.00 179.00 180.00 181.00 182.00 183.00 184.00 185.00 186.00 187.00 188.00 189.00 190.00 191.00 192.00 193.00 194.00 195.00 196.00 197.00 198.00 199.00 200.00 201.00 202.00 203.00 204.00 205.00 206.00 207.00 208.00 209.00 210.00 211.00 212.00

PROGRESSIVE  
PROGETTO

-5.84 -3.95 -3.65 -3.13 -2.75 0.00 2.75 3.12 3.42 3.72 4.29

PARZIALI  
PROGETTO

1.89 0.30 0.52 0.38 2.75 2.75 0.37 0.30 0.30 0.30 0.57

QUOTE  
PROGETTO

189.98 195.00 195.35 195.60 195.52 195.43 195.13 195.13 195.43 195.93



























PROFILO Asse4

SEZIONE 223

PROGRESSIVA 2220.00

A STERRO m<sup>2</sup> 0.39  
B RIPORTO m<sup>2</sup> 20.17

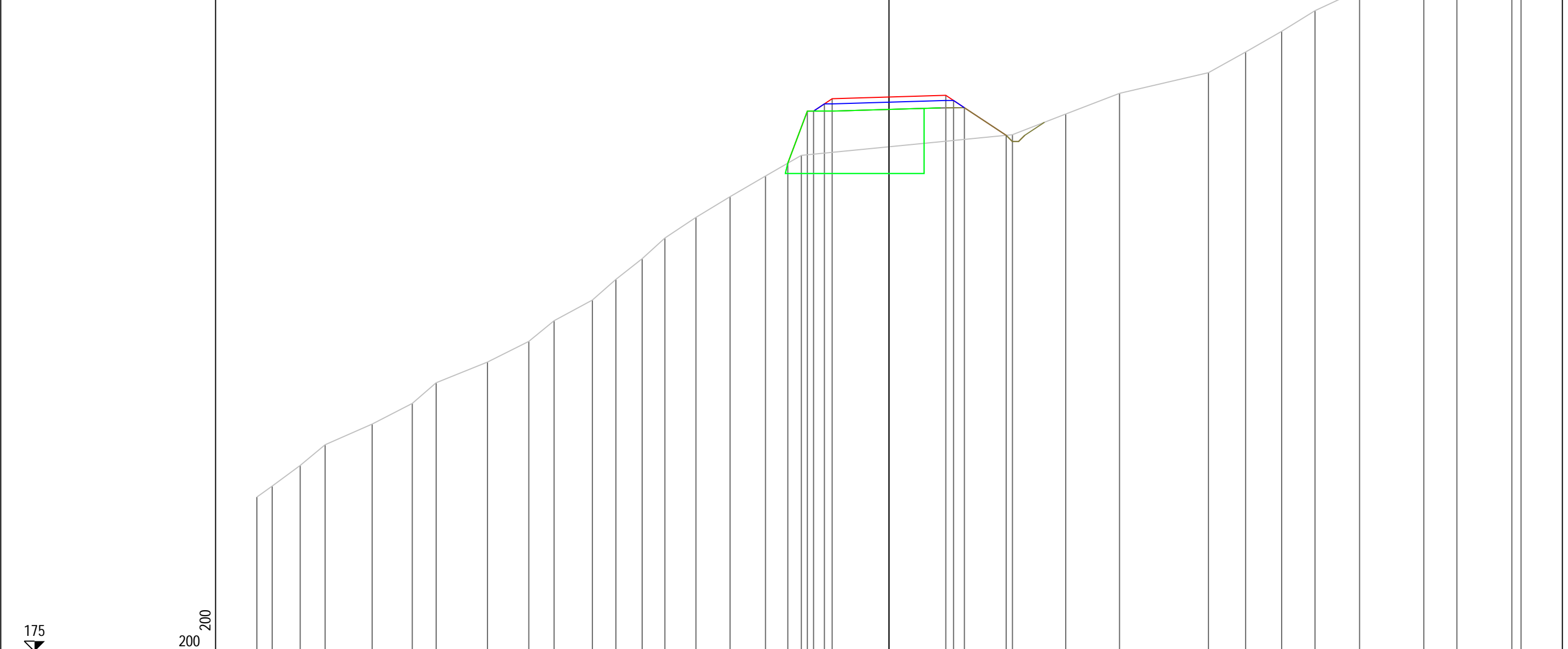

PROGRESSIVE TERRENO	182.47	183.00	184.00	185.00	186.00	187.00	188.00	189.00	190.00	191.00	192.00	193.00	194.00	195.00	196.00	197.00	198.00	199.00	200.00	201.00	202.00	203.00	204.00	205.00	206.00	207.00	208.00	209.00	210.00	210.27
PARZIALI TERRENO		0.74	1.36	1.20	2.28	1.94	1.16	2.48	2.00	1.23	1.85	1.14	1.27	1.10	1.51	1.65	1.71	1.74	10.22	2.58	2.60	4.31	1.80	1.74	1.62	2.15	3.11	1.60	2.66	0.45
QUOTE TERRENO	182.47	183.00	184.00	185.00	186.00	187.00	188.00	189.00	190.00	191.00	192.00	193.00	194.00	195.00	196.00	197.00	198.00	199.00	200.00	201.00	202.00	203.00	204.00	205.00	206.00	207.00	208.00	209.00	210.00	210.27
PROGRESSIVE PROGETTO																			198.62	201.14	201.14	201.49	201.74							
PARZIALI PROGETTO																		0.95	0.30	0.52	0.38	2.75	2.75	0.38	0.52	2.02				
QUOTE PROGETTO																		198.62	201.14	201.14	201.49	201.74								











PROFILO Asse4

SEZIONE 228

PROGRESSIVA 2270.00

B RIPORTO m² 23.47

180

200 200

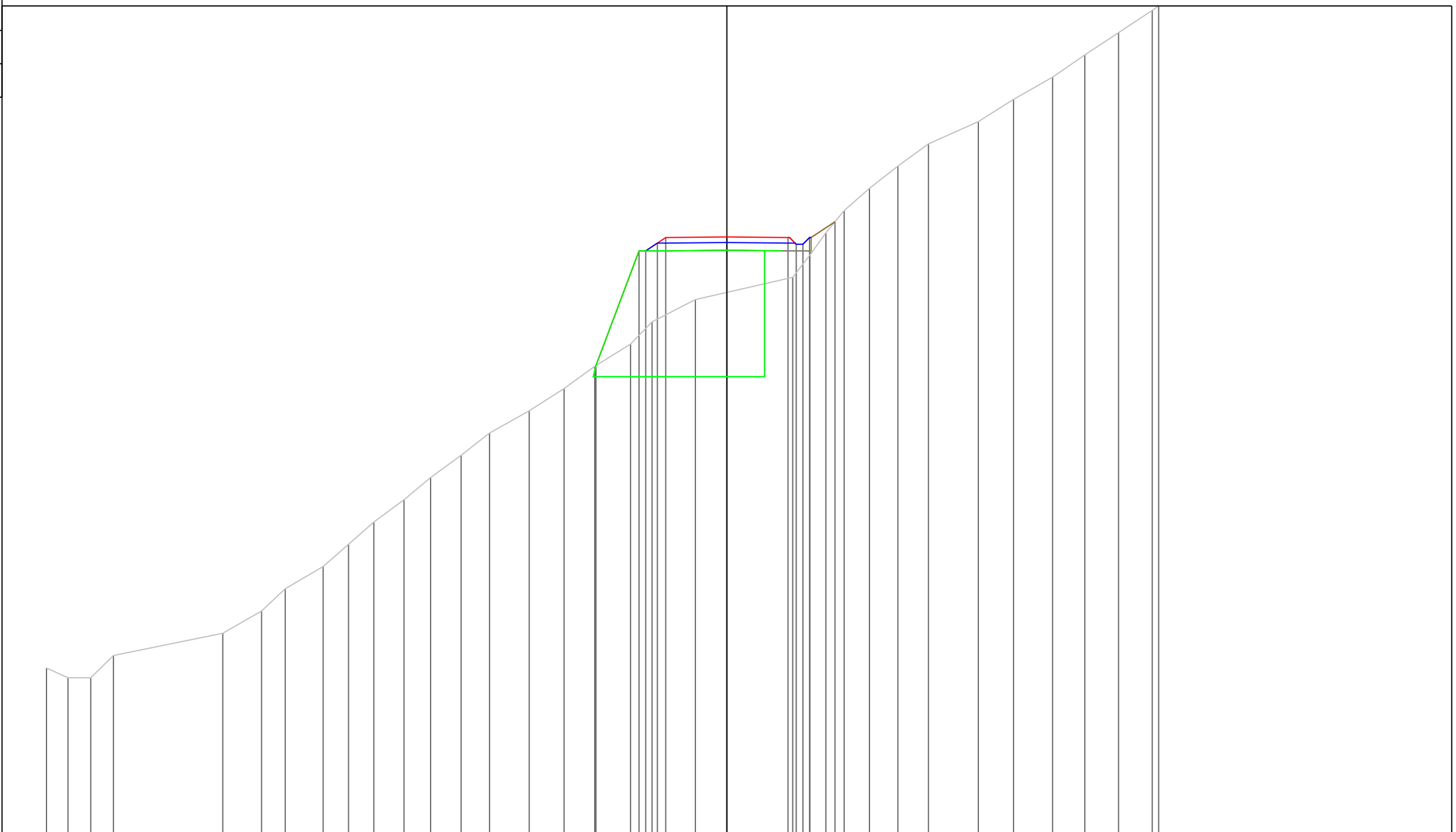

PROGRESSIVE TERRENO	-30.60	-29.63	-28.61	-27.59		-22.67	-20.93	-19.86	-18.16	-17.02	-15.88	-14.52	-13.32	-11.95	-10.67	-8.89	-7.32	-5.94	-4.33	-3.36	-1.42		2.96	3.73	4.45	5.27	6.41	7.69	9.07	11.31	12.89	14.65	16.10	17.62	19.13	19.42
PARZIALI TERRENO	0.97	1.02	1.02	4.92	1.74	1.07	1.70	1.14	1.14	1.36	1.20	1.37	1.28	1.78	1.57	1.38	1.61	0.97	1.94	4.38	0.77	0.72	0.82	1.14	1.28	1.38	2.24	1.58	1.76	1.45	1.52	1.51	0.29			
QUOTE TERRENO	187.44	187.00	187.00	188.00	189.00	190.00	191.00	192.00	193.00	194.00	195.00	196.00	197.00	198.00	199.00	200.00	201.00	202.00	203.00	204.00	205.00	206.00	207.00	208.00	209.00	210.00	211.00	212.00	213.00	214.00	215.00	216.00	217.00	217.20		
PROGRESSIVE PROGETTO																		-5.89	-3.95	-3.65	-3.12	-2.75	0.00	2.75	3.12	3.42	3.72	4.86								
PARZIALI PROGETTO																		1.94	0.30	0.53	0.37	2.75	2.75	0.37	0.30	0.30	1.14									
QUOTE PROGETTO																		201.03	206.19	206.19	206.54	206.79	206.82	206.79	206.49	206.49	206.79	207.50								

PROFILO Asse4

SEZIONE 229

PROGRESSIVA 2280.00

A STERRO m<sup>2</sup> 0.87  
B RIPORTO m<sup>2</sup> 17.54

182

200  
200

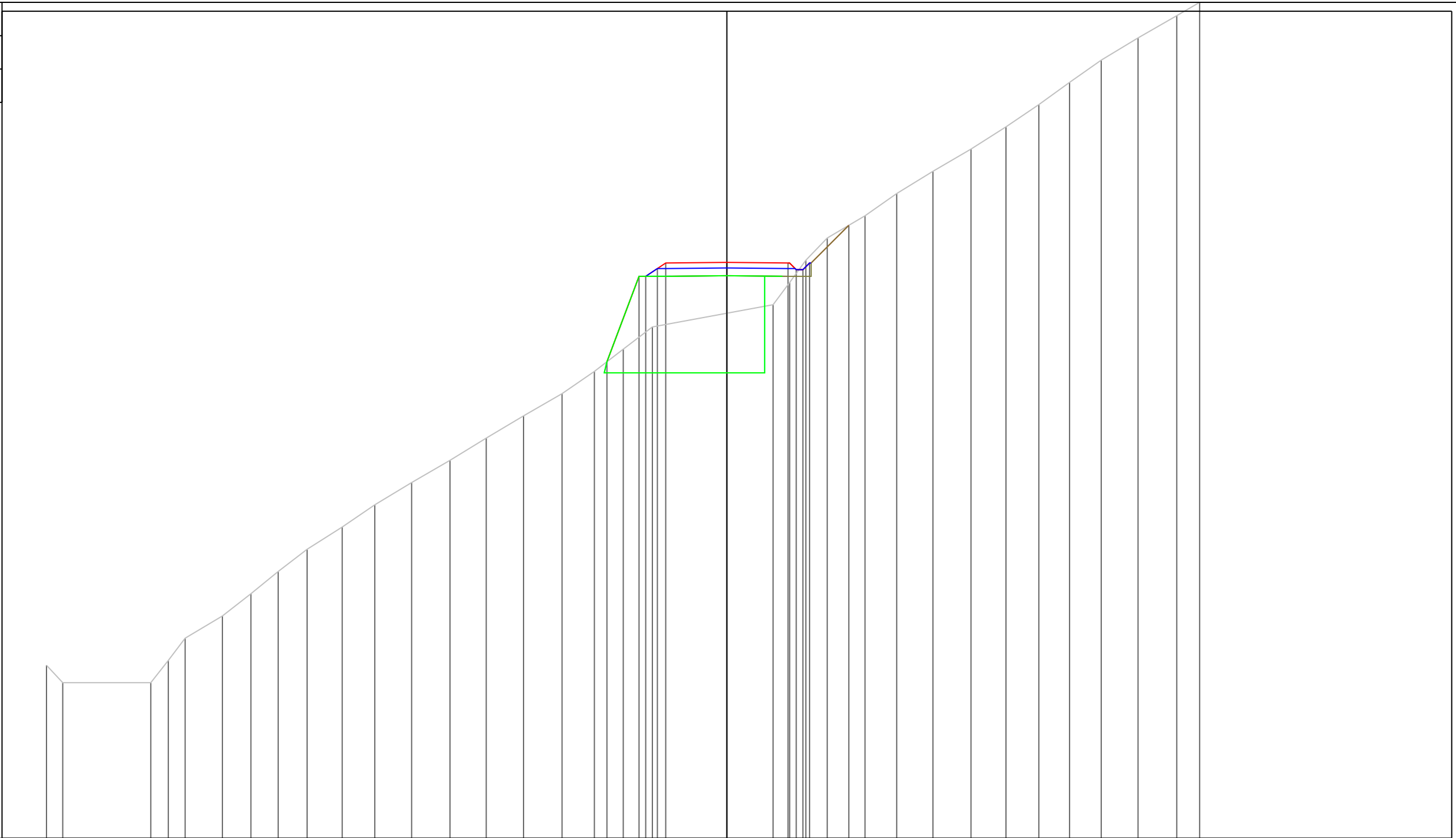

PROGRESSIVE TERRENO	-30.60	-29.87		-25.91	-25.12	-24.36	-22.69	-21.41	-20.18	-18.88	-17.30	-15.83	-14.18	-12.45	-10.82	-9.14	-7.41	-5.96	-4.66	-3.35		2.08	2.82	3.55	4.51	6.21	7.64	9.27	10.98	12.55	14.03	15.41	16.84	18.49	20.23	21.26	
PARZIALI TERRENO	0.73	3.96		0.79	0.76	1.67	1.28	1.23	1.30	1.58	1.47	1.65	1.73	1.63	1.68	1.73	1.45	1.30	1.31	5.43		0.74	0.73	0.96	1.70	1.43	1.63	1.71	1.57	1.48	1.38	1.43	1.65	1.74	1.03		
QUOTE TERRENO	189.78	189.00		189.00	190.00	191.00	192.00	193.00	194.00	195.00	196.00	197.00	198.00	199.00	200.00	201.00	202.00	203.00	204.00	205.00		206.00	207.00	208.00	209.00	210.00	211.00	212.00	213.00	214.00	215.00	216.00	217.00	218.00	219.00	219.60	
PROGRESSIVE PROGETTO																		-5.39	-3.95	-3.65	-3.12	-2.75		0.00		2.75	3.12	3.42	3.72	5.49							
PARZIALI PROGETTO																		1.44	0.30	0.53	0.37	2.75		2.75	0.37	0.30	0.30	1.77									
QUOTE PROGETTO																		203.43	207.28	207.28	207.63	207.88		207.90		207.88	207.58	207.58	207.88	209.57							







PROFILO Asse4

SEZIONE 232

PROGRESSIVA 2310.00

A STERRO m<sup>2</sup> 0.53  
 B RIPORTO m<sup>2</sup> 24.13

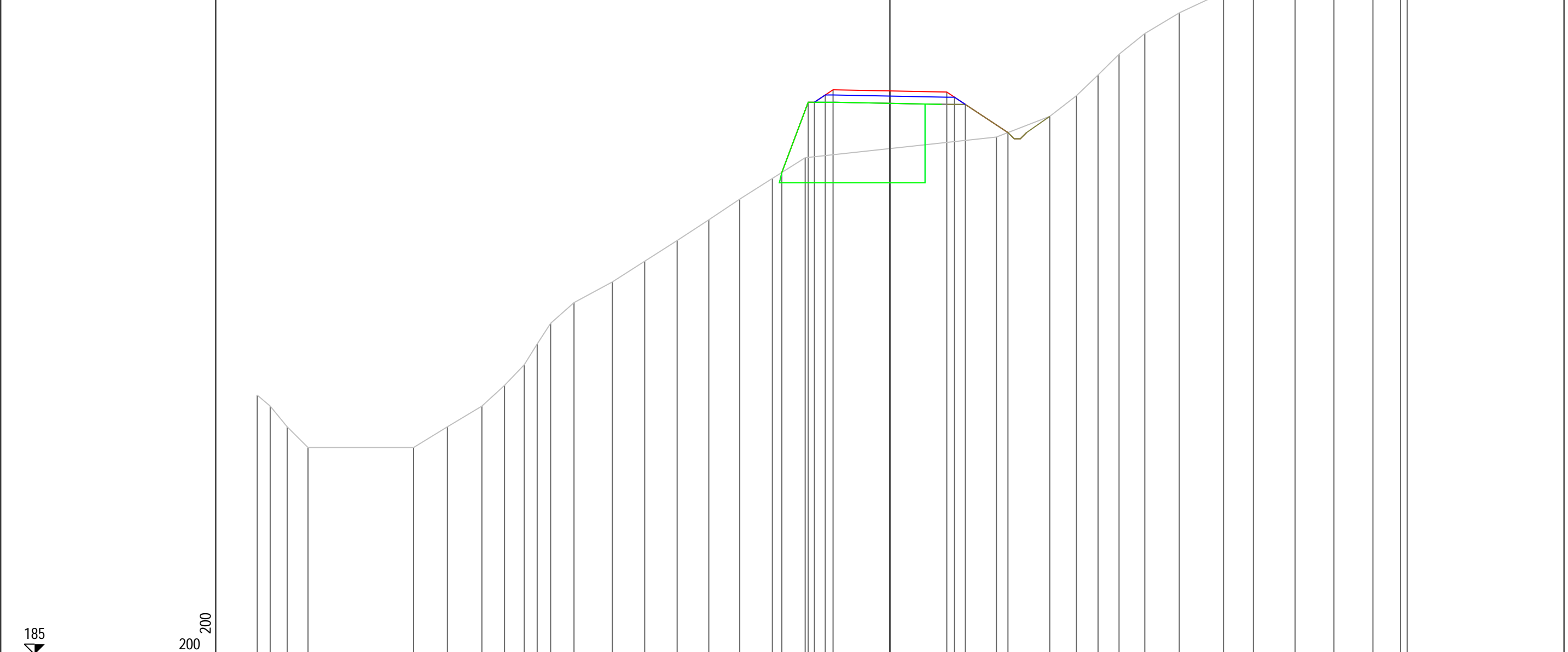

PROGRESSIVE TERRENO	-30.60	-29.97	-29.15	-28.14	-23.03	-21.40	-19.73	-18.64	-17.68	-17.06	-16.41	-15.28	-13.42	-11.86	-10.29	-8.76	-7.26	-5.69	-4.10	5.15	7.73	9.02	10.07	11.08	12.33	13.99	16.13	17.58	19.60	21.47	23.36	24.69	25.01
PARZIALI TERRENO	0.63	0.82	1.01	5.11	1.63	1.67	1.09	0.96	0.62	0.65	1.13	1.86	1.56	1.57	1.53	1.50	1.57	1.59	9.25	2.58	1.29	1.05	1.01	1.25	1.66	2.14	1.45	2.02	1.87	1.89	1.33	0.32	
QUOTE TERRENO	197.53	197.00	196.00	195.00	195.00	196.00	197.00	198.00	199.00	200.00	201.00	202.00	203.00	204.00	205.00	206.00	207.00	208.00	209.00	210.00	211.00	212.00	213.00	214.00	215.00	216.00	217.00	218.00	219.00	220.00	221.00	222.00	222.20
PROGRESSIVE PROGETTO																		-5.23	-3.95	-3.65	-3.12	-2.75	0.00	2.75	3.13	3.65	5.71						
PARZIALI PROGETTO																		1.28	0.30	0.53	0.37	2.75	2.75	0.38	0.52	2.06							
QUOTE PROGETTO																		208.29	211.68	211.68	212.03	212.28	212.23	212.17	211.92	211.57	210.22						

PROFILO Asse4

SEZIONE 233

PROGRESSIVA 2320.00

A STERRO m<sup>2</sup> 0.28  
 B RIPORTO m<sup>2</sup> 39.47

185

200  
200

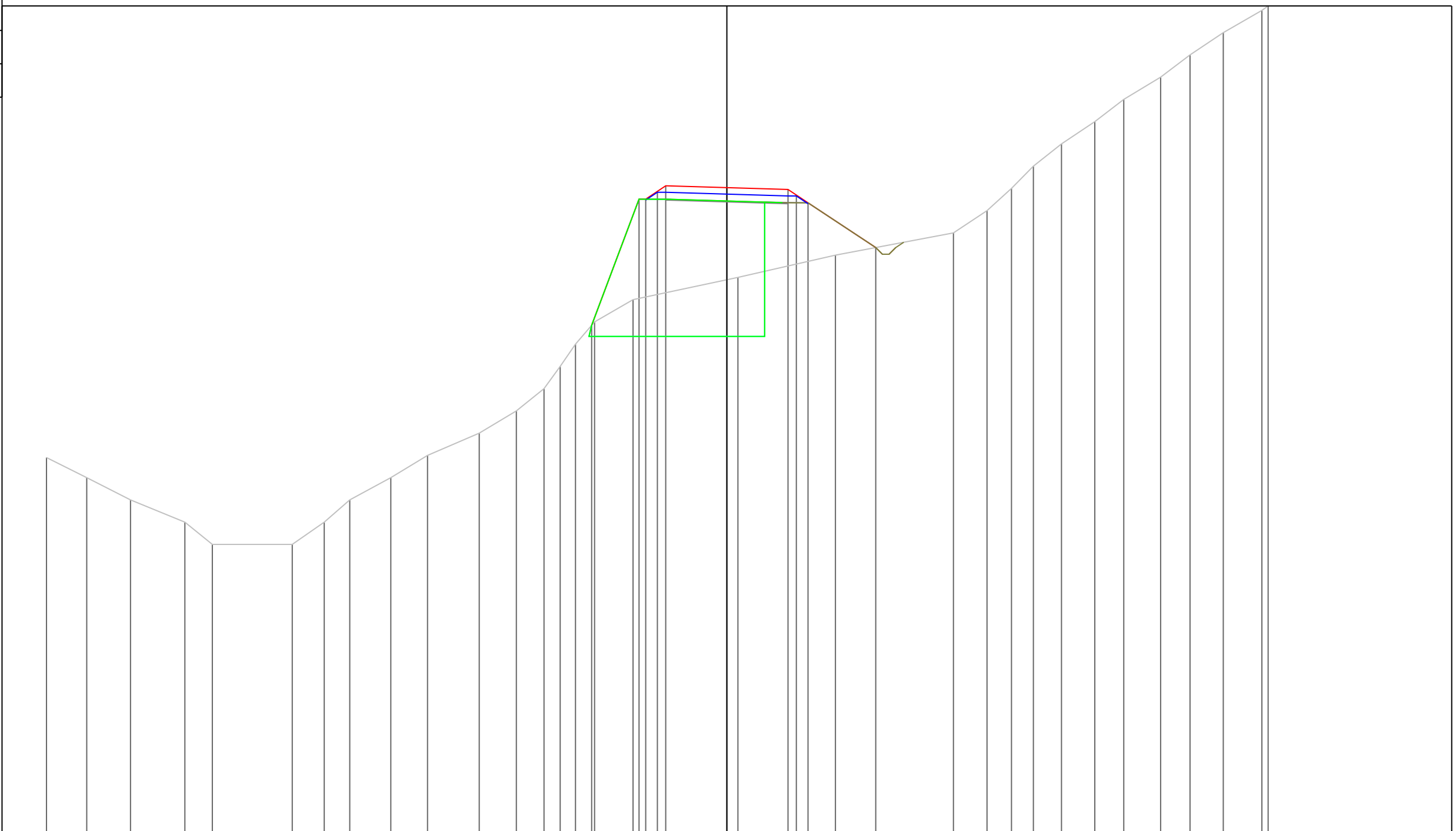

PROGRESSIVE TERRENO	-30.60	-28.79	-26.82	-24.38	-23.14	-19.55	-18.11	-16.96	-15.11	-13.46	-11.14	-9.47	-8.22	-7.50	-6.81	-5.95	-4.22	0.50	4.88	10.19	11.70	12.80	13.79	15.05	16.55	17.85	19.51	20.83	22.33	24.06	24.34
PARZIALI TERRENO	1.81	1.97	2.44	1.24	3.59	1.44	1.15	1.85	1.65	2.32	1.67	1.25	0.72	0.69	0.86	1.73	4.72	4.38	5.31	1.51	1.10	0.99	1.26	1.50	1.30	1.66	1.32	1.50	1.73	0.28	
QUOTE TERRENO	201.90	201.00	200.00	199.00	198.00	198.00	199.00	200.00	201.00	202.00	203.00	204.00	205.00	206.00	207.00	208.00	209.00	210.00	211.00	212.00	213.00	214.00	215.00	216.00	217.00	218.00	219.00	220.00	221.00	222.00	222.20
PROGRESSIVE PROGETTO																-6.08	-3.95	-3.65	-3.13	0.00	2.75	3.13	3.65								6.70
PARZIALI PROGETTO																2.13	0.30	0.52	0.38	2.75	2.75	0.38	0.52	3.05							
QUOTE PROGETTO																207.85	213.52	213.52	213.87	214.12	214.03	213.95	213.70	213.35							211.34

PROFILO Asse4

SEZIONE 234

PROGRESSIVA 2330.00

A STERRO m<sup>2</sup> 0.79  
 B RIPORTO m<sup>2</sup> 40.23

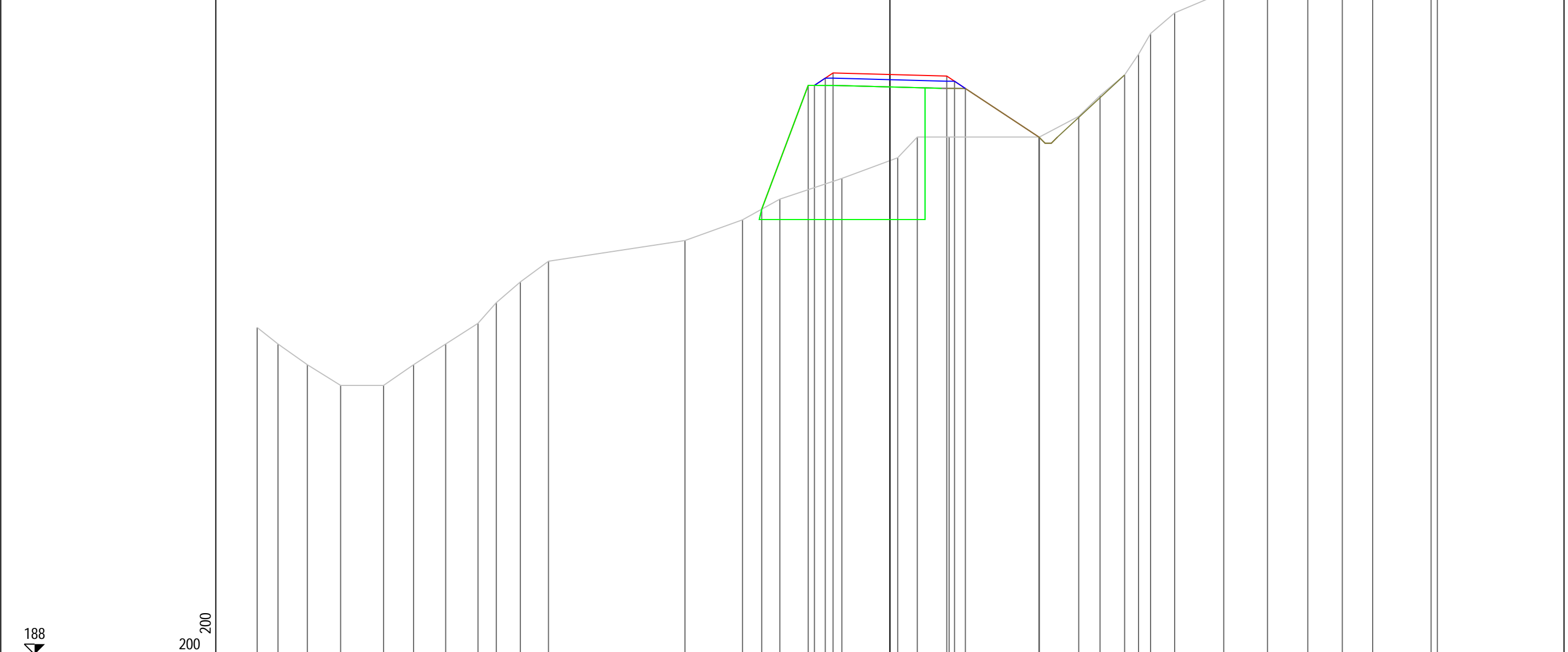

188

200  
200

PROGRESSIVE TERRENO	-30.60	-29.59	-28.17	-26.56	-24.49	-23.04	-21.48	-19.92	-19.03	-17.87	-16.51	-9.91	-7.13	-5.32	-2.32	0.38	1.32	2.86	7.23	9.13	10.16	11.35	12.02	12.61	13.77	16.14	18.26	20.21	21.88	23.35	26.17	26.48
PARZIALI TERRENO	1.01	1.42	1.61	2.07	1.45	1.56	1.56	0.89	1.16	1.36	6.60	2.78	1.81	3.00	2.70	0.94	1.54	4.37	1.90	1.03	1.19	0.67	0.59	1.16	2.37	2.12	1.95	1.67	1.47	2.82	0.31	
QUOTE TERRENO	203.80	203.00	202.00	201.00	201.00	202.00	203.00	204.00	205.00	206.00	207.00	208.00	209.00	210.00	211.00	212.00	213.00	213.00	213.00	214.00	215.00	216.00	217.00	218.00	219.00	220.00	221.00	222.00	223.00	224.00	225.00	225.20
PROGRESSIVE PROGETTO														-6.20	-3.95	-3.65	-3.13	-2.75	0.00	2.75	3.12	3.65	7.21									
PARZIALI PROGETTO														2.25	0.30	0.52	0.38	2.75	2.75	0.37	0.53	3.56										
QUOTE PROGETTO														209.51	215.50	215.50	215.85	216.10	216.02	215.95	215.70	215.35	213.00									





PROFILO Asse4

SEZIONE 237

PROGRESSIVA 2360.00

A STERRO m<sup>2</sup> 13.89  
 B RIPORTO m<sup>2</sup> 1.98

200  
 200  
 200

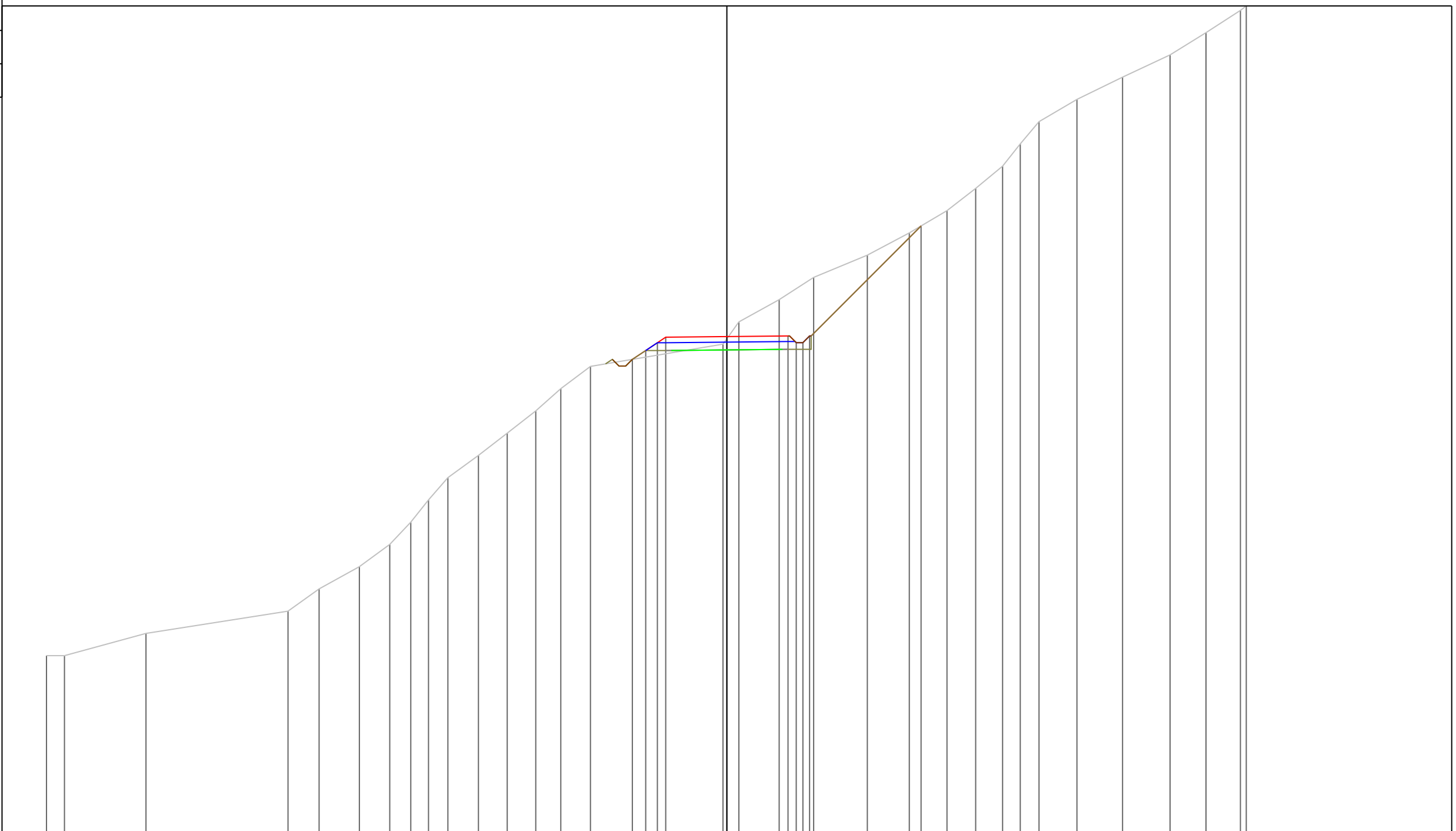

PROGRESSIVE TERRENO	-30.60	-29.79	-26.13	-19.74	-18.34	-16.53	-15.16	-14.22	-13.42	-12.55	-11.17	-9.88	-8.59	-7.47	-6.14	-0.17	0.54	2.35	3.90	6.32	8.21	9.90	11.19	12.40	13.20	14.04	15.74	17.80	19.93	21.55	23.10	23.36
PARZIALI TERRENO	0.81	3.66	6.39	1.40	1.81	1.37	0.94	0.80	0.87	1.38	1.29	1.29	1.12	1.33	5.97	0.71	1.81	1.55	2.42	1.89	1.69	1.29	1.21	0.80	0.84	1.70	2.06	2.13	1.62	1.55	0.26	
QUOTE TERRENO	208.00	208.00	209.00	210.00	211.00	212.00	213.00	214.00	215.00	216.00	217.00	218.00	219.00	220.00	221.00	222.00	223.00	224.00	225.00	226.00	227.00	228.00	229.00	230.00	231.00	232.00	233.00	234.00	235.00	236.00	237.00	237.20
PROGRESSIVE PROGETTO																0.00	2.75	3.12	3.42	3.72	8.73											
PARZIALI PROGETTO																0.60	0.52	0.38	2.75	2.75	0.37	0.30	0.30	5.01								
QUOTE PROGETTO																221.32	221.71	222.06	222.31	222.34	222.37	222.07	222.37	227.31								















PROFILO Asse4

SEZIONE 244

PROGRESSIVA 2430.00

A STERRO m<sup>2</sup> 52.63  
B RIPORTO m<sup>2</sup> 4.98

218

200  
200

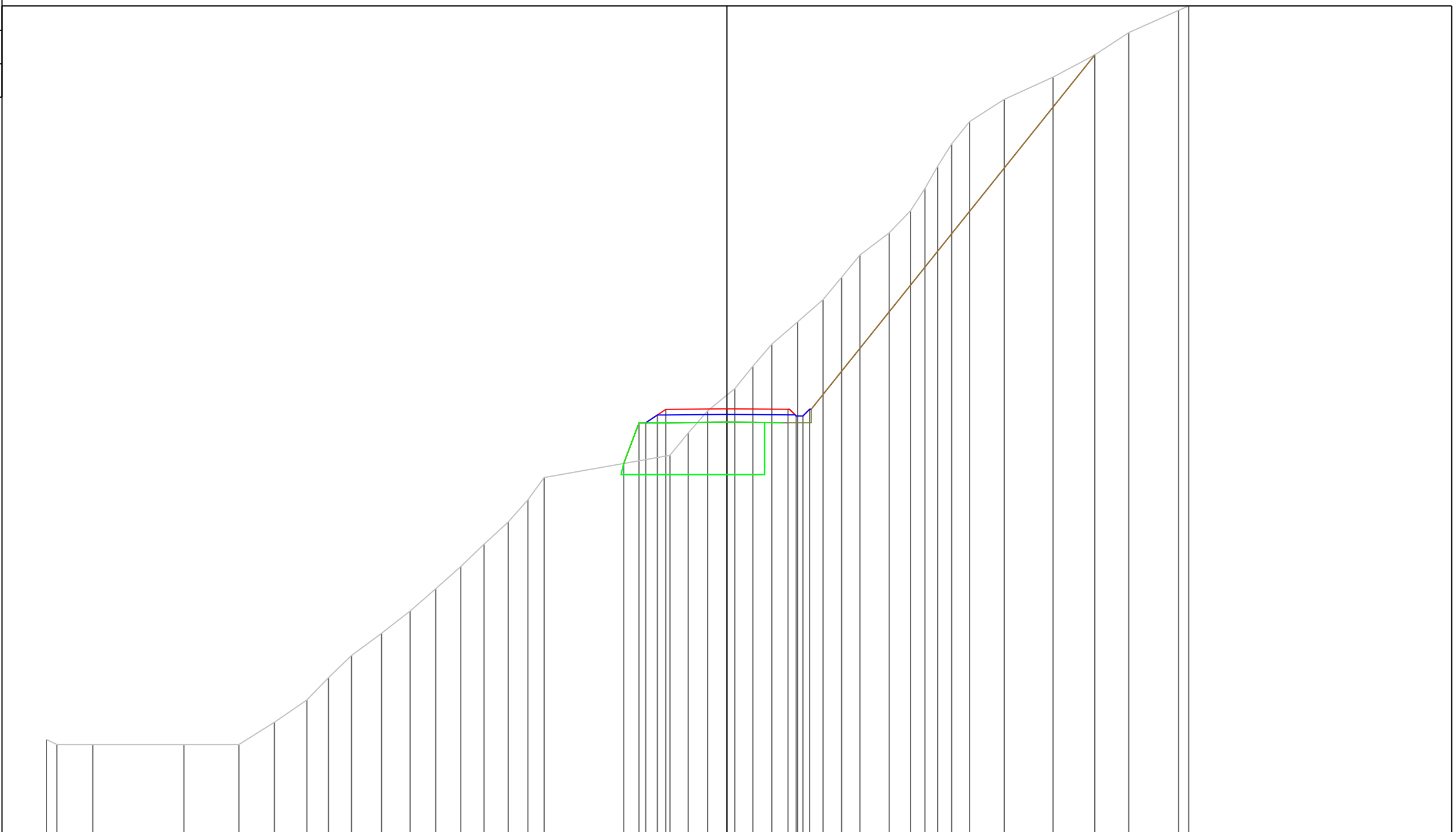

PROGRESSIVE TERRENO	-30.60	-30.14	-28.52	-24.42	-21.94	-20.35	-18.89	-17.92	-16.88	-15.53	-14.24	-13.10	-11.97	-10.92	-9.84	-8.95	-8.22	-2.56	-1.74	-0.86	0.36	1.17	2.02	3.19	4.33	5.16	5.98	7.30	8.27	8.91	9.48	10.11	10.92	12.47	14.67	16.55	18.07	20.31	20.77
PARZIALI TERRENO	0.46	1.62	4.10	2.48	1.59	1.46	0.97	1.04	1.35	1.29	1.14	1.13	1.05	1.08	0.89	0.73	5.66	0.82	0.88	1.22	0.81	0.85	1.17	1.14	0.83	0.82	1.32	0.97	0.64	0.57	0.63	0.81	1.55	2.20	1.88	1.52	2.24	0.46	
QUOTE TERRENO	222.22	222.00	222.00	222.00	222.00	223.00	224.00	225.00	226.00	227.00	228.00	229.00	230.00	231.00	232.00	233.00	234.00	235.00	236.00	237.00	238.00	239.00	240.00	241.00	242.00	243.00	244.00	245.00	246.00	247.00	248.00	249.00	250.00	251.00	252.00	253.00	254.00	255.00	255.20
PROGRESSIVE PROGETTO																		-4.64	-3.95	-3.65	-3.13	-2.75	0.00	2.75	3.12	3.42	3.72							16.55					
PARZIALI PROGETTO																		0.69	0.30	0.52	0.38	2.75	2.75	0.37	0.30	0.30													
QUOTE PROGETTO																		234.63	236.46	236.46	236.81	237.06	237.09	237.07	236.77	236.77	237.07								253.00				

















PROFILO Asse4

SEZIONE 252

PROGRESSIVA 2510.00

A STERRO m<sup>2</sup> 62.76

238

200  
200

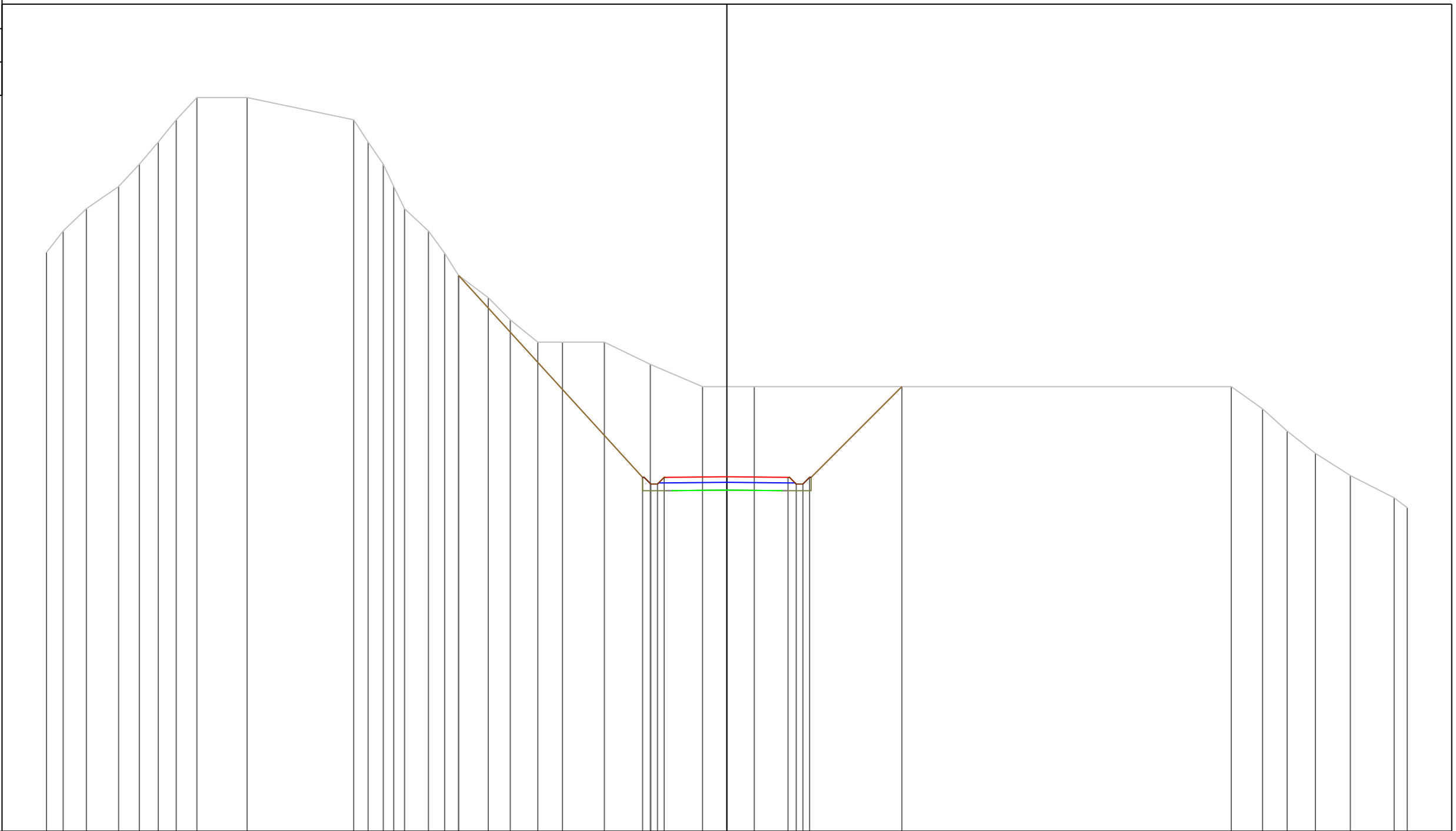

PROGRESSIVE TERRENO	-30.60	-29.85	-28.81	-27.36	-26.42	-25.57	-24.76	-23.84	-21.58	-16.78	-16.14	-15.45	-14.98	-14.50	-13.42	-12.69	-12.07	-10.73	-9.74	-8.50	-7.39	-5.51	-3.44	-1.09	1.23	22.69	24.09	25.20	26.47	28.04	30.01	30.60		
PARZIALI TERRENO	0.75	1.04	1.45	0.94	0.85	0.81	0.92	2.26	4.80	0.64	0.69	0.47	0.48	1.08	0.73	0.62	1.34	0.99	1.24	1.11	1.88	2.07	2.35	2.32	21.46	1.40	1.11	1.27	1.57	1.97	0.59			
QUOTE TERRENO	264.03	265.00	266.00	267.00	268.00	269.00	270.00	271.00	271.00	270.00	269.00	268.00	267.00	266.00	265.00	264.00	263.00	262.00	261.00	260.00	260.00	260.00	260.00	259.00	258.00	258.00	258.00	257.00	256.00	255.00	254.00	253.00	252.55	
PROGRESSIVE PROGETTO															-12.07								-3.79	-3.42	-3.12	-2.82	0.00	2.75	3.12	3.42	3.72	7.87		
PARZIALI PROGETTO																				8.28			0.37	0.30	0.30	2.82	2.75	0.37	0.30	0.30	4.15			
QUOTE PROGETTO															263.00								253.92	253.62	253.62	253.92	253.95	253.92	253.62	253.62	253.92	258.00		















PROFILO Asse4

SEZIONE 259

PROGRESSIVA 2580.00

A STERRO m<sup>2</sup> 30.86

242

200  
200

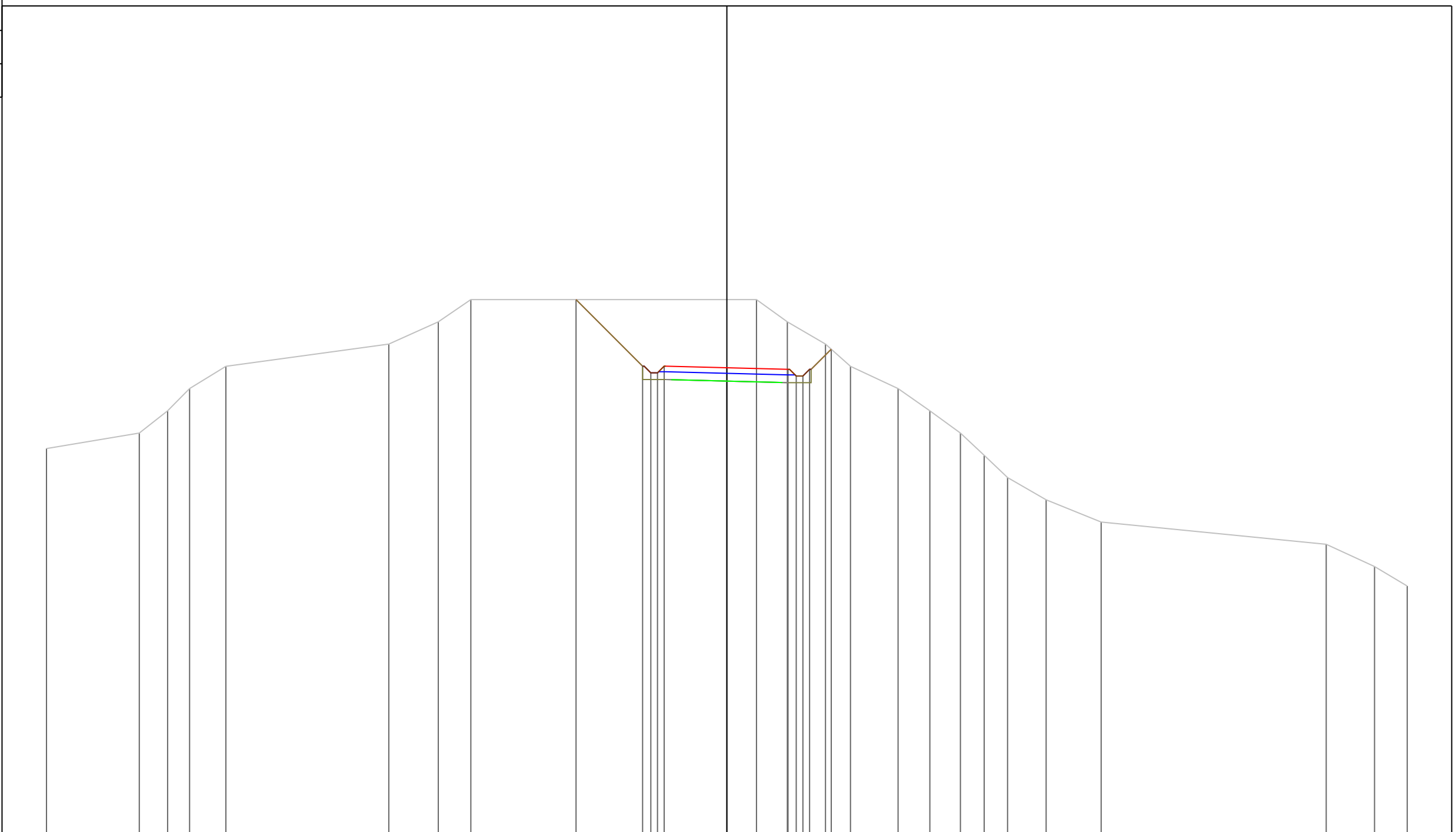

PROGRESSIVE TERRENO	-30.60	-26.43	-25.15	-24.16	-22.53		-15.20	-12.98	-11.51		1.33	2.72	4.44	5.56	7.70	9.13	10.50	11.57	12.62	14.36	16.83		26.96	29.13	30.60
PARZIALI TERRENO		4.17	1.28	0.99	1.63	7.33	2.22	1.47		12.84	1.39	1.72	1.12	2.14	1.43	1.37	1.07	1.05	1.74	2.47		10.13		2.17	1.47
QUOTE TERRENO	259.30	260.00	261.00	262.00	263.00		264.00	265.00	266.00		266.00	265.00	264.00	263.00	262.00	261.00	260.00	259.00	258.00	257.00	256.00		255.00	254.00	253.12
PROGRESSIVE PROGETTO							-6.78	-3.79	-3.42	-3.12	-2.82	0.00	2.75	3.12	3.42	3.72	4.69								
PARZIALI PROGETTO							2.99	0.37	0.30	0.30	2.82	2.75	0.37	0.30	0.30	0.97									
QUOTE PROGETTO							266.00	263.01	262.71	262.71	263.01	262.94	262.86	262.56	262.56	262.86	263.77								



PROFILO Asse4

SEZIONE 261

PROGRESSIVA 2600.00

A STERRO m<sup>2</sup> 18.67  
 B RIPORTO m<sup>2</sup> 1.35

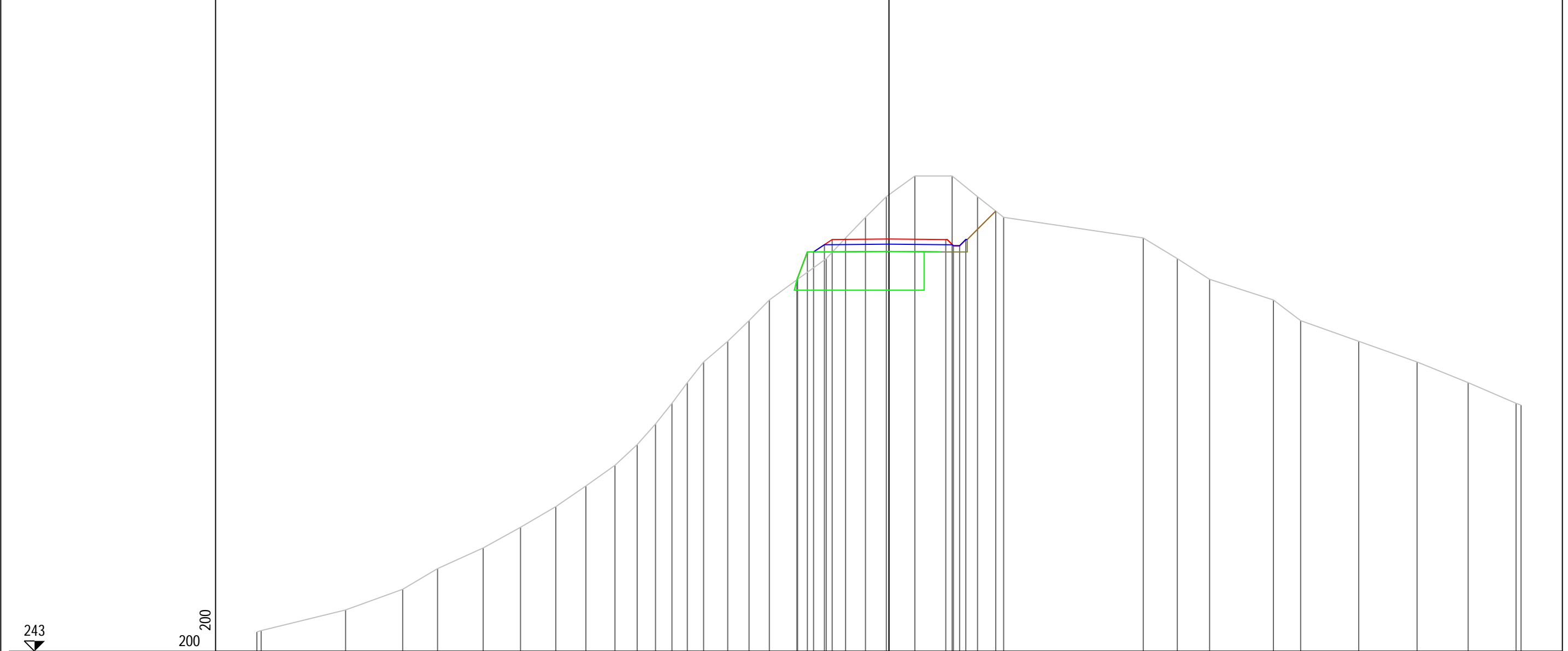

PROGRESSIVE TERRENO	-30.60	-30.39	-26.31	-23.54	-21.85	-19.65	-17.84	-16.13	-14.67	-13.26	-12.19	-11.30	-10.51	-9.76	-8.97	-7.81	-6.77	-5.79	-4.42	-3.04	-2.10	-1.14	-0.13	1.25	3.06	4.29	5.55	12.31	13.96	15.52	18.61	19.93	22.74	25.57	28.04	30.36	30.60																										
PARZIALI TERRENO	0.21	4.08	2.77	1.69	2.20	1.81	1.71	1.46	1.41	1.07	0.89	0.79	0.75	0.79	1.16	1.04	0.98	1.37	1.38	0.94	0.96	1.01	1.38	1.81	1.23	1.26	6.76	1.65	1.56	3.09	1.32	2.81	2.83	2.47	2.32	0.24																											
QUOTE TERRENO	243.94	244.00	245.00	246.00	247.00	248.00	249.00	250.00	251.00	252.00	253.00	254.00	255.00	256.00	257.00	258.00	259.00	260.00	261.00	262.00	263.00	264.00	265.00	266.00	266.00	265.00	264.00	263.00	262.00	261.00	260.00	259.00	258.00	257.00	256.00	255.00	254.91																										
PROGRESSIVE PROGETTO																													-4.46	-3.95	-3.65	-3.12	-2.75	0.00															2.75	3.12	3.42	3.72	5.17										
PARZIALI PROGETTO																		0.51	0.30	0.53	0.37	2.75	2.75	0.37	0.30	0.30	1.45																																				
QUOTE PROGETTO																		260.98	262.33	262.33	262.68	262.93	262.95	262.92	262.62	262.62	262.92	264.30																																			

PROFILO Asse4

SEZIONE 262

PROGRESSIVA 2610.00

A STERRO m² 0.18  
B RIPORTO m² 18.28

240

200  
200

PROGRESSIVE  
TERRENO

-30.60 -29.03 -25.99 -24.40 -23.04 -21.75 -20.25 -18.44 -16.83 -15.61 -14.33 -12.55 -11.04 -9.85 -8.56 -7.37 -6.36 -5.32 -4.24 -3.34 -2.52 7.52 9.37 10.88 12.27 17.16 18.70 19.61 22.12 24.67 26.40 28.91 30.60

PARZIALI  
TERRENO

1.57 3.04 1.59 1.36 1.29 1.50 1.81 1.61 1.22 1.28 1.78 1.51 1.19 1.29 1.19 1.01 1.04 1.08 0.90 0.82 10.04 1.85 1.51 1.39 4.89 1.54 0.91 2.51 2.55 1.73 2.51 1.69

QUOTE  
TERRENO

241.62 242.00 243.00 244.00 245.00 246.00 247.00 248.00 249.00 250.00 251.00 252.00 253.00 254.00 255.00 256.00 257.00 258.00 259.00 260.00 261.00 261.00 260.00 259.00 258.00 257.00 256.00 255.00 254.00 253.00 252.00 251.00 250.34

PROGRESSIVE  
PROGETTO

-5.66 -3.95 -3.65 -3.12 -2.75 0.00 2.75 3.13 3.65 5.58

PARZIALI  
PROGETTO

1.71 0.30 0.63 0.37 2.75 2.75 0.38 0.52 1.93

QUOTE  
PROGETTO

262.68 262.22 262.22 262.57 262.82 262.85 262.87 262.62 262.27 261.00

PROFILO Asse4

SEZIONE 263

PROGRESSIVA 2620.00

B RIPORTO m<sup>2</sup> 29.34

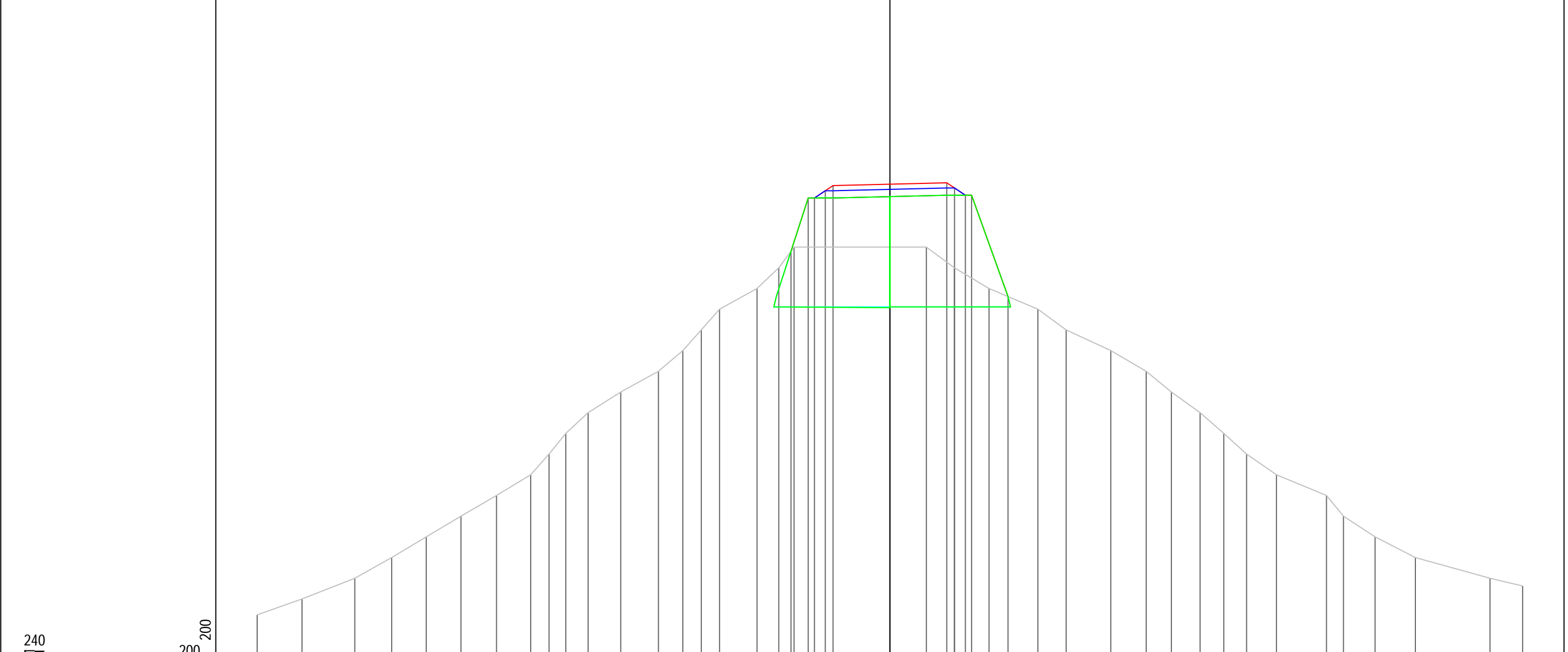

PROGRESSIVE TERRENO	-30.60	-28.43	-25.88	-24.09	-22.42	-20.74	-19.02	-17.37	-16.48	-15.67	-14.60	-13.02	-11.19	-10.01	-9.12	-8.24	-6.43	-5.37	-4.63		1.76	3.12	4.79	7.16	8.52	10.68	12.39	13.61	15.00	16.15	17.25	18.69	21.11	21.93	23.46	25.41	29.02	30.60	
PARZIALI TERRENO		2.17	2.55	1.79	1.67	1.68	1.72	1.65	0.89	0.81	1.07	1.58	1.83	1.18	0.89	0.88	1.81	1.06	0.74		6.39	1.36	1.67	2.37	1.36	2.16	1.71	1.22	1.39	1.15	1.10	1.44	2.42	0.82	1.53	1.95	3.61	1.58	
QUOTE TERRENO	242.23	243.00	244.00	245.00	246.00	247.00	248.00	249.00	250.00	251.00	252.00	253.00	254.00	255.00	256.00	257.00	258.00	259.00	260.00		260.00	259.00	258.00	257.00	256.00	255.00	254.00	253.00	252.00	251.00	250.00	249.00	248.00	247.00	246.00	245.00	244.00	243.63	
PROGRESSIVE PROGETTO																					-4.78	-3.95	-3.65	-3.12	-2.75	0.00			2.75	3.13	3.65	3.95	5.71						
PARZIALI PROGETTO																				0.83	0.30	0.53	0.37	2.75		2.75	0.38	0.52	0.30	1.76									
QUOTE PROGETTO																				259.80	262.37	262.37	262.72	262.97	263.04		263.11	262.86	262.51	262.51	257.61								



PROFILO Asse4

SEZIONE 264

PROGRESSIVA 2630.00

B RIPORTO m² 21.17

240  
200 200

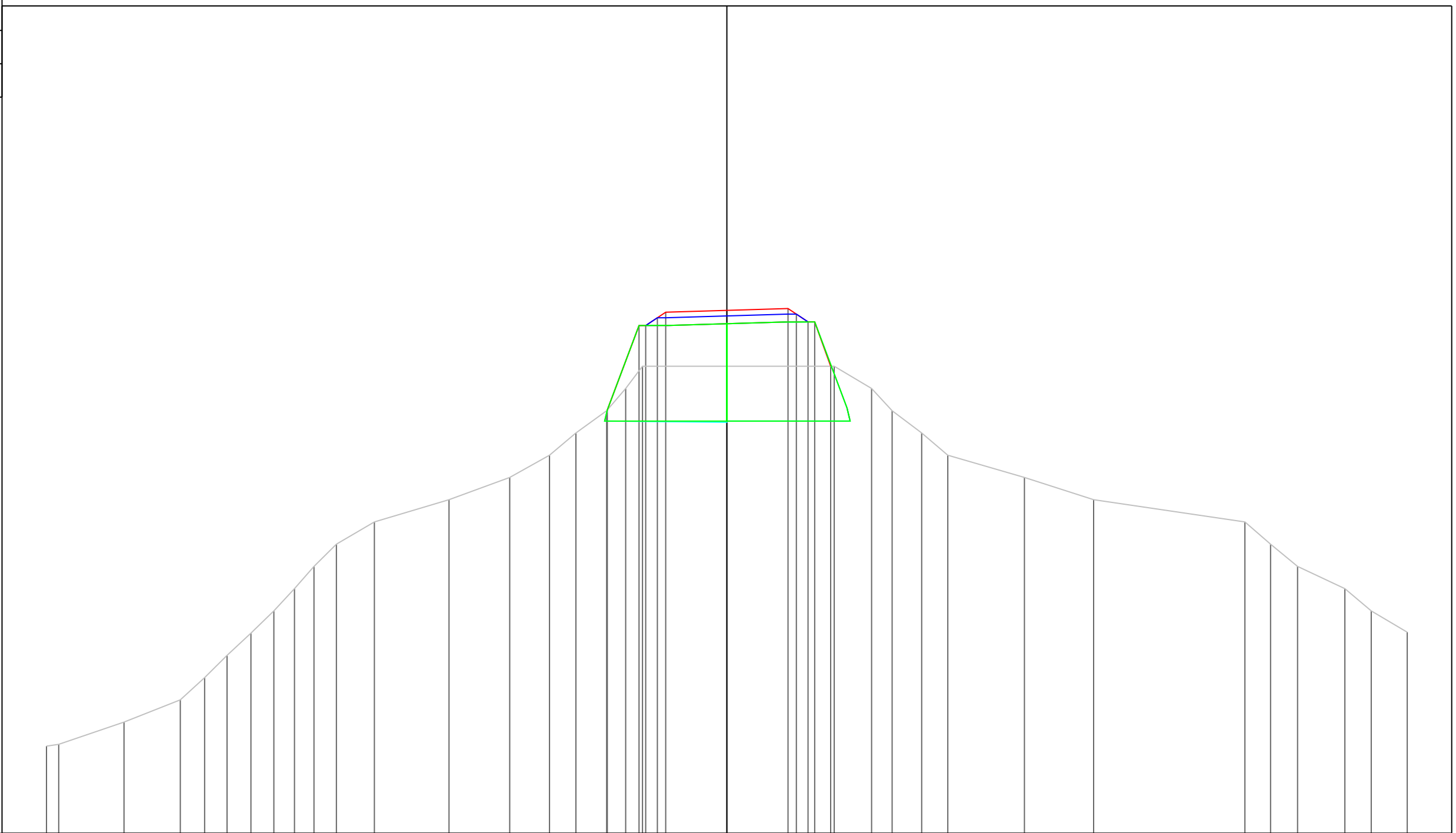

PROGRESSIVE TERRENO	-30.60	-30.05	-27.11	-24.58	-23.49	-22.48	-21.41	-20.37	-19.45	-18.57	-17.56	-15.85	-12.50	-9.77	-7.98	-6.79	-5.41	-4.55	-3.79	4.83	6.51	7.43	8.76	9.94	13.38	16.50	23.30	24.45	25.67	27.80	28.98	30.60
PARZIALI TERRENO	0.55	2.94	2.53	1.09	1.01	1.07	1.04	0.92	0.88	1.01	1.71	3.35	2.73	1.79	1.19	1.38	0.86	0.76	8.62	1.68	0.92	1.33	1.18	3.44	3.12	6.80	1.15	1.22	2.13	1.18	1.62	
QUOTE TERRENO	243.92	244.00	245.00	246.00	247.00	248.00	249.00	250.00	251.00	252.00	253.00	254.00	255.00	256.00	257.00	258.00	259.00	260.00	261.00	261.00	260.00	259.00	258.00	257.00	256.00	255.00	254.00	253.00	252.00	251.00	250.00	249.04
PROGRESSIVE PROGETTO																	-5.38	-3.95	-3.65	0.00	2.75	3.13	3.65	3.95	4.67							
PARZIALI PROGETTO																	1.43	0.30	0.52	0.38	2.75	2.75	0.38	0.52	0.30	0.72						
QUOTE PROGETTO																	259.03	262.83	262.83	263.18	263.43	263.51	263.59	263.34	262.99	261.00						







PROFILO Asse4

SEZIONE 268

PROGRESSIVA 2670.00

A STERRO m<sup>2</sup> 51.43

249

200  
200

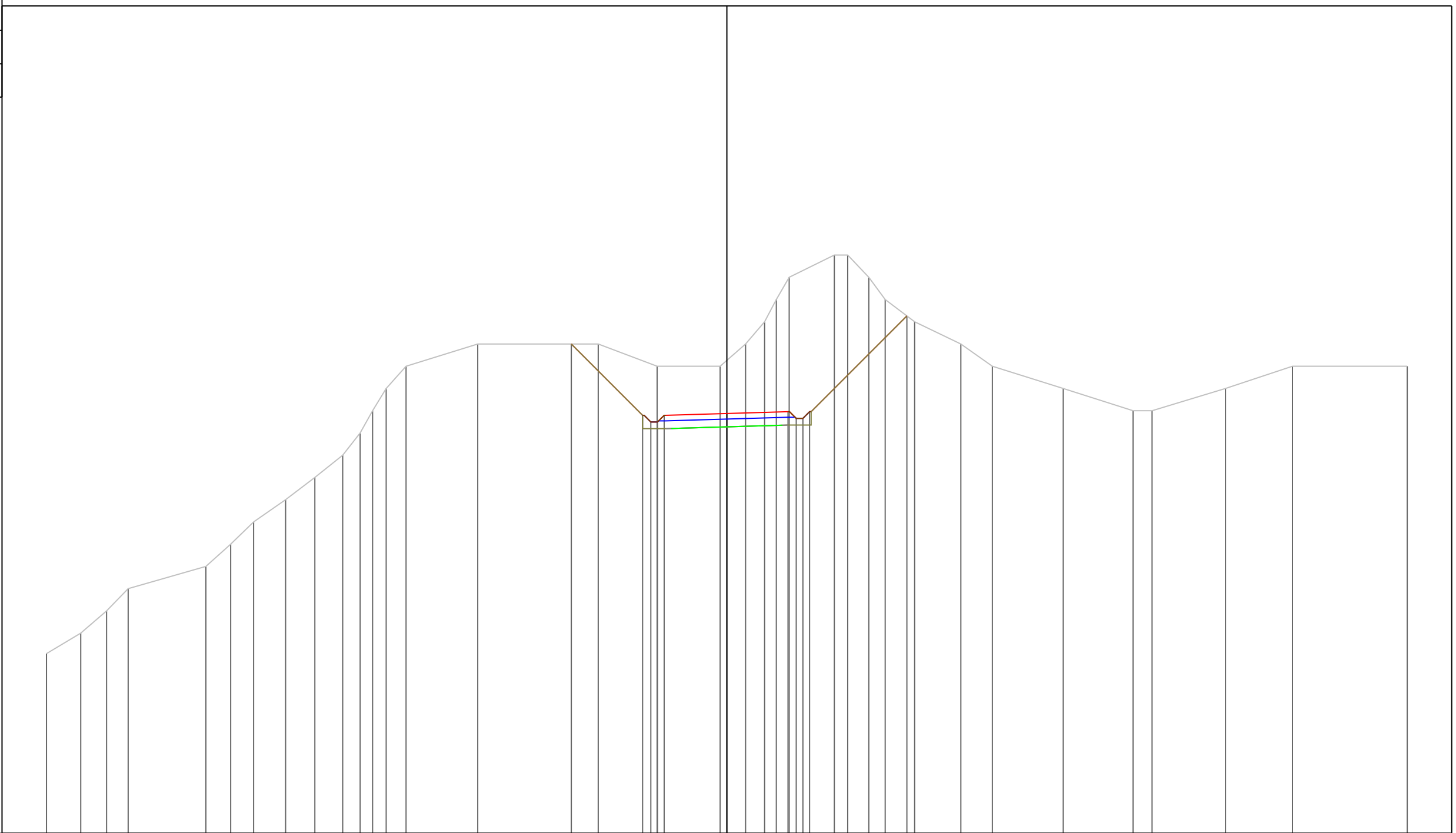

PROGRESSIVE  
TERRENO

-30.60 -29.06 -27.90 -26.93 -23.43 -22.32 -21.28 -19.85 -18.53 -17.28 -16.49 -15.93 -15.32 -14.43 -11.20 -5.79 -3.14 -0.30 0.84 1.70 2.22 2.80 4.83 5.43 6.38 7.12 8.44 10.52 11.94 15.13 18.27 19.12 22.42 25.44 30.60

PARZIALI  
TERRENO

1.54 1.16 0.97 3.50 1.11 1.04 1.43 1.32 1.25 0.79 0.56 0.61 0.89 3.23 5.41 2.65 2.84 1.14 0.86 0.52 0.58 2.03 0.60 0.95 0.74 1.32 2.08 1.42 3.19 3.14 0.85 3.30 3.02 5.16

QUOTE  
TERRENO

257.08 258.00 259.00 260.00 261.00 262.00 263.00 264.00 265.00 266.00 267.00 268.00 269.00 270.00 271.00 271.00 270.00 270.00 271.00 272.00 273.00 274.00 275.00 275.00 274.00 273.00 272.00 271.00 270.00 269.00 268.00 268.00 269.00 270.00 270.00

PROGRESSIVE  
PROGETTO

-7.00 -3.79 -3.42 -3.12 -2.82 0.00 2.75 3.12 3.42 3.72 8.10

PARZIALI  
PROGETTO

3.21 0.37 0.30 0.30 2.82 2.75 0.37 0.30 0.30 4.38

QUOTE  
PROGETTO

271.00 267.79 267.49 267.79 267.96 267.66 267.66 267.96 272.26



















PROFILO Asse4

SEZIONE 277

PROGRESSIVA 2760.00

A STERRO m² 0.73  
B RIPORTO m² 7.95

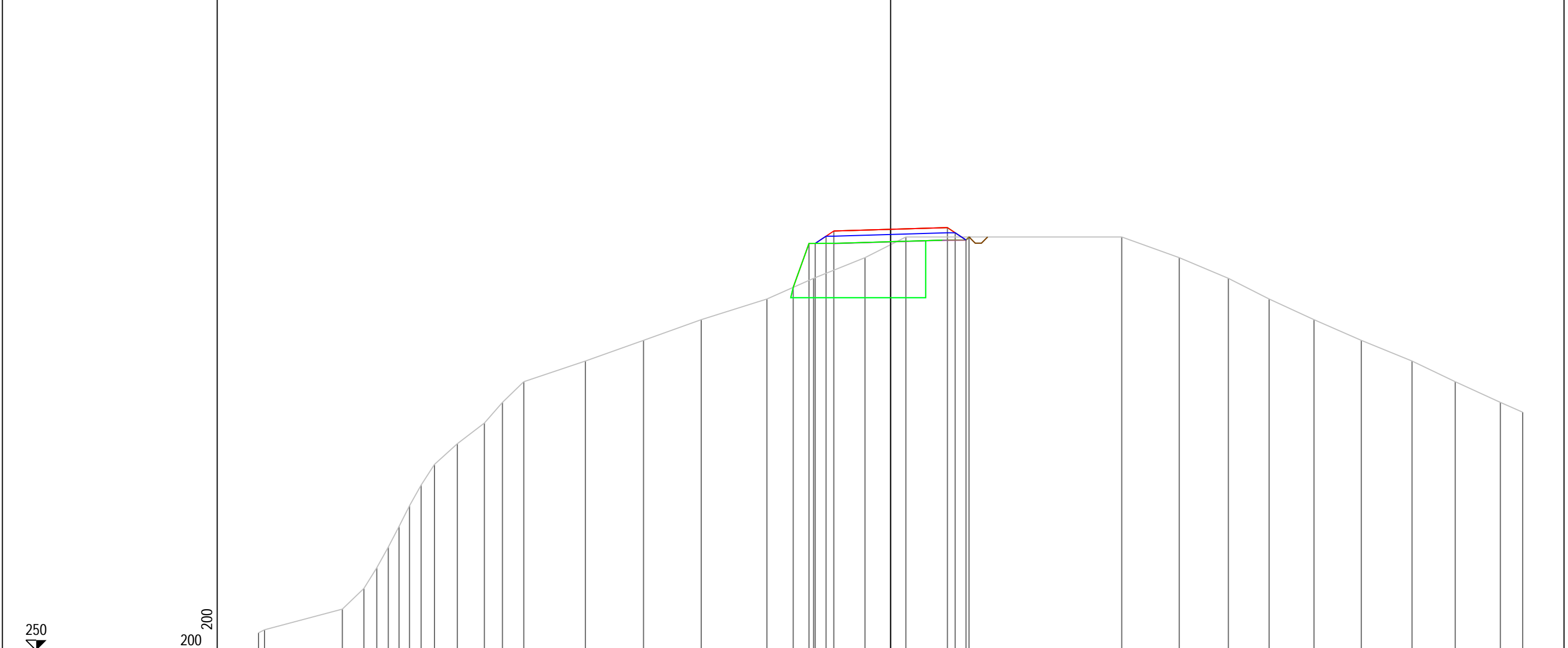

PROGRESSIVE TERRENO	-30.60	-30.31	-26.54	-25.50	-24.88	-24.32	-23.80	-23.29	-22.73	-22.08	-20.98	-19.67	-18.79	-17.76	-14.78	-11.96	-9.17	-5.99	-3.73	-1.24	0.74	11.19	13.97	16.35	18.32	20.50	22.79	25.24	27.33	29.52	30.60
PARZIALI TERRENO	0.29	3.77	1.04	0.62	0.56	0.52	0.51	0.56	0.65	1.10	1.31	0.88	1.03	2.98	2.82	2.79	3.18	2.26	2.49	1.98	10.45	2.78	2.38	1.97	2.18	2.29	2.45	2.09	2.19	1.08	
QUOTE TERRENO	250.85	251.00	252.00	253.00	254.00	255.00	256.00	257.00	258.00	259.00	260.00	261.00	262.00	263.00	264.00	265.00	266.00	267.00	268.00	269.00	270.00	270.00	269.00	268.00	267.00	266.00	265.00	264.00	263.00	262.00	261.52
PROGRESSIVE PROGETTO																			-4.72	-3.95	-3.65	-3.12	-2.75	0.00	2.75	3.13	3.65	3.80			
PARZIALI PROGETTO																			0.77	0.30	0.63	0.37	2.75	2.75	0.38	0.52	0.15				
QUOTE PROGETTO																			267.56	269.69	269.69	270.04	270.29	270.37	270.45	270.20	269.85	270.00			

PROFILO Asse4

SEZIONE 278

PROGRESSIVA 2770.00

A STERRO m<sup>2</sup> 0.18  
 B RIPORTO m<sup>2</sup> 13.04

250  
 200 200

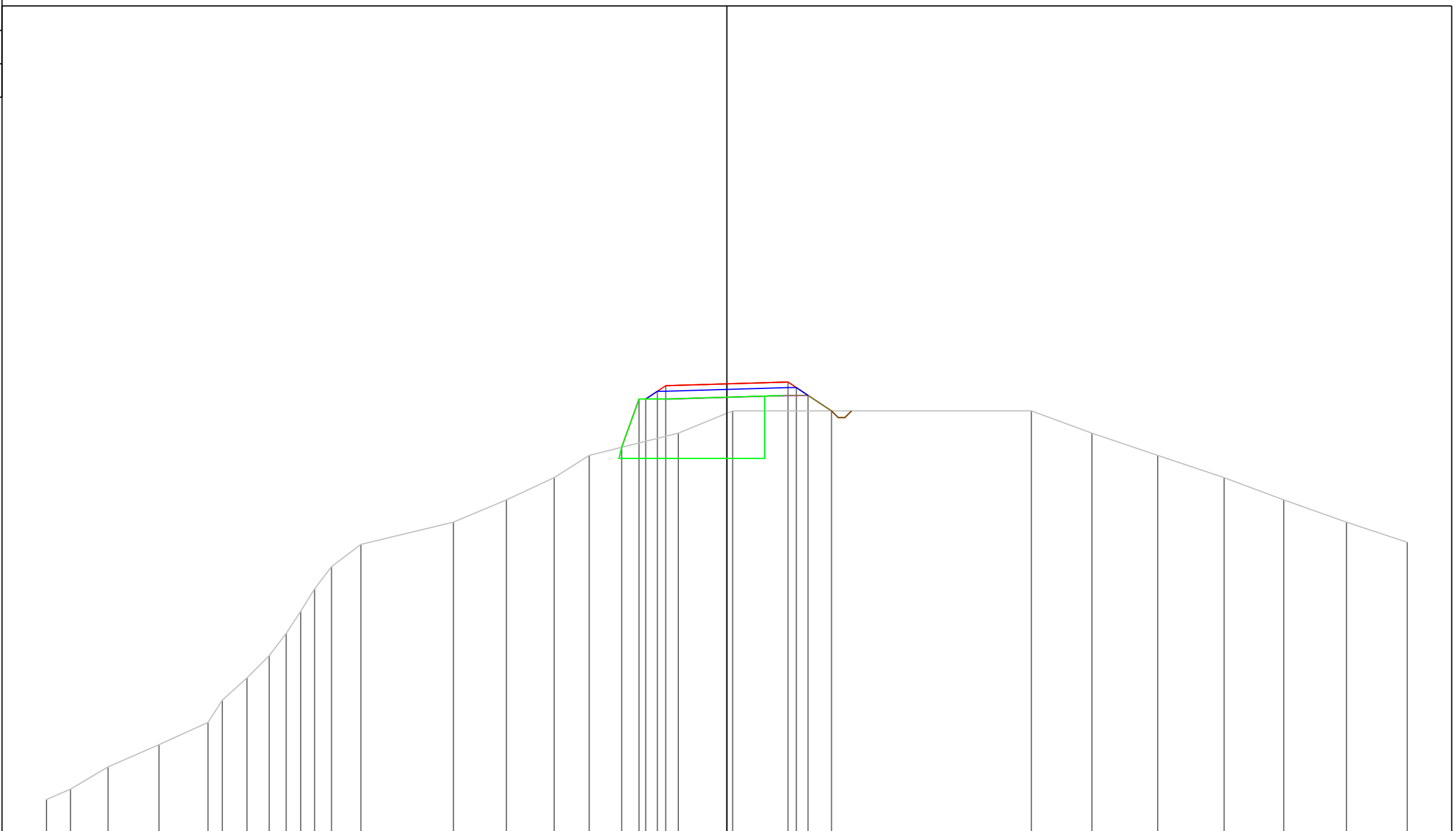

PROGRESSIVE TERRENO	-30.60	-29.52	-27.83	-25.54	-23.34	-22.69	-21.58	-20.58	-19.82	-19.17	-18.54	-17.78	-16.46	-12.30	-9.92	-7.77	-6.19	-2.18	0.26	13.70	16.42	19.38	22.36	25.05	27.87	30.60
PARZIALI TERRENO	1.08	1.69	2.29	2.20	0.65	1.11	1.00	0.76	0.65	0.63	0.76	1.32	4.16	2.38	2.15	1.58	4.01	2.44	13.44	2.72	2.96	2.98	2.69	2.82	2.73	
QUOTE TERRENO	251.53	252.00	253.00	254.00	255.00	256.00	257.00	258.00	259.00	260.00	261.00	262.00	263.00	264.00	265.00	266.00	267.00	268.00	269.00	269.00	268.00	267.00	266.00	265.00	264.00	263.10
PROGRESSIVE PROGETTO																			0.00							
PARZIALI PROGETTO																			2.75	2.75	0.38	0.52	1.06			
QUOTE PROGETTO																			267.36	270.22	270.30	270.05	269.70	269.00		
																			4.73							
																			3.95							
																			3.65							
																			3.13							
																			2.75							
																			0.38							
																			0.52							
																			0.38							
																			2.75							
																			0.00							
																			0.78							
																			4.73							
																			0.30							
																			3.95							
																			3.65							
																			3.13							
																			2.75							
																			0.38							
																			0.52							
																			0.38							
																			2.75							
																			0.00							
																			0.78							
																			4.73							

PROFILO Asse4

SEZIONE 279

PROGRESSIVA 2780.00

A STERRO m² 0.25  
B RIPORTO m² 21.44

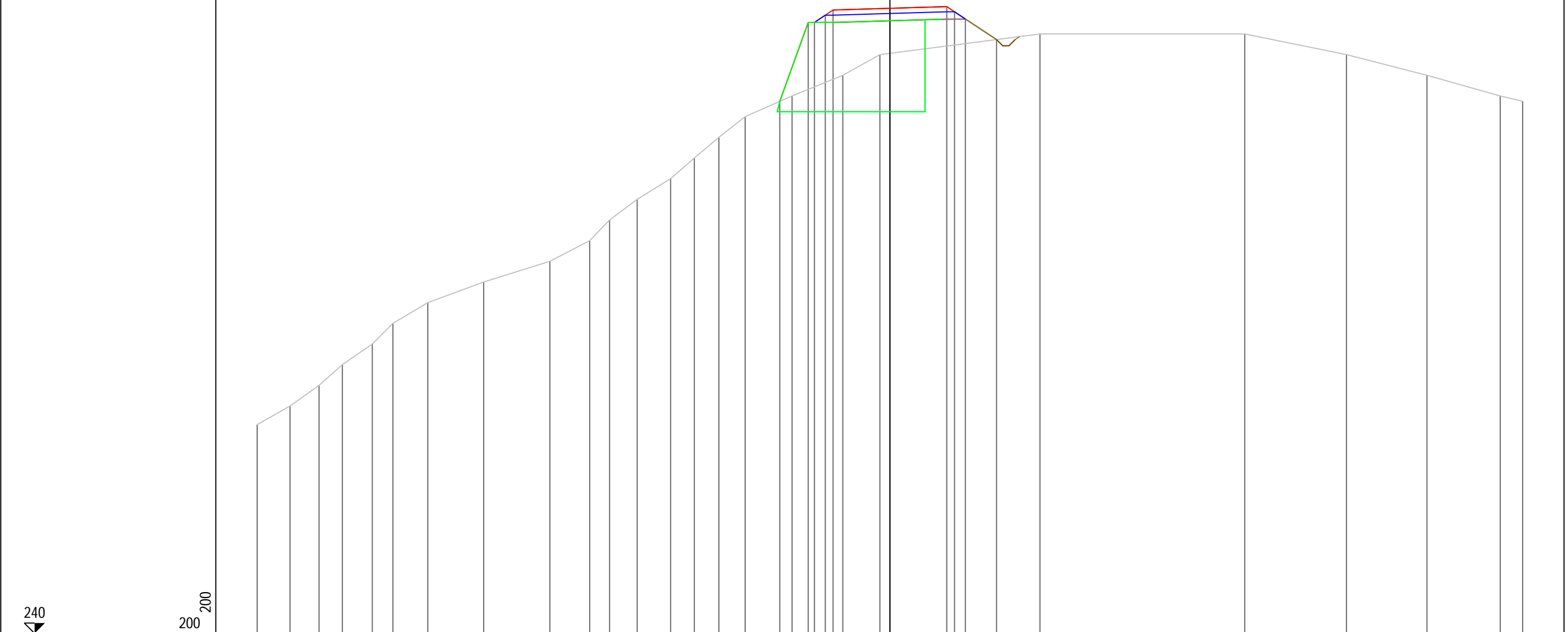

240

200  
200

PROGRESSIVE TERRENO	-30.60	-29.01	-27.61	-26.48	-25.03	-24.03	-22.35	-19.65	-16.44	-14.52	-13.56	-12.22	-10.60	-9.46	-8.27	-7.00	-4.73	-2.28	-0.48	7.26	17.16	22.08	25.97	29.52	30.60
PARZIALI TERRENO	1.59	1.40	1.13	1.45	1.00	1.68	2.70	3.21	1.92	0.96	1.34	1.62	1.14	1.19	1.27	2.27	2.45	1.80	7.74	9.90	4.92	3.89	3.55	1.08	
QUOTE TERRENO	250.10	251.00	252.00	253.00	254.00	255.00	256.00	257.00	258.00	259.00	260.00	261.00	262.00	263.00	264.00	265.00	266.00	267.00	268.00	269.00	269.00	268.00	267.00	266.00	265.74
PROGRESSIVE PROGETTO																	-5.33	-3.95	-3.65	0.00	2.75	3.13	3.65	5.16	
PARZIALI PROGETTO																	1.38	0.30	0.53	2.75	2.75	0.38	0.52	1.51	
QUOTE PROGETTO																	265.74	269.56	269.56	270.16	270.24	270.32	270.07	269.72	268.73



PROFILO Asse4

SEZIONE 280

PROGRESSIVA 2790.00

A STERRO m<sup>2</sup> 0.86  
B RIPORTO m<sup>2</sup> 40.19

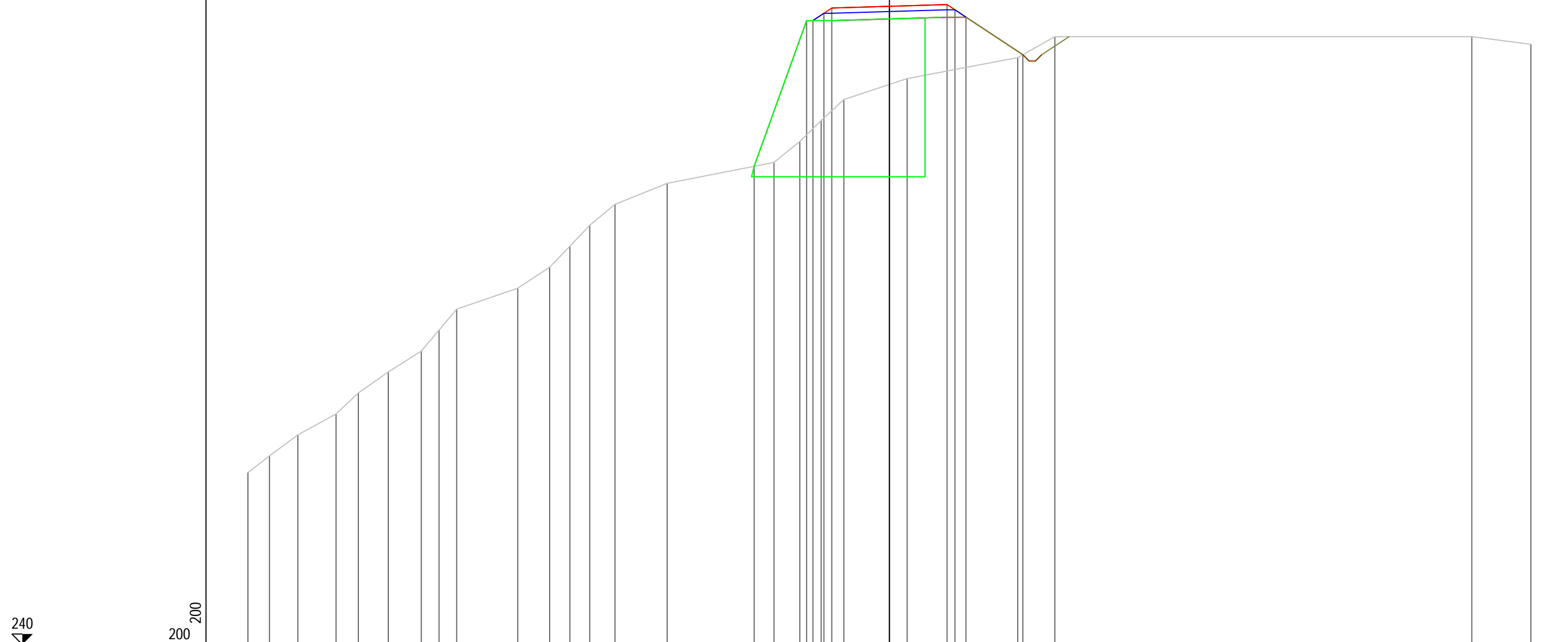

240

200  
200

PROGRESSIVE TERRENO	-30.60	-29.57	-28.22	-26.40	-25.33	-23.91	-22.33	-21.48	-20.64	-17.73	-16.21	-15.24	-14.30	-13.09	-10.60	-5.51	-4.27	-3.26	-2.17	0.85	6.12	7.89	27.78	30.60	
PARZIALI TERRENO	1.03	1.35	1.82	1.07	1.42	1.58	0.85	0.84	2.91	1.52	0.97	0.94	1.21	2.49	5.09	1.24	1.01	1.09	3.02	5.27	1.77	19.89	2.82		
QUOTE TERRENO	248.20	249.00	250.00	251.00	252.00	253.00	254.00	255.00	256.00	257.00	258.00	259.00	260.00	261.00	262.00	263.00	264.00	265.00	266.00	267.00	268.00	269.00	269.00	268.63	
PROGRESSIVE PROGETTO																-6.45	-3.95	-3.65	-3.12	-2.75	0.00	2.75	3.13	3.65	6.37
PARZIALI PROGETTO																2.50	0.30	0.53	0.37	2.75	2.75	0.38	0.52	2.72	
QUOTE PROGETTO																262.81	269.77	269.77	270.12	270.37	270.45	270.53	270.28	269.93	268.14

PROFILO Asse4

SEZIONE 281

PROGRESSIVA 2800.00

A STERRO m<sup>2</sup> 0.14  
 B RIPORTO m<sup>2</sup> 40.87

238

200  
 200

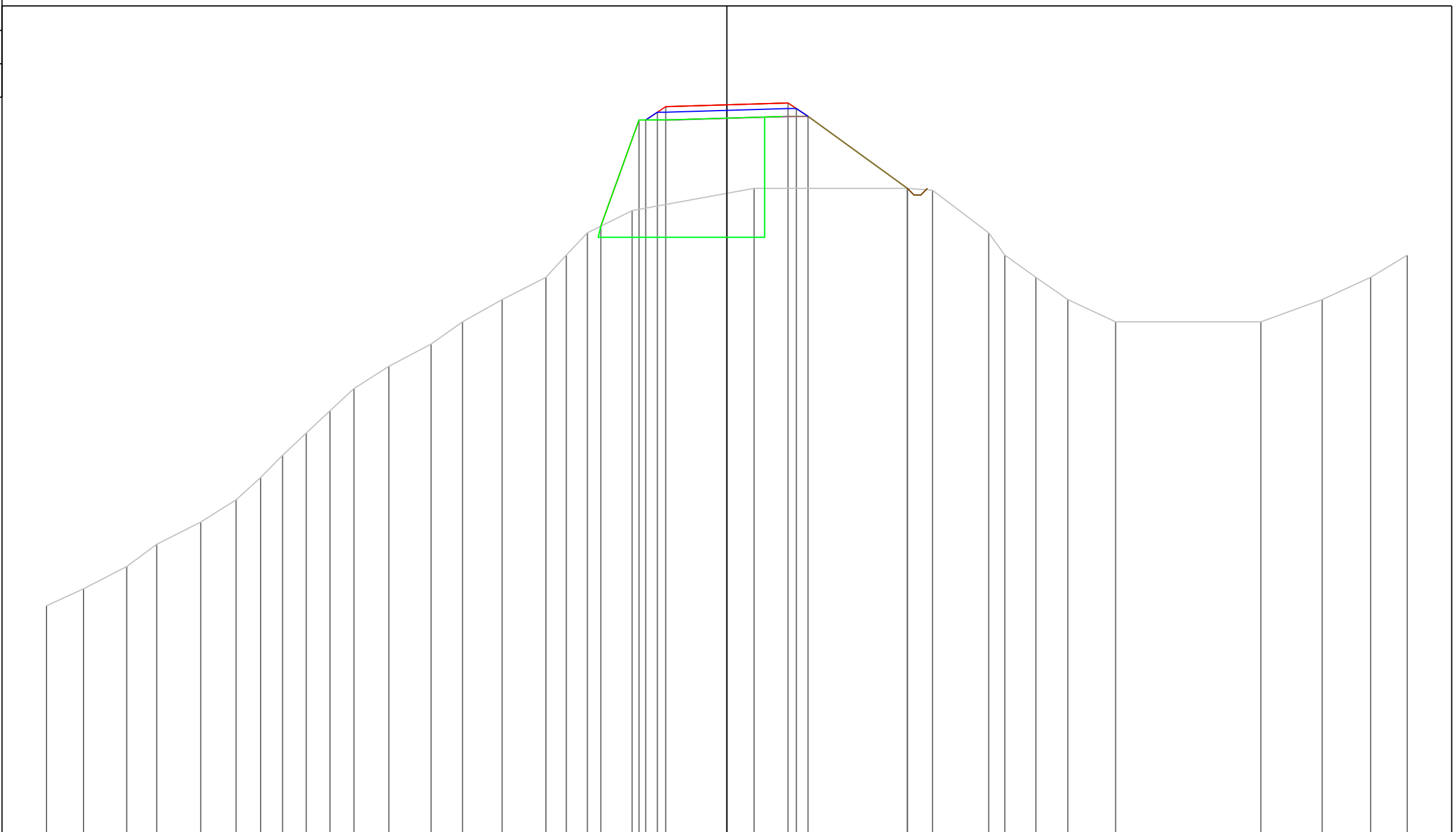

PROGRESSIVE TERRENO	-30.60	-28.93	-26.99	-25.64	-23.66	-22.07	-20.97	-19.98	-18.92	-17.85	-16.77	-15.20	-13.30	-11.89	-10.11	-8.14	-7.22	-6.27	-4.26	1.22	8.12	9.25	11.78	12.50	13.90	15.34	17.48	24.02	26.77	28.95	30.60
PARZIALI TERRENO	1.67	1.94	1.35	1.98	1.59	1.10	0.99	1.06	1.07	1.08	1.57	1.90	1.41	1.78	1.97	0.92	0.95	2.01	5.48	6.90	1.13	2.53	0.72	1.40	1.44	2.14	6.54	2.75	2.18	1.65	
QUOTE TERRENO	248.24	249.00	250.00	251.00	252.00	253.00	254.00	255.00	256.00	257.00	258.00	259.00	260.00	261.00	262.00	263.00	264.00	265.00	266.00	267.00	267.00	266.91	265.00	264.00	263.00	262.00	261.00	261.00	262.00	263.00	264.00
PROGRESSIVE PROGETTO																		-5.67	-3.95	-3.65	-3.12	-2.75	0.00	2.75	3.13	3.65	8.12				
PARZIALI PROGETTO																		1.72	0.30	0.53	0.37	2.75	2.75	0.38	0.52	4.47					
QUOTE PROGETTO																		265.30	270.07	270.42	270.67	270.76	270.84	270.59	270.24	267.00					





PROFILO Asse4

SEZIONE 284

PROGRESSIVA 2830.00

A STERRO m<sup>2</sup> 21.40

241

200  
200

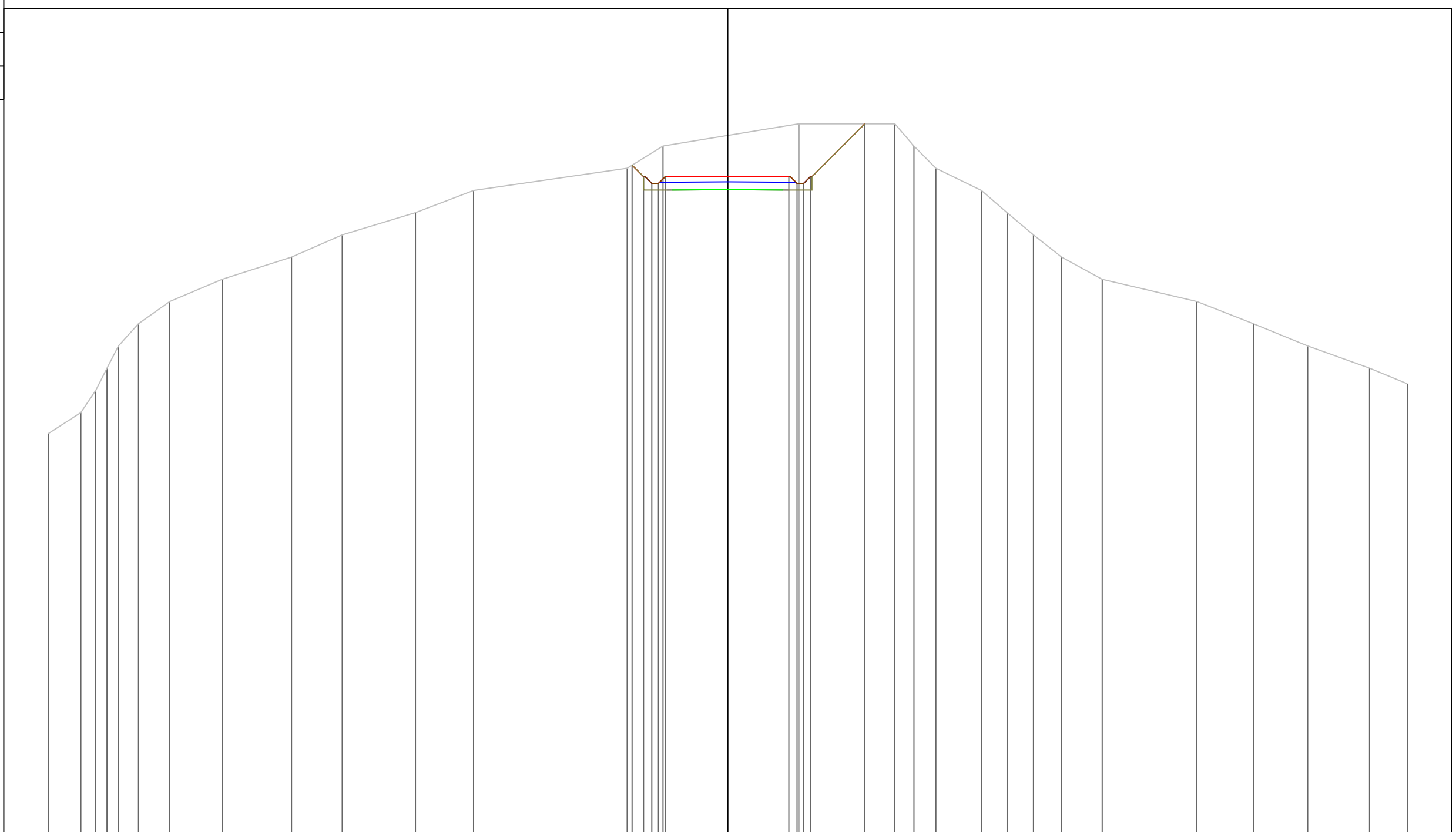

PROGRESSIVE TERRENO	-30.60	-29.13	-28.46	-27.95	-27.44	-26.53	-25.13	-22.76	-19.64	-17.36	-14.06	-11.45	-4.53	-2.92	3.20	7.52	8.38	9.37	11.42	12.58	13.77	15.03	16.86	21.12	23.67	26.11	28.90	30.60
PARZIALI TERRENO	1.47	0.67	0.51	0.51	0.91	1.40	2.37	3.12	2.28	3.30	2.61	6.92	1.61	6.12	4.32	0.86	0.99	2.05	1.16	1.19	1.26	1.83	4.26	2.55	2.44	2.79	1.70	
QUOTE TERRENO	259.05	260.00	261.00	262.00	263.00	264.00	265.00	266.00	267.00	268.00	269.00	270.00	271.00	272.00	273.00	273.00	272.00	271.00	270.00	269.00	268.00	267.00	266.00	265.00	264.00	263.00	262.00	261.30
PROGRESSIVE PROGETTO													-4.31	-3.79	-3.42	-3.12	-2.82	0.00	2.75	3.12	3.42	3.72	6.17					
PARZIALI PROGETTO													0.52	0.37	0.30	0.30	2.82	2.75	0.37	0.30	0.30	0.30	2.45					
QUOTE PROGETTO													271.14	270.62	270.32	270.32	270.62	270.64	270.62	270.32	270.32	270.62	273.00					













PROFILO Asse4

SEZIONE 290

PROGRESSIVA 2890.00

A STERRO m<sup>2</sup> 14.19  
 B RIPORTO m<sup>2</sup> 0.40

240  
 200 200

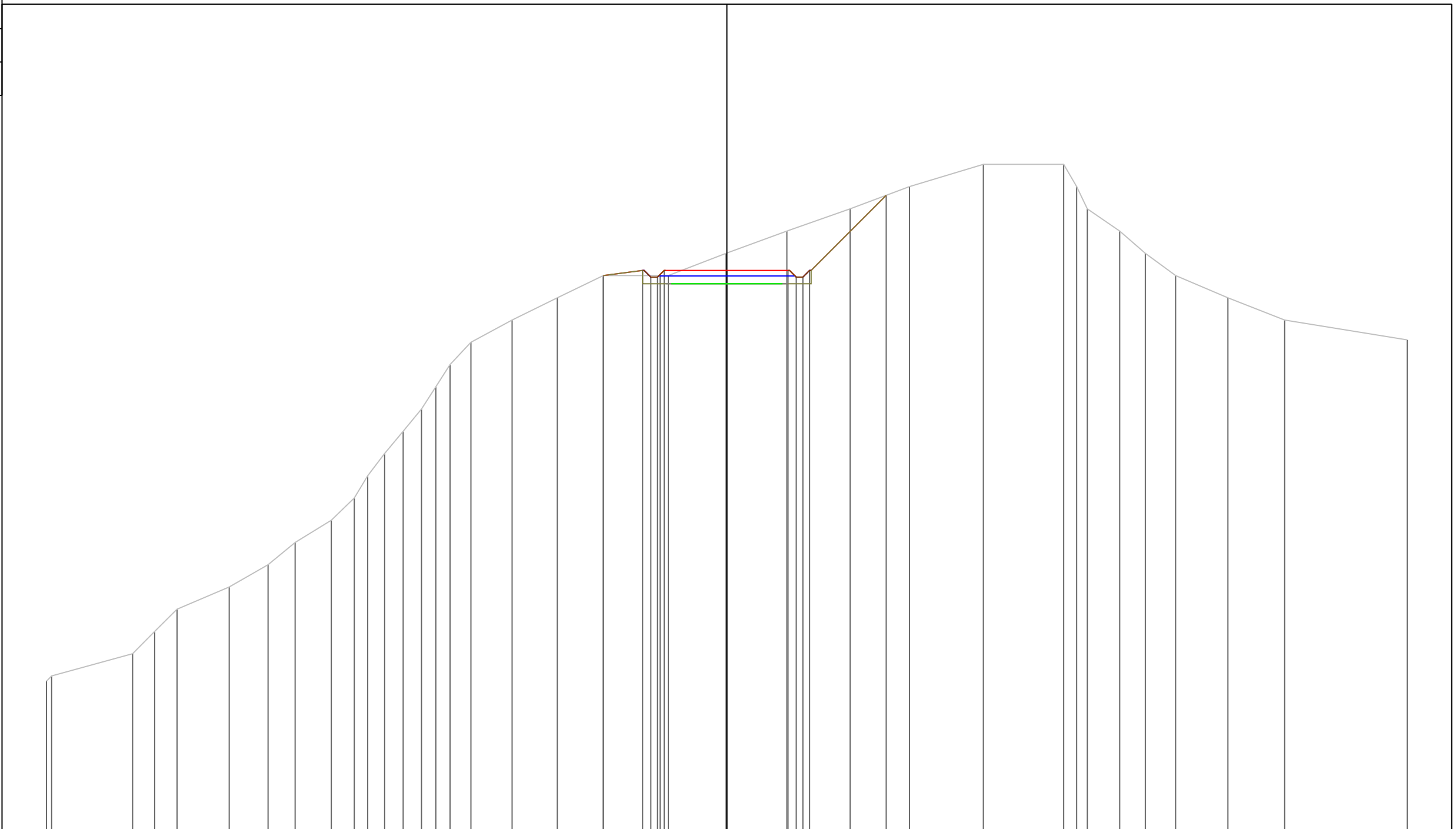

PROGRESSIVE TERRENO	-30.60	-30.37	-26.73	-25.74	-24.73	-22.38	-20.63	-19.42	-17.79	-16.76	-16.15	-15.39	-14.56	-13.73	-13.09	-12.45	-11.51	-9.66	-7.63	-5.56	-3.00	-2.63	-0.03	2.70	5.54	8.22	11.54	15.15	15.73	16.21	17.67	18.82	20.18	22.53	25.09	30.60		
PARZIALI TERRENO	0.23	3.64	0.99	1.01	2.35	1.75	1.21	1.63	1.03	0.61	0.76	0.83	0.83	0.64	0.64	0.64	0.94	1.85	2.03	2.07	2.56	0.37	2.60	2.73	2.84	2.68	3.32	3.61	0.58	0.48	1.46	1.15	1.36	2.35	2.56	5.51		
QUOTE TERRENO	246.76	247.00	248.00	249.00	250.00	251.00	252.00	253.00	254.00	255.00	256.00	257.00	258.00	259.00	260.00	261.00	262.00	263.00	264.00	265.00	265.00	265.00	265.00	266.00	267.00	268.00	269.00	270.00	270.00	269.00	268.00	267.00	266.00	265.00	264.00	263.00	262.11	
PROGRESSIVE PROGETTO																				-5.56	-3.79	-3.42	-3.12	-2.82	0.00	2.75	3.12	3.42	3.72									
PARZIALI PROGETTO																				1.77	0.37	0.30	0.30	2.82	2.75	0.37	0.30	0.30	3.45									
QUOTE PROGETTO																				265.00	265.23	264.93	264.93	265.23	265.23	265.23	265.23	264.93	264.93	265.23	268.61							

PROFILO Asse4

SEZIONE 291

PROGRESSIVA 2900.00

A STERRO m<sup>2</sup> 13.44  
 B RIPORTO m<sup>2</sup> 0.14

240

200  
 200

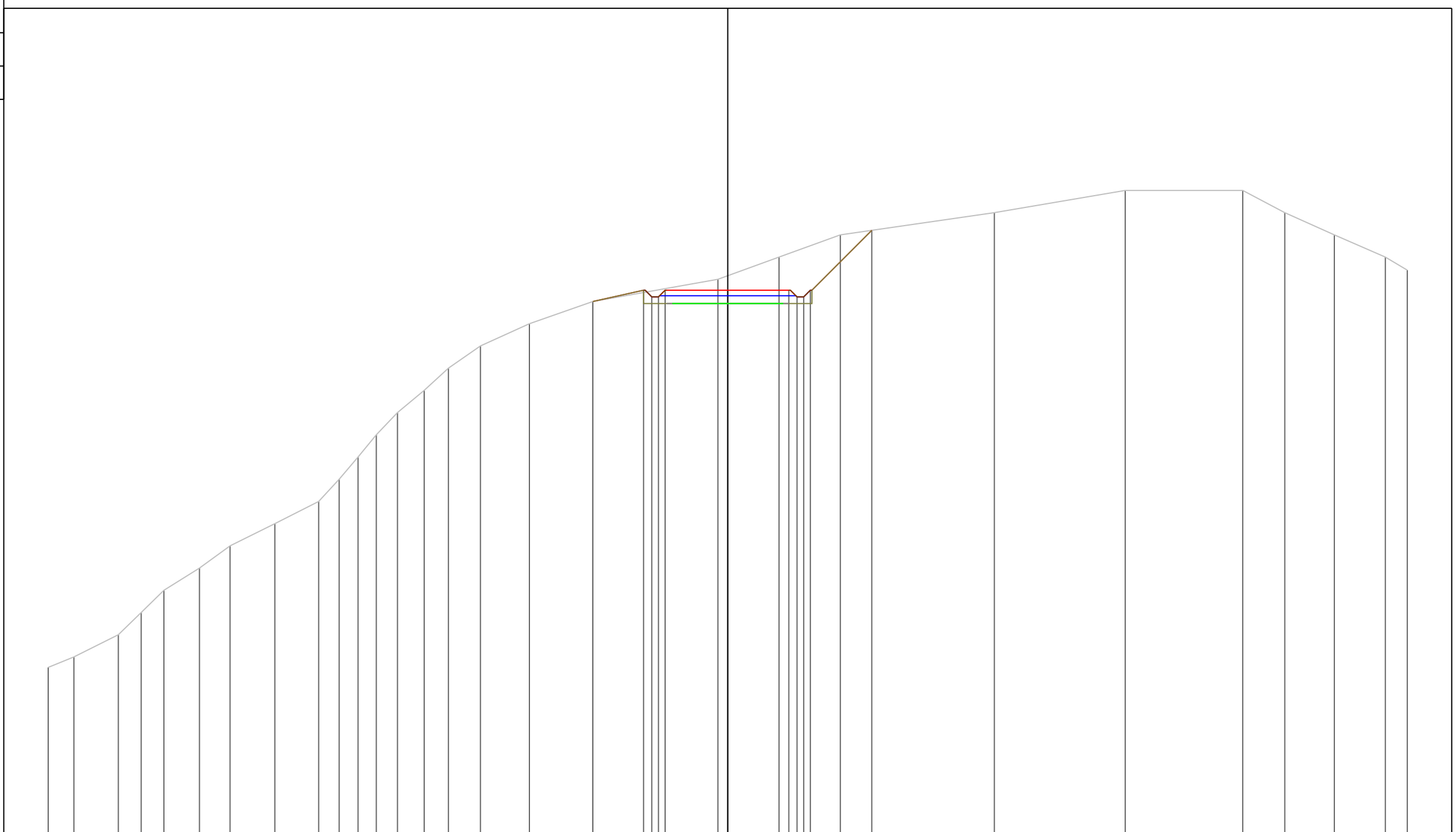

PROGRESSIVE TERRENO	-30.60	-29.44	-27.44	-26.41	-25.39	-23.79	-22.41	-20.39	-18.42	-17.50	-16.65	-15.83	-14.87	-13.67	-12.58	-11.14	-8.93	-6.08	-0.44	2.31	5.07	12.01	17.90	23.19	25.08	27.31	29.61	30.60	
PARZIALI TERRENO	1.16	2.00	1.03	1.02	1.60	1.38	2.02	1.97	0.92	0.85	0.82	0.96	1.20	1.09	1.44	2.21	2.85	5.64	2.75	2.76	6.94	5.89	5.29	1.89	2.23	2.30	0.99		
QUOTE TERRENO	247.53	248.00	249.00	250.00	251.00	252.00	253.00	254.00	255.00	256.00	257.00	258.00	259.00	260.00	261.00	262.00	263.00	264.00	265.00	266.00	267.00	268.00	269.00	269.00	268.00	267.00	266.00	265.41	
PROGRESSIVE PROGETTO																		-6.08	0.00	2.75	3.12	3.42	3.72						
PARZIALI PROGETTO																		2.29	0.37	0.30	0.30	2.82	2.75	0.37	0.30	0.30	2.77		
QUOTE PROGETTO																		264.00	264.51	264.51	264.21	264.51	264.51	264.51	264.21	264.51	264.21	264.51	267.20

PROFILO Asse4

SEZIONE 292

PROGRESSIVA 2910.00

A STERRO m<sup>2</sup> 10.00

240

200  
200

PROGRESSIVE TERRENO	-30.60	-26.65	-23.03	-19.62	-15.55	-10.03	-7.05	-4.01	2.61	7.27	13.16	20.37	26.75	30.60
PARZIALI TERRENO		3.95	3.62	3.41	4.07	5.52	2.98	3.04	6.62	4.66	5.89	7.21	6.38	3.85
QUOTE TERRENO	257.09	258.00	259.00	260.00	261.00	262.00	263.00	264.00	265.00	266.00	267.00	268.00	269.00	269.00
PROGRESSIVE PROGETTO								-3.80	0.00	2.75	5.36			
PARZIALI PROGETTO								0.38	2.82	2.75	1.64			
QUOTE PROGETTO								264.03	264.02	264.02	265.59			
								263.72		263.72				
								263.72		263.72				
								264.02		264.02				

PROFILO Asse4

SEZIONE 293

PROGRESSIVA 2920.00

A STERRO m<sup>2</sup> 7.55  
B RIPORTO m<sup>2</sup> 0.08

240  
200  
200

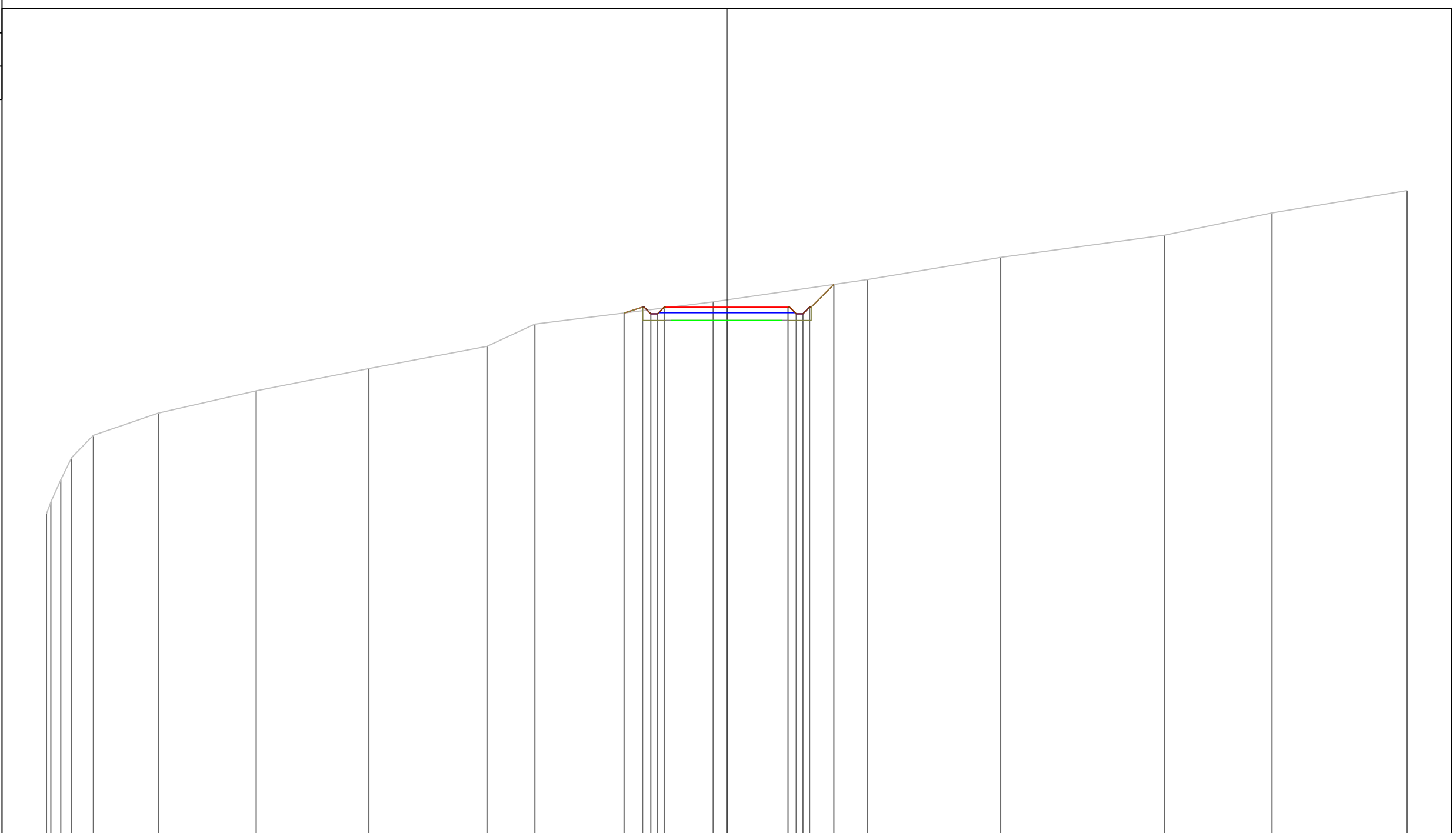

PROGRESSIVE TERRENO	254.47	255.00	256.00	257.00	258.00	259.00	260.00	261.00	262.00	263.00	264.00	265.00	266.00	267.00	268.00	269.00	269.01			
PARZIALI TERRENO	0.20	0.44	0.49	0.98	2.93	4.39	5.07	5.31	2.16	8.02	6.92	6.01	7.37	4.83	6.05	0.03				
QUOTE TERRENO	-30.60	-30.40	-29.96	-29.47	-28.49	-25.56	-21.17	-16.10	-10.79	-8.63	-0.61	6.31	12.32	19.69	24.52	30.57	30.60			
PROGRESSIVE PROGETTO											4.62	2.75	3.12	3.42	3.72	4.81				
PARZIALI PROGETTO											0.83	0.37	0.30	0.30	2.82	2.75	0.37	0.30	0.30	1.09
QUOTE PROGETTO											263.50	263.76	263.46	263.46	263.76	264.78				

PROFILO Asse4

SEZIONE 294

PROGRESSIVA 2925.46

A STERRO m<sup>2</sup> 62.41  
 B RIPORTO m<sup>2</sup> 0.40

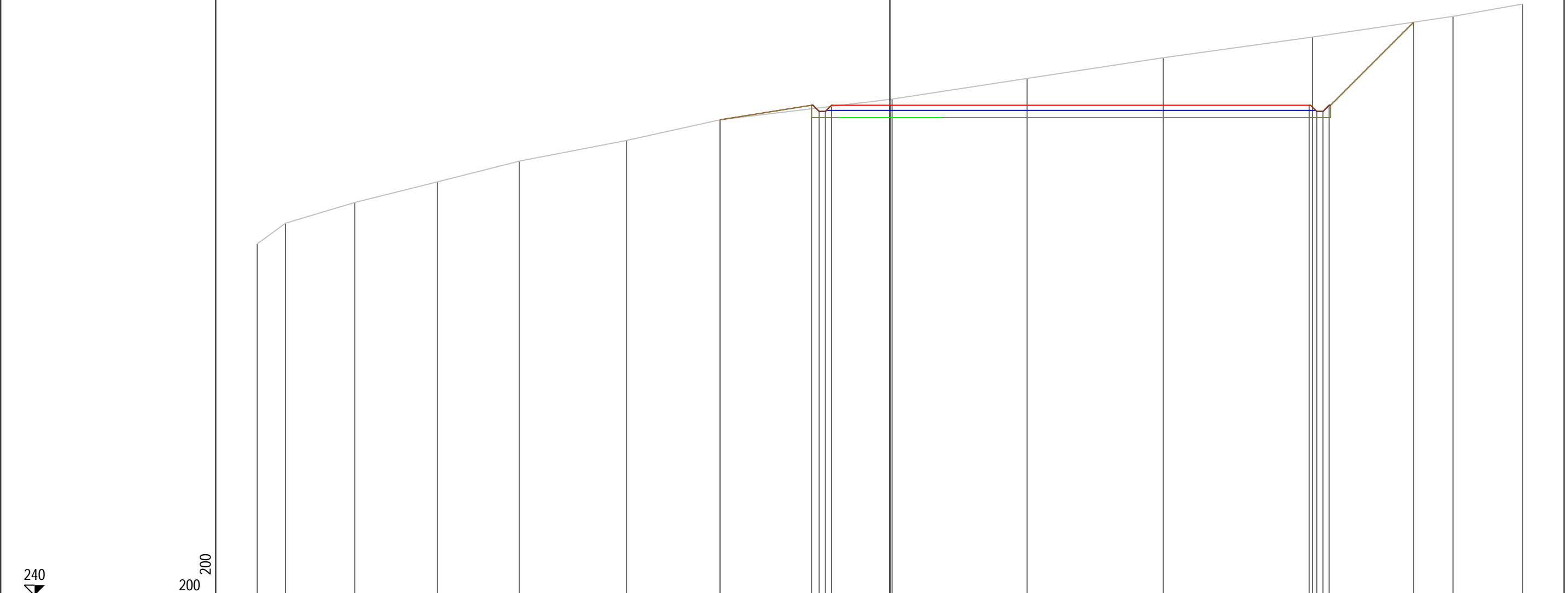

PROGRESSIVE TERRENO	-30.60	-29.23	-25.88	-21.88	-17.92	-12.74	-8.21	0.11	6.64	13.22	20.44	27.23	30.60
PARZIALI TERRENO	1.37	3.35	4.00	3.96	5.18	4.53	8.32	6.53	6.58	7.22	6.79	3.37	
QUOTE TERRENO	257.00	258.00	259.00	260.00	261.00	262.00	263.00	264.00	265.00	266.00	267.00	268.00	268.60
PROGRESSIVE PROGETTO							-8.21	0.00			20.27	25.33	
PARZIALI PROGETTO						4.42	0.37	2.82	20.27		0.37	4.09	
QUOTE PROGETTO						263.00	263.70	263.70	263.70		263.70	267.72	

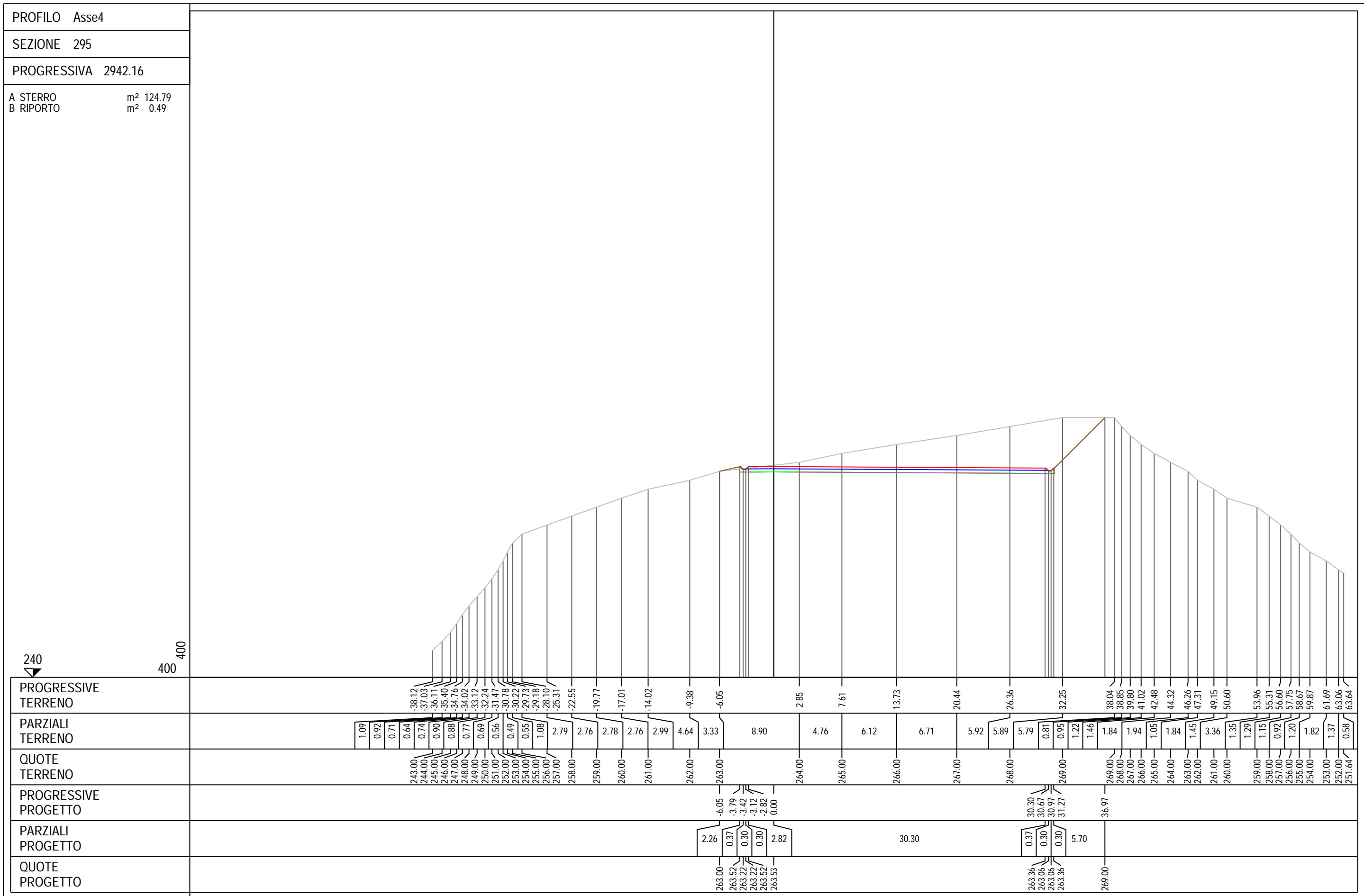



PROFILO Asse4

SEZIONE 296

PROGRESSIVA 2953.43

A STERRO m<sup>2</sup> 0.11  
 B RIPORTO m<sup>2</sup> 19.65

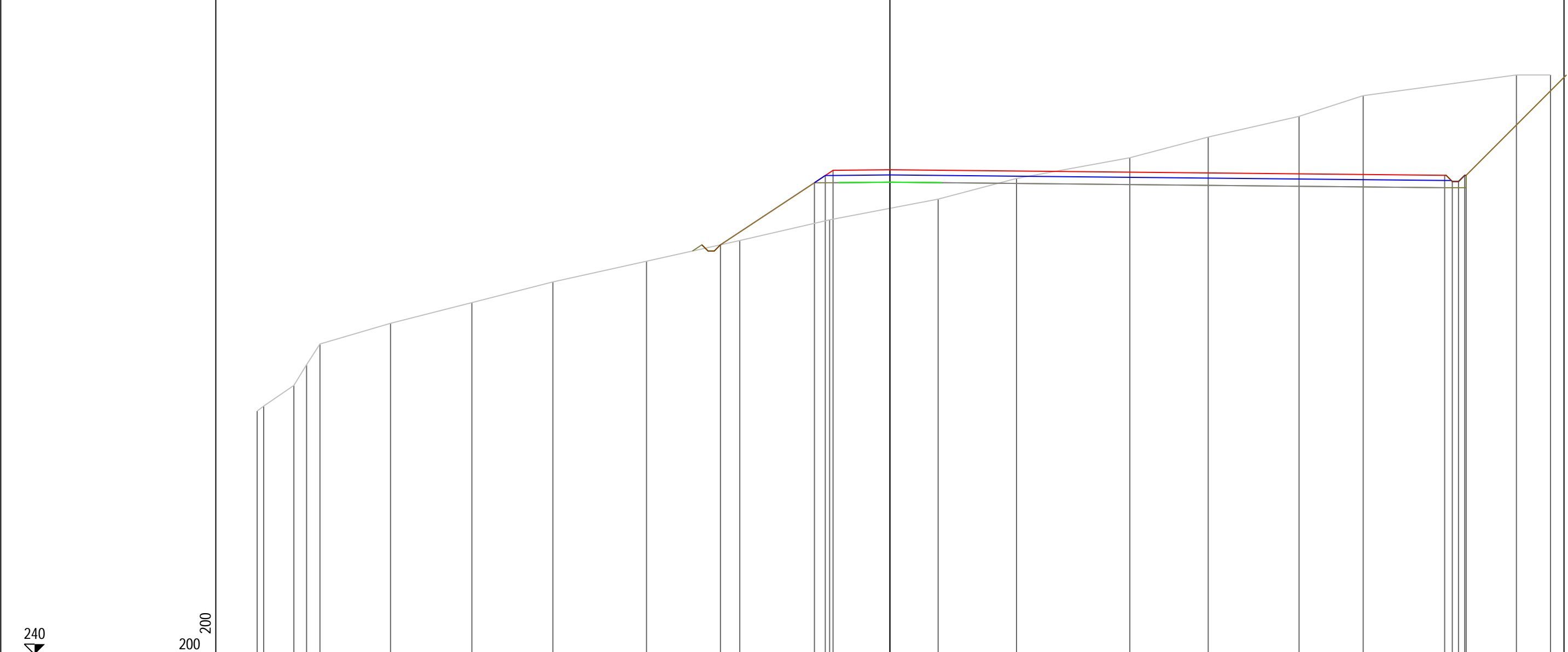

PROGRESSIVE TERRENO	251.76	252.00	253.00	254.00	255.00	256.00	257.00	258.00	259.00	260.00	261.00	262.00	263.00	264.00	265.00	266.00	267.00	268.00	268.00	
PARZIALI TERRENO	0.32	1.46	0.61	0.65	3.41	3.93	3.92	4.53	4.51	4.34	5.25	3.79	5.48	3.79	4.40	3.10	7.41	1.65		
QUOTE TERRENO	-30.60	-30.28	-28.82	-28.21	-27.56	-24.15	-20.22	-16.30	-11.77	-7.26	-2.92	2.33	6.12	11.60	15.39	19.79	22.89	30.30	31.95	
PROGRESSIVE PROGETTO										-8.19	-3.65	-3.13	-2.75	0.00						
PARZIALI PROGETTO										4.54	0.52	0.38	2.75		26.83					4.92
QUOTE PROGETTO										263.79	263.14	263.39	263.42							

PROFILO Asse4

SEZIONE 297

PROGRESSIVA 2969.42

A STERRO m<sup>2</sup> 31.22  
 B RIPORTO m<sup>2</sup> 55.60

240  
 200 200

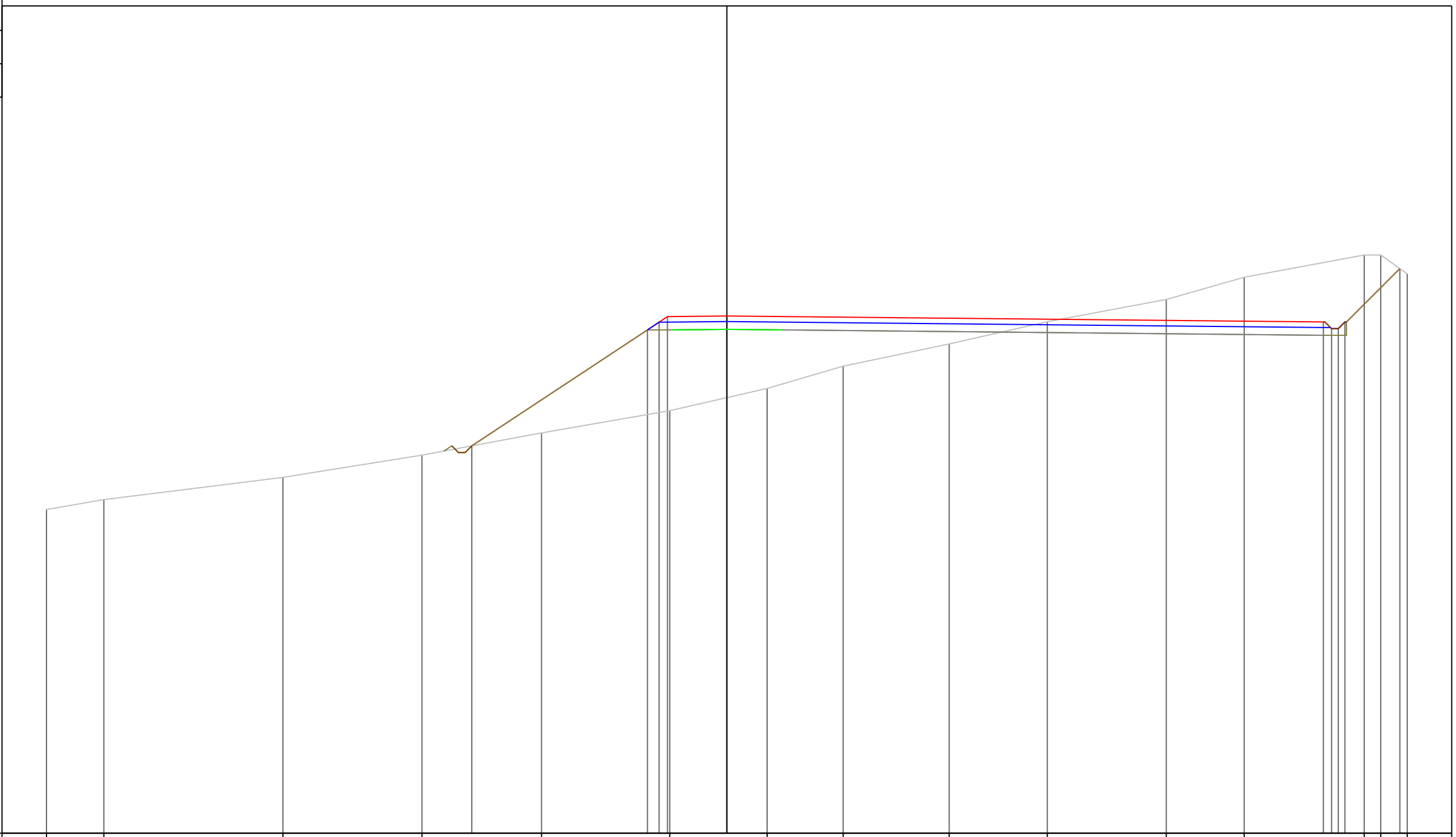

PROGRESSIVE TERRENO	-30.60	-28.02		-19.97	-13.71	-8.34	-2.57	1.81	5.23	10.00	14.41	19.76	23.27	28.66	29.41	30.60		
PARZIALI TERRENO	2.58	8.05	6.26	5.37	5.77	4.38	3.42	4.77	4.41	5.35	3.51	5.39	0.75	1.19				
QUOTE TERRENO	254.55	255.00	256.00	257.00	258.00	259.00	260.00	261.00	262.00	263.00	264.00	265.00	266.00	266.00	265.15			
PROGRESSIVE PROGETTO				-11.47			-3.57	-3.05	-2.67	0.00				26.83	27.20	27.50	27.80	30.27
PARZIALI PROGETTO					7.90		0.52	0.38	2.67		26.83			0.37	0.30	0.30	2.47	
QUOTE PROGETTO				267.42			262.63	262.98	263.23	263.26				262.99	262.69	262.69	262.99	265.39

PROFILO Asse4

SEZIONE 298

PROGRESSIVA 2969.44

A STERRO m<sup>2</sup> 31.07  
 B RIPORTO m<sup>2</sup> 158.46

243

200  
 200

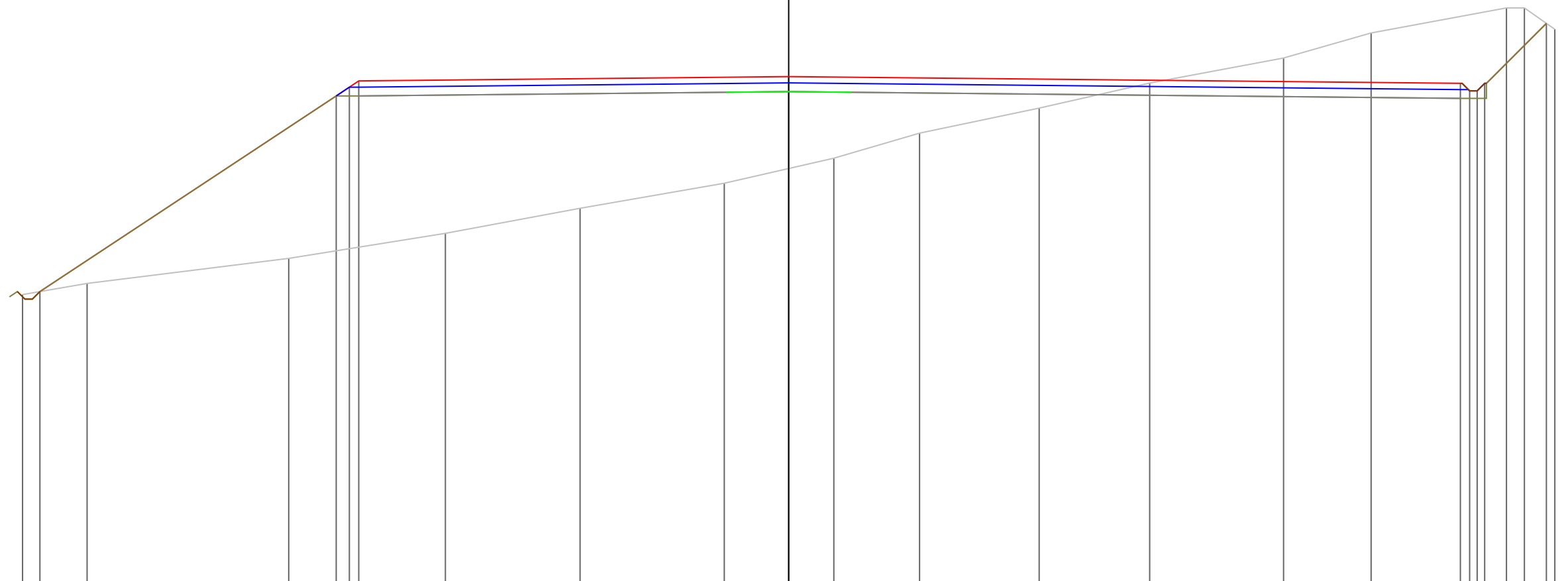

PROGRESSIVE TERRENO	-30.60	-28.02	-19.97	-13.71	-8.33	-2.57	1.80	5.23	10.00	14.42	19.77	23.26	28.67	29.39	30.60		
PARZIALI TERRENO	2.58	8.05	6.26	5.38	5.76	4.37	3.43	4.77	4.42	5.35	3.49	5.41	0.72	1.21			
QUOTE TERRENO	254.55	255.00	256.00	257.00	258.00	259.00	260.00	261.00	262.00	263.00	264.00	265.00	266.00	266.00	265.15		
PROGRESSIVE PROGETTO	-29.91		-18.07	-17.55	-17.17		0.00						26.83	27.20	27.50	27.80	30.26
PARZIALI PROGETTO		11.84	0.52	0.38		17.17			26.83				0.37	0.30	0.30	2.46	
QUOTE PROGETTO	254.67		262.49	262.84	263.09		263.26						262.99	262.69	262.69	262.99	265.38

PROFILO Asse4

SEZIONE 299

PROGRESSIVA 2983.43

A STERRO m<sup>2</sup> 26.43  
 B RIPORTO m<sup>2</sup> 128.24

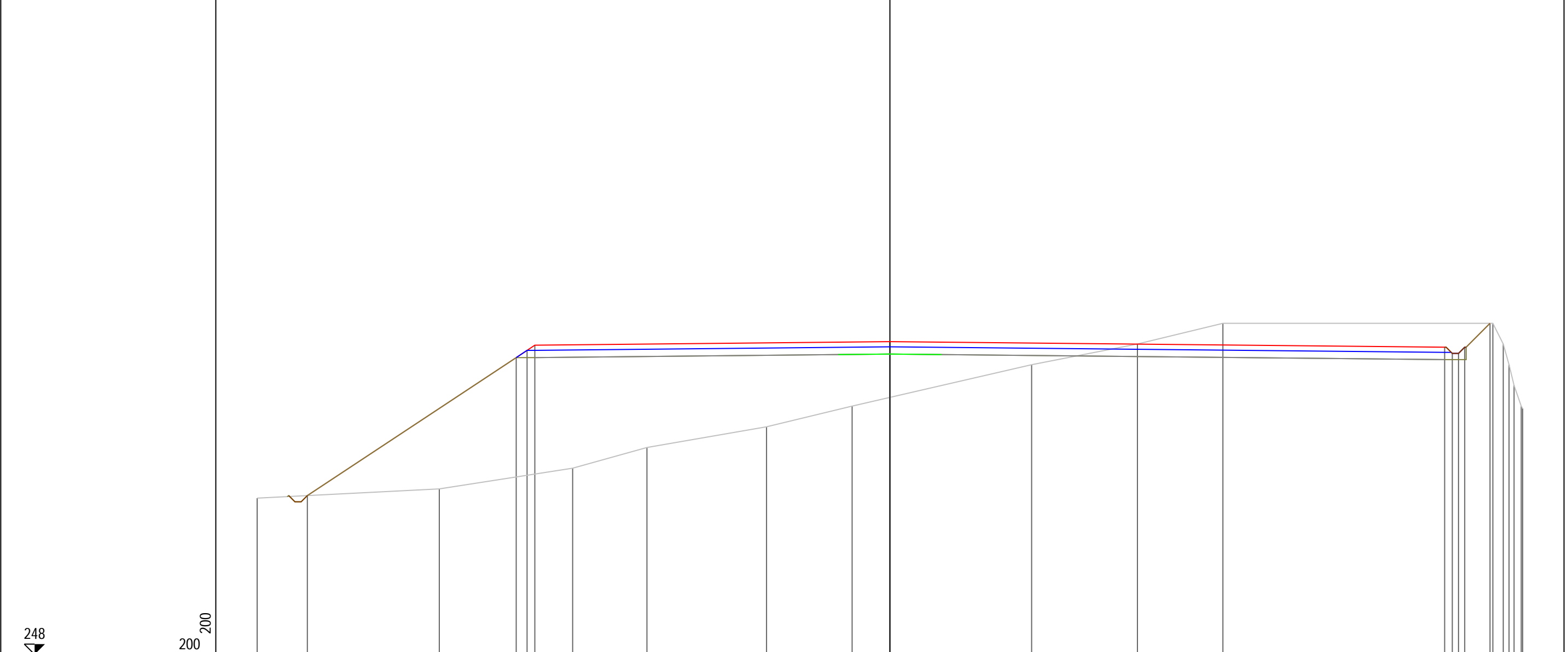

PROGRESSIVE TERRENO	-30.60	-21.79	-15.34	-11.75	-5.97	-1.83	6.85	11.97	16.10	29.16	29.66	29.94	30.18	30.53	30.60
PARZIALI TERRENO	8.81	6.45	3.59	5.78	4.14	8.68	5.12	4.13	13.06	0.50	0.28	0.24	0.35	0.07	
QUOTE TERRENO	255.55	256.00	257.00	258.00	259.00	260.00	262.00	263.00	264.00	264.00	263.00	262.00	261.00	260.00	259.88
PROGRESSIVE PROGETTO	-28.17	-18.07	-17.55	-17.17	0.00					26.83	27.20	27.50	27.80	29.02	
PARZIALI PROGETTO	10.10	0.52	0.38	17.17					26.83	0.37	0.30	0.30	1.22		
QUOTE PROGETTO	265.68	262.34	262.69	262.94	263.11					262.85	262.55	262.55	262.85	264.00	

PROFILO Asse4

SEZIONE 300

PROGRESSIVA 2994.73

A STERRO m<sup>2</sup> 15.60  
B RIPORTO m<sup>2</sup> 87.29

245

200  
200

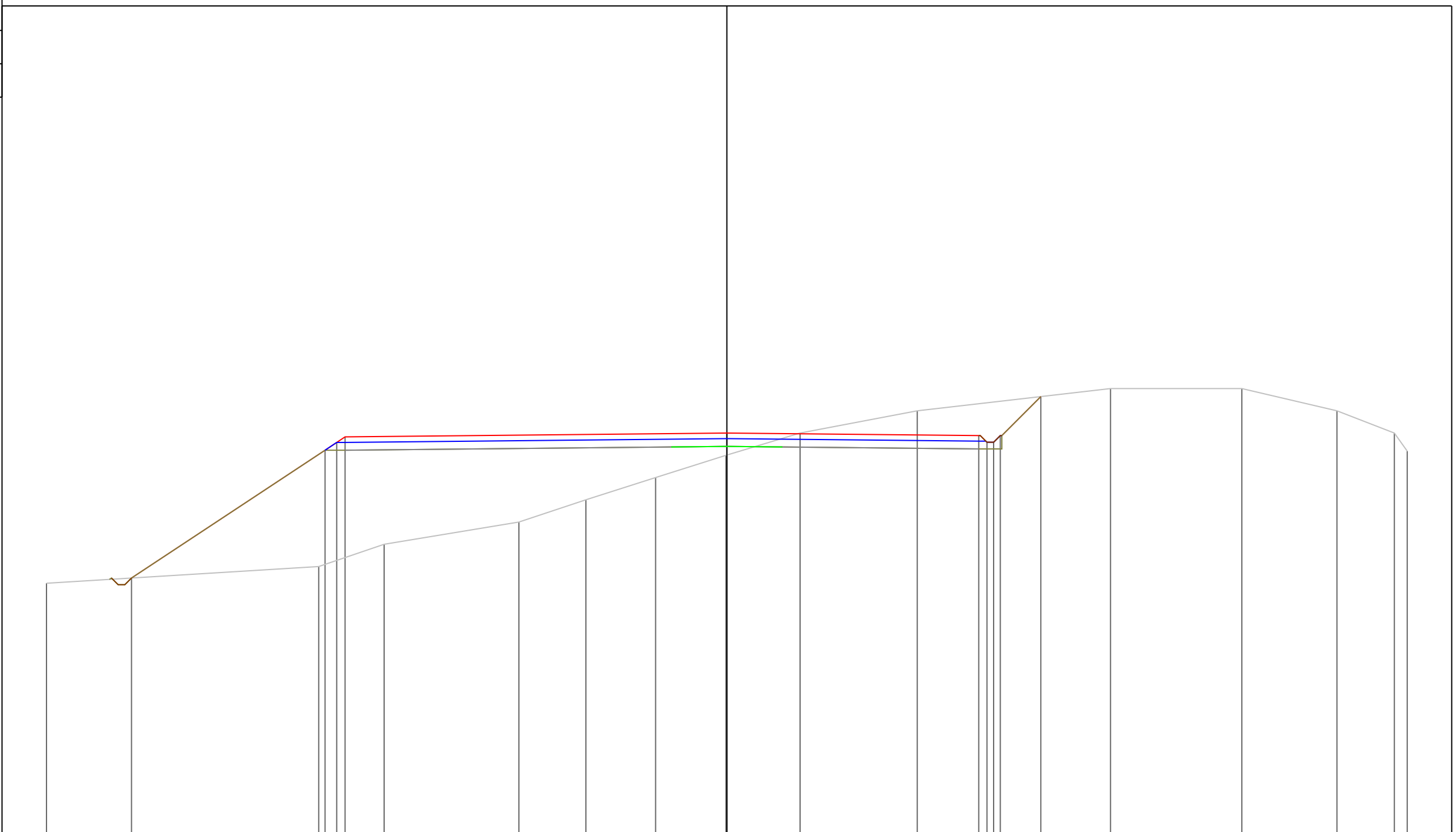

PROGRESSIVE TERRENO	-30.60		-18.36	-15.42		-9.35	-6.34	-3.21	-0.04	3.29	8.56		17.25	23.16	27.44	30.02	30.60
PARZIALI TERRENO		12.24	2.94	6.07	3.01	3.13	3.17	3.33	5.27	8.69	5.91	4.28	2.58	0.58			
QUOTE TERRENO	256.25		257.00	258.00	259.00	260.00	261.00	262.00	263.00	264.00		265.00	266.00	267.00	268.00	269.00	270.00
PROGRESSIVE PROGETTO		-26.78	-18.07	-17.55	-17.17			0.00				11.33	11.70	12.00	12.30	14.12	
PARZIALI PROGETTO		8.71	0.52	0.38		17.17			11.33		0.37	0.30	0.30	1.82			
QUOTE PROGETTO	256.48		262.23	262.58	262.83		263.00				262.89	262.59	262.59	262.89	264.64		

PROFILO Asse4

SEZIONE 301

PROGRESSIVA 3041.92

A STERRO m<sup>2</sup> 6.08  
B RIPORTO m<sup>2</sup> 26.06

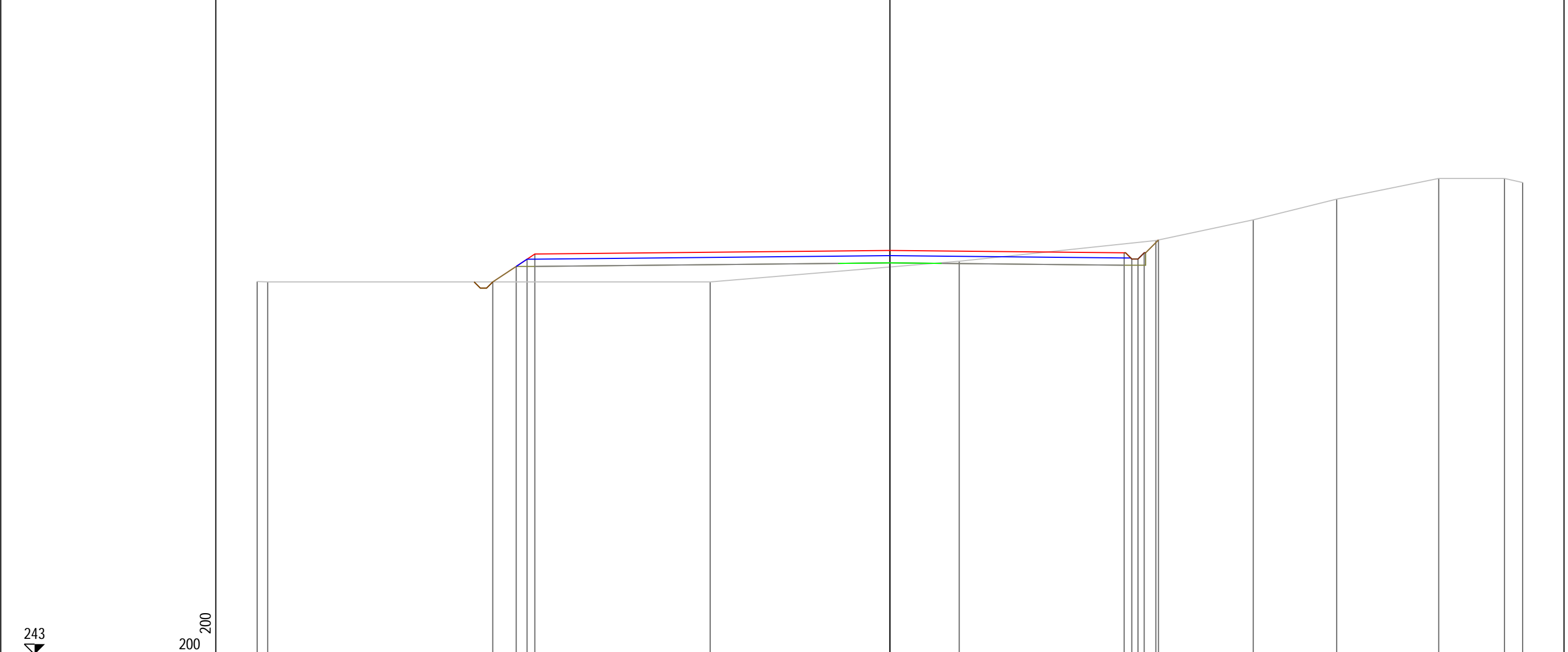

PROGRESSIVE TERRENO	-30.60	-30.09		-8.69		3.35		12.86	17.57	21.61	26.54	29.72	30.60
PARZIALI TERRENO	0.51		21.40		12.04		9.51		4.71	4.04	4.93	3.18	0.88
QUOTE TERRENO	261.02	261.00		261.00		262.00		263.00	264.00	265.00	266.00	266.00	265.80
PROGRESSIVE PROGETTO		-19.21	-18.07	-17.55	-17.17		0.00		11.33	11.70	12.00	12.30	12.99
PARZIALI PROGETTO		1.14	0.52	0.38		17.17		11.33	0.37	0.30	0.30	0.30	0.69
QUOTE PROGETTO		261.00	261.75	262.10	262.35		262.52		262.41	262.11	262.11	262.41	263.03



PROFILO Asse4

SEZIONE 303

PROGRESSIVA 3044.92

A STERRO m<sup>2</sup> 7.91  
 B RIPORTO m<sup>2</sup> 4.09

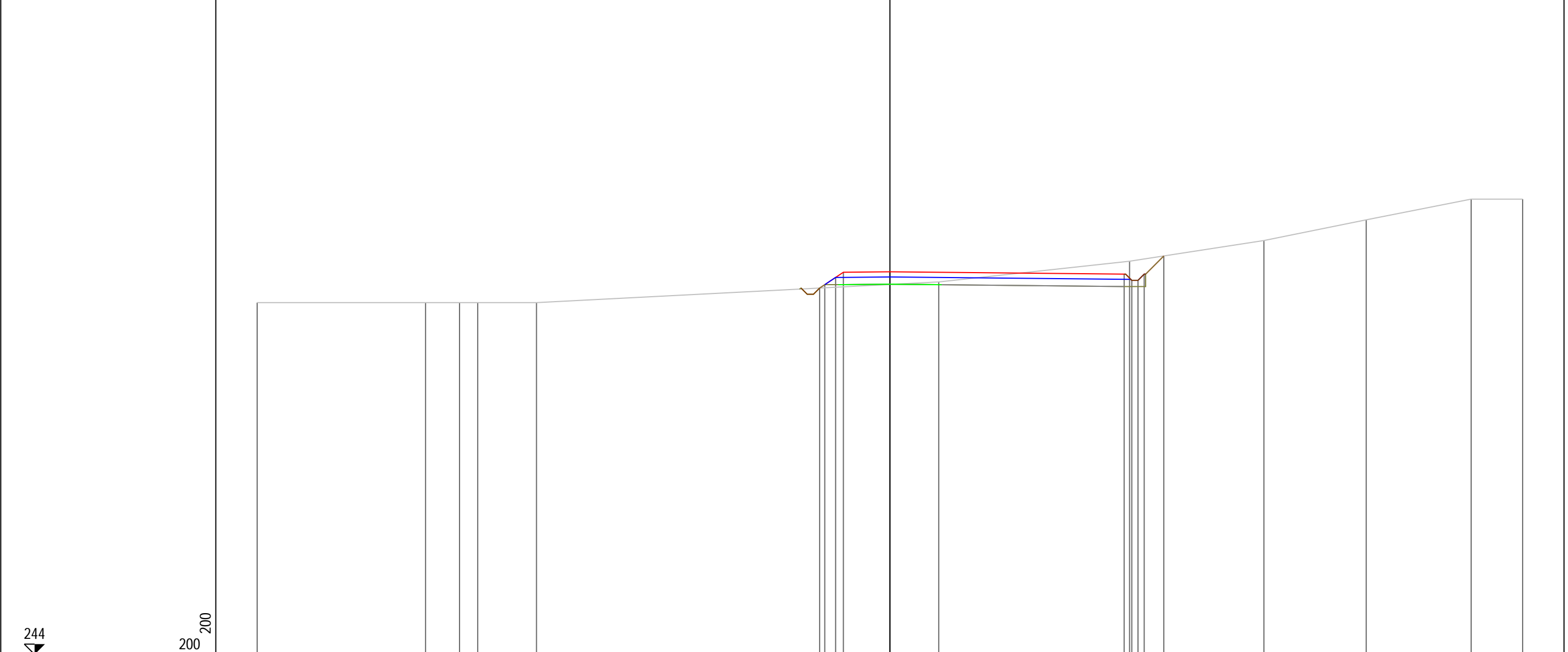

PROGRESSIVE TERRENO	-30.60	-22.46	-20.81	-19.93	-17.09		2.36		11.59	18.09	23.03	28.11	30.60		
PARZIALI TERRENO		8.14	1.65	0.88	2.84	19.45		9.23		6.50	4.94	5.08	2.49		
QUOTE TERRENO	261.00	261.00	261.00	261.00	261.00		262.00		263.00	264.00	265.00	266.00	266.00		
PROGRESSIVE PROGETTO															
PARZIALI PROGETTO							0.25	0.52	0.38	2.25	11.33	0.37	0.30	0.30	0.95
QUOTE PROGETTO							261.70	261.87	262.22	262.47	262.49	263.25	263.25	263.25	263.25



PROFILO Asse4

SEZIONE 304

PROGRESSIVA 3044.94

A STERRO m<sup>2</sup> 10.40  
 B RIPORTO m<sup>2</sup> 4.05

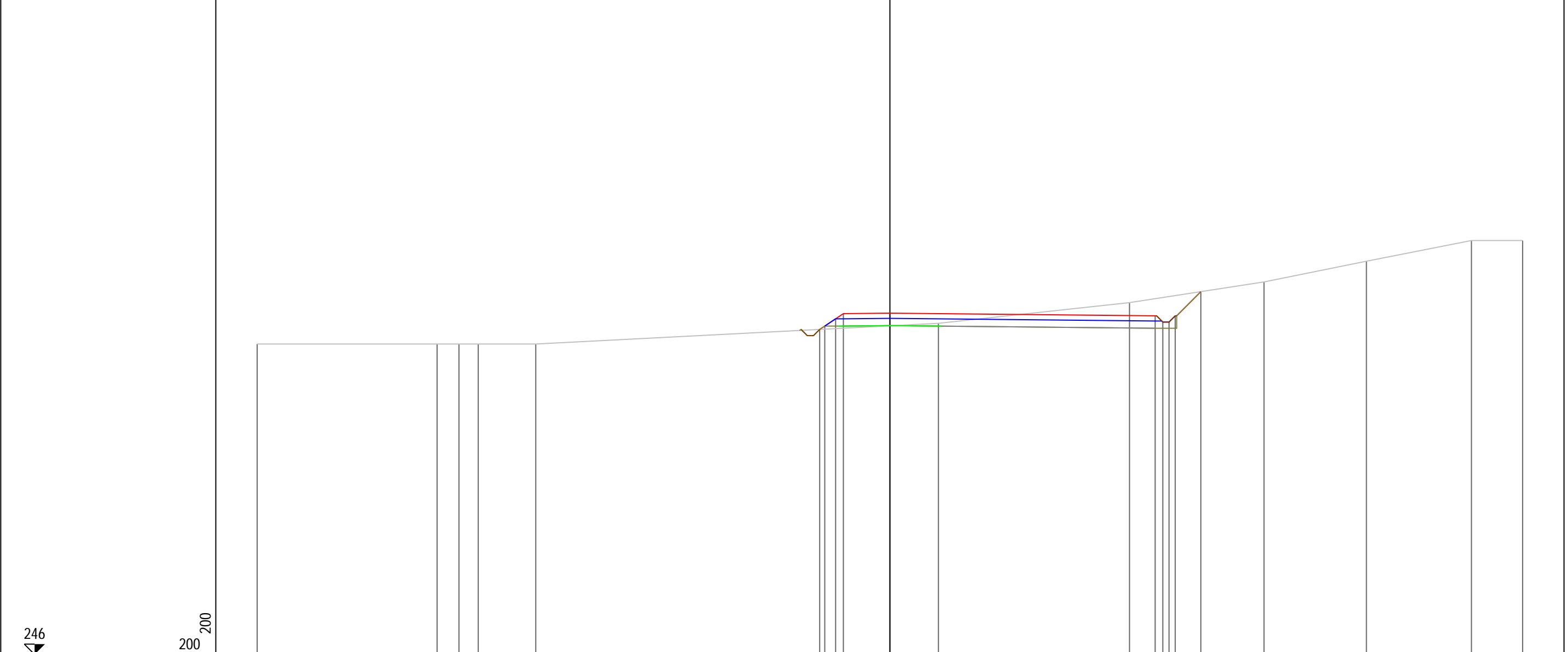

PROGRESSIVE TERRENO	-30.60	-21.90	-20.84	-19.91	-17.13		2.35		11.59	18.09	23.04	28.12	30.60		
PARZIALI TERRENO	8.70	1.06	0.93	2.78	19.48	9.24	6.50	4.95	5.08	2.48					
QUOTE TERRENO	261.00	261.00	261.00	261.00	261.00	262.00	263.00	264.00	265.00	266.00	266.00				
PROGRESSIVE PROGETTO						3.40	3.15	2.63	2.25	0.00	12.83	13.20	13.50	13.80	15.04
PARZIALI PROGETTO						0.25	0.52	0.38	2.25	12.83	0.37	0.30	0.30	1.24	
QUOTE PROGETTO						261.71	261.87	262.22	262.47	262.49	262.36	262.06	262.36	263.53	

PROFILO Asse4

SEZIONE 305

PROGRESSIVA 3050.92

A STERRO m<sup>2</sup> 16.48  
B RIPORTO m<sup>2</sup> 0.91

248

200  
200

PROGRESSIVE TERRENO	-30.60	-3.84	9.65	19.83	25.36	30.60
PARZIALI TERRENO	26.76	13.49	10.18	5.53	5.24	
QUOTE TERRENO	261.03	262.00	263.00	264.00	265.00	265.00
PROGRESSIVE PROGETTO		-3.96 -3.29 -2.92 -2.62 -2.32	0.00	12.83 13.20 13.50 13.80	15.10	
PARZIALI PROGETTO		0.67 0.37 0.30 0.30	2.32	12.83	1.30	
QUOTE PROGETTO		262.00 262.41 262.11 262.41	262.43	262.30 262.00 262.30	263.54	

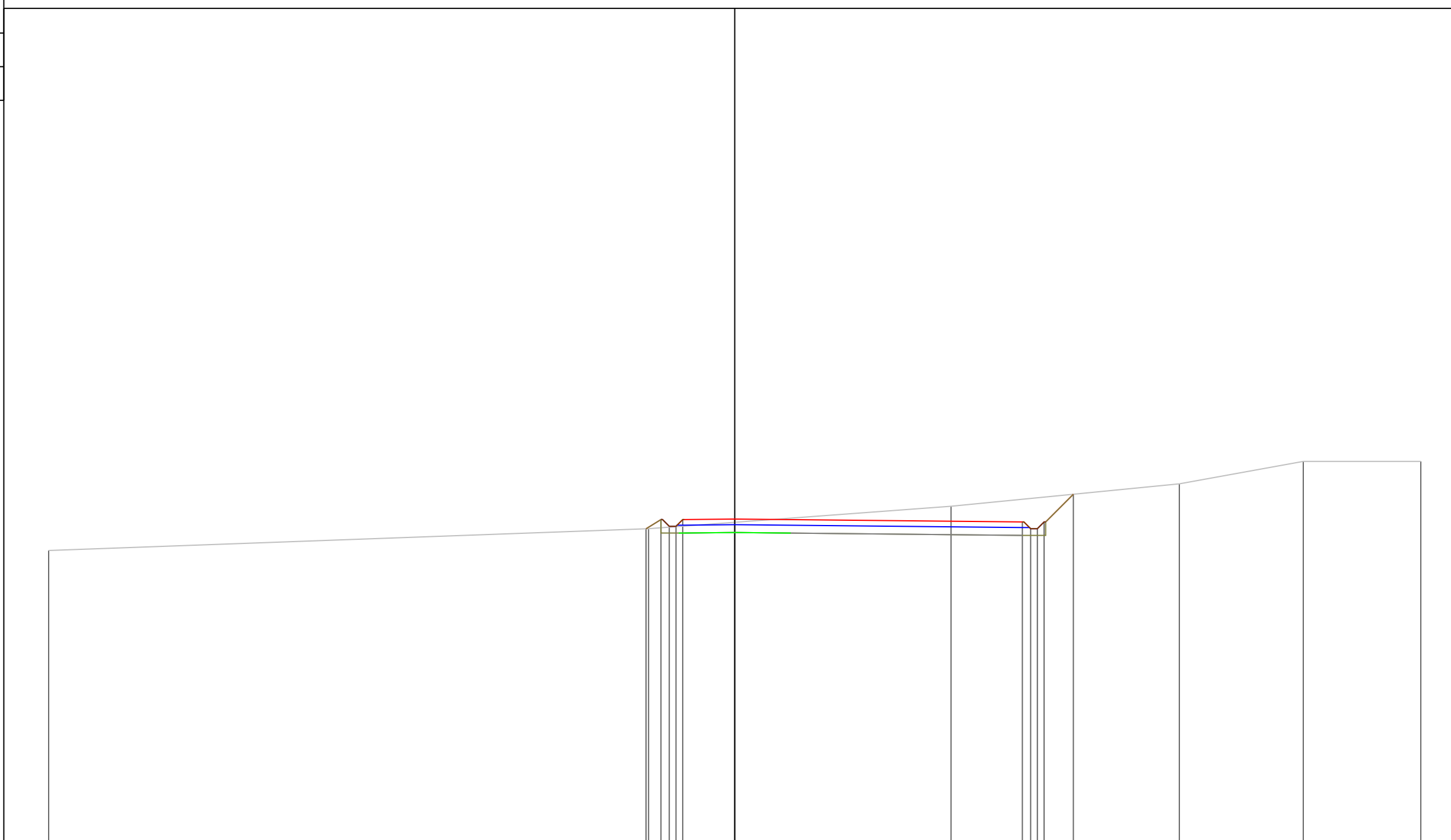

PROFILO Asse4

SEZIONE 306

PROGRESSIVA 3050.94

A STERRO m<sup>2</sup> 13.79  
 B RIPORTO m<sup>2</sup> 0.91

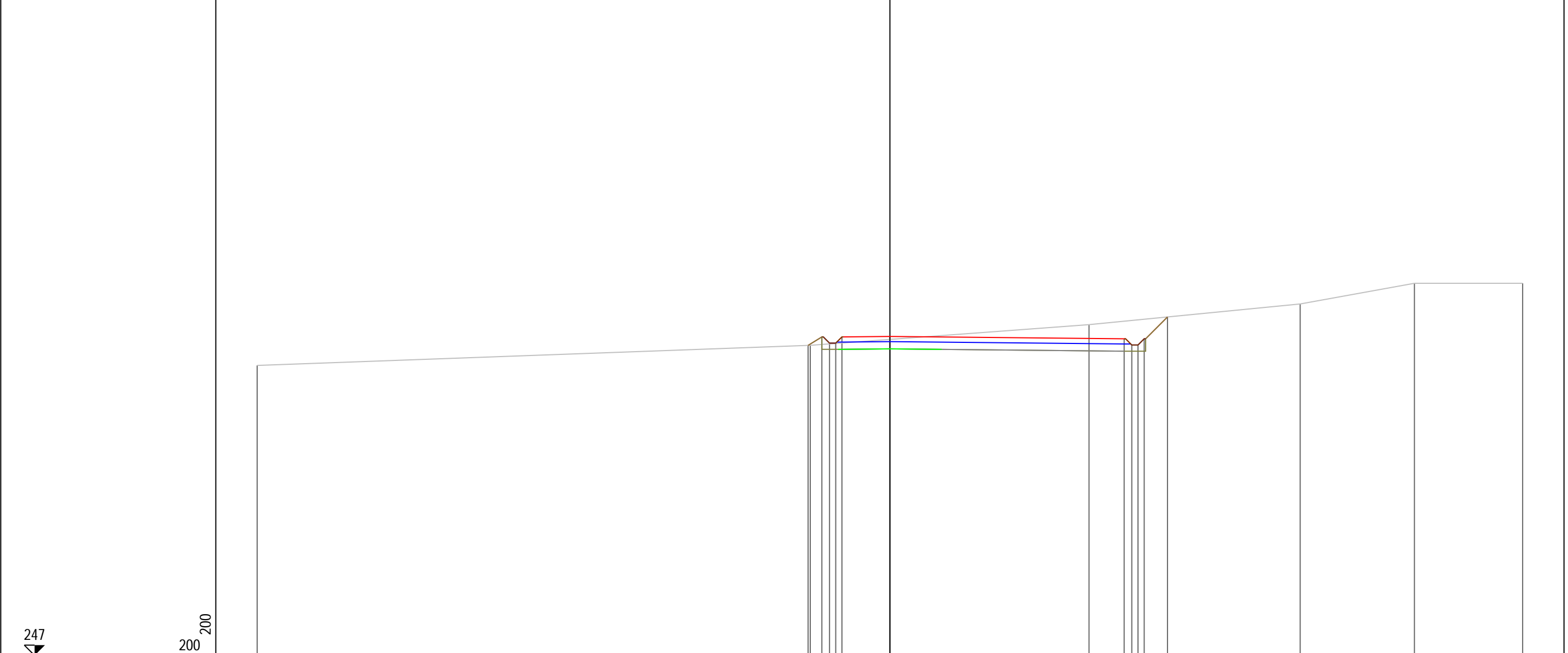

PROGRESSIVE TERRENO	-30.60	-3.85	9.63	19.84	25.37	30.60
PARZIALI TERRENO	26.75	13.48	10.21	5.53	5.23	
QUOTE TERRENO	261.03	262.00	263.00	264.00	265.00	265.00
PROGRESSIVE PROGETTO		-3.96 -3.29 -2.92 -2.62 -2.32	0.00	11.33 11.70 12.00 12.30	13.42	
PARZIALI PROGETTO		0.67 0.37 0.30 0.30	2.32	11.33 0.37 0.30 0.30	1.12	
QUOTE PROGETTO		262.00 262.41 262.11 262.41	262.43	262.32 262.02 262.32	263.37	





PROFILO Asse4

SEZIONE 309

PROGRESSIVA 3090.92

A STERRO m<sup>2</sup> 5.90  
B RIPORTO m<sup>2</sup> 34.78

234

200  
200

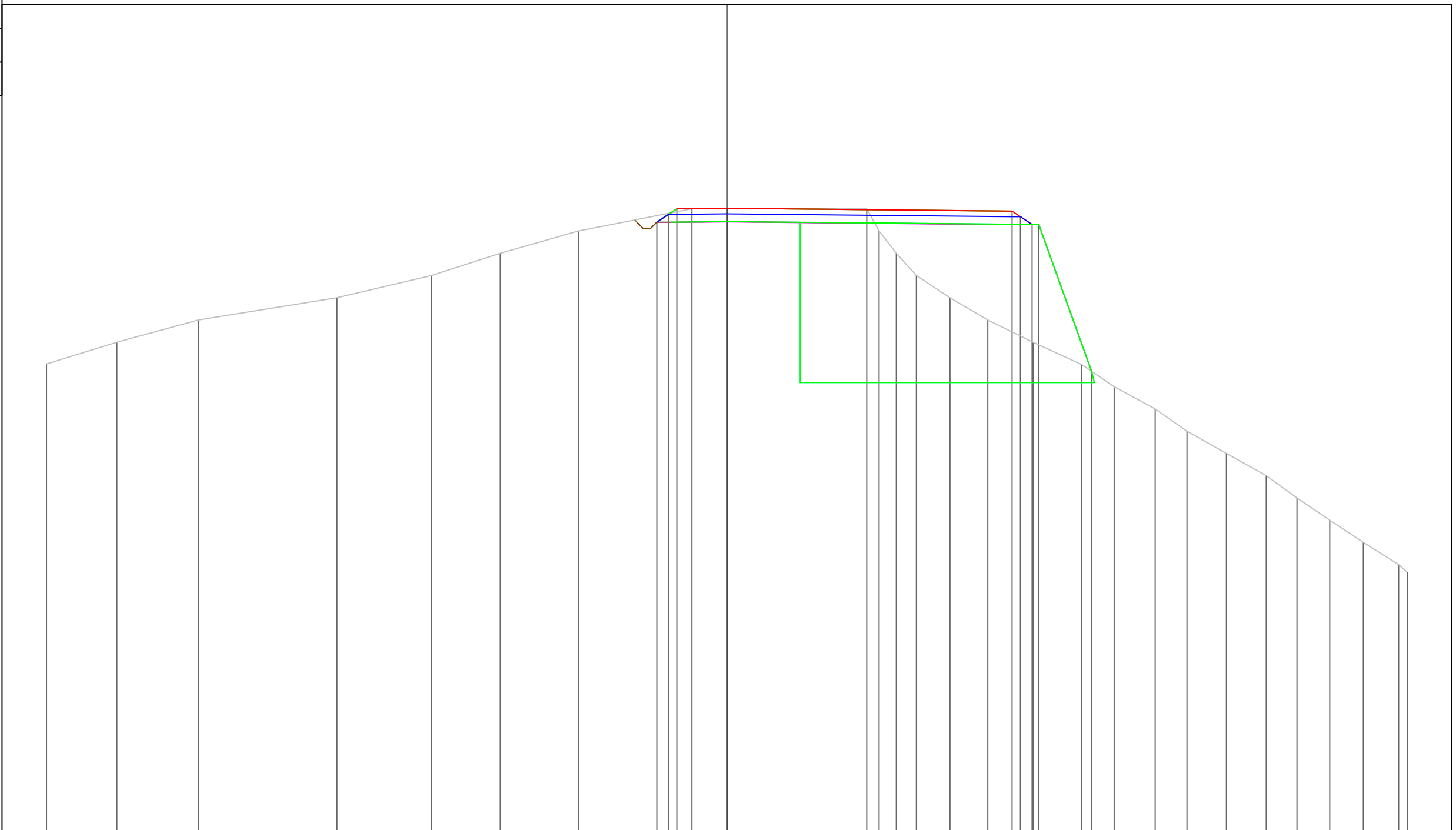

PROGRESSIVE TERRENO	-30.60	-27.44	-23.77	-17.54	-13.29	-10.19	-6.68	-1.57		6.29	6.85	7.62	8.52	10.03	11.74	13.77	15.95	17.42	19.26	20.69	22.47	24.26	25.64	27.11	28.63	30.21	30.60
PARZIALI TERRENO	3.16	3.67	6.23	4.25	3.10	3.51	5.11	7.86	0.56	0.77	0.90	1.51	1.71	2.03	2.18	1.47	1.84	1.43	1.78	1.79	1.38	1.47	1.52	1.58	0.39		
QUOTE TERRENO	255.02	256.00	257.00	258.00	259.00	260.00	261.00	262.00	262.00	261.00	260.00	259.00	258.00	257.00	256.00	255.00	254.00	253.00	252.00	251.00	250.00	249.00	248.00	247.00	246.00	245.65	
PROGRESSIVE PROGETTO									-3.15	-2.63	-2.25	0.00			12.83	13.20	13.73	14.03	16.41								
PARZIALI PROGETTO									0.52	0.38	2.25			12.83	0.37	0.53	0.30	2.38									
QUOTE PROGETTO									261.40	261.75	262.00	262.02			261.89	261.64	261.29	261.29	254.69								



