

COMMITTENTE:



PROGETTAZIONE:



S.O. COORDINAMENTO DI SISTEMA E PFTE

PROGETTO DI FATTIBILITA' TECNICO ECONOMICA DI 2°FASE

RADDOPPIO DECIMOMANNU-VILLAMASSARGIA

Lotto 2

Book sezioni trasversali

SCALA :

1:200

COMMESSA LOTTO FASE ENTE TIPO DOC. OPERA/DISCIPLINA PROGR. REV.

RR0P 02 R 14 W9 IF 00 00 001 B

Revis.	Descrizione	Redatto	Data	Verificato	Data	Approvato	Data	Autorizzato	Data
A	Emissione esecutiva	L.Zonnino	Mar 2023	G.Crisà	Mar 2023	T. Paoletti	Mar 2023	G. Ingrosso	Lug 2023
B	Emissione esecutiva	L.Zonnino	Lug 2023	G.Crisà	Lug 2023	T. Paoletti	Lug 2023	G. Ingrosso	Lug 2023

ITALFERRE S.p.A.
COORDINAMENTO DI SISTEMA
Dott. Ing. GIULIANO INGROSSO
Ordine degli Ingegneri di ROMA N. 20802

Materiale	Area(m2)
Scavo	12.964
Rilevato	0.029
Scotico	7.494
SuperCompattato	3.810
Subballast	1.524
Inerbimento	0.219

Prog. = 0+000.000

Q. Rif. = -1.000

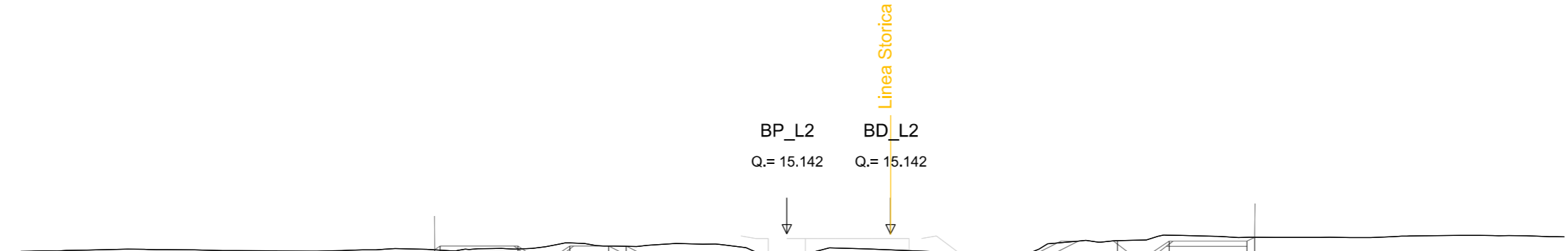

Quote Terreno		14.531 14.531		14.556		14.672		14.672		14.660		14.704		14.738		14.768		14.244		14.593		14.525		14.126		14.247		14.885		14.899		14.950		15.091		15.098						
Quote Progetto		14.531		14.672		14.672		14.672		14.672		14.247		13.822		13.822		13.952		14.012		13.952		13.822		14.242		14.862		14.362		14.362		14.862		14.862		15.010				
Dist. Progr. Progetto		-13.583		-10.372		-9.622		-8.372		-6.872		-5.350		-4.850		-4.350		0.000		2.000		4.000		8.350		8.850		12.752		13.502		14.002		14.752		17.752		18.047				
Dist. Parziali		0.211		3.000		0.750		0.500		0.750		1.500		0.671		0.088		0.500		0.500		4.350		2.000		2.000		4.350		0.500		3.902		0.750		0.500		0.750		3.000		0.295

Materiale	Area(m2)
Scavo	15.942
Rilevato	0.069
Scotico	7.428
SuperCompattato	3.810
Subballast	1.524
Inerbimento	0.172

Prog. = 0+050.000

Q. Rif. = -1.000

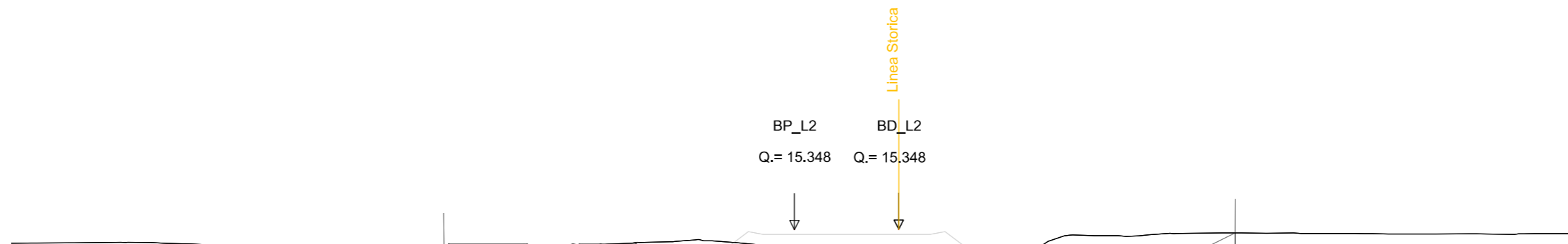

Quote Terreno	14.685	14.698	14.699	14.748	14.770	14.811	14.857	14.872	14.883	14.917	14.443	14.736	14.695	14.329	14.369	15.113	15.132	15.116	15.117	15.210	15.225		
Quote Progetto	14.685	14.811	14.811	14.311	14.311	14.811	14.811	14.453	14.448	14.028	14.159	14.219	14.159	14.028	14.329	14.448	14.460	13.960	13.960	14.460	14.460	15.225	
Dist. Progr. Progetto	-13.425	-13.237	-10.237	-9.487	-8.987	-8.237	-6.737	-6.066	-5.350	-4.850	-4.350	-0.000	2.000	4.000	8.350	8.611	8.850	10.350	11.100	11.600	12.350	15.350	16.880
Dist. Parziali	0.188	3.000	0.750	0.500	0.750	1.500	0.671	0.685	0.500	0.500	4.350	2.000	2.000	4.350	0.500	1.500	0.750	0.500	0.750	3.000	1.530		

Materiale	Area(m2)
Scavo	12.878
Rilevato	0.482
Scotico	7.384
SuperCompattato	3.810
Subballast	1.524
Inerbimento	0.139

Prog. = 0+150.000

Q. Rif. = 0,000

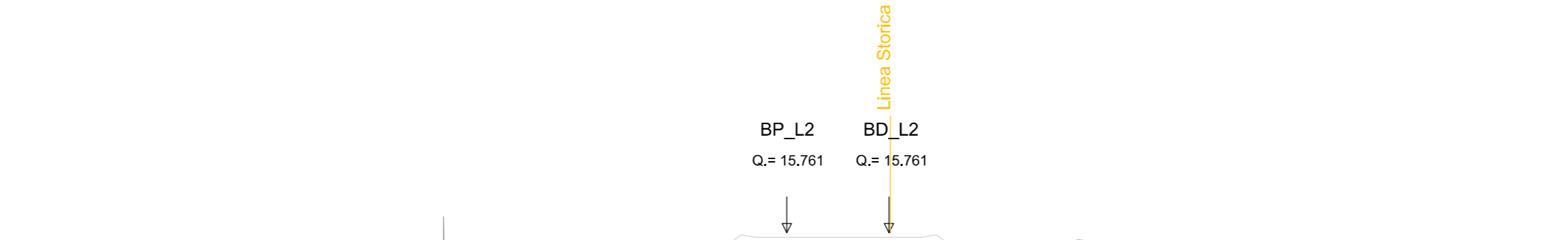

Quote Terreno			15.085		15.010		14.761		15.084		14.713		14.491	
Quote Progetto			15.085		15.164		14.572		14.572		14.441		14.873	
Dist. Progr. Progetto			-13.234		-10.116		-0.000		4.000		8.350		15.350	
Dist. Parziali			0.118		0.750		4.350		2.000		0.500		1.146	

Materiale	Area(m2)
Scavo	13.068
Rilevato	0.224
Scotico	7.475
SuperCompattato	3.810
Subballast	1.524
Inerbimento	0.205

Prog. = 0+200.000

Q. Rif. = 0,000

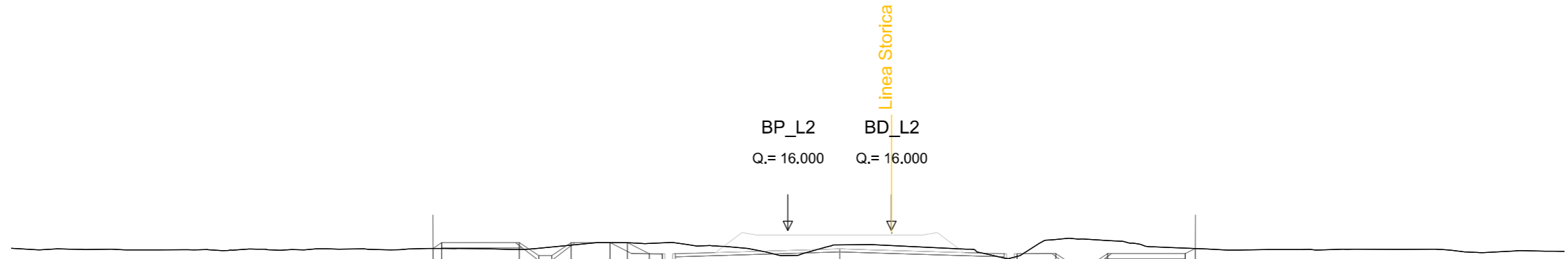

Quote Terreno		15.309	15.310	15.267	15.315	15.363	15.435	15.531	15.528	15.501	15.523	15.033	15.443	15.417	14.939	15.000	15.655	15.681	15.664	15.615	15.321	15.306		
Quote Progetto		15.309	15.531	15.531	15.031	15.031	15.531	15.531	15.531	15.105	15.100	14.680	14.811	14.871	14.811	14.680	15.100	15.112	14.612	14.612	15.112	15.112	15.112	15.306
Dist. Progr. Progetto		-13.703	-13.371	-10.371	-9.621	-9.121	-8.371	-6.871	-6.200	-5.350	-4.850	-4.350	-0.000	2.000	4.000	8.350	8.850	10.350	11.100	11.600	12.350	15.350	15.737	
Dist. Parziali		0.332	3.000	0.750	0.500	0.750	1.500	0.671	0.685	0.500	0.500	4.350	2.000	2.000	4.350	0.500	1.500	0.750	0.500	0.750	3.000	0.387		

Materiale	Area(m2)
Scavo	10.394
Rilevato	0.145
Scotico	7.405
SuperCompattato	3.810
Subballast	1.524
Inerbimento	0.155

Prog. = 0+250.000

Q. Rif. = 0,000

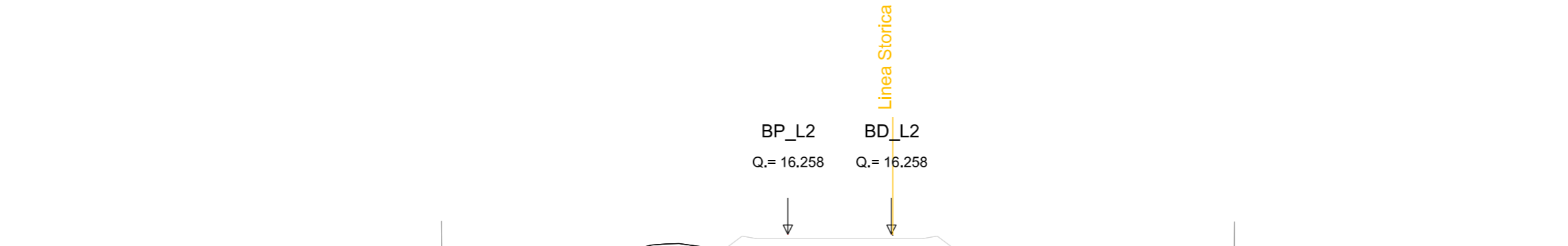

Quote Terreno		15.468	15.544	15.541	15.651	15.713	15.819	15.877	15.887	15.226	15.573	15.547	15.352	15.358	15.581	15.553	15.557	15.550	15.448				
Quote Progetto		15.468	15.651	15.651	15.151	15.151	15.651	15.363	15.358	14.938	15.068	15.128	15.068	14.938	15.358	15.601	15.101	15.101	15.601	15.601	15.438		
Dist. Progr. Progetto		-13.374	-13.098	-10.098	-9.348	-8.848	-8.098	-6.598	-5.927	-5.350	-4.850	-4.350	-0.000	2.000	4.000	8.350	8.850	11.998	12.748	13.248	13.998	16.998	17.243
Dist. Parziali		0.276	3.000	0.750	0.500	0.750	1.500	0.663	0.677	0.500	0.500	4.350	2.000	2.000	4.350	0.500	3.148	0.750	0.500	0.750	3.000	0.245	

Materiale	Area(m2)
Scavo	8.831
Rilevato	0.494
Scotico	7.577
SuperCompattato	3.810
Subballast	1.524
Inerbimento	0.320

Prog. = 0+300.000

Q. Rif. = 0.000

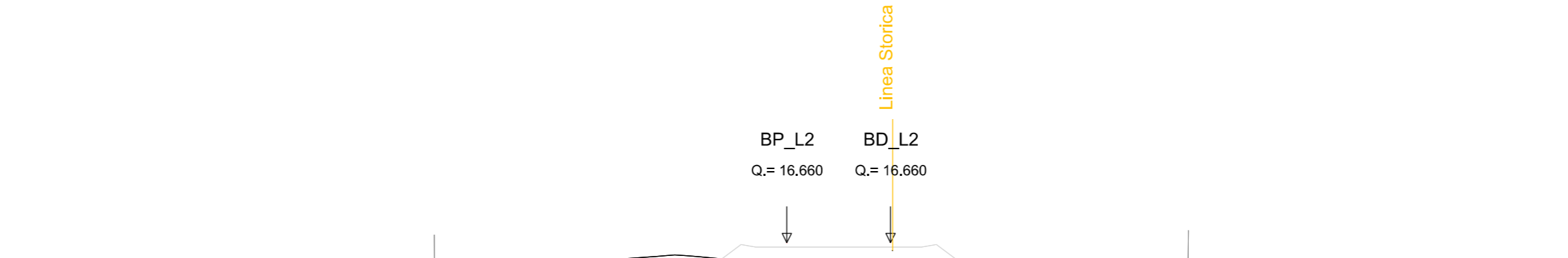

	15.667	15.681	15.796	15.839	15.871	15.918	16.029	16.063	16.101	16.141	16.183	15.579	15.827	15.770	15.459	15.692	15.870	15.965	15.983	15.994	15.830	
Quote Terreno	15.667	15.681	15.796	15.839	15.871	15.918	16.029	16.063	16.101	16.141	16.183	15.579	15.827	15.770	15.459	15.692	15.870	15.965	15.983	15.994	15.830	
Quote Progetto	15.667	16.029	16.029	15.529	15.529	16.029	16.029	16.029	15.765	15.760	15.340	15.471	15.531	15.471	15.340	15.760	15.772	15.272	15.272	15.772	15.772	15.772
Dist. Progr. Progetto	-13.592	-13.049	-10.049	-9.299	-8.799	-8.049	-6.549	-5.878	-5.350	-4.850	-4.350	-0.000	2.000	4.000	8.350	8.850	9.166	10.350	11.100	11.600	12.350	15.350
Dist. Parziali	0.543	3.000	0.750	0.500	0.750	1.500	0.511	0.528	0.500	0.500	4.350	2.000	2.000	4.350	0.500	1.500	0.750	0.500	0.750	3.000	0.129	

Materiale	Area(m2)
Scavo	11.196
Rilevato	0.193
Scotico	7.610
SuperCompattato	4.064
Subballast	1.547
Inerbimento	1.052

Prog. = 0+450.000

Q. Rif. = 1.000

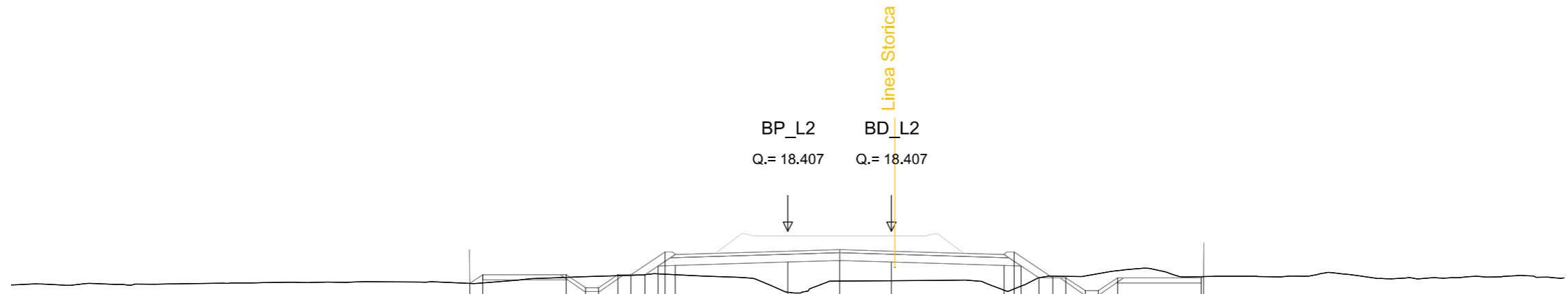

Quote Terreno	16.391 16.408	16.624 16.651 16.667 16.690 16.705 16.724 16.741 16.756 16.772	16.050	16.477	16.493	16.131 16.149 16.167 16.185 16.203 16.221 16.239 16.257 16.275 16.293 16.311 16.329	16.654
Quote Progetto	16.391 16.724	16.724 16.224 16.224 16.724 16.724 16.724 17.066 17.606 17.086	17.216	17.276	17.216	17.086 17.606 17.066 16.607 16.663 16.607 16.607 16.107 16.107 16.607	16.607 16.654
Dist. Progr. Progetto	-12.287 -11.788	-8.563 -7.813 -7.313 -6.563 -6.063 -5.522 -5.010 -4.741 -4.350	-0.000	2.000	4.000	8.350 8.741 9.010 9.698 10.239 10.739 11.489 11.989 12.739	15.964 16.059
Dist. Parziali	0.499	3.225	4.350	2.000	2.000	4.350	0.095

Materiale	Area(m2)
Scavo	11.917
Rilevato	0.057
Scotico	8.549
SuperCompattato	4.064
Subballast	1.547
Inerbimento	1.706

Prog. = 0+700.000

Q. Rif. = 1.000

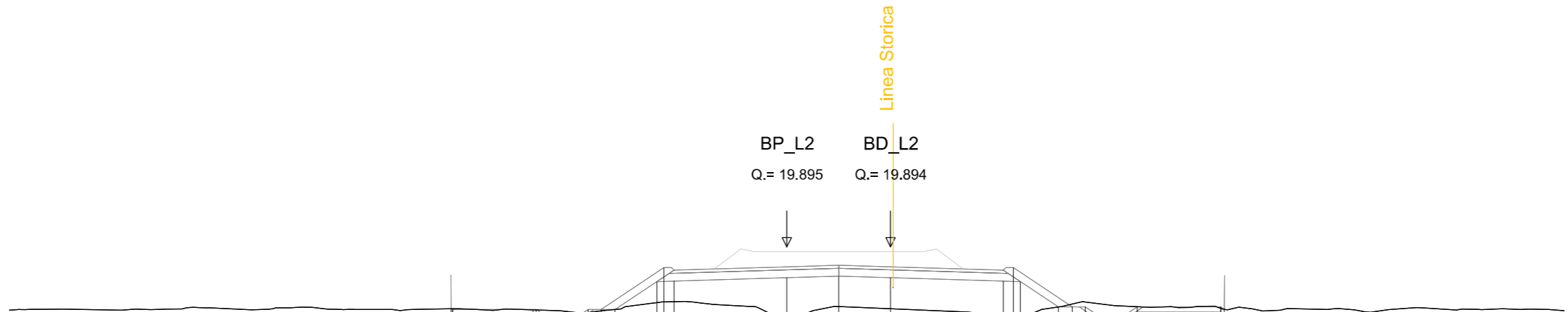

Quote Terreno		17.504	17.461	17.435	17.392	17.361	17.325	17.425	17.477	17.444	17.778	17.163	17.590	17.507	17.103	17.127	17.577	17.688	17.769	17.875	17.824	17.586	17.588	17.488		
Quote Progetto		17.504	17.477	17.477	16.977	16.977	17.477	17.477	17.477	18.553	19.093	18.573	18.703	18.763	18.703	18.573	19.093	17.577	17.577	17.577	17.077	17.077	17.577	17.577	17.485	
Dist. Progr. Progetto		-12.946	-12.890	-9.665	-8.915	-8.415	-7.665	-7.165	-6.625	-5.010	-4.741	-4.350	-0.000	2.000	4.000	8.350	8.741	9.010	10.474	11.015	11.515	12.265	12.765	13.515	16.740	16.877
Dist. Parziali		0.056	3.225	0.750	0.500	0.750	0.500	0.540	1.615	0.660	4.350	2.000	2.000	4.350	0.660	1.464	0.541	0.500	0.750	0.500	0.750	3.225	0.137			

Materiale	Area(m2)
Scavo	9.874
Rilevato	1.244
Scotico	8.568
SuperCompattato	4.064
Subballast	1.547
Inerbimento	1.716

Prog. = 0+800.000

Q. Rif. = 2.000

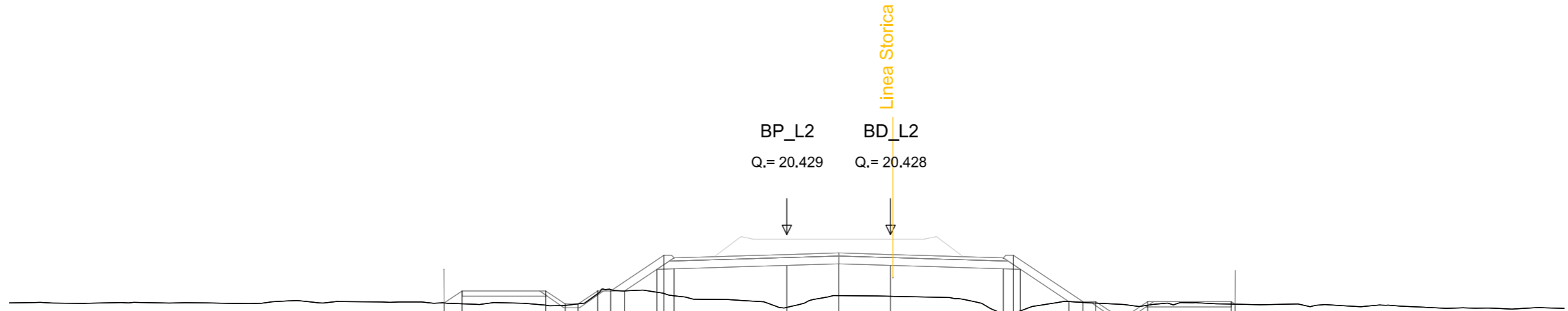

	1	2	3	4	5	6	7	8	9	10	11	12	13	14	15	16	17	18	19	20	21	22	23	24	25	26	27	28	29	30	31	32	33	34	35	36	37	38	39	40	41	42	43	44	45	46	47	48	49	50	51	52	53	54	55	56	57	58	59	60	61	62	63	64	65	66	67	68	69	70	71	72	73	74	75	76	77	78	79	80	81	82	83	84	85	86	87	88	89	90	91	92	93	94	95	96	97	98	99	100
Quote Terreno	17.793	17.758	17.710	17.699	17.759	18.148	18.308	18.254	18.254	18.088	18.266	18.068	17.625	18.073	18.051	17.373	17.482	17.843	17.812	17.786	17.749	17.712	17.706	17.746																																																																												
Quote Progetto	17.793	18.254	18.254	17.754	17.754	18.254	18.254	18.254	18.254	19.088	19.627	19.107	19.238	19.298	19.238	19.107	19.627	17.843	17.843	17.843	17.343	17.343	17.843	17.843																																																																												
Dist. Progr. Progetto	-13.217	-12.525	-9.300	-8.550	-8.050	-7.300	-6.800	-6.259	-5.010	-4.741	-4.350	-0.000	2.000	2.000	4.000	8.350	8.741	9.010	10.877	11.418	11.918	12.668	13.168	13.918	17.143	17.292																																																																										
Dist. Parziali	0.692	3.225	0.750	0.500	0.750	0.500	0.541	1.249	0.660	4.350	2.000	2.000	4.350	0.660	1.867	0.541	0.500	0.750	0.500	0.750	3.225	0.149																																																																														

Materiale	Area(m2)
Scavo	16.294
Rilevato	0.013
Scotico	8.833
SuperCompattato	4.064
Subballast	1.547
Inerbimento	1.918

Prog. = 1+050.000

Q. Rif. = 2.000

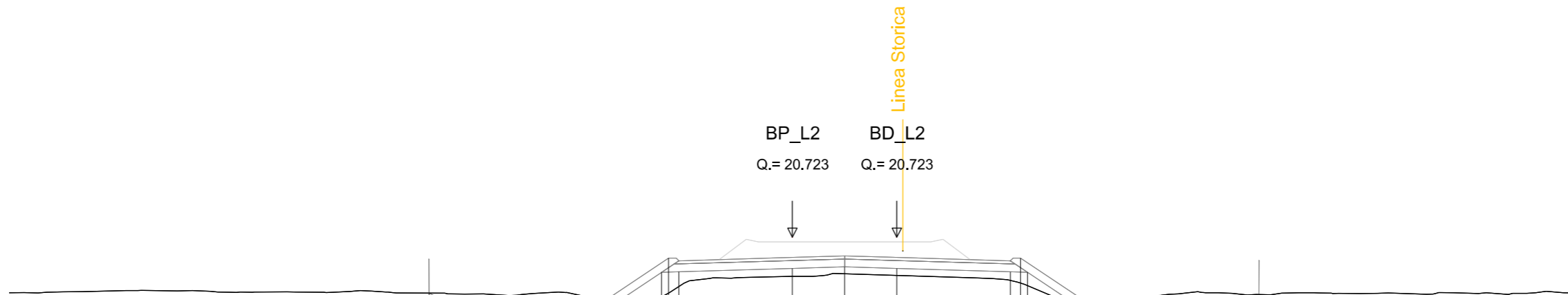

	1	2	3	4	5	6	7	8	9	10	11	12	13	14	15	16	17	18	19	20	21	22	23	24	25	26	27	28	29	30	31	32	33	34	35	36	37	38	39	40	41	42	43	44	45	46	47	48	49	50	51	52	53	54	55	56	57	58	59	60	61	62	63	64	65	66	67	68	69	70	71	72	73	74	75	76	77	78	79	80	81	82	83	84	85	86	87	88	89	90	91	92	93	94	95	96	97	98	99	100
Quote Terreno	18.588	18.556	18.573	18.617	18.603	18.441	18.366	18.175	18.445	18.835	19.225	19.328	19.266	19.073	18.869	18.158	18.190	18.240	18.340	18.430	18.471	18.549	18.536																																																																													
Quote Progetto	18.588	18.175	18.175	17.675	17.675	18.175	18.175	18.175	19.382	19.922	19.402	19.592	19.532	19.402	19.922	18.158	18.158	18.158	17.658	17.658	18.158	18.158	18.536																																																																													
Dist. Progr. Progetto	-13.913	-13.086	-9.861	-9.111	-8.611	-7.861	-7.361	-6.820	-5.010	-4.741	-4.350	-0.000	2.000	4.000	8.350	8.741	9.010	10.846	11.387	11.887	12.637	13.137	13.887	17.112	17.867																																																																											
Dist. Parziali	0.827	3.225	0.750	0.500	0.750	0.500	0.541	1.810	0.660	4.350	2.000	2.000	4.350	0.660	1.836	0.541	0.500	0.750	0.500	0.750	3.225	0.755																																																																														

Materiale	Area(m2)
Scavo	15.858
Rilevato	0.058
Scotico	8.882
SuperCompattato	4.064
Subballast	1.547
Inerbimento	1.962

Prog. = 1+100.000

Q. Rif. = 2.000

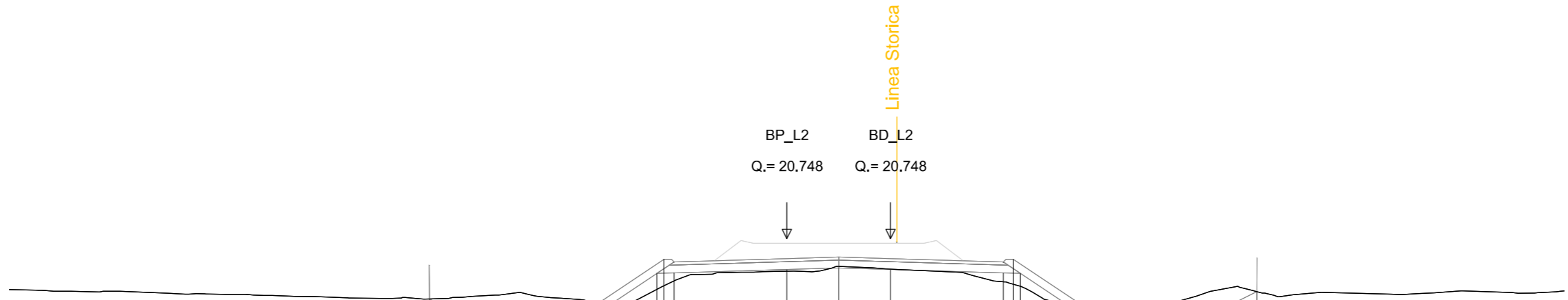

Quote Terreno	18.423 18.437	18.595 18.482 18.453	18.396 18.280 18.128	18.793 18.932 19.119	19.487	19.675	19.570	19.085 18.986	18.190 18.115 18.194	18.297 18.259 18.218	18.853	18.703
Quote Progetto	18.423 18.128	18.128 17.628 17.628	18.128 18.128 18.128	19.407 19.947 19.427	19.557	19.617	19.557	19.427 19.947 19.407	18.190 18.190 18.190	17.690 17.690 18.190	18.190	18.703
Dist. Progr. Progetto	-13.784 -13.194	-9.969 -9.219 -8.719	-7.969 -7.469 -6.928	-5.010 -4.741 -4.350	-0.000	2.000	4.000	8.350 8.741 9.010	10.836 11.376 11.876	12.626 13.126 13.876	17.101	18.128
Dist. Parziali	0.590	3.225	0.750 0.500 0.750 0.500 0.541	1.918 0.660	4.350	2.000	2.000	4.350	0.660 1.826	0.540 0.500 0.750 0.500 0.750	3.225	1.027

Materiale	Area(m2)
Scavo	9.558
Rilevato	2.569
Scotico	6.350
SuperCompattato	3.810
Subballast	1.524
Inerbimento	0.000

Prog. = 1+200.000

Q. Rif. = 4.000

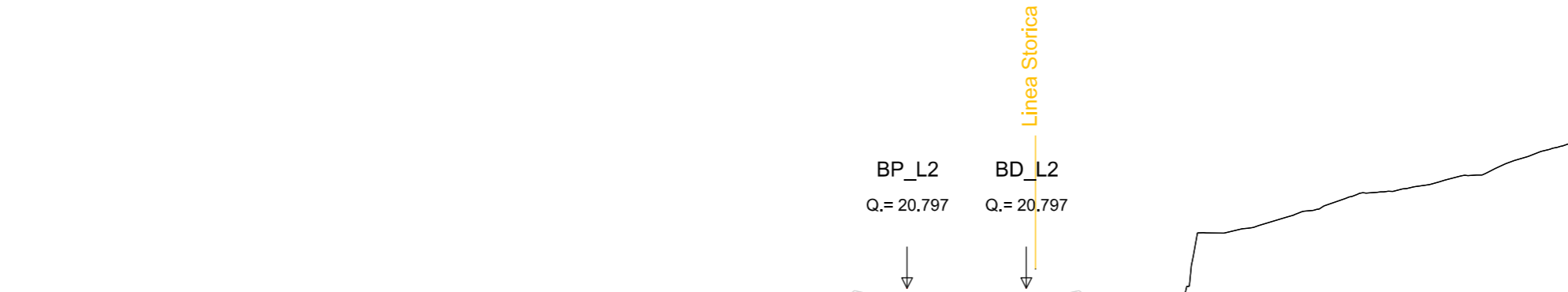

Quote Terreno	19.335	19.347	18.880	18.971	19.267	19.649	19.882	20.186	20.375	20.370	20.310	
Quote Progetto	19.335	19.896	19.896	19.396	19.396	19.896	19.817	19.896	19.607	19.667	19.607	19.476
Dist. Progr. Progetto	-11.192	-10.350	-7.350	-6.600	-6.100	-5.350	-5.091	-4.850	-0.000	2.000	4.000	8.350
Dist. Parziali	0.842	3.000	0.750	0.500	0.750	0.500	0.500	4.350	2.000	2.000	4.350	

Materiale	Area(m2)
Scavo	10.849
Rilevato	1.842
Scotico	6.350
SuperCompattato	3.937
Subballast	1.535
Inerbimento	0.608

Prog. = 1+250.000

Q. Rif. = 3.000

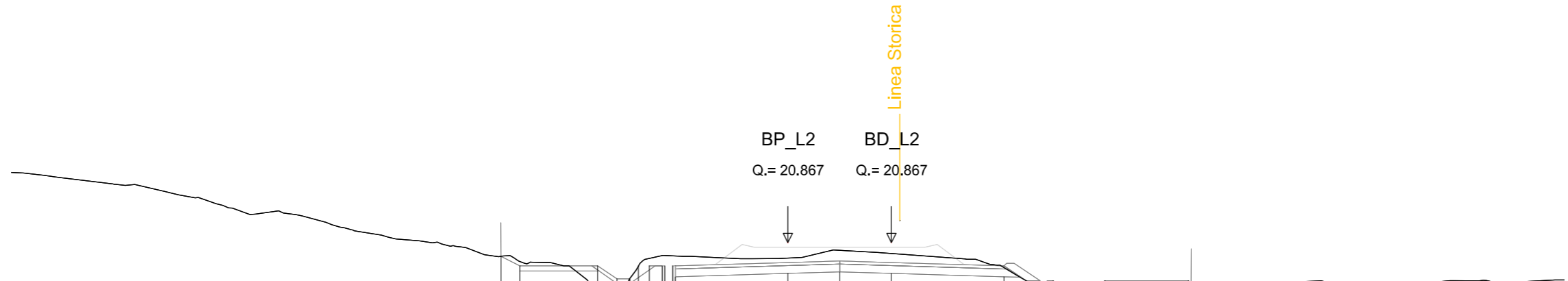

Quote Terreno			20.332	20.132		18.889	18.960	18.989	19.533	20.369	20.367	20.267	20.564	20.445		19.894	18.889	18.764	18.769	18.755		19.323		
Quote Progetto			20.332	19.965	19.965	19.465	19.465	19.965	19.965	19.965	19.965	19.676	19.736	19.676	19.545	19.545	19.396	18.896	18.896	19.396		19.396	19.323	
Dist. Progr. Progetto			-11.083	-10.350	-7.350	-6.600	-6.100	-5.773	-5.350	-4.850	-4.750	-4.450	-4.350	-0.000	2.000	4.000	8.350	10.245	10.995	11.495	12.245		15.470	15.580
Dist. Parziali			0.733	3.000	0.750	0.500	0.750	0.500	0.500	4.350		2.000	2.000	4.350	1.895	0.750	0.500	0.750	3.225	0.110				

Materiale	Area(m2)
Scavo	10.112
Rilevato	4.807
Scotico	6.476
SuperCompattato	3.937
Subballast	1.535
Inerbimento	0.132

Prog. = 1+300.000

Q. Rif. = 4.000

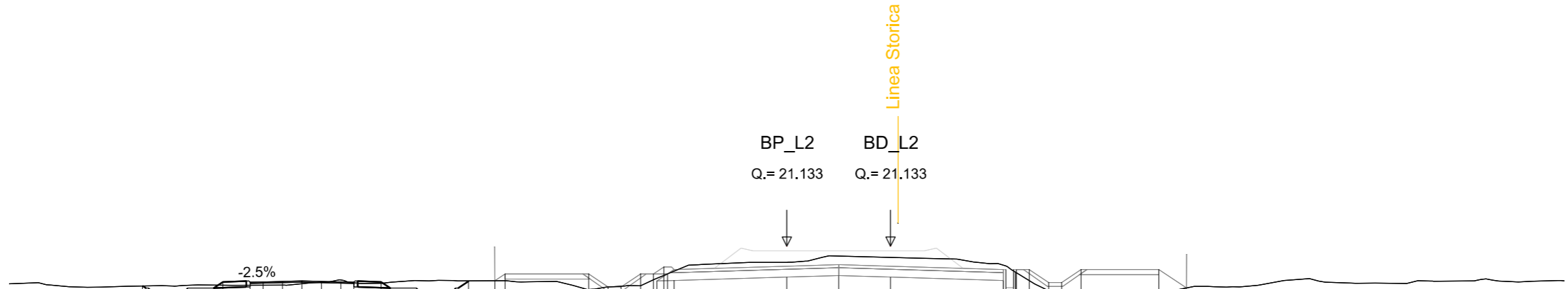

Quote Terreno	Quote Progetto	Dist. Progr. Progetto	Dist. Parziali
19.605	19.605	-24.861	0.100
19.517	19.517	-24.729	0.100
19.517	19.517	-24.619	0.500
19.017	19.017	-24.119	0.600
19.517	19.517	-23.619	1.000
19.633	19.633	-22.109	1.404
19.753	19.753	-21.755	0.000
19.743	19.743	-20.705	2.000
19.632	19.632	-20.205	2.000
19.635	19.635	-19.455	2.000
19.686	19.686	-18.705	2.000
19.742	19.742	-17.955	0.000
19.828	19.828	-17.205	1.254
19.723	19.723	-16.705	1.010
19.799	19.799	-15.301	0.500
19.737	19.737	-14.281	0.500
19.017	19.017	-13.781	0.500
19.807	19.807	-13.281	0.500
19.798	19.798	-12.781	0.500
19.812	19.812	-12.671	0.500
19.763	19.763	-12.278	0.395
19.809	19.809	-11.263	0.395
20.064	20.064	-10.868	3.225
19.466	19.466	-7.643	0.750
19.561	19.561	-6.893	0.500
19.587	19.587	-6.393	0.750
19.606	19.606	-5.643	0.500
20.064	20.064	-5.143	0.750
20.064	20.064	-5.010	0.500
20.331	20.331	-4.741	0.500
20.064	20.064	-4.602	0.232
19.811	19.811	-4.350	4.350
20.510	19.942	-0.000	2.000
20.750	20.002	2.000	2.000
20.699	19.942	4.000	4.350
20.401	19.811	8.350	0.500
19.807	20.231	8.450	0.500
19.419	20.231	8.750	0.500
19.223	20.131	8.815	0.500
19.163	20.231	8.850	0.750
19.358	20.231	9.350	3.000
19.523	20.231	10.100	1.062
	19.731	10.600	
	20.231	11.350	
	20.231	14.350	
	19.523	15.412	

Materiale	Area(m2)
Scavo	7.921
Rilevato	5.401
Scotico	6.350
SuperCompattato	3.937
Subballast	1.535
Inerbimento	0.576

Prog. = 1+350.000

Q. Rif. = 4.000

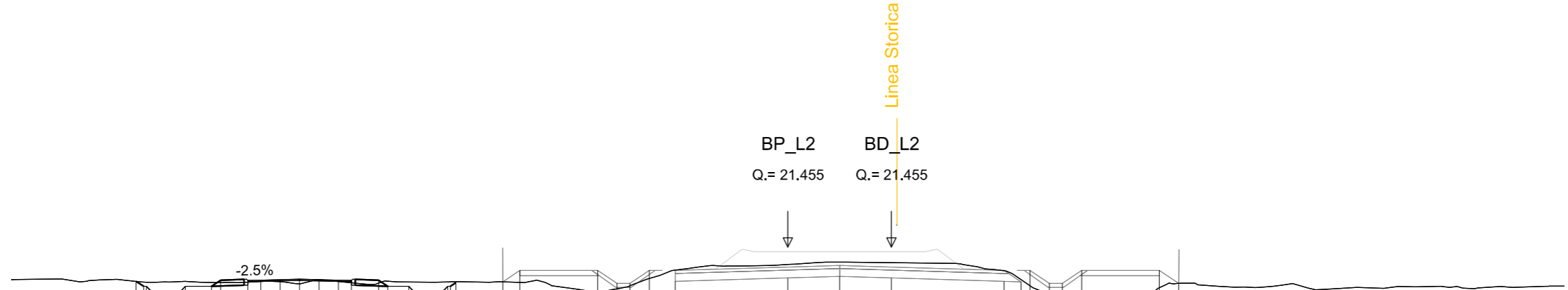

	Quote Terreno	Quote Progetto	Dist. Progr. Progetto	Dist. Parziali
	20.136	20.136	-25.176	0.000
	19.941	19.941	-24.883	0.386
	19.941	19.941	-24.773	0.386
	19.441	19.441	-24.273	0.500
	19.441	19.441	-23.773	0.500
	20.135	19.941	-23.273	1.000
	20.087	19.941	-22.263	1.404
	20.176	20.176	-21.909	0.000
	20.166	20.166	-20.859	0.000
	20.179	20.179	-20.359	2.000
	20.127	20.179	-19.609	2.000
	20.119	20.216	-18.859	2.000
	20.038	20.197	-18.109	2.000
	20.198	20.179	-17.359	0.000
	20.126	20.166	-16.859	1.253
	20.078	20.176	-15.809	0.804
	20.064	19.940	-15.456	0.500
	20.136	19.940	-14.642	0.500
	20.110	19.440	-14.142	0.500
	20.104	19.440	-13.642	0.500
	20.099	19.940	-13.142	0.500
	20.115	19.940	-13.032	0.500
	20.116	20.081	-12.821	1.814
	20.116	20.116	-11.007	0.657
	20.091	20.554	-10.350	3.000
	19.710	20.554	-7.350	0.750
	19.841	20.054	-6.600	0.500
	19.964	20.054	-6.100	0.750
	20.242	20.554	-5.350	1.000
	20.567	20.134	-4.350	4.350
	20.783	20.264	-0.000	2.000
	20.876	20.324	2.000	2.000
	20.854	20.264	4.000	4.350
	20.544	20.134	8.350	0.660
	20.196	20.114	9.010	0.340
	19.988	20.554	9.350	0.750
	19.630	20.054	10.100	0.500
	19.524	20.054	10.600	0.750
	19.497	20.554	11.350	3.000
	19.886	20.554	14.350	0.748
	20.055	20.055	15.098	

Materiale	Area(m2)
Scavo	11.543
Rilevato	0.373
Scotico	7.216
SuperCompattato	4.064
Subballast	1.547
Inerbimento	0.865

Prog. = 1+400.000

Q. Rif. = 4.000

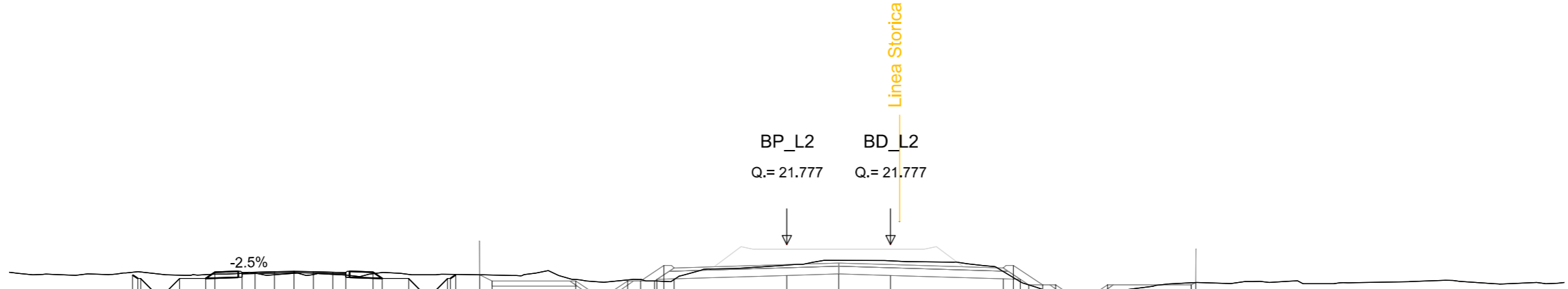

Quote Terreno	Quote Progetto	Dist. Progr. Progetto	Dist. Parziali
20.790	20.609	-25.241	0.660
20.790	20.473	-25.037	0.660
20.790	20.473	-24.927	0.500
20.790	19.973	-24.427	0.500
20.790	19.973	-23.927	0.500
20.790	20.473	-23.427	1.000
20.633	20.473	-22.417	1.404
20.633	20.709	-22.063	0.000
20.699	20.699	-21.013	2.000
20.675	20.711	-20.513	
20.618	20.730	-19.763	
20.618	20.749	-19.013	
20.672	20.730	-18.263	2.000
20.624	20.711	-17.513	
20.629	20.698	-17.013	0.990
20.600	20.708	-15.963	0.676
20.655	20.473	-14.590	0.577
20.629	20.473	-14.090	1.010
20.613	19.973	-13.590	0.918
20.613	20.473	-13.090	0.500
20.613	20.473	-12.980	0.200
20.613	20.473	-12.773	0.200
20.614	20.614	-11.848	0.925
20.602	20.374	-11.368	0.480
20.434	20.374	-8.143	3.225
20.345	19.874	-7.393	0.750
20.337	19.874	-6.893	0.500
20.412	20.374	-6.143	0.750
20.431	20.374	-5.643	0.500
20.374	20.412	-5.103	0.500
20.374	20.436	-5.010	0.500
20.430	20.976	-4.741	0.660
20.430	20.456	-4.350	0.660
20.985	20.586	-0.000	4.350
21.167	20.646	2.000	2.000
21.154	20.586	4.000	2.000
20.741	20.456	8.350	4.350
20.741	20.976	8.741	0.660
20.741	20.436	9.010	0.340
20.741	20.223	9.330	0.500
20.741	20.223	9.870	0.750
20.741	20.223	10.370	0.500
20.741	20.223	11.120	0.750
20.741	19.723	11.620	
20.741	20.223	12.370	3.225
20.302	20.223	15.595	0.179
20.302	20.312	15.774	

Materiale	Area(m2)
Scavo	12.892
Rilevato	0.219
Scotico	7.702
SuperCompattato	3.810
Subballast	1.524
Inerbimento	0.411

Prog. = 1+450.000

Q. Rif. = 5.000

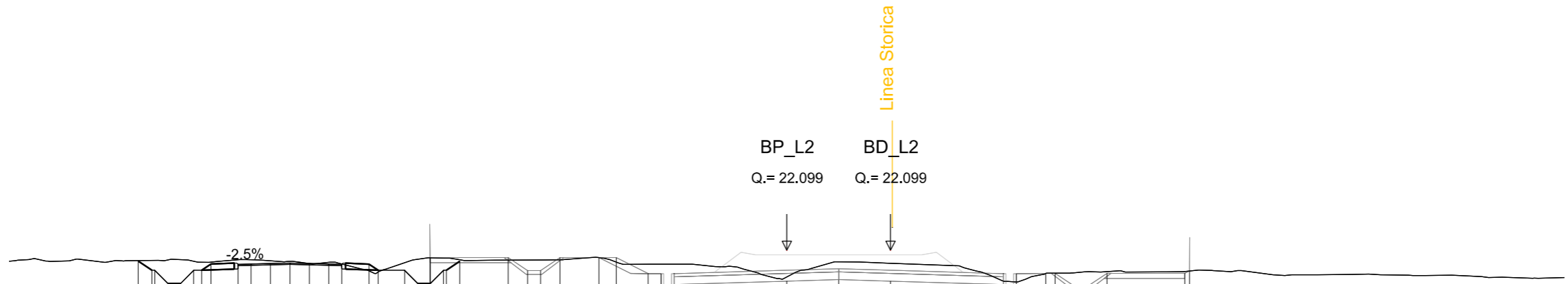

Quote Terreno	Quote Progetto	Dist. Progr. Progetto	Dist. Parziali
21.704	21.686	-25.022	0.500
21.710	21.332	-24.491	0.500
21.717	21.332	-24.381	0.500
21.720	20.832	-23.881	0.500
21.740	21.332	-22.881	0.500
21.648	21.568	-22.217	0.500
21.642	21.558	-21.167	1.404
21.735	21.570	-20.667	0.000
21.736	21.589	-19.917	0.000
21.693	21.607	-19.167	2.000
21.673	21.589	-18.417	2.000
21.586	21.570	-17.667	2.000
21.635	21.567	-17.167	2.000
21.573	21.332	-16.117	0.000
21.307	21.331	-15.764	1.253
21.259	20.831	-14.744	1.010
21.922	21.811	-13.763	0.808
21.752	21.819	-13.751	0.000
21.811	20.831	-13.744	0.000
21.700	21.331	-13.244	0.000
21.737	21.331	-13.134	0.000
21.721	21.676	-12.617	1.866
21.724	21.819	-10.751	0.750
21.725	21.319	-10.001	0.500
21.733	21.319	-9.501	0.750
21.819	21.819	-8.751	1.500
21.819	21.819	-7.251	0.671
21.643	21.819	-6.580	0.500
21.562	21.204	-5.350	0.685
21.382	21.199	-4.850	0.500
21.562	20.779	-4.350	0.500
21.069	20.909	-0.000	4.350
21.655	20.969	2.000	2.000
21.595	20.909	4.000	2.000
20.909	20.779	8.350	4.350
20.880	21.199	8.850	0.500
21.206	21.207	9.992	1.500
21.232	21.211	10.350	0.750
21.271	20.711	11.100	0.500
21.278	20.711	11.600	0.750
21.302	21.211	12.350	3.000
21.302	21.211	15.350	0.184
21.302	21.302	15.534	

Materiale	Area(m2)
Scavo	14.421
Rilevato	0.104
Scotico	7.678
SuperCompattato	3.810
Subballast	1.524
Inerbimento	0.508

Prog. = 1+500.000

Q. Rif. = 5.000



Quote Terreno	Quote Progetto	Dist. Progr. Progetto	Dist. Parziali
22.505	22.449	-25.148	0.508
22.499	22.114	-24.645	0.500
22.467	22.114	-24.535	0.500
22.460	21.614	-24.035	0.500
22.423	21.614	-23.535	0.500
22.423	22.114	-22.725	0.500
22.423	22.350	-22.371	0.500
22.465	22.340	-21.321	1.404
22.330	22.352	-20.821	0.000
22.417	22.371	-20.071	0.000
22.444	22.390	-19.321	2.000
22.373	22.371	-18.571	0.000
22.419	22.352	-17.821	2.000
22.410	22.340	-17.321	0.000
22.387	22.350	-16.271	1.253
22.264	22.114	-15.918	1.010
22.477	22.114	-14.898	0.278
22.368	22.310	-14.721	0.500
22.399	22.491	-14.451	0.500
22.368	22.491	-14.398	0.500
22.399	21.614	-13.898	0.500
22.399	22.114	-13.398	0.500
22.399	22.114	-13.288	0.500
22.364	22.114	-13.288	0.500
22.547	22.514	-12.687	1.236
22.521	22.491	-11.451	0.750
22.517	21.991	-10.701	0.500
22.510	21.991	-10.201	0.750
22.498	22.491	-9.451	1.500
22.491	22.491	-7.951	0.671
22.386	22.491	-7.280	1.245
21.446	21.231	-5.350	0.888
21.941	21.521	-4.850	0.500
21.933	21.101	-4.350	0.500
21.479	21.101	-0.000	4.350
21.449	21.291	2.000	2.000
21.662	21.231	4.000	2.000
22.230	21.526	8.350	4.350
22.268	21.526	8.850	0.500
22.230	22.268	9.350	0.888
22.268	22.268	10.835	0.800
22.231	22.268	11.506	0.671
22.193	22.268	13.006	1.500
22.175	21.768	13.756	0.750
22.157	21.768	14.256	0.500
22.034	22.268	15.006	0.750
22.034	22.034	18.006	3.000
22.034	22.034	18.359	0.353

Materiale	Area(m2)
Scavo	16.223
Rilevato	0.093
Scotico	7.950
SuperCompattato	3.810
Subballast	1.524
Inerbimento	0.487

Prog. = 1+550.000

Q. Rif. = 6.000

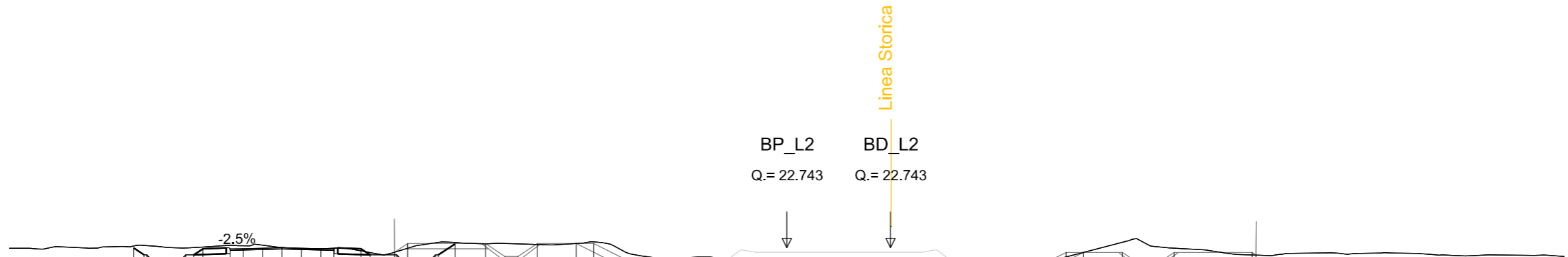

Quote Terreno	Quote Progetto	Dist. Progr. Progetto	Dist. Parziali
22.805	22.730	-25.201	0.487
22.815	22.462	-24.799	0.500
22.825	21.962	-24.189	0.500
22.835	21.962	-23.189	0.500
22.845	22.462	-22.879	0.500
22.855	22.688	-21.476	0.500
22.865	22.700	-20.976	1.403
22.875	22.719	-20.226	0.000
22.885	22.738	-19.476	2.000
22.895	22.719	-18.726	2.000
22.905	22.700	-17.976	2.000
22.915	22.688	-17.476	0.000
22.925	22.697	-16.425	1.254
22.935	22.462	-15.131	0.941
22.945	22.565	-14.627	0.000
22.955	22.901	-14.552	0.000
22.965	21.962	-14.052	0.500
22.975	22.462	-13.552	0.500
22.985	22.462	-13.442	0.500
22.995	22.892	-12.797	1.170
23.005	22.886	-11.627	0.750
23.015	22.901	-10.877	0.500
23.025	22.401	-10.377	0.750
23.035	22.901	-9.627	1.500
23.045	22.901	-8.127	0.671
23.055	22.901	-7.456	1.421
23.065	21.848	-5.350	0.888
23.075	21.843	-4.850	0.500
23.085	21.423	-4.350	0.500
21.771	21.553	-0.000	4.350
22.218	21.613	2.000	2.000
22.193	21.553	4.000	2.000
21.829	21.423	8.350	4.350
21.788	21.843	8.850	0.500
21.912	21.848	9.350	0.500
22.385	22.560	10.774	0.671
22.560	22.560	11.445	1.500
22.950	22.560	12.945	0.750
22.983	22.060	13.695	0.500
22.785	22.060	14.195	0.750
22.721	22.560	14.945	3.000
22.468	22.560	17.945	0.152
22.458	22.458	18.097	

Materiale	Area(m2)
Scavo	14.138
Rilevato	0.237
Scotico	7.898
SuperCompattato	3.810
Subballast	1.524
Inerbimento	0.563

Prog. = 1+600.000

Q. Rif. = 6.000

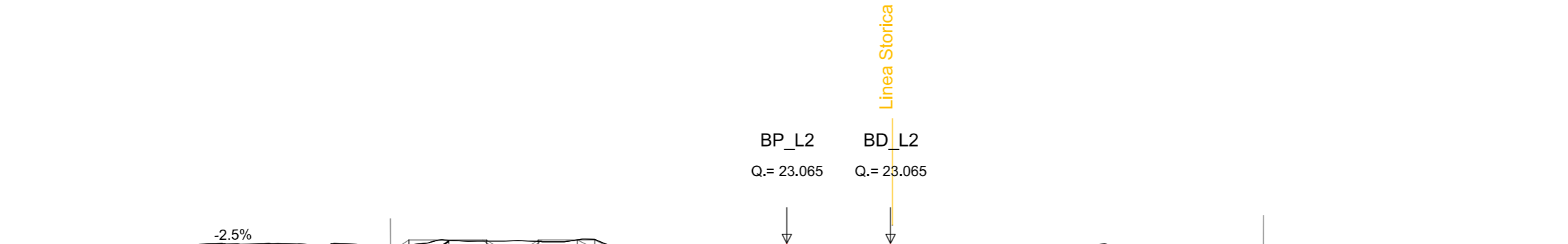

Quote Terreno	Quote Progetto	Dist. Progr. Progetto	Dist. Parziali
22.911	22.957	-25.746	0.000
22.911	22.779	-25.480	0.000
22.911	22.779	-25.370	0.000
22.911	22.279	-24.870	0.500
22.911	22.279	-24.370	0.500
22.911	22.779	-23.869	0.500
22.911	22.780	-23.033	0.500
22.911	22.990	-22.680	0.826
22.911	23.015	-21.630	1.403
22.911	23.018	-21.130	0.000
22.911	23.036	-20.380	0.000
22.911	23.036	-19.630	2.000
22.911	23.040	-18.880	2.000
22.911	23.018	-18.130	2.000
22.911	23.005	-17.630	2.000
22.911	23.015	-16.580	0.000
22.911	22.779	-16.226	1.254
22.911	22.733	-15.284	0.942
22.911	22.779	-15.206	0.000
22.911	22.279	-14.706	0.942
22.911	23.201	-14.583	0.000
22.911	22.279	-14.206	0.000
22.911	22.779	-13.706	0.000
22.911	22.779	-13.596	0.000
22.911	23.187	-13.044	0.552
23.156	23.201	-11.583	1.461
23.160	22.701	-10.833	0.750
23.170	22.701	-10.333	0.500
23.145	23.201	-9.583	0.750
23.201	23.201	-8.083	1.500
23.218	23.201	-7.412	0.671
22.865	22.170	-5.350	1.377
22.813	22.165	-4.850	0.888
22.759	21.745	-4.350	0.500
22.059	21.875	-0.000	4.350
22.546	21.935	2.000	2.000
22.515	21.875	4.000	2.000
22.141	21.745	8.350	4.350
22.123	22.165	8.850	0.500
22.278	22.170	9.350	0.500
22.862	22.996	11.001	0.888
22.996	22.996	11.672	0.966
22.923	22.996	11.672	0.671
22.895	22.996	13.172	1.500
22.883	22.496	13.922	0.750
22.835	22.496	14.422	0.500
22.864	22.996	15.172	0.750
22.854	22.996	18.172	3.000
22.854	22.854	18.385	0.213

Materiale	Area(m2)
Scavo	14.664
Rilevato	0.830
Scotico	7.724
SuperCompattato	3.810
Subballast	1.524
Inerbimento	0.385

Prog. = 1+650.000

Q. Rif. = 6.000

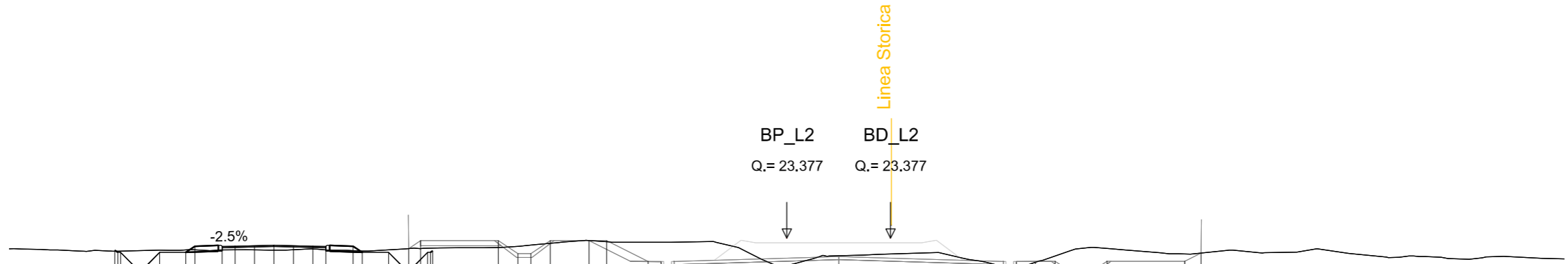

Quote Terreno	Quote Progetto	Dist. Progr. Progetto	Dist. Parziali
22.909	22.909	-25.927	0.000
22.829	22.829	-25.807	0.000
22.829	22.829	-25.697	0.000
22.329	22.329	-25.197	0.000
22.829	22.829	-24.697	0.500
22.829	22.829	-24.197	0.500
22.903	22.903	-23.187	0.500
22.916	23.065	-22.834	1.000
22.926	23.055	-21.784	1.403
22.922	23.067	-21.284	0.000
22.927	23.086	-20.534	0.000
22.918	23.105	-19.784	2.000
22.931	23.086	-19.034	2.000
22.960	23.067	-18.284	2.000
22.923	23.065	-17.784	2.000
22.889	23.065	-16.734	0.000
22.882	22.829	-16.380	1.254
22.927	22.829	-15.360	1.010
22.856	22.329	-14.860	0.909
22.856	22.976	-14.126	0.226
22.856	22.329	-13.860	0.000
22.887	22.829	-13.750	0.000
22.887	22.887	-13.663	0.000
23.020	22.887	-13.663	2.537
23.063	23.285	-11.126	0.750
23.113	22.785	-10.376	0.500
23.180	22.785	-9.876	0.750
23.285	23.285	-9.126	1.500
23.285	23.285	-7.626	0.671
23.239	23.285	-6.955	0.920
23.219	22.482	-5.350	0.888
23.217	22.477	-4.850	0.500
23.220	22.057	-4.350	0.500
22.325	22.188	-0.000	4.350
22.700	22.248	2.000	2.000
22.765	22.188	4.000	2.000
22.283	22.057	8.350	4.350
22.256	22.477	8.850	0.500
22.449	22.449	9.595	1.500
22.688	22.489	10.350	0.750
22.948	21.989	11.100	0.500
23.007	21.989	11.600	0.500
22.981	22.489	12.350	0.750
22.770	22.489	15.350	3.000
22.805	22.805	15.981	0.631

Materiale	Area(m2)
Scavo	13.591
Rilevato	0.194
Scotico	7.497
SuperCompattato	3.810
Subballast	1.524
Inerbimento	0.221

Prog. = 1+700.000

Q. Rif. = 6.000

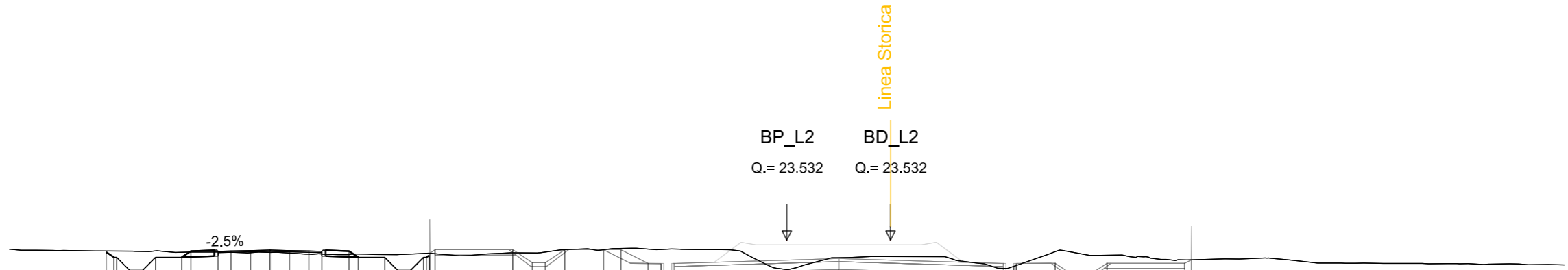

Quote Terreno	Quote Progetto	Dist. Progr. Progetto	Dist. Parziali
23.110	23.071	-26.258	0.000
23.106	22.873	-25.961	0.000
23.097	22.851	-25.851	0.000
23.114	22.373	-25.351	0.500
23.095	22.873	-24.351	0.500
23.073	22.873	-23.341	1.000
23.068	23.109	-22.888	1.403
23.049	23.099	-21.438	0.000
23.055	23.111	-20.688	2.000
23.035	23.130	-19.938	2.000
22.994	23.149	-19.188	2.000
22.978	23.130	-18.438	2.000
22.976	23.111	-17.938	0.000
22.976	23.099	-16.888	1.254
22.976	22.873	-16.534	1.010
22.976	22.873	-15.514	0.918
22.976	22.873	-15.014	0.500
22.976	22.873	-14.514	0.500
22.976	22.873	-14.014	0.500
22.976	22.873	-13.904	0.500
22.976	22.873	-13.804	0.500
22.976	22.873	-13.769	0.500
22.976	22.873	-13.569	0.500
23.044	23.161	-10.569	3.000
23.037	23.161	-9.819	0.750
23.074	22.661	-9.319	0.500
23.163	22.661	-8.569	0.750
23.161	23.161	-7.069	1.500
23.213	23.161	-6.399	0.670
23.188	22.637	-5.350	0.685
23.174	22.632	-4.850	0.500
23.191	22.212	-4.350	0.500
22.396	22.343	-0.000	4.350
22.856	22.403	2.000	2.000
22.901	22.343	4.000	2.000
22.417	22.212	8.350	4.350
22.666	22.526	8.754	0.500
23.087	22.632	8.850	1.500
23.049	22.644	10.350	0.750
22.957	22.144	11.100	0.500
22.949	22.144	11.600	0.750
22.773	22.644	12.350	3.000
22.773	22.775	15.350	0.262
22.773	22.775	15.612	

Materiale	Area(m2)
Scavo	12.625
Rilevato	4.983
Scotico	7.732
SuperCompattato	3.810
Subballast	1.524
Inerbimento	0.432

Prog. = 1+750.000

Q. Rif. = 7.000

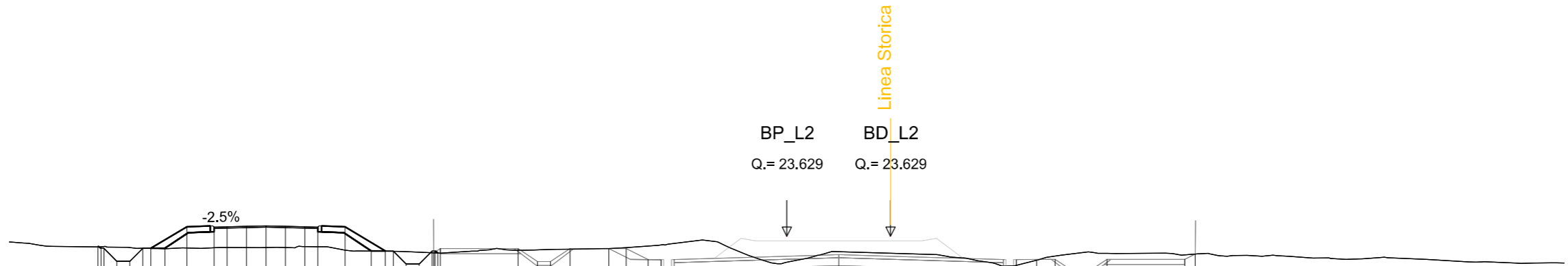

Quote Terreno	Quote Progetto	Dist. Progr. Progetto	Dist. Parziali
23.249	23.249	-26.574	0.000
23.169	23.169	-26.454	0.500
23.169	23.169	-26.344	0.500
22.669	22.669	-25.844	0.500
23.169	23.169	-25.344	0.500
23.169	23.169	-24.844	0.500
23.169	23.169	-24.534	0.500
23.169	23.169	-23.993	0.500
23.176	23.176	-23.142	0.541
23.150	23.150	-22.092	0.901
23.179	23.179	-21.592	1.000
23.187	24.013	-20.842	0.000
23.186	24.032	-20.092	2.000
23.195	24.013	-19.342	2.000
23.197	23.994	-18.592	2.000
23.194	23.992	-18.092	0.000
23.232	23.064	-17.042	0.850
23.226	23.064	-16.034	0.850
23.226	23.063	-15.493	1.058
23.094	23.063	-15.183	0.541
23.058	22.563	-14.683	0.500
23.052	22.563	-14.183	0.500
23.048	23.063	-13.683	0.500
23.038	22.989	-13.573	0.500
23.014	23.063	-13.468	0.500
23.000	22.993	-13.468	0.500
23.157	23.157	-13.366	3.000
23.089	23.157	-10.366	0.750
23.106	22.657	-9.616	0.500
23.121	22.657	-9.116	0.750
23.132	23.157	-8.366	1.500
23.157	23.157	-6.866	0.671
23.194	23.157	-6.195	0.688
23.252	22.734	-5.350	0.500
23.257	22.729	-4.850	0.500
23.353	22.309	-4.350	4.350
22.631	22.440	-0.000	2.000
23.033	22.500	2.000	2.000
22.973	22.440	4.000	4.350
22.475	22.309	8.350	0.500
22.508	22.729	8.850	1.500
22.705	22.705	9.639	0.750
22.864	22.741	10.350	0.500
22.960	22.241	11.100	0.750
23.022	22.241	11.600	3.000
22.968	22.741	12.350	0.405
22.943	22.741	15.350	
22.943	22.943	15.755	

Materiale	Area(m2)
Scavo	8.854
Rilevato	17.999
Scotico	7.746
SuperCompattato	3.937
Subballast	1.535
Inerbimento	0.303

Prog. = 1+800.000

Q. Rif. = 6.000

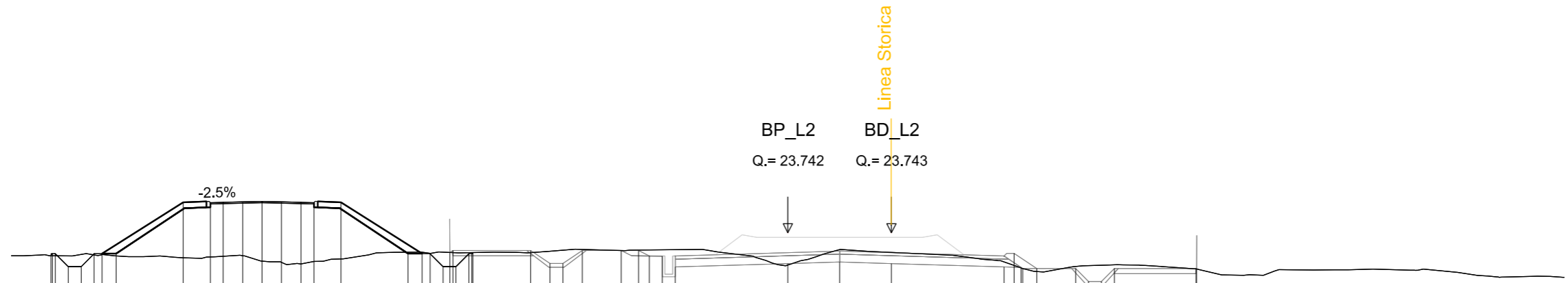

Quote Terreno	Quote Progetto	Dist. Progr. Progetto	Dist. Parziali
22.899	22.899	-28.465	0.000
22.937	22.937	-28.407	0.000
22.438	22.438	-27.797	0.500
22.904	22.938	-27.297	0.500
22.898	22.938	-26.797	0.000
22.848	22.938	-26.487	0.541
22.778	22.938	-25.946	2.638
22.805	24.919	-23.358	1.000
22.833	24.909	-22.308	0.000
22.857	24.921	-21.808	2.000
22.649	24.940	-21.058	
22.599	24.959	-20.308	2.000
22.540	24.940	-19.558	
22.631	24.922	-18.808	0.000
22.731	24.909	-17.258	0.850
22.991	22.938	-14.671	2.637
22.989	22.938	-14.130	
22.949	22.938	-13.820	0.541
22.968	22.438	-13.320	0.000
22.978	22.438	-13.053	0.000
22.975	23.056	-12.938	0.500
23.028	23.056	-12.820	0.750
23.070	22.556	-12.320	0.500
23.102	23.056	-12.210	1.500
23.056	23.056	-12.168	0.000
23.074	23.056	-9.938	0.000
23.074	22.847	-9.188	0.417
23.084	22.842	-8.688	0.500
23.089	22.422	-7.938	0.500
22.495	22.553	-0.000	4.350
23.093	22.613	2.000	2.000
22.982	22.553	4.000	2.000
22.614	22.422	8.350	4.350
22.368	22.942	8.741	0.660
22.247	22.403	9.010	0.541
22.438	22.360	9.074	1.500
22.471	22.360	9.615	0.500
22.487	21.860	11.115	0.500
22.504	21.860	12.115	0.500
22.345	22.360	12.615	3.150
	22.345	15.765	0.022
		15.787	

Materiale	Area(m2)
Scavo	10.801
Rilevato	4.931
Scotico	7.317
SuperCompattato	4.064
Subballast	1.547
Inerbimento	0.591

Prog. = 1+850.000

Q. Rif. = 6.000

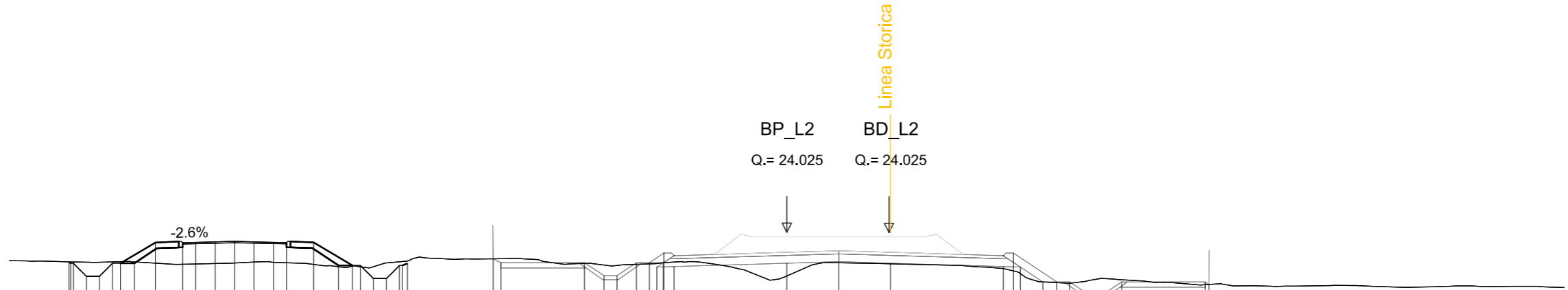

Quote Terreno	Quote Progetto	Dist. Progr. Progetto	Dist. Parziali
22.872	22.872	-27.686	0.400
22.833	22.833	-27.628	0.400
22.833	22.833	-27.518	0.500
22.870	22.833	-26.019	0.500
22.870	22.833	-26.019	0.500
22.883	22.833	-25.710	0.541
22.883	22.834	-25.169	0.864
22.835	23.632	-24.355	1.000
22.794	23.623	-23.305	0.000
22.806	23.636	-22.805	2.001
22.823	23.656	-22.054	2.001
22.838	23.675	-21.304	2.001
22.876	23.657	-20.554	0.000
22.870	23.639	-19.803	0.850
22.852	23.627	-19.303	1.004
22.786	23.638	-18.253	0.541
22.786	22.748	-17.299	0.000
22.698	22.748	-16.758	0.000
22.723	22.747	-16.447	0.000
22.698	22.247	-15.946	0.000
22.698	22.247	-15.445	0.501
22.698	22.247	-14.944	0.000
22.811	22.748	-14.834	0.000
22.811	22.748	-14.633	0.000
23.000	23.000	-11.329	3.304
22.850	22.850	-11.028	0.301
22.850	22.850	-7.803	3.225
22.828	22.350	-7.053	0.750
22.765	22.350	-6.553	0.500
22.746	22.850	-5.803	0.750
22.791	22.850	-5.303	0.500
22.811	22.684	-4.762	0.298
22.811	22.224	-4.741	0.298
22.811	22.704	-4.350	0.298
22.340	22.835	-0.000	4.350
22.847	22.895	2.000	2.000
22.811	22.835	4.000	2.000
22.629	22.704	8.350	4.350
22.338	23.224	8.741	0.660
22.109	22.684	9.010	0.862
22.086	22.109	9.872	0.541
22.086	22.109	10.413	0.500
22.171	22.109	10.913	0.750
22.244	21.609	11.663	0.500
22.197	21.609	12.163	0.750
22.197	22.109	12.913	3.225
22.005	22.109	16.138	0.142
22.005	22.015	16.280	0.142

Materiale	Area(m2)
Scavo	14.243
Rilevato	0.031
Scotico	9.046
SuperCompattato	4.064
Subballast	1.547
Inerbimento	2.064

Prog. = 1+900.000

Q. Rif. = 5.000

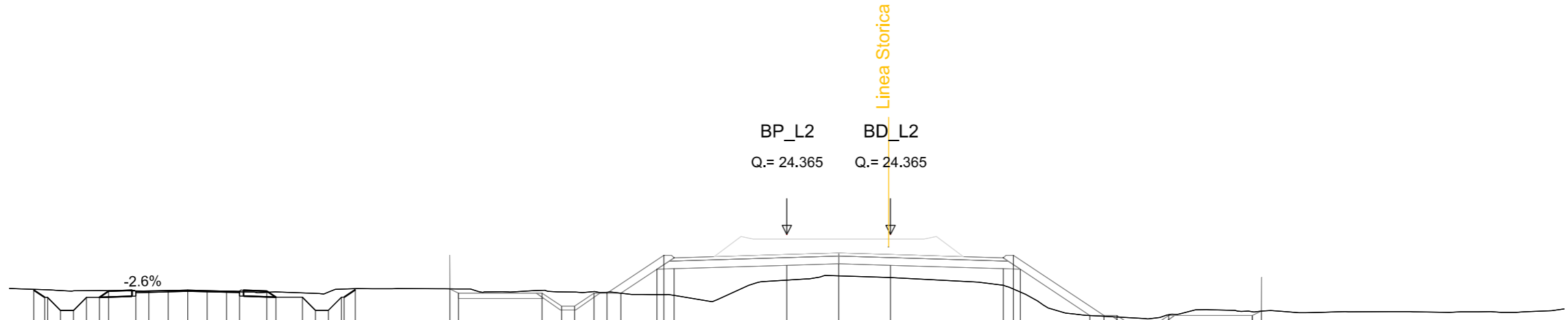

Quote Terreno	Quote Progetto	Dist. Progr. Progetto	Dist. Parziali
22.250	22.220	-29.053	
22.238	21.936	-28.628	0.405
22.238	21.937	-28.518	0.405
22.238	21.437	-28.019	0.499
22.238	21.437	-27.520	0.499
22.238	21.938	-27.021	0.499
22.238	21.938	-26.519	0.499
22.238	22.174	-26.165	1.405
22.190	22.165	-25.114	0.000
22.191	22.178	-24.614	2.001
22.197	22.198	-23.863	
22.190	22.217	-23.113	2.001
22.181	22.199	-22.362	
22.172	22.181	-21.612	0.000
22.154	22.169	-21.112	1.254
22.137	22.180	-20.061	1.011
22.108	21.945	-19.707	0.908
22.108	21.945	-18.686	0.500
22.108	21.446	-18.186	0.500
22.108	21.446	-17.686	0.500
22.108	21.947	-17.185	0.500
22.250	21.947	-17.075	0.500
22.272	22.234	-16.645	0.500
22.265			3.646
22.265	22.265	-12.999	0.334
	22.098	-12.665	
			3.225
22.209	22.098	-9.440	0.750
22.142	21.598	-8.690	0.500
22.142	21.598	-8.190	0.750
22.164	22.098	-7.440	0.500
22.136	22.098	-6.940	0.541
22.098	22.098	-6.399	1.389
22.044	23.024	-5.010	0.660
22.012	23.564	-4.741	
	23.044	-4.350	4.350
22.601	23.174	-0.000	
		2.000	2.000
22.769	23.234	2.000	
22.703	23.174	4.000	4.350
22.405	23.044	8.350	0.660
22.405	23.564	8.741	2.682
22.405	23.024	9.010	
21.236	21.236	11.692	0.541
21.200	21.236	12.233	0.500
21.180	21.236	12.733	0.750
21.137	20.736	13.483	0.500
21.113	20.736	13.983	0.750
21.268	21.236	14.733	
			3.225
21.385	21.236	17.958	0.347
21.409	21.409	18.305	

Materiale	Area(m2)
Scavo	17.006
Rilevato	0.084
Scotico	10.620
SuperCompattato	4.064
Subballast	1.547
Inerbimento	3.182

Prog. = 1+950.000

Q. Rif. = 5.000

	Quote Terreno	Quote Progetto	Dist. Progr. Progetto	Dist. Parziali
	21.805	20.932	-29.719	0.500
	21.780	20.932	-29.219	0.500
	21.761	21.432	-28.719	0.500
	21.748	21.432	-28.408	0.500
	21.731	21.668	-28.055	1.404
	21.705	21.658	-27.004	0.000
	21.702	21.670	-26.504	2.001
	21.664	21.689	-25.753	
	21.621	21.707	-25.003	
	21.590	21.689	-24.252	2.002
	21.579	21.670	-23.502	0.000
	21.555	21.657	-23.001	1.254
	21.547	21.667	-21.950	1.011
	21.496	21.431	-20.576	0.500
	21.637	20.931	-20.076	0.500
	21.637	20.931	-19.575	0.501
	21.683	21.431	-19.075	0.500
	21.726	21.431	-18.965	0.541
	21.721	21.646	-18.642	3.342
	21.759	21.759	-15.865	0.660
	21.715	21.135	-14.618	4.350
	21.490	21.135	-11.393	2.000
	21.330	20.635	-10.643	2.000
	21.232	20.635	-10.143	4.350
	21.217	21.135	-9.393	0.660
	21.181	21.135	-8.893	0.541
	21.135	21.135	-8.352	3.342
	21.686	23.363	-5.010	0.660
	21.859	23.903	-4.741	2.000
	22.473	23.383	-4.350	4.350
	22.473	23.514	-0.000	2.000
	22.770	23.574	2.000	2.000
	22.679	23.514	4.000	4.350
	22.118	23.383	8.350	0.660
	21.866	23.903	8.741	3.878
	20.778	23.363	9.010	0.541
	20.778	20.778	12.888	0.500
	20.738	20.778	13.429	0.750
	20.686	20.778	13.929	0.500
	20.699	20.278	14.679	0.750
	20.712	20.278	15.179	0.500
	20.856	20.778	15.929	0.750
	20.778	20.778	19.154	3.225
	20.712	20.712	19.252	0.098

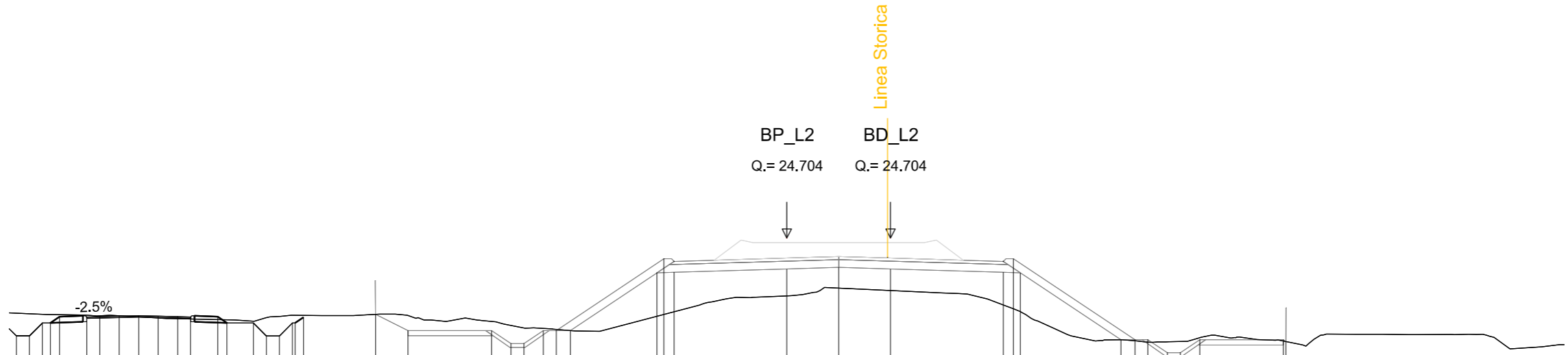

Materiale	Area(m2)
Scavo	15.328
Rilevato	12.631
Scotico	10.349
SuperCompattato	4.064
Subballast	1.547
Inerbimento	3.007

Prog. = 2+100.000

Q. Rif. = 6.000

	Quote Terreno	Quote Progetto	Dist. Progr. Progetto	Dist. Parziali
	21.936	21.400	-29.964	0.500
	21.935	21.901	-29.462	0.500
	21.933	21.901	-29.151	0.343
		21.901	-28.608	2.196
	21.954	23.583	-26.462	1.001
	21.977	23.572	-25.411	0.000
	21.983	23.584	-24.910	2.002
	21.961	23.601	-24.160	
	21.943	23.619	-23.409	2.002
	21.934	23.599	-22.658	
	21.910	23.579	-21.908	0.000
	21.899	23.566	-21.407	0.850
	21.803	23.575	-20.356	
		21.915	-18.254	2.153
		21.915	-17.714	
		21.915	-17.405	0.540
	22.110	21.416	-16.905	0.800
	22.144	21.416	-16.406	0.489
	22.151	21.916	-15.907	0.000
	22.144	21.916	-15.797	0.000
	22.140	22.093	-15.532	0.844
	22.159	22.159	-14.688	0.351
	22.164	21.983	-14.337	3.225
	22.212	21.983	-11.112	0.750
	22.228	21.483	-10.362	0.500
	22.151	21.483	-9.862	0.750
	22.198	21.983	-9.112	0.500
	22.033	21.983	-8.612	0.541
	21.963	21.983	-8.071	3.061
	22.089	24.024	-5.010	0.660
	22.122	24.564	-4.741	
		24.044	-4.350	4.350
	22.597	24.174	-0.000	2.000
		24.234	2.000	2.000
	22.899	24.174	4.000	4.350
	22.449	24.044	8.350	0.660
	22.243	24.564	8.741	3.618
		24.024	9.010	
	21.612	21.612	12.628	0.540
	21.547	21.612	13.168	0.500
	21.540	21.612	13.668	0.750
	21.529	21.112	14.418	0.500
	21.517	21.112	14.918	0.750
	21.577	21.612	15.668	3.225
	21.868	21.612	18.893	0.618
	21.921	21.921	19.511	

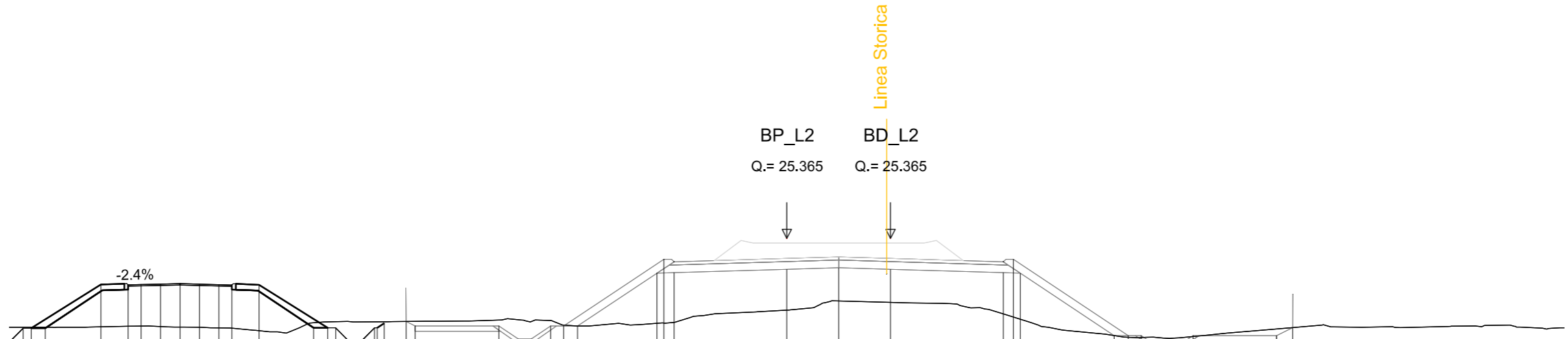

Materiale	Area(m2)
Scavo	15.070
Rilevato	0.104
Scotico	9.375
SuperCompattato	4.064
Subballast	1.547
Inerbimento	2.341

Prog. = 2+150.000

Q. Rif. = 6.000

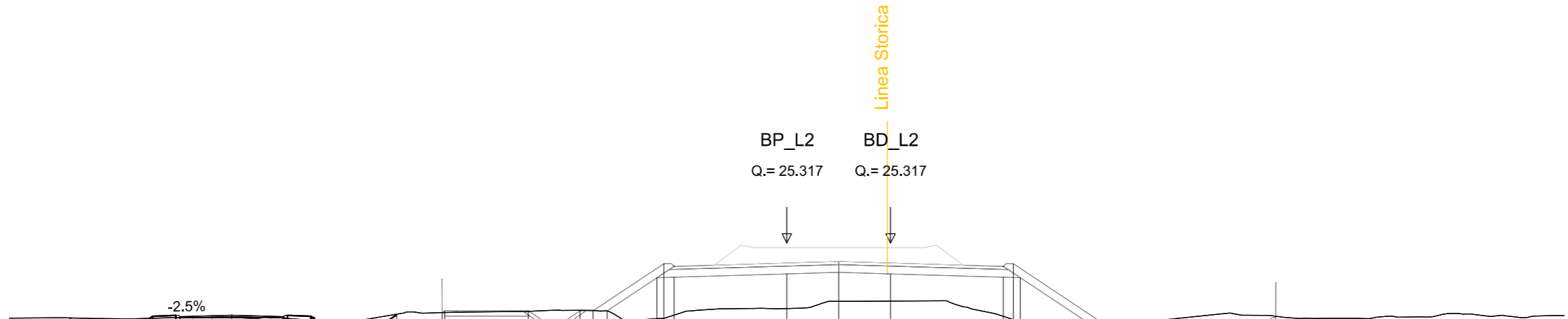

Quote Terreno	Quote Progetto	Dist. Progr. Progetto	Dist. Parziali
22.416	22.400	-27.666	0.000
22.416	22.250	-27.442	0.226
22.404	21.750	-26.831	0.500
22.399	21.750	-26.331	0.608
22.384	22.250	-25.831	1.001
22.402	22.250	-24.820	1.404
22.411	22.485	-24.466	0.000
22.431	22.475	-23.416	2.002
22.433	22.488	-22.915	2.001
22.432	22.506	-22.165	0.000
22.431	22.525	-21.414	2.134
22.410	22.506	-20.664	0.919
22.461	22.487	-19.914	0.501
22.421	22.475	-19.413	0.501
22.338	22.485	-18.363	0.541
22.355	22.242	-17.119	1.921
22.338	21.742	-16.618	0.660
22.390	21.742	-16.117	4.350
22.493	22.242	-15.616	0.750
22.570	22.242	-15.505	0.500
22.620	22.542	-15.053	0.541
22.629	22.629	-13.296	1.921
22.695	22.695	-13.197	0.660
22.670	22.695	-9.972	4.350
22.710	22.195	-9.222	0.750
22.718	22.195	-8.722	0.500
22.720	22.695	-7.972	0.750
22.712	22.695	-7.472	0.500
22.695	22.695	-6.931	0.541
22.394	23.976	-5.010	1.921
22.530	24.515	-4.741	0.660
22.530	23.995	-4.350	4.350
22.784	24.126	-0.000	2.000
23.065	24.186	2.000	2.000
23.073	24.126	4.000	4.350
22.487	23.995	8.350	0.660
22.386	24.515	8.741	2.810
22.386	23.976	9.010	0.541
22.102	22.102	11.820	0.500
22.183	22.102	12.361	0.750
22.215	22.102	12.861	0.500
22.262	21.602	13.611	0.500
22.308	21.602	14.111	0.750
22.385	22.102	14.861	3.225
22.524	22.102	18.086	0.771
22.488	22.488	18.857	

Materiale	Area(m2)
Scavo	13.600
Rilevato	0.275
Scotico	8.352
SuperCompattato	4.064
Subballast	1.547
Inerbimento	1.607

Prog. = 2+200.000

Q. Rif. = 7.000

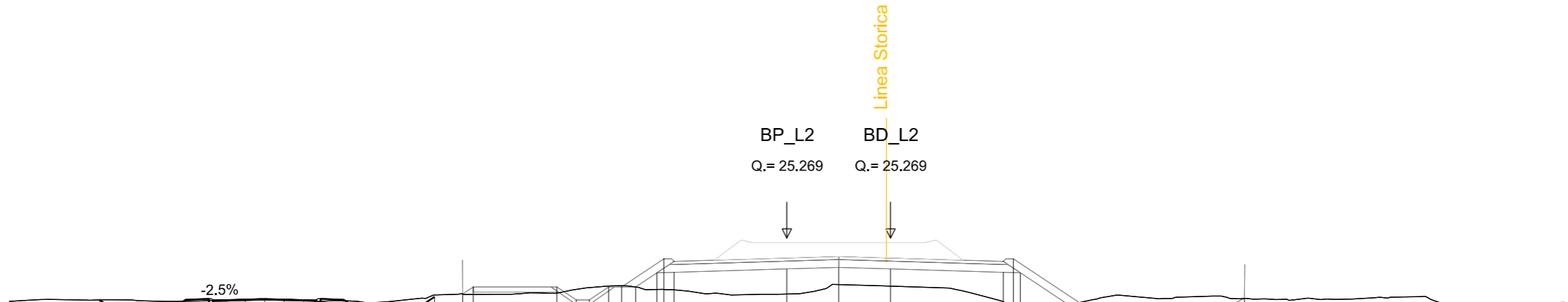

	Quote Terreno	Quote Progetto	Dist. Progr. Progetto	Dist. Parziali
	22.882	22.878	-26.508	0.000
	22.883	22.650	-26.165	0.000
	22.884	22.650	-26.055	0.500
	22.883	22.150	-25.555	0.600
	22.838	22.650	-24.555	1.000
	22.821	22.650	-23.545	1.404
	22.821	22.886	-23.191	0.000
	22.858	22.876	-22.141	2.000
	22.875	22.889	-21.641	2.001
	22.901	22.907	-20.891	0.000
	22.903	22.926	-20.141	1.253
	22.898	22.908	-19.391	1.011
	22.865	22.889	-18.640	0.900
	22.831	22.877	-18.140	0.500
	22.848	22.887	-17.090	0.000
	22.838	22.651	-16.737	0.518
	22.793	22.651	-15.716	1.086
	22.826	22.151	-15.216	0.404
	22.881	22.151	-14.716	3.225
	22.945	22.651	-14.216	0.750
	23.073	22.651	-14.106	0.500
	23.110	22.997	-13.588	0.541
	23.098	22.110	-12.502	0.822
	23.106	23.379	-12.098	0.660
	23.139	23.379	-8.873	4.350
	23.286	22.879	-8.123	0.750
	23.355	22.879	-7.623	0.500
	23.416	23.379	-6.873	0.750
	23.379	23.379	-6.373	0.500
	23.379	23.379	-5.832	0.541
	23.379	23.928	-5.010	0.822
	23.284	24.467	-4.741	0.660
	23.268	23.947	-4.350	
	23.106	24.078	-0.000	2.000
	23.471	24.138	2.000	2.000
	23.416	24.078	4.000	4.350
	22.806	23.947	8.350	0.660
	22.588	24.467	8.741	1.863
	22.588	23.928	9.010	0.541
	22.686	22.686	10.873	0.500
	22.809	22.686	11.414	0.750
	22.907	22.686	11.914	0.500
	23.056	22.186	12.664	0.750
	23.032	22.186	13.164	0.500
	22.963	22.686	13.914	0.750
	22.933	22.686	17.139	3.225
	22.943	22.943	17.653	0.514

Materiale	Area(m2)
Scavo	12.126
Rilevato	0.276
Scotico	7.737
SuperCompattato	4.064
Subballast	1.547
Inerbimento	1.147

Prog. = 2+250.000

Q. Rif. = 7.000

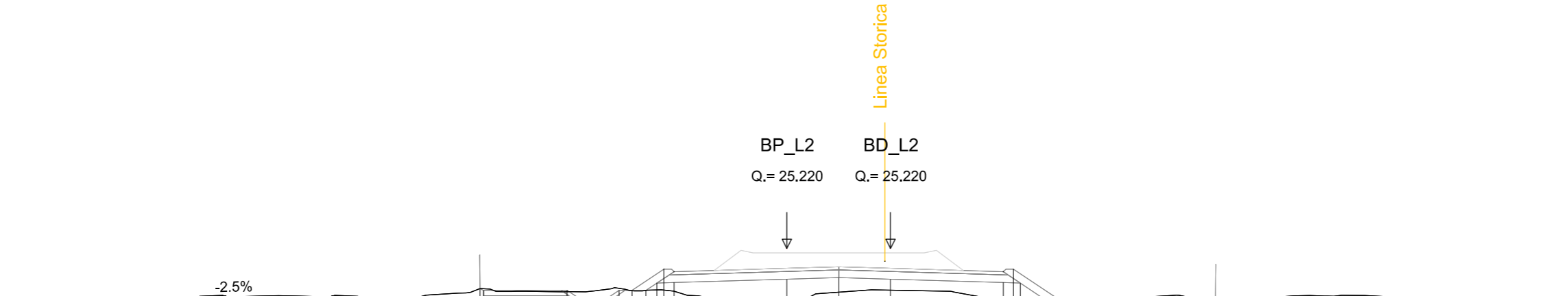

Quote Terreno	Quote Progetto	Dist. Progr. Progetto	Dist. Parziali
23.186	23.186	-25.726	0.000
23.120	23.120	-25.626	0.100
23.120	23.120	-25.516	0.500
22.620	22.620	-25.016	0.600
23.270	23.270	-24.516	1.000
23.276	23.276	-24.016	1.404
23.288	23.288	-22.652	0.000
23.289	23.289	-21.602	2.000
23.287	23.287	-21.102	2.000
23.293	23.293	-20.352	0.000
23.278	23.278	-19.602	2.123
23.250	23.250	-18.852	0.000
23.264	23.264	-18.102	0.900
23.252	23.252	-17.602	0.500
23.274	23.274	-16.552	0.500
23.136	23.136	-15.319	0.500
23.096	23.096	-14.819	0.500
23.096	23.096	-14.319	0.500
23.300	23.300	-13.819	0.500
23.308	23.308	-13.708	0.500
23.420	23.420	-13.396	0.660
23.420	23.420	-11.836	0.137
23.665	23.665	-11.699	3.225
23.597	23.597	-7.724	0.750
23.545	23.545	-7.224	0.500
23.597	23.597	-6.474	0.750
23.605	23.605	-5.974	0.500
23.679	23.679	-5.433	0.541
23.583	23.583	-5.010	0.423
23.597	23.597	-4.741	0.660
23.576	23.576	-4.350	4.350
23.567	23.567	-4.350	2.000
23.250	24.030	-0.000	2.000
23.528	24.090	2.000	2.000
23.604	24.030	4.000	4.350
23.146	23.899	8.350	0.660
23.192	24.419	8.741	1.031
23.245	23.880	9.010	0.541
23.274	23.192	10.041	0.500
23.310	23.192	10.582	0.750
23.293	23.192	11.082	0.500
23.303	22.692	11.832	0.500
23.303	22.692	12.332	0.750
23.303	23.192	13.082	3.225
23.308	23.192	16.307	0.232
23.308	23.308	16.539	

Materiale	Area(m2)
Scavo	11.839
Rilevato	0.146
Scotico	7.185
SuperCompattato	4.064
Subballast	1.547
Inerbimento	0.450

Prog. = 2+300.000

Q. Rif. = 8.000

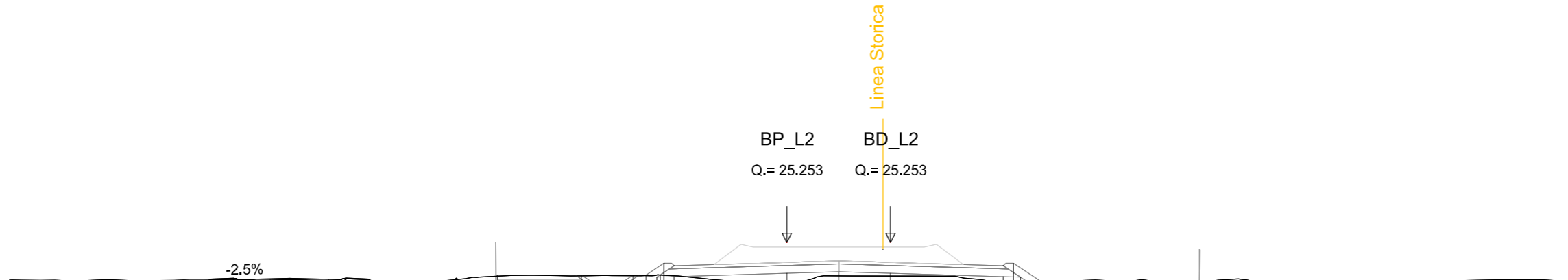

	Quote Terreno	Quote Progetto	Dist. Progr. Progetto	Dist. Parziali
	23.794	23.748	-25.442	0.660
	23.779	23.589	-25.204	0.200
	23.779	23.589	-25.094	0.500
	23.785	23.089	-24.594	0.600
	23.782	23.589	-23.594	1.000
	23.797	23.590	-22.584	1.403
	23.796	23.825	-22.231	0.000
	23.803	23.815	-21.181	2.000
	23.810	23.828	-20.681	2.000
	23.775	23.847	-19.931	2.000
	23.785	23.866	-19.181	2.000
	23.783	23.847	-18.431	0.000
	23.700	23.828	-17.681	1.254
	23.705	23.816	-17.181	1.010
	23.694	23.826	-16.131	0.500
	23.646	23.590	-15.777	0.500
	23.597	23.590	-14.757	0.500
	23.608	23.090	-14.257	0.500
	23.684	23.590	-13.757	0.500
	23.782	23.590	-13.257	0.500
	23.622	23.590	-12.725	0.500
	23.622	23.872	-12.725	0.500
	23.957	23.947	-11.223	0.419
	23.957	23.993	-11.154	0.536
	23.961	23.993	-7.929	3.225
	23.977	23.493	-7.179	0.750
	23.966	23.493	-6.679	0.500
	23.966	23.993	-5.929	0.750
	23.966	23.993	-5.429	0.500
	23.966	23.912	-5.010	0.500
	23.966	23.993	-4.888	0.500
	23.966	24.452	-4.741	0.500
	23.966	23.932	-4.350	0.500
	23.687	24.062	-0.000	4.350
	23.960	24.122	2.000	2.000
	23.952	24.062	4.000	2.000
	23.551	23.932	8.350	4.350
	23.507	24.452	8.741	0.660
	23.507	23.912	9.010	0.472
	23.507	23.597	9.482	0.541
	23.750	23.597	10.023	0.500
	23.781	23.597	10.523	0.750
	23.800	23.597	10.523	0.500
	23.775	23.097	11.273	0.750
	23.775	23.097	11.773	0.500
	23.775	23.597	12.523	0.750
	23.676	23.597	15.748	3.225
	23.676	23.676	15.907	0.159

Materiale	Area(m2)
Scavo	12.973
Rilevato	0.107
Scotico	6.858
SuperCompattato	4.064
Subballast	1.547
Inerbimento	0.408

Prog. = 2+350.000

Q. Rif. = 8.000

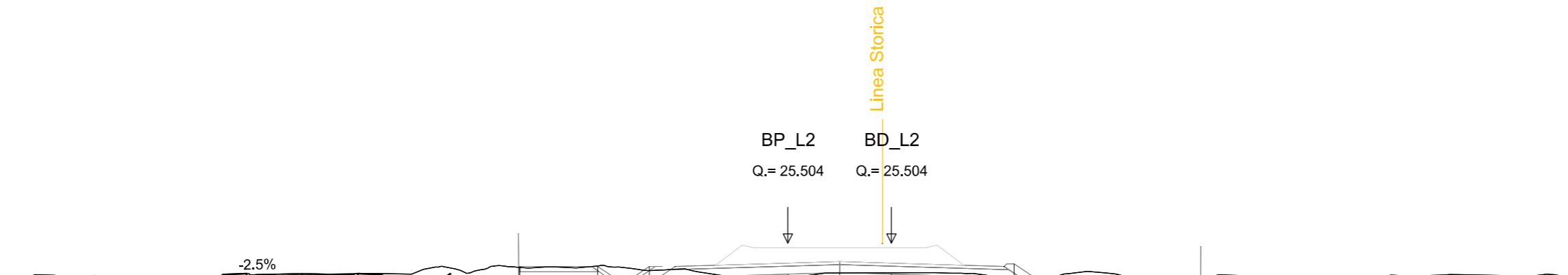

	Quote Terreno	Quote Progetto	Dist. Progr. Progetto	Dist. Parziali
	24.228	24.228	-25.036	0.660
	24.059	24.059	-24.783	0.266
	24.059	24.059	-24.673	0.110
	23.559	23.559	-24.173	0.500
	24.220	23.559	-23.673	0.600
	24.220	24.059	-23.173	0.600
	24.240	24.059	-22.163	1.000
	24.266	24.295	-21.809	1.404
	24.285	24.285	-20.799	0.000
	24.298	24.298	-20.259	0.000
	24.274	24.316	-19.509	2.000
	24.292	24.316	-18.759	2.000
	24.245	24.335	-18.009	2.000
	24.245	24.316	-17.259	0.000
	24.221	24.298	-16.759	1.254
	24.286	24.285	-15.709	0.000
	24.318	24.295	-15.045	0.000
	24.325	24.060	-14.545	0.500
	24.334	23.560	-14.045	0.500
	24.326	23.560	-13.545	0.500
	24.309	24.060	-13.045	0.660
	24.501	24.060	-12.545	0.660
	24.508	24.060	-12.045	0.660
	24.543	24.337	-11.545	0.660
	24.568	24.572	-10.396	2.623
	24.568	24.603	-10.350	0.046
	24.624	24.603	-7.350	3.000
	24.580	24.103	-6.600	0.750
	24.532	24.103	-6.100	0.500
	24.466	24.603	-5.350	0.750
	24.466	24.163	-5.010	0.340
	24.498	24.183	-4.350	0.660
	24.202	24.313	-0.000	4.350
	24.352	24.373	2.000	2.000
	24.361	24.313	4.000	2.000
	24.120	24.183	8.350	4.350
	24.088	24.703	8.741	0.660
	23.925	24.163	9.010	0.356
	24.234	23.925	9.366	0.541
	24.410	23.925	9.907	0.500
	24.368	23.925	10.407	0.750
	24.344	23.425	11.157	0.500
	24.344	23.425	11.657	0.750
	24.344	23.925	12.407	3.225
	24.080	23.925	15.632	0.309
	24.080	24.080	15.941	0.309

Materiale	Area(m2)
Scavo	14.653
Rilevato	0.060
Scotico	7.708
SuperCompattato	4.064
Subballast	1.547
Inerbimento	0.415

Prog. = 2+400.000

Q. Rif. = 8.000

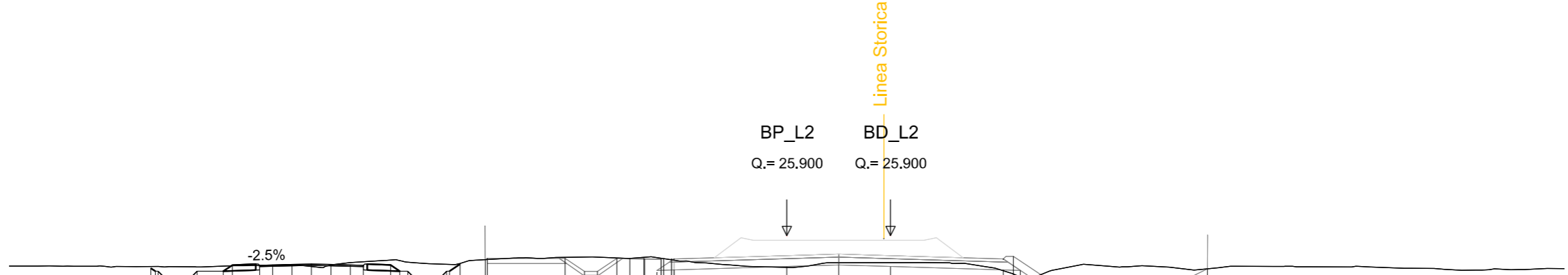

Quote Terreno	Quote Progetto	Dist. Progr. Progetto	Dist. Parziali
24.700	24.644	-24.535	0.166
24.700	24.529	-24.361	0.500
24.704	24.529	-24.251	0.698
24.699	24.029	-23.751	1.000
24.746	24.765	-21.741	1.403
24.743	24.755	-20.388	0.000
24.753	24.767	-19.838	2.000
24.776	24.786	-19.088	2.001
24.706	24.805	-18.338	0.000
24.762	24.786	-17.587	1.253
24.862	24.767	-16.837	0.000
24.958	24.755	-16.337	0.500
24.874	24.765	-15.287	0.500
24.808	24.529	-14.934	0.000
24.798	24.529	-14.624	0.971
24.825	24.029	-14.124	0.079
24.970	24.029	-13.624	3.000
25.065	24.029	-13.014	0.750
25.075	24.529	-12.605	0.500
25.037	24.529	-11.634	0.750
25.024	24.802	-11.555	0.500
25.070	24.971	-11.555	0.500
25.075	25.024	-11.555	0.500
25.037	25.024	-8.555	0.750
25.065	24.524	-7.805	0.500
24.676	24.524	-7.305	0.500
24.856	25.024	-6.555	0.750
24.857	25.024	-6.055	0.500
24.545	25.024	-5.514	0.750
24.418	25.075	-5.485	0.500
24.324	25.005	-5.010	0.500
24.438	24.479	-4.850	0.500
24.593	24.998	-4.750	0.500
24.737	24.998	-4.450	0.750
24.778	24.998	-4.350	0.500
24.717	24.578	-4.350	0.500
24.582	24.324	8.350	0.660
24.623	25.098	8.741	0.351
	24.324	9.010	0.500
	24.559	9.361	0.750
	24.324	9.902	0.500
	24.324	10.402	0.750
	24.324	11.152	3.225
	23.824	11.652	0.598
	24.324	12.402	
	24.324	15.627	
	24.623	16.225	

Materiale	Area(m2)
Scavo	11.271
Rilevato	0.064
Scotico	7.712
SuperCompattato	4.064
Subballast	1.547
Inerbimento	0.418

Prog. = 2+450.000

Q. Rif. = 9.000

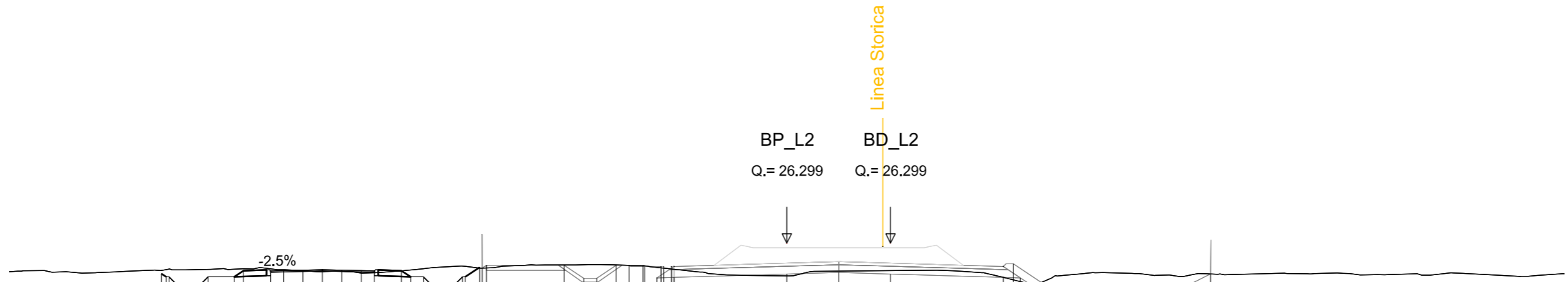

Quote Terreno	Quote Progetto	Dist. Progr. Progetto	Dist. Parziali
25.210	25.121	-24.123	0.188
25.210	24.998	-23.940	0.500
25.210	24.998	-23.830	0.500
25.210	24.998	-23.330	1.000
25.210	24.998	-22.830	1.404
25.210	24.998	-21.320	0.000
25.210	24.998	-20.966	2.000
25.210	25.224	-19.916	2.000
25.210	25.237	-19.416	2.000
25.210	25.256	-18.666	2.000
25.210	25.274	-17.916	2.000
25.210	25.256	-17.166	2.000
25.210	25.237	-16.416	2.000
25.210	25.225	-15.916	2.000
25.210	25.213	-14.866	2.000
25.210	25.213	-14.512	2.000
25.210	24.999	-14.014	1.254
25.210	24.999	-13.515	1.254
25.210	24.499	-13.015	0.499
25.210	24.999	-12.515	0.499
25.210	24.999	-12.005	0.500
25.210	25.369	-11.850	0.500
25.210	25.336	-11.747	0.500
25.210	25.444	-11.586	0.500
25.210	25.444	-8.586	3.000
25.210	24.944	-7.836	3.000
25.210	24.944	-7.336	3.000
25.210	25.444	-6.586	0.750
25.210	25.444	-6.086	0.500
25.210	25.444	-5.545	0.500
25.210	25.404	-5.485	0.750
25.210	24.958	-5.010	0.500
25.210	25.398	-4.850	0.500
25.210	25.398	-4.750	0.500
25.210	25.398	-4.450	0.500
25.210	25.398	-4.350	0.500
25.034	25.108	-0.000	4.350
25.217	25.168	2.000	2.000
25.236	25.108	4.000	2.000
24.981	24.978	8.350	4.350
24.888	25.498	8.741	0.660
24.739	24.739	9.010	0.328
25.048	24.958	9.338	0.541
25.096	24.739	9.879	0.500
25.145	24.739	10.379	0.750
25.156	24.739	11.129	0.500
25.156	24.239	11.629	0.750
25.156	24.739	12.379	3.225
25.077	24.739	15.604	0.744
25.111	25.111	16.348	0.744

Materiale	Area(m2)
Scavo	12.481
Rilevato	0.687
Scotico	6.815
SuperCompattato	4.064
Subballast	1.547
Inerbimento	0.377

Prog. = 2+500.000

Q. Rif. = 9.000

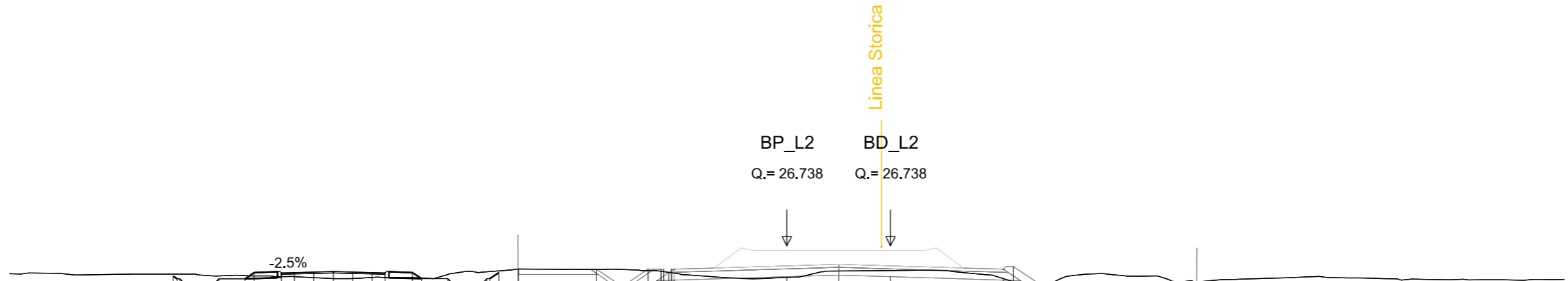

	Quote Terreno	Quote Progetto	Dist. Progr. Progetto	Dist. Parziali
	25.040	25.569	-23.672	
	25.040	25.468	-23.521	0.100
	25.040	25.468	-23.411	0.100
	25.040	24.968	-22.911	0.500
	25.578	25.468	-21.911	0.500
	25.589	25.704	-20.900	1.001
	25.589	25.694	-19.497	1.403
	25.546	25.706	-18.997	0.000
	25.546	25.725	-18.247	2.000
	25.513	25.744	-17.497	
	25.470	25.725	-16.747	
	25.470	25.707	-15.997	2.000
	25.479	25.694	-15.497	
	25.521	25.704	-14.447	0.000
	25.521	25.469	-14.093	1.254
	25.515	25.469	-13.073	
	25.508	24.969	-12.573	1.010
	25.635	24.969	-12.073	0.908
	25.751	25.469	-11.573	0.500
	25.751	25.704	-11.463	0.500
	25.774	25.704	-11.110	0.500
	25.846	25.846	-10.367	0.700
	25.846	25.837	-10.350	0.674
	25.846	25.837	-7.350	
	25.826	25.337	-6.600	3.000
	25.826	25.337	-6.100	
	25.835	25.837	-5.350	0.750
	25.817	25.837	-4.850	0.500
	25.783	25.837	-4.750	0.750
	25.783	25.713	-4.552	0.348
	25.783	25.837	-4.450	0.500
	25.783	25.417	-4.350	0.500
	25.523	25.548	-0.000	4.350
	25.765	25.608	2.000	2.000
	25.786	25.548	4.000	2.000
	25.475	25.417	8.350	4.350
	25.389	25.937	8.741	0.660
	25.200	25.397	9.010	0.741
	25.356	25.217	9.281	0.500
	25.596	25.217	9.822	0.750
	25.647	25.217	10.322	0.500
	25.653	24.717	11.072	0.750
	25.653	24.717	11.572	
	25.385	25.217	12.322	3.225
	25.385	25.347	15.547	0.260
		25.347	15.807	

Materiale	Area(m2)
Scavo	14.421
Rilevato	0.588
Scotico	7.191
SuperCompattato	4.064
Subballast	1.547
Inerbimento	0.540

Prog. = 2+550.000

Q. Rif. = 10.000

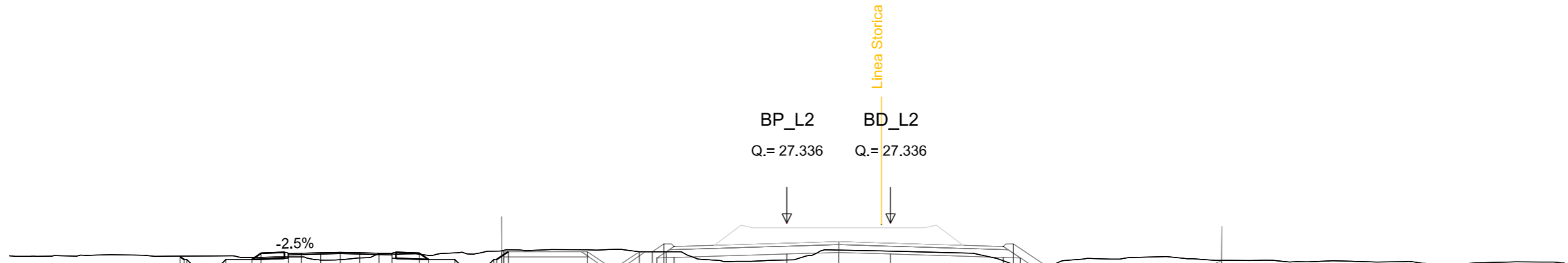

	Quote Terreno	Quote Progetto	Dist. Progr. Progetto	Dist. Parziali
	26.065	26.041	-23.407	0.000
	26.067	25.938	-23.252	0.155
	26.069	25.938	-23.142	0.110
	26.074	25.438	-22.642	0.500
	26.074	25.438	-22.142	0.500
	26.074	25.938	-21.642	0.500
	26.074	25.938	-20.632	1.000
	26.074	26.174	-20.279	1.403
	26.016	26.174	-19.229	0.000
	26.037	26.174	-18.729	2.000
	26.037	26.195	-17.979	2.000
	25.905	26.214	-17.229	2.000
	25.905	26.195	-16.479	2.000
	25.926	26.177	-15.729	0.000
	25.992	26.164	-15.229	1.254
	26.147	26.174	-14.179	1.010
	26.154	26.939	-13.825	0.918
	26.138	25.439	-12.805	0.500
	26.092	25.439	-12.305	0.000
	26.190	25.939	-11.805	0.000
	26.148	25.939	-11.305	0.000
	26.195	26.272	-10.993	0.000
	26.195	26.234	-10.917	0.000
	26.233	26.234	-10.740	0.000
	26.233	26.234	-10.740	0.000
	26.232	26.015	-4.350	3.048
	26.234	26.234	-7.692	0.750
	26.307	25.734	-6.942	0.500
	26.314	25.734	-6.442	0.750
	26.326	26.234	-5.692	0.500
	26.233	26.234	-5.192	0.750
	26.233	26.535	-5.010	0.500
	26.233	26.234	-4.741	0.309
	26.232	26.234	-4.651	0.309
	26.232	26.015	-4.350	4.350
	25.918	26.145	-0.000	2.000
	26.298	26.205	2.000	2.000
	26.259	26.145	4.000	4.350
	25.884	26.015	8.350	0.660
	25.678	26.535	8.741	0.721
	25.514	25.995	9.010	0.541
	25.900	25.514	9.731	0.750
	25.968	25.514	10.272	0.500
	25.965	25.514	10.772	0.500
	25.951	25.014	11.522	0.750
	25.951	25.514	12.022	3.225
	25.939	25.514	12.772	0.775
	25.901	25.901	15.997	
	25.901	25.901	16.772	

Materiale	Area(m2)
Scavo	12.805
Rilevato	0.195
Scotico	7.108
SuperCompattato	4.064
Subballast	1.547
Inerbimento	0.459

Prog. = 2+600.000

Q. Rif. = 10.000

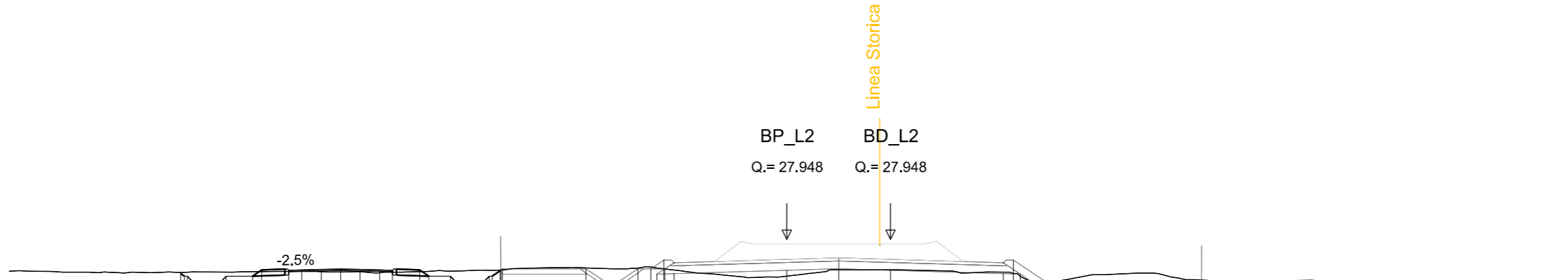

Quote Terreno	Quote Progetto	Dist. Progr. Progetto	Dist. Parziali
26.630	26.630	-23.385	
26.531	26.531	-23.236	
26.531	26.531	-23.126	
26.031	26.031	-22.626	
26.031	26.031	-22.126	
26.531	26.531	-21.626	
26.531	26.531	-20.616	
26.667	26.667	-20.262	
26.757	26.757	-19.212	
26.705	26.705	-18.712	
26.769	26.769	-17.962	
26.788	26.788	-17.212	
26.710	26.710	-16.462	
26.703	26.703	-15.712	
26.692	26.692	-15.212	
26.701	26.701	-14.162	
26.660	26.660	-13.808	
26.682	26.682	-12.979	
26.712	26.712	-12.479	
26.712	26.712	-11.979	
26.722	26.722	-11.479	
26.736	26.736	-11.369	
26.758	26.758	-11.056	
26.758	26.758	-11.032	
26.766	26.766	-10.972	
26.809	26.809	-7.747	
26.809	26.809	-6.997	
26.309	26.309	-6.497	
26.844	26.844	-5.747	
26.821	26.821	-5.247	
26.812	26.812	-5.010	
26.839	26.839	-4.741	
26.848	26.848	-4.707	
26.819	26.819	-4.350	
26.765	26.765	-4.350	
26.532	26.757	-0.000	3.225
26.772	26.817	2.000	0.750
26.777	26.757	4.000	0.500
26.686	26.626	8.350	0.500
26.599	27.146	8.741	0.660
26.553	26.607	9.010	0.499
26.362	26.274	9.509	0.541
26.494	26.274	10.050	0.500
26.586	26.274	10.550	0.750
26.602	26.774	11.300	0.500
26.602	25.774	11.800	0.750
26.382	26.274	12.550	0.500
26.382	26.382	15.775	3.225
26.382	26.382	15.991	0.216

Materiale	Area(m2)
Scavo	15.115
Rilevato	0.014
Scotico	6.911
SuperCompattato	4.064
Subballast	1.547
Inerbimento	0.446

Prog. = 2+650.000

Q. Rif. = 11.000

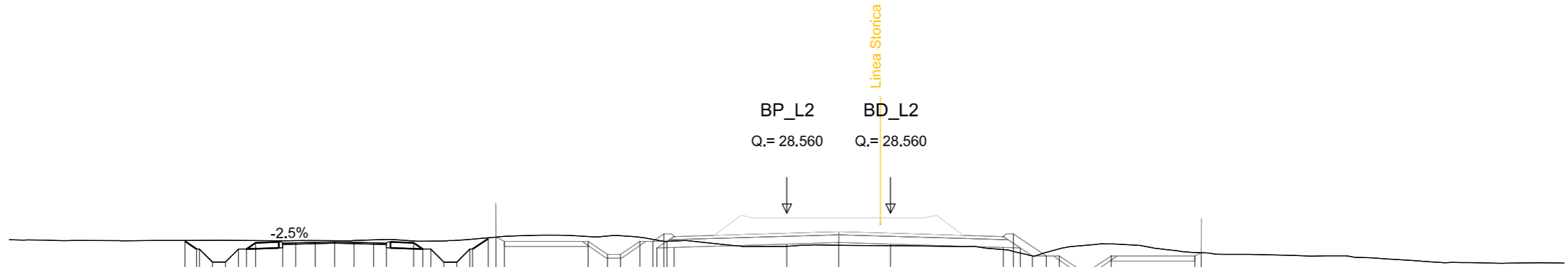

Quote Terreno	Quote Progetto	Dist. Progr. Progetto	Dist. Parziali
27.505	27.476	-23.214	
27.510	27.179	-22.768	
27.515	27.179	-22.658	
27.519	26.679	-22.158	0.446
27.519	26.679	-21.658	0.500
27.519	27.179	-20.848	0.500
27.519	27.415	-20.495	0.500
27.519	27.404	-19.445	1.403
27.504	27.417	-18.944	0.000
27.496	27.436	-18.194	2.001
27.501	27.454	-17.444	
27.504	27.435	-16.694	
27.500	27.417	-15.944	
27.508	27.404	-15.444	2.000
27.530	27.414	-14.394	0.000
27.545	27.178	-14.104	1.253
27.488	26.678	-13.731	0.000
27.479	26.678	-12.731	0.500
27.486	27.178	-12.231	0.500
27.513	27.178	-12.121	0.000
27.549	27.578	-11.521	0.500
27.613	27.638	-11.221	0.300
27.628	27.474	-10.893	0.328
27.657	27.474	-7.668	3.225
27.682	26.974	-6.918	
27.683	26.974	-6.418	0.750
27.631	27.474	-5.668	0.500
27.631	27.219	-5.168	0.750
27.631	27.758	-5.010	0.500
27.631	27.474	-4.741	0.388
27.488	27.474	-4.627	0.327
27.488	27.238	-4.350	
27.282	27.369	-0.000	4.350
27.321	27.429	2.000	2.000
27.308	27.369	4.000	2.000
27.157	27.238	8.350	4.350
27.157	27.758	8.741	0.660
27.157	27.219	9.010	0.461
27.157	27.051	9.471	0.541
27.184	26.911	10.012	0.500
27.296	26.911	10.512	0.750
27.340	26.411	11.262	0.500
27.371	26.411	11.762	0.750
27.371	26.911	12.512	3.225
27.036	26.911	15.737	0.250
27.036	27.036	15.987	

Materiale	Area(m2)
Scavo	10.780
Rilevato	0.036
Scotico	7.627
SuperCompattato	3.937
Subballast	1.535
Inerbimento	0.356

Prog. = 2+700.000

Q. Rif. = 12.000

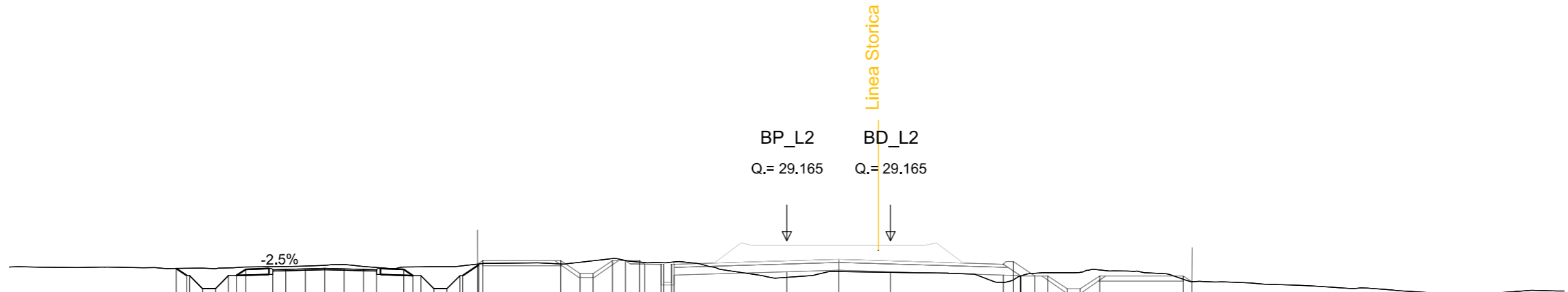

Quote Terreno	Quote Progetto	Dist. Progr. Progetto	Dist. Parziali
28.101	28.098	-23.557	0.000
28.100	27.827	-23.150	0.000
28.099	27.827	-23.040	0.500
28.098	27.327	-22.540	0.500
28.097	27.327	-22.040	0.500
28.096	27.827	-21.540	1.403
28.095	28.062	-20.877	0.000
28.094	28.052	-19.827	2.000
28.093	28.065	-18.577	0.000
28.168	28.102	-17.077	2.000
28.176	28.083	-16.327	2.000
28.193	28.064	-15.827	2.000
28.220	28.052	-14.777	0.000
28.251	28.062	-14.423	1.254
28.176	27.826	-14.113	0.000
28.137	27.326	-13.613	0.000
28.156	27.326	-13.113	0.500
28.165	27.826	-12.613	0.500
28.168	27.826	-12.503	0.500
28.168	28.272	-11.924	0.000
28.168	28.240	-11.881	0.000
28.202	28.404	-11.726	0.000
28.404	28.404	-8.726	3.000
28.404	27.904	-7.976	0.750
28.274	27.904	-7.476	0.500
28.340	28.404	-6.726	0.750
28.397	28.404	-6.226	0.500
28.482	28.270	-5.485	0.500
28.404	28.264	-4.850	0.200
28.340	28.264	-4.750	0.635
28.374	28.264	-4.450	0.500
28.353	27.844	-4.350	4.350
27.758	27.974	-0.000	2.000
27.981	28.034	2.000	2.000
27.951	27.974	4.000	4.350
27.561	27.844	8.350	0.669
27.809	28.364	8.741	0.544
27.915	27.824	9.010	0.500
27.935	27.812	9.027	0.750
27.934	27.812	9.568	0.500
27.949	27.812	10.068	0.750
28.040	27.312	10.818	3.225
27.812	27.312	11.318	0.334
27.812	27.812	12.068	
27.812	27.812	15.293	
27.589	27.589	15.627	

Materiale	Area(m2)
Scavo	1.514
Rilevato	0.629
Scotico	7.702
SuperCompattato	3.937
Subballast	1.535
Inerbimento	0.411

Prog. = 2+750.000

Q. Rif. = 12.000

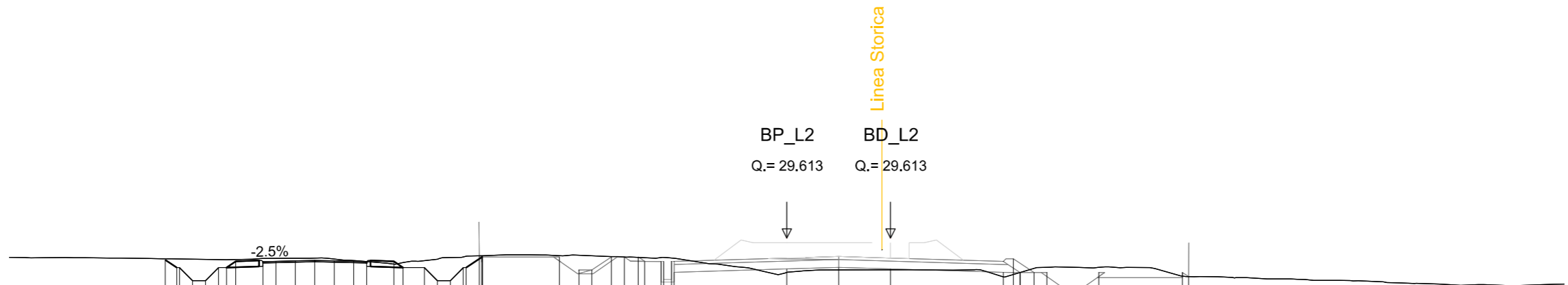

Quote Terreno	Quote Progetto	Dist. Progr. Progetto	Dist. Parziali
28.812	28.768	-23.976	
28.807	28.474	-23.535	
28.797	28.474	-23.425	
28.790	27.974	-22.925	
28.783	27.974	-22.425	0.440
28.767	28.474	-21.925	0.500
28.760	28.474	-21.615	0.500
28.712	28.710	-21.261	0.500
28.825	28.700	-20.211	1.404
28.829	28.712	-19.711	0.000
28.832	28.731	-18.961	0.000
28.838	28.750	-18.211	2.000
28.802	28.731	-17.461	2.000
28.743	28.712	-16.711	2.000
28.702	28.700	-16.211	0.000
28.665	28.709	-15.161	1.253
28.663	28.474	-14.808	0.818
28.742	28.473	-13.480	0.500
28.706	27.973	-12.980	0.500
28.680	27.973	-12.481	0.500
28.680	28.473	-12.371	0.500
28.680	28.473	-11.866	0.500
28.680	28.929	-11.771	0.500
28.680	28.881	-11.735	0.500
28.680	28.897	-11.735	0.500
28.931	28.881	-8.771	2.964
28.948	28.381	-8.021	0.750
28.928	28.381	-7.521	0.500
28.898	28.881	-6.771	0.750
28.881	28.881	-6.271	0.500
28.881	28.881	-5.730	0.750
28.881	28.881	-5.485	0.500
28.881	28.718	-4.850	0.245
28.881	28.881	-4.750	0.635
28.881	28.711	-4.450	0.500
28.881	28.711	-4.350	4.350
28.288	28.422	-0.000	2.000
28.381	28.482	2.000	2.000
28.385	28.422	4.000	4.350
28.116	28.291	8.350	0.617
28.288	28.811	8.741	0.524
28.484	28.283	8.993	0.750
28.484	28.272	9.010	0.500
28.491	28.283	9.534	0.750
28.478	28.283	10.034	0.500
28.483	28.283	10.784	0.750
28.483	27.783	11.284	3.225
28.483	28.283	12.034	0.238
28.140	28.283	15.259	0.238
28.140	28.124	15.497	

Materiale	Area(m2)
Scavo	9.997
Rilevato	0.133
Scotico	7.668
SuperCompattato	3.937
Subballast	1.535
Inerbimento	0.335

Prog. = 2+800.000

Q. Rif. = 13.000

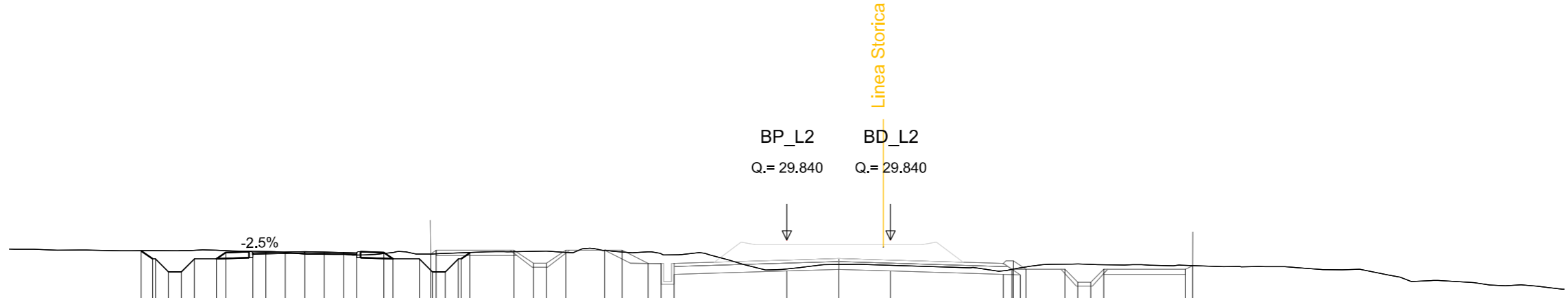

Quote Terreno	Quote Progetto	Dist. Progr. Progetto	Dist. Parziali
29.432	29.420	-24.912	
29.433	29.122	-24.465	
29.434	29.122	-24.355	
29.435	28.622	-23.854	0.447
29.436	29.122	-22.854	0.500
29.440	29.122	-21.999	0.500
29.448	29.358	-21.646	0.500
29.447	29.348	-20.596	0.845
29.410	29.360	-20.096	1.403
29.403	29.379	-19.346	0.000
29.362	29.397	-18.596	0.000
29.302	29.379	-17.846	2.000
29.294	29.360	-17.096	
29.287	29.347	-16.596	2.000
29.285	29.357	-15.546	
29.263	29.121	-15.192	0.000
29.323	29.121	-14.172	1.254
29.364	29.305	-13.742	
29.303	29.621	-13.672	1.010
29.303	29.448	-13.527	0.000
29.303	28.621	-13.172	0.000
29.303	28.621	-12.672	0.335
29.303	29.121	-12.562	0.335
29.303	29.121	-12.229	0.335
29.394	29.343	-10.527	1.702
29.407	29.448	-9.777	0.750
29.416	28.948	-9.777	0.500
29.363	29.448	-8.527	0.750
29.448	29.448	-7.027	1.500
29.381	29.448	-6.356	0.671
29.388	29.448	-5.350	0.685
29.311	28.945	-4.850	0.500
29.272	28.940	-4.350	0.500
28.728	28.650	-0.000	4.350
28.901	28.710	2.000	2.000
28.868	28.650	4.000	2.000
28.659	28.520	8.350	4.350
28.606	28.717	8.685	0.335
28.606	29.040	8.741	0.216
28.913	28.500	9.010	1.500
28.903	28.717	9.226	0.500
28.891	28.717	10.726	0.500
28.891	28.217	11.726	0.500
28.891	28.217	11.726	
28.891	28.717	12.226	3.150
28.864	28.717	15.376	0.275
28.864	28.854	15.651	

Materiale	Area(m2)
Scavo	11.906
Rilevato	0.086
Scotico	8.799
SuperCompattato	3.810
Subballast	1.524
Inerbimento	0.679

Prog. = 2+850.000

Q. Rif. = 13.000

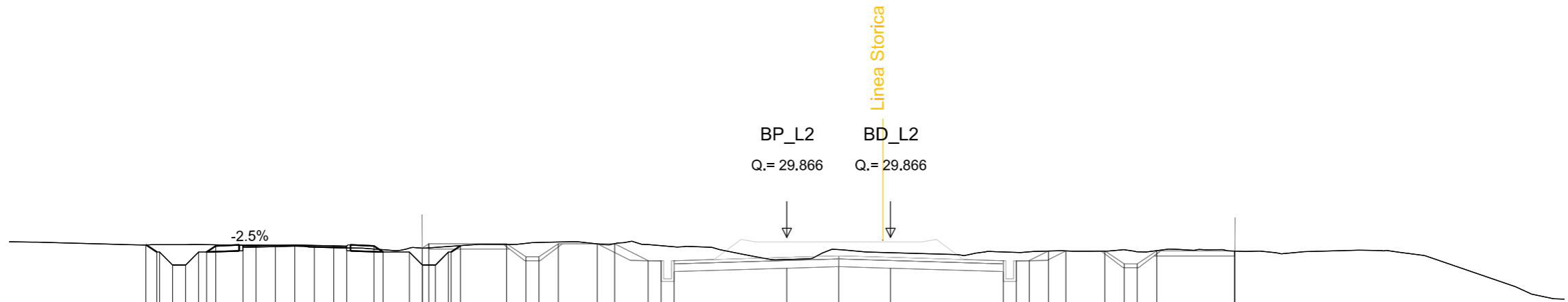

Quote Terreno	Quote Progetto	Dist. Progr. Progetto	Dist. Parziali
29.574	29.584	-24.726	0.400
29.569	29.303	-24.304	0.500
29.565	29.303	-24.194	0.600
29.587	28.803	-23.694	0.800
29.582	29.303	-23.194	0.900
29.581	29.303	-22.694	1.000
29.581	29.539	-22.030	1.100
29.569	29.529	-20.980	1.200
29.571	29.541	-20.480	1.300
29.559	29.560	-19.730	1.404
29.542	29.579	-18.980	0.000
29.487	29.560	-18.230	2.000
29.468	29.541	-17.480	2.000
29.458	29.529	-16.980	2.000
29.417	29.539	-15.930	0.000
29.394	29.303	-15.577	1.253
29.455	29.303	-14.557	1.010
29.418	29.450	-14.064	0.000
29.418	28.803	-14.057	1.010
29.418	29.617	-13.813	0.000
29.418	28.803	-13.557	0.000
29.418	29.303	-13.057	0.000
29.418	29.303	-12.947	0.000
29.418	29.303	-12.590	0.000
29.592	29.541	-12.590	1.777
29.639	29.617	-10.813	0.750
29.670	29.117	-10.063	0.500
29.686	29.117	-9.563	0.750
29.617	29.617	-8.813	1.500
29.626	29.617	-7.313	0.671
29.588	29.617	-6.642	0.607
29.506	28.971	-5.350	0.686
29.506	28.966	-4.850	0.500
29.506	28.546	-4.350	0.500
29.013	28.677	-0.000	4.350
29.394	28.737	2.000	2.000
29.278	28.677	4.000	2.000
29.304	28.546	8.350	4.350
29.287	28.966	8.850	0.500
29.309	28.971	9.350	0.500
29.339	29.345	10.097	0.686
29.345	29.345	10.768	0.671
29.333	29.345	10.768	1.500
29.390	29.345	12.268	0.750
29.311	28.845	13.018	0.500
29.355	28.845	13.518	0.750
29.355	28.845	14.268	0.750
29.336	29.345	17.268	3.000
29.335	29.335	17.282	0.014

Materiale	Area(m2)
Scavo	8.562
Rilevato	11.939
Scotico	7.712
SuperCompattato	4.064
Subballast	1.547
Inerbimento	1.109

Prog. = 2+900.000

Q. Rif. = 11.000

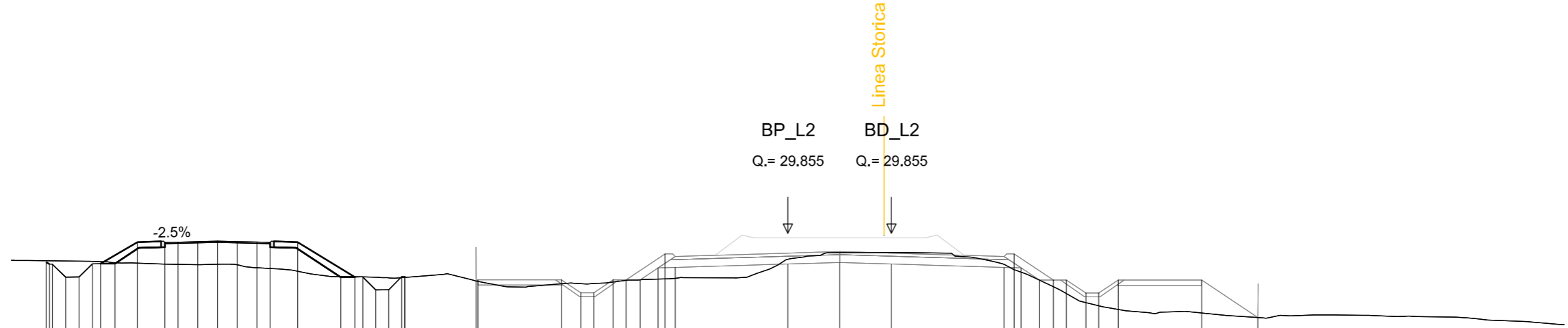

	Quote Terreno	Quote Progetto	Dist. Progr. Progetto	Dist. Parziali
	28.700	28.735	-28.648	0.060
	28.700	28.524	-28.524	0.176
	28.700	28.658	-28.411	0.115
	28.700	28.163	-27.896	0.515
	28.700	28.168	-27.381	0.515
	28.700	28.673	-26.866	0.515
	28.700	28.676	-26.547	0.308
	28.700	28.753	-25.990	0.557
	28.700	28.681	-25.990	0.915
	28.697	29.505	-25.126	1.014
	28.657	29.495	-24.061	0.000
	28.646	29.507	-23.553	2.030
	28.639	29.526	-22.792	
	28.652	29.545	-22.031	
	28.631	29.526	-21.270	2.029
	28.524	29.508	-20.509	0.000
	28.488	29.495	-20.002	0.862
	28.383	29.505	-18.936	1.721
	28.383	28.152	-17.266	0.540
	28.383	28.158	-16.726	0.000
	28.175	28.161	-16.416	0.499
	28.175	27.667	-15.917	0.499
	28.166	27.672	-15.418	0.000
	28.151	28.177	-14.918	0.750
	28.127	28.178	-14.808	0.500
	28.127	28.178	-14.808	0.541
	28.127	28.178	-14.808	0.696
	28.127	28.178	-14.808	0.660
	28.127	28.173	-14.789	4.350
	28.005	28.005	-12.039	
	28.005	28.050	-11.972	2.750
	27.899	28.050	-8.747	0.067
	27.899	27.550	-7.997	3.225
	27.906	27.550	-7.497	0.750
	27.913	28.050	-6.747	0.500
	27.967	28.050	-6.247	0.750
	28.032	28.050	-5.706	0.500
	28.050	28.050	-5.010	0.541
	28.050	28.054	-4.741	0.696
	28.050	28.054	-4.741	0.660
	28.050	28.534	-4.350	4.350
	28.846	28.664	-0.000	2.000
	29.101	28.724	2.000	2.000
	29.106	28.664	4.000	2.000
	28.649	28.534	8.350	4.350
	28.448	29.054	8.741	0.660
	28.041	28.514	9.010	0.709
	27.787	28.041	9.719	0.541
	27.525	28.041	9.719	0.500
	27.172	28.041	10.260	0.750
	27.050	28.041	10.760	0.500
	26.910	27.541	11.510	0.500
	26.910	27.541	12.010	0.750
	26.910	28.041	12.760	3.225
	26.770	28.041	15.985	2.169
	26.594	26.594	18.154	

Materiale	Area(m2)
Scavo	14.868
Rilevato	0.029
Scotico	11.102
SuperCompattato	4.064
Subballast	1.547
Inerbimento	3.536

Prog. = 2+950.000

Q. Rif. = 9.000

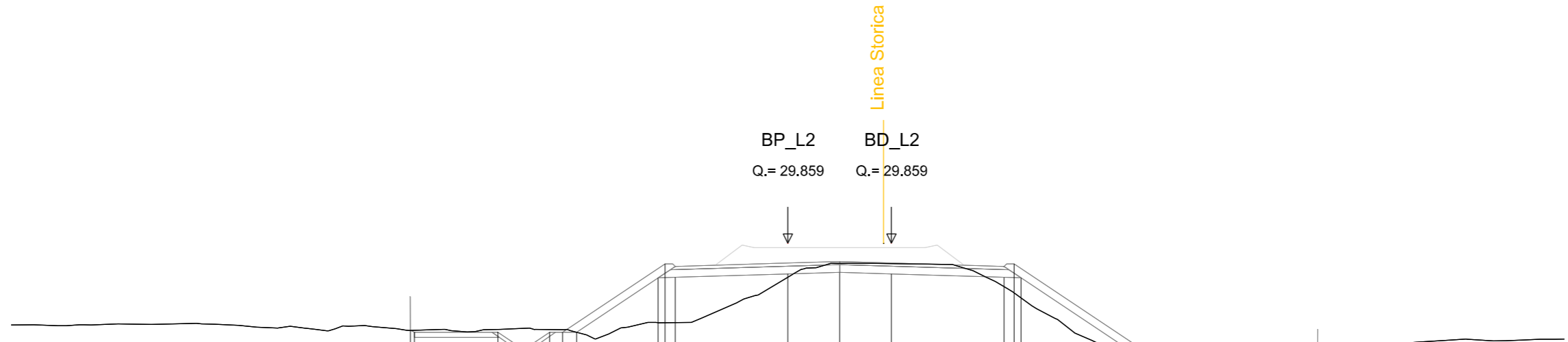

	0.151	3.225	0.750	0.500	0.750	0.500	0.541	3.151	0.660	4.350	2.000	2.000	4.350	0.660	5.033	0.540	0.500	0.750	0.500	0.750	3.225	0.150			
Quote Terreno	26.497	26.497	26.528	26.557	26.573	26.522	26.516	26.417	26.787	26.792	28.543	29.075	29.067	28.178	27.940	25.163	25.138	25.106	24.832	24.817	25.245	25.245			
Quote Progetto	26.493	26.417	26.417	25.917	25.917	26.417	26.417	26.417	28.518	29.058	28.669	28.729	28.669	28.538	29.058	28.518	25.163	25.163	25.163	24.663	24.663	25.163	25.163		
Dist. Progr. Progetto	-14.578	-14.427	-11.202	-10.452	-9.952	-9.202	-8.702	-8.161	-5.010	-4.741	-4.350	-0.000	2.000	4.000	8.350	8.741	9.010	14.043	14.583	15.083	15.833	16.333	17.083	20.308	20.458
Dist. Parziali	0.151	3.225	0.750	0.500	0.750	0.500	0.541	3.151	0.660	4.350	2.000	2.000	4.350	0.660	5.033	0.540	0.500	0.750	0.500	0.750	3.225	0.150			

Materiale	Area(m2)
Scavo	10.728
Rilevato	0.075
Scotico	9.014
SuperCompattato	4.064
Subballast	1.547
Inerbimento	2.069

Prog. = 3+000.000

Q. Rif. = 11.000

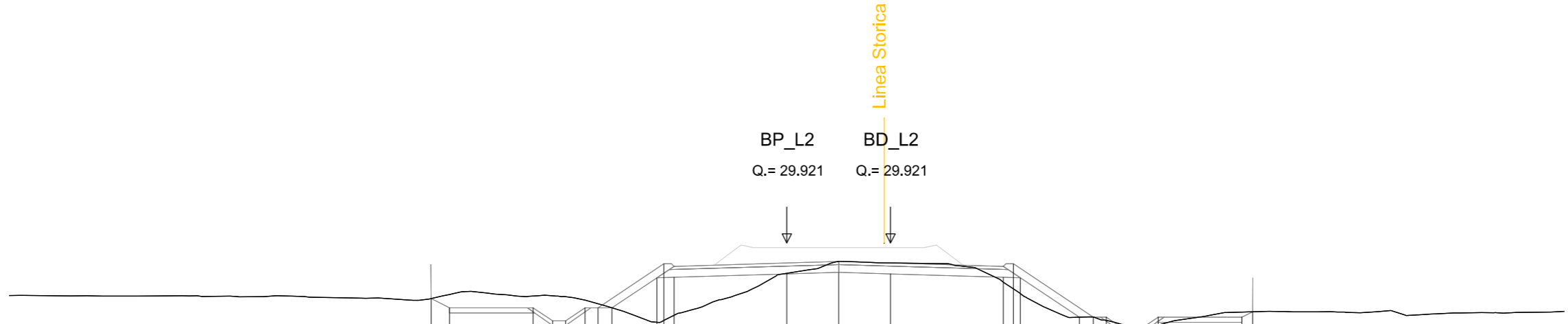

Quote Terreno		27.779	27.936		27.876	27.885	27.885	27.722	27.581	27.423		26.859	27.137		28.756	29.216	29.154		28.419	28.978	27.063	27.088	26.937	26.779	26.748	26.761		27.269	27.291	
Quote Progetto		27.779	27.423		27.423	26.923	26.923	27.423	27.423	27.423		28.580	28.120	28.600	28.730	28.790	28.730		28.600	29.120	28.580	27.063	27.063	26.563	26.563	27.063		27.063	27.271	
Dist. Progr. Progetto		-13.722	-13.010		-9.785	-9.035	-8.535	-7.785	-7.285	-6.744		-5.010	-4.741	-4.350	-0.000	2.000	4.000		8.350	8.741	9.010	11.284	11.825	12.325	13.075	13.575	14.325		17.550	17.965
Dist. Parziali		0.712	3.225		0.750	0.500	0.750	0.500	0.541	1.734		0.660	4.350		2.000	2.000		4.350	0.660	2.274		0.541	0.500	0.750	0.500	0.750		3.225	0.415	

Materiale	Area(m2)
Scavo	16.196
Rilevato	0.031
Scotico	7.804
SuperCompattato	4.064
Subballast	1.547
Inerbimento	0.827

Prog. = 3+100.000

Q. Rif. = 12.000

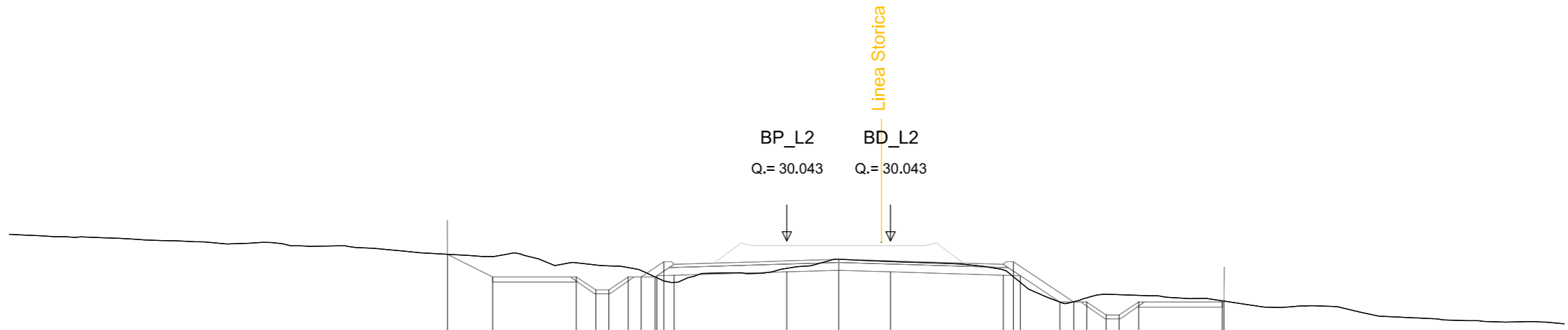

Quote Terreno		29.526	29.441	29.204	29.116	29.082	29.017	28.903	28.856	28.846	28.985	29.333	29.252	28.927	28.856	27.690	27.700	27.850	27.988	27.971	27.944	27.724	
Quote Progetto		29.526	28.656	28.656	28.156	28.156	28.656	28.656	28.656	28.703	28.242	28.853	28.913	28.853	28.722	29.242	28.703	27.690	27.690	27.690	27.190	27.690	27.690
Dist. Progr. Progetto		-13.087	-11.346	-8.121	-7.371	-6.871	-6.121	-5.621	-5.080	-5.010	-4.741	-0.000	2.000	4.000	8.350	8.741	9.010	10.529	11.069	11.569	12.319	12.819	13.569
Dist. Parziali		1.741	3.225	0.750	0.500	0.750	0.500	0.500	0.547	0.868	4.350	2.000	2.000	4.350	0.660	1.519	0.540	0.500	0.750	0.500	0.750	3.225	0.069

Materiale	Area(m2)
Scavo	12.644
Rilevato	0.185
Scotico	7.710
SuperCompattato	4.064
Subballast	1.547
Inerbimento	0.885

Prog. = 3+150.000

Q. Rif. = 12.000

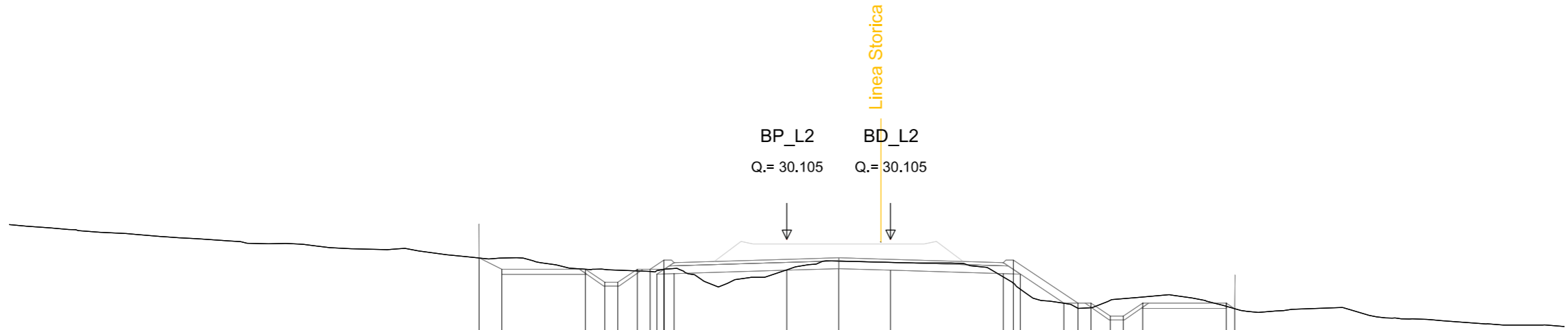

	29.387	29.382	28.951	28.945	28.917	28.886	28.880	28.980	28.930	29.263	29.214	28.656	28.475	27.644	27.447	27.466	27.756	27.818	27.880	27.529	
Quote Terreno	29.387	29.382	28.951	28.945	28.917	28.886	28.880	28.980	28.930	29.263	29.214	28.656	28.475	27.644	27.447	27.466	27.756	27.818	27.880	27.529	
Quote Progetto	29.387	28.951	28.951	28.451	28.451	28.951	28.764	29.304	28.914	28.974	28.914	28.784	29.304	27.644	27.644	27.644	27.144	27.144	27.644	27.644	27.427
Dist. Progr. Progetto	-11.869	-10.995	-7.770	-7.020	-6.520	-5.770	-5.270	-5.010	-0.000	2.000	4.000	8.350	8.741	10.690	11.230	11.730	12.480	12.980	13.730	16.955	17.280
Dist. Parziali	0.874	3.225	0.750	0.500	0.750	0.500	0.280	0.378	4.350	2.000	2.000	4.350	0.660	1.680	0.540	0.500	0.750	0.500	0.750	3.225	0.325

Materiale	Area(m2)
Scavo	11.198
Rilevato	0.676
Scotico	8.798
SuperCompattato	3.937
Subballast	1.535
Inerbimento	1.201

Prog. = 3+200.000

Q. Rif. = 12.000

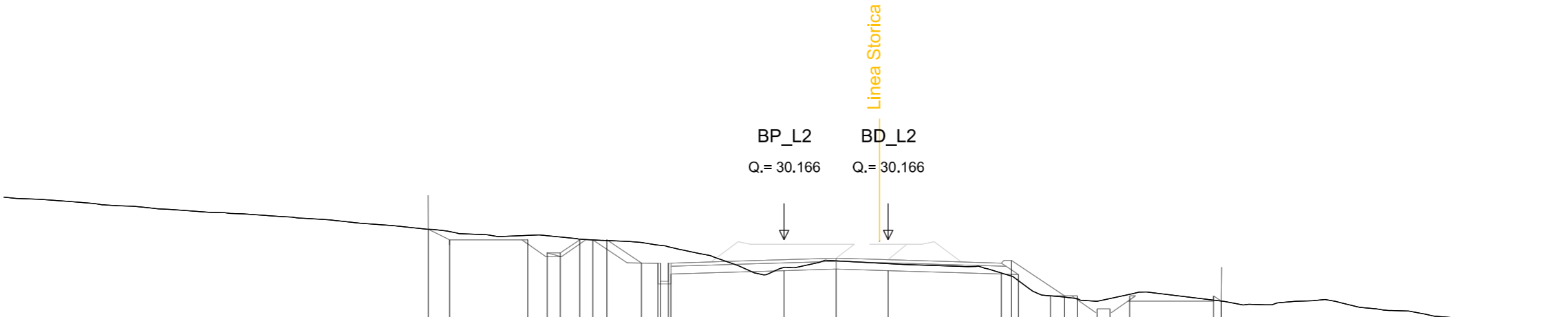

Quote Terreno				30.567	30.478	30.331	30.320	30.270	30.183	30.157	30.134	30.057	29.999	29.999	29.101	29.355	29.246				28.983	28.586	28.005	27.954	27.892	27.798	27.900	28.063			27.804		
Quote Progetto				30.567	30.157	30.157	29.657	30.157	30.157	30.157	29.272	29.265	29.265	28.845	28.976	29.036	28.976	28.845	28.845	29.365	28.825	28.005	28.005	28.005	27.505	27.505	27.505	28.005			28.005	27.804	
Dist. Progr. Progetto				-13.674	-12.855	-9.855	-9.105	-8.605	-7.855	-7.355	-6.814	-5.485	-4.850	-4.750	-4.450	-4.350	-0.000	2.000	4.000		8.350	8.741	9.010	10.240	10.781	11.281	12.031	12.531	13.281			16.506	16.808
Dist. Parziali	0.819	3.000	0.750	0.500	0.750	0.500	0.541	0.779	0.550	0.635	0.500		4.350		2.000	2.000		4.350	0.660	1.230	0.541	0.500	0.750	0.500	0.750	3.225			0.302				

Materiale	Area(m2)
Scavo	14.164
Rilevato	0.479
Scotico	8.561
SuperCompattato	3.937
Subballast	1.535
Inerbimento	1.168

Prog. = 3+250.000

Q. Rif. = 13.000

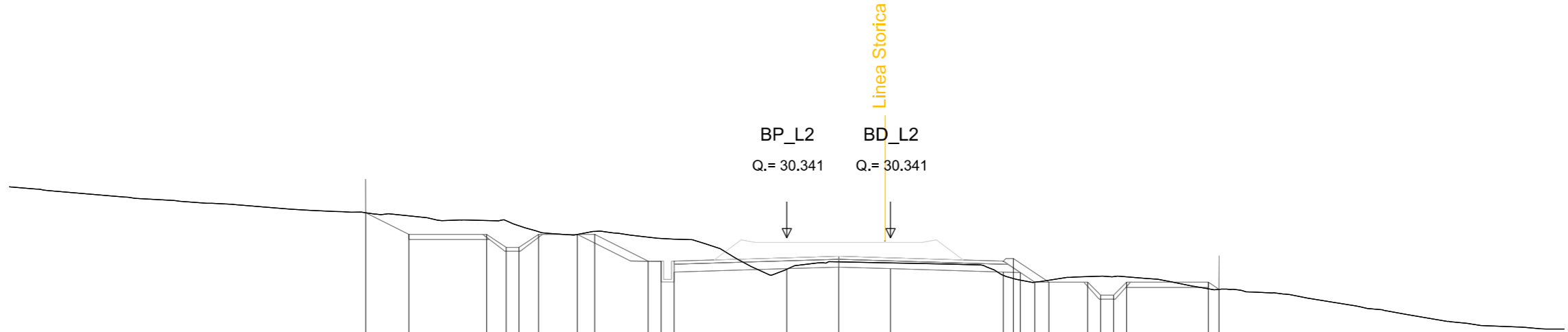

Quote Terreno		31.307	31.190	31.009	30.998	30.804	30.577	30.475	30.475	30.589	29.129	29.417	29.376	28.997	28.769	28.630	28.709	28.847	28.864	28.843	28.839	28.375	28.355			
Quote Progetto		31.307	30.475	30.475	29.975	29.975	30.475	30.475	30.475	30.475	29.151	29.211	29.151	29.021	29.541	29.001	28.630	28.630	28.630	28.130	28.130	28.630	28.630	28.355		
Dist. Progr. Progetto		-16.243	-14.579	-11.579	-10.829	-10.329	-9.579	-8.079	-7.408	-5.350	-4.850	-4.350	-0.000	2.000	4.000	8.350	8.741	9.010	9.567	10.108	11.608	12.108	12.608	13.108	16.258	16.669
Dist. Parziali		1.664	3.000	0.750	0.500	0.750	1.500	0.671	1.373	0.888	0.500	0.500	4.350	2.000	2.000	4.350	0.660	0.557	0.541	1.500	0.500	0.500	0.500	3.150	0.411	

Materiale	Area(m2)
Scavo	13.789
Rilevato	2.583
Scotico	8.217
SuperCompattato	4.064
Subballast	1.547
Inerbimento	1.492

Prog. = 3+300.000

Q. Rif. = 12.000

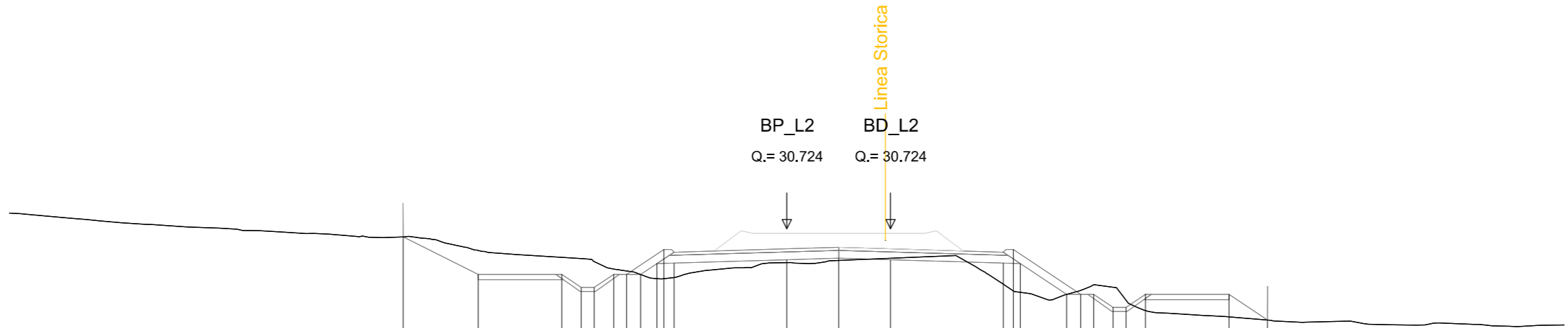

	30.409	29.889	29.621	29.575	29.459	29.174	29.101	28.963	28.883	28.848	29.421	29.504	29.586	28.586	28.275	28.194	28.347	28.347	28.562	28.471	27.971	27.569	27.327	27.208	
Quote Terreno	30.409	29.889	29.621	29.575	29.459	29.174	29.101	28.963	28.883	28.848	29.421	29.504	29.586	28.586	28.275	28.194	28.347	28.347	28.562	28.471	27.971	27.569	27.327	27.208	
Quote Progetto	30.409	28.963	28.963	28.463	28.463	28.963	28.963	28.963	29.383	29.923	29.533	29.593	29.533	29.403	29.923	29.363	28.194	28.194	28.194	27.694	27.694	28.194	28.194	27.208	27.208
Dist. Progr. Progetto	-14.798	-11.905	-8.680	-7.930	-7.430	-6.680	-6.180	-5.640	-5.010	-4.741	-4.350	-0.000	2.000	4.000	8.350	8.741	9.010	10.794	11.334	11.834	12.584	13.084	13.834	17.059	18.538
Dist. Parziali		2.893	3.225	0.750	0.500	0.750	0.500	0.540	0.630	0.660	4.350	2.000	2.000	4.350	0.660	1.784	0.540	0.500	0.750	0.500	0.750	3.225		1.479	

Materiale	Area(m2)
Scavo	18.417
Rilevato	0.164
Scotico	9.548
SuperCompattato	4.064
Subballast	1.547
Inerbimento	2.433

Prog. = 3+350.000

Q. Rif. = 12.000

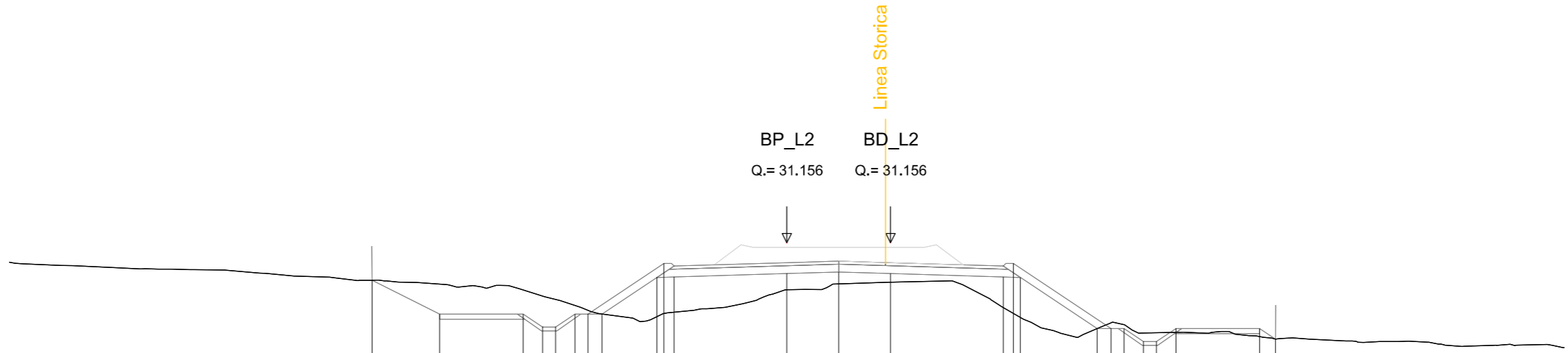

Quote Terreno		29.706	29.558	29.335	28.994	28.986	28.736	28.573	28.403	28.201	28.273	29.343	29.567	29.629	28.649	28.573	27.843	28.065	27.992	27.670	27.681	27.697	27.536	27.433	
Quote Progetto		29.706	28.403	28.403	27.903	27.903	28.403	28.403	28.403	29.815	30.355	29.966	30.026	29.966	29.835	30.355	29.815	27.843	27.843	27.843	27.343	27.843	27.843	27.843	27.433
Dist. Progr. Progetto		-16.001	-13.394	-10.169	-9.419	-8.919	-8.169	-7.669	-7.129	-5.010	-4.741	-0.000	2.000	4.000	8.350	8.741	9.010	11.968	12.509	13.009	13.759	14.259	15.009	18.234	18.849
Dist. Parziali		2.607	3.225	0.750	0.500	0.750	0.500	0.540	2.119	0.660	4.350	2.000	2.000	4.350	0.660	2.958	0.541	0.500	0.750	0.500	0.750	3.225	0.615		

Materiale	Area(m2)
Scavo	17.187
Rilevato	1.179
Scotico	10.280
SuperCompattato	4.064
Subballast	1.547
Inerbimento	2.939

Prog. = 3+400.000

Q. Rif. = 12.000

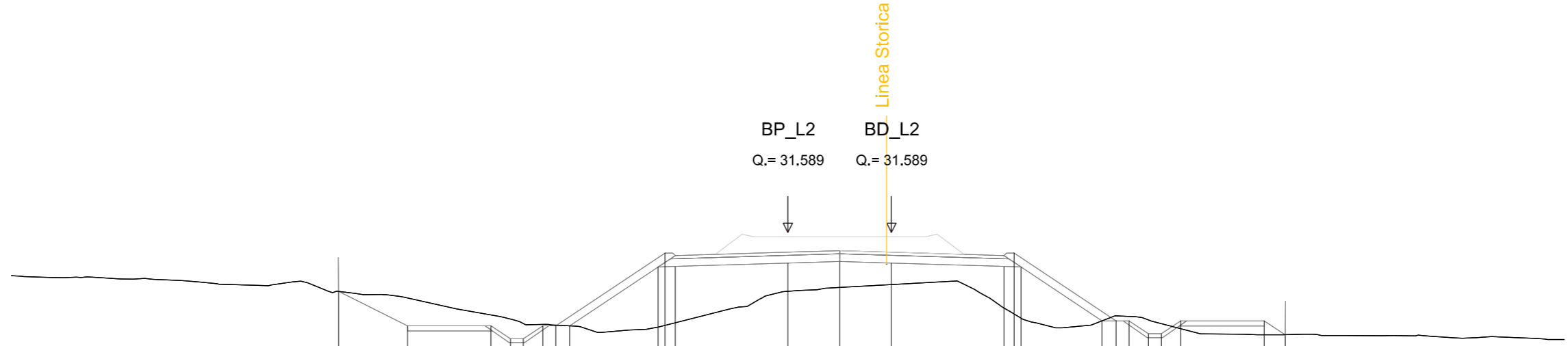

Quote Terreno			29.303	29.048	28.395	28.231	28.061	28.029	27.959	27.971				28.662	28.270	28.164	28.355	28.335	28.201	28.058	27.862				27.626	27.626				
Quote Progetto			29.303	27.971	27.971	27.471	27.471	27.971	27.971	27.971				30.268	30.788	30.248	28.164	28.164	28.164	27.664	27.664	28.164				28.164	27.626			
Dist. Progr. Progetto			-17.354	-14.691	-11.466	-10.716	-10.216	-9.466	-8.966	-8.425				-5.010	-4.741	-4.350	-0.000	2.000	4.000	8.350	8.741	9.010	12.135	12.676	13.176	13.926	14.426	15.176	18.401	19.208
Dist. Parziali				2.663	3.225	0.750	0.500	0.750	0.500	0.541	3.415	0.660	4.350		2.000	2.000	4.350	0.660	3.125				0.541	0.500	0.750	0.500	0.750	3.225	0.807	

Materiale	Area(m2)
Scavo	16.289
Rilevato	0.358
Scotico	8.688
SuperCompattato	3.937
Subballast	1.535
Inerbimento	1.716

Prog. = 3+450.000

Q. Rif. = 11.000

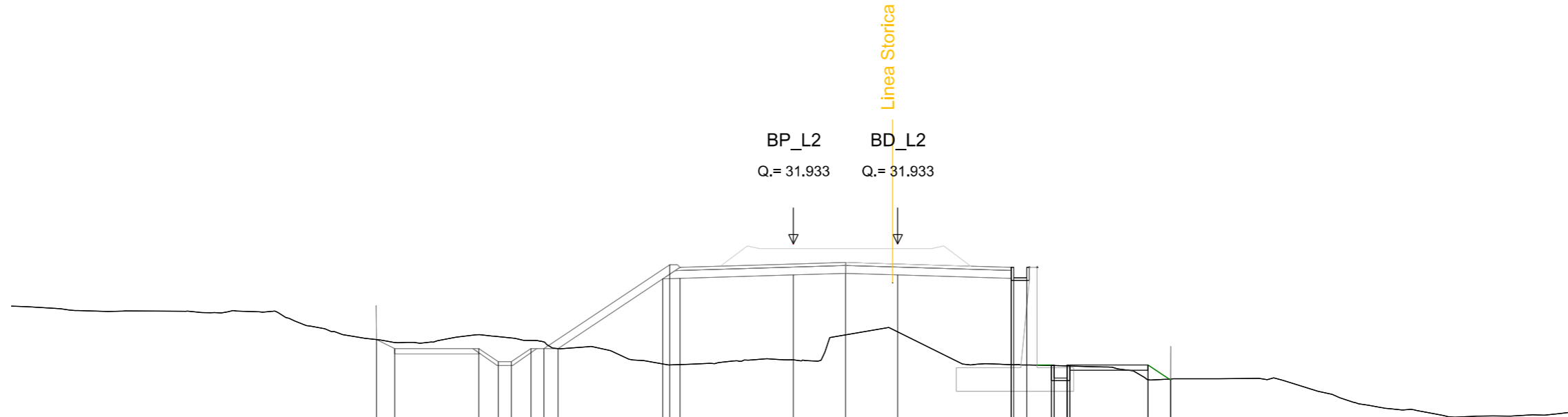

	0.700	3.225	0.750	0.500	0.750	0.500	0.540	4.017	0.660	4.350	2.000	2.000	4.350	1.000	0.868	0.868	0.868	3.100	0.000	0.868	0.000	
Quote Terreno	28.264	28.153	28.450	28.373	28.322	28.231	28.171	27.914	27.330	27.305	27.487	28.444	28.562	27.298	27.280	27.270	27.262	26.723	26.747			
Quote Progetto	28.264	27.914	27.914	27.414	27.414	27.914	27.914	27.914	30.592	31.132	30.612	30.743	30.803	30.743	30.612	31.032	31.032	31.032	31.032	31.032	27.286	27.286
Dist. Progr. Progetto	-15.992	-15.292	-12.067	-11.317	-10.817	-10.067	-9.567	-9.027	-5.010	-4.741	-4.350	-0.000	2.000	4.000	8.350	8.350	8.350	8.450	8.950	9.900	9.900	10.000
Dist. Parziali	0.700	3.225	0.750	0.500	0.750	0.500	0.540	4.017	0.660	4.350	2.000	2.000	4.350	1.000	0.868	0.868	0.868	3.100	0.000	0.868	0.000	

Materiale	Area(m2)
Scavo	20.405
Rilevato	0.029
Scotico	11.527
SuperCompattato	4.064
Subballast	1.547
Inerbimento	3.759

Prog. = 3+500.000

Q. Rif. = 11.000

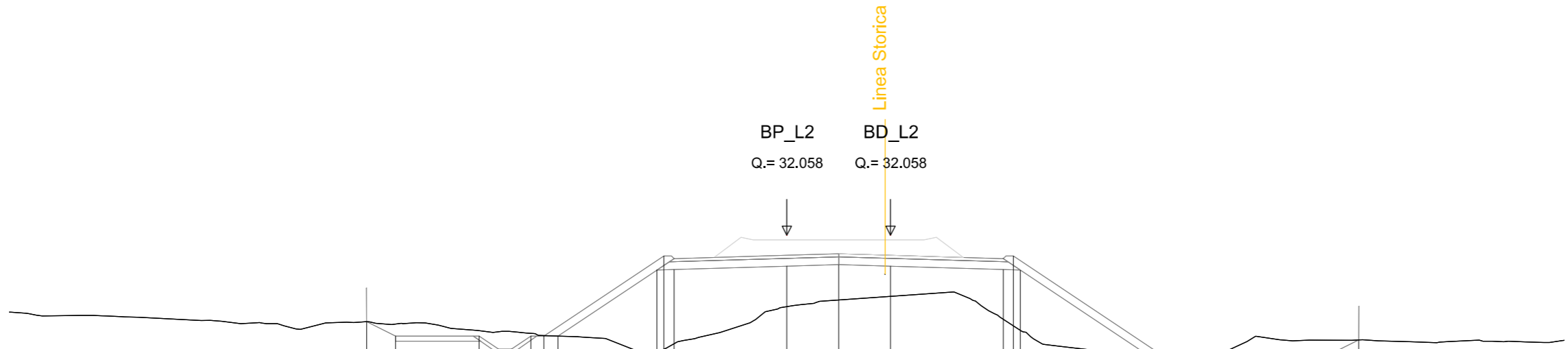

Quote Terreno			28.727	28.634		28.380	28.337	28.347	28.277	28.192	28.171		27.538	27.873		29.306	29.563	29.703		28.816	28.867		27.241	27.265	27.466	27.559	27.538	27.731		28.012	28.024		
Quote Progetto			28.727	28.171		28.171	27.671	27.671	28.171	28.171	28.171		30.717	31.257	30.737		30.868	30.928	30.868		30.737	31.257	30.717		27.241	27.241	27.241	26.741	26.741	27.241		27.241	28.024
Dist. Progr. Progetto			-16.207	-15.095		-11.870	-11.120	-10.620	-9.870	-9.370	-8.830		-5.010	-4.741	-4.350		-0.000	2.000	4.000		8.350	8.741	9.010		14.225	14.766	15.266	16.016	16.516	17.266		20.491	22.058
Dist. Parziali			1.112	3.225		0.750	0.500	0.750	0.500	0.540		3.820	0.660		4.350		2.000	2.000		4.350	0.660		5.215		0.541	0.500	0.750	0.500	0.750		3.225	1.567	

Materiale	Area(m2)
Scavo	18.967
Rilevato	0.027
Scotico	10.865
SuperCompattato	4.064
Subballast	1.547
Inerbimento	3.421

Prog. = 3+550.000

Q. Rif. = 12.000

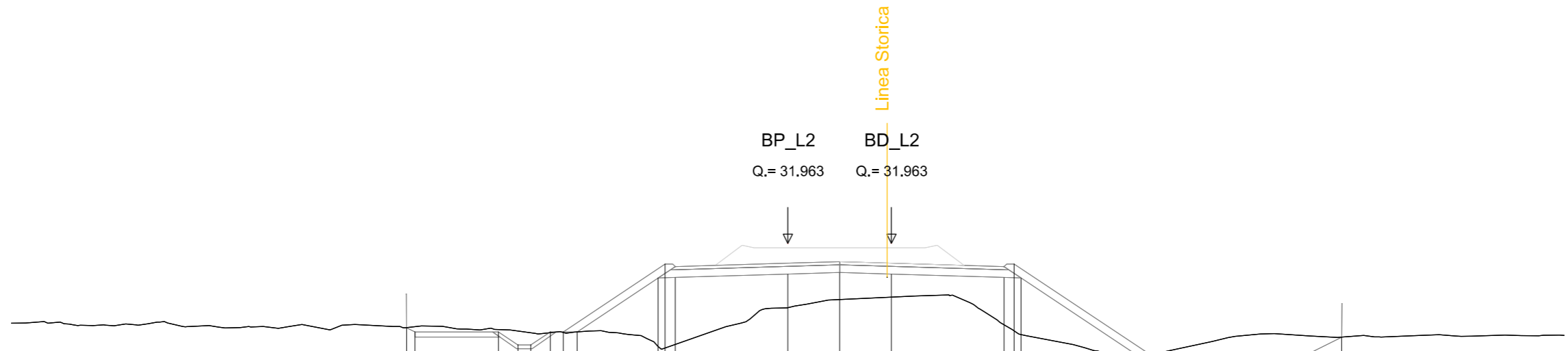

	1	2	3	4	5	6	7	8	9	10	11	12	13	14	15	16	17	18	19	20	21	22	23	24	25	26	27	28	29	30	31	32	33	34	35	36	37	38	39	40	41	42	43	44	45	46	47	48	49	50	51	52	53	54	55	56	57	58	59	60	61	62	63	64	65	66	67	68	69	70	71	72	73	74	75	76	77	78	79	80	81	82	83	84	85	86	87	88	89	90	91	92	93	94	95	96	97	98	99	100
Quote Terreno	28.799	28.631	28.573	28.504	28.510	28.517	28.538	28.538	27.975	28.056	29.474	29.787	29.881	28.816	28.391	27.566	27.583	27.790	27.951	28.059	28.227	28.399	28.334																																																																													
Quote Progetto	28.700	28.538	28.538	28.038	28.538	28.538	28.538	30.622	31.162	30.642	30.773	30.833	30.773	30.642	31.162	30.622	27.566	27.566	27.566	27.066	27.066	27.566	27.566	28.334																																																																												
Dist. Progr. Progetto	-14.727	-14.402	-11.177	-10.427	-9.927	-9.177	-8.677	-8.136	-5.010	-4.741	-4.350	-0.000	2.000	4.000	8.350	8.741	9.010	13.593	14.134	14.634	15.384	15.884	16.634	19.859	21.394																																																																											
Dist. Parziali	0.325	3.225	0.750	0.500	0.750	0.500	0.541	3.126	0.660	4.350	2.000	2.000	4.350	0.660	4.583	0.541	0.500	0.750	0.500	0.750	3.225	1.535																																																																														

Materiale	Area(m2)
Scavo	7.722
Rilevato	0.057
Scotico	8.013
SuperCompattato	4.064
Subballast	1.547
Inerbimento	1.328

Prog. = 3+700.000

Q. Rif. = 13.000

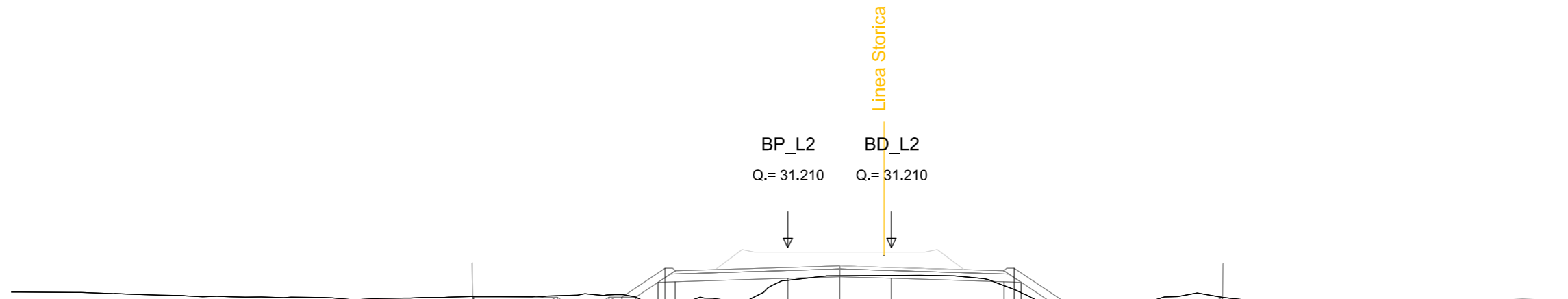

Quote Terreno		29.319 29.319		29.352		29.944		30.131		29.749 29.749		29.289	
Quote Progetto		29.319 29.296		29.296 28.796 29.375 28.710 29.296 29.386 29.385 29.296 29.869 28.896 28.911		30.019		30.019		29.889 30.409 29.869 29.104 29.046 29.001 29.104 28.867 28.739 28.913		29.104 29.289	
Dist. Progr. Progetto		-12.183 -12.135		-8.910 -8.160 -7.660 -6.910 -6.410 -5.869 -5.010 -4.741 -4.350		-0.000		4.000		8.350 8.741 9.010 10.158 10.698 11.198 11.948 12.448 13.198		16.423 16.793	
Dist. Parziali		0.048	3.225	0.750 0.500 0.750 0.500 0.541 0.859 0.660	4.350	2.000	2.000	4.350	0.660 1.148 0.540 0.500 0.750 0.500 0.750	3.225	0.370		

Materiale	Area(m2)
Scavo	5.117
Rilevato	1.540
Scotico	7.046
SuperCompattato	4.064
Subballast	1.547
Inerbimento	0.788

Prog. = 3+750.000

Q. Rif. = 14.000

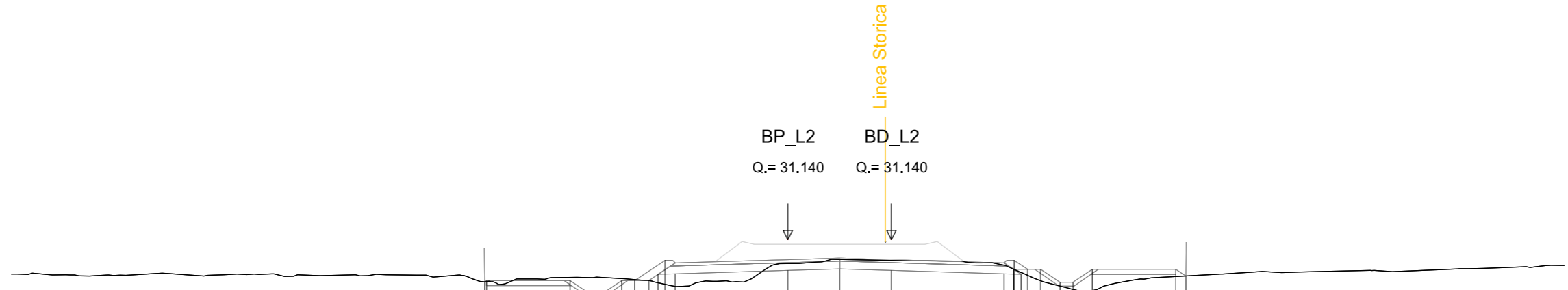

	0.073	3.225	0.750	0.500	0.750	0.500	0.541	0.362	0.660	4.350	2.000	2.000	4.350	0.370	0.290	0.500	0.750	0.500	0.750	3.225	0.388				
Quote Terreno	29.509	29.557	29.557	29.057	29.670	29.678	29.632	29.557	29.799	29.466	29.327	30.214	30.377	30.339	30.149	29.882	29.759	29.549	29.344	29.216	29.170	29.733			
Quote Progetto	29.509	29.557	29.557	29.057	29.670	29.678	29.632	29.557	29.799	30.339	29.819	30.009	29.949	30.339	29.992	30.339	29.799	29.992	29.992	29.492	29.992	29.992			
Dist. Progr. Progetto	-11.711	-11.638	-8.413	-7.663	-7.163	-6.413	-5.913	-5.372	-5.010	-4.741	-4.350	-0.000	2.000	4.000	8.350	8.720	8.741	9.010	9.261	9.761	10.511	11.011	11.761	14.986	15.374
Dist. Parziali	0.073	3.225	0.750	0.500	0.750	0.500	0.541	0.362	0.660	4.350	2.000	2.000	4.350	0.370	0.290	0.500	0.750	0.500	0.750	3.225	0.388				

Materiale	Area(m2)
Scavo	12.292
Rilevato	0.185
Scotico	7.229
SuperCompattato	3.810
Subballast	1.524
Inerbimento	0.028

Prog. = 4+100.000

Q. Rif. = 16.000

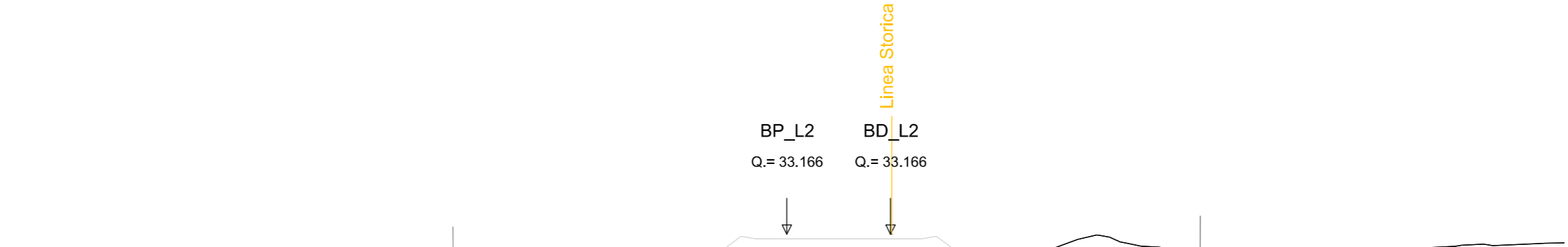

Quote Terreno	32.151 32.153	32.091	32.080 32.210	32.286	32.319	32.306 32.308 32.308	32.421	32.198	32.617	32.567	32.025 31.972	32.232	32.648	32.919 33.051	33.068	32.494 32.574
Quote Progetto	32.151 32.319	32.319	31.819 31.819	32.319	32.319	32.319 32.271	32.266 31.846	31.977	32.037	31.977	31.846 32.266	32.232	32.278	31.778 33.051	32.278	32.278 32.574
Dist. Progr. Progetto	-12.870 -12.618	-9.618	-8.868 -8.368	-7.618	-6.118	-5.447 -5.350	-4.850 -4.350	-0.000	2.000	4.000	8.350 8.850	9.533	10.350	11.100 11.600	12.350	15.350 15.941
Dist. Parziali	0.252 3.000	0.750 0.500	0.750	1.500	0.000 0.000	0.500	4.350	2.000	2.000	4.350	0.500 1.500	0.750 0.500	0.750	3.000	0.591	

Materiale	Area(m2)
Scavo	18.093
Rilevato	0.474
Scotico	8.988
SuperCompattato	3.810
Subballast	1.524
Inerbimento	0.691

Prog. = 4+150.000

Q. Rif. = 16.000

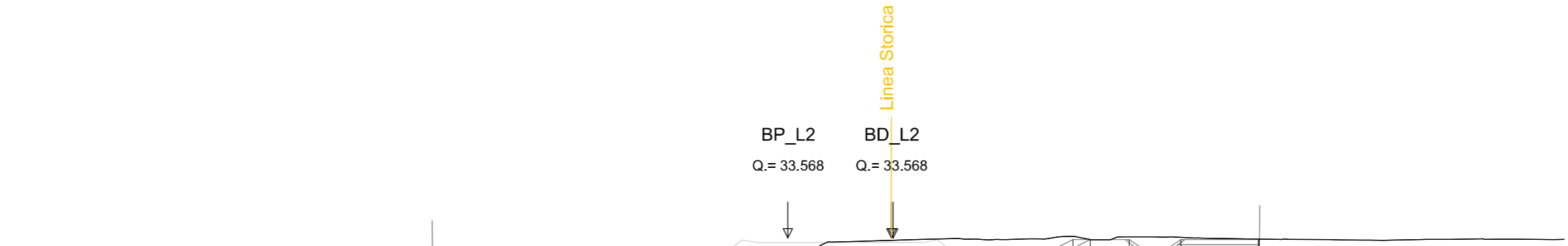

	0.291	3.000	0.750	0.500	0.750	1.500	0.671	0.688	0.500	0.500	4.350	2.000	2.000	4.350	0.500	0.500	0.885	0.976	0.671	1.500	0.750	0.500	0.750	3.000	0.035		
Quote Terreno	32.937	32.947	32.848	32.863	32.913	32.962	33.131	33.144	33.137	33.124	33.204	32.564	33.413	33.475	33.500	33.513	33.529	33.622	33.504	33.610	33.606	33.588	33.521	33.521	33.521	33.521	
Quote Progetto	32.937	33.131	33.131	32.631	33.131	33.131	33.131	33.131	32.673	32.668	32.248	32.379	32.439	32.379	32.248	32.668	32.673	33.504	33.504	33.504	33.504	33.004	33.004	33.504	33.504	33.504	33.504
Dist. Progr. Progetto	-13.727	-13.436	-10.436	-9.686	-9.186	-8.436	-6.936	-6.265	-5.350	-4.850	-4.350	-0.000	2.000	4.000	8.350	8.850	9.350	11.011	11.682	13.182	13.932	14.432	15.182	18.182	18.217	18.217	
Dist. Parziali	0.291	3.000	0.750	0.500	0.750	1.500	0.671	0.688	0.500	0.500	4.350	2.000	2.000	4.350	0.500	0.500	0.885	0.976	0.671	1.500	0.750	0.500	0.750	3.000	0.035	0.035	

Materiale	Area(m2)
Scavo	10.938
Rilevato	0.785
Scotico	7.336
SuperCompattato	3.810
Subballast	1.524
Inerbimento	0.105

Prog. = 4+200.000

Q. Rif. = 17.000

Quote Terreno	Quote Progetto	Dist. Progr. Progetto	Dist. Parziali
33.489	33.582	-29.381	
33.597	33.597	-28.607	
33.574	33.574	-27.834	
33.502	33.552	-27.060	
33.529	33.537	-26.545	2.062
33.525	33.543	-25.462	0.000
33.511	33.305	-25.097	1.293
33.511	33.303	-24.571	0.516
33.513	32.801	-24.055	0.515
33.525	32.799	-23.540	0.306
33.527	33.297	-23.024	0.515
33.539	33.296	-22.911	0.306
33.547	33.547	-22.586	0.306
33.550	33.505		
			9.132
33.534	33.534	-13.454	0.583
33.573	33.242	-12.871	3.000
33.154	33.242	-9.871	0.750
33.120	32.742	-9.121	0.500
33.128	32.742	-8.621	0.750
33.171	33.242	-7.871	1.500
33.242	33.242	-6.371	0.000
33.242	33.242	-5.700	0.350
33.372	33.067	-5.350	0.500
33.372	33.062	-4.850	0.500
33.387	32.642	-4.350	0.500
			4.350
33.323	32.773	-0.000	2.000
33.374	32.833	2.000	2.000
33.330	32.773	4.000	
			4.350
33.176	32.642	8.350	0.500
32.979	33.062	8.850	1.500
32.979	32.979	8.994	0.750
32.501	33.074	10.350	0.500
32.808	32.574	11.100	0.500
33.058	32.574	11.600	0.750
33.118	33.074	12.350	
			3.000
32.908	33.074	15.350	0.304
32.871	32.871	15.654	

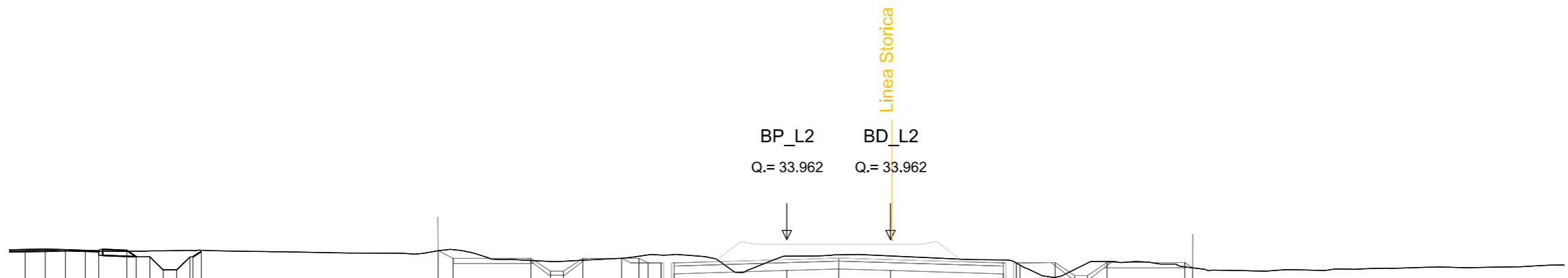

Materiale	Area(m2)
Scavo	9.490
Rilevato	1.179
Scotico	7.251
SuperCompattato	3.810
Subballast	1.524
Inerbimento	0.012

Prog. = 4+250.000

Q. Rif. = 17.000

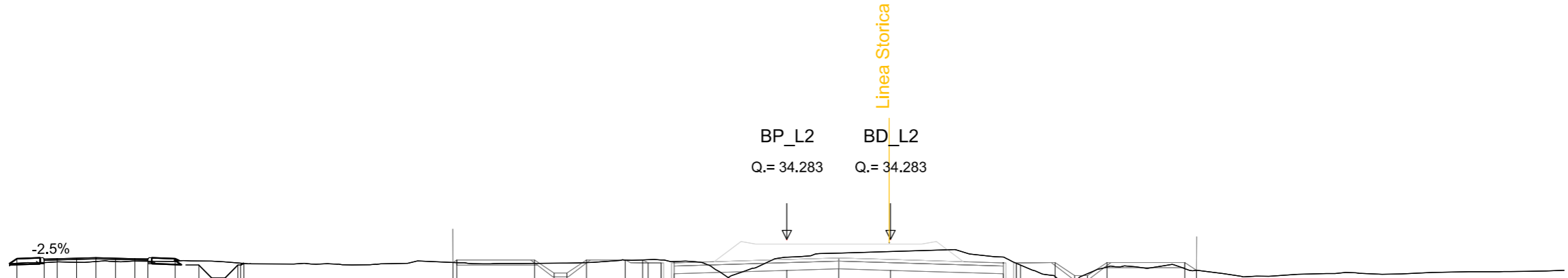

	Quote Terreno	Quote Progetto	Dist. Progr. Progetto	Dist. Parziali
	33.369	33.541	-29.702	
	33.395	33.532	-28.651	0.000
	33.417	33.544	-28.151	2.000
	33.408	33.563	-27.401	
	33.435	33.583	-26.651	2.001
	33.430	33.564	-25.900	0.000
	33.452	33.546	-25.150	1.809
	33.448	33.533	-24.650	0.939
	33.440	33.544	-23.681	0.500
	33.440	33.300	-22.180	0.500
	33.457	32.800	-21.680	0.500
	33.453	32.801	-21.180	0.500
	33.418	33.301	-21.070	0.500
	33.399	33.301	-20.942	0.500
	33.374	33.374		
				8.064
	33.394	33.394	-12.878	0.147
	33.493	33.493	-12.731	3.000
				0.750
	33.366	33.493	-9.731	0.500
	33.372	32.993	-8.981	0.750
	33.375	32.993	-8.481	0.750
	33.391	33.493	-7.731	1.500
				0.000
	33.493	33.493	-6.231	0.500
	33.493	33.493	-5.560	0.500
	33.488	33.388	-4.850	0.500
	33.489	33.383	-4.850	0.500
	33.437	32.963	-4.350	4.350
				2.000
	33.602	33.093	-0.000	2.000
				2.000
	33.759	33.153	2.000	4.350
				0.500
	33.820	33.093	4.000	1.500
				0.750
	33.606	32.963	8.350	0.500
	33.360	33.383	8.850	0.500
				0.750
	32.858	33.300	9.012	3.000
	32.693	33.394	10.350	0.450
	32.968	32.894	11.100	
	33.220	32.894	11.600	
		33.394	12.350	
				3.000
	33.162	33.394	15.350	
	33.095	33.095	15.800	

Materiale	Area(m2)
Scavo	11.578
Rilevato	13.369
Scotico	6.761
SuperCompattato	3.937
Subballast	1.535
Inerbimento	0.338

Prog. = 4+300.000

Q. Rif. = 17.000

	Quote Terreno	Quote Progetto	Dist. Progr. Progetto	Dist. Parziali
	33.595	33.567	-29.923	0.000
	33.601	33.067	-29.422	0.502
	33.607	33.068	-28.920	0.501
	33.611	33.568	-28.419	0.501
	33.606	33.568	-27.908	0.543
	33.599	33.569	-27.365	1.905
	33.540			
	33.576	35.060	-25.510	1.006
	33.551	35.053	-24.454	0.000
	33.560	35.067	-23.952	2.011
	33.520	35.087	-23.197	2.011
	33.520	35.108	-22.443	0.000
	33.487	35.091	-21.689	0.855
	33.466	35.075	-20.935	2.142
	33.475	35.063	-20.432	0.545
	33.461	35.076	-19.376	0.504
		33.439	-17.284	0.505
		33.440	-16.739	0.504
		33.440	-16.225	0.504
	33.466	32.940	-15.721	0.504
	33.479	32.941	-15.216	0.504
	33.477	33.441	-14.712	0.504
	33.470	33.441	-14.207	0.504
	33.467	33.441	-13.702	0.504
	33.464	33.426	-13.197	0.504
				2.637
	33.383	33.383	-11.899	0.461
	33.390	33.152	-11.438	3.225
				0.750
	33.426	33.152	-8.213	0.500
	33.400	32.652	-7.463	0.750
	33.345	32.652	-6.963	0.500
	33.289	33.152	-6.213	0.500
	33.243	33.152	-5.713	0.500
	33.152	33.152	-5.172	0.500
	33.260	33.260	-5.010	0.500
	33.152	33.800	-4.741	0.500
	33.152	33.800	-4.350	0.660
				4.350
	33.915	33.411	-0.000	2.000
	34.089	33.471	2.000	2.000
	34.056	33.411	4.000	4.350
				0.500
	33.909	33.280	8.350	0.500
	33.889	33.700	8.450	0.500
	33.889	33.700	8.750	0.500
	33.244	33.700	8.850	0.500
	33.131	33.626	9.097	0.750
	32.853	33.700	9.350	3.000
		33.200	10.100	0.744
		33.200	10.600	
		33.700	11.350	
	33.175	33.700	14.350	
	33.204	33.204	15.094	

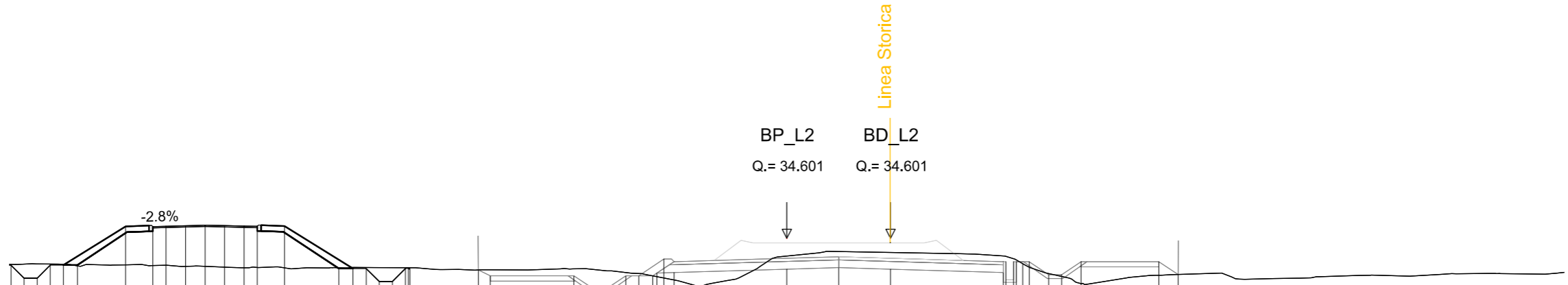

Materiale	Area(m2)
Scavo	12.361
Rilevato	13.438
Scotico	6.860
SuperCompattato	3.937
Subballast	1.535
Inerbimento	0.409

Prog. = 4+350.000

Q. Rif. = 17.000

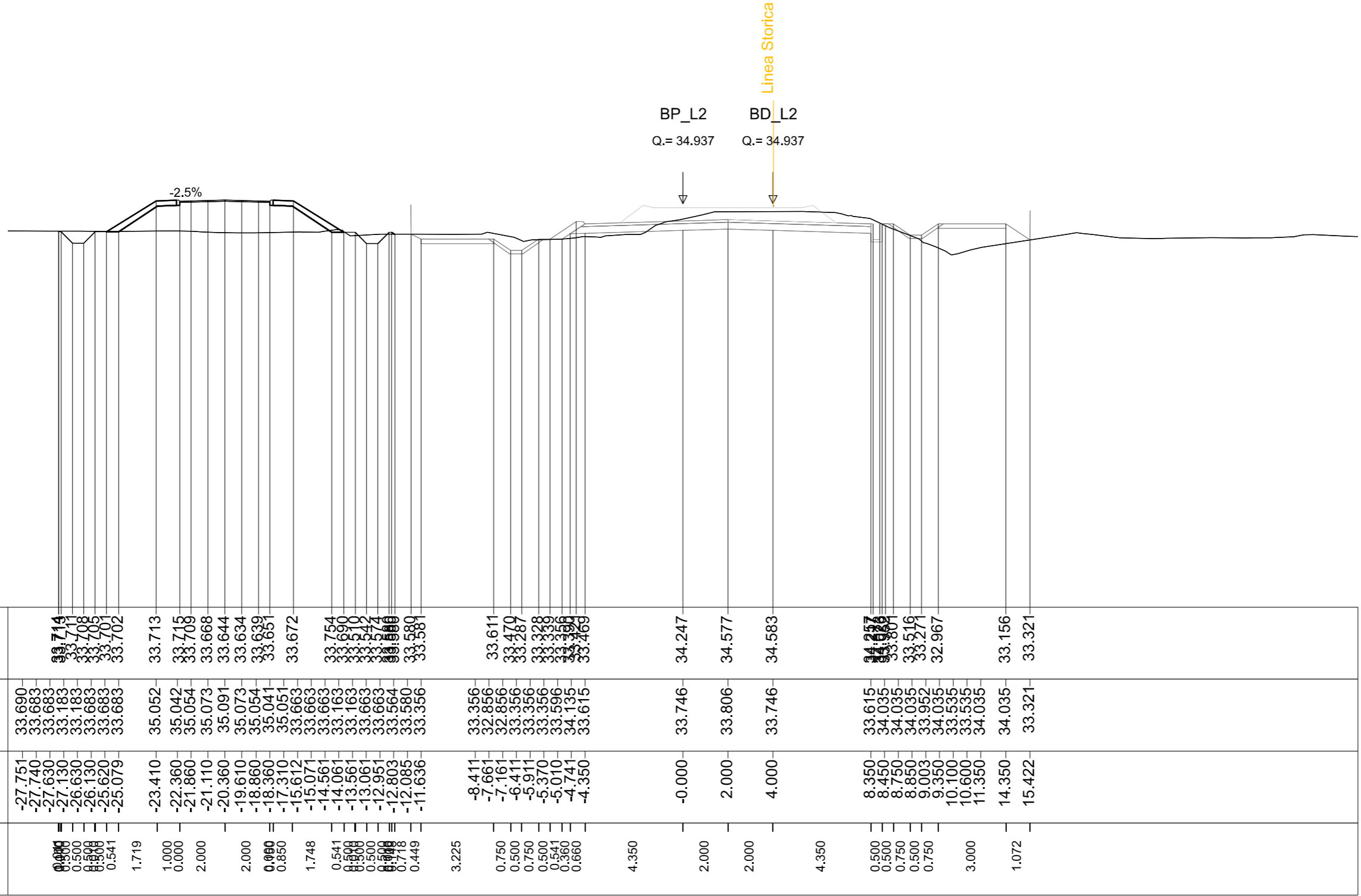

Materiale	Area(m2)
Scavo	14.114
Rilevato	2.527
Scotico	7.198
SuperCompattato	3.937
Subballast	1.535
Inerbimento	0.653

Prog. = 4+400.000

Q. Rif. = 17.000

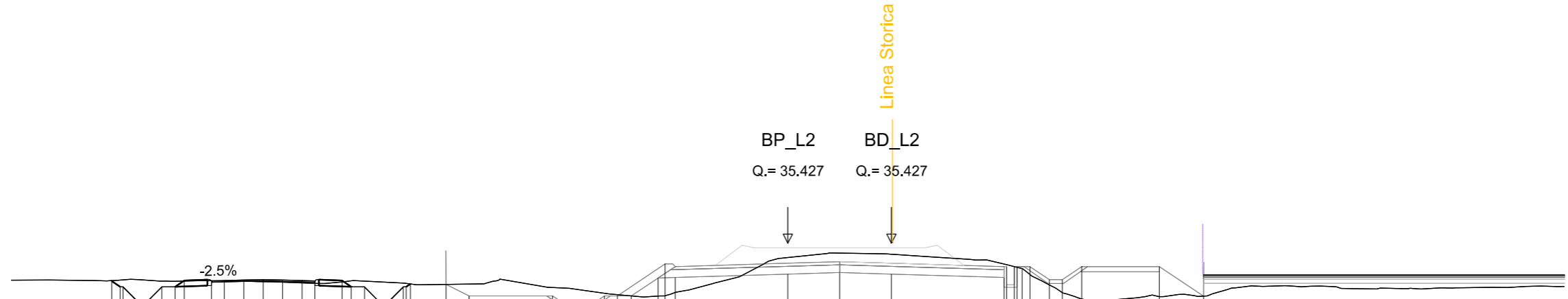

Quote Terreno	Quote Progetto	Dist. Progr. Progetto	Dist. Parziali
33.965	33.965	-26.114	
33.749	33.749	-25.790	
33.749	33.749	-25.680	
33.249	33.249	-25.180	
33.249	33.249	-24.680	
33.749	33.749	-24.180	
33.963	33.749	-23.670	
33.963	33.963	-23.317	
33.969	33.975	-22.267	
33.976	33.987	-21.767	1.403
33.969	34.006	-21.017	0.000
33.959	34.025	-20.267	2.000
33.944	34.006	-19.517	
33.923	33.975	-18.767	2.000
33.894	33.985	-17.217	
33.874	33.749	-16.863	0.000
33.933	33.749	-16.353	1.254
33.963	33.249	-15.853	0.500
33.937	33.749	-15.353	0.500
33.917	33.749	-14.853	0.500
33.897	33.749	-14.743	0.500
33.887	33.857	-14.582	0.500
33.839	33.839	-13.201	1.381
33.853	33.853	-12.312	0.889
			3.225
33.717	33.395	-9.087	0.750
33.671	32.895	-8.337	0.500
33.602	33.602	-7.837	0.750
33.500	33.395	-7.087	0.500
33.445	33.395	-6.587	0.541
33.395	33.395	-6.046	1.036
33.386	34.086	-5.010	0.660
33.530	34.626	-4.741	
	34.106	-4.350	4.350
34.876	34.236	-0.000	2.000
35.047	34.296	2.000	2.000
35.005	34.236	4.000	4.350
34.000	34.106	8.350	0.500
34.000	34.526	8.450	0.500
34.000	34.526	8.750	0.750
33.820	34.526	8.850	0.500
33.524	34.447	9.052	0.750
33.281	34.526	9.350	3.000
	34.026	10.100	
	34.026	10.600	
	34.526	11.350	
33.366	34.526	14.350	1.707
33.387	33.387	16.057	

Materiale	Area(m2)
Scavo	14.111
Rilevato	4.201
Scotico	6.977
SuperCompattato	3.937
Subballast	1.535
Inerbimento	0.494

Prog. = 4+450.000

Q. Rif. = 18.000

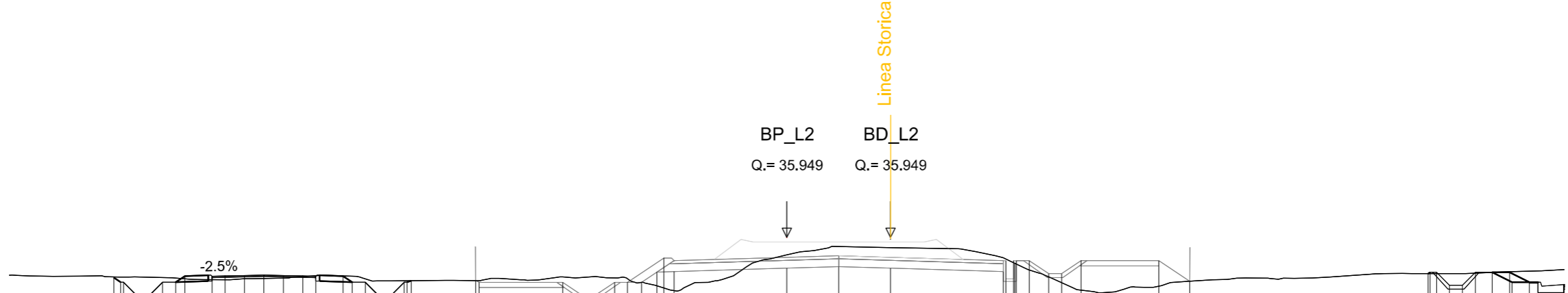

Dist. Parziali	Dist. Progr. Progetto	Quote Progetto	Quote Terreno
0.000	-25.960	34.392	34.417
0.200	-25.697	34.216	34.417
0.500	-25.587	34.217	34.418
0.500	-25.087	34.217	34.407
0.500	-24.087	34.217	34.396
0.500	-23.577	34.217	34.377
1.404	-23.223	34.452	34.348
0.000	-22.173	34.442	34.348
0.000	-21.673	34.455	34.316
2.000	-20.923	34.474	34.313
2.000	-20.173	34.493	34.351
2.000	-19.423	34.474	34.364
0.000	-18.673	34.455	34.378
1.253	-18.173	34.443	34.378
0.500	-17.123	34.453	34.431
0.500	-16.770	34.217	34.470
0.500	-16.260	34.217	34.461
0.500	-15.760	33.717	34.344
0.500	-15.260	33.717	34.344
0.500	-14.760	34.217	34.561
0.500	-14.650	34.217	34.560
0.500	-14.490	34.273	34.560
2.486	-12.004	34.279	34.279
0.135	-11.869	34.212	34.212
3.225	-8.644	34.212	34.419
0.750	-7.894	33.712	34.399
0.500	-7.394	33.712	34.433
0.750	-6.644	34.212	34.384
0.500	-6.144	34.212	34.353
0.540	-5.604	34.212	34.212
0.594	-5.010	34.608	34.212
0.660	-4.741	35.147	34.078
4.350	-4.350	34.627	33.888
2.000	-0.000	34.758	35.271
2.000	2.000	34.818	35.595
4.350	4.000	34.758	35.554
0.500	8.350	34.627	35.158
0.500	8.450	35.047	34.958
0.500	8.750	35.047	34.690
0.500	8.799	35.047	34.424
0.750	8.850	35.047	34.199
3.000	9.350	35.047	33.909
1.191	10.100	34.547	34.061
9.191	10.600	34.547	34.253
0.000	11.350	35.047	34.253
0.000	14.350	35.047	34.061
0.000	15.541	34.253	34.253
0.000	24.732	34.545	34.550
0.500	24.813	34.599	34.552
0.500	25.063	34.599	34.552
0.500	25.563	34.099	34.565
0.762	26.063	34.099	34.597
0.329	26.563	34.600	34.626
1.000	27.213	34.600	34.626
0.000	27.863	34.600	34.654
0.000	27.975	34.219	34.704
0.000	28.646	34.219	34.704
0.000	28.975	34.219	34.704
0.000	29.975	33.819	33.819

Materiale	Area(m2)
Scavo	11.970
Rilevato	12.853
Scotico	6.955
SuperCompattato	3.937
Subballast	1.535
Inerbimento	0.478

Prog. = 4+500.000

Q. Rif. = 19.000

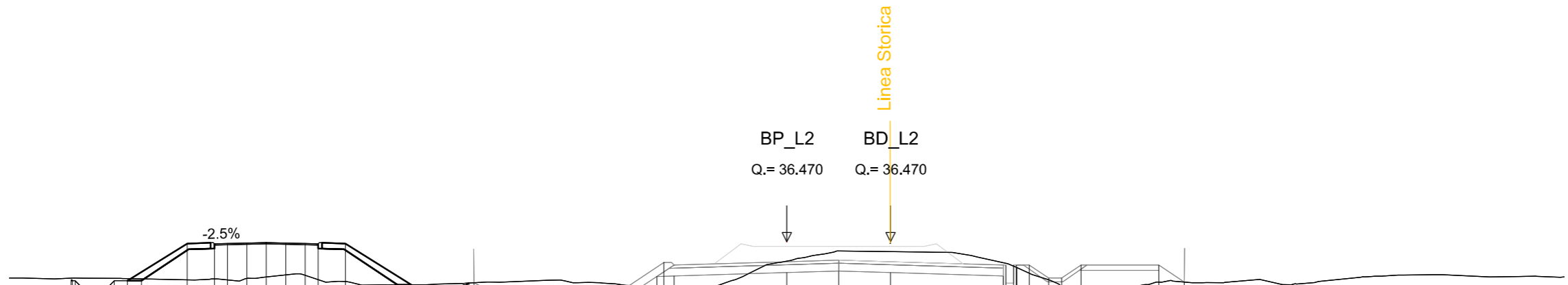

Quote Terreno	Quote Progetto	Dist. Progr. Progetto	Dist. Parziali
34.999	34.999	-27.614	0.540
34.963	34.963	-27.559	0.500
34.963	34.963	-27.449	0.500
35.071	34.463	-26.949	0.500
35.059	34.463	-26.449	0.500
35.057	34.963	-25.949	0.500
35.055	34.963	-25.439	0.540
35.046	34.963	-24.899	1.819
35.034	34.963	-23.130	1.000
34.999	36.398	-22.080	0.000
35.033	36.388	-21.580	2.000
34.996	36.401	-20.830	2.000
35.056	36.420	-20.080	2.000
35.108	36.439	-19.330	2.000
35.190	36.420	-18.580	0.000
35.174	36.389	-17.830	0.850
35.005	36.399	-17.080	2.053
34.934	36.308	-16.330	0.541
34.806	34.808	-15.580	0.500
34.807	34.808	-14.830	0.500
34.806	34.308	-14.080	0.500
34.808	34.308	-13.330	0.541
34.848	34.308	-12.580	0.660
34.848	34.880	-11.830	3.225
34.886	34.886	-11.080	0.750
34.763	34.763	-10.330	0.500
34.714	34.763	-9.580	0.750
34.967	34.763	-8.830	0.500
34.895	34.263	-8.080	0.541
34.890	34.263	-7.330	0.660
34.845	34.763	-6.580	4.350
34.785	34.763	-5.830	2.000
34.763	34.763	-5.080	2.000
34.726	35.130	-4.330	4.350
34.726	35.669	-3.580	0.500
34.714	35.149	-2.830	0.500
35.723	35.280	-0.000	0.750
36.113	35.340	2.000	3.000
36.087	35.280	4.000	0.983
35.669	35.149	8.350	
35.253	35.569	8.450	
35.003	35.569	8.750	
34.747	35.569	8.873	
34.467	35.474	8.873	
34.913	35.569	9.350	
34.914	35.069	10.100	
	35.069	10.600	
	35.569	11.350	
	35.569	14.350	
	34.914	15.333	

Materiale	Area(m2)
Scavo	12.304
Rilevato	15.921
Scotico	7.069
SuperCompattato	3.937
Subballast	1.535
Inerbimento	0.560

Prog. = 4+550.000

Q. Rif. = 19.000

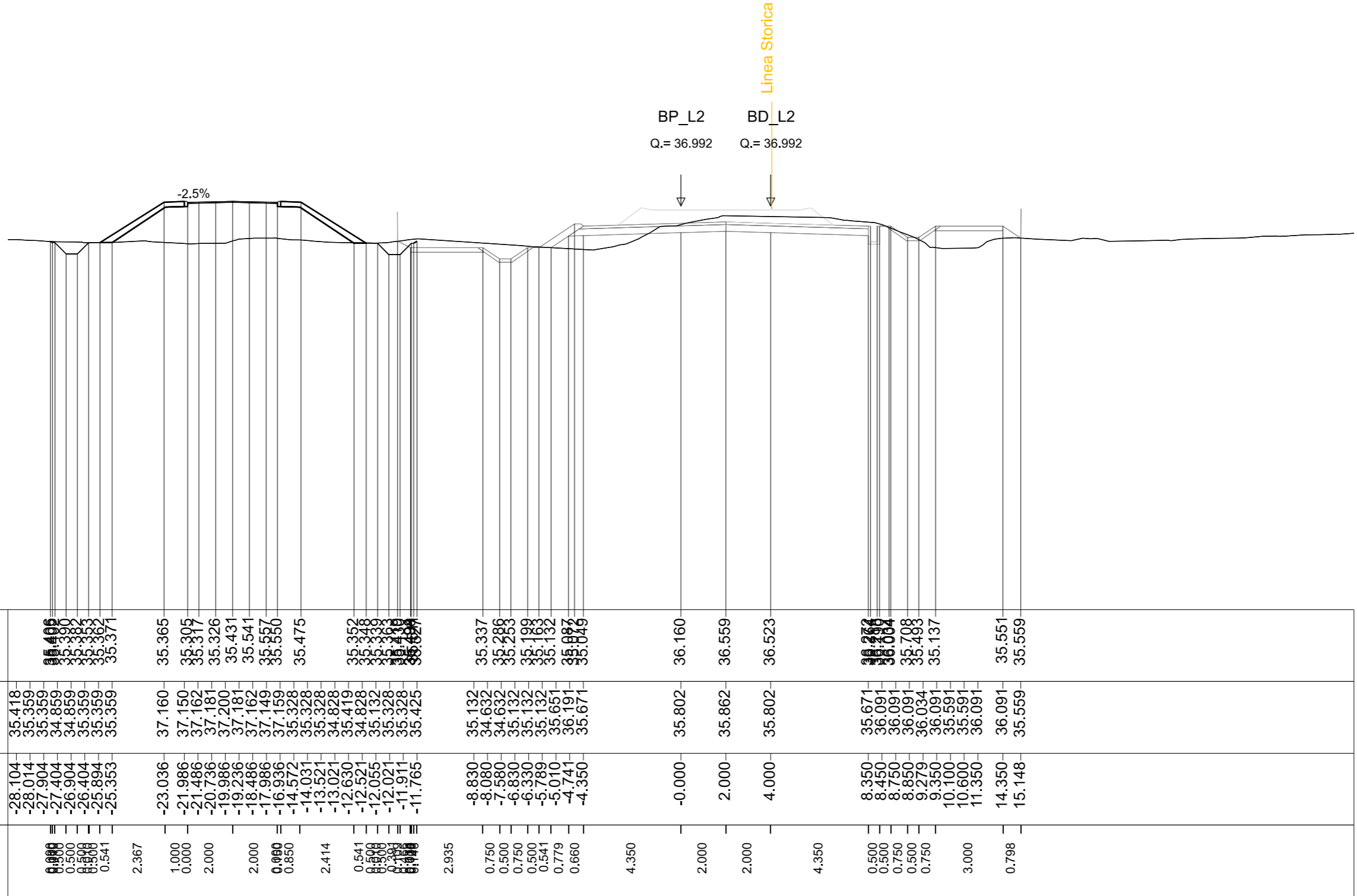

Materiale	Area(m2)
Scavo	11.341
Rilevato	4.253
Scotico	7.081
SuperCompattato	3.937
Subballast	1.535
Inerbimento	0.569

Prog. = 4+600.000

Q. Rif. = 20.000

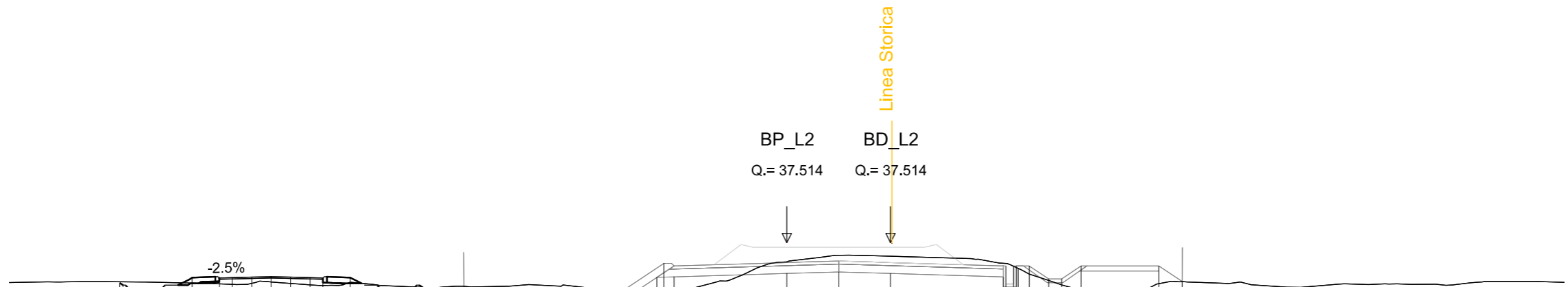

Quote Terreno	Quote Progetto	Dist. Progr. Progetto	Dist. Parziali
35.954	35.954	-25.735	0.000
35.869	35.869	-25.608	0.100
35.869	35.869	-25.498	0.500
35.369	35.369	-24.998	0.000
35.995	35.995	-24.498	0.000
35.986	35.986	-23.998	0.000
35.974	35.974	-23.998	0.000
35.950	36.159	-22.942	2.096
35.919	36.149	-21.892	0.000
35.899	36.162	-21.392	2.000
35.940	36.180	-20.642	2.000
35.993	36.199	-19.892	2.000
35.937	36.180	-19.142	0.000
35.881	36.162	-18.392	0.000
35.861	36.149	-17.892	1.939
35.988	36.159	-16.842	0.908
35.873	35.873	-15.793	0.500
35.873	35.373	-15.293	0.500
35.872	35.373	-14.793	0.500
35.845	35.873	-14.293	0.500
35.845	35.873	-14.183	0.500
35.819	35.873	-14.183	0.500
35.749	35.726	-13.962	1.503
35.829	35.829	-12.459	0.381
35.804	35.638	-12.078	3.225
35.837	35.638	-8.853	0.750
35.818	35.138	-8.103	0.500
35.759	35.138	-7.603	0.750
35.669	35.638	-6.853	0.500
35.669	35.638	-6.353	0.541
35.638	35.638	-5.812	0.802
35.615	36.173	-5.010	0.660
35.615	36.713	-4.741	4.350
35.615	36.193	-4.350	2.000
36.767	36.324	-0.000	2.000
37.026	36.384	2.000	2.000
36.986	36.324	4.000	4.350
36.716	36.193	8.350	0.500
36.298	36.613	8.450	0.500
36.298	36.613	8.750	0.500
36.059	36.613	8.850	0.750
35.884	36.523	8.921	3.000
35.605	36.613	9.350	0.901
35.605	36.113	10.100	
35.605	36.113	10.600	
35.605	36.113	11.350	
35.928	36.613	14.350	
36.012	36.012	15.251	

Materiale	Area(m2)
Scavo	12.245
Rilevato	3.137
Scotico	6.805
SuperCompattato	3.937
Subballast	1.535
Inerbimento	0.370

Prog. = 4+650.000

Q. Rif. = 20.000

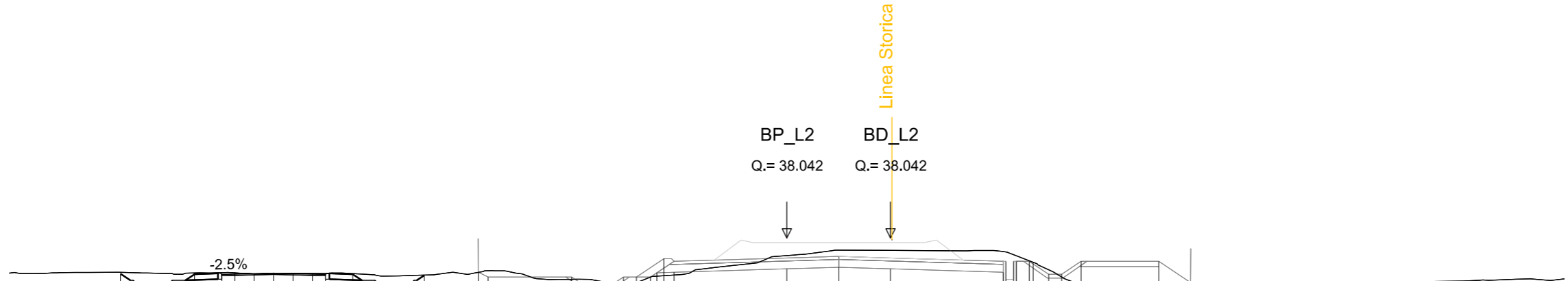

Quote Terreno	Quote Progetto	Dist. Progr. Progetto	Dist. Parziali
36.715	36.663	-25.707	
36.705	36.407	-25.322	0.386
36.698	36.407	-25.212	0.386
36.679	35.907	-24.712	0.500
36.669	35.907	-24.212	0.500
36.667	36.407	-23.712	0.500
36.661	36.407	-23.202	0.500
36.645	36.633	-22.849	1.403
36.701	36.645	-21.799	0.000
36.699	36.664	-21.299	0.000
36.652	36.664	-20.549	2.000
36.674	36.663	-19.799	2.000
36.678	36.664	-19.049	2.000
36.677	36.633	-18.299	0.000
36.671	36.407	-17.799	1.254
36.666	36.407	-16.749	0.500
36.618	35.907	-16.395	0.500
36.614	35.907	-15.885	0.500
36.574	36.407	-14.885	0.500
36.580	36.407	-14.385	0.500
36.605	36.602	-14.275	0.500
36.613	36.602	-13.984	0.660
36.718	36.718	-11.897	2.087
36.533	36.533	-11.527	0.370
36.444	36.533	-8.302	3.225
36.438	36.033	-7.552	0.750
36.345	36.033	-7.062	0.500
36.206	36.533	-6.302	0.750
36.317	36.533	-5.802	0.500
36.317	36.701	-5.261	0.541
36.317	36.701	-5.010	0.251
36.317	37.240	-4.741	0.660
36.317	36.720	-4.350	4.350
37.366	36.851	-0.000	2.000
37.572	36.911	2.000	2.000
37.562	36.851	4.000	4.350
37.508	36.720	8.350	0.500
37.364	37.140	8.450	0.500
36.815	37.140	8.750	0.500
36.541	37.140	8.850	0.500
36.248	37.140	9.350	0.750
36.304	37.104	9.505	3.000
36.327	36.640	10.100	1.220
	36.640	10.600	
	37.140	11.350	
	37.140	14.350	
	36.327	15.570	

Materiale	Area(m2)
Scavo	13.029
Rilevato	3.957
Scotico	6.939
SuperCompattato	3.937
Subballast	1.535
Inerbimento	0.466

Prog. = 4+700.000

Q. Rif. = 21.000

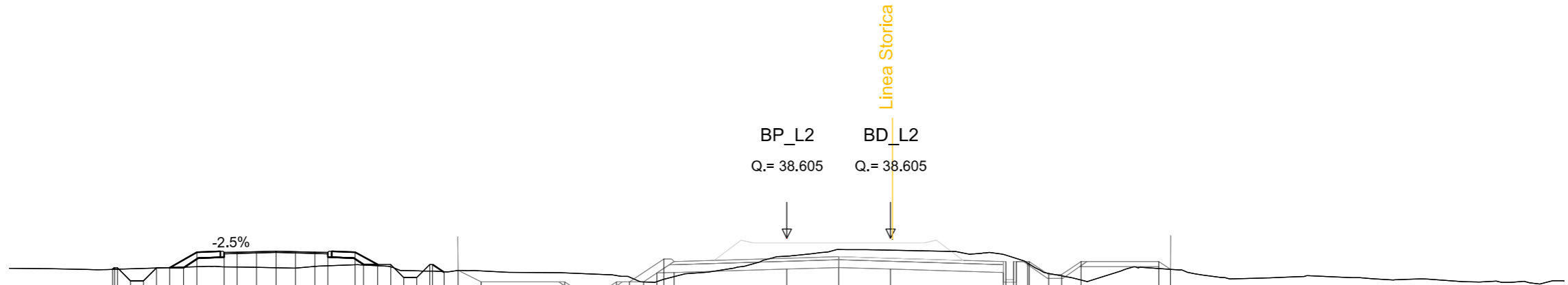

Quote Terreno	Quote Progetto	Dist. Progr. Progetto	Dist. Parziali
37.411	37.411	-26.012	0.000
37.466	37.466	-25.929	0.000
37.466	37.466	-25.819	0.500
36.966	36.966	-25.320	0.500
37.466	37.466	-24.320	0.500
37.466	37.466	-23.810	0.541
37.470	37.466	-23.269	0.564
37.487	38.064	-22.755	1.000
37.503	38.054	-21.705	0.000
37.501	38.067	-21.205	2.000
37.496	38.086	-20.455	2.000
37.480	38.104	-19.705	2.000
37.466	38.086	-18.955	2.000
37.453	38.067	-18.205	0.000
37.516	38.055	-17.705	0.850
37.544	37.592	-16.330	0.375
37.581	37.592	-15.789	0.541
37.541	37.592	-15.279	0.500
37.500	37.092	-14.779	0.500
37.399	37.592	-14.278	0.501
37.347	37.592	-13.778	0.000
37.300	37.592	-13.668	0.482
37.311	37.290	-13.216	0.534
37.364	37.364	-12.682	0.889
37.344	36.919	-11.793	3.225
37.268	36.919	-8.568	0.750
37.238	36.419	-7.818	0.500
37.218	36.419	-7.318	0.750
37.166	36.919	-6.568	0.500
36.919	36.919	-6.068	0.541
36.919	36.919	-5.527	0.517
36.919	36.919	-5.010	0.660
36.919	37.804	-4.741	4.350
37.120	37.284	-4.350	2.000
37.910	37.415	-0.000	2.000
38.168	37.475	2.000	2.000
38.145	37.415	4.000	4.350
37.990	37.284	8.350	0.500
37.936	37.704	8.450	0.500
37.848	37.704	8.750	0.500
37.245	37.704	8.850	0.750
37.154	37.648	9.290	3.000
36.991	37.704	9.350	0.448
37.406	37.204	10.100	
37.406	37.204	10.600	
37.406	37.704	11.350	
37.406	37.704	14.350	
37.406	37.406	14.798	

Materiale	Area(m2)
Scavo	10.015
Rilevato	14.521
Scotico	7.260
SuperCompattato	3.810
Subballast	1.524
Inerbimento	0.096

Prog. = 4+750.000

Q. Rif. = 22.000

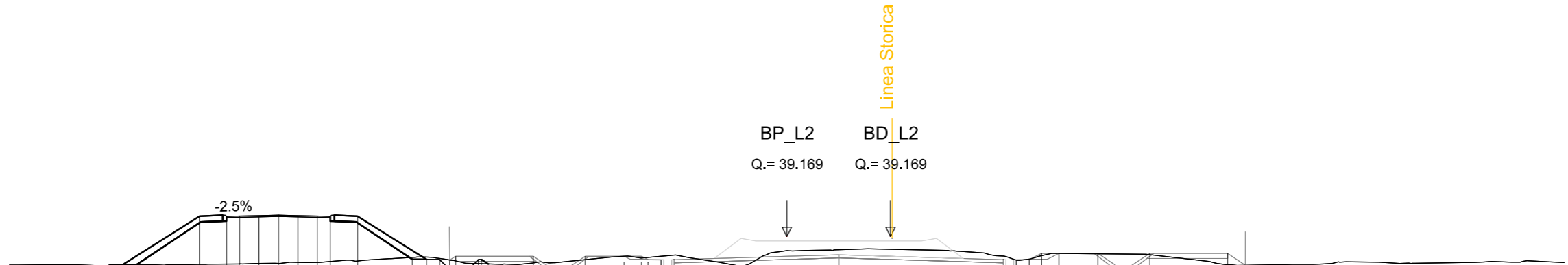

Quote Terreno	Quote Progetto	Dist. Progr. Progetto	Dist. Parziali
38.060	38.060	-27.773	0.000
38.079	38.079	-27.745	0.000
38.079	38.079	-27.635	0.500
37.579	37.579	-27.135	0.500
38.079	38.079	-26.635	0.500
38.039	38.079	-26.135	0.500
38.031	38.079	-25.625	0.541
38.066	38.079	-25.084	2.472
38.090	39.949	-22.662	1.000
38.102	39.939	-21.612	0.000
38.110	39.952	-21.112	2.000
38.127	39.971	-20.362	2.000
38.129	39.990	-19.612	2.000
38.170	39.971	-18.862	0.000
38.167	39.952	-18.112	0.850
38.201	39.950	-17.612	0.850
38.220	38.283	-14.446	2.166
38.220	38.283	-13.905	0.541
38.220	38.283	-13.395	0.500
38.357	38.253	-13.003	0.500
38.370	37.783	-12.895	0.100
38.370	38.403	-12.778	0.100
38.259	37.783	-12.395	0.100
38.259	38.283	-11.895	0.100
38.130	38.283	-11.785	0.100
38.110	38.283	-11.785	0.100
38.110	38.100	-11.510	1.732
38.144	38.403	-9.778	0.750
38.154	37.903	-9.028	0.500
38.196	37.903	-8.528	0.750
38.271	38.403	-7.778	1.500
38.403	38.182	-6.278	0.000
38.388	38.182	-5.607	0.325
38.388	38.161	-5.350	0.500
38.400	38.269	-4.850	0.500
38.444	37.849	-4.350	0.500
38.623	37.980	-0.000	4.350
38.657	38.040	2.000	2.000
38.674	37.980	4.000	2.000
38.408	37.849	8.350	4.350
38.254	38.269	8.850	0.500
38.293	38.274	9.350	0.500
38.421	38.514	9.829	0.500
38.514	38.514	10.500	1.500
38.498	38.514	12.000	0.750
38.490	38.014	12.750	0.500
38.485	38.014	13.250	0.750
38.463	38.514	14.000	3.000
38.077	38.514	17.000	0.686
38.057	38.057	17.686	

Materiale	Area(m2)
Scavo	9.927
Rilevato	3.443
Scotico	8.285
SuperCompattato	3.810
Subballast	1.524
Inerbimento	0.184

Prog. = 4+800.000

Q. Rif. = 23.000

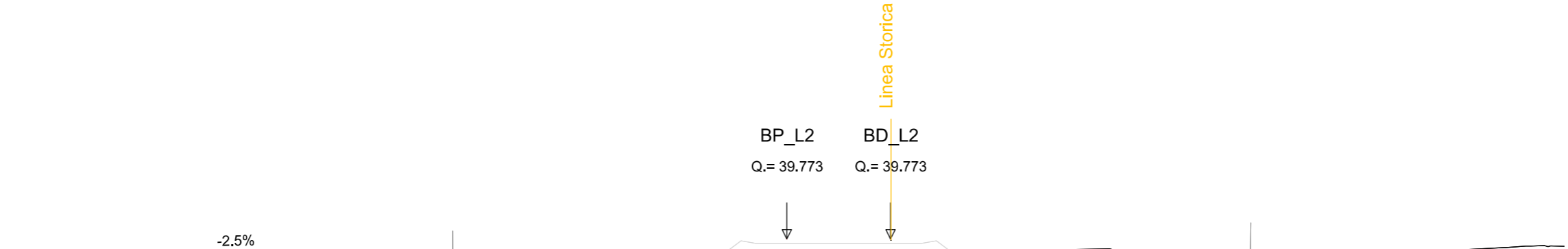

Quote Terreno	Quote Progetto	Dist. Progr. Progetto	Dist. Parziali
38.730	38.730	-25.729	0.000
38.803	38.803	-25.619	0.500
38.303	38.303	-25.509	0.500
38.303	38.303	-24.509	0.500
38.785	38.804	-23.499	0.500
38.792	38.804	-22.958	0.500
38.811	39.319	-22.568	0.541
38.796	39.309	-21.518	0.440
38.777	39.321	-21.018	1.000
38.772	39.340	-20.268	0.000
38.770	39.359	-19.518	2.000
38.768	39.340	-18.768	
38.800	39.321	-18.018	
38.773	39.309	-17.518	
38.779	39.319	-16.468	2.000
38.782	38.765	-16.021	0.000
38.777	38.765	-15.480	0.850
38.772	38.265	-14.970	0.497
38.755	38.265	-14.470	0.541
38.763	38.265	-13.970	0.500
38.770	38.765	-13.470	0.500
38.771	38.771	-13.333	0.500
38.789	38.786	-12.884	0.500
38.786	38.942	-12.649	0.235
38.794	38.942		3.000
38.771	38.442	-9.649	0.750
38.691	38.442	-8.899	0.500
38.659	38.442	-8.399	0.750
38.942	38.942	-7.649	1.500
38.942	38.942	-6.149	0.000
38.942	38.942	-5.479	0.398
38.056	38.878	-5.350	0.500
39.077	38.873	-4.850	0.500
39.089	38.453	-4.350	0.500
39.107	38.584	-0.000	4.350
39.219	38.644	2.000	2.000
39.212	38.584	4.000	2.000
38.838	38.453	8.350	4.350
38.854	38.873	8.850	0.500
38.958	38.878	9.350	0.500
39.220	39.361	10.315	0.671
39.361	39.361	10.986	1.500
39.379	39.361	12.486	0.750
39.211	38.861	13.236	0.500
39.155	38.861	13.736	0.750
39.118	39.361	14.486	3.000
39.083	39.361	17.486	0.399
39.094	39.094	17.885	

Materiale	Area(m2)
Scavo	17.382
Rilevato	0.889
Scotico	10.075
SuperCompattato	3.810
Subballast	1.524
Inerbimento	1.474

Prog. = 4+900.000

Q. Rif. = 24.000

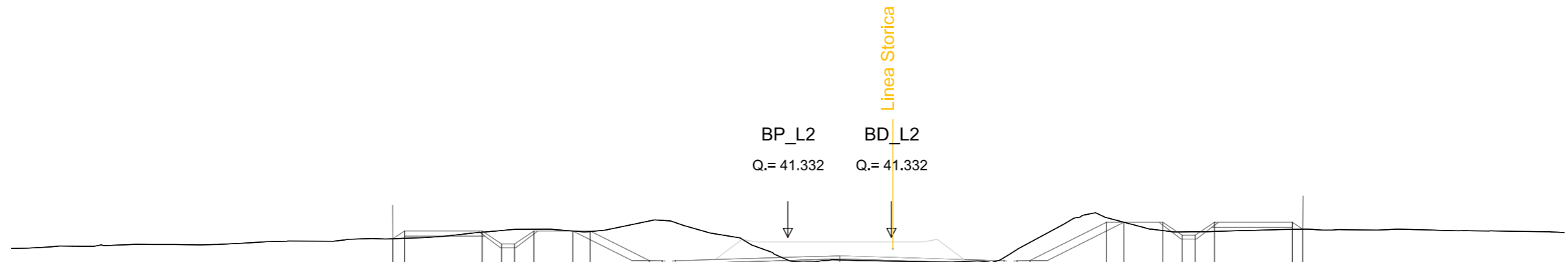

Quote Terreno		41.281 41.281 41.296		41.534 41.534 41.597 41.643 41.646		41.581 41.581 41.558		41.966 41.966 41.990 41.908		40.455		40.461		40.414		40.554 40.554 40.859 41.137		42.097 41.918		41.595 41.546 41.553 41.561		41.647 41.647		
Quote Progetto		41.281 41.581		41.581 41.081 41.081 41.581		41.581 41.581		40.437 40.432 40.012		40.142		40.202		40.142		40.012 40.432 40.437		41.918 41.918		41.918 41.418 41.418 41.918		41.918 41.647		
Dist. Progr. Progetto		-15.257 -14.808		-11.808 -11.058 -10.558 -9.808		-8.308 -7.638		-5.350 -4.850 -4.350		-0.000		2.000		4.000		8.350 8.850 9.350		12.312 12.983		14.483 15.233 15.733 16.483		19.483 19.888		
Dist. Parziali		0.449 3.000		0.750 0.500 0.750		1.500 0.670 1.603		0.888 0.500 0.500		4.350		2.000 2.000		4.350		0.500 0.500 0.888		2.277		0.671 1.500		0.750 0.500 0.750		3.000 0.405

Materiale	Area(m2)
Scavo	23.128
Rilevato	0.761
Scotico	7.881
SuperCompattato	3.937
Subballast	1.535
Inerbimento	0.540

Prog. = 5+050.000

Q. Rif. = 25.000

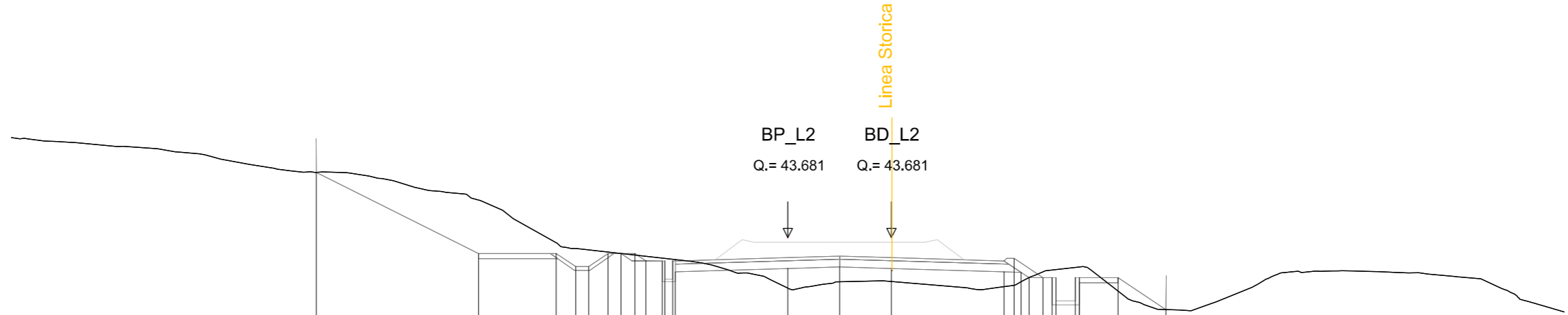

Quote Terreno		46.200		45.132		43.484	43.261	43.206	43.123	43.067	43.066	42.986	42.889	42.833		41.730	41.974	41.988		41.792	41.877	42.364	42.486	42.564		41.618	40.904					
Quote Progetto		46.200		43.067	43.067	42.567	43.067	43.067	42.787	42.780	42.780	42.780	42.780	42.780	42.360		42.491	42.551	42.491		42.360	42.880	42.341	42.137	42.137	42.137		42.137	40.904			
Dist. Progr. Progetto		-18.213		-11.946	-8.946	-8.196	-7.696	-6.946	-6.446	-5.906	-5.485	-4.850	-4.750	-4.450	-4.350		-0.000	2.000	4.000		8.350	8.741	9.010	9.315	9.856	10.206	10.356	11.106	11.256	11.256	12.756	14.606
Dist. Parziali			6.267		3.000	0.750	0.500	0.500	0.500	0.428	0.428	0.635	0.500		4.350		2.000	2.000		4.350	0.660	0.305	0.341	0.660	0.000	1.650		1.850				

Materiale	Area(m2)
Scavo	19.664
Rilevato	0.393
Scotico	7.186
SuperCompattato	3.937
Subballast	1.535
Inerbimento	1.853

Prog. = 5+150.000

Q. Rif. = 26.000

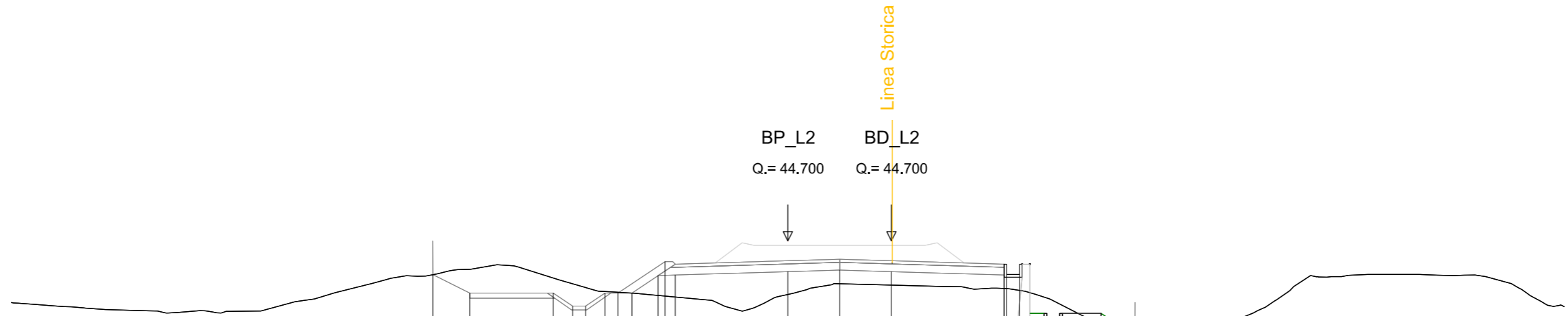

Quote Terreno		43.394	43.600	43.264	43.044	42.902	42.742	42.715	42.684	42.594	42.534	42.631	43.042	42.991	42.864	42.789	42.500	42.269	41.451	41.076							
Quote Progetto		43.394	42.684	42.684	42.184	42.184	42.684	42.684	42.684	43.359	43.899	43.379	43.510	43.570	43.510	43.800	43.379	43.800	43.800	41.900	41.900	41.900	41.900	41.900	41.900	41.900	41.033
Dist. Progr. Progetto		-13.709	-12.288	-9.063	-8.313	-7.813	-7.063	-6.563	-6.023	-5.010	-4.741	-4.350	-0.000	2.000	4.000	8.350	8.350	8.450	8.950	9.900	10.000	10.500	10.500	10.600	12.100	13.400	
Dist. Parziali		1.421	3.225	0.750	0.500	0.750	0.500	0.540	1.013	0.660	4.350	2.000	2.000	4.350	1.000	0.660	0.600	0.600	1.600	1.300							

Materiale	Area(m2)
Scavo	11.152
Rilevato	0.584
Scotico	7.077
SuperCompattato	4.064
Subballast	1.547
Inerbimento	0.566

Prog. = 5+200.000

Q. Rif. = 27.000

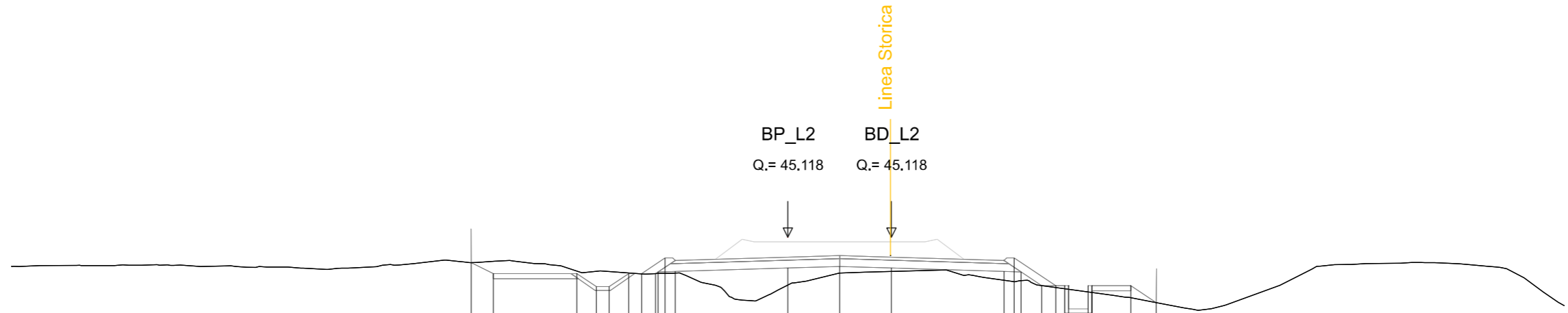

Quote Terreno		44.138	44.138	44.186		43.811	43.797	43.790	43.735	43.699	43.717	43.731		43.271	43.731	43.797		43.457	43.394	43.247	43.174	43.167	42.986		42.780	42.590			
Quote Progetto		44.138	43.711			43.711	43.211	43.211	43.711	43.711	43.711	43.777	44.317	43.797	43.927	43.987	43.927		43.797	44.317	43.777	43.247	43.247	43.247	43.247	43.047	43.247	42.590	
Dist. Progr. Progetto		-12.227	-11.374			-8.149	-7.399	-6.899	-6.149	-5.649	-5.109	-5.010	-4.741	-4.350	-0.000	2.000	4.000		8.350	8.741	9.010	9.805	10.346	10.696	10.846	11.596	11.746	13.246	14.230
Dist. Parziali		0.853		3.225		0.750	0.500	0.750	0.500	0.500	0.568	0.666		4.350		2.000	2.000		4.350	0.660	0.795	0.541	0.668	0.668	0.668	1.650	0.984		

Materiale	Area(m2)
Scavo	28.190
Rilevato	0.257
Scotico	9.578
SuperCompattato	3.937
Subballast	1.535
Inerbimento	2.177

Prog. = 5+300.000

Q. Rif. = 29.000

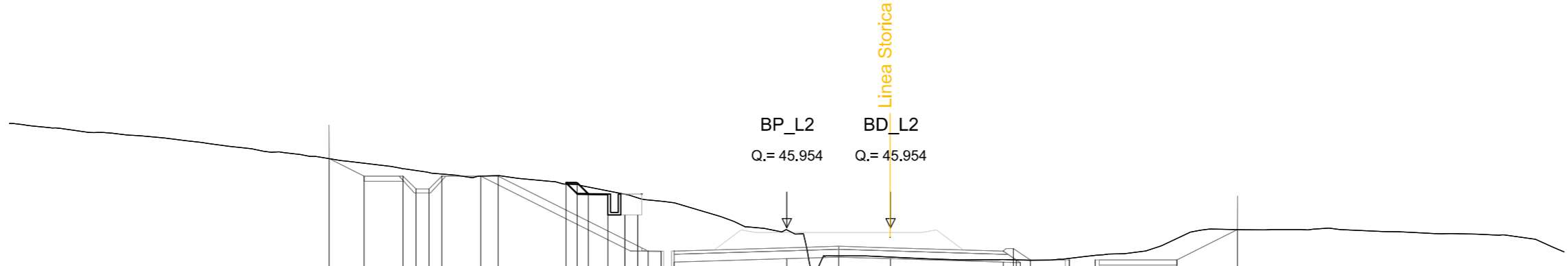

	1	2	3	4	5	6	7	8	9	10	11	12	13	14	15	16	17	18	19	20	21	22	23	24	25	26	27	28	29	30	31	32	33	34	35	36	37	38	39	40	41	42	43	44	45	46	47	48	49	50	51	52	53	54	55	56	57	58	59	60	61	62	63	64	65	66	67	68	69	70	71	72	73	74	75	76	77	78	79	80	81	82	83	84	85	86	87	88	89	90	91	92	93	94	95	96	97	98	99	100	101	102	103	104	105	106	107	108	109	110	111	112	113	114	115	116	117	118	119	120	121	122	123	124	125	126	127	128	129	130	131	132	133	134	135	136	137	138	139	140	141	142	143	144	145	146	147	148	149	150	151	152	153	154	155	156	157	158	159	160	161	162	163	164	165	166	167	168	169	170	171	172	173	174	175	176	177	178	179	180	181	182	183	184	185	186	187	188	189	190	191	192	193	194	195	196	197	198	199	200
Quote Terreno	48.625	48.450	48.233	48.189	48.087	48.028	47.951	47.971	47.696	47.642	47.553	47.529	47.379	47.249	47.132	47.082	46.982	46.922	45.873	44.872	44.829	44.729	44.729	44.705	44.777	44.893	45.542	45.885																																																																																																																																																																												
Quote Progetto	48.625	47.951	47.951	47.451	47.451	47.951	47.951	47.951	47.696	47.696	47.261	47.254	46.454	46.454	46.059	45.054	44.634	44.764	44.824	44.764	44.634	45.154	44.717	44.614	44.717	44.217	44.717	44.717	45.885																																																																																																																																																																											
Dist. Progr. Progetto	-17.653	-16.306	-14.806	-14.306	-13.806	-13.306	-11.806	-11.136	-8.515	-8.091	-7.656	-6.900	-6.250	-5.750	-5.350	-4.850	-4.350	-0.000	2.000	4.000	8.350	8.741	8.855	9.010	9.396	10.896	10.896	11.896	15.046	17.381																																																																																																																																																																										
Dist. Parziali	1.347	1.500	0.500	0.500	0.500	1.500	0.670	2.621	0.668	1.185	0.650	0.668	0.500	0.500	4.350	2.000	2.000	4.350	0.505	0.386	1.500	0.000	1.000	0.000	3.150	2.335																																																																																																																																																																														

Materiale	Area(m2)
Scavo	70.006
Rilevato	0.211
Scotico	14.249
SuperCompattato	3.937
Subballast	1.535
Inerbimento	5.011

Prog. = 5+350.000

Q. Rif. = 29.000

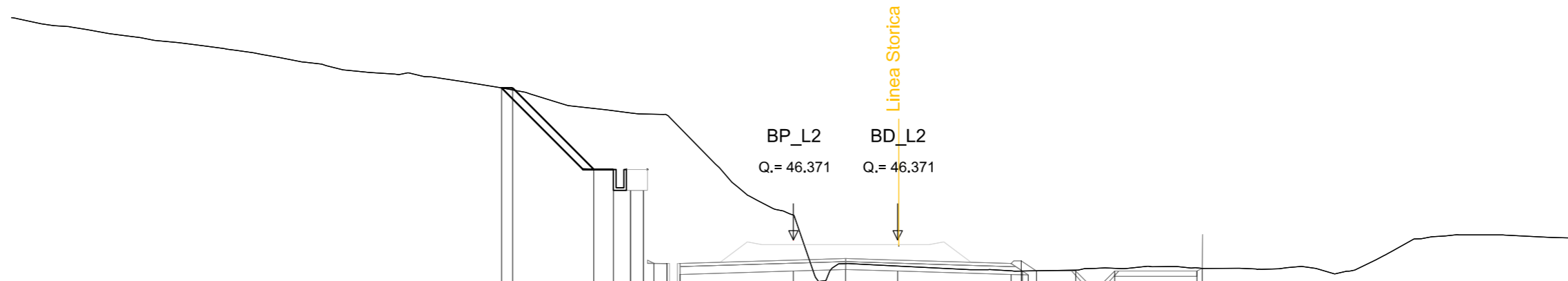

Quote Terreno		52.195	52.195	51.408	51.319	51.235	51.151	50.1664	47.322	45.464	45.371	45.181	45.181	45.181	45.216	45.216	45.285	45.285	45.286	45.286					
Quote Progetto		52.195	52.195	49.079	49.071	48.271	48.271	45.476	45.471	45.051	45.182	45.242	45.182	45.051	45.571	45.181	45.032	45.181	45.181	44.681	44.681				
Dist. Progr. Progetto		-11.196	-10.772	-7.656	-6.900	-6.250	-5.750	-5.350	-4.850	-4.350	-0.000	2.000	2.000	4.000	8.350	8.741	8.785	9.010	9.326	10.826	11.326	11.826	12.326	15.476	15.685
Dist. Parziali			3.111	0.000	1.185	0.650	0.500	0.500	0.500	4.350	2.000	2.000	4.350	0.435	0.316	1.500	0.500	0.500	0.500	3.150	0.209				

Materiale	Area(m2)
Scavo	148.503
Rilevato	0.123
Scotico	17.724
SuperCompattato	3.810
Subballast	1.524
Inerbimento	7.475

Prog. = 5+400.000

Q. Rif. = 30.000

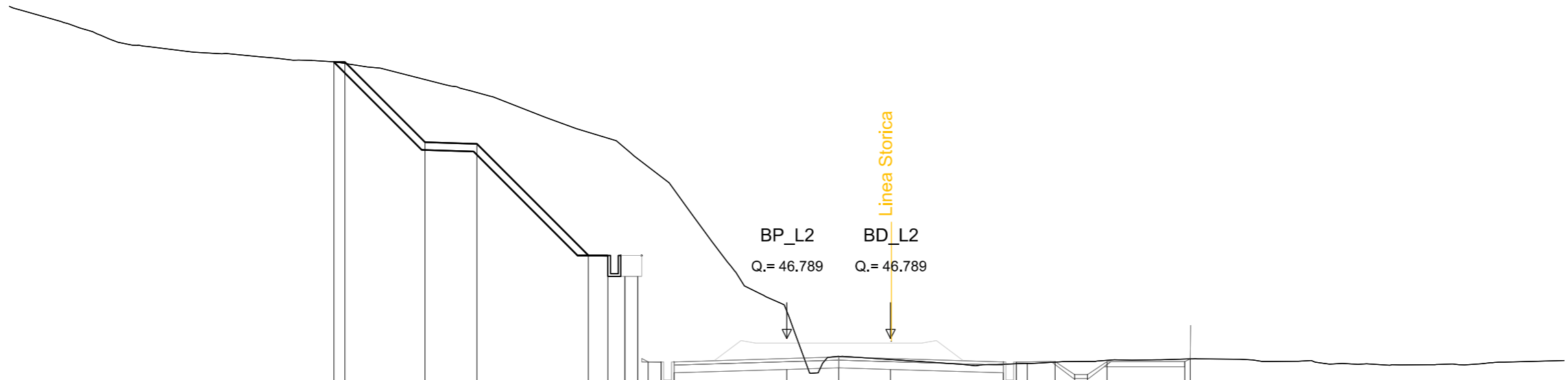

Quote Terreno		57.459		56.775		56.273		54.740		47.838		46.104		45.981		45.800		45.879		45.901		45.906		45.950		46.000		
Quote Progetto		57.450		54.357		54.297		49.997		45.600		45.660		45.600		45.469		45.901		45.401		45.401		45.901		45.901		46.008
Dist. Progr. Progetto		-17.473		-13.957		-11.957		-7.656		-0.000		2.000		4.000		8.350		10.350		11.100		11.600		12.350		15.350		15.564
Dist. Parziali		0.424	2.964	2.000	4.000	0.000	1.185	0.650	0.400	0.500	0.500	4.350	2.000	2.000	4.350	0.500	1.500	0.750	0.500	0.750	3.000	0.214						

