

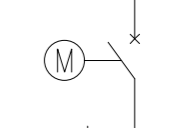

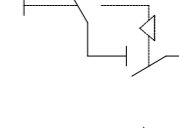

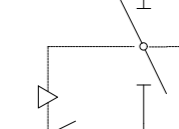

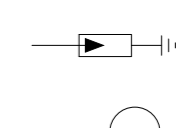
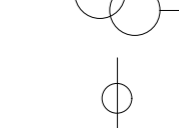
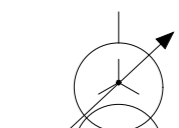
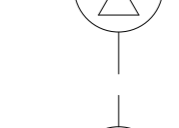
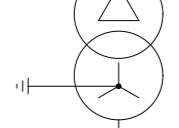

# LEGENDA

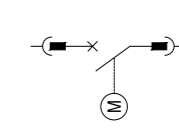
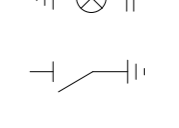
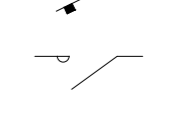
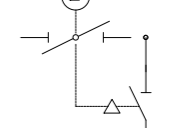
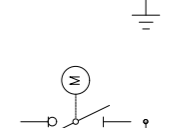
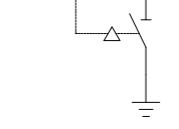
-  INTERRUTTORE AT CON COMANDO MOTORIZZATO
-  SEZIONATORE MANUALE AT CON INTERBLOCCO LAME DI TERRA
-  SEZIONATORE MOTORIZZATO ROTATIVO AT CON INTERBLOCCO LAME DI TERRA
-  SCARICATORE
-  TRASFORMATORE DI TENSIONE
-  TRASFORMATORE DI CORRENTE
-  TRASFORMATORE DI POTENZA (COMMUTATORE SOTTO CARICO MOTORIZZATO)
-  TRASFORMATORE SERVIZI AUSILIARI
-  GENERATORE ASINCRONO
-  FUSIBILE
-  INTERRUTTORE MT ASPORTABILE CON COMANDO MOTORIZZATO
-  INDICATORE CAPACITIVO PRESENZA TENSIONE
-  LAME DI MESSA A TERRA
-  INTERRUTTORE AUTOMATICO
-  CONTATORE DI MANOVRA
-  SEZIONATORE ROTATIVO CON MESSA A TERRA
-  SEZIONATORE ROTATIVO SOTTOCARICO CON MESSA A TERRA
-  LAMPADA DI SEGNALAZIONE
-  BLOCCO A CHIAVE, CHIAVE LIBERA IN APERTO
-  BLOCCO A CHIAVE, CHIAVE LIBERA IN CHIUSO
-  CONTATORE DI ENERGIA ATTIVA/REATTIVA ENTRANTE-USCENTE PER MISURE FISCALI
-  MODULO IBRIDO 150 kV (Maggiori dettagli sono riportati nell'elaborato "GEOE083 Relazione tecnica descrittiva connessione RTN Terna")
-  TA A 3 NUCLEI
-  SEZIONATORE
-  TV CAPACITIVO
-  TERMINALE ARIA - CAVO

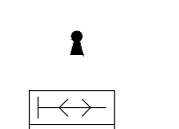

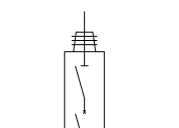
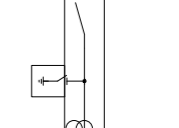
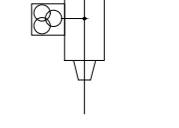
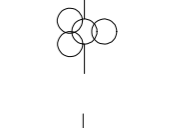
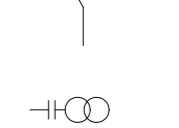
## IMPIANTO EOLICO

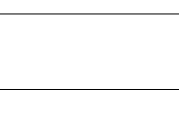
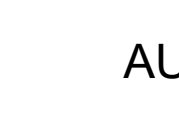
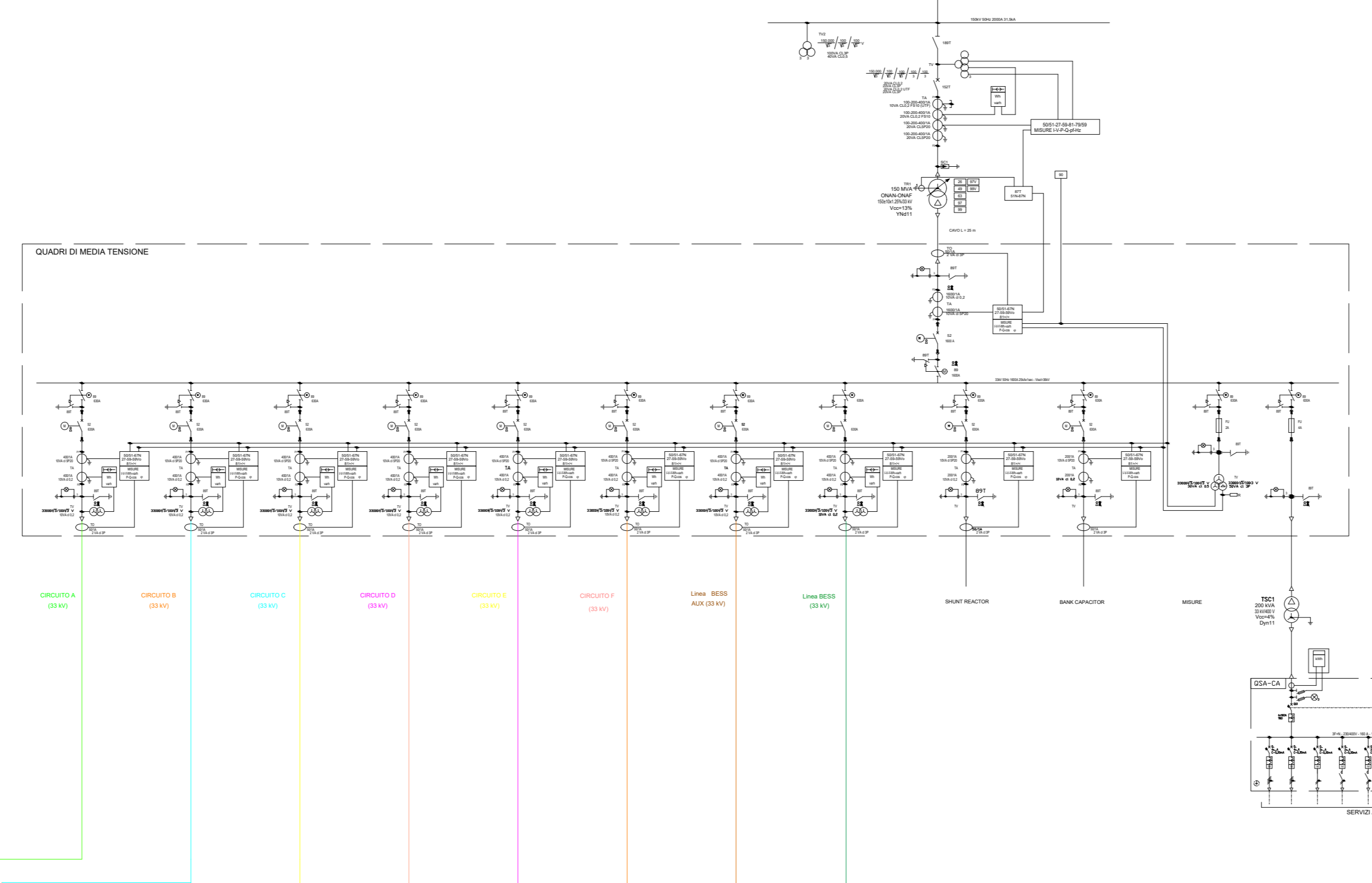
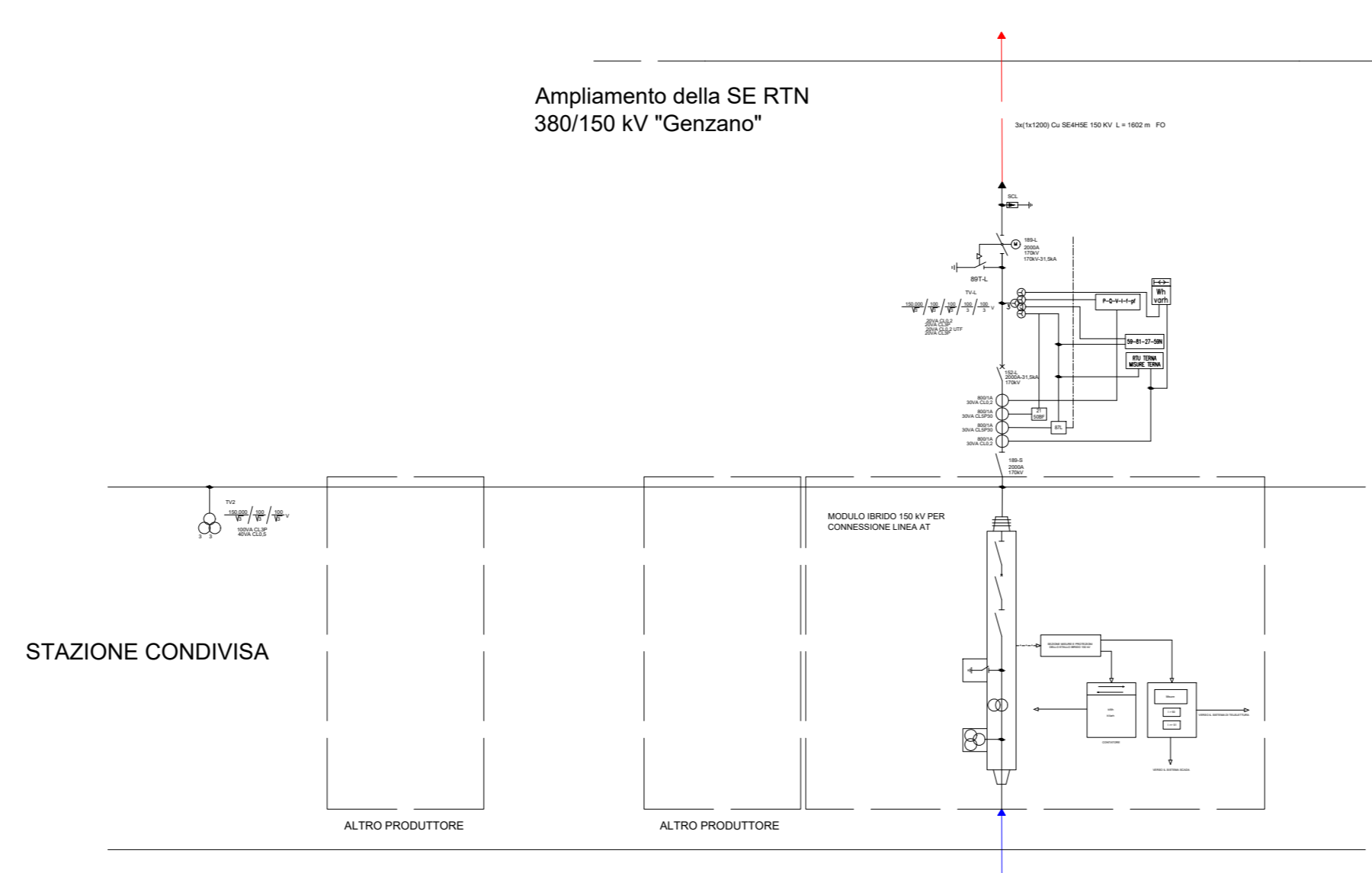
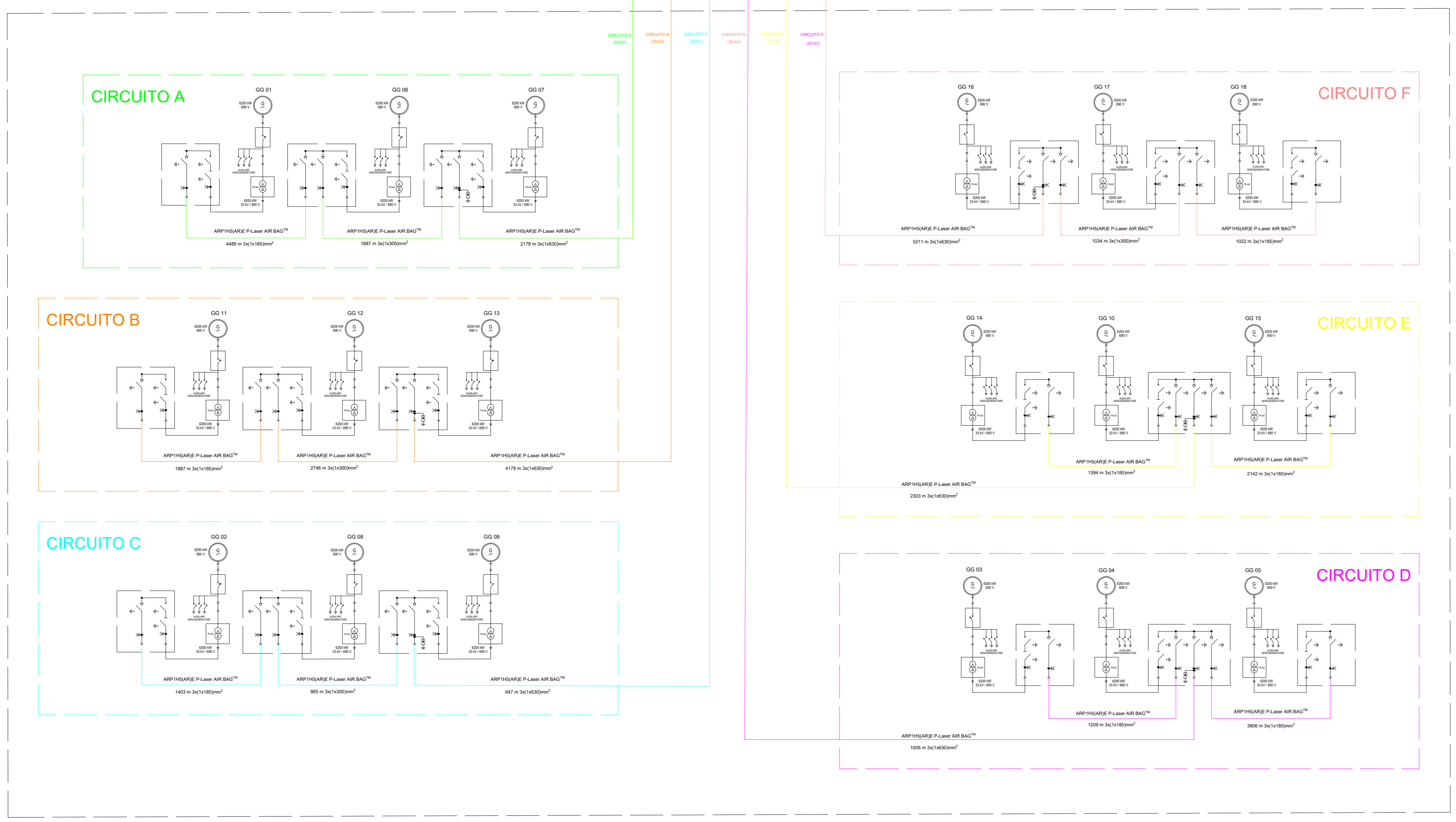
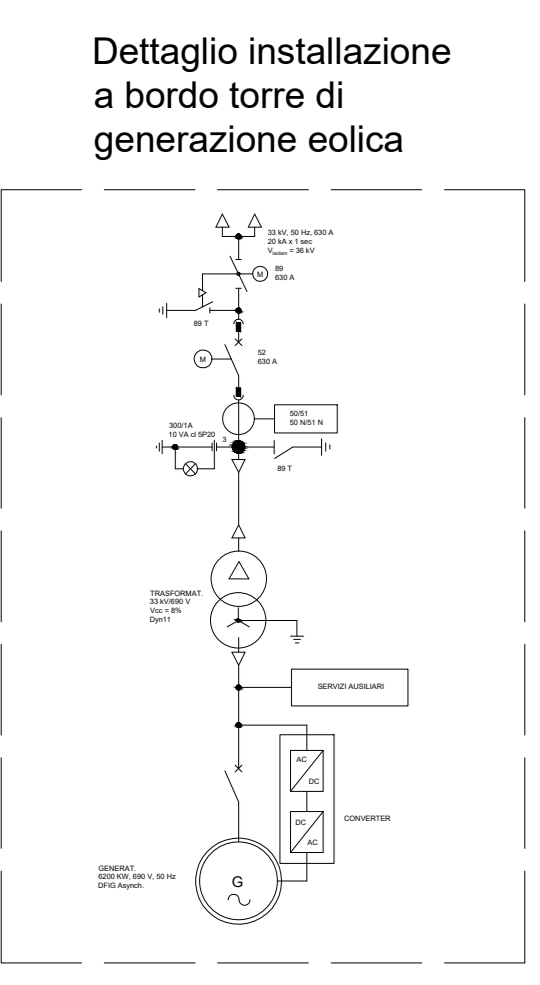

## IMPIANTO BESS (BATTERY ENERGY STORAGE SYSTEM)

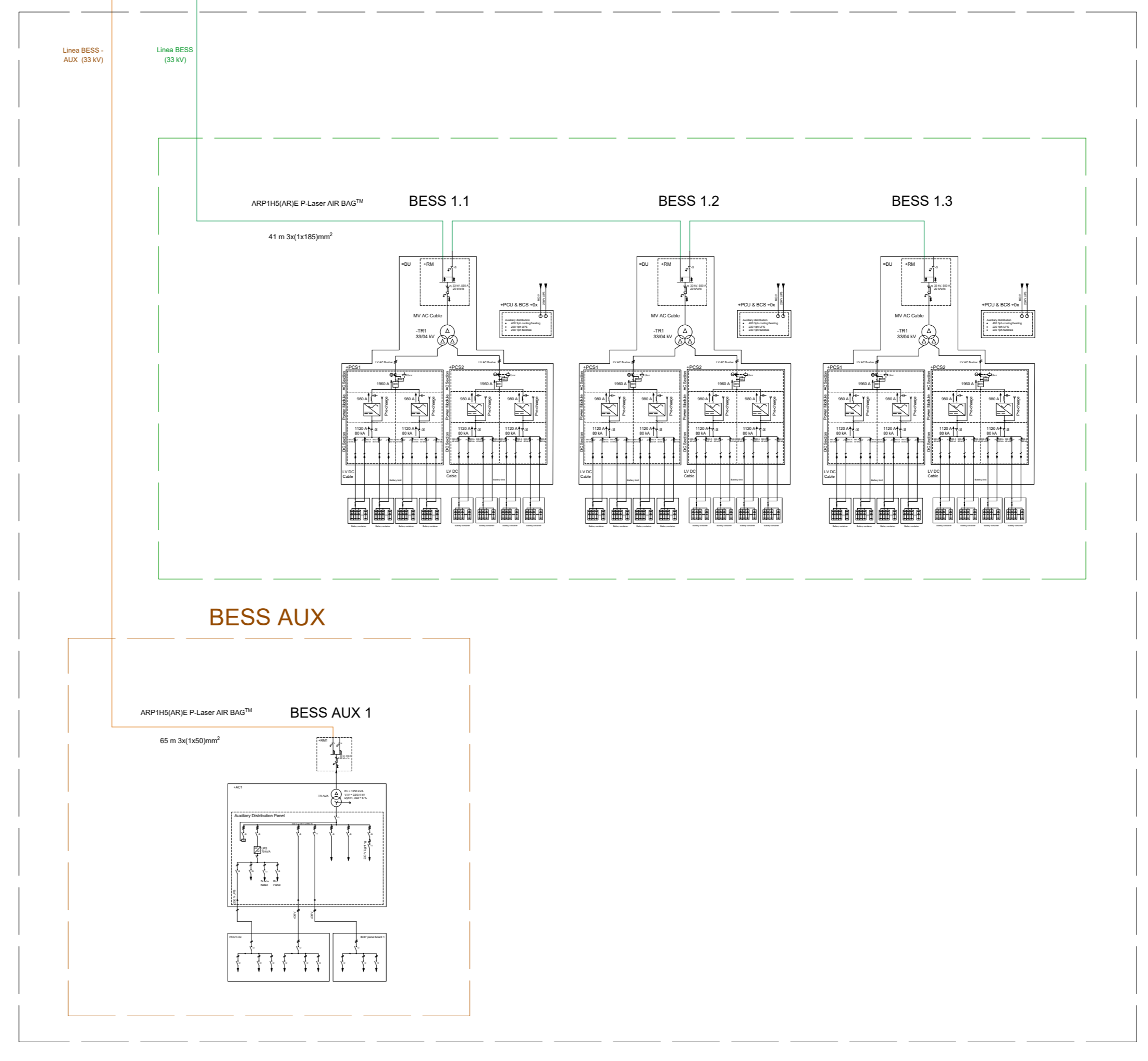

AUTORIZZAZIONE UNICA EX D. LGS. N. 387/2003



PROGETTO DEFINITIVO  
PARCO EOLICO GENZANO











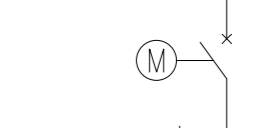
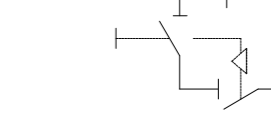

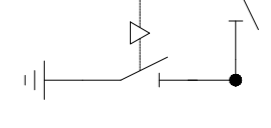
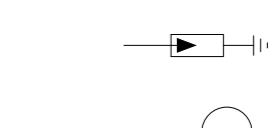
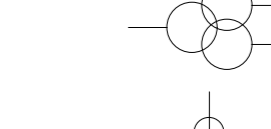
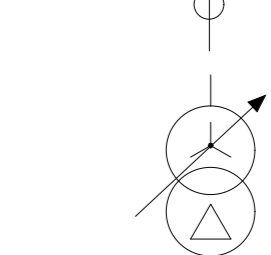
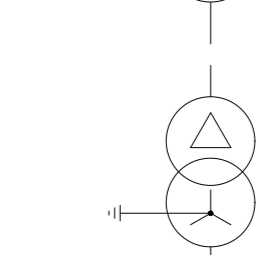
Titolo elaborato:

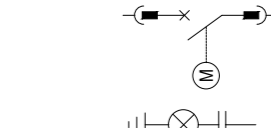
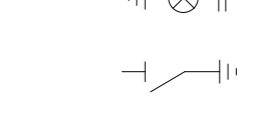
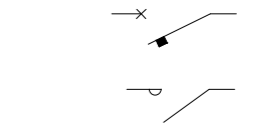
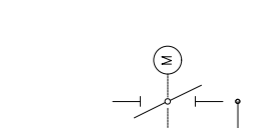
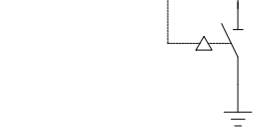
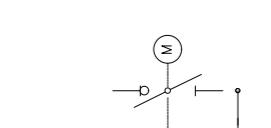
SCHEMA UNIFILARE IMPIANTO UTENTE

SS	LT	GD	Prima emissione	04/08/2023	00
REDDATTO	CONTR.	APPROV.	DESCRIZIONE REVISIONE DOCUMENTO	DATA	REV

<p><b>PROPRONTE</b></p>  <p><b>LUCANIA PRIME S.R.L.</b> Via A. De Gasperi n.8 74023 Grottaglie (TA)</p>	<p><b>CONSULENZA</b></p>  <p><b>GE.CO.D'OR. S.R.L.</b> Via A. De Gasperi n.8 74023 Grottaglie (TA)</p> <p><b>PROGETTISTA</b> Ing. Gaetano D'Oronzio Via Goito 14 - Colobraro (MT)</p>
--	--

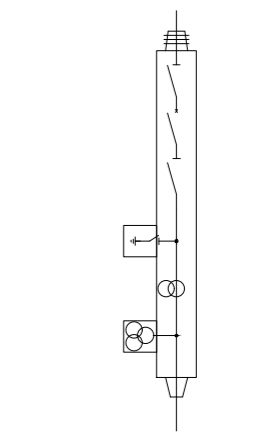
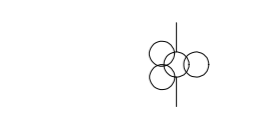
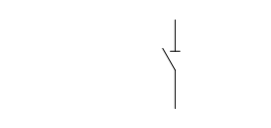
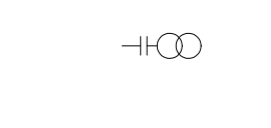
# LEGENDA

-  INTERRUTTORE AT CON COMANDO MOTORIZZATO
-  SEZIONATORE MANUALE AT CON INTERBLOCCO LAME DI TERRA
-  SEZIONATORE MOTORIZZATO ROTATIVO AT CON INTERBLOCCO LAME DI TERRA
-  SCARICATORE
-  TRASFORMATORE DI TENSIONE
-  TRASFORMATORE DI CORRENTE
-  TRASFORMATORE DI POTENZA (COMMUTATORE SOTTO CARICO MOTORIZZATO)
-  TRASFORMATORE SERVIZI AUSILIARI
-  GENERATORE ASINCRONO
-  FUSIBILE
-  INTERRUTTORE MT ASPORTABILE CON COMANDO MOTORIZZATO
-  INDICATORE CAPACITIVO PRESENZA TENSIONE
-  LAME DI MESSA A TERRA
-  INTERRUTTORE AUTOMATICO
-  CONTATORE DI MANOVRA
-  SEZIONATORE ROTATIVO CON MESSA A TERRA
-  SEZIONATORE ROTATIVO SOTTOCARICO CON MESSA A TERRA
-  LAMPADA DI SEGNALAZIONE
-  BLOCCO A CHIAVE, CHIAVE LIBERA IN APERTO
-  BLOCCO A CHIAVE, CHIAVE LIBERA IN CHIUSO
-  CONTATORE DI ENERGIA ATTIVA/REATTIVA ENTRANTE-USCENTE PER MISURE FISCALI
-  MODULO IBRIDO 150 kV (Maggiori dettagli sono riportati nell'elaborato "GEOE083 Relazione tecnica descrittiva connessione RTN Terna")
-  TA A 3 NUCLEI
-  SEZIONATORE
-  TV CAPACITIVO
-  TERMINALE ARIA - CAVO

## IMPIANTO EOLICO

Dettaglio installazione a bordo torre di generazione eolica

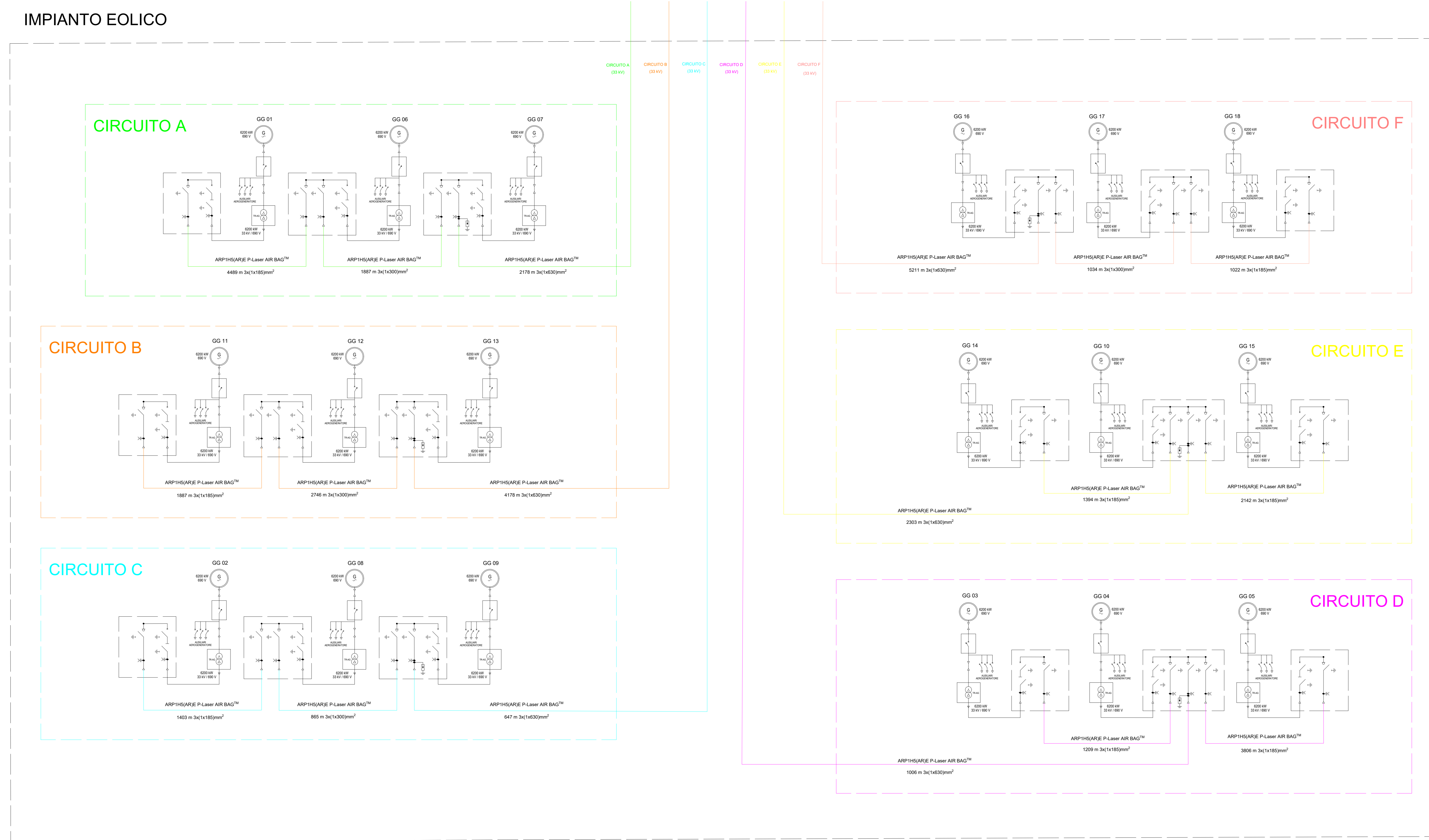
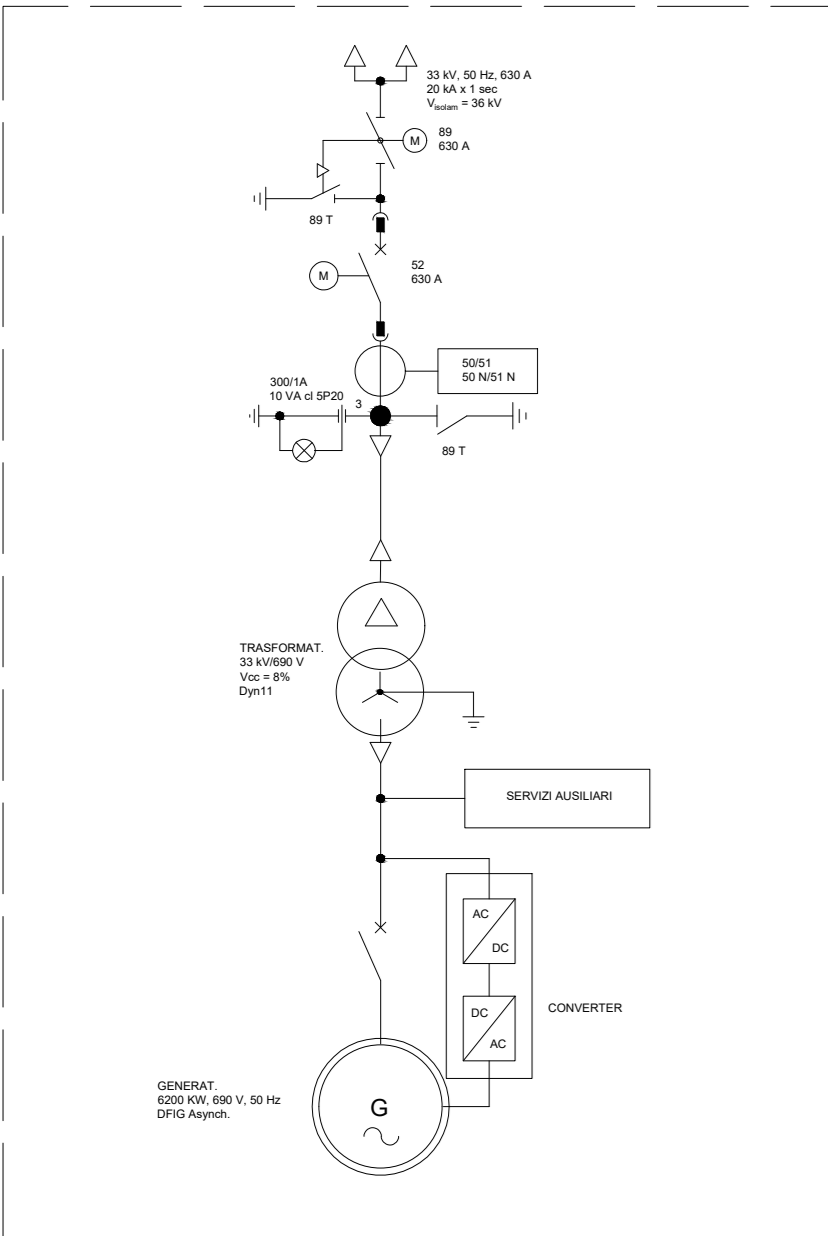

AUTORIZZAZIONE UNICA EX D. LGS. N. 387/2003

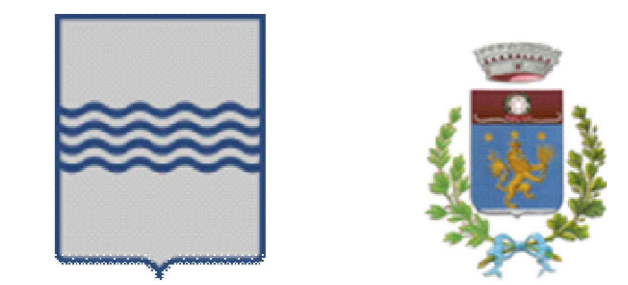

PROGETTO DEFINITIVO  
PARCO EOLICO GENZANO

Titolo elaborato:

SCHEMA UNIFILARE IMPIANTO UTENTE

SS	LT	GD	Prima emissione	04/08/2023	00
REDDATTO	CONTR.	APPROV.	DESCRIZIONE REVISIONE DOCUMENTO	DATA	REV

PROPONENTE

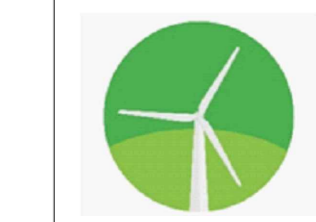

LUCANIA PRIME S.R.L.  
Via A. De Gasperi n.8  
74023 Grottaglie (TA)

CONSULENZA







GE.CO.D'OR. S.R.L.  
Via A. De Gasperi n.8  
74023 Grottaglie (TA)

PROGETTISTA  
Ing. Gaetano D'Oronzio  
Via Goito 14 - Colobraro (MT)

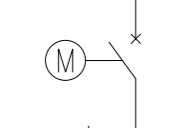
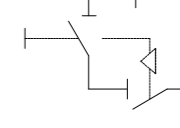
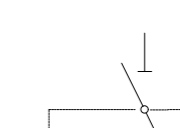
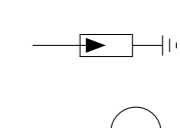
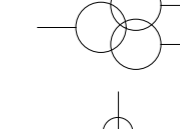
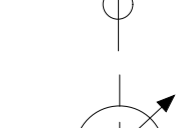
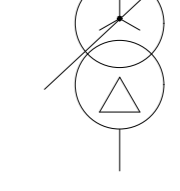
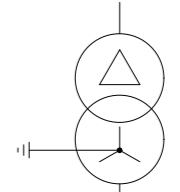
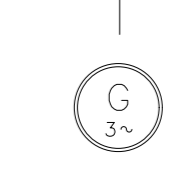
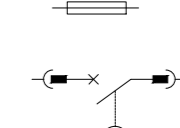
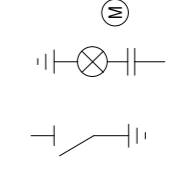
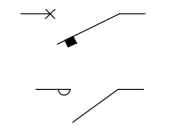
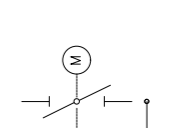
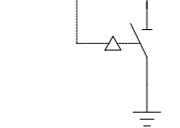
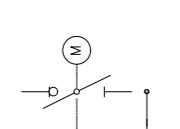
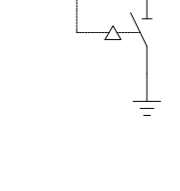
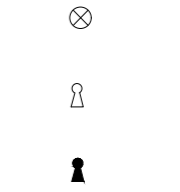
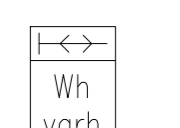
# IMPIANTO BESS (BATTERY ENERGY STORAGE SYSTEM)

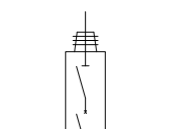
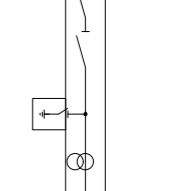
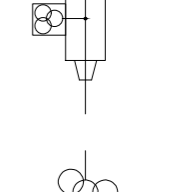
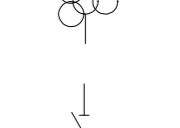
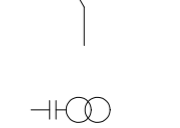
## LEGENDA

-  INTERRUTTORE AT CON COMANDO MOTORIZZATO
-  SEZIONATORE MANUALE AT CON INTERBLOCCO LAME DI TERRA
-  SEZIONATORE MOTORIZZATO ROTATIVO AT CON INTERBLOCCO LAME DI TERRA
-  SCARICATORE
-  TRASFORMATORE DI TENSIONE
-  TRASFORMATORE DI CORRENTE
-  TRASFORMATORE DI POTENZA (COMMUTATORE SOTTO CARICO MOTORIZZATO)
-  TRASFORMATORE SERVIZI AUSILIARI
-  GENERATORE ASINCRONO
-  FUSIBILE
-  INTERRUTTORE MT ASPORTABILE CON COMANDO MOTORIZZATO
-  INDICATORE CAPACITIVO PRESENZA TENSIONE
-  LAME DI MESSA A TERRA
-  INTERRUTTORE AUTOMATICO
-  CONTATORE DI MANOVRA
-  SEZIONATORE ROTATIVO CON MESSA A TERRA
-  SEZIONATORE ROTATIVO SOTTOCARICO CON MESSA A TERRA
-  LAMPADA DI SEGNALAZIONE
-  BLOCCO A CHIAVE, CHIAVE LIBERA IN APERTO
-  BLOCCO A CHIAVE, CHIAVE LIBERA IN CHIUSO
-  CONTATORE DI ENERGIA ATTIVA/REATTIVA ENTRANTE-USCENTE PER MISURE FISCALI
-  MODULO IBRIDO 150 kV (Maggiori dettagli sono riportati nell'elaborato "GEOE083 Relazione tecnica descrittiva connessione RTN Terna")
-  TA A 3 NUCLEI
-  SEZIONATORE
-  TV CAPACITIVO
-  TERMINALE ARIA - CAVO

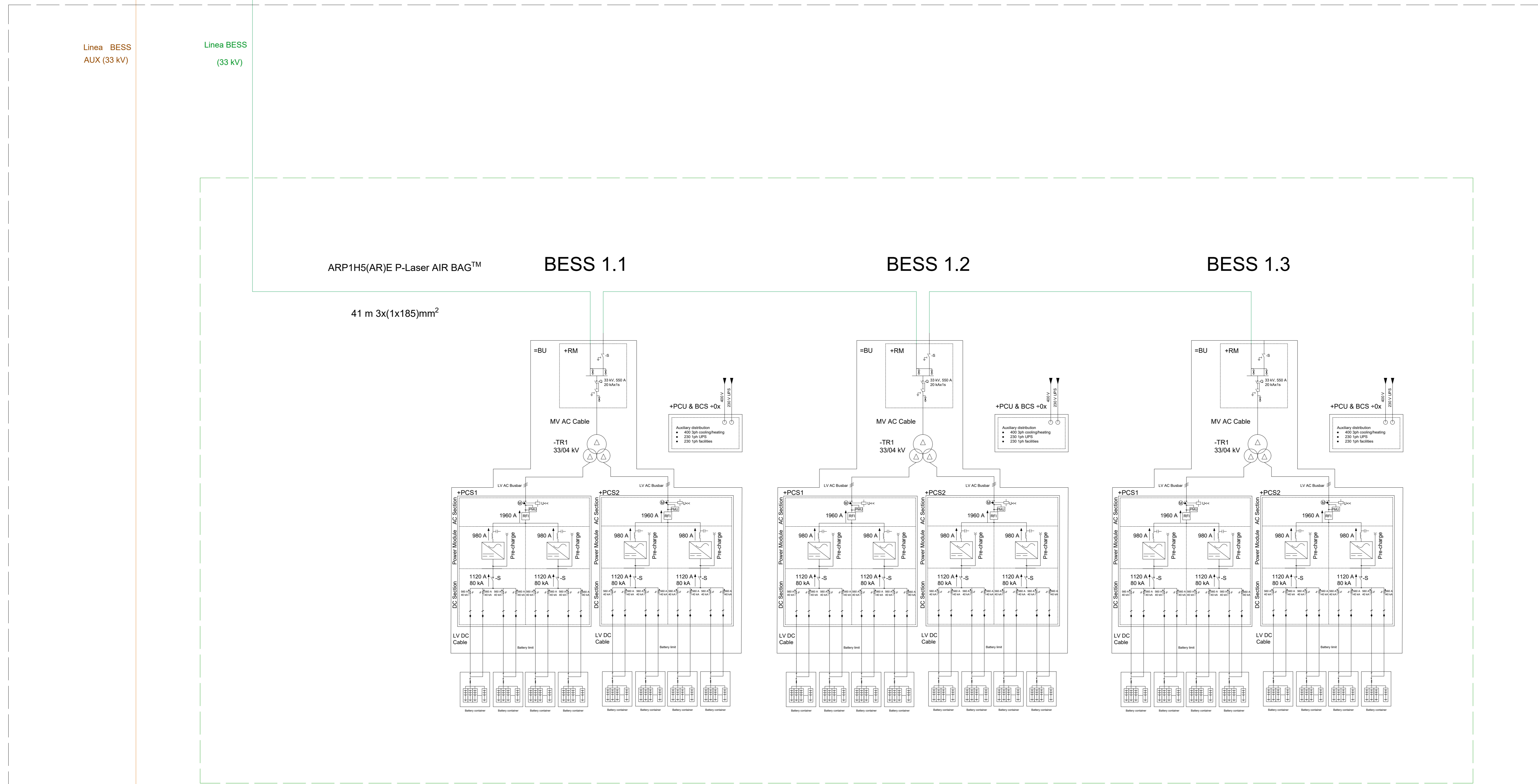

Linea BESS AUX (33 kV)

Linea BESS (33 kV)

ARP1H5(AR)E P-Laser AIR BAG™

BESS 1.1

BESS 1.2

BESS 1.3

41 m 3x(1x185)mm<sup>2</sup>

## BESS AUX

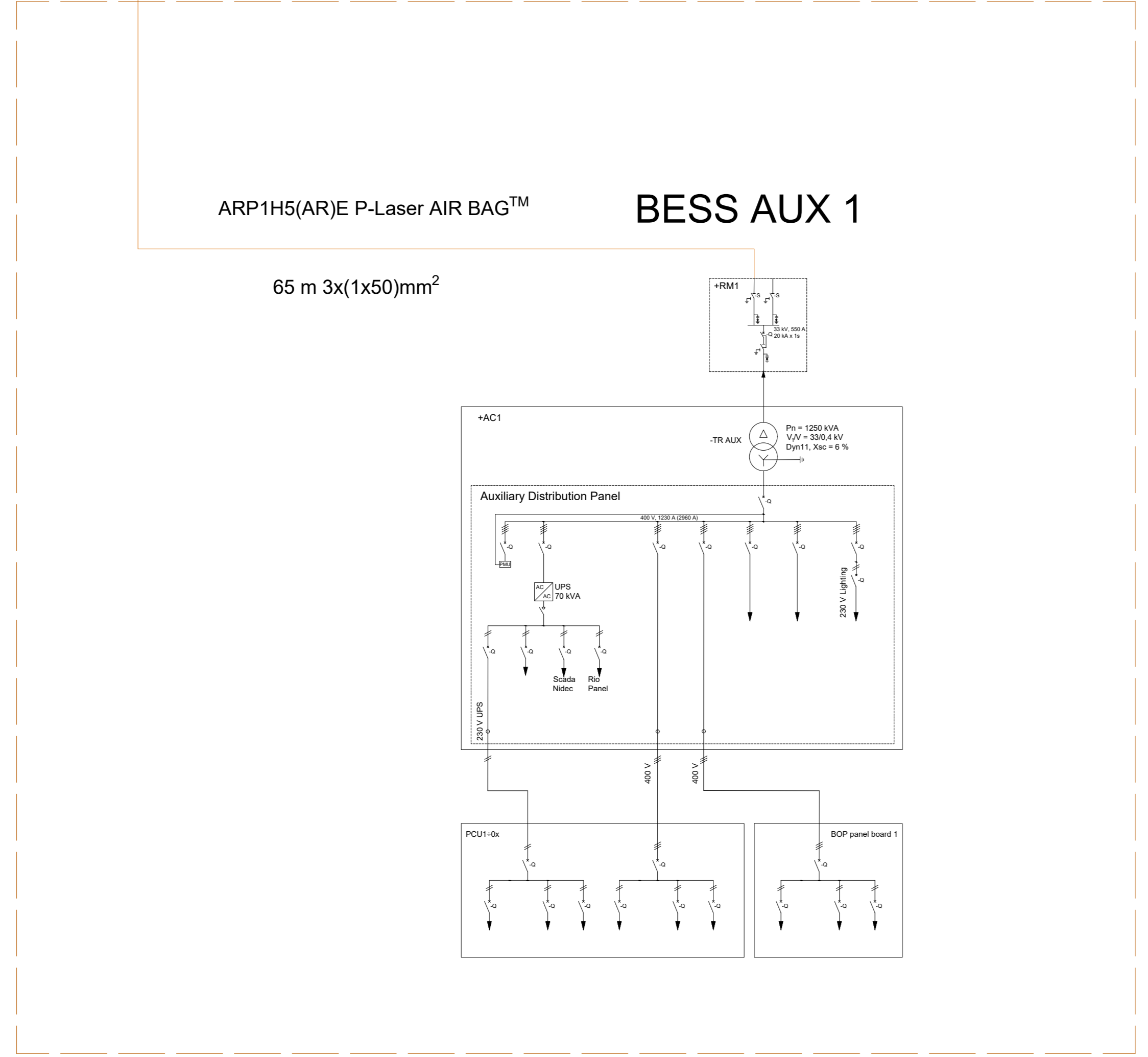

ARP1H5(AR)E P-Laser AIR BAG™

BESS AUX 1

65 m 3x(1x50)mm<sup>2</sup>

AUTORIZZAZIONE UNICA EX D. LGS. N. 387/2003

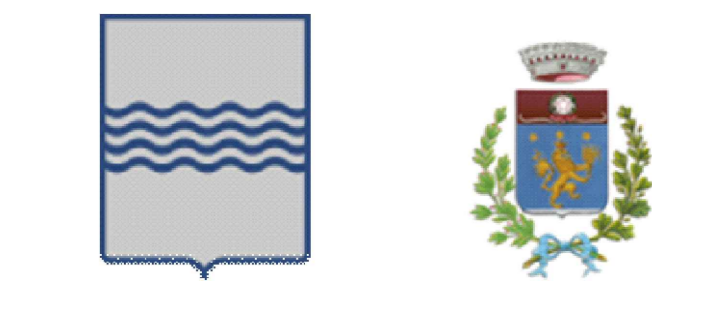

PROGETTO DEFINITIVO  
PARCO EOLICO GENZANO







TITOLO ELABORATO:

SCHEMA UNIFILARE IMPIANTO UTENTE

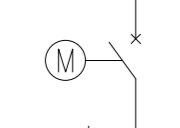
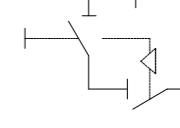
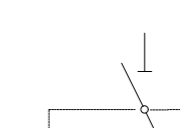
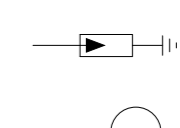
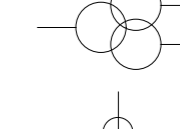
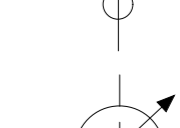
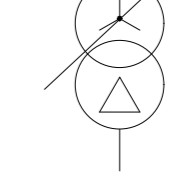
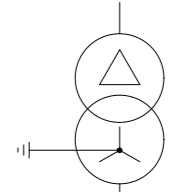
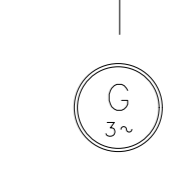
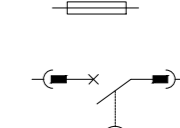
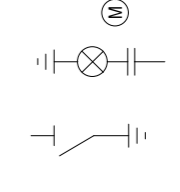
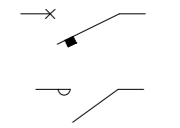
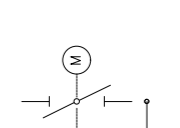
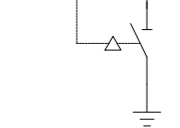
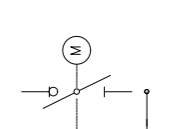
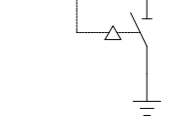
SS	LT	GD	Prima emissione	04/08/2023	00
REDDATTO	CONTR.	APPROV.	DESCRIZIONE REVISIONE DOCUMENTO	DATA	REV

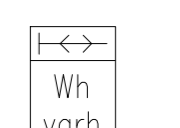
<p><b>PROPRONTE</b></p>  <p><b>LUCANIA PRIME S.R.L.</b> Via A. De Gasperi n.8 74023 Grottaglie (TA)</p>	<p><b>CONSULENZA</b></p>  <p><b>GE.CO.D'OR. S.R.L.</b> Via A. De Gasperi n.8 74023 Grottaglie (TA)</p> <p><b>PROGETTISTA</b> Ing. Gaetano D'Oronzio Via Goito 14 - Colobraro (MT)</p>
--	--

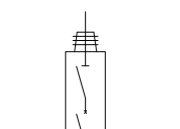
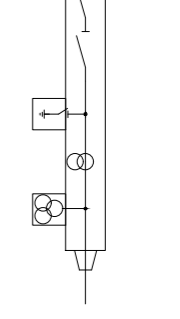
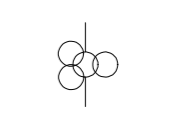
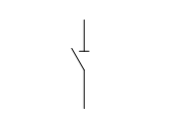
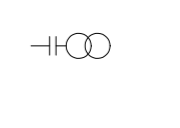
# LEGENDA

-  INTERRUTTORE AT CON COMANDO MOTORIZZATO
-  SEZIONATORE MANUALE AT CON INTERBLOCCO LAME DI TERRA
-  SEZIONATORE MOTORIZZATO ROTATIVO AT CON INTERBLOCCO LAME DI TERRA
-  SCARICATORE
-  TRASFORMATORE DI TENSIONE
-  TRASFORMATORE DI CORRENTE
-  TRASFORMATORE DI POTENZA (COMMUTATORE SOTTO CARICO MOTORIZZATO)
-  TRASFORMATORE SERVIZI AUSILIARI
-  GENERATORE ASINCRONO
-  FUSIBILE
-  INTERRUTTORE MT ASPORTABILE CON COMANDO MOTORIZZATO
-  INDICATORE CAPACITIVO PRESENZA TENSIONE
-  LAME DI MESSA A TERRA
-  INTERRUTTORE AUTOMATICO
-  CONTATORE DI MANOVRA
-  SEZIONATORE ROTATIVO CON MESSA A TERRA
-  SEZIONATORE ROTATIVO SOTTOCARICO CON MESSA A TERRA
-  LAMPADA DI SEGNALAZIONE
-  BLOCCO A CHIAVE, CHIAVE LIBERA IN APERTO
-  BLOCCO A CHIAVE, CHIAVE LIBERA IN CHIUSO
-  CONTATORE DI ENERGIA ATTIVA/REATTIVA ENTRANTE-USCENTE PER MISURE FISCALI
-  MODULO IBRIDO 150 kV (Maggiori dettagli sono riportati nell'elaborato "GEOE083 Relazione tecnica descrittiva connessione RTN Terna")
-  TA A 3 NUCLEI
-  SEZIONATORE
-  TV CAPACITIVO
-  TERMINALE ARIA - CAVO

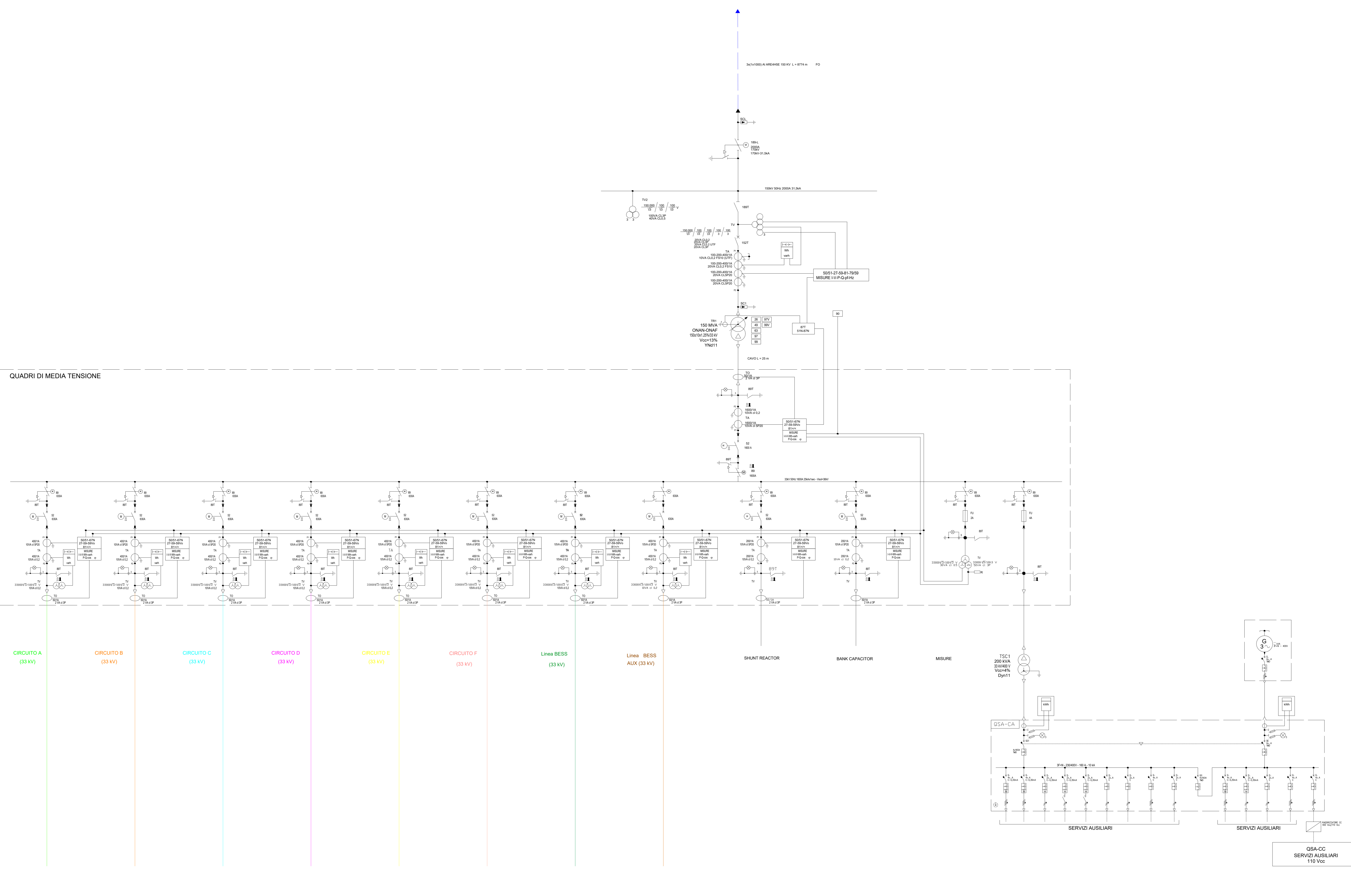

**AUTORIZZAZIONE UNICA EX D. LGS. N. 387/2003**



**PROGETTO DEFINITIVO  
PARCO EOLICO GENZANO**

Titolo elaborato:

**SCHEMA UNIFILARE IMPIANTO UTENTE**

SS	LT	GD	Prima emissione	04/08/2023	00
REDDATTO	CONTR.	APPROV.	DESCRIZIONE REVISIONE DOCUMENTO	DATA	REV

<p><b>PROPONENTE</b></p>  <p><b>LUCANIA PRIME S.R.L.</b> Via A. De Gasperi n.8 74023 Grottaglie (TA)</p>	<p><b>CONSULENZA</b></p>  <p><b>GE.CO.D'OR S.R.L.</b> Via A. De Gasperi n.8 74023 Grottaglie (TA)</p> <p><b>PROGETTISTA</b> Ing. Gaetano D'Oronzio Via Goito 14 - Colobraro (MT)</p>
---	---

Codice GEOE072	Formato A0	Scala -	Foglio 4/5
-------------------	---------------	------------	---------------

# Ampliamento SE RTN 380/150 kV "Genzano"

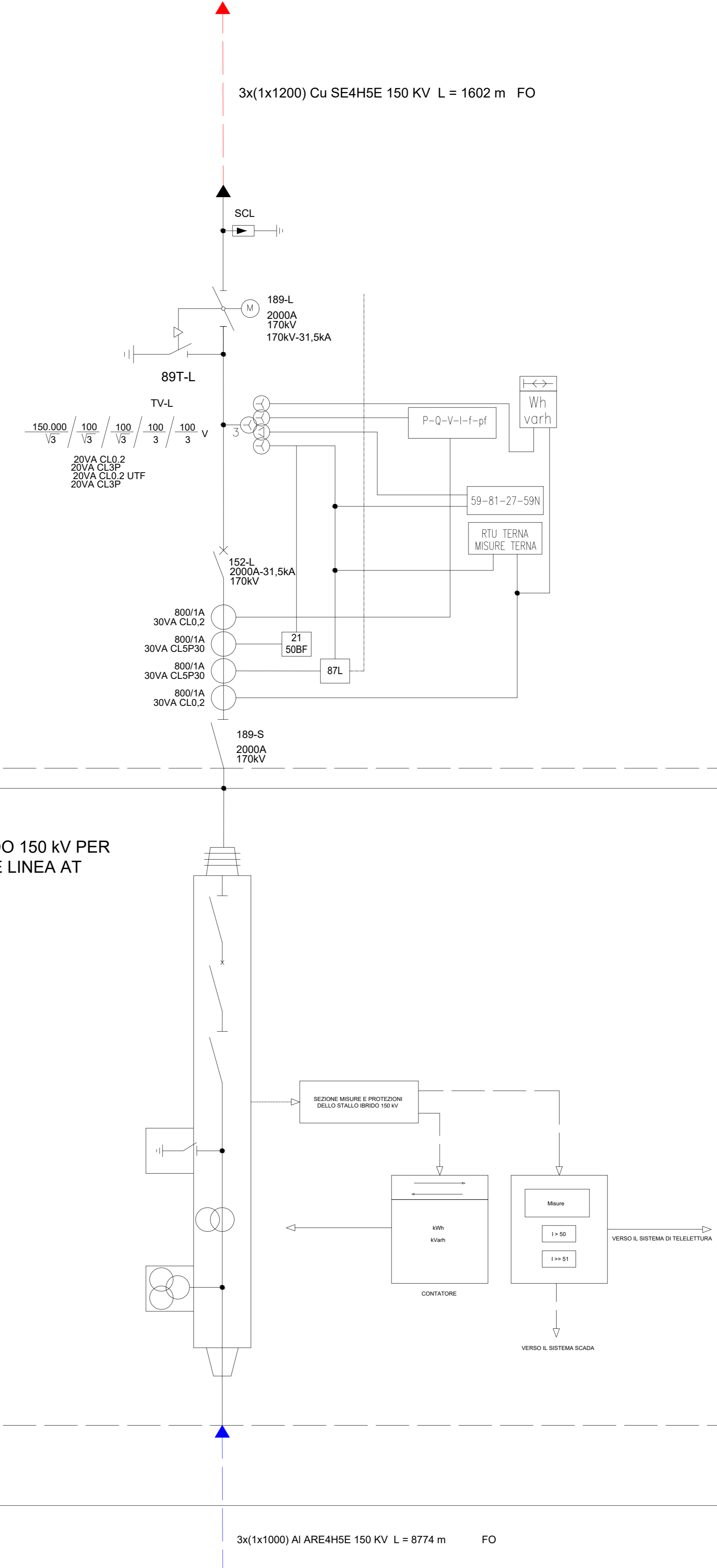

## LEGENDA

- INTERRUTTORE AT CON COMANDO MOTORIZZATO
- SEZIONATORE MANUALE AT CON INTERBLOCCO LAME DI TERRA
- SEZIONATORE MOTORIZZATO ROTATIVO AT CON INTERBLOCCO LAME DI TERRA
- SCARICATORE
- TRASFORMATORE DI TENSIONE
- TRASFORMATORE DI CORRENTE
- TRASFORMATORE DI POTENZA (COMMUTATORE SOTTO CARICO MOTORIZZATO)
- TRASFORMATORE SERVIZI AUSILIARI
- GENERATORE ASINCRONO
- FUSIBILE
- INTERRUTTORE MT ASPORTABILE CON COMANDO MOTORIZZATO
- INDICATORE CAPACITIVO PRESENZA TENSIONE
- LAME DI MESSA A TERRA
- INTERRUTTORE AUTOMATICO
- CONTATORE DI MANOVRA
- SEZIONATORE ROTATIVO CON MESSA A TERRA
- SEZIONATORE ROTATIVO SOTTOCARICO CON MESSA A TERRA
- LAMPADA DI SEGNALAZIONE
- BLOCCO A CHIAVE, CHIAVE LIBERA IN APERTO
- BLOCCO A CHIAVE, CHIAVE LIBERA IN CHIUSO
- CONTATORE DI ENERGIA ATTIVA/REATTIVA ENTRANTE-USCENTE PER MISURE FISCALI
- MODULO IBRIDO 150 kV (Maggiori dettagli sono riportati nell'elaborato "GEOE083 Relazione tecnica descrittiva connessione RTN Terna")
- TA A 3 NUCLEI
- SEZIONATORE
- TV CAPACITIVO
- TERMINALE ARIA - CAVO

STAZIONE CONDIVISA



ALTRO PRODUTTORE

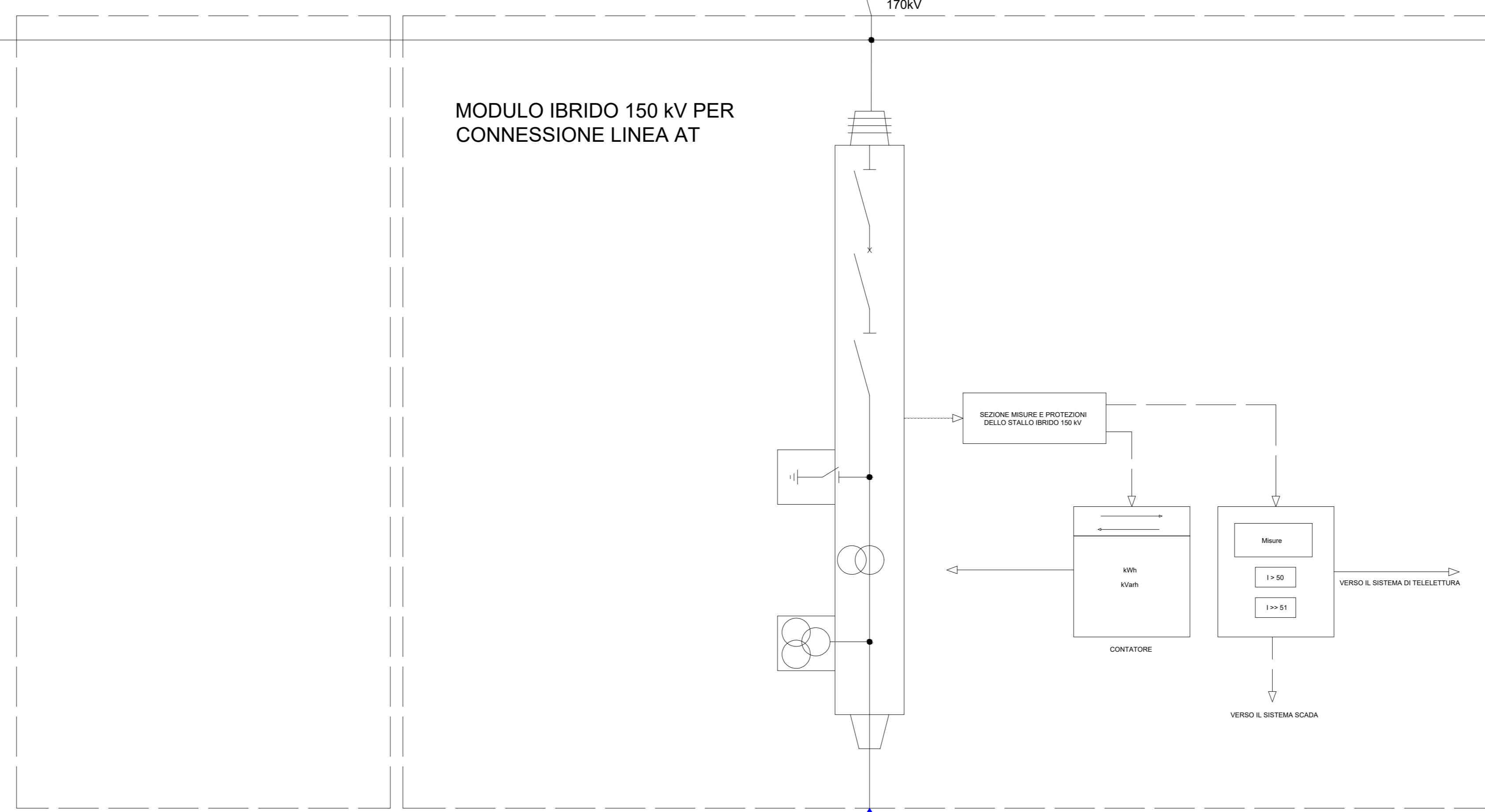

ALTRO PRODUTTORE

AUTORIZZAZIONE UNICA EX D. LGS. N. 387/2003

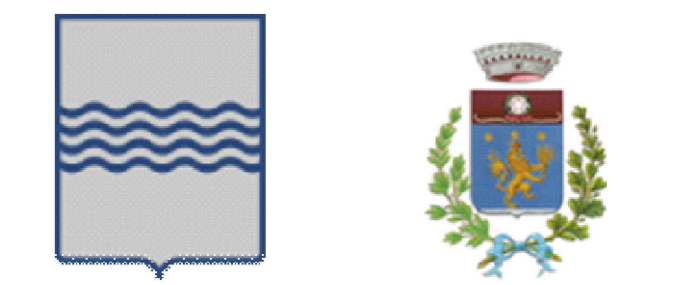

PROGETTO DEFINITIVO  
PARCO EOLICO GENZANO

Titolo elaborato:

SCHEMA UNIFILARE IMPIANTO UTENTE

SS	LT	GD	Prima emissione	04/08/2023	00
REDDATTO	CONTR.	APPROV.	DESCRIZIONE REVISIONE DOCUMENTO	DATA	REV

PROPONENTE	CONSULENZA
 <b>LUCANIA PRIME S.R.L.</b> Via A. De Gasperi n.8 74023 Grottaglie (TA)	 <b>GE.CO.D'OR. S.R.L.</b> Via A. De Gasperi n.8 74023 Grottaglie (TA)
<b>PROGETTISTA</b> Ing. Gaetano D'Oronzio Via Goito 14 - Colobraro (MT)	