

Rev.	Data	Descrizione	Dis.	Contr.	Appr.
0	09/2023	EMISSIONE PER PROCEDURA DI VIA	MU	GF	QR
Progettazione e SIA:		Incaricato:	Committente:		
 <small>www.iatprogetti.it</small> IAT Consulenza e progetti S.r.l. Via Giua s.n.c. - 09122 - Cagliari (CA)		Queequeg Renewables, ltd 2nd Floor, the Works, 14 Turnham Green Terrace Mews, W41QU London (UK) 	Repsol Orria S.r.l. Via Michele Mercati 39 00197 Roma - RM		
PROGETTO DI COSTRUZIONE ED ESERCIZIO DI UN IMPIANTO EOLICO DELLA POTENZA DI 99,2 MW DENOMINATO "ORRIA" DA REALIZZARSI NEI COMUNI DI NULVI (SS) E SEDINI (SS) CON LE RELATIVE OPERE DI CONNESSIONE ELETTRICHE			Commessa n°: 2022/0352 Dis. n°: WIND002-TC12		
SEZIONI TRASVERSALI RAPPRESENTATIVE VIABILITÀ DI IMPIANTO			Revisione:		
			Scala: -		
Nome documento: WIND002-TC12_Sezioni trasversali rappresentative viabilità di impianto			Sostituisce il:		
			Sostituito dal:		

SEZIONI TRASVERSALI
Profilo longitudinale tratto 1-2
Viabilità di impianto postazione aerogeneratore T01

Nota: Le canalette di deflusso delle acque meteoriche, non indicate nel presente elaborato, sono rappresentate graficamente nelle sezioni stradali tipo dell'elaborato "WIND002-TC13_Piazzole aerogeneratori e strade di servizio - Particolari costruttivi", individuate planimetricamente nell'elaborato "WIND002-TC14_Opere di regimazione acque superficiali - Planimetria generale" e quantificate nell'elaborato "WIND002-RC6_Computo Metrico Estimativo".

DISEGNI DI RIFERIMENTO

TAVOLA	DESCRIZIONE
WIND002-TC8	Piazzole e viabilità - Planimetria di progetto - Fase di cantiere
WIND002-TC11	Profili longitudinali viabilità di impianto
WIND002-TC13	Piazzole aerogeneratori e strade di servizio - Particolari costruttivi
WIND002-TC14	Opere di regimazione acque superficiali - Planimetria generale

Sezione: 6
 Progressiva: 20.000
 Q. Progetto: 436.664

434.00

Quote Terreno	435.94 435.98		436.65 436.67		437.44 437.44
Quote Progetto		436.38 436.20	436.26 436.67	436.20 437.00	
Parziali		2.50	2.50	0.40	
Progressiva		-2.73 -2.50	0.00	2.50 2.50	
Dislivelli		-0.00 0.20	-0.41	-0.75 -0.00	

Sezione: 7
 Progressiva: 40.000
 Q. Progetto: 436.132

434.00

Quote Terreno	435.42		435.96 436.13		436.71 436.87
Quote Progetto		435.84 435.67	435.73 436.13	435.67 436.44	
Parziali		2.50	2.50	0.37	
Progressiva		-2.73 -2.50	0.00	2.50 2.87	
Dislivelli		0.00 0.20	-0.40	-0.73 -0.00	

Sezione: 8
 Progressiva: 48.567
 Q. Progetto: 435.792

434.00

Quote Terreno	435.10	435.57	435.76	435.79	436.50
Quote Progetto		435.51 435.45	435.39	435.33 436.08	
Parziali		0.35 2.50	2.50	0.35	
Progressiva		-2.85 -2.50	0.00	2.50 2.85	
Dislivelli		0.00 0.31	-0.39	-0.72 -0.00	

Sezione: 9
 Progressiva: 50.000
 Q. Progetto: 435.734

434.00

Quote Terreno	435.03	435.49	435.72	435.81	436.43
Quote Progetto		435.44 435.40	435.33	435.27 436.01	
Parziali		0.38 2.50	2.50	0.34	
Progressiva		-2.86 -2.50	0.00	2.50 2.84	
Dislivelli		0.00 0.32	-0.39	-0.71 0.00	

Sezione: 10
 Progressiva: 60.000
 Q. Progetto: 435.337

433.00

Quote Terreno	434.65	434.90	435.25	435.35	436.09
Quote Progetto		435.06 435.00	434.94	434.87 435.66	
Parziali		0.34 2.50	2.50	0.39	
Progressiva		-2.84 -2.50	0.00	2.50 2.89	
Dislivelli		0.00 0.30	-0.41	-0.74 0.00	

Sezione: 11
 Progressiva: 61.452
 Q. Progetto: 435.286

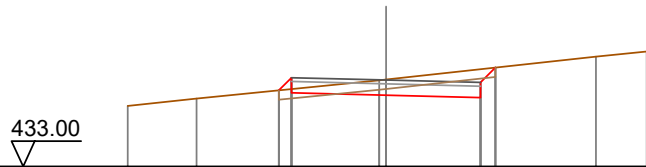

Quote Terreno	434.60	434.80		435.28	435.30		435.91	436.04
Quote Progetto			435.02	434.95	434.89	435.30	434.82	435.62
Parziali			0.33	2.50	2.50		0.39	
Progressiva			-2.83	-2.50	0.00		2.50	2.89
Dislivelli			0.00	0.30	-0.41		-0.75	0.00

Sezione: 12
 Progressiva: 70.000
 Q. Progetto: 435.053

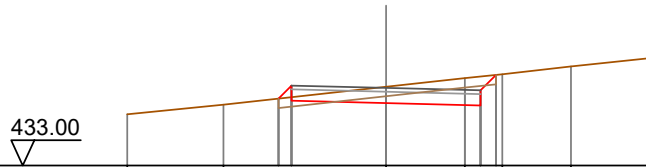

Quote Terreno	434.36	434.61		435.08	435.31		435.62	435.83
Quote Progetto			434.77	434.72	434.65	435.08	434.59	435.40
Parziali			0.34	2.50	2.50		0.41	
Progressiva			-2.84	-2.50	0.00		2.50	2.91
Dislivelli			0.00	0.31	-0.43		-0.77	0.00

Sezione: 13
 Progressiva: 74.338
 Q. Progetto: 434.942

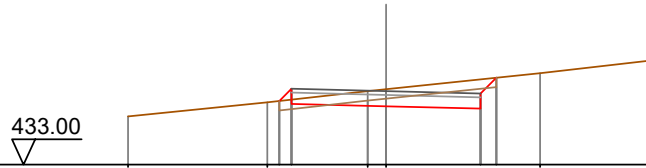

Quote Terreno	434.27	434.65		434.94	434.99		435.42	435.74
Quote Progetto			434.68	434.60	434.54	434.99	434.48	435.30
Parziali			0.32	2.50	2.50		0.42	
Progressiva			-2.82	-2.50	0.00		2.50	2.92
Dislivelli			-0.00	0.29	-0.45		-0.77	0.00

Sezione: 14
 Progressiva: 80.000
 Q. Progetto: 434.797

433.00

Quote Terreno	434.18	434.42	434.65	434.87	435.02	435.42	435.62
Quote Progetto			434.58 434.33	434.40		434.33 435.18	
Parziali			2.50	2.50		0.45	
Progressiva			-2.65 -2.50	0.00		2.50 2.95	
Dislivelli			0.00 0.14	-0.47		-0.80 0.00	

Sezione: 15
 Progressiva: 100.000
 Q. Progetto: 434.064

432.00

Quote Terreno	433.19	433.59	433.62	433.68	434.14	434.78	434.82
Quote Progetto			433.87 433.60	433.66		433.60 434.43	
Parziali			2.50	2.50		0.42	
Progressiva			-2.63 -2.50	0.00		2.50 2.92	
Dislivelli			0.00 0.11	-0.47		-0.78 -0.00	

Sezione: 16
 Progressiva: 106.687
 Q. Progetto: 433.712

432.00

Quote Terreno	433.10	433.37	433.47	433.75	433.96	434.29	434.43
Quote Progetto			433.47 433.37	433.31		433.25 434.04	
Parziali			0.31 2.50	2.50		0.39	
Progressiva			-2.81 -2.50	0.00		2.50 2.89	
Dislivelli			0.00 0.28	-0.44		-0.75 -0.00	

Sezione: 17
 Progressiva: 110.000
 Q. Progetto: 433.538

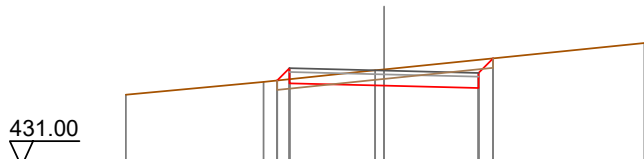

Quote Terreno	432.90	433.24	433.54	433.57	434.27
Quote Progetto		433.27	433.20	433.14	433.08
Parziali		0.33	2.50	2.50	0.39
Progressiva		-2.83	-2.50	0.00	2.50
Dislivelli		0.00	0.29	-0.43	-0.75

Sezione: 18
 Progressiva: 110.729
 Q. Progetto: 433.499

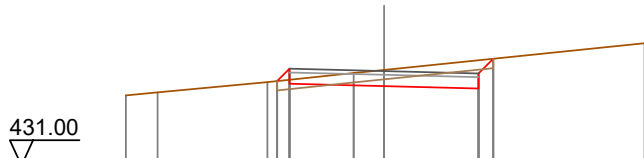

Quote Terreno	432.85	432.94	433.21	433.45	433.63	434.23
Quote Progetto			433.24	433.16	433.10	433.04
Parziali			0.33	2.50	2.50	0.39
Progressiva			-2.83	-2.50	0.00	2.50
Dislivelli			-0.00	0.29	-0.43	-0.75

Sezione: 19
 Progressiva: 114.771
 Q. Progetto: 433.287

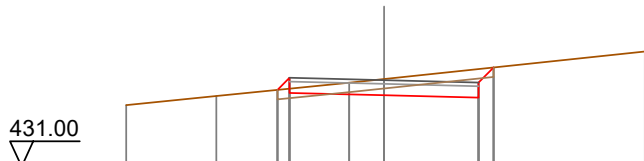

Quote Terreno	432.63	432.87	433.22	433.31	434.04
Quote Progetto			433.03	432.89	432.82
Parziali			0.32	2.50	2.50
Progressiva			-2.82	-2.50	0.00
Dislivelli			0.00	0.29	-0.43

Sezione: 20
 Progressiva: 120.000
 Q. Progetto: 433.011

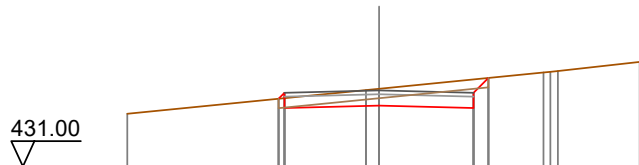

Quote Terreno		432.39		433.02	433.06		433.49	433.53	433.77
Quote Progetto			432.79	432.55	432.61	432.55	433.34		
Parziali			2.50	2.50	0.39				
Progressiva			-2.66	-2.50	0.00	2.50	2.89		
Dislivelli			-0.00	0.14	-0.44	-0.75	0.00		

Sezione: 21
 Progressiva: 124.349
 Q. Progetto: 432.782

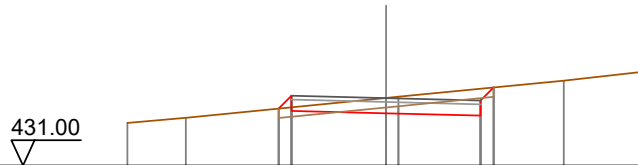

Quote Terreno		432.13	432.26		432.79	432.82		433.25	433.49
Quote Progetto				432.51	432.38	432.32	433.06		
Parziali				0.34	2.50	2.50	0.34		
Progressiva				-2.84	-2.50	0.00	2.50	2.84	
Dislivelli				-0.00	0.30	-0.40	-0.71	0.00	

Sezione: 22
 Progressiva: 130.000
 Q. Progetto: 432.491

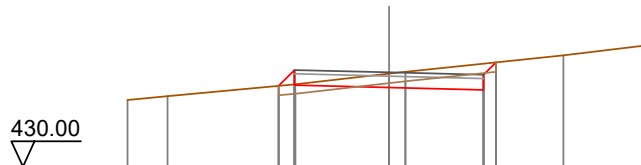

Quote Terreno		431.76	431.86		432.46	432.51		432.94	433.21
Quote Progetto				432.14	432.09	432.03	432.76		
Parziali				0.42	2.50	2.50	0.33		
Progressiva				-2.92	-2.50	0.00	2.50	2.83	
Dislivelli				0.00	0.38	-0.37	-0.69	0.00	

Sezione: 23
 Progressiva: 136.632
 Q. Progetto: 432.155

430.00

Quote Terreno	431.34	431.36	431.69	431.75	432.11	432.31	432.54	432.73	432.95
Quote Progetto			431.75	431.82	431.75	432.11	431.69	432.44	
Parziali			0.46	2.50	2.50	0.35			
Progressiva			-2.96	-2.50	0.00	2.50	2.85		
Dislivelli			-0.00	0.41	-0.36	-0.71	-0.00		

Sezione: 24
 Progressiva: 140.000
 Q. Progetto: 431.984

430.00

Quote Terreno	431.16	431.37	431.47	431.60	431.94	432.28	432.82
Quote Progetto			431.60	431.65	431.58	431.52	432.26
Parziali			0.44	2.50	2.50	0.34	
Progressiva			-2.94	-2.50	0.00	2.50	2.84
Dislivelli			0.00	0.39	-0.35	-0.70	0.00

Sezione: 25
 Progressiva: 148.916
 Q. Progetto: 431.555

429.00

Quote Terreno	430.57	431.14	431.51	431.57	431.57	431.57	432.56
Quote Progetto		431.14	431.22	431.16	431.16	431.09	432.00
Parziali		0.48	2.50	2.50	0.50		
Progressiva		-2.98	-2.50	0.00	2.50	3.00	
Dislivelli		0.00	0.41	-0.41	-0.83	0.00	

Sezione: 26
 Progressiva: 160.000
 Q. Progetto: 431.178

429.00

Quote Terreno	-430.04		-430.85	-431.16	-431.51	-431.75	-432.22	-432.33
Quote Progetto			430.67 430.72	430.78	430.72	431.67		
Parziali			0.44 2.50	2.50	0.56			
Progressiva			-2.94 -2.50	0.00	2.50	3.06		
Dislivelli			0.00 0.37	-0.38	-0.86	0.00		

Sezione: 27
 Progressiva: 171.324
 Q. Progetto: 430.834

428.00

Quote Terreno	-429.88	-430.19	-430.28	-430.82	-431.61	-432.07
Quote Progetto			430.28 430.51	430.43	430.36 431.36	
Parziali			0.63 2.50	2.50	0.61	
Progressiva			-3.13 -2.50	0.00	2.50 3.11	
Dislivelli			0.00 0.52	-0.39	-0.90 0.00	

Sezione: 28
 Progressiva: 179.605
 Q. Progetto: 430.714

428.00

Quote Terreno	-429.81		-430.42	-430.53	-430.66	-430.70	-431.44	-431.98
Quote Progetto			430.30 430.39	430.31	430.24	431.26		
Parziali			0.49 2.50	2.50	0.62			
Progressiva			-2.99 -2.50	0.00	2.50 3.12			
Dislivelli			-0.00 0.43	-0.38	-0.91 0.00			

Sezione: 29
 Progressiva: 180.000
 Q. Progetto: 430.711

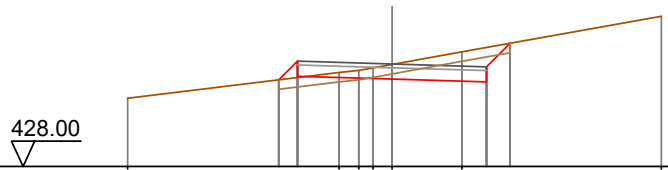

Quote Terreno	-429.80		430.49	430.54	430.61	430.70	431.03	431.97
Quote Progetto		430.29	430.39		430.31		430.24	431.26
Parziali		0.49	2.50		2.50		0.62	
Progressiva		-2.99	-2.50		0.00		2.50	3.12
Dislivelli		0.00	0.43		-0.39		-0.91	-0.00

Sezione: 30
 Progressiva: 187.885
 Q. Progetto: 430.715

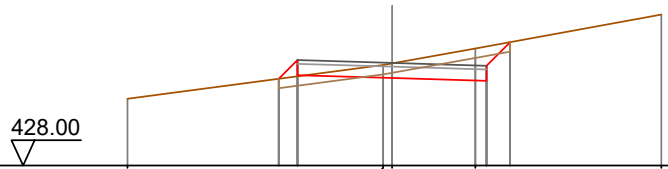

Quote Terreno	-429.77		430.66	430.70		431.09		431.99
Quote Progetto		430.30	430.39	430.31		430.24	431.26	
Parziali		0.49	2.50	2.50		0.62		
Progressiva		-2.99	-2.50	0.00		2.50	3.12	
Dislivelli		0.00	0.43	-0.39		-0.91	-0.00	

Sezione: 31
 Progressiva: 200.000
 Q. Progetto: 430.605

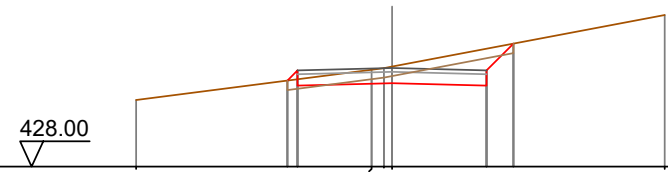

Quote Terreno	-429.76		430.56	430.65				432.01
Quote Progetto		430.27	430.14	430.21		430.14	431.25	
Parziali		0.27	2.50	2.50		0.71		
Progressiva		-2.77	-2.50	0.00		2.50	3.21	
Dislivelli		-0.00	0.23	-0.44		-0.98	0.00	

Sezione: 32
 Progressiva: 220.000
 Q. Progetto: 430.060

428.00

Quote Terreno	429.42		429.98	430.02	431.38	
Quote Progetto		429.77	429.60	429.66	429.60	430.61
Parziali			2.50	2.50	0.62	
Progressiva		-2.73	-2.50	0.00	2.50	3.12
Dislivelli		0.00	0.21	-0.36	-0.90	-0.00

Sezione: 33
 Progressiva: 240.000
 Q. Progetto: 430.148

428.00

Quote Terreno	429.45		430.06	430.15	431.33	
Quote Progetto		429.84	429.69	429.75	429.69	430.64
Parziali			2.50	2.50	0.56	
Progressiva		-2.74	-2.50	0.00	2.50	3.06
Dislivelli		-0.00	0.22	-0.37	-0.86	-0.00

Sezione: 34
 Progressiva: 249.732
 Q. Progetto: 430.311

428.00

Quote Terreno	429.59		430.29	430.32	430.40	431.47
Quote Progetto		430.02	429.84	429.91	429.99	430.81
Parziali			2.50	2.50	0.42	
Progressiva		-2.72	-2.50	0.00	2.50	2.92
Dislivelli		0.00	0.20	-0.41	-0.75	0.00

Sezione: 35
 Progressiva: 250.000
 Q. Progetto: 430.317

428.00

Quote Terreno	429.59		430.30	430.36		431.48
Quote Progetto		430.02	429.84	429.92	429.99	430.81
Parziali			2.50	2.50	0.42	
Progressiva		-2.72	-2.50	0.00	2.50	2.92
Dislivelli		0.00	0.20	-0.41	-0.75	-0.00

Sezione: 36
 Progressiva: 253.229
 Q. Progetto: 430.398

428.00

Quote Terreno	429.65		430.38			431.50
Quote Progetto		430.09	429.92	430.00	430.07	430.87
Parziali			2.50	2.50	0.40	
Progressiva		-2.74	-2.50	0.00	2.50	2.90
Dislivelli		-0.00	0.21	-0.39	-0.73	0.00

Sezione: 37
 Progressiva: 256.727
 Q. Progetto: 430.510

428.00

Quote Terreno	429.67	430.01		430.44	430.48		431.01	431.56
Quote Progetto		430.13	430.03	430.11	430.18	430.89		
Parziali		0.31	2.50	2.50	0.30			
Progressiva		-2.81	-2.50	0.00	2.50	2.80		
Dislivelli		0.00	0.27	-0.33	-0.65	0.00		

Sezione: 38
 Progressiva: 260.000
 Q. Progetto: 430.637

428.00

Quote Terreno	-429.66				430.47	430.56	430.60	430.88	431.58
Quote Progetto			430.12	430.17	430.24			430.17	430.90
Parziali			0.45	2.50	2.50			0.33	
Progressiva			-2.95	-2.50	0.00			2.50	2.83
Dislivelli			0.00	0.40	-0.23			-0.67	0.00

Sezione: 39
 Progressiva: 280.000
 Q. Progetto: 431.879

428.00

Quote Terreno	-429.77	-429.91	-430.09			430.87		431.43	431.50	431.97
Quote Progetto			430.25	431.42		431.48		431.42	431.32	
Parziali				1.57	2.50	2.50		0.49		
Progressiva			-4.07	-2.50	0.00			2.50	2.99	
Dislivelli			0.00	1.33	0.61			0.17	0.00	

Sezione: 40
 Progressiva: 300.000
 Q. Progetto: 433.231

429.00

Quote Terreno	-430.66	-431.08	-431.22			431.71			432.48	432.59	432.61	432.75
Quote Progetto		431.13	432.77			432.83		432.77	432.19			
Parziali			2.04	2.50	2.50			0.98				
Progressiva		-4.54	-2.50	0.00				2.50	3.48			
Dislivelli		-0.00	1.80	1.12				0.71	0.00			

Sezione: 41
 Progressiva: 318.964
 Q. Progetto: 433.776

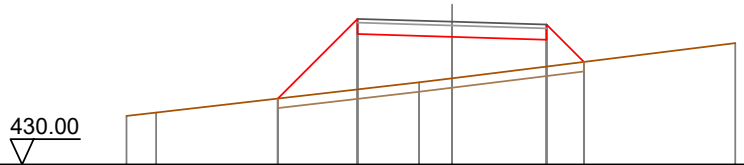

Quote Terreno	-431.28	-431.37			-432.17	-432.28			-433.21
Quote Progetto			431.74	433.45	433.38	433.30	432.71		
Parziali			2.11	2.50	2.50	0.99			
Progressiva			-4.61	-2.50	0.00	2.50	3.49		
Dislivelli			0.00	1.87	1.10	0.71	-0.00		

Sezione: 42
 Progressiva: 320.000
 Q. Progetto: 433.785

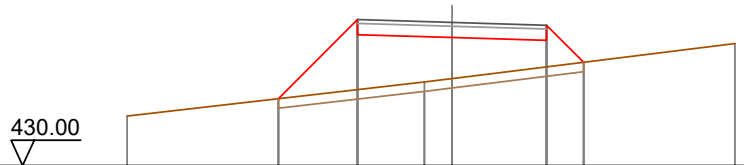

Quote Terreno	-431.31				-432.21	-432.30			-433.23
Quote Progetto			431.77	433.46	433.39	433.31	432.73		
Parziali			2.09	2.50	2.50	0.98			
Progressiva			-4.59	-2.50	0.00	2.50	3.48		
Dislivelli			-0.00	1.85	1.09	0.70	0.00		

Sezione: 43
 Progressiva: 322.893
 Q. Progetto: 433.799

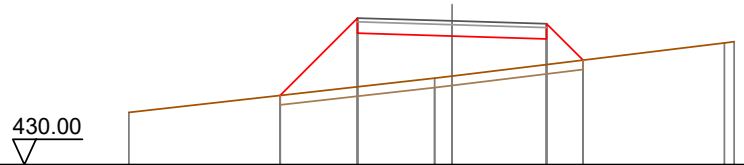

Quote Terreno	-431.38				-432.29	-432.34			-433.22	-433.25
Quote Progetto			431.83	433.47	433.40	433.32	432.76			
Parziali			2.05	2.50	2.50	0.96				
Progressiva			-4.55	-2.50	0.00	2.50	3.46			
Dislivelli			0.00	1.82	1.06	0.68	0.00			

Sezione: 44
 Progressiva: 324.500
 Q. Progetto: 433.800

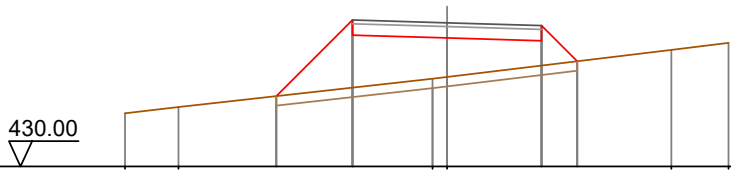

Quote Terreno	431.41	431.57			432.32	432.37		433.08	433.27
Quote Progetto			431.86	433.48	433.40	433.33	432.78		
Parziali			2.02	2.50	2.50	0.94			
Progressiva			-4.52	-2.50	0.00	2.50	3.44		
Dislivelli			-0.00	1.79	1.03	0.66	0.00		

SEZIONI TRASVERSALI

Profilo longitudinale tratto 3-4

Viabilità di impianto postazione aerogeneratore T02

Nota: Le canalette di deflusso delle acque meteoriche, non indicate nel presente elaborato, sono rappresentate graficamente nelle sezioni stradali tipo dell'elaborato "WIND002-TC13_Piazzole aerogeneratori e strade di servizio - Particolari costruttivi", individuate planimetricamente nell'elaborato "WIND002-TC14_Opere di regimazione acque superficiali - Planimetria generale" e quantificate nell'elaborato "WIND002-RC6_Computo Metrico Estimativo".

DISEGNI DI RIFERIMENTO

TAVOLA	DESCRIZIONE
WIND002-TC8	Piazzole e viabilità - Planimetria di progetto - Fase di cantiere
WIND002-TC11	Profili longitudinali viabilità di impianto
WIND002-TC13	Piazzole aerogeneratori e strade di servizio - Particolari costruttivi
WIND002-TC14	Opere di regimazione acque superficiali - Planimetria generale

Sezione: 3
 Progressiva: 8.950
 Q. Progetto: 477.446

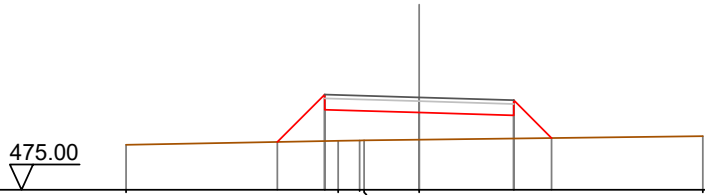

Quote Terreno	476.19		476.27	477.12	476.30	476.31	477.05	476.33		476.42
Quote Progetto			476.27	477.12			477.05	476.97	476.37	
Parziali			1.25	2.50			2.50	1.00		
Progressiva			-3.75	-2.50			0.00	2.50	3.50	
Dislivelli			0.00	1.23			0.72	0.61	-0.00	

Sezione: 4
 Progressiva: 10.000
 Q. Progetto: 477.369

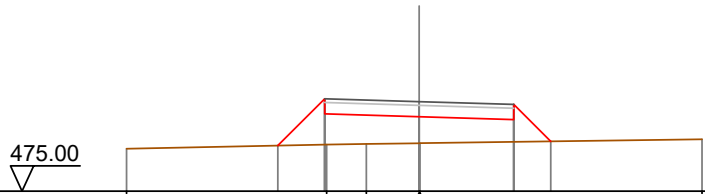

Quote Terreno	476.12		476.20	477.04	476.23	476.25	476.27	476.27	476.89	476.37
Quote Progetto			476.20	477.04			476.97	476.89	476.32	
Parziali			1.24	2.50			2.50	0.98		
Progressiva			-3.74	-2.50			0.00	2.50	3.48	
Dislivelli			0.00	1.21			0.70	0.59	-0.00	

Sezione: 5
 Progressiva: 14.961
 Q. Progetto: 477.006

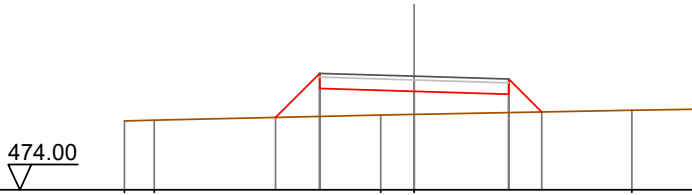

Quote Terreno		475.82	475.84			475.98	476.00			476.10	476.13
Quote Progetto				475.92	476.68		476.61		476.53	476.06	
Parziali				1.17	2.50		2.50		0.87		
Progressiva				-3.67	-2.50		0.00		2.50	3.37	
Dislivelli				0.00	1.14		0.61		0.49	0.00	

Sezione: 6
 Progressiva: 18.309
 Q. Progetto: 476.765

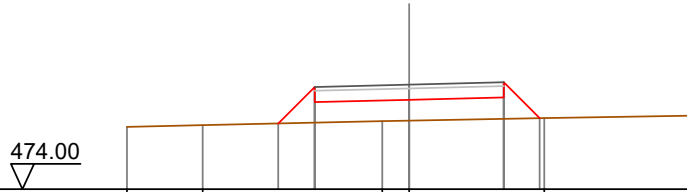

Quote Terreno		475.65	475.69			475.80	475.81			475.88	475.94
Quote Progetto				475.74	476.30		476.36		476.43	475.88	
Parziali				0.96	2.50		2.50		0.95		
Progressiva				-3.46	-2.50		0.00		2.50	3.45	
Dislivelli				0.00	0.94		0.55		0.57	-0.00	

Sezione: 7
 Progressiva: 20.000
 Q. Progetto: 476.650

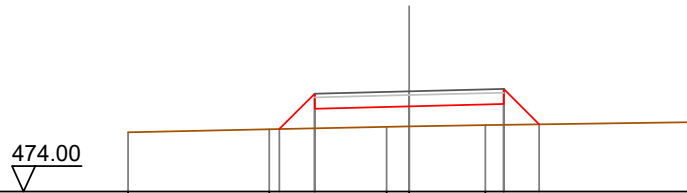

Quote Terreno		475.57		475.65		475.71	475.72		475.76		475.83
Quote Progetto				475.65	476.19		476.25		476.31	475.78	
Parziali				0.93	2.50		2.50		0.94		
Progressiva				-3.43	-2.50		0.00		2.50	3.44	
Dislivelli				0.00	0.92		0.53		0.55	-0.00	

Sezione: 8
 Progressiva: 30.000
 Q. Progetto: 476.077

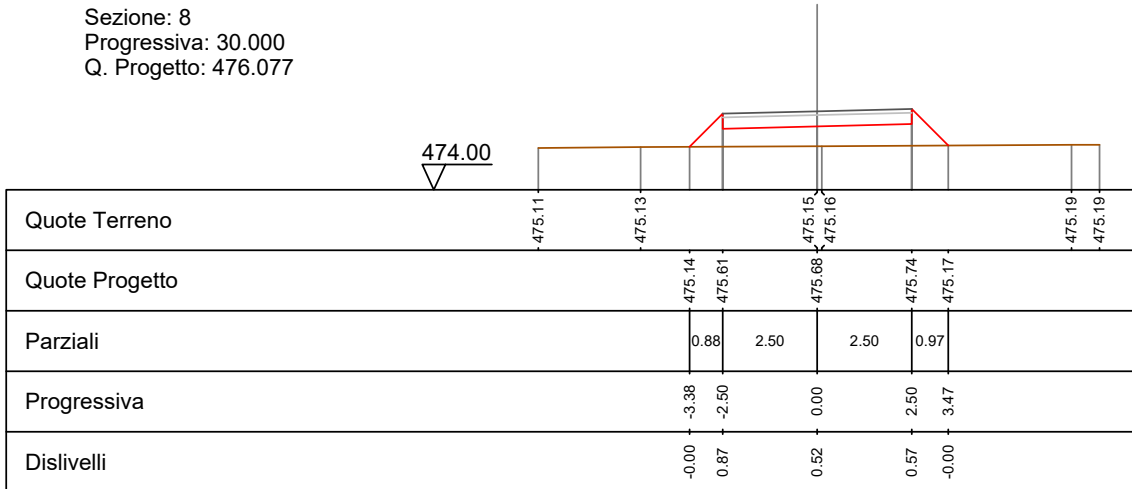

Sezione: 9
 Progressiva: 40.000
 Q. Progetto: 475.545

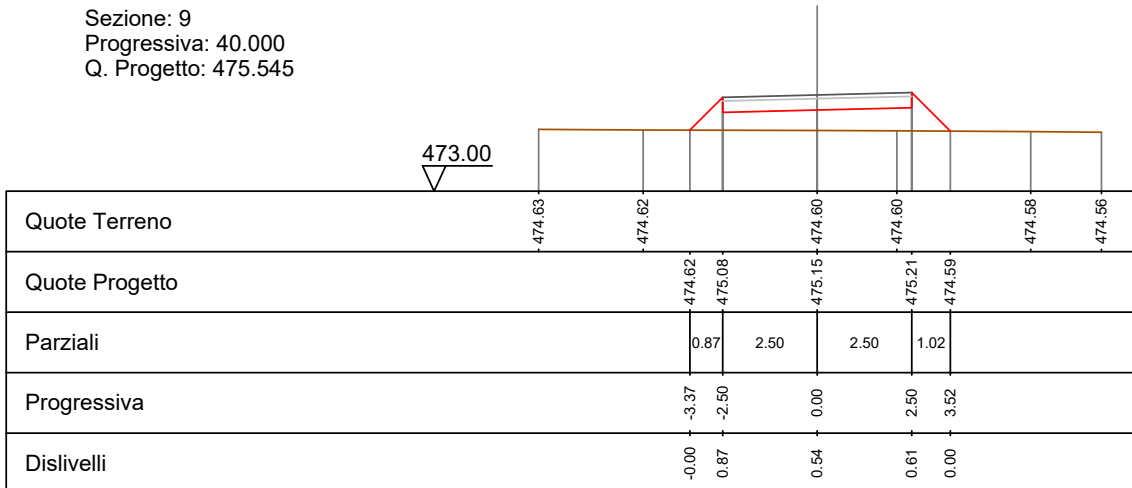

Sezione: 10
 Progressiva: 44.736
 Q. Progetto: 475.293

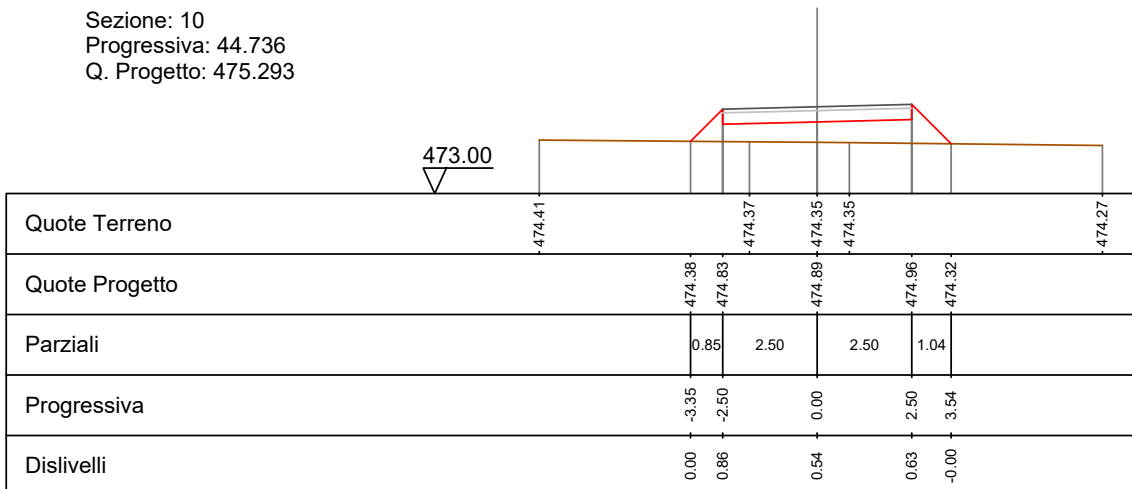

Sezione: 11
 Progressiva: 50.000
 Q. Progetto: 475.013

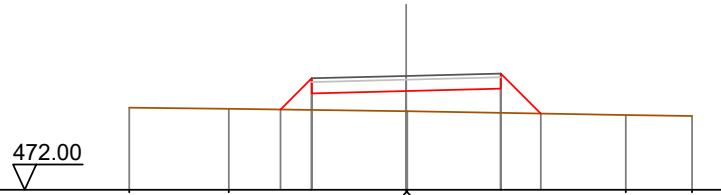

Quote Terreno	-474.17	-474.14	-474.12	-474.55	-474.08	-474.08	-473.98	-473.95
Quote Progetto			474.12	474.55	474.61	474.68	474.02	
Parziali			0.83	2.50	2.50	1.06		
Progressiva			-3.33	-2.50	0.00	2.50	3.56	
Dislivelli			0.00	0.84	0.53	0.64	0.00	

Sezione: 12
 Progressiva: 60.000
 Q. Progetto: 474.482

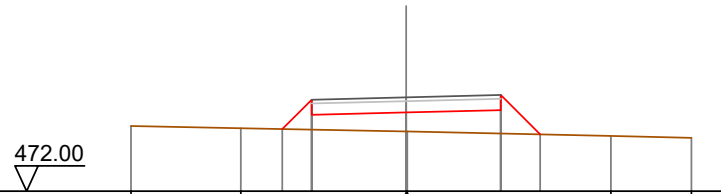

Quote Terreno	-473.72	-473.66	-473.64	-474.02	-473.58	-473.58	-473.46	-473.41
Quote Progetto			473.64	474.02	474.08	474.14	473.50	
Parziali			0.78	2.50	2.50	1.04		
Progressiva			-3.28	-2.50	0.00	2.50	3.54	
Dislivelli			0.00	0.79	0.50	0.62	0.00	

Sezione: 13
 Progressiva: 70.000
 Q. Progetto: 473.950

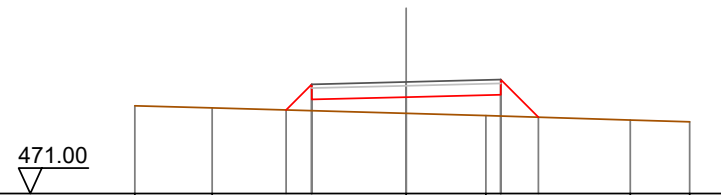

Quote Terreno	-473.32	-473.26	-473.21	-473.49	-473.12	-473.06	-472.94	-472.90
Quote Progetto			473.21	473.49	473.55	473.61	473.02	
Parziali			0.88	2.50	2.50	0.99		
Progressiva			-3.18	-2.50	0.00	2.50	3.49	
Dislivelli			-0.00	0.70	0.43	0.56	0.00	

Sezione: 14
 Progressiva: 71.164
 Q. Progetto: 473.888

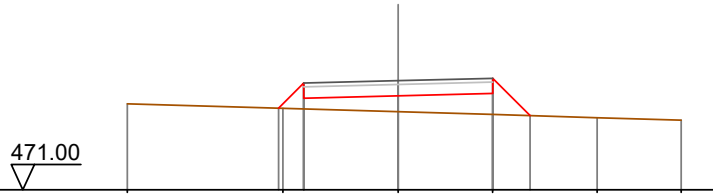

Quote Terreno		473.27		473.16	473.16	473.07		473.00		472.91	472.84
Quote Progetto				473.16	473.43	473.49		473.55	473.00		
Parziali				0.66	2.50	2.50		0.99			
Progressiva				-3.16	-2.50	0.00		2.50	3.49		
Dislivelli				0.00	0.68	0.42		0.55	-0.00		

Sezione: 15
 Progressiva: 80.000
 Q. Progetto: 473.419

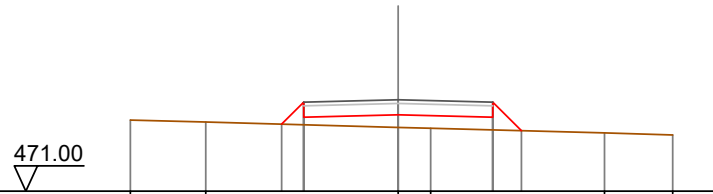

Quote Terreno		472.88	472.83			472.69	472.66			472.54	472.49
Quote Progetto				472.77	472.96	473.02	472.96	472.60			
Parziali				0.58	2.50	2.50	0.76				
Progressiva				-3.08	-2.50	0.00	2.50	3.26			
Dislivelli				0.00	0.60	0.33	0.34	-0.00			

Sezione: 16
 Progressiva: 100.000
 Q. Progetto: 472.417

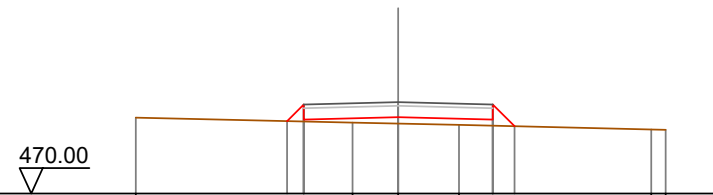

Quote Terreno		472.00			471.87	471.85	471.82			471.69	471.68
Quote Progetto				471.91	471.95	472.02	471.95	471.78			
Parziali				0.44	2.50	2.50	0.57				
Progressiva				-2.94	-2.50	0.00	2.50	3.07			
Dislivelli				-0.00	0.45	0.17	0.16	-0.00			

Sezione: 17
 Progressiva: 120.000
 Q. Progetto: 471.513

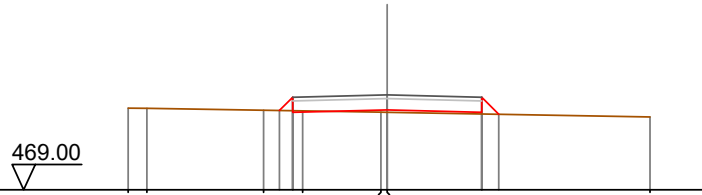

Quote Terreno	-471.16	-471.15	-471.11	-471.09	-471.06	-471.05	-470.93
Quote Progetto			-471.10	-471.05	-471.11	-471.05	-471.00
Parziali			0.35	2.50	2.50	0.45	
Progressiva			-2.85	-2.50	0.00	2.50	2.95
Dislivelli			0.00	0.36	0.06	0.04	-0.00

Sezione: 18
 Progressiva: 122.216
 Q. Progetto: 471.419

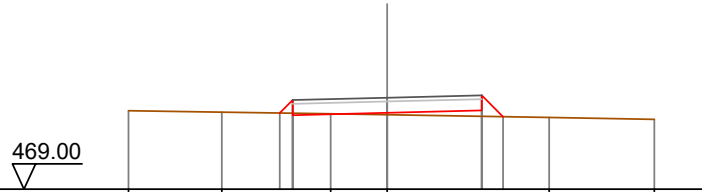

Quote Terreno	-471.07	-471.04	-470.99	-470.97	-470.90	-470.85	
Quote Progetto			-471.01	-470.96	-471.02	-471.08	
Parziali			0.34	2.50	2.50	0.57	
Progressiva			-2.84	-2.50	0.00	2.50	3.07
Dislivelli			0.00	0.35	0.05	0.16	0.00

Sezione: 19
 Progressiva: 125.814
 Q. Progetto: 471.269

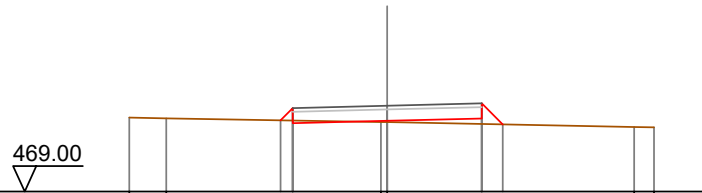

Quote Terreno	-470.95	-470.94	-470.84	-470.83	-470.71	-470.70	
Quote Progetto			-470.88	-470.87	-470.93	-470.77	
Parziali			0.32	2.50	2.50	0.56	
Progressiva			-2.82	-2.50	0.00	2.50	3.06
Dislivelli			0.00	0.33	0.03	0.15	0.00

Sezione: 20
 Progressiva: 129.412
 Q. Progetto: 471.122

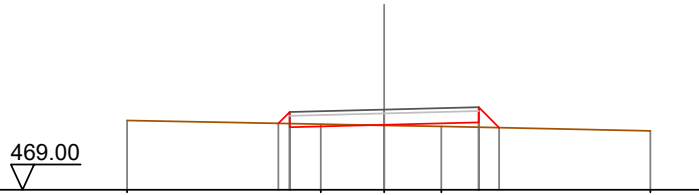

Quote Terreno		470.84		470.74	470.70	470.68		470.56
Quote Progetto			470.76	470.66	470.72	470.78	470.64	
Parziali			0.30	2.50	2.50	0.54		
Progressiva			-2.80	-2.50	0.00	2.50	3.04	
Dislivelli			0.00	0.31	0.02	0.13	-0.00	

Sezione: 21
 Progressiva: 140.000
 Q. Progetto: 470.507

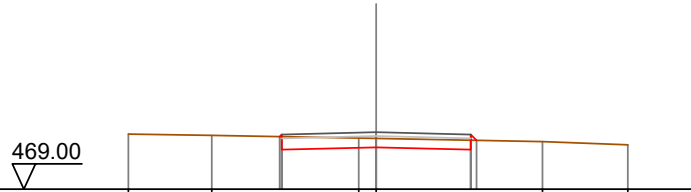

Quote Terreno		470.46	470.42		470.35	470.34		470.26	470.17
Quote Progetto				470.39	470.04	470.11	470.34	470.04	470.29
Parziali				2.50	2.50				
Progressiva				-2.55	-2.50	0.00	2.50	2.65	
Dislivelli				0.00	0.06	-0.24	-0.25	0.00	

Sezione: 22
 Progressiva: 152.806
 Q. Progetto: 469.481

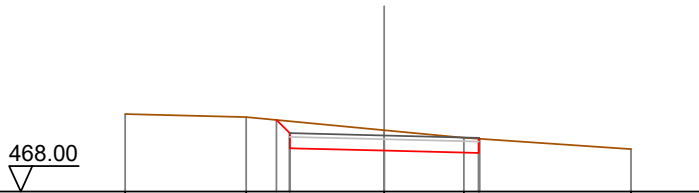

Quote Terreno		470.05	469.97		469.62	469.42		469.12
Quote Progetto			469.89	469.14	469.08	469.02	469.39	
Parziali			0.35	2.50	2.50			
Progressiva			-2.85	-2.50	0.00	2.50	2.55	
Dislivelli			0.00	-0.32	-0.54	-0.38	0.00	

Sezione: 23
 Progressiva: 160.000
 Q. Progetto: 468.760

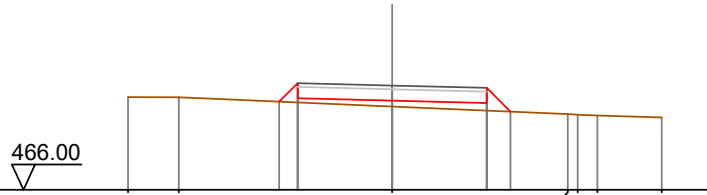

Quote Terreno	468.45	468.45			468.20			468.00	467.99	467.96	467.92
Quote Progetto				468.33	468.42	468.36	468.20	468.30	468.07		
Parziali				0.49	2.50	2.50		0.63			
Progressiva				-2.99	-2.50	0.00		2.50	3.13		
Dislivelli				-0.00	0.51	0.15		0.20	0.00		

Sezione: 24
 Progressiva: 170.000
 Q. Progetto: 467.582

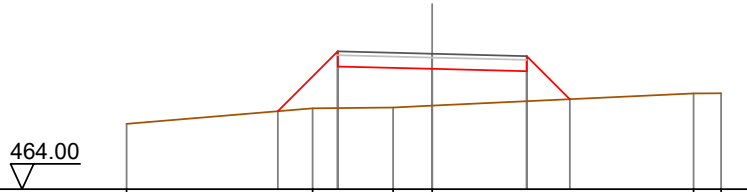

Quote Terreno	465.73			466.14		466.16	466.21			466.53	466.54
Quote Progetto			466.06	467.24		467.18	467.12	466.38			
Parziali				1.58	2.50	2.50	1.14				
Progressiva			-4.08	-2.50	0.00	2.50	3.64				
Dislivelli			0.00	1.50	0.97	0.79	-0.00				

Sezione: 25
 Progressiva: 178.473
 Q. Progetto: 466.509

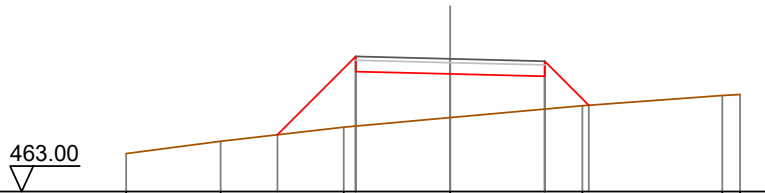

Quote Terreno	464.00	464.33		464.70		464.95		465.27		465.54	465.57
Quote Progetto			464.50	466.17		466.11	466.05	465.28			
Parziali				2.07	2.50	2.50	1.17				
Progressiva			-4.57	-2.50	0.00	2.50	3.67				
Dislivelli			0.00	1.84	1.15	0.87	0.00				

Sezione: 26
 Progressiva: 180.000
 Q. Progetto: 466.316

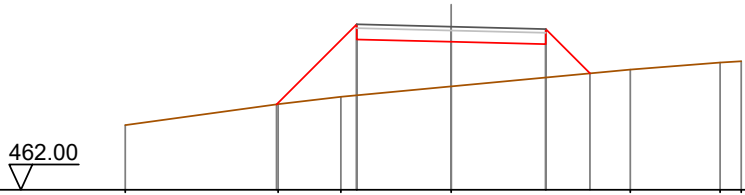

Quote Terreno	-463.71	-464.27	-464.46	-464.74	-465.18	-465.40
Quote Progetto		464.26	465.98	465.92	465.85	465.08
Parziali		2.12	2.50	2.50	1.17	
Progressiva		-4.62	-2.50	0.00	2.50	3.67
Dislivelli		-0.00	1.88	1.18	0.88	-0.00

Sezione: 27
 Progressiva: 190.000
 Q. Progetto: 465.080

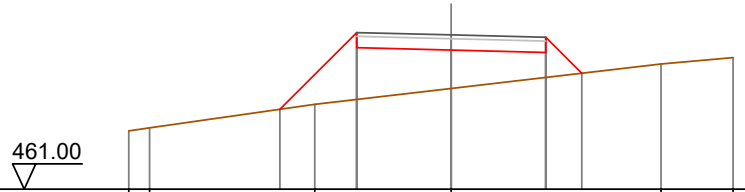

Quote Terreno	-462.54	-462.62	-463.24	-463.66	-464.31	-464.48
Quote Progetto			463.11	464.74	464.68	464.07
Parziali			2.03	2.50	2.50	0.95
Progressiva			-4.53	-2.50	0.00	2.50
Dislivelli			0.00	1.77	1.02	0.66

Sezione: 28
 Progressiva: 200.000
 Q. Progetto: 464.026

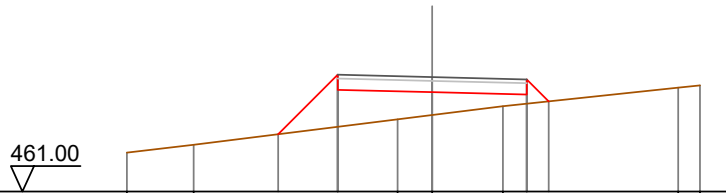

Quote Terreno	-462.03	-462.24	-462.91	-463.02	-463.26	-463.75	-463.81
Quote Progetto			462.51	463.69	463.63	463.56	463.38
Parziali			1.57	2.50	2.50	0.56	
Progressiva			-4.07	-2.50	0.00	2.50	3.08
Dislivelli			0.00	1.38	0.60	0.24	0.00

Sezione: 29
 Progressiva: 204.140
 Q. Progetto: 463.650

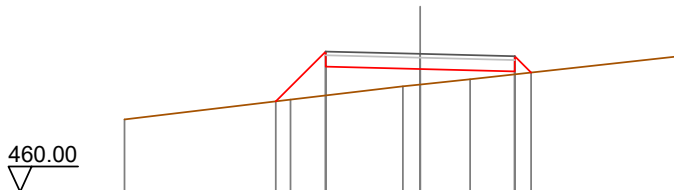

Quote Terreno	461.91	462.44	462.79	462.84	462.98	463.60
Quote Progetto		462.39	463.31	463.25	463.19	463.16
Parziali		1.32	2.50	2.50	0.43	
Progressiva		-3.82	-2.50	0.00	2.50	2.93
Dislivelli		-0.00	1.16	0.41	0.08	0.00

Sezione: 30
 Progressiva: 220.000
 Q. Progetto: 462.527

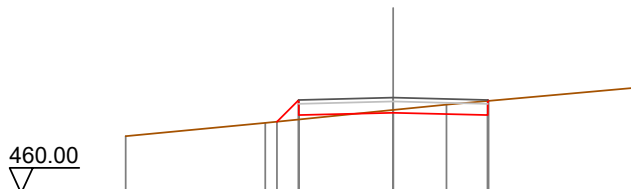

Quote Terreno	461.51	461.86	462.20	462.34	462.80	
Quote Progetto		461.89	462.13	462.06	462.44	
Parziali		0.57	2.50	2.50		
Progressiva		-3.07	-2.50	0.00	2.50	
Dislivelli		-0.00	0.52	-0.07	-0.37	0.00

Sezione: 31
 Progressiva: 240.000
 Q. Progetto: 461.670

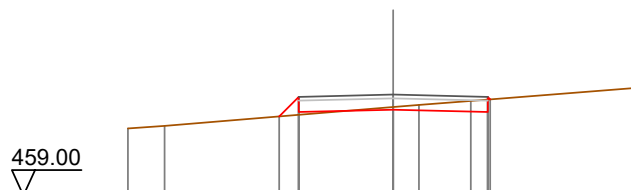

Quote Terreno	460.77	460.84	461.34	461.40	461.50	461.86
Quote Progetto		461.09	461.27	461.21	461.54	
Parziali		0.52	2.50	2.50		
Progressiva		-3.02	-2.50	0.00	2.50	2.57
Dislivelli		-0.00	0.47	-0.07	-0.33	0.00

Sezione: 32
 Progressiva: 249.639
 Q. Progetto: 461.283

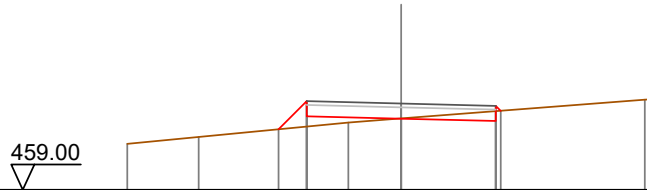

Quote Terreno	460.21	460.40	460.60	460.78	460.88	460.82	461.09	461.38	461.40
Quote Progetto			460.60	460.95	460.88	460.82	461.09		
Parziali			0.74	2.50	2.50				
Progressiva			-3.24	-2.50	0.00	2.50	2.63		
Dislivelli			-0.00	0.67	-0.00	-0.26	0.00		

Sezione: 33
 Progressiva: 249.926
 Q. Progetto: 461.272

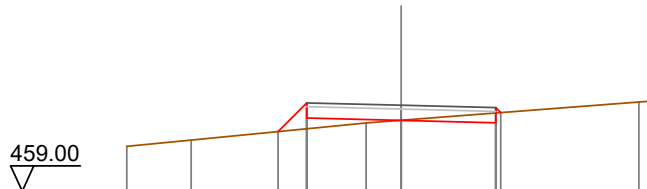

Quote Terreno	460.19	460.35	460.58	460.80	460.87	460.81	461.08	461.36	461.38
Quote Progetto			460.58	460.93	460.87	460.81	461.08		
Parziali			0.76	2.50	2.50				
Progressiva			-3.26	-2.50	0.00	2.50	2.63		
Dislivelli			-0.00	0.68	-0.00	-0.26	0.00		

Sezione: 34
 Progressiva: 250.213
 Q. Progetto: 461.260

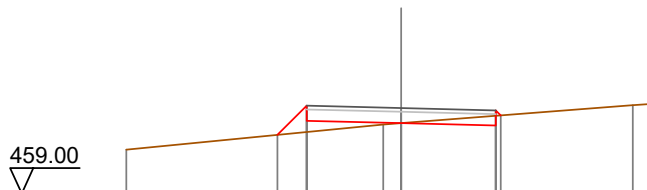

Quote Terreno	460.16		460.55		460.82	460.86	460.80	461.34	461.37
Quote Progetto			460.55	460.92	460.86	460.86	461.06		
Parziali			0.77	2.50	2.50				
Progressiva			-3.27	-2.50	0.00	2.50	2.63		
Dislivelli			-0.00	0.70	-0.00	-0.26	0.00		

Sezione: 38
 Progressiva: 302.298
 Q. Progetto: 457.426

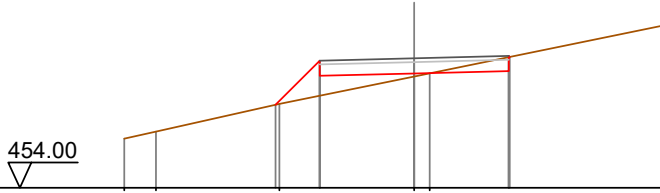

Quote Terreno	455.30	455.49	456.22	456.95	457.03	458.28
Quote Progetto			456.20	456.96	457.03	457.46
Parziali			1.17	2.50	2.50	
Progressiva			-3.67	-2.50	0.00	2.50
Dislivelli			0.00	0.93	0.08	-0.37

Sezione: 39
 Progressiva: 307.407
 Q. Progetto: 457.003

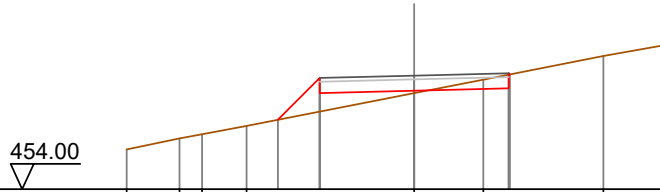

Quote Terreno	455.05	455.34	455.45	455.67	456.54	456.90	457.52	457.79
Quote Progetto				455.84	456.54	456.60	456.67	457.04
Parziali				1.10	2.50	2.50		
Progressiva				-3.60	-2.50	0.00	2.50	2.53
Dislivelli				0.00	0.89	0.06	-0.36	0.00

Sezione: 40
 Progressiva: 310.000
 Q. Progetto: 456.789

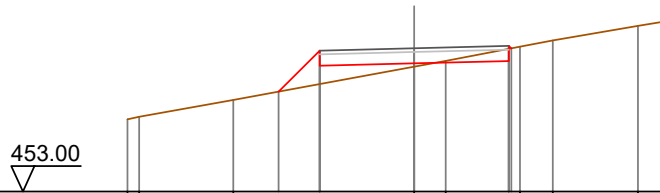

Quote Terreno	454.91	454.97	455.42	456.30	456.46	456.83	457.00	457.38	457.49
Quote Progetto				456.64	456.33	456.39	456.45	456.78	
Parziali				1.09	2.50	2.50			
Progressiva				-3.59	-2.50	0.00	2.50	2.57	
Dislivelli				0.00	0.89	0.09	-0.32	0.00	

Sezione: 41
 Progressiva: 312.516
 Q. Progetto: 456.581

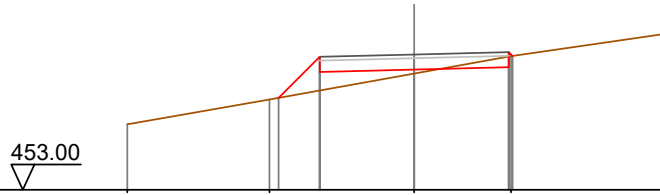

Quote Terreno		454.73		455.39		456.08		456.54		457.12
Quote Progetto			455.43	456.12		456.18		456.54		
Parziali			1.09	2.50		2.50				
Progressiva			-3.59	-2.50		0.00		2.50	2.60	
Dislivelli			-0.00	0.89		0.10		-0.28	0.00	

Sezione: 42
 Progressiva: 320.000
 Q. Progetto: 455.961

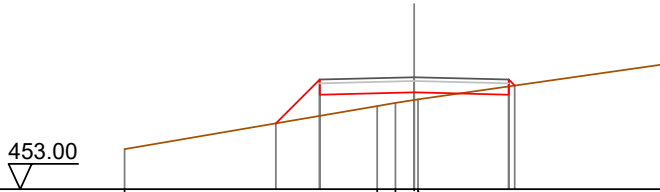

Quote Terreno		454.06				455.20		455.28		455.37		456.31
Quote Progetto			454.74	455.50		455.56		455.50		455.74		
Parziali			1.16	2.50		2.50						
Progressiva			-3.66	-2.50		0.00		2.50	2.66			
Dislivelli			0.00	0.96		0.20		-0.22	-0.00			

Sezione: 43
 Progressiva: 340.000
 Q. Progetto: 454.306

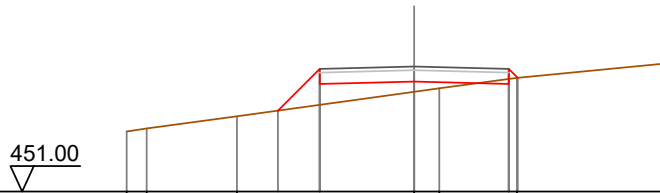

Quote Terreno		452.59		452.67		452.99				453.64		453.73		454.01		454.39
Quote Progetto						453.14		453.84		453.91		453.84		454.01		
Parziali						1.11		2.50		2.50						
Progressiva						-3.61		-2.50		0.00		2.50	2.74			
Dislivelli						0.00		0.95		0.27		-0.13	0.00			

Sezione: 47
 Progressiva: 376.564
 Q. Progetto: 451.570

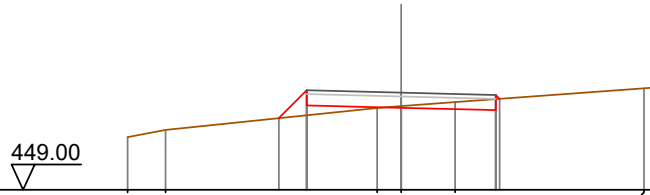

Quote Terreno	450.40	450.59		450.90	451.17	451.21	451.32	451.68	451.70
Quote Progetto				450.90	451.23	451.17	451.11	451.41	
Parziali				0.74	2.50		2.50		
Progressiva				-3.24	-2.50	0.00	2.50	2.60	
Dislivelli				0.00	0.66	-0.04	-0.29	0.00	

Sezione: 48
 Progressiva: 380.000
 Q. Progetto: 451.415

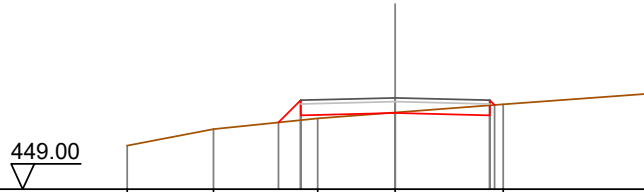

Quote Terreno	450.15	450.59		450.77	450.87	451.03	451.24	451.52
Quote Progetto				450.77	450.95	451.02	450.95	451.23
Parziali				0.59	2.50		2.50	
Progressiva				-3.09	-2.50	0.00	2.50	2.63
Dislivelli				-0.00	0.53	-0.01	-0.26	-0.00

Sezione: 49
 Progressiva: 400.000
 Q. Progetto: 450.626

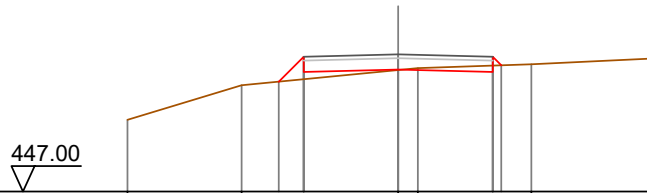

Quote Terreno	448.89	449.81		449.90	450.16	450.21	450.26	450.37	450.52
Quote Progetto				449.90	450.16	450.23	450.16	450.34	
Parziali				0.66	2.50		2.50		
Progressiva				-3.16	-2.50	0.00	2.50	2.72	
Dislivelli				0.00	0.59	0.01	-0.17	-0.00	

Sezione: 50
 Progressiva: 413.168
 Q. Progetto: 450.107

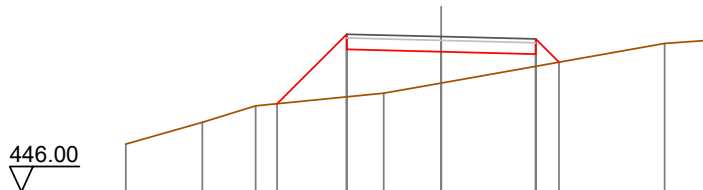

Quote Terreno	447.26	447.84	448.27	448.61	448.88	449.93	450.01
Quote Progetto			448.33	449.77	449.71	449.64	449.43
Parziali			1.84	2.50	2.50	0.61	
Progressiva			-4.34	-2.50	0.00	2.50	3.11
Dislivelli			0.00	1.66	0.83	0.32	-0.00

Sezione: 51
 Progressiva: 420.000
 Q. Progetto: 449.837

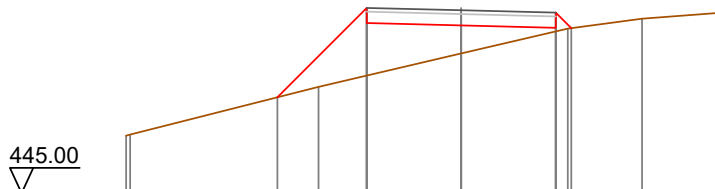

Quote Terreno	446.52	446.55	447.81	448.69	449.35	449.61	449.78
Quote Progetto			447.54	449.50	449.44	449.37	449.37
Parziali			2.36	2.50	2.50	0.41	
Progressiva			-4.86	-2.50	0.00	2.50	2.91
Dislivelli			0.00	1.79	0.74	0.10	0.00

Sezione: 52
 Progressiva: 430.000
 Q. Progetto: 449.488

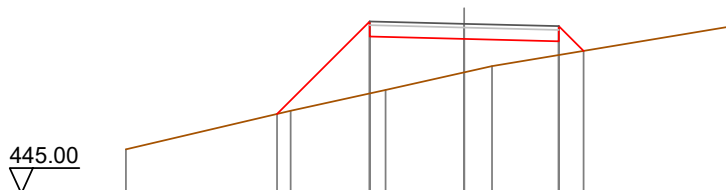

Quote Terreno	446.17	447.19	447.74	448.20	448.37	449.44
Quote Progetto		447.10	449.15	449.09	449.03	448.77
Parziali		2.45	2.50	2.50	0.65	
Progressiva		-4.95	-2.50	0.00	2.50	3.15
Dislivelli		-0.00	1.90	0.88	0.36	-0.00

Sezione: 53
 Progressiva: 430.226
 Q. Progetto: 449.482

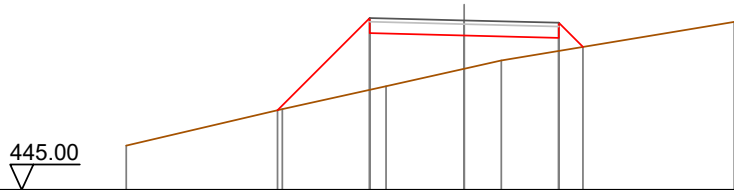

Quote Terreno	446.17	447.14	447.74	448.20	448.42	449.44
Quote Progetto		447.11	449.14	449.08	449.02	448.78
Parziali		2.44	2.50	2.50	0.64	
Progressiva		-4.94	-2.50	0.00	2.50	3.14
Dislivelli		0.00	1.90	0.88	0.35	0.00

Sezione: 54
 Progressiva: 440.000
 Q. Progetto: 449.302

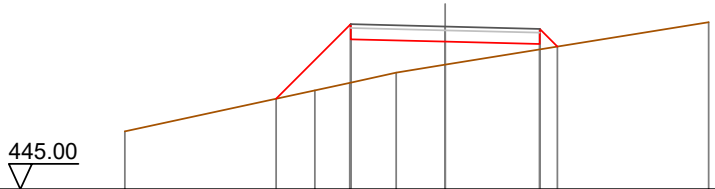

Quote Terreno	446.53	447.61	447.81	448.08	448.29	449.42
Quote Progetto		447.39	448.96	448.90	448.84	448.77
Parziali		1.97	2.50	2.50	0.47	
Progressiva		-4.47	-2.50	0.00	2.50	2.97
Dislivelli		0.00	1.55	0.61	0.14	-0.00

Sezione: 55
 Progressiva: 447.283
 Q. Progetto: 449.183

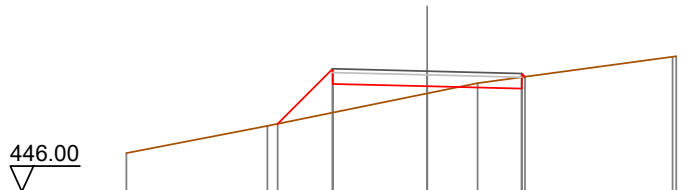

Quote Terreno	447.01	447.74	448.59	448.86	449.56	449.57
Quote Progetto		447.79	448.85	448.78	448.72	449.03
Parziali		1.46	2.50	2.50		
Progressiva		-3.96	-2.50	0.00	2.50	2.59
Dislivelli		0.00	1.16	0.19	-0.30	0.00

Sezione: 56
 Progressiva: 448.480
 Q. Progetto: 449.164

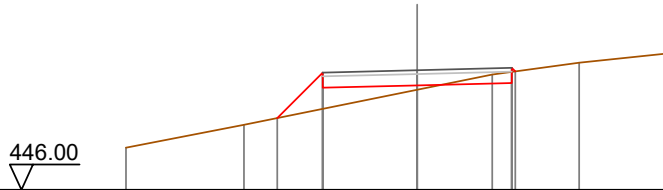

Quote Terreno	447.12	447.72	448.65	449.05	449.36	449.61
Quote Progetto		447.90	448.70	448.76	448.83	449.13
Parziali			1.20	2.50	2.50	
Progressiva		-3.70	-2.50	0.00	2.50	2.59
Dislivelli		0.00	0.96	0.11	-0.30	-0.00

Sezione: 57
 Progressiva: 450.000
 Q. Progetto: 449.139

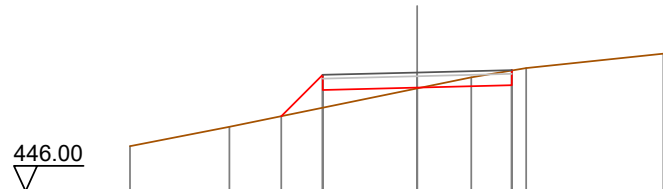

Quote Terreno	447.19	447.70	448.72	449.01	449.26	449.64
Quote Progetto		447.98	448.68	448.74	448.80	449.13
Parziali			1.09	2.50	2.50	
Progressiva		-3.59	-2.50	0.00	2.50	
Dislivelli		0.00	0.87	0.02	-0.39	

Sezione: 58
 Progressiva: 457.891
 Q. Progetto: 449.011

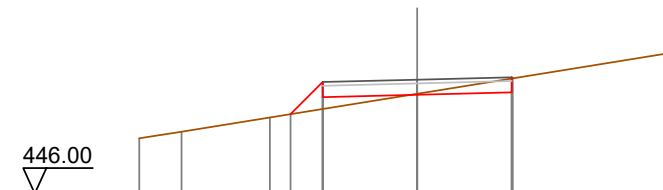

Quote Terreno	447.46	447.63	448.01	448.64	449.05	449.69
Quote Progetto		448.10	448.55	448.61	448.67	449.05
Parziali			0.85	2.50	2.50	
Progressiva		-3.35	-2.50	0.00	2.50	2.55
Dislivelli		-0.00	0.71	-0.03	-0.37	-0.00

Sezione: 59
 Progressiva: 460.000
 Q. Progetto: 448.976

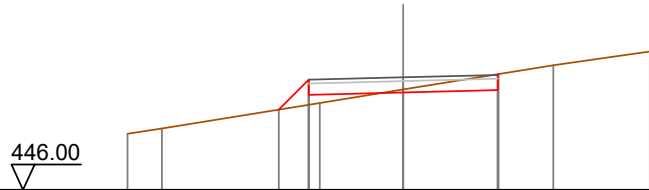

Quote Terreno	447.48	447.62	448.30	448.65	449.30	449.66
Quote Progetto			448.12	448.51	448.64	449.06
Parziali			0.79	2.50	2.50	
Progressiva			-3.29	-2.50	0.00	2.50
Dislivelli			0.00	0.66	-0.08	-0.42

Sezione: 60
 Progressiva: 467.303
 Q. Progetto: 448.810

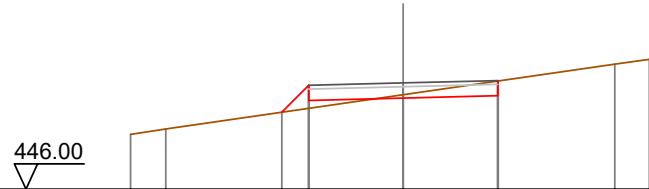

Quote Terreno	447.45	447.59	448.04	448.50	449.31	449.43
Quote Progetto			448.35	448.41	448.47	
Parziali			0.71	2.50	2.50	
Progressiva			-3.21	-2.50	0.00	2.50
Dislivelli			-0.00	0.61	-0.09	-0.39

Sezione: 61
 Progressiva: 468.969
 Q. Progetto: 448.757

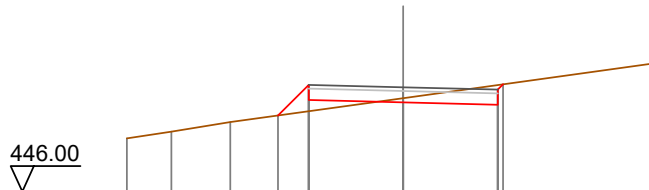

Quote Terreno	447.40	447.58	447.83	448.47	449.39
Quote Progetto			448.01	448.36	448.29
Parziali			0.81	2.50	2.50
Progressiva			-3.31	-2.50	0.00
Dislivelli			0.00	0.70	-0.11

Sezione: 62
 Progressiva: 470.000
 Q. Progetto: 448.721

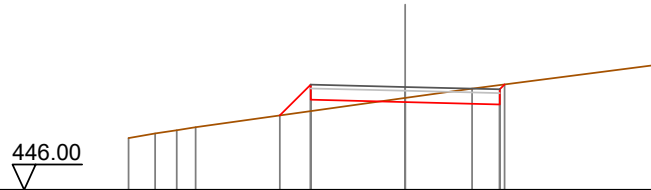

Quote Terreno	447.37	447.49	447.58	447.66			448.43	448.68	449.30
Quote Progetto			447.97	448.38			448.32	448.26	448.79
Parziali			0.81	2.50			2.50		
Progressiva			-3.31	-2.50			0.00	2.50	2.63
Dislivelli			0.00	0.70			-0.11	-0.51	0.00

Sezione: 63
 Progressiva: 480.000
 Q. Progetto: 448.265

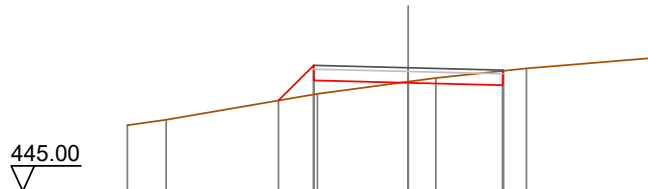

Quote Terreno	446.74	446.89	447.58	447.90	447.99	448.25	448.53
Quote Progetto			447.40	447.93	447.87	447.80	448.18
Parziali			0.93	2.50	2.50		
Progressiva			-3.43	-2.50	0.00	2.50	2.52
Dislivelli			0.00	0.77	-0.03	-0.38	-0.00

Sezione: 64
 Progressiva: 480.596
 Q. Progetto: 448.232

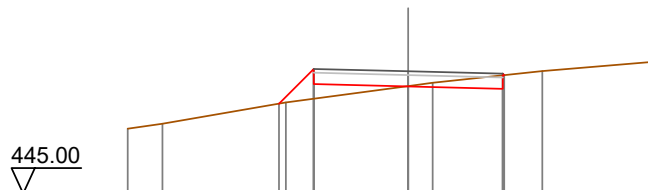

Quote Terreno	446.72	446.84	447.41	447.84	447.93	448.24	448.49
Quote Progetto			447.38	447.89	447.83	447.77	448.13
Parziali			0.92	2.50	2.50		
Progressiva			-3.42	-2.50	0.00	2.50	2.54
Dislivelli			0.00	0.79	-0.01	-0.36	0.00

Sezione: 65
 Progressiva: 490.000
 Q. Progetto: 447.609

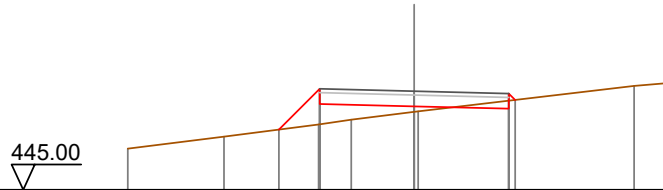

Quote Terreno	-446.09	-446.41	-446.59	-446.73	-446.86	-447.06	-447.08	-447.75	-447.82
Quote Progetto			446.59	447.27	446.86	447.21	447.15	447.38	
Parziali			1.08	2.50		2.50			
Progressiva			-3.58	-2.50		0.00	2.50	2.67	
Dislivelli			0.00	0.94		0.15	-0.21	-0.00	

Sezione: 66
 Progressiva: 492.223
 Q. Progetto: 447.435

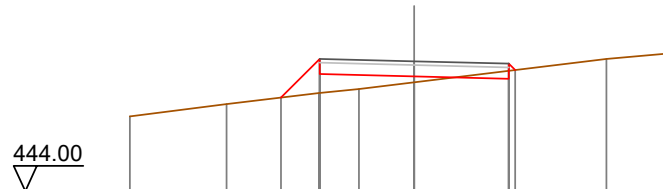

Quote Terreno	-445.98	-446.31	-446.48	-446.60	-446.70	-446.88	-447.04	-447.50	-447.64
Quote Progetto			446.48	447.10	446.70	447.04	446.97	447.20	
Parziali			1.02	2.50		2.50			
Progressiva			-3.52	-2.50		0.00	2.50	2.67	
Dislivelli			0.00	0.90		0.15	-0.21	-0.00	

Sezione: 67
 Progressiva: 500.000
 Q. Progetto: 446.751

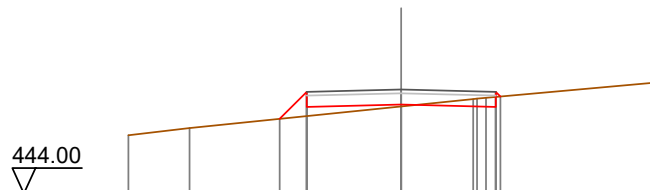

Quote Terreno	-445.54	-445.73	-445.97	-446.29	-446.30	-446.50	-446.53	-446.93
Quote Progetto			445.97	446.29	446.35	446.29	446.56	
Parziali			0.71	2.50		2.50		
Progressiva			-3.21	-2.50		0.00	2.50	2.62
Dislivelli			-0.00	0.64		0.05	-0.27	0.00

Sezione: 68
 Progressiva: 520.000
 Q. Progetto: 444.855

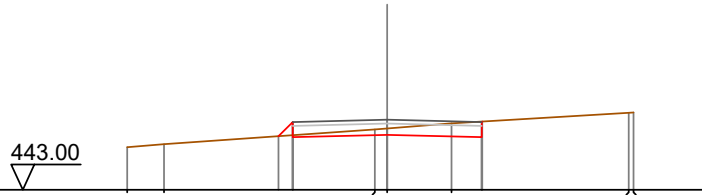

Quote Terreno		444.13	444.21		444.60	444.62	444.76	445.04	445.05
Quote Progetto				444.42	444.39	444.46	444.39		
Parziali				0.37	2.50	2.50			
Progressiva				-2.87	-2.50	0.00	2.50		
Dislivelli				-0.00	0.35	-0.17	-0.41		

Sezione: 69
 Progressiva: 535.341
 Q. Progetto: 443.401

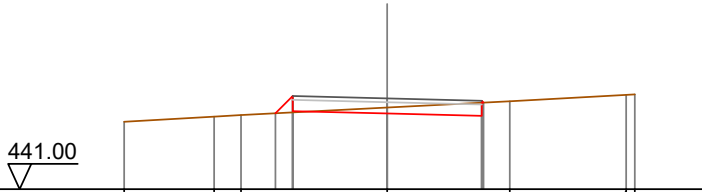

Quote Terreno		442.76	442.92	442.96		443.16	443.33	443.49	443.51
Quote Progetto				443.01	443.06	443.00	442.94	443.29	
Parziali				0.46	2.50	2.50			
Progressiva				-2.96	-2.50	0.00	2.50	2.55	
Dislivelli				0.00	0.43	-0.16	-0.35	0.00	

Sezione: 70
 Progressiva: 540.000
 Q. Progetto: 442.959

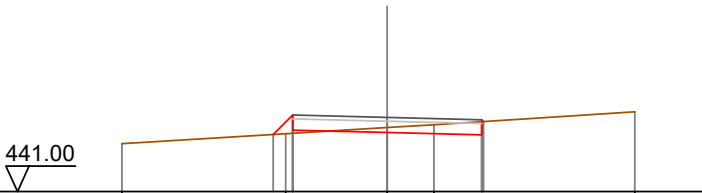

Quote Terreno		442.27		442.53		442.69	442.77		443.11
Quote Progetto			442.51	442.62		442.56	442.50	442.86	
Parziali			0.51	2.50	2.50				
Progressiva			-3.01	-2.50	0.00	2.50	2.55		
Dislivelli			0.00	0.48	-0.13	-0.35	0.00		

Sezione: 71
 Progressiva: 540.465
 Q. Progetto: 442.915

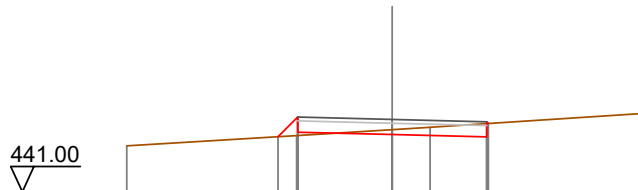

Quote Terreno		442.21		442.46	442.58	442.49		442.65	442.71		443.07
Quote Progetto				442.46	442.58			442.52		442.45	442.81
Parziali				0.52	2.50			2.50		0.00	2.54
Progressiva				-3.02	-2.50			0.00		2.50	2.54
Dislivelli				0.00	0.49			-0.13		-0.35	0.00

Sezione: 72
 Progressiva: 545.590
 Q. Progetto: 442.430

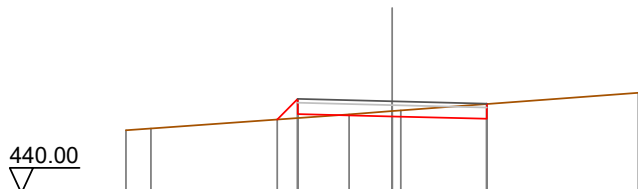

Quote Terreno		441.67	441.71		442.08	442.17	442.19				442.66
Quote Progetto				441.95	442.09			442.03		441.97	
Parziali				0.54	2.50			2.50			
Progressiva				-3.04	-2.50			0.00		2.50	
Dislivelli				0.00	0.50			-0.14		-0.39	

Sezione: 73
 Progressiva: 560.000
 Q. Progetto: 441.261

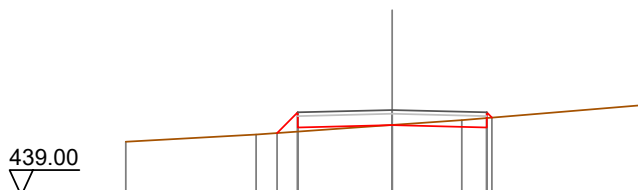

Quote Terreno		440.42		440.61		440.86	440.87		440.99		441.39
Quote Progetto				440.65	440.80			440.86	440.80	441.06	
Parziali				0.55	2.50			2.50		0.00	
Progressiva				-3.05	-2.50			0.00		2.50	2.64
Dislivelli				0.00	0.51			-0.00		-0.25	0.00

Sezione: 74
 Progressiva: 568.723
 Q. Progetto: 440.757

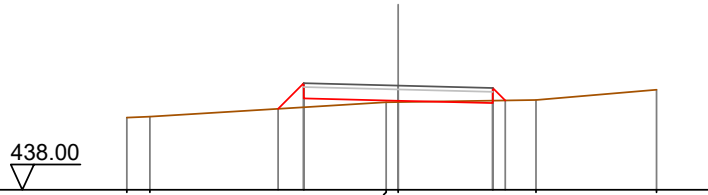

Quote Terreno	439.91	439.93		440.32	440.32		440.38	440.65
Quote Progetto			440.14	440.42	440.36	440.32	440.29	440.37
Parziali			0.68	2.50	2.50	0.33		
Progressiva			-3.18	-2.50	0.00	2.50	2.83	
Dislivelli			0.00	0.64	0.03	-0.07	-0.00	

Sezione: 75
 Progressiva: 570.000
 Q. Progetto: 440.696

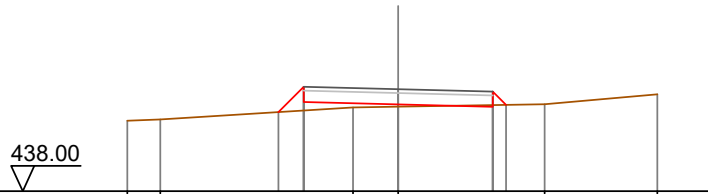

Quote Terreno	439.86	439.90		440.22	440.24		440.30	440.56
Quote Progetto			440.09	440.36	440.30	440.23	440.28	
Parziali			0.67	2.50	2.50	0.35		
Progressiva			-3.17	-2.50	0.00	2.50	2.85	
Dislivelli			0.00	0.62	0.06	-0.04	0.00	

Sezione: 76
 Progressiva: 571.722
 Q. Progetto: 440.619

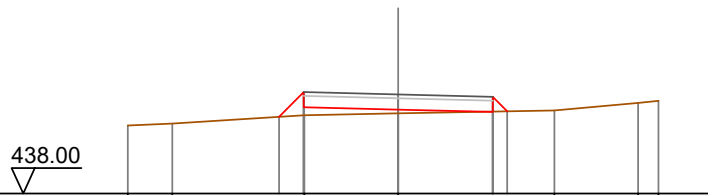

Quote Terreno	439.80	439.85		440.12	440.12		440.20	440.40	440.45
Quote Progetto			440.03	440.28	440.22	440.16	440.17		
Parziali			0.65	2.50	2.50	0.38			
Progressiva			-3.15	-2.50	0.00	2.50	2.88		
Dislivelli			0.00	0.61	0.10	-0.01	0.00		

Sezione: 77
 Progressiva: 574.720
 Q. Progetto: 440.499

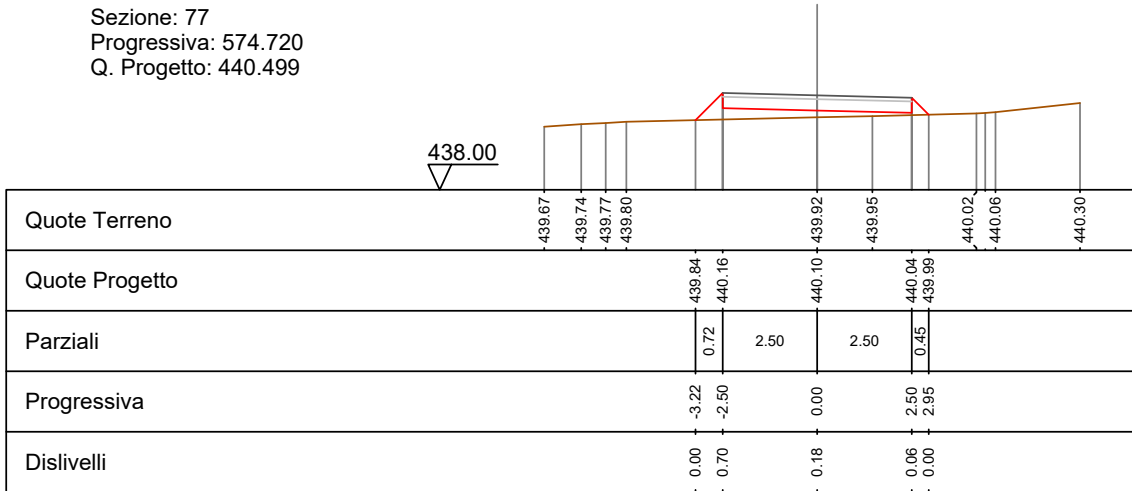

Sezione: 78
 Progressiva: 580.000
 Q. Progetto: 440.323

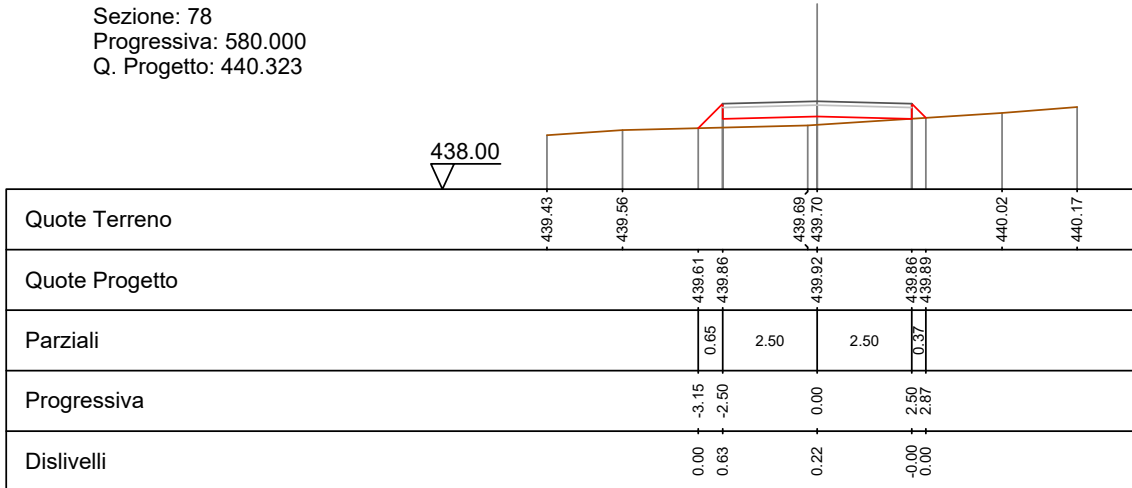

Sezione: 79
 Progressiva: 600.000
 Q. Progetto: 439.519

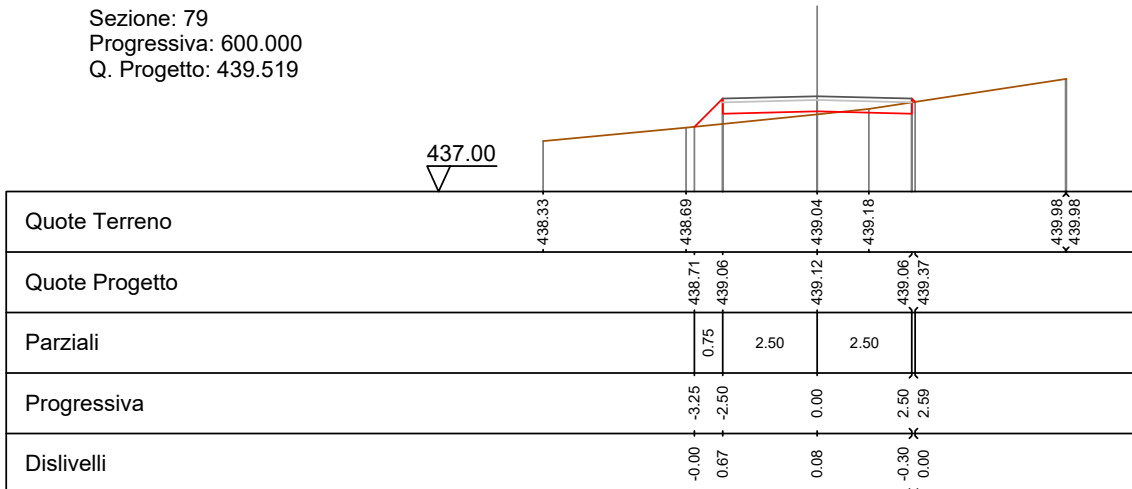

Sezione: 80
 Progressiva: 620.000
 Q. Progetto: 437.965

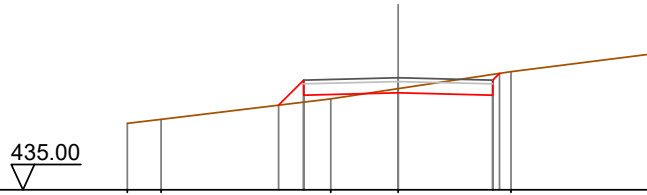

Quote Terreno		436.76	436.86		437.41	437.68	438.13	438.59
Quote Progetto				437.24	437.50	437.57	437.50	438.08
Parziali				0.66	2.50	2.50		
Progressiva				-3.16	-2.50	0.00	2.50	2.68
Dislivelli				0.00	0.58	-0.11	-0.55	0.00

Sezione: 81
 Progressiva: 625.107
 Q. Progetto: 437.439

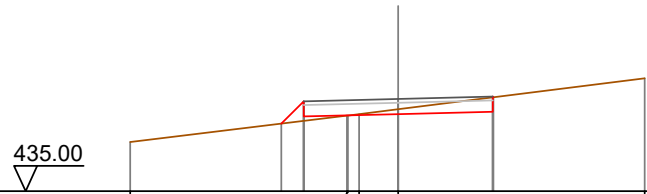

Quote Terreno		436.30		437.00	437.04	437.17		437.99
Quote Progetto			436.79	436.98	437.04	437.10		
Parziali			0.59	2.50	2.50			
Progressiva			-3.09	-2.50	0.00	2.50		
Dislivelli			0.00	0.52	-0.13	-0.38		

Sezione: 82
 Progressiva: 629.123
 Q. Progetto: 436.987

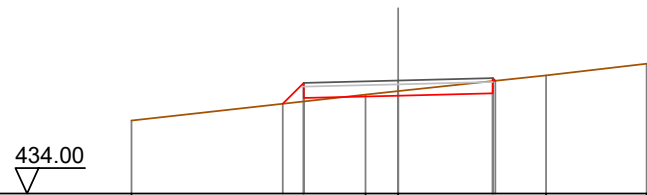

Quote Terreno		435.93		436.62	436.71		437.13	437.43
Quote Progetto			436.37	436.52	436.59	436.65	436.98	
Parziali			0.55	2.50	2.50			
Progressiva			-3.05	-2.50	0.00	2.50	2.57	
Dislivelli			-0.00	0.49	-0.12	-0.32	0.00	

Sezione: 83
 Progressiva: 630.000
 Q. Progetto: 436.884

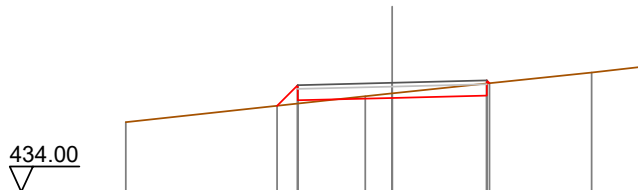

Quote Terreno	435.84		436.53		437.16	437.30
Quote Progetto		436.28	436.42	436.48	436.55	436.87
Parziali		0.54	2.50	2.50		
Progressiva		-3.04	-2.50	0.00	2.50	2.57
Dislivelli		0.00	0.49	-0.12	-0.32	0.00

Sezione: 84
 Progressiva: 633.139
 Q. Progetto: 436.503

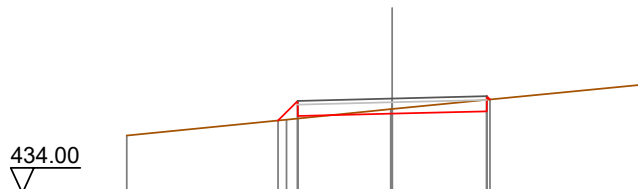

Quote Terreno	435.52		436.22		436.87	
Quote Progetto		435.92	436.10	436.17	436.48	
Parziali		0.52	2.50	2.50		
Progressiva		-3.02	-2.50	0.00	2.50	2.59
Dislivelli		-0.00	0.47	-0.12	-0.30	-0.00

Sezione: 85
 Progressiva: 638.246
 Q. Progetto: 435.840

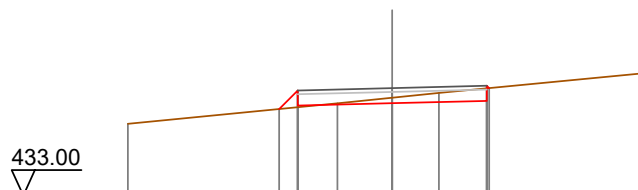

Quote Terreno	434.89		435.44		435.71	436.23
Quote Progetto		435.29	435.38	435.44	435.50	435.84
Parziali		0.49	2.50	2.50		
Progressiva		-2.99	-2.50	0.00	2.50	2.56
Dislivelli		0.00	0.44	-0.14	-0.33	0.00

Sezione: 86
 Progressiva: 640.000
 Q. Progetto: 435.599

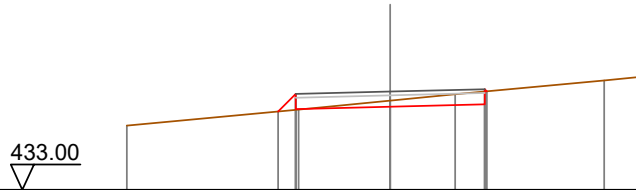

Quote Terreno	434.70	435.07	435.14	435.20	435.36	435.53	435.89	435.98
Quote Progetto		435.07	435.14	435.20	435.20	435.26	435.61	
Parziali		0.47	2.50	2.50				
Progressiva		-2.97	-2.50	0.00		2.50	2.56	
Dislivelli		0.00	0.42	-0.16		-0.34	0.00	

Sezione: 87
 Progressiva: 650.000
 Q. Progetto: 434.111

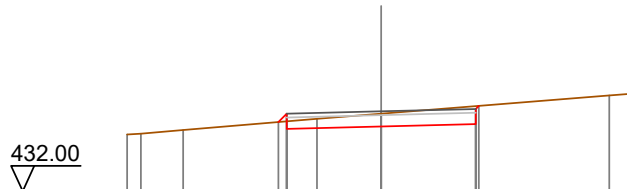

Quote Terreno	433.50	433.52	433.62	433.92	434.05	434.53	434.57
Quote Progetto			433.83	433.65	433.71	433.77	434.26
Parziali			2.50	2.50			
Progressiva			-2.72	-2.50	0.00	2.50	2.58
Dislivelli			-0.00	0.20	-0.34	-0.48	0.00

Sezione: 88
 Progressiva: 660.000
 Q. Progetto: 432.586

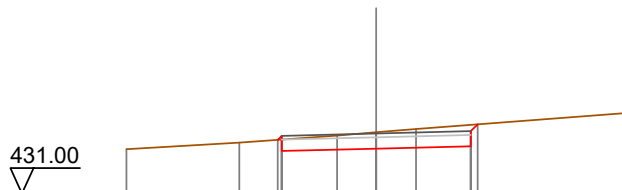

Quote Terreno	432.17	432.34	432.53	432.62	432.71	433.13
Quote Progetto		432.42	432.12	432.19	432.25	432.83
Parziali			2.50	2.50		
Progressiva		-2.61	-2.50	0.00	2.50	2.68
Dislivelli		0.00	0.10	-0.43	-0.57	0.00

Sezione: 89
 Progressiva: 663.808
 Q. Progetto: 432.054

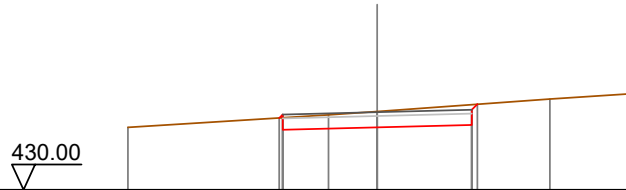

Quote Terreno		431.65		431.98	432.07		432.40	432.54
Quote Progetto			431.90	431.59		431.65	431.72	432.27
Parziali				2.50		2.50		
Progressiva			-2.59	-2.50	0.00		2.50	2.65
Dislivelli			-0.00	0.09	-0.42		-0.54	-0.00

Sezione: 90
 Progressiva: 670.000
 Q. Progetto: 431.252

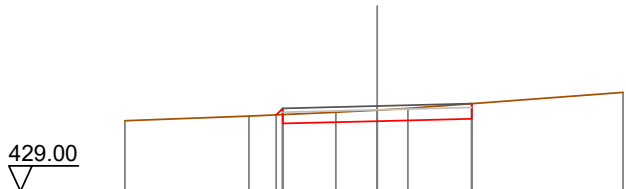

Quote Terreno		430.86	430.99	431.09	431.14	431.19		431.61
Quote Progetto			431.02	430.79	430.85	431.14	430.91	
Parziali				2.50		2.50		
Progressiva			-2.67	-2.50	0.00		2.50	
Dislivelli			0.00	0.16	-0.29		-0.40	

Sezione: 90
 Progressiva: 670.000
 Q. Progetto: 431.252

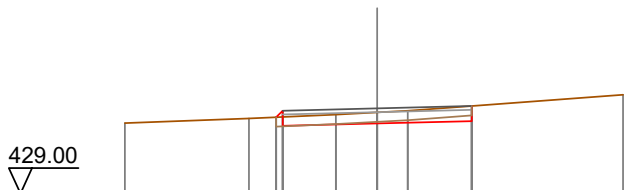

Quote Terreno		430.86	430.99	431.09	431.14	431.19		431.61
Quote Progetto			431.02	430.79	430.85	431.14	430.91	
Parziali				2.50		2.50		
Progressiva			-2.67	-2.50	0.00		2.50	
Dislivelli			0.00	0.16	-0.29		-0.40	

Sezione: 91
 Progressiva: 680.000
 Q. Progetto: 430.122

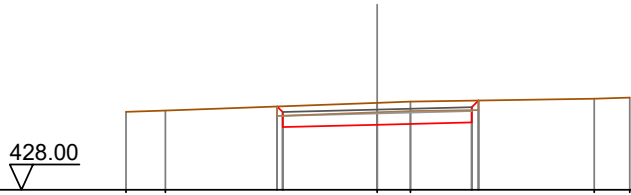

Quote Terreno	430.06	430.10		430.30	430.33		430.41	430.44
Quote Progetto			430.20	429.66	429.72	430.30	429.78	430.36
Parziali			2.50		2.50			
Progressiva			-2.65	-2.50	0.00		2.50	2.68
Dislivelli			0.00	-0.15	-0.58		-0.57	0.00

Sezione: 92
 Progressiva: 689.370
 Q. Progetto: 429.247

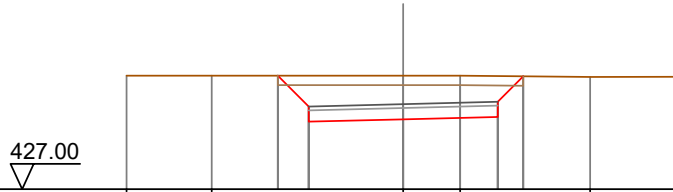

Quote Terreno	430.00	430.00		430.00	430.00		429.97	429.97
Quote Progetto			430.00	428.78	428.85	430.00	428.91	429.98
Parziali			0.82	2.50	2.50		0.67	
Progressiva			-3.32	-2.50	0.00		2.50	3.17
Dislivelli			0.00	-0.82	-1.15		-1.08	-0.00

Sezione: 93
 Progressiva: 700.000
 Q. Progetto: 428.470

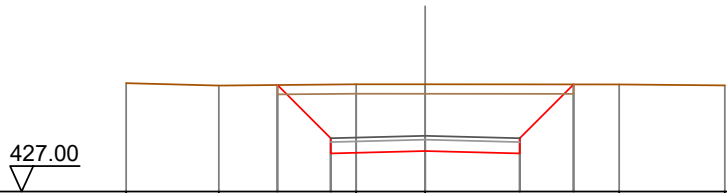

Quote Terreno	429.86	429.80		429.84	429.83		429.83	429.81
Quote Progetto			429.82	428.01	428.07	428.01	429.83	
Parziali			1.41	2.50	2.50	1.42		
Progressiva			-3.91	-2.50	0.00	2.50	3.92	
Dislivelli			-0.00	-1.42	-1.76	-1.83	0.00	

Sezione: 94
 Progressiva: 717.606
 Q. Progetto: 427.683

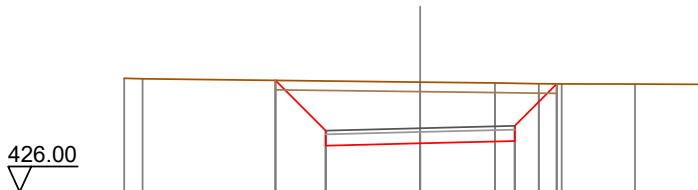

Quote Terreno	429.00	428.99				428.88	428.86	428.85	428.85	428.84
Quote Progetto			428.95	427.22	427.28	427.35	428.86			
Parziali			1.33	2.50	2.50	1.11				
Progressiva			-3.83	-2.50	0.00	2.50	3.61			
Dislivelli			-0.00	-1.31	-1.62	-1.52	0.00			

Sezione: 95
 Progressiva: 720.000
 Q. Progetto: 427.624

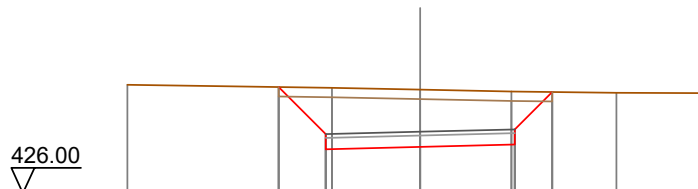

Quote Terreno	428.87					428.69		428.66	428.64
Quote Progetto		428.81	427.16	427.22	427.29	428.68			
Parziali		1.24	2.50	2.50	0.99				
Progressiva		-3.74	-2.50	0.00	2.50	3.49			
Dislivelli		-0.00	-1.23	-1.51	-1.40	0.00			

Sezione: 96
 Progressiva: 730.000
 Q. Progetto: 427.501

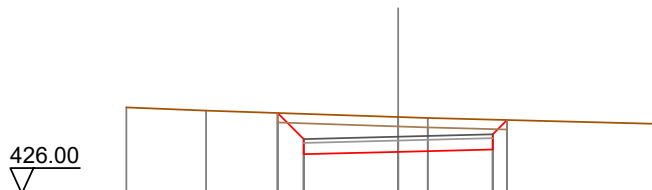

Quote Terreno	428.28	428.19			428.02	428.00		427.84
Quote Progetto			428.13	427.04	427.10	427.16	427.94	
Parziali			0.69	2.50	2.50	0.38		
Progressiva			-3.19	-2.50	0.00	2.50	2.88	
Dislivelli			0.00	-0.67	-0.92	-0.79	-0.00	

Sezione: 97
 Progressiva: 733.000
 Q. Progetto: 427.500

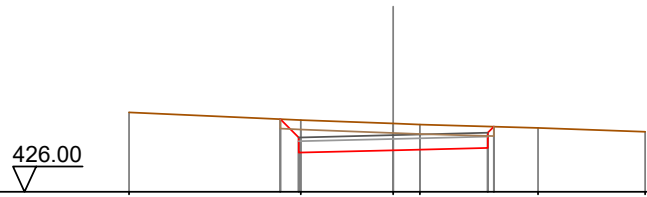

Quote Terreno	428.10	427.92	427.81	427.78	427.69	427.59
Quote Progetto		427.04	427.10		427.16	427.72
Parziali		0.49	2.50	2.50		
Progressiva		-2.99	0.00		2.50	2.66
Dislivelli		-0.00	-0.47	-0.71	-0.57	0.00

SEZIONI TRASVERSALI
Profilo longitudinale tratto 5-6
Viabilità di impianto postazione aerogeneratore T03

Nota: Le canalette di deflusso delle acque meteoriche, non indicate nel presente elaborato, sono rappresentate graficamente nelle sezioni stradali tipo dell'elaborato "WIND002-TC13_Piazzole aerogeneratori e strade di servizio - Particolari costruttivi", individuate planimetricamente nell'elaborato "WIND002-TC14_Opere di regimazione acque superficiali - Planimetria generale" e quantificate nell'elaborato "WIND002-RC6_Computo Metrico Estimativo".

DISEGNI DI RIFERIMENTO

TAVOLA	DESCRIZIONE
WIND002-TC8	Piazzole e viabilità - Planimetria di progetto - Fase di cantiere
WIND002-TC11	Profili longitudinali viabilità di impianto
WIND002-TC13	Piazzole aerogeneratori e strade di servizio - Particolari costruttivi
WIND002-TC14	Opere di regimazione acque superficiali - Planimetria generale

Sezione: 1
 Progressiva: 0.000
 Q. Progetto: 400.140

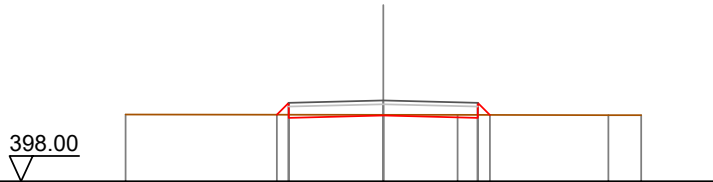

Quote Terreno	399.77		399.76	399.76	399.75	399.75
Quote Progetto		399.76	399.74	399.68	399.76	
Parziali		0.31	2.50	2.50	0.32	
Progressiva		-2.81	-2.50	0.00	2.50	2.82
Dislivelli		-0.00	0.31	-0.02	-0.08	0.00

Sezione: 2
 Progressiva: 20.000
 Q. Progetto: 400.042

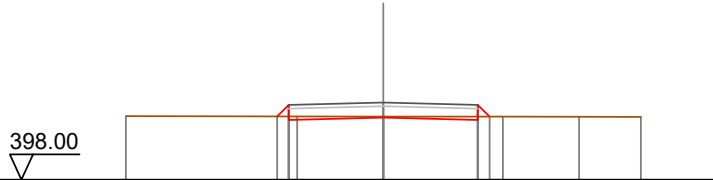

Quote Terreno	399.68		399.67	399.67	399.67	399.66	399.66
Quote Progetto		399.67	399.58	399.64	399.58	399.67	
Parziali		0.31	2.50	2.50	0.31		
Progressiva		-2.81	-2.50	0.00	2.50	2.81	
Dislivelli		0.00	0.31	-0.03	-0.09	0.00	

Sezione: 3
 Progressiva: 40.000
 Q. Progetto: 399.944

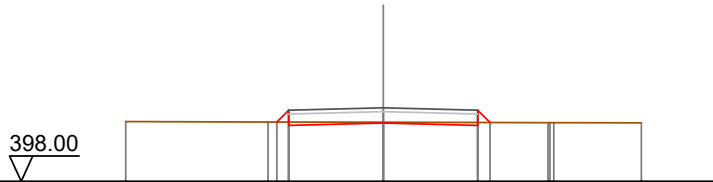

Quote Terreno	399.56	399.57	399.56	399.55	399.55	399.55
Quote Progetto		399.57	399.54	399.48	399.56	
Parziali		0.31	2.50	2.50	0.33	
Progressiva		-2.81	0.00	2.50	2.83	
Dislivelli		-0.00	-0.02	-0.08	-0.00	

Sezione: 4
 Progressiva: 42.850
 Q. Progetto: 399.930

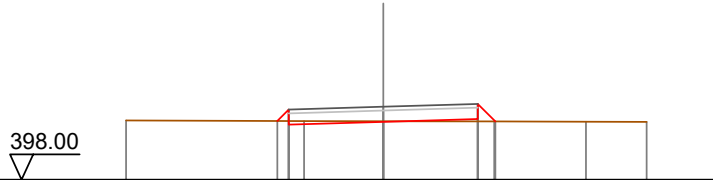

Quote Terreno	399.57	399.55	399.55	399.54	399.53	399.53
Quote Progetto		399.55	399.53	399.60	399.54	
Parziali		0.30	2.50	0.46		
Progressiva		-2.80	0.00	2.50	2.96	
Dislivelli		0.00	-0.02	0.06	0.00	

Sezione: 5
 Progressiva: 44.078
 Q. Progetto: 399.924

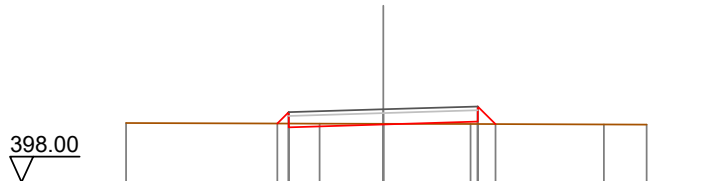

Quote Terreno	399.56	399.55	399.54	399.54	399.53	399.52	399.52
Quote Progetto		399.55	399.52	399.60	399.53		
Parziali		0.30	2.50	0.47			
Progressiva		-2.80	0.00	2.50	2.97		
Dislivelli		0.00	-0.02	0.07	0.00		

Sezione: 6
 Progressiva: 45.307
 Q. Progetto: 399.918

398.00

Quote Terreno	399.55		399.54	399.54	399.53	399.51	399.51
Quote Progetto		399.54	399.44	399.52	399.59	399.52	
Parziali		0.30	2.50	2.50	0.47		
Progressiva		-2.80	-2.50	0.00	2.50	2.97	
Dislivelli		0.00	0.30	-0.02	0.07	-0.00	

Sezione: 7
 Progressiva: 60.000
 Q. Progetto: 399.846

398.00

Quote Terreno	399.48	399.48	399.47	399.45	399.45	399.42	
Quote Progetto			399.47	399.45	399.38	399.44	
Parziali			0.32	2.50	2.50	0.34	
Progressiva			-2.82	-2.50	0.00	2.50	2.84
Dislivelli			0.00	0.32	-0.01	-0.06	0.00

Sezione: 8
 Progressiva: 80.000
 Q. Progetto: 399.747

398.00

Quote Terreno	399.39	399.37	399.37	399.35	399.32	399.31
Quote Progetto		399.37	399.28	399.35	399.28	399.33
Parziali		0.32	2.50	2.50	0.35	
Progressiva		-2.82	-2.50	0.00	2.50	2.85
Dislivelli		0.00	0.32	-0.00	-0.05	-0.00

Sezione: 9
 Progressiva: 84.736
 Q. Progetto: 399.724

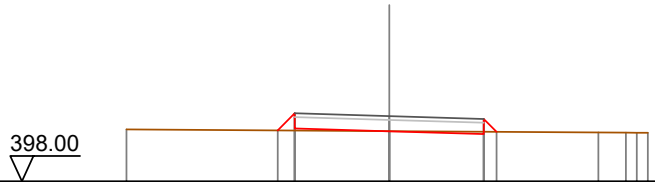

Quote Terreno	399.37		399.33		399.29	399.29	399.28
Quote Progetto		399.35	399.40	399.32	399.25	399.31	
Parziali		0.45	2.50	2.50	0.34		
Progressiva		-2.95	-2.50	0.00	2.50	2.84	
Dislivelli		-0.00	0.45	-0.00	-0.06	0.00	

Sezione: 10
 Progressiva: 86.783
 Q. Progetto: 399.714

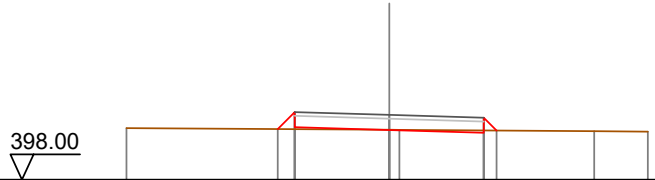

Quote Terreno	399.36		399.32	399.32		399.28	399.27
Quote Progetto		399.34	399.39	399.31	399.24	399.30	
Parziali		0.45	2.50	2.50	0.34		
Progressiva		-2.95	-2.50	0.00	2.50	2.84	
Dislivelli		0.00	0.45	-0.01	-0.06	0.00	

Sezione: 11
 Progressiva: 88.830
 Q. Progetto: 399.704

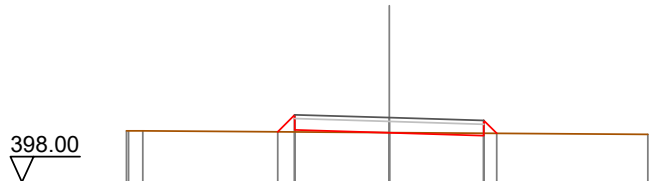

Quote Terreno	399.36	399.35		399.31		399.26
Quote Progetto		399.33	399.38	399.30	399.23	399.29
Parziali		0.45	2.50	2.50	0.34	
Progressiva		-2.95	-2.50	0.00	2.50	2.84
Dislivelli		-0.00	0.45	-0.00	-0.06	-0.00

Sezione: 12
 Progressiva: 100.000
 Q. Progetto: 399.649

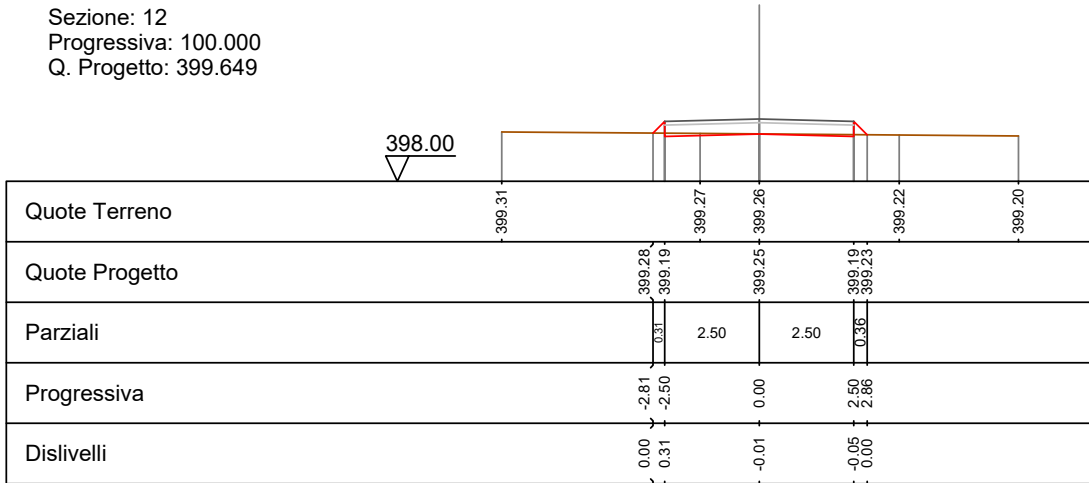

Sezione: 13
 Progressiva: 120.000
 Q. Progetto: 399.587

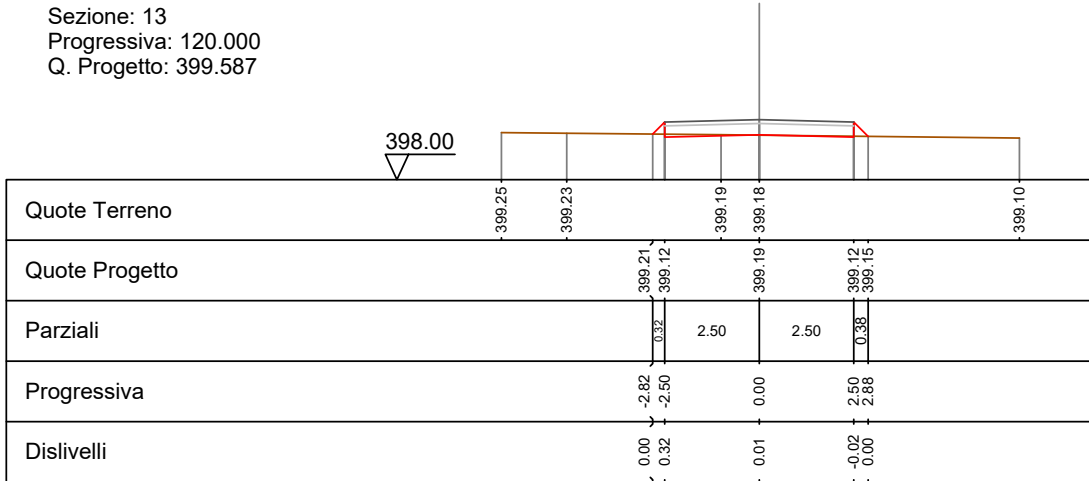

Sezione: 14
 Progressiva: 140.000
 Q. Progetto: 399.556

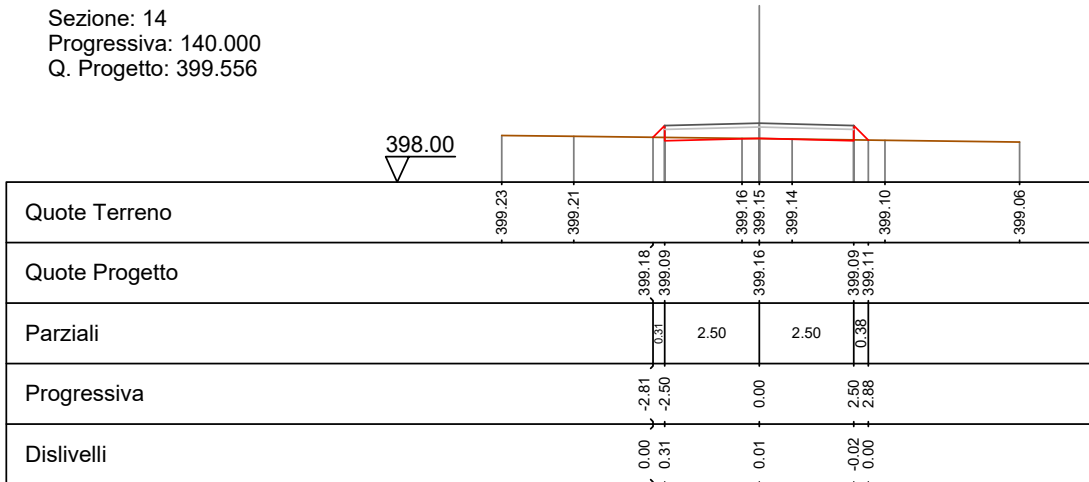

Sezione: 15
 Progressiva: 152.111
 Q. Progetto: 399.547

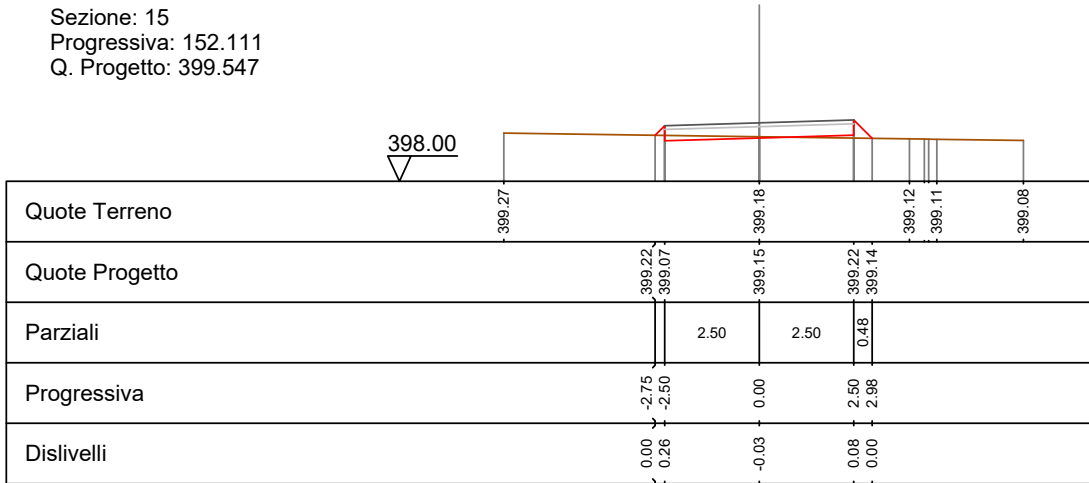

Sezione: 16
 Progressiva: 152.757
 Q. Progetto: 399.550

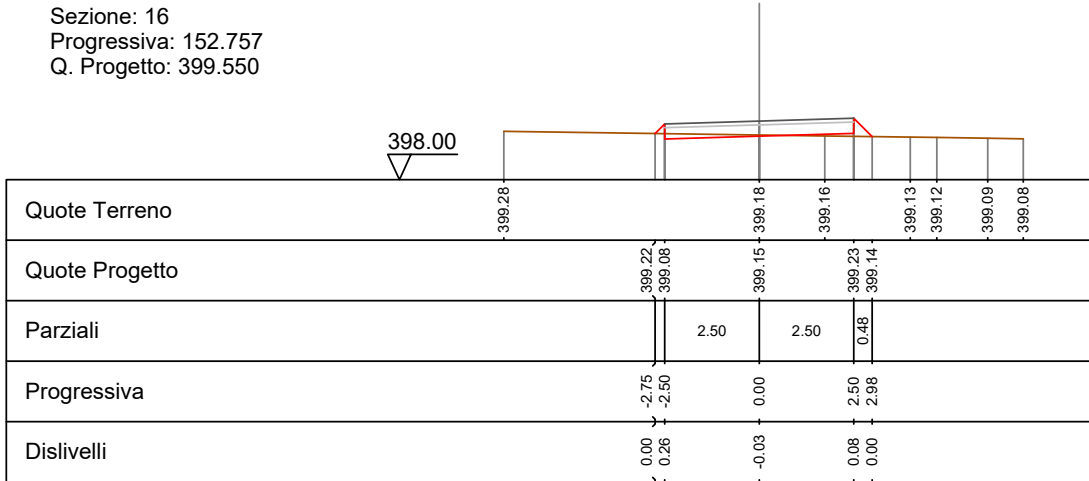

Sezione: 17
 Progressiva: 153.403
 Q. Progetto: 399.554

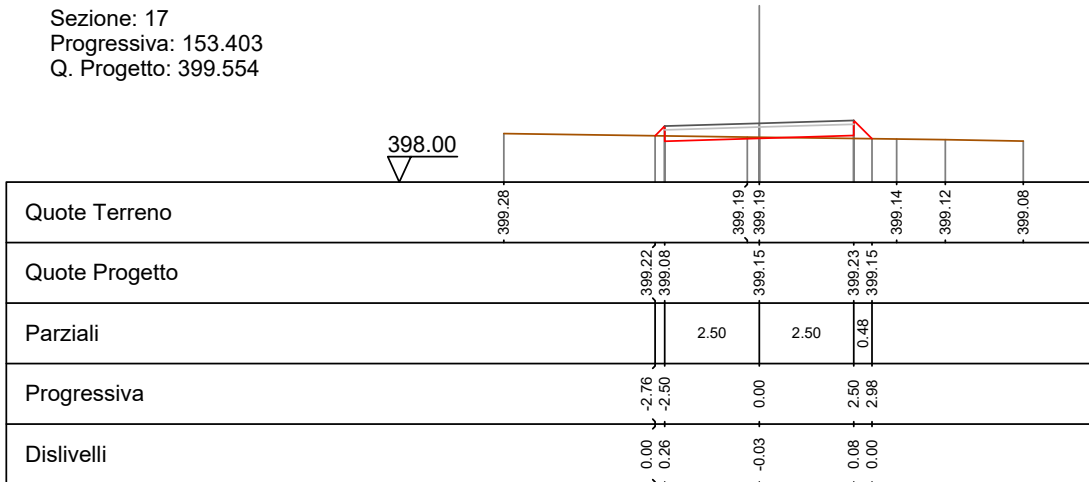

Sezione: 18
 Progressiva: 160.000
 Q. Progetto: 399.632

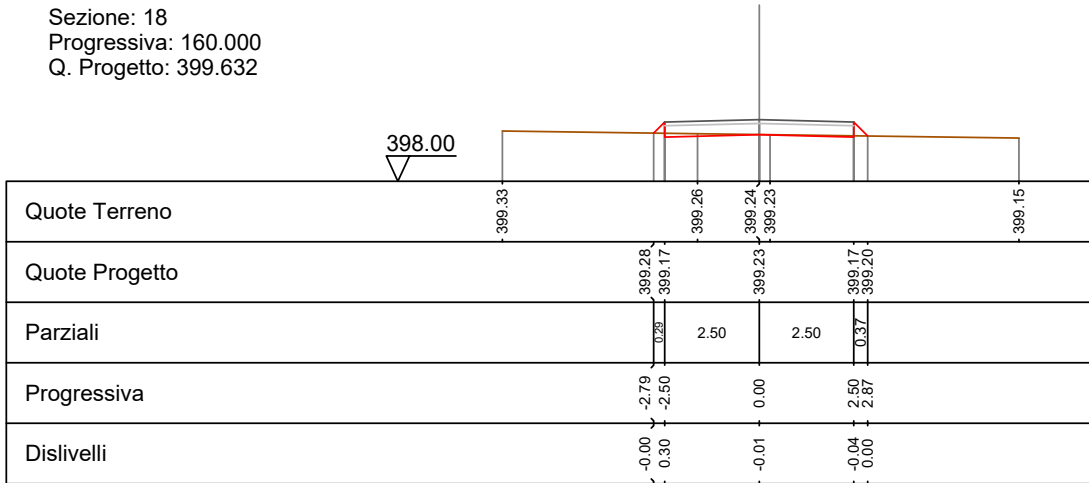

Sezione: 19
 Progressiva: 170.500
 Q. Progetto: 399.767

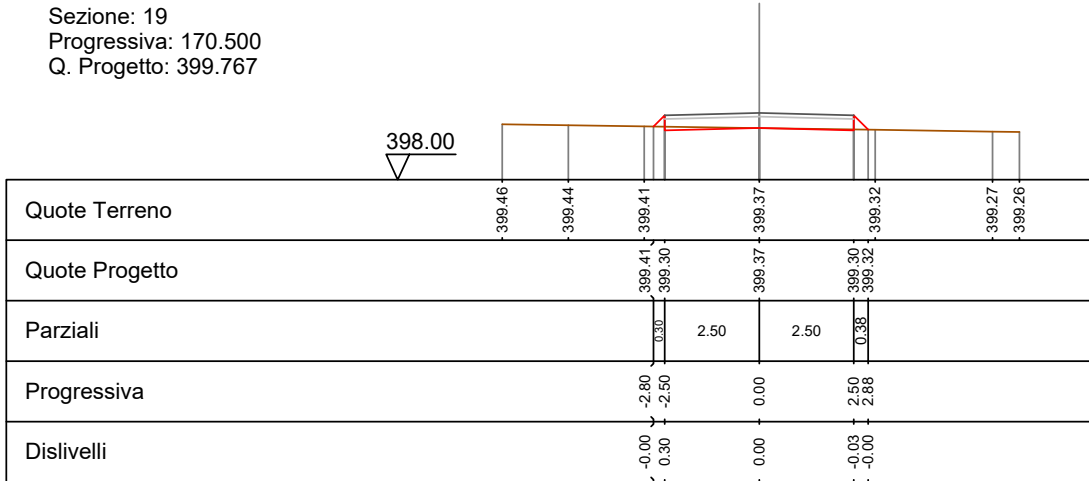

Sezione: 20
 Progressiva: 180.000
 Q. Progetto: 399.889

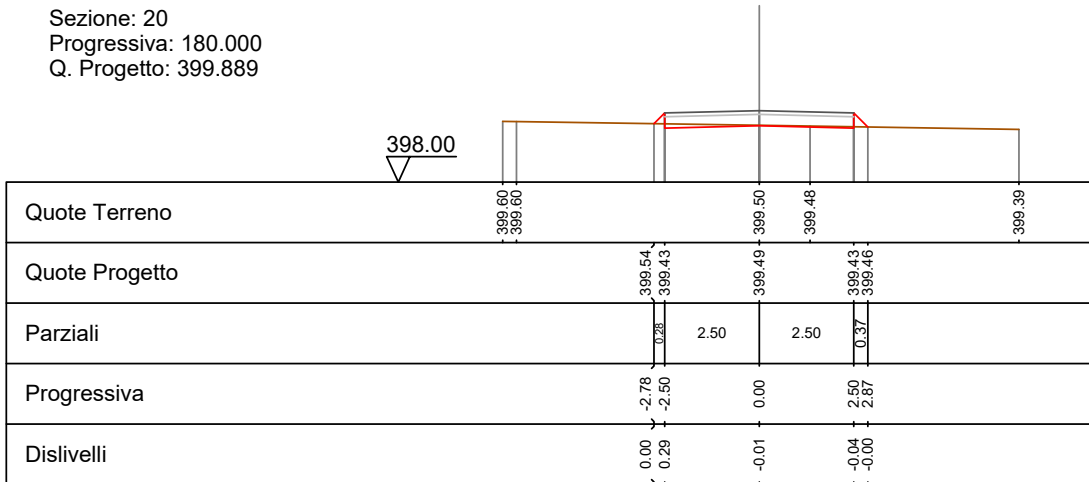

Sezione: 21
 Progressiva: 200.000
 Q. Progetto: 400.337

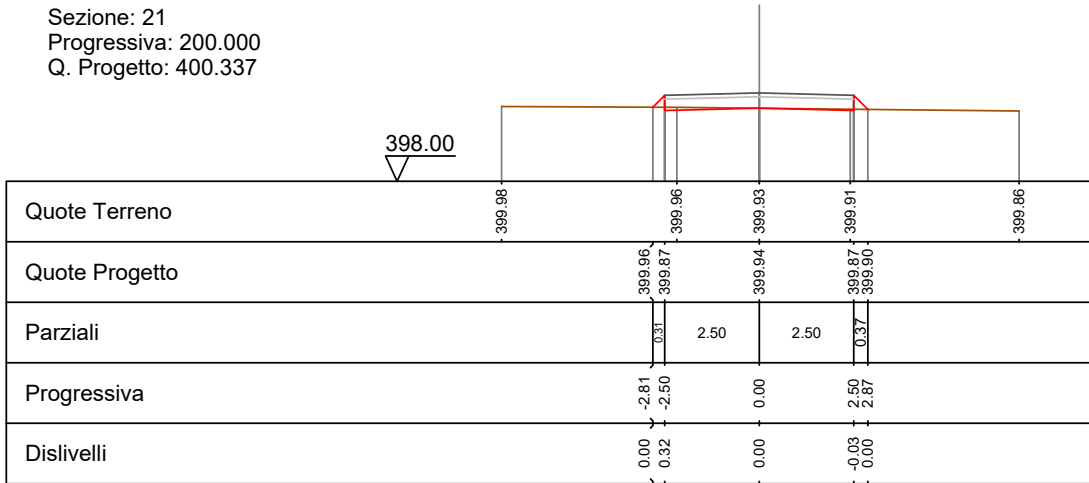

Sezione: 22
 Progressiva: 220.000
 Q. Progetto: 400.843

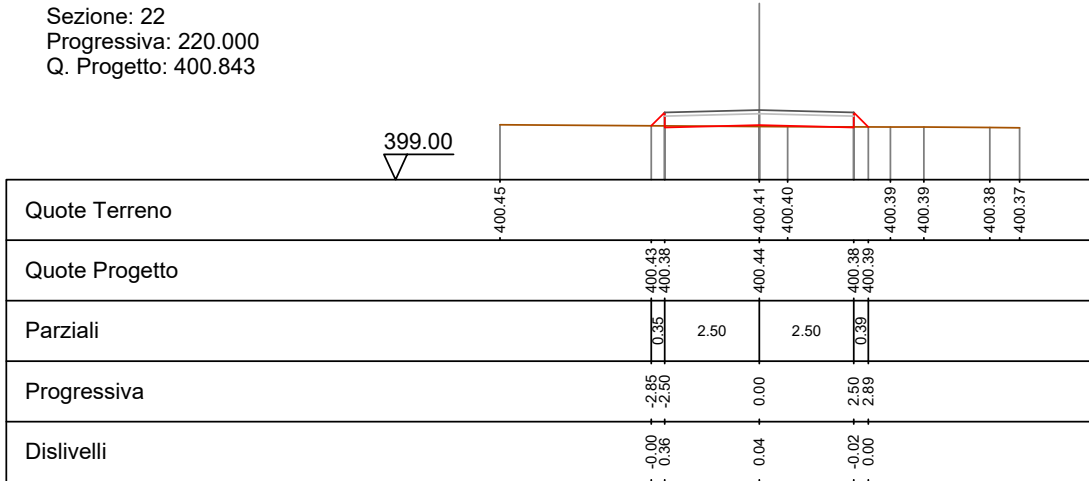

Sezione: 23
 Progressiva: 240.000
 Q. Progetto: 401.660

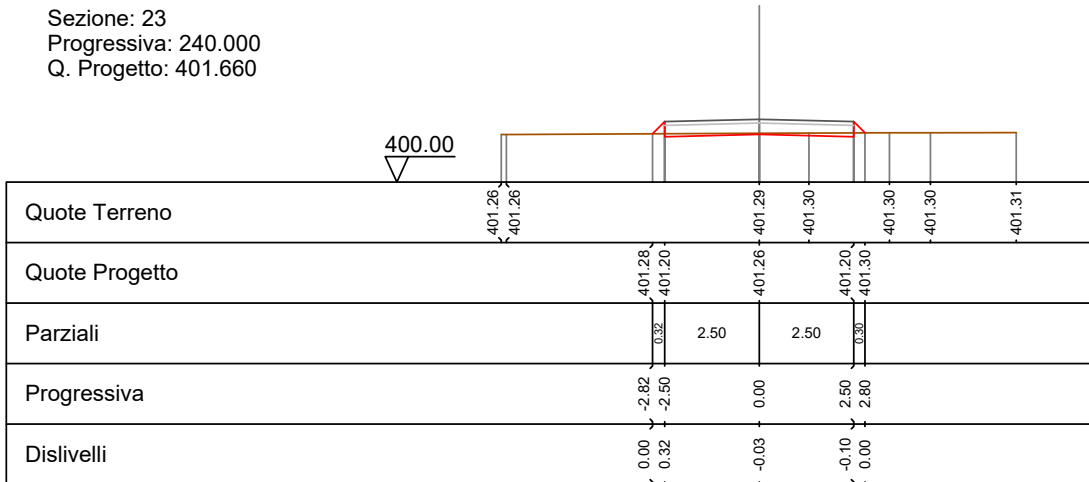

Sezione: 24
 Progressiva: 243.312
 Q. Progetto: 401.800

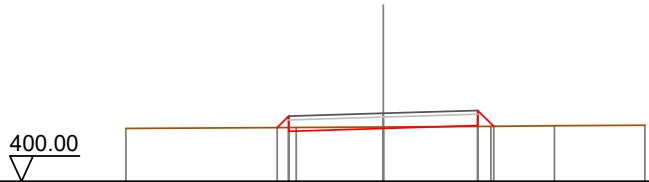

Quote Terreno	-401.40								
Quote Progetto		401.42	401.32	401.40	401.45				
Parziali		0.30	2.50	2.50	0.42				
Progressiva		-2.80	-2.50	0.00	2.50	2.92			
Dislivelli		0.00	0.30	-0.04	0.02	-0.00			

Sezione: 25
 Progressiva: 248.725
 Q. Progetto: 402.028



Quote Terreno	-401.61								
Quote Progetto		401.66	401.55	401.63	401.70				
Parziali		0.29	2.50	2.50	0.37				
Progressiva		-2.79	-2.50	0.00	2.50	2.87			
Dislivelli		0.00	0.29	-0.06	-0.02	-0.00			

Sezione: 26
 Progressiva: 250.000
 Q. Progetto: 402.082

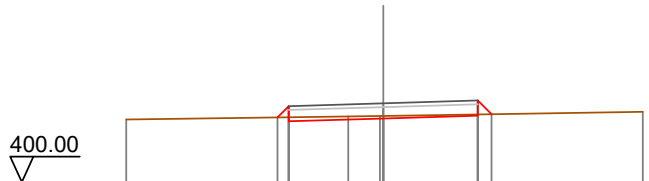

Quote Terreno	-401.65								
Quote Progetto		401.71	401.61	401.68	401.76				
Parziali		0.30	2.50	2.50	0.36				
Progressiva		-2.80	-2.50	0.00	2.50	2.86			
Dislivelli		0.00	0.29	-0.07	-0.03	0.00			

Sezione: 27
 Progressiva: 254.137
 Q. Progetto: 402.256

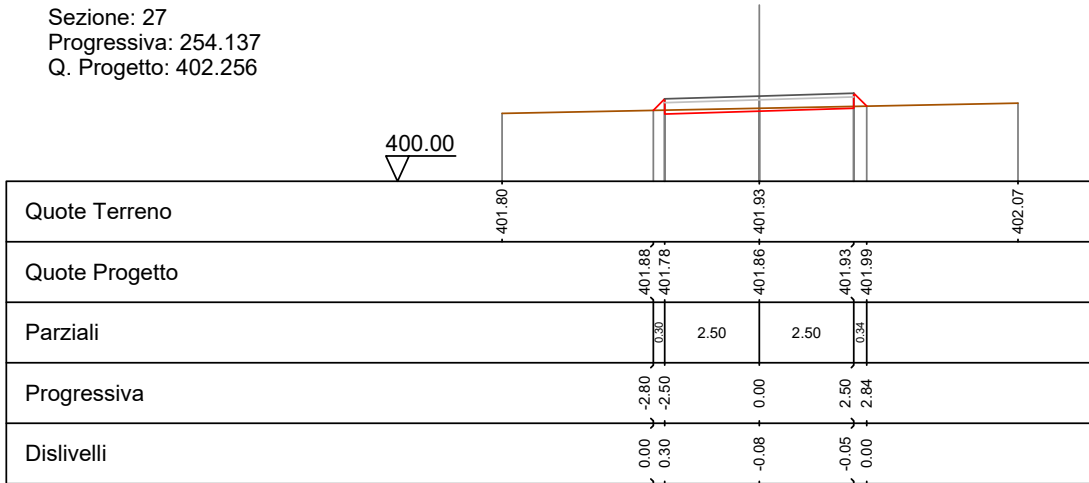

Sezione: 28
 Progressiva: 260.000
 Q. Progetto: 402.503

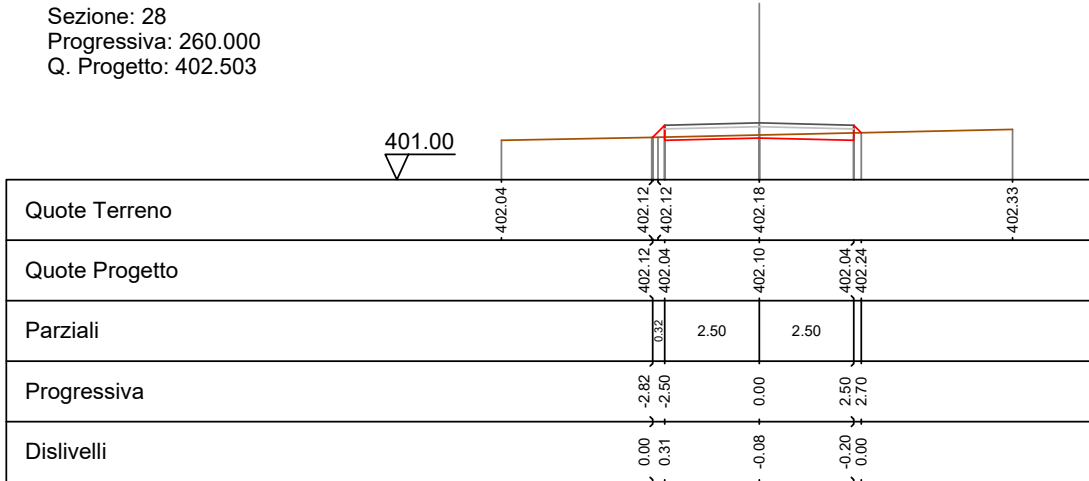

Sezione: 29
 Progressiva: 280.000
 Q. Progetto: 403.346

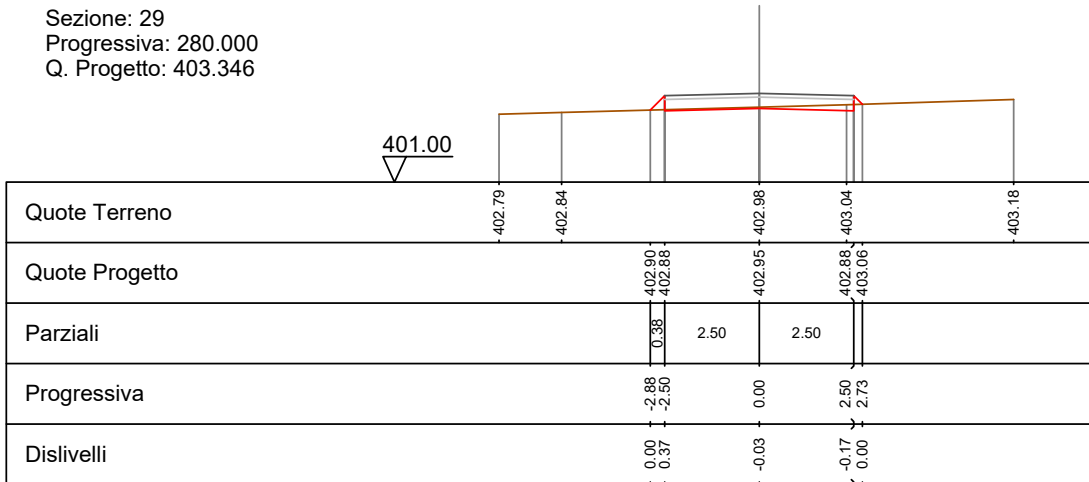

Sezione: 30
 Progressiva: 300.000
 Q. Progetto: 404.141

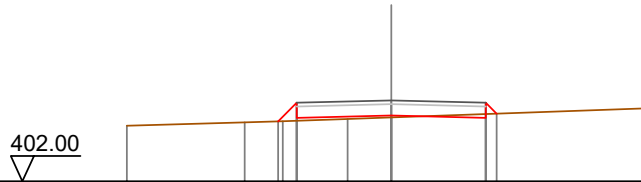

Quote Terreno	403.47	403.56	403.59	403.65	403.69	403.93
Quote Progetto			403.59	403.68	403.74	403.68
Parziali			0.49	2.50	2.50	0.28
Progressiva			-2.99	-2.50	0.00	2.50
Dislivelli			0.00	0.48	0.05	-0.10
						-0.00

Sezione: 31
 Progressiva: 320.000
 Q. Progetto: 404.773

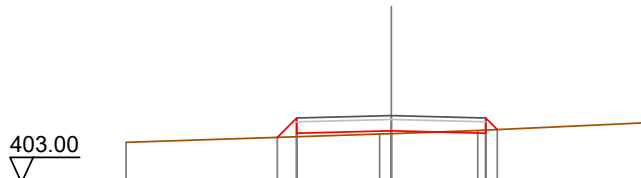

Quote Terreno	404.07			404.29	404.30	404.38	404.59
Quote Progetto			404.20	404.37	404.30	404.31	404.40
Parziali			0.51	2.50	2.50	0.31	
Progressiva			-3.01	-2.50	0.00	2.50	2.81
Dislivelli			0.00	0.50	0.08	-0.08	0.00

Sezione: 32
 Progressiva: 340.000
 Q. Progetto: 405.404

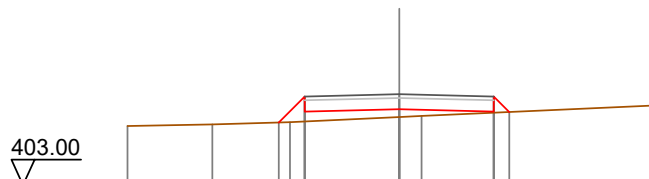

Quote Terreno	404.56	404.60	404.66	404.80	404.83	405.11
Quote Progetto			404.66	405.00	404.94	404.93
Parziali			0.69	2.50	2.50	0.41
Progressiva			-3.19	-2.50	0.00	2.50
Dislivelli			0.00	0.66	0.21	0.03
						0.00

Sezione: 33
 Progressiva: 352.813
 Q. Progetto: 405.809

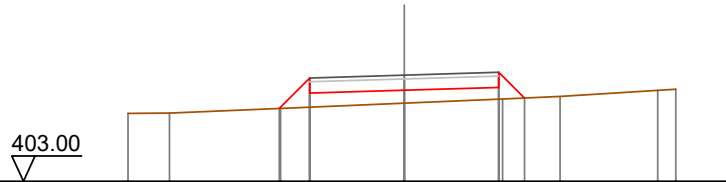

Quote Terreno	404.80	404.81	404.93	405.07	405.18	405.25	405.40	405.44
Quote Progetto			404.93	405.41	405.48	405.20		
Parziali			0.81	2.50	2.50	0.68		
Progressiva			-3.31	-2.50	0.00	2.50	3.18	
Dislivelli			-0.00	0.77	0.34	0.31	0.00	

Sezione: 34
 Progressiva: 355.707
 Q. Progetto: 405.900

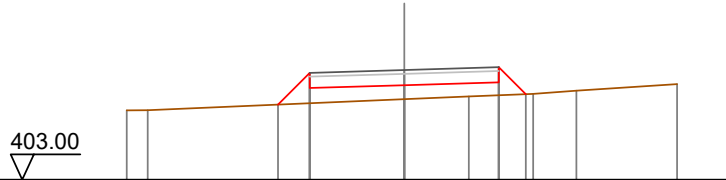

Quote Terreno	404.83	404.84	404.99	405.13	405.20	405.27	405.35	405.53
Quote Progetto			404.99	405.50	405.58	405.26		
Parziali			0.84	2.50	2.50	0.71		
Progressiva			-3.34	-2.50	0.00	2.50	3.21	
Dislivelli			0.00	0.80	0.37	0.34	-0.00	

Sezione: 35
 Progressiva: 358.602
 Q. Progetto: 405.992

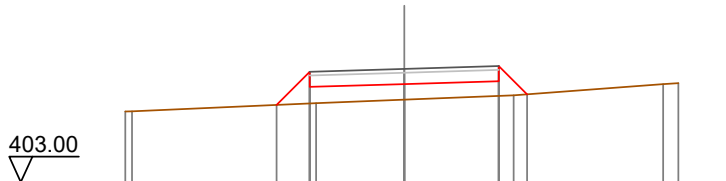

Quote Terreno	404.87	404.87	405.04	405.18	405.29	405.59	405.62
Quote Progetto			405.04	405.59	405.67	405.32	
Parziali			0.88	2.50	2.50	0.75	
Progressiva			-3.38	-2.50	0.00	2.50	3.25
Dislivelli			0.00	0.84	0.41	0.39	0.00

Sezione: 36
 Progressiva: 360.000
 Q. Progetto: 406.036

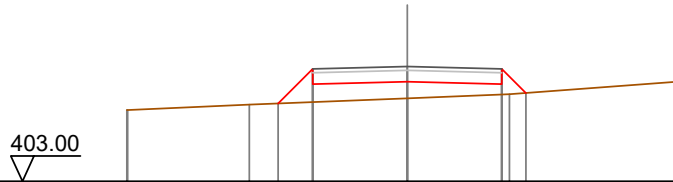

Quote Terreno	404.89	405.03		405.20	405.30	405.64
Quote Progetto		405.06	405.57	405.64	405.57	405.34
Parziali		0.91	2.50	2.50	0.64	
Progressiva		-3.41	-2.50	0.00	2.50	3.14
Dislivelli		-0.00	0.88	0.44	0.28	-0.00

Sezione: 37
 Progressiva: 380.000
 Q. Progetto: 406.949

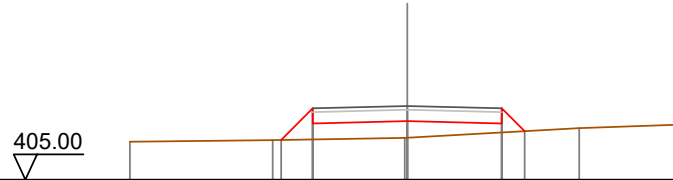

Quote Terreno	406.00	406.05		406.11	406.36	406.45
Quote Progetto		406.05	406.49	406.55	406.49	406.28
Parziali		0.84	2.50	2.50	0.60	
Progressiva		-3.34	-2.50	0.00	2.50	3.10
Dislivelli		0.00	0.82	0.44	0.24	0.00

Sezione: 38
 Progressiva: 400.000
 Q. Progetto: 408.419

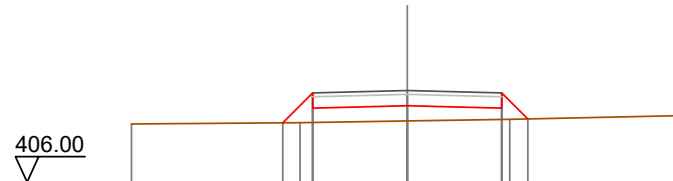

Quote Terreno	407.53	407.57		407.61	407.66	407.76
Quote Progetto		407.57	407.96	408.02	407.96	407.67
Parziali		0.79	2.50	2.50	0.69	
Progressiva		-3.29	-2.50	0.00	2.50	3.19
Dislivelli		0.00	0.78	0.40	0.30	-0.00

Sezione: 39
 Progressiva: 403.380
 Q. Progetto: 408.671

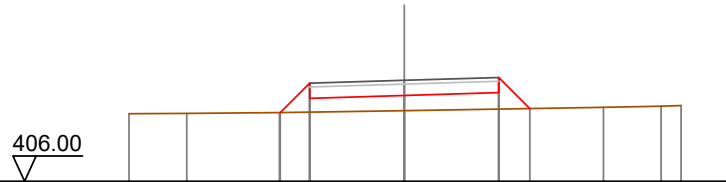

Quote Terreno	407.79	407.80	407.82	407.87	407.96	407.99	408.01
Quote Progetto			407.82	408.27	408.35	407.92	
Parziali			0.78	2.50	2.50	0.82	
Progressiva			-3.28	-2.50	0.00	2.50	3.32
Dislivelli			0.00	0.77	0.40	0.43	-0.00

Sezione: 40
 Progressiva: 405.573
 Q. Progetto: 408.834

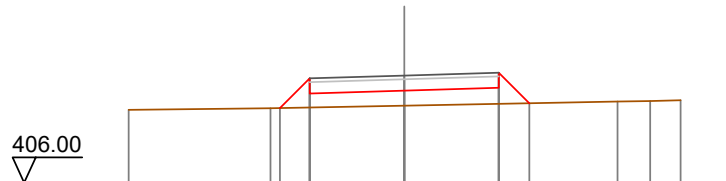

Quote Terreno	407.93	407.97	408.04	408.15	408.16	408.18
Quote Progetto		407.97	408.43	408.51	408.10	
Parziali		0.79	2.50	2.50	0.81	
Progressiva		-3.29	-2.50	0.00	2.50	3.31
Dislivelli		0.00	0.77	0.40	0.42	-0.00

Sezione: 41
 Progressiva: 407.766
 Q. Progetto: 408.998

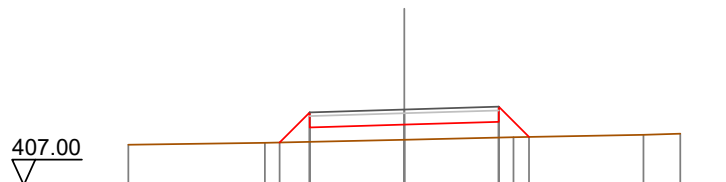

Quote Terreno	408.06	408.12	408.20	408.27	408.33	408.36
Quote Progetto		408.12	408.60	408.67	408.27	
Parziali		0.80	2.50	2.50	0.80	
Progressiva		-3.30	-2.50	0.00	2.50	3.30
Dislivelli		0.00	0.78	0.40	0.42	-0.00

Sezione: 42
 Progressiva: 420.000
 Q. Progetto: 409.873

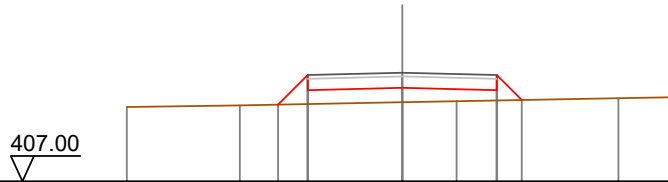

Quote Terreno	408.97	409.01		409.09	409.12		409.20	409.22
Quote Progetto			409.03	409.41	409.47		409.41	409.15
Parziali			0.78	2.50	2.50		0.66	
Progressiva			-3.28	-2.50	0.00		2.50	3.16
Dislivelli			-0.00	0.77	0.38		0.27	0.00

Sezione: 43
 Progressiva: 440.000
 Q. Progetto: 410.947

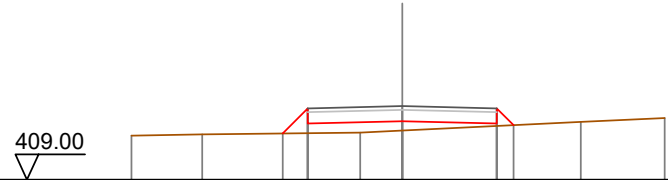

Quote Terreno	410.16	410.20		410.24	410.30		410.53	410.63
Quote Progetto			410.22	410.48	410.55		410.48	410.44
Parziali			0.66	2.50	2.50		0.44	
Progressiva			-3.16	-2.50	0.00		2.50	2.94
Dislivelli			-0.00	0.66	0.25		0.06	0.00

Sezione: 44
 Progressiva: 449.007
 Q. Progetto: 411.614

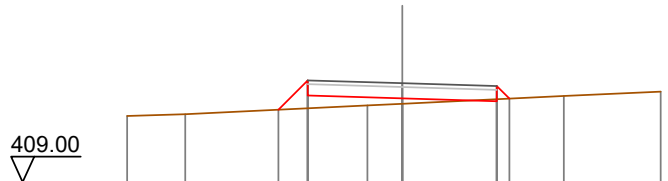

Quote Terreno	410.75	410.80		411.03	411.07		411.28	411.39
Quote Progetto			410.91	411.29	411.21		411.14	411.21
Parziali			0.78	2.50	2.50		0.33	
Progressiva			-3.28	-2.50	0.00		2.50	2.83
Dislivelli			0.00	0.74	0.14		-0.05	0.00

Sezione: 45
 Progressiva: 450.000
 Q. Progetto: 411.697

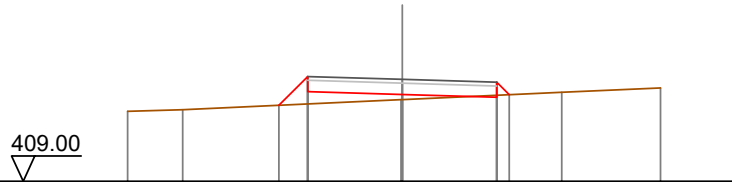

Quote Terreno	410.85	410.89			411.16	411.16			411.36	411.47
Quote Progetto			411.01	411.37	411.30	411.30	411.22	411.29		
Parziali			0.76	2.50	2.50	0.33				
Progressiva			-3.26	-2.50	0.00	2.50	2.83			
Dislivelli			-0.00	0.73	0.14	-0.05	0.00			

Sezione: 46
 Progressiva: 460.000
 Q. Progetto: 412.649

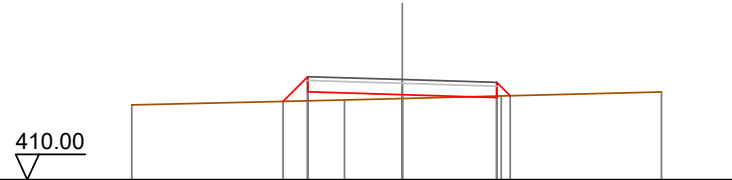

Quote Terreno	411.98			412.11	412.15			412.21	412.32
Quote Progetto			412.07	412.32	412.25	412.17	412.22		
Parziali			0.65	2.50	2.50	0.35			
Progressiva			-3.15	-2.50	0.00	2.50	2.85		
Dislivelli			0.00	0.64	0.10	-0.04	0.00		

Sezione: 47
 Progressiva: 466.970
 Q. Progetto: 413.376

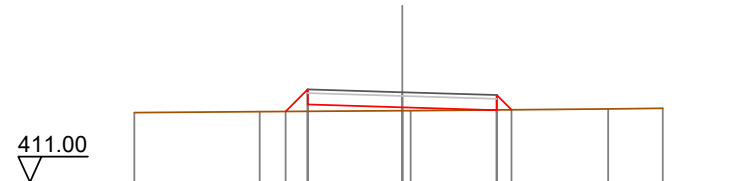

Quote Terreno	412.84	412.86			412.89	412.89			412.93	412.95
Quote Progetto			412.87	413.05	412.98	412.90	412.91			
Parziali			0.58	2.50	2.50	0.39				
Progressiva			-3.08	-2.50	0.00	2.50	2.89			
Dislivelli			-0.00	0.58	0.09	-0.01	0.00			

Sezione: 48
 Progressiva: 470.000
 Q. Progetto: 413.692

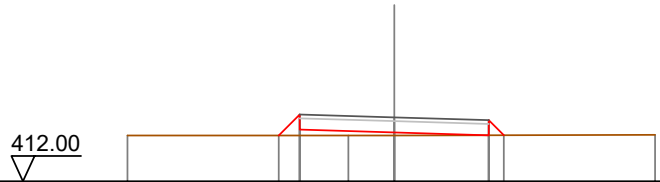

Quote Terreno		413.21		413.21	413.21		413.21		413.23
Quote Progetto			413.21	413.37		413.29		413.22	413.22
Parziali			0.56	2.50		2.50		0.40	
Progressiva			-3.06	-2.50		0.00		2.50	2.90
Dislivelli			0.00	0.56		0.08		-0.00	0.00

Sezione: 49
 Progressiva: 480.000
 Q. Progetto: 414.735

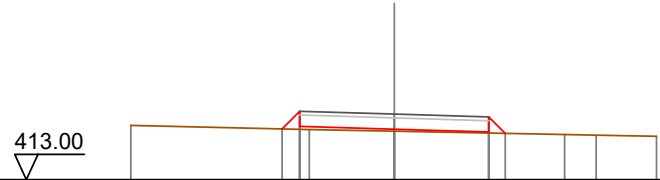

Quote Terreno		414.43		414.33		414.28		414.19	414.18	414.15
Quote Progetto			414.34	414.41		414.34		414.26	414.22	
Parziali			0.47	2.50		2.50		0.44		
Progressiva			-2.97	-2.50		0.00		2.50	2.94	
Dislivelli			0.00	0.48		0.05		0.03	0.00	

Sezione: 50
 Progressiva: 484.932
 Q. Progetto: 415.250

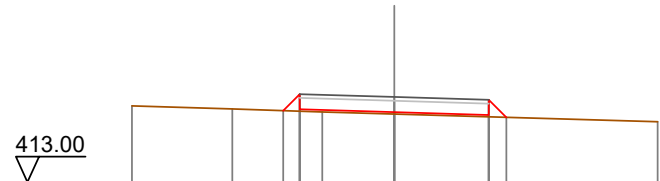

Quote Terreno		415.02		414.93		414.85		414.80		414.59
Quote Progetto			414.89	414.92		414.85		414.77	414.71	
Parziali			0.44	2.50		2.50		0.46		
Progressiva			-2.94	-2.50		0.00		2.50	2.96	
Dislivelli			0.00	0.45		0.05		0.05	0.00	

Sezione: 51
 Progressiva: 500.000
 Q. Progetto: 416.821

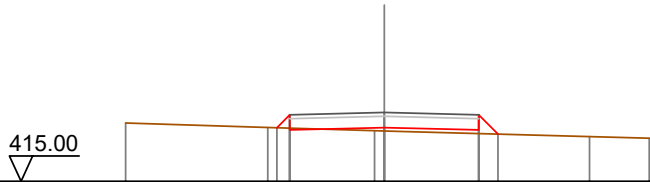

Quote Terreno	416.54	416.42	416.34	416.18	416.14
Quote Progetto		416.42	416.42	416.36	416.25
Parziali		0.34	2.50	2.50	0.51
Progressiva		-2.84	-2.50	0.00	2.50
Dislivelli		-0.00	0.35	0.09	0.09

Sezione: 52
 Progressiva: 520.000
 Q. Progetto: 418.907

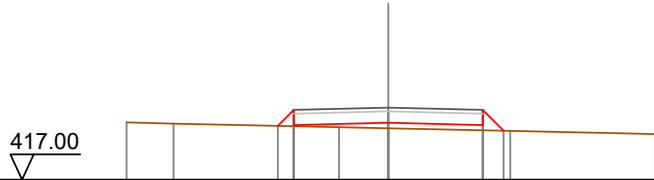

Quote Terreno	418.51	418.48	418.39	418.36	418.29	418.21
Quote Progetto			418.42	418.51	418.44	418.30
Parziali			0.42	2.50	2.50	0.55
Progressiva			-2.92	-2.50	0.00	2.50
Dislivelli			0.00	0.43	0.15	0.14

Sezione: 53
 Progressiva: 539.069
 Q. Progetto: 420.896

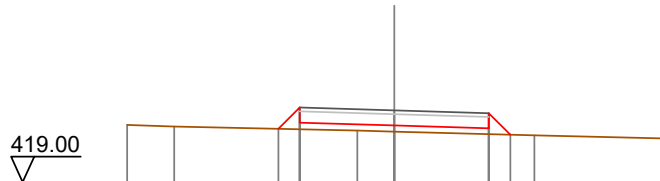

Quote Terreno	420.51	420.47	420.36	420.33	420.23	420.15
Quote Progetto			420.41	420.50	420.42	420.25
Parziali			0.56	2.50	2.50	0.57
Progressiva			-3.06	-2.50	0.00	2.50
Dislivelli			0.00	0.58	0.16	0.15

Sezione: 54
 Progressiva: 540.000
 Q. Progetto: 420.993

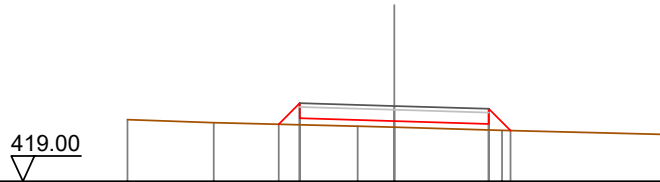

Quote Terreno		420.63		420.55		420.46		420.43		420.35		420.24
Quote Progetto				420.51		420.67		420.59		420.52		420.34
Parziali				0.56		2.50		2.50		0.57		
Progressiva				-3.06		-2.50		0.00		2.50		3.07
Dislivelli				-0.00		0.57		0.16		0.16		-0.00

Sezione: 55
 Progressiva: 541.005
 Q. Progetto: 421.098

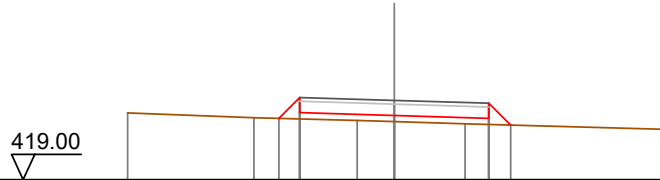

Quote Terreno		420.76		420.64		420.57		420.54		420.48		420.33
Quote Progetto				420.62		420.77		420.70		420.62		420.44
Parziali				0.55		2.50		2.50		0.58		
Progressiva				-3.05		-2.50		0.00		2.50		3.08
Dislivelli				-0.00		0.57		0.16		0.16		0.00

Sezione: 56
 Progressiva: 542.940
 Q. Progetto: 421.300

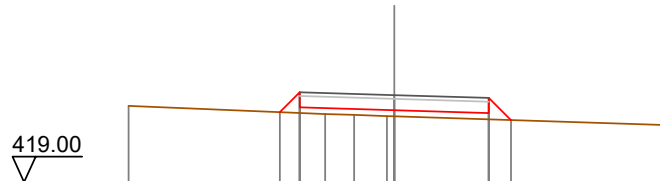

Quote Terreno		421.02		420.85		420.80		420.78		420.74		420.51
Quote Progetto				420.85		420.97		420.90		420.82		420.64
Parziali				0.53		2.50		2.50		0.59		
Progressiva				-3.03		-2.50		0.00		2.50		3.09
Dislivelli				0.00		0.55		0.16		0.17		0.00

Sezione: 57
 Progressiva: 560.000
 Q. Progetto: 423.079

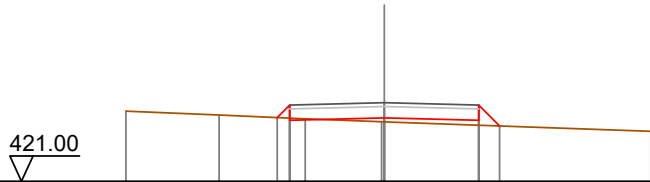

Quote Terreno	422.86	422.76	422.65	422.58	422.57	422.32
Quote Progetto			422.60	422.68	422.62	422.47
Parziali			0.33	2.50	2.50	0.55
Progressiva			-2.83	-2.50	0.00	2.50
Dislivelli			-0.00	0.35	0.11	0.13

Sezione: 58
 Progressiva: 580.000
 Q. Progetto: 425.162

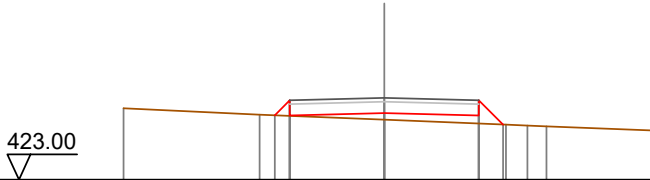

Quote Terreno	424.89	424.72	424.59	424.46	424.43	424.30
Quote Progetto		424.70	424.76	424.70	424.46	424.41
Parziali		0.40	2.50	2.50	0.64	
Progressiva		-2.90	-2.50	0.00	2.50	3.14
Dislivelli		0.00	0.41	0.18	0.22	0.00

Sezione: 59
 Progressiva: 600.000
 Q. Progetto: 426.835

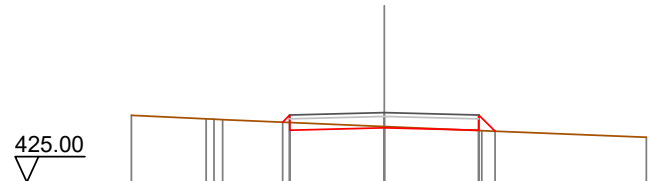

Quote Terreno	426.77	426.67	426.65	426.47	426.36	426.19
Quote Progetto			426.58	426.44	426.37	426.34
Parziali			0.43	2.50	2.50	0.43
Progressiva			-2.69	-2.50	0.00	2.50
Dislivelli			0.00	0.20	-0.03	0.01

Sezione: 60
 Progressiva: 607.366
 Q. Progetto: 427.394

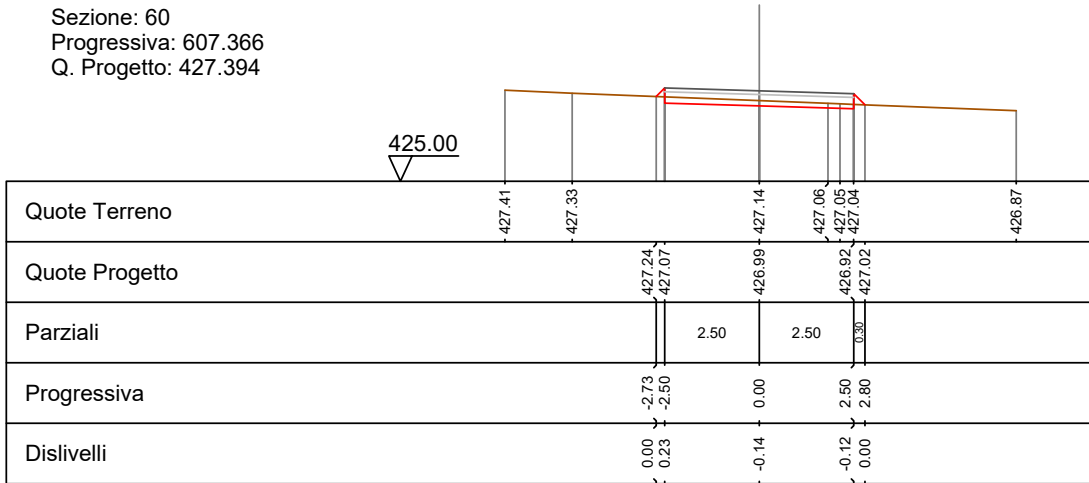

Sezione: 61
 Progressiva: 608.312
 Q. Progetto: 427.466

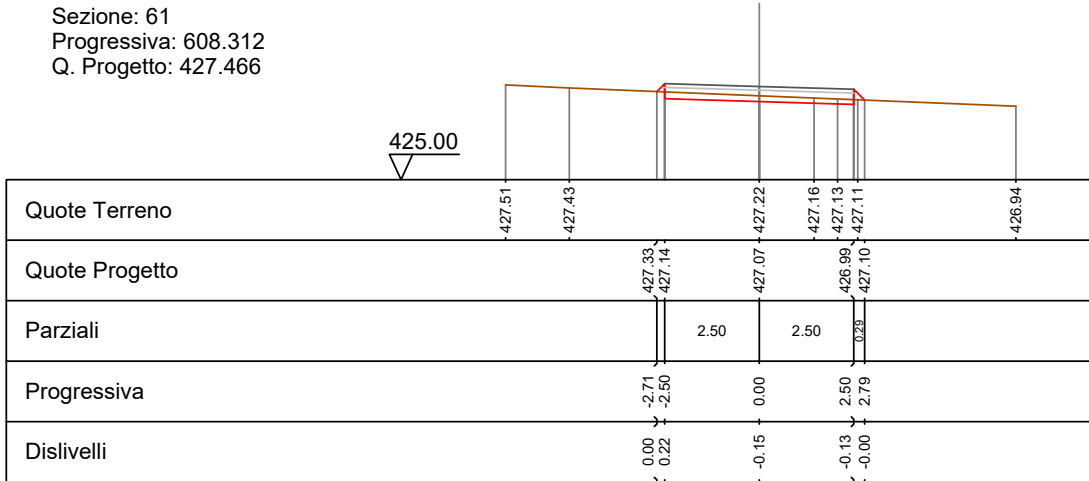

Sezione: 62
 Progressiva: 609.258
 Q. Progetto: 427.538

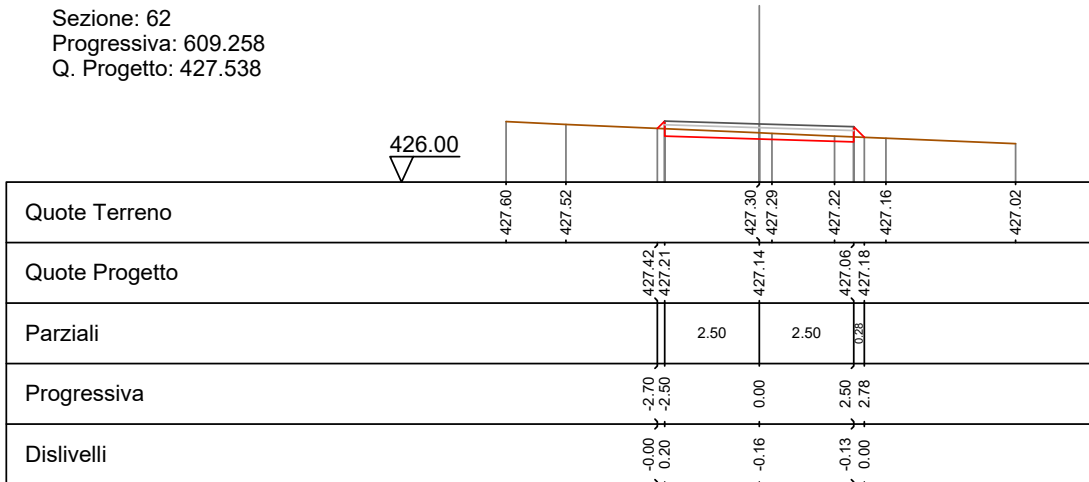

Sezione: 63
 Progressiva: 611.216
 Q. Progetto: 427.686

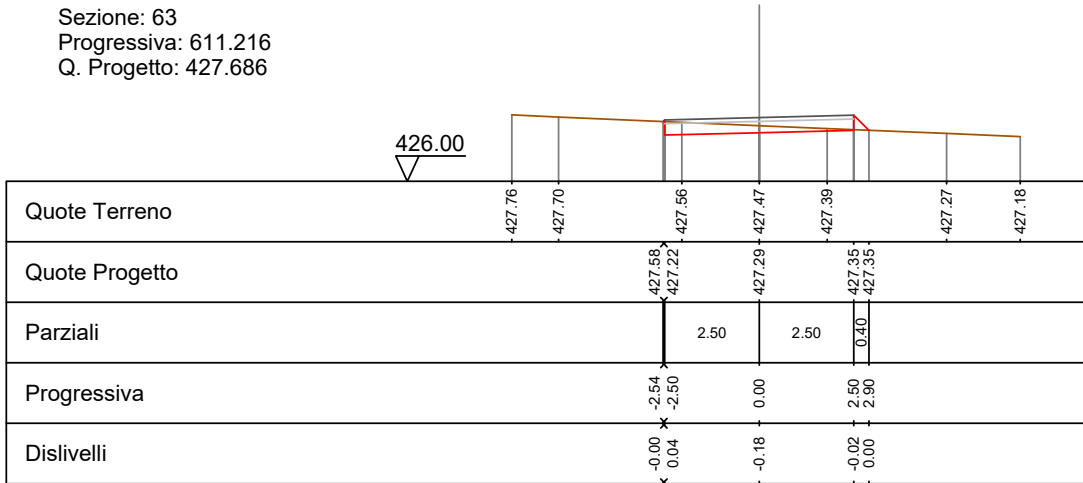

Sezione: 64
 Progressiva: 620.000
 Q. Progetto: 428.353

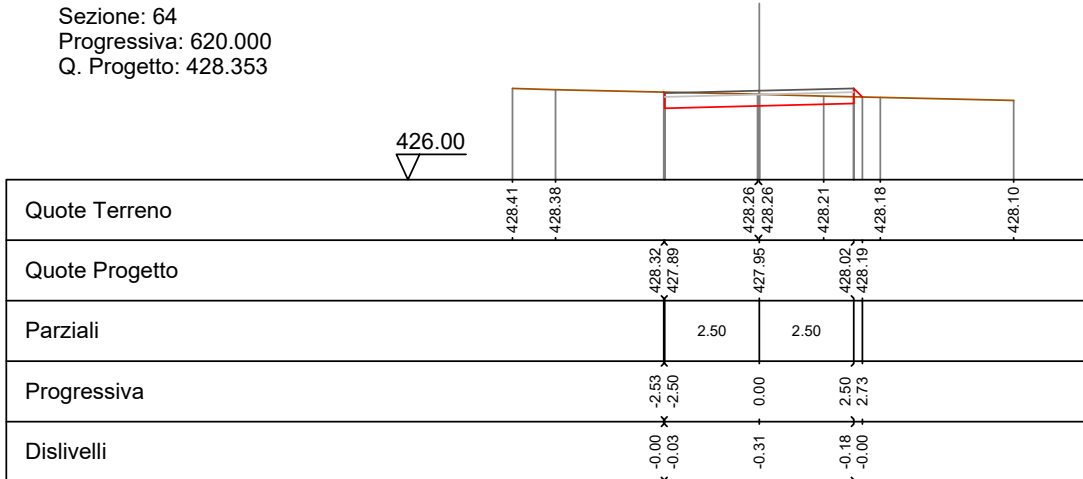

Sezione: 64
 Progressiva: 620.000
 Q. Progetto: 428.353

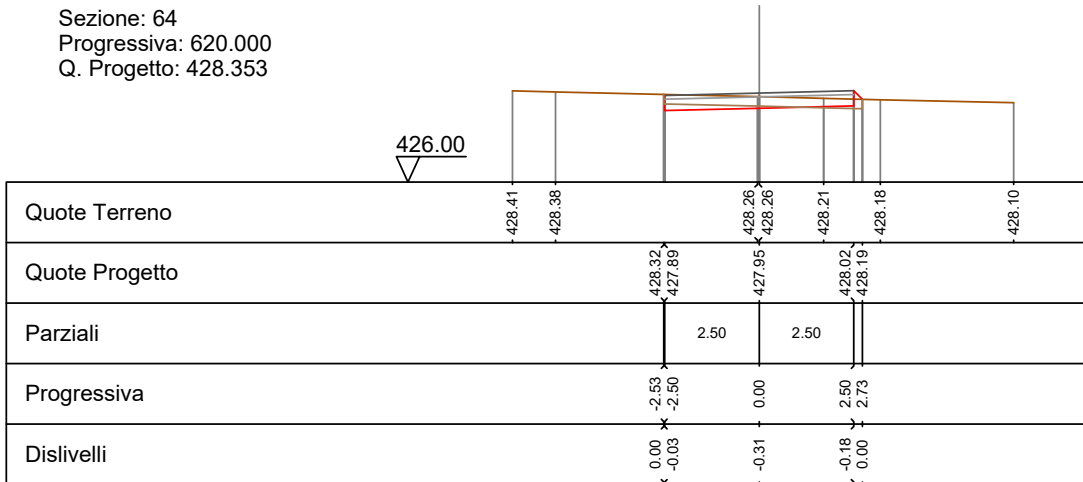

Sezione: 65
 Progressiva: 630.000
 Q. Progetto: 429.112

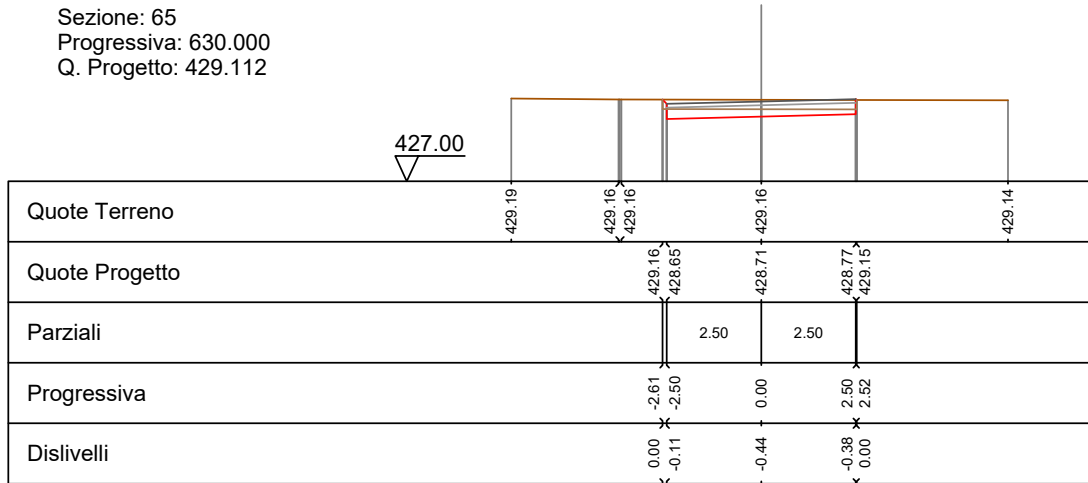

Sezione: 66
 Progressiva: 638.799
 Q. Progetto: 429.837

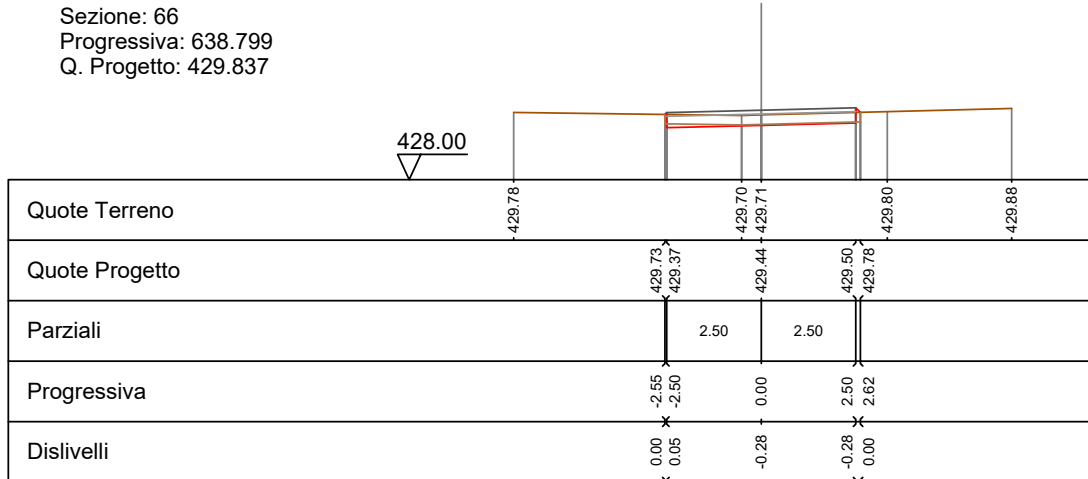

Sezione: 67
 Progressiva: 640.000
 Q. Progetto: 429.949

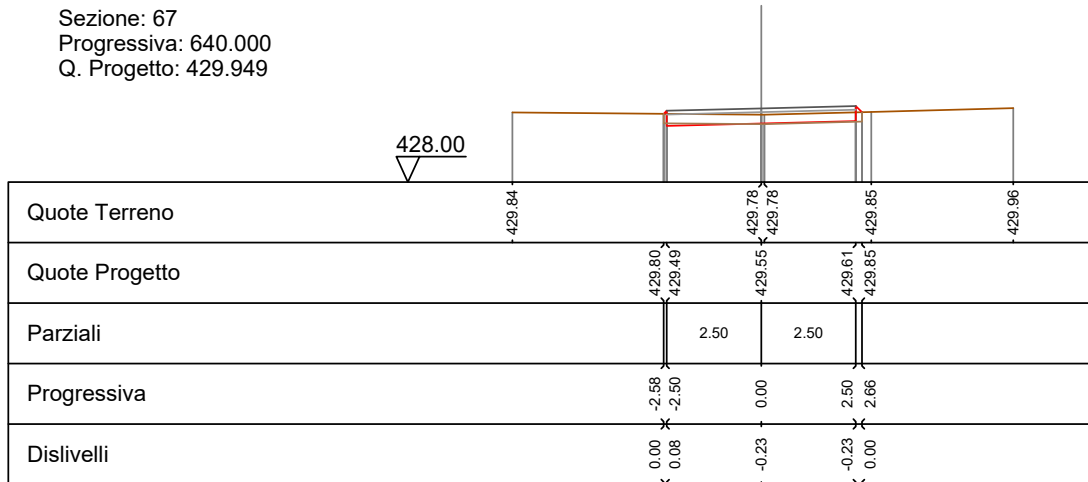

Sezione: 68
 Progressiva: 650.000
 Q. Progetto: 430.987

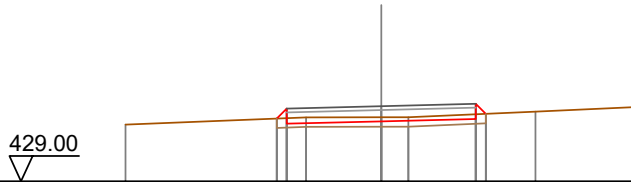

Quote Terreno	430.50	430.66	430.69	430.69	430.69	430.84	430.97
Quote Progetto		430.52	430.59	430.59	430.65	430.79	
Parziali		0.25	2.50	2.50	0.25		
Progressiva		-2.76	-2.50	0.00	2.50	2.76	
Dislivelli		0.00	0.25	-0.11	-0.12	0.00	

Sezione: 69
 Progressiva: 660.000
 Q. Progetto: 432.228

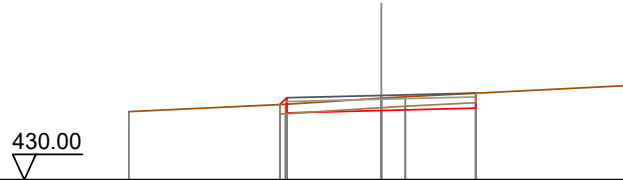

Quote Terreno	431.80	432.00	432.15	432.19	432.49
Quote Progetto		431.99	431.77	431.83	431.89
Parziali		2.50	2.50		
Progressiva		-2.68	-2.50	0.00	2.50
Dislivelli		-0.00	0.17	-0.33	-0.40

Sezione: 70
 Progressiva: 666.381
 Q. Progetto: 433.128

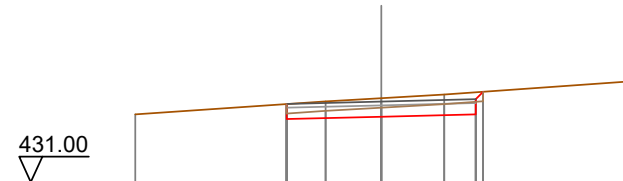

Quote Terreno	432.79	433.13	433.22	433.31	433.67
Quote Progetto		432.67	432.73	432.79	433.39
Parziali		2.50	2.50		
Progressiva		-2.50	0.00	2.50	2.70
Dislivelli		-0.00	-0.49	-0.58	0.00

Sezione: 71
 Progressiva: 671.795
 Q. Progetto: 433.939

432.00

Quote Terreno	433.69	433.80	433.94	433.54	434.09	434.25	434.30	434.44	434.47
Quote Progetto			433.94	433.48	433.54	433.60	434.25		
Parziali			2.50	2.50					
Progressiva			-2.56	-2.50	0.00	2.50	2.74		
Dislivelli			0.00	-0.07	-0.55	-0.63	0.00		

Sezione: 72
 Progressiva: 680.000
 Q. Progetto: 435.170

433.00

Quote Terreno	434.84	434.95	435.17	434.77	435.31	435.37	435.57	435.85
Quote Progetto			435.17	434.71	434.77	434.83	435.57	
Parziali			2.50	2.50	0.34			
Progressiva			-2.56	-2.50	0.00	2.50	2.84	
Dislivelli			0.00	-0.07	-0.60	-0.71	0.00	

Sezione: 73
 Progressiva: 686.918
 Q. Progetto: 436.189

434.00

Quote Terreno	435.74	435.85	436.19	435.79	436.38	436.78	437.01
Quote Progetto			436.19	435.73	435.79	436.67	
Parziali			2.50	2.50	0.41		
Progressiva			-2.51	-2.51	0.00	2.50	2.91
Dislivelli			0.00	-0.60	-0.60	-0.77	0.00

Sezione: 74
 Progressiva: 690.000
 Q. Progetto: 436.615

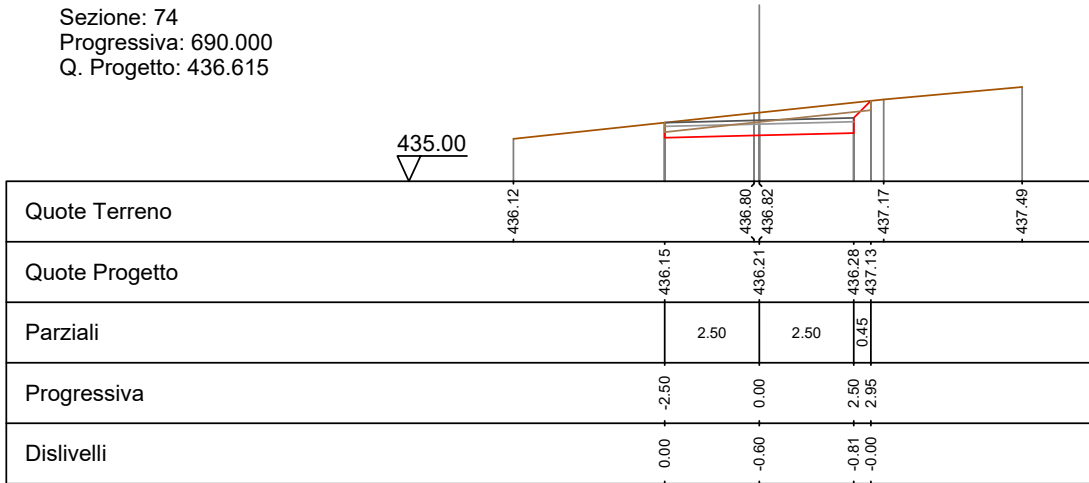

Sezione: 75
 Progressiva: 700.000
 Q. Progetto: 437.861

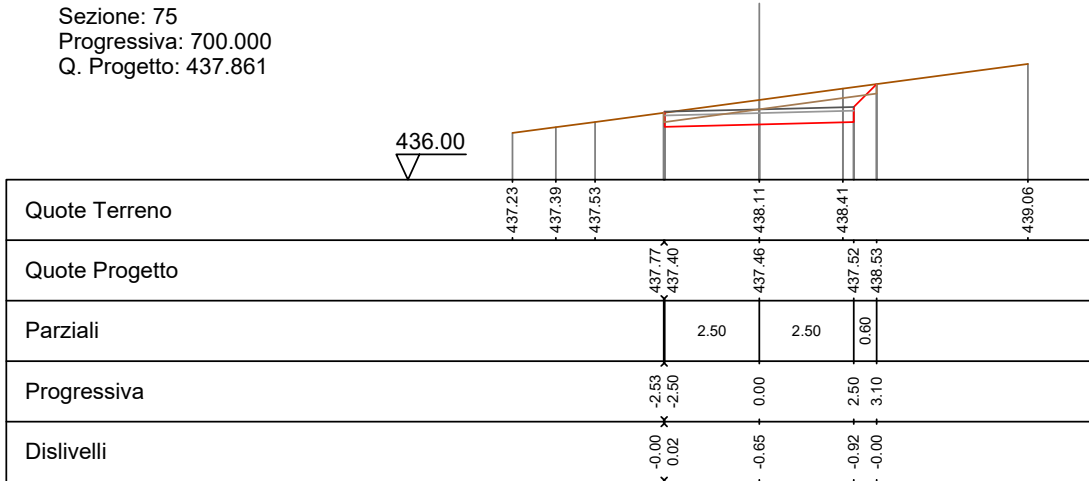

Sezione: 76
 Progressiva: 702.041
 Q. Progetto: 438.090

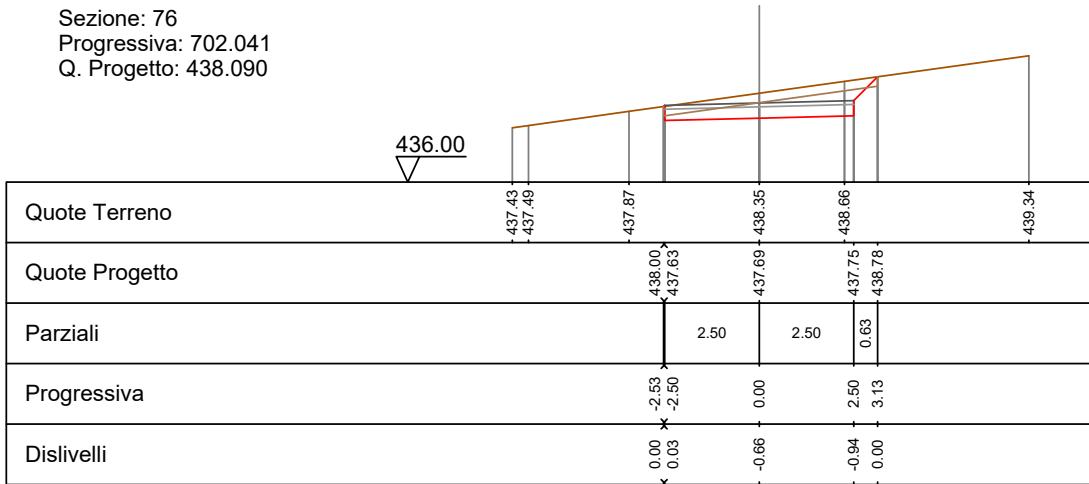

Sezione: 77
 Progressiva: 720.000
 Q. Progetto: 439.742

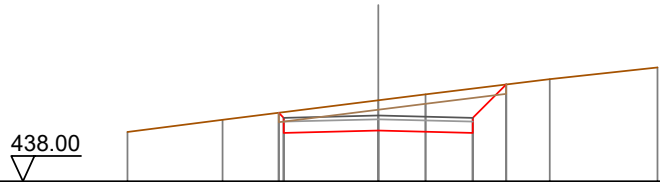

Quote Terreno	439.31	439.63	440.14	440.30	440.70	441.01
Quote Progetto		439.81	439.28	439.34	439.28	440.56
Parziali			2.50	2.50	0.88	
Progressiva		-2.63	-2.50	0.00	2.50	3.38
Dislivelli		-0.00	-0.15	-0.80	-1.17	0.00

Sezione: 78
 Progressiva: 724.558
 Q. Progetto: 440.057

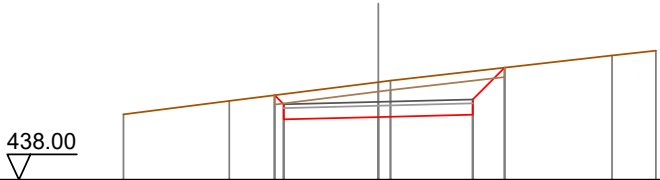

Quote Terreno	439.73	440.08	440.58	440.62	441.28	441.41
Quote Progetto		440.23	439.59	439.66	439.72	440.96
Parziali			2.50	2.50	0.84	
Progressiva		-2.74	-2.50	0.00	2.50	3.34
Dislivelli		0.00	-0.27	-0.92	-1.15	0.00

Sezione: 79
 Progressiva: 730.000
 Q. Progetto: 440.379

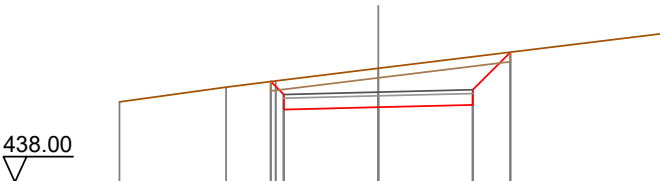

Quote Terreno	440.12	440.51	440.68	441.01	441.43	441.92
Quote Progetto		440.66	439.92	439.98	440.04	441.43
Parziali		0.34	2.50	2.50	0.99	
Progressiva		-2.84	-2.50	0.00	2.50	3.49
Dislivelli		0.00	-0.39	-1.03	-1.27	-0.00

Sezione: 80
 Progressiva: 737.588
 Q. Progetto: 440.729

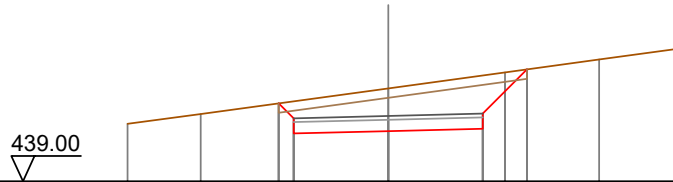

Quote Terreno	440.52	440.78		441.06	440.27	440.33	441.46	441.88	441.96	442.22	442.51
Quote Progetto				441.06	440.27	440.33	441.46	440.39	441.96		
Parziali				0.40	2.50		2.50	1.17			
Progressiva				-2.90	-2.50		0.00	2.50	3.67		
Dislivelli				0.00	-0.45		-1.13	-1.41	0.00		

Sezione: 81
 Progressiva: 740.000
 Q. Progetto: 440.816

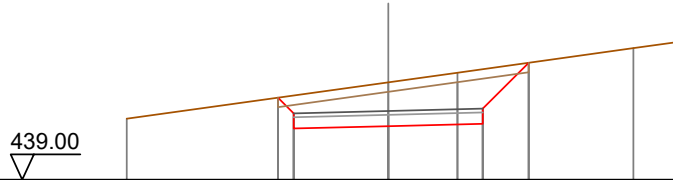

Quote Terreno	440.61			441.17	440.35	440.42	441.57	441.83	442.09	442.48	442.65
Quote Progetto				441.17	440.35	440.42	441.57	440.48	442.09		
Parziali				0.42	2.50		2.50	1.21			
Progressiva				-2.92	-2.50		0.00	2.50	3.71		
Dislivelli				0.00	-0.47		-1.16	-1.44	-0.00		

Sezione: 82
 Progressiva: 750.000
 Q. Progetto: 441.052

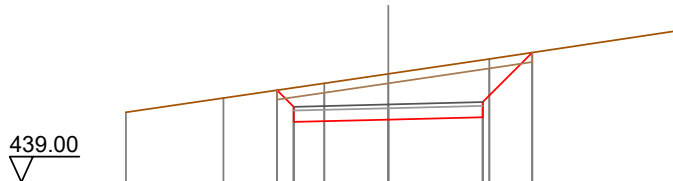

Quote Terreno	440.84	441.22		441.61	441.86	440.65	441.86	442.25	442.42	443.02
Quote Progetto				441.43	440.59	440.65	441.86	440.71	442.42	
Parziali				0.44	2.50		2.50	1.31		
Progressiva				-2.94	-2.50		0.00	2.50	3.81	
Dislivelli				-0.00	-0.50		-1.21	-1.51	0.00	

Sezione: 83
 Progressiva: 750.618
 Q. Progetto: 441.060

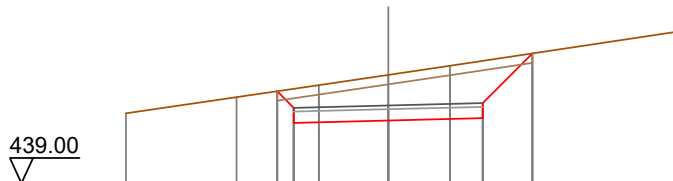

Quote Terreno	440.85	441.28	441.60	441.87	442.11	443.04
Quote Progetto			441.44 440.60	440.66	440.72	442.44
Parziali			0.44 2.50	2.50	1.31	
Progressiva			-2.94 -2.50	0.00	2.50	3.81
Dislivelli			-0.00 -0.50	-1.21	-1.52	0.00

Sezione: 84
 Progressiva: 760.000
 Q. Progetto: 441.148

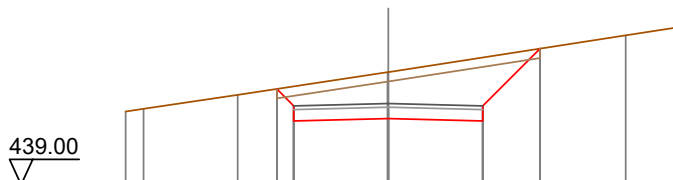

Quote Terreno	440.93	441.01	441.37	441.98	442.95	443.22
Quote Progetto			441.53 440.69	440.75	440.69	442.60
Parziali			0.45 2.50	2.50	1.51	
Progressiva			-2.95 -2.50	0.00	2.50	4.01
Dislivelli			0.00 -0.51	-1.23	-1.68	-0.00

Sezione: 85
 Progressiva: 780.000
 Q. Progetto: 441.300

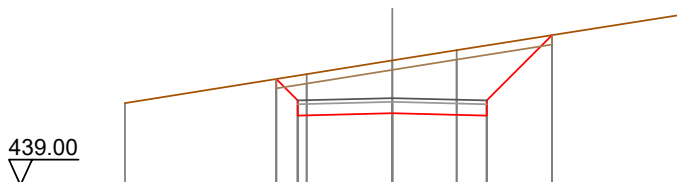

Quote Terreno	441.16	441.81	441.93	442.30	442.57	443.56
Quote Progetto		440.84 441.81	440.84	440.90	440.84	442.96
Parziali		0.57 2.50	2.50	2.50	1.73	
Progressiva		-3.07 -2.50	0.00	2.50	4.23	
Dislivelli		0.00 -0.66	-1.40	-1.86	0.00	

Sezione: 86
 Progressiva: 783.000
 Q. Progetto: 441.300

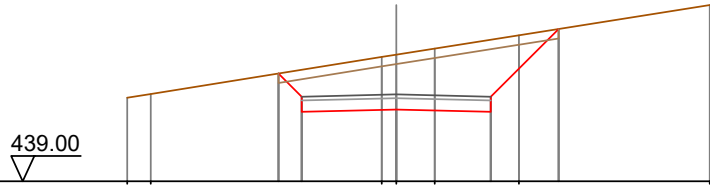

Quote Terreno	441.21	441.31		442.29	442.35	442.51	442.86	443.66
Quote Progetto			441.85	440.84	440.90	440.84	443.03	
Parziali			0.61	2.50	2.50	1.79		
Progressiva			-3.11	-2.50	0.00	2.50	4.29	
Dislivelli			0.00	-0.71	-1.45	-1.91	-0.00	

SEZIONI TRASVERSALI
Profilo longitudinale tratto 7-8
Viabilità di impianto postazione aerogeneratore T04

Nota: Le canalette di deflusso delle acque meteoriche, non indicate nel presente elaborato, sono rappresentate graficamente nelle sezioni stradali tipo dell'elaborato "WIND002-TC13_Piazzole aerogeneratori e strade di servizio - Particolari costruttivi", individuate planimetricamente nell'elaborato "WIND002-TC14_Opere di regimazione acque superficiali - Planimetria generale" e quantificate nell'elaborato "WIND002-RC6_Computo Metrico Estimativo".

DISEGNI DI RIFERIMENTO

TAVOLA	DESCRIZIONE
WIND002-TC8	Piazzole e viabilità - Planimetria di progetto - Fase di cantiere
WIND002-TC11	Profili longitudinali viabilità di impianto
WIND002-TC13	Piazzole aerogeneratori e strade di servizio - Particolari costruttivi
WIND002-TC14	Opere di regimazione acque superficiali - Planimetria generale

Sezione: 1
 Progressiva: 0.000
 Q. Progetto: 427.619

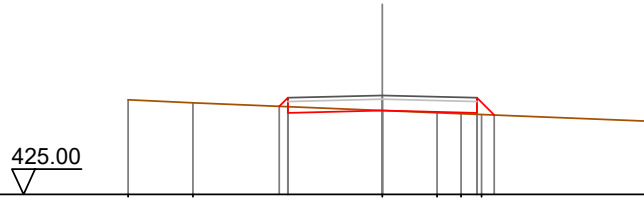

Quote Terreno	427.50	427.42		427.22	427.16	427.13	427.11	426.94
Quote Progetto			427.33	427.16	427.22	427.16	427.10	
Parziali				2.50	2.50	0.46		
Progressiva			-2.73	-2.50	0.00	2.50	2.96	
Dislivelli			0.00	0.24	-0.00	0.04	-0.00	

Sezione: 2
 Progressiva: 20.000
 Q. Progetto: 429.601

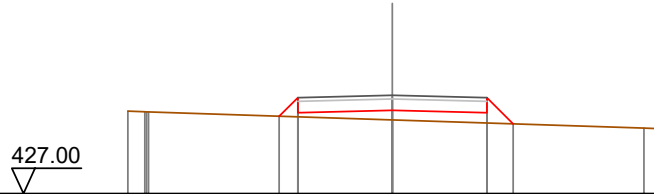

Quote Terreno	429.18	429.16		428.95			428.73	428.71
Quote Progetto			429.05	429.14	429.20	429.14	428.84	
Parziali			0.49	2.50	2.50	0.69		
Progressiva			-2.99	-2.50	0.00	2.50	3.19	
Dislivelli			0.00	0.51	0.25	0.27	0.00	

Sezione: 3
 Progressiva: 30.133
 Q. Progetto: 430.605

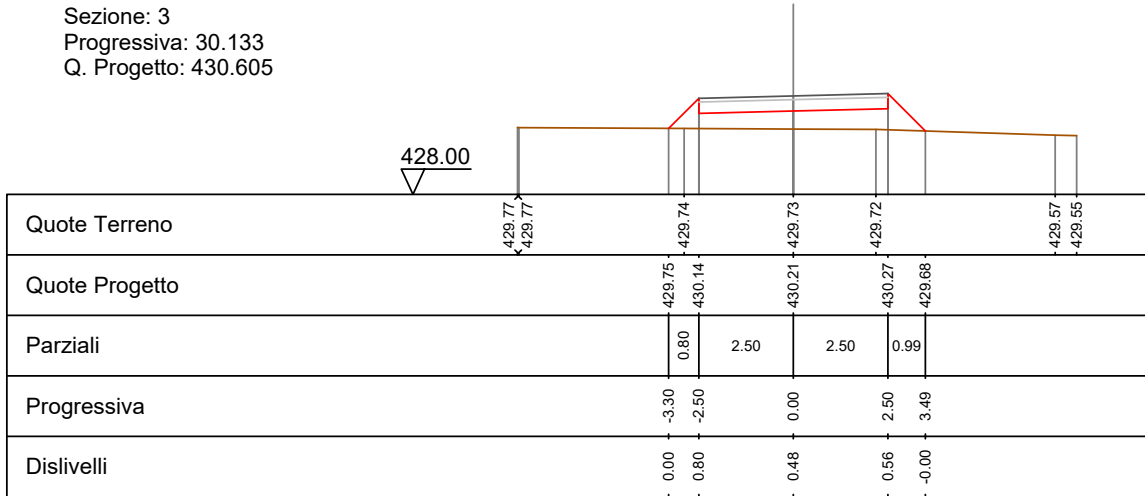

Sezione: 4
 Progressiva: 31.297
 Q. Progetto: 430.721

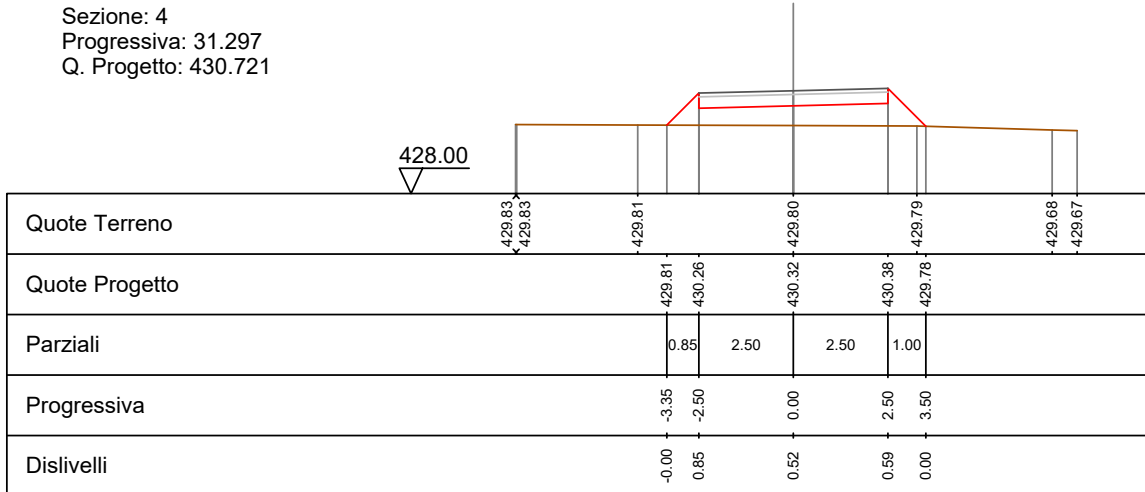

Sezione: 5
 Progressiva: 32.462
 Q. Progetto: 430.836

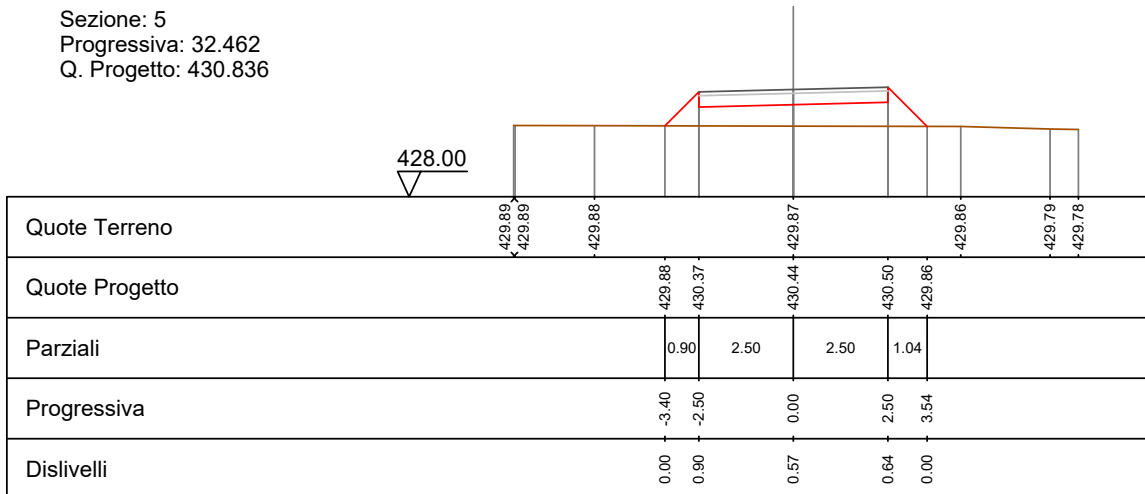

Sezione: 6
 Progressiva: 40.000
 Q. Progetto: 431.583

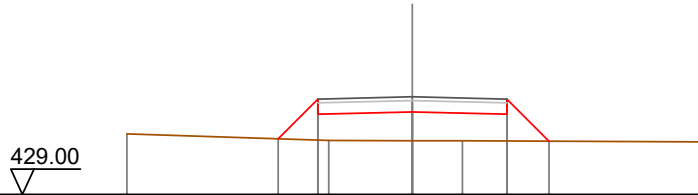

Quote Terreno	430.60			430.43		430.42		430.39
Quote Progetto		430.47	431.12		431.18		431.12	430.41
Parziali		1.05	2.50		2.50		1.11	
Progressiva		-3.55	-2.50		0.00		2.50	3.61
Dislivelli		0.00	1.08		0.76		0.71	-0.00

Sezione: 7
 Progressiva: 60.000
 Q. Progetto: 433.565

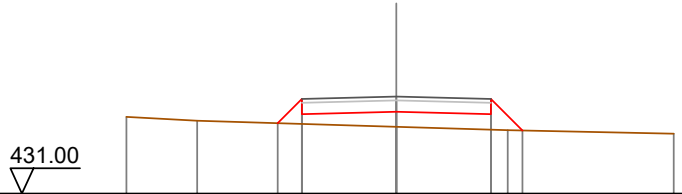

Quote Terreno	433.03	432.93			432.77		432.68	432.59
Quote Progetto			432.86	433.10		433.17	433.10	432.67
Parziali			0.64	2.50		2.50	0.83	
Progressiva			-3.14	-2.50		0.00	2.50	3.33
Dislivelli			-0.00	0.66		0.40	0.41	-0.00

Sezione: 8
 Progressiva: 71.816
 Q. Progetto: 434.737

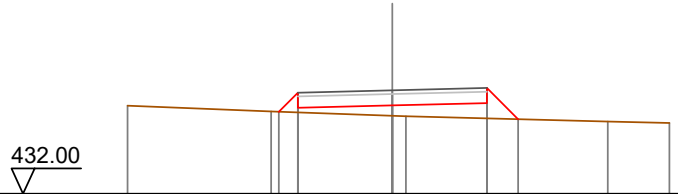

Quote Terreno	434.33		434.18		434.06	434.05		433.91	433.87
Quote Progetto			434.17	434.27		434.34		434.40	433.97
Parziali			0.50	2.50		2.50		0.83	
Progressiva			-3.00	-2.50		0.00		2.50	3.33
Dislivelli			0.00	0.52		0.27		0.41	0.00

Sezione: 9
 Progressiva: 73.030
 Q. Progetto: 434.857

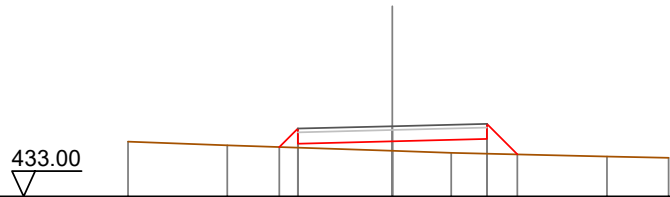

Quote Terreno	434.45	434.35		434.21	434.15		434.06	434.02
Quote Progetto			434.31	434.46	434.52	434.11		
Parziali			0.49	2.50	2.50	0.81		
Progressiva			-2.99	0.00	2.50	3.31		
Dislivelli			0.00	0.25	0.39	-0.00		

Sezione: 10
 Progressiva: 74.243
 Q. Progetto: 434.977

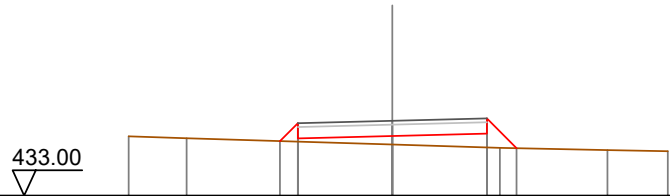

Quote Terreno	434.57	434.52		434.35	434.26		434.20	434.17
Quote Progetto			434.44	434.58	434.64	434.25		
Parziali			0.47	2.50	2.50	0.78		
Progressiva			-2.97	0.00	2.50	3.28		
Dislivelli			0.00	0.23	0.37	0.00		

Sezione: 11
 Progressiva: 80.000
 Q. Progetto: 435.548

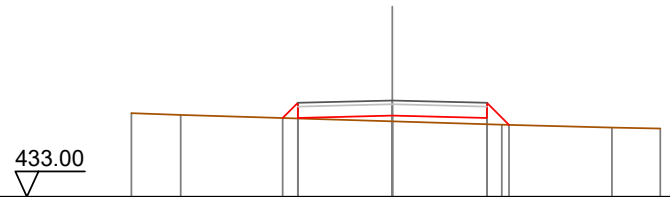

Quote Terreno	435.21	435.17		434.99	434.91		434.83	434.81
Quote Progetto			435.08	435.15	435.09	434.90		
Parziali			0.40	2.50	2.50	0.58		
Progressiva			-2.90	0.00	2.50	3.08		
Dislivelli			-0.00	0.15	0.17	0.00		

Sezione: 12
 Progressiva: 100.000
 Q. Progetto: 437.530

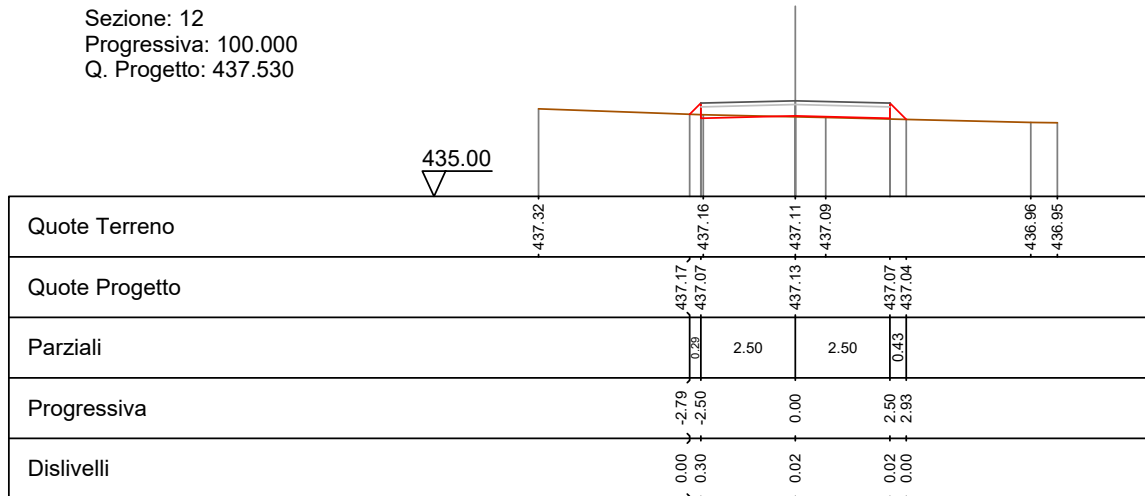

Sezione: 13
 Progressiva: 120.000
 Q. Progetto: 439.507

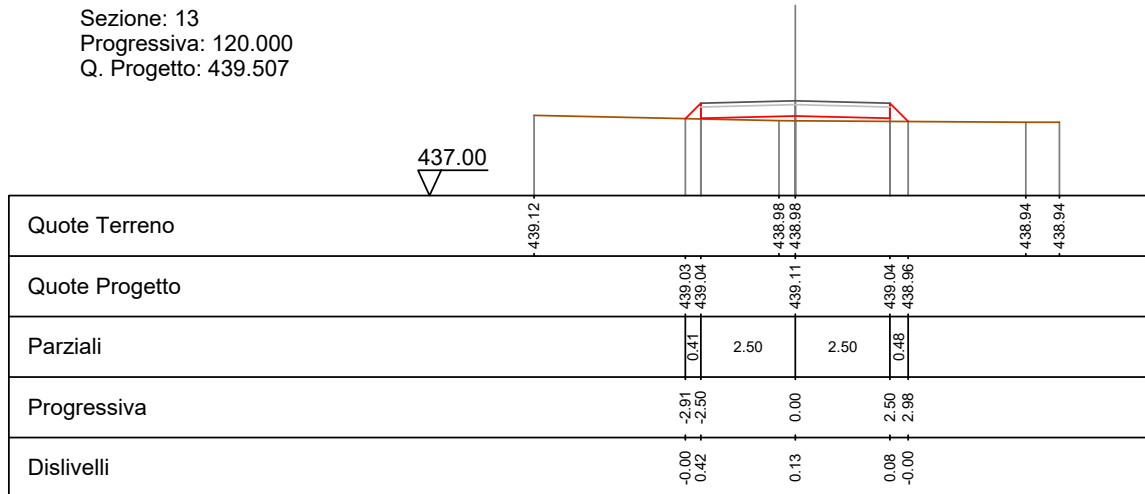

Sezione: 14
 Progressiva: 126.803
 Q. Progetto: 440.105

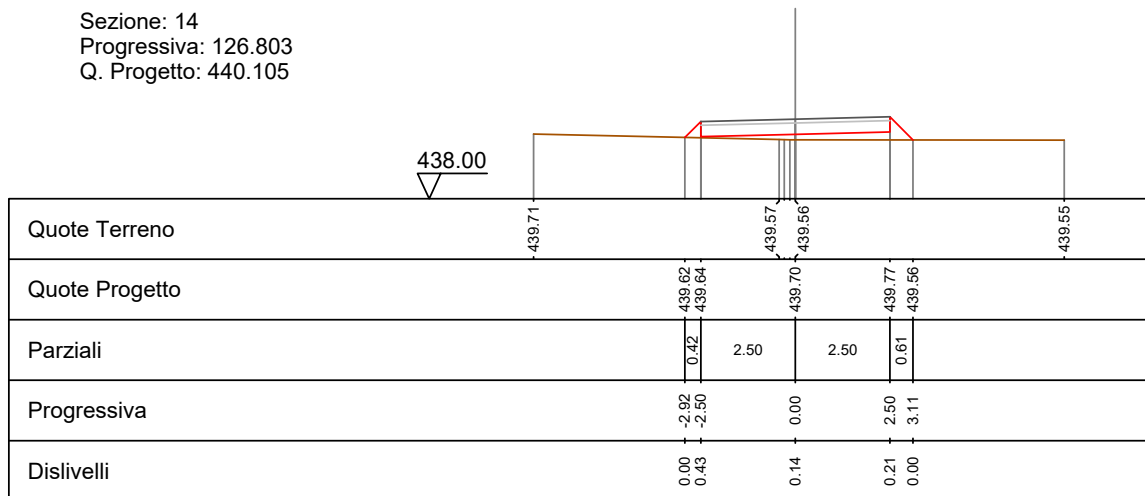

Sezione: 15
 Progressiva: 130.000
 Q. Progetto: 440.374

438.00

Quote Terreno	439.95		439.79	439.79	439.78	439.79
Quote Progetto		439.86	439.91	439.97	440.04	
Parziali		0.45	2.50	2.50	0.65	
Progressiva		-2.95	-2.50	0.00	2.50	3.15
Dislivelli		0.00	0.46	0.18	0.25	-0.00

Sezione: 16
 Progressiva: 130.213
 Q. Progetto: 440.392

438.00

Quote Terreno	439.97		439.81	439.81	439.80	439.81
Quote Progetto		439.90	439.93	439.99	440.05	
Parziali		0.43	2.50	2.50	0.65	
Progressiva		-2.93	-2.50	0.00	2.50	3.15
Dislivelli		-0.00	0.45	0.18	0.25	0.00

Sezione: 17
 Progressiva: 133.622
 Q. Progetto: 440.678

439.00

Quote Terreno	440.23		440.06	440.06	440.07	440.05
Quote Progetto	440.22	440.13	440.22	440.28	440.34	440.06
Parziali		0.48	2.50	2.50	0.68	
Progressiva		-2.98	-2.50	0.00	2.50	3.18
Dislivelli		0.00	0.49	0.21	0.28	-0.00

Sezione: 18
 Progressiva: 140.000
 Q. Progetto: 441.214

439.00

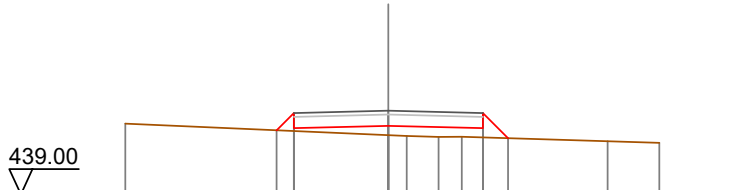

Quote Terreno	440.87			440.57	440.54	440.52	440.52		440.41	440.36
Quote Progetto			440.70	440.81			440.75	440.49		
Parziali			0.46	2.50		2.50	0.66			
Progressiva			-2.96	0.00		2.50	3.16			
Dislivelli			0.00	0.48		0.24	0.00			

Sezione: 19
 Progressiva: 160.000
 Q. Progetto: 442.895

440.00

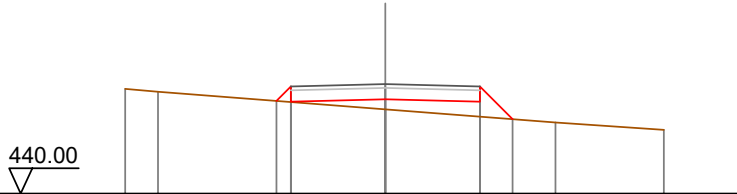

Quote Terreno	442.77	442.69		442.23			441.88	441.69
Quote Progetto			442.45	442.50		442.43	441.97	
Parziali			0.38	2.50		2.50	0.86	
Progressiva			-2.88	0.00		2.50	3.36	
Dislivelli			-0.00	0.41		0.40	-0.00	

Sezione: 20
 Progressiva: 167.270
 Q. Progetto: 443.506

441.00

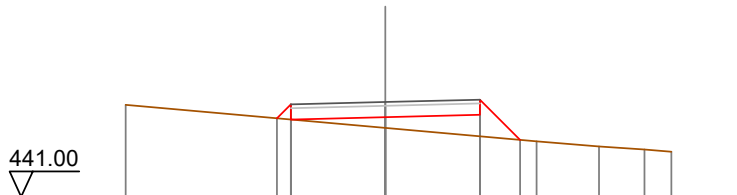

Quote Terreno	443.43			442.82			442.47	442.33	442.25	442.19
Quote Progetto			443.08	443.11		443.17	442.51			
Parziali			0.37	2.50		2.50	1.06			
Progressiva			-2.87	0.00		2.50	3.56			
Dislivelli			-0.00	0.40		0.57	-0.00			

Sezione: 21
 Progressiva: 170.000
 Q. Progetto: 443.735

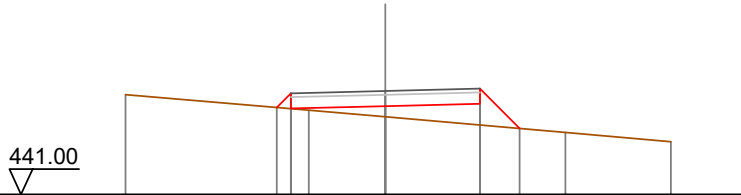

Quote Terreno	443.64		443.23		443.05		442.64	442.40
Quote Progetto		443.30 443.27		443.34		443.40 442.75		
Parziali		0.37 2.50		2.50		1.05		
Progressiva		-2.87 -2.50		0.00		2.50 3.55		
Dislivelli		0.00 0.40		0.28		0.56 0.00		

Sezione: 22
 Progressiva: 171.472
 Q. Progetto: 443.859

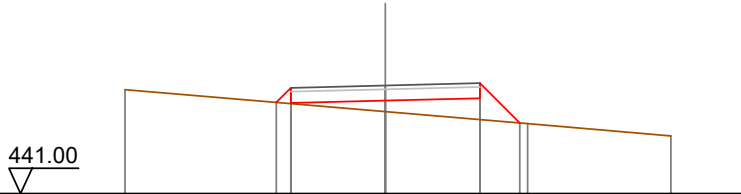

Quote Terreno	443.75			443.17			442.85	442.53
Quote Progetto		443.41 443.40		443.46		443.52 442.87		
Parziali		0.38 2.50		2.50		1.05		
Progressiva		-2.88 -2.50		0.00		2.50 3.55		
Dislivelli		-0.00 0.42		0.29		0.56 0.00		

Sezione: 23
 Progressiva: 175.674
 Q. Progetto: 444.212

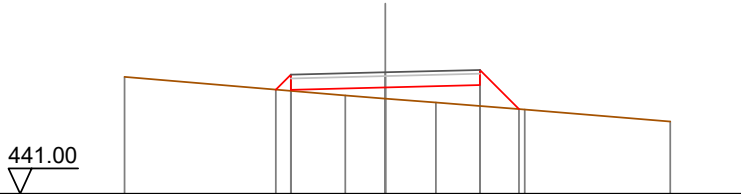

Quote Terreno	444.09		443.60		443.52		443.41		443.23	442.91
Quote Progetto		443.75 443.75		443.81		443.87 443.24				
Parziali		0.40 2.50		2.50		1.03				
Progressiva		-2.90 -2.50		0.00		2.50 3.53				
Dislivelli		-0.00 0.43		0.30		0.55 0.00				

Sezione: 24
 Progressiva: 180.000
 Q. Progetto: 444.576

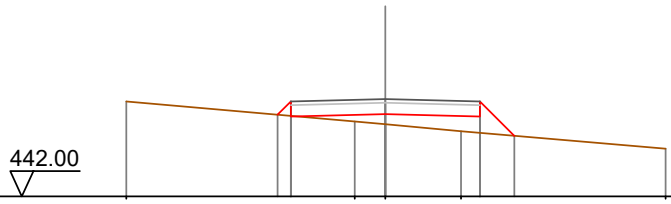

Quote Terreno	444.51		443.98	443.91	443.72	443.26
Quote Progetto		444.16	444.11	444.18	444.11	443.60
Parziali		0.35	2.50	2.50	0.91	
Progressiva		-2.85	-2.50	0.00	2.50	3.41
Dislivelli		-0.00	0.38	0.27	0.43	-0.00

Sezione: 25
 Progressiva: 183.018
 Q. Progetto: 444.830

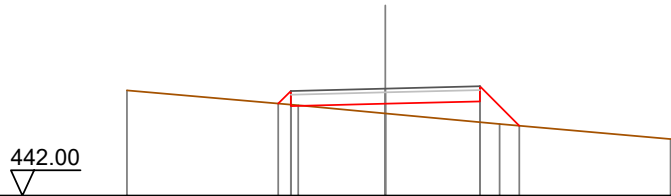

Quote Terreno	444.78		444.39	444.17	443.89	443.50
Quote Progetto		444.43	444.37	444.43	444.49	443.85
Parziali		0.33	2.50	2.50	1.04	
Progressiva		-2.83	-2.50	0.00	2.50	3.54
Dislivelli		0.00	0.36	0.26	0.55	0.00

Sezione: 26
 Progressiva: 184.939
 Q. Progetto: 444.991

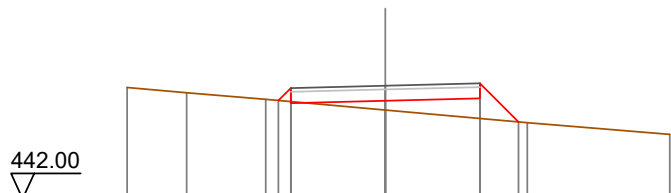

Quote Terreno	444.94	444.80	444.63	444.35	444.01	443.70	
Quote Progetto			444.60	444.59	444.65	444.03	
Parziali			0.33	2.50	2.50	1.02	
Progressiva			-2.83	-2.50	0.00	2.50	3.52
Dislivelli			-0.00	0.36	0.24	0.53	-0.00

Sezione: 27
 Progressiva: 186.861
 Q. Progetto: 445.153

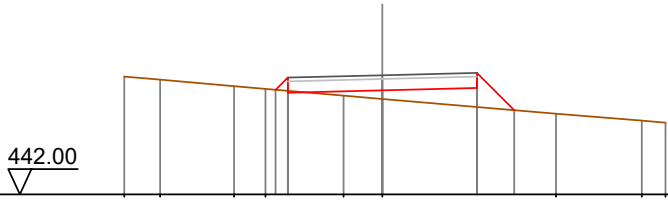

Quote Terreno		445.12	445.04	444.86	444.79	444.61	444.53	444.13	443.95	443.90
Quote Progetto					444.77	444.69	444.75	444.82	444.23	
Parziali					0.32	2.50	2.50	0.99		
Progressiva					-2.82	-2.50	0.00	2.50	3.49	
Dislivelli					0.00	0.35	0.23	0.50	0.00	

Sezione: 28
 Progressiva: 200.000
 Q. Progetto: 446.257

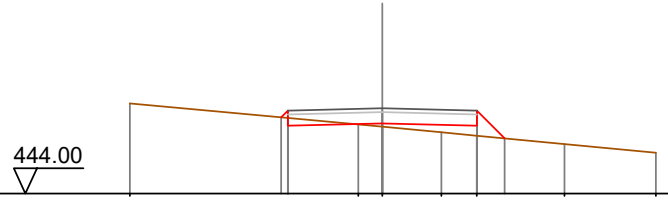

Quote Terreno		446.38		445.83	445.77	445.62	445.53	445.31	445.08
Quote Progetto				446.02	445.79	445.86	445.79	445.46	
Parziali				2.50	2.50	0.73			
Progressiva				-2.68	-2.50	0.00	2.50	3.23	
Dislivelli				-0.00	0.19	0.09	0.27	-0.00	

Sezione: 29
 Progressiva: 220.000
 Q. Progetto: 447.938

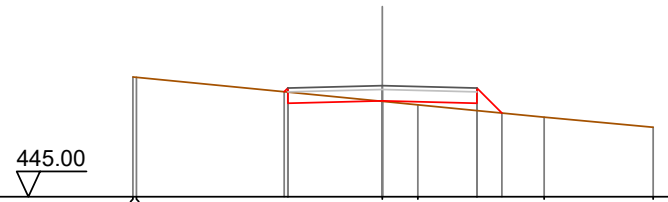

Quote Terreno		448.17	448.16		447.52	447.43		447.11	446.84
Quote Progetto				447.78	447.48	447.54	447.48	447.22	
Parziali				2.50	2.50	0.66			
Progressiva				-2.60	-2.50	0.00	2.50	3.16	
Dislivelli				-0.00	0.11	0.01	0.20	-0.00	

Sezione: 30
 Progressiva: 240.000
 Q. Progetto: 449.619

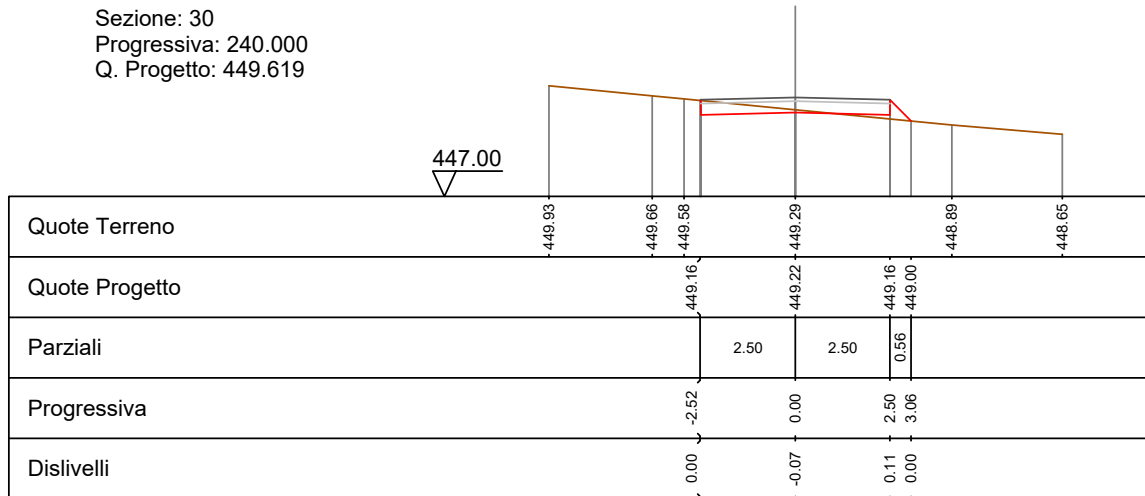

Quote Terreno	449.93	449.66	449.58	449.29	449.16	448.89	448.65
Quote Progetto			449.16	449.22	449.16	449.00	
Parziali			2.50	2.50	0.56		
Progressiva			-2.52	0.00	2.50	3.06	
Dislivelli			0.00	-0.07	0.11	0.00	

Sezione: 31
 Progressiva: 259.990
 Q. Progetto: 451.590

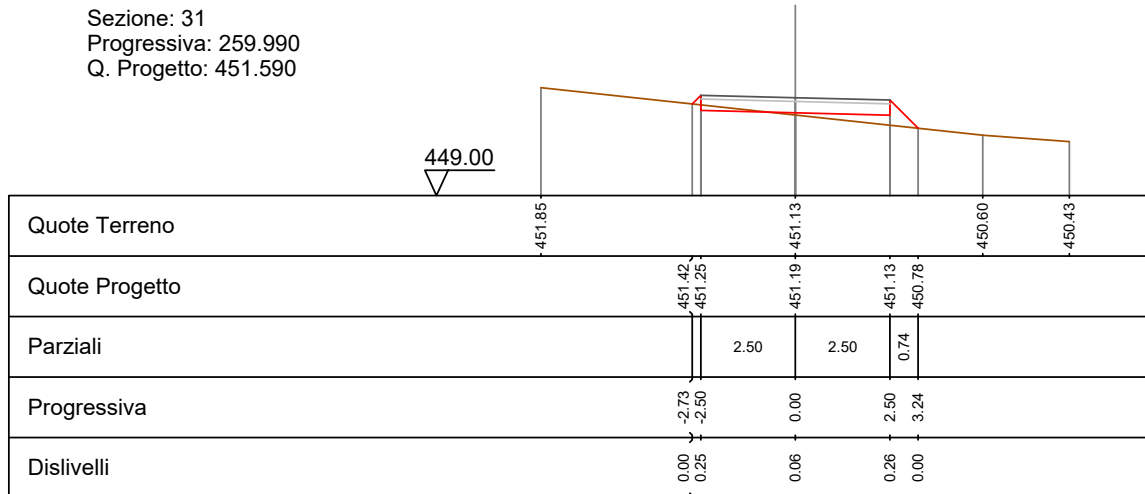

Quote Terreno	451.85			451.13		450.60	450.43
Quote Progetto		451.42	451.25	451.19	451.13	450.78	
Parziali		2.50	2.50	0.74			
Progressiva		-2.73	-2.50	0.00	2.50	3.24	
Dislivelli		0.00	0.25	0.06	0.26	0.00	

Sezione: 32
 Progressiva: 264.947
 Q. Progetto: 452.193

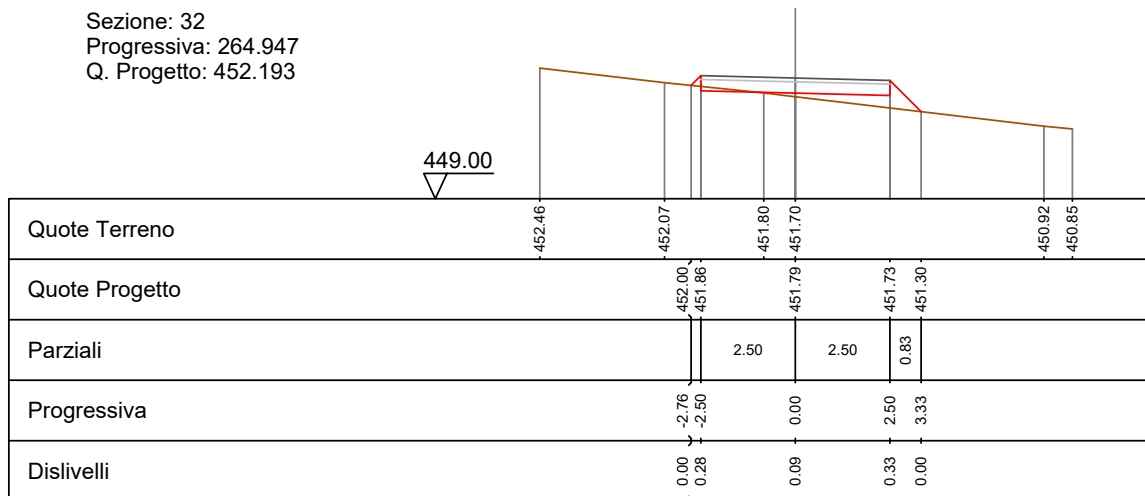

Quote Terreno	452.46	452.07	451.80	451.70		450.92	450.85
Quote Progetto		452.00	451.86	451.79	451.73	451.30	
Parziali		2.50	2.50	0.83			
Progressiva		-2.76	-2.50	0.00	2.50	3.33	
Dislivelli		0.00	0.28	0.09	0.33	0.00	

Sezione: 33
 Progressiva: 269.905
 Q. Progetto: 452.801

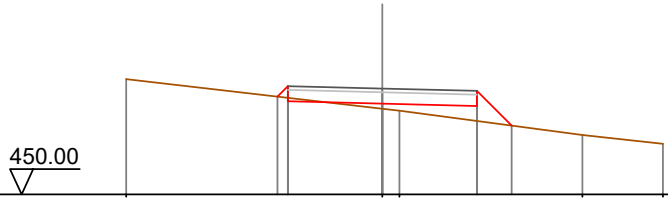

Quote Terreno	453.05		452.27		451.57	451.34
Quote Progetto		452.59	452.46	452.40	452.34	
Parziali		0.28	2.50	2.50	0.92	
Progressiva		-2.78	-2.50	0.00	2.50	3.42
Dislivelli		0.00	0.31	0.13	0.40	0.00

Sezione: 34
 Progressiva: 280.000
 Q. Progetto: 454.038

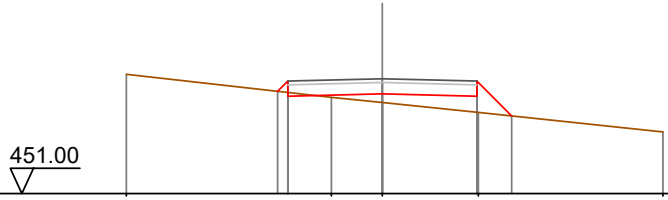

Quote Terreno	454.16		453.41		453.15	452.63
Quote Progetto		453.71	453.58	453.64	453.56	453.06
Parziali		0.27	2.50	2.50	0.92	
Progressiva		-2.77	-2.50	0.00	2.50	3.42
Dislivelli		0.00	0.30	0.23	0.42	0.00

Sezione: 35
 Progressiva: 300.000
 Q. Progetto: 456.490

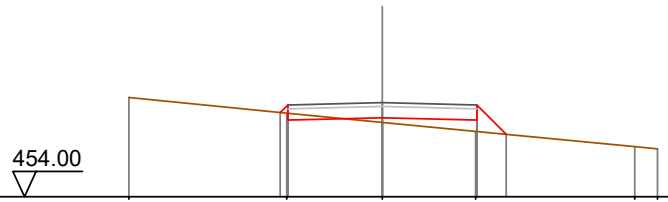

Quote Terreno	456.63		455.97		455.73	455.33	455.27
Quote Progetto		456.23	456.03	456.09	456.03	455.85	
Parziali			2.50	2.50	0.77		
Progressiva		-2.70	-2.50	0.00	2.50	3.27	
Dislivelli		0.00	0.22	0.12	0.30	-0.00	

Sezione: 36
 Progressiva: 320.000
 Q. Progetto: 459.218

456.00

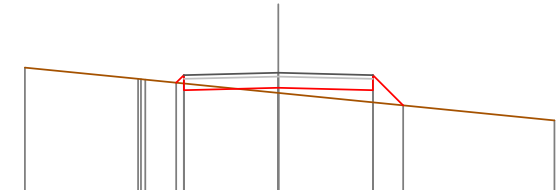

Quote Terreno	459.35	459.06	459.04	458.82	458.68	457.96
Quote Progetto		458.95	458.76	458.82	458.76	458.36
Parziali			2.50	2.50	0.80	
Progressiva		-2.70	-2.50	0.00	2.50	3.30
Dislivelli		0.00	0.22	0.13	0.32	0.00

Sezione: 37
 Progressiva: 333.127
 Q. Progetto: 461.227

458.00

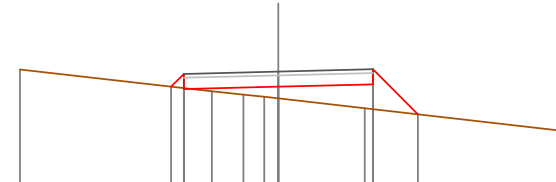

Quote Terreno	461.28	460.83	460.76	460.71	460.62	460.56	460.52	460.26	459.64
Quote Progetto		460.83	460.76	460.83	460.89	460.89	460.10		
Parziali		0.34	2.50	2.50	1.19				
Progressiva		-2.84	-2.50	0.00	2.50	3.69			
Dislivelli		0.00	0.37	0.31	0.66	0.00			

Sezione: 38
 Progressiva: 338.106
 Q. Progetto: 461.989

459.00

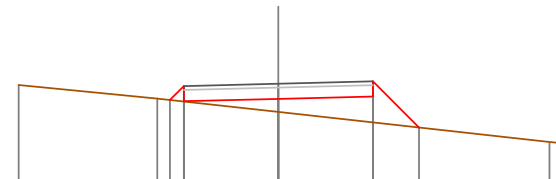

Quote Terreno	461.96	461.60	461.24	461.24	461.65	460.39	460.39
Quote Progetto		461.56	461.53	461.59	461.65	460.83	
Parziali		0.37	2.50	2.50	1.22		
Progressiva		-2.87	-2.50	0.00	2.50	3.72	
Dislivelli		0.00	0.41	0.35	0.69	0.00	

Sezione: 39
 Progressiva: 340.000
 Q. Progetto: 462.279

459.00

Quote Terreno	462.22	462.19		461.97		461.84	461.82		461.54		461.25		460.79	460.70
Quote Progetto						461.84	461.82		461.88		461.94		461.15	
Parziali						0.38	2.50		2.50		1.19			
Progressiva						-2.88	-2.50		0.00		2.50		3.69	
Dislivelli						0.00	0.42		0.34		0.66		0.00	

Sezione: 40
 Progressiva: 343.086
 Q. Progetto: 462.751

460.00

Quote Terreno	462.67	462.58	462.51			462.30	462.29		462.02			461.48	461.22
Quote Progetto						462.30	462.29		462.35		462.41		461.66
Parziali						0.39	2.50		2.50		1.15		
Progressiva						-2.89	-2.50		0.00		2.50		3.65
Dislivelli						0.00	0.42		0.33		0.64		0.00

Sezione: 41
 Progressiva: 360.000
 Q. Progetto: 465.340

462.00

Quote Terreno	465.53			464.97	464.79		464.54			463.79
Quote Progetto				464.88	464.94		464.88		464.32	
Parziali				2.50	2.50		0.96			
Progressiva				-2.67	-2.50		2.50		3.46	
Dislivelli				-0.00	0.19		0.43		0.00	

Sezione: 42
 Progressiva: 380.000
 Q. Progetto: 468.401

465.00

Quote Terreno		468.97		468.24	468.05	467.86		467.09	466.78
Quote Progetto			468.40	467.94	468.00		467.94	467.51	
Parziali				2.50		2.50		0.83	
Progressiva			-2.56	-2.50	0.00		2.50	3.33	
Dislivelli			0.00	-0.05		-0.05		0.28	0.00

Sezione: 43
 Progressiva: 400.000
 Q. Progetto: 471.462

467.00

Quote Terreno		471.61	471.56		471.15		470.38	470.07	469.78	469.65	469.36	468.94
Quote Progetto				470.92	471.00		471.06	471.00	469.63			
Parziali				0.48	2.50		2.50	1.77				
Progressiva				-2.98	-2.50		0.00	2.50	4.27			
Dislivelli				0.00	0.56		0.68	1.06	0.00			

Sezione: 44
 Progressiva: 409.831
 Q. Progetto: 472.966

468.00

Quote Terreno		472.80		471.62	471.48	471.38				469.97
Quote Progetto			472.09	472.50	472.57	472.63	470.66			
Parziali			0.81	2.50	2.50	2.36				
Progressiva			-3.31	-2.50	0.00	2.50	4.86			
Dislivelli			0.00	0.95	1.06	1.55	0.00			

Sezione: 47
 Progressiva: 427.069
 Q. Progetto: 475.604

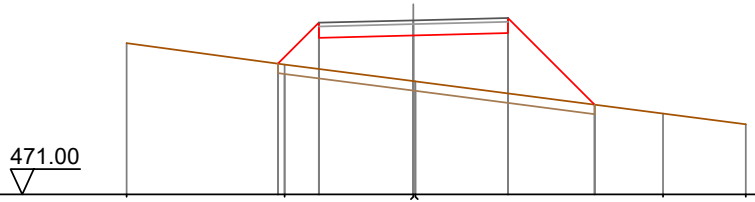

Quote Terreno		475.00		474.44		474.00		473.99		473.14		472.86
Quote Progetto			474.46	475.14		475.20		475.27		473.37		
Parziali			1.08	2.50		2.50		2.29				
Progressiva			-3.58	-2.50		0.00		2.50		4.79		
Dislivelli			0.00	1.22		1.21		1.59		0.00		

Sezione: 48
 Progressiva: 437.403
 Q. Progetto: 477.186

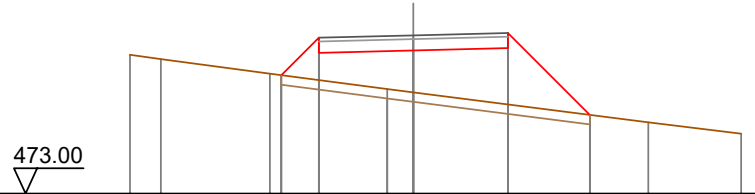

Quote Terreno		476.67		476.56		476.17		475.77		475.68		474.88		474.58
Quote Progetto				476.13		476.72		476.79		476.85		475.08		
Parziali				0.99		2.50		2.50		2.17				
Progressiva				-3.49		-2.50		0.00		2.50		4.67		
Dislivelli				0.00		1.12		1.11		1.49		0.00		

Sezione: 49
 Progressiva: 440.000
 Q. Progetto: 477.583

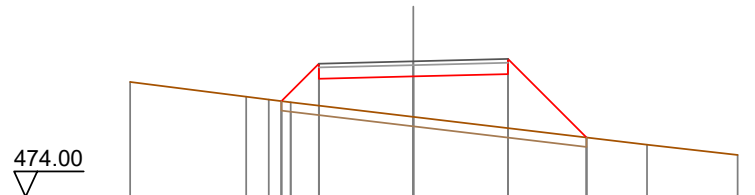

Quote Terreno		477.04		476.65		476.57		476.50		476.11		475.38		475.11
Quote Progetto				476.53		477.12		477.18		477.25		475.57		
Parziali				0.99		2.50		2.50		2.08				
Progressiva				-3.49		-2.50		0.00		2.50		4.58		
Dislivelli				0.00		1.11		1.07		1.43		-0.00		

Sezione: 50
 Progressiva: 447.470
 Q. Progetto: 478.726

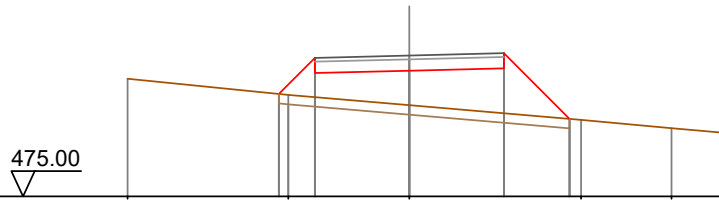

Quote Terreno	478.11	477.69	477.41	477.03	476.80	476.69
Quote Progetto		477.71	478.26	478.33	478.39	477.05
Parziali		0.95	2.50	2.50	1.74	
Progressiva		-3.45	-2.50	0.00	2.50	4.24
Dislivelli		-0.00	1.04	0.91	1.19	0.00

Sezione: 51
 Progressiva: 450.000
 Q. Progetto: 479.113

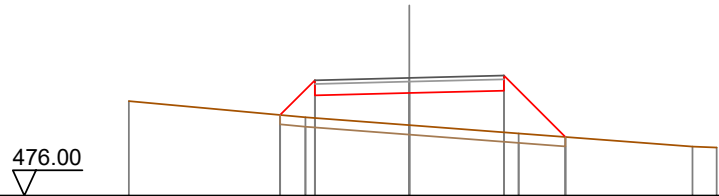

Quote Terreno	478.50	478.07	477.86	477.64	477.30	477.27
Quote Progetto		478.13	478.65	478.71	478.78	477.55
Parziali		0.92	2.50	2.50	1.63	
Progressiva		-3.42	-2.50	0.00	2.50	4.13
Dislivelli		0.00	1.00	0.85	1.10	-0.00

Sezione: 52
 Progressiva: 457.537
 Q. Progetto: 480.267

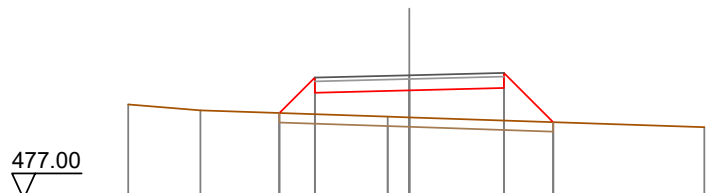

Quote Terreno	479.49	479.34	479.17	479.15	478.89	
Quote Progetto		479.27	479.80	479.87	479.93	479.03
Parziali		0.94	2.50	2.50	1.30	
Progressiva		-3.44	-2.50	0.00	2.50	3.80
Dislivelli		-0.00	0.97	0.71	0.86	0.00

Sezione: 53
 Progressiva: 460.000
 Q. Progetto: 480.644

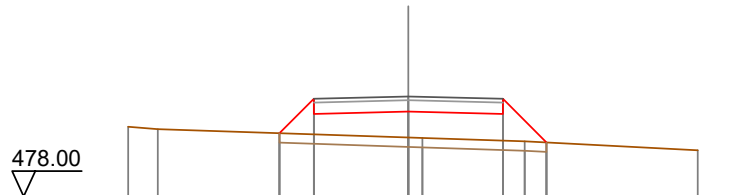

Quote Terreno	479.84	479.78		479.56	479.55	479.46	479.22
Quote Progetto			479.67	480.18	480.24	480.18	479.43
Parziali			0.91	2.50	2.50	1.15	
Progressiva			-3.41	-2.50	0.00	2.50	3.65
Dislivelli			0.00	0.94	0.68	0.70	-0.00

Sezione: 54
 Progressiva: 480.000
 Q. Progetto: 483.705

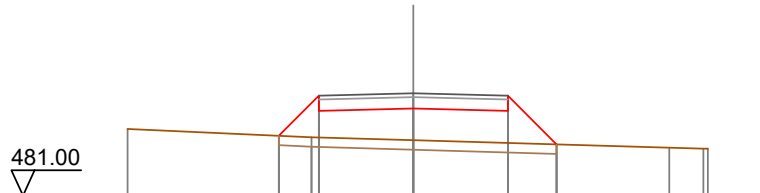

Quote Terreno	482.76		482.54	482.47		482.27	482.24	482.24
Quote Progetto			482.58	483.24	483.30	483.24	482.35	
Parziali			1.06	2.50	2.50	1.29		
Progressiva			-3.56	-2.50	0.00	2.50	3.79	
Dislivelli			0.00	1.10	0.84	0.85	0.00	

Sezione: 55
 Progressiva: 499.939
 Q. Progetto: 486.756

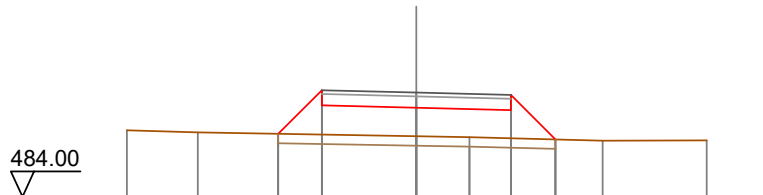

Quote Terreno	485.76	485.70		485.60	485.58		485.48	485.49
Quote Progetto			485.66	486.42	486.36	486.29	485.52	
Parziali			1.15	2.50	2.50	1.18		
Progressiva			-3.65	-2.50	0.00	2.50	3.68	
Dislivelli			0.00	1.17	0.76	0.75	0.00	

Sezione: 56
 Progressiva: 510.000
 Q. Progetto: 488.296

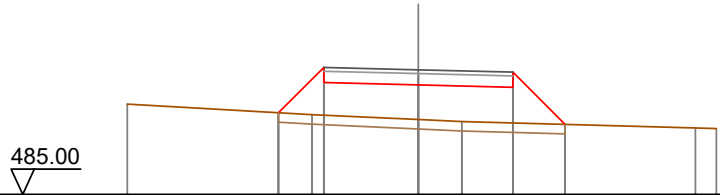

Quote Terreno		487.39		487.11		487.90		486.93		486.76	486.74
Quote Progetto			487.16	487.96		487.90		487.83	486.85		
Parziali			1.20	2.50		2.50		1.38			
Progressiva			-3.70	-2.50		0.00		2.50	3.88		
Dislivelli			0.00	1.26		0.92		0.94	0.00		

Sezione: 57
 Progressiva: 519.069
 Q. Progetto: 489.684

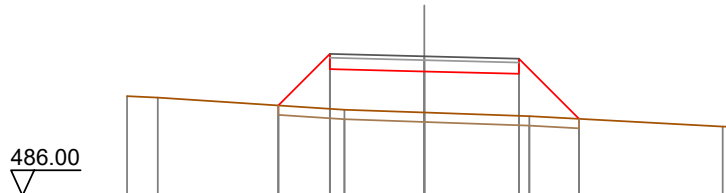

Quote Terreno		488.63		488.59		488.27		488.20		488.10	487.83	487.82
Quote Progetto				488.38	489.35		489.28		489.22	488.03		
Parziali				1.36	2.50		2.50		1.59			
Progressiva				-3.86	-2.50		0.00		2.50	4.09		
Dislivelli				-0.00	1.45		1.09		1.11	-0.00		

Sezione: 58
 Progressiva: 520.000
 Q. Progetto: 489.826

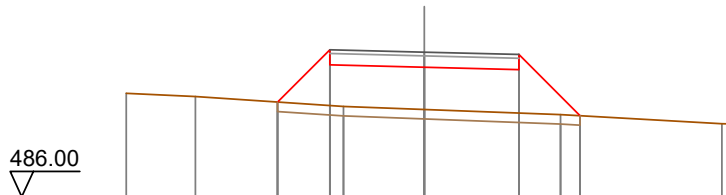

Quote Terreno		488.74		488.65		488.39		488.31		488.17	487.93	487.93
Quote Progetto				488.50	489.49		489.43		489.36	488.14		
Parziali				1.38	2.50		2.50		1.62			
Progressiva				-3.88	-2.50		0.00		2.50	4.12		
Dislivelli				0.00	1.48		1.12		1.15	0.00		

Sezione: 59
 Progressiva: 530.000
 Q. Progetto: 491.302

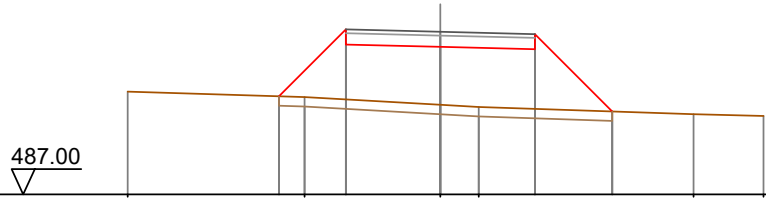

Quote Terreno	489.72	489.57	490.96	489.37	489.31	490.84	489.19	489.12	489.07
Quote Progetto		489.60	490.96	490.90	489.31	490.84	489.19		
Parziali		1.77	2.50	2.50	2.04				
Progressiva		-4.27	-2.50	0.00	2.50	4.54			
Dislivelli		0.00	1.85	1.53	1.58	-0.00			

Sezione: 60
 Progressiva: 538.199
 Q. Progetto: 492.365

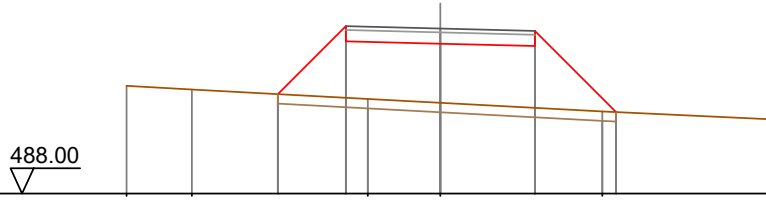

Quote Terreno	490.85	490.75	490.50	490.40	490.17	489.97
Quote Progetto		490.63	492.03	491.96	491.90	490.16
Parziali		1.80	2.50	2.50	2.15	
Progressiva		-4.30	-2.50	0.00	2.50	4.65
Dislivelli		-0.00	1.89	1.56	1.63	0.00

Sezione: 61
 Progressiva: 540.000
 Q. Progetto: 492.580

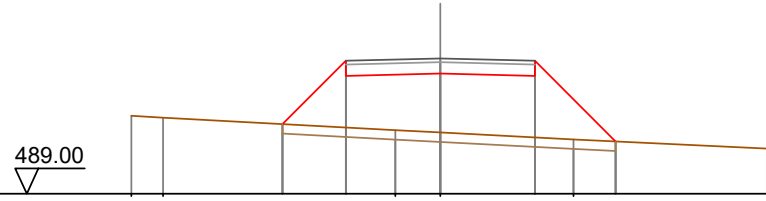

Quote Terreno	491.06	491.01	490.68	490.62	490.43	490.20
Quote Progetto		490.84	492.12	492.18	492.12	490.38
Parziali		1.67	2.50	2.50	2.13	
Progressiva		-4.17	-2.50	0.00	2.50	4.63
Dislivelli		0.00	1.76	1.56	1.63	-0.00

Sezione: 62
 Progressiva: 549.271
 Q. Progetto: 493.582

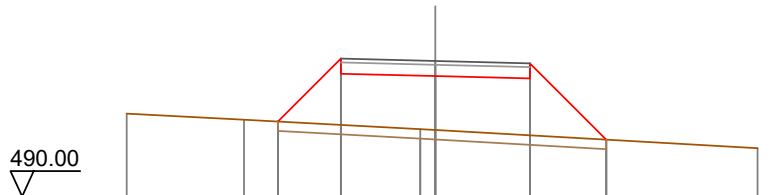

Quote Terreno	-492.19	-492.03	-491.98	-493.24	-491.78	-491.76	-491.27
Quote Progetto		491.98	493.24	493.18	493.12	491.50	
Parziali		1.66	2.50	2.50	2.02		
Progressiva		-4.16	-2.50	0.00	2.50	4.52	
Dislivelli		0.00	1.75	1.43	1.51	-0.00	

Sezione: 63
 Progressiva: 550.000
 Q. Progetto: 493.654

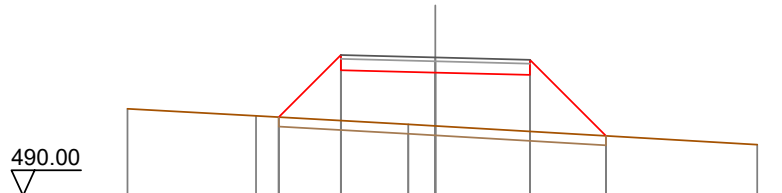

Quote Terreno	-492.29	-492.11	-491.89	-491.84	-491.35	
Quote Progetto		492.08	493.32	493.25	493.19	491.58
Parziali		1.64	2.50	2.50	2.01	
Progressiva		-4.14	-2.50	0.00	2.50	4.51
Dislivelli		0.00	1.73	1.41	1.49	0.00

Sezione: 64
 Progressiva: 560.000
 Q. Progetto: 494.525

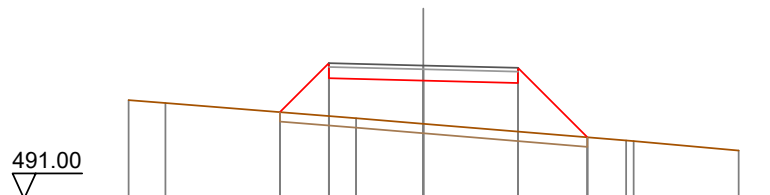

Quote Terreno	-493.61	-493.53	-493.13	-492.98	-492.54	-492.52	-492.28
Quote Progetto			493.29	494.19	494.12	494.06	492.62
Parziali			1.30	2.50	2.50	1.84	
Progressiva			-3.80	-2.50	0.00	2.50	4.34
Dislivelli			-0.00	1.40	1.14	1.29	0.00

Sezione: 65
 Progressiva: 565.121
 Q. Progetto: 494.893

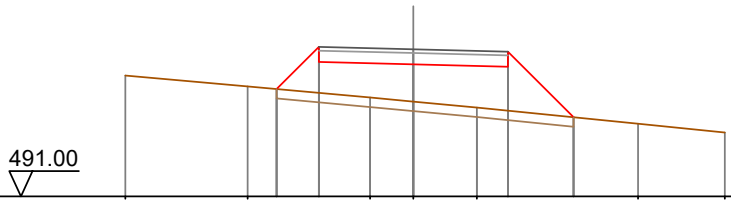

Quote Terreno	494.20	493.91		493.62	493.51	493.35		492.92	492.69
Quote Progetto			493.84	494.56	494.49	494.43	493.09		
Parziali			1.12	2.50	2.50	1.74			
Progressiva		-3.62	-2.50	0.00	2.50	4.24			
Dislivelli		-0.00	1.22	0.98	1.16	0.00			

Sezione: 66
 Progressiva: 570.000
 Q. Progetto: 495.194

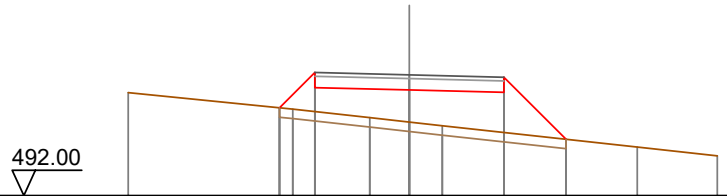

Quote Terreno	494.72	494.29	494.06	493.95	493.85		493.28	493.05
Quote Progetto		494.32	494.86	494.79	494.73	493.49		
Parziali		0.93	2.50	2.50	1.64			
Progressiva		-3.43	-2.50	0.00	2.50	4.14		
Dislivelli		-0.00	1.03	0.85	1.06	-0.00		

Sezione: 67
 Progressiva: 580.000
 Q. Progetto: 495.662

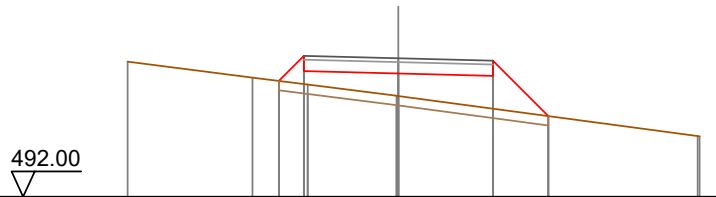

Quote Terreno	495.57	495.15	494.97	494.67	494.67		493.61	493.60
Quote Progetto		495.06	495.32	495.26	495.20	494.13		
Parziali		0.66	2.50	2.50	1.47			
Progressiva		-3.16	-2.50	0.00	2.50	3.97		
Dislivelli		0.00	0.74	0.60	0.87	0.00		

Sezione: 68
 Progressiva: 580.971
 Q. Progetto: 495.697

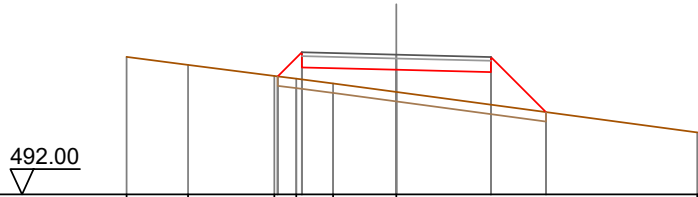

Quote Terreno		495.64		495.43		495.12	495.06	494.94		494.71		493.64	
Quote Progetto						495.36	495.36			495.30		495.23	494.18
Parziali						0.64	2.50			2.50		1.46	
Progressiva						-3.14	-2.50			0.00		2.50	3.96
Dislivelli						0.00	0.72			0.59		0.86	0.00

Sezione: 69
 Progressiva: 600.000
 Q. Progetto: 496.000

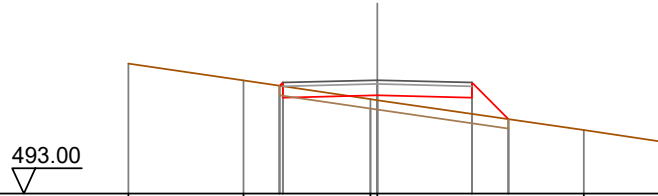

Quote Terreno		496.44		495.99		495.50	495.47			494.68		494.38	
Quote Progetto						495.85	495.54			495.60		495.54	494.97
Parziali							2.50			2.50		0.97	
Progressiva						-2.59	-2.50			0.00		2.50	3.47
Dislivelli						0.00	0.10			0.13		0.43	-0.00

SEZIONI TRASVERSALI
Profilo longitudinale tratto 9-10
Viabilità di impianto postazione aerogeneratore T05

Nota: Le canalette di deflusso delle acque meteoriche, non indicate nel presente elaborato, sono rappresentate graficamente nelle sezioni stradali tipo dell'elaborato "WIND002-TC13_Piazzole aerogeneratori e strade di servizio - Particolari costruttivi", individuate planimetricamente nell'elaborato "WIND002-TC14_Opere di regimazione acque superficiali - Planimetria generale" e quantificate nell'elaborato "WIND002-RC6_Computo Metrico Estimativo".

DISEGNI DI RIFERIMENTO

TAVOLA	DESCRIZIONE
WIND002-TC8	Piazzole e viabilità - Planimetria di progetto - Fase di cantiere
WIND002-TC11	Profili longitudinali viabilità di impianto
WIND002-TC13	Piazzole aerogeneratori e strade di servizio - Particolari costruttivi
WIND002-TC14	Opere di regimazione acque superficiali - Planimetria generale

Sezione: 4
 Progressiva: 20.000
 Q. Progetto: 506.440

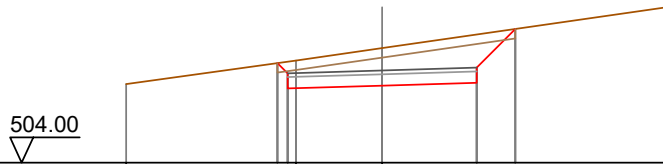

Quote Terreno	506.08	506.70	507.03	508.11
Quote Progetto		506.63 505.96	506.04	506.11 507.54
Parziali		0.27 2.50	2.50	1.02
Progressiva		-2.77 -2.50	0.00	2.50 3.52
Dislivelli		0.00 -0.31	-0.99	-1.28 0.00

Sezione: 5
 Progressiva: 27.714
 Q. Progetto: 506.492

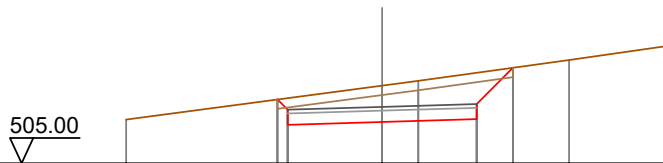

Quote Terreno	506.16	507.06	507.18	507.73	508.09
Quote Progetto		506.69 506.02	506.09	506.17 507.53	
Parziali		0.27 2.50	2.50	0.96	
Progressiva		-2.77 -2.50	0.00	2.50 3.46	
Dislivelli		-0.00 -0.31	-0.96	-1.23 0.00	

Sezione: 6
 Progressiva: 30.000
 Q. Progetto: 506.485

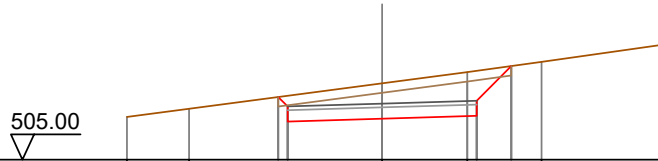

Quote Terreno	-506.13	-506.35			-507.02	-507.32	-507.59	-508.04
Quote Progetto			506.66	506.01	506.08	506.16	507.48	
Parziali				2.50	2.50	0.92		
Progressiva			-2.75	-2.50	0.00	2.50	3.42	
Dislivelli			0.00	-0.28	-0.94	-1.19	0.00	

Sezione: 7
 Progressiva: 40.000
 Q. Progetto: 506.330

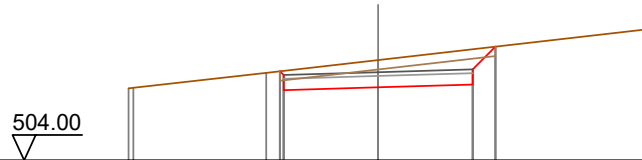

Quote Terreno	-505.90	-505.92			-506.65			-507.47
Quote Progetto			506.35	505.85	505.93	506.00	507.01	
Parziali				2.50	2.50	0.60		
Progressiva			-2.60	-2.50	0.00	2.50	3.10	
Dislivelli			0.00	-0.11	-0.72	-0.93	0.00	

Sezione: 8
 Progressiva: 50.000
 Q. Progetto: 505.975

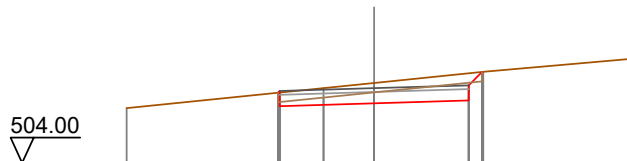

Quote Terreno	-505.45				-505.98	-506.11	-506.41	-506.76
Quote Progetto			505.85	505.50	505.57	505.57	506.40	
Parziali				2.50	2.50		0.35	
Progressiva			-2.55	-2.50	0.00	2.50	2.85	
Dislivelli			0.00	0.04	-0.54	-0.72	0.00	

Sezione: 9
 Progressiva: 54.010
 Q. Progetto: 505.792

504.00

Quote Terreno	505.24	505.48	505.57	505.86	506.21	506.47
Quote Progetto			505.61 505.32	505.39	505.47 506.13	
Parziali			2.50	2.50	0.28	
Progressiva			-2.61 -2.50	0.00	2.50 2.76	
Dislivelli			0.00 0.10	-0.47	-0.63 -0.00	

Sezione: 10
 Progressiva: 60.000
 Q. Progetto: 505.519

503.00

Quote Terreno	504.88			505.48 505.49	505.88	506.09 506.13
Quote Progetto			505.24 505.06	505.12	505.06 505.76	
Parziali			2.50	2.50	0.31	
Progressiva			-2.71 -2.50	0.00	2.50 2.81	
Dislivelli			-0.00 0.19	-0.37	-0.68 0.00	

Sezione: 11
 Progressiva: 64.095
 Q. Progetto: 505.333

503.00

Quote Terreno	504.71	504.79		505.34	505.48	505.94
Quote Progetto			505.09 504.86	504.93	505.01 505.69	
Parziali			2.50	2.50		
Progressiva			-2.67 -2.50	0.00	2.50 2.68	
Dislivelli			0.00 0.16	-0.41	-0.57 0.00	

Sezione: 12
 Progressiva: 70.000
 Q. Progetto: 505.086

503.00

Quote Terreno	504.55	504.96	505.13	505.72
Quote Progetto		504.89 504.61	504.69	504.76 505.37
Parziali		2.50	2.50	
Progressiva		-2.62 -2.50	0.00	2.50 2.71
Dislivelli		0.00 0.11	-0.44	-0.59 -0.00

Sezione: 13
 Progressiva: 73.192
 Q. Progetto: 504.966

503.00

Quote Terreno	504.43	504.49	504.73	505.00	505.33	505.60
Quote Progetto			504.78 504.49	504.57	504.64 505.24	
Parziali			2.50	2.50		
Progressiva			-2.61 -2.50	0.00	2.50 2.70	
Dislivelli			0.00 0.10	-0.44	-0.58 0.00	

Sezione: 14
 Progressiva: 80.000
 Q. Progetto: 504.741

503.00

Quote Terreno	504.15	504.30	504.51	504.77	505.21	505.28	505.34
Quote Progetto			504.54 504.27	504.34	504.42 505.00		
Parziali			2.50	2.50			
Progressiva			-2.62 -2.50	0.00	2.50 2.68		
Dislivelli			0.00 0.11	-0.43	-0.57 0.00		

Sezione: 15
 Progressiva: 82.289
 Q. Progetto: 504.674

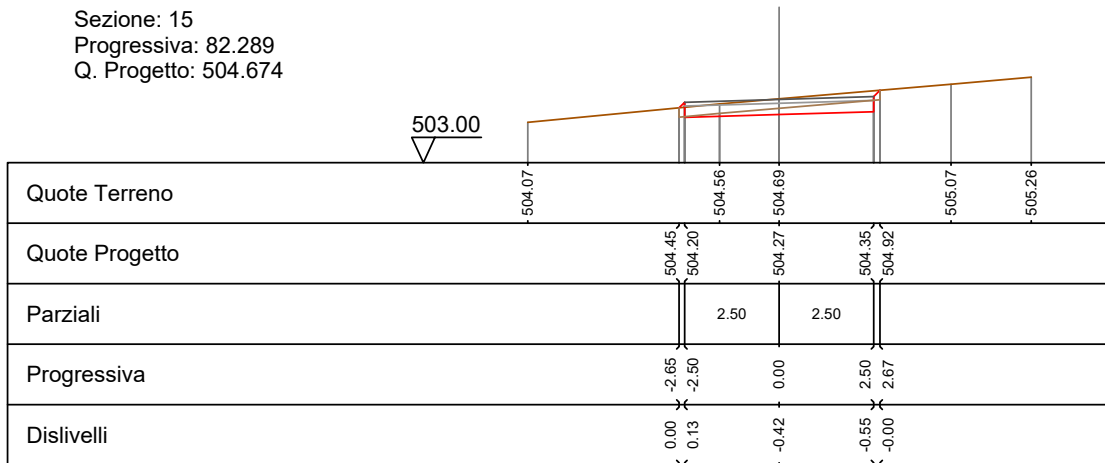

Sezione: 16
 Progressiva: 100.000
 Q. Progetto: 504.158

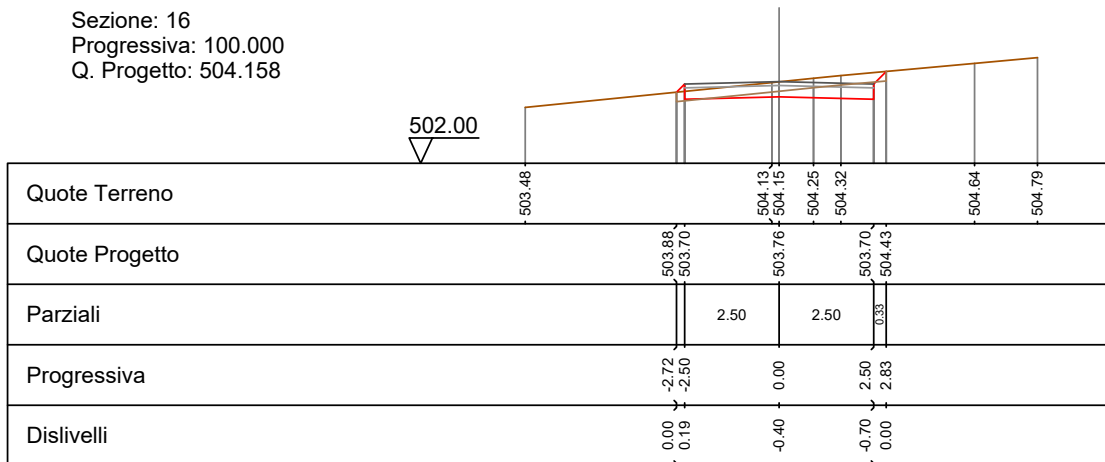

Sezione: 17
 Progressiva: 106.014
 Q. Progetto: 503.986

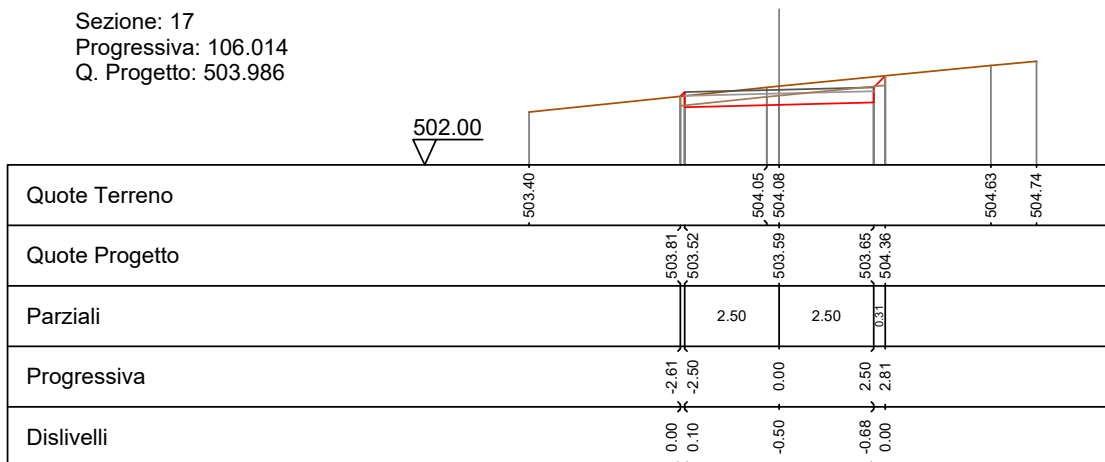

Sezione: 18
 Progressiva: 110.000
 Q. Progetto: 503.892

502.00

Quote Terreno	503.37	503.93	504.02	504.67
Quote Progetto		503.77 503.43	503.49	503.55 504.29
Parziali		2.50	2.50	0.36
Progressiva		-2.56 -2.50	0.00	2.50 2.84
Dislivelli		0.00 0.05	-0.53	-0.71 -0.00

Sezione: 19
 Progressiva: 113.128
 Q. Progetto: 503.832

502.00

Quote Terreno	503.34	503.87	503.99	504.47	504.64
Quote Progetto		503.74 503.37	503.43	503.49 504.26	
Parziali		2.50	2.50	0.36	
Progressiva		-2.53 -2.50	0.00	2.50 2.86	
Dislivelli		0.00 0.03	-0.55	-0.73 -0.00	

Sezione: 20
 Progressiva: 120.000
 Q. Progetto: 503.745

502.00

Quote Terreno	503.18	503.74	503.83 503.86	504.52
Quote Progetto		503.60 503.28	503.35	503.41 504.14
Parziali		2.50	2.50	0.33
Progressiva		-2.58 -2.50	0.00	2.50 2.83
Dislivelli		0.00 0.07	-0.52	-0.70 0.00

Sezione: 21
 Progressiva: 120.242
 Q. Progetto: 503.743

502.00

Quote Terreno	503.18	503.74	503.85	503.86	504.52	
Quote Progetto		503.60	503.28	503.34	503.41	504.13
Parziali			2.50	2.50	0.33	
Progressiva		-2.58	-2.50	0.00	2.50	2.83
Dislivelli		0.00	0.08	-0.52	-0.70	0.00

Sezione: 22
 Progressiva: 140.000
 Q. Progetto: 503.836

502.00

Quote Terreno	503.03	503.77	503.82	504.46		
Quote Progetto		503.47	503.37	503.44	503.37	504.05
Parziali		0.31	2.50	2.50	0.28	
Progressiva		-2.81	-2.50	0.00	2.50	2.78
Dislivelli		-0.00	0.28	-0.33	-0.65	0.00

Sezione: 23
 Progressiva: 160.000
 Q. Progetto: 504.440

502.00

Quote Terreno	503.56	504.28	504.41	504.50	504.59	504.96
Quote Progetto		503.98	503.98	504.04	503.98	504.55
Parziali		0.40	2.50	2.50		
Progressiva		-2.90	-2.50	0.00	2.50	2.68
Dislivelli		-0.00	0.36	-0.24	-0.56	0.00

Sezione: 24
 Progressiva: 180.000
 Q. Progetto: 505.443

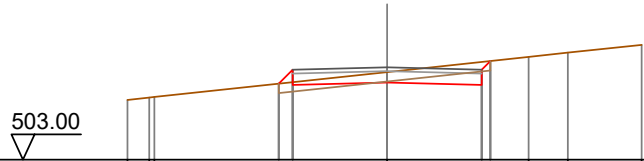

Quote Terreno	504.58	504.66			505.32		505.72	505.83	506.04
Quote Progetto			505.01	504.98	505.04		504.98	505.61	
Parziali			0.37	2.50		2.50			
Progressiva			-2.87	-2.50	0.00		2.50	2.73	
Dislivelli			-0.00	0.33		-0.28		-0.61	0.00

Sezione: 25
 Progressiva: 192.131
 Q. Progetto: 505.828

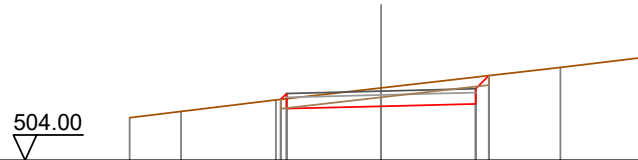

Quote Terreno	505.13	505.29	505.60		505.91		506.45	506.71	
Quote Progetto			505.61	505.37	505.43		505.49	506.24	
Parziali				2.50		2.50		0.35	
Progressiva			-2.65	-2.50	0.00		2.50	2.85	
Dislivelli			0.00	0.14		-0.49		-0.71	0.00

Sezione: 26
 Progressiva: 200.000
 Q. Progetto: 505.921

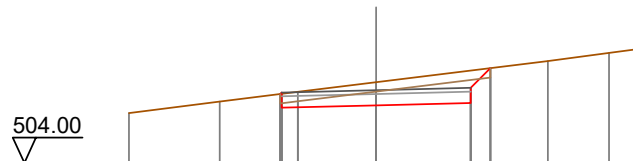

Quote Terreno	505.32	505.62	505.88		506.13		506.69	506.91	507.02
Quote Progetto			505.82	505.46	505.52		505.59	506.50	
Parziali				2.50		2.50		0.52	
Progressiva			-2.54	-2.50	0.00		2.50	3.02	
Dislivelli			-0.00	0.03		-0.61		-0.86	-0.00

Sezione: 27
 Progressiva: 201.285
 Q. Progetto: 505.924

504.00

Quote Terreno	505.33	505.66	506.14	506.59	506.97	507.03
Quote Progetto		505.82 505.46	505.52	505.59 505.51		
Parziali		2.50	2.50	0.52		
Progressiva		-2.54 -2.50	0.00	2.50 3.02		
Dislivelli		-0.00 0.03	-0.61	-0.86 -0.00		

Sezione: 28
 Progressiva: 210.000
 Q. Progetto: 505.860

504.00

Quote Terreno	505.24	505.84	505.95	505.99	506.07	506.91
Quote Progetto		505.73 505.40	505.46	505.52 506.42		
Parziali		2.50	2.50	0.49		
Progressiva		-2.57 -2.50	0.00	2.50 2.99		
Dislivelli		0.00 0.06	-0.58	-0.83 0.00		

Sezione: 29
 Progressiva: 210.438
 Q. Progetto: 505.853

504.00

Quote Terreno	505.22	505.95	505.98	506.03	506.89
Quote Progetto		505.71 505.39	505.45	505.52 506.40	
Parziali		2.50	2.50	0.48	
Progressiva		-2.56 -2.50	0.00	2.50 2.98	
Dislivelli		0.00 0.07	-0.58	-0.82 0.00	

Sezione: 30
 Progressiva: 220.000
 Q. Progetto: 505.599

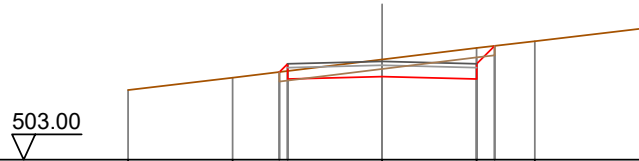

Quote Terreno	-504.84	-505.17	-505.65	-505.96	-506.13	-506.48
Quote Progetto		505.32 505.14	505.20	505.14 506.01		
Parziali			2.50	2.50	0.47	
Progressiva		-2.72 -2.50	0.00	2.50 2.97		
Dislivelli		-0.00 0.19	-0.45	-0.82 0.00		

Sezione: 31
 Progressiva: 240.000
 Q. Progetto: 504.497

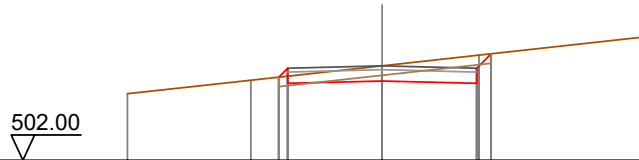

Quote Terreno	-503.76	-504.12	-504.50	-504.78	-505.28
Quote Progetto		504.20 504.03	504.10	504.03 504.82	
Parziali			2.50	2.50	0.38
Progressiva		-2.74 -2.50	0.00	2.50 2.88	
Dislivelli		-0.00 0.21	-0.40	-0.74 0.00	

Sezione: 32
 Progressiva: 255.534
 Q. Progetto: 503.487

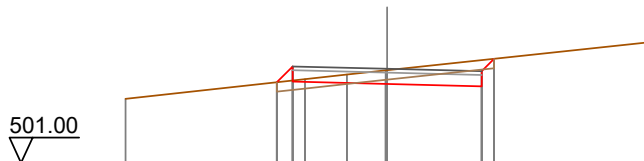

Quote Terreno	-502.69	-503.21	-503.34	-503.44 503.45	-504.18
Quote Progetto		503.13 503.15	503.09	503.02 503.75	
Parziali		0.42	2.50	2.50	0.33
Progressiva		-2.92 -2.50	0.00	2.50 2.83	
Dislivelli		-0.00 0.37	-0.36	-0.69 -0.00	

Sezione: 33
 Progressiva: 256.163
 Q. Progetto: 503.447

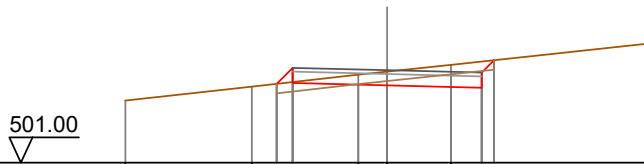

Quote Terreno	502.64	503.01	503.33	503.41	503.59	504.14
Quote Progetto		503.09	503.11	503.05	502.98	503.71
Parziali		0.42	2.50	2.50	0.33	
Progressiva		-2.92	-2.50	0.00	2.50	2.83
Dislivelli		-0.00	0.38	-0.36	-0.69	0.00

Sezione: 34
 Progressiva: 256.791
 Q. Progetto: 503.407

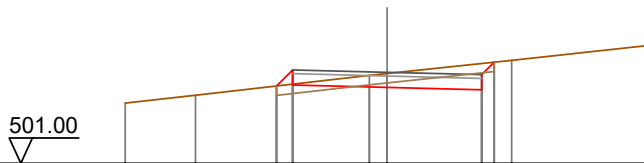

Quote Terreno	502.59	502.80	503.32	503.37	503.72	504.11
Quote Progetto		503.04	503.07	503.01	502.94	503.67
Parziali		0.42	2.50	2.50	0.33	
Progressiva		-2.92	-2.50	0.00	2.50	2.83
Dislivelli		-0.00	0.38	-0.37	-0.69	0.00

Sezione: 35
 Progressiva: 260.000
 Q. Progetto: 503.203

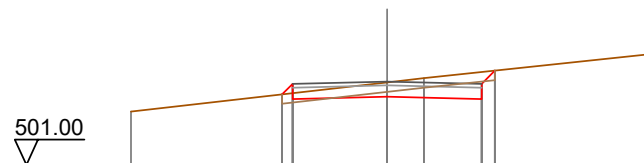

Quote Terreno	502.41	502.86	503.18	503.29	503.91
Quote Progetto		502.74	502.80	502.74	503.49
Parziali		0.24	2.50	2.50	0.35
Progressiva		-2.78	-2.50	0.00	2.50
Dislivelli		-0.00	0.24	-0.38	-0.71

Sezione: 36
 Progressiva: 280.000
 Q. Progetto: 502.023

500.00

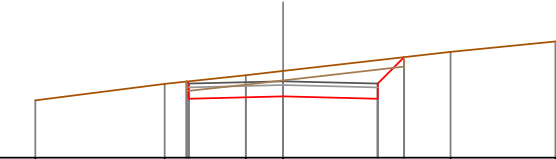

Quote Terreno	501.52	501.95	502.18	502.29	502.80	503.08
Quote Progetto		502.01 501.56	501.62	501.56	502.66	
Parziali		2.50	2.50	0.70		
Progressiva		-2.55 -2.50	0.00	2.50	3.20	
Dislivelli		0.00 -0.06	-0.67	-1.02	0.00	

Sezione: 37
 Progressiva: 300.000
 Q. Progetto: 500.878

499.00

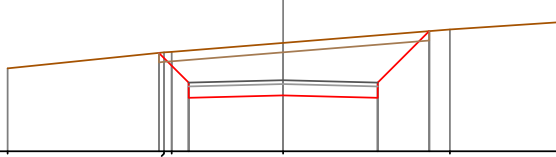

Quote Terreno	501.20	501.62 501.63	501.87	502.22	502.45
Quote Progetto		501.60 500.42	500.48	500.42	502.18
Parziali		0.79	2.50	2.50	1.36
Progressiva		-3.29 -2.50	0.00	2.50	3.86
Dislivelli		0.00 -0.85	-1.39	-1.65	0.00

Sezione: 38
 Progressiva: 320.000
 Q. Progetto: 499.838

498.00

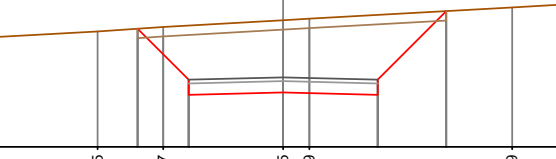

Quote Terreno	500.89	501.05	501.17	501.35	501.39	501.69	501.82
Quote Progetto		501.12	499.38	499.44	499.38	501.59	
Parziali		1.35	2.50	2.50	1.81		
Progressiva		-3.85 -2.50	0.00	2.50	4.31		
Dislivelli		0.00 -1.43	-1.91	-2.11	-0.00		

Sezione: 39
 Progressiva: 320.858
 Q. Progetto: 499.807

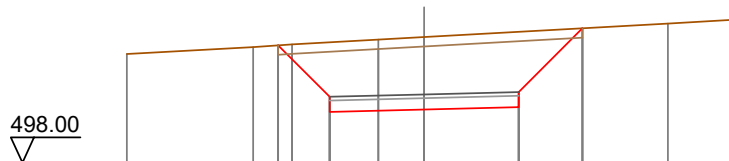

Quote Terreno	500.88	501.06	501.13	501.26	501.33		501.68	501.78
Quote Progetto		501.10	499.34		499.41	499.47	501.56	
Parziali			1.36	2.50	2.50	1.69		
Progressiva		-3.86	-2.50		0.00	2.50	4.19	
Dislivelli		0.00	-1.44		-1.92	-1.99	0.00	

Sezione: 40
 Progressiva: 330.000
 Q. Progetto: 499.570

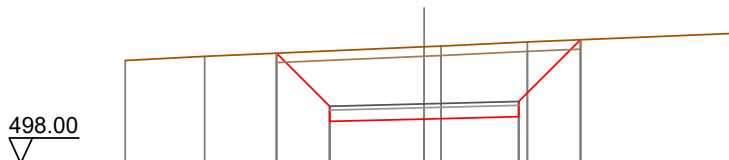

Quote Terreno	500.72	500.83			501.06	501.10	501.21	501.43
Quote Progetto			500.91	499.11	499.17	499.23	501.27	
Parziali			1.40	2.50	2.50	1.63		
Progressiva			-3.90	-2.50	0.00	2.50	4.13	
Dislivelli			0.00	-1.47	-1.91	-1.97	0.00	

Sezione: 41
 Progressiva: 332.787
 Q. Progetto: 499.531

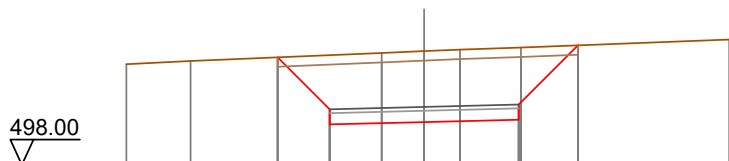

Quote Terreno	500.66	500.75			500.96	501.01	501.05	501.10	501.31
Quote Progetto			500.84	499.07		499.13	499.19	501.16	
Parziali			1.38	2.50	2.50	1.57			
Progressiva			-3.88	-2.50	0.00	2.50	4.07		
Dislivelli			-0.00	-1.43	-1.88	-1.91	0.00		

Sezione: 42
 Progressiva: 340.000
 Q. Progetto: 499.500

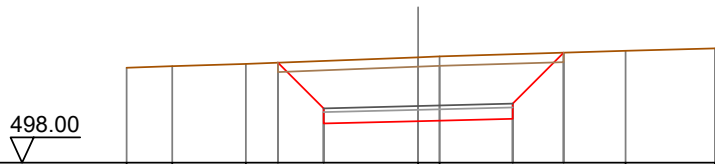

Quote Terreno	500.51	500.56	500.61	500.65	499.04	498.10	500.79	500.81	500.96	501.02
Quote Progetto				500.65	499.04	498.10	500.79	500.81	500.91	
Parziali				1.21	2.50	2.50	1.35			
Progressiva				-3.71	-2.50	0.00	2.50	3.85		
Dislivelli				0.00	-1.26	-1.69	-1.71	0.00		

Sezione: 43
 Progressiva: 343.000
 Q. Progetto: 499.500

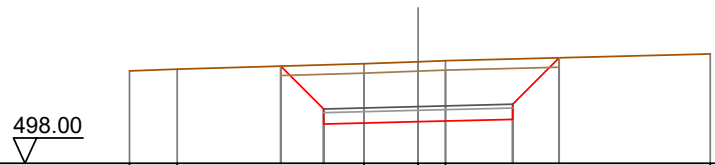

Quote Terreno	500.44	500.49	500.57	500.63	500.69	500.71	500.89
Quote Progetto			500.57	499.04	498.10	500.79	500.89
Parziali			1.13	2.50	2.50	1.23	
Progressiva			-3.63	-2.50	0.00	2.50	3.73
Dislivelli			0.00	-1.17	-1.59	-1.60	-0.00

SEZIONI TRASVERSALI
Profilo longitudinale tratto 11-12
Viabilità di impianto postazione aerogeneratore T06

Nota: Le canalette di deflusso delle acque meteoriche, non indicate nel presente elaborato, sono rappresentate graficamente nelle sezioni stradali tipo dell'elaborato "WIND002-TC13_Piazzole aerogeneratori e strade di servizio - Particolari costruttivi", individuate planimetricamente nell'elaborato "WIND002-TC14_Opere di regimazione acque superficiali - Planimetria generale" e quantificate nell'elaborato "WIND002-RC6_Computo Metrico Estimativo".

DISEGNI DI RIFERIMENTO

TAVOLA	DESCRIZIONE
WIND002-TC8	Piazzole e viabilità - Planimetria di progetto - Fase di cantiere
WIND002-TC11	Profili longitudinali viabilità di impianto
WIND002-TC13	Piazzole aerogeneratori e strade di servizio - Particolari costruttivi
WIND002-TC14	Opere di regimazione acque superficiali - Planimetria generale

Sezione: 4
 Progressiva: 24.500
 Q. Progetto: 554.531

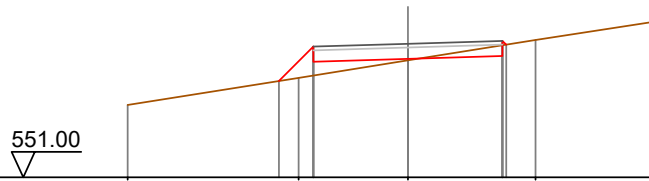

Quote Terreno	-552.91	-553.63	-554.09	-554.63	-555.13
Quote Progetto		553.65	554.06	554.13	554.21
Parziali		0.91	2.50	2.50	
Progressiva		-3.41	-2.50	0.00	2.50
Dislivelli		-0.00	0.77	0.04	-0.29
					0.00

Sezione: 5
 Progressiva: 25.222
 Q. Progetto: 554.516

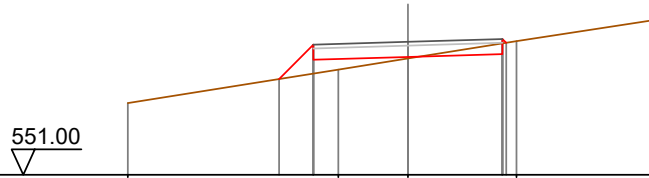

Quote Terreno	-552.90	-553.78	-554.08	-554.53	-555.10
Quote Progetto		553.63	554.04	554.12	554.19
Parziali		0.91	2.50	2.50	
Progressiva		-3.41	-2.50	0.00	2.50
Dislivelli		0.00	0.76	0.04	-0.28
					0.00

Sezione: 9
 Progressiva: 60.000
 Q. Progetto: 553.563

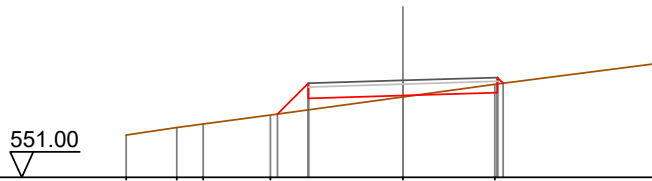

Quote Terreno	552.12	552.32	552.41	552.65	553.13	553.46	554.00
Quote Progetto				552.67	553.09	553.16	553.24
Parziali				0.82	2.50	2.50	
Progressiva				-3.32	-2.50	0.00	2.50
Dislivelli				-0.00	0.70	0.04	-0.23
							-0.00

Sezione: 10
 Progressiva: 62.537
 Q. Progetto: 553.483

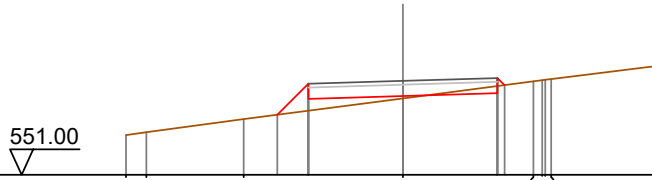

Quote Terreno	552.05	552.13	552.47		553.02	553.47	553.87
Quote Progetto				552.59	553.01	553.08	553.16
Parziali				0.82	2.50	2.50	
Progressiva				-3.32	-2.50	0.00	2.50
Dislivelli				0.00	0.71	0.06	-0.19
							-0.00

Sezione: 11
 Progressiva: 64.762
 Q. Progetto: 553.409

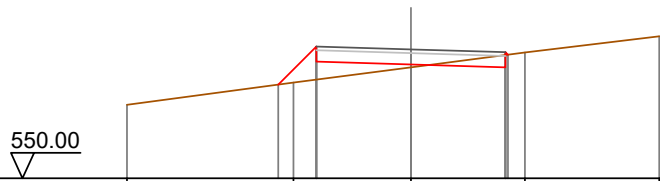

Quote Terreno	551.94	552.53		552.93	553.33	553.76
Quote Progetto		552.48	553.08	553.01	552.93	553.27
Parziali		1.01	2.50	2.50		
Progressiva		-3.51	-2.50	0.00	2.50	2.56
Dislivelli		-0.00	0.88	0.07	-0.33	0.00

Sezione: 12
 Progressiva: 69.280
 Q. Progetto: 553.258

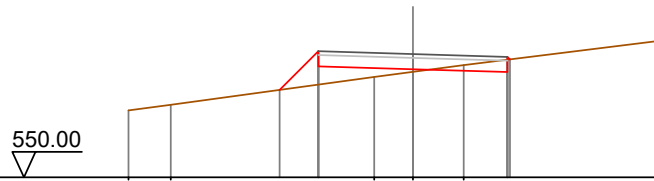

Quote Terreno	-551.77	-551.92			-552.65	-552.79	-552.97		-553.61
Quote Progetto			552.31	552.93	552.86	552.78	553.12		
Parziali			1.02	2.50	2.50				
Progressiva			-3.52	-2.50	0.00	2.50	2.56		
Dislivelli			0.00	0.88	0.07	-0.33	0.00		

Sezione: 13
 Progressiva: 70.000
 Q. Progetto: 553.237

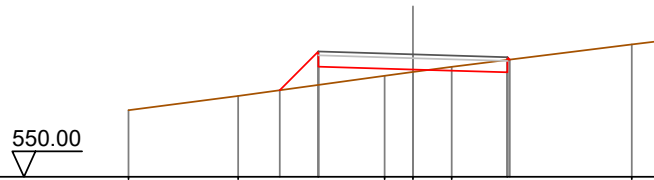

Quote Terreno	-551.76	-552.14			-552.67	-552.77	-552.91		-553.50	-553.59
Quote Progetto			552.29	552.91	552.84	552.76	553.10			
Parziali			1.02	2.50	2.50					
Progressiva			-3.52	-2.50	0.00	2.50	2.56			
Dislivelli			0.00	0.88	0.07	-0.33	0.00			

Sezione: 14
 Progressiva: 73.799
 Q. Progetto: 553.143

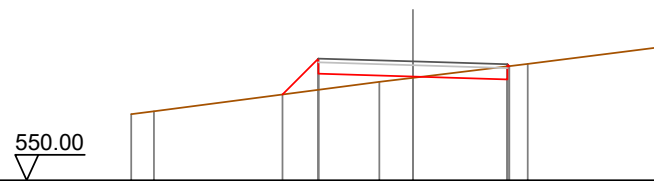

Quote Terreno	-551.75	-551.83			-552.60	-552.71	-552.88		-553.52
Quote Progetto			552.27	552.82	552.74	552.67	553.02		
Parziali			0.95	2.50	2.50				
Progressiva			-3.45	-2.50	0.00	2.50	2.55		
Dislivelli			-0.00	0.82	0.03	-0.34	0.00		

Sezione: 15
 Progressiva: 80.000
 Q. Progetto: 553.051

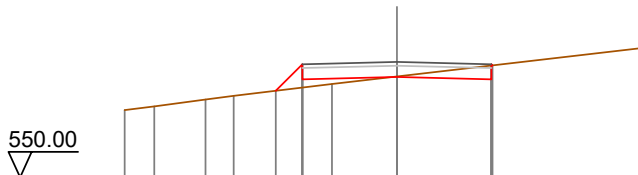

Quote Terreno		551.78	551.88	552.06	552.15	552.29	552.47	552.67	552.99	553.42
Quote Progetto						552.29	552.59	552.65	552.96	
Parziali						0.70	2.50	2.50		
Progressiva						-3.20	-2.50	0.00	2.50	2.53
Dislivelli						0.00	0.62	-0.01	-0.37	0.00

Sezione: 16
 Progressiva: 88.633
 Q. Progetto: 552.998

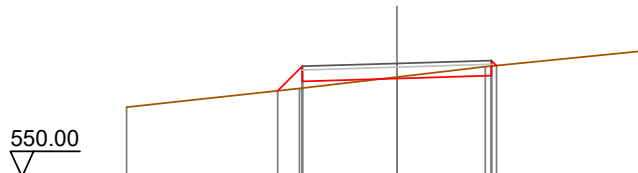

Quote Terreno		551.84		552.33		552.64		552.91		553.34
Quote Progetto				552.27	552.52	552.60		552.67	552.94	
Parziali				0.65	2.50	2.50				
Progressiva				-3.15	-2.50	0.00		2.50	2.63	
Dislivelli				0.00	0.58	-0.04		-0.25	-0.00	

Sezione: 17
 Progressiva: 90.000
 Q. Progetto: 552.983

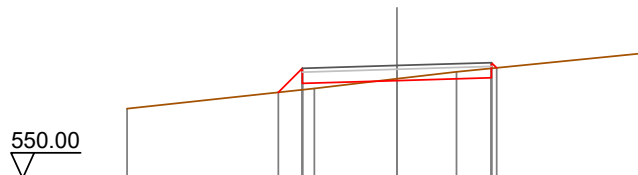

Quote Terreno		551.84		552.38		552.63		552.82		553.32
Quote Progetto				552.27	552.51	552.58		552.66	552.92	
Parziali				0.63	2.50	2.50				
Progressiva				-3.13	-2.50	0.00		2.50	2.64	
Dislivelli				0.00	0.57	-0.05		-0.25	0.00	

Sezione: 18
 Progressiva: 100.000
 Q. Progetto: 552.777

550.00

Quote Terreno	-551.74	-551.84	-552.22	-552.42	-552.77	-552.99
Quote Progetto			552.15 552.30	552.38	552.45 552.66	
Parziali			0.56 2.50	2.50		
Progressiva			-3.06 -2.50	0.00	2.50 2.69	
Dislivelli			0.00 0.50	-0.05	-0.19 0.00	

Sezione: 19
 Progressiva: 106.563
 Q. Progetto: 552.553

550.00

Quote Terreno	-551.59	-551.89	-552.00	-552.16	-552.64	-552.66
Quote Progetto			551.93 552.08	552.15	552.23 552.36	
Parziali			0.55 2.50	2.50	0.28	
Progressiva			-3.05 -2.50	0.00	2.50 2.76	
Dislivelli			-0.00 0.51	-0.00	-0.12 -0.00	

Sezione: 20
 Progressiva: 110.000
 Q. Progetto: 552.408

550.00

Quote Terreno	-551.47	-551.73	-552.00	-552.04	-552.42	-552.48
Quote Progetto			551.80 551.93	552.01	552.08 552.19	
Parziali			0.54 2.50	2.50	0.28	
Progressiva			-3.04 -2.50	0.00	2.50 2.79	
Dislivelli			0.00 0.50	0.01	-0.09 0.00	

Sezione: 21
 Progressiva: 120.000
 Q. Progetto: 551.939

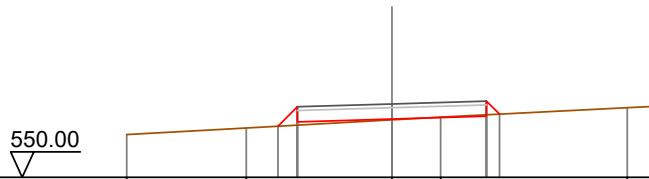

Quote Terreno	-551.13	-551.30	-551.52	-551.59	-551.84	-551.87
Quote Progetto		551.35	551.54	551.61	551.67	
Parziali		0.51	2.50	2.50	0.34	
Progressiva		-3.01	-2.50	0.00	2.50	2.84
Dislivelli		0.00	0.48	0.02	-0.04	0.00

Sezione: 22
 Progressiva: 124.492
 Q. Progetto: 551.728

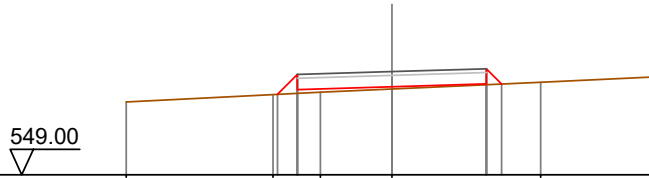

Quote Terreno	-550.93	-551.12	-551.18	-551.27	-551.45	-551.58
Quote Progetto		551.13	551.25	551.33	551.40	551.40
Parziali		0.53	2.50	2.50	0.40	
Progressiva		-3.03	-2.50	0.00	2.50	2.90
Dislivelli		0.00	0.50	0.06	0.02	0.00

Sezione: 23
 Progressiva: 140.000
 Q. Progetto: 551.025

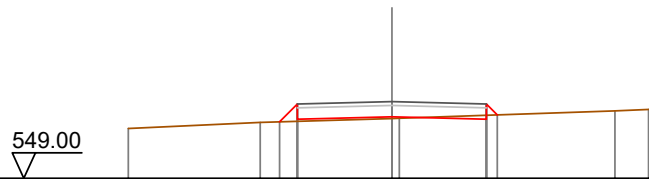

Quote Terreno	-550.32	-550.48	-550.58	-550.59	-550.78	-550.82
Quote Progetto		550.49	550.56	550.63	550.56	550.68
Parziali		0.47	2.50	2.50	0.28	
Progressiva		-2.97	-2.50	0.00	2.50	2.79
Dislivelli		0.00	0.46	0.05	-0.10	-0.00

Sezione: 24
 Progressiva: 143.115
 Q. Progetto: 550.912

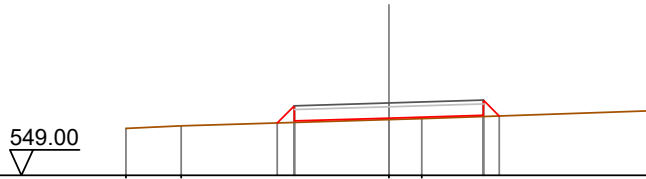

Quote Terreno	-550.24	-550.31			550.47	550.50				-550.71
Quote Progetto			550.38	550.44	550.51		550.59	550.57		
Parziali			0.45	2.50		2.50		0.42		
Progressiva			-2.95	-2.50	0.00		2.50	2.92		
Dislivelli			0.00	0.44	0.04		0.03	0.00		

Sezione: 25
 Progressiva: 150.000
 Q. Progetto: 550.706

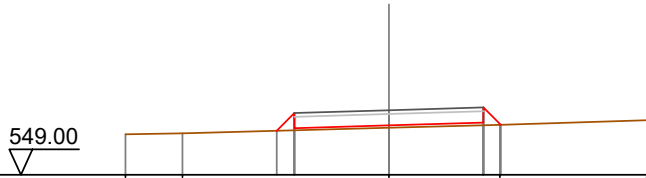

Quote Terreno	-550.07	-550.10			550.24		550.32			550.44	550.45
Quote Progetto			550.16	550.23	550.31		550.38	550.32			
Parziali			0.47	2.50		2.50		0.46			
Progressiva			-2.97	-2.50	0.00		2.50	2.96			
Dislivelli			-0.00	0.46	0.06		0.07	-0.00			

Sezione: 26
 Progressiva: 151.040
 Q. Progetto: 550.681

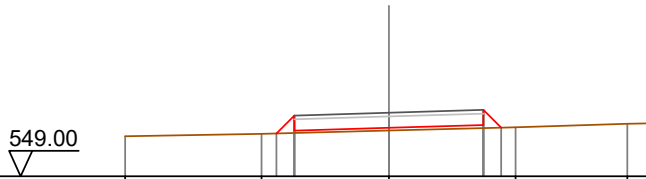

Quote Terreno	-550.06	-550.12			550.21		550.30			550.39	550.40
Quote Progetto			550.13	550.21	550.28		550.36	550.29			
Parziali			0.48	2.50		2.50		0.47			
Progressiva			-2.98	-2.50	0.00		2.50	2.97			
Dislivelli			0.00	0.46	0.07		0.08	0.00			

Sezione: 27
 Progressiva: 158.965
 Q. Progetto: 550.533

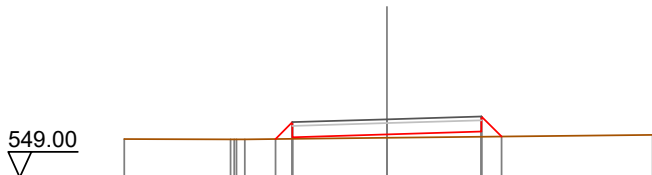

Quote Terreno	550.01	550.00	550.00	550.01	550.04	550.13	550.21	550.12
Quote Progetto			550.01	550.06			550.21	550.08
Parziali			0.44	2.50	2.50		0.53	
Progressiva			-2.94	-2.50	0.00		2.50	3.03
Dislivelli			0.00	0.44	0.09		0.14	0.00

Sezione: 28
 Progressiva: 160.000
 Q. Progetto: 550.519

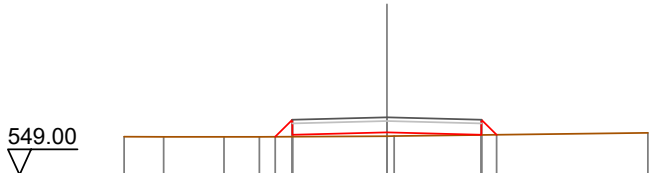

Quote Terreno	550.01	550.00	550.00	550.00	550.02	550.02		550.11
Quote Progetto			550.00	550.06			550.06	550.06
Parziali			0.45	2.50	2.50		0.40	
Progressiva			-2.95	-2.50	0.00		2.50	2.90
Dislivelli			0.00	0.45	0.10		0.01	0.00

Sezione: 29
 Progressiva: 180.000
 Q. Progetto: 550.455

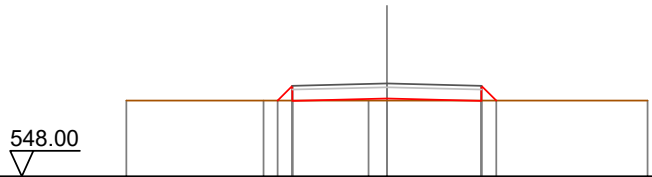

Quote Terreno	550.00	550.00	550.00	550.00	550.05	550.00	549.99	550.00
Quote Progetto		550.00	549.99		550.05		549.99	550.00
Parziali		0.39	2.50	2.50		0.39		
Progressiva		-2.89	-2.50	0.00		2.50	2.89	
Dislivelli		0.00	0.39	0.05		-0.01	0.00	

Sezione: 30
 Progressiva: 200.000
 Q. Progetto: 550.438

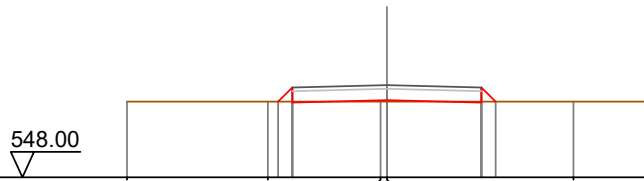

Quote Terreno	-550.00	550.00	550.00	550.00	550.00	-550.00	-550.00
Quote Progetto		550.00 549.98	550.04	549.98 550.00			
Parziali		0.38 2.50	2.50	0.38			
Progressiva		-2.88 -2.50	0.00	2.50 2.88			
Dislivelli		0.00 0.38	0.04	-0.02 0.00			

Sezione: 31
 Progressiva: 209.944
 Q. Progetto: 550.430

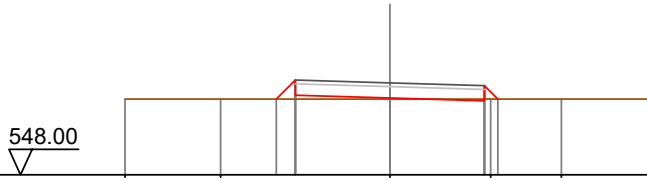

Quote Terreno	-550.00	-550.00	550.00	550.00	550.00	-550.00	-550.00
Quote Progetto			550.00 550.10	550.03	549.95 550.00		
Parziali			0.50 2.50	2.50	0.35		
Progressiva			-3.00 -2.50	0.00	2.50 2.85		
Dislivelli			0.00 0.50	0.03	-0.05 0.00		

Sezione: 32
 Progressiva: 220.000
 Q. Progetto: 550.422

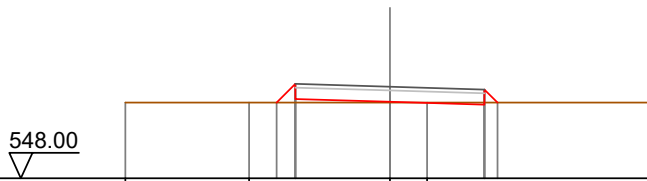

Quote Terreno	-550.00	550.00	550.00	550.00	550.00	-550.00	-550.00
Quote Progetto			550.00 550.10	550.02	549.95 550.00		
Parziali			0.50 2.50	2.50	0.35		
Progressiva			-3.00 -2.50	0.00	2.50 2.85		
Dislivelli			0.00 0.50	0.02	-0.05 0.00		

Sezione: 33
 Progressiva: 225.024
 Q. Progetto: 550.417

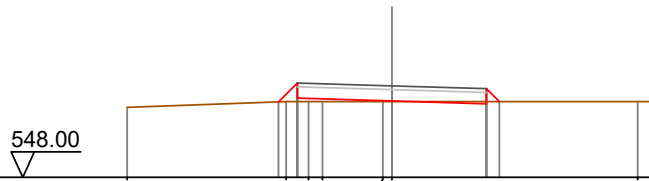

Quote Terreno	549.85	550.00	550.00	550.00	550.00	550.00
Quote Progetto		549.99	550.09	550.02	549.94	550.00
Parziali		0.50	2.50	2.50	0.34	
Progressiva		-3.00	-2.50	0.00	2.50	2.84
Dislivelli		0.00	0.49	0.02	-0.06	0.00

Sezione: 34
 Progressiva: 230.000
 Q. Progetto: 550.410

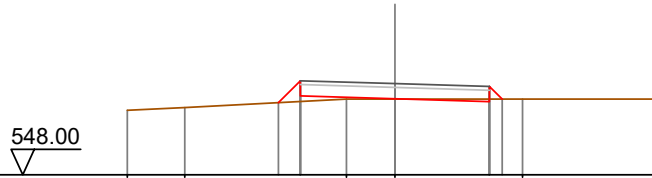

Quote Terreno	549.70	549.78	550.00	550.00	550.00	550.00
Quote Progetto			549.91	550.09	550.01	549.94
Parziali			0.58	2.50	2.50	0.34
Progressiva			-3.08	-2.50	0.00	2.50
Dislivelli			0.00	0.55	0.01	-0.06

Sezione: 35
 Progressiva: 240.104
 Q. Progetto: 550.266

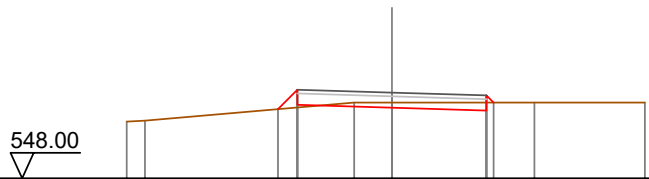

Quote Terreno	549.50	549.52	550.00	550.00	550.00	550.00
Quote Progetto			549.83	549.94	549.87	549.79
Parziali			0.51	2.50	2.50	
Progressiva			-3.01	-2.50	0.00	2.50
Dislivelli			0.00	0.47	-0.13	-0.21

Sezione: 36
 Progressiva: 252.296
 Q. Progetto: 549.820

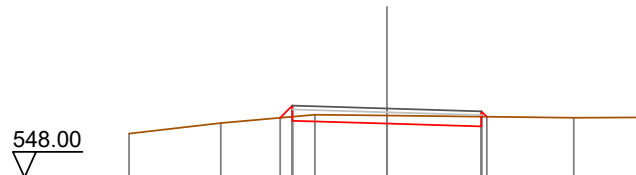

Quote Terreno	549.16	549.43	549.86	549.63	549.57	549.58
Quote Progetto			549.57	549.42	549.34	549.60
Parziali			0.32	2.50	2.50	
Progressiva			-2.82	0.00	2.50	2.64
Dislivelli			0.00	-0.21	-0.26	-0.00

Sezione: 37
 Progressiva: 257.963
 Q. Progetto: 549.511

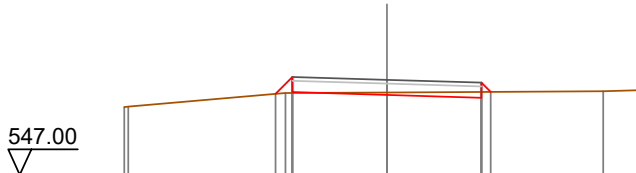

Quote Terreno	548.79	548.80	549.16	549.18	549.21	549.24
Quote Progetto			549.14	549.11	549.04	549.19
Parziali			0.45	2.50	2.50	
Progressiva			-2.95	0.00	2.50	2.74
Dislivelli			-0.00	-0.07	-0.15	0.00

Sezione: 38
 Progressiva: 260.000
 Q. Progetto: 549.384

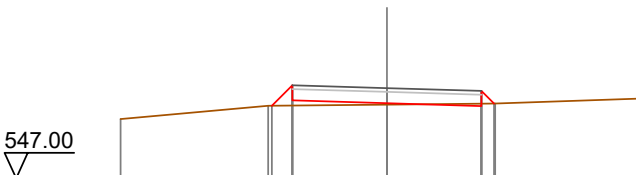

Quote Terreno	548.56	548.92	548.95	548.98	548.98	549.11
Quote Progetto		548.92	548.98	548.91	548.98	
Parziali		0.54	2.50	2.50	0.33	
Progressiva		-3.04	0.00	2.50	2.83	
Dislivelli		-0.00	0.04	-0.06	0.00	

Sezione: 39
 Progressiva: 263.631
 Q. Progetto: 549.145

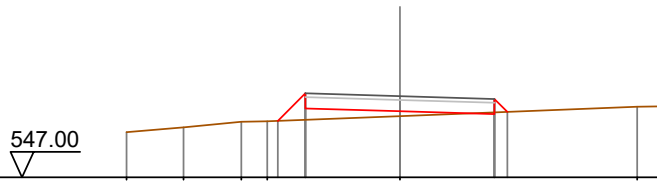

Quote Terreno	548.19	548.32	548.47	548.48	548.62	548.86	548.87
Quote Progetto			548.49	548.82	548.75	548.67	548.73
Parziali			0.73	2.50	2.50	0.34	
Progressiva			-3.23	-2.50	0.00	2.50	2.84
Dislivelli			0.00	0.70	0.13	-0.05	0.00

Sezione: 40
 Progressiva: 280.000
 Q. Progetto: 548.195

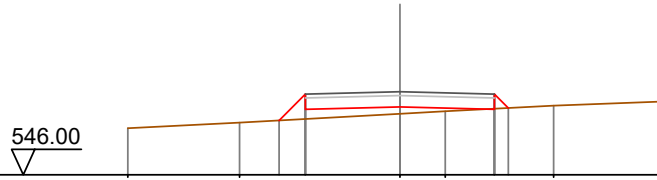

Quote Terreno	547.23	547.38		547.61	547.68	547.83	547.93
Quote Progetto			547.44	547.73	547.79	547.73	547.77
Parziali			0.70	2.50	2.50	0.37	
Progressiva			-3.20	-2.50	0.00	2.50	2.87
Dislivelli			0.00	0.66	0.18	-0.01	0.00

Sezione: 41
 Progressiva: 300.000
 Q. Progetto: 547.329

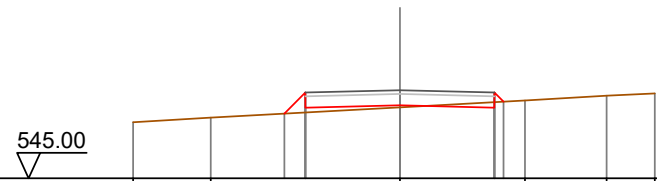

Quote Terreno	546.48	546.60		546.88		547.06	547.18	547.24
Quote Progetto			546.71	546.87	546.93	546.87	547.03	
Parziali			0.56	2.50	2.50			
Progressiva			-3.06	-2.50	0.00	2.50	2.74	
Dislivelli			0.00	0.53	0.05	-0.15	0.00	

Sezione: 42
 Progressiva: 302.933
 Q. Progetto: 547.230

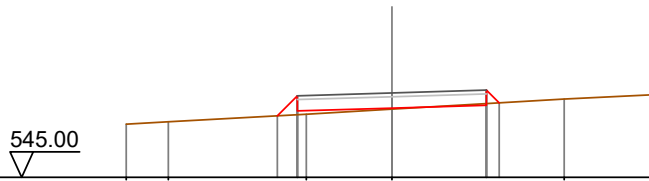

Quote Terreno		546.40	546.47		546.67		546.80		547.07	547.18
Quote Progetto				546.63	546.75		546.83		546.90	546.97
Parziali				0.53	2.50		2.50		0.34	
Progressiva				-3.03	-2.50		0.00		2.50	2.84
Dislivelli				-0.00	0.50		0.03		-0.04	-0.00

Sezione: 43
 Progressiva: 306.789
 Q. Progetto: 547.109

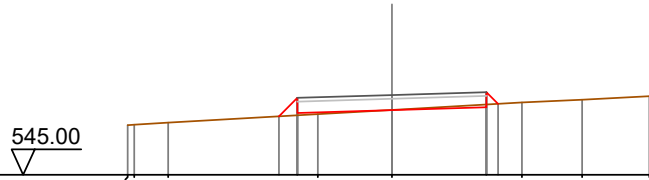

Quote Terreno		546.31	546.38		546.60		546.72		546.91	546.99	547.08
Quote Progetto				546.55	546.63		546.71		546.78	546.88	
Parziali				0.49	2.50		2.50		0.31		
Progressiva				-2.99	-2.50		0.00		2.50	2.81	
Dislivelli				0.00	0.46		-0.01		-0.07	-0.00	

Sezione: 44
 Progressiva: 310.000
 Q. Progetto: 547.018

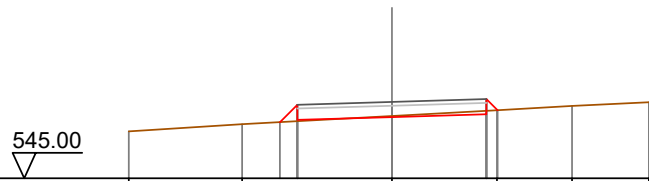

Quote Terreno		546.24		546.43		546.65		546.80		546.91	547.01
Quote Progetto				546.48	546.54		546.62		546.69	546.80	
Parziali				0.46	2.50		2.50		0.29		
Progressiva				-2.96	-2.50		0.00		2.50	2.79	
Dislivelli				0.00	0.44		-0.03		-0.09	-0.00	

Sezione: 45
 Progressiva: 310.644
 Q. Progetto: 547.001

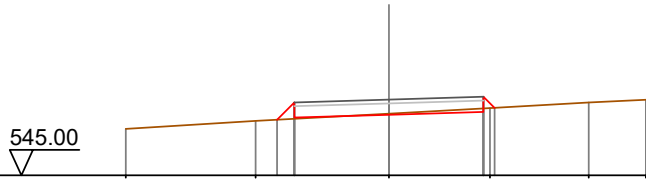

Quote Terreno	-546.23	-546.44	-546.63	-546.78	-546.92	-547.00
Quote Progetto		546.47 546.53	546.60	546.68 546.78		
Parziali		0.46 2.50	2.50	0.28 2.50		
Progressiva		-2.96 -2.50	0.00	2.50 2.79		
Dislivelli		-0.00 0.43	-0.03	-0.09 0.00		

Sezione: 46
 Progressiva: 320.000
 Q. Progetto: 546.789

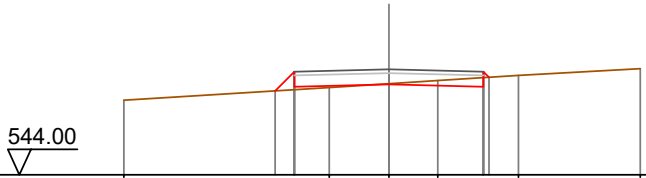

Quote Terreno	-545.97	-546.31	-546.41	-546.49	-546.63	-546.80
Quote Progetto		546.22 546.33	546.39	546.33 546.58		
Parziali		0.51 2.50	2.50			
Progressiva		-3.01 -2.50	0.00	2.50 2.65		
Dislivelli		0.00 0.48	-0.02	-0.24 0.00		

Sezione: 47
 Progressiva: 340.000
 Q. Progetto: 546.573

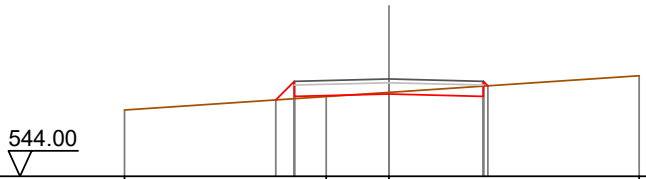

Quote Terreno	-545.75	-546.11	-546.22	-546.66
Quote Progetto		546.02 546.11	546.17	546.11 546.39
Parziali		0.49 2.50	2.50	
Progressiva		-2.99 -2.50	0.00	2.50 2.62
Dislivelli		0.00 0.46	-0.04	-0.27 -0.00

Sezione: 48
 Progressiva: 360.000
 Q. Progetto: 546.511

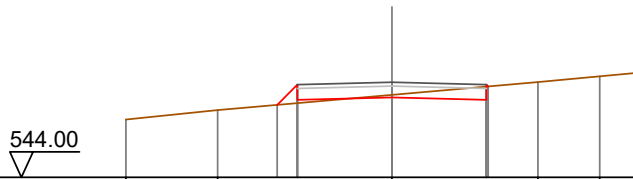

Quote Terreno		-545.53		-545.78		545.91		546.05		546.18		546.52		546.67		546.77
Quote Progetto						545.91		546.05		546.11		546.05		546.40		
Parziali						0.54		2.50		2.50						
Progressiva						-3.04		-2.50		0.00		2.50		2.55		
Dislivelli						0.00		0.49		-0.07		-0.35		-0.00		

Sezione: 49
 Progressiva: 380.000
 Q. Progetto: 546.300

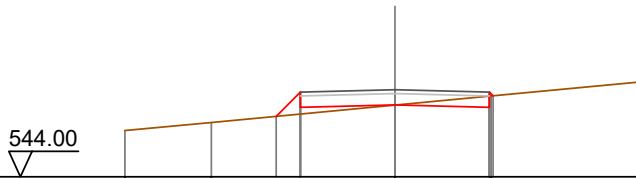

Quote Terreno		-545.22		-545.43		545.60		545.84		545.89		546.14		546.52
Quote Progetto						545.60		545.84		545.90		546.14		
Parziali						0.64		2.50		2.50				
Progressiva						-3.14		-2.50		0.00		2.50		2.60
Dislivelli						0.00		0.58		0.01		-0.29		-0.00

Sezione: 50
 Progressiva: 386.253
 Q. Progetto: 546.130

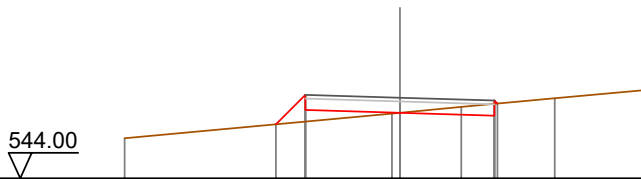

Quote Terreno		-545.06				545.71		545.73		545.89		546.12		546.34
Quote Progetto						545.43		545.81		545.73		545.66		545.98
Parziali						0.78		2.50		2.50				
Progressiva						-3.28		-2.50		0.00		2.50		2.58
Dislivelli						0.00		0.71		-0.00		-0.31		0.00

Sezione: 51
 Progressiva: 388.703
 Q. Progetto: 546.050

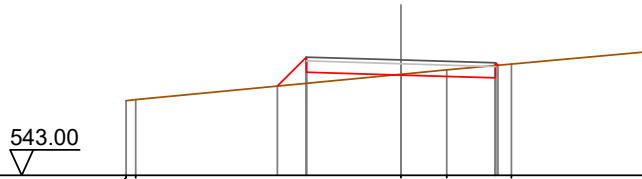

Quote Terreno	544.97	545.00			545.67	545.79	545.94	546.27
Quote Progetto			545.36	545.72	545.65	545.57	545.91	
Parziali			0.77	2.50	2.50			
Progressiva			-3.27	-2.50	0.00	2.50	2.57	
Dislivelli			0.00	0.69	-0.02	-0.33	0.00	

Sezione: 52
 Progressiva: 390.000
 Q. Progetto: 546.004

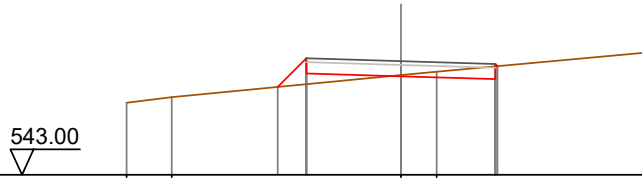

Quote Terreno	544.90	545.05			545.64	545.73	546.24
Quote Progetto			545.32	545.68	545.60	545.53	545.87
Parziali			0.76	2.50	2.50		
Progressiva			-3.26	-2.50	0.00	2.50	2.56
Dislivelli			0.00	0.68	-0.03	-0.34	0.00

Sezione: 53
 Progressiva: 391.153
 Q. Progetto: 545.962

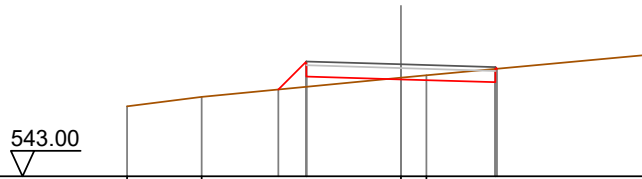

Quote Terreno	544.85	545.10			545.61	545.67	546.21
Quote Progetto			545.29	545.64	545.56	545.49	545.84
Parziali			0.74	2.50	2.50		
Progressiva			-3.24	-2.50	0.00	2.50	2.54
Dislivelli			-0.00	0.67	-0.05	-0.35	0.00

Sezione: 54
 Progressiva: 400.000
 Q. Progetto: 545.576

543.00

Quote Terreno	-544.47	-544.84	-545.01	-545.11	-545.24	-545.35	-545.35	-545.91	-545.92
Quote Progetto			545.01	545.11		545.18	545.11	545.57	
Parziali			0.50	2.50		2.50			
Progressiva			-3.00	-2.50		0.00	2.50	2.56	
Dislivelli			0.00	0.42		-0.17	-0.45	-0.00	

Sezione: 55
 Progressiva: 413.860
 Q. Progetto: 544.764

542.00

Quote Terreno	-543.69	-544.01	-544.22	-544.44	-544.58	-544.59	-545.03	-545.14
Quote Progetto			544.22	544.44	544.36	544.59	544.29	544.80
Parziali			0.62	2.50	2.50			
Progressiva			-3.12	-2.50	0.00	2.50	2.61	
Dislivelli			-0.00	0.56	-0.21	-0.50	0.00	

Sezione: 56
 Progressiva: 419.616
 Q. Progetto: 544.352

541.00

Quote Terreno	-542.99	-543.04	-543.38	-543.55	-544.03	-543.99	-544.17	-544.38	-544.44	-544.58	-544.74
Quote Progetto				543.55	544.03	543.95	544.17	543.88	544.32		
Parziali				0.87	2.50	2.50					
Progressiva				-3.37	-2.50	0.00	2.50	2.54			
Dislivelli				-0.00	0.76	-0.04	-0.44	0.00			

Sezione: 57
 Progressiva: 420.000
 Q. Progetto: 544.323

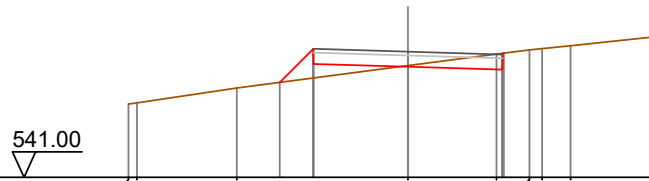

Quote Terreno	542.94	542.97	543.36	543.51	544.00	543.95	543.85	544.26	544.37	544.40	544.48	544.72
Quote Progetto				543.51	544.00	543.92	543.85	544.28	544.28	544.40	544.48	544.72
Parziali				0.89	2.50	2.50						
Progressiva				-3.39	-2.50	0.00	2.50	2.54				
Dislivelli				-0.00	0.77	-0.03	-0.43	0.00				

Sezione: 58
 Progressiva: 425.372
 Q. Progetto: 543.895

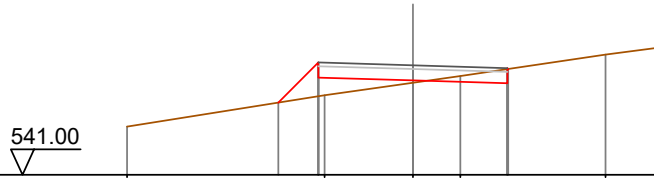

Quote Terreno	542.27			543.10	543.43	543.61		544.18	544.36
Quote Progetto			542.91	543.57	543.50	543.42	543.80		
Parziali			1.06	2.50	2.50				
Progressiva			-3.56	-2.50	0.00	2.50	2.52		
Dislivelli			0.00	0.89	0.06	-0.38	-0.00		

Sezione: 59
 Progressiva: 440.000
 Q. Progetto: 542.856

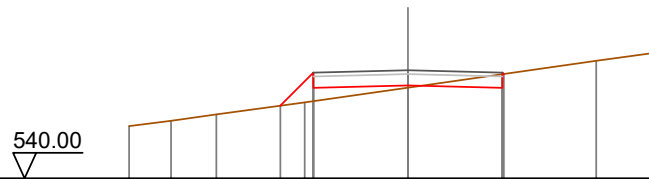

Quote Terreno	541.38	541.52	541.69	542.01	542.40		543.11	543.32
Quote Progetto				541.92	542.39	542.46	542.39	542.76
Parziali				0.87	2.50	2.50		
Progressiva				-3.37	-2.50	0.00	2.50	2.53
Dislivelli				-0.00	0.75	0.06	-0.36	0.00

Sezione: 60
 Progressiva: 460.000
 Q. Progetto: 542.057

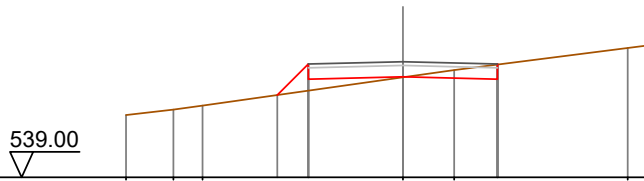

Quote Terreno	-540.64	-540.79	-540.89			541.64	541.84		542.42	542.49
Quote Progetto				541.17	541.59	541.66	541.59			
Parziali				0.82	2.50	2.50				
Progressiva				-3.32	-2.50	0.00	2.50			
Dislivelli				0.00	0.70	0.01	-0.39			

Sezione: 61
 Progressiva: 463.948
 Q. Progetto: 541.927

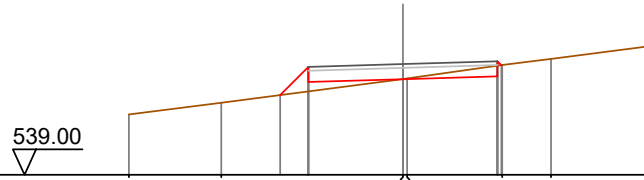

Quote Terreno	-540.59	-540.90				541.53	541.55	541.90	542.07	542.41
Quote Progetto				541.11	541.45	541.53	541.60	541.90		
Parziali				0.74	2.50	2.50				
Progressiva				-3.24	-2.50	0.00	2.50	2.60		
Dislivelli				0.00	0.65	-0.00	-0.28	0.00		

Sezione: 62
 Progressiva: 470.000
 Q. Progetto: 541.728

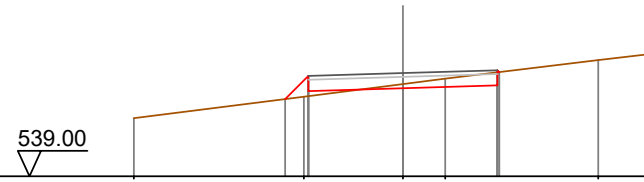

Quote Terreno	-540.54					541.44	541.58		542.07	542.24
Quote Progetto				541.04	541.25	541.33	541.40	541.75		
Parziali				0.61	2.50	2.50				
Progressiva				-3.11	-2.50	0.00	2.50	2.55		
Dislivelli				0.00	0.54	-0.11	-0.35	-0.00		

Sezione: 63
 Progressiva: 473.106
 Q. Progetto: 541.625

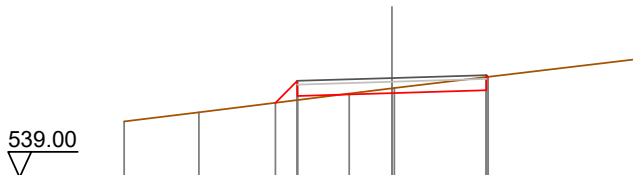

Quote Terreno	-540.48	-540.72		-541.21	-541.35	-541.36		-542.13
Quote Progetto			540.97	541.15		541.23	541.30	541.66
Parziali			0.58	2.50		2.50		
Progressiva			-3.08	-2.50		0.00	2.50	2.54
Dislivelli			-0.00	0.51		-0.13	-0.35	-0.00

Sezione: 64
 Progressiva: 480.000
 Q. Progetto: 541.398

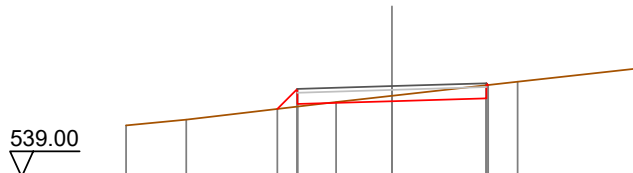

Quote Terreno	-540.36	-540.51		-540.98	-541.14		-541.51	-541.87
Quote Progetto			540.79	540.92		541.00	541.07	541.43
Parziali			0.53	2.50		2.50		
Progressiva			-3.03	-2.50		0.00	2.50	2.55
Dislivelli			0.00	0.47		-0.14	-0.35	-0.00

Sezione: 65
 Progressiva: 482.264
 Q. Progetto: 541.328

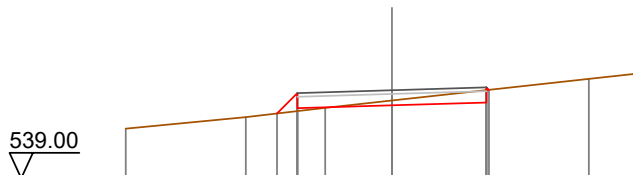

Quote Terreno	-540.31	-540.62		-540.86	-541.05		-541.63	-541.78
Quote Progetto			540.71	540.85		540.93	541.00	541.34
Parziali			0.54	2.50		2.50		
Progressiva			-3.04	-2.50		0.00	2.50	2.57
Dislivelli			0.00	0.48		-0.13	-0.33	-0.00

Sezione: 66
 Progressiva: 500.000
 Q. Progetto: 540.984

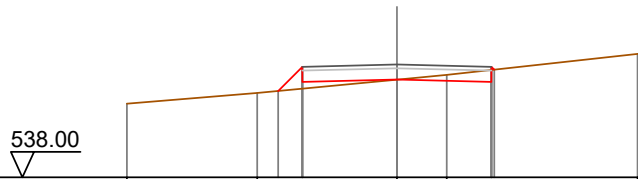

Quote Terreno	539.95	540.23	540.28	540.58	540.71	541.26	541.28
Quote Progetto			540.28	540.58	540.52	540.85	
Parziali			0.64	2.50	2.50		
Progressiva		-3.14	-2.50	0.00	2.50	2.68	
Dislivelli		0.00	0.58	0.00	-0.32	0.00	

Sezione: 67
 Progressiva: 509.068
 Q. Progetto: 540.813

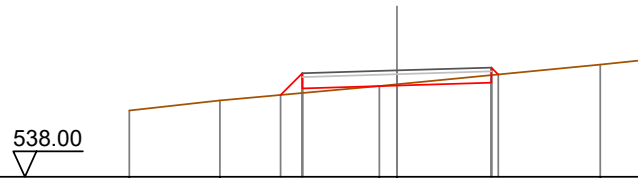

Quote Terreno	539.75	540.02	540.16	540.40	540.44	540.97	541.10
Quote Progetto			540.16	540.41	540.49	540.71	
Parziali			0.58	2.50	2.50		
Progressiva		-3.08	-2.50	0.00	2.50	2.68	
Dislivelli		0.00	0.52	-0.03	-0.20	0.00	

Sezione: 68
 Progressiva: 510.000
 Q. Progetto: 540.789

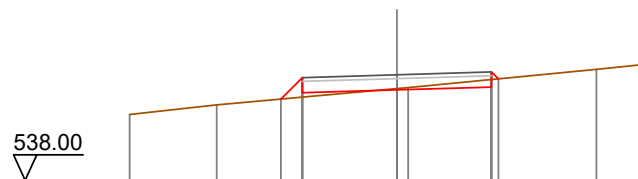

Quote Terreno	539.74	539.99	540.15	540.42	540.45	540.93	541.08
Quote Progetto			540.31	540.39	540.46	540.68	
Parziali			0.57	2.50	2.50		
Progressiva		-3.07	-2.50	0.00	2.50	2.68	
Dislivelli		0.00	0.52	-0.03	-0.20	0.00	

Sezione: 69
 Progressiva: 511.685
 Q. Progetto: 540.743

538.00

Quote Terreno	-539.71	-539.95		540.39	-540.55		-540.87	-541.03
Quote Progetto			540.11	540.34	540.42	540.63		
Parziali			0.55	2.50	2.50			
Progressiva			-3.05	-2.50	0.00	2.50	2.68	
Dislivelli			0.00	0.50	-0.04	-0.20	0.00	

Sezione: 70
 Progressiva: 514.302
 Q. Progetto: 540.659

538.00

Quote Terreno	-539.66	-539.89		540.32		-540.71	-540.77	-540.84	-540.93
Quote Progetto			540.06	540.18	540.26	540.33	540.56		
Parziali			0.53	2.50	2.50				
Progressiva			-3.03	-2.50	0.00	2.50	2.68		
Dislivelli			-0.00	0.48	-0.06	-0.21	0.00		

Sezione: 71
 Progressiva: 520.000
 Q. Progetto: 540.430

538.00

Quote Terreno	-539.37	-539.60		540.03	540.04		-540.51	-540.67
Quote Progetto			539.76	539.97	540.03	539.97	540.28	
Parziali			0.60	2.50	2.50			
Progressiva			-3.10	-2.50	0.00	2.50	2.59	
Dislivelli			0.00	0.55	-0.01	-0.30	0.00	

Sezione: 72
 Progressiva: 540.000
 Q. Progetto: 539.499

537.00

Quote Terreno	538.45	538.67		539.20		539.68	539.85
Quote Progetto			538.88	539.10	539.04		
Parziali			0.56	2.50	2.50		
Progressiva			-3.06	-2.50	0.00	2.50	
Dislivelli			0.00	0.50	-0.10	-0.41	

Sezione: 73
 Progressiva: 560.000
 Q. Progetto: 538.824

536.00

Quote Terreno	537.73	537.95		538.51	538.53		539.12	539.30
Quote Progetto			538.18	538.36	538.42	538.36	538.84	
Parziali			0.58	2.50	2.50			
Progressiva			-3.08	-2.50	0.00	2.50	2.58	
Dislivelli			0.00	0.51	-0.11	-0.47	0.00	

Sezione: 74
 Progressiva: 580.000
 Q. Progetto: 538.469

536.00

Quote Terreno	537.19	537.44		538.08	538.12		538.78	539.01
Quote Progetto			537.70	538.01	538.07	538.01	538.47	
Parziali			0.71	2.50	2.50			
Progressiva			-3.21	-2.50	0.00	2.50	2.56	
Dislivelli			0.00	0.61	-0.05	-0.45	0.00	

Sezione: 75
 Progressiva: 582.444
 Q. Progetto: 538.448

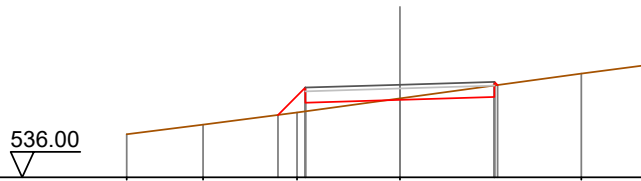

Quote Terreno		-537.14		-537.39		537.65	537.71		538.09		538.74	538.98
Quote Progetto						537.97			538.05		538.12	538.44
Parziali						0.73	2.50		2.50			
Progressiva						-3.23	-2.50		0.00		2.50	2.68
Dislivelli						0.00	0.63		-0.04		-0.31	0.00

Sezione: 76
 Progressiva: 588.240
 Q. Progetto: 538.291

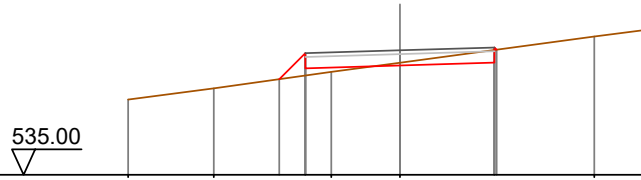

Quote Terreno		-536.99		-537.28		537.53	537.72		537.96		538.66	538.84
Quote Progetto						537.82			537.89		537.97	538.31
Parziali						0.69	2.50		2.50			
Progressiva						-3.19	-2.50		0.00		2.50	2.56
Dislivelli						0.00	0.59		-0.07		-0.33	0.00

Sezione: 77
 Progressiva: 590.000
 Q. Progetto: 538.239

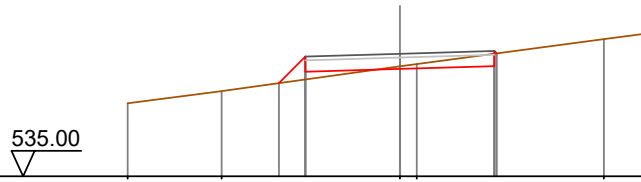

Quote Terreno		-536.93		-537.25		537.91	537.97		537.97		538.63	538.78
Quote Progetto						537.46	537.76		537.84		537.91	538.25
Parziali						0.70	2.50		2.50			
Progressiva						-3.20	-2.50		0.00		2.50	2.56
Dislivelli						0.00	0.60		-0.07		-0.33	-0.00

Sezione: 78
 Progressiva: 594.037
 Q. Progetto: 538.095

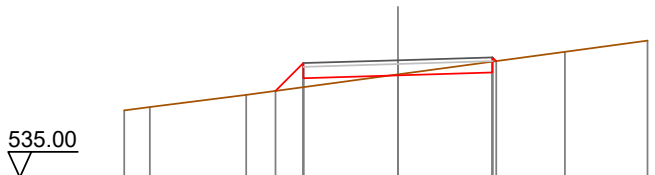

Quote Terreno		-536.77	-536.86	-537.18		537.28	537.62	537.72		538.32	538.62
Quote Progetto						537.28	537.62	537.70	537.77	538.07	
Parziali						0.74	2.50	2.50			
Progressiva						-3.24	-2.50	0.00	2.50	2.60	
Dislivelli						0.00	0.64	-0.03	-0.29	0.00	

Sezione: 79
 Progressiva: 600.000
 Q. Progetto: 537.824

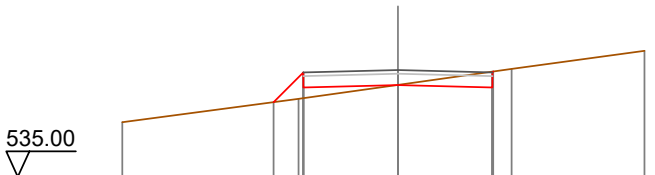

Quote Terreno		-536.44		537.06		537.43		537.85		538.33
Quote Progetto				536.97	537.36	537.42		537.36	537.78	
Parziali				0.79	2.50	2.50				
Progressiva				-3.29	-2.50	0.00	2.50	2.52		
Dislivelli				-0.00	0.68	-0.00	-0.42	0.00		

Sezione: 80
 Progressiva: 620.000
 Q. Progetto: 536.731

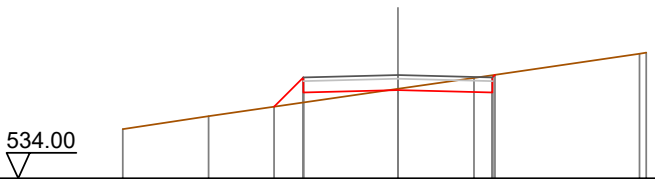

Quote Terreno		-535.30	-535.64			536.36		536.65		537.29	537.32
Quote Progetto					536.89	536.27	536.33	536.27	536.74		
Parziali					0.78	2.50	2.50				
Progressiva					-3.28	-2.50	0.00	2.50	2.57		
Dislivelli					0.00	0.67	-0.03	-0.46	-0.00		

Sezione: 81
 Progressiva: 640.000
 Q. Progetto: 535.635

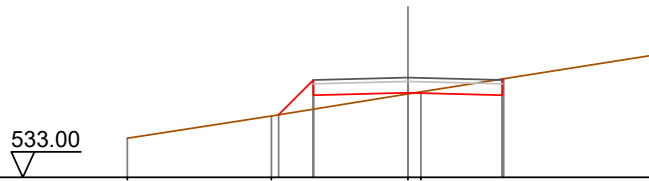

Quote Terreno	-534.03	-534.62	-535.20	-535.26	-536.24
Quote Progetto		534.65	535.17	535.23	535.17
Parziali		0.92	2.50	2.50	
Progressiva		-3.42	-2.50	0.00	2.50
Dislivelli		0.00	0.77	0.03	-0.43

Sezione: 82
 Progressiva: 640.737
 Q. Progetto: 535.594

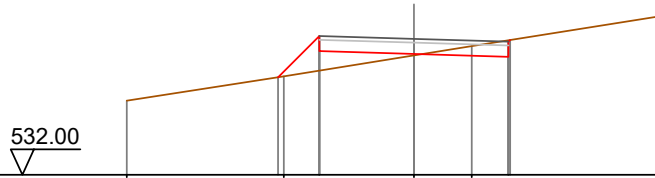

Quote Terreno	-533.96	-534.60	-535.16	-535.40	-536.20
Quote Progetto		534.58	535.27	535.19	535.12
Parziali		1.09	2.50	2.50	
Progressiva		-3.59	-2.50	0.00	2.50
Dislivelli		-0.00	0.92	0.04	-0.44

Sezione: 83
 Progressiva: 650.000
 Q. Progetto: 535.131

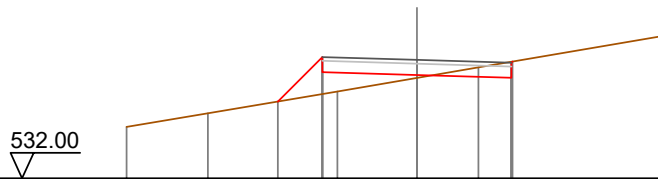

Quote Terreno	-533.36	-533.72	-534.29	-534.65	-534.93	-535.77
Quote Progetto			534.03	534.81	534.73	534.66
Parziali			1.18	2.50	2.50	
Progressiva			-3.68	-2.50	0.00	2.50
Dislivelli			0.00	0.98	0.08	-0.43

Sezione: 84
 Progressiva: 659.218
 Q. Progetto: 534.833

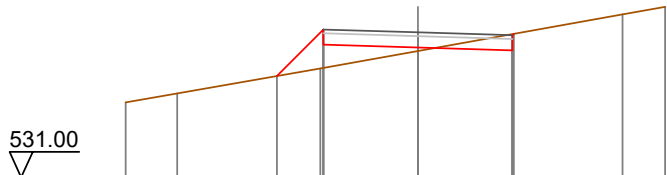

Quote Terreno	532.98	533.22		533.88	534.34		535.31	535.51
Quote Progetto			533.68	534.51	534.43	534.36	534.79	
Parziali			1.23	2.50	2.50			
Progressiva			-3.73	-2.50	0.00	2.50	2.54	
Dislivelli			0.00	1.01	0.09	-0.43	0.00	

Sezione: 85
 Progressiva: 660.000
 Q. Progetto: 534.815

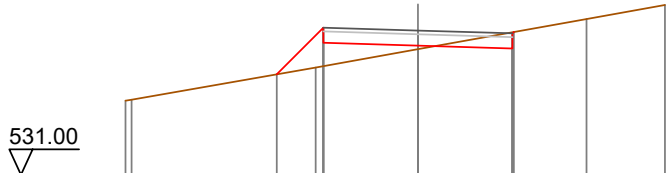

Quote Terreno	532.96	532.99		533.84	534.32		535.12	535.49
Quote Progetto			533.66	534.49	534.42	534.34	534.78	
Parziali			1.23	2.50	2.50			
Progressiva			-3.73	-2.50	0.00	2.50	2.53	
Dislivelli			-0.00	1.02	0.09	-0.43	0.00	

Sezione: 86
 Progressiva: 670.000
 Q. Progetto: 534.700

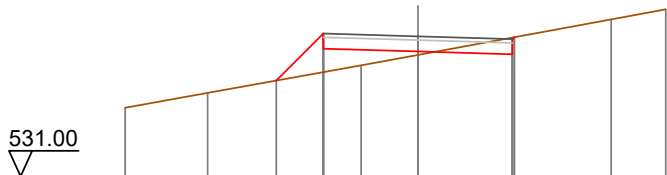

Quote Terreno	532.81	533.21		533.93	534.21		535.15	535.41
Quote Progetto			533.53	534.38	534.30	534.23	534.68	
Parziali			1.24	2.50	2.50			
Progressiva			-3.74	-2.50	0.00	2.50	2.55	
Dislivelli			0.00	1.02	0.09	-0.44	-0.00	

Sezione: 87
 Progressiva: 677.698
 Q. Progetto: 534.748

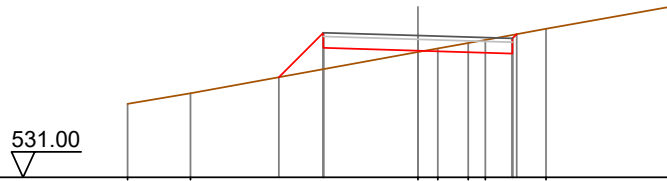

Quote Terreno	532.94	533.22			534.31	534.41	534.55	534.83	534.93	535.50
Quote Progetto			533.64	534.42	534.35		534.27	534.78		
Parziali				1.18	2.50		2.50			
Progressiva			-3.68	-2.50	0.00		2.50	2.61		
Dislivelli			-0.00	0.96	0.04		-0.49	0.00		

Sezione: 88
 Progressiva: 680.000
 Q. Progetto: 534.785

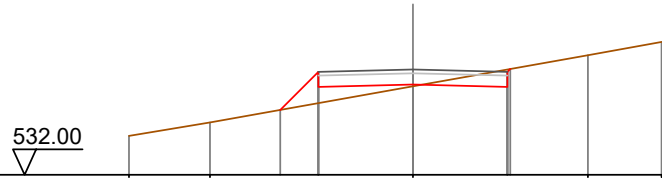

Quote Terreno	533.03	533.38			534.34			535.16	535.51
Quote Progetto			533.71	534.32	534.38		534.32	534.80	
Parziali			1.01	2.50	2.50				
Progressiva			-3.51	-2.50	0.00		2.50	2.57	
Dislivelli			-0.00	0.83	0.05		-0.46	0.00	

Sezione: 89
 Progressiva: 681.582
 Q. Progetto: 534.817

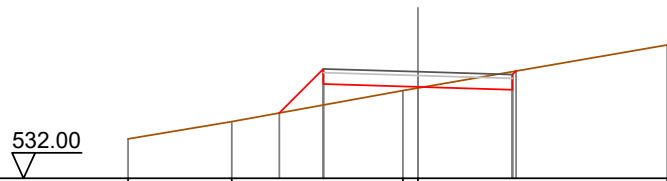

Quote Terreno	533.04	533.50			534.32	534.39			535.53
Quote Progetto			533.73	534.49	534.42		534.34	534.84	
Parziali			1.17	2.50	2.50				
Progressiva			-3.67	-2.50	0.00		2.50	2.59	
Dislivelli			0.00	0.95	0.03		-0.48	-0.00	

Sezione: 90
 Progressiva: 690.000
 Q. Progetto: 535.070

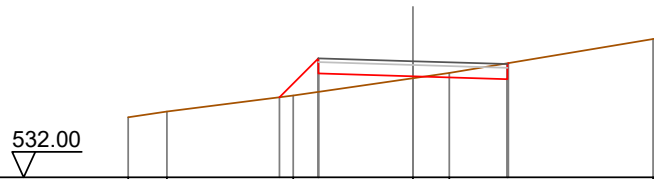

Quote Terreno	533.59	533.74	534.16	534.62	534.76	535.66	535.69
Quote Progetto			534.11	534.74	534.67	534.59	535.02
Parziali			1.03	2.50	2.50		
Progressiva			-3.53	-2.50	0.00	2.50	2.52
Dislivelli			-0.00	0.89	0.05	-0.42	0.00

Sezione: 91
 Progressiva: 700.105
 Q. Progetto: 535.556

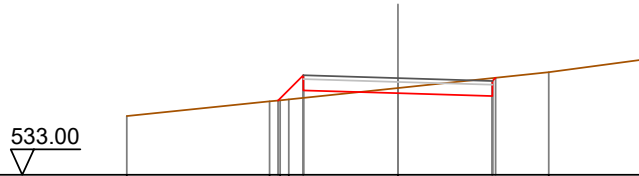

Quote Terreno	534.55	534.94	534.99	535.30	535.71	536.06
Quote Progetto		534.96	535.23	535.16	535.08	535.56
Parziali		0.67	2.50	2.50		
Progressiva		-3.17	-2.50	0.00	2.50	2.58
Dislivelli		0.00	0.60	-0.14	-0.47	-0.00

Sezione: 92
 Progressiva: 710.000
 Q. Progetto: 536.093

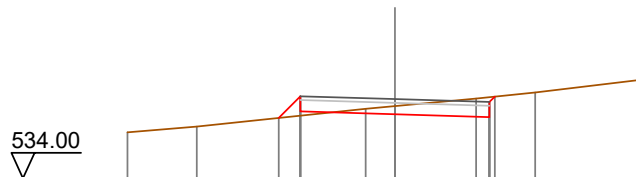

Quote Terreno	535.21	535.37	535.84	535.91	536.11	536.27	536.62
Quote Progetto			535.60	535.77	535.69	535.62	536.16
Parziali			0.57	2.50	2.50		
Progressiva			-3.07	-2.50	0.00	2.50	2.64
Dislivelli			0.00	0.51	-0.22	-0.53	0.00

Sezione: 93
 Progressiva: 718.629
 Q. Progetto: 536.561

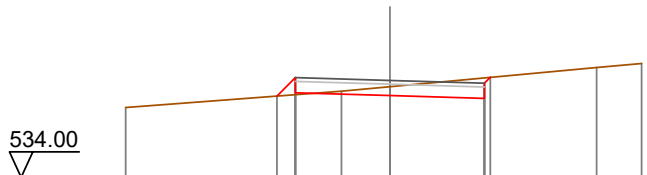

Quote Terreno	-535.84		536.28	536.40		536.90	537.01
Quote Progetto		536.15	536.24	536.16	536.09	536.64	
Parziali		0.49	2.50	2.50			
Progressiva		-2.99	-2.50	0.00	2.50	2.66	
Dislivelli		0.00	0.45	-0.23	-0.54	-0.00	

Sezione: 94
 Progressiva: 720.000
 Q. Progetto: 536.635

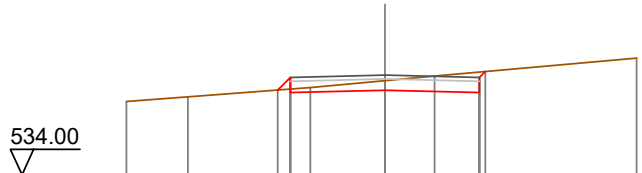

Quote Terreno	-535.94	-536.06	-536.30	-536.49	-536.61		-537.09
Quote Progetto			536.24	536.17	536.24	536.17	536.73
Parziali			0.33	2.50	2.50		
Progressiva			-2.83	-2.50	0.00	2.50	2.66
Dislivelli			0.00	0.31	-0.25	-0.54	0.00

Sezione: 95
 Progressiva: 740.000
 Q. Progetto: 537.711

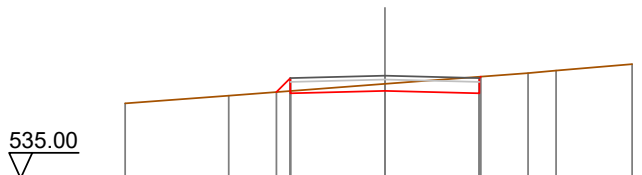

Quote Terreno	-536.98		537.19	537.50		537.78	537.85	538.02
Quote Progetto			537.28	537.25	537.31	537.25	537.69	
Parziali			0.37	2.50	2.50			
Progressiva			-2.87	-2.50	0.00	2.50	2.54	
Dislivelli			-0.00	0.34	-0.18	-0.44	-0.00	

Sezione: 96
 Progressiva: 760.000
 Q. Progetto: 538.566

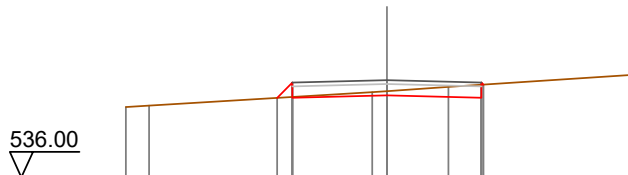

Quote Terreno		-537.86	-537.90			-538.25	-538.28		-538.39		-538.71
Quote Progetto				538.10	538.10		538.17		538.10	538.45	
Parziali				0.40	2.50		2.50				
Progressiva				-2.90	-2.50		0.00		2.50	2.55	
Dislivelli				0.00	0.38		-0.11		-0.34	0.00	

Sezione: 97
 Progressiva: 779.858
 Q. Progetto: 539.109

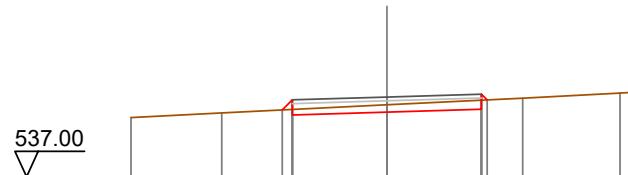

Quote Terreno		-538.57	-538.69			-538.90		-539.08		-539.21	-539.24
Quote Progetto				538.77	538.63		538.71		538.78	539.03	
Parziali				0.27	2.50		2.50				
Progressiva				-2.77	-2.50		0.00		2.50	2.65	
Dislivelli				0.00	0.25		-0.19		-0.24	0.00	

Sezione: 98
 Progressiva: 790.000
 Q. Progetto: 539.304

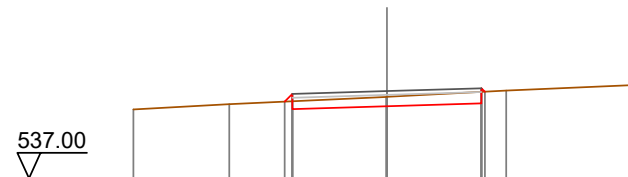

Quote Terreno		-538.82	-538.96			-539.15		-539.32		-539.47	
Quote Progetto				539.03	538.83		538.90		538.98	539.29	
Parziali					2.50		2.50				
Progressiva				-2.70	-2.50		0.00		2.50	2.59	
Dislivelli				0.00	0.19		-0.25		-0.30	0.00	

Sezione: 99
 Progressiva: 791.164
 Q. Progetto: 539.327

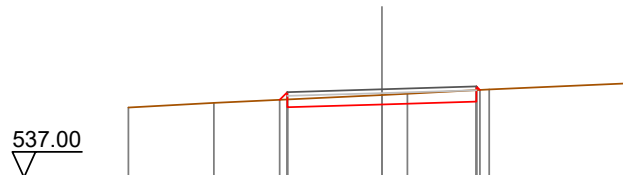

Quote Terreno	538.84	538.97	539.05	538.85	539.18	539.21	539.32	539.48	539.49
Quote Progetto			539.05	538.85	538.83		539.00	539.31	
Parziali					2.50		2.50		
Progressiva			-2.70	-2.50	0.00		2.50	2.59	
Dislivelli			0.00	0.19	-0.25		-0.30	0.00	

Sezione: 100
 Progressiva: 800.000
 Q. Progetto: 539.498

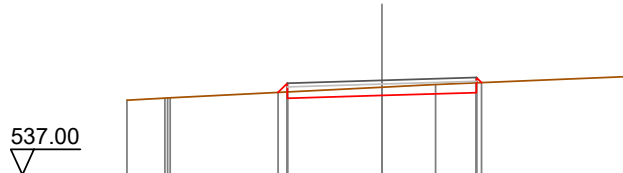

Quote Terreno	538.97	539.03	539.04	539.18	539.32	539.39	539.60	
Quote Progetto				539.18	539.10	539.17	539.44	
Parziali				2.50		2.50		
Progressiva				-2.74	-2.50	0.00	2.50	2.64
Dislivelli				0.00	0.23	-0.22	-0.26	0.00

Sezione: 100
 Progressiva: 800.000
 Q. Progetto: 539.498

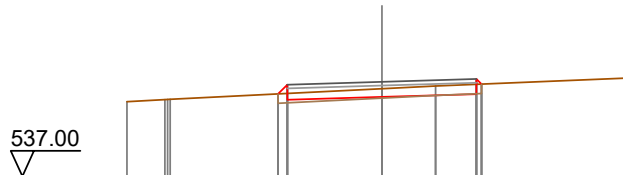

Quote Terreno	538.97	539.03	539.04	539.18	539.32	539.39	539.60	
Quote Progetto				539.18	539.10	539.17	539.44	
Parziali				2.50		2.50		
Progressiva				-2.74	-2.50	0.00	2.50	2.64
Dislivelli				-0.00	0.23	-0.22	-0.26	0.00

Sezione: 101
 Progressiva: 802.471
 Q. Progetto: 539.545

537.00

Quote Terreno	539.00	539.06	539.16	539.34	539.41	539.62	539.63
Quote Progetto			539.20 539.07	539.15	539.22 539.46		
Parziali			0.07 2.50	2.50			
Progressiva			-2.77 -2.50	0.00	2.50 2.66		
Dislivelli			-0.00 0.26	-0.20	-0.24 0.00		

Sezione: 102
 Progressiva: 820.000
 Q. Progetto: 539.884

538.00

Quote Terreno	539.24	539.28	539.53	539.55	539.60	539.66	539.80
Quote Progetto			539.42 539.42	539.48	539.42 539.66		
Parziali			0.40 2.50	2.50			
Progressiva			-2.90 -2.50	0.00	2.50 2.66		
Dislivelli			-0.00 0.38	-0.06	-0.23 0.00		

Sezione: 103
 Progressiva: 834.618
 Q. Progetto: 540.131

538.00

Quote Terreno	539.49	539.53	539.76	539.77	539.84	539.90
Quote Progetto			539.66 539.66	539.73	539.81 539.85	
Parziali			0.40 2.50	2.50	0.36 2.86	
Progressiva			-2.90 -2.50	0.00	2.50 2.86	
Dislivelli			0.00 0.38	-0.03	-0.04 0.00	

Sezione: 104
 Progressiva: 840.000
 Q. Progetto: 540.196

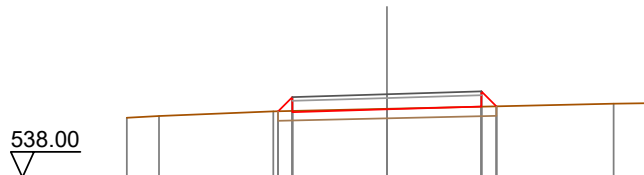

Quote Terreno	-539.57	-539.62	-539.74	-539.81	-539.94	-539.96
Quote Progetto			539.74 539.72	539.80	539.87 539.87	
Parziali			0.38 2.50	2.50	0.40	
Progressiva			-2.88 -2.50	0.00	2.50 2.90	
Dislivelli			0.00 0.37	-0.01	0.01 0.00	

Sezione: 105
 Progressiva: 850.000
 Q. Progetto: 540.293

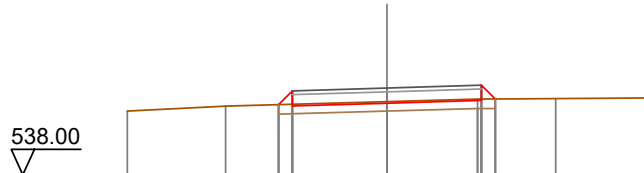

Quote Terreno	-539.68	-539.81	-539.93	-540.00	-540.01	-540.03
Quote Progetto			539.85 539.82	539.89	539.97 540.00	
Parziali			0.36 2.50	2.50	0.37	
Progressiva			-2.86 -2.50	0.00	2.50 2.87	
Dislivelli			0.00 0.36	-0.04	-0.03 0.00	

Sezione: 106
 Progressiva: 860.000
 Q. Progetto: 540.388

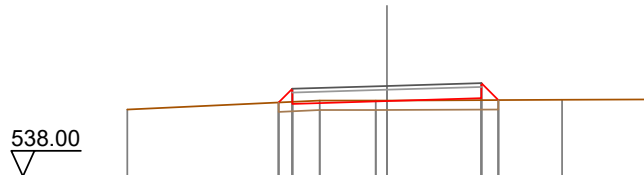

Quote Terreno	-539.76	-540.00	-540.00	-540.02	-540.03
Quote Progetto		539.95 539.91	539.99	540.06 540.01	
Parziali		0.36 2.50	2.50	0.45	
Progressiva		-2.86 -2.50	0.00	2.50 2.95	
Dislivelli		0.00 0.35	-0.01	0.05 0.00	

Sezione: 107
 Progressiva: 861.790
 Q. Progetto: 540.402

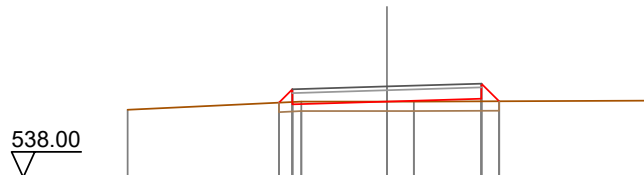

Quote Terreno	539.78	540.00	540.00	540.00	540.03
Quote Progetto		539.97	539.93	540.00	540.08
Parziali		0.36	2.50	2.50	0.47
Progressiva		-2.86	-2.50	0.00	2.50
Dislivelli		0.00	0.34	0.00	0.07

Sezione: 108
 Progressiva: 870.000
 Q. Progetto: 540.385

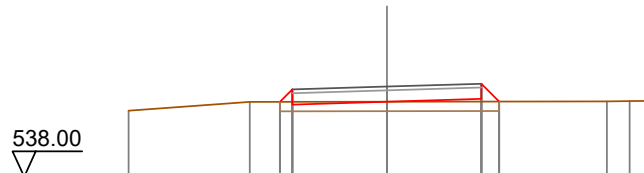

Quote Terreno	539.75	539.98	539.99	539.99	540.00
Quote Progetto		539.98	539.91	540.06	539.99
Parziali		0.33	2.50	2.50	0.47
Progressiva		-2.83	-2.50	0.00	2.50
Dislivelli		0.00	0.33	0.00	0.07

Sezione: 109
 Progressiva: 880.000
 Q. Progetto: 540.182

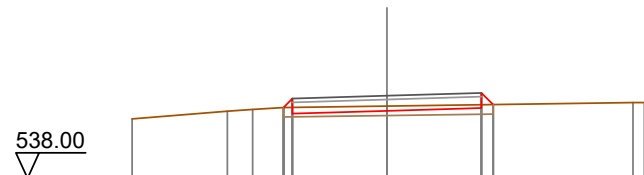

Quote Terreno	539.57	539.77	539.82	539.87	539.91	540.00	540.00
Quote Progetto			539.87	539.71	539.78	539.86	539.95
Parziali				2.50	2.50	0.31	
Progressiva			-2.74	-2.50	0.00	2.50	2.81
Dislivelli			0.00	0.24	-0.12	-0.08	0.00

Sezione: 109
 Progressiva: 880.000
 Q. Progetto: 540.182

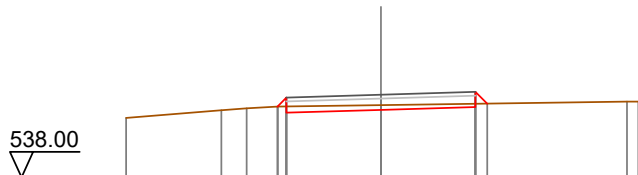

Quote Terreno	539.57	539.77	539.82	539.87	539.91	540.00	540.00
Quote Progetto			539.87	539.71	539.78	539.86	539.95
Parziali				2.50	2.50	0.31	
Progressiva			-2.74	-2.50	0.00	2.50	2.81
Dislivelli			-0.00	0.24	-0.12	-0.09	0.00

Sezione: 110
 Progressiva: 888.962
 Q. Progetto: 539.830

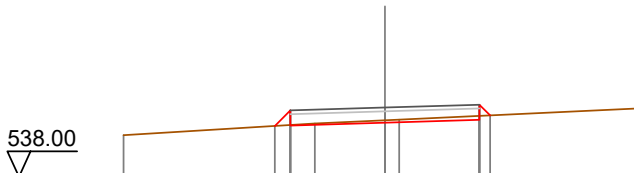

Quote Terreno	539.10		539.41	539.49	539.51		539.81
Quote Progetto			539.34	539.36	539.43	539.51	539.62
Parziali			0.41	2.50	2.50	0.28	
Progressiva			-2.91	-2.50	0.00	2.50	2.78
Dislivelli			-0.00	0.39	-0.06	-0.10	0.00

Sezione: 111
 Progressiva: 900.000
 Q. Progetto: 539.175

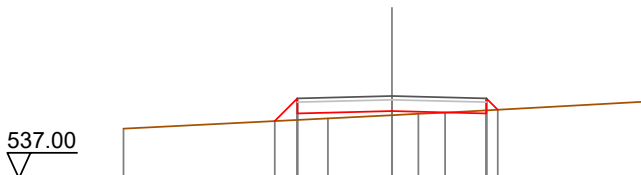

Quote Terreno	538.31		538.58	538.67	538.70	538.74	539.03
Quote Progetto			538.51	538.71	538.78	538.71	538.81
Parziali			0.60	2.50	2.50	0.30	
Progressiva			-3.10	-2.50	0.00	2.50	2.80
Dislivelli			0.00	0.57	0.11	-0.08	0.00

Sezione: 112
 Progressiva: 920.000
 Q. Progetto: 537.546

535.00

Quote Terreno	-536.79	-536.88	-536.95	-537.09	-537.14	-537.38
Quote Progetto			536.95 537.08	537.15	537.08 537.21	
Parziali			0.53 2.50	2.50	0.28	
Progressiva			-3.03 -2.50	0.00	2.50 2.78	
Dislivelli			-0.00 0.51	0.06	-0.11 0.00	

Sezione: 113
 Progressiva: 939.053
 Q. Progetto: 535.952

534.00

Quote Terreno	-535.27			-535.53 -535.55	-535.62	-535.67	-535.79
Quote Progetto			535.41 535.63	535.55	535.48 535.63		
Parziali			0.61 2.50	2.50			
Progressiva			-3.11 -2.50	0.00	2.50 2.75		
Dislivelli			0.00 0.59	0.02	-0.14 0.00		

Sezione: 114
 Progressiva: 940.000
 Q. Progetto: 535.873

534.00

Quote Terreno	-535.18			-535.45	-535.54 -535.56 -535.57	-535.62	-535.72
Quote Progetto			535.33 535.55	535.47	535.40 535.56		
Parziali			0.62 2.50	2.50			
Progressiva			-3.12 -2.50	0.00	2.50 2.74		
Dislivelli			-0.00 0.59	0.02	-0.15 0.00		

Sezione: 115
 Progressiva: 940.387
 Q. Progetto: 535.841

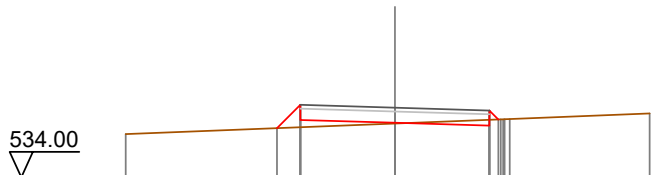

Quote Terreno	535.14			535.42	535.53	535.54	535.69
Quote Progetto		535.30	535.52	535.44	535.37	535.53	
Parziali		0.62	2.50	2.50			
Progressiva		-3.12	-2.50	0.00	2.50	2.74	
Dislivelli		0.00	0.59	0.02	-0.15	0.00	

Sezione: 116
 Progressiva: 941.722
 Q. Progetto: 535.729

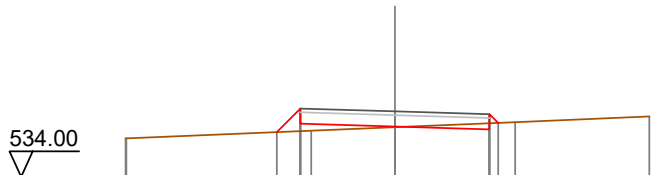

Quote Terreno	535.02	535.02		535.22	535.31	535.44	535.59
Quote Progetto			535.18	535.40	535.33	535.25	535.42
Parziali			0.62	2.50	2.50		
Progressiva			-3.12	-2.50	0.00	2.50	2.73
Dislivelli			0.00	0.60	0.02	-0.16	-0.00

Sezione: 117
 Progressiva: 955.572
 Q. Progetto: 534.571

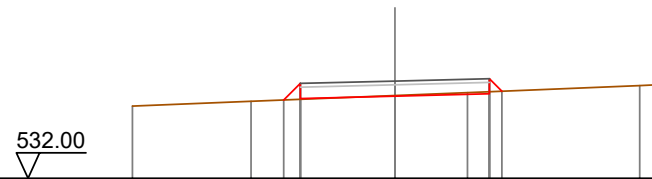

Quote Terreno	533.91	534.03		534.19	534.27	534.45	534.47
Quote Progetto			534.07	534.11	534.17	534.23	534.30
Parziali			0.44	2.50	2.50	0.33	
Progressiva			-2.94	-2.50	0.00	2.50	2.83
Dislivelli			0.00	0.42	-0.02	-0.06	-0.00

Sezione: 118
 Progressiva: 960.000
 Q. Progetto: 534.200

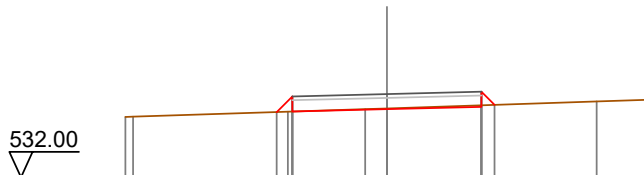

Quote Terreno	533.60	533.60	533.73	533.80	533.82	534.01	534.05
Quote Progetto			533.72	533.74	533.80	533.86	533.92
Parziali			0.41	2.50	2.50	0.35	
Progressiva			-2.91	-2.50	0.00	2.50	2.85
Dislivelli			0.00	0.40	-0.02	-0.04	0.00

Sezione: 119
 Progressiva: 970.000
 Q. Progetto: 533.364

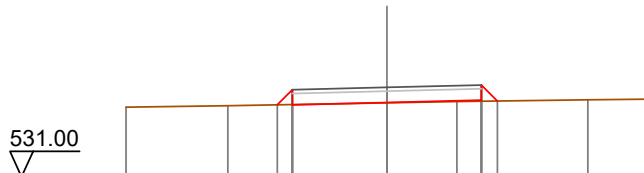

Quote Terreno	532.84	532.88	532.95	532.99	533.04	533.05	
Quote Progetto			532.90	532.90	533.03	533.00	
Parziali			0.40	2.50	2.50	0.42	
Progressiva			-2.90	-2.50	0.00	2.50	2.92
Dislivelli			-0.00	0.39	0.01	0.03	0.00

Sezione: 120
 Progressiva: 977.990
 Q. Progetto: 532.696

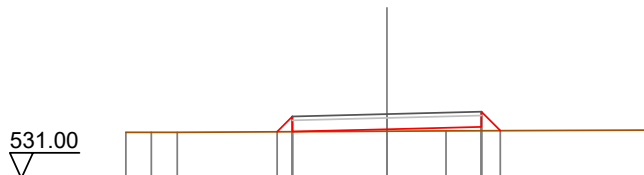

Quote Terreno	532.21	532.21	532.21	532.25	532.25	532.27	
Quote Progetto			532.23	532.30	532.36	532.26	
Parziali			0.40	2.50	2.50	0.50	
Progressiva			-2.90	-2.50	0.00	2.50	3.00
Dislivelli			0.00	0.40	0.05	0.10	-0.00

Sezione: 121
 Progressiva: 980.000
 Q. Progetto: 532.528

531.00

Quote Terreno	-532.06	-532.06	-532.06	-532.07	-532.07	-532.07	-532.07
Quote Progetto			532.06	532.07	532.13	532.19	532.07
Parziali			0.40	2.50	2.50	0.52	
Progressiva			-2.90	-2.50	0.00	2.50	3.02
Dislivelli			0.00	0.40	0.06	0.12	0.00

Sezione: 122
 Progressiva: 990.000
 Q. Progetto: 531.691

530.00

Quote Terreno	-531.29	-531.26	-531.22	-531.19	-531.10		
Quote Progetto			531.23	531.23	531.29	531.35	531.15
Parziali			0.40	2.50	2.50	0.60	
Progressiva			-2.90	-2.50	0.00	2.50	3.10
Dislivelli			-0.00	0.41	0.10	0.20	0.00

Sezione: 123
 Progressiva: 1000.000
 Q. Progetto: 530.890

529.00

Quote Terreno	-530.55	-530.42	-530.40	-530.35	-530.26	
Quote Progetto		530.46	530.43	530.49	530.55	530.35
Parziali		0.37	2.50	2.50	0.61	
Progressiva		-2.87	-2.50	0.00	2.50	3.11
Dislivelli		0.00	0.38	0.09	0.19	0.00

Sezione: 124
 Progressiva: 1000.408
 Q. Progetto: 530.861

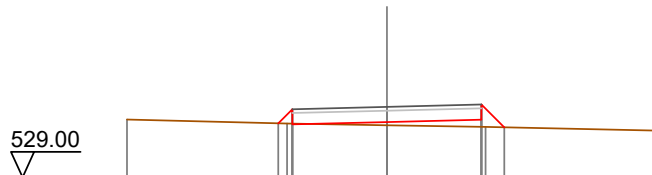

Quote Terreno	530.53	530.42	530.38	530.33	530.24
Quote Progetto		530.43 530.40	530.46	530.52 530.32	
Parziali		0.37 2.50	2.50	0.60	
Progressiva		-2.87 -2.50	0.00	2.50 3.10	
Dislivelli		0.00 0.38	0.09	0.19 0.00	

Sezione: 125
 Progressiva: 1016.417
 Q. Progetto: 529.951

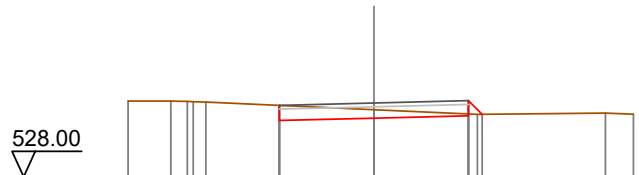

Quote Terreno	530.00	530.00	529.98	529.77	529.65	529.66
Quote Progetto			529.49	529.55	529.61 529.65	
Parziali			2.50	2.50	0.36	
Progressiva			-2.50	0.00	2.50 2.86	
Dislivelli			-0.00	-0.22	-0.05 0.00	

Sezione: 126
 Progressiva: 1018.916
 Q. Progetto: 529.825

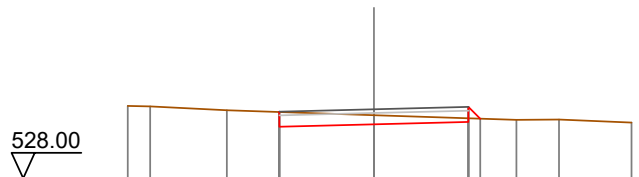

Quote Terreno	529.91	529.90	529.80	529.67	529.54	529.55	529.47
Quote Progetto			529.36	529.42	529.49 529.58		
Parziali			2.50	2.50	0.31		
Progressiva			-2.51	0.00	2.50 2.81		
Dislivelli			0.00	-0.24	-0.10 0.00		

Sezione: 127
 Progressiva: 1020.000
 Q. Progetto: 529.770

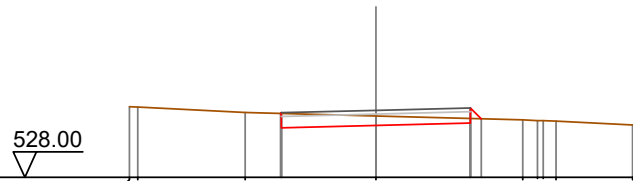

Quote Terreno	529.86	529.86	529.71	529.62	529.52	529.48	529.38
Quote Progetto			529.69	529.37	529.43	529.55	
Parziali			2.50	2.50	0.28		
Progressiva			-2.52	0.00	2.50	2.79	
Dislivelli			0.00	-0.25	-0.12	0.00	

Sezione: 128
 Progressiva: 1021.416
 Q. Progetto: 529.699

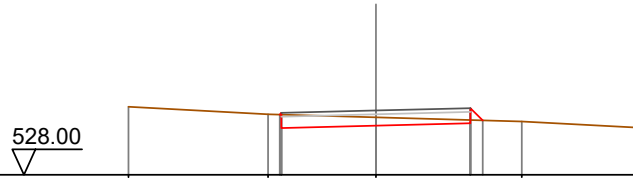

Quote Terreno	529.80	529.60	529.52	529.41	529.25
Quote Progetto		529.59	529.30	529.36	
Parziali		2.50	2.50	0.32	
Progressiva		-2.55	0.00	2.50	2.82
Dislivelli		0.00	-0.22	-0.09	0.00

Sezione: 129
 Progressiva: 1040.000
 Q. Progetto: 528.661

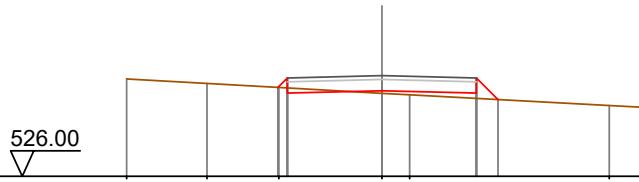

Quote Terreno	528.57	528.46	528.35	528.19	528.15	527.87	527.81
Quote Progetto			528.35	528.26	528.20	528.03	
Parziali			2.50	2.50	0.57		
Progressiva			-2.75	0.00	2.50	3.07	
Dislivelli			0.00	0.07	0.14	0.00	

Sezione: 130
 Progressiva: 1046.354
 Q. Progetto: 528.172

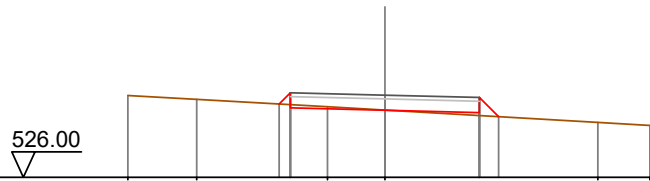

Quote Terreno	528.16	528.06	527.86	527.78	527.45	527.37
Quote Progetto			527.94 527.83	527.77	527.71 527.60	
Parziali			0.30 2.50	2.50	0.51	
Progressiva			-2.80 -2.50	0.00	2.50 3.01	
Dislivelli			0.00 0.31	-0.01	0.08 0.00	

Sezione: 131
 Progressiva: 1050.000
 Q. Progetto: 527.854

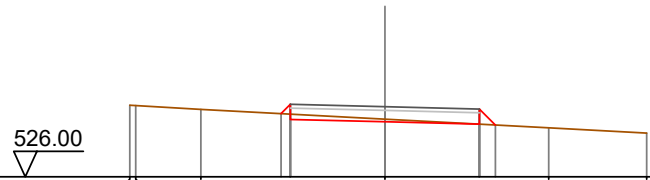

Quote Terreno	527.89	527.88	527.78	527.52	527.29	527.16
Quote Progetto			527.67 527.52	527.45	527.39 527.37	
Parziali			2.50	2.50	0.42	
Progressiva			-2.75 -2.50	0.00	2.50 2.92	
Dislivelli			-0.00 0.26	-0.07	0.00 0.00	

Sezione: 132
 Progressiva: 1055.180
 Q. Progetto: 527.356

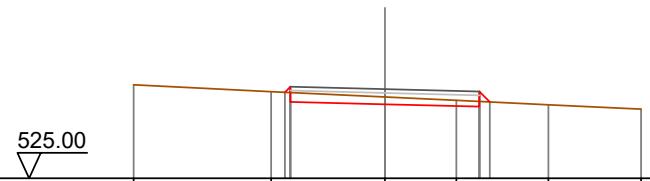

Quote Terreno	527.47	527.29	527.15	527.06	526.94	526.83
Quote Progetto		527.27 527.02	526.96	526.89 527.02		
Parziali		2.50	2.50	0.28		
Progressiva		-2.65 -2.50	0.00	2.50 2.78		
Dislivelli		0.00 0.15	-0.19	-0.14 0.00		

Sezione: 133
 Progressiva: 1060.000
 Q. Progetto: 526.844

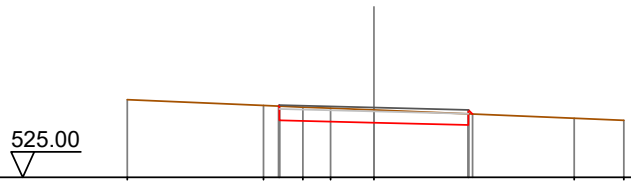

Quote Terreno	-527.05	-526.90	-526.86	-526.83	-526.78	-526.56	-526.51
Quote Progetto		526.88	526.51		526.44	526.38	526.67
Parziali			2.50		2.50		
Progressiva		-2.52	-2.50		0.00	2.50	2.61
Dislivelli		0.00	0.02		-0.33	-0.29	0.00

Sezione: 134
 Progressiva: 1064.006
 Q. Progetto: 526.383

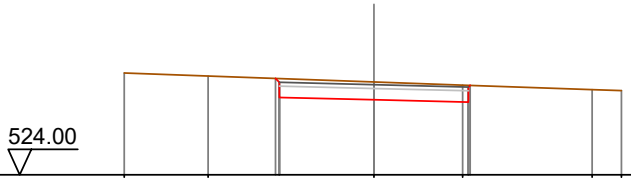

Quote Terreno	-526.69	-526.61		-526.46	-526.37	-526.25	-526.23
Quote Progetto			526.55	526.05	525.98	525.92	526.36
Parziali				2.50		2.50	
Progressiva			-2.60	-2.50	0.00	2.50	2.54
Dislivelli			0.00	-0.10	-0.47	-0.45	0.00

Sezione: 135
 Progressiva: 1064.862
 Q. Progetto: 526.280

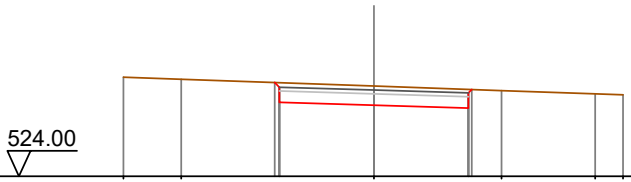

Quote Terreno	-526.62	-526.57		-526.38		-526.26	-526.18	-526.15
Quote Progetto			526.48	525.95	525.88	525.80	526.29	
Parziali				2.50		2.50		
Progressiva			-2.62	-2.50	0.00	2.50	2.59	
Dislivelli			0.00	-0.12	-0.51	-0.49	0.00	

Sezione: 136
 Progressiva: 1070.000
 Q. Progetto: 525.631

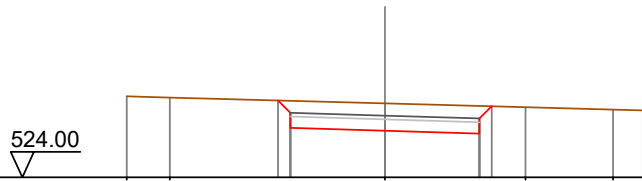

Quote Terreno		-526.14	-526.11		525.95		525.85		-525.79	-525.77
Quote Progetto				526.03	525.31	525.23	525.16	525.88		
Parziali				0.33	2.50	2.50	0.32			
Progressiva				-2.83	-2.50	0.00	2.50	2.82		
Dislivelli				0.00	-0.32	-0.72	-0.73	0.00		

Sezione: 137
 Progressiva: 1080.000
 Q. Progetto: 524.236

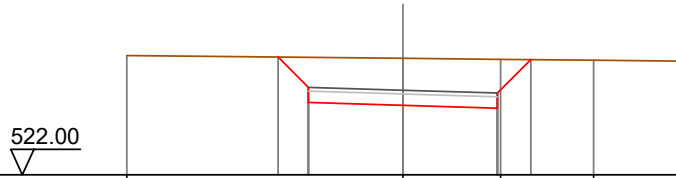

Quote Terreno		-525.15			525.08		525.05		525.03	-525.00
Quote Progetto				525.11	523.91	523.84	523.76	525.05		
Parziali				0.80	2.50	2.50	0.88			
Progressiva				-3.30	-2.50	0.00	2.50	3.38		
Dislivelli				-0.00	-0.79	-1.24	-1.29	0.00		

Sezione: 137
 Progressiva: 1080.000
 Q. Progetto: 524.236

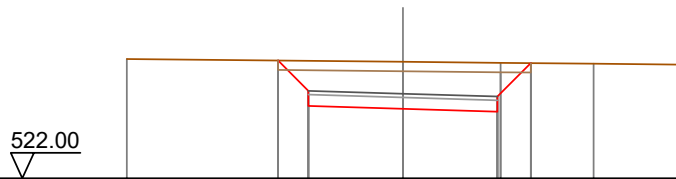

Quote Terreno		-525.15			525.08		525.05		525.03	-525.00
Quote Progetto				525.11	523.91	523.84	523.76	525.05		
Parziali				0.80	2.50	2.50	0.88			
Progressiva				-3.30	-2.50	0.00	2.50	3.38		
Dislivelli				0.00	-0.79	-1.24	-1.29	0.00		

Sezione: 138
 Progressiva: 1090.000
 Q. Progetto: 522.938

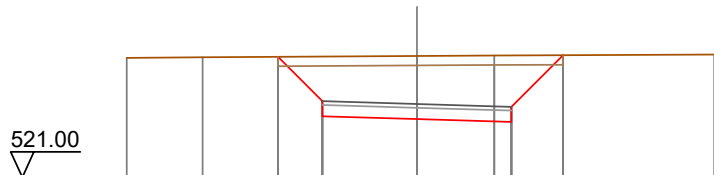

Quote Terreno	524.16	524.17		524.21	524.22	524.24
Quote Progetto			524.19	522.61	522.54	522.46
Parziali			1.17	2.50	2.50	1.36
Progressiva			-3.67	-2.50	0.00	2.50
Dislivelli			0.00	-1.18	-1.67	-1.76

Sezione: 139
 Progressiva: 1092.669
 Q. Progetto: 522.626

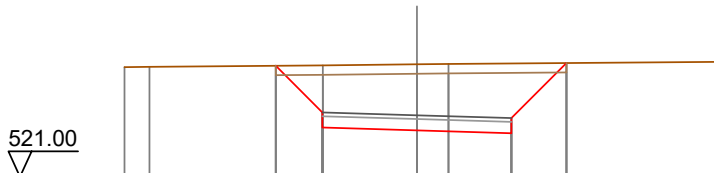

Quote Terreno	523.90	523.91		523.95	523.97	523.98	524.04
Quote Progetto			523.94	522.30	522.23	522.15	524.01
Parziali			1.23	2.50	2.50	1.46	
Progressiva			-3.73	-2.50	0.00	2.50	3.96
Dislivelli			0.00	-1.25	-1.75	-1.84	0.00

Sezione: 140
 Progressiva: 1100.000
 Q. Progetto: 521.844

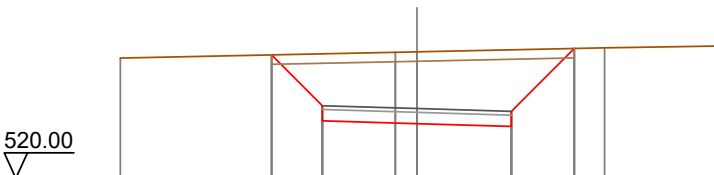

Quote Terreno	523.18		523.33	523.34		523.45	523.50
Quote Progetto		523.26	521.52	521.44	521.37	523.43	
Parziali		1.34	2.50	2.50	1.66		
Progressiva		-3.84	-2.50	0.00	2.50	4.16	
Dislivelli		0.00	-1.37	-1.90	-2.03	-0.00	

Sezione: 141
 Progressiva: 1110.000
 Q. Progetto: 520.953

519.00

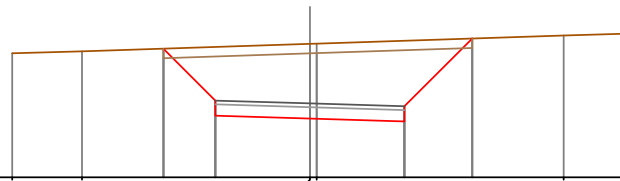

Quote Terreno	-522.28	-522.33			522.53	522.53				522.75	522.79
Quote Progetto			522.40	520.63	520.55	520.48	522.67				
Parziali			1.37	2.50	2.50	1.79					
Progressiva			-3.87	-2.50	0.00	2.50	4.29				
Dislivelli			0.00	-1.42	-1.97	-2.13	0.00				

Sezione: 142
 Progressiva: 1120.000
 Q. Progetto: 520.264

518.00

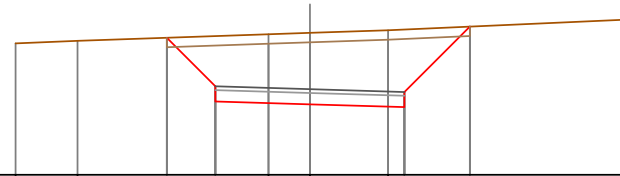

Quote Terreno	-521.47	-521.54			-521.72	-521.75					-522.10
Quote Progetto			521.62	519.94	519.86	519.79	521.92				
Parziali			1.29	2.50	2.50	1.73					
Progressiva			-3.79	-2.50	0.00	2.50	4.23				
Dislivelli			-0.00	-1.33	-1.89	-2.05	0.00				

Sezione: 143
 Progressiva: 1120.475
 Q. Progetto: 520.236

518.00

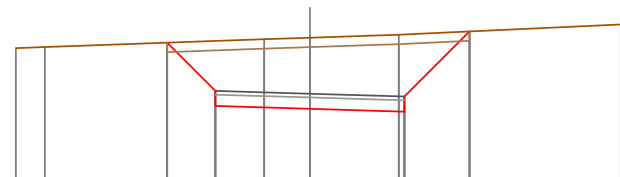

Quote Terreno	-521.44	-521.47			-521.68	-521.72					-522.07
Quote Progetto			521.59	519.91	519.84	519.76	521.88				
Parziali			1.27	2.50	2.50	1.72					
Progressiva			-3.77	-2.50	0.00	2.50	4.22				
Dislivelli			-0.00	-1.32	-1.88	-2.04	0.00				

Sezione: 144
 Progressiva: 1122.843
 Q. Progetto: 520.104

518.00

Quote Terreno	-521.26						
Quote Progetto		521.40	519.64	519.70	519.77	521.68	-521.86
Parziali			1.36	2.50	2.50	1.51	
Progressiva		-3.86	-2.50	0.00	2.50	4.01	
Dislivelli		0.00	-1.41	-1.84	-1.86	0.00	

Sezione: 145
 Progressiva: 1130.000
 Q. Progetto: 519.776

518.00

Quote Terreno	-520.85	-520.87					
Quote Progetto			520.90	519.31	519.38	519.44	521.06
Parziali			1.18	2.50	2.50	1.22	
Progressiva			-3.68	-2.50	0.00	2.50	3.72
Dislivelli			0.00	-1.20	-1.59	-1.59	0.00

Sezione: 146
 Progressiva: 1140.120
 Q. Progetto: 519.486

518.00

Quote Terreno	-520.18						
Quote Progetto		520.15	519.02	519.09	520.18	519.15	520.17
Parziali		0.73	2.50	2.50	0.62		
Progressiva		-3.23	-2.50	0.00	2.50	3.12	
Dislivelli		-0.00	-0.73	-1.09	-1.03	0.00	

Sezione: 147
 Progressiva: 1143.000
 Q. Progetto: 519.441

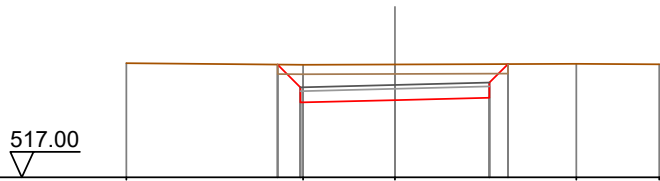

Quote Terreno	520.02	519.97	519.98	520.00	519.99	
Quote Progetto		519.98	518.98	519.04	519.10	519.99
Parziali		0.60	2.50	2.50	0.49	
Progressiva		-3.10	-2.50	0.00	2.50	2.99
Dislivelli		0.00	-0.60	-0.94	-0.89	-0.00

SEZIONI TRASVERSALI
Profilo longitudinale tratto 13-14
Viabilità di impianto postazione aerogeneratore T07

Nota: Le canalette di deflusso delle acque meteoriche, non indicate nel presente elaborato, sono rappresentate graficamente nelle sezioni stradali tipo dell'elaborato "WIND002-TC13_Piazzole aerogeneratori e strade di servizio - Particolari costruttivi", individuate planimetricamente nell'elaborato "WIND002-TC14_Opere di regimazione acque superficiali - Planimetria generale" e quantificate nell'elaborato "WIND002-RC6_Computo Metrico Estimativo".

DISEGNI DI RIFERIMENTO

TAVOLA	DESCRIZIONE
WIND002-TC8	Piazzole e viabilità - Planimetria di progetto - Fase di cantiere
WIND002-TC11	Profili longitudinali viabilità di impianto
WIND002-TC13	Piazzole aerogeneratori e strade di servizio - Particolari costruttivi
WIND002-TC14	Opere di regimazione acque superficiali - Planimetria generale

Sezione: 2
 Progressiva: 20.000
 Q. Progetto: 539.447

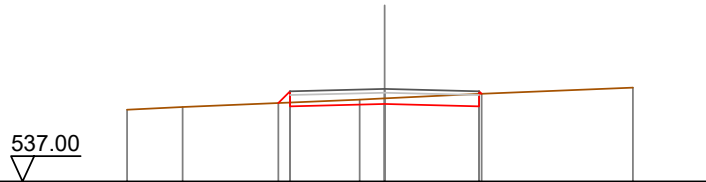

Quote Terreno	538.90	538.97		539.16	539.20	539.32	539.48
Quote Progetto			539.07	538.98	539.05	538.96	539.32
Parziali			0.31	2.50	2.50		
Progressiva			-2.81	-2.50	0.00	2.50	2.57
Dislivelli			0.00	0.30	-0.15	-0.33	0.00

Sezione: 3
 Progressiva: 36.663
 Q. Progetto: 540.042

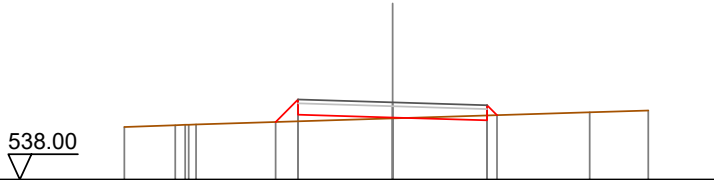

Quote Terreno	539.39	539.44	539.46		539.62		539.78	539.83
Quote Progetto				539.52	539.72	539.64	539.57	539.70
Parziali				0.59	2.50	2.50	0.28	
Progressiva				-3.09	-2.50	0.00	2.50	2.76
Dislivelli				0.00	0.58	0.02	-0.13	0.00

Sezione: 4
 Progressiva: 40.000
 Q. Progetto: 540.105

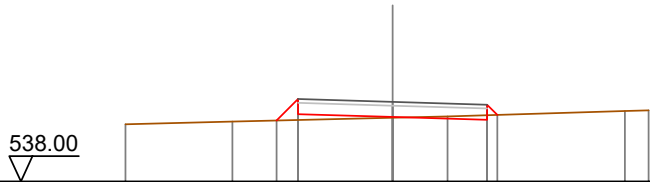

Quote Terreno	539.51	539.59	539.61	539.78	539.69	539.72	539.86	539.88
Quote Progetto			539.61	539.78	539.70	539.63	539.76	
Parziali			0.57	2.50	2.50	0.27		
Progressiva			-3.07	-2.50	0.00	2.50	2.77	
Dislivelli			-0.00	0.55	0.02	-0.12	-0.00	

Sezione: 5
 Progressiva: 50.000
 Q. Progetto: 540.232

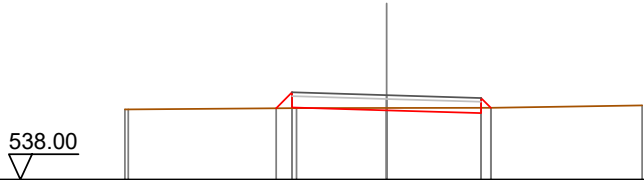

Quote Terreno	539.86	539.86	539.89	539.90	539.90	539.90	539.96
Quote Progetto			539.89	539.91	539.83	539.76	539.90
Parziali			0.42	2.50	2.50		
Progressiva			-2.92	-2.50	0.00	2.50	2.76
Dislivelli			-0.00	0.42	-0.06	-0.14	0.00

Sezione: 6
 Progressiva: 60.000
 Q. Progetto: 540.358

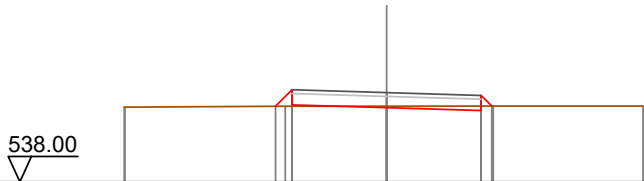

Quote Terreno	539.97	540.00	540.00	540.00	540.00	540.00	540.00
Quote Progetto		540.00	540.03	539.96	539.88	540.00	
Parziali		0.44	2.50	2.50	0.28		
Progressiva		-2.94	-2.50	0.00	2.50	2.78	
Dislivelli		0.00	0.43	-0.04	-0.12	-0.00	

Sezione: 7
 Progressiva: 60.738
 Q. Progetto: 540.367

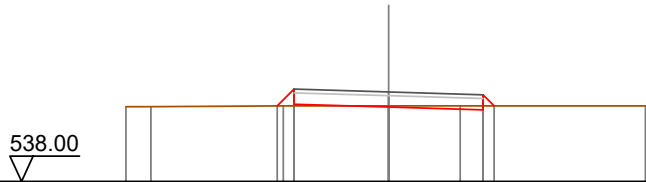

Quote Terreno	539.98	539.98	540.00	540.00	540.00	540.00	
Quote Progetto			540.00	540.04	539.97	539.88	540.00
Parziali			0.44	2.50	2.50	0.28	
Progressiva			-2.94	-2.50	0.00	2.50	2.79
Dislivelli			0.00	0.44	-0.03	-0.11	0.00

Sezione: 8
 Progressiva: 70.000
 Q. Progetto: 540.553

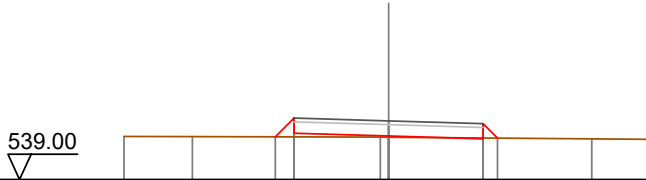

Quote Terreno	540.14	540.14	540.12	540.12	540.08	540.06	
Quote Progetto			540.13	540.23	540.15	540.08	540.10
Parziali			0.50	2.50	2.50	0.38	
Progressiva			-3.00	-2.50	0.00	2.50	2.88
Dislivelli			0.00	0.50	0.03	-0.02	0.00

Sezione: 9
 Progressiva: 80.000
 Q. Progetto: 540.892

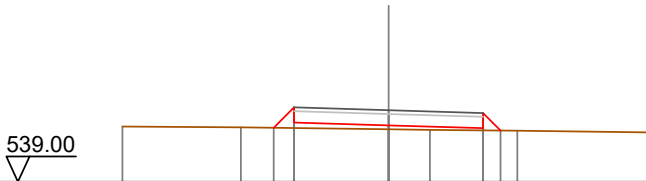

Quote Terreno	540.46	540.44	540.43	540.39	540.37	540.35	540.30
Quote Progetto			540.43	540.57	540.49	540.42	540.36
Parziali			0.54	2.50	2.50	0.46	
Progressiva			-3.04	-2.50	0.00	2.50	2.96
Dislivelli			0.00	0.55	0.11	0.06	-0.00

Sezione: 10
 Progressiva: 84.814
 Q. Progetto: 541.059

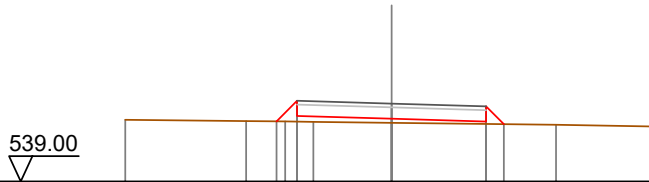

Quote Terreno	540.63	540.60	540.59	540.57	540.55	540.50	540.45
Quote Progetto			540.59	540.73	540.66	540.58	540.51
Parziali			0.54	2.50	2.50	0.47	
Progressiva			-3.04	-2.50	0.00	2.50	2.97
Dislivelli			0.00	0.55	0.11	0.06	-0.00

Sezione: 11
 Progressiva: 97.446
 Q. Progetto: 541.497

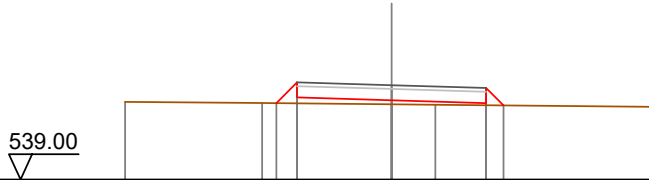

Quote Terreno	541.06	541.03	541.02	541.17	540.99	540.98	540.93
Quote Progetto			541.02	541.17	541.10	541.02	540.96
Parziali			0.55	2.50	2.50	0.46	
Progressiva			-3.05	-2.50	0.00	2.50	2.96
Dislivelli			0.00	0.55	0.11	0.05	0.00

Sezione: 12
 Progressiva: 100.000
 Q. Progetto: 541.585

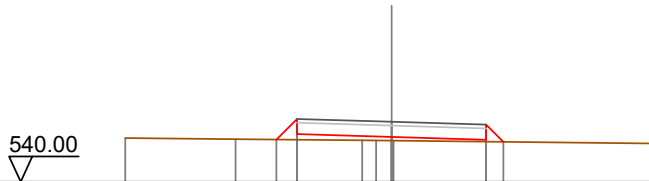

Quote Terreno	541.15	541.13	541.12	541.26	541.09	541.09	541.11	541.01
Quote Progetto			541.12	541.26	541.19	541.11	541.06	
Parziali			0.55	2.50	2.50	0.45		
Progressiva			-3.05	-2.50	0.00	2.50	2.95	
Dislivelli			0.00	0.55	0.10	0.05	0.00	

Sezione: 13
 Progressiva: 106.042
 Q. Progetto: 541.795

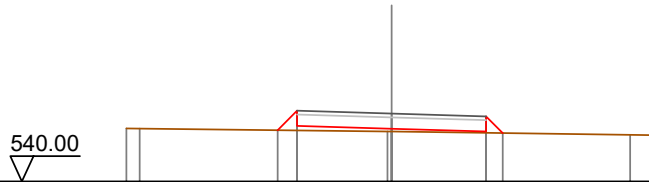

Quote Terreno	541.40	541.40		541.32	541.32		541.23	541.22
Quote Progetto			541.36	541.47	541.39	541.32	541.28	
Parziali			0.51	2.50	2.50	0.44		
Progressiva			-3.01	-2.50	0.00	2.50	2.94	
Dislivelli			-0.00	0.52	0.07	0.03	0.00	

Sezione: 14
 Progressiva: 110.000
 Q. Progetto: 541.932

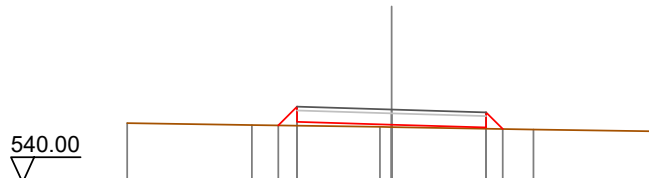

Quote Terreno	541.57	541.52		541.47	541.47		541.40	541.36
Quote Progetto			541.51	541.61	541.53	541.46	541.42	
Parziali			0.49	2.50	2.50	0.44		
Progressiva			-2.99	-2.50	0.00	2.50	2.94	
Dislivelli			0.00	0.50	0.06	0.03	0.00	

Sezione: 15
 Progressiva: 114.637
 Q. Progetto: 542.093

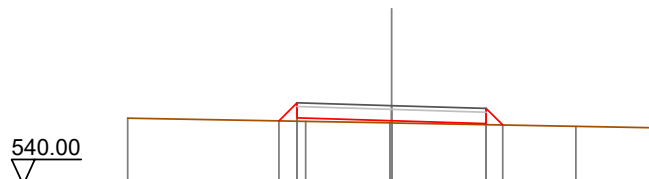

Quote Terreno	541.76	541.69	541.77	541.68	541.64	541.64	541.55	541.51
Quote Progetto		541.69	541.77	541.69	541.69	541.62	541.56	
Parziali		0.48	2.50	2.50	0.44			
Progressiva		-2.98	-2.50	0.00	2.50	2.94		
Dislivelli		0.00	0.49	0.06	0.03	0.00		

Sezione: 16
 Progressiva: 120.000
 Q. Progetto: 542.275

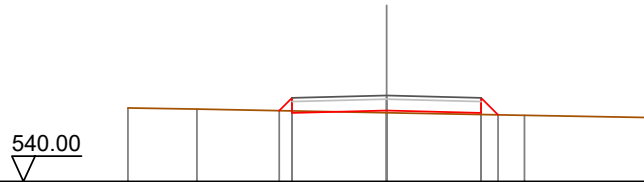

Quote Terreno	541.94	541.91		541.82		541.75	541.69
Quote Progetto			541.87	541.87	541.81	541.76	
Parziali			0.34	2.50	2.50	0.45	
Progressiva			-2.84	-2.50	0.00	2.50	2.95
Dislivelli			0.00	0.35	0.06	0.04	-0.00

Sezione: 17
 Progressiva: 140.000
 Q. Progetto: 542.823

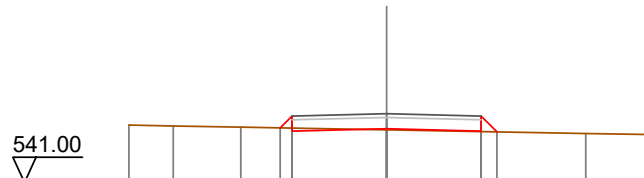

Quote Terreno	542.52	542.50	542.47		542.40		542.30	542.27
Quote Progetto				542.45	542.36	542.42	542.36	542.34
Parziali				0.31	2.50	2.50	0.42	
Progressiva				-2.81	-2.50	0.00	2.50	2.92
Dislivelli				0.00	0.32	0.03	0.01	0.00

Sezione: 18
 Progressiva: 160.000
 Q. Progetto: 543.165

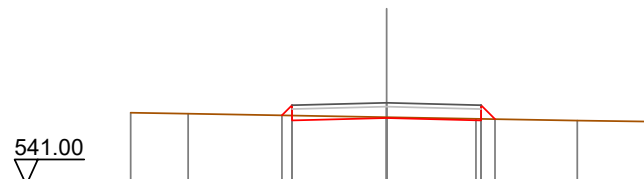

Quote Terreno	542.91	542.88		542.79		542.75	542.70	542.67
Quote Progetto			542.84	542.70	542.76	542.70	542.74	
Parziali			0.27	2.50	2.50	0.37		
Progressiva			-2.77	-2.50	0.00	2.50	2.87	
Dislivelli			-0.00	0.27	-0.02	-0.04	0.00	

Sezione: 19
 Progressiva: 179.179
 Q. Progetto: 543.325

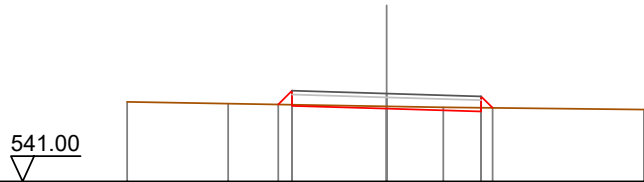

Quote Terreno	543.10	543.06		542.99	542.96	542.90
Quote Progetto			543.04 543.00	542.92	542.85 542.95	
Parziali			0.36 2.50	2.50	0.30	
Progressiva			-2.86 -2.50	0.00	2.50 2.80	
Dislivelli			0.00 0.37	-0.06	-0.10 -0.00	

Sezione: 20
 Progressiva: 180.000
 Q. Progetto: 543.331

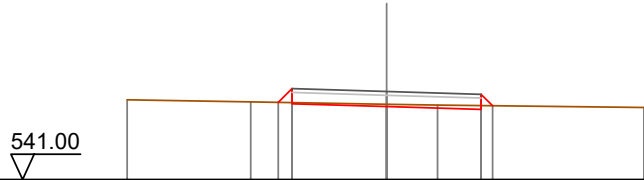

Quote Terreno	543.11	543.05		542.99	542.97	542.91
Quote Progetto			543.04 543.01	542.93	542.86 542.95	
Parziali			0.36 2.50	2.50	0.30	
Progressiva			-2.86 -2.50	0.00	2.50 2.80	
Dislivelli			0.00 0.37	-0.06	-0.10 0.00	

Sezione: 21
 Progressiva: 182.334
 Q. Progetto: 543.347

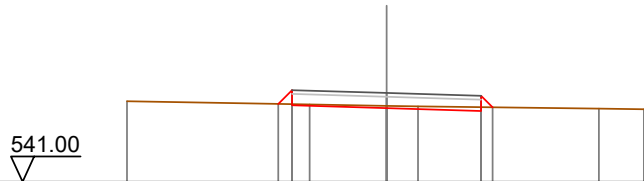

Quote Terreno	543.13		543.04	543.01	542.99	542.94	542.92
Quote Progetto			543.06 543.02	542.95	542.87 542.97		
Parziali			0.36 2.50	2.50	0.30		
Progressiva			-2.86 -2.50	0.00	2.50 2.80		
Dislivelli			0.00 0.37	-0.06	-0.10 0.00		

Sezione: 22
 Progressiva: 185.489
 Q. Progetto: 543.369

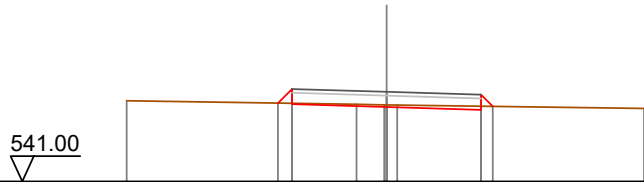

Quote Terreno	543.14		543.04	543.03	543.02		542.98
Quote Progetto			543.07	543.04	542.97		542.89
Parziali			0.37	2.50	2.50		0.37
Progressiva			-2.87	-2.50	0.00		2.50
Dislivelli			-0.00	0.38	-0.06		-0.10

Sezione: 23
 Progressiva: 200.000
 Q. Progetto: 543.432

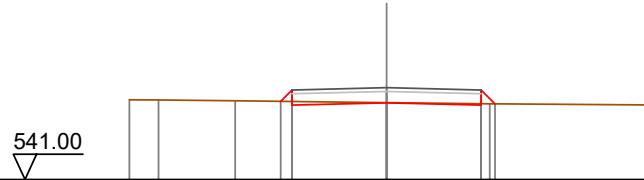

Quote Terreno	543.11	543.10	543.08		543.04		543.00	542.97
Quote Progetto				543.07	542.97		543.00	542.97
Parziali				0.30	2.50	2.50	0.37	
Progressiva				-2.80	-2.50	0.00	2.50	2.87
Dislivelli				-0.00	0.30	-0.00	-0.04	0.00

Sezione: 24
 Progressiva: 220.000
 Q. Progetto: 543.406

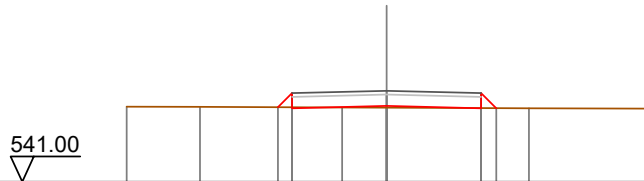

Quote Terreno	542.99	542.98		542.96	542.96		542.94	542.94
Quote Progetto				542.97	542.94		543.01	542.94
Parziali				0.37	2.50	2.50	0.40	
Progressiva				-2.87	-2.50	0.00	2.50	2.90
Dislivelli				0.00	0.37	0.05	-0.00	0.00

Sezione: 25
 Progressiva: 225.468
 Q. Progetto: 543.377

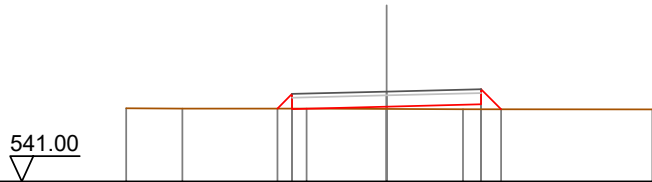

Quote Terreno	542.93	542.93	542.93	542.92	542.91	542.91
Quote Progetto			542.93 542.91	542.98	543.04 542.91	
Parziali			0.39 2.50	2.50	0.53	
Progressiva			-2.89 -2.50	0.00	2.50 3.03	
Dislivelli			-0.00 0.39	0.06	0.13 0.00	

Sezione: 26
 Progressiva: 230.000
 Q. Progetto: 543.345

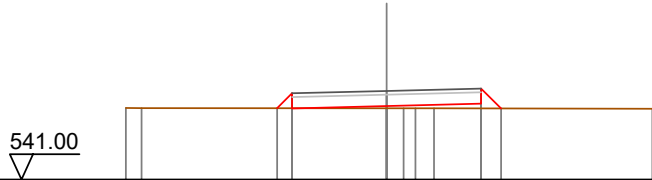

Quote Terreno	542.89	542.89	542.89	542.88	542.88	542.87
Quote Progetto			542.89 542.88	542.94	543.01 542.88	
Parziali			0.39 2.50	2.50	0.53	
Progressiva			-2.89 -2.50	0.00	2.50 3.03	
Dislivelli			-0.00 0.39	0.06	0.13 0.00	

Sezione: 27
 Progressiva: 240.000
 Q. Progetto: 543.253



Quote Terreno	542.80	542.80	542.79	542.79	542.78	542.78
Quote Progetto		542.80 542.79	542.85	542.92 542.79		
Parziali		0.39 2.50	2.50	0.53		
Progressiva		-2.89 -2.50	0.00	2.50 3.03		
Dislivelli		0.00 0.39	0.06	0.13 0.00		

Sezione: 28
 Progressiva: 246.979
 Q. Progetto: 543.183

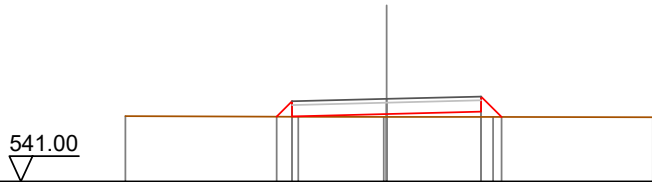

Quote Terreno	-542.73	-542.71	-542.70	-542.71	-542.70
Quote Progetto		542.71	542.78	542.85	542.71
Parziali		0.41	2.50	2.50	0.54
Progressiva		-2.91	0.00	2.50	3.04
Dislivelli		0.00	0.08	0.14	0.00

Sezione: 29
 Progressiva: 250.000
 Q. Progetto: 543.149

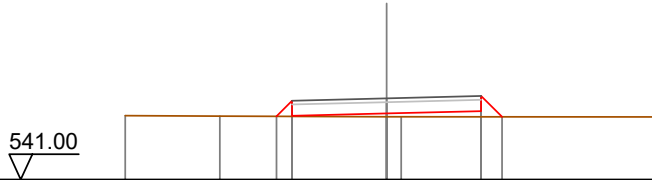

Quote Terreno	-542.69	-542.68	-542.66	-542.66	-542.66
Quote Progetto		542.67	542.75	542.81	542.66
Parziali		0.41	2.50	2.50	0.55
Progressiva		-2.91	0.00	2.50	3.05
Dislivelli		-0.00	0.09	0.15	-0.00

Sezione: 30
 Progressiva: 260.000
 Q. Progetto: 543.013



Quote Terreno	-542.56	-542.54	-542.52	-542.51	-542.49
Quote Progetto		542.53	542.61	542.68	542.51
Parziali		0.42	2.50	2.50	0.57
Progressiva		-2.92	0.00	2.50	3.07
Dislivelli		0.00	0.09	0.17	0.00

Sezione: 31
 Progressiva: 268.491
 Q. Progetto: 542.871

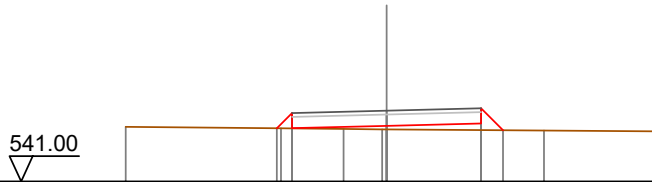

Quote Terreno	542.45	542.41	542.39	542.38	542.38	542.35	542.32
Quote Progetto		542.41	542.41	542.47	542.47	542.53	542.35
Parziali		0.40	2.50	2.50	0.58		
Progressiva		-2.90	-2.50	0.00	2.50	3.08	
Dislivelli		0.00	0.41	0.09	0.17	0.00	

Sezione: 32
 Progressiva: 280.000
 Q. Progetto: 542.640

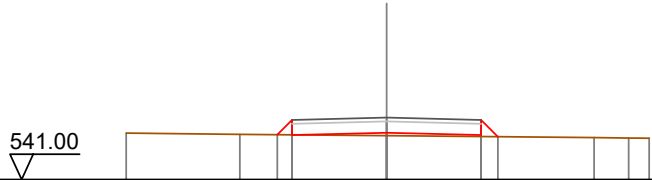

Quote Terreno	542.23	542.20	542.16	542.11	542.10	542.09
Quote Progetto		542.19	542.18	542.24	542.18	542.13
Parziali		0.39	2.50	2.50	0.44	
Progressiva		-2.89	-2.50	0.00	2.50	2.94
Dislivelli		-0.00	0.39	0.08	0.04	0.00

Sezione: 33
 Progressiva: 300.000
 Q. Progetto: 542.132

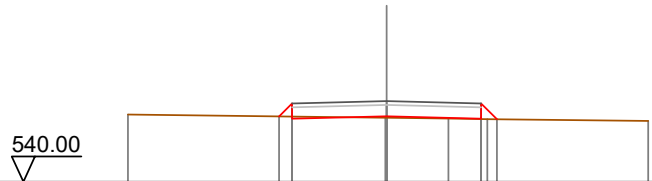

Quote Terreno	541.78	541.73	541.69	541.67	541.66	541.61
Quote Progetto		541.73	541.73	541.67	541.65	
Parziali		0.34	2.50	2.50	0.42	
Progressiva		-2.84	-2.50	0.00	2.50	2.92
Dislivelli		0.00	0.35	0.04	0.01	0.00

Sezione: 34
 Progressiva: 306.490
 Q. Progetto: 541.939

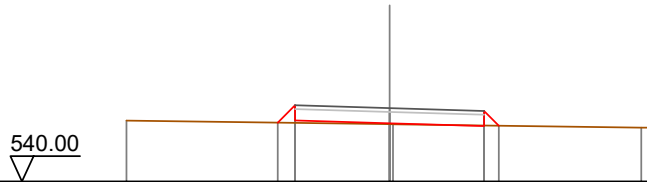

Quote Terreno	541.61		541.51		541.42
Quote Progetto		541.55	541.54	541.46	541.47
Parziali		0.46	2.50	2.50	0.39
Progressiva		-2.96	0.00	2.50	2.89
Dislivelli		0.00	0.02	-0.02	0.00

Sezione: 35
 Progressiva: 310.000
 Q. Progetto: 541.828

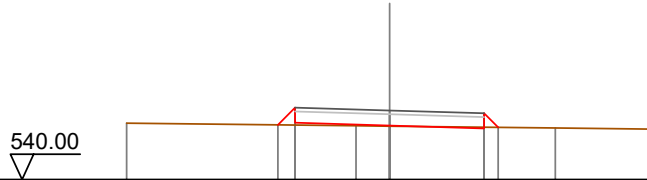

Quote Terreno	541.49		541.42		541.37	541.34
Quote Progetto		541.45	541.43	541.35	541.38	
Parziali		0.46	2.50	2.50	0.37	
Progressiva		-2.96	0.00	2.50	2.87	
Dislivelli		0.00	0.01	-0.03	0.00	

Sezione: 36
 Progressiva: 314.848
 Q. Progetto: 541.668

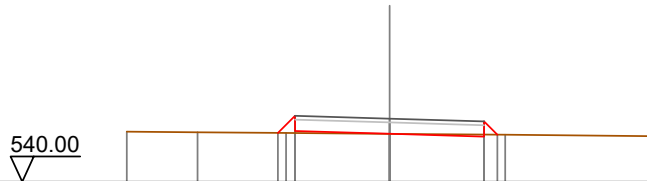

Quote Terreno	541.33	541.31	541.29	541.27	541.24	541.21
Quote Progetto			541.29	541.27	541.19	541.24
Parziali			0.45	2.50	2.50	0.35
Progressiva			-2.95	0.00	2.50	2.85
Dislivelli			0.00	0.00	-0.05	0.00

Sezione: 37
 Progressiva: 320.000
 Q. Progetto: 541.492

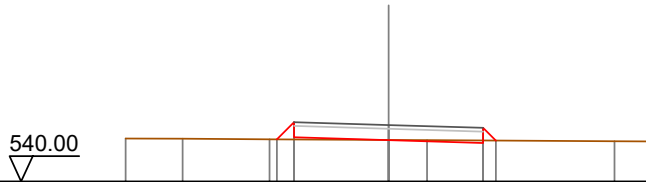

Quote Terreno	541.14	541.13	541.11	541.10	541.09	541.06	541.06
Quote Progetto			541.11	541.09	541.02	541.08	
Parziali			0.45	2.50	2.50	0.34	
Progressiva			-2.95	0.00	2.50	2.84	
Dislivelli			0.00	-0.00	-0.07	0.00	

Sezione: 38
 Progressiva: 323.206
 Q. Progetto: 541.382

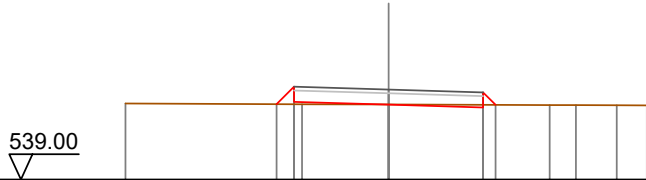

Quote Terreno	541.01	540.99	540.99	540.97	540.97	540.97	540.96
Quote Progetto		541.00	541.06	540.98	540.91	540.98	
Parziali		0.46	2.50	2.50	0.33		
Progressiva		-2.96	0.00	2.50	2.83		
Dislivelli		0.00	-0.00	-0.07	0.00		

Sezione: 39
 Progressiva: 340.000
 Q. Progetto: 540.805

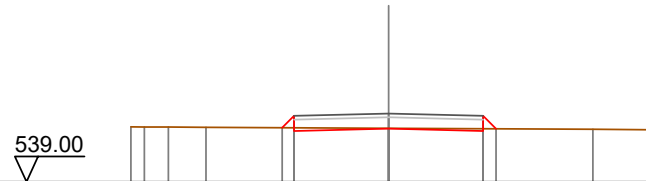

Quote Terreno	540.45	540.45	540.44	540.42	540.39	540.38
Quote Progetto		540.43	540.34	540.40	540.34	540.40
Parziali		0.31	2.50	2.50	0.34	
Progressiva		-2.81	0.00	2.50	2.84	
Dislivelli		0.00	-0.01	-0.06	0.00	

Sezione: 40
 Progressiva: 360.000
 Q. Progetto: 540.389

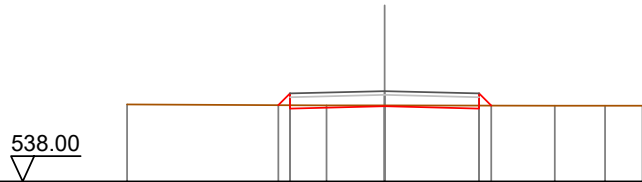

Quote Terreno	540.03		540.01	540.01		540.00	540.00	540.00
Quote Progetto		540.02	539.93	539.99	540.01	539.93	540.01	
Parziali		0.31	2.50	2.50		0.32		
Progressiva		-2.81	-2.50	0.00		2.50	2.82	
Dislivelli		0.00	0.31	-0.02		-0.08	0.00	

Sezione: 41
 Progressiva: 380.000
 Q. Progetto: 540.407

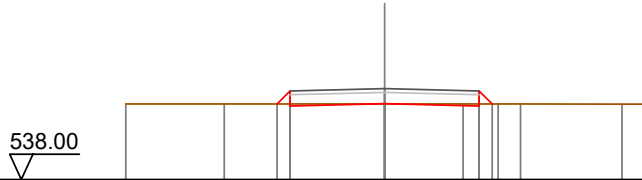

Quote Terreno	540.00	540.00		540.00	540.00	540.00	540.00	539.99
Quote Progetto			540.00	540.01	540.00	539.94	540.00	
Parziali			0.34	2.50	2.50	0.34		
Progressiva			-2.84	-2.50	0.00	2.50	2.84	
Dislivelli			0.00	0.01		-0.06	0.00	

Sezione: 42
 Progressiva: 399.711
 Q. Progetto: 540.077

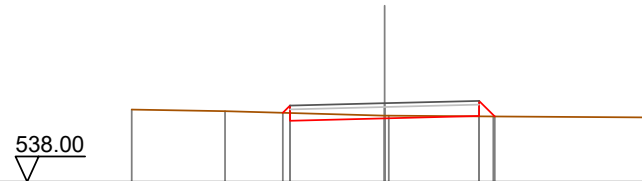

Quote Terreno	539.91	539.87		539.75	539.75	539.73	539.73	539.70
Quote Progetto			539.82	539.66	539.74	539.73	539.73	
Parziali			0.20	2.50	2.50	0.41		
Progressiva			-2.69	-2.50	0.00	2.50	2.91	
Dislivelli			0.00	-0.07		0.01	0.00	

Sezione: 43
 Progressiva: 400.000
 Q. Progetto: 540.070

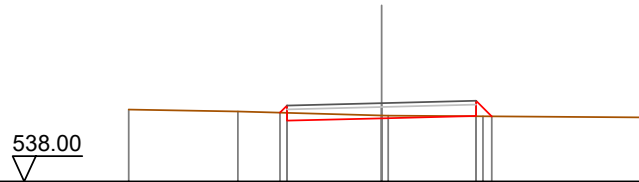

Quote Terreno	539.90	539.85	539.74	539.72	539.69
Quote Progetto		539.82	539.67	539.73	539.72
Parziali			2.50	2.50	0.41
Progressiva		-2.69	0.00	2.50	2.91
Dislivelli		0.00	-0.07	0.01	0.00

Sezione: 44
 Progressiva: 410.000
 Q. Progetto: 539.831

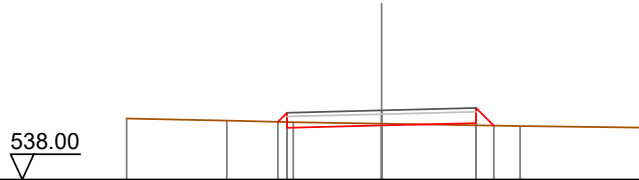

Quote Terreno	539.62	539.56	539.52	539.48	539.41	539.37
Quote Progetto		539.53	539.37	539.43	539.49	539.43
Parziali			2.50	2.50	0.47	
Progressiva		-2.74	0.00	2.50	2.97	
Dislivelli		0.00	-0.05	0.06	-0.00	

Sezione: 45
 Progressiva: 414.516
 Q. Progetto: 539.721

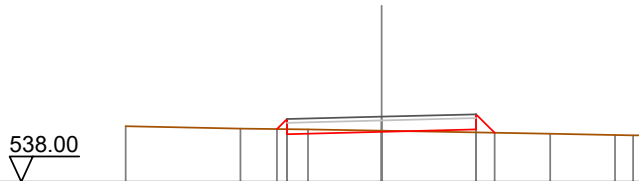

Quote Terreno	539.47	539.40	539.38	539.35	539.27	539.24	539.23
Quote Progetto		539.39	539.26	539.32	539.38	539.30	
Parziali			2.50	2.50	0.49		
Progressiva		-2.77	0.00	2.50	2.99		
Dislivelli		-0.00	-0.03	0.08	0.00		

Sezione: 46
 Progressiva: 420.000
 Q. Progetto: 539.550

538.00

Quote Terreno	539.29	539.24		539.16	539.14		539.06	539.03
Quote Progetto			539.21	539.09	539.15		539.21	539.11
Parziali			0.28	2.50	2.50		0.51	
Progressiva			-2.78	-2.50	0.00		2.50	3.01
Dislivelli			0.00	0.28	-0.01		0.10	0.00

Sezione: 47
 Progressiva: 429.321
 Q. Progetto: 539.145

537.00

Quote Terreno	538.86	538.84		538.74	538.72		538.66	538.63
Quote Progetto			538.78	538.68	538.74		538.81	538.68
Parziali			0.31	2.50	2.50		0.53	
Progressiva			-2.81	-2.50	0.00		2.50	3.03
Dislivelli			0.00	0.31	0.02		0.12	0.00

Sezione: 48
 Progressiva: 440.000
 Q. Progetto: 538.501

536.00

Quote Terreno	538.18	538.15		538.10	538.08		538.02	538.00
Quote Progetto			538.12	538.04	538.10		538.04	538.04
Parziali			0.32	2.50	2.50		0.40	
Progressiva			-2.82	-2.50	0.00		2.50	2.90
Dislivelli			0.00	0.32	0.02		-0.01	-0.00

Sezione: 49
 Progressiva: 460.000
 Q. Progetto: 537.053

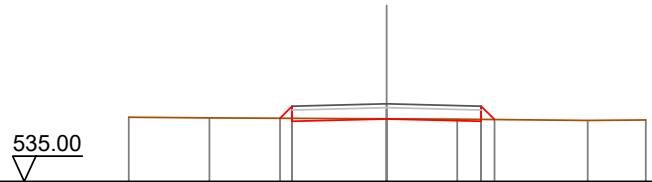

Quote Terreno	536.70	536.68		536.66	536.65		536.61	536.62
Quote Progetto			536.67	536.65	536.59	536.64		
Parziali			0.32	2.50	2.50	0.35		
Progressiva			-2.82	-2.50	0.00	2.50	2.85	
Dislivelli			0.00	0.32	-0.00	-0.05	-0.00	

Sezione: 50
 Progressiva: 479.486
 Q. Progetto: 535.638

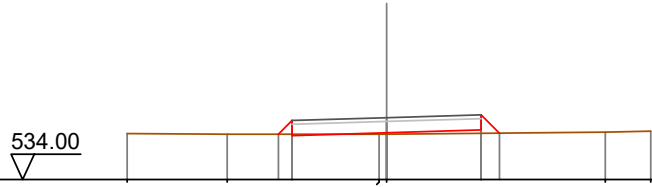

Quote Terreno	535.22	535.20		535.20	535.20		535.25	535.28
Quote Progetto			535.20	535.16	535.24	535.31	535.23	
Parziali			0.36	2.50	2.50	0.49		
Progressiva			-2.86	-2.50	0.00	2.50	2.99	
Dislivelli			0.00	0.36	0.04	0.09	0.00	

Sezione: 51
 Progressiva: 480.000
 Q. Progetto: 535.600

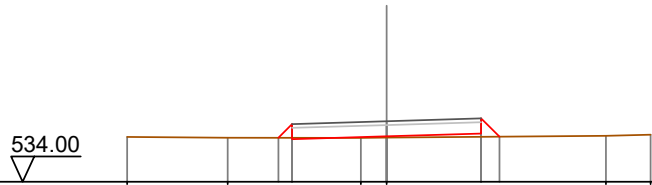

Quote Terreno	535.19	535.17		535.16	535.17		535.22	535.24
Quote Progetto			535.16	535.13	535.20	535.28	535.19	
Parziali			0.36	2.50	2.50	0.48		
Progressiva			-2.86	-2.50	0.00	2.50	2.98	
Dislivelli			0.00	0.36	0.03	0.09	-0.00	

Sezione: 52
 Progressiva: 481.996
 Q. Progetto: 535.455

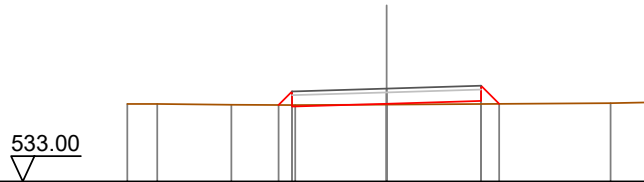

Quote Terreno	535.05	535.05	535.03	535.02	535.03	535.07	535.09
Quote Progetto				535.02	535.06	535.13	535.05
Parziali				0.36	2.50	2.50	0.48
Progressiva				-2.86	0.00	2.50	2.98
Dislivelli				0.00	0.02	0.08	0.00

Sezione: 53
 Progressiva: 484.507
 Q. Progetto: 535.273

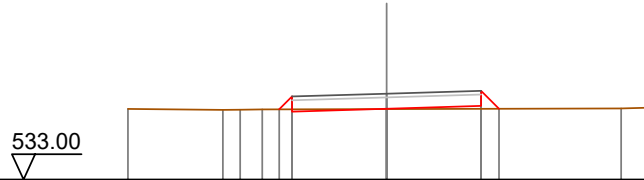

Quote Terreno	534.87	534.84	534.85	534.86	534.87	534.88	534.90
Quote Progetto				534.86	534.87	534.95	534.87
Parziali				0.34	2.50	2.50	0.47
Progressiva				-2.84	0.00	2.50	2.97
Dislivelli				0.00	0.01	0.08	0.00

Sezione: 54
 Progressiva: 500.000
 Q. Progetto: 533.990

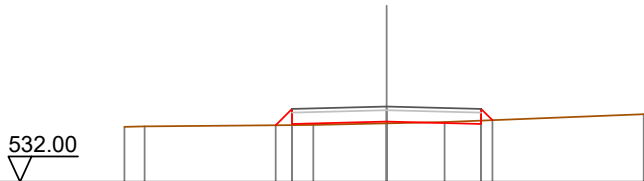

Quote Terreno	533.45	533.46	533.50	533.53	533.55	533.56	533.78
Quote Progetto			533.50	533.53	533.59	533.53	533.63
Parziali			0.43	2.50	2.50	0.30	
Progressiva			-2.93	0.00	2.50	2.80	
Dislivelli			0.00	0.04	-0.09	0.00	

Sezione: 55
 Progressiva: 506.346
 Q. Progetto: 533.439

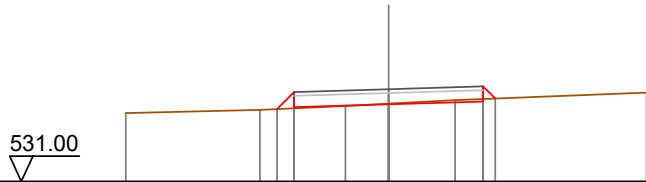

Quote Terreno	532.81	532.89	532.99	533.06	533.15	533.35
Quote Progetto		532.91	532.96	533.04	533.11	533.19
Parziali		0.45	2.50	2.50	0.32	
Progressiva		-2.95	-2.50	0.00	2.50	2.82
Dislivelli		0.00	0.43	-0.02	-0.07	0.00

Sezione: 56
 Progressiva: 510.000
 Q. Progetto: 533.121

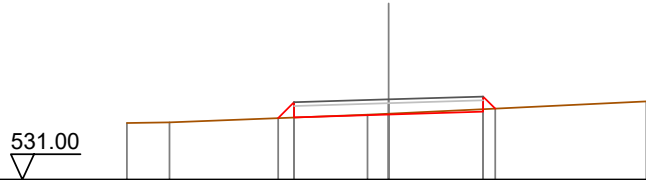

Quote Terreno	532.50	532.51	532.72	532.74	532.80	533.07
Quote Progetto			532.63	532.65	532.72	532.88
Parziali			0.42	2.50	2.50	0.32
Progressiva			-2.92	-2.50	0.00	2.50
Dislivelli			0.00	0.40	-0.02	-0.07

Sezione: 57
 Progressiva: 520.000
 Q. Progetto: 532.252

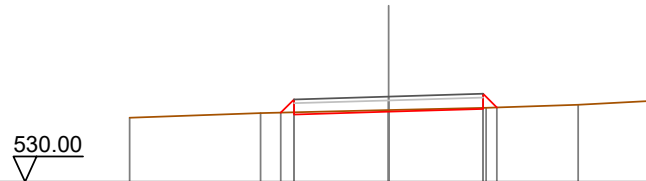

Quote Terreno	531.69	531.81	531.89	531.96	532.03	532.13
Quote Progetto		531.83	531.85	531.93	531.97	
Parziali		0.35	2.50	2.50	0.36	
Progressiva		-2.85	-2.50	0.00	2.50	2.86
Dislivelli		0.00	0.34	-0.04	-0.03	0.00

Sezione: 58
 Progressiva: 522.509
 Q. Progetto: 532.034

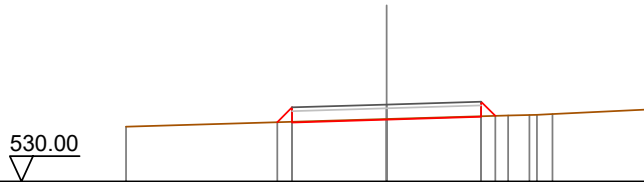

Quote Terreno	531.45			531.65		531.74	531.76	531.78	531.90
Quote Progetto			531.57	531.63		531.71	531.73		
Parziali			0.39	2.50	2.50	0.37			
Progressiva			-2.89	0.00		2.50	2.87		
Dislivelli			0.00	-0.02		-0.01	0.00		

Sezione: 59
 Progressiva: 530.000
 Q. Progetto: 531.441

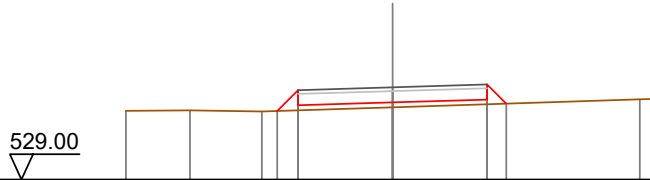

Quote Terreno	530.82	530.83	530.80	530.91			531.12	531.14
Quote Progetto			530.81	530.97	531.04		531.12	531.01
Parziali			0.55	2.50	2.50		0.51	
Progressiva			-3.05	0.00			2.50	3.01
Dislivelli			-0.00	0.13			0.12	-0.00

Sezione: 60
 Progressiva: 538.671
 Q. Progetto: 530.895

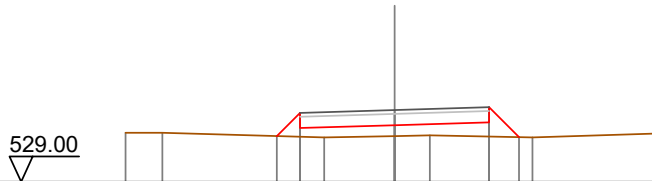

Quote Terreno	530.30	530.29		530.17	530.21	530.23		530.17	530.29
Quote Progetto			530.21	530.42	530.50		530.57	530.18	
Parziali			0.61	2.50	2.50		0.79		
Progressiva			-3.11	0.00			2.50	3.29	
Dislivelli			-0.00	0.29			0.37	0.00	

Sezione: 61
 Progressiva: 540.000
 Q. Progetto: 530.825

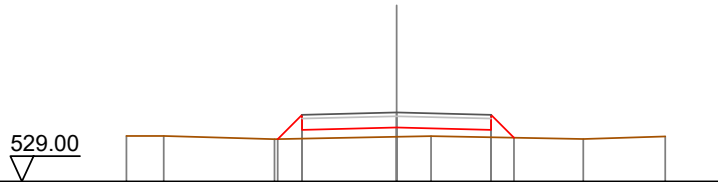

Quote Terreno	530.20	530.20	530.12	530.18	530.20	530.12	530.19
Quote Progetto			530.12	530.43		530.36	530.16
Parziali			0.64	2.50	2.50	0.61	
Progressiva			-3.14	0.00	0.00	2.50	3.11
Dislivelli			0.63	0.24	0.00	0.19	0.00

Sezione: 62
 Progressiva: 560.000
 Q. Progetto: 529.935

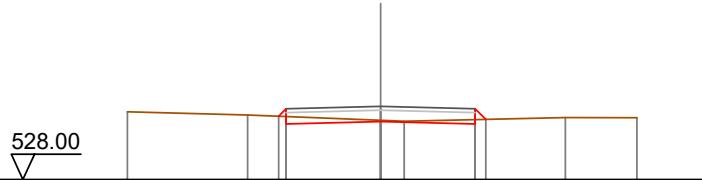

Quote Terreno	528.79	528.71	529.57	529.54	529.64	529.64
Quote Progetto		529.68	529.54	529.47	529.47	529.59
Parziali			2.50	2.50	0.28	
Progressiva		-2.70	0.00	0.00	2.50	2.78
Dislivelli		0.00	-0.03	0.00	-0.11	-0.00

Sezione: 63
 Progressiva: 580.000
 Q. Progetto: 528.421

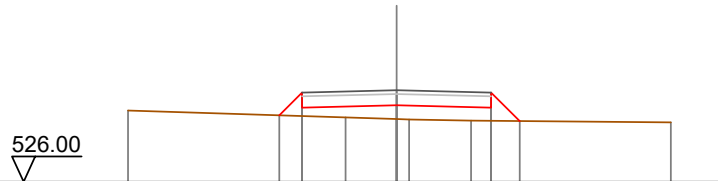

Quote Terreno	527.88	527.76	527.70	527.66	527.61	527.57
Quote Progetto		527.96	528.02	527.96	527.60	
Parziali		0.60	2.50	2.50	0.75	
Progressiva		-3.10	0.00	0.00	2.50	3.25
Dislivelli		0.62	0.36	0.00	0.35	0.00

Sezione: 64
 Progressiva: 589.155
 Q. Progetto: 527.458

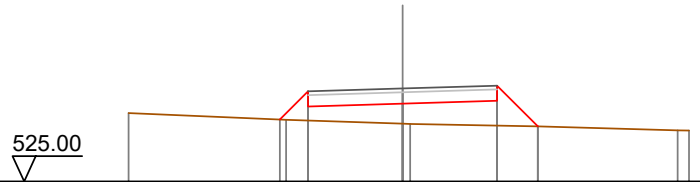

Quote Terreno	526.81	526.63	526.53	526.46	526.35
Quote Progetto		526.64	527.06	527.13	526.46
Parziali		0.74	2.50	2.50	1.08
Progressiva		-3.24	-2.50	0.00	2.50
Dislivelli		0.00	0.77	0.53	0.66
					-0.00

Sezione: 65
 Progressiva: 590.000
 Q. Progetto: 527.360

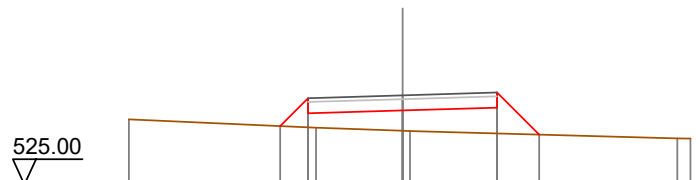

Quote Terreno	526.73	526.51	526.42	526.22
Quote Progetto		526.55	526.96	527.04
Parziali		0.74	2.50	2.50
Progressiva		-3.24	-2.50	0.00
Dislivelli		0.00	0.77	0.54
				0.68
				0.00

Sezione: 66
 Progressiva: 599.669
 Q. Progetto: 526.197

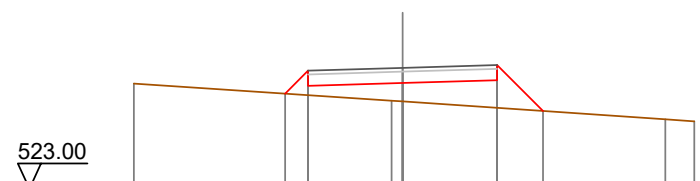

Quote Terreno	525.78	525.52	525.33	524.84
Quote Progetto		525.72	525.80	525.87
Parziali		0.61	2.50	2.50
Progressiva		-3.11	-2.50	0.00
Dislivelli		0.00	0.65	0.49
				0.73
				0.00

Sezione: 67
 Progressiva: 600.000
 Q. Progetto: 526.158

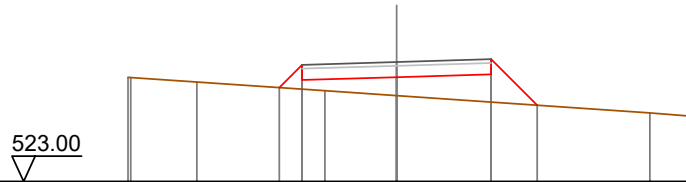

Quote Terreno	525.75	525.63	525.48	525.68	525.40	525.76	525.83	525.01	524.81	524.73
Quote Progetto			525.48	525.68		525.76	525.83	525.01		
Parziali			0.60	2.50	2.50	1.22				
Progressiva			-3.10	-2.50	0.00	2.50	3.72			
Dislivelli			0.00	0.64	0.49	0.73	0.00			

Sezione: 68
 Progressiva: 610.183
 Q. Progetto: 525.036

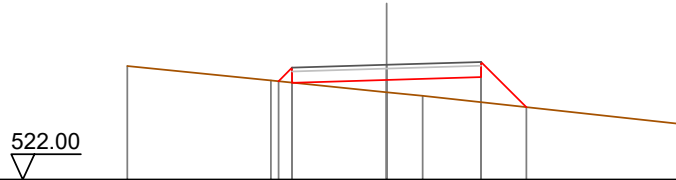

Quote Terreno	525.01	524.62	524.60	524.56	524.31	524.21	524.71	523.91	523.48
Quote Progetto			524.60	524.56	524.64	524.71	523.91		
Parziali			0.36	2.50	2.50	1.20			
Progressiva			-2.86	-2.50	0.00	2.50	3.70		
Dislivelli			0.00	0.39	0.32	0.67	0.00		

Sezione: 69
 Progressiva: 611.568
 Q. Progetto: 524.895

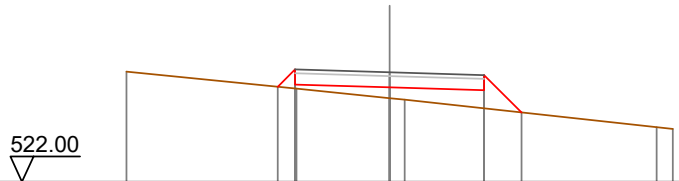

Quote Terreno	524.91	524.51	524.57	524.46	524.21	524.17	524.42	523.83	523.44	523.40
Quote Progetto		524.51	524.57	524.46	524.50	524.42	523.83			
Parziali		0.46	2.50	2.50	0.99					
Progressiva		-2.96	-2.50	0.00	2.50	3.49				
Dislivelli		0.00	0.51	0.29	0.48	0.00				

Sezione: 70
 Progressiva: 620.000
 Q. Progetto: 524.105

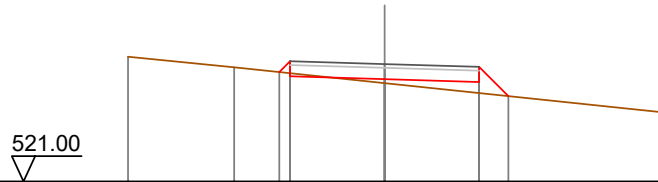

Quote Terreno	-524.30	-524.02	-523.89	-523.78	-523.60	-523.63	-523.26	-522.84
Quote Progetto			523.89	523.78	523.70	523.63	523.26	
Parziali			0.20	2.50	2.50	0.77		
Progressiva			-2.79	-2.50	0.00	2.50	3.27	
Dislivelli			0.00	0.32	0.10	0.29	0.00	

Sezione: 71
 Progressiva: 625.471
 Q. Progetto: 523.650

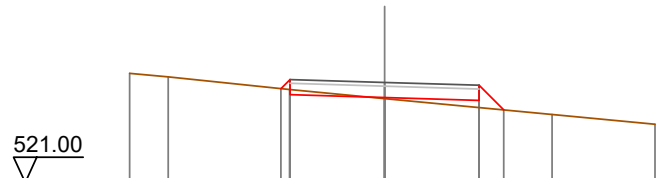

Quote Terreno	-523.89	-523.79	-523.46	-523.22	-522.80	-522.54
Quote Progetto			523.48	523.25	523.17	522.92
Parziali			2.50	2.50	0.65	
Progressiva			-2.74	-2.50	0.00	3.15
Dislivelli			0.00	0.27	0.03	0.19

Sezione: 72
 Progressiva: 630.000
 Q. Progetto: 523.308

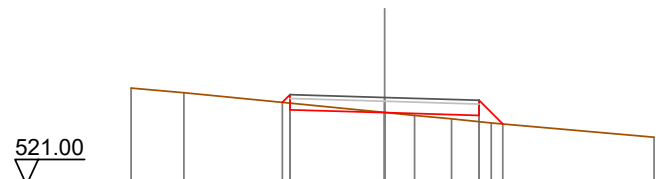

Quote Terreno	-523.56	-523.43	-523.18	-522.91	-522.83	-522.74	-522.63	-522.26
Quote Progetto			523.18	522.91	522.83	522.63	522.61	
Parziali			2.50	2.50	0.62			
Progressiva			-2.70	-2.50	0.00	2.50	3.12	
Dislivelli			0.00	0.22	-0.00	0.16	0.00	

Sezione: 73
 Progressiva: 639.373
 Q. Progetto: 522.699

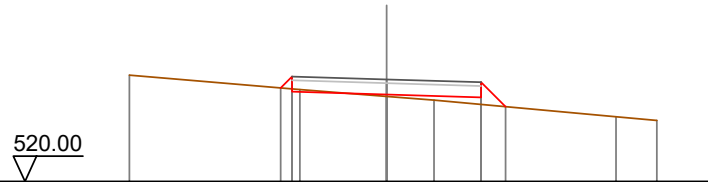

Quote Terreno	522.81	522.43	522.25	522.15	521.71	521.61
Quote Progetto		522.47 522.37	522.30	522.22 521.98		
Parziali		0.30 2.50	2.50	0.65		
Progressiva		-2.80 -2.50	0.00	2.50 3.15		
Dislivelli		0.00 0.33	0.05	0.19 0.00		

Sezione: 74
 Progressiva: 640.000
 Q. Progetto: 522.663

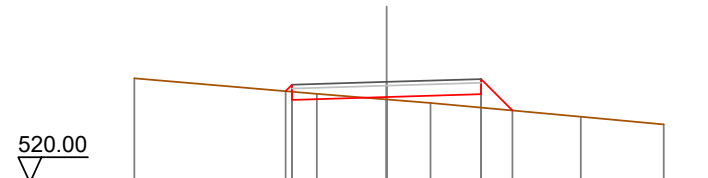

Quote Terreno	522.76	522.35	522.20	522.11	521.74	521.54
Quote Progetto		522.42 522.19	522.26	522.34 521.91		
Parziali		2.50	2.50	0.83		
Progressiva		-2.67 -2.50	0.00	2.50 3.33		
Dislivelli		-0.00 0.18	0.06	0.35 0.00		

Sezione: 75
 Progressiva: 649.979
 Q. Progetto: 522.149

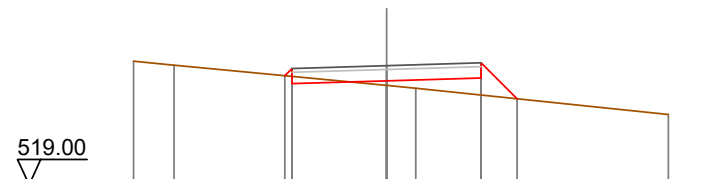

Quote Terreno	522.27	522.16	521.63	521.55	520.86
Quote Progetto		521.88 521.67	521.75	521.82 521.27	
Parziali		2.50	2.50	0.95	
Progressiva		-2.69 -2.50	0.00	2.50 3.45	
Dislivelli		-0.00 0.21	0.12	0.45 0.00	

Sezione: 76
 Progressiva: 660.000
 Q. Progetto: 521.723

519.00

Quote Terreno	-521.99	-521.33	-521.08	-520.59	-520.54
Quote Progetto		521.58 521.25	521.32	521.40 520.98	
Parziali		2.50	2.50	0.82	
Progressiva		-2.56 -2.50	0.00	2.50 3.32	
Dislivelli		-0.00 0.07	-0.00	0.33 0.00	

Sezione: 77
 Progressiva: 660.556
 Q. Progetto: 521.706

519.00

Quote Terreno	-521.99	-521.36	-521.05	-520.53
Quote Progetto		521.58 521.23	521.31	521.38 520.98
Parziali		2.50	2.50	0.80
Progressiva		-2.55 -2.50	0.00	2.50 3.30
Dislivelli		-0.00 0.06	-0.01	0.32 0.00

Sezione: 78
 Progressiva: 668.519
 Q. Progetto: 521.514

519.00

Quote Terreno	-521.99	-521.72	-521.49	-521.24	-521.06	-520.74	-520.55	-520.45
Quote Progetto			521.50 521.19	521.11	521.04 520.93			
Parziali			2.50	2.50	0.51			
Progressiva			-2.59 -2.50	0.00	2.50 3.01			
Dislivelli			-0.00 0.10	-0.12	0.06 0.00			

Sezione: 79
 Progressiva: 670.000
 Q. Progetto: 521.484

519.00

Quote Terreno	-521.87	-521.79	-521.44	-521.22	-520.80	-520.69	-520.62	-520.34
Quote Progetto			521.48 521.16	521.08		521.01 520.92		
Parziali			2.50	2.50		0.49		
Progressiva			-2.58 -2.50	0.00		2.50 2.99		
Dislivelli			0.00 0.08	-0.14		0.04 0.00		

Sezione: 80
 Progressiva: 675.193
 Q. Progetto: 521.380

519.00

Quote Terreno	-521.77	-521.71	-521.24	-521.14	-520.87	-520.56	-520.43
Quote Progetto			521.39 521.06	520.98	520.91 520.84		
Parziali			2.50	2.50	0.46		
Progressiva			-2.57 -2.50	0.00	2.50 2.96		
Dislivelli			0.00 0.07	-0.16	0.02 0.00		

Sezione: 81
 Progressiva: 680.000
 Q. Progetto: 521.284

519.00

Quote Terreno	-521.63	-521.14	-521.08	-521.01	-520.46	-520.36
Quote Progetto		521.26 520.96		520.88	520.81 520.77	
Parziali		2.50		2.50	0.44	
Progressiva		-2.60 -2.50		0.00	2.50 2.94	
Dislivelli		0.00 0.11		-0.14	0.00 0.00	

Sezione: 82
 Progressiva: 681.866
 Q. Progetto: 521.247

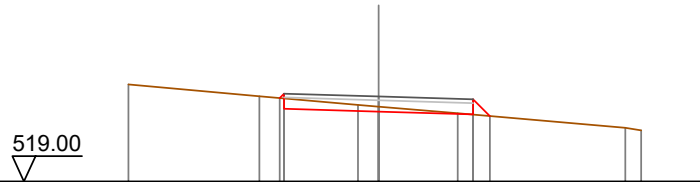

Quote Terreno	521.57	521.25	521.03	520.98	520.80	520.42	520.35
Quote Progetto		521.21	520.92	520.85	520.77	520.73	
Parziali			2.50	2.50	0.44		
Progressiva		-2.62	-2.50	0.00	2.50	2.94	
Dislivelli		0.00	0.13	-0.13	0.00	0.00	

Sezione: 83
 Progressiva: 700.000
 Q. Progetto: 520.885

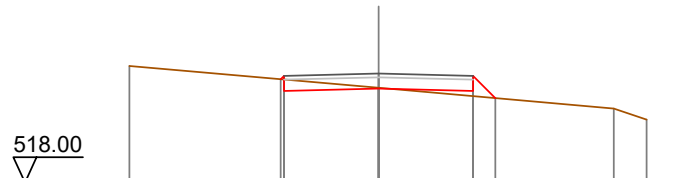

Quote Terreno	521.09		520.51			519.96	519.66
Quote Progetto		520.73	520.42	520.49	520.42	520.23	
Parziali			2.50	2.50	0.59		
Progressiva		-2.59	-2.50	0.00	2.50	3.09	
Dislivelli		0.00	0.10	-0.02	0.14	-0.00	

Sezione: 84
 Progressiva: 720.000
 Q. Progetto: 520.515

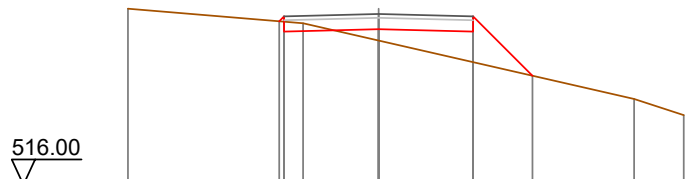

Quote Terreno	520.66		519.81			518.27	517.84
Quote Progetto		520.32	520.05	520.12	520.05	518.88	
Parziali			2.50	2.50	1.57		
Progressiva		-2.63	-2.50	0.00	2.50	4.07	
Dislivelli		0.00	0.14	0.30	0.81	0.00	

Sezione: 85
 Progressiva: 720.616
 Q. Progetto: 520.510

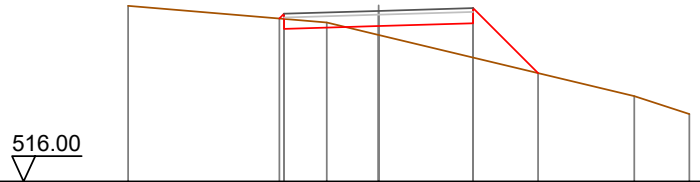

Quote Terreno		520.65		520.20	519.88		518.26	517.78
Quote Progetto			520.31	520.03	520.11	520.18	518.87	
Parziali				2.50	2.50	1.72		
Progressiva			-2.63	-2.50	0.00	2.50	4.22	
Dislivelli			0.00	0.14	0.23	0.91	-0.00	

Sezione: 86
 Progressiva: 730.000
 Q. Progetto: 520.523

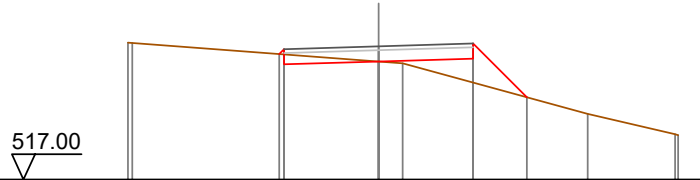

Quote Terreno		520.62	520.61		520.12	520.07		518.74	518.20	518.17
Quote Progetto				520.32	520.05	520.12	520.20	519.18		
Parziali					2.50	2.50	1.42			
Progressiva				-2.63	-2.50	0.00	2.50	3.92		
Dislivelli				-0.00	0.14	0.00	0.63	0.00		

Sezione: 87
 Progressiva: 733.158
 Q. Progetto: 520.556

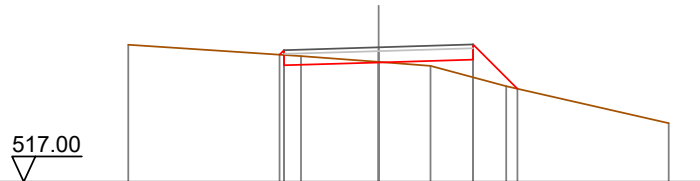

Quote Terreno		520.62		520.32	520.17	520.07	519.53		518.55
Quote Progetto			520.36	520.08	520.16	520.23	519.46		
Parziali				2.50	2.50	1.17			
Progressiva			-2.62	-2.50	0.00	2.50	3.67		
Dislivelli			-0.00	0.13	-0.01	0.47	-0.00		

Sezione: 88
 Progressiva: 740.000
 Q. Progetto: 520.626

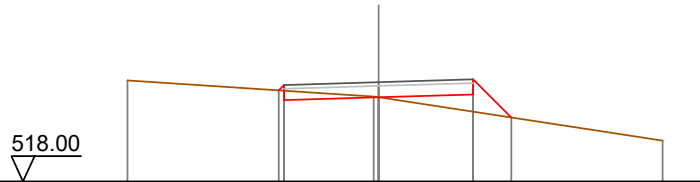

Quote Terreno	520.67		520.25	520.23		519.08
Quote Progetto		520.41	520.15	520.23	520.30	519.69
Parziali			2.50	2.50	1.01	
Progressiva		-2.64	-2.50	0.00	2.50	3.51
Dislivelli		0.00	0.15	0.00	0.46	0.00

Sezione: 89
 Progressiva: 745.699
 Q. Progetto: 520.684



Quote Terreno	520.73		520.35	520.27		519.85
Quote Progetto		520.48	520.21	520.28	520.36	520.16
Parziali			2.50	2.50	0.59	
Progressiva		-2.63	-2.50	0.00	2.50	3.09
Dislivelli		0.00	0.14	-0.07	0.15	0.00

Sezione: 90
 Progressiva: 749.544
 Q. Progetto: 520.723

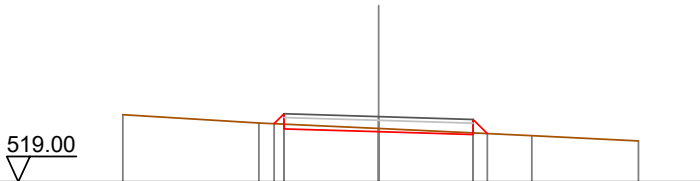

Quote Terreno	520.77		520.41		520.22	520.08
Quote Progetto		520.53	520.32	520.25	520.27	
Parziali		0.28	2.50	2.50	0.37	
Progressiva		-2.76	-2.50	0.00	2.50	2.87
Dislivelli		-0.00	0.28	-0.08	-0.04	-0.00

Sezione: 91
 Progressiva: 750.000
 Q. Progetto: 520.728

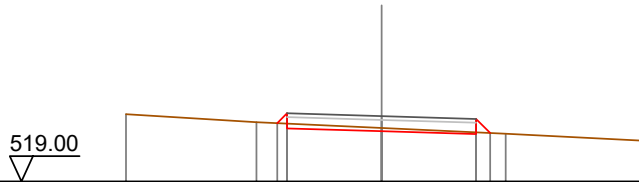

Quote Terreno	520.78	520.57	520.41	520.26	520.08
Quote Progetto		520.54 520.40	520.33	520.25 520.28	
Parziali		0.28 2.50	2.50	0.37	
Progressiva		-2.76 -2.50	0.00	2.50 2.87	
Dislivelli		0.00 0.27	-0.09	-0.05 0.00	

Sezione: 92
 Progressiva: 760.000
 Q. Progetto: 520.830

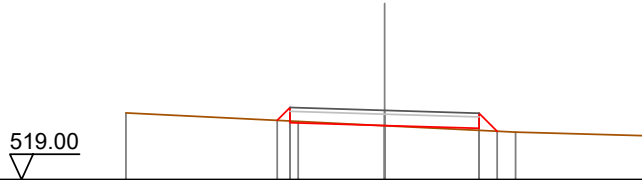

Quote Terreno	520.76	520.54	520.43	520.25	520.16
Quote Progetto		520.57 520.51	520.43	520.36 520.28	
Parziali		0.34 2.50	2.50	0.48	
Progressiva		-2.84 -2.50	0.00	2.50 2.98	
Dislivelli		0.00 0.35	0.00	0.05 0.00	

Sezione: 93
 Progressiva: 760.575
 Q. Progetto: 520.836

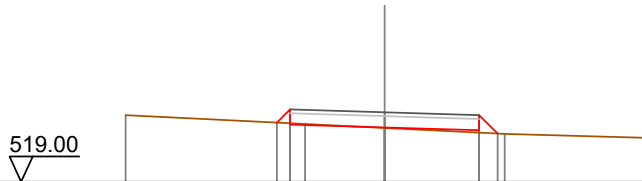

Quote Terreno	520.76	520.53	520.42	520.26	520.16
Quote Progetto		520.56 520.51	520.44	520.36 520.27	
Parziali		0.35 2.50	2.50	0.49	
Progressiva		-2.85 -2.50	0.00	2.50 2.99	
Dislivelli		-0.00 0.36	0.01	0.06 0.00	

Sezione: 94
 Progressiva: 770.000
 Q. Progetto: 520.928

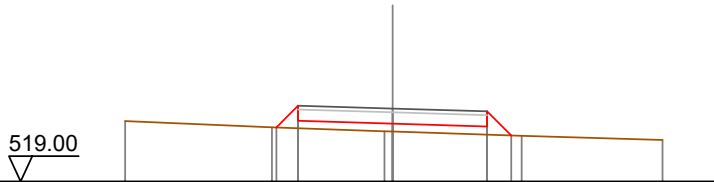

Quote Terreno	520.59	520.43	520.33	520.32	520.21	520.10
Quote Progetto		520.43	520.53	520.45	520.22	
Parziali		0.57	2.50	2.50	0.64	
Progressiva		-3.07	-2.50	0.00	2.50	3.14
Dislivelli		0.00	0.59	0.21	0.22	-0.00

Sezione: 95
 Progressiva: 771.607
 Q. Progetto: 520.934

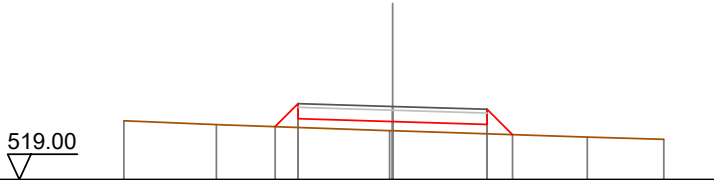

Quote Terreno	520.56	520.46	520.30	520.29	520.12	520.07	
Quote Progetto			520.40	520.53	520.46	520.19	
Parziali			0.61	2.50	2.50	0.67	
Progressiva			-3.11	-2.50	0.00	2.50	3.17
Dislivelli			0.00	0.63	0.24	0.25	0.00

Sezione: 96
 Progressiva: 780.000
 Q. Progetto: 520.886

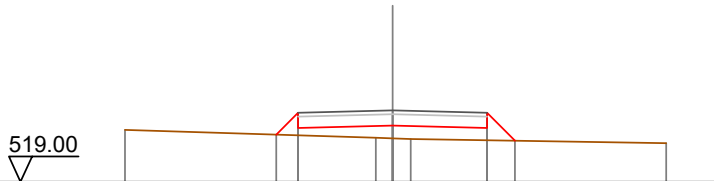

Quote Terreno	520.37		520.16	520.15	520.13	520.02
Quote Progetto		520.25	520.49	520.42	520.09	
Parziali		0.58	2.50	2.50	0.74	
Progressiva		-3.08	-2.50	0.00	2.50	3.24
Dislivelli		0.00	0.60	0.34	0.32	0.00

Sezione: 97
 Progressiva: 788.674
 Q. Progetto: 520.688

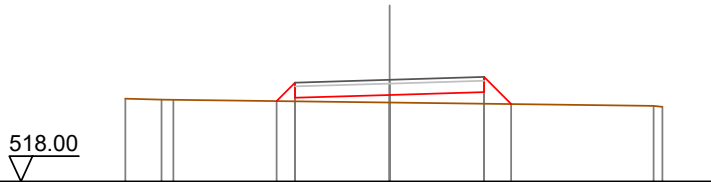

Quote Terreno	520.19	520.16	520.16				520.09			520.00	519.97
Quote Progetto				520.13	520.21		520.29		520.36	520.05	
Parziali				0.49	2.50		2.50		0.71		
Progressiva				-2.99	-2.50		0.00		2.50	3.21	
Dislivelli				-0.00	0.49		0.20		0.31	-0.00	

Sezione: 98
 Progressiva: 790.000
 Q. Progetto: 520.644

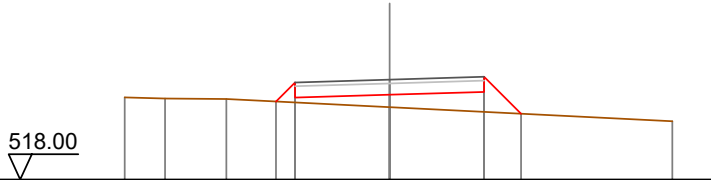

Quote Terreno	520.17	520.14	520.13				519.92				519.54
Quote Progetto				520.06	520.17		520.24		520.32	519.74	
Parziali				0.50	2.50		2.50		0.98		
Progressiva				-3.00	-2.50		0.00		2.50	3.48	
Dislivelli				-0.00	0.53		0.33		0.53	-0.00	

Sezione: 99
 Progressiva: 800.000
 Q. Progetto: 520.202

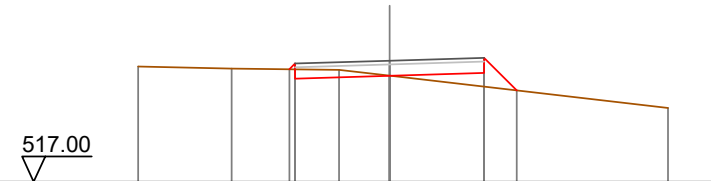

Quote Terreno	520.05		519.99		519.96		519.81				518.95
Quote Progetto				519.98	519.73		519.80		519.88	519.42	
Parziali					2.50		2.50		0.86		
Progressiva				-2.65	-2.50		0.00		2.50	3.36	
Dislivelli				0.00	0.15		-0.00		0.36	0.00	

Sezione: 100
 Progressiva: 810.000
 Q. Progetto: 519.645

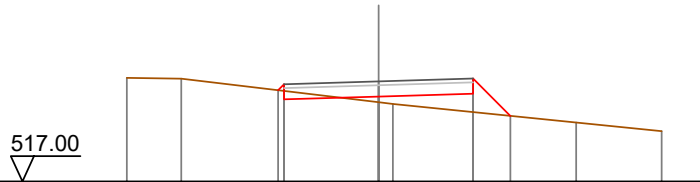

Quote Terreno	519.74	519.72		519.09	519.05		518.56	518.33
Quote Progetto			519.41	519.17	519.25	519.32	518.73	
Parziali				2.50	2.50	0.99		
Progressiva			-2.66	-2.50	0.00	2.50	3.49	
Dislivelli			0.00	0.18	0.15	0.49	-0.00	

Sezione: 101
 Progressiva: 812.920
 Q. Progetto: 519.505

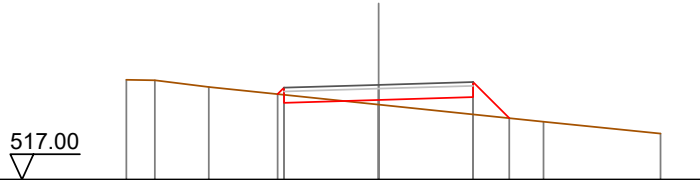

Quote Terreno	519.64	519.63	519.45		518.98		518.53	518.22
Quote Progetto				519.26	519.03	519.11	519.18	518.63
Parziali					2.50	2.50	0.95	
Progressiva				-2.67	-2.50	0.00	2.50	3.45
Dislivelli				0.00	0.19	0.12	0.46	0.00

Sezione: 102
 Progressiva: 820.000
 Q. Progetto: 519.237

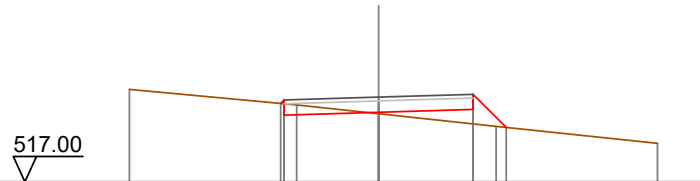

Quote Terreno	519.44		519.03	518.80		518.47		518.02
Quote Progetto		519.07	518.76	518.84	518.91	518.44		
Parziali			2.50	2.50	0.87			
Progressiva		-2.58	-2.50	0.00	2.50	3.37		
Dislivelli		0.00	0.10	0.04	0.38	0.00		

Sezione: 103
 Progressiva: 830.000
 Q. Progetto: 519.030

516.00

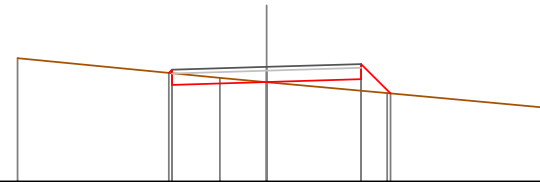

Quote Terreno	-519.26	-518.74	-518.63	-518.34	-517.96
Quote Progetto		518.87 518.55	518.63	518.70 518.33	
Parziali		2.50	2.50	0.78	
Progressiva		-2.59 -2.50	0.00	2.50 3.28	
Dislivelli		0.00 0.09	0.00	0.31 -0.00	

Sezione: 104
 Progressiva: 837.165
 Q. Progetto: 519.004

516.00

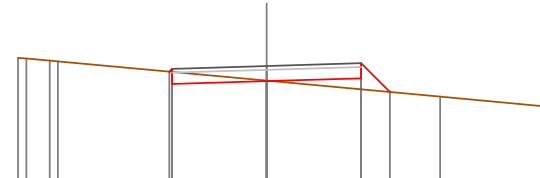

Quote Terreno	519.22 519.20 519.15 519.13	-518.62	-518.19	-517.94
Quote Progetto		518.85 518.53	518.60	518.68 518.32
Parziali		2.50	2.50	0.76
Progressiva		-2.57 -2.50	0.00	2.50 3.26
Dislivelli		0.00 0.08	-0.01	0.29 0.00

Sezione: 105
 Progressiva: 839.108
 Q. Progetto: 519.011

516.00

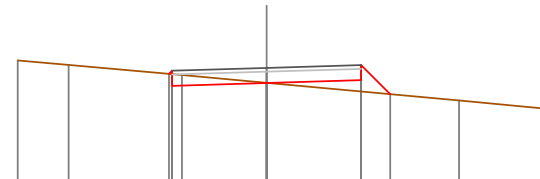

Quote Terreno	-519.21	-519.09	-518.62	-518.62	-518.15	-517.94
Quote Progetto			518.85 518.54	518.61	518.69 518.32	
Parziali			2.50	2.50	0.77	
Progressiva			-2.58 -2.50	0.00	2.50 3.27	
Dislivelli			0.00 0.09	-0.01	0.30 -0.00	

Sezione: 106
 Progressiva: 840.000
 Q. Progetto: 519.014

516.00

Quote Terreno	519.21	519.07	518.85	518.69	518.62	518.69	518.13	517.95
Quote Progetto			518.85	518.54	518.61	518.69	518.32	
Parziali			2.50	2.50	0.77			
Progressiva			-2.59	-2.50	0.00	2.50	3.27	
Dislivelli			0.00	0.10	-0.00	0.30	0.00	

Sezione: 107
 Progressiva: 845.640
 Q. Progetto: 519.034

516.00

Quote Terreno	519.21	519.17	518.92	518.63	518.55	518.12	517.97
Quote Progetto			518.86	518.63	518.71	518.33	
Parziali			2.50	2.50	0.78		
Progressiva			-2.60	-2.50	2.50	3.28	
Dislivelli			0.00	0.11	0.01	0.31	0.00

Sezione: 108
 Progressiva: 850.000
 Q. Progetto: 519.049

517.00

Quote Terreno	519.24	518.96	518.77	518.65	518.30	518.01
Quote Progetto			518.87	518.65	518.72	518.35
Parziali			2.50	2.50	0.78	
Progressiva			-2.60	-2.50	2.50	3.28
Dislivelli			0.00	0.11	0.00	0.31

Sezione: 109
 Progressiva: 852.172
 Q. Progetto: 519.057

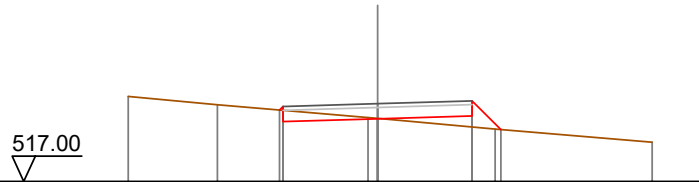

Quote Terreno	519.25	519.03	518.69	518.67	518.38	518.04
Quote Progetto			518.89	518.66	518.73	518.37
Parziali			2.50	2.50	0.76	
Progressiva			-2.59	0.00	2.50	3.26
Dislivelli			0.10	-0.01	0.29	0.00

Sezione: 110
 Progressiva: 860.000
 Q. Progetto: 519.084

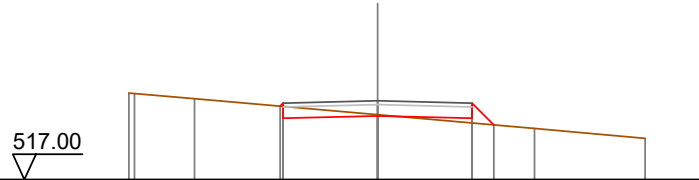

Quote Terreno	519.29	519.28	519.14	518.72	518.35	518.09
Quote Progetto			518.94	518.68	518.62	518.45
Parziali			2.50	2.50	0.57	
Progressiva			-2.56	0.00	2.50	3.07
Dislivelli			0.00	-0.03	0.12	0.00

Sezione: 111
 Progressiva: 877.425
 Q. Progetto: 518.903

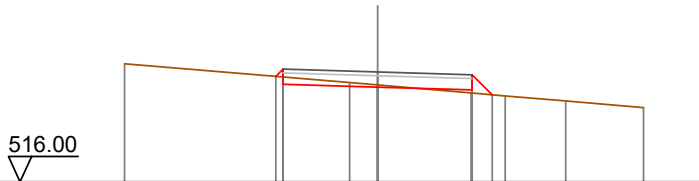

Quote Terreno	519.12		518.62	518.56	518.35	518.27	518.14	517.96
Quote Progetto			518.79	518.50	518.43	518.30		
Parziali			2.50	2.50	0.53			
Progressiva			-2.69	0.00	2.50	3.03		
Dislivelli			0.00	-0.06	0.08	0.00		

Sezione: 112
 Progressiva: 880.000
 Q. Progetto: 518.830

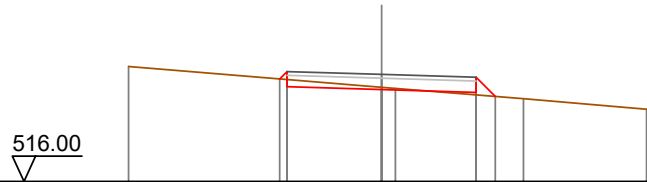

Quote Terreno	519.04		518.49		518.19		517.91
Quote Progetto		518.71	518.43		518.36		
Parziali		2.50	2.50		0.51		
Progressiva		-2.69	0.00		2.50		3.01
Dislivelli		0.00	-0.06		0.07		0.00

Sezione: 113
 Progressiva: 889.531
 Q. Progetto: 518.456

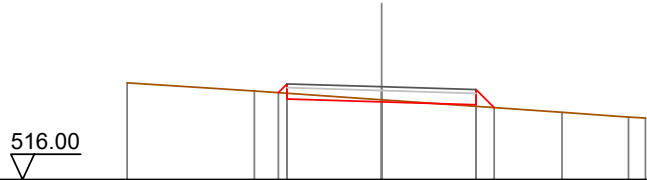

Quote Terreno	518.56		518.11		517.78		517.66
Quote Progetto		518.30	518.06		517.98		
Parziali		2.50	2.50		0.48		
Progressiva		-2.73	0.00		2.50		2.98
Dislivelli		0.00	-0.05		0.04		0.00

Sezione: 114
 Progressiva: 890.000
 Q. Progetto: 518.433

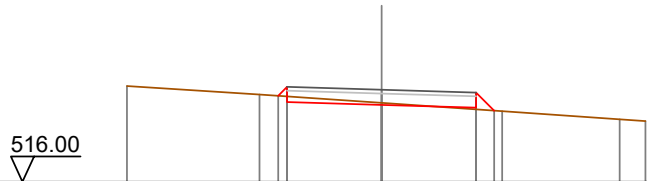

Quote Terreno	518.53		518.09		517.87		517.65
Quote Progetto		518.27	518.03		517.96		
Parziali		2.50	2.50		0.48		
Progressiva		-2.73	0.00		2.50		2.98
Dislivelli		0.00	-0.05		0.05		0.00

Sezione: 115
 Progressiva: 900.000
 Q. Progetto: 517.856

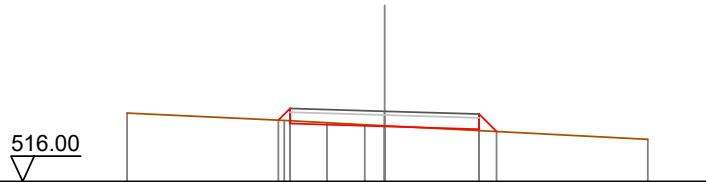

Quote Terreno	517.81	517.61	517.56	517.50	517.47	517.12
Quote Progetto		517.62	517.53	517.46	517.38	517.32
Parziali		0.31	2.50	2.50	0.48	
Progressiva		-2.81	-2.50	0.00	2.50	2.96
Dislivelli		0.00	0.32	-0.02	0.04	0.00

Sezione: 116
 Progressiva: 901.637
 Q. Progetto: 517.744

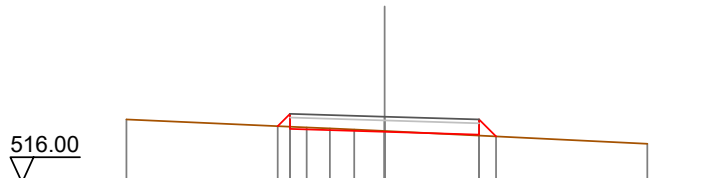

Quote Terreno	517.67	517.46	517.43	517.41	517.37	517.02
Quote Progetto		517.49	517.42	517.34	517.27	517.22
Parziali		0.33	2.50	2.50	0.45	
Progressiva		-2.83	-2.50	0.00	2.50	2.95
Dislivelli		0.00	0.34	-0.02	0.03	0.00

Sezione: 117
 Progressiva: 920.000
 Q. Progetto: 516.395

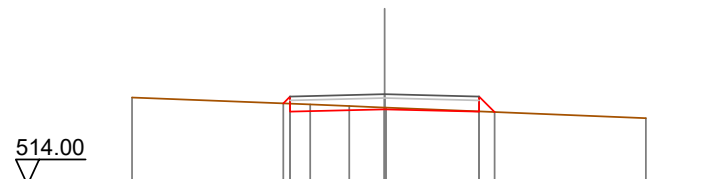

Quote Terreno	516.31	516.12	516.08	516.04	516.04	515.76
Quote Progetto		516.15	515.93	515.99	515.93	515.92
Parziali			2.50	2.50	0.41	
Progressiva		-2.68	-2.50	0.00	2.50	2.91
Dislivelli		0.00	0.19	-0.05	-0.01	0.00

Sezione: 118
 Progressiva: 940.000
 Q. Progetto: 514.920

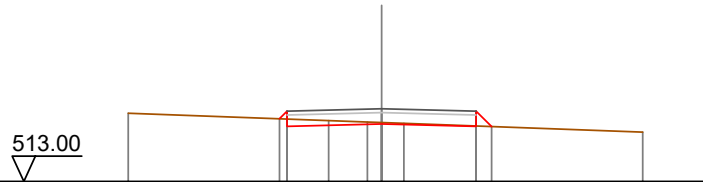

Quote Terreno	514.80		514.61		514.30
Quote Progetto		514.66	514.46	514.52	514.46
Parziali			2.50	2.50	0.41
Progressiva		-2.70	-2.50	0.00	2.50
Dislivelli		0.00	0.21	-0.04	-0.01

Sezione: 119
 Progressiva: 960.000
 Q. Progetto: 513.446

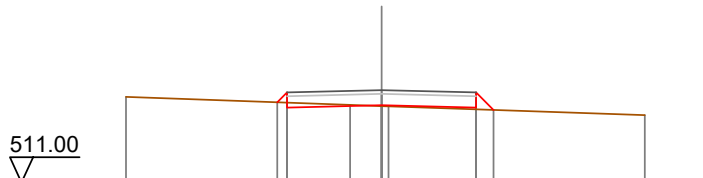

Quote Terreno	513.27		513.05		512.79
Quote Progetto		513.12	512.98	513.05	512.98
Parziali			2.50	2.50	0.46
Progressiva		-2.76	-2.50	0.00	2.50
Dislivelli		0.00	0.27	0.02	0.05

Sezione: 120
 Progressiva: 967.963
 Q. Progetto: 512.859

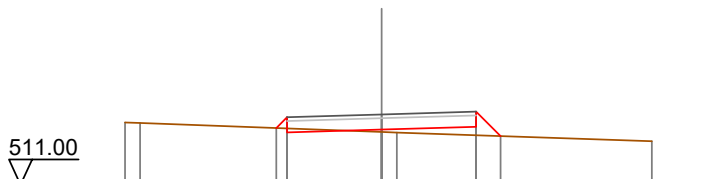

Quote Terreno	512.65		512.40		512.15
Quote Progetto		512.50	512.46	512.53	512.29
Parziali			2.50	2.50	0.65
Progressiva		-2.79	-2.50	0.00	2.50
Dislivelli		0.00	0.30	0.06	0.22

Sezione: 121
 Progressiva: 970.000
 Q. Progetto: 512.709

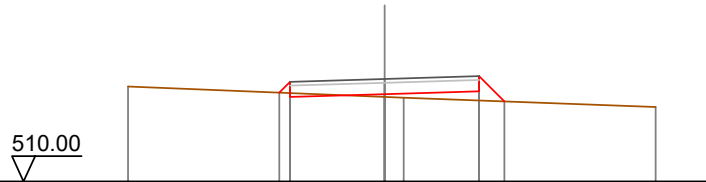

Quote Terreno	512.51		512.24		511.97
Quote Progetto		512.35	512.31	512.38	512.12
Parziali		0.20	2.50	2.50	0.67
Progressiva		-2.79	0.00	2.50	3.17
Dislivelli		-0.00	0.07	0.24	0.00

Sezione: 122
 Progressiva: 978.328
 Q. Progetto: 512.098

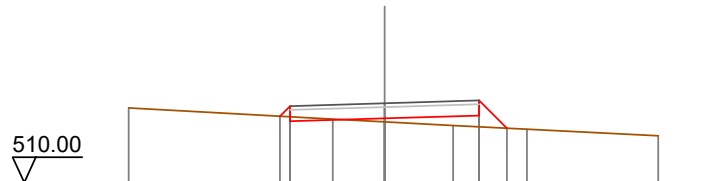

Quote Terreno	511.97		511.68	511.61	511.51	511.41	511.24
Quote Progetto		511.76	511.62	511.70	511.77	511.44	
Parziali		0.27	2.50	2.50	0.73		
Progressiva		-2.77	0.00	2.50	3.23		
Dislivelli		0.00	0.09	0.30	-0.00		

Sezione: 123
 Progressiva: 980.000
 Q. Progetto: 511.983

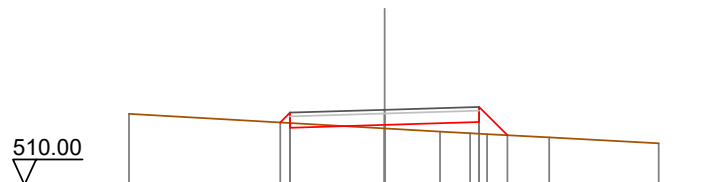

Quote Terreno	511.88		511.41	511.36	511.34	511.25	511.09
Quote Progetto		511.65	511.58	511.66	511.31		
Parziali		0.28	2.50	2.50	0.75		
Progressiva		-2.76	0.00	2.50	3.25		
Dislivelli		0.00	0.09	0.31	0.00		

Sezione: 124
 Progressiva: 988.692
 Q. Progetto: 511.475

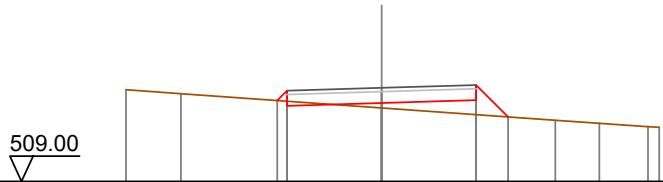

Quote Terreno	511.43	511.32			510.94			510.62	510.54	510.45	510.43
Quote Progetto			511.14	511.00	511.08		511.15	510.71			
Parziali			0.28	2.50	2.50	0.84					
Progressiva			-2.76	-2.50	0.00	2.50	3.34				
Dislivelli			0.00	0.28	0.13	0.38	-0.00				

Sezione: 125
 Progressiva: 1000.000
 Q. Progetto: 510.956

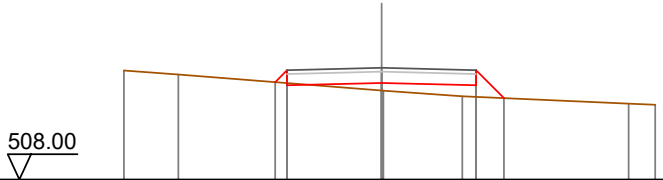

Quote Terreno	510.89	510.78			510.36	510.35	510.21		510.01	509.98
Quote Progetto			510.58	510.49	510.56		510.49	510.16		
Parziali			0.32	2.50	2.50	0.74				
Progressiva			-2.82	-2.50	0.00	2.50	3.24			
Dislivelli			-0.00	0.34	0.20	0.30	0.00			

Sezione: 126
 Progressiva: 1007.490
 Q. Progetto: 510.615

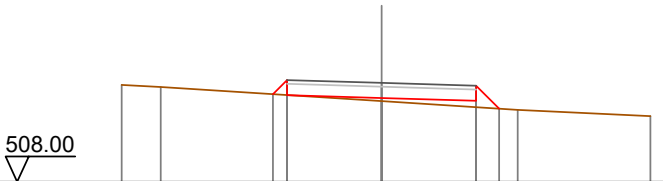

Quote Terreno	510.56	510.50			510.13			509.90		509.73
Quote Progetto			510.32	510.26	510.21		510.14	509.93		
Parziali			0.37	2.50	2.50	0.61				
Progressiva			-2.87	-2.50	0.00	2.50	3.11			
Dislivelli			0.00	0.40	0.08	0.17	0.00			

Sezione: 127
 Progressiva: 1010.000
 Q. Progetto: 510.500

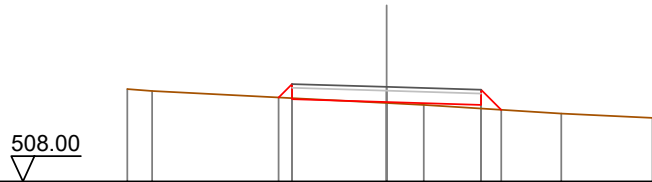

Quote Terreno	510.44	510.39			510.07	510.02		509.79	509.68
Quote Progetto			510.22	510.16	510.10		510.03	509.89	
Parziali			0.36	2.50	2.50		0.53		
Progressiva			-2.86	-2.50	0.00		2.50	3.03	
Dislivelli			0.00	0.37	0.03		0.10	0.00	

Sezione: 128
 Progressiva: 1020.000
 Q. Progetto: 510.045

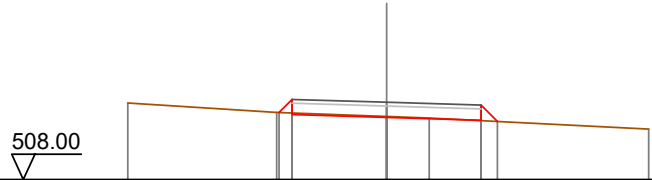

Quote Terreno	510.02		509.78		509.67	509.63		509.34
Quote Progetto			509.77	509.72	509.64		509.57	509.54
Parziali			0.35	2.50	2.50		0.43	
Progressiva			-2.85	-2.50	0.00		2.50	2.93
Dislivelli			-0.00	0.36	-0.03		0.01	0.00

Sezione: 129
 Progressiva: 1027.366
 Q. Progetto: 509.663

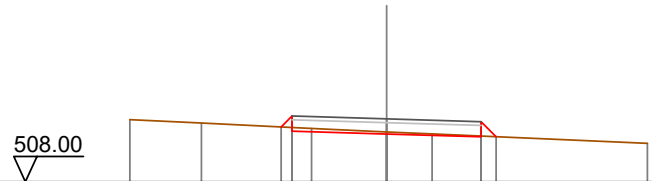

Quote Terreno	509.64	509.55		509.41	509.32	509.26		509.02
Quote Progetto			509.45	509.34	509.26		509.19	509.19
Parziali			0.23	2.50	2.50		0.40	
Progressiva			-2.79	-2.50	0.00		2.50	2.90
Dislivelli			-0.00	0.30	-0.06		-0.02	0.00

Sezione: 130
 Progressiva: 1030.000
 Q. Progetto: 509.500

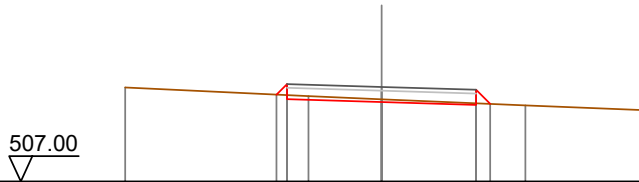

Quote Terreno	509.49	509.26	509.17	509.01	508.89
Quote Progetto		509.30 509.17	509.10	509.02 509.05	
Parziali		0.28 2.50	2.50	0.37	
Progressiva		-2.78 -2.50	0.00	2.50 2.87	
Dislivelli		-0.00 0.29	-0.07	-0.04 0.00	

Sezione: 131
 Progressiva: 1040.000
 Q. Progetto: 508.759

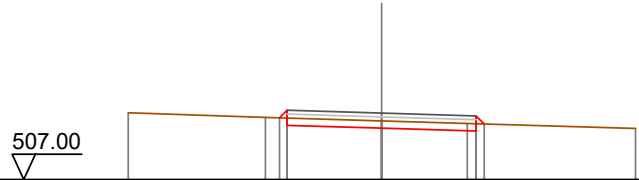

Quote Terreno	508.77	508.64	508.55	508.48	508.35
Quote Progetto		508.63 508.43	508.36	508.28 508.47	
Parziali		0.28 2.50	2.50	0.37	
Progressiva		-2.70 -2.50	0.00	2.50 2.71	
Dislivelli		0.00 0.21	-0.19	-0.19 0.00	

Sezione: 132
 Progressiva: 1047.241
 Q. Progetto: 508.181

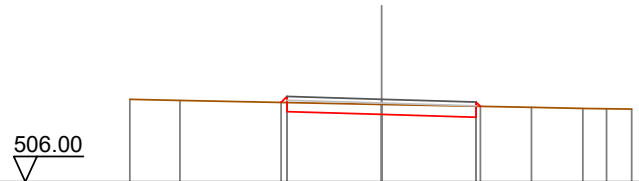

Quote Terreno	508.18	508.15	508.05	507.97	507.94	507.93	507.92
Quote Progetto			508.10 507.86	507.78	507.71 507.99		
Parziali			0.28 2.50	2.50	0.37		
Progressiva			-2.66 -2.50	0.00	2.50 2.61		
Dislivelli			0.00 0.16	-0.26	-0.29 0.00		

Sezione: 133
 Progressiva: 1049.544
 Q. Progetto: 507.997

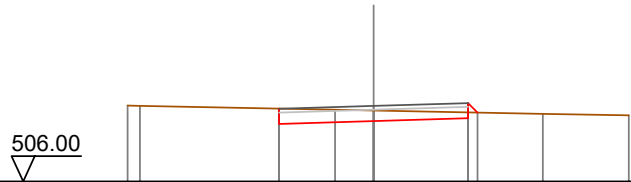

Quote Terreno		508.01	508.00		507.90	507.88		507.79	507.75
Quote Progetto				507.52		507.60		507.67	507.82
Parziali					2.50		2.50		
Progressiva				-2.50		0.00		2.50	2.75
Dislivelli				0.00		-0.28		-0.16	-0.00

Sezione: 134
 Progressiva: 1050.000
 Q. Progetto: 507.960

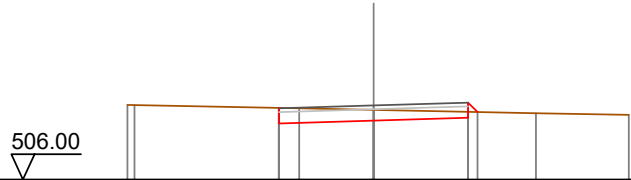

Quote Terreno		507.98	507.97		507.88	507.84		507.76	507.71
Quote Progetto				507.49		507.56		507.64	507.79
Parziali					2.50		2.50		
Progressiva				-2.51		0.00		2.50	2.75
Dislivelli				0.00		-0.28		-0.16	0.00

Sezione: 135
 Progressiva: 1060.000
 Q. Progetto: 507.181



Quote Terreno		507.37		507.27		507.13		507.07		506.94	506.91
Quote Progetto				507.23		506.71		506.86		507.04	
Parziali						2.50		2.50			
Progressiva				-2.62		-2.50		0.00		2.50	2.72
Dislivelli				0.00		-0.12		-0.35		-0.19	0.00

Sezione: 136
 Progressiva: 1061.924
 Q. Progetto: 507.049



Quote Terreno	507.25	507.23			507.00	506.95	506.76
Quote Progetto			507.10	506.57	506.65	506.72	506.90
Parziali				2.50		2.50	
Progressiva			-2.63	-2.50	0.00	2.50	2.72
Dislivelli			-0.00	-0.12	-0.35	-0.19	0.00

Sezione: 137
 Progressiva: 1070.000
 Q. Progetto: 506.562



Quote Terreno	506.81	506.69			506.49	506.43	506.21	506.17
Quote Progetto			506.61	506.09	506.16	506.24	506.36	
Parziali				2.50		2.50	0.28	
Progressiva			-2.63	-2.50	0.00	2.50	2.78	
Dislivelli			0.00	-0.12	-0.32	-0.13	-0.00	

Sezione: 138
 Progressiva: 1074.305
 Q. Progetto: 506.314

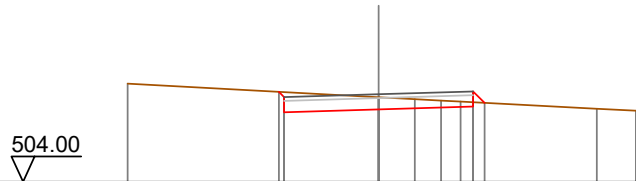

Quote Terreno	506.59				506.24	506.18	506.15	506.12	505.83	505.88
Quote Progetto		506.38	505.84		505.91		505.98	506.09		
Parziali			2.50		2.50		0.30			
Progressiva		-2.64	-2.50		0.00		2.50	2.80		
Dislivelli		0.00	-0.13		-0.32		-0.11	0.00		

Sezione: 139
 Progressiva: 1080.000
 Q. Progetto: 505.987

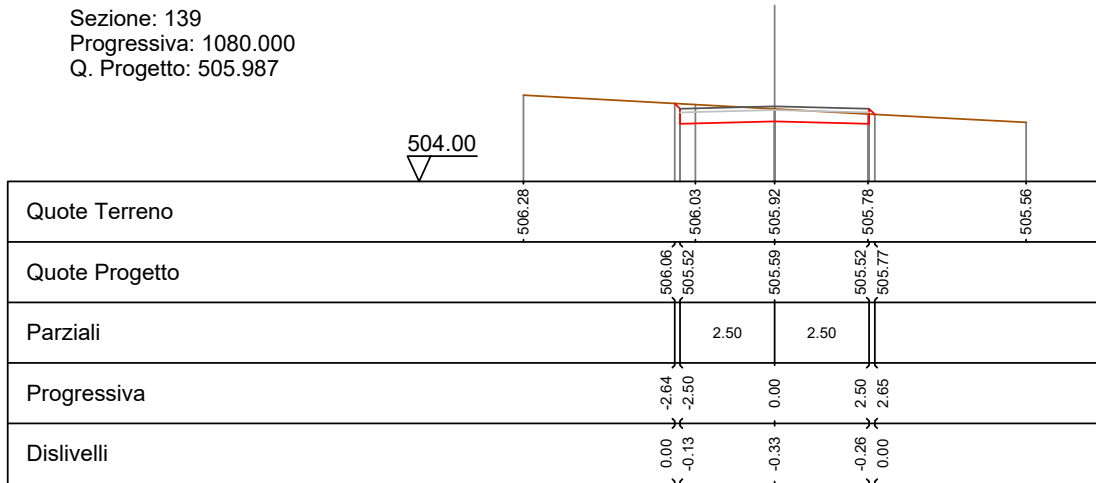

Sezione: 140
 Progressiva: 1088.672
 Q. Progetto: 505.478

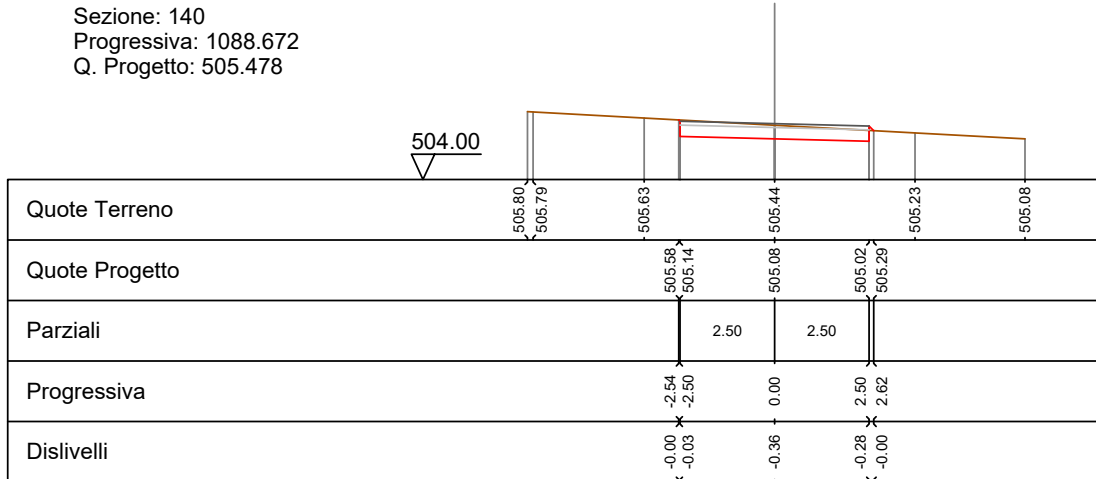

Sezione: 141
 Progressiva: 1090.000
 Q. Progetto: 505.396

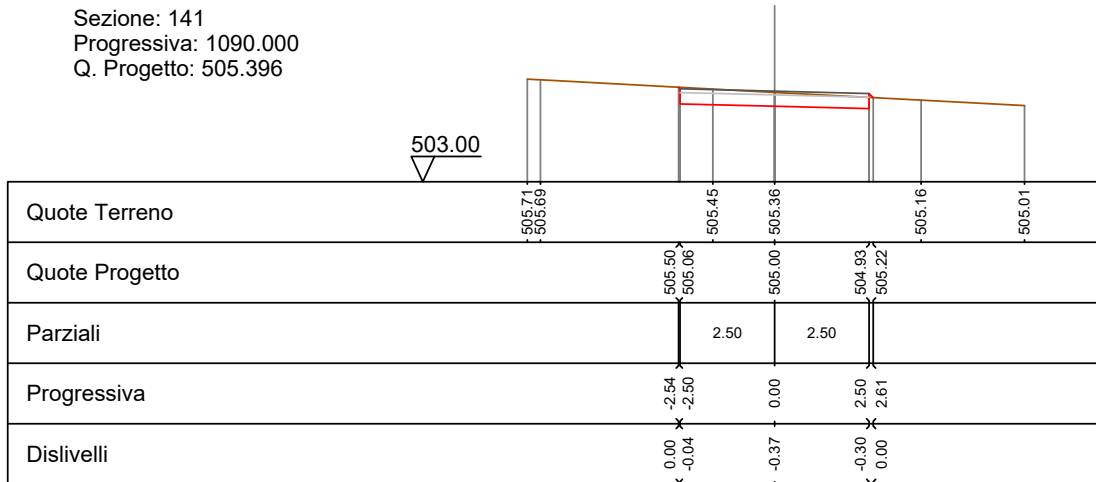

Sezione: 142
 Progressiva: 1100.000
 Q. Progetto: 504.736



Quote Terreno	505.02	505.00		504.80	504.75		504.58	504.48
Quote Progetto			504.85	504.40	504.34	504.27	504.64	
Parziali			2.50		2.50			
Progressiva			-2.56	-2.50	0.00	2.50	2.53	
Dislivelli			0.00	-0.05	-0.41	-0.37	0.00	

Sezione: 143
 Progressiva: 1102.407
 Q. Progetto: 504.566

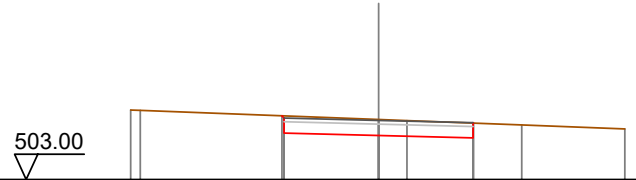

Quote Terreno	504.84	504.83		504.59	504.56		504.44	504.34
Quote Progetto			504.69	504.23	504.17	504.10		
Parziali			2.50		2.50			
Progressiva			-2.56	-2.50	0.00	2.50		
Dislivelli			0.00	-0.06	-0.42	-0.39		

Sezione: 144
 Progressiva: 1110.000
 Q. Progetto: 504.001

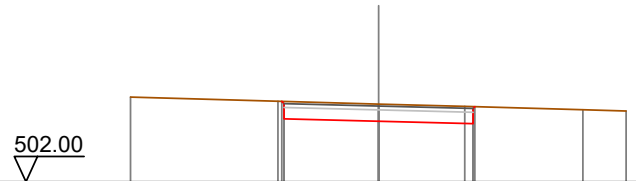

Quote Terreno	504.24		504.13		504.05		503.99	503.90	503.87
Quote Progetto		504.13	503.66		503.60		503.54	503.98	
Parziali			2.50		2.50				
Progressiva		-2.56	-2.50		0.00		2.50	2.55	
Dislivelli		0.00	-0.06		-0.45		-0.45	-0.00	

Sezione: 145
 Progressiva: 1116.143
 Q. Progetto: 503.526

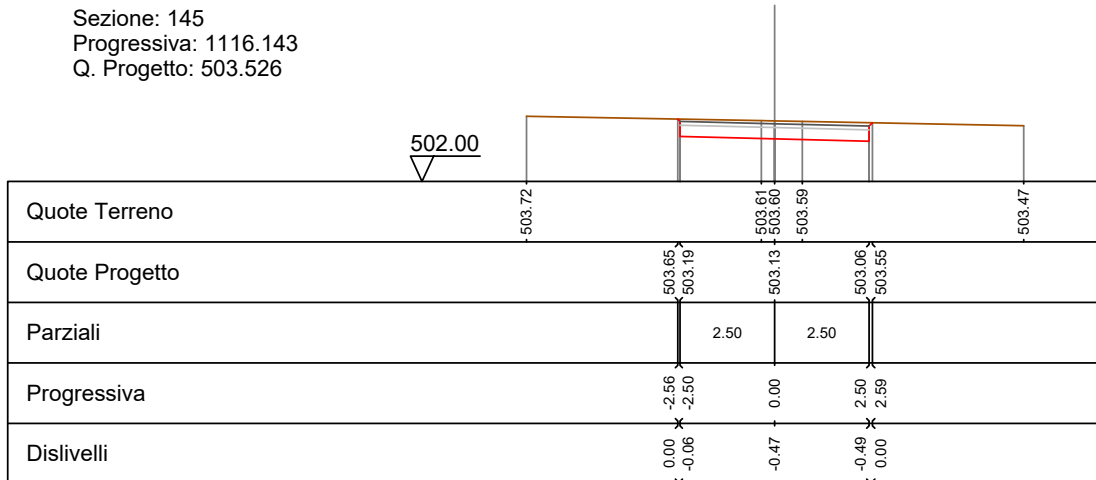

Sezione: 146
 Progressiva: 1116.693
 Q. Progetto: 503.483

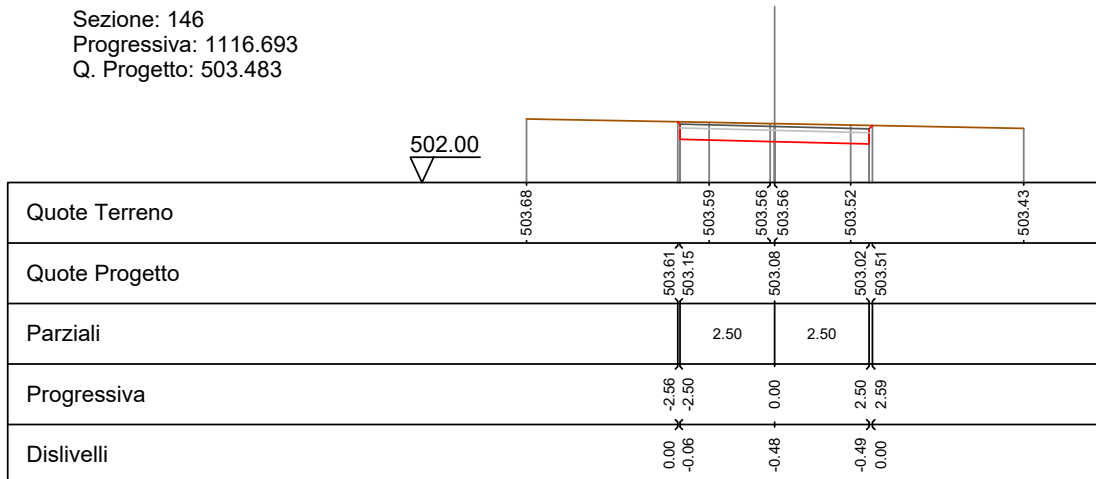

Sezione: 147
 Progressiva: 1120.000
 Q. Progetto: 503.227

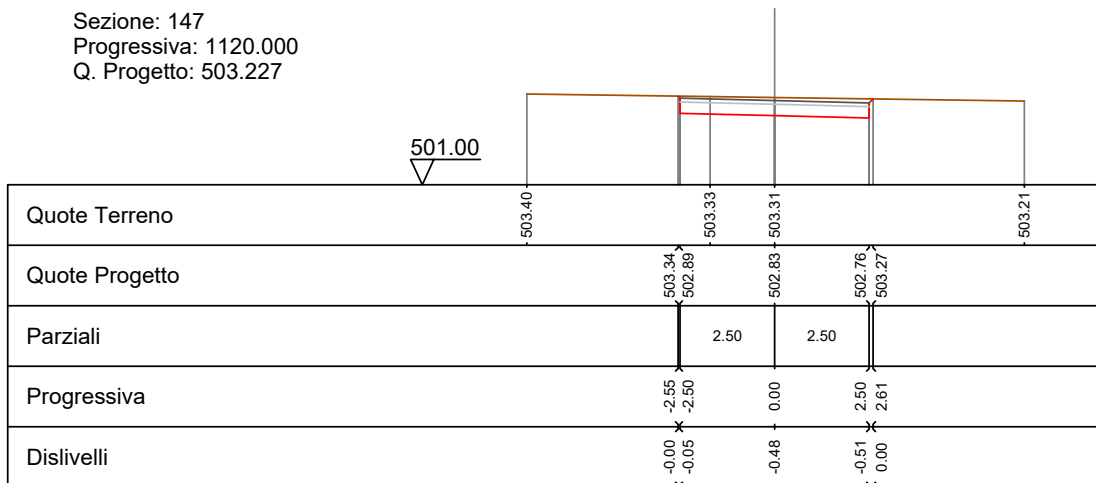

Sezione: 148
 Progressiva: 1130.000
 Q. Progetto: 502.453

500.00

Quote Terreno	502.53		502.53		502.53	502.53	502.54
Quote Progetto		502.12	502.05	501.98	502.53		
Parziali		2.50	2.50				
Progressiva		-2.51	0.00	2.50	2.64		
Dislivelli		0.00	-0.48	-0.54	0.00		

Sezione: 149
 Progressiva: 1140.000
 Q. Progetto: 501.679

500.00

Quote Terreno	501.65	501.65	501.73	501.75	501.81	501.86
Quote Progetto		501.71	501.34	501.28	501.22	501.79
Parziali		2.50	2.50			
Progressiva		-2.53	-2.50	0.00	2.50	2.67
Dislivelli		-0.00	0.03	-0.47	-0.57	-0.00

Sezione: 150
 Progressiva: 1144.037
 Q. Progetto: 501.367

499.00

Quote Terreno	501.30	501.34	501.44	501.49	501.51	501.55	501.59
Quote Progetto		501.38	501.03	500.97	501.49	501.50	
Parziali		2.50	2.50				
Progressiva		-2.55	-2.50	0.00	2.50	2.69	
Dislivelli		0.00	0.04	-0.47	-0.59	-0.00	

Sezione: 151
 Progressiva: 1150.000
 Q. Progetto: 500.934



Quote Terreno	500.78	500.80	500.84			500.99		501.06		501.17	501.21
Quote Progetto				500.90	500.60	500.53		500.47	501.08		
Parziali					2.50		2.50				
Progressiva				-2.59	-2.50	0.00		2.50	2.71		
Dislivelli				-0.00	0.09	-0.46		-0.60	0.00		

Sezione: 152
 Progressiva: 1160.000
 Q. Progetto: 500.367

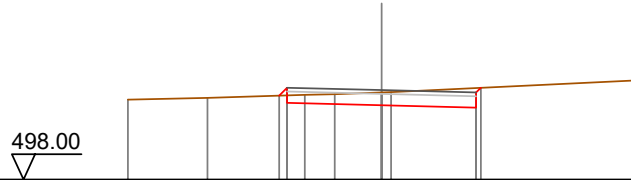

Quote Terreno	500.12	500.16	500.24	500.26	500.31	500.31				500.62
Quote Progetto			500.22	500.03		499.97		499.90	500.43	
Parziali				2.50		2.50				
Progressiva			-2.71	-2.50	0.00		2.50	2.62		
Dislivelli			-0.00	0.20	-0.34		-0.52	-0.00		

Sezione: 153
 Progressiva: 1170.000
 Q. Progetto: 500.001

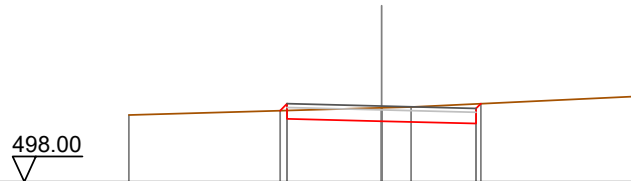

Quote Terreno	499.77				499.95	499.98				500.25
Quote Progetto		499.88	499.66		499.60		499.54	500.06		
Parziali			2.50		2.50					
Progressiva		-2.69	-2.50	0.00		2.50	2.62			
Dislivelli		0.00	0.18	-0.35		-0.52	0.00			

Sezione: 154
 Progressiva: 1171.380
 Q. Progetto: 499.966

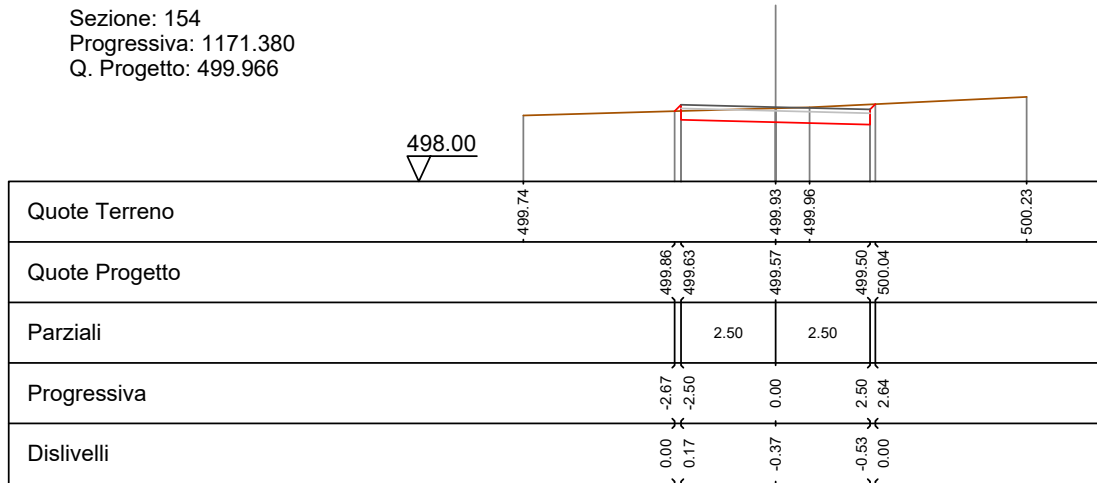

Sezione: 155
 Progressiva: 1180.000
 Q. Progetto: 499.816

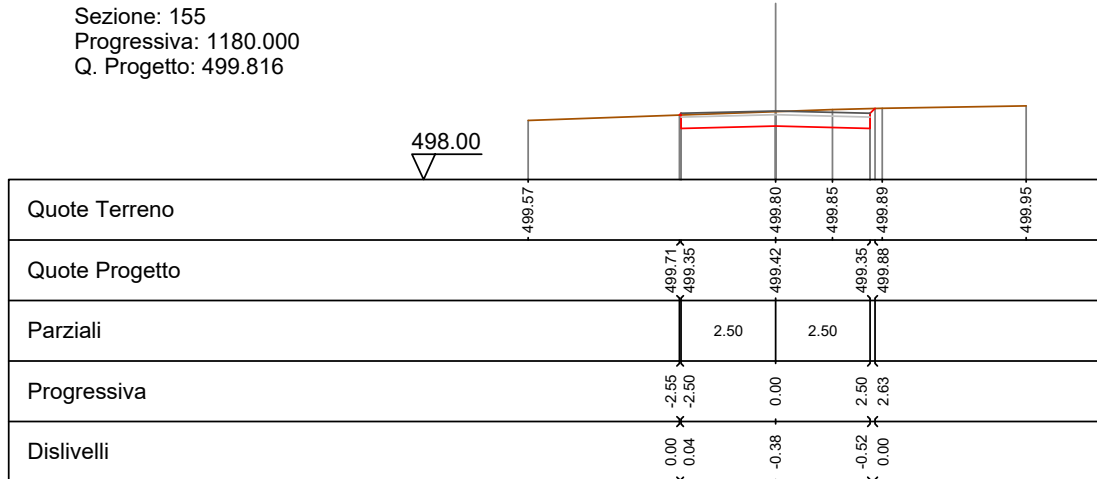

Sezione: 156
 Progressiva: 1192.258
 Q. Progetto: 499.627

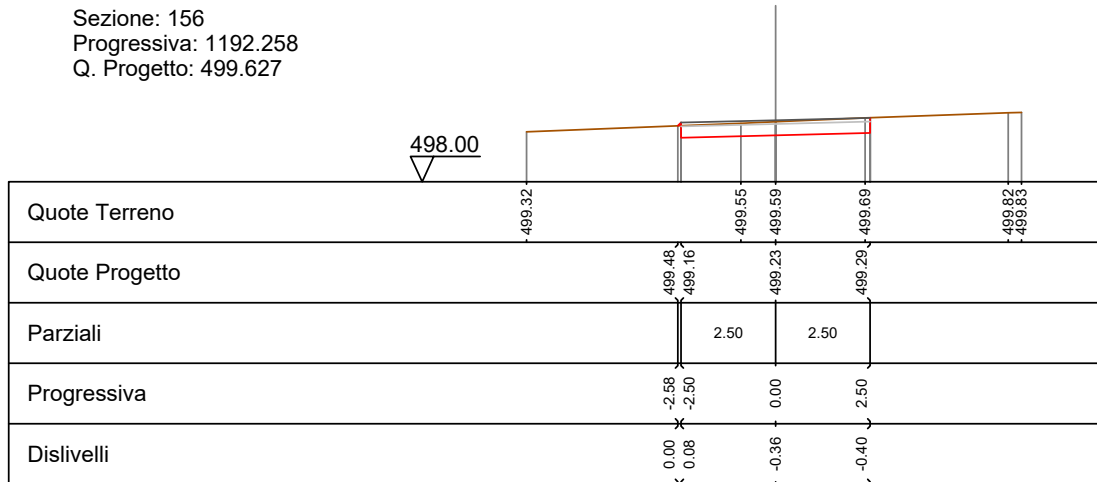

Sezione: 157
 Progressiva: 1200.000
 Q. Progetto: 499.480

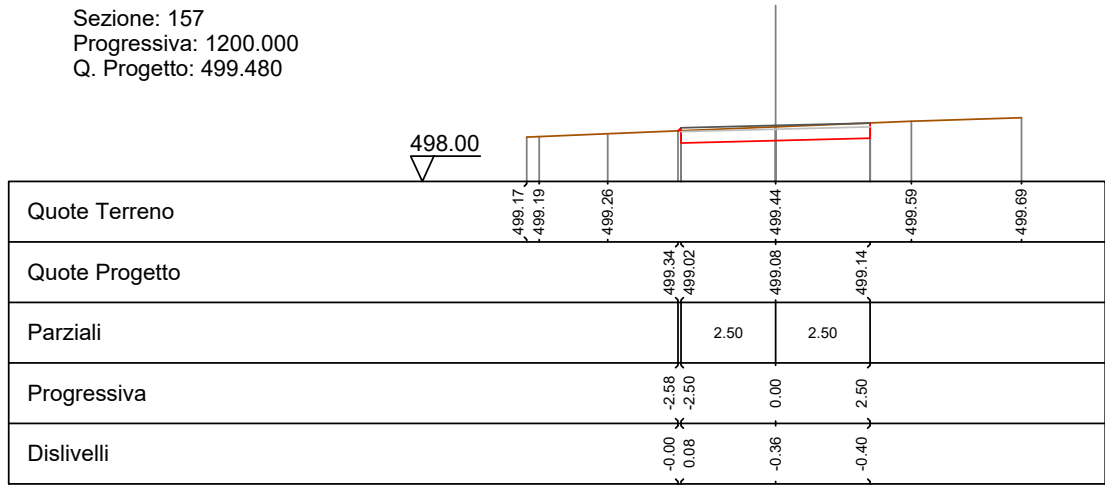

Sezione: 158
 Progressiva: 1210.000
 Q. Progetto: 499.185

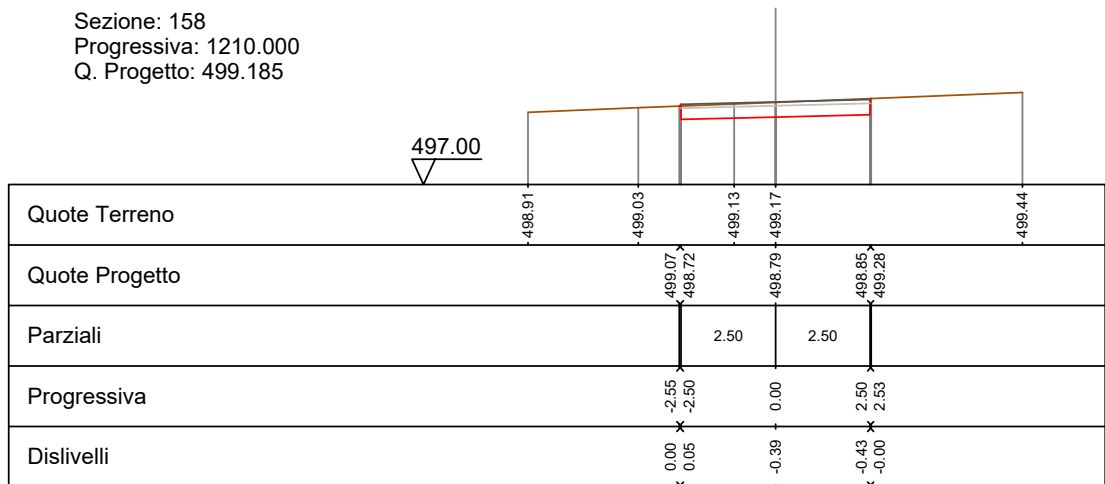

Sezione: 159
 Progressiva: 1220.000
 Q. Progetto: 498.773

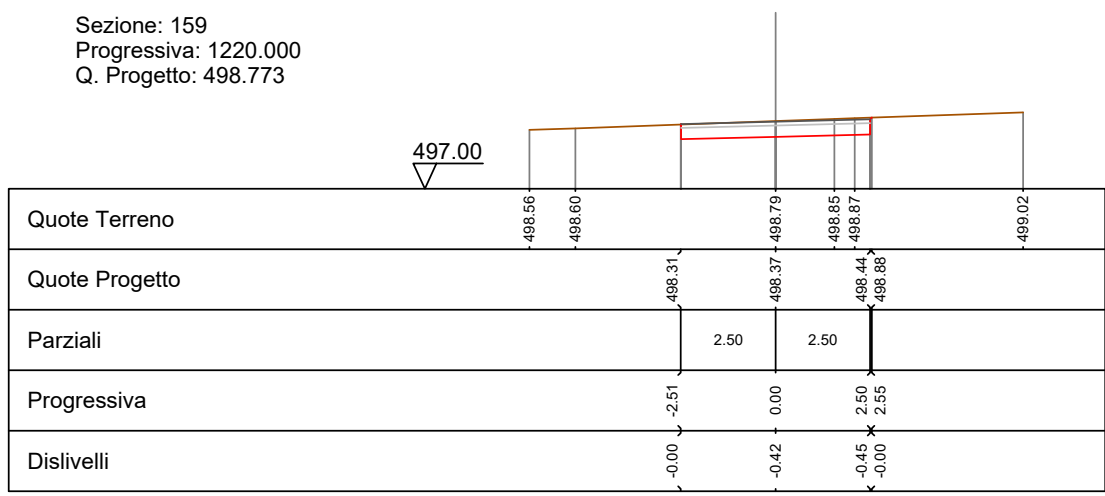

Sezione: 160
 Progressiva: 1229.603
 Q. Progetto: 498.265

496.00

Quote Terreno	498.15	498.24	498.31	498.45	498.49
Quote Progetto		498.25 497.80	497.86	497.93 498.38	
Parziali		2.50	2.50		
Progressiva		-2.54 -2.50	0.00	2.50 2.55	
Dislivelli		0.00 -0.04	-0.45	-0.45 0.00	

Sezione: 161
 Progressiva: 1230.000
 Q. Progetto: 498.241

496.00

Quote Terreno	498.13	498.23	498.29	498.41	498.46
Quote Progetto		498.22 497.78	497.84	497.90 498.36	
Parziali		2.50	2.50		
Progressiva		-2.55 -2.50	0.00	2.50 2.55	
Dislivelli		0.00 -0.05	-0.45	-0.45 0.00	

Sezione: 162
 Progressiva: 1240.000
 Q. Progetto: 497.648

496.00

Quote Terreno	497.63	497.67	497.71	497.74	497.79
Quote Progetto		497.68 497.19	497.25	497.31 497.73	
Parziali		2.50	2.50		
Progressiva		-2.50 -2.50	0.00	2.50 2.52	
Dislivelli		-0.00 -0.09	-0.46	-0.42 0.00	

Sezione: 163
 Progressiva: 1250.000
 Q. Progetto: 497.054

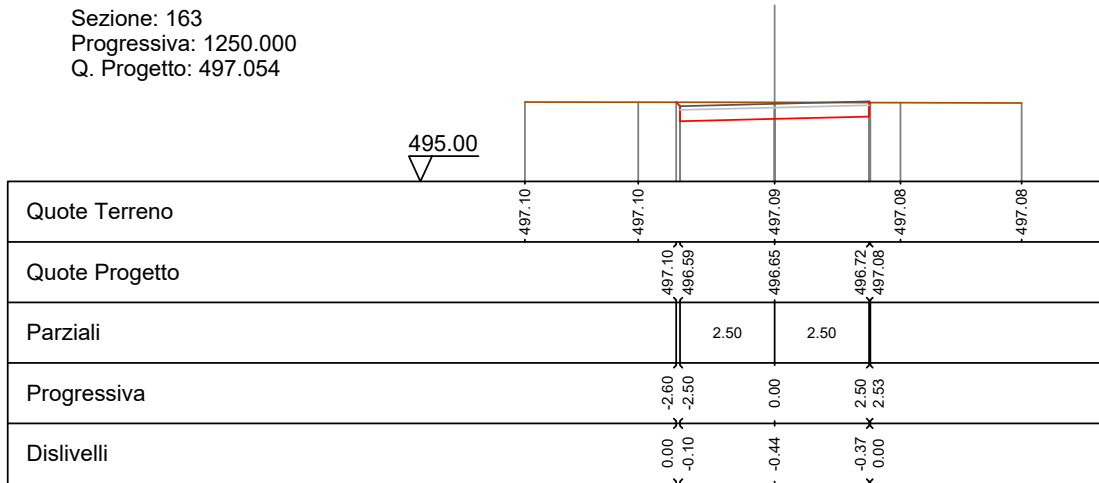

Sezione: 164
 Progressiva: 1260.000
 Q. Progetto: 496.460

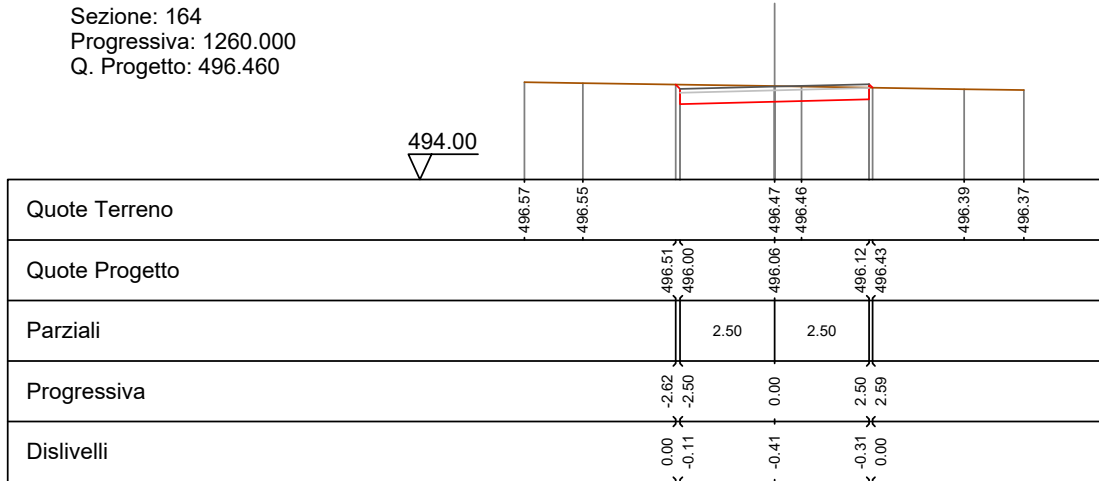

Sezione: 165
 Progressiva: 1266.947
 Q. Progetto: 496.052

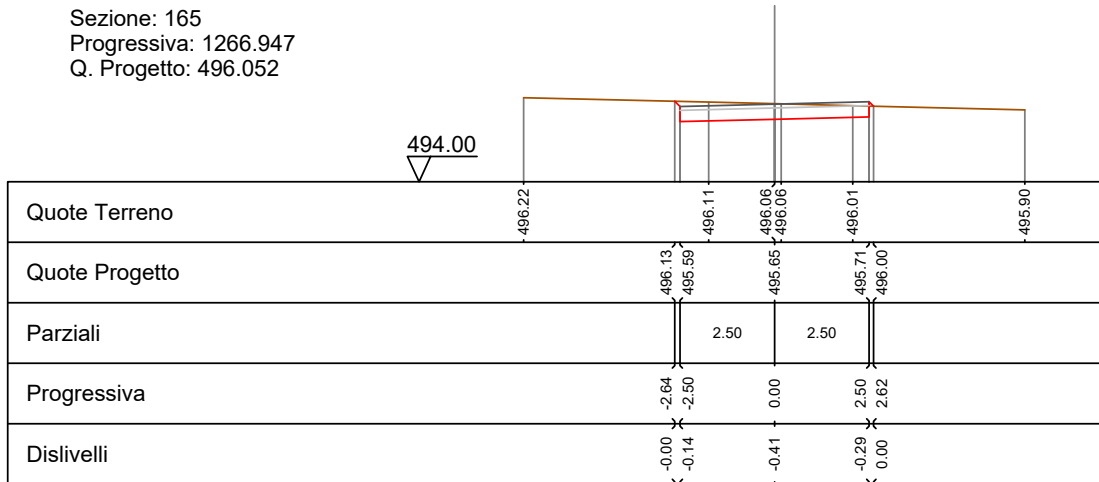

Sezione: 166
 Progressiva: 1280.000
 Q. Progetto: 495.291

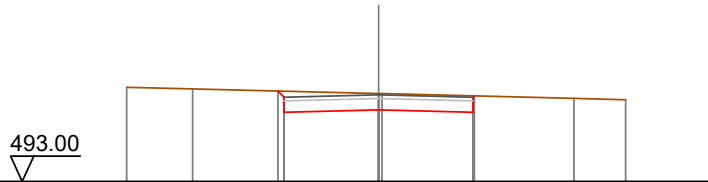

Quote Terreno	495.19	495.45	495.33	495.32	495.20	495.16	
Quote Progetto			495.39	494.83	494.89	494.83	495.26
Parziali			2.50	2.50			
Progressiva			-2.66	-2.50	0.00	2.50	2.53
Dislivelli			-0.00	-0.16	-0.43	-0.43	-0.00

Sezione: 167
 Progressiva: 1295.520
 Q. Progetto: 494.387

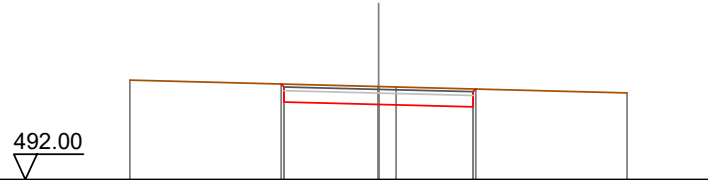

Quote Terreno	494.63	494.46	494.45	494.29			
Quote Progetto		494.53	494.05	493.99	494.46	493.92	494.39
Parziali		2.50	2.50				
Progressiva		-2.58	-2.50	0.00	2.50	2.57	
Dislivelli		0.00	-0.08	-0.47	-0.47	-0.00	

Sezione: 168
 Progressiva: 1300.000
 Q. Progetto: 494.126

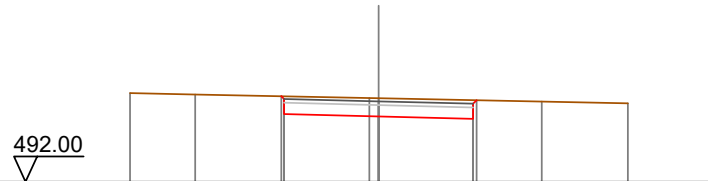

Quote Terreno	494.34	494.31	494.21	494.21	494.12	494.07		
Quote Progetto			494.26	493.79	493.73	494.21	493.66	494.16
Parziali			2.50	2.50				
Progressiva			-2.57	-2.50	0.00	2.50	2.59	
Dislivelli			0.00	-0.07	-0.48	-0.49	0.00	

Sezione: 169
 Progressiva: 1303.147
 Q. Progetto: 493.943

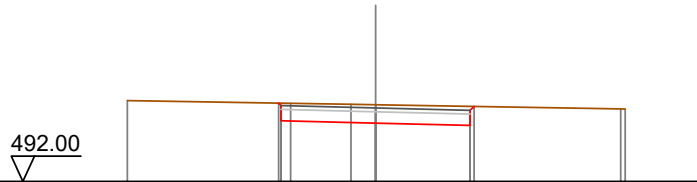

Quote Terreno	494.14	494.07	494.04	494.03	493.92	493.91
Quote Progetto		494.07	493.61	493.54	493.48	493.98
Parziali			2.50	2.50		
Progressiva		-2.57	-2.50	0.00	2.50	2.60
Dislivelli		-0.00	-0.06	-0.48	-0.50	0.00

Sezione: 170
 Progressiva: 1310.000
 Q. Progetto: 493.544

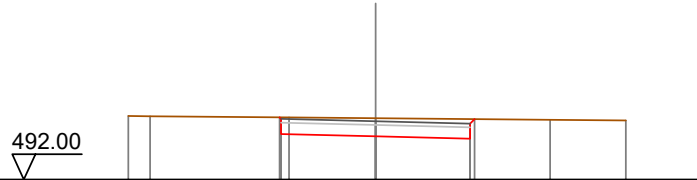

Quote Terreno	493.68	493.68	493.64	493.62	493.58	493.56
Quote Progetto			493.65	493.21	493.14	493.08
Parziali			2.50	2.50		
Progressiva		-2.54	-2.50	0.00	2.50	2.62
Dislivelli		0.00	-0.04	-0.48	-0.52	0.00

Sezione: 171
 Progressiva: 1310.774
 Q. Progetto: 493.499



Quote Terreno	493.63	493.62	493.60	493.58	493.55	493.52
Quote Progetto			493.60	493.16	493.10	493.04
Parziali			2.50	2.50		
Progressiva		-2.54	-2.50	0.00	2.50	2.62
Dislivelli		-0.00	-0.04	-0.48	-0.52	0.00

Sezione: 172
 Progressiva: 1320.000
 Q. Progetto: 492.961

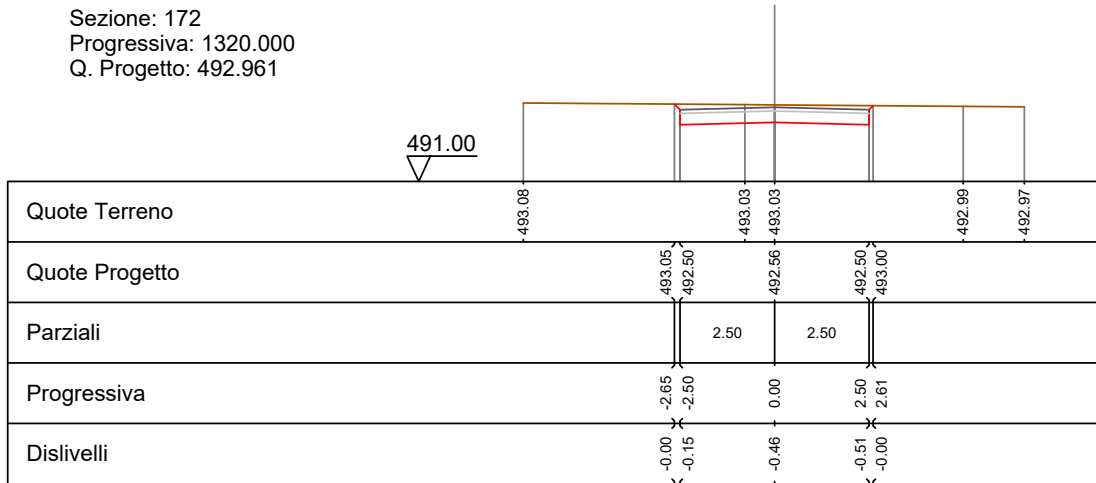

Sezione: 173
 Progressiva: 1340.000
 Q. Progetto: 491.796

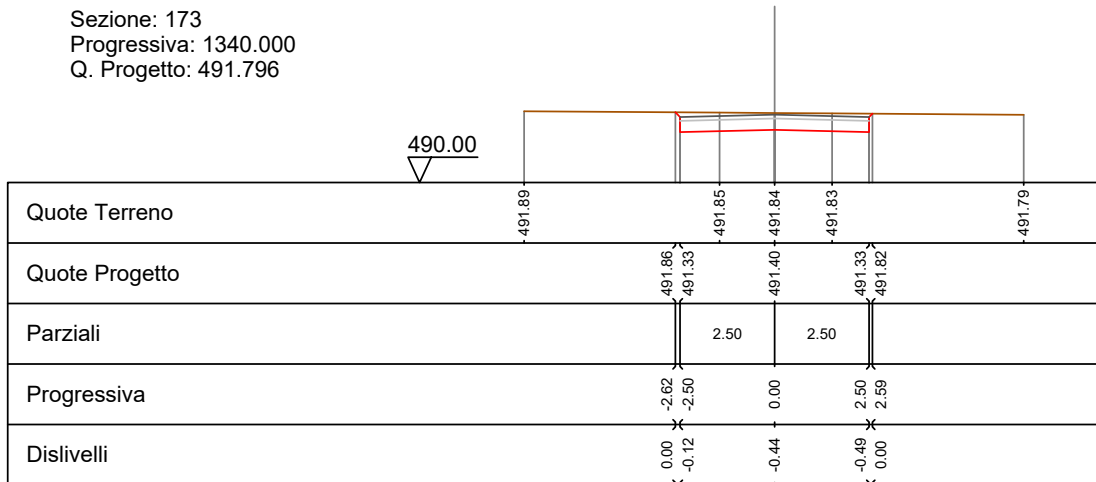

Sezione: 174
 Progressiva: 1341.296
 Q. Progetto: 491.721

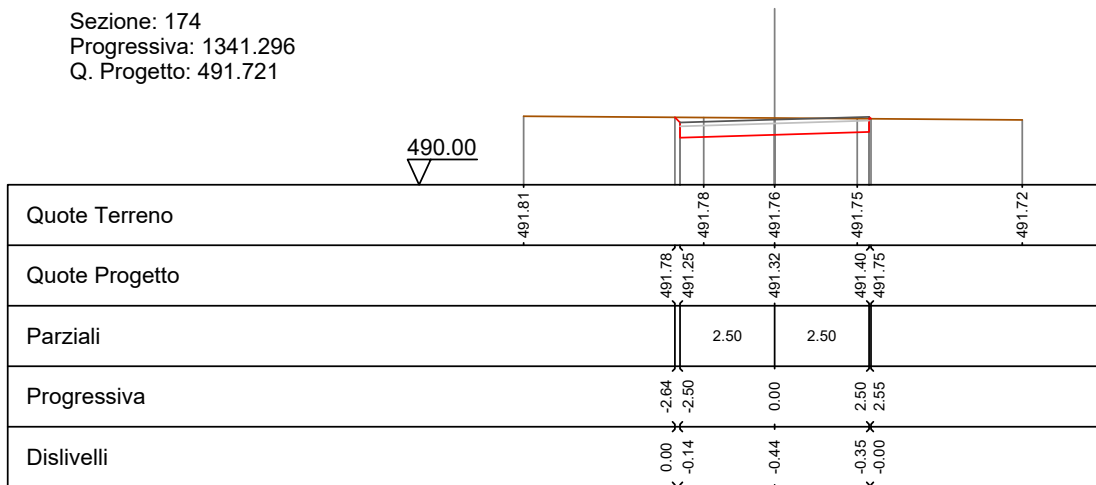

Sezione: 175
 Progressiva: 1347.851
 Q. Progetto: 491.339

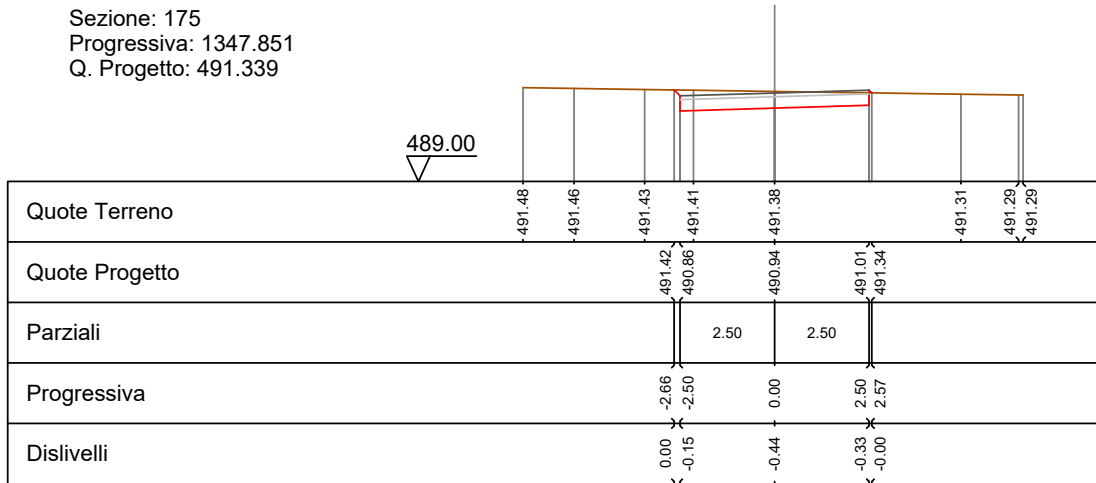

Sezione: 176
 Progressiva: 1350.000
 Q. Progetto: 491.214

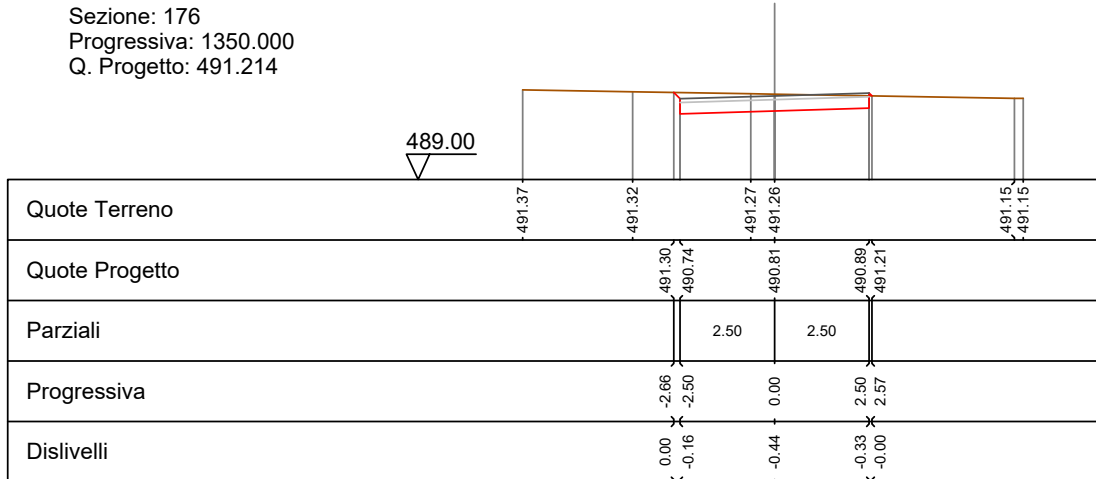

Sezione: 177
 Progressiva: 1354.405
 Q. Progetto: 490.957

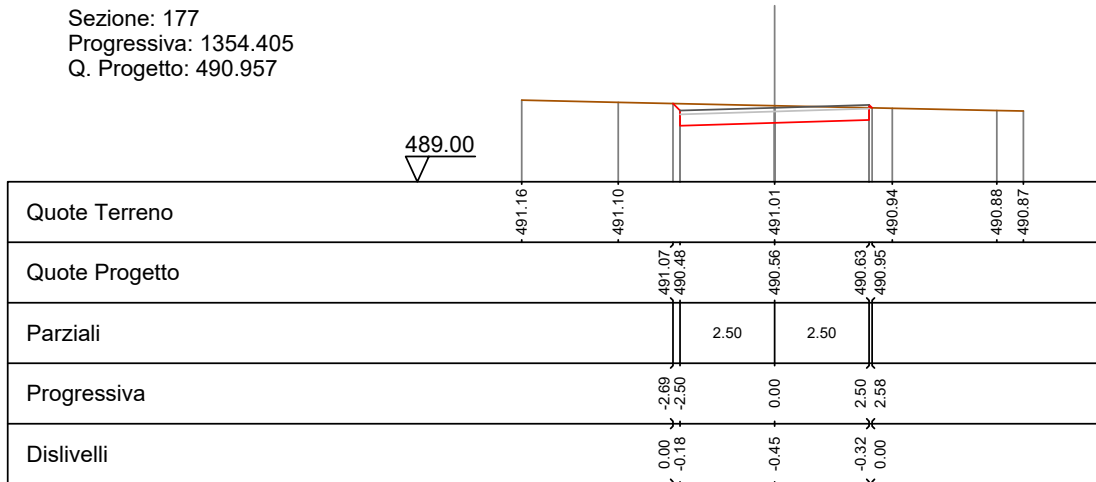

Sezione: 178
 Progressiva: 1360.000
 Q. Progetto: 490.667

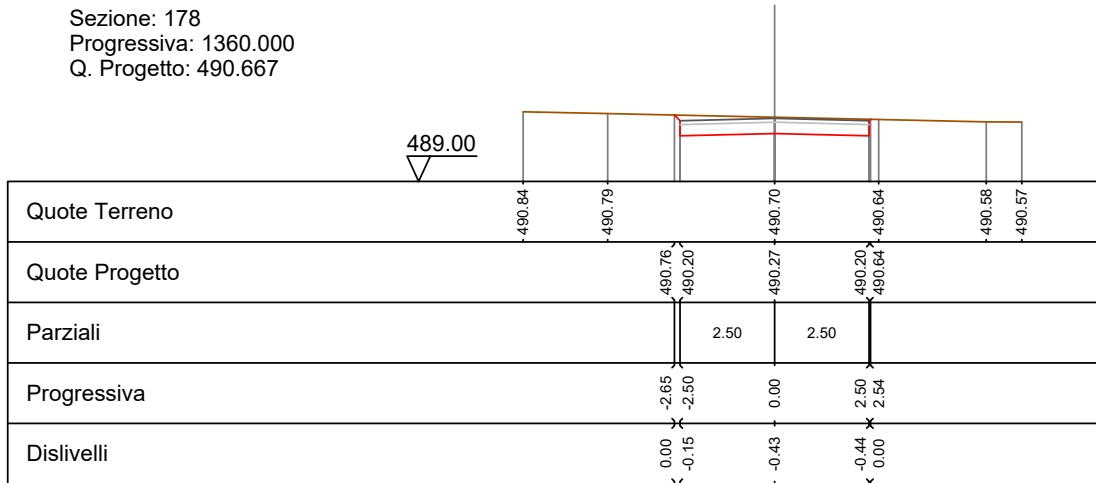

Sezione: 179
 Progressiva: 1380.000
 Q. Progetto: 490.015

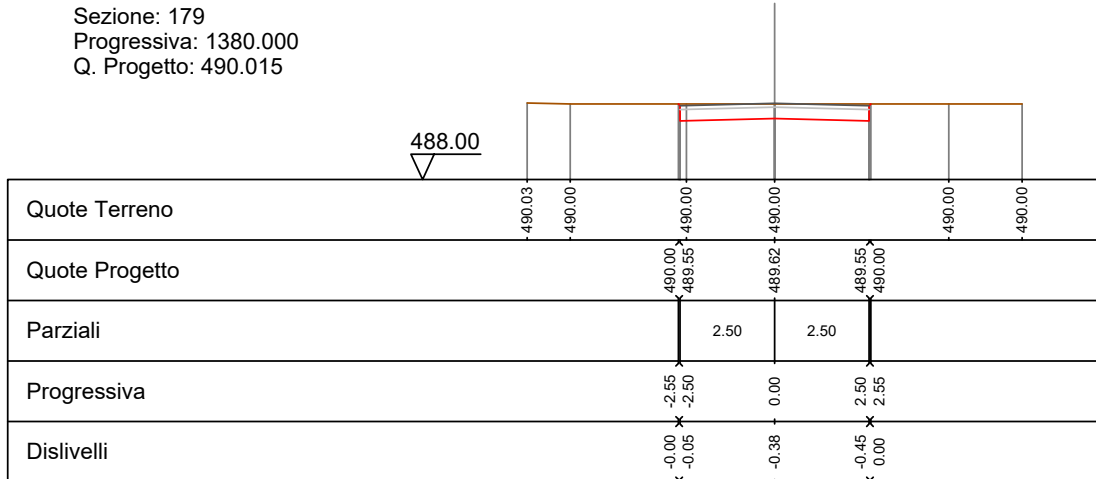

Sezione: 180
 Progressiva: 1399.018
 Q. Progetto: 489.212

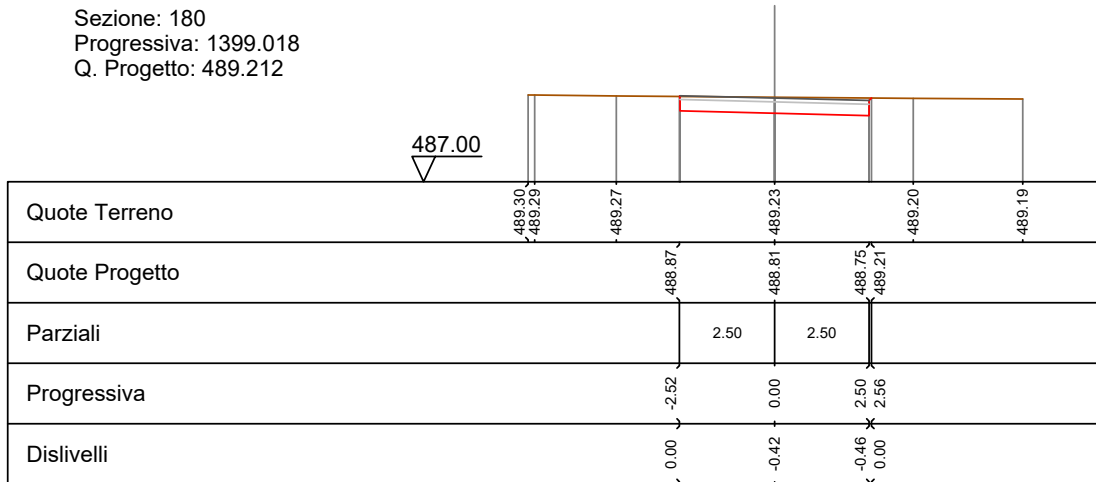

Sezione: 181
 Progressiva: 1400.000
 Q. Progetto: 489.151

487.00

Quote Terreno	489.21	489.21	489.18	489.16	489.13	489.12
Quote Progetto			489.18 488.81	488.75	488.69 489.14	
Parziali			2.50	2.50		
Progressiva			-2.54 -2.50	0.00	2.50 2.55	
Dislivelli			-0.00 0.04	-0.41	-0.45 0.00	

Sezione: 182
 Progressiva: 1410.162
 Q. Progetto: 488.425

486.00

Quote Terreno	488.35	488.35	488.38	488.39	488.40	488.43
Quote Progetto			488.36 488.09	488.03	487.96 488.39	
Parziali			2.50	2.50		
Progressiva			-2.63 -2.50	0.00	2.50 2.53	
Dislivelli			-0.00 0.13	-0.35	-0.43 0.00	

Sezione: 183
 Progressiva: 1420.000
 Q. Progetto: 487.686

486.00

Quote Terreno	487.53	487.59	487.62	487.62	487.72	487.76
Quote Progetto		487.58 487.35	487.29	487.22 487.67		
Parziali		2.50	2.50			
Progressiva		-2.67 -2.50	0.00	2.50 2.55		
Dislivelli		-0.00 0.17	-0.33	-0.45 -0.00		

Sezione: 184
 Progressiva: 1421.306
 Q. Progetto: 487.588

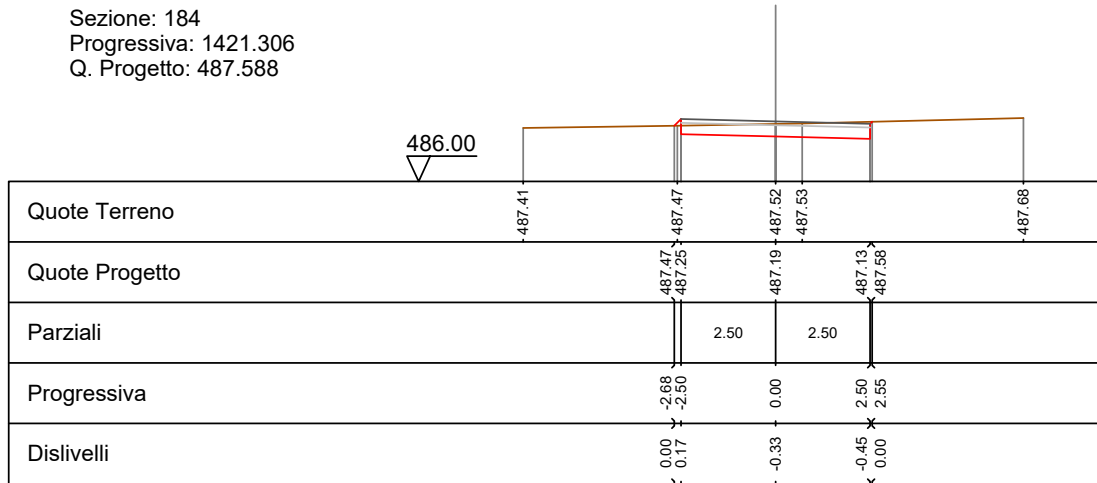

Sezione: 185
 Progressiva: 1440.000
 Q. Progetto: 486.183

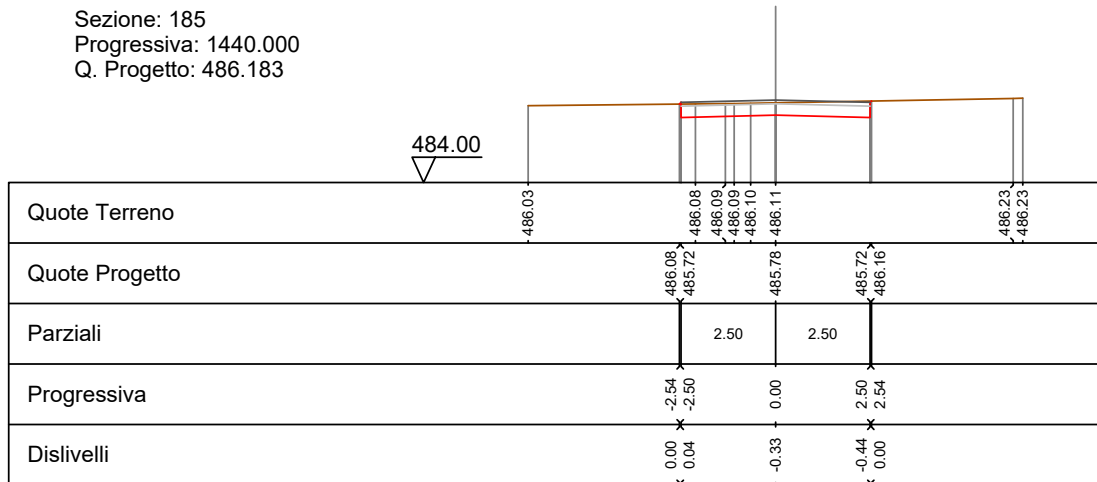

Sezione: 186
 Progressiva: 1460.000
 Q. Progetto: 484.681

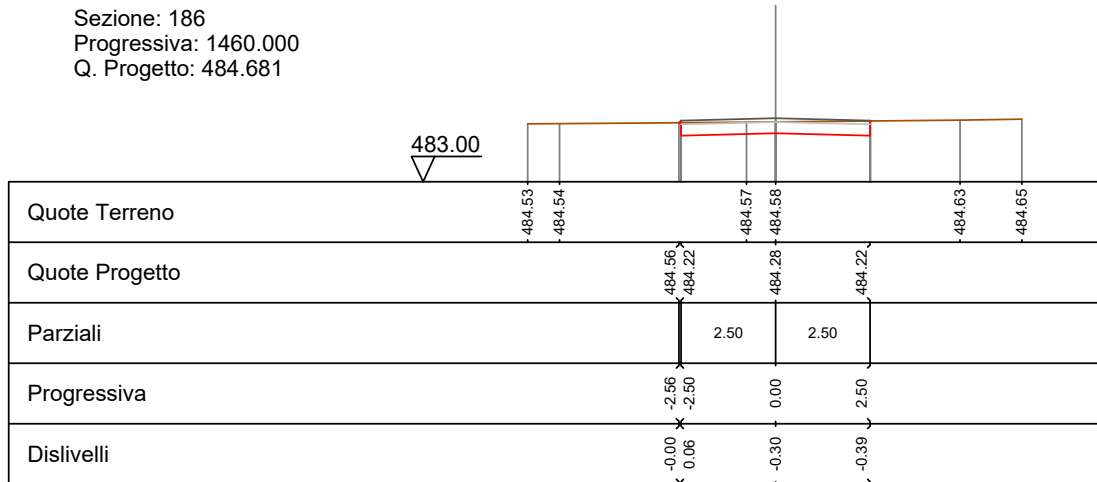

Sezione: 187
 Progressiva: 1461.499
 Q. Progetto: 484.568

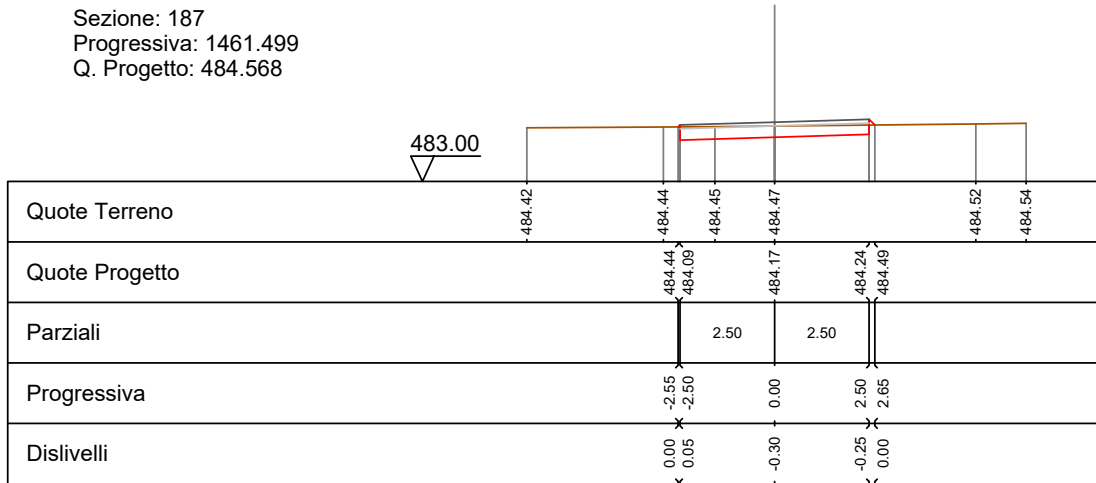

Sezione: 188
 Progressiva: 1470.000
 Q. Progetto: 483.929

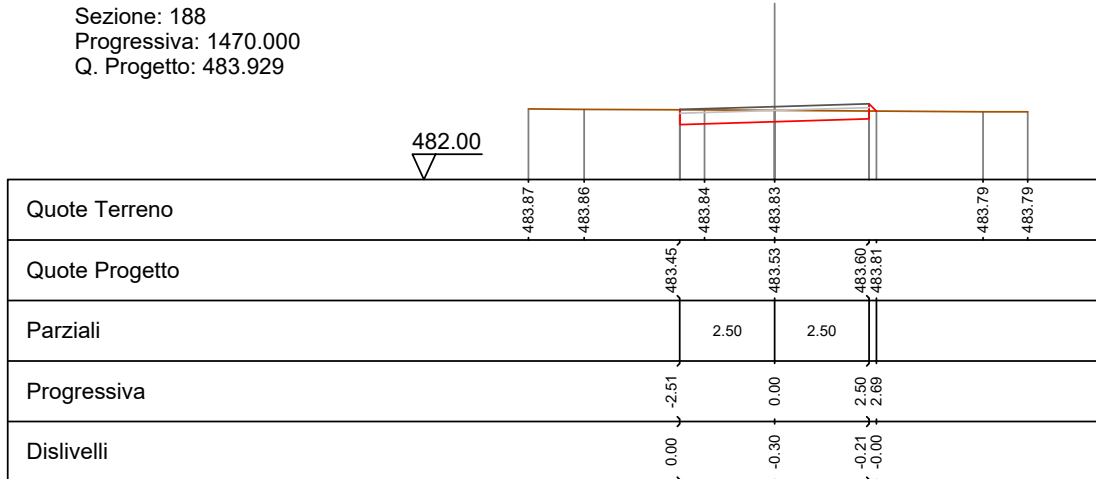

Sezione: 189
 Progressiva: 1472.553
 Q. Progetto: 483.735

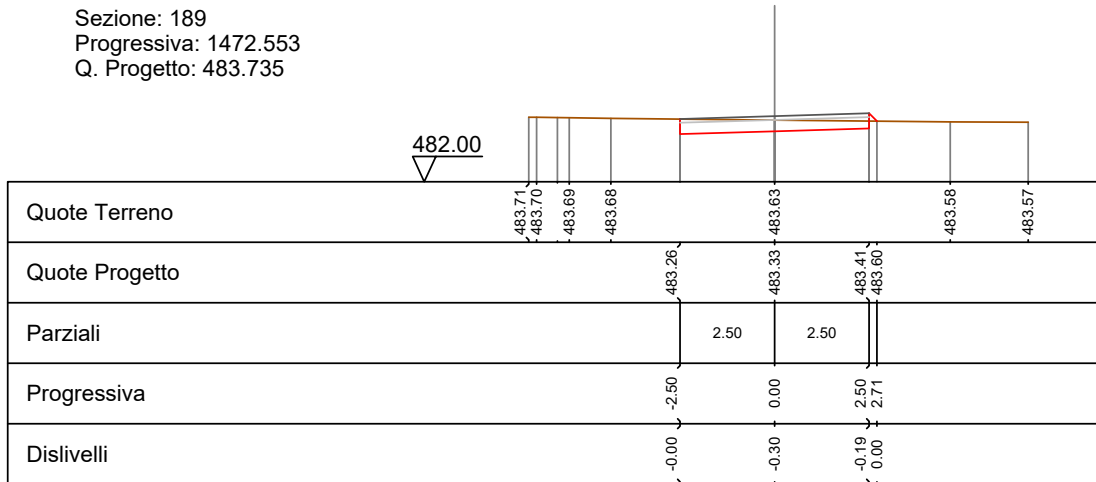

Sezione: 192
 Progressiva: 1500.000
 Q. Progetto: 481.187

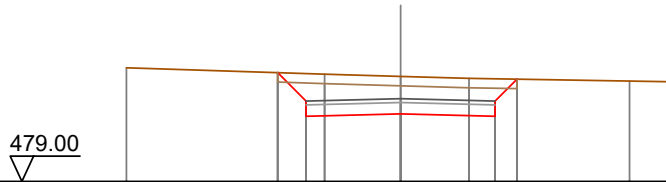

Quote Terreno	-482.01		-481.84	-481.78	-481.73		-481.65	-481.64
Quote Progetto		481.88	480.72	480.79	480.72	481.70		
Parziali		0.75	2.50	2.50	0.58			
Progressiva		-3.25	-2.50	0.00	2.50	3.08		
Dislivelli		-0.00	-0.73	-0.99	-0.99	0.00		

Sezione: 193
 Progressiva: 1520.000
 Q. Progetto: 479.409

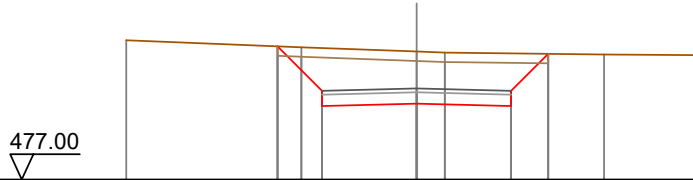

Quote Terreno	-480.68		-480.50	-480.39	-480.36		-480.31	-480.29
Quote Progetto		480.52	478.95	479.01	478.95	480.33		
Parziali		1.18	2.50	2.50	0.98			
Progressiva		-3.68	-2.50	0.00	2.50	3.48		
Dislivelli		0.00	-1.13	-1.38	-1.39	0.00		

Sezione: 194
 Progressiva: 1524.195
 Q. Progetto: 479.123

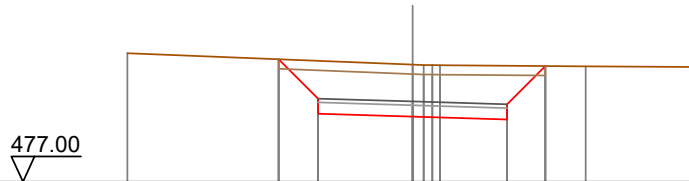

Quote Terreno	-480.40		-480.10	-480.08		-480.05	-480.04
Quote Progetto		480.24	478.80	478.72	478.65	480.06	
Parziali		1.04	2.50	2.50	1.01		
Progressiva		-3.54	-2.50	0.00	2.50	3.51	
Dislivelli		-0.00	-1.00	-1.37	-1.42	0.00	

Sezione: 195
 Progressiva: 1530.000
 Q. Progetto: 478.785

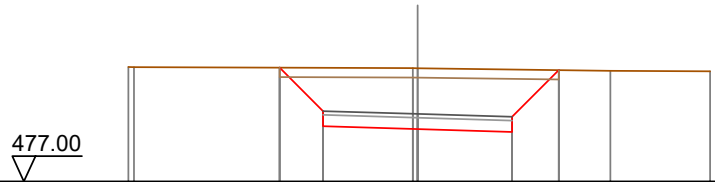

Quote Terreno	480.03	480.02		480.00	479.99		479.93	479.91
Quote Progetto			480.01	478.46	478.38	478.31	479.95	
Parziali			1.15	2.50	2.50	1.24		
Progressiva			-3.65	-2.50	0.00	2.50	3.74	
Dislivelli			-0.00	-1.15	-1.61	-1.65	0.00	

Sezione: 196
 Progressiva: 1534.393
 Q. Progetto: 478.574

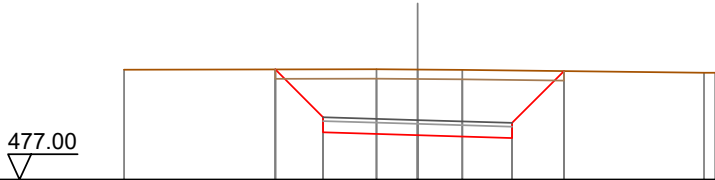

Quote Terreno	479.90		479.92	479.91	479.90		479.83	479.83
Quote Progetto		479.91	478.25	478.17	478.10	479.87		
Parziali		1.26	2.50	2.50	1.37			
Progressiva		-3.76	-2.50	0.00	2.50	3.87		
Dislivelli		0.00	-1.27	-1.74	-1.79	0.00		

Sezione: 197
 Progressiva: 1540.000
 Q. Progetto: 478.361

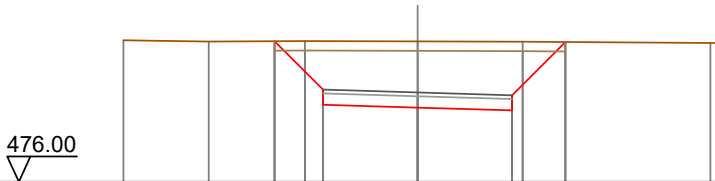

Quote Terreno	479.74	479.71	479.72	479.71	479.70		479.67	479.67
Quote Progetto		479.72	478.04	477.96	477.89	479.69		
Parziali		1.28	2.50	2.50	1.41			
Progressiva		-3.78	-2.50	0.00	2.50	3.91		
Dislivelli		0.00	-1.28	-1.75	-1.82	-0.00		

Sezione: 198
 Progressiva: 1544.590
 Q. Progetto: 478.234

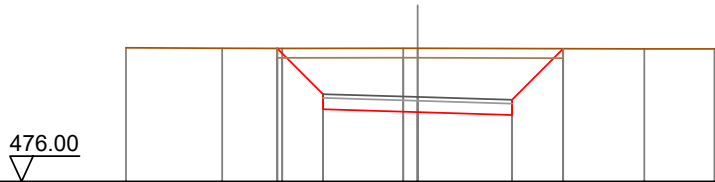

Quote Terreno	-479.53	-479.52	-479.52	-479.52	-479.52	-479.50	-479.51
Quote Progetto			479.52	477.91	477.83	477.76	479.51
Parziali			1.21	2.50	2.50	1.35	
Progressiva			-3.71	-2.50	0.00	2.50	3.85
Dislivelli			-0.00	-1.21	-1.69	-1.75	0.00

Sezione: 199
 Progressiva: 1550.884
 Q. Progetto: 478.128

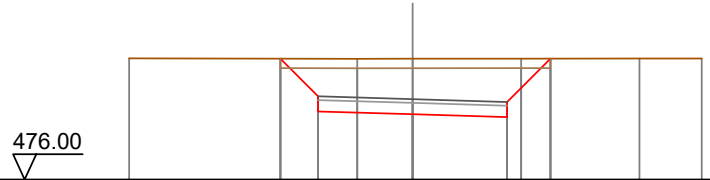

Quote Terreno	-479.21	-479.20	-479.20	-479.20	-479.20	-479.20	-479.20
Quote Progetto			479.20	477.80	477.73	477.65	479.20
Parziali			1.00	2.50	2.50	1.15	
Progressiva			-3.50	-2.50	0.00	2.50	3.65
Dislivelli			0.00	-0.99	-1.47	-1.55	0.00

Sezione: 200
 Progressiva: 1551.721
 Q. Progetto: 478.120

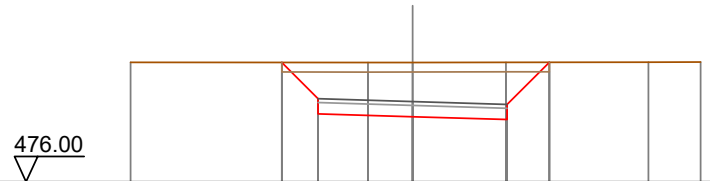

Quote Terreno	-479.16	-479.15	-479.15	-479.15	-479.16	-479.16	-479.17
Quote Progetto			479.15	477.79	477.72	477.64	479.16
Parziali			0.96	2.50	2.50	1.11	
Progressiva			-3.46	-2.50	0.00	2.50	3.61
Dislivelli			0.00	-0.96	-1.43	-1.51	0.00

Sezione: 201
 Progressiva: 1552.558
 Q. Progetto: 478.113

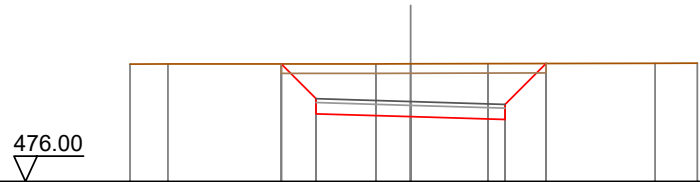

Quote Terreno	-479.10	-479.11		-479.11	-479.11	-479.12		-479.13	-479.13
Quote Progetto			479.11	477.79	477.71	477.64	479.12		
Parziali			0.92	2.50	2.50	1.08			
Progressiva			-3.42	-2.50	0.00	2.50	3.58		
Dislivelli			0.00	-0.92	-1.40	-1.48	0.00		

Sezione: 202
 Progressiva: 1556.000
 Q. Progetto: 478.100

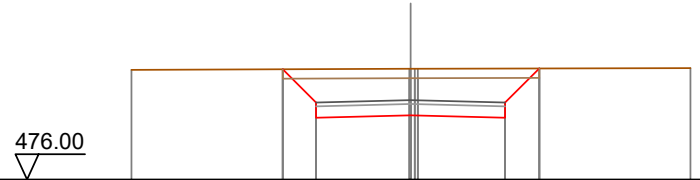

Quote Terreno	-478.90		-478.93	-478.93		-478.95
Quote Progetto		478.92	477.64	477.70	477.64	478.94
Parziali		0.88	2.50	2.50	0.90	
Progressiva		-3.38	-2.50	0.00	2.50	3.40
Dislivelli		0.00	-0.88	-1.23	-1.30	0.00

Sezione: 203
 Progressiva: 1560.000
 Q. Progetto: 478.100

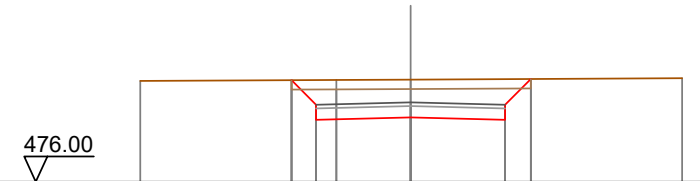

Quote Terreno	-478.67		-478.69	-478.70		-478.74
Quote Progetto		478.69	477.64	477.70	477.64	478.72
Parziali		0.65	2.50	2.50	0.68	
Progressiva		-3.15	-2.50	0.00	2.50	3.18
Dislivelli		0.00	-0.65	-1.00	-1.08	0.00

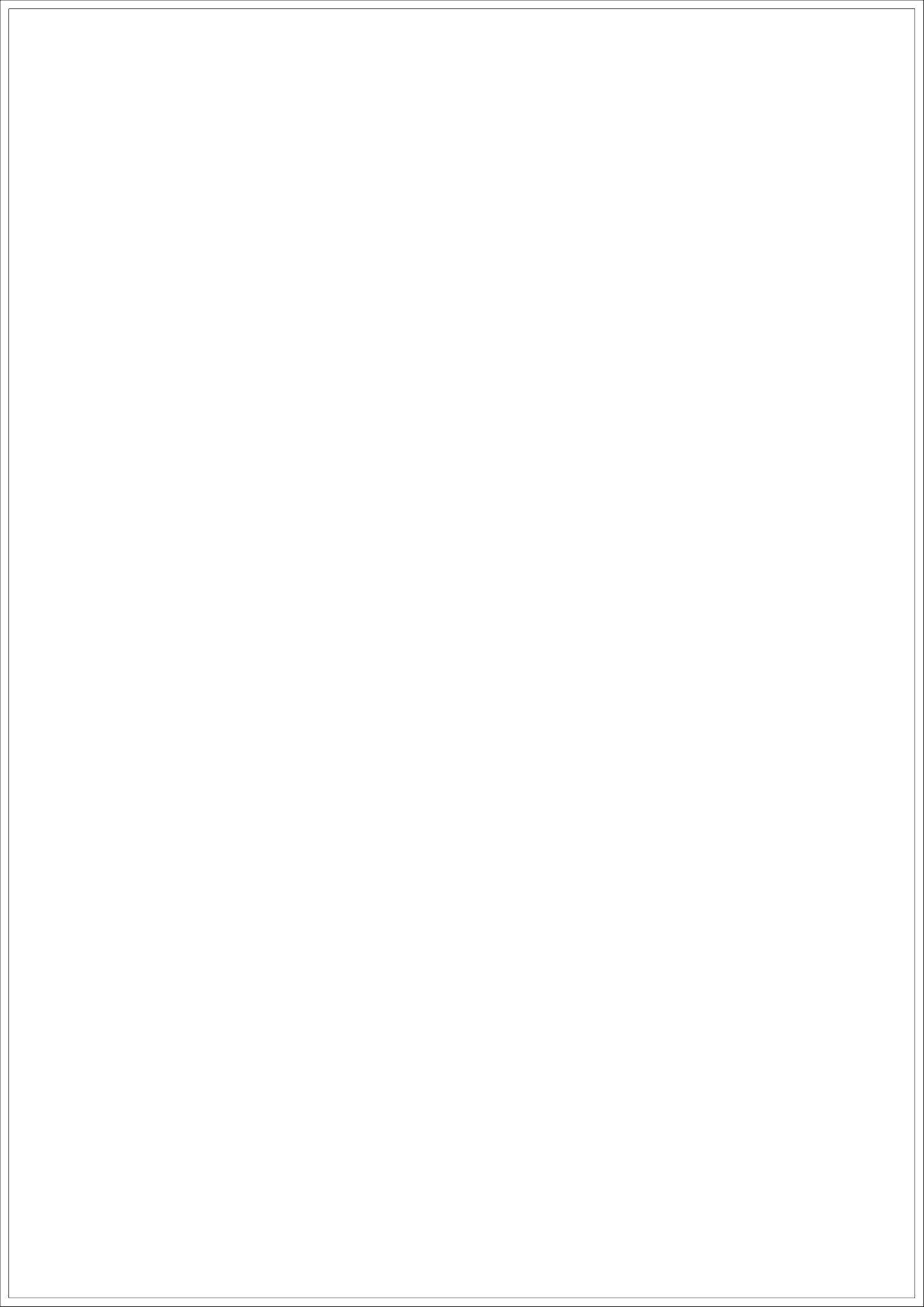

SEZIONI TRASVERSALI
Profilo longitudinale tratto 15-16
Viabilità di impianto postazione aerogeneratore T08

Nota: Le canalette di deflusso delle acque meteoriche, non indicate nel presente elaborato, sono rappresentate graficamente nelle sezioni stradali tipo dell'elaborato "WIND002-TC13_Piazzole aerogeneratori e strade di servizio - Particolari costruttivi", individuate planimetricamente nell'elaborato "WIND002-TC14_Opere di regimazione acque superficiali - Planimetria generale" e quantificate nell'elaborato "WIND002-RC6_Computo Metrico Estimativo".

DISEGNI DI RIFERIMENTO

TAVOLA	DESCRIZIONE
WIND002-TC8	Piazzole e viabilità - Planimetria di progetto - Fase di cantiere
WIND002-TC11	Profili longitudinali viabilità di impianto
WIND002-TC13	Piazzole aerogeneratori e strade di servizio - Particolari costruttivi
WIND002-TC14	Opere di regimazione acque superficiali - Planimetria generale

Sezione: 3
 Progressiva: 40.000
 Q. Progetto: 561.823

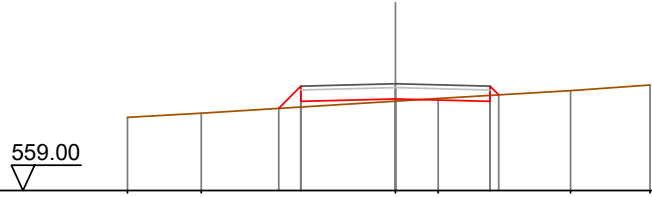

Quote Terreno		560.94	561.05			561.36	561.43		561.64	561.79
Quote Progetto				561.17	561.36	561.42		561.36	561.53	
Parziali				0.59	2.50	2.50				
Progressiva				-3.09	-2.50	0.00		2.50	2.73	
Dislivelli				0.00	0.55	0.06		-0.16	0.00	

Sezione: 4
 Progressiva: 52.265
 Q. Progetto: 561.930

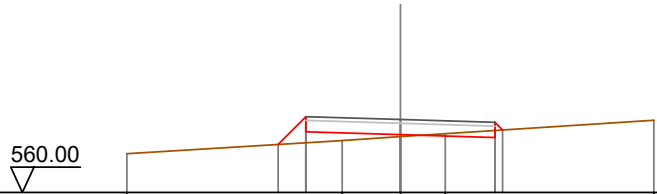

Quote Terreno		561.02			561.38	561.48		561.55		561.91
Quote Progetto				561.27	561.61	561.53		561.46	561.65	
Parziali				0.73	2.50	2.50				
Progressiva				-3.23	-2.50	0.00		2.50	2.70	
Dislivelli				0.00	0.69	0.05		-0.18	0.00	

Sezione: 5
 Progressiva: 55.104
 Q. Progetto: 561.938

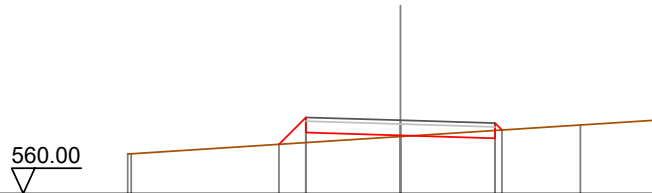

Quote Terreno	561.04	561.05			561.30	561.61	561.54	561.46	561.68	561.81	561.94
Quote Progetto					561.30	561.61	561.54	561.46	561.68		
Parziali					0.71	2.50	2.50				
Progressiva					-3.21	-2.50	0.00	2.50	2.68		
Dislivelli					0.00	0.67	0.03	-0.20	0.00		

Sezione: 6
 Progressiva: 57.944
 Q. Progetto: 561.945

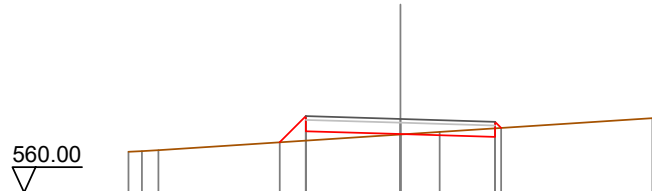

Quote Terreno	561.08	561.09	561.12				561.54	561.60			561.96
Quote Progetto							561.55	561.47	561.71		
Parziali							0.69	2.50	2.50		
Progressiva							-3.19	-2.50	0.00	2.50	2.66
Dislivelli							0.00	0.65	0.01	-0.23	-0.00

Sezione: 7
 Progressiva: 60.000
 Q. Progetto: 561.951

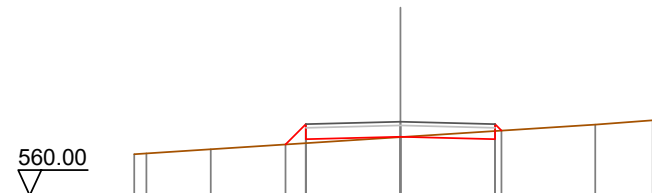

Quote Terreno	561.09	561.11	561.22				561.54			561.87	561.99
Quote Progetto							561.55	561.49	561.72		
Parziali							0.54	2.50	2.50		
Progressiva							-3.04	-2.50	0.00	2.50	2.67
Dislivelli							0.00	0.50	0.01	-0.22	0.00

Sezione: 8
 Progressiva: 71.340
 Q. Progetto: 561.980

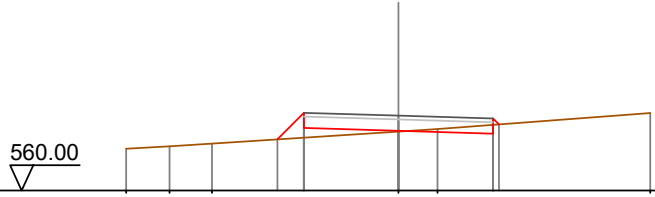

Quote Terreno	561.11	561.17	561.24			561.56	561.63		562.05
Quote Progetto				561.35	561.65	561.58		561.50	561.75
Parziali				0.70	2.50	2.50			
Progressiva				-3.20	-2.50	0.00		2.50	2.66
Dislivelli				-0.00	0.66	0.02		-0.23	0.00

Sezione: 9
 Progressiva: 78.981
 Q. Progetto: 562.000

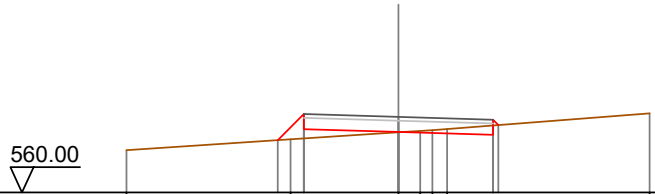

Quote Terreno	561.12			561.41		561.59	561.65	561.68		562.09
Quote Progetto				561.38	561.67	561.60		561.52	561.78	
Parziali				0.69	2.50	2.50				
Progressiva				-3.19	-2.50	0.00		2.50	2.64	
Dislivelli				0.00	0.65	0.01		-0.25	-0.00	

Sezione: 10
 Progressiva: 80.000
 Q. Progetto: 562.002

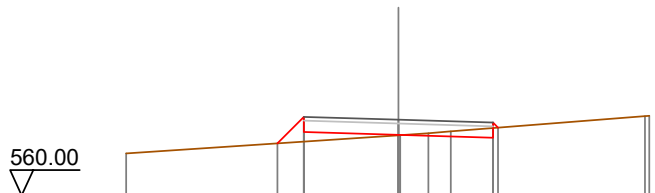

Quote Terreno	561.11					561.59	561.59	561.64	561.69		562.10	562.11
Quote Progetto				561.38	561.68	561.60		561.53	561.79			
Parziali				0.70	2.50	2.50						
Progressiva				-3.20	-2.50	0.00		2.50	2.63			
Dislivelli				-0.00	0.65	0.01		-0.25	0.00			

Sezione: 11
 Progressiva: 86.622
 Q. Progetto: 562.030

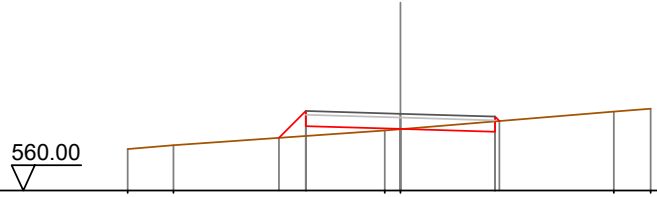

Quote Terreno	561.10	561.20			561.59	561.62			562.09	562.16
Quote Progetto			561.39	561.70	561.63		561.55	561.84		
Parziali			0.71	2.50	2.50					
Progressiva			-3.21	-2.50	0.00		2.50	2.62		
Dislivelli			0.00	0.66	0.01		-0.27	-0.00		

Sezione: 12
 Progressiva: 90.643
 Q. Progetto: 562.043

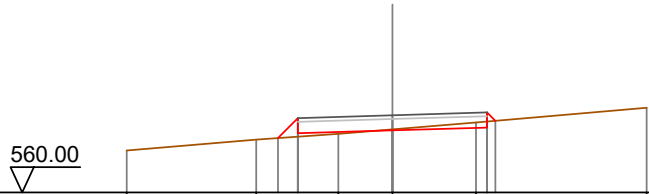

Quote Terreno	561.11		561.40		561.55		561.67		561.85	562.24
Quote Progetto			561.44	561.57	561.64		561.72	561.90		
Parziali			0.53	2.50	2.50					
Progressiva			-3.03	-2.50	0.00		2.50	2.72		
Dislivelli			0.00	0.49	-0.03		-0.16	0.00		

Sezione: 13
 Progressiva: 100.000
 Q. Progetto: 561.952

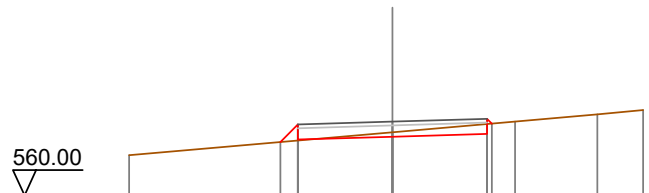

Quote Terreno	561.06				561.67			561.95	562.15	562.26
Quote Progetto			561.41	561.48	561.55		561.63	561.90		
Parziali			0.47	2.50	2.50					
Progressiva			-2.97	-2.50	0.00		2.50	2.63		
Dislivelli			0.00	0.42	-0.12		-0.26	0.00		

Sezione: 14
 Progressiva: 100.945
 Q. Progetto: 561.934

560.00

Quote Terreno	-561.05										
Quote Progetto			561.40	561.46		561.53	561.66		561.61	561.89	
Parziali			0.46	2.50		2.50					
Progressiva			-2.96	-2.50		0.00			2.50	2.62	
Dislivelli			0.00	0.42		-0.12			-0.27	0.00	

Sezione: 15
 Progressiva: 110.000
 Q. Progetto: 561.662

559.00

Quote Terreno	-560.74	-560.95									
Quote Progetto			561.04	561.19		561.26			561.34	561.61	
Parziali			0.54	2.50		2.50					
Progressiva			-3.04	-2.50		0.00			2.50	2.62	
Dislivelli			-0.00	0.49		-0.10			-0.26	-0.00	

Sezione: 16
 Progressiva: 111.247
 Q. Progetto: 561.612

559.00

Quote Terreno	-560.86	-560.81									
Quote Progetto			560.98	561.14		561.21			561.29	561.56	
Parziali			0.56	2.50		2.50					
Progressiva			-3.06	-2.50		0.00			2.50	2.62	
Dislivelli			0.00	0.51		-0.09			-0.27	0.00	

Sezione: 17
 Progressiva: 119.509
 Q. Progetto: 561.229

559.00

Quote Terreno	560.22	560.37	560.48	560.70	560.79	560.96	561.62
Quote Progetto			560.48		560.83	560.90	561.11
Parziali			0.68	2.50		2.50	
Progressiva			-3.18	-2.50	0.00	2.50	2.70
Dislivelli			0.00	0.61	0.04	-0.18	0.00

Sezione: 18
 Progressiva: 120.000
 Q. Progetto: 561.208

559.00

Quote Terreno	560.22	560.40	560.67	560.76	560.89	561.59
Quote Progetto		560.45	560.73	560.81	560.88	561.08
Parziali		0.69	2.50		2.50	
Progressiva		-3.19	-2.50	0.00	2.50	2.70
Dislivelli		0.00	0.62	0.05	-0.17	0.00

Sezione: 19
 Progressiva: 120.973
 Q. Progetto: 561.167

559.00

Quote Terreno	560.22	560.43	560.63	560.70	560.76	561.50	561.54
Quote Progetto		560.69	560.77	560.84	561.03		
Parziali		0.66	2.50		2.50		
Progressiva		-3.16	-2.50	0.00	2.50	2.71	
Dislivelli		0.00	0.63	0.07	-0.16	0.00	

Sezione: 20
 Progressiva: 122.437
 Q. Progetto: 561.109

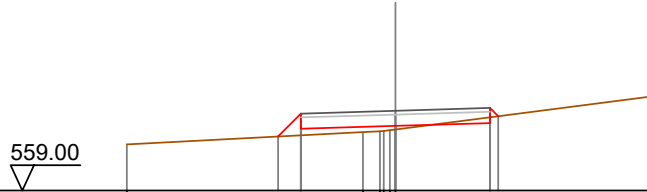

Quote Terreno	560.22		560.55	560.61		561.48
Quote Progetto		560.43	560.63	560.71	560.78	560.97
Parziali		0.60	2.50	2.50		
Progressiva		-3.10	-2.50	0.00	2.50	2.72
Dislivelli		0.00	0.57	0.10	-0.15	0.00

Sezione: 21
 Progressiva: 139.290
 Q. Progetto: 560.752

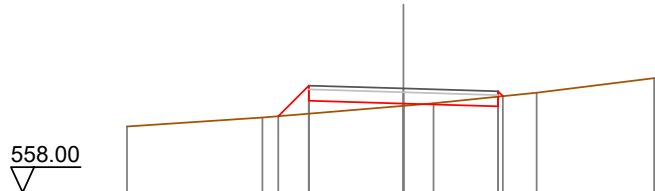

Quote Terreno	559.75		559.98	560.29	560.36		560.64		561.02
Quote Progetto			560.02	560.43	560.35		560.28	560.55	
Parziali			0.81	2.50	2.50				
Progressiva			-3.31	-2.50	0.00		2.50	2.63	
Dislivelli			0.00	0.74	0.06		-0.26	0.00	

Sezione: 22
 Progressiva: 140.000
 Q. Progetto: 560.747

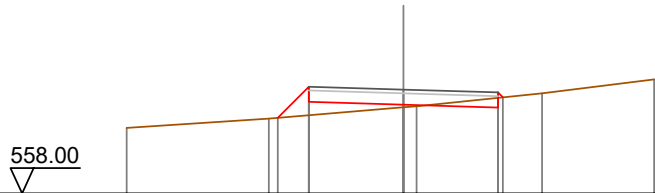

Quote Terreno	559.73		559.98	560.28	560.31		560.65		561.02
Quote Progetto			560.00	560.42	560.35		560.27	560.54	
Parziali			0.82	2.50	2.50				
Progressiva			-3.32	-2.50	0.00		2.50	2.63	
Dislivelli			0.00	0.75	0.07		-0.26	0.00	

Sezione: 23
 Progressiva: 141.273
 Q. Progetto: 560.739

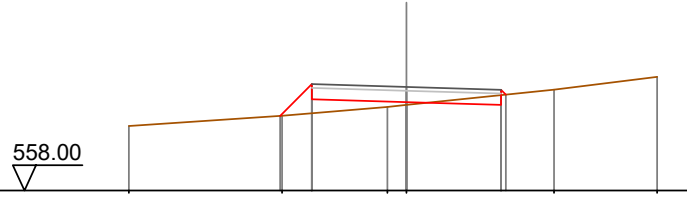

Quote Terreno	559.71	559.97	560.21	560.26	560.67	561.01
Quote Progetto		559.97	560.41	560.34	560.26	560.53
Parziali		0.84	2.50	2.50		
Progressiva		-3.34	-2.50	0.00	2.50	2.63
Dislivelli		0.00	0.77	0.08	-0.26	0.00

Sezione: 24
 Progressiva: 143.255
 Q. Progetto: 560.727

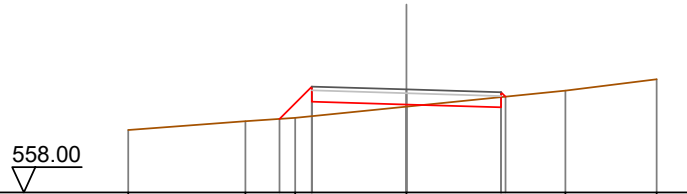

Quote Terreno	559.66	559.89	559.97	560.27	560.69	560.99
Quote Progetto		559.95	560.40	560.33	560.25	560.53
Parziali		0.86	2.50	2.50		
Progressiva		-3.36	-2.50	0.00	2.50	2.62
Dislivelli		0.00	0.78	0.06	-0.27	0.00

Sezione: 25
 Progressiva: 154.453
 Q. Progetto: 560.655

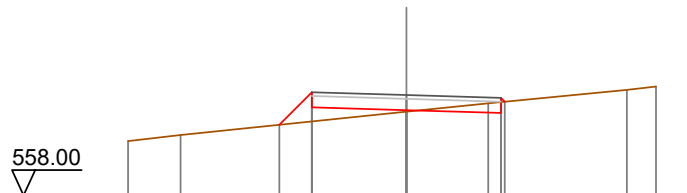

Quote Terreno	559.44	559.60	559.87	560.22	560.44	560.79	560.88
Quote Progetto			559.87	560.26	560.18	560.48	
Parziali			0.86	2.50	2.50		
Progressiva			-3.36	-2.50	0.00	2.50	2.60
Dislivelli			-0.00	0.77	0.04	-0.29	-0.00

Sezione: 26
 Progressiva: 160.000
 Q. Progetto: 560.620

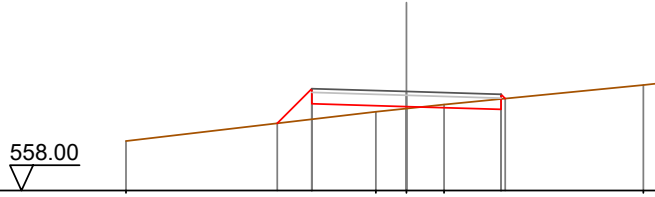

Quote Terreno	559.31			560.09	560.17	560.27		560.79	560.83
Quote Progetto		559.78	560.30		560.22		560.15	560.43	
Parziali		0.92	2.50		2.50				
Progressiva		-3.42	-2.50		0.00		2.50	2.61	
Dislivelli		0.00	0.81		0.05		-0.28	0.00	

Sezione: 27
 Progressiva: 162.219
 Q. Progetto: 560.606

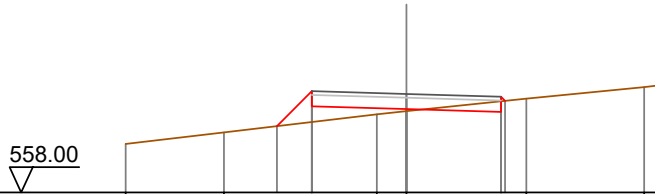

Quote Terreno	559.28	559.59		560.07	560.15		560.48	560.79	560.82
Quote Progetto			559.76	560.28		560.21	560.13	560.42	
Parziali			0.93	2.50		2.50			
Progressiva			-3.43	-2.50		0.00	2.50	2.61	
Dislivelli			0.00	0.82		0.06	-0.28	0.00	

Sezione: 28
 Progressiva: 169.985
 Q. Progetto: 560.551

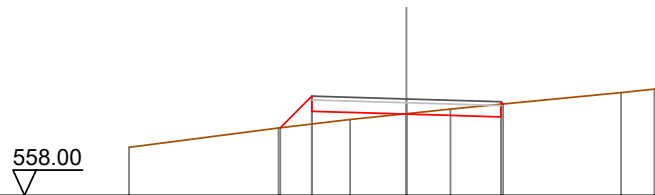

Quote Terreno	559.27	559.78	560.01	560.16	560.28		560.72	560.82
Quote Progetto		559.79	560.23		560.15		560.08	560.42
Parziali		0.84	2.50		2.50			
Progressiva		-3.34	-2.50		0.00		2.50	2.56
Dislivelli		0.00	0.74		-0.01		-0.34	-0.00

Sezione: 29
 Progressiva: 180.000
 Q. Progetto: 560.465

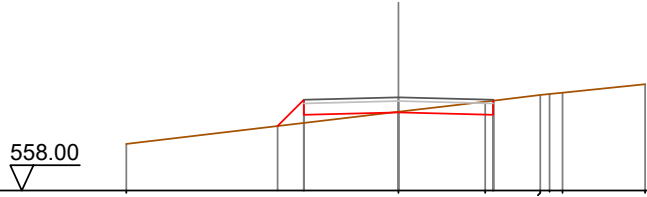

Quote Terreno	559.23			560.08	560.35	560.53	560.59	560.81
Quote Progetto		559.71	560.00	560.07	560.38			
Parziali		0.70	2.50	2.50				
Progressiva		-3.20	-2.50	0.00	2.50	2.52		
Dislivelli		-0.00	0.62	-0.02	-0.37	0.00		

Sezione: 30
 Progressiva: 200.000
 Q. Progetto: 560.285

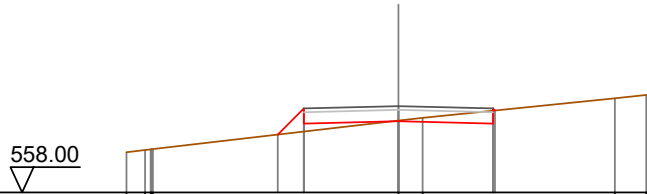

Quote Terreno	559.07	559.15		559.90	559.96		560.49	560.56
Quote Progetto			559.53	559.82	559.88	559.82	560.17	
Parziali			0.69	2.50	2.50			
Progressiva			-3.19	-2.50	0.00	2.50	2.55	
Dislivelli			0.00	0.61	-0.02	-0.34	-0.00	

Sezione: 31
 Progressiva: 200.339
 Q. Progetto: 560.281

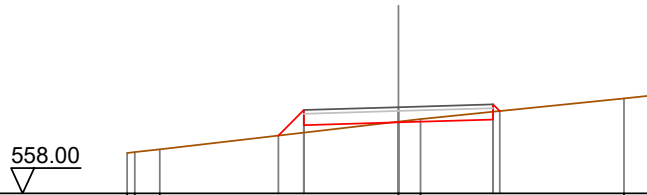

Quote Terreno	559.07	559.09	559.17		559.90	559.97		560.51	560.59
Quote Progetto				559.53	559.81	559.88	559.96	560.18	
Parziali				0.68	2.50	2.50			
Progressiva				-3.18	-2.50	0.00	2.50	2.68	
Dislivelli				-0.00	0.60	-0.02	-0.20	-0.00	

Sezione: 32
 Progressiva: 205.708
 Q. Progetto: 560.207

558.00



Quote Terreno	559.01	559.46	559.73	559.81	559.81	560.08	560.51
Quote Progetto		559.46	559.73	559.81	559.81	560.08	
Parziali		0.68	2.50	2.50			
Progressiva		-3.18	-2.50	0.00	2.50	2.70	
Dislivelli		0.00	0.60	-0.01	-0.18	-0.00	

Sezione: 33
 Progressiva: 210.000
 Q. Progetto: 560.142

557.00

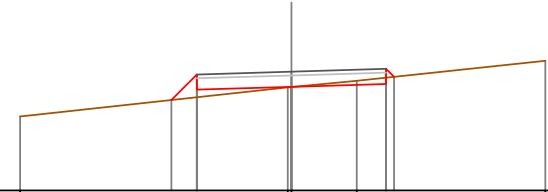

Quote Terreno	558.96	559.39	559.67	559.73	559.74	559.90	560.43
Quote Progetto		559.39	559.67	559.74	559.74	559.82	560.01
Parziali		0.68	2.50	2.50			
Progressiva		-3.18	-2.50	0.00	2.50	2.71	
Dislivelli		0.00	0.60	0.01	-0.17	0.00	

Sezione: 34
 Progressiva: 211.077
 Q. Progetto: 560.126

557.00

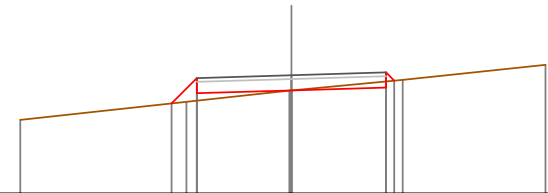

Quote Terreno	558.94	559.42	559.72	559.72	560.00	560.40
Quote Progetto		559.38	559.65	559.73	559.80	559.98
Parziali		0.67	2.50	2.50		
Progressiva		-3.17	-2.50	0.00	2.50	2.72
Dislivelli		-0.00	0.60	0.00	-0.16	0.00

Sezione: 35
 Progressiva: 220.000
 Q. Progetto: 559.996

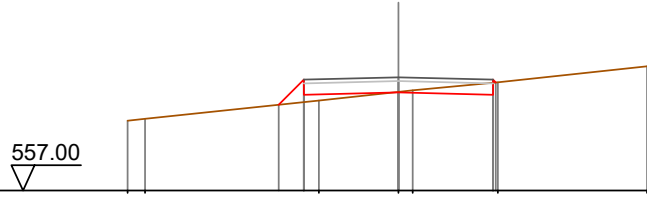

Quote Terreno		558.85	558.90		559.38		559.61	559.65		559.86		560.29
Quote Progetto				559.27	559.53		559.60		559.53	559.86		
Parziali				0.66	2.50		2.50					
Progressiva				-3.16	-2.50		0.00		2.50	2.58		
Dislivelli				0.00	0.60		-0.01		-0.32	0.00		

Sezione: 36
 Progressiva: 240.000
 Q. Progetto: 560.015

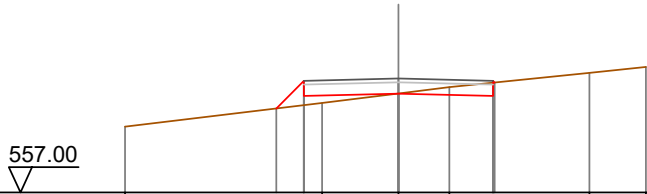

Quote Terreno		558.74			559.37		559.62		559.79		560.16	560.32
Quote Progetto				559.22	559.55		559.62		559.55	559.91		
Parziali				0.73	2.50		2.50					
Progressiva				-3.23	-2.50		0.00		2.50	2.55		
Dislivelli				0.00	0.64		-0.00		-0.35	-0.00		

Sezione: 37
 Progressiva: 260.000
 Q. Progetto: 559.923

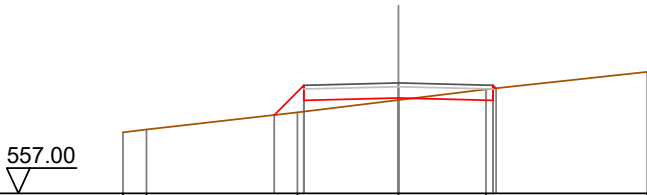

Quote Terreno		558.62	558.69		559.14		559.47		559.75		560.22	
Quote Progetto				559.07	559.46		559.52		559.46	559.78		
Parziali				0.79	2.50		2.50					
Progressiva				-3.29	-2.50		0.00		2.50	2.56		
Dislivelli				-0.00	0.70		0.05		-0.31	-0.00		

Sezione: 38
 Progressiva: 277.624
 Q. Progetto: 559.693

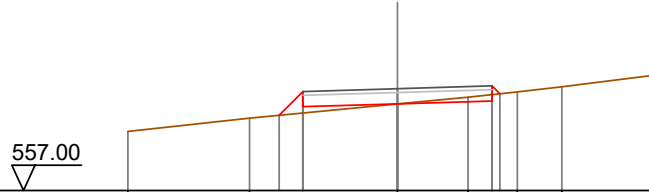

Quote Terreno		558.56		558.91		558.99	559.22		559.29		559.47	559.61	559.74	560.04
Quote Progetto						558.99	559.22		559.29		559.37	559.56		
Parziali						0.63	2.50		2.50					
Progressiva						-3.13	-2.50		0.00		2.50	2.71		
Dislivelli						0.00	0.57		0.00		-0.17	0.00		

Sezione: 39
 Progressiva: 280.000
 Q. Progetto: 559.661

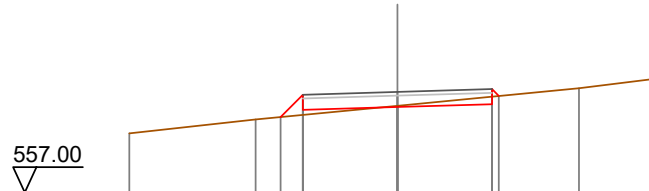

Quote Terreno		558.57		558.93		558.99	559.19		559.29		559.76	559.99	
Quote Progetto						558.99	559.19		559.26		559.34	559.55	
Parziali						0.59	2.50		2.50				
Progressiva						-3.09	-2.50		0.00		2.50	2.68	
Dislivelli						-0.00	0.53		-0.03		-0.20	-0.00	

Sezione: 40
 Progressiva: 282.548
 Q. Progetto: 559.626

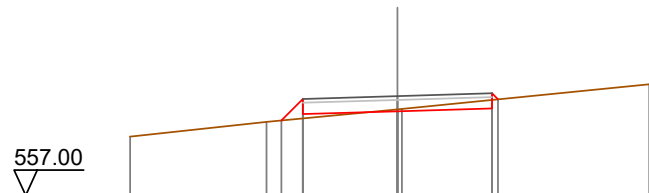

Quote Terreno		558.55		558.95		559.28	559.29		559.29		559.94	
Quote Progetto						558.98	559.15		559.23		559.30	559.54
Parziali						0.57	2.50		2.50			
Progressiva						-3.07	-2.50		0.00		2.50	2.66
Dislivelli						0.00	0.51		-0.05		-0.22	0.00

Sezione: 41
 Progressiva: 287.471
 Q. Progetto: 559.561

557.00

Quote Terreno	558.50	558.70	558.93	558.99	559.07	559.16	559.23	559.88
Quote Progetto			558.93	559.09		559.16		559.24
Parziali			0.55	2.50		2.50		559.49
Progressiva			-3.05	-2.50		0.00		2.50
Dislivelli			0.00	0.50		-0.07		-0.24

Sezione: 42
 Progressiva: 300.000
 Q. Progetto: 559.573

557.00

Quote Terreno	558.44	558.49			559.15	559.17	559.24	559.26	559.48	559.84
Quote Progetto			558.85	559.11	559.17		559.11	559.44		
Parziali			0.66	2.50		2.50				
Progressiva			-3.16	-2.50		0.00		2.50	2.57	
Dislivelli			0.00	0.59		-0.00		-0.32	-0.00	

Sezione: 43
 Progressiva: 318.029
 Q. Progetto: 559.761

557.00

Quote Terreno	558.48				559.33	559.55		559.78	559.85
Quote Progetto		558.94	559.44		559.36	559.29	559.60		
Parziali		0.90	2.50		2.50				
Progressiva		-3.40	-2.50		0.00		2.50	2.59	
Dislivelli		0.00	0.79		0.03		-0.31	0.00	

Sezione: 44
 Progressiva: 320.000
 Q. Progetto: 559.777

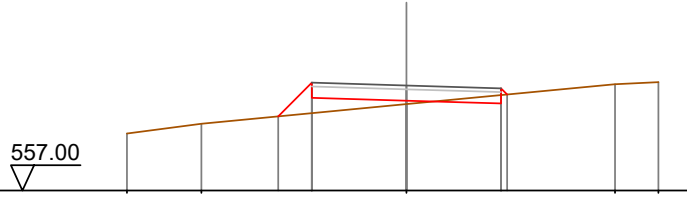

Quote Terreno	-558.51	-558.77			-559.28			-559.81	-559.87
Quote Progetto			558.96	559.45	559.38	559.30	559.54		
Parziali			0.89	2.50	2.50				
Progressiva			-3.39	-2.50	0.00	2.50	2.66		
Dislivelli			0.00	0.81	0.09	-0.22	0.00		

Sezione: 45
 Progressiva: 322.655
 Q. Progetto: 559.787

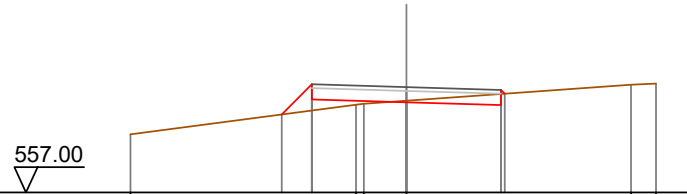

Quote Terreno	-558.54			-559.32	-559.35	-559.43		-559.85	-559.88
Quote Progetto			559.06	559.46	559.39	559.31	559.61		
Parziali			0.80	2.50	2.50				
Progressiva			-3.30	-2.50	0.00	2.50	2.60		
Dislivelli			0.00	0.69	-0.04	-0.29	0.00		

Sezione: 46
 Progressiva: 327.281
 Q. Progetto: 559.769

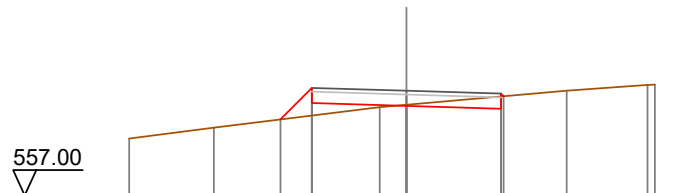

Quote Terreno	-558.50	-558.79		-559.33	-559.40		-559.77	-559.92	-559.93
Quote Progetto			559.01	559.44	559.37	559.29	559.62		
Parziali			0.83	2.50	2.50				
Progressiva			-3.33	-2.50	0.00	2.50	2.57		
Dislivelli			0.00	0.73	-0.03	-0.32	0.00		

Sezione: 47
 Progressiva: 340.000
 Q. Progetto: 559.501

557.00

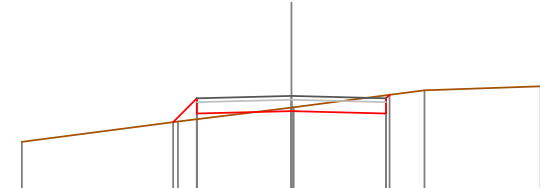

Quote Terreno		558.29		558.82		559.19 559.20		559.65		559.76
Quote Progetto				558.81 559.04		559.10		559.04 559.53		
Parziali				0.63	2.50	2.50				
Progressiva				-3.13	-2.50	0.00		2.50 2.59		
Dislivelli				0.00 0.55		-0.09		-0.48 0.00		

Sezione: 48
 Progressiva: 360.000
 Q. Progetto: 558.467

556.00

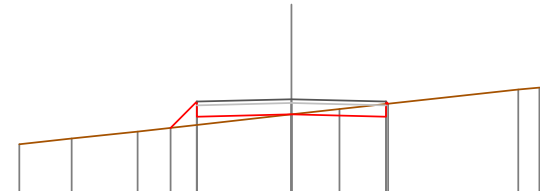

Quote Terreno		557.27		557.43		557.61		558.07		558.21		558.72 558.76
Quote Progetto						557.71 558.00		558.07		558.00 558.35		
Parziali						0.70	2.50	2.50				
Progressiva						-3.20	-2.50	0.00		2.50 2.56		
Dislivelli						0.00 0.62		0.00		-0.34 -0.00		

Sezione: 49
 Progressiva: 361.861
 Q. Progetto: 558.355

556.00



Quote Terreno		557.15		557.32		557.71		557.93		558.09		558.41		558.64
Quote Progetto						557.58 557.88		557.95		558.03 558.23				
Parziali						0.70	2.50	2.50						
Progressiva						-3.20	-2.50	0.00		2.50 2.70				
Dislivelli						0.00 0.62		0.02		-0.18 0.00				

Sezione: 50
 Progressiva: 364.613
 Q. Progetto: 558.188

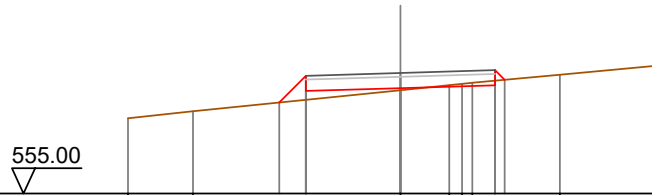

Quote Terreno	556.99	557.18			557.73	557.86	557.93	558.14	558.38
Quote Progetto			557.41	557.71	557.79	557.86	558.01		
Parziali			0.71	2.50	2.50				
Progressiva			-3.21	-2.50	0.00	2.50	2.76		
Dislivelli			0.00	0.63	0.05	-0.12	0.00		

Sezione: 51
 Progressiva: 367.365
 Q. Progetto: 558.021

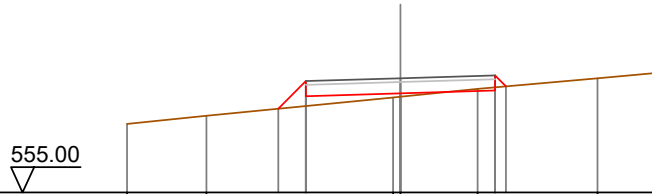

Quote Terreno	556.82	557.03			557.51	557.53	557.74	558.02	558.16
Quote Progetto			557.22	557.55	557.62	557.70	557.81		
Parziali			0.73	2.50	2.50	0.29			
Progressiva			-3.23	-2.50	0.00	2.50	2.79		
Dislivelli			0.00	0.66	0.09	-0.08	0.00		

Sezione: 52
 Progressiva: 380.000
 Q. Progetto: 557.256

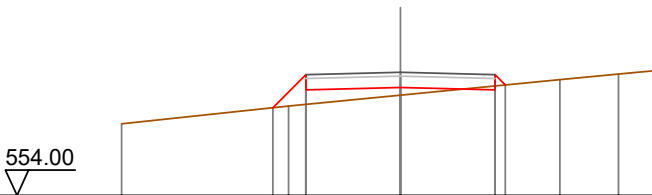

Quote Terreno	555.89		556.36		556.65			557.06	557.21	557.31
Quote Progetto			556.32	556.79	556.86	556.79	556.92			
Parziali			0.88	2.50	2.50	0.27				
Progressiva			-3.38	-2.50	0.00	2.50	2.77			
Dislivelli			0.00	0.79	0.21	-0.10	0.00			

Sezione: 53
 Progressiva: 400.000
 Q. Progetto: 556.047

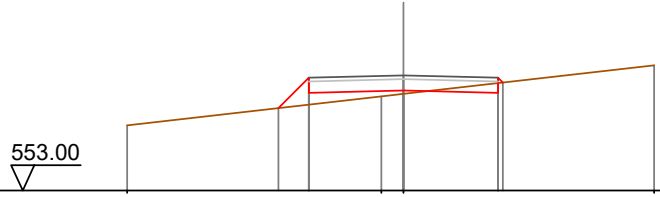

Quote Terreno	554.72			555.49	555.56		556.31
Quote Progetto		555.18	555.58	555.65	555.58	555.85	
Parziali		0.81	2.50	2.50			
Progressiva		-3.31	-2.50	0.00	2.50	2.63	
Dislivelli		0.00	0.71	0.09	-0.26	0.00	

Sezione: 54
 Progressiva: 420.000
 Q. Progetto: 555.121

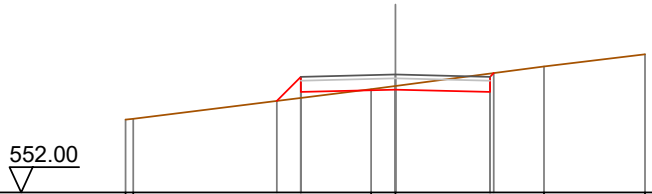

Quote Terreno	553.93	553.95		554.73	554.82		555.33	555.66
Quote Progetto			554.42	554.66	554.72	554.66	555.16	
Parziali			0.64	2.50	2.50			
Progressiva			-3.14	-2.50	0.00	2.50	2.60	
Dislivelli			-0.00	0.56	-0.10	-0.49	0.00	

Sezione: 55
 Progressiva: 440.000
 Q. Progetto: 554.686

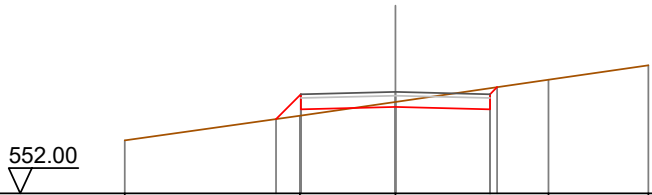

Quote Terreno	553.40			554.05	554.42		555.01	555.39
Quote Progetto		553.96	554.22	554.29	554.22	554.81		
Parziali		0.66	2.50	2.50				
Progressiva		-3.16	-2.50	0.00	2.50	2.69		
Dislivelli		0.00	0.57	-0.13	-0.56	-0.00		

Sezione: 56
 Progressiva: 460.000
 Q. Progetto: 554.742

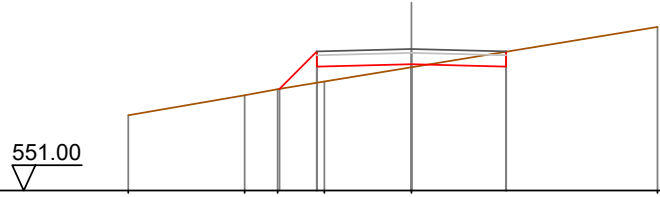

Quote Terreno		552.99	553.52	553.68	553.89	554.26	555.33
Quote Progetto				553.69	554.28	554.34	554.28
Parziali				0.99	2.50	2.50	
Progressiva				-3.49	-2.50	0.00	2.50
Dislivelli				0.00	0.83	0.08	-0.39

Sezione: 57
 Progressiva: 476.762
 Q. Progetto: 555.166

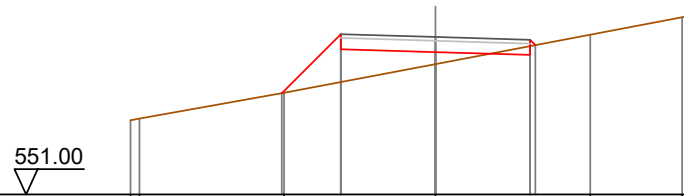

Quote Terreno		552.96	553.01	553.68	554.45	555.23	555.69
Quote Progetto				553.68	554.84	554.77	554.69
Parziali				1.56	2.50	2.50	
Progressiva				-4.06	-2.50	0.00	2.50
Dislivelli				-0.00	1.27	0.32	-0.23

Sezione: 58
 Progressiva: 480.131
 Q. Progetto: 555.293

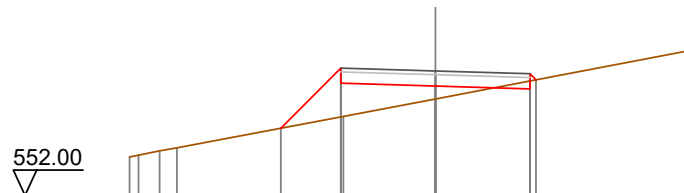

Quote Terreno		553.02	553.07	553.18	553.26	554.09	554.55
Quote Progetto						554.97	554.89
Parziali						1.59	2.50
Progressiva						-4.09	-2.50
Dislivelli						0.00	1.29

Sezione: 59
 Progressiva: 483.500
 Q. Progetto: 555.433

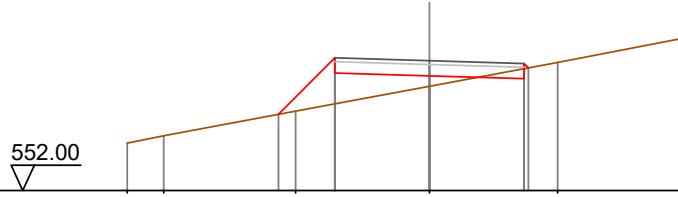

Quote Terreno		553.25	553.45		554.10		554.76		555.39	556.01
Quote Progetto				554.02	555.11		555.03	554.96	555.24	
Parziali				1.49	2.50		2.50			
Progressiva				-3.99	-2.50		0.00	2.50	2.61	
Dislivelli				-0.00	1.22		0.28	-0.26	-0.00	

Sezione: 60
 Progressiva: 500.000
 Q. Progetto: 556.324

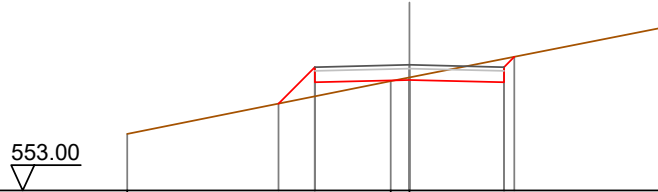

Quote Terreno		554.50				555.89	555.99			557.32
Quote Progetto				555.30	555.86		555.92	555.86	556.54	
Parziali				0.96	2.50		2.50			
Progressiva				-3.46	-2.50		0.00	2.50	2.77	
Dislivelli				0.00	0.77		-0.06	-0.62	0.00	

Sezione: 61
 Progressiva: 520.000
 Q. Progetto: 557.361

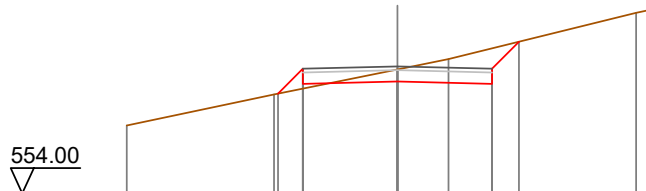

Quote Terreno		555.80		556.62		557.28		557.55		558.78	558.97
Quote Progetto				556.64	556.90		556.96	556.90	558.01		
Parziali				0.66	2.50		2.50		0.71		
Progressiva				-3.16	-2.50		0.00	2.50	3.21		
Dislivelli				-0.00	0.52		-0.32	-0.94	0.00		

Sezione: 62
 Progressiva: 537.980
 Q. Progetto: 557.631

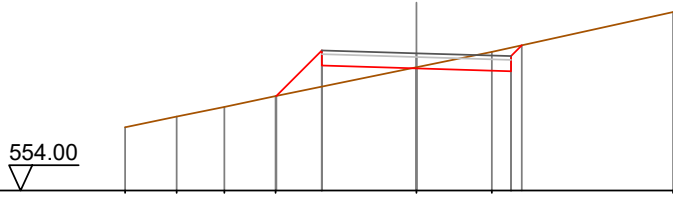

Quote Terreno	555.67	555.96	556.21	556.50	557.23	557.67	558.72
Quote Progetto			556.50	557.31	557.23	557.16	557.84
Parziali			1.20	2.50	2.50	0.28	
Progressiva			-3.70	-2.50	0.00	2.50	2.79
Dislivelli			0.00	0.96	-0.03	-0.62	0.00

Sezione: 63
 Progressiva: 540.000
 Q. Progetto: 557.621

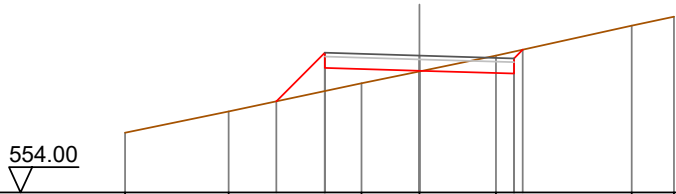

Quote Terreno	555.56	556.14		556.89	557.20	557.62	558.41	558.65
Quote Progetto			556.41	557.30	557.22	557.15	557.78	
Parziali			1.28	2.50	2.50			
Progressiva			-3.78	-2.50	0.00	2.50	2.73	
Dislivelli			0.00	1.01	0.02	-0.58	0.00	

Sezione: 64
 Progressiva: 542.588
 Q. Progetto: 557.596

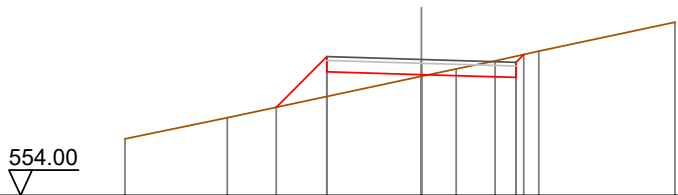

Quote Terreno	555.50	556.06			557.15	557.35	557.56	557.82	558.58
Quote Progetto			556.33	557.27	557.20	557.12	557.73		
Parziali			1.34	2.50	2.50				
Progressiva			-3.84	-2.50	0.00	2.50	2.71		
Dislivelli			0.00	1.05	0.05	-0.56	0.00		

Sezione: 65
 Progressiva: 547.196
 Q. Progetto: 557.525

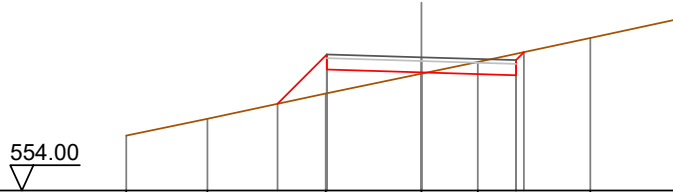

Quote Terreno	-555.45	-555.90	-556.30	-557.20	-557.09	-557.40	-558.03	-558.52
Quote Progetto			556.30	557.20	557.12	557.05	557.66	
Parziali			1.30	2.50	2.50			
Progressiva			-3.80	-2.50	0.00	2.50	2.71	
Dislivelli			-0.00	1.03	0.03	-0.56	-0.00	

Sezione: 66
 Progressiva: 560.000
 Q. Progetto: 557.316

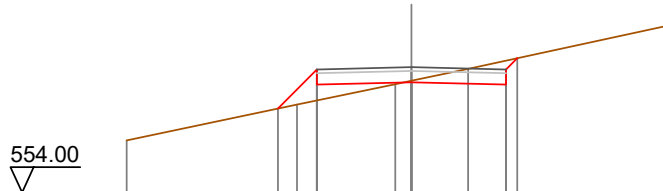

Quote Terreno	-555.38	-556.33	-556.87	-556.96	-557.27	-558.42
Quote Progetto		556.22	556.85	556.92	556.85	557.55
Parziali		1.03	2.50	2.50	0.30	
Progressiva		-3.53	-2.50	0.00	2.50	2.80
Dislivelli		0.00	0.82	-0.04	-0.63	0.00

Sezione: 67
 Progressiva: 567.456
 Q. Progetto: 557.138

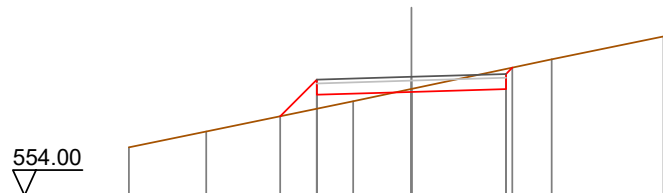

Quote Terreno	-555.27	-555.69	-556.49	-556.82	-557.60	-558.20
Quote Progetto		556.09	556.66	556.74	556.81	557.38
Parziali		0.97	2.50	2.50		
Progressiva		-3.47	-2.50	0.00	2.50	2.67
Dislivelli		0.00	0.77	-0.08	-0.53	-0.00

Sezione: 68
 Progressiva: 570.000
 Q. Progetto: 557.052

554.00

Quote Terreno	555.23	556.00	556.37	556.76	556.82	558.11
Quote Progetto		556.04	556.58	556.65	556.73	557.30
Parziali		0.93	2.50	2.50		
Progressiva		-3.43	-2.50	0.00	2.50	2.67
Dislivelli		-0.00	0.74	-0.10	-0.54	0.00

Sezione: 69
 Progressiva: 575.829
 Q. Progetto: 556.805

554.00

Quote Terreno	555.03	555.38	556.10	556.50	556.82	557.80
Quote Progetto			555.83	556.33	556.41	556.48
Parziali			0.90	2.50	2.50	
Progressiva			-3.40	-2.50	0.00	2.50
Dislivelli			-0.00	0.72	-0.09	-0.50

Sezione: 70
 Progressiva: 580.000
 Q. Progetto: 556.587

553.00

Quote Terreno	554.82		555.91	556.25		557.01	557.25	557.48
Quote Progetto			555.60	556.11	556.19	556.26	556.73	
Parziali			0.91	2.50	2.50			
Progressiva			-3.41	-2.50	0.00	2.50	2.57	
Dislivelli			0.00	0.73	-0.06	-0.46	0.00	

Sezione: 71
 Progressiva: 584.202
 Q. Progetto: 556.332

553.00

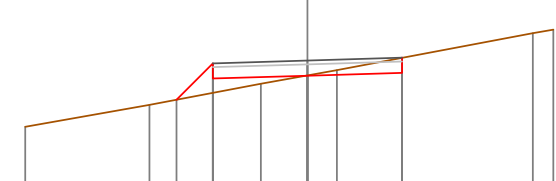

Quote Terreno	554.58	555.16	555.72	555.94	556.08	557.06	557.15
Quote Progetto		555.30	555.86	555.93	556.01		
Parziali		0.96	2.50	2.50			
Progressiva		-3.46	-2.50	0.00	2.50		
Dislivelli		0.00	0.78	-0.01	-0.40		

Sezione: 72
 Progressiva: 600.000
 Q. Progetto: 555.431

552.00

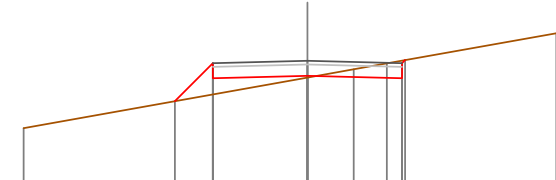

Quote Terreno	553.65			554.99	555.20	555.36	556.16
Quote Progetto		554.36	554.97	555.03	554.97	555.45	
Parziali		1.01	2.50	2.50			
Progressiva		-3.51	-2.50	0.00	2.50	2.58	
Dislivelli		0.00	0.83	0.04	-0.47	0.00	

Sezione: 73
 Progressiva: 615.803
 Q. Progetto: 555.020

552.00

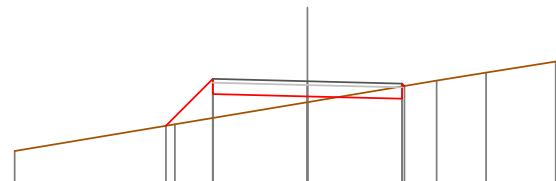

Quote Terreno	553.18	553.88	554.47	555.04	555.25	555.54
Quote Progetto		553.84	554.68	554.62	554.56	554.89
Parziali		1.24	2.50	2.50		
Progressiva		-3.74	-2.50	0.00	2.50	2.56
Dislivelli		-0.00	1.03	0.15	-0.33	0.00

Sezione: 74
 Progressiva: 620.000
 Q. Progetto: 554.995

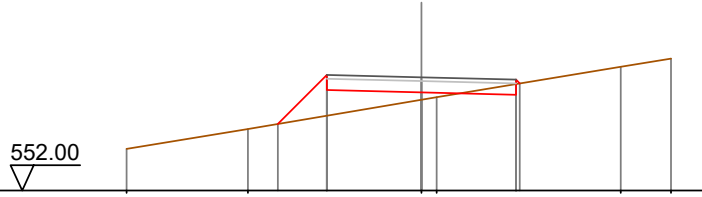

Quote Terreno	-553.10	-553.63	-554.06	-554.40	-554.47	-555.27	-555.49
Quote Progetto		553.76	554.66	554.59	554.53	554.83	
Parziali			1.30	2.50	2.50		
Progressiva		-3.80	-2.50	0.00	2.50	2.60	
Dislivelli		0.00	1.08	0.20	-0.28	-0.00	

Sezione: 75
 Progressiva: 630.000
 Q. Progetto: 555.077

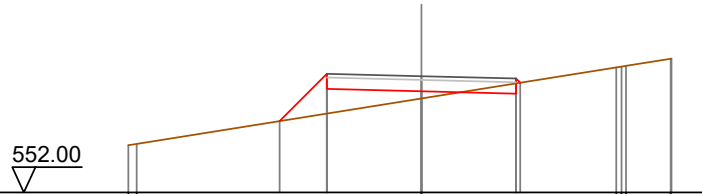

Quote Terreno	-553.25	-553.28	-554.06	-554.49	-555.31	-555.35	-555.54
Quote Progetto			553.89	554.74	554.68	554.61	554.90
Parziali			1.25	2.50	2.50		
Progressiva		-3.75	-2.50	0.00	2.50	2.61	
Dislivelli		0.00	1.05	0.19	-0.27	0.00	

Sezione: 76
 Progressiva: 632.896
 Q. Progetto: 555.138

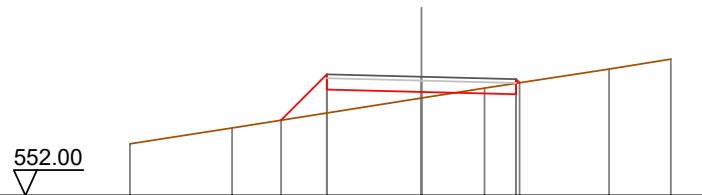

Quote Terreno	-553.37	-553.78	-554.06	-554.58	-554.84	-555.34	-555.60
Quote Progetto			553.99	554.74	554.68	554.98	
Parziali			1.21	2.50	2.50		
Progressiva		-3.71	-2.50	0.00	2.50	2.60	
Dislivelli		0.00	1.02	0.16	-0.29	-0.00	

Sezione: 77
 Progressiva: 640.000
 Q. Progetto: 555.359

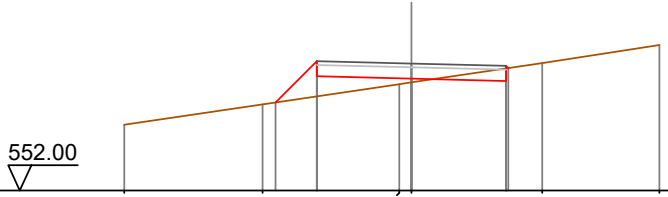

Quote Terreno	553.74	554.28	554.81	554.86	555.37	555.85
Quote Progetto		554.33	555.02	554.96	554.90	555.24
Parziali		1.09	2.50	2.50		
Progressiva		-3.59	-2.50	0.00	2.50	2.56
Dislivelli		0.00	0.93	0.10	-0.33	0.00

Sezione: 78
 Progressiva: 649.989
 Q. Progetto: 555.841

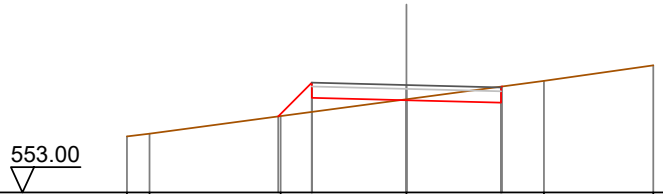

Quote Terreno	554.48	554.56	555.02	555.47	555.95	556.36
Quote Progetto			555.01	555.44	555.38	555.80
Parziali			0.89	2.50	2.50	
Progressiva			-3.39	-2.50	0.00	2.50
Dislivelli			-0.00	0.77	-0.03	-0.42

Sezione: 79
 Progressiva: 660.000
 Q. Progetto: 556.472

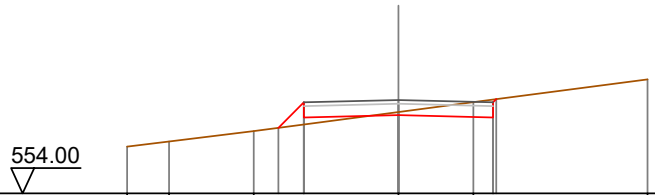

Quote Terreno	555.24	555.37	555.65	556.15	556.42	557.02
Quote Progetto			555.73	556.07	556.01	556.49
Parziali			0.67	2.50	2.50	
Progressiva			-3.17	-2.50	0.00	2.50
Dislivelli			0.00	0.59	-0.08	-0.47

Sezione: 80
 Progressiva: 680.000
 Q. Progetto: 557.686

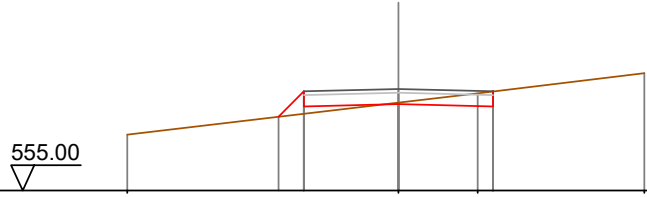

Quote Terreno	556.48			557.29	557.32	557.57	558.11
Quote Progetto			556.95	557.22		557.22	
Parziali			0.67	2.50	2.50		
Progressiva			-3.17	-2.50	0.00	2.50	
Dislivelli			0.00	0.59	-0.04	-0.40	

Sezione: 81
 Progressiva: 688.016
 Q. Progetto: 558.087

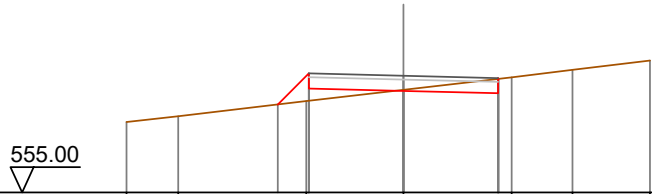

Quote Terreno	556.86	557.01		557.42	557.71	558.05	558.24	558.49
Quote Progetto			557.33	557.75	557.69	557.62		
Parziali			0.82	2.50	2.50			
Progressiva			-3.32	-2.50	0.00	2.50		
Dislivelli			0.00	0.72	-0.03	-0.38		

Sezione: 82
 Progressiva: 689.654
 Q. Progetto: 558.162

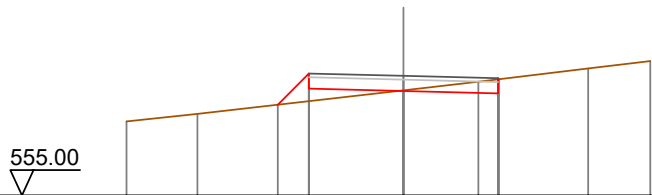

Quote Terreno	556.96	557.16		557.78	558.01	558.36	558.55
Quote Progetto			557.40	557.82	557.76	557.70	558.07
Parziali			0.83	2.50	2.50		
Progressiva			-3.33	-2.50	0.00	2.50	2.53
Dislivelli			0.00	0.73	-0.02	-0.37	0.00

Sezione: 83
 Progressiva: 690.000
 Q. Progetto: 558.178

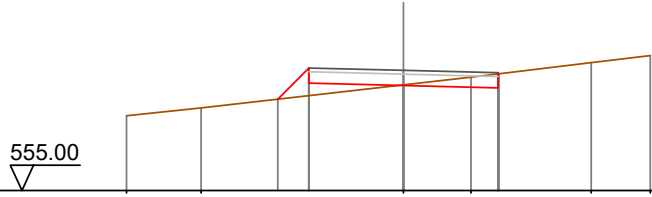

Quote Terreno	556.98	557.18			557.78	557.79	558.00		558.38	558.57
Quote Progetto			557.42	557.84			557.72	558.09		
Parziali			0.82	2.50		2.50				
Progressiva			-3.32	-2.50		0.00	2.50	2.53		
Dislivelli			-0.00	0.73		-0.02	-0.37	0.00		

Sezione: 84
 Progressiva: 691.292
 Q. Progetto: 558.235

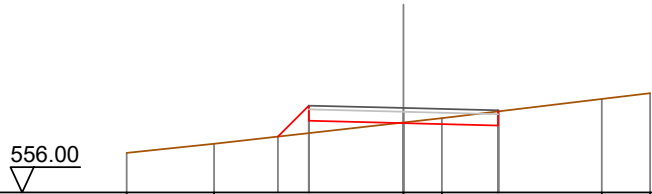

Quote Terreno	557.05	557.29			557.85	557.97		558.48	558.62
Quote Progetto			557.48	557.90			557.77	558.15	
Parziali			0.82	2.50		2.50			
Progressiva			-3.32	-2.50		0.00	2.50	2.52	
Dislivelli			0.00	0.73		-0.02	-0.37	-0.00	

Sezione: 85
 Progressiva: 700.000
 Q. Progetto: 558.617

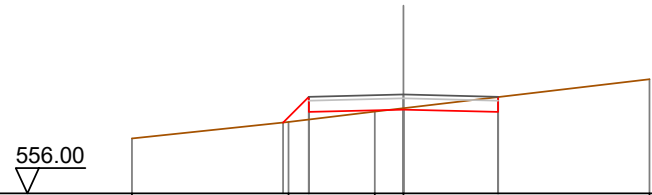

Quote Terreno	557.45		557.89		558.17	558.25			559.02
Quote Progetto			557.87	558.15			558.22	558.15	
Parziali			0.68	2.50		2.50			
Progressiva			-3.18	-2.50		0.00	2.50		
Dislivelli			-0.00	0.60		-0.04	-0.39		

Sezione: 86
 Progressiva: 720.000
 Q. Progetto: 559.245

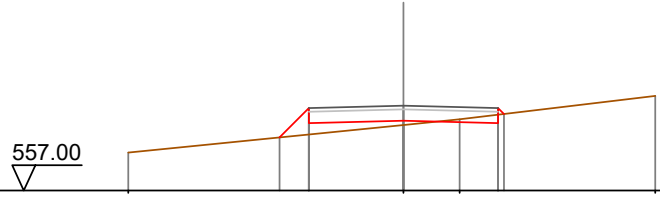

Quote Terreno		558.00			558.73		558.88		559.50
Quote Progetto			558.40		558.85		558.78		559.02
Parziali			0.78	2.50		2.50			
Progressiva			-3.28	-2.50	0.00	2.50	2.66		
Dislivelli			-0.00	0.70	0.11	-0.22	0.00		

Sezione: 87
 Progressiva: 740.000
 Q. Progetto: 559.427

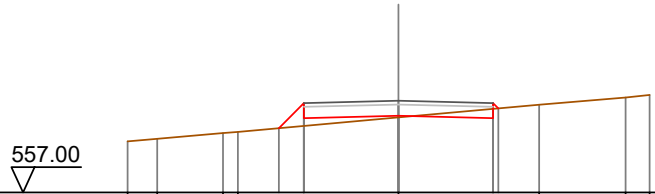

Quote Terreno		558.35	558.42	558.57	558.60		558.99		559.32	559.51	559.58
Quote Progetto				558.70	558.96		559.03		558.96	559.22	
Parziali				0.66	2.50		2.50				
Progressiva				-3.16	-2.50	0.00	2.50	2.64			
Dislivelli				0.00	0.60	0.04	-0.24	0.00			

Sezione: 88
 Progressiva: 747.488
 Q. Progetto: 559.495

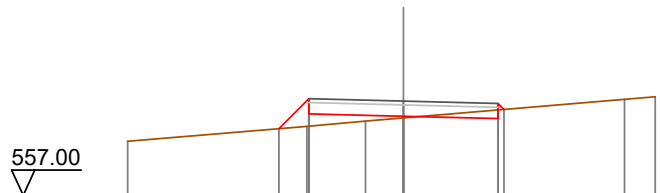

Quote Terreno		558.43			558.83	558.97	559.05			559.54	559.61
Quote Progetto			558.77		559.16		559.09		559.03	559.27	
Parziali			0.79	2.50		2.50					
Progressiva			-3.29	-2.50	0.00	2.50	2.66				
Dislivelli			0.00	0.73	0.04	-0.23	0.00				

Sezione: 89
 Progressiva: 749.466
 Q. Progetto: 559.513

557.00

Quote Terreno	-558.46	-558.79	-558.89	-558.91	-559.06	-559.62
Quote Progetto						
Parziali		0.78	2.50	2.50		
Progressiva		-3.28	-2.50	0.00	2.50	2.67
Dislivelli		0.00	0.72	0.05	-0.22	0.00

Sezione: 90
 Progressiva: 750.000
 Q. Progetto: 559.517

557.00

Quote Terreno	-558.47	-558.51	-558.80	-558.90	-558.98	-559.07	-559.62
Quote Progetto							
Parziali			0.78	2.50	2.50		
Progressiva			-3.28	-2.50	0.00	2.50	2.67
Dislivelli			0.00	0.72	0.05	-0.22	0.00

Sezione: 91
 Progressiva: 751.445
 Q. Progetto: 559.530

557.00

Quote Terreno	-558.49	-558.82	-558.94	-559.08	-559.16	-559.63
Quote Progetto						
Parziali		0.78	2.50	2.50		
Progressiva		-3.28	-2.50	0.00	2.50	2.67
Dislivelli		0.00	0.71	0.05	-0.22	0.00

Sezione: 92
 Progressiva: 760.000
 Q. Progetto: 559.606

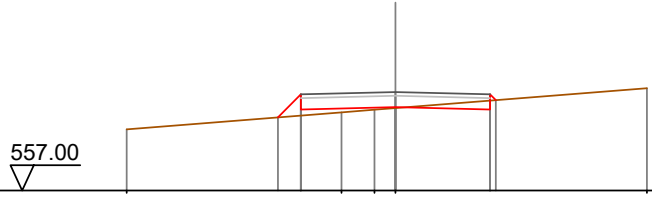

Quote Terreno		558.62			559.07	559.14	559.18			559.71
Quote Progetto				558.93	559.14		559.21		559.14	559.39
Parziali				0.61	2.50		2.50			
Progressiva				-3.11	-2.50		0.00		2.50	2.65
Dislivelli				0.00	0.56		0.02		-0.24	0.00

Sezione: 93
 Progressiva: 780.000
 Q. Progetto: 559.536

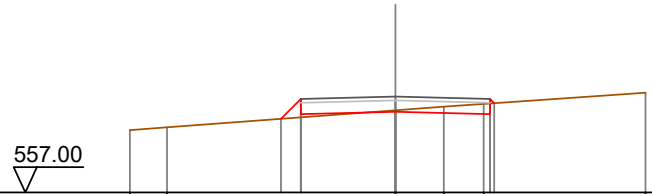

Quote Terreno		558.65	558.72			559.17		559.27	559.34	559.64
Quote Progetto				558.95	559.07	559.14		559.07	559.36	
Parziali				0.52	2.50		2.50			
Progressiva				-3.02	-2.50	0.00		2.50	2.61	
Dislivelli				0.00	0.49	-0.04		-0.28	0.00	

Sezione: 94
 Progressiva: 800.000
 Q. Progetto: 559.205

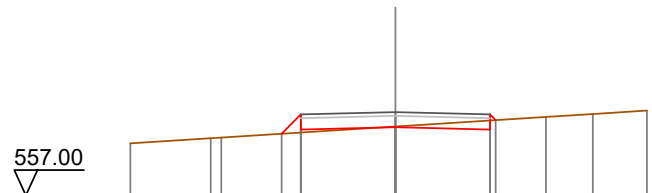

Quote Terreno		558.38	558.51	558.53		558.82		559.08	559.15	559.24
Quote Progetto					558.63	558.74		558.80	558.74	558.99
Parziali					0.51	2.50		2.50		
Progressiva					-3.01	-2.50		0.00	2.50	2.65
Dislivelli					0.00	0.48		-0.02	-0.24	0.00

Sezione: 95
 Progressiva: 817.364
 Q. Progetto: 558.915

557.00

Quote Terreno	558.01		558.25	558.31	558.45	558.84	558.86
Quote Progetto			558.25	558.58	558.52	558.45	558.62
Parziali			0.72	2.50	2.50		
Progressiva			-3.22	-2.50	0.00	2.50	2.74
Dislivelli			0.00	0.68	0.07	-0.15	0.00

Sezione: 96
 Progressiva: 819.169
 Q. Progetto: 558.885

556.00

Quote Terreno	557.97		558.21	558.28	558.41	558.62	558.83
Quote Progetto			558.21	558.55	558.49	558.42	558.58
Parziali			0.73	2.50	2.50		
Progressiva			-3.23	-2.50	0.00	2.50	2.74
Dislivelli			0.00	0.69	0.07	-0.14	-0.00

Sezione: 97
 Progressiva: 820.000
 Q. Progetto: 558.871

556.00

Quote Terreno	557.95	558.08	558.27	558.29	558.40	558.81	
Quote Progetto			558.20	558.53	558.47	558.41	558.56
Parziali			0.74	2.50	2.50		
Progressiva			-3.24	-2.50	0.00	2.50	2.74
Dislivelli			0.00	0.69	0.08	-0.14	-0.00

Sezione: 98
 Progressiva: 820.973
 Q. Progetto: 558.855

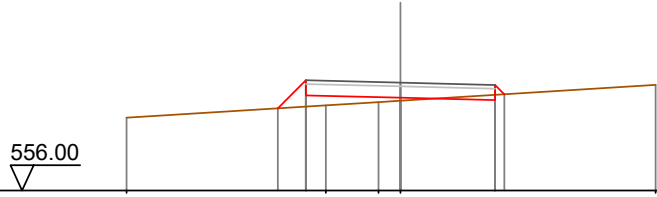

Quote Terreno	557.93		558.25	558.34	558.38	558.79
Quote Progetto		558.17	558.52	558.45	558.39	558.55
Parziali		0.74	2.50	2.50		
Progressiva		-3.24	-2.50	0.00	2.50	2.75
Dislivelli		-0.00	0.70	0.08	-0.14	0.00

Sezione: 99
 Progressiva: 840.000
 Q. Progetto: 558.400

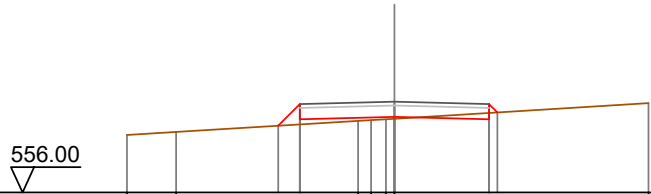

Quote Terreno	557.52	557.60		557.89	557.91	557.95	558.36
Quote Progetto			557.77	557.94	558.00	557.94	558.12
Parziali			0.57	2.50	2.50		
Progressiva			-3.07	-2.50	0.00	2.50	2.72
Dislivelli			0.00	0.54	0.05	-0.17	-0.00

Sezione: 100
 Progressiva: 860.000
 Q. Progetto: 557.825

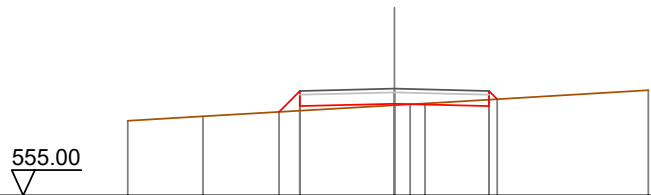

Quote Terreno	556.98	557.09		557.39	557.41	557.43	557.78
Quote Progetto			557.21	557.36	557.43	557.36	557.55
Parziali			0.55	2.50	2.50		
Progressiva			-3.05	-2.50	0.00	2.50	2.72
Dislivelli			0.00	0.52	0.04	-0.17	0.00

Sezione: 101
 Progressiva: 880.000
 Q. Progetto: 557.130

555.00

Quote Terreno	556.34	556.49	556.56	556.67	556.73	556.85	556.88	557.11
Quote Progetto			556.56	556.67	556.73	556.67	556.88	
Parziali			0.51	2.50	2.50			
Progressiva			-3.01	-2.50	0.00	2.50	2.69	
Dislivelli			0.00	0.48	0.00	-0.20	0.00	

Sezione: 102
 Progressiva: 884.180
 Q. Progetto: 556.969

555.00

Quote Terreno	556.19	556.40	556.41	556.51	556.57	556.63	556.72	556.96
Quote Progetto			556.41	556.51	556.57	556.63	556.73	
Parziali			0.50	2.50	2.50	0.30		
Progressiva			-3.00	-2.50	0.00	2.50	2.80	
Dislivelli			0.00	0.47	-0.01	-0.09	0.00	

Sezione: 103
 Progressiva: 884.819
 Q. Progetto: 556.944

555.00

Quote Terreno	556.17	556.39	556.41	556.55	556.61	556.70	556.93
Quote Progetto		556.39	556.48	556.54	556.61	556.71	
Parziali		0.49	2.50	2.50	0.30		
Progressiva		-2.99	-2.50	0.00	2.50	2.80	
Dislivelli		0.00	0.47	-0.01	-0.09	-0.00	

Sezione: 104
 Progressiva: 885.458
 Q. Progetto: 556.919

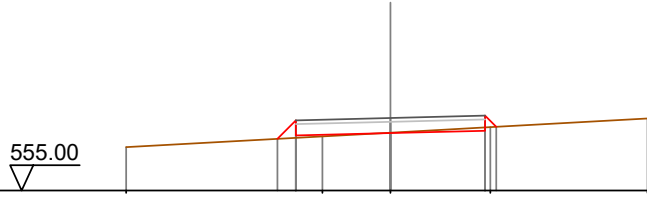

Quote Terreno	556.15		556.43	556.53	556.68	556.90
Quote Progetto		556.37	556.46	556.52	556.58	556.68
Parziali		0.49	2.50	2.50	0.30	
Progressiva		-2.99	-2.50	0.00	2.50	2.80
Dislivelli		0.00	0.46	-0.01	-0.09	0.00

Sezione: 105
 Progressiva: 900.000
 Q. Progetto: 556.312

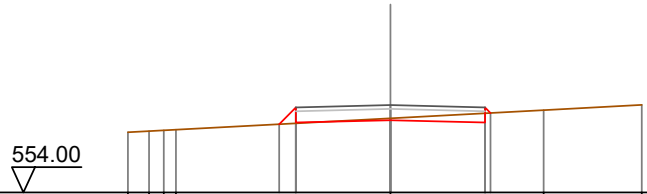

Quote Terreno	555.59	555.62	555.66		555.96		555.85	556.10	556.18	556.32
Quote Progetto				555.81	555.85	555.91	555.85	556.10		
Parziali				0.44	2.50	2.50				
Progressiva				-2.94	-2.50	0.00	2.50	2.65		
Dislivelli				0.00	0.42	-0.05	-0.25	0.00		

Sezione: 106
 Progressiva: 912.927
 Q. Progetto: 555.719

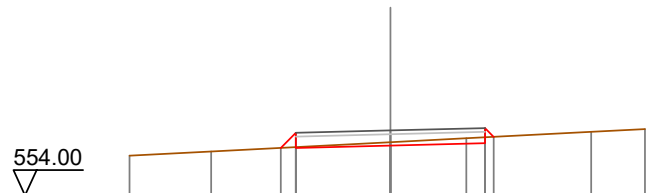

Quote Terreno	555.05	555.16		555.26	555.41	555.51	555.68	555.76
Quote Progetto			555.26	555.26	555.32	555.38	555.55	
Parziali			0.40	2.50	2.50			
Progressiva			-2.90	-2.50	0.00	2.50	2.73	
Dislivelli			-0.00	0.38	-0.09	-0.16	0.00	

Sezione: 107
 Progressiva: 918.478
 Q. Progetto: 555.448

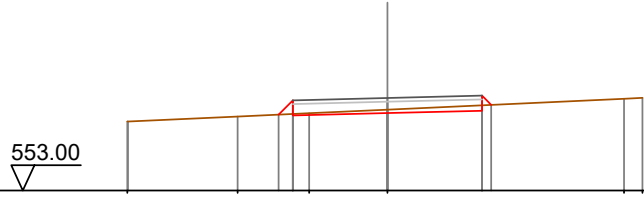

Quote Terreno	554.82	554.96	555.01 554.99	555.04	555.05 555.14	555.11 555.27	555.43 555.45
Quote Progetto							
Parziali			0.38	2.50	2.50		
Progressiva			-2.88 -2.50		0.00	2.50 2.75	
Dislivelli			0.00 0.36		-0.09	-0.14 0.00	

Sezione: 108
 Progressiva: 920.000
 Q. Progetto: 555.373

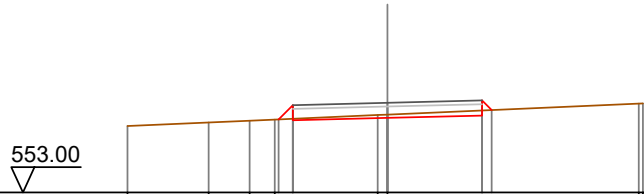

Quote Terreno	554.76	554.85	554.90 554.93	554.93 554.91	555.05 555.06	555.04 555.18	555.35 555.36
Quote Progetto							
Parziali			0.38	2.50	2.50		
Progressiva			-2.88 -2.50		0.00	2.50 2.75	
Dislivelli			0.00 0.36		-0.09	-0.13 0.00	

Sezione: 109
 Progressiva: 924.029
 Q. Progetto: 555.169

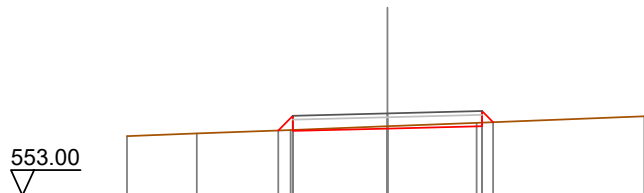

Quote Terreno	554.57	554.64	554.72 554.71	554.73	554.83	554.92 554.94	555.09
Quote Progetto							
Parziali			0.39	2.50	2.50	0.28	
Progressiva			-2.89 -2.50		0.00	2.50 2.79	
Dislivelli			0.00 0.37		-0.06	-0.09 0.00	

Sezione: 110
 Progressiva: 940.000
 Q. Progetto: 554.170

552.00

Quote Terreno	553.61		553.75	553.71	553.77	553.85	553.94	553.95	554.10
Quote Progetto									
Parziali			0.36	2.50		2.50			
Progressiva			-2.86	-2.50		0.00	2.50	2.66	
Dislivelli			0.00	0.34		-0.08	-0.23	-0.00	

Sezione: 111
 Progressiva: 960.000
 Q. Progetto: 552.776

551.00

Quote Terreno	552.27		552.39	552.31	552.45	552.49	552.31	552.59	552.72	552.74
Quote Progetto										
Parziali			0.32	2.50		2.50				
Progressiva			-2.82	-2.50		0.00	2.50	2.62		
Dislivelli			-0.00	0.31		-0.12	-0.27	0.00		

Sezione: 112
 Progressiva: 962.703
 Q. Progetto: 552.587

551.00

Quote Terreno	552.08		552.20	552.12	552.23	552.28	552.29	552.25	552.40	552.54
Quote Progetto										
Parziali			0.32	2.50		2.50				
Progressiva			-2.82	-2.50		0.00	2.50	2.75		
Dislivelli			0.00	0.31		-0.11	-0.14	0.00		

Sezione: 113
 Progressiva: 963.245
 Q. Progetto: 552.550

551.00

Quote Terreno	552.04	552.14	552.25	552.25	552.50
Quote Progetto		552.17	552.09	552.15	552.35
Parziali		0.32	2.50	2.50	0.32
Progressiva		-2.82	-2.50	0.00	2.50
Dislivelli		0.00	0.31	-0.10	-0.13

Sezione: 114
 Progressiva: 963.786
 Q. Progetto: 552.512

551.00

Quote Terreno	552.01	552.06	552.21	552.21	552.44
Quote Progetto		552.13	552.05	552.11	552.17
Parziali		0.32	2.50	2.50	0.32
Progressiva		-2.82	-2.50	0.00	2.50
Dislivelli		0.00	0.31	-0.10	-0.13

Sezione: 115
 Progressiva: 974.627
 Q. Progetto: 551.756

550.00

Quote Terreno	551.16	551.17	551.20	551.37	551.41	551.52	551.68
Quote Progetto		551.28	551.29	551.36	551.42	551.48	
Parziali		0.41	2.50	2.50	0.34		
Progressiva		-2.91	-2.50	0.00	2.50	2.84	
Dislivelli		0.00	0.40	-0.02	-0.04	-0.00	

Sezione: 116
 Progressiva: 980.000
 Q. Progetto: 551.382

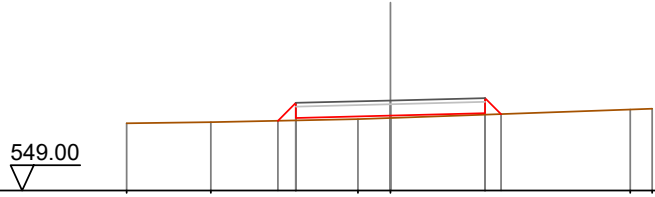

Quote Terreno	-550.78	-550.81	-550.84	-550.89	-550.92	-551.04	-551.14	-551.17
Quote Progetto			550.84	550.98	550.92	551.04	551.02	
Parziali			0.48	2.50	2.50	0.42		
Progressiva			-2.98	-2.50	0.00	2.50	2.92	
Dislivelli			0.00	0.47	0.06	0.04	0.00	

Sezione: 117
 Progressiva: 990.000
 Q. Progetto: 550.724

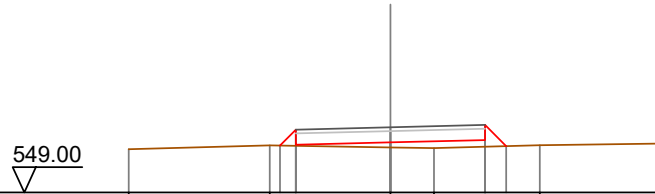

Quote Terreno	-550.14	-550.25	-550.24	-550.19	-550.17	-550.25	-550.29
Quote Progetto			550.24	550.32	550.39	550.23	
Parziali			0.42	2.50	2.50	0.56	
Progressiva			-2.92	-2.50	0.00	2.50	3.06
Dislivelli			0.00	0.43	0.13	0.18	0.00

Sezione: 117
 Progressiva: 990.000
 Q. Progetto: 550.724

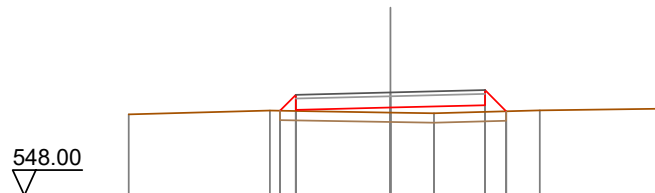

Quote Terreno	-550.14	-550.25	-550.24	-550.19	-550.17	-550.25	-550.29
Quote Progetto			550.24	550.32	550.39	550.23	
Parziali			0.42	2.50	2.50	0.56	
Progressiva			-2.92	-2.50	0.00	2.50	3.06
Dislivelli			-0.00	0.43	0.13	0.18	0.00

Sezione: 118
 Progressiva: 1000.000
 Q. Progetto: 550.213

548.00

Quote Terreno	549.91	549.89	549.88	549.88	549.86	549.83
Quote Progetto			549.87	549.75	549.81	549.88
Parziali			0.28	2.50	2.50	0.43
Progressiva			-2.78	-2.50	0.00	2.50
Dislivelli			0.00	0.28	-0.05	0.02
						0.00

Sezione: 119
 Progressiva: 1010.000
 Q. Progetto: 549.715

548.00

Quote Terreno	549.55		549.44	549.41	549.39	549.31
Quote Progetto			549.46	549.31	549.38	549.37
Parziali			2.50	2.50	0.40	
Progressiva			-2.69	-2.50	0.00	2.50
Dislivelli			0.00	0.20	-0.10	-0.00
						-0.00

Sezione: 120
 Progressiva: 1016.110
 Q. Progetto: 549.410

547.00

Quote Terreno	549.34	549.28	549.18	549.14	549.14	549.06	548.97
Quote Progetto			549.22	548.95	549.01	549.07	549.07
Parziali			2.50	2.50	0.41		
Progressiva			-2.63	-2.50	0.00	2.50	2.91
Dislivelli			-0.00	0.14	-0.13	-0.00	0.00

Sezione: 121
 Progressiva: 1020.000
 Q. Progetto: 549.217

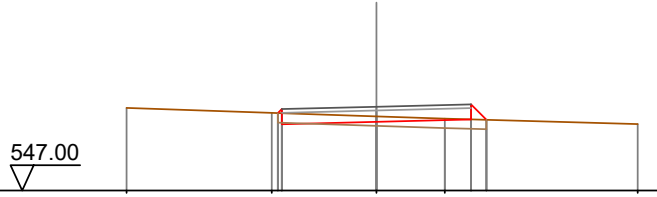

Quote Terreno	549.19	549.05	548.96	548.90	548.76
Quote Progetto		549.05 548.75	548.82	548.88 548.87	
Parziali		2.50	2.50	0.41	
Progressiva		-2.61 -2.50	0.00	2.50 2.91	
Dislivelli		0.00 0.11	-0.14	-0.00 0.00	

Sezione: 122
 Progressiva: 1030.000
 Q. Progetto: 548.723

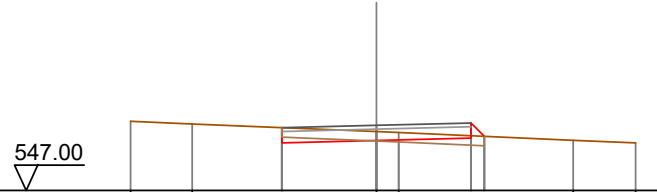

Quote Terreno	548.83	548.76	548.56	548.53	548.33	548.26
Quote Progetto			548.26	548.32	548.39 548.43	
Parziali			2.50	2.50	0.35	
Progressiva			-2.50	0.00	2.50 2.85	
Dislivelli			-0.00	-0.24	-0.06 0.00	

Sezione: 123
 Progressiva: 1040.000
 Q. Progetto: 548.312

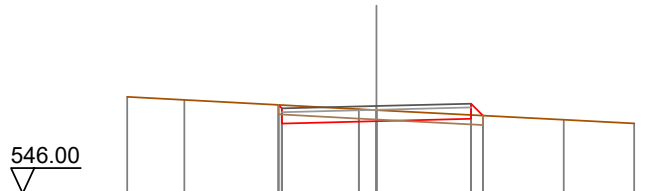

Quote Terreno	548.56	548.48	548.23	548.20	547.95	547.85
Quote Progetto			548.34 547.85	547.91	547.97 548.06	
Parziali			2.50	2.50	0.32	
Progressiva			-2.59 -2.50	0.00	2.50 2.82	
Dislivelli			0.00 -0.09	-0.29	-0.10 0.00	

Sezione: 124
 Progressiva: 1050.000
 Q. Progetto: 548.011

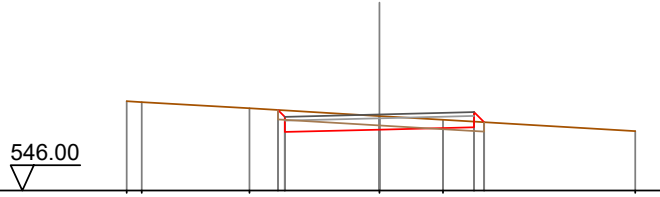

Quote Terreno	548.36	548.34	548.18	547.97	547.87	547.57
Quote Progetto			548.13	547.61	547.67	547.81
Parziali			2.50	2.50	0.21	
Progressiva			-2.68	0.00	2.50	2.77
Dislivelli			0.00	-0.36	-0.15	0.00

Sezione: 125
 Progressiva: 1057.593
 Q. Progetto: 547.857

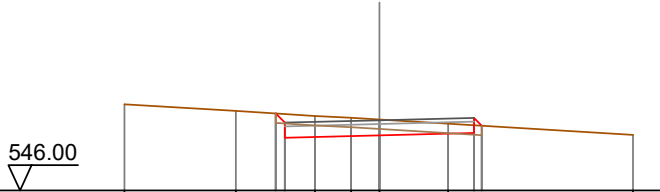

Quote Terreno	548.28	548.11	547.97	547.92	547.88	547.77	547.47
Quote Progetto			548.04	547.39	547.46	547.52	547.71
Parziali			2.50	2.50			
Progressiva			-2.74	0.00	2.50	2.71	
Dislivelli			0.00	-0.42	-0.21	0.00	

Sezione: 126
 Progressiva: 1060.000
 Q. Progetto: 547.821

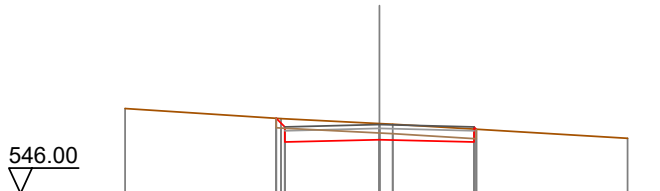

Quote Terreno	548.24	547.98	547.85	547.83	547.46	
Quote Progetto		547.99	547.36	547.42	547.36	547.70
Parziali			2.50	2.50		
Progressiva			-2.73	0.00	2.50	2.56
Dislivelli			0.00	-0.43	-0.34	-0.00

Sezione: 127
 Progressiva: 1080.000
 Q. Progetto: 547.368

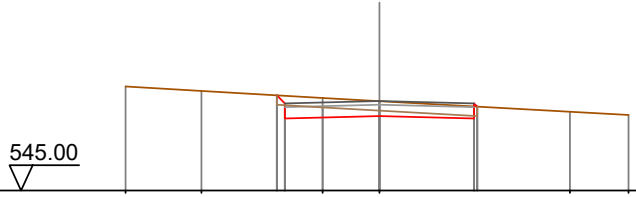

Quote Terreno		547.75	547.64		547.45	547.36		547.08	547.00
Quote Progetto				547.52	546.91	546.97		546.91	547.22
Parziali				2.50		2.50			
Progressiva				-2.71	-2.50	0.00		2.50	2.59
Dislivelli				0.00	-0.20	-0.40		-0.32	0.00

Sezione: 128
 Progressiva: 1100.000
 Q. Progetto: 546.783

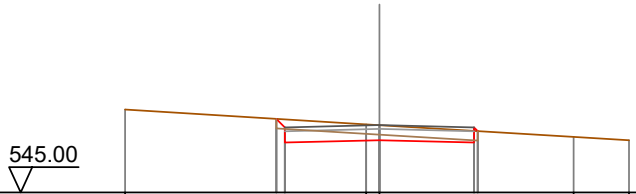

Quote Terreno		547.19			546.80	546.78		546.47	546.38
Quote Progetto				546.95	546.32	546.38		546.32	546.62
Parziali				2.50		2.50			
Progressiva				-2.73	-2.50	0.00		2.50	2.60
Dislivelli				0.00	-0.21	-0.40		-0.31	0.00

Sezione: 129
 Progressiva: 1120.000
 Q. Progetto: 546.199

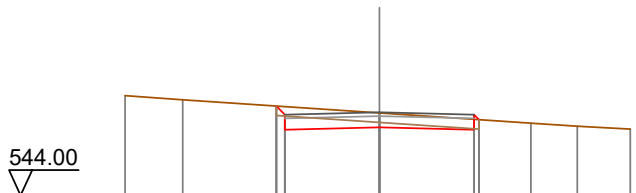

Quote Terreno		546.64	546.53		546.18		545.91	545.83	545.75
Quote Progetto				546.36	545.74	545.80		545.74	546.00
Parziali				2.50		2.50			
Progressiva				-2.73	-2.50	0.00		2.50	2.63
Dislivelli				-0.00	-0.21	-0.38		-0.28	0.00

Sezione: 130
 Progressiva: 1140.000
 Q. Progetto: 545.676

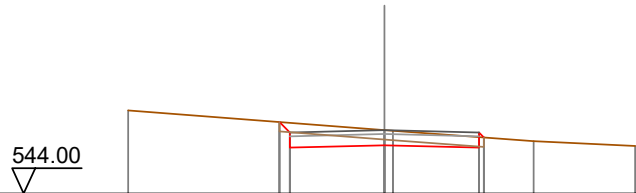

Quote Terreno	546.20		545.68	545.66	545.39	545.26
Quote Progetto		545.69	545.21		545.21	545.48
Parziali		0.28	2.50	2.50		
Progressiva		-2.78	-2.50	0.00	2.50	2.63
Dislivelli		-0.00	-0.26	-0.40	-0.28	-0.00

Sezione: 131
 Progressiva: 1160.000
 Q. Progetto: 545.582

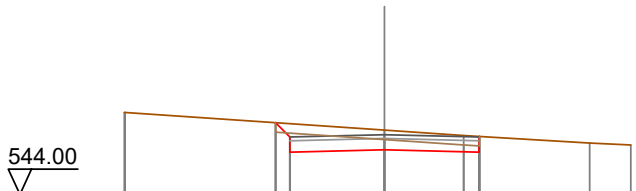

Quote Terreno	546.17		545.90	545.70	545.56	545.38	545.31
Quote Progetto		545.90	545.12		545.12		
Parziali		0.33	2.50	2.50			
Progressiva		-2.88	-2.50	0.00	2.50		
Dislivelli		0.00	-0.35	-0.52	-0.42		

Sezione: 132
 Progressiva: 1170.974
 Q. Progetto: 545.595

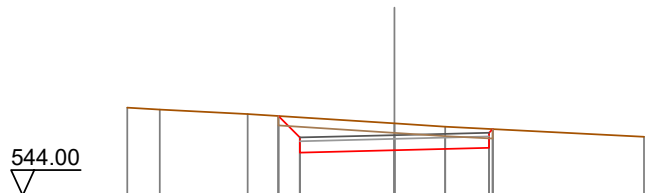

Quote Terreno	546.32	546.27	546.15	545.91	545.82	545.55	
Quote Progetto			546.10	545.20	545.26	545.76	
Parziali			0.57	2.50	2.50		
Progressiva			-3.07	-2.50	0.00	2.50	2.60
Dislivelli			-0.00	-0.53	-0.71	-0.50	0.00

Sezione: 133
 Progressiva: 1172.505
 Q. Progetto: 545.597

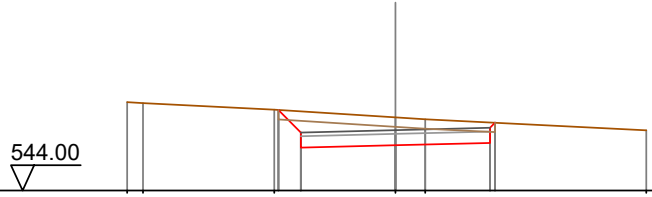

Quote Terreno	546.34	546.31	546.14	545.94	545.89	545.59
Quote Progetto			546.13	545.20	545.26	545.79
Parziali			0.60	2.50	2.50	
Progressiva			-3.10	-2.50	0.00	2.50
Dislivelli			-0.00	-0.56	-0.74	-0.54

Sezione: 134
 Progressiva: 1174.036
 Q. Progetto: 545.599

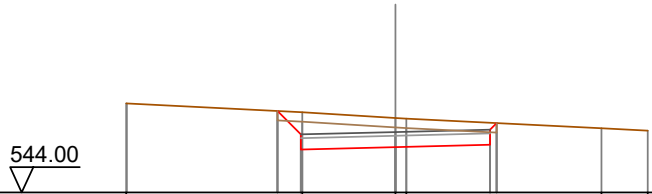

Quote Terreno	546.35		546.12	545.97	545.95	545.70
Quote Progetto			546.16	545.20	545.26	545.84
Parziali			0.62	2.50	2.50	
Progressiva			-3.12	-2.50	0.00	2.50
Dislivelli			0.00	-0.59	-0.77	-0.58

Sezione: 135
 Progressiva: 1180.000
 Q. Progetto: 545.600

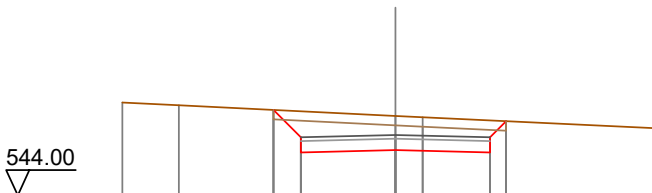

Quote Terreno	546.46	546.38		546.10	546.07	545.77
Quote Progetto			546.26	545.20	545.14	545.96
Parziali			0.72	2.50	2.50	
Progressiva			-3.22	-2.50	0.00	2.50
Dislivelli			0.00	-0.69	-0.90	-0.85

Sezione: 136
 Progressiva: 1183.500
 Q. Progetto: 545.600

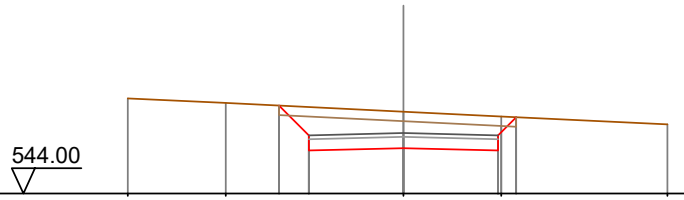

Quote Terreno	546.52	546.39	546.33	545.14	546.16	546.04	545.83
Quote Progetto			546.33	545.14	545.20	546.04	546.02
Parziali			0.79	2.50	2.50	0.48	
Progressiva			-3.29	-2.50	0.00	2.50	2.98
Dislivelli			-0.00	-0.75	-0.96	-0.90	0.00

SEZIONI TRASVERSALI
Profilo longitudinale tratto 17-18
Viabilità di impianto postazione aerogeneratore T09

Nota: Le canalette di deflusso delle acque meteoriche, non indicate nel presente elaborato, sono rappresentate graficamente nelle sezioni stradali tipo dell'elaborato "WIND002-TC13_Piazzole aerogeneratori e strade di servizio - Particolari costruttivi", individuate planimetricamente nell'elaborato "WIND002-TC14_Opere di regimazione acque superficiali - Planimetria generale" e quantificate nell'elaborato "WIND002-RC6_Computo Metrico Estimativo".

DISEGNI DI RIFERIMENTO

TAVOLA	DESCRIZIONE
WIND002-TC8	Piazzole e viabilità - Planimetria di progetto - Fase di cantiere
WIND002-TC11	Profili longitudinali viabilità di impianto
WIND002-TC13	Piazzole aerogeneratori e strade di servizio - Particolari costruttivi
WIND002-TC14	Opere di regimazione acque superficiali - Planimetria generale

Sezione: 2
 Progressiva: 20.000
 Q. Progetto: 416.916

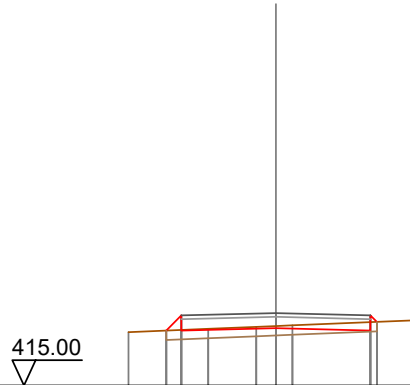

Quote Terreno		-416.41		-416.50		-416.55	-416.57	-416.59		-416.72
Quote Progetto			416.45	416.45		416.52			416.45	416.68
Parziali			0.40	2.50		2.50			0.22	
Progressiva			-2.90	-2.50		0.00			2.50	2.67
Dislivelli			0.00	0.38		-0.06			-0.22	0.00

Sezione: 3
 Progressiva: 22.988
 Q. Progetto: 417.243

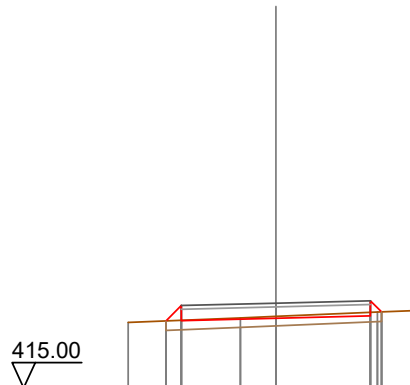

Quote Terreno		-416.73		-416.85		-416.89		-417.01		-417.05
Quote Progetto			416.77	416.78		416.84		416.91	417.01	
Parziali			0.41	2.50		2.50		0.28		
Progressiva			-2.91	-2.50		0.00		2.50	2.79	
Dislivelli			-0.00	0.39		-0.05		-0.09	-0.00	

Sezione: 4
 Progressiva: 27.682
 Q. Progetto: 417.755

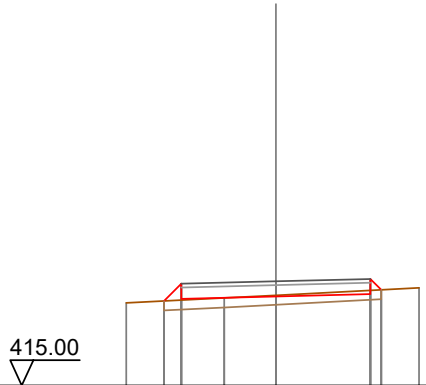

Quote Terreno		417.18		417.31		417.39		417.58
Quote Progetto		417.23	417.29		417.36		417.42	417.53
Parziali		0.46	2.50		2.50		0.28	
Progressiva		2.96	2.50		0.00		2.50	2.79
Dislivelli		0.00	0.44		-0.03		-0.10	0.00

Sezione: 5
 Progressiva: 30.000
 Q. Progetto: 417.996

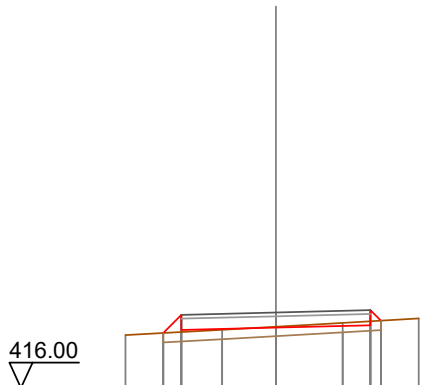

Quote Terreno		417.40		417.54		417.62		417.72	417.84
Quote Progetto		417.45	417.53		417.60		417.66	417.78	
Parziali		0.48	2.50		2.50		0.28		
Progressiva		2.98	2.50		0.00		2.50	2.78	
Dislivelli		0.00	0.45		-0.03		-0.11	0.00	

Sezione: 6
 Progressiva: 32.375
 Q. Progetto: 418.232

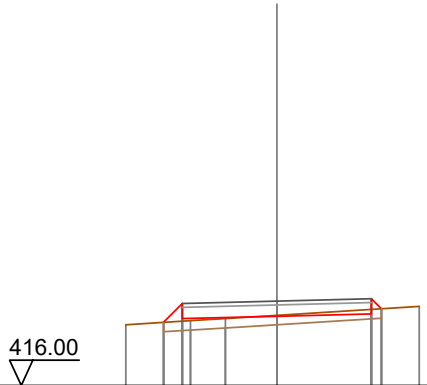

Quote Terreno	417.61	417.72	417.77	417.86	418.09
Quote Progetto	417.67	417.77	417.83	417.89	418.03
Parziali	0.50	2.50	2.50	0.28	
Progressiva	-3.00	-2.50	0.00	2.50	2.76
Dislivelli	-0.00	0.47	-0.03	-0.12	0.00

Sezione: 7
 Progressiva: 40.000
 Q. Progetto: 418.910

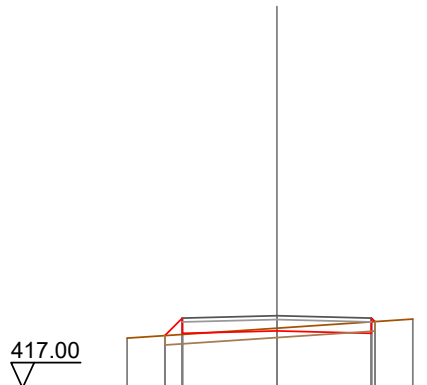

Quote Terreno	418.32	418.39	418.58	418.82
Quote Progetto	418.39	418.45	418.51	418.75
Parziali	0.46	2.50	2.50	
Progressiva	-2.96	-2.50	0.00	2.50
Dislivelli	0.00	0.43	-0.07	-0.30

Sezione: 8
 Progressiva: 60.000
 Q. Progetto: 419.974

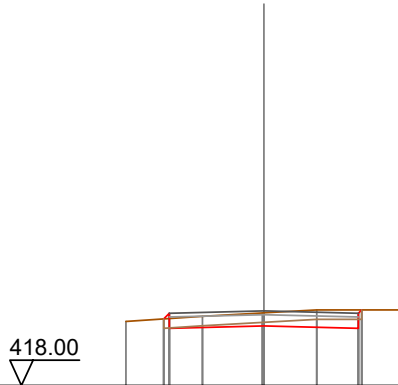

Quote Terreno	-419.70	-419.83	-419.92	-420.00	-420.00
Quote Progetto	419.76	419.51	419.57	419.51	420.00
Parziali		2.50	2.50		
Progressiva	-2.65	-2.50	0.00	2.50	2.59
Dislivelli	0.00	0.14	-0.35	-0.49	0.00

Sezione: 9
 Progressiva: 68.971
 Q. Progetto: 420.168

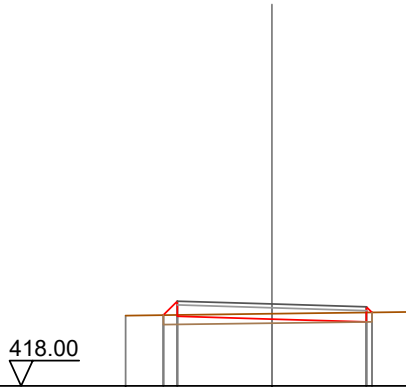

Quote Terreno	-419.86	-419.91	-419.96		
Quote Progetto	419.88	419.64	419.69	419.95	
Parziali	0.37	2.50	2.50		
Progressiva	-2.87	-2.50	0.00	2.50	2.65
Dislivelli	0.00	0.36	-0.14	-0.25	0.00

Sezione: 10
 Progressiva: 70.000
 Q. Progetto: 420.180

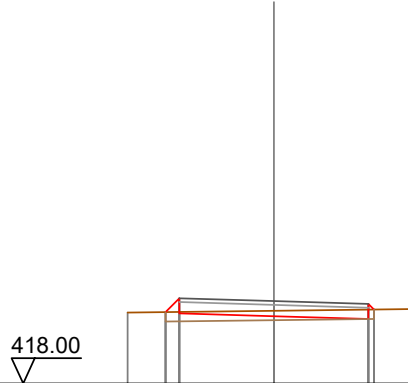

Quote Terreno	-419.88		419.92		-419.97
Quote Progetto	419.89	419.86	419.78	419.71	419.96
Parziali	0.37	2.50	2.50		
Progressiva	-2.87	-2.50	0.00	2.50	2.65
Dislivelli	0.00	0.36	-0.14	-0.25	0.00

Sezione: 11
 Progressiva: 80.000
 Q. Progetto: 420.186

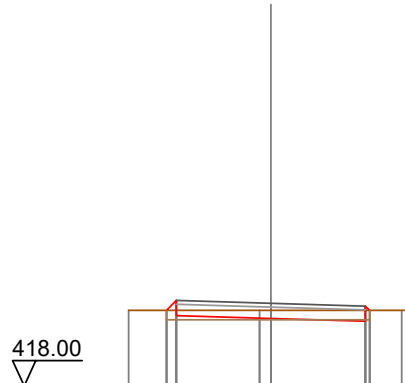

Quote Terreno	-420.00		420.00		-420.00
Quote Progetto	420.00	419.86	419.79	419.71	420.00
Parziali	0.26	2.50	2.50		
Progressiva	-2.76	-2.50	0.00	2.50	2.61
Dislivelli	0.00	0.26	-0.21	-0.29	0.00

Sezione: 12
 Progressiva: 82.742
 Q. Progetto: 420.158

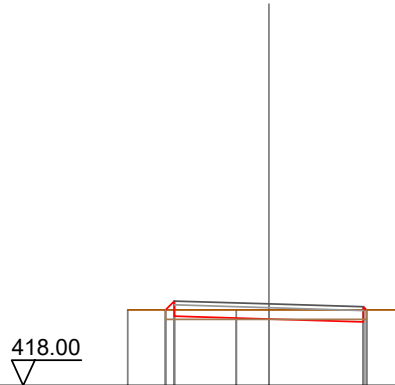

Quote Terreno	420.00	420.00	420.00	420.00
Quote Progetto	420.00	419.83	419.76	419.88
Parziali		2.50	2.50	
Progressiva	-2.73	-2.50	0.00	2.50
Dislivelli	0.00	0.23	-0.24	-0.32

Sezione: 13
 Progressiva: 90.000
 Q. Progetto: 420.099

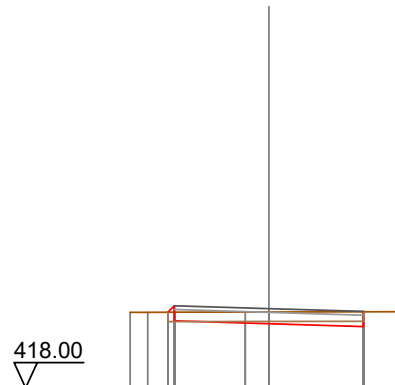

Quote Terreno	420.00	420.00	420.01	420.01	420.02
Quote Progetto	420.00	419.77	419.70	419.62	
Parziali		2.50	2.50		
Progressiva	-2.67	-2.50	0.00	2.50	
Dislivelli	0.00	0.17	-0.31	-0.39	

Sezione: 14
 Progressiva: 96.513
 Q. Progetto: 420.126

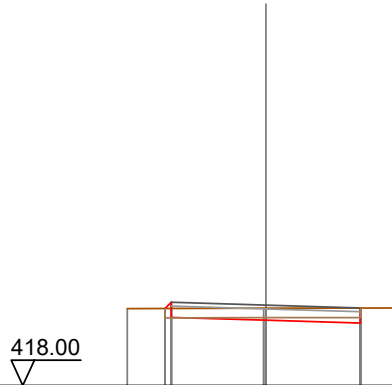

Quote Terreno	-420.03	-420.04	-419.80	-420.05	-420.05	-420.05
Quote Progetto	420.04	419.80	419.73	420.05	419.85	420.05
Parziali		2.50	2.50			
Progressiva	-2.67	-2.50	0.00	2.50		
Dislivelli	0.00	0.17	-0.32	-0.40		

Sezione: 15
 Progressiva: 100.000
 Q. Progetto: 420.176

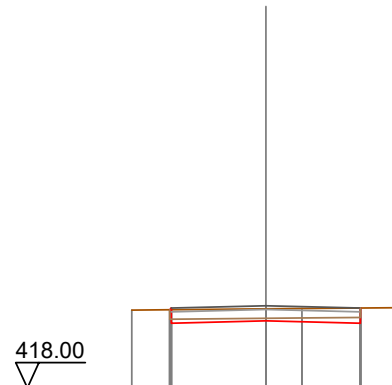

Quote Terreno	420.06	420.07	419.71	420.09	420.10	420.12
Quote Progetto	420.07	419.71	419.78	420.09	419.71	420.12
Parziali		2.50	2.50			
Progressiva	-2.54	-2.50	0.00	2.50		
Dislivelli	0.00	0.04	-0.32	-0.40		

Sezione: 16
 Progressiva: 120.000
 Q. Progetto: 420.867

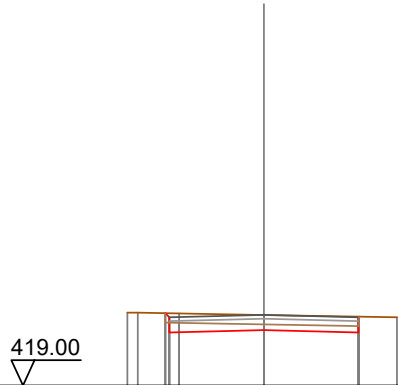

Quote Terreno	420.93	420.93	420.91	420.87	420.80
Quote Progetto	420.91	420.40	420.47	420.40	420.40
Parziali		2.50	2.50		
Progressiva	-2.61	-2.50	0.00	2.50	
Dislivelli	-0.00	-0.11	-0.40	-0.42	

Sezione: 17
 Progressiva: 140.000
 Q. Progetto: 421.698

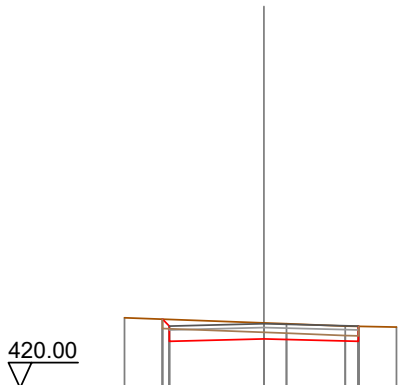

Quote Terreno	421.86	421.72	421.70	421.63	421.61
Quote Progetto	421.82	421.30	421.24	421.24	421.24
Parziali		2.50	2.50		
Progressiva	-2.69	-2.50	0.00	2.50	
Dislivelli	-0.00	-0.18	-0.42	-0.39	

Sezione: 18
 Progressiva: 160.000
 Q. Progetto: 422.026

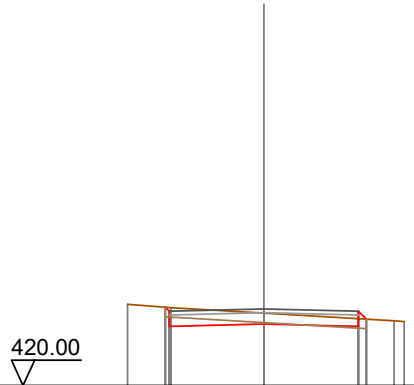

Quote Terreno	422.15	422.06	421.91	421.71	421.69
Quote Progetto	422.07	421.66	421.63	421.66	421.75
Parziali		2.50	2.50		
Progressiva	-2.61	-2.50	0.00	2.50	2.71
Dislivelli	-0.00	-0.10	-0.29	-0.20	-0.00

Sezione: 19
 Progressiva: 170.866
 Q. Progetto: 421.939

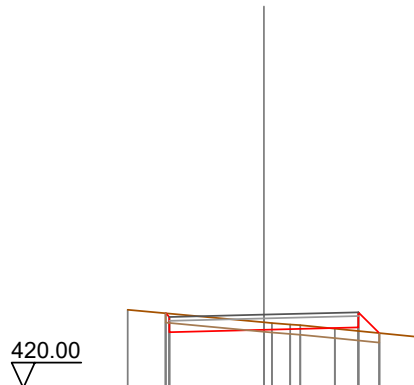

Quote Terreno	422.07	421.74	421.66	421.57	421.35
Quote Progetto	421.98	421.72	421.54	421.60	421.45
Parziali		2.50	2.50	0.55	
Progressiva	-2.60	-2.50	0.00	2.50	3.05
Dislivelli	-0.00	-0.09	-0.20	0.10	-0.00

Sezione: 20
 Progressiva: 180.000
 Q. Progetto: 421.872

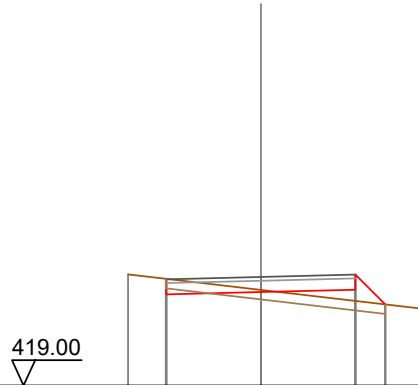

Quote Terreno	-421.94	-421.53	-421.03
Quote Progetto	421.41	421.47	421.15
Parziali		2.50	2.50
Progressiva	-2.51	0.00	2.50
Dislivelli	0.00	-0.06	0.30

Sezione: 20
 Progressiva: 180.000
 Q. Progetto: 421.872

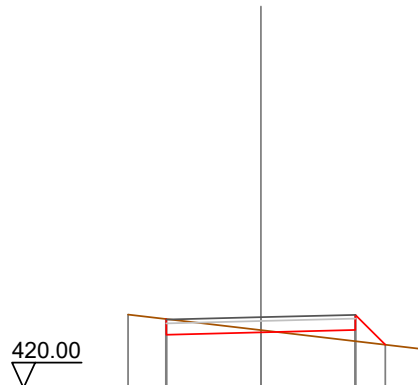

Quote Terreno	-421.94	-421.53	-421.03
Quote Progetto	421.41	421.47	421.15
Parziali		2.50	2.50
Progressiva	-2.51	0.00	2.50
Dislivelli	-0.00	-0.06	0.30

Sezione: 21
 Progressiva: 181.108
 Q. Progetto: 421.870

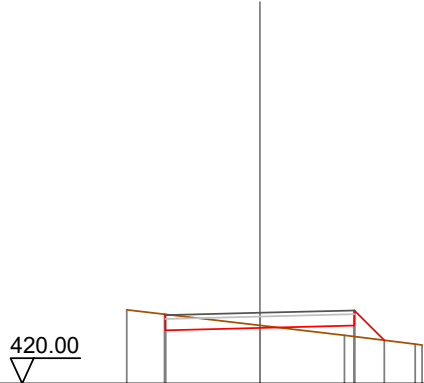

Quote Terreno		421.95		421.54		421.28		421.04		421.02
Quote Progetto		421.83		421.41		421.47		421.53		421.14
Parziali			2.50		2.50		0.79			
Progressiva		-2.52		0.00		2.50		3.29		
Dislivelli		0.00		-0.07		0.29		0.00		

Sezione: 22
 Progressiva: 190.000
 Q. Progetto: 421.950

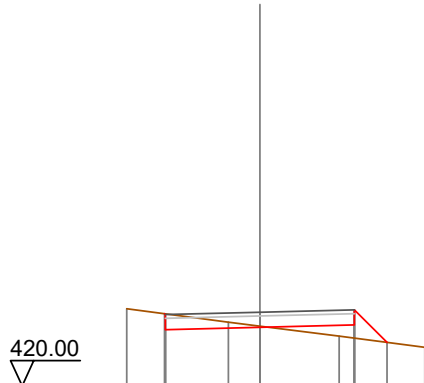

Quote Terreno		422.04		421.69		421.58		421.32		421.02
Quote Progetto		421.91		421.49		421.55		421.61		421.15
Parziali			2.50		2.50		0.86			
Progressiva		-2.52		0.00		2.50		3.36		
Dislivelli		0.00		-0.03		0.35		-0.00		

Sezione: 23
 Progressiva: 191.349
 Q. Progetto: 421.976

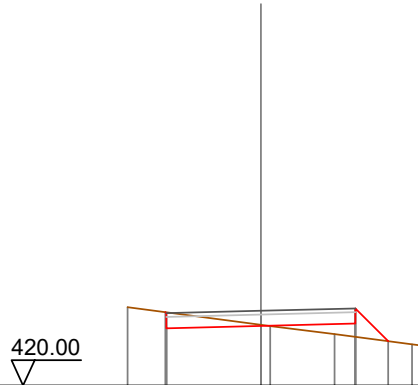

Quote Terreno		422.07		421.60	421.57	421.36		421.09	421.04
Quote Progetto		421.94	421.51	421.58		421.64	421.17		
Parziali			2.50		2.50	0.87			
Progressiva		-2.53	-2.50	0.00		2.50	3.37		
Dislivelli		0.00	-0.02	-0.03		0.35	0.00		

Sezione: 24
 Progressiva: 200.000
 Q. Progetto: 422.227

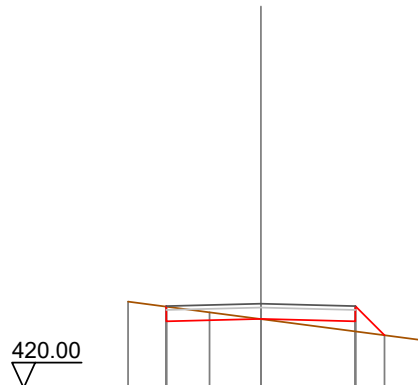

Quote Terreno		422.29		422.00	421.82			421.26
Quote Progetto		421.76		421.83		421.76	421.39	
Parziali			2.50		2.50	0.77		
Progressiva		-2.51		0.00		2.50	3.27	
Dislivelli		0.00		0.00		0.27	-0.00	

Sezione: 25
 Progressiva: 220.000
 Q. Progetto: 422.925

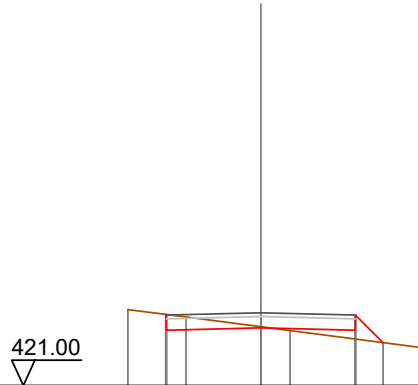

Quote Terreno		423.01		422.81		422.55		422.45		422.00
Quote Progetto		422.46		422.46		422.52		422.46		422.13
Parziali			2.50		2.50		0.73			
Progressiva		-2.52		0.00		2.50		3.23		
Dislivelli		-0.00		-0.03		0.23		-0.00		

Sezione: 26
 Progressiva: 240.000
 Q. Progetto: 423.540

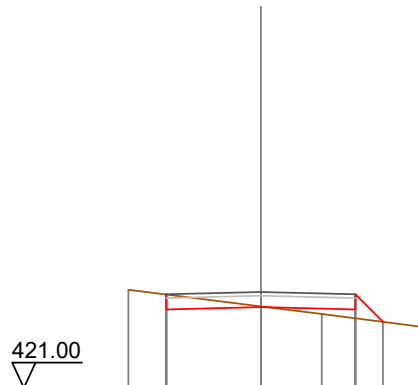

Quote Terreno		423.60		423.16		422.96		422.62
Quote Progetto		423.08		423.14		423.08		422.75
Parziali			2.50		2.50		0.73	
Progressiva		-2.51		0.00		2.50		3.23
Dislivelli		0.00		-0.02		0.23		-0.00

Sezione: 27
 Progressiva: 252.782
 Q. Progetto: 423.687

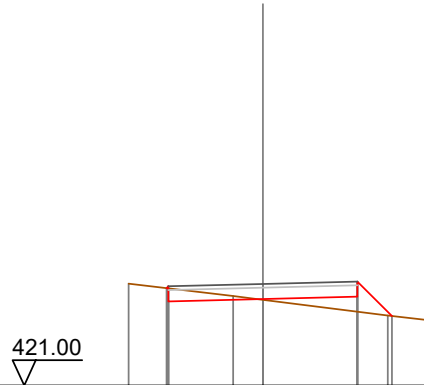

Quote Terreno	423.69	423.37	423.27	422.85	422.73
Quote Progetto	423.57	423.22	423.29	423.35	422.84
Parziali		2.50	2.50	0.91	
Progressiva	-2.55	-2.50	0.00	2.50	3.41
Dislivelli	0.00	0.06	0.02	0.40	0.00

Sezione: 28
 Progressiva: 259.060
 Q. Progetto: 423.755

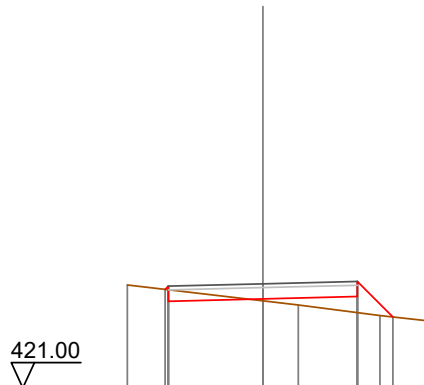

Quote Terreno	423.72	423.30	423.19	422.92	422.77
Quote Progetto	423.61	423.29	423.35	423.42	422.88
Parziali		2.50	2.50	0.94	
Progressiva	-2.59	-2.50	0.00	2.50	3.44
Dislivelli	0.00	0.10	0.05	0.42	0.00

Sezione: 29
 Progressiva: 260.000
 Q. Progetto: 423.765

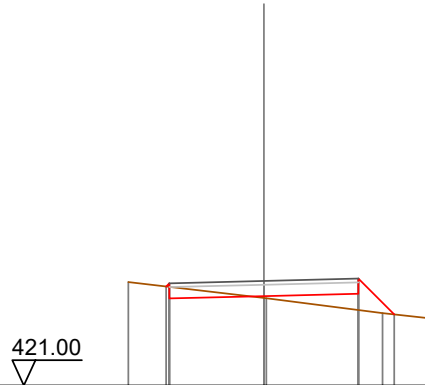

Quote Terreno	423.74		423.32		422.92	422.77
Quote Progetto	423.62	423.30	423.37	423.43	422.88	
Parziali		2.50	2.50	0.95		
Progressiva	-2.58	-2.50	0.00	2.50	3.45	
Dislivelli	-0.00	0.09	0.05	0.43	0.00	

Sezione: 30
 Progressiva: 265.337
 Q. Progetto: 423.823

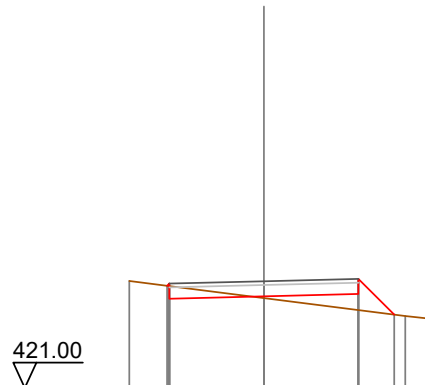

Quote Terreno	423.83		423.38		422.90	422.82
Quote Progetto	423.70	423.36	423.42	423.49	422.94	
Parziali		2.50	2.50	0.95		
Progressiva	-2.56	-2.50	0.00	2.50	3.45	
Dislivelli	-0.00	0.07	0.05	0.43	0.00	

Sezione: 31
 Progressiva: 280.000
 Q. Progetto: 423.896

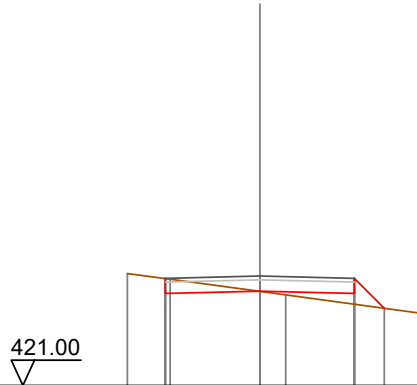

Quote Terreno	423.96	423.81	423.49	423.40	422.91
Quote Progetto	423.43	423.50	423.43	423.04	
Parziali		2.50	2.50	0.79	
Progressiva	-2.50	0.00	2.50	3.29	
Dislivelli	0.00	0.01	0.28	0.00	

Sezione: 32
 Progressiva: 300.000
 Q. Progetto: 423.490

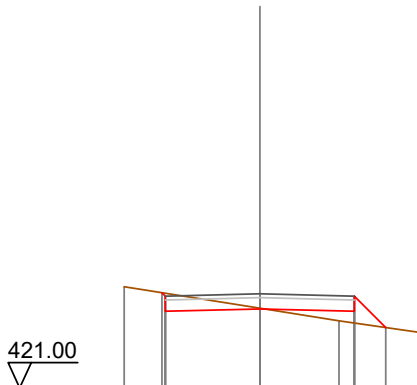

Quote Terreno	423.68	423.11	422.78	422.45
Quote Progetto	423.52	423.09	423.03	422.60
Parziali		2.50	2.50	0.83
Progressiva	-2.59	0.00	2.50	3.33
Dislivelli	-0.00	-0.02	0.31	0.00

Sezione: 33
 Progressiva: 304.831
 Q. Progetto: 423.377

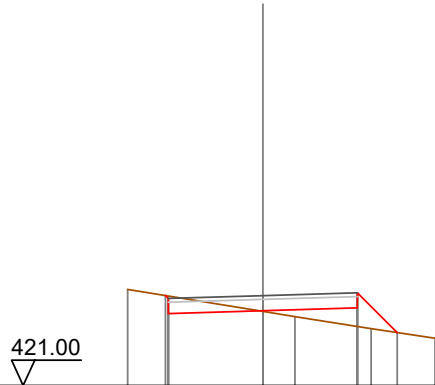

Quote Terreno	423.54	422.96	422.82	422.50	422.25
Quote Progetto	423.38	422.90	422.98	423.05	422.40
Parziali		2.50	2.50	1.05	
Progressiva		-2.58	0.00	2.50	3.55
Dislivelli	0.00	-0.06	0.02	0.49	0.00

Sezione: 34
 Progressiva: 308.053
 Q. Progetto: 423.302

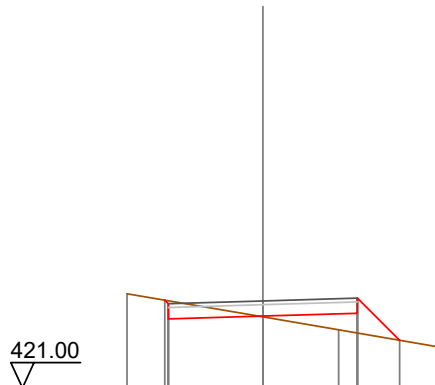

Quote Terreno	423.49	422.88	422.54	422.09	
Quote Progetto	423.32	422.83	422.98	422.26	
Parziali		2.50	2.50	1.12	
Progressiva		-2.59	0.00	2.50	3.62
Dislivelli	0.00	-0.08	0.02	0.52	0.00

Sezione: 35
 Progressiva: 310.000
 Q. Progetto: 423.256

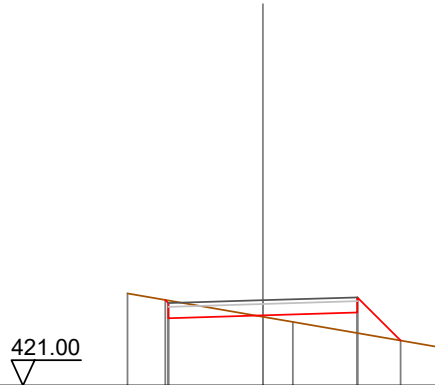

Quote Terreno	423.43		422.82	422.68		422.02
Quote Progetto	423.26	422.78	422.86	422.93	422.19	
Parziali		2.50	2.50	1.14		
Progressiva	-2.58	-2.50	0.00	2.50	3.64	
Dislivelli	0.00	-0.07	0.04	0.54	-0.00	

Sezione: 36
 Progressiva: 311.276
 Q. Progetto: 423.226

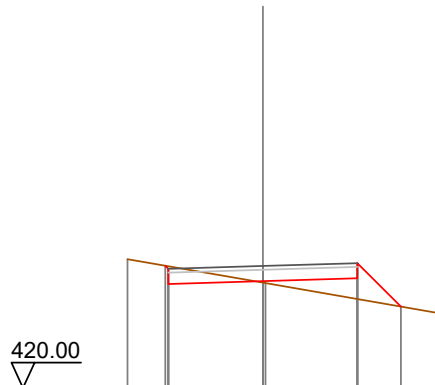

Quote Terreno	423.40		422.79	422.77		421.98
Quote Progetto	423.23	422.75	422.83	422.90	422.15	
Parziali		2.50	2.50	1.15		
Progressiva	-2.58	-2.50	0.00	2.50	3.65	
Dislivelli	0.00	-0.07	0.04	0.55	-0.00	

Sezione: 37
 Progressiva: 320.000
 Q. Progetto: 423.037

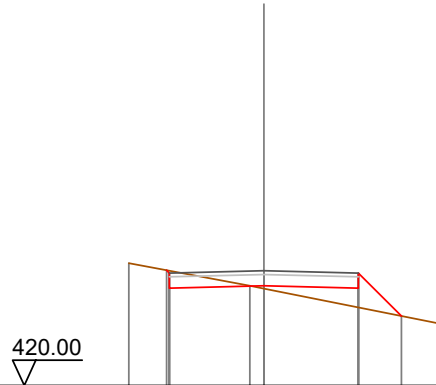

Quote Terreno	423.24	422.64	422.56	421.64
Quote Progetto	423.05	422.57	422.64	421.84
Parziali		2.50	2.50	1.14
Progressiva	-2.57	-2.50	0.00	2.50
Dislivelli	-0.00	-0.06	0.07	0.51

Sezione: 38
 Progressiva: 340.000
 Q. Progetto: 423.123

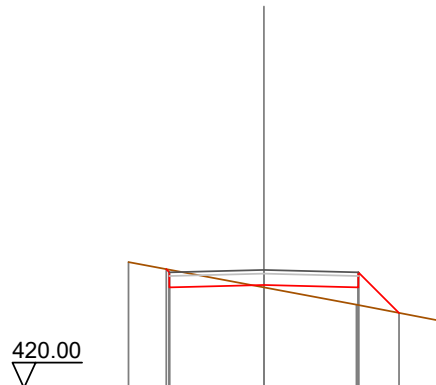

Quote Terreno	423.33	422.66	422.20	421.79
Quote Progetto	423.14	422.66	422.66	421.99
Parziali		2.50	2.50	1.08
Progressiva	-2.58	-2.50	0.00	2.50
Dislivelli	0.00	-0.07	0.06	0.47

Sezione: 39
 Progressiva: 357.377
 Q. Progetto: 423.775

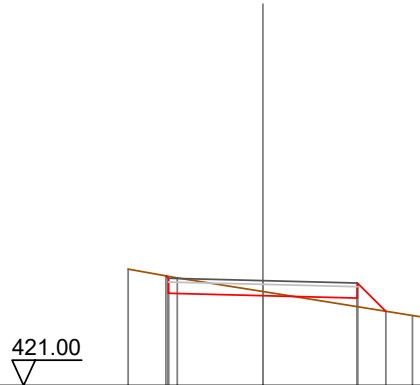

Quote Terreno	424.08	423.85	423.48	422.85	422.80
Quote Progetto	423.90	423.44	423.38	423.31	422.96
Parziali		2.50	2.50	0.75	
Progressiva		-2.56	0.00	2.50	3.25
Dislivelli	0.00	-0.05	-0.11	0.23	0.00

Sezione: 40
 Progressiva: 360.000
 Q. Progetto: 423.885

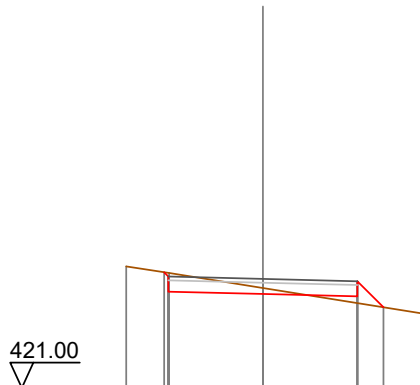

Quote Terreno	424.21	424.04	423.64	422.98	
Quote Progetto	424.06	423.55	423.49	423.42	423.14
Parziali		2.50	2.50	0.69	
Progressiva		-2.61	0.00	2.50	3.19
Dislivelli	0.00	-0.10	-0.16	0.18	0.00

Sezione: 41
 Progressiva: 366.116
 Q. Progetto: 424.163

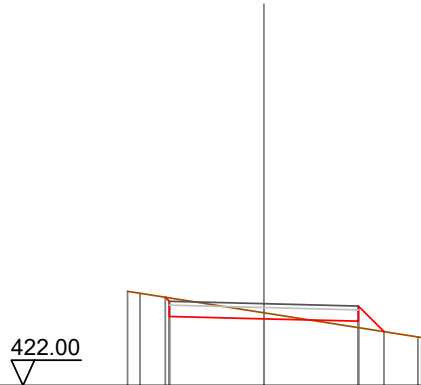

Quote Terreno	424.49	424.44		423.92		423.29	423.27
Quote Progetto		424.33	423.83	423.76		423.70	423.43
Parziali			2.50	2.50		0.67	
Progressiva		-2.61	-2.50	0.00		2.50	3.17
Dislivelli		0.00	-0.09	-0.16		0.17	0.00

Sezione: 42
 Progressiva: 370.000
 Q. Progetto: 424.378

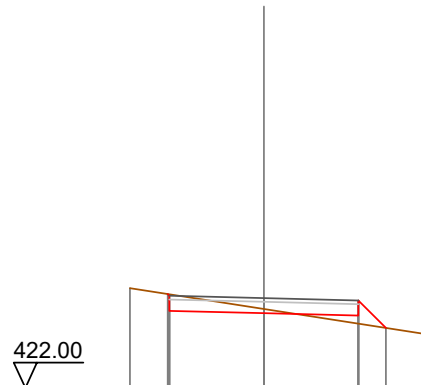

Quote Terreno	424.64			424.09			423.43
Quote Progetto		424.48	424.04	423.98		423.92	423.59
Parziali			2.50	2.50		0.73	
Progressiva		-2.54	-2.50	0.00		2.50	3.23
Dislivelli		-0.00	-0.04	-0.11		0.21	0.00

Sezione: 43
 Progressiva: 374.855
 Q. Progetto: 424.688

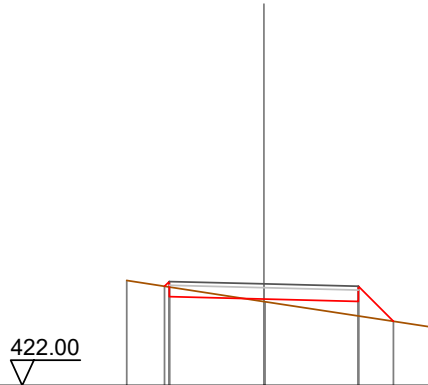

Quote Terreno	424.78	424.22	424.22	423.55
Quote Progetto	424.62	424.35	424.23	423.70
Parziali		2.50	2.50	0.93
Progressiva	-2.63	-2.50	0.00	2.50
Dislivelli	-0.00	0.15	0.07	0.39

Sezione: 44
 Progressiva: 380.000
 Q. Progetto: 425.068

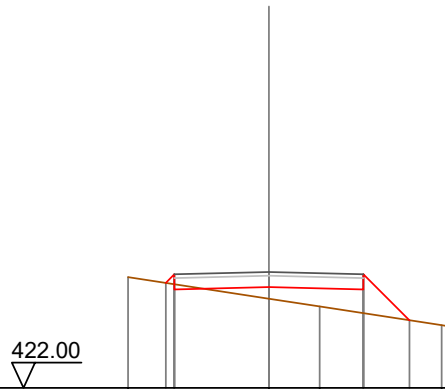

Quote Terreno	424.93	424.36	424.16	423.64
Quote Progetto	424.78	424.61	424.61	423.79
Parziali		2.50	2.50	1.22
Progressiva	-2.73	-2.50	0.00	2.50
Dislivelli	0.00	0.26	0.31	0.63

Sezione: 45
 Progressiva: 400.000
 Q. Progetto: 427.057

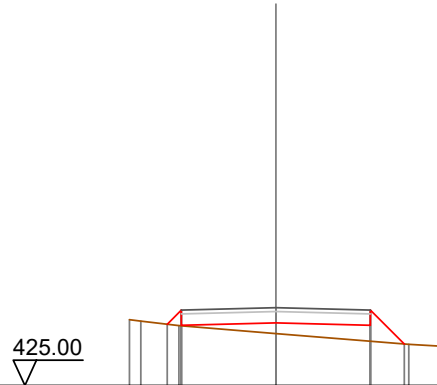

Quote Terreno	426.74	426.70	426.58	426.37	426.09	426.04
Quote Progetto		426.62	426.59	426.66	426.59	426.10
Parziali		0.37	2.50	2.50	0.90	
Progressiva		-2.87	-2.50	0.00	2.50	3.40
Dislivelli		0.00	0.42	0.28	0.42	0.00

Sezione: 46
 Progressiva: 420.000
 Q. Progetto: 429.707

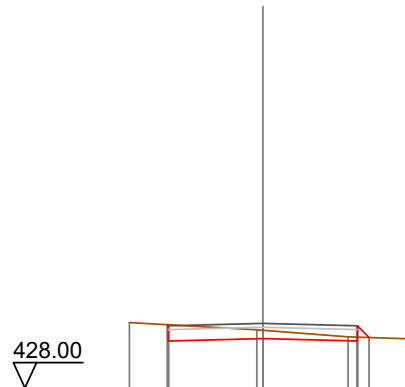

Quote Terreno	429.73	429.54	429.53	429.35	429.30	
Quote Progetto		429.67	429.24	429.31	429.24	429.34
Parziali			2.50	2.50	0.31	
Progressiva		-2.53	-2.50	0.00	2.50	2.81
Dislivelli		0.00	-0.03	-0.22	-0.10	0.00

Sezione: 47
 Progressiva: 440.000
 Q. Progetto: 431.801

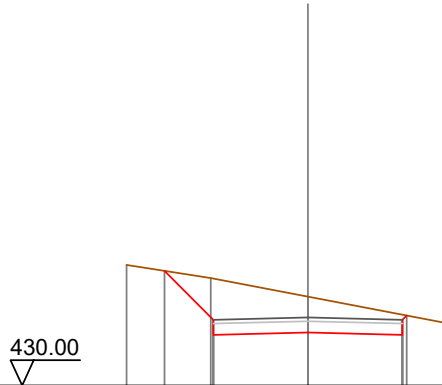

Quote Terreno		433.19	432.84	432.35	431.66
Quote Progetto		433.03	431.34	431.40	431.85
Parziali			1.29	2.50	2.50
Progressiva		-3.79	-2.50	0.00	2.50
Dislivelli		0.00	-1.09	-0.95	-0.53

Sezione: 48
 Progressiva: 460.000
 Q. Progetto: 433.086

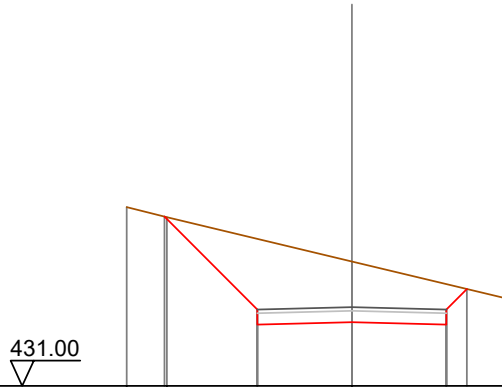

Quote Terreno		435.73	435.46	434.29	433.32
Quote Progetto		435.48	432.62	432.69	433.56
Parziali			2.46	2.50	2.50
Progressiva		-4.96	-2.50	0.00	2.50
Dislivelli		-0.00	-1.87	-1.61	-1.07

Sezione: 49
 Progressiva: 480.045
 Q. Progetto: 433.621

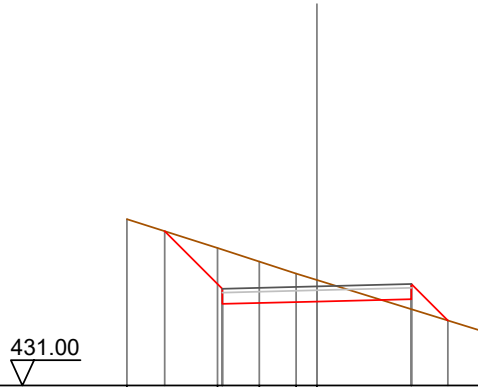

Quote Terreno	-435.40	-434.64	-434.28	-433.96	-433.79	-432.41
Quote Progetto	435.08	433.16	433.22	433.28	432.72	
Parziali		1.52	2.50	2.50	0.96	
Progressiva	-4.02	-2.50	0.00	2.50	3.46	
Dislivelli	0.00	-1.04	-0.57	0.27	0.00	

Sezione: 50
 Progressiva: 485.056
 Q. Progetto: 433.721

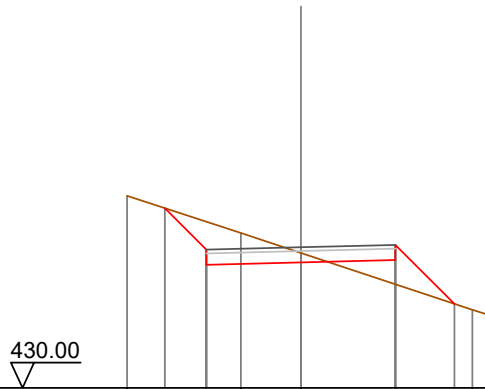

Quote Terreno	-435.08	-434.10	-433.57	-432.07	-431.90
Quote Progetto	434.76	433.26	433.32	433.38	432.22
Parziali		1.10	2.50	2.50	1.56
Progressiva	-3.60	-2.50	0.00	2.50	4.06
Dislivelli	0.00	-0.74	-0.25	0.64	0.00

Sezione: 51
 Progressiva: 490.067
 Q. Progetto: 433.868

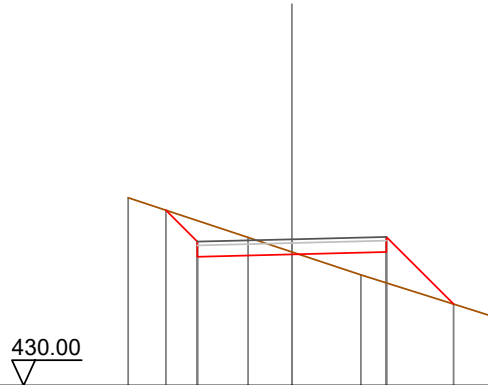

Quote Terreno		434.97		433.92	433.53	432.93		431.84
Quote Progetto			434.64	433.41	433.47	433.53	432.15	
Parziali			0.83	2.50	2.50	1.78		
Progressiva			-3.33	-2.50	0.00	2.50	4.28	
Dislivelli		0.00	-0.56	-0.07	0.82	0.00		

Sezione: 52
 Progressiva: 500.000
 Q. Progetto: 434.307

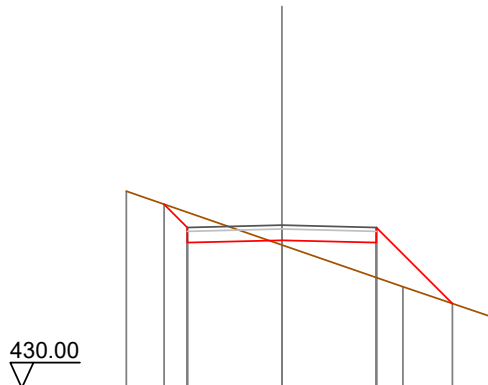

Quote Terreno		435.20		433.78	432.68		431.89
Quote Progetto			434.86	433.91	433.84	432.23	
Parziali			0.61	2.50	2.50	2.01	
Progressiva			-3.11	-2.50	0.00	2.50	4.51
Dislivelli		0.00	-0.40	0.12	0.92	-0.00	

Sezione: 53
 Progressiva: 520.000
 Q. Progetto: 435.730

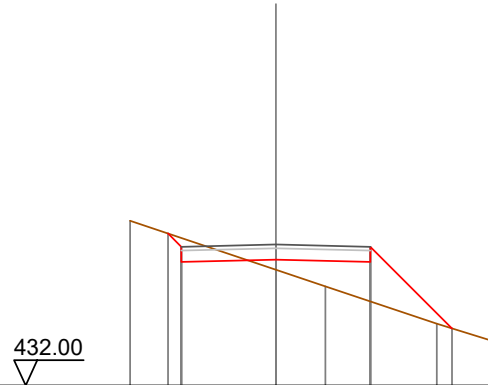

Quote Terreno	-436.36		435.06	-434.62	-433.63	-433.20
Quote Progetto		436.02 435.27	435.33	435.27	433.51	
Parziali		0.35 2.50	2.50	2.16		
Progressiva		-2.85 -2.50	0.00	2.50	4.66	
Dislivelli		0.00 -0.24	0.27	1.04	0.00	

Sezione: 54
 Progressiva: 540.000
 Q. Progetto: 437.025



Quote Terreno	-436.77		435.27	-434.70		-432.70
Quote Progetto		436.39 436.56	436.62	436.56		433.05
Parziali		0.57 2.50	2.50	3.92		
Progressiva		-3.07 -2.50	0.00	2.50		6.42
Dislivelli		0.00 0.79	1.35	2.16		0.00

Sezione: 55
 Progressiva: 550.971
 Q. Progetto: 437.400

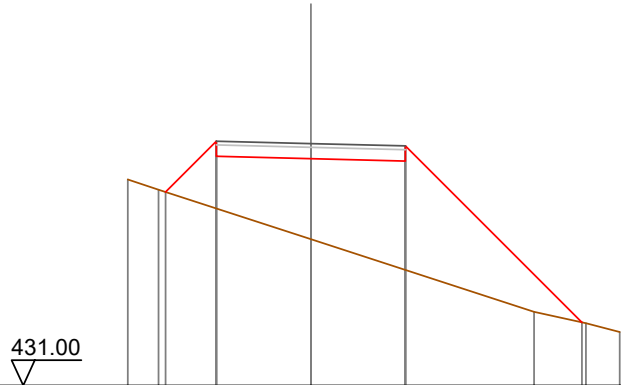

Quote Terreno		436.45	436.18		434.87		432.95	432.65	432.42
Quote Progetto			436.12	437.06	437.00	436.94		432.67	432.42
Parziali			1.34	2.50	2.50		4.67		
Progressiva			-3.84	-2.50	0.00	2.50		7.17	
Dislivelli			0.00	1.78	2.13	2.88		0.00	

Sezione: 56
 Progressiva: 560.000
 Q. Progetto: 437.528

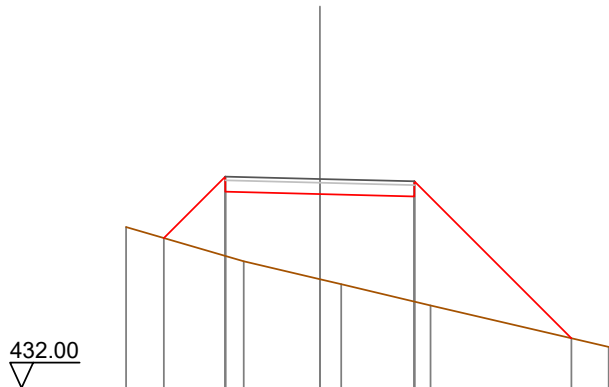

Quote Terreno		436.25		435.35	434.88	434.75	434.18		433.08
Quote Progetto			435.96	437.19	437.13	437.07		433.31	433.08
Parziali			1.63	2.50	2.50		4.15		
Progressiva			-4.13	-2.50	0.00	2.50		6.65	
Dislivelli			-0.00	2.10	2.25	2.78		0.00	

Sezione: 57
 Progressiva: 560.400
 Q. Progetto: 437.531

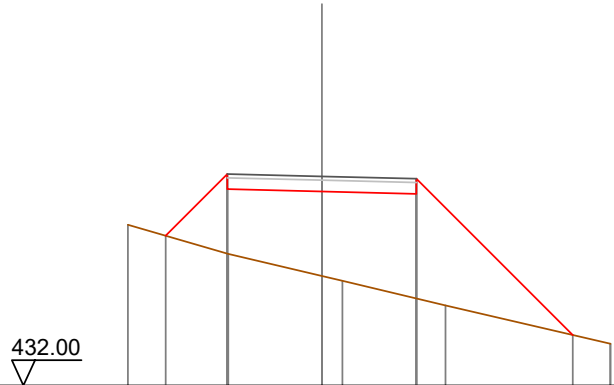

Quote Terreno		436.25		435.48		434.90		434.77		434.12		433.10
Quote Progetto			435.96		437.19		437.13		437.07			433.33
Parziali				1.63		2.50		2.50		4.13		
Progressiva			-4.13		-2.50		0.00		2.50			6.63
Dislivelli			-0.00		2.10		2.23		2.77			0.00

Sezione: 58
 Progressiva: 569.829
 Q. Progetto: 437.595

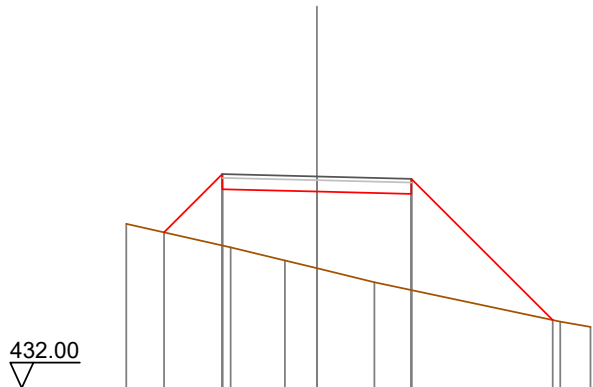

Quote Terreno		436.34		435.72		435.37		435.17		434.79		433.75		433.61
Quote Progetto			436.12		437.26		437.19		437.13			433.80		433.61
Parziali				1.54		2.50		2.50		3.74				
Progressiva			-4.04		-2.50		0.00		2.50			6.24		
Dislivelli			-0.00		1.89		2.03		2.54			-0.00		

Sezione: 59
 Progressiva: 580.000
 Q. Progetto: 437.663

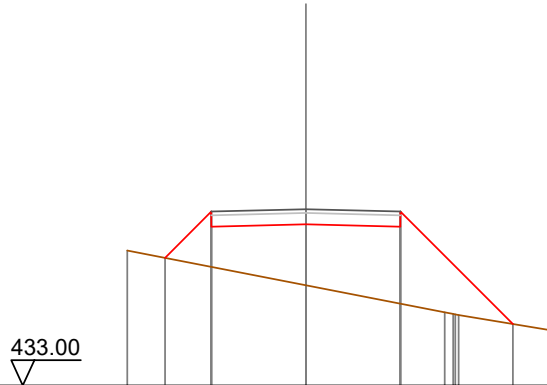

Quote Terreno		436.57			435.65		434.94	434.87		434.46
Quote Progetto			436.38	437.20		437.26		437.20		434.63
Parziali			1.22	2.50		2.50		2.97		
Progressiva			-3.72	-2.50		0.00		2.50		5.47
Dislivelli			0.00	1.46		1.61		2.04		0.00

Sezione: 60
 Progressiva: 600.000
 Q. Progetto: 437.798

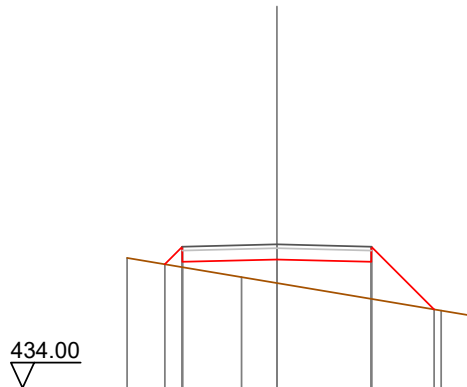

Quote Terreno		437.44			436.93		436.78		436.05	435.91
Quote Progetto			437.27	437.34		437.40		437.34	436.08	
Parziali			0.46	2.50		2.50		1.66		
Progressiva			-2.96	-2.50		0.00		2.50	4.16	
Dislivelli			0.00	0.54		0.62		0.98	0.00	

Sezione: 61
 Progressiva: 620.000
 Q. Progetto: 438.331

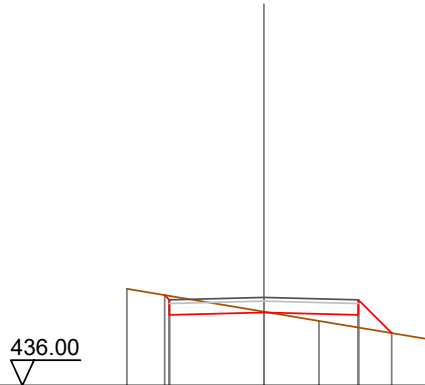

Quote Terreno	438.56			437.95	437.71		437.22
Quote Progetto	438.39	437.87		437.93	437.87	437.39	
Parziali		2.50		2.50	0.88		
Progressiva	-2.62	-2.50		0.00	2.50	3.38	
Dislivelli	0.00	-0.10		-0.02	0.33	-0.00	

Sezione: 62
 Progressiva: 631.125
 Q. Progetto: 438.952

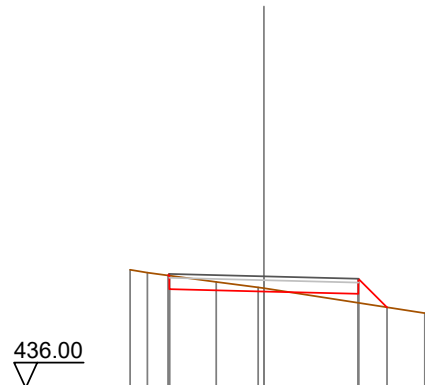

Quote Terreno	439.13	439.05		438.80	438.66	438.64		437.98
Quote Progetto	438.98	438.61		438.55	438.49	438.13		
Parziali		2.50		2.50	0.76			
Progressiva	-2.54	-2.50		0.00	2.50	3.26		
Dislivelli	-0.00	0.04		-0.09	0.24	0.00		

Sezione: 63
 Progressiva: 635.468
 Q. Progetto: 439.211

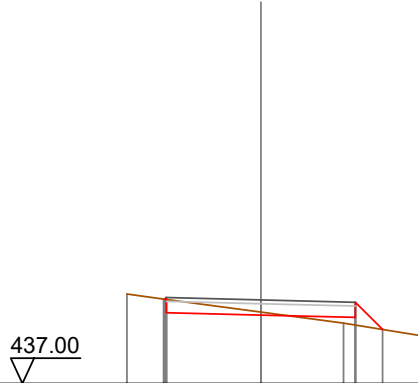

Quote Terreno	439.37	439.23	438.89	438.60	438.27
Quote Progetto	438.87	438.81	438.75	438.43	438.27
Parziali		2.50	2.50	0.72	
Progressiva	-2.54	-2.50	0.00	2.50	3.22
Dislivelli	0.00	0.05	-0.08	0.20	0.00

Sezione: 64
 Progressiva: 639.812
 Q. Progetto: 439.474

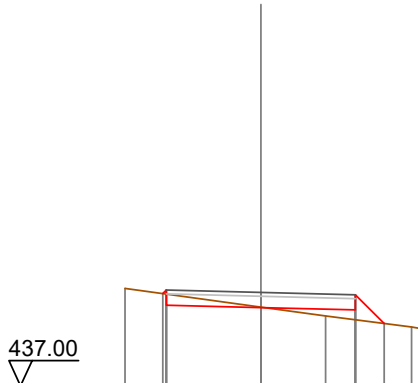

Quote Terreno	439.58	439.14	439.09	438.85	438.56
Quote Progetto	439.44	439.14	439.07	439.01	438.65
Parziali		2.50	2.50	0.76	
Progressiva	-2.59	-2.50	0.00	2.50	3.26
Dislivelli	-0.00	0.11	-0.01	0.26	0.00

Sezione: 65
 Progressiva: 660.000
 Q. Progetto: 441.169

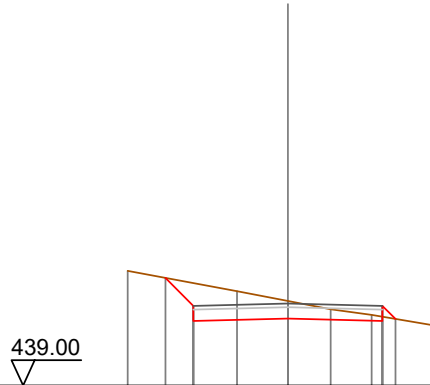

Quote Terreno		-442.03		-441.49	-441.23	-441.02	-440.87	-440.59
Quote Progetto			441.85	440.71	440.77		440.71	440.76
Parziali			0.74	2.50		2.50	0.34	
Progressiva			-3.24	-2.50	0.00		2.50	2.84
Dislivelli			-0.00	-0.60	-0.47		-0.11	0.00

Sezione: 66
 Progressiva: 669.682
 Q. Progetto: 442.276

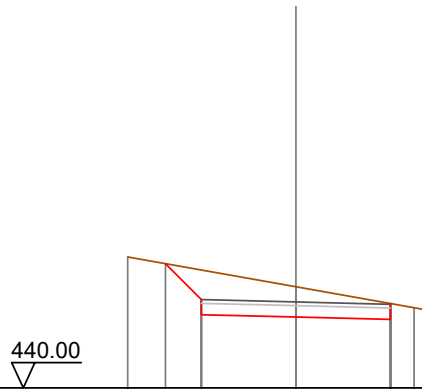

Quote Terreno		-443.46		-442.68		-442.12	-442.05
Quote Progetto			443.29	441.94	441.88	441.81	
Parziali			0.95	2.50		2.50	
Progressiva			-3.45	-2.50	0.00	2.50	
Dislivelli			0.00	-0.78	-0.80	-0.42	

Sezione: 67
 Progressiva: 670.000
 Q. Progetto: 442.316

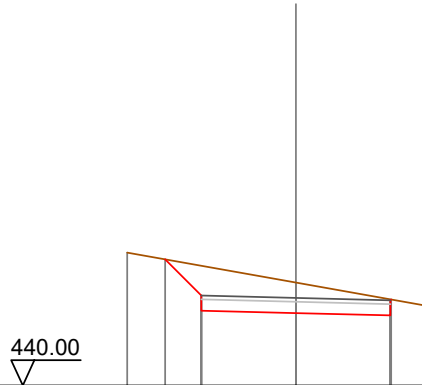

Quote Terreno	443.52			442.72		442.10
Quote Progetto	443.34			441.92		441.85 442.27
Parziali		0.96	2.50	2.50		
Progressiva		-3.46	-2.50	0.00	2.50	2.52
Dislivelli		-0.00	-0.79	-0.81	-0.42	-0.00

Sezione: 68
 Progressiva: 678.530
 Q. Progetto: 443.399

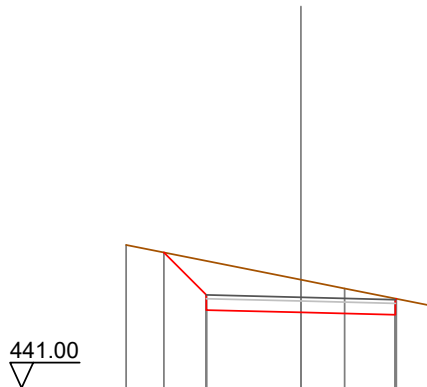

Quote Terreno	444.78			443.86		443.63	443.16
Quote Progetto	444.58			443.00		442.94	443.36
Parziali		1.12	2.50	2.50			
Progressiva		-3.62	-2.50	0.00	2.50	2.52	
Dislivelli		0.00	-0.90	-0.86	-0.43	0.00	

Sezione: 69
 Progressiva: 680.000
 Q. Progetto: 443.586

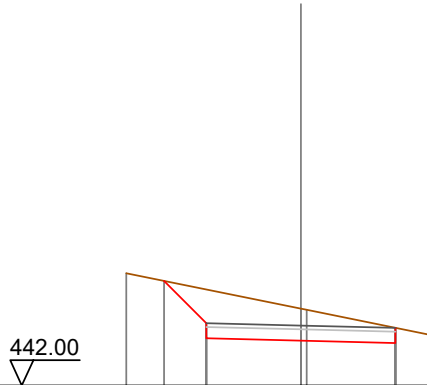

Quote Terreno		444.97			444.03	444.00			443.32
Quote Progetto			444.77	443.25		443.19		443.12	
Parziali			1.12	2.50		2.50			
Progressiva			-3.62	-2.50		0.00		2.50	
Dislivelli			0.00	-0.89		-0.85		-0.40	

Sezione: 70
 Progressiva: 687.378
 Q. Progetto: 444.523

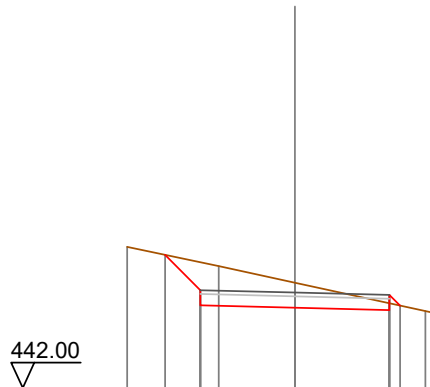

Quote Terreno		445.73			445.22	444.78			444.03	443.96
Quote Progetto			445.52	444.19		444.12		444.06	444.18	
Parziali			0.93	2.50		2.50		0.28		
Progressiva			-3.43	-2.50		0.00		2.50	2.78	
Dislivelli			0.00	-0.74		-0.66		-0.18	0.00	

Sezione: 71
 Progressiva: 700.000
 Q. Progetto: 446.128

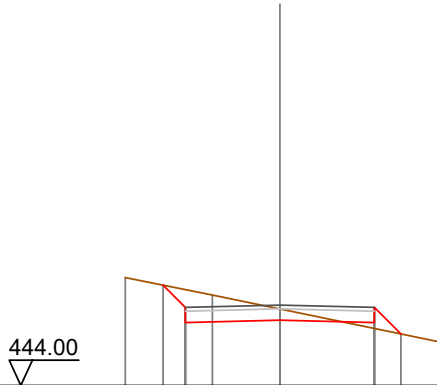

Quote Terreno	-446.86						
Quote Progetto	446.65	445.67	445.73	445.67	445.36		
Parziali	0.59	2.50	2.50	0.70			
Progressiva	-3.09	-2.50	0.00	2.50	3.20		
Dislivelli	0.00	-0.47	-0.30	0.16	-0.00		

Sezione: 72
 Progressiva: 720.000
 Q. Progetto: 448.670

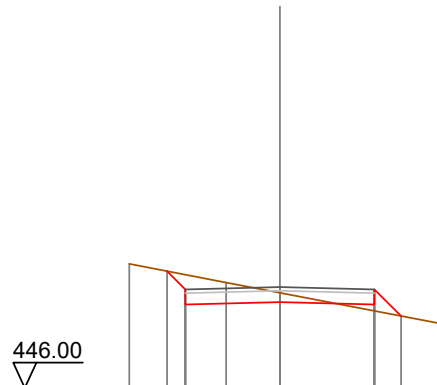

Quote Terreno	-449.28						
Quote Progetto	449.09	448.21	448.27	448.21	447.90		
Parziali	0.48	2.50	2.50	0.70			
Progressiva	-2.98	-2.50	0.00	2.50	3.20		
Dislivelli	0.00	-0.39	-0.25	0.17	0.00		

Sezione: 73
 Progressiva: 736.844
 Q. Progetto: 450.962

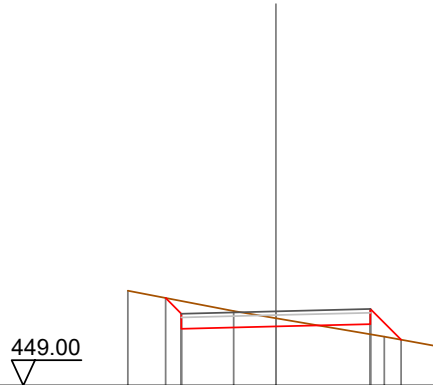

Quote Terreno		451.51		450.97	450.78		450.29		450.03
Quote Progetto			451.32	450.50	450.56		450.62	450.21	
Parziali			0.42	2.50		2.50	0.81		
Progressiva			-2.92	-2.50	0.00		2.50	3.31	
Dislivelli			0.00	-0.34		-0.22		0.27	0.00

Sezione: 74
 Progressiva: 740.000
 Q. Progetto: 451.417

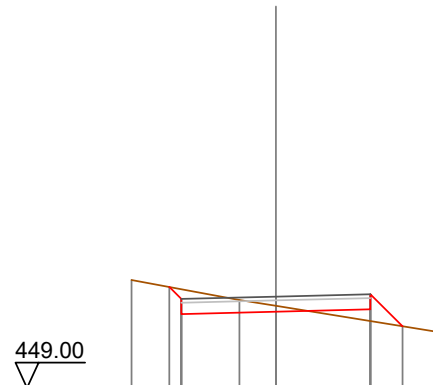

Quote Terreno		451.86		451.33	451.17				450.47
Quote Progetto			451.67	450.95	451.02		451.08	450.63	
Parziali			0.32	2.50		2.50	0.85		
Progressiva			-2.82	-2.50	0.00		2.50	3.35	
Dislivelli			0.00	-0.26		-0.16		0.31	0.00

Sezione: 75
 Progressiva: 745.957
 Q. Progetto: 452.275

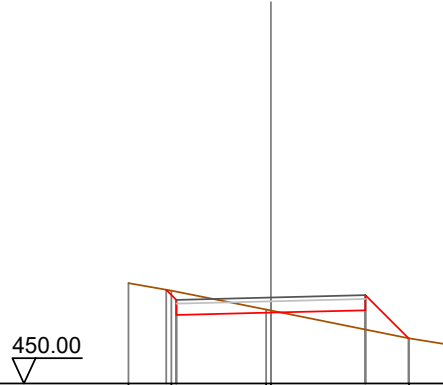

Quote Terreno	-452.66	-452.46	-451.96	-451.20	-451.04
Quote Progetto	452.48	451.81	451.87	451.94	451.20
Parziali	0.77	2.50	2.50	1.14	
Progressiva	-2.77	-2.50	0.00	2.50	3.64
Dislivelli	-0.00	-0.22	-0.06	0.51	0.00

Sezione: 76
 Progressiva: 750.000
 Q. Progetto: 452.857

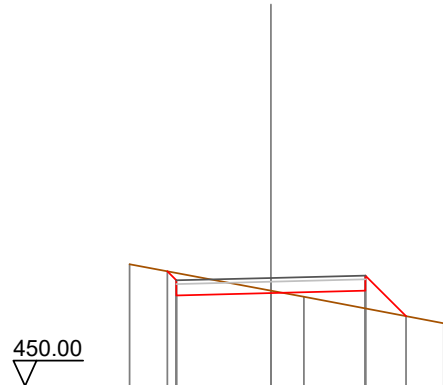

Quote Terreno	453.22	452.52	452.36	451.66
Quote Progetto	453.03	452.39	452.52	451.85
Parziali	2.50	2.50	1.07	
Progressiva	-2.74	-2.50	0.00	2.50
Dislivelli	0.00	-0.19	-0.07	0.47

Sezione: 77
 Progressiva: 755.071
 Q. Progetto: 453.587

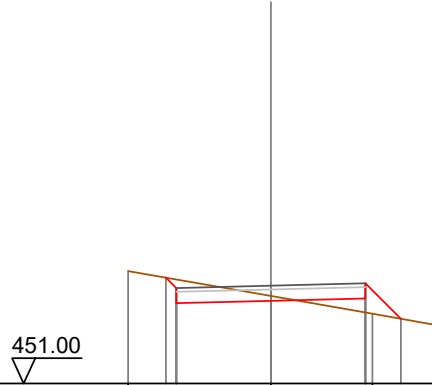

Quote Terreno	-453.97					
Quote Progetto	453.80	453.12	453.19	453.25	452.71	452.53
Parziali	0.77	2.50	2.50	0.94		
Progressiva	-2.77	-2.50	0.00	2.50	3.44	
Dislivelli	0.00	-0.23	-0.13	0.37	-0.00	

Sezione: 78
 Progressiva: 760.000
 Q. Progetto: 454.297

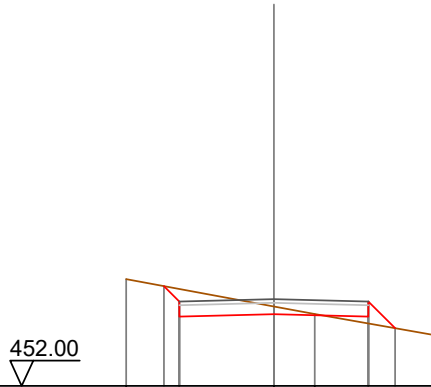

Quote Terreno	-454.83					
Quote Progetto	454.64	453.83	453.90	453.83	453.53	453.35
Parziali	0.41	2.50	2.50	0.71		
Progressiva	-2.91	-2.50	0.00	2.50	3.21	
Dislivelli	-0.00	-0.33	-0.21	0.18	0.00	

Sezione: 79
 Progressiva: 780.000
 Q. Progetto: 457.178

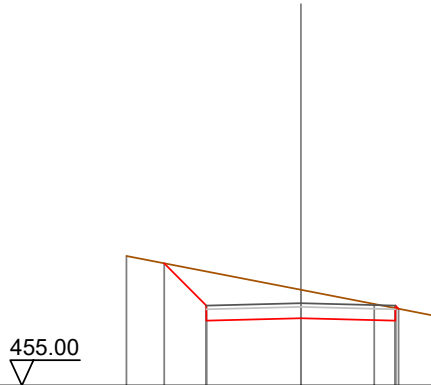

Quote Terreno		-458.42									
Quote Progetto			458.23	456.72		456.78	457.53		457.16	456.72	457.03
Parziali			1.12	2.50		2.50					
Progressiva			-3.62	-2.50		0.00			2.50	2.58	
Dislivelli			-0.00	-0.90		-0.75			-0.33	-0.00	

Sezione: 80
 Progressiva: 800.000
 Q. Progetto: 460.057

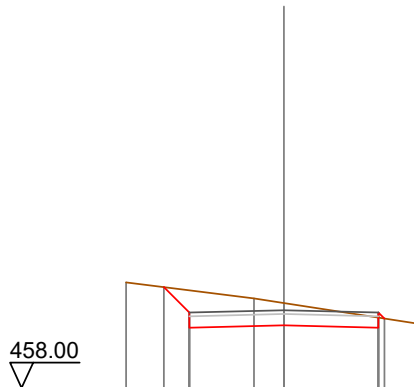

Quote Terreno			460.79			460.37	460.25				459.68
Quote Progetto				460.67	459.59		459.66	460.25		459.59	459.84
Parziali				0.67	2.50		2.50				
Progressiva				-3.17	-2.50		0.00		2.50	2.66	
Dislivelli				-0.00	-0.59		-0.59		-0.27	0.00	

Sezione: 81
 Progressiva: 820.000
 Q. Progetto: 462.474

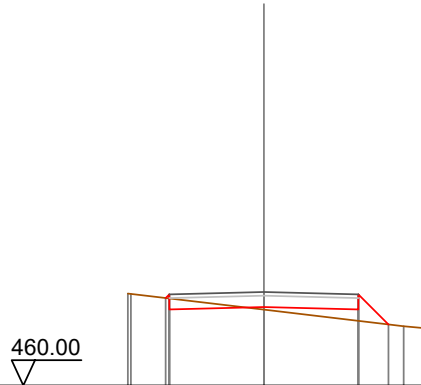

Quote Terreno	462.43	462.42	462.01	461.57	461.51
Quote Progetto	462.31	462.01	462.07	462.01	461.62
Parziali		2.50	2.50	0.80	
Progressiva	-2.60	-2.50	0.00	2.50	3.30
Dislivelli	0.00	0.11	0.07	0.30	-0.00

Sezione: 82
 Progressiva: 832.047
 Q. Progetto: 463.545

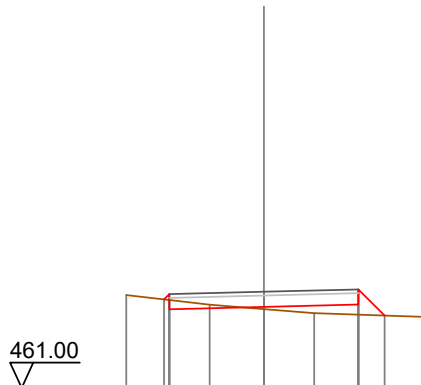

Quote Terreno	463.46	463.20	463.09	462.98	462.88
Quote Progetto	463.34	463.08	463.14	463.21	462.92
Parziali		2.50	2.50	0.69	
Progressiva	-2.64	-2.50	0.00	2.50	3.19
Dislivelli	0.00	0.16	0.06	0.27	0.00

Sezione: 83
 Progressiva: 840.000
 Q. Progetto: 464.193

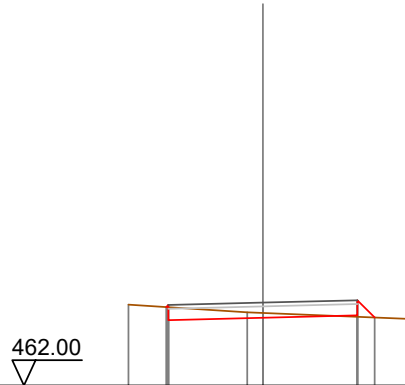

Quote Terreno	464.14	463.94	463.92	463.76
Quote Progetto	464.07	463.73	463.79	463.86
Parziali		2.50	2.50	0.46
Progressiva	-2.56	-2.50	0.00	2.50
Dislivelli	0.00	0.06	-0.13	0.04

Sezione: 84
 Progressiva: 842.824
 Q. Progetto: 464.416

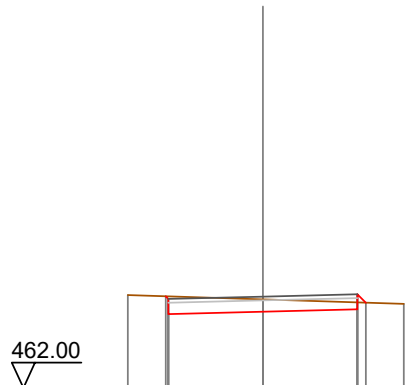

Quote Terreno	464.46	464.34	464.22
Quote Progetto	464.42	463.95	464.08
Parziali		2.50	2.50
Progressiva	-2.57	-2.50	2.50
Dislivelli	0.00	-0.07	-0.33

Sezione: 85
 Progressiva: 850.000
 Q. Progetto: 464.913

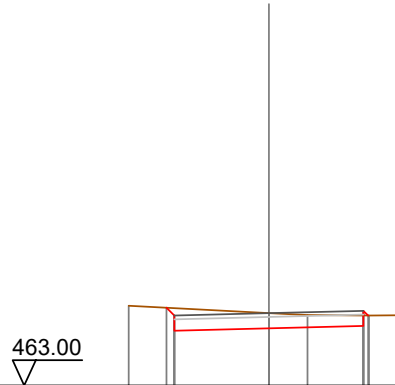

Quote Terreno		465.11		464.92		464.86		464.85		464.86
Quote Progetto		465.06		464.51		464.85		464.59		464.85
Parziali			2.50		2.50					
Progressiva		-2.71		0.00		2.50		2.62		
Dislivelli		0.00	-0.20	-0.40		-0.28		0.00		

Sezione: 86
 Progressiva: 853.601
 Q. Progetto: 465.123

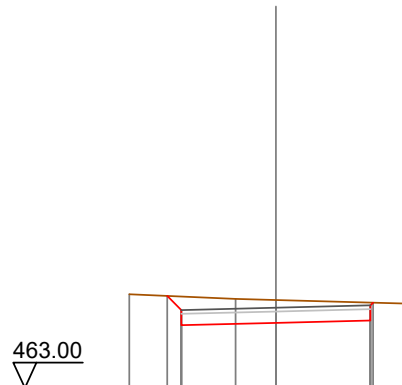

Quote Terreno		465.48		465.35		465.33		465.23	
Quote Progetto		465.44		464.72		465.25		464.79	
Parziali		0.38		2.50		2.50			
Progressiva		-2.88		0.00		2.50		2.57	
Dislivelli		0.00	-0.36	-0.60		-0.47		0.00	

Sezione: 87
 Progressiva: 860.000
 Q. Progetto: 465.432

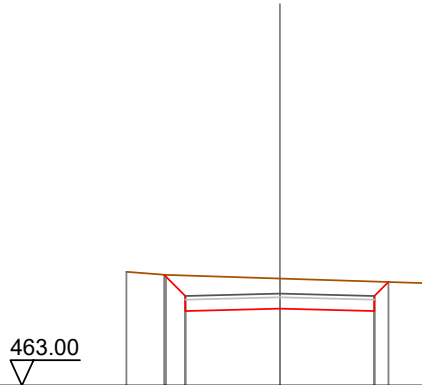

Quote Terreno	466.01	465.92	465.83	465.71
Quote Progetto	465.93	464.97	465.03	465.74
Parziali	0.56	2.50	2.50	0.37
Progressiva	-3.06	-2.50	0.00	2.50
Dislivelli	-0.00	-0.54	-0.80	-0.78

Sezione: 88
 Progressiva: 880.000
 Q. Progetto: 465.868

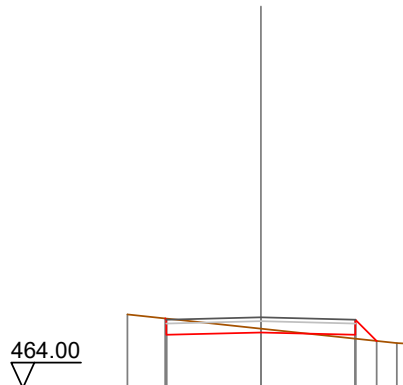

Quote Terreno	465.94	465.57	465.19	465.16
Quote Progetto	465.84	465.41	465.47	465.24
Parziali	2.50	2.50	0.56	
Progressiva	-2.53	-2.50	0.00	2.50
Dislivelli	-0.00	-0.03	-0.10	0.10

Sezione: 89
 Progressiva: 900.000
 Q. Progetto: 465.505

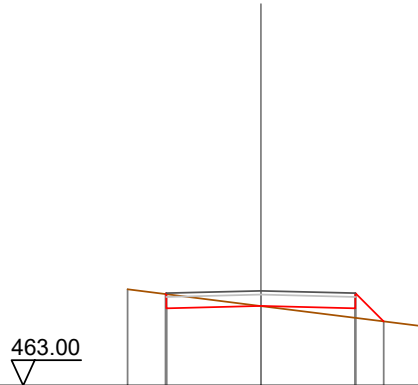

Quote Terreno	465.54	465.10	465.04	464.57
Quote Progetto	465.42	465.10	465.04	464.70
Parziali	2.50	2.50	0.75	
Progressiva	-2.52	0.00	2.50	3.25
Dislivelli	0.00	0.00	0.25	0.00

Sezione: 90
 Progressiva: 905.350
 Q. Progetto: 465.280

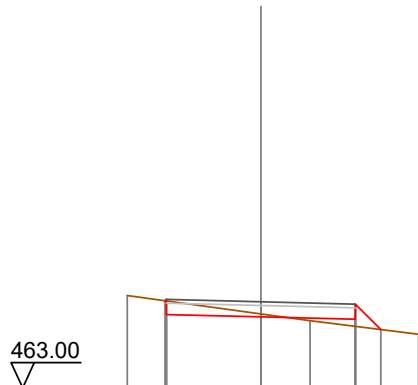

Quote Terreno	465.44	464.96	464.78	464.42
Quote Progetto	465.31	464.88	464.82	464.55
Parziali	2.50	2.50	0.67	
Progressiva	-2.54	0.00	2.50	3.17
Dislivelli	0.00	-0.08	0.19	0.00

Sezione: 91
 Progressiva: 907.548
 Q. Progetto: 465.186

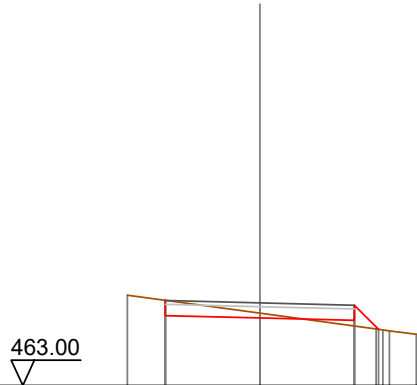

Quote Terreno		465.39		464.91		464.50	464.45	464.35
Quote Progetto		464.85		464.79		464.72	464.49	464.35
Parziali			2.50		2.50		0.64	
Progressiva		-2.51		0.00		2.50	3.14	
Dislivelli		-0.00		-0.13		0.15	0.00	

Sezione: 92
 Progressiva: 909.746
 Q. Progetto: 465.091

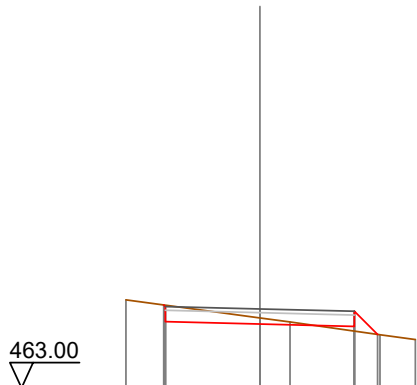

Quote Terreno		465.33		464.85		464.75		464.41	464.28
Quote Progetto		465.20		464.69		464.63		464.42	464.28
Parziali			2.50		2.50		0.61		
Progressiva		-2.54		0.00		2.50	3.11		
Dislivelli		0.00		-0.16		0.13	0.00		

Sezione: 95
 Progressiva: 940.000
 Q. Progetto: 463.702

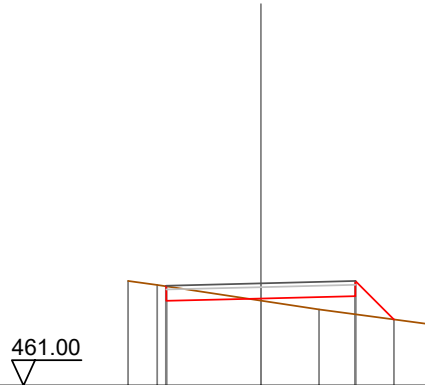

Quote Terreno		463.77	463.66	463.24	463.01	463.36	462.61
Quote Progetto		463.24	463.30	463.36	462.75		
Parziali			2.50	2.50	1.02		
Progressiva		-2.52	0.00	2.50	3.52		
Dislivelli		-0.00	0.06	0.48	0.00		

Sezione: 96
 Progressiva: 950.000
 Q. Progetto: 463.001

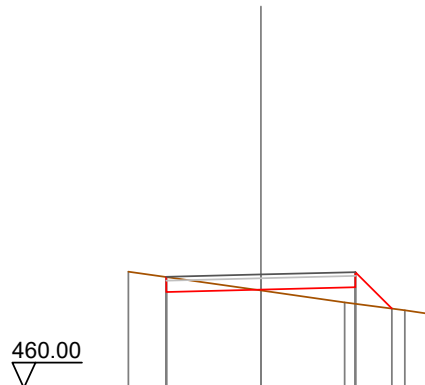

Quote Terreno		463.08	462.58	462.26	462.05	461.96
Quote Progetto		462.54	462.60	462.66	462.10	
Parziali			2.50	2.50	0.96	
Progressiva		-2.50	0.00	2.50	3.46	
Dislivelli		0.00	0.02	0.44	0.00	

Sezione: 97
 Progressiva: 956.524
 Q. Progetto: 462.522

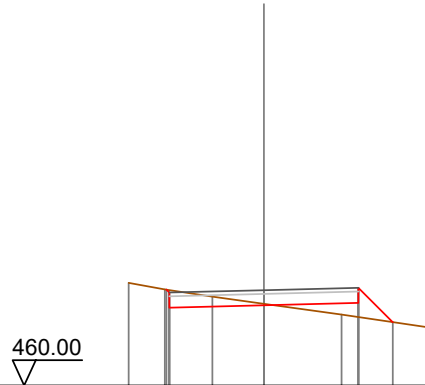

Quote Terreno	-462.71	-462.54	-462.35	-462.16	-461.87	-461.53
Quote Progetto	462.53	462.06		462.12	462.18	461.68
Parziali		2.50		2.50	0.91	
Progressiva	-2.58	-2.50		0.00	2.50	3.41
Dislivelli	0.00	-0.06		-0.04	0.37	0.00

Sezione: 98
 Progressiva: 960.000
 Q. Progetto: 462.266

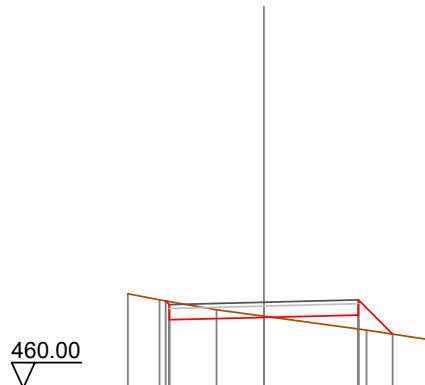

Quote Terreno	-462.49	-462.33	-462.07	-461.90	-461.53	-461.27
Quote Progetto	462.30	461.80		461.87	461.93	461.42
Parziali		2.50		2.50	0.91	
Progressiva	-2.60	-2.50		0.00	2.50	3.41
Dislivelli	0.00	-0.08		-0.03	0.37	0.00

Sezione: 99
 Progressiva: 970.000
 Q. Progetto: 461.531

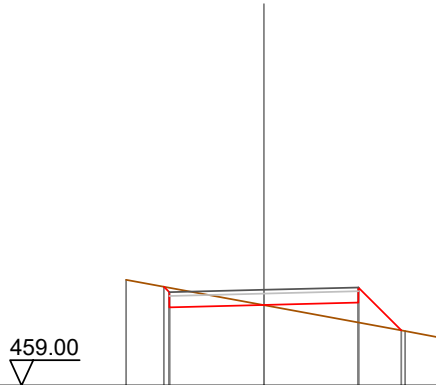

Quote Terreno	461.80		461.13		460.44	460.27
Quote Progetto	461.61	461.07	461.13	461.19	460.46	
Parziali		2.50	2.50	1.13		
Progressiva	-2.64	-2.50	0.00	2.50	3.63	
Dislivelli	0.00	-0.12	0.00	0.52	0.00	

Sezione: 100
 Progressiva: 977.167
 Q. Progetto: 461.004

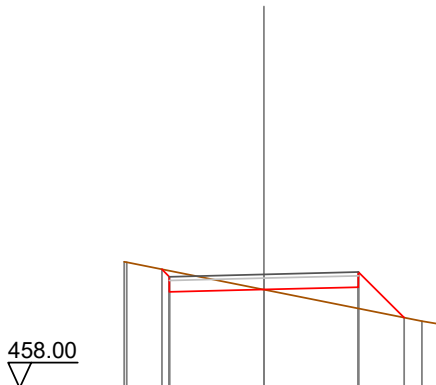

Quote Terreno	461.34	461.32	460.60		459.77	459.68
Quote Progetto	461.14	460.54	460.60	460.67	459.86	
Parziali		2.50	2.50	1.21		
Progressiva	-2.70	-2.50	0.00	2.50	3.71	
Dislivelli	0.00	-0.16	0.01	0.57	-0.00	

Sezione: 101
 Progressiva: 980.000
 Q. Progetto: 460.796

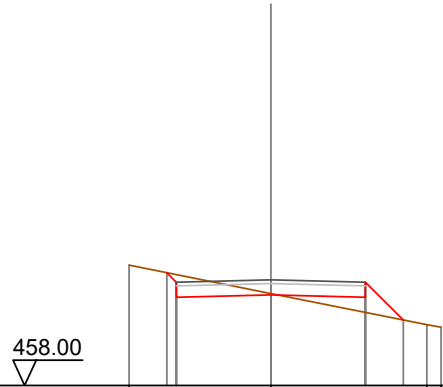

Quote Terreno	461.18		460.43		459.61	459.54
Quote Progetto	460.98	460.33	460.40	460.33	459.73	
Parziali		2.50	2.50	1.00		
Progressiva	-2.75	-2.50	0.00	2.50	3.50	
Dislivelli	0.00	-0.20	-0.04	0.40	0.00	

Sezione: 102
 Progressiva: 995.356
 Q. Progetto: 459.860

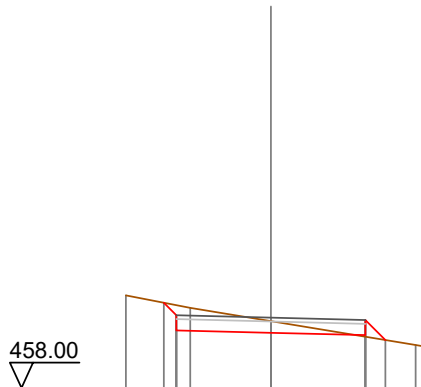

Quote Terreno	460.45		459.77		459.14	459.10
Quote Progetto	460.26	459.52	459.46	459.40	459.27	
Parziali		0.33	2.50	2.50	0.53	
Progressiva	-2.83	-2.50	0.00	2.50	3.03	
Dislivelli	0.00	-0.27	-0.31	0.04	0.00	

Sezione: 103
 Progressiva: 1000.000
 Q. Progetto: 459.669

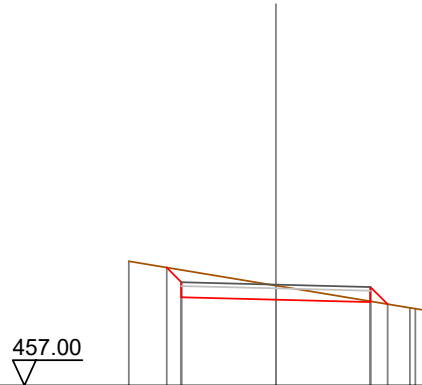

Quote Terreno	460.29		459.64		459.05	458.99
Quote Progetto		460.12		459.27		459.21
Parziali		0.39	2.50	2.50	0.46	
Progressiva		-2.89	-2.50	0.00	2.50	2.96
Dislivelli		-0.00	-0.32	-0.37	-0.02	-0.00

Sezione: 104
 Progressiva: 1007.635
 Q. Progetto: 459.450

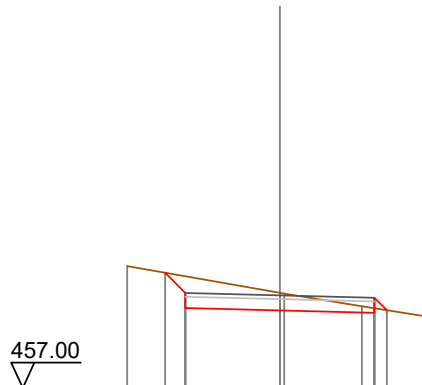

Quote Terreno	460.22		459.52		459.16	458.90
Quote Progetto		460.05		459.05		459.06
Parziali		0.54	2.50	2.50	0.33	
Progressiva		-3.04	-2.50	0.00	2.50	2.83
Dislivelli		0.00	-0.44	-0.47	-0.12	0.00

Sezione: 105
 Progressiva: 1010.000
 Q. Progetto: 459.406

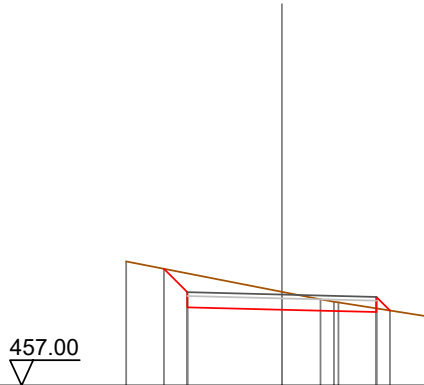

Quote Terreno	-460.28			459.48	-459.28	459.20		-458.83
Quote Progetto		460.09	459.07	459.01		458.84	458.88	
Parziali		0.62	2.50		2.50	0.36		
Progressiva		-3.12	-2.50	0.00		2.50	2.88	
Dislivelli		0.00	-0.50	-0.47		-0.10	0.00	

Sezione: 106
 Progressiva: 1019.915
 Q. Progetto: 459.342

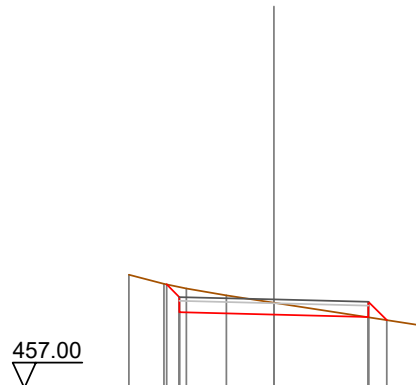

Quote Terreno	-459.99			459.26				-458.64
Quote Progetto		459.74	459.00	458.94		458.88	458.80	
Parziali		0.34	2.50		2.50	0.48		
Progressiva		-2.84	-2.50	0.00		2.50	2.98	
Dislivelli		0.00	-0.27	-0.31		0.01	-0.00	

Sezione: 107
 Progressiva: 1040.000
 Q. Progetto: 459.795

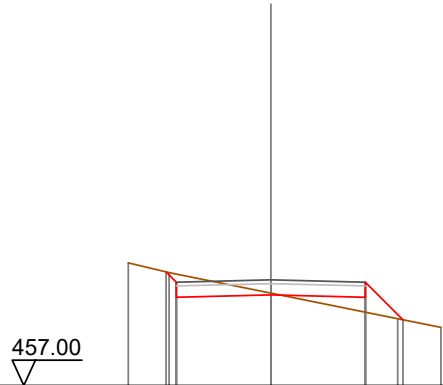

Quote Terreno	460.24	459.99	459.44	458.77	458.54
Quote Progetto	460.01	459.33	459.40	459.33	458.74
Parziali	0.77	2.50	2.50	0.99	
Progressiva	-2.77	-2.50	0.00	2.50	3.49
Dislivelli	-0.00	-0.21	-0.05	0.39	-0.00

Sezione: 108
 Progressiva: 1060.000
 Q. Progetto: 460.314

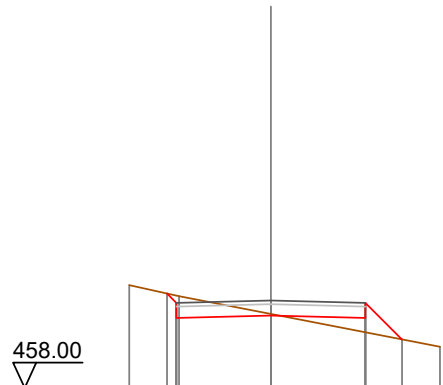

Quote Terreno	460.72	460.43	459.96	459.09	
Quote Progetto	460.50	459.85	459.91	459.85	459.28
Parziali		2.50	2.50	0.97	
Progressiva	-2.75	-2.50	0.00	2.50	3.47
Dislivelli	-0.00	-0.19	-0.04	0.38	0.00

Sezione: 109
 Progressiva: 1080.000
 Q. Progetto: 460.078

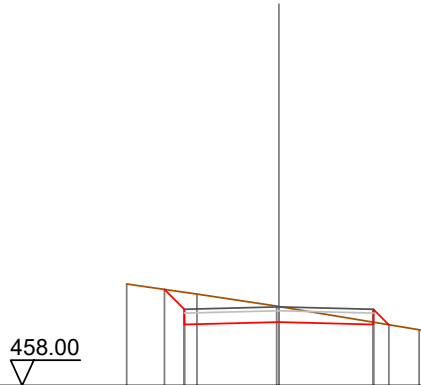

Quote Terreno		460.68		460.10		459.47
Quote Progetto		460.54	459.82	459.68	459.82	459.61
Parziali		0.53	2.50	2.50	0.41	
Progressiva		-3.03	-2.50	0.00	2.50	2.91
Dislivelli		0.00	-0.45	-0.41	-0.06	0.00

Sezione: 110
 Progressiva: 1081.155
 Q. Progetto: 460.040

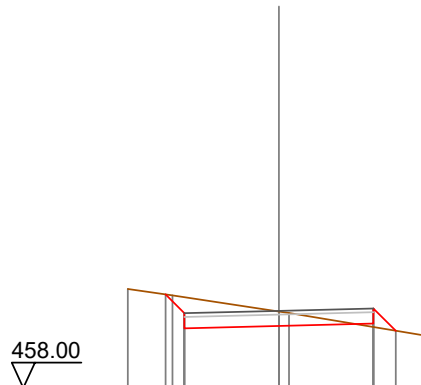

Quote Terreno		460.62		460.02		459.35
Quote Progetto		460.47	459.58	459.64	459.70	459.51
Parziali		0.50	2.50	2.50	0.59	
Progressiva		-3.00	-2.50	0.00	2.50	3.09
Dislivelli		0.00	-0.42	-0.38	0.09	0.00

Sezione: 111
 Progressiva: 1090.000
 Q. Progetto: 459.660

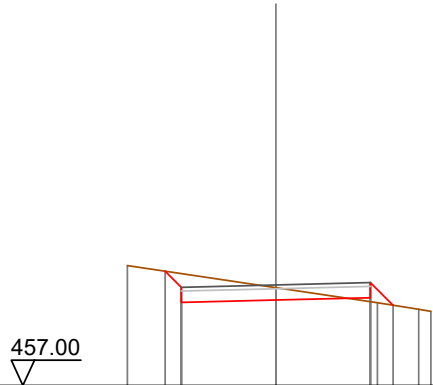

Quote Terreno	460.17		459.59	459.19	459.02	458.96
Quote Progetto		460.02 459.20	459.26	459.32 459.12		
Parziali		0.43 2.50	2.50	0.60		
Progressiva		-2.93 -2.50	0.00	2.50 3.10		
Dislivelli		-0.00 -0.36	-0.33	0.10 0.00		

Sezione: 112
 Progressiva: 1100.000
 Q. Progetto: 459.044

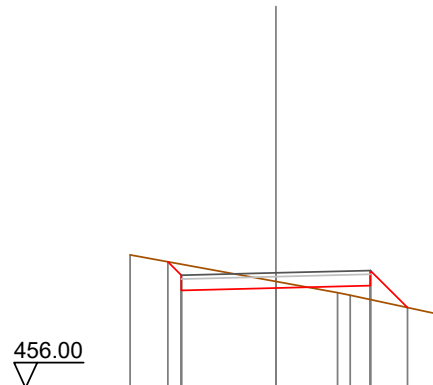

Quote Terreno	459.52		458.82	458.45	457.92	457.91
Quote Progetto		459.34 458.58	458.64	458.71 458.13		
Parziali		0.36 2.50	2.50	0.98		
Progressiva		-2.86 -2.50	0.00	2.50 3.48		
Dislivelli		-0.00 -0.29	-0.17	0.37 0.00		

Sezione: 113
 Progressiva: 1105.816
 Q. Progetto: 458.649

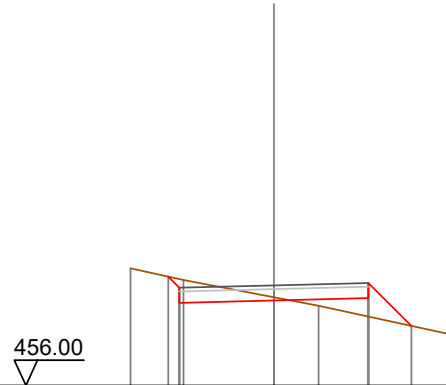

Quote Terreno		459.10		458.33		457.36
Quote Progetto		458.88	458.19	458.25	458.31	457.58
Parziali		0.28	2.50	2.50	1.14	
Progressiva		-2.79	-2.50	0.00	2.50	3.64
Dislivelli		0.00	-0.23	-0.08	0.49	-0.00

Sezione: 114
 Progressiva: 1110.000
 Q. Progetto: 458.364

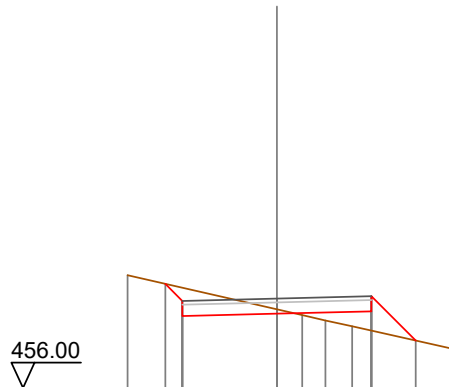

Quote Terreno		458.98		458.08		457.03
Quote Progetto		458.75	457.90	457.96	458.03	457.26
Parziali		0.45	2.50	2.50	1.17	
Progressiva		-2.95	-2.50	0.00	2.50	3.67
Dislivelli		-0.00	-0.35	-0.12	0.51	-0.00

Sezione: 115
 Progressiva: 1120.000
 Q. Progetto: 457.684

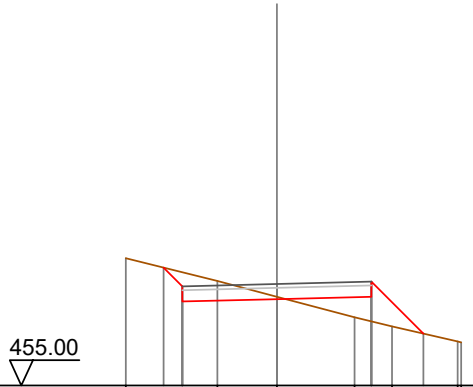

Quote Terreno		458.37		457.76	457.35	456.80	456.56	456.16	456.14
Quote Progetto		458.12	457.22	457.28	457.35	456.37			
Parziali		0.50	2.50	2.50	1.38				
Progressiva		-3.00	-2.50	0.00	2.50	3.88			
Dislivelli		0.00	-0.37	-0.06	0.65	-0.00			

Sezione: 116
 Progressiva: 1130.000
 Q. Progetto: 457.004

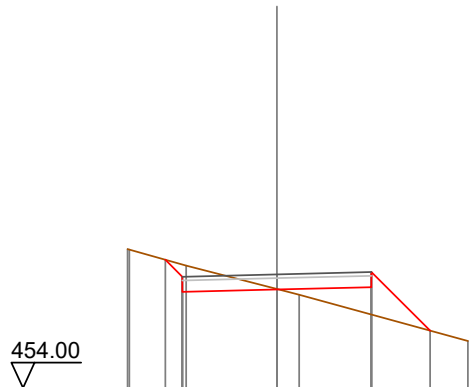

Quote Terreno		457.67	457.66	457.24	456.62	456.47		455.24
Quote Progetto		457.39	456.54	456.60	456.67	455.52		
Parziali		0.45	2.50	2.50	1.55			
Progressiva		-2.95	-2.50	0.00	2.50	4.05		
Dislivelli		0.00	-0.32	-0.02	0.72	-0.00		

Sezione: 117
 Progressiva: 1130.478
 Q. Progetto: 456.972

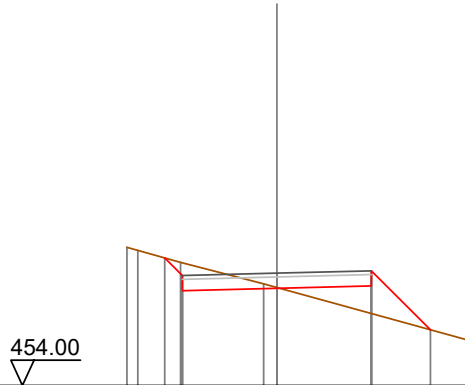

Quote Terreno		457.66	457.57	457.26	456.69	456.59		455.20
Quote Progetto			457.37	456.51	456.57		456.63	455.47
Parziali			0.47	2.50	2.50		1.56	
Progressiva			-2.97	-2.50	0.00		2.50	4.06
Dislivelli			0.00	-0.34	-0.02		0.73	0.00

Sezione: 118
 Progressiva: 1140.000
 Q. Progetto: 456.410

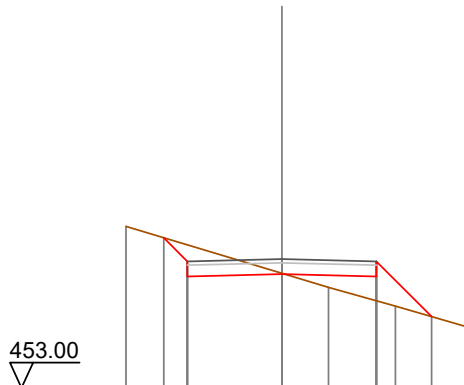

Quote Terreno		457.27		456.03	455.66	455.16	454.60
Quote Progetto			456.97	456.01	455.95	454.89	
Parziali			0.62	2.50	2.50	1.46	
Progressiva			-3.12	-2.50	0.00	2.50	3.96
Dislivelli			-0.00	-0.44	-0.02	0.64	0.00

Sezione: 119
 Progressiva: 1160.000
 Q. Progetto: 455.669

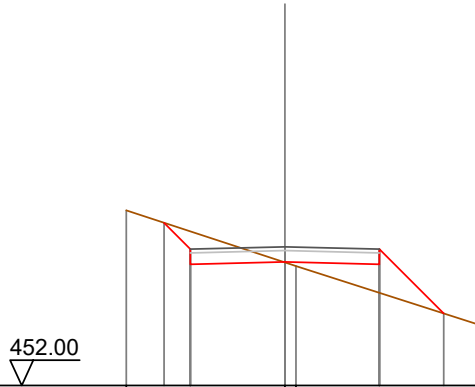

Quote Terreno		-456.63		455.25		-453.58
Quote Progetto			456.30	455.27	455.21	453.91
Parziali			0.70	2.50	2.50	1.70
Progressiva			-3.20	-2.50	0.00	2.50
Dislivelli			-0.00	-0.47	0.01	0.76

Sezione: 120
 Progressiva: 1180.000
 Q. Progetto: 454.989

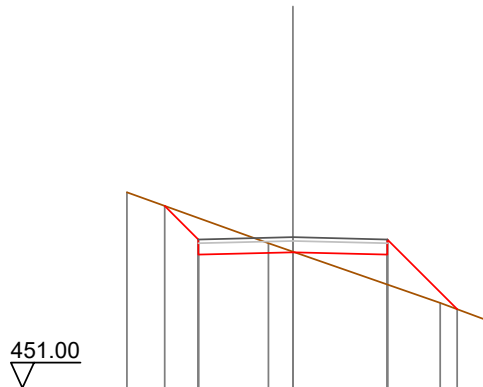

Quote Terreno		-456.18		454.83		-452.71
Quote Progetto			455.92	454.59	454.53	453.08
Parziali			0.89	2.50	2.50	1.84
Progressiva			-3.39	-2.50	0.00	2.50
Dislivelli			0.00	-0.57	-0.01	0.79

Sezione: 121
 Progressiva: 1195.444
 Q. Progetto: 454.745

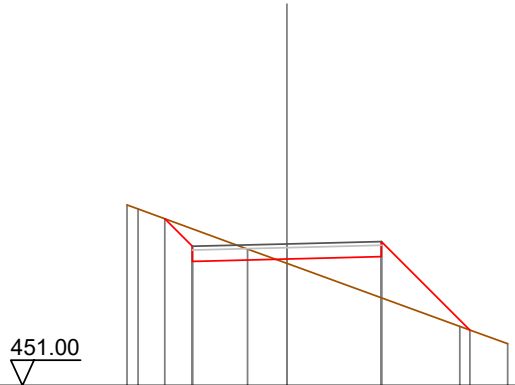

Quote Terreno		455.78	455.67		454.61	454.23		452.56	452.10
Quote Progetto			455.41	454.28		454.35	454.41	452.47	
Parziali			0.73	2.50		2.50	2.34		
Progressiva			-3.23	-2.50		0.00	2.50	4.84	
Dislivelli			0.00	-0.46		0.11	1.09	0.00	

Sezione: 122
 Progressiva: 1197.834
 Q. Progetto: 454.734

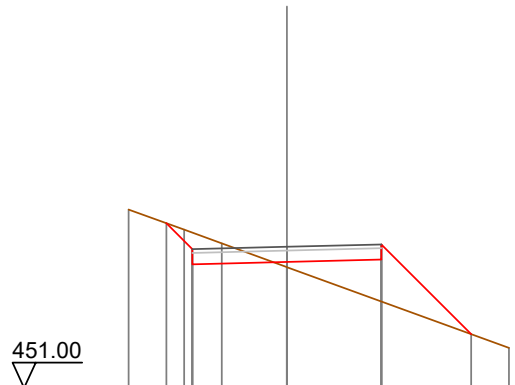

Quote Terreno		455.72	455.36	455.19	454.82	454.20		452.06
Quote Progetto			455.36	454.27		454.33	454.40	452.43
Parziali			0.69	2.50		2.50	2.37	
Progressiva			-3.19	-2.50		0.00	2.50	4.87
Dislivelli			0.00	-0.44		0.14	1.11	-0.00

Sezione: 123
 Progressiva: 1200.000
 Q. Progetto: 454.724

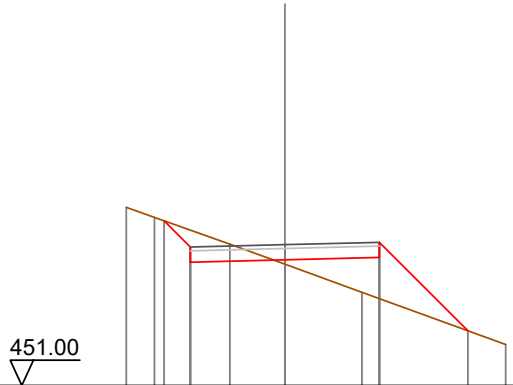

Quote Terreno		-455.71	-455.45	-454.74	-454.21	-453.47	-452.09
Quote Progetto			455.36	454.26	454.32	454.39	452.45
Parziali			0.69	2.50	2.50	2.34	
Progressiva			-3.19	-2.50	0.00	2.50	4.84
Dislivelli			0.00	-0.45	0.12	1.09	0.00

Sezione: 124
 Progressiva: 1200.224
 Q. Progetto: 454.723

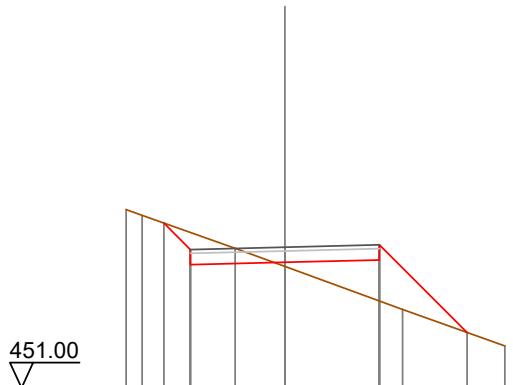

Quote Terreno		-455.72	-455.56	-454.69	-454.21	-453.08	-452.11
Quote Progetto			455.36	454.26	454.32	454.39	452.47
Parziali			0.70	2.50	2.50	2.32	
Progressiva			-3.20	-2.50	0.00	2.50	4.82
Dislivelli			-0.00	-0.45	0.11	1.08	0.00

Sezione: 125
 Progressiva: 1220.000
 Q. Progetto: 454.632

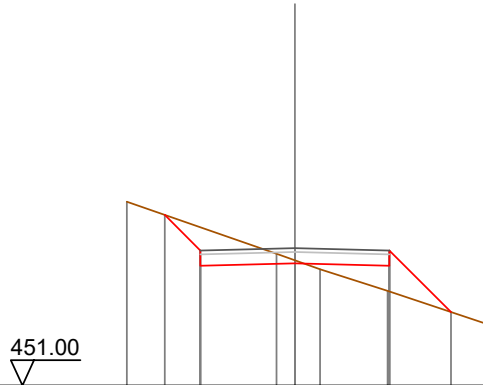

Quote Terreno		455.86		454.48	454.31	454.07	453.50	452.61
Quote Progetto		455.51	454.17	454.23	454.17	452.94		
Parziali			0.94	2.50	2.50	1.63		
Progressiva			-3.44	-2.50	0.00	2.50	4.13	
Dislivelli		0.00	-0.61	-0.08	0.68	-0.00		

Sezione: 126
 Progressiva: 1223.061
 Q. Progetto: 454.618

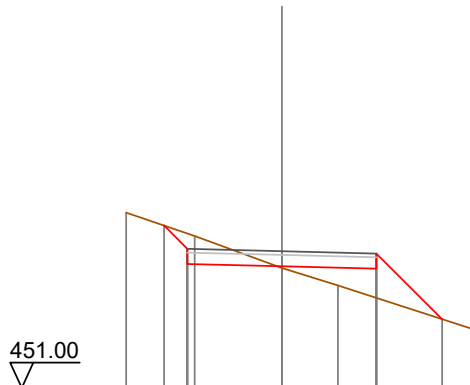

Quote Terreno		455.64		454.22	454.17	453.71		452.49
Quote Progetto		455.30	454.28	454.22	454.16	452.82		
Parziali			0.62	2.50	2.50	1.74		
Progressiva			-3.12	-2.50	0.00	2.50	4.24	
Dislivelli		-0.00	-0.41	0.05	0.77	0.00		

Sezione: 127
 Progressiva: 1230.000
 Q. Progetto: 454.586

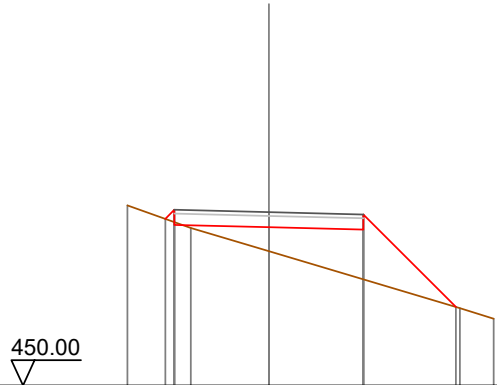

Quote Terreno	-454.76	-454.17	-453.55	-452.05	-451.77
Quote Progetto	454.41	454.23	454.19	454.12	452.08
Parziali		2.50	2.50	2.44	
Progressiva	-2.74	-2.50	0.00	2.50	4.94
Dislivelli	-0.00	0.33	0.63	1.32	-0.00

Sezione: 128
 Progressiva: 1240.000
 Q. Progetto: 454.540

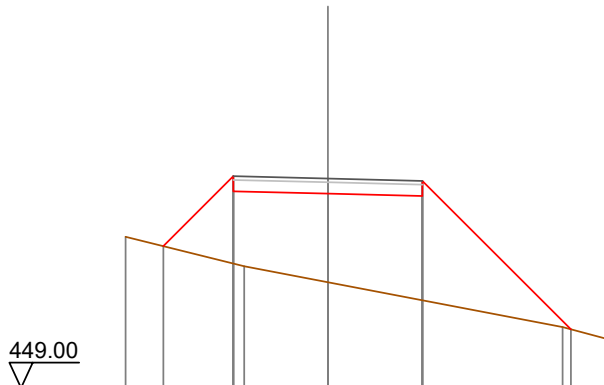

Quote Terreno	-453.00	-452.22	-451.80	-450.61	-450.28
Quote Progetto	452.75	454.20	454.14	454.08	450.55
Parziali		1.85	2.50	2.50	3.93
Progressiva	-4.35	-2.50	0.00	2.50	6.43
Dislivelli	0.00	2.31	2.34	2.76	0.00

Sezione: 129
 Progressiva: 1250.000
 Q. Progetto: 454.494

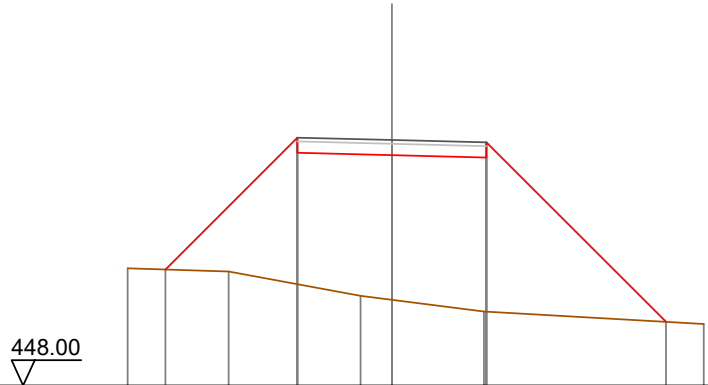

Quote Terreno		451.10	451.02		450.37	450.27	449.96		449.63
Quote Progetto		451.07		454.16		454.09	454.03		449.68
Parziali			3.49		2.50		2.50		4.75
Progressiva		-5.99		-2.50		0.00	2.50		7.25
Dislivelli		0.00		3.88		3.83	4.08		-0.00

Sezione: 130
 Progressiva: 1260.000
 Q. Progetto: 454.456

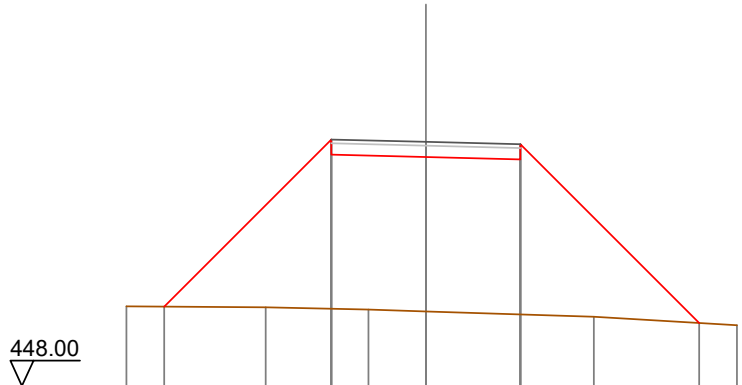

Quote Terreno		450.11	450.08		450.02	449.97		449.83	449.61
Quote Progetto		450.10		454.12		454.06	453.99		449.67
Parziali			4.42		2.50		2.50		4.73
Progressiva		-6.92		-2.50		0.00	2.50		7.23
Dislivelli		0.00		4.48		4.08	4.10		0.00

Sezione: 131
 Progressiva: 1263.242
 Q. Progetto: 454.471

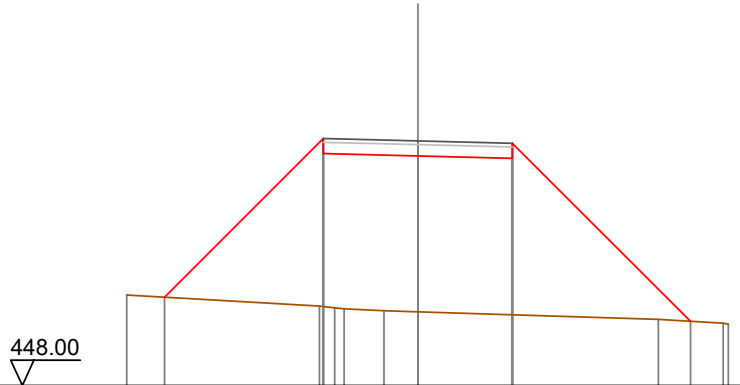

Quote Terreno		-450.39		-450.10	-450.03	-449.98	-449.95		-449.75	-449.65	-449.62
Quote Progetto		450.33		454.13		454.07		454.01		449.70	
Parziali			4.20		2.50		2.50		4.71		
Progressiva		-6.70		-2.50		0.00		2.50		7.21	
Dislivelli		0.00		4.44		4.12		4.14		0.00	

Sezione: 132
 Progressiva: 1270.000
 Q. Progetto: 454.555

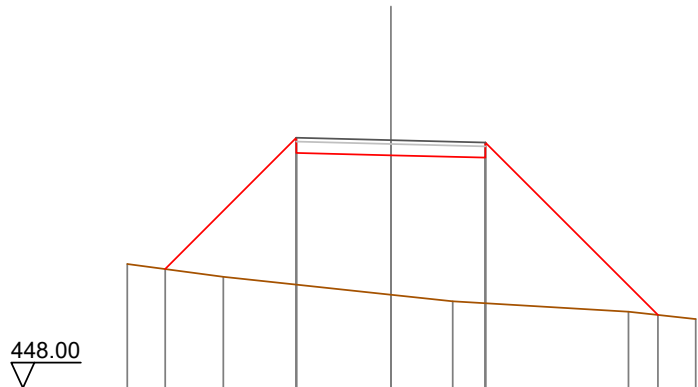

Quote Terreno		-451.28		-450.94		-450.47		-450.29		-450.02	-449.82
Quote Progetto		451.15		454.22		454.15		454.09		449.93	
Parziali			3.47		2.50		2.50		4.56		
Progressiva		-5.97		-2.50		0.00		2.50		7.06	
Dislivelli		0.00		3.88		3.69		3.85		0.00	

Sezione: 133
 Progressiva: 1280.000
 Q. Progetto: 454.711

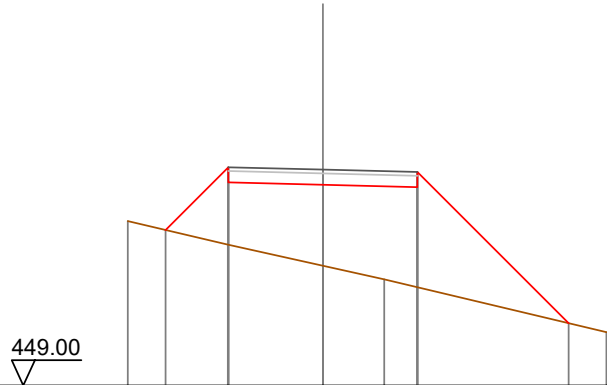

Quote Terreno		453.35		452.73		452.17		451.81		450.41
Quote Progetto			453.11	454.37	454.31	454.25			450.65	
Parziali			1.66	2.50	2.50	4.00				
Progressiva			-4.16	-2.50	0.00	2.50			6.50	
Dislivelli		0.00	2.05	2.14	2.65	0.00				

Sezione: 134
 Progressiva: 1290.000
 Q. Progetto: 455.034

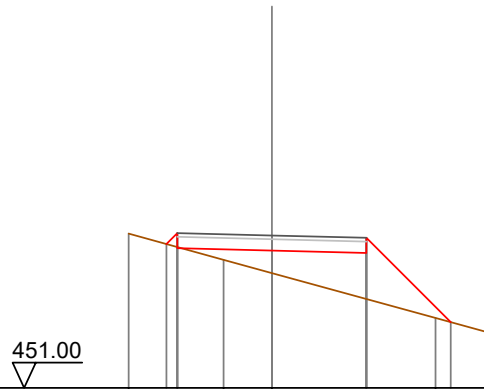

Quote Terreno		455.08		454.39		454.04		452.85		452.47
Quote Progetto			454.81	454.70	454.63	454.57		452.74		
Parziali			0.28	2.50	2.50	2.23				
Progressiva			-2.79	-2.50	0.00	2.50		4.73		
Dislivelli		-0.00	0.37	0.59	1.22	0.00				

Sezione: 135
 Progressiva: 1300.000
 Q. Progetto: 455.557

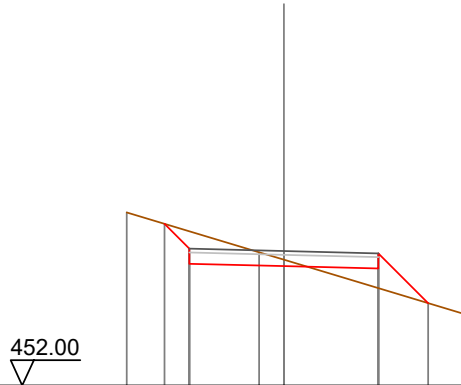

Quote Terreno		-456.58		-455.52	-455.33			-453.88
Quote Progetto			456.28	455.22		455.16		455.09
Parziali			0.66	2.50		2.50		1.32
Progressiva			-3.16	-2.50		0.00		2.50
Dislivelli			-0.00	-0.46		-0.17		0.52

Sezione: 136
 Progressiva: 1303.422
 Q. Progetto: 455.783

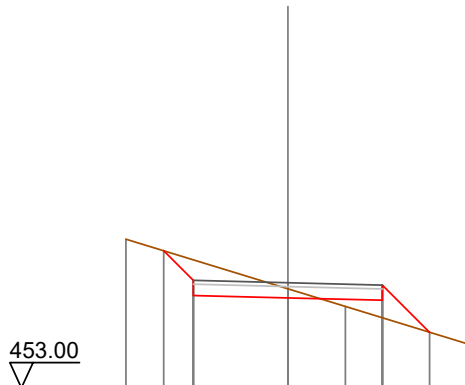

Quote Terreno		-456.94		-455.62	-455.16			-454.16
Quote Progetto			456.63	455.45		455.38		455.32
Parziali			0.78	2.50		2.50		1.25
Progressiva			-3.28	-2.50		0.00		2.50
Dislivelli			0.00	-0.54		-0.24		0.47

Sezione: 137
 Progressiva: 1320.000
 Q. Progetto: 457.122

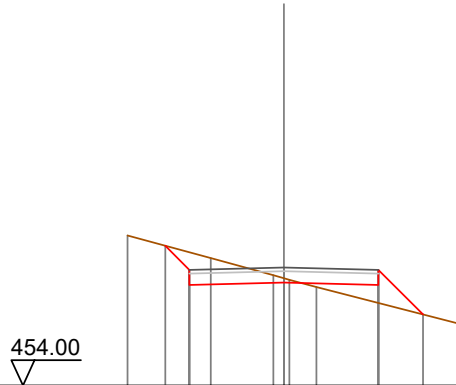

Quote Terreno	-457.97	-457.37	-456.92	-456.80	-456.60	-455.62
Quote Progetto	457.70	456.66	456.72	456.66	455.88	
Parziali		0.64	2.50	2.50	1.18	
Progressiva		-3.14	-2.50	0.00	2.50	3.68
Dislivelli		0.00	-0.46	-0.12	0.48	-0.00

Sezione: 138
 Progressiva: 1340.000
 Q. Progetto: 458.791

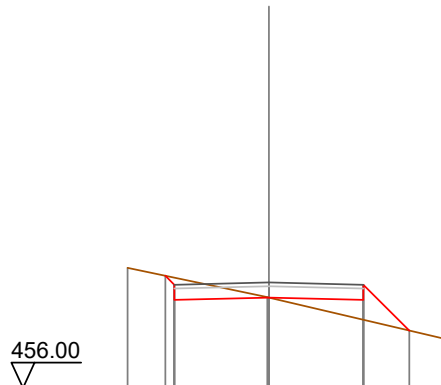

Quote Terreno	458.18	458.40	458.39	457.28		
Quote Progetto	458.97	458.33	458.39	457.52		
Parziali		2.50	2.50	1.21		
Progressiva		-2.74	-2.50	2.50	3.71	
Dislivelli		0.00	-0.19	0.00	0.53	-0.00

Sezione: 139
 Progressiva: 1346.094
 Q. Progetto: 459.225

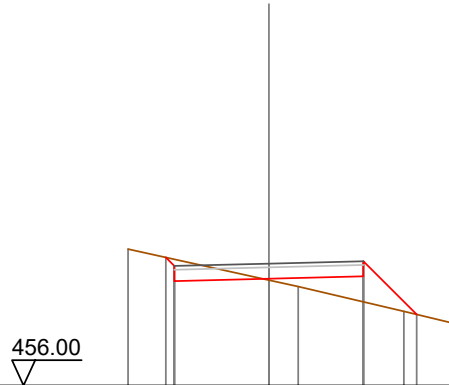

Quote Terreno	459.61		458.79		457.96	457.64
Quote Progetto	458.76		458.82		458.88	457.88
Parziali		2.50	2.50	1.41		
Progressiva	-2.73	-2.50	0.00	2.50	3.91	
Dislivelli	0.00	-0.18	0.04	0.67	0.00	

Sezione: 140
 Progressiva: 1347.931
 Q. Progetto: 459.341

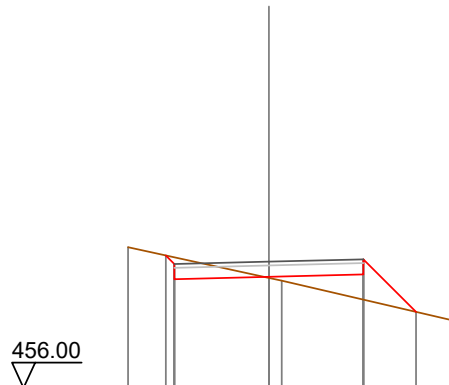

Quote Terreno	459.72		458.84		457.80	457.78
Quote Progetto	458.88		458.94		459.01	458.01
Parziali		2.50	2.50	1.39		
Progressiva	-2.73	-2.50	0.00	2.50	3.89	
Dislivelli	-0.00	-0.18	0.03	0.67	0.00	

Sezione: 141
 Progressiva: 1349.767
 Q. Progetto: 459.450

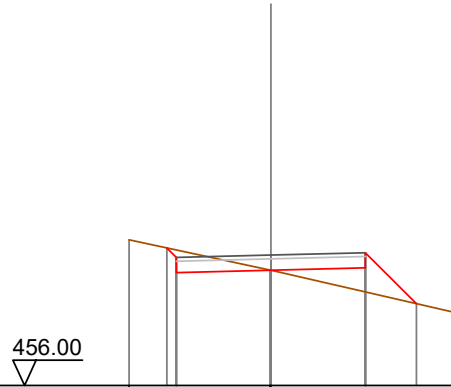

Quote Terreno		459.85		459.05	459.05		457.94
Quote Progetto		459.64	458.99	459.05	459.11	458.16	
Parziali			2.50	2.50	1.35		
Progressiva		-2.75	-2.50	0.00	2.50	3.85	
Dislivelli		0.00	-0.20	0.00	0.64	0.00	

Sezione: 142
 Progressiva: 1360.000
 Q. Progetto: 459.934

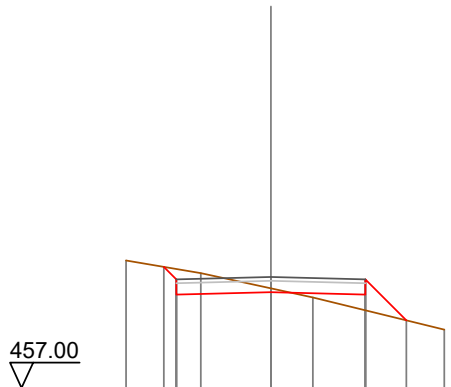

Quote Terreno		460.37		459.63	459.39		458.54
Quote Progetto		460.20	459.47	459.53	459.47	458.79	
Parziali			0.33	2.50	2.50	1.08	
Progressiva		-2.83	-2.50	0.00	2.50	3.58	
Dislivelli		-0.00	-0.27	-0.10	0.42	0.00	

Sezione: 143
 Progressiva: 1380.000
 Q. Progetto: 460.355

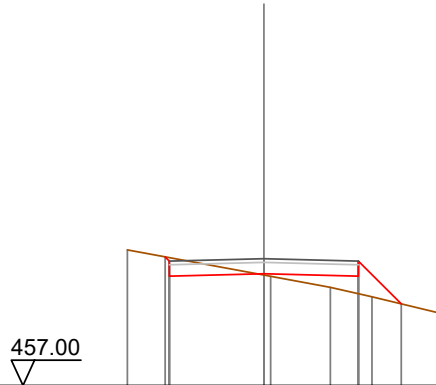

Quote Terreno		-460.59		-459.92	-459.60	-459.35	-458.92
Quote Progetto		460.40	459.89	459.95	459.89	459.16	
Parziali			2.50		2.50	1.13	
Progressiva		-2.61	-2.50	0.00	2.50	3.63	
Dislivelli		0.00	-0.09	0.03	0.46	-0.00	

Sezione: 144
 Progressiva: 1400.000
 Q. Progetto: 461.092

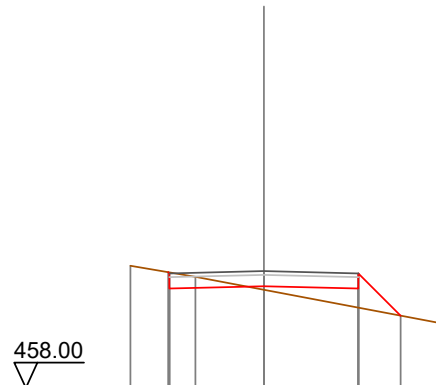

Quote Terreno		461.23		460.60		459.72
Quote Progetto		461.06	460.63	460.69	460.63	459.91
Parziali			2.50		2.50	1.12
Progressiva		-2.53	-2.50	0.00	2.50	3.62
Dislivelli		0.00	-0.03	0.10	0.51	0.00

Sezione: 145
 Progressiva: 1412.467
 Q. Progetto: 461.942

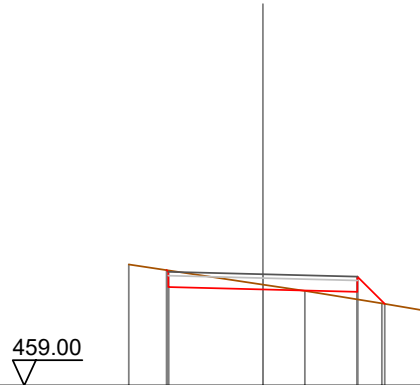

Quote Terreno	462.20	461.60	461.67	461.50	461.17	460.99
Quote Progetto	461.60	461.54	461.48	461.16	460.99	
Parziali		2.50	2.50	0.72		
Progressiva	-2.55	-2.50	0.00	2.50	3.22	
Dislivelli	0.00	-0.04	-0.13	0.20	0.00	

Sezione: 146
 Progressiva: 1418.321
 Q. Progetto: 462.364

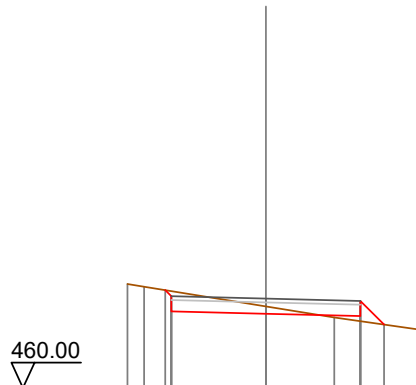

Quote Terreno	462.75	462.68	462.16	461.86	461.53
Quote Progetto	462.59	462.03	461.96	461.90	461.68
Parziali		2.50	2.50	0.62	
Progressiva	-2.86	-2.50	0.00	2.50	3.12
Dislivelli	-0.00	-0.13	-0.19	0.14	0.00

Sezione: 147
 Progressiva: 1420.000
 Q. Progetto: 462.474

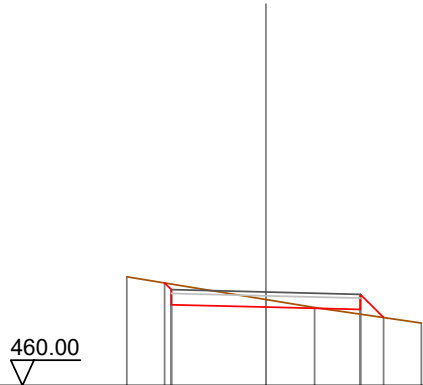

Quote Terreno		462.88		462.27		462.06		461.65
Quote Progetto		462.71		462.07		462.01		461.80
Parziali			2.50		2.50		0.61	
Progressiva		-2.68		0.00		2.50		3.11
Dislivelli		0.00		-0.20		0.12		0.00

Sezione: 148
 Progressiva: 1424.175
 Q. Progetto: 462.723

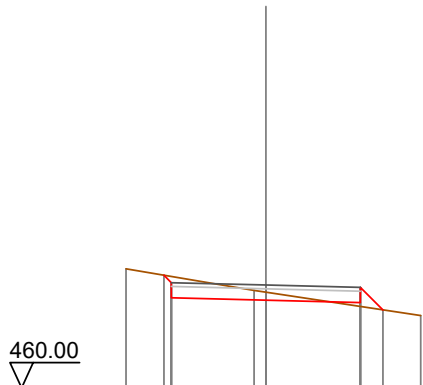

Quote Terreno		463.15		462.58		462.53		461.91
Quote Progetto		462.98		462.32		462.26		462.07
Parziali			2.50		2.50		0.59	
Progressiva		-2.70		0.00		2.50		3.09
Dislivelli		0.00		-0.21		0.11		0.00

Sezione: 149
 Progressiva: 1440.000
 Q. Progetto: 463.348

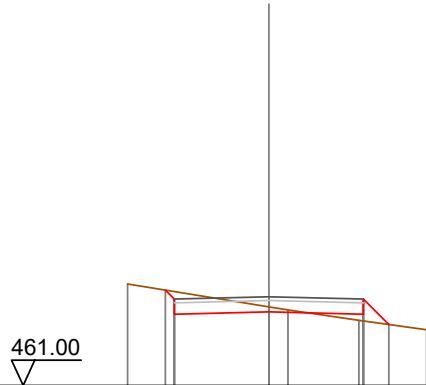

Quote Terreno	463.68	463.08	463.00	462.72	462.48
Quote Progetto	463.52	462.89	462.95	462.89	462.61
Parziali		2.50	2.50	0.67	
Progressiva	-2.74	-2.50	0.00	2.50	3.17
Dislivelli	-0.00	-0.20	-0.13	0.18	-0.00

Sezione: 150
 Progressiva: 1452.892
 Q. Progetto: 463.488

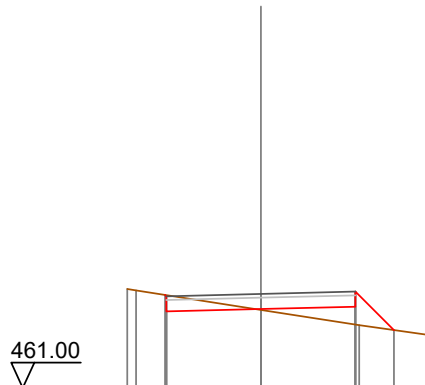

Quote Terreno	463.62	463.06	463.06	462.66	462.39
Quote Progetto	463.58	463.09	463.09	463.15	462.53
Parziali		2.50	2.50	1.02	
Progressiva	-2.53	-2.50	0.00	2.50	3.52
Dislivelli	0.00	-0.03	0.02	0.47	0.00

Sezione: 151
 Progressiva: 1460.000
 Q. Progetto: 463.427

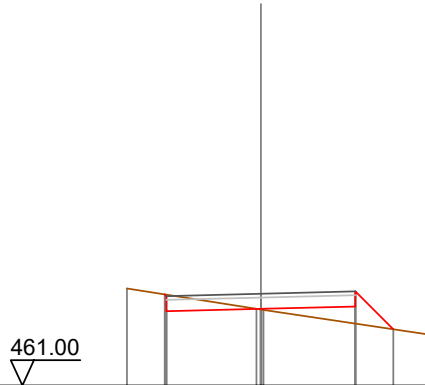

Quote Terreno	463.57	463.03	463.00	462.34
Quote Progetto	463.41	462.96	463.03	462.99
Parziali		2.50	2.50	1.00
Progressiva	-2.54	-2.50	0.00	2.50
Dislivelli	0.00	-0.04	0.02	0.45

Sezione: 152
 Progressiva: 1464.479
 Q. Progetto: 463.377

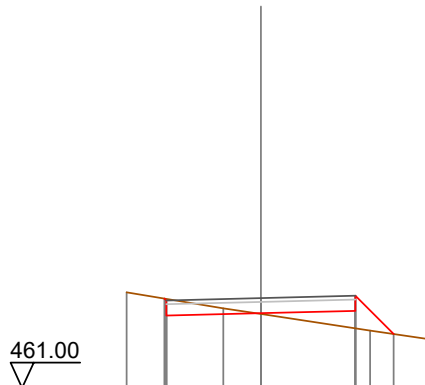

Quote Terreno	463.53	463.11	462.96	462.52	462.28
Quote Progetto	463.37	462.91	462.98	463.04	462.43
Parziali		2.50	2.50	1.01	
Progressiva	-2.55	-2.50	0.00	2.50	3.51
Dislivelli	0.00	-0.04	0.02	0.46	0.00

Sezione: 153
 Progressiva: 1470.000
 Q. Progetto: 463.361

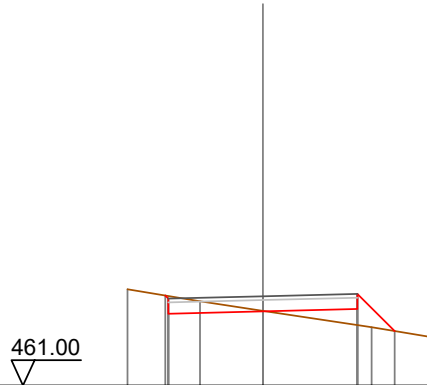

Quote Terreno	463.54	463.23	462.98	462.54	462.27
Quote Progetto	463.38	462.90	462.96	463.02	462.44
Parziali		2.50	2.50	0.98	
Progressiva	-2.58	-2.50	0.00	2.50	3.48
Dislivelli	0.00	-0.07	-0.02	0.43	-0.00

Sezione: 154
 Progressiva: 1476.065
 Q. Progetto: 463.413

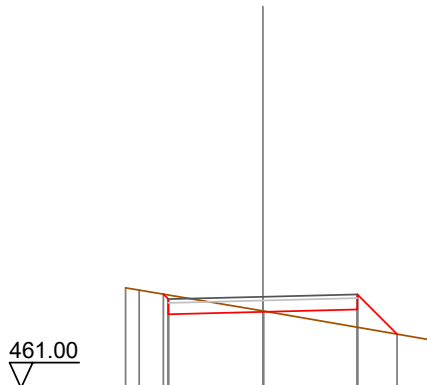

Quote Terreno	463.65	463.59	463.04	463.04	462.25
Quote Progetto	463.48	462.95	463.01	463.08	462.43
Parziali		2.50	2.50	1.05	
Progressiva	-2.63	-2.50	0.00	2.50	3.55
Dislivelli	0.00	-0.11	-0.03	0.47	0.00

Sezione: 155
 Progressiva: 1478.257
 Q. Progetto: 463.445

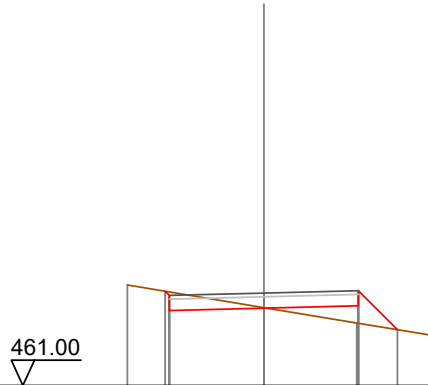

Quote Terreno	463.66	463.06	462.65	462.31
Quote Progetto	463.49 462.98	463.05	463.11 462.48	462.31
Parziali		2.50	2.50	1.03
Progressiva	-2.61 -2.50	0.00	2.50	3.53
Dislivelli	0.00 -0.09	-0.02	0.46	-0.00

Sezione: 156
 Progressiva: 1480.000
 Q. Progetto: 463.471

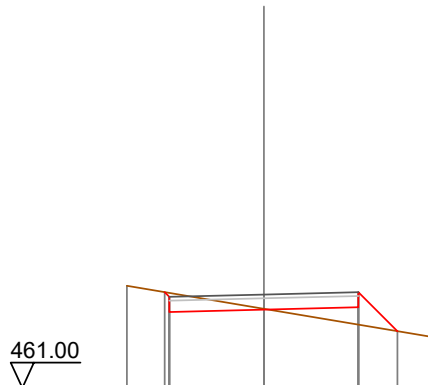

Quote Terreno	463.70	463.09	462.65	462.33
Quote Progetto	463.53 463.01	463.07	463.13 462.50	462.33
Parziali		2.50	2.50	1.03
Progressiva	-2.62 -2.50	0.00	2.50	3.53
Dislivelli	-0.00 -0.10	-0.02	0.46	-0.00

Sezione: 157
 Progressiva: 1485.373
 Q. Progetto: 463.551

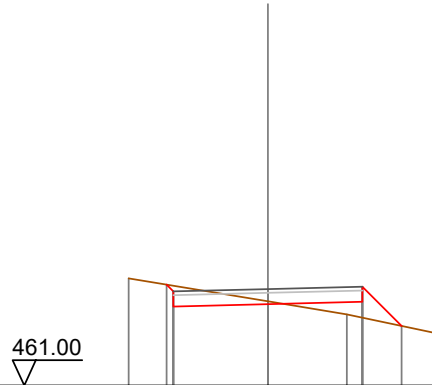

Quote Terreno	463.83		463.23	462.88	462.37
Quote Progetto	463.09		463.15	463.21	462.59
Parziali		2.50	2.50	1.04	
Progressiva	-2.88	-2.50	0.00	2.50	3.54
Dislivelli	-0.00	-0.15	-0.08	0.42	0.00

Sezione: 158
 Progressiva: 1490.000
 Q. Progetto: 463.596

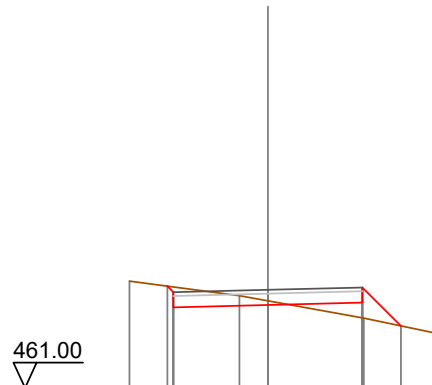

Quote Terreno	463.83		463.44	463.30	462.85	462.43
Quote Progetto	463.09		463.13	463.20	463.26	462.64
Parziali		2.50	2.50	1.02		
Progressiva	-2.86	-2.50	0.00	2.50	3.52	
Dislivelli	0.00	-0.14	-0.11	0.41	0.00	

Sezione: 159
 Progressiva: 1492.490
 Q. Progetto: 463.602

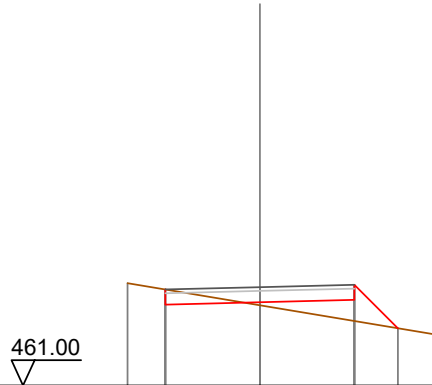

Quote Terreno		463.71	463.12		462.35
Quote Progetto		463.14	463.20	463.26	462.51
Parziali			2.50	2.50	1.15
Progressiva		-2.50	0.00	2.50	3.65
Dislivelli		-0.00	0.08	0.56	-0.00

Sezione: 160
 Progressiva: 1500.000
 Q. Progetto: 463.545

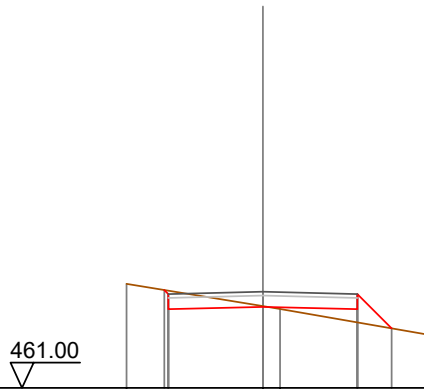

Quote Terreno		463.75	463.16		462.41
Quote Progetto		463.59	463.15	463.08	462.58
Parziali			2.50	2.50	0.90
Progressiva		-2.61	0.00	2.50	3.40
Dislivelli		-0.00	-0.02	0.35	0.00

Sezione: 161
 Progressiva: 1520.000
 Q. Progetto: 463.162

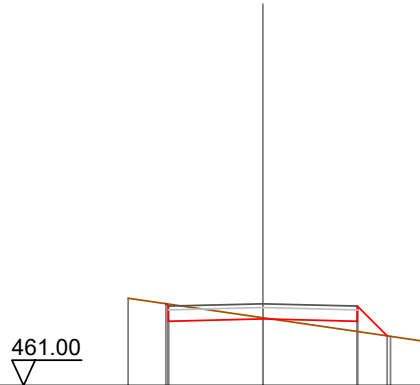

Quote Terreno	463.31	462.79	462.30	462.16
Quote Progetto	463.16 462.70	462.76	462.70 462.31	
Parziali	2.50	2.50	0.79	
Progressiva	-2.57 -2.50	0.00	2.50 3.29	
Dislivelli	-0.00 -0.06	-0.03	0.27 0.00	

Sezione: 162
 Progressiva: 1531.105
 Q. Progetto: 462.969

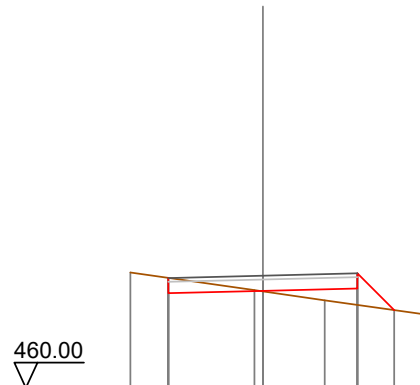

Quote Terreno	463.05	462.59 462.56	462.32	461.92
Quote Progetto	462.51	462.57	462.63 462.06	
Parziali	2.50	2.50	0.97	
Progressiva	-2.51	0.00	2.50 3.47	
Dislivelli	0.00	0.01	0.43 0.00	

Sezione: 163
 Progressiva: 1539.676
 Q. Progetto: 462.959

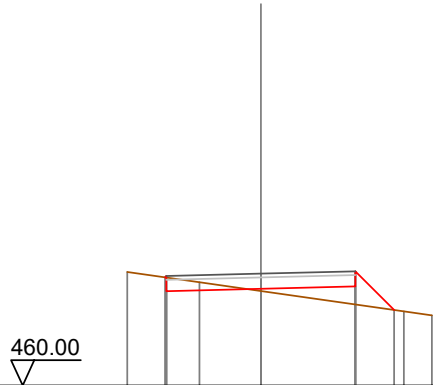

Quote Terreno	463.00	462.73	462.50		461.96	461.86
Quote Progetto		462.86 462.50	462.56		462.62	462.00
Parziali		2.50	2.50		1.02	
Progressiva		-2.54 -2.50	0.00		2.50	3.52
Dislivelli		0.00 0.04	0.06		0.48	0.00

Sezione: 164
 Progressiva: 1540.000
 Q. Progetto: 462.962

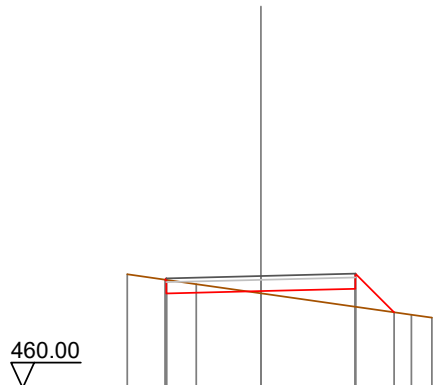

Quote Terreno	463.01	462.75	462.50		461.94	461.86
Quote Progetto		462.86 462.50	462.56		462.62	462.00
Parziali		2.50	2.50		1.02	
Progressiva		-2.54 -2.50	0.00		2.50	3.52
Dislivelli		0.00 0.04	0.06		0.48	0.00

Sezione: 165
 Progressiva: 1548.247
 Q. Progetto: 463.096

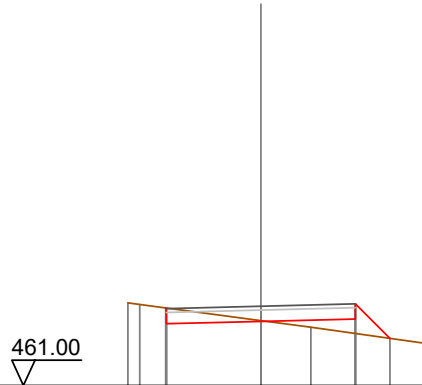

Quote Terreno		463.18	463.14	462.72	462.54	462.11
Quote Progetto		462.63	462.70	462.76	462.25	
Parziali			2.50	2.50	0.91	
Progressiva		-2.52	0.00	2.50	3.41	
Dislivelli		-0.00	-0.02	0.38	-0.00	

Sezione: 166
 Progressiva: 1560.000
 Q. Progetto: 463.515

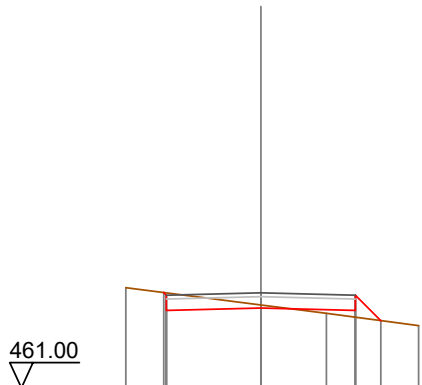

Quote Terreno		463.65	463.20	462.97	462.65
Quote Progetto		463.52	463.11	463.05	462.78
Parziali			2.50	2.50	0.67
Progressiva		-2.57	0.00	2.50	3.17
Dislivelli		-0.00	-0.08	0.18	0.00

Sezione: 167
 Progressiva: 1580.000
 Q. Progetto: 464.196

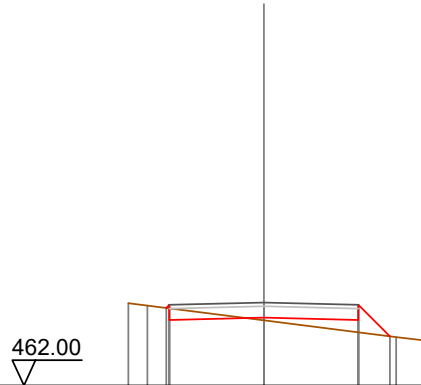

Quote Terreno	464.18	464.11		463.72		463.28	463.18
Quote Progetto	464.05	463.73		463.80		463.73	463.30
Parziali		2.50		2.50		0.83	
Progressiva	-2.58	-2.50		0.00		2.50	3.33
Dislivelli	0.00	0.09		0.07		0.33	0.00

Sezione: 168
 Progressiva: 1600.000
 Q. Progetto: 464.126

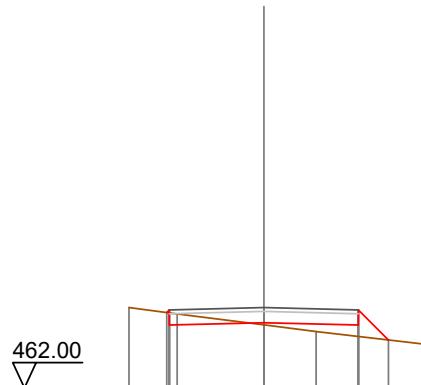

Quote Terreno	464.13	463.96		463.67		463.49	463.15
Quote Progetto	463.99	463.66		463.73		463.66	463.27
Parziali		2.50		2.50		0.79	
Progressiva	-2.57	-2.50		0.00		2.50	3.29
Dislivelli	-0.00	0.08		0.06		0.30	0.00

Sezione: 169
 Progressiva: 1613.772
 Q. Progetto: 463.617

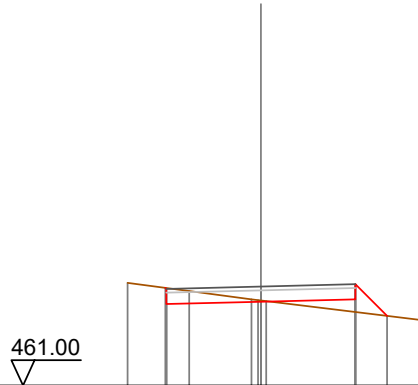

Quote Terreno		463.71		463.28		462.72
Quote Progetto		463.58	463.15	463.22	463.28	462.84
Parziali			2.50	2.50	0.84	
Progressiva		-2.53	-2.50	0.00	2.50	3.34
Dislivelli		-0.00	-0.02	-0.03	0.34	0.00

Sezione: 170
 Progressiva: 1617.380
 Q. Progetto: 463.448

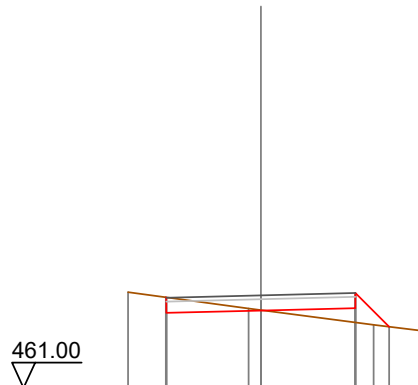

Quote Terreno		463.53		463.10		462.49
Quote Progetto		462.99	463.05	463.11	462.62	
Parziali			2.50	2.50	0.89	
Progressiva		-2.51	0.00	2.50	3.39	
Dislivelli		0.00	-0.01	0.38	0.00	

Sezione: 171
 Progressiva: 1620.000
 Q. Progetto: 463.325

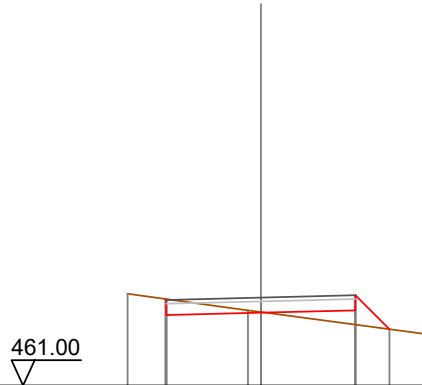

Quote Terreno	463.43	462.99	462.94		462.35
Quote Progetto	463.29	462.86	462.93	462.99	462.49
Parziali		2.50	2.50	0.90	
Progressiva	-2.53	-2.50	0.00	2.50	3.40
Dislivelli	-0.00	-0.02	-0.02	0.38	-0.00

Sezione: 172
 Progressiva: 1620.988
 Q. Progetto: 463.279

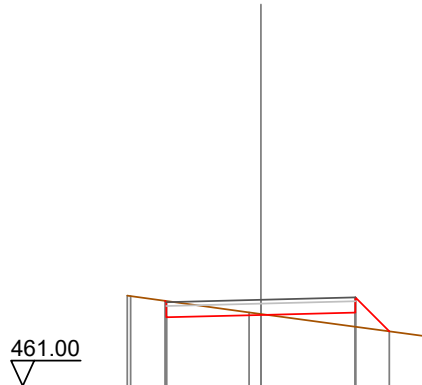

Quote Terreno	463.39	463.38	462.95	462.90	462.31
Quote Progetto	463.25	462.82	462.88	462.94	462.45
Parziali		2.50	2.50	0.89	
Progressiva	-2.54	-2.50	0.00	2.50	3.39
Dislivelli	-0.00	-0.03	-0.02	0.37	-0.00

Sezione: 173
 Progressiva: 1640.000
 Q. Progetto: 462.382

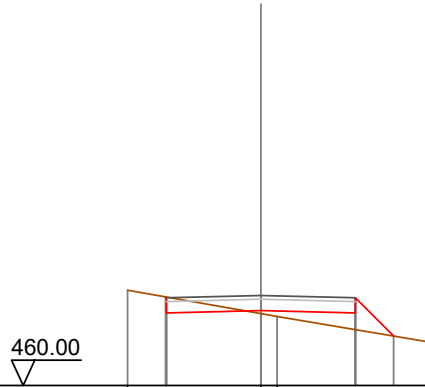

Quote Terreno		462.52		461.90	461.83		461.14
Quote Progetto		462.34	461.92	461.98	461.92	461.31	
Parziali			2.50	2.50	1.01		
Progressiva		-2.52	-2.50	0.00	2.50	3.51	
Dislivelli		0.00	-0.02	0.08	0.44	-0.00	

Sezione: 174
 Progressiva: 1660.000
 Q. Progetto: 461.299

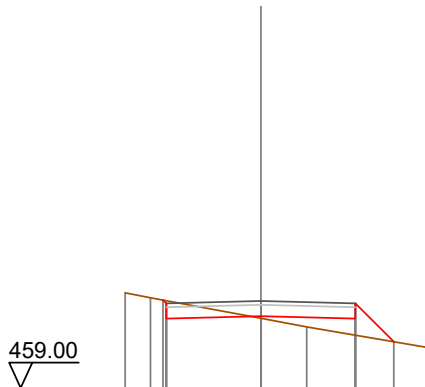

Quote Terreno		461.52		460.84	460.62		460.05
Quote Progetto		461.32	460.84	460.90	460.84	460.22	
Parziali			2.50	2.50	1.01		
Progressiva		-2.59	-2.50	0.00	2.50	3.51	
Dislivelli		-0.00	-0.07	0.06	0.44	-0.00	

Sezione: 175
 Progressiva: 1675.248
 Q. Progetto: 460.471

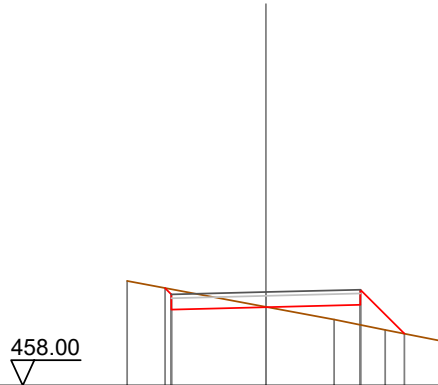

Quote Terreno	-460.76				
Quote Progetto	460.58 460.01		460.07	460.13 459.37	459.17
Parziali		2.50	2.50	1.16	
Progressiva	-2.67 -2.50		0.00	2.50 3.66	
Dislivelli	0.00 -0.14		-0.01	0.53 -0.00	

Sezione: 176
 Progressiva: 1680.000
 Q. Progetto: 460.214

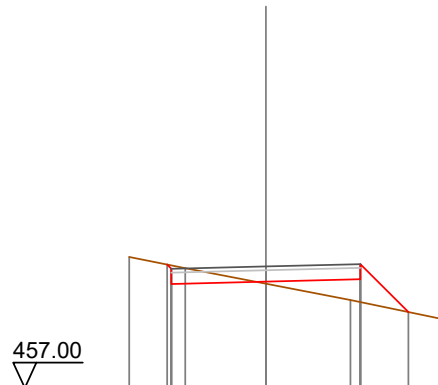

Quote Terreno	-460.46				
Quote Progetto	460.26 459.75		459.81	459.88 459.01	458.80
Parziali		2.50	2.50	1.27	
Progressiva	-2.61 -2.50		0.00	2.50 3.77	
Dislivelli	0.00 -0.09		0.06	0.60 0.00	

Sezione: 177
 Progressiva: 1681.467
 Q. Progetto: 460.134

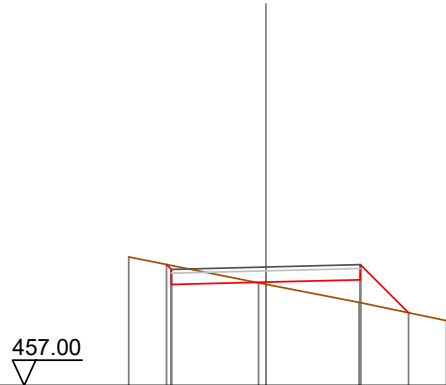

Quote Terreno	-460.40	-459.71	-459.68	-459.20	-458.71
Quote Progetto	460.20	459.67	459.73	459.80	458.92
Parziali		2.50	2.50	1.27	
Progressiva	-2.63	-2.50	0.00	2.50	3.77
Dislivelli	-0.00	-0.10	0.06	0.61	0.00

Sezione: 178
 Progressiva: 1687.686
 Q. Progetto: 459.787

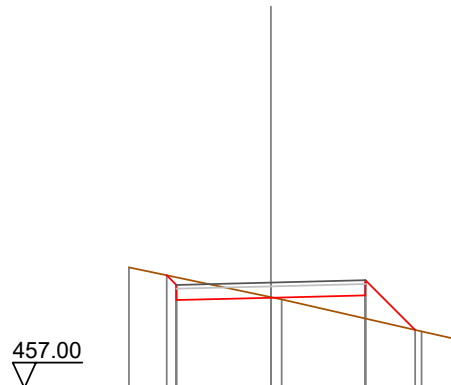

Quote Terreno	-460.19	-459.40	-459.34	-458.50	-458.31
Quote Progetto	459.98	459.32	459.39	459.45	458.54
Parziali		2.50	2.50	1.31	
Progressiva	-2.76	-2.50	0.00	2.50	3.81
Dislivelli	0.00	-0.20	-0.02	0.61	-0.00

Sezione: 179
 Progressiva: 1700.000
 Q. Progetto: 458.891

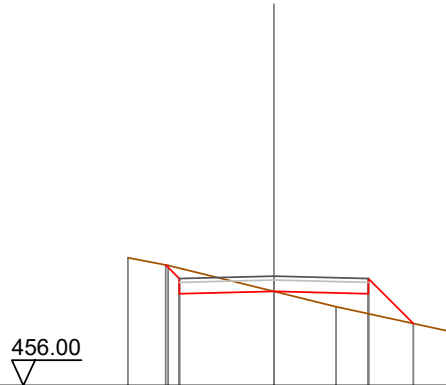

Quote Terreno	-459.38	-459.18	-458.49	-458.09	-457.42
Quote Progetto	-459.19	-458.43	-458.49	-458.43	-457.64
Parziali		0.36	2.50	2.50	1.19
Progressiva		-2.86	0.00	2.50	3.69
Dislivelli		0.00	0.00	0.53	0.00

Sezione: 180
 Progressiva: 1720.000
 Q. Progetto: 457.216

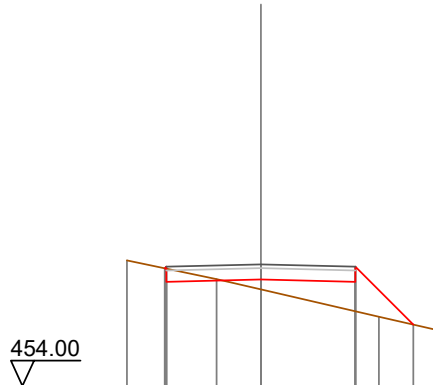

Quote Terreno	-457.32	-456.83	-456.55	-455.83	-455.39
Quote Progetto	-457.11	-456.75	-456.82	-456.75	-455.62
Parziali		2.50	2.50	1.53	
Progressiva		-2.54	0.00	2.50	4.03
Dislivelli		-0.00	0.26	0.78	-0.00

Sezione: 181
 Progressiva: 1733.560
 Q. Progetto: 456.358

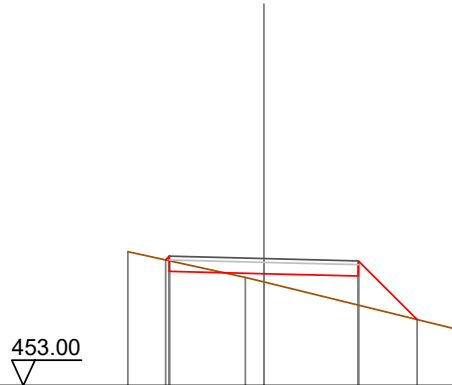

Quote Terreno	456.54		455.86		454.50
Quote Progetto	456.32	456.02	455.96	455.90	454.75
Parziali		2.50	2.50	1.55	
Progressiva	-2.60	-2.50	0.00	2.50	4.05
Dislivelli	0.00	0.12	0.22	0.77	-0.00

Sezione: 182
 Progressiva: 1739.368
 Q. Progetto: 456.103

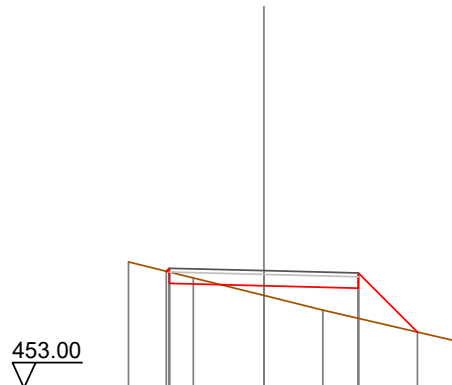

Quote Terreno	456.33		455.91		454.25
Quote Progetto	456.09	455.77	455.70	455.64	454.48
Parziali		2.50	2.50	1.56	
Progressiva	-2.58	-2.50	0.00	2.50	4.06
Dislivelli	0.00	0.10	0.26	0.80	0.00

Sezione: 183
 Progressiva: 1740.000
 Q. Progetto: 456.080

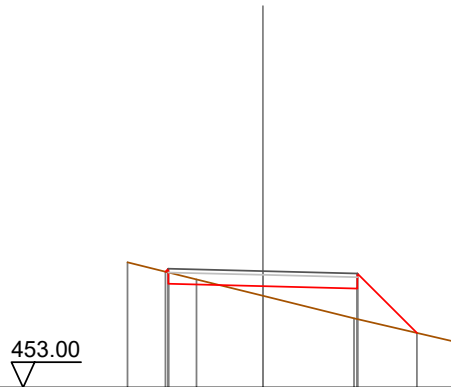

Quote Terreno		456.31	455.86	455.43	454.83	454.21
Quote Progetto		456.06	455.74	455.68	455.62	454.44
Parziali			2.50	2.50	1.57	
Progressiva		-2.58	-2.50	0.00	2.50	4.07
Dislivelli		0.00	0.10	0.25	0.81	0.00

Sezione: 184
 Progressiva: 1745.176
 Q. Progetto: 455.916

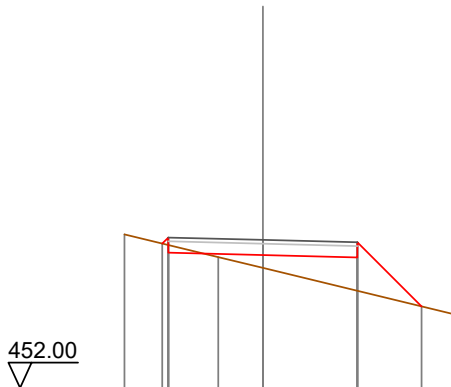

Quote Terreno		456.06	455.46	455.18	454.45	453.92
Quote Progetto		455.82	455.58	455.52	455.45	454.16
Parziali			2.50	2.50	1.70	
Progressiva		-2.86	-2.50	0.00	2.50	4.20
Dislivelli		0.00	0.20	0.34	0.88	0.00

Sezione: 185
 Progressiva: 1748.218
 Q. Progetto: 455.845

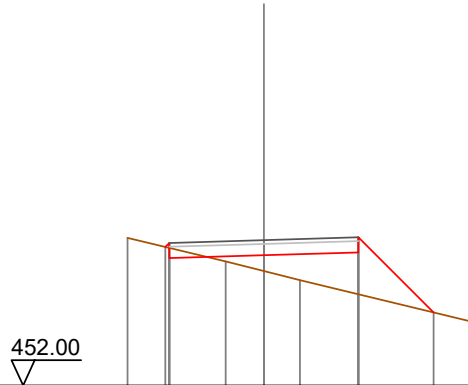

Quote Terreno	455.91	455.28	455.03	454.79	453.69
Quote Progetto	455.67	455.37	455.45	455.52	453.83
Parziali		2.50	2.50	1.99	
Progressiva	-2.61	-2.50	0.00	2.50	4.49
Dislivelli	-0.00	0.13	0.42	1.11	-0.00

Sezione: 186
 Progressiva: 1750.000
 Q. Progetto: 455.812

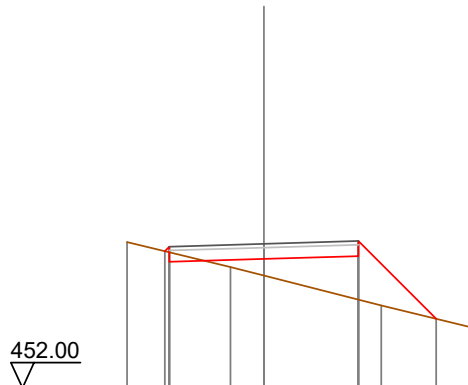

Quote Terreno	455.86	455.20	454.97	454.18	453.59
Quote Progetto	455.62	455.34	455.41	455.49	453.83
Parziali		2.50	2.50	2.06	
Progressiva	-2.62	-2.50	0.00	2.50	4.56
Dislivelli	0.00	0.15	0.44	1.15	-0.00

Sezione: 187
 Progressiva: 1760.000
 Q. Progetto: 455.745

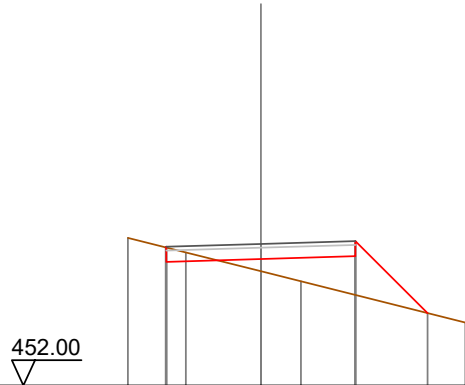

Quote Terreno	-455.90	-455.52	-455.02	-454.76		-453.66
Quote Progetto		455.27	455.34	455.42		453.91
Parziali		2.50	2.50	1.91		
Progressiva		-2.52	0.00	2.50		4.41
Dislivelli		0.00	0.32	1.03		0.00

Sezione: 187
 Progressiva: 1760.000
 Q. Progetto: 455.745

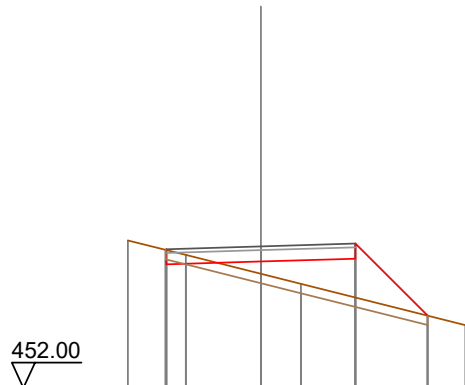

Quote Terreno	-455.90	-455.52	-455.02	-454.76		-453.66
Quote Progetto		455.27	455.34	455.42		453.91
Parziali		2.50	2.50	1.91		
Progressiva		-2.52	0.00	2.50		4.41
Dislivelli		0.00	0.32	1.03		0.00

Sezione: 188
 Progressiva: 1770.000
 Q. Progetto: 455.878

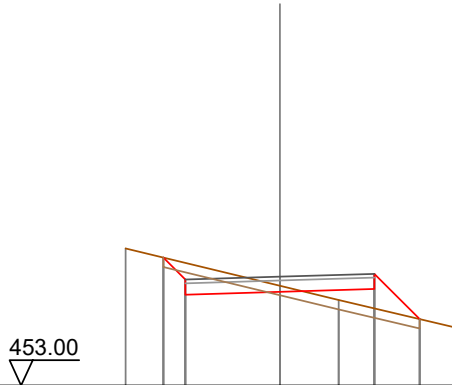

Quote Terreno		456.63		455.64	455.26		454.52
Quote Progetto		456.38	455.40	455.48	455.55	454.76	
Parziali		0.58	2.50	2.50	1.20		
Progressiva		-3.08	-2.50	0.00	2.50	3.70	
Dislivelli		-0.00	-0.44	-0.16	0.51	0.00	

Sezione: 189
 Progressiva: 1775.504
 Q. Progetto: 456.036

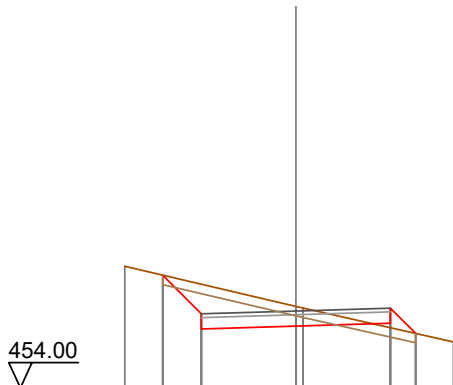

Quote Terreno		457.22		456.16	456.11		455.22
Quote Progetto		456.98	455.56	455.64	455.71	455.44	
Parziali		1.02	2.50	2.50	0.67		
Progressiva		-3.52	-2.50	0.00	2.50	3.17	
Dislivelli		0.00	-0.78	-0.52	0.12	0.00	

Sezione: 190
 Progressiva: 1780.000
 Q. Progetto: 456.211

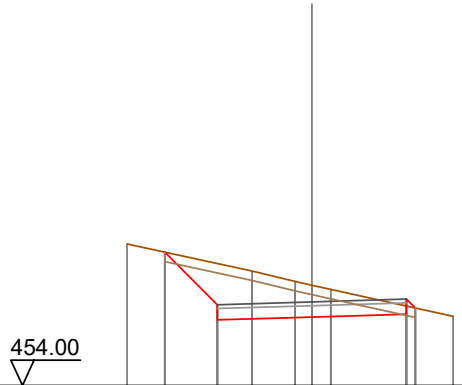

Quote Terreno		-457.74		-457.03	-456.75	-456.65	-456.54		-455.83
Quote Progetto			457.53	455.74		455.81		455.89	456.05
Parziali			1.39	2.50		2.50			
Progressiva			-3.89	-2.50		0.00		2.50	2.73
Dislivelli			0.00	-1.09		-0.84		-0.22	-0.00

Sezione: 191
 Progressiva: 1790.000
 Q. Progetto: 456.682

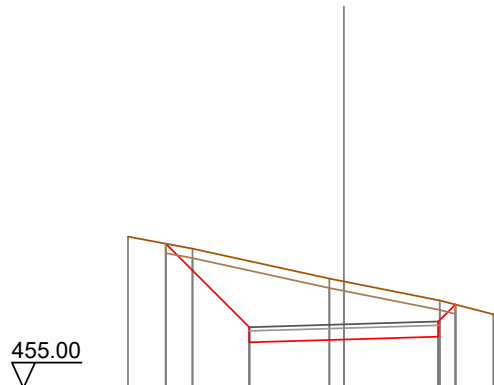

Quote Terreno		-459.00		-458.69		-457.90	-457.82		-457.31	-456.95
Quote Progetto			458.82		456.21		456.28		456.36	457.21
Parziali			2.21		2.50		2.50		0.45	
Progressiva			-4.71		-2.50		0.00		2.50	2.95
Dislivelli			0.00		-1.75		-1.54		-0.96	-0.00

Sezione: 192
 Progressiva: 1800.000
 Q. Progetto: 457.129

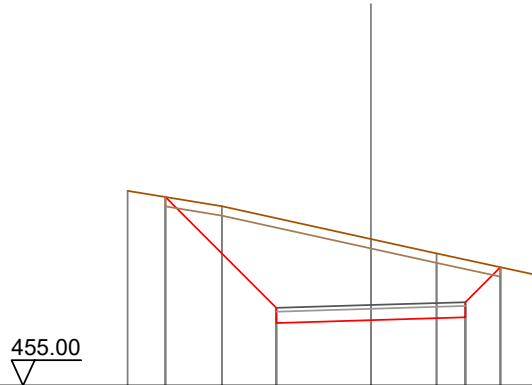

Quote Terreno		-460.15	-459.74	-458.87	-458.49	-457.91
Quote Progetto		459.99	456.65	456.73	456.80	458.13
Parziali			2.93	2.50	2.50	0.93
Progressiva		-5.43	-2.50	0.00	2.50	3.43
Dislivelli		0.00	-2.37	-2.15	-1.52	-0.00

Sezione: 193
 Progressiva: 1802.791
 Q. Progetto: 457.223

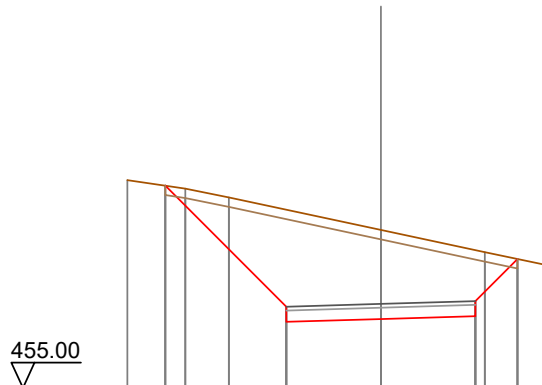

Quote Terreno		-460.50	-460.27	-460.04	-459.18	-458.59	-458.20
Quote Progetto		460.35	456.75	456.82	456.90	458.41	
Parziali			3.20	2.50	2.50	1.11	
Progressiva		-5.70	-2.50	0.00	2.50	3.61	
Dislivelli		0.00	-2.57	-2.36	-1.74	-0.00	

Sezione: 194
 Progressiva: 1804.865
 Q. Progetto: 457.284

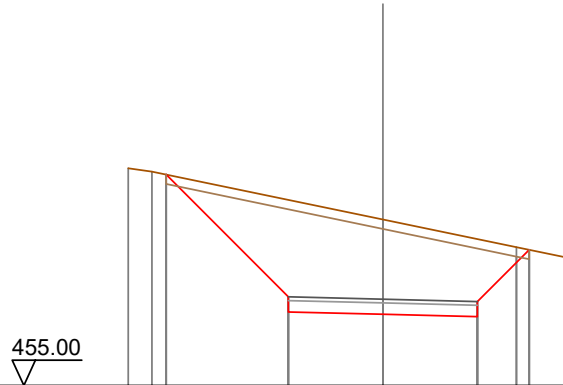

Quote Terreno	-460.75	-460.66		-459.39	-458.66	-458.38
Quote Progetto		460.68	456.95	456.88	456.82	458.59
Parziali		3.23	2.50	2.50	1.37	
Progressiva		-5.73	-2.50	0.00	2.50	3.87
Dislivelli		-0.00	-2.56	-2.51	-2.05	0.00

Sezione: 195
 Progressiva: 1810.000
 Q. Progetto: 457.396

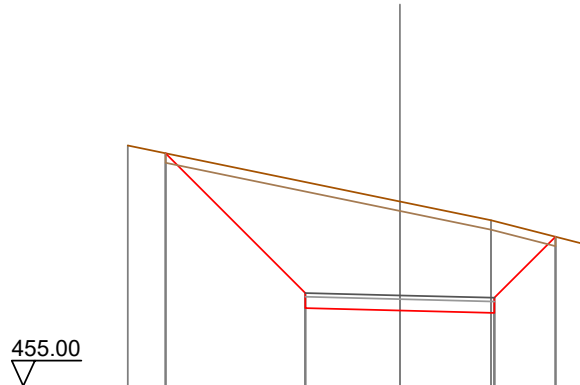

Quote Terreno	-461.36		-459.88	-459.38	-458.71	-458.69
Quote Progetto		461.15	457.06	457.00	456.93	458.95
Parziali		3.70	2.50	2.50	1.61	
Progressiva		-6.20	-2.50	0.00	2.50	4.11
Dislivelli		0.00	-2.94	-2.88	-2.43	0.00

Sezione: 196
 Progressiva: 1820.000
 Q. Progetto: 457.465

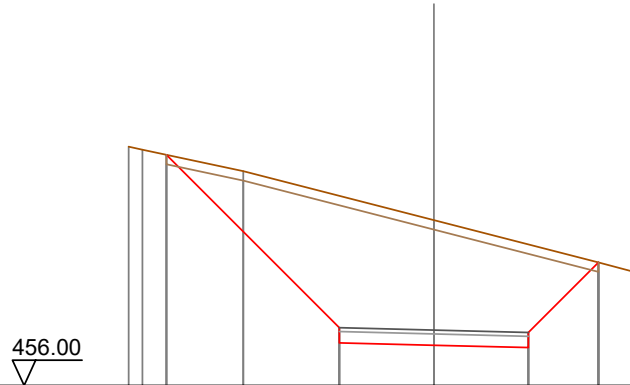

Quote Terreno		-462.32 -462.24		-461.67		-460.37		-459.26		-458.99
Quote Progetto			462.10		457.13		457.06		457.00	
Parziali				4.57		2.50		2.50		1.85
Progressiva			-7.07		-2.50		0.00		2.50	
Dislivelli			0.00		-3.49		-3.31		-2.73	

Sezione: 197
 Progressiva: 1830.000
 Q. Progetto: 457.465

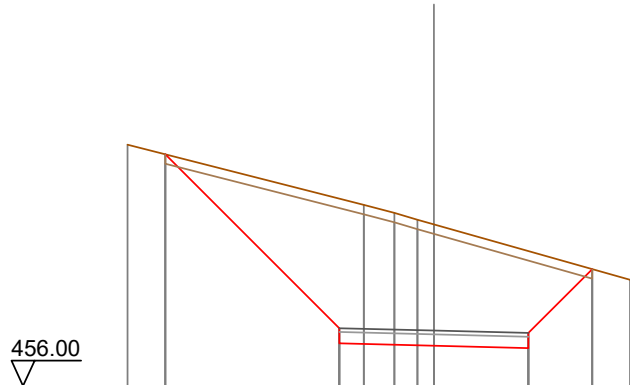

Quote Terreno		-462.38		-460.79		-460.58		-460.40		-460.27		-458.81
Quote Progetto			462.13		457.13		457.06		457.00		459.09	
Parziali				4.60		2.50		2.50		1.69		
Progressiva			-7.10		-2.50		0.00		2.50		4.19	
Dislivelli			0.00		-3.43		-3.21		-2.56		-0.00	

Sezione: 198
 Progressiva: 1833.528
 Q. Progetto: 457.448

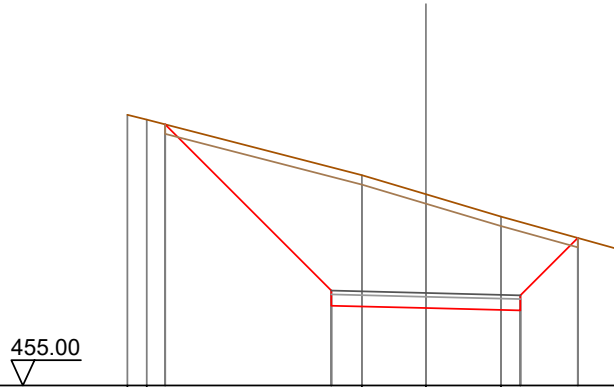

Quote Terreno	-462.16	-462.03	-460.56	-460.06	-459.47	-458.63
Quote Progetto	461.90	457.11	457.05	456.99	458.90	
Parziali		4.39	2.50	2.50	1.52	
Progressiva	-6.89	-2.50	0.00	2.50	4.02	
Dislivelli	0.00	-3.26	-3.01	-2.34	0.00	

Sezione: 199
 Progressiva: 1840.000
 Q. Progetto: 457.353

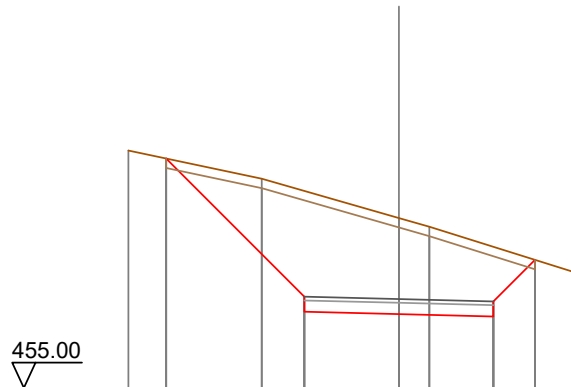

Quote Terreno	-461.28	-460.54	-459.50	-459.26	-458.08
Quote Progetto	461.07	457.02	456.95	456.89	458.39
Parziali		3.65	2.50	2.50	1.10
Progressiva	-6.15	-2.50	0.00	2.50	3.60
Dislivelli	0.00	-2.80	-2.54	-1.84	-0.00

Sezione: 200
 Progressiva: 1850.000
 Q. Progetto: 457.040

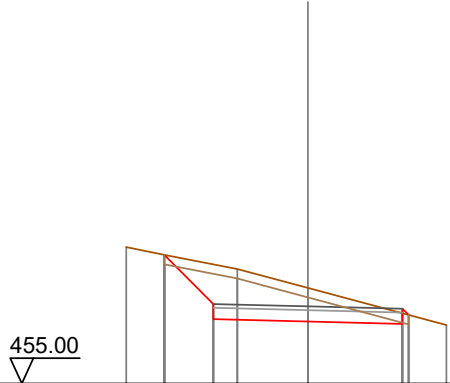

Quote Terreno		458.61	458.40	458.03	457.53	456.55
Quote Progetto		458.41	456.70	456.64	456.59	456.82
Parziali			1.30	2.50	2.50	
Progressiva			-3.80	-2.50	0.00	2.50
Dislivelli			0.00	-1.05	-0.89	-0.28
						-0.00

Sezione: 201
 Progressiva: 1860.000
 Q. Progetto: 456.528

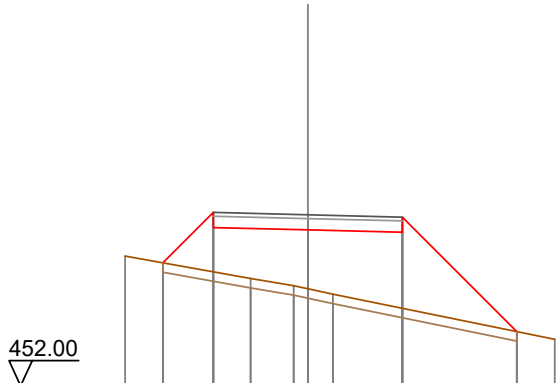

Quote Terreno		455.43	454.84	454.65	454.43	453.24
Quote Progetto		455.26	456.19	456.13	456.07	453.44
Parziali			1.33	2.50	2.50	3.03
Progressiva			-3.83	-2.50	0.00	2.50
Dislivelli			-0.00	1.57	1.56	2.01
						-0.00

Sezione: 202
 Progressiva: 1862.191
 Q. Progetto: 456.388

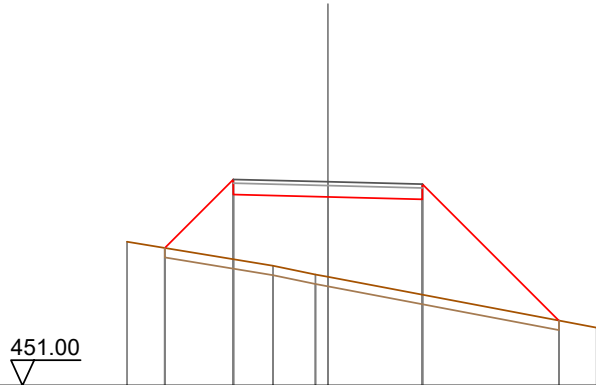

Quote Terreno		-454.80		-454.17	-453.94	-453.87				
Quote Progetto			454.64	456.05		455.99	455.93		452.72	
Parziali			1.81	2.50		2.50	3.61			
Progressiva			-4.31	-2.50	0.00	2.50		6.11		
Dislivelli		0.00	2.11		2.11	2.52		0.00		

Sezione: 203
 Progressiva: 1864.028
 Q. Progetto: 456.264

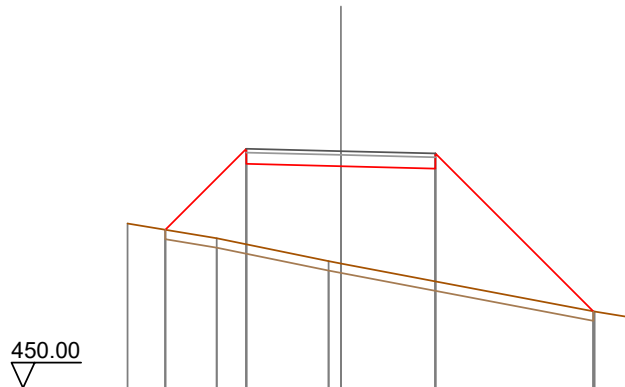

Quote Terreno		-454.35		-453.96	-453.35	-453.29				
Quote Progetto			454.19	455.93		455.86	455.80		452.03	451.87
Parziali			2.14	2.50		2.50	4.17			
Progressiva			-4.64	-2.50	0.00	2.50		6.67		
Dislivelli		0.00	2.53		2.57	2.98		0.00		

Sezione: 204
 Progressiva: 1870.000
 Q. Progetto: 455.856

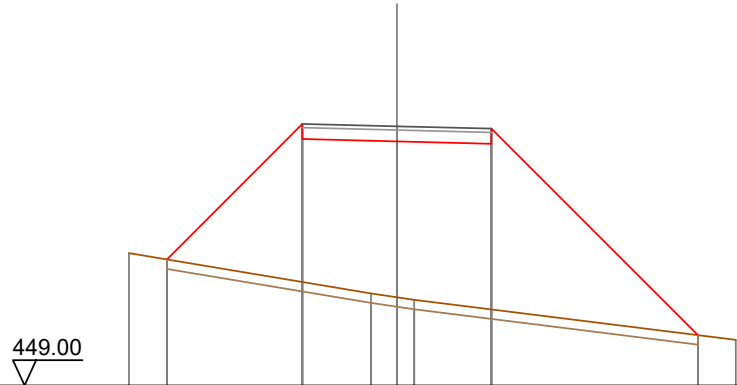

Quote Terreno		-452.50		-451.44		-450.21
Quote Progetto		452.33	455.52	455.46	455.39	450.33
Parziali			3.58	2.50	2.50	5.46
Progressiva		-6.08	-2.50	0.00	2.50	7.96
Dislivelli		0.00	4.18	4.12	4.38	0.00

Sezione: 205
 Progressiva: 1880.000
 Q. Progetto: 455.173

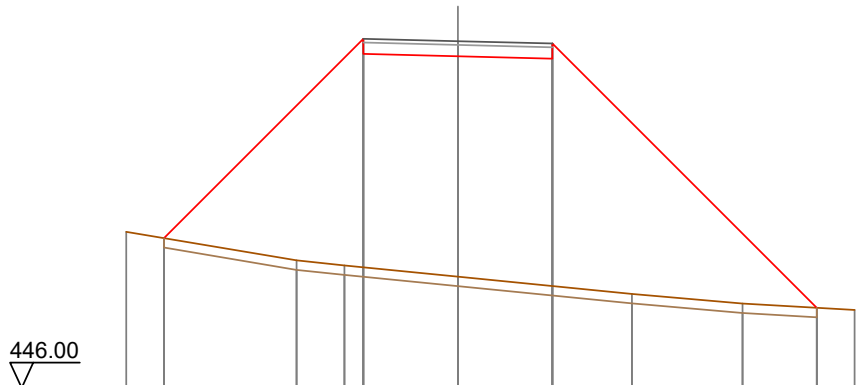

Quote Terreno		450.13	449.37	449.24	448.94	448.49	448.23	448.06
Quote Progetto		449.96	454.84	454.77	454.71	448.12		
Parziali			5.27	2.50	2.50	6.99		
Progressiva		-7.77	-2.50	0.00	2.50	9.49		
Dislivelli		0.00	6.05	5.83	6.01	-0.00		

Sezione: 205
 Progressiva: 1880.000
 Q. Progetto: 455.173

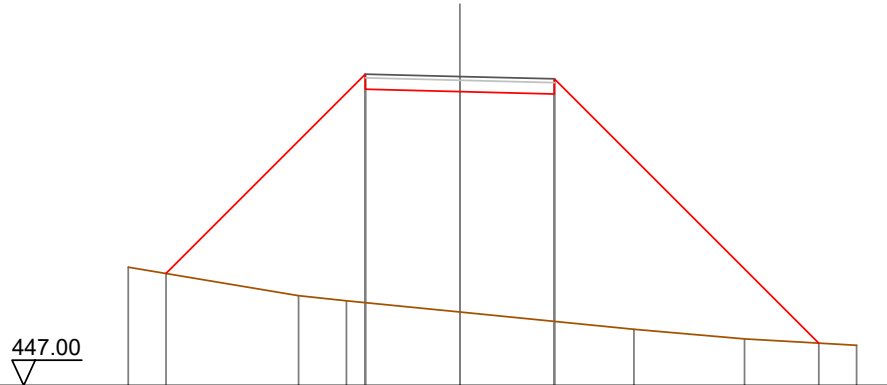

Quote Terreno	-450.13	-449.37	-449.24	-448.94	-448.49	-448.23	-448.06
Quote Progetto	449.96	454.84	454.77	454.71		448.12	
Parziali		5.27	2.50	2.50	6.99		
Progressiva	-7.77		-2.50	0.00	2.50		9.49
Dislivelli	0.00		6.05	5.83	6.01		0.00

Sezione: 206
 Progressiva: 1890.000
 Q. Progetto: 454.490

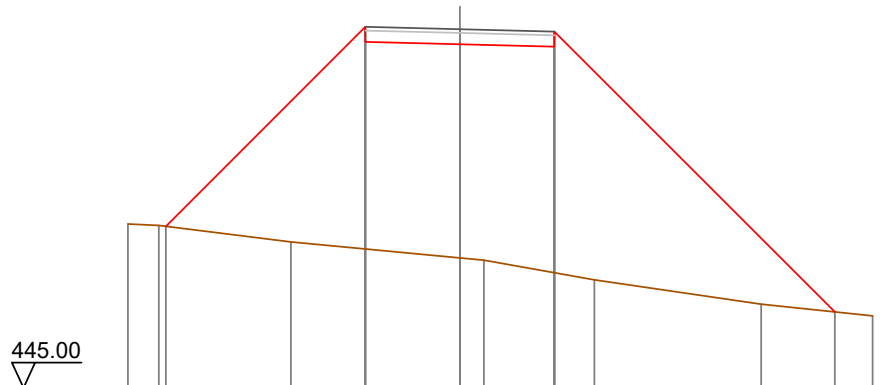

Quote Terreno	449.34	449.30	448.86	448.44	448.38	447.86	447.22	446.91
Quote Progetto	449.27	454.15	454.09	454.03		447.01		
Parziali		5.28	2.50	2.50	7.41			
Progressiva	-7.78		-2.50	0.00	2.50			9.91
Dislivelli	0.00		5.87	5.65	5.98			0.00

Sezione: 207
 Progressiva: 1894.781
 Q. Progetto: 454.160

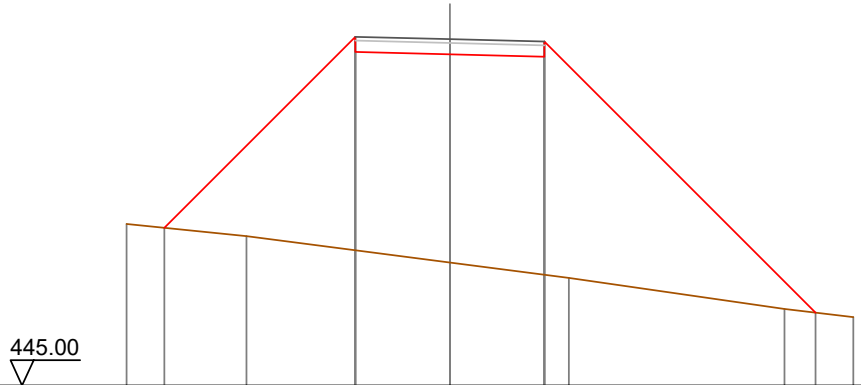

Quote Terreno	-449.27	-448.95	-453.82	-448.25	-447.85	-447.02	-446.81
Quote Progetto	449.17		453.82	453.76	453.70	446.93	
Parziali		5.05	2.50	2.50		7.17	
Progressiva	-7.55		-2.50	0.00	2.50		9.67
Dislivelli	0.00		5.65	5.51	5.77		0.00

Sezione: 208
 Progressiva: 1900.000
 Q. Progetto: 453.758

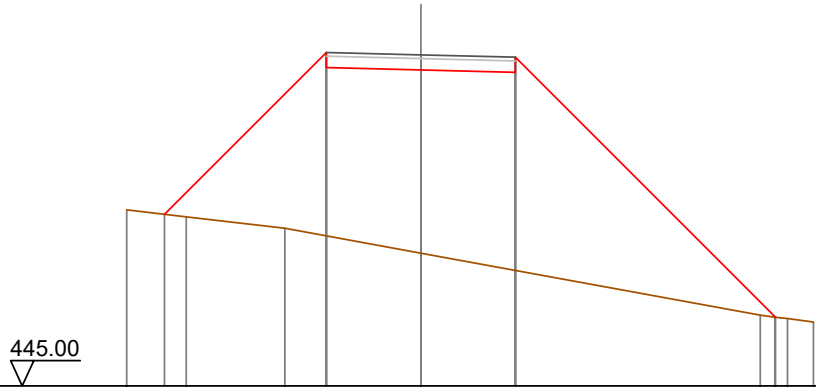

Quote Terreno	-449.66	-449.47	-449.17	-448.51		-446.87	-446.79	-446.69
Quote Progetto	449.54		453.42	453.36	453.30	446.82		
Parziali		4.28	2.50	2.50		6.88		
Progressiva	-6.78		-2.50	0.00	2.50		9.38	
Dislivelli	0.00		4.85	4.84	5.24		-0.00	

Sezione: 209
 Progressiva: 1910.000
 Q. Progetto: 452.953

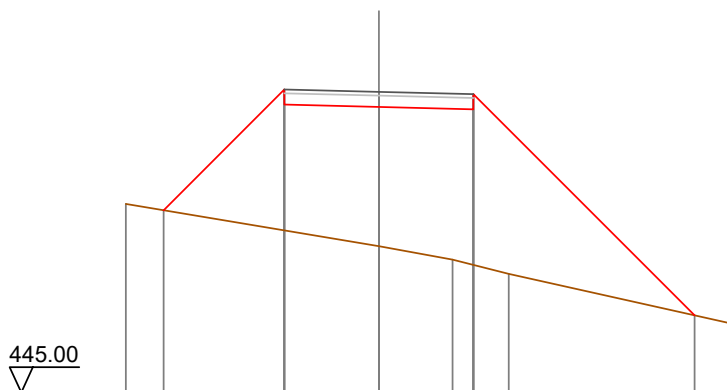

Quote Terreno	-449.99									-446.82
Quote Progetto		449.82	452.82	452.55	452.49					447.04
Parziali		3.19	2.50	2.50	5.85					
Progressiva		-5.69	-2.50	0.00	2.50					8.35
Dislivelli		-0.00	3.73	3.68	4.11					0.00

Sezione: 210
 Progressiva: 1920.000
 Q. Progetto: 452.147

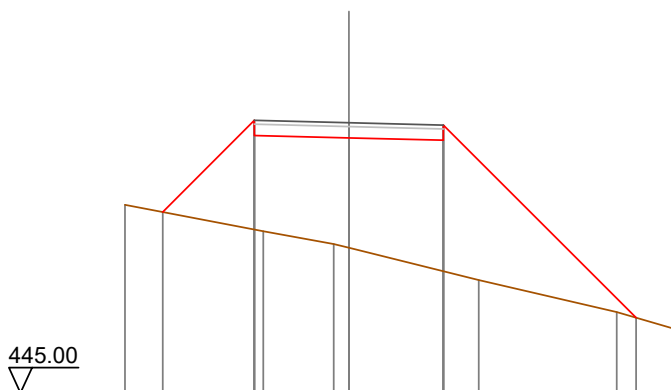

Quote Terreno	-449.98									
Quote Progetto		449.79	451.81	451.75	451.68					446.99
Parziali		2.42	2.50	2.50	5.09					
Progressiva		-4.92	-2.50	0.00	2.50					7.59
Dislivelli		0.00	2.88	2.91	3.46					-0.00

Sezione: 211
 Progressiva: 1925.534
 Q. Progetto: 451.701

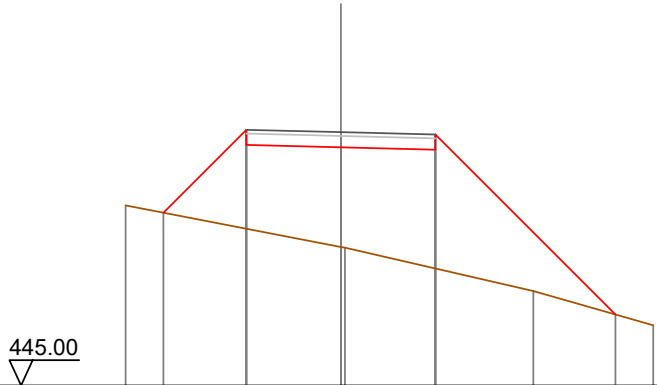

Quote Terreno		449.76		448.66	448.64		447.50		446.59
Quote Progetto		449.57	451.36	451.30	451.30	451.24		446.88	
Parziali			2.19	2.50	2.50		4.76		
Progressiva		-4.69	-2.50	0.00	2.50		7.26		
Dislivelli		0.00	2.62	2.64	3.15		-0.00		

Sezione: 212
 Progressiva: 1931.939
 Q. Progetto: 451.185

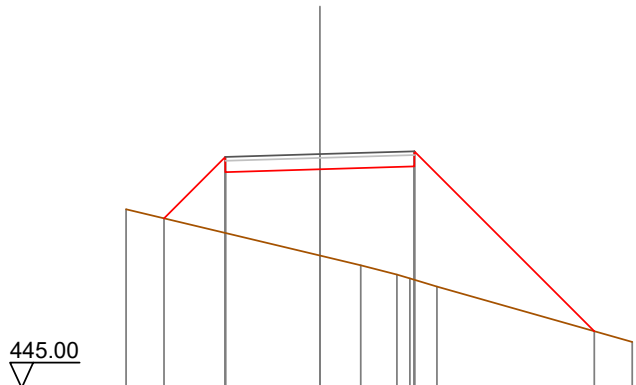

Quote Terreno		449.72		448.50	448.25	448.00	447.90	447.68		446.22
Quote Progetto		449.49	450.71	450.78	450.86	450.86	446.50			
Parziali			1.62	2.50	2.50		4.76			
Progressiva		-4.12	-2.50	0.00	2.50		7.26			
Dislivelli		0.00	2.01	2.28	3.00		-0.00			

Sezione: 213
 Progressiva: 1940.000
 Q. Progetto: 450.535

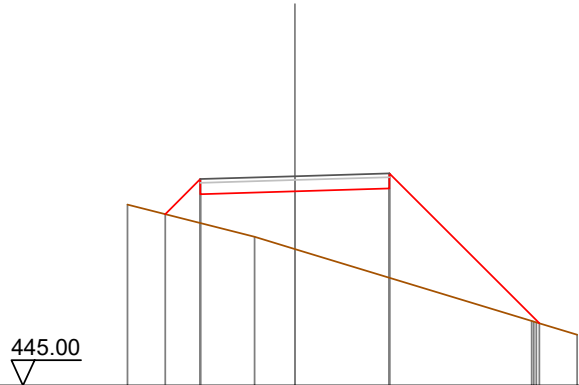

Quote Terreno		449.79		448.93	448.61		446.71	446.67	446.34
Quote Progetto			449.53	450.06	450.14	450.21		446.85	
Parziali			0.93	2.50	2.50		3.96		
Progressiva			-3.43	-2.50	0.00	2.50		6.46	
Dislivelli		0.00	1.16		1.53	2.36		-0.00	

Sezione: 214
 Progressiva: 1940.262
 Q. Progetto: 450.514

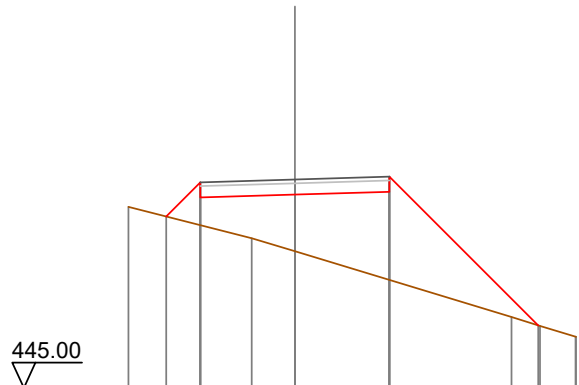

Quote Terreno		449.79		448.96	448.62		446.88	446.64	446.35
Quote Progetto			449.54	450.04	450.11	450.19		446.65	
Parziali			0.90	2.50	2.50		3.93		
Progressiva			-3.40	-2.50	0.00	2.50		6.43	
Dislivelli		0.00	1.13		1.50	2.33		0.00	

Sezione: 215
 Progressiva: 1948.585
 Q. Progetto: 449.872

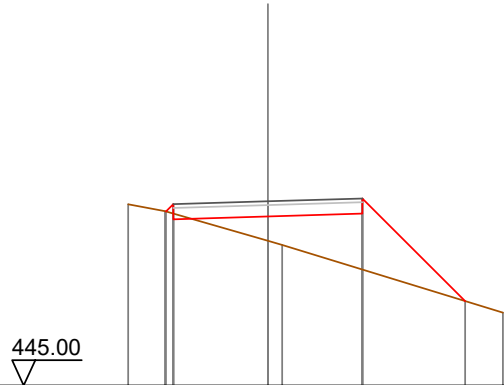

Quote Terreno	-449.79	-449.61	-448.93	-448.72	-446.93
Quote Progetto	449.60	449.40	449.47	449.55	447.23
Parziali		2.50	2.50	2.71	
Progressiva	-2.70	-2.50	0.00	2.50	5.21
Dislivelli	0.00	0.25	0.65	1.48	-0.00

Sezione: 216
 Progressiva: 1952.384
 Q. Progetto: 449.622

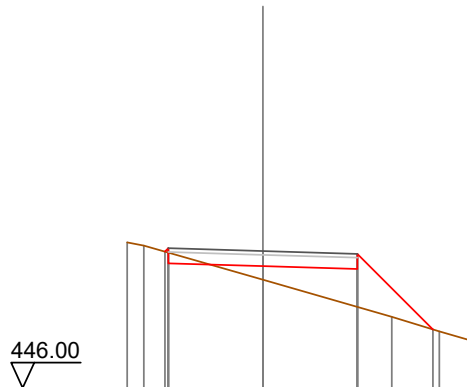

Quote Terreno	-449.85	-449.77	-448.86	-447.88	-447.50	-447.26
Quote Progetto	449.61	449.30	449.22	449.15	447.55	
Parziali		2.50	2.50	2.00		
Progressiva	-2.59	-2.50	0.00	2.50	4.50	
Dislivelli	-0.00	0.12	0.36	1.00	-0.00	

Sezione: 217
 Progressiva: 1960.000
 Q. Progetto: 449.207

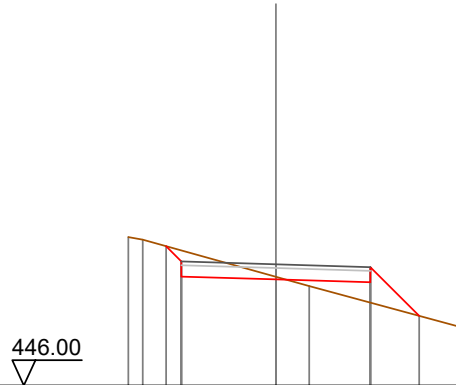

Quote Terreno	-449.93	-449.86	-448.88	-448.63	-447.57
Quote Progetto	449.88	448.88	448.81	448.73	447.84
Parziali		0.40	2.50	2.50	1.29
Progressiva		-2.90	0.00	2.50	3.79
Dislivelli		0.00	-0.07	0.54	0.00

Sezione: 218
 Progressiva: 1970.000
 Q. Progetto: 448.838

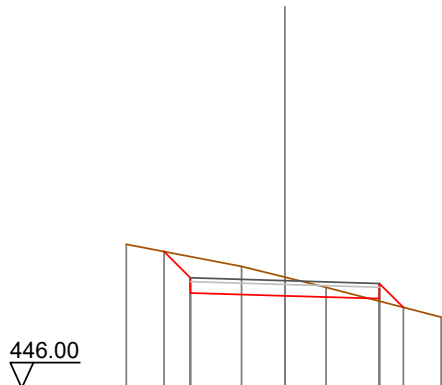

Quote Terreno	-449.80	-449.22	-448.93	-448.66	-447.87
Quote Progetto	449.61	448.51	448.44	448.36	448.13
Parziali		0.69	2.50	2.50	0.63
Progressiva		-3.19	0.00	2.50	3.13
Dislivelli		0.00	-0.49	0.07	-0.00

Sezione: 219
 Progressiva: 1970.414
 Q. Progetto: 448.827

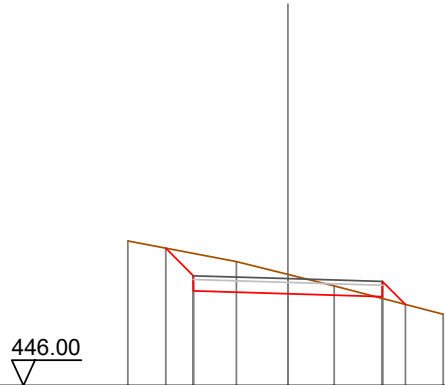

Quote Terreno		-449.82		-449.28		-448.94		-448.63		-447.88
Quote Progetto			449.63	448.50		448.43		448.35	448.14	
Parziali			0.73	2.50		2.50		0.61		
Progressiva			-3.23	-2.50		0.00		2.50	3.11	
Dislivelli			0.00	-0.59		-0.51		0.05	-0.00	

Sezione: 220
 Progressiva: 1980.000
 Q. Progetto: 448.571

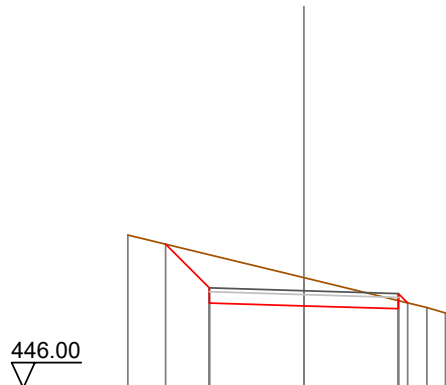

Quote Terreno		-450.05		-448.92		-448.13		-447.98	
Quote Progetto			449.80	448.25		448.17		448.10	448.25
Parziali			1.16	2.50		2.50			
Progressiva			-3.66	-2.50		0.00		2.50	2.74
Dislivelli			0.00	-0.88		-0.75		-0.22	0.00

Sezione: 221
 Progressiva: 1988.444
 Q. Progetto: 448.345

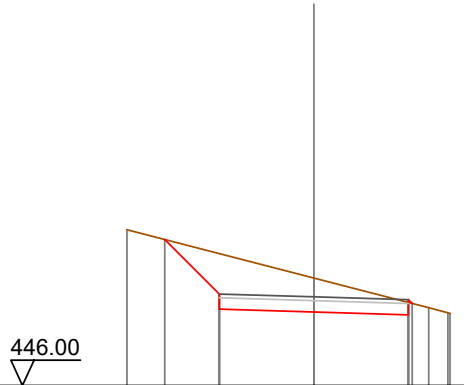

Quote Terreno		450.12			448.84		448.06	447.91
Quote Progetto			449.86	448.02	447.94		447.87	448.17
Parziali			1.44	2.50	2.50			
Progressiva			-3.94	-2.50	0.00		2.50	2.60
Dislivelli			-0.00	-1.07	-0.90		-0.33	0.00

Sezione: 222
 Progressiva: 2000.000
 Q. Progetto: 448.036

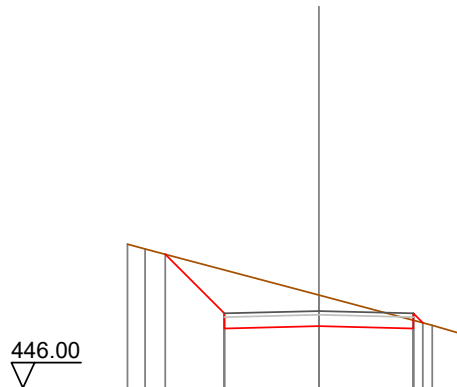

Quote Terreno		449.80			448.46		448.66	447.44
Quote Progetto			449.54	447.57	447.64		447.57	447.72
Parziali			1.56	2.50	2.50			
Progressiva			-4.06	-2.50	0.00		2.50	2.75
Dislivelli			0.00	-1.15	-0.82		-0.22	0.00

Sezione: 223
 Progressiva: 2020.000
 Q. Progetto: 447.501

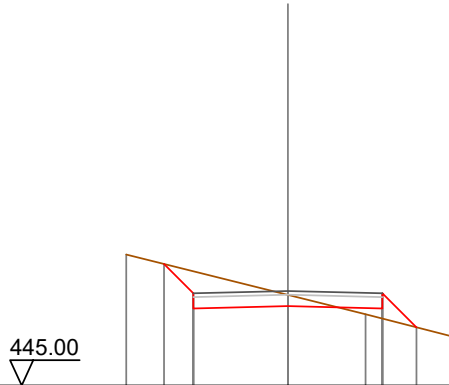

Quote Terreno		448.47		447.40	446.88	446.28
Quote Progetto		448.22	447.04	447.10	447.04	446.54
Parziali		0.78	2.50	2.50	0.90	
Progressiva		-3.28	-2.50	0.00	2.50	3.40
Dislivelli		-0.00	-0.58	-0.30	0.27	-0.00

Sezione: 224
 Progressiva: 2040.000
 Q. Progetto: 446.966

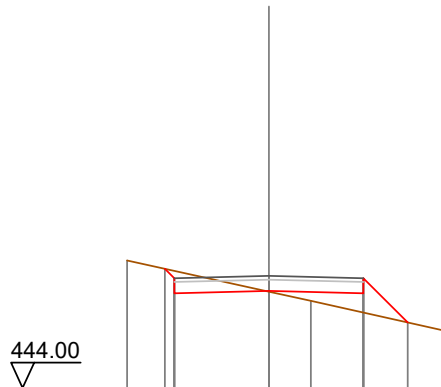

Quote Terreno		447.37		446.55	446.30	445.51
Quote Progetto		447.15	446.50	446.57	446.50	445.73
Parziali			2.50	2.50	1.17	
Progressiva		-2.75	-2.50	0.00	2.50	3.67
Dislivelli		-0.00	-0.19	0.02	0.51	0.00

Sezione: 225
 Progressiva: 2060.000
 Q. Progetto: 446.431

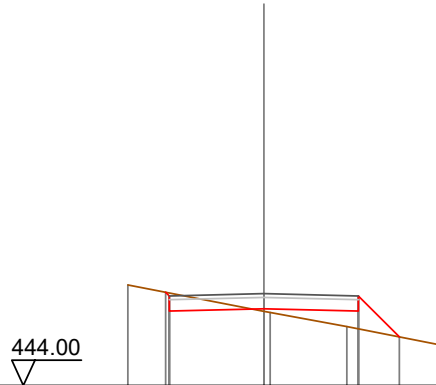

Quote Terreno	446.66		445.96	445.93	445.56	445.09
Quote Progetto	446.47	445.97	446.03	445.97	445.29	
Parziali		2.50	2.50	1.08		
Progressiva	-2.60	-2.50	0.00	2.50	3.58	
Dislivelli	-0.00	-0.08	0.07	0.47	0.00	

Sezione: 226
 Progressiva: 2080.000
 Q. Progetto: 445.865

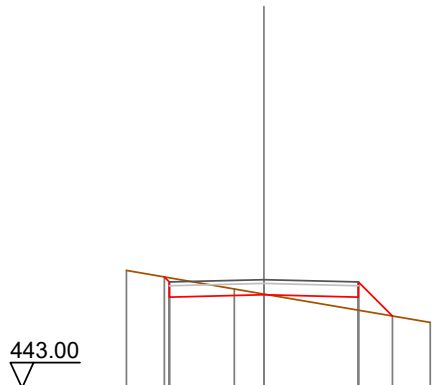

Quote Terreno	446.11		445.62	445.48	444.73
Quote Progetto	445.94	445.40	445.46	445.40	444.90
Parziali		2.50	2.50	0.90	
Progressiva	-2.63	-2.50	0.00	2.50	3.40
Dislivelli	-0.00	-0.11	-0.02	0.35	0.00

Sezione: 227
 Progressiva: 2085.315
 Q. Progetto: 445.635

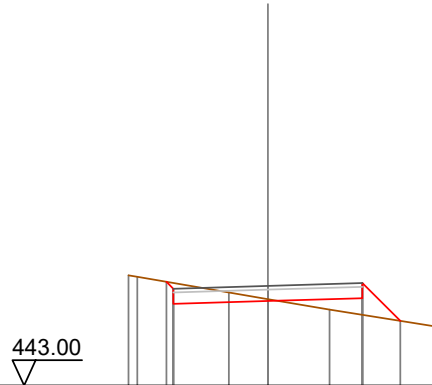

Quote Terreno	445.91	445.88		445.46	445.28	445.01		444.55
Quote Progetto		445.75	445.16		445.24	445.31	444.71	
Parziali				2.50		2.50	1.00	
Progressiva		-2.69	-2.50		0.00	2.50	3.50	
Dislivelli		-0.00	-0.15		-0.05	0.44	-0.00	

Sezione: 228
 Progressiva: 2090.000
 Q. Progetto: 445.386

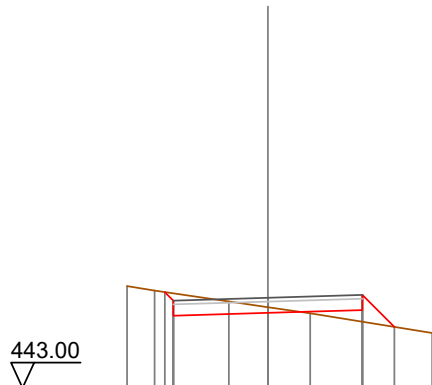

Quote Terreno	445.69	445.57		445.29	445.14	444.97		444.46
Quote Progetto		445.53	444.91		444.99	445.06	444.62	
Parziali				2.50		2.50	0.84	
Progressiva		-2.72	-2.50		0.00	2.50	3.34	
Dislivelli		-0.00	-0.19		-0.15	0.31	-0.00	

Sezione: 229
 Progressiva: 2100.000
 Q. Progetto: 444.705

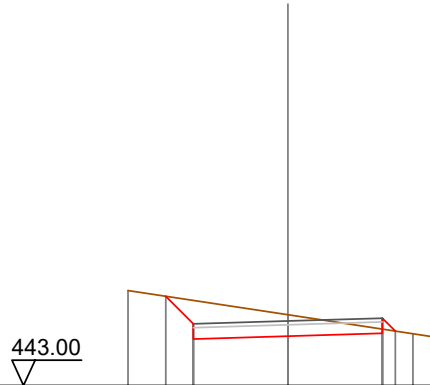

Quote Terreno		445.51		444.87		444.37	444.29
Quote Progetto			445.36	444.23		444.31	444.44
Parziali			0.73	2.50		2.50	0.34
Progressiva			-3.23	-2.50		0.00	2.50
Dislivelli			0.00	-0.62		-0.57	-0.11

Sezione: 230
 Progressiva: 2102.065
 Q. Progetto: 444.540

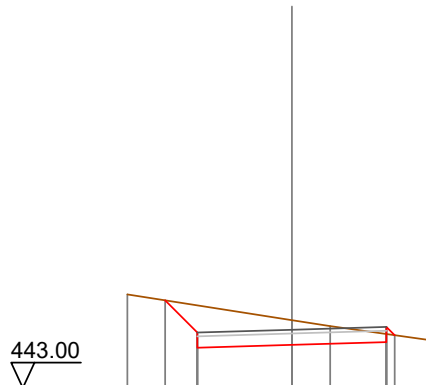

Quote Terreno		445.47		444.79		444.64	444.25
Quote Progetto			445.32	444.06		444.14	444.39
Parziali			0.85	2.50		2.50	0.00
Progressiva			-3.35	-2.50		0.00	2.50
Dislivelli			0.00	-0.72		-0.65	-0.21

Sezione: 231
 Progressiva: 2110.000
 Q. Progetto: 443.823

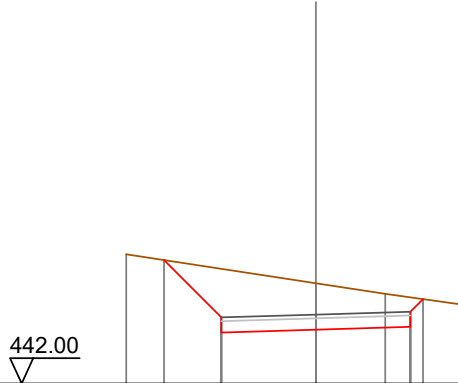

Quote Terreno		-445.42			444.65		-444.37		-444.09
Quote Progetto			445.27	443.35	443.42		443.50	444.23	
Parziali				1.52	2.50		2.50	0.33	
Progressiva			-4.02	-2.50	0.00		2.50	2.83	
Dislivelli			0.00	-1.29	-1.23		-0.78	0.00	

Sezione: 232
 Progressiva: 2118.814
 Q. Progetto: 442.878

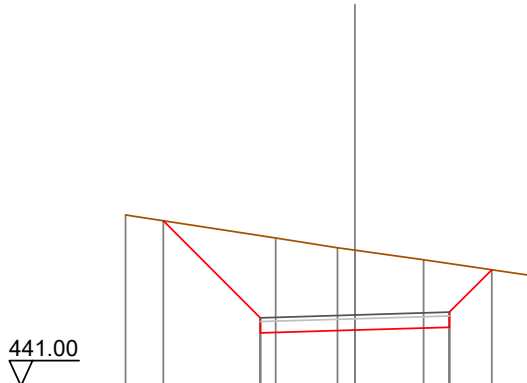

Quote Terreno		-445.52		-444.91	-444.66	-444.59	-444.34		-443.93
Quote Progetto			445.37	442.40	442.48		442.55	444.07	
Parziali				2.57	2.50		2.50	1.12	
Progressiva			-5.07	-2.50	0.00		2.50	3.62	
Dislivelli			-0.00	-2.17	-2.11		-1.68	0.00	

Sezione: 233
 Progressiva: 2120.000
 Q. Progetto: 442.738

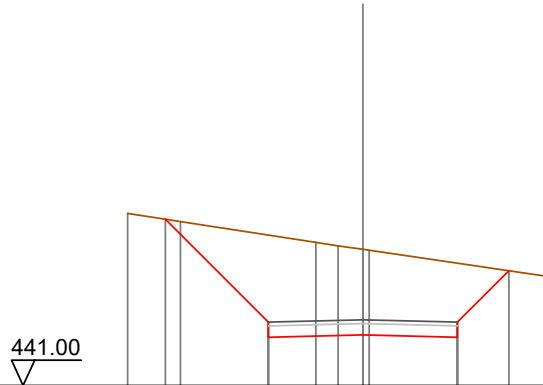

Quote Terreno	-445.55	-445.34	-444.79	-444.69	-444.60	-444.58	-443.89
Quote Progetto		445.40	442.28	442.34	442.28	444.04	
Parziali		2.72	2.50	2.50	1.36		
Progressiva		-5.22	-2.50	0.00	2.50	3.86	
Dislivelli		0.00	-2.30	-2.26	-1.96	0.00	

Sezione: 234
 Progressiva: 2140.000
 Q. Progetto: 439.978

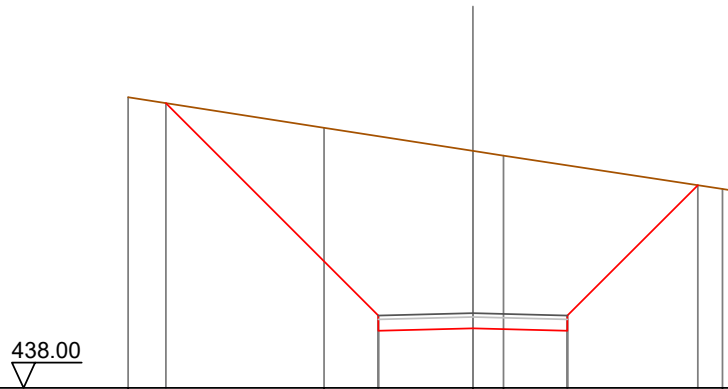

Quote Terreno	-445.69	-444.88	-444.27	-444.15	-443.26
Quote Progetto	445.53	439.52	439.58	439.52	443.36
Parziali		5.62	2.50	2.50	3.45
Progressiva		-8.12	-2.50	0.00	2.50
Dislivelli		0.00	-4.74	-4.69	-4.37

Sezione: 235
 Progressiva: 2146.907
 Q. Progetto: 438.943

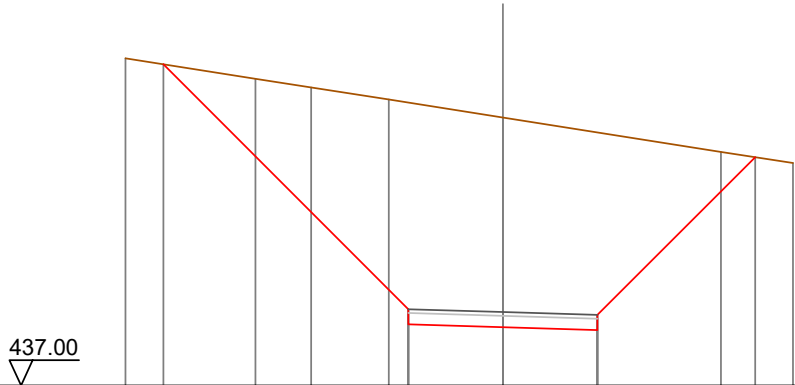

Quote Terreno	-445.66	-445.11	-444.88	-444.56	-444.09	-443.18	-442.88
Quote Progetto	445.50			438.62	438.54	438.47	443.04
Parziali		6.48		2.50	2.50	4.17	
Progressiva	-8.98			-2.50	0.00	2.50	6.67
Dislivelli	0.00			-5.47	-5.55	-5.23	-0.00

Sezione: 236
 Progressiva: 2150.000
 Q. Progetto: 438.479

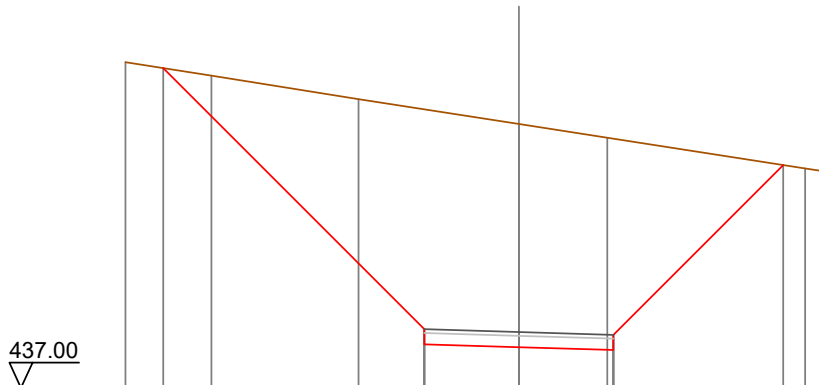

Quote Terreno	-445.62	-445.26	-444.64	-443.98	-443.62	-442.81	-442.74
Quote Progetto	445.46			438.15	438.08	438.00	442.90
Parziali		6.90		2.50	2.50	4.49	
Progressiva	-9.40			-2.50	0.00	2.50	6.99
Dislivelli	0.00			-5.82	-5.90	-5.59	0.00

Sezione: 237
 Progressiva: 2160.000
 Q. Progetto: 436.994

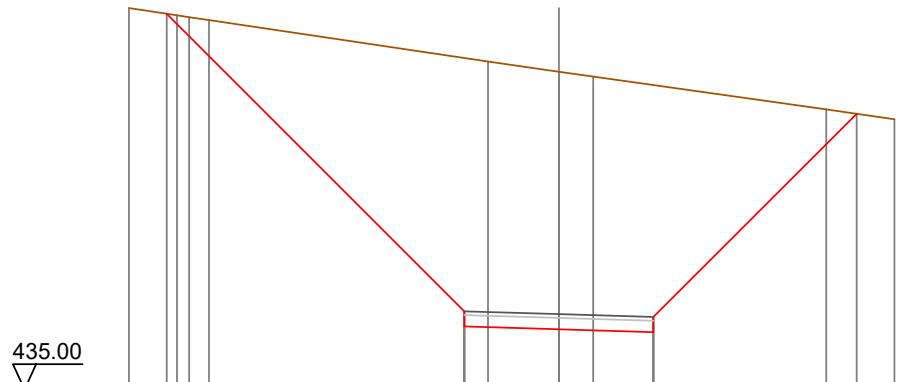

Quote Terreno	-445.09	-444.90	-444.85	-444.77	-443.67	-443.41	-443.28	-442.41	-442.15
Quote Progetto		444.94			436.67	436.59	436.52		442.29
Parziali			7.87		2.50	2.50		5.37	
Progressiva		-10.37			-2.50	0.00	2.50		7.87
Dislivelli		0.00			-6.70	-6.81	-6.53		-0.00

Sezione: 237
 Progressiva: 2160.000
 Q. Progetto: 436.994

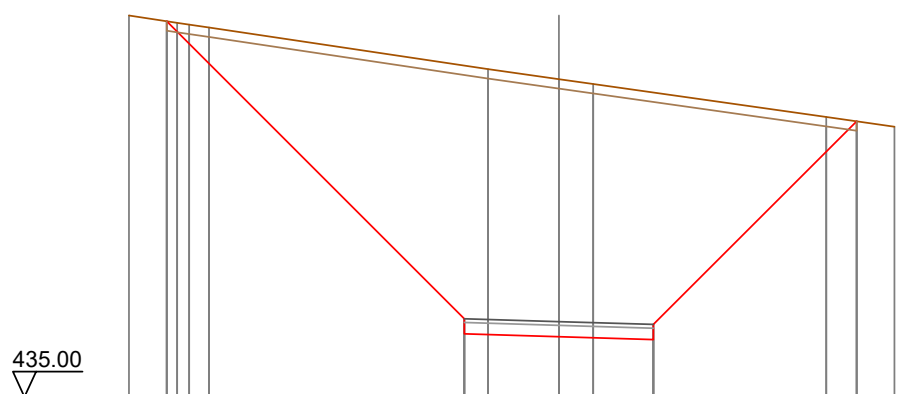

Quote Terreno	-445.09	-444.90	-444.85	-444.77	-443.67	-443.41	-443.28	-442.41	-442.15
Quote Progetto		444.94			436.67	436.59	436.52		442.29
Parziali			7.87		2.50	2.50		5.37	
Progressiva		-10.37			-2.50	0.00	2.50		7.87
Dislivelli		0.00			-6.70	-6.81	-6.53		-0.00

Sezione: 238
 Progressiva: 2170.000
 Q. Progetto: 435.672

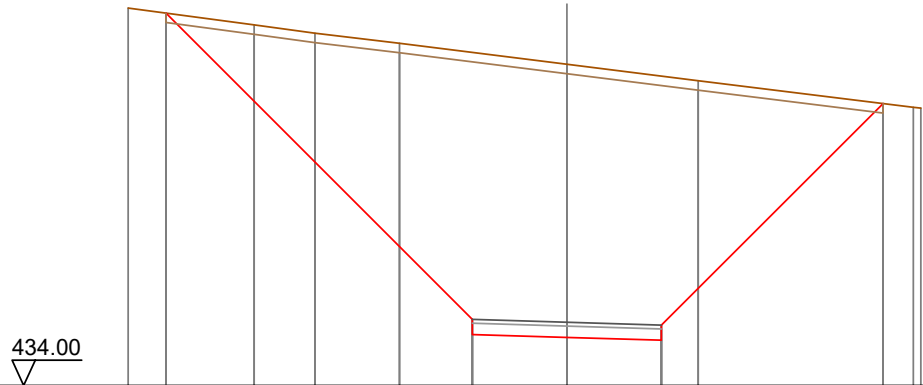

Quote Terreno	-443.98	-443.54	-443.32	-443.05	-435.35	-442.50	-442.06	-441.36	-441.34
Quote Progetto		443.85			435.35	435.27	435.20		441.46
Parziali			8.10		2.50	2.50		5.86	
Progressiva		-10.60			-2.50	0.00	2.50		8.36
Dislivelli		0.00			-7.06	-7.23	-6.99		0.00

Sezione: 239
 Progressiva: 2176.774
 Q. Progetto: 434.894

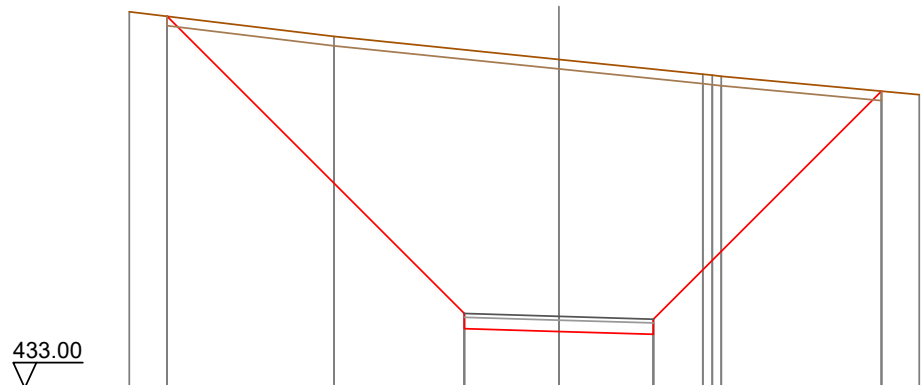

Quote Terreno	-442.95	-442.30		-441.69	-441.30	-441.25		-440.76
Quote Progetto		442.83		434.57	434.49	434.42		440.85
Parziali			7.86	2.50	2.50		6.03	
Progressiva		-10.36		-2.50	0.00	2.50		8.53
Dislivelli		-0.00		-6.98	-7.19	-7.01		0.00

Sezione: 240
 Progressiva: 2180.000
 Q. Progetto: 434.556

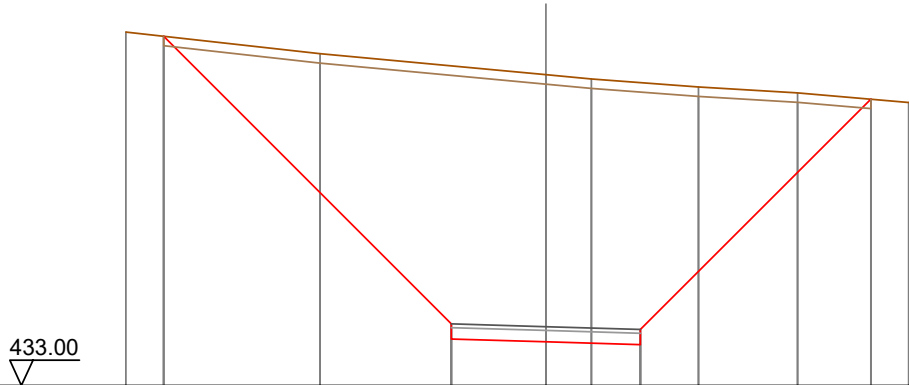

Quote Terreno	-442.35	-441.78	-441.22	-441.11	-440.90	-440.74	-440.49
Quote Progetto	442.24	434.23	434.16	434.08	440.57		
Parziali		7.61	2.50	2.50	6.09		
Progressiva	-10.11	-2.50	0.00	2.50	8.59		
Dislivelli	0.00	-6.82	-7.06	-6.93	0.00		

Sezione: 241
 Progressiva: 2190.000
 Q. Progetto: 433.642

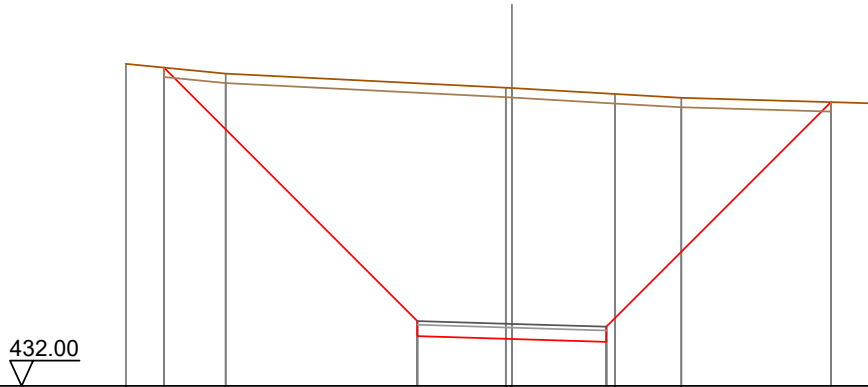

Quote Terreno	-440.52	-440.26	-439.89	-439.88	-439.72	-439.62	-439.48
Quote Progetto	440.42	433.32	433.24	433.17	439.51		
Parziali		6.70	2.50	2.50	5.94		
Progressiva	-9.20	-2.50	0.00	2.50	8.44		
Dislivelli	-0.00	-6.29	-6.64	-6.57	-0.00		

Sezione: 242
 Progressiva: 2200.000
 Q. Progetto: 432.930

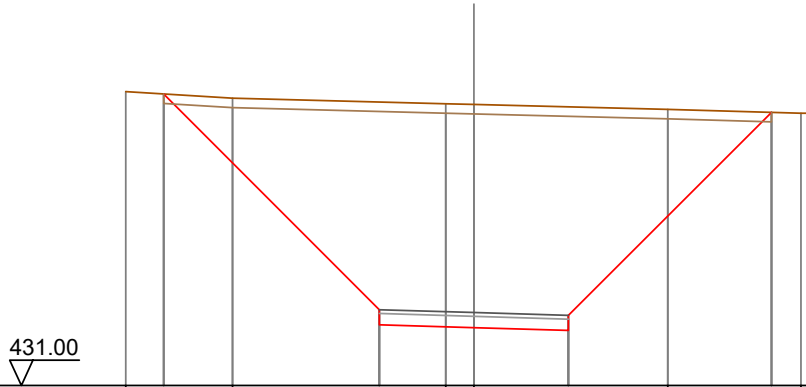

Quote Terreno		438.77	438.60		438.45	438.43		438.30	438.20	438.20
Quote Progetto		438.71		432.61	432.53	432.46			438.22	
Parziali			5.71		2.50	2.50		5.37		
Progressiva		-8.21		-2.50	0.00	2.50			7.87	
Dislivelli		0.00		-5.49	-5.90	-5.91			0.00	

Sezione: 243
 Progressiva: 2206.641
 Q. Progetto: 432.569

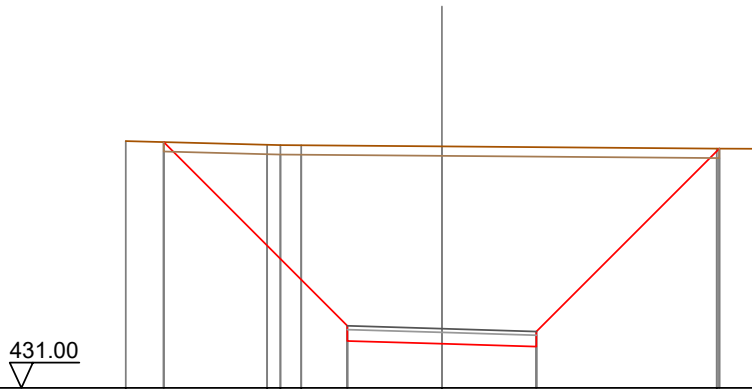

Quote Terreno		437.53	437.43	437.42	437.42	437.39		437.33	437.33
Quote Progetto		437.50		432.24	432.17	432.09		437.33	
Parziali			4.86		2.50	2.50		4.84	
Progressiva		-7.36		-2.50	0.00	2.50			7.34
Dislivelli		0.00		-4.77	-5.22	-5.28			0.00

Sezione: 244
 Progressiva: 2220.000
 Q. Progetto: 432.110

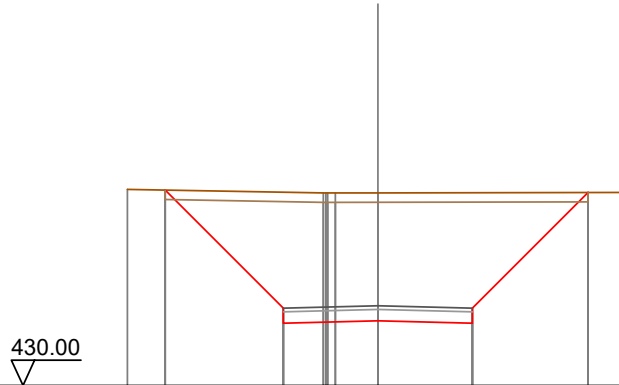

Quote Terreno	-435.19	-435.10	-435.09	-435.10	-435.11
Quote Progetto	435.17	431.65	431.71	431.65	435.11
Parziali		3.12	2.50	2.50	3.06
Progressiva	-5.62	-2.50	0.00	2.50	5.56
Dislivelli	-0.00	-3.07	-3.39	-3.45	-0.00

Sezione: 245
 Progressiva: 2227.074
 Q. Progetto: 432.012

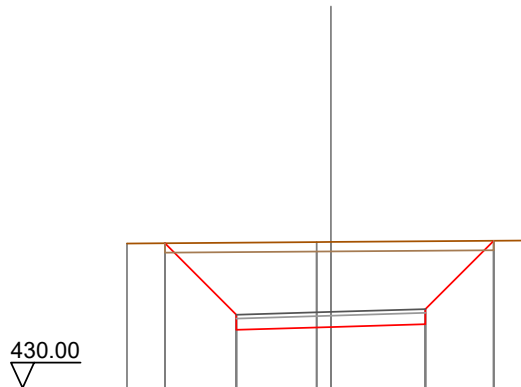

Quote Terreno	433.82	433.86	433.86	433.90
Quote Progetto	433.83	431.54	431.61	433.69
Parziali		1.89	2.50	1.81
Progressiva	-4.39	-2.50	0.00	2.50
Dislivelli	0.00	-1.91	-2.25	-2.19

Sezione: 246
 Progressiva: 2228.000
 Q. Progetto: 432.006

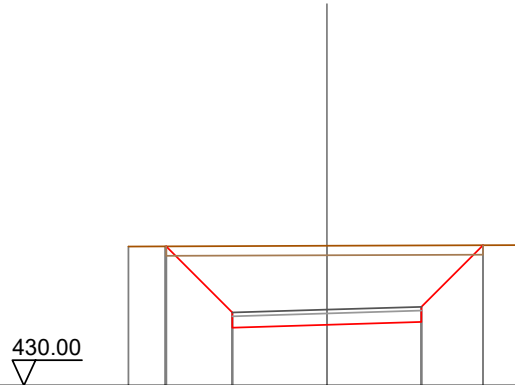

Quote Terreno		433.68	433.68		433.70		433.71
Quote Progetto		433.68	431.53		431.61		433.71
Parziali			1.75	2.50	2.50	1.63	
Progressiva		-4.25	-2.50		0.00	2.50	4.13
Dislivelli		0.00	-1.76		-2.09	-2.02	0.00

SEZIONI TRASVERSALI
Profilo longitudinale tratto 19-20
Viabilità di impianto postazione aerogeneratore T10

Nota: Le canalette di deflusso delle acque meteoriche, non indicate nel presente elaborato, sono rappresentate graficamente nelle sezioni stradali tipo dell'elaborato "WIND002-TC13_Piazzole aerogeneratori e strade di servizio - Particolari costruttivi", individuate planimetricamente nell'elaborato "WIND002-TC14_Opere di regimazione acque superficiali - Planimetria generale" e quantificate nell'elaborato "WIND002-RC6_Computo Metrico Estimativo".

DISEGNI DI RIFERIMENTO

TAVOLA	DESCRIZIONE
WIND002-TC8	Piazzole e viabilità - Planimetria di progetto - Fase di cantiere
WIND002-TC11	Profili longitudinali viabilità di impianto
WIND002-TC13	Piazzole aerogeneratori e strade di servizio - Particolari costruttivi
WIND002-TC14	Opere di regimazione acque superficiali - Planimetria generale

Sezione: 1
 Progressiva: 0.000
 Q. Progetto: 559.691

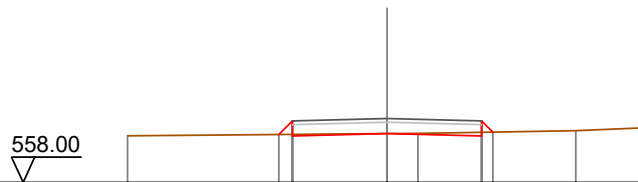

Quote Terreno	559.24			559.29	559.30		559.37	559.44
Quote Progetto		559.27	559.23	559.29		559.23	559.33	
Parziali		0.36	2.50	2.50		0.30		
Progressiva		-2.86	-2.50	0.00		2.50	2.80	
Dislivelli		0.00	0.36	-0.00		-0.10	-0.00	

Sezione: 2
 Progressiva: 8.161
 Q. Progetto: 559.185

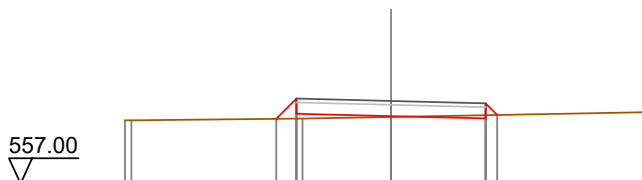

Quote Terreno	558.67	558.67		558.72	558.76			558.89
Quote Progetto			558.71	558.85	558.78	558.72	558.82	
Parziali			0.53	2.50	2.50	0.33		
Progressiva			-3.03	-2.50	0.00	2.50	2.81	
Dislivelli			-0.00	0.53	0.02	-0.09	-0.00	

Sezione: 3
 Progressiva: 10.000
 Q. Progetto: 559.061

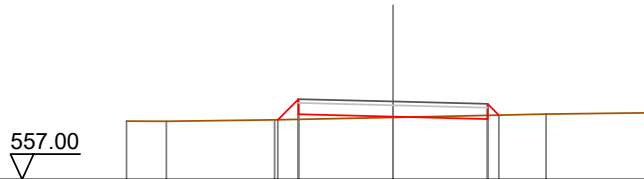

Quote Terreno	-558.54	-558.54	-558.57	-558.64	-558.73	-558.76
Quote Progetto			558.58 558.72	558.66	558.60 558.70	
Parziali			0.55 2.50	2.50	0.30	
Progressiva			-3.05 -2.50	0.00	2.50 2.80	
Dislivelli			0.00 0.54	0.02	-0.10 0.00	

Sezione: 4
 Progressiva: 20.000
 Q. Progetto: 558.286

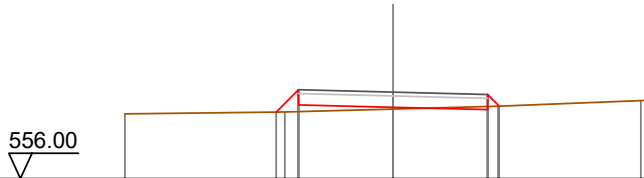

Quote Terreno	-557.71	-557.76	-557.84	-557.92	-558.06	-558.07
Quote Progetto		557.76 557.95	557.89	557.82 557.92	558.06 558.07	
Parziali		0.59 2.50	2.50	0.30		
Progressiva		-3.09 -2.50	0.00	2.50 2.81		
Dislivelli		0.00 0.58	0.05	-0.08 0.00		

Sezione: 5
 Progressiva: 21.371
 Q. Progetto: 558.175

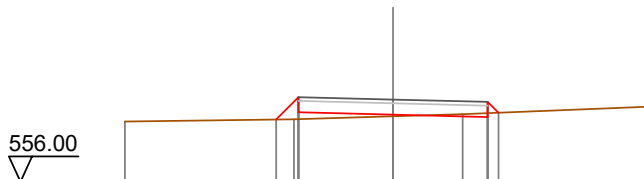

Quote Terreno	-557.59	-557.65	-557.73	-557.79	-557.99
Quote Progetto		557.65 557.84	557.77	557.71 557.82	
Parziali		0.59 2.50	2.50	0.29	
Progressiva		-3.09 -2.50	0.00	2.50 2.79	
Dislivelli		-0.00 0.58	0.04	-0.10 0.00	

Sezione: 6
 Progressiva: 30.000
 Q. Progetto: 557.470

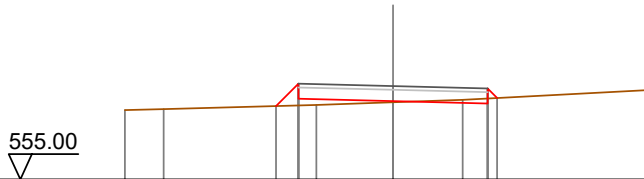

Quote Terreno	-556.83	-556.88	-556.97	-557.04	-557.11	-557.37
Quote Progetto		556.94	557.13	557.07	557.01	557.15
Parziali		0.59	2.50	2.50		
Progressiva		-3.09	-2.50	0.00	2.50	2.75
Dislivelli		-0.00	0.58	0.03	-0.13	0.00

Sezione: 7
 Progressiva: 34.582
 Q. Progetto: 557.104

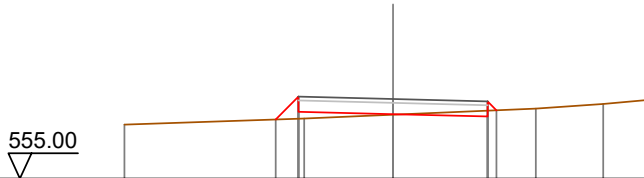

Quote Terreno	-556.43	-556.59	-556.69	-556.85	-556.98	-557.08
Quote Progetto		556.56	556.77	556.70	556.64	556.81
Parziali		0.60	2.50	2.50		
Progressiva		-3.10	-2.50	0.00	2.50	2.74
Dislivelli		0.00	0.58	0.02	-0.15	0.00

Sezione: 8
 Progressiva: 34.964
 Q. Progetto: 557.076

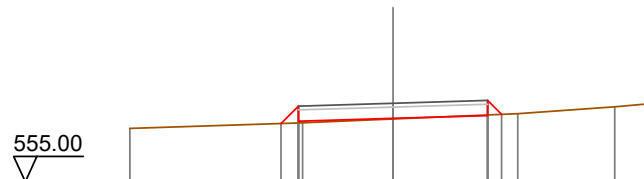

Quote Terreno	-556.41	-556.56	-556.66	-556.80	-556.98	-557.07
Quote Progetto		556.54	556.60	556.68	556.75	556.78
Parziali		0.46	2.50	2.50	0.37	
Progressiva		-2.96	-2.50	0.00	2.50	2.87
Dislivelli		0.00	0.45	0.02	-0.02	0.00

Sezione: 9
 Progressiva: 40.000
 Q. Progetto: 556.723

555.00

Quote Terreno	-556.08	-556.17	-556.19	-556.35	-556.79
Quote Progetto		556.17	556.25	556.32	556.40
Parziali		0.48	2.50	2.50	0.27
Progressiva		-2.98	-2.50	0.00	2.50
Dislivelli		-0.00	0.46	-0.02	-0.11

Sezione: 10
 Progressiva: 50.000
 Q. Progetto: 556.130

554.00

Quote Terreno	-555.50	-555.63	-555.66	-555.75	-555.85
Quote Progetto		555.63	555.66	555.73	555.81
Parziali		0.43	2.50	2.50	0.32
Progressiva		-2.93	-2.50	0.00	2.50
Dislivelli		-0.00	0.42	-0.02	-0.06

Sezione: 11
 Progressiva: 52.529
 Q. Progetto: 555.980

554.00

Quote Terreno	-555.36	-555.44	-555.53	-555.58	-555.61
Quote Progetto		555.48	555.51	555.58	555.66
Parziali		0.43	2.50	2.50	0.31
Progressiva		-2.93	-2.50	0.00	2.50
Dislivelli		0.00	0.41	-0.00	-0.07

Sezione: 12
 Progressiva: 60.000
 Q. Progetto: 555.469

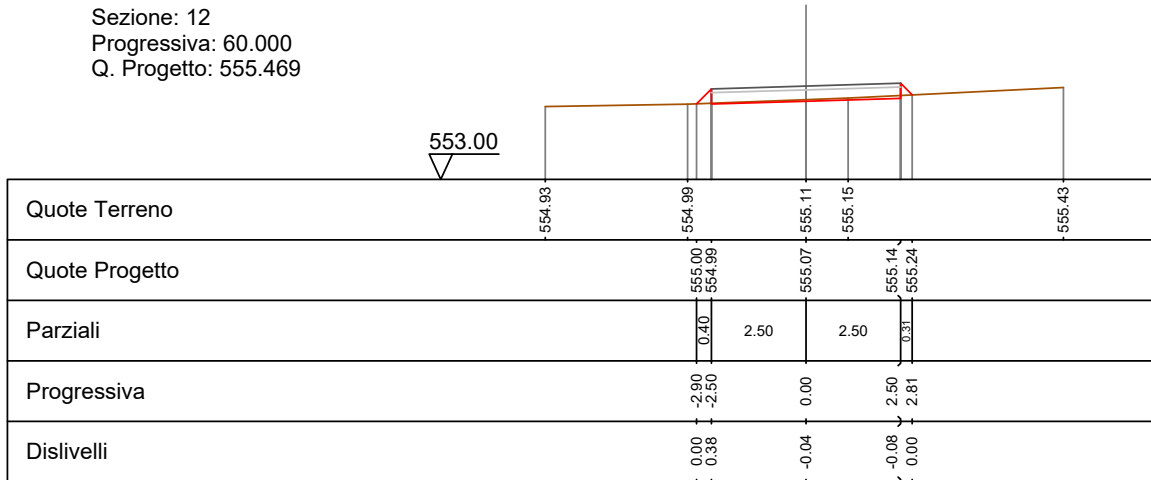

Sezione: 13
 Progressiva: 70.093
 Q. Progetto: 554.732

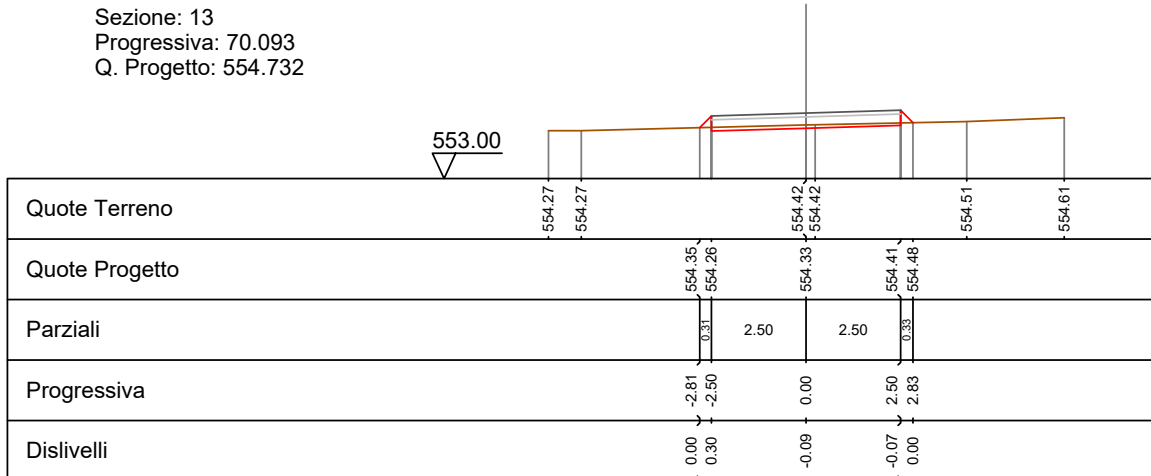

Sezione: 14
 Progressiva: 70.709
 Q. Progetto: 554.687

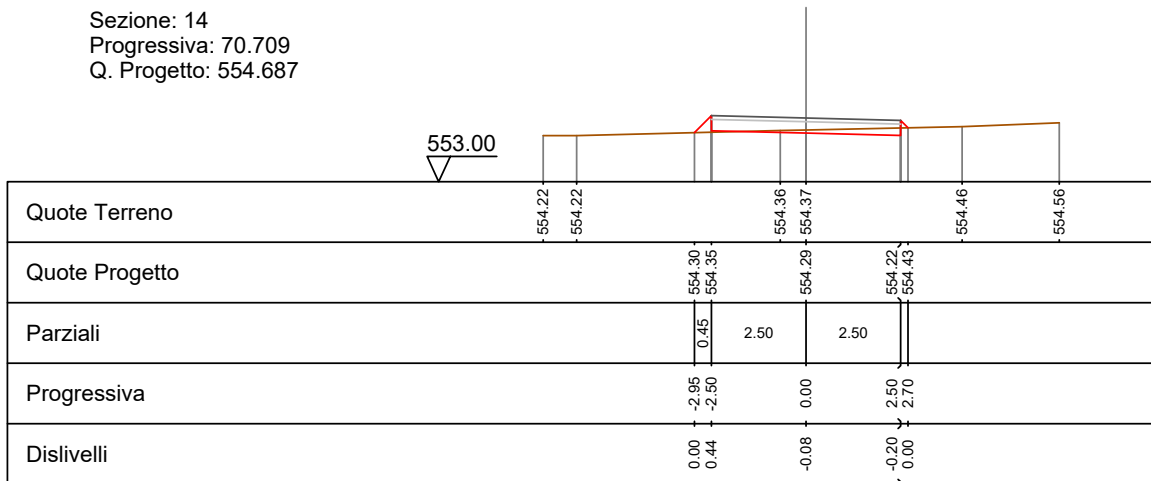

Sezione: 15
 Progressiva: 75.076
 Q. Progetto: 554.368

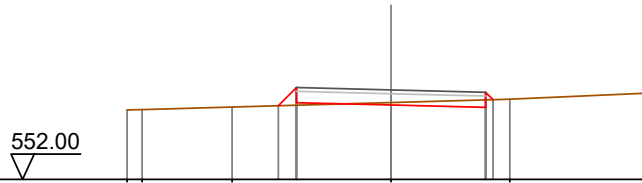

Quote Terreno	553.84	553.85	553.92	553.95	554.03	553.91	554.12	554.28
Quote Progetto				553.95	554.03	553.97	553.91	554.11
Parziali				0.48	2.50	2.50		
Progressiva				-2.98	-2.50	0.00	2.50	2.70
Dislivelli				0.00	0.47	-0.07	-0.20	0.00

Sezione: 16
 Progressiva: 79.444
 Q. Progetto: 554.049

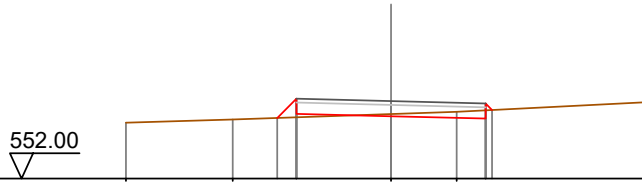

Quote Terreno	553.48	553.56	553.60	553.71	553.77	554.02	
Quote Progetto			553.60	553.71	553.65	553.59	553.81
Parziali			0.51	2.50	2.50		
Progressiva			-3.01	-2.50	0.00	2.50	2.67
Dislivelli			0.00	0.49	-0.06	-0.22	0.00

Sezione: 17
 Progressiva: 80.000
 Q. Progetto: 554.008

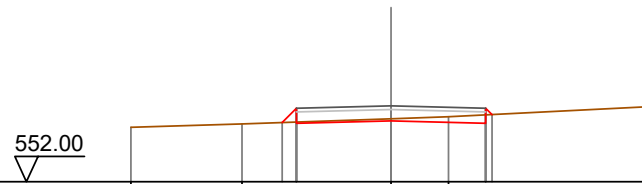

Quote Terreno	553.44	553.53	553.57	553.67	553.72	553.98	
Quote Progetto			553.57	553.61	553.55	553.78	
Parziali			0.38	2.50	2.50		
Progressiva			-2.88	-2.50	0.00	2.50	2.67
Dislivelli			0.00	0.37	-0.06	-0.22	0.00

Sezione: 18
 Progressiva: 100.000
 Q. Progetto: 552.904

550.00

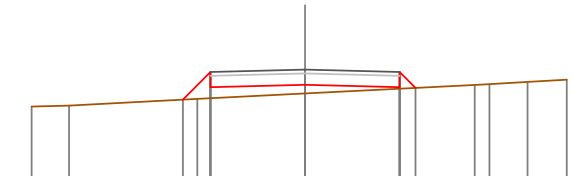

Quote Terreno	-551.93	-551.95	-552.13	-552.27	-552.50	-552.52	-552.58	-552.64
Quote Progetto			552.11	552.44	552.50	552.44	552.42	
Parziali			0.73	2.50	2.50	0.42		
Progressiva			-3.23	-2.50	0.00	2.50	2.92	
Dislivelli			0.00	0.69	0.23	0.04	0.00	

Sezione: 19
 Progressiva: 109.476
 Q. Progetto: 552.584

550.00

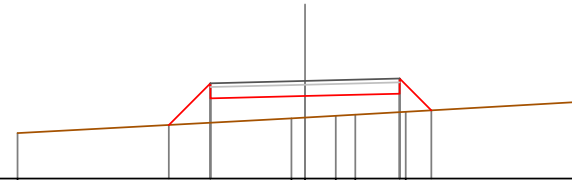

Quote Terreno	-551.20			-551.59	-551.61	-551.66	-551.69	-551.77	-552.04
Quote Progetto			551.42	552.18	552.25	551.80			
Parziali			1.10	2.50	2.50	0.84			
Progressiva			-3.60	-2.50	0.00	2.50	3.34		
Dislivelli			-0.00	1.04	0.57	0.49	-0.00		

Sezione: 20
 Progressiva: 110.000
 Q. Progetto: 552.566

550.00

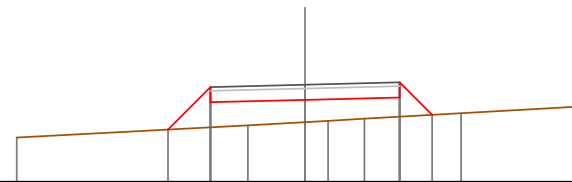

Quote Terreno	-551.17			-551.49	-551.58	-551.61	-551.67	-551.81	-552.00
Quote Progetto			551.38	552.10	552.17	552.23	551.77		
Parziali			1.12	2.50	2.50	0.86			
Progressiva			-3.62	-2.50	0.00	2.50	3.36		
Dislivelli			0.00	1.06	0.59	0.51	-0.00		

Sezione: 21
 Progressiva: 120.000
 Q. Progetto: 552.325

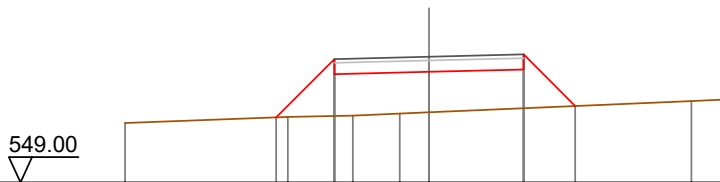

Quote Terreno	-550.57	-550.73	-550.77	-550.82	-550.86	-551.15	-551.19
Quote Progetto		550.72	551.86	551.93	551.99	551.02	
Parziali			1.54	2.50	2.50	1.37	
Progressiva		-4.04	-2.50	0.00	2.50	3.87	
Dislivelli		0.00	1.50	1.07	1.03	0.00	

Sezione: 22
 Progressiva: 128.286
 Q. Progetto: 552.249

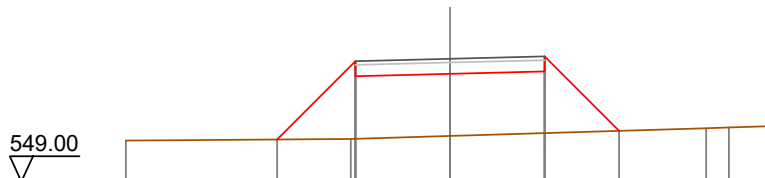

Quote Terreno	-550.09	-550.13	-550.21	-550.41	-550.43	-550.46
Quote Progetto		550.11	551.79	551.85	551.91	550.34
Parziali			2.07	2.50	2.50	1.97
Progressiva		-4.57	-2.50	0.00	2.50	4.47
Dislivelli		0.00	2.05	1.64	1.63	0.00

Sezione: 23
 Progressiva: 130.000
 Q. Progetto: 552.235

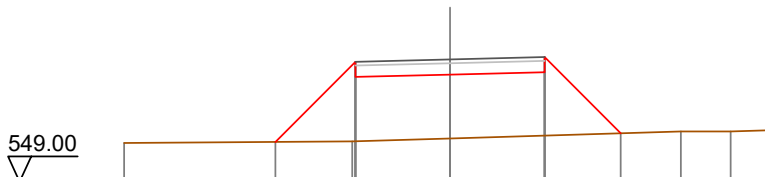

Quote Terreno	-550.02	-550.07	-550.15	-550.33	-550.33	-550.36
Quote Progetto		550.05	551.77	551.84	551.90	550.28
Parziali			2.12	2.50	2.50	2.01
Progressiva		-4.62	-2.50	0.00	2.50	4.51
Dislivelli		0.00	2.10	1.69	1.68	0.00

Sezione: 24
 Progressiva: 140.000
 Q. Progetto: 552.154

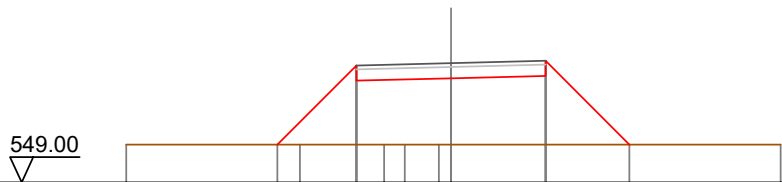

Quote Terreno	-550.00	-550.00	-550.00	-550.00	-550.00	-550.00
Quote Progetto		550.00	551.69	551.75	551.82	550.00
Parziali			2.09	2.50	2.50	2.22
Progressiva		-4.59	-2.50	0.00	2.50	4.72
Dislivelli		0.00	2.09	1.75	1.82	0.00

Sezione: 24
 Progressiva: 140.000
 Q. Progetto: 552.154

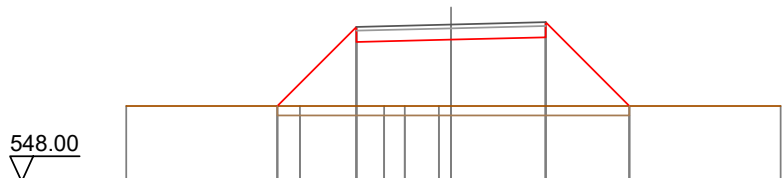

Quote Terreno	-550.00	-550.00	-550.00	-550.00	-550.00	-550.00
Quote Progetto		550.00	551.69	551.75	551.82	550.00
Parziali			2.09	2.50	2.50	2.22
Progressiva		-4.59	-2.50	0.00	2.50	4.72
Dislivelli		0.00	2.09	1.75	1.82	0.00

Sezione: 25
 Progressiva: 147.097
 Q. Progetto: 552.096

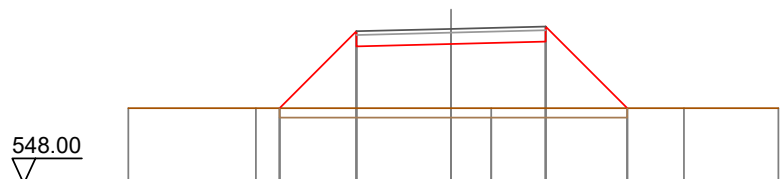

Quote Terreno	-550.00	-550.00	-550.00	-550.00	-550.00	-550.00
Quote Progetto		550.00	551.63	551.70	551.76	550.00
Parziali			2.03	2.50	2.50	2.16
Progressiva		-4.53	-2.50	0.00	2.50	4.66
Dislivelli		0.00	2.03	1.70	1.76	0.00

Sezione: 26
 Progressiva: 154.294
 Q. Progetto: 552.038

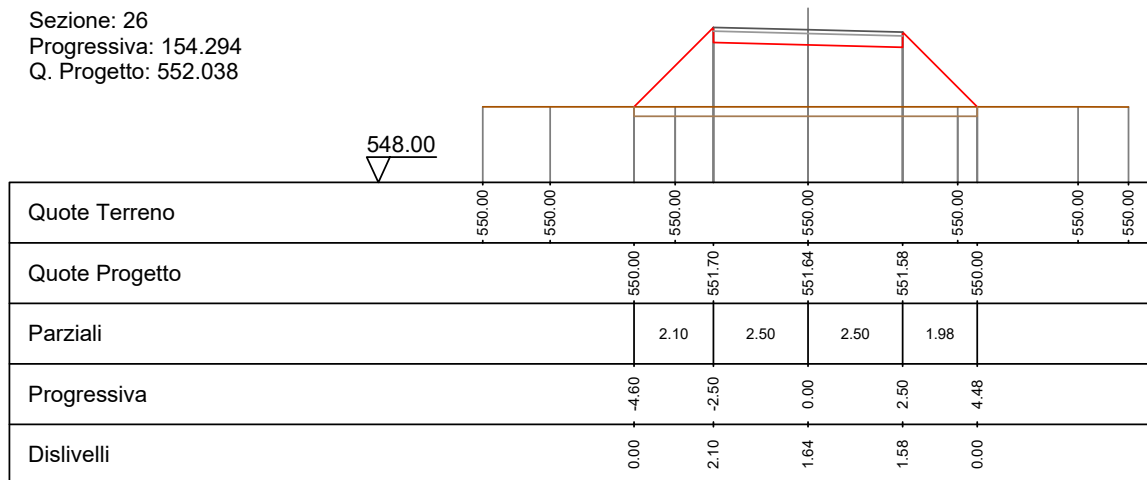

Sezione: 27
 Progressiva: 160.000
 Q. Progetto: 551.986

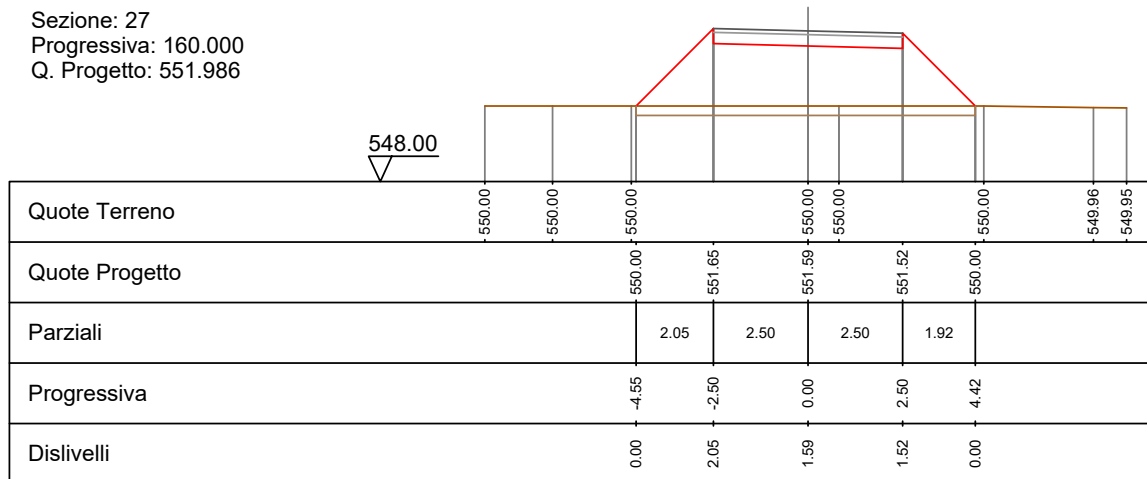

Sezione: 28
 Progressiva: 170.000
 Q. Progetto: 551.757

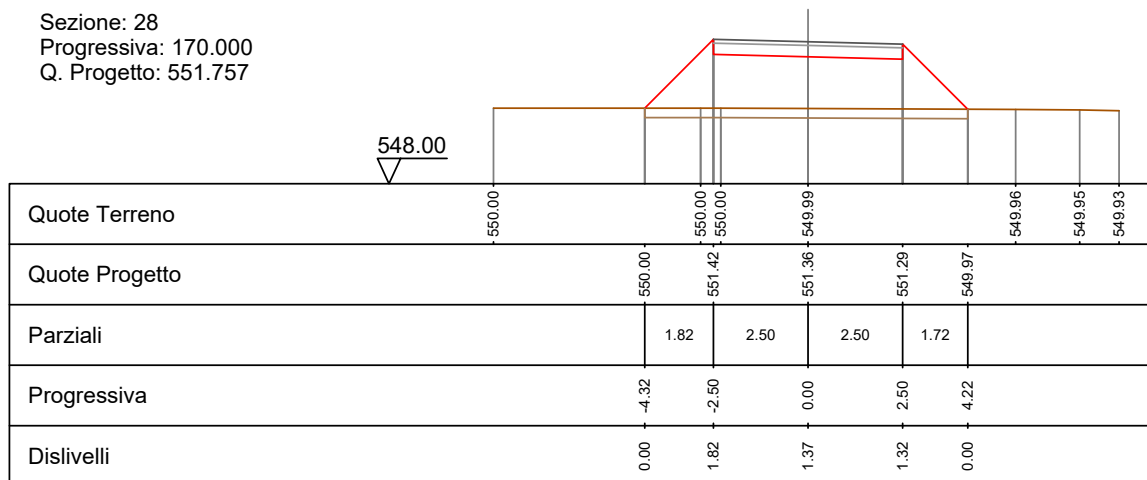

Sezione: 29
 Progressiva: 177.765
 Q. Progetto: 551.441

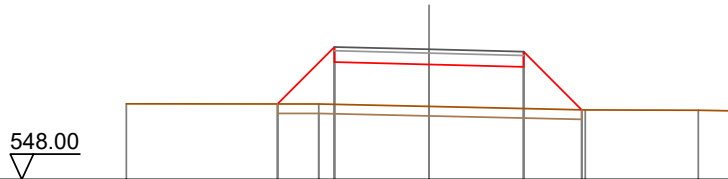

Quote Terreno	-550.00	-550.00	-551.10	-549.93	-549.84	-549.83	-549.81
Quote Progetto		550.00	551.10	551.04	550.98	549.84	
Parziali		1.51	2.50	2.50	1.54		
Progressiva		-4.01	-2.50	0.00	2.50	4.04	
Dislivelli		0.00	1.52	1.11	1.10	0.00	

Sezione: 30
 Progressiva: 180.000
 Q. Progetto: 551.328

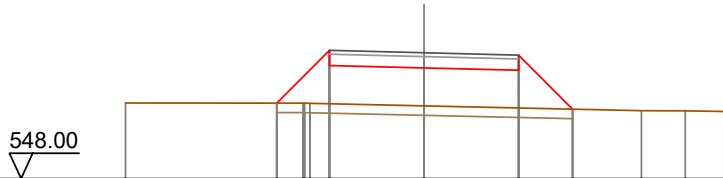

Quote Terreno	-550.00	-550.00	-549.99	-549.92	-549.79	-549.79	-549.77
Quote Progetto		550.00	550.99	550.93	550.87	549.84	
Parziali		1.39	2.50	2.50	1.43		
Progressiva		-3.89	-2.50	0.00	2.50	3.93	
Dislivelli		0.00	1.41	1.00	1.00	-0.00	

Sezione: 31
 Progressiva: 190.000
 Q. Progetto: 550.697

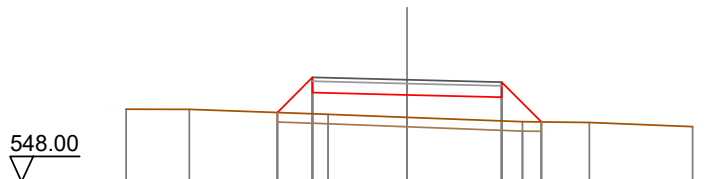

Quote Terreno	-549.92	-549.91	-549.78	-549.70	-549.59	-549.57	-549.46
Quote Progetto			549.83	550.36	550.30	550.23	549.58
Parziali			0.93	2.50	2.50	1.05	
Progressiva			-3.43	-2.50	0.00	2.50	3.55
Dislivelli			0.00	0.96	0.59	0.62	0.00

Sezione: 31
 Progressiva: 190.000
 Q. Progetto: 550.697

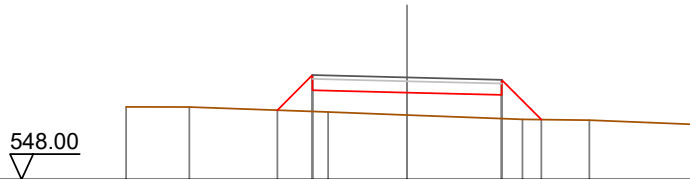

Quote Terreno	-549.92	-549.91	-549.78	-549.70	-549.59	-549.57	-549.46
Quote Progetto			549.83	550.36	550.30	550.23	549.58
Parziali			0.93	2.50	2.50	1.05	
Progressiva			-3.43	-2.50	0.00	2.50	3.55
Dislivelli			0.00	0.96	0.59	0.62	-0.00

Sezione: 32
 Progressiva: 200.000
 Q. Progetto: 549.886

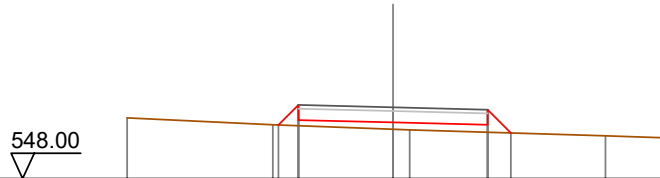

Quote Terreno	-549.60	-549.42	-549.31	-549.29	-549.13	-549.08
Quote Progetto		549.42	549.55	549.49	549.42	549.21
Parziali		0.53	2.50	2.50	0.61	
Progressiva		-3.03	-2.50	0.00	2.50	3.11
Dislivelli		0.00	0.55	0.18	0.20	0.00

Sezione: 33
 Progressiva: 201.235
 Q. Progetto: 549.782

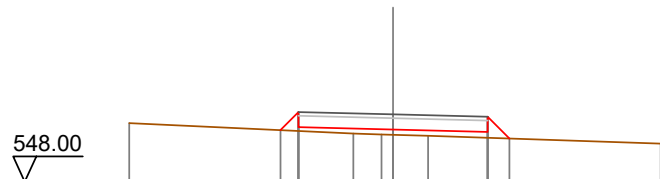

Quote Terreno	-549.55	-549.37	-549.28	-549.25	-549.24	-549.21	-549.01
Quote Progetto		549.44	549.38	549.32	549.14		
Parziali		0.48	2.50	2.50	0.58		
Progressiva		-2.98	-2.50	0.00	2.50	3.08	
Dislivelli		0.00	0.50	0.14	0.16	-0.00	

Sezione: 34
 Progressiva: 213.640
 Q. Progetto: 548.871

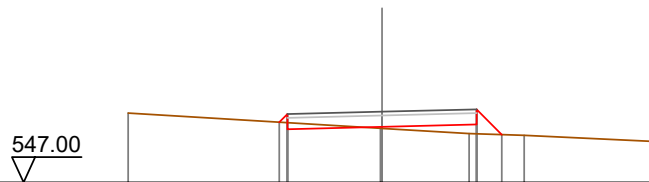

Quote Terreno		548.83		548.43	548.43	548.29	548.25	548.09
Quote Progetto			548.59	548.41	548.47	548.53	548.26	
Parziali				2.50	2.50	0.67		
Progressiva			-2.72	-2.50	0.00	2.50	3.17	
Dislivelli			0.00	0.23	0.04	0.25	0.00	

Sezione: 35
 Progressiva: 220.000
 Q. Progetto: 548.523

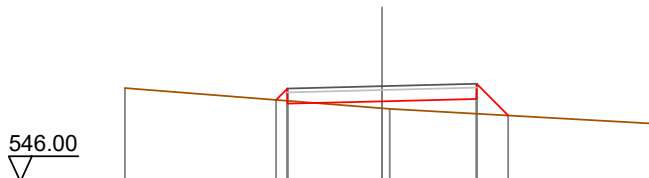

Quote Terreno		548.48		547.94	547.92			547.53
Quote Progetto			548.16	548.06	548.12	548.19	547.75	
Parziali			0.30	2.50	2.50	0.84		
Progressiva			-2.80	-2.50	0.00	2.50	3.34	
Dislivelli			0.00	0.32	0.18	0.39	0.00	

Sezione: 36
 Progressiva: 230.000
 Q. Progetto: 548.141

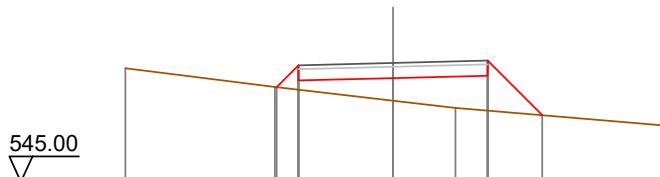

Quote Terreno		548.00	547.51	547.14	546.95		546.49	546.43
Quote Progetto			547.50	547.68	547.74	547.80	546.76	
Parziali			0.58	2.50	2.50	1.44		
Progressiva			-3.08	-2.50	0.00	2.50	3.94	
Dislivelli			0.00	0.64	0.60	0.92	-0.00	

Sezione: 37
 Progressiva: 238.369
 Q. Progetto: 547.976

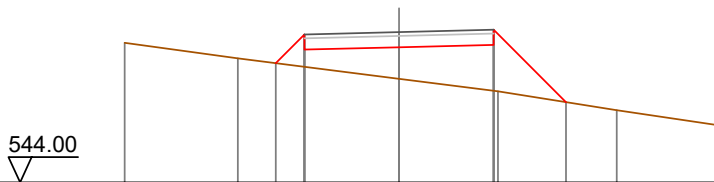

Quote Terreno	-547.69	-547.28							
Quote Progetto			547.16	547.51		547.58	546.74	547.64	546.41
Parziali			0.76	2.50		2.50		1.92	
Progressiva			-3.26	-2.50		0.00		2.50	4.42
Dislivelli			0.00	0.85		0.83		1.21	0.00

Sezione: 38
 Progressiva: 240.000
 Q. Progetto: 547.960

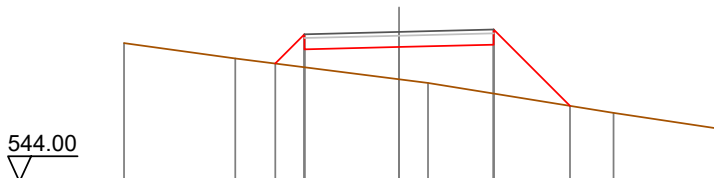

Quote Terreno	-547.66	-547.26							
Quote Progetto			547.12	547.50		547.56	546.61	547.62	546.00
Parziali			0.77	2.50		2.50		2.02	
Progressiva			-3.27	-2.50		0.00		2.50	4.52
Dislivelli			0.00	0.87		0.85		1.29	-0.00

Sezione: 39
 Progressiva: 250.000
 Q. Progetto: 547.978

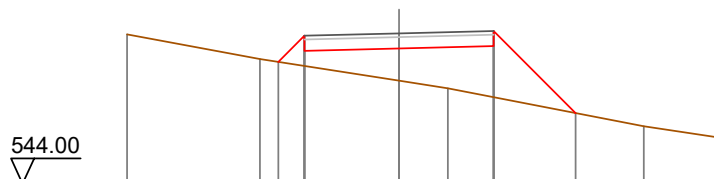

Quote Terreno	-547.95	-547.30							
Quote Progetto			547.22	547.52		547.58	546.73	547.64	545.87
Parziali			0.69	2.50		2.50		2.17	
Progressiva			-3.19	-2.50		0.00		2.50	4.67
Dislivelli			-0.00	0.80		0.85		1.35	0.00

Sezione: 40
 Progressiva: 260.000
 Q. Progetto: 548.197

544.00

Quote Terreno		-548.53		-547.56	-547.39		-546.78		-545.98
Quote Progetto			547.86	547.73	547.80		547.86	546.68	
Parziali			0.28	2.50	2.50		1.58		
Progressiva			-2.78	-2.50	0.00		2.50	4.08	
Dislivelli			-0.00	0.32	0.41		0.91	0.00	

Sezione: 41
 Progressiva: 263.099
 Q. Progetto: 548.305

545.00

Quote Terreno		-548.77	-548.49		-547.69	-547.65		-547.33		-546.64	-546.39
Quote Progetto				548.12	547.84	547.90		547.97	547.06		
Parziali				2.50	2.50			1.31			
Progressiva				-2.62	-2.50	0.00		2.50	3.81		
Dislivelli				0.00	0.14	0.21		0.69	0.00		

Sezione: 42
 Progressiva: 264.463
 Q. Progetto: 548.359

545.00

Quote Terreno		-548.92		-548.03	-547.83	-547.68	-547.56		-547.27		-546.58
Quote Progetto			548.27	548.02	547.96		547.90	547.24			
Parziali				2.50	2.50		1.05				
Progressiva			-2.65	-2.50	0.00		2.50	3.55			
Dislivelli			0.00	0.18	0.13		0.48	0.00			

Sezione: 43
 Progressiva: 270.000
 Q. Progetto: 548.615

546.00

Quote Terreno	-549.55	-549.32			548.41		547.89	-547.14
Quote Progetto			548.86	548.28	548.22		548.15	547.86
Parziali				2.50	2.50		0.69	
Progressiva			-2.69	-2.50	0.00		2.50	3.19
Dislivelli			-0.00	-0.15	-0.19		0.17	0.00

Sezione: 44
 Progressiva: 280.000
 Q. Progetto: 549.235

546.00

Quote Terreno	-550.47	-550.18			549.27			-548.32	-547.96
Quote Progetto			549.83	548.90	548.83		548.77	548.72	
Parziali			0.53	2.50	2.50		0.45		
Progressiva			-3.03	-2.50	0.00		2.50	2.95	
Dislivelli			0.00	-0.43	-0.44		-0.03	0.00	

Sezione: 45
 Progressiva: 281.966
 Q. Progetto: 549.380

547.00

Quote Terreno	-550.61	-550.28			549.41			-548.42	-548.08
Quote Progetto			549.97	549.04	548.98		548.92	548.86	
Parziali			0.52	2.50	2.50		0.46		
Progressiva			-3.02	-2.50	0.00		2.50	2.96	
Dislivelli			-0.00	-0.43	-0.43		-0.03	0.00	

Sezione: 46
 Progressiva: 290.000
 Q. Progetto: 550.004

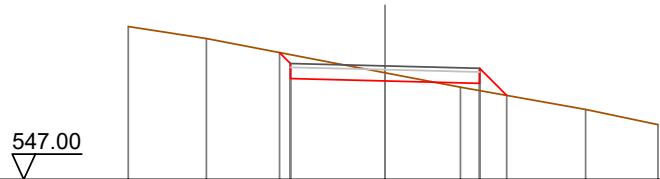

Quote Terreno	-551.04	-550.73			-549.82	-549.44		-548.85	-548.45
Quote Progetto			550.36	549.67	549.60	549.54	549.22		
Parziali			0.28	2.50	2.50	0.72			
Progressiva			-2.79	-2.50	0.00	2.50	3.22		
Dislivelli			0.00	-0.23	-0.22	0.19	-0.00		

Sezione: 47
 Progressiva: 299.469
 Q. Progetto: 550.610

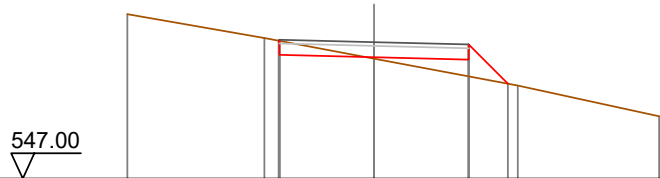

Quote Terreno	-551.35	-550.72			-550.17		-549.46	-548.65
Quote Progetto			550.65	550.27	550.21	550.15	549.51	
Parziali				2.50	2.50	1.04		
Progressiva			-2.53	-2.50	0.00	2.50	3.54	
Dislivelli			0.00	0.03	0.04	0.44	0.00	

Sezione: 48
 Progressiva: 300.000
 Q. Progetto: 550.638

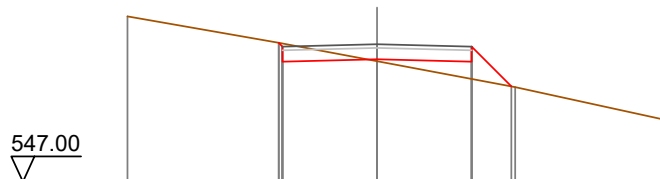

Quote Terreno	-551.38	-550.68			-550.19		-549.50	-548.65
Quote Progetto			550.68	550.18	550.24	550.18	549.52	
Parziali				2.50	2.50	1.05		
Progressiva			-2.60	-2.50	0.00	2.50	3.55	
Dislivelli			-0.00	-0.08	0.05	0.46	0.00	

Sezione: 49
 Progressiva: 308.541
 Q. Progetto: 551.023

547.00

Quote Terreno	551.57	550.87	550.48	550.20	550.01	549.25	548.79
Quote Progetto		550.56	550.62	550.69	549.65		
Parziali		2.50	2.50	1.44			
Progressiva		-2.59	0.00	2.50	3.94		
Dislivelli		-0.00	0.20	0.72	0.00		

Sezione: 50
 Progressiva: 310.000
 Q. Progetto: 551.079

547.00

Quote Terreno	551.60	550.94	550.47	550.31	549.88	548.86
Quote Progetto		550.82	550.88	550.74	549.72	
Parziali		2.50	2.50	1.42		
Progressiva		-2.61	0.00	2.50	3.92	
Dislivelli		0.00	0.21	0.73	-0.00	

Sezione: 51
 Progressiva: 315.976
 Q. Progetto: 551.310

548.00

Quote Terreno	551.82	550.77	550.75	550.97	550.03	549.29	549.28
Quote Progetto		550.85	550.91	550.97	550.03		
Parziali		2.50	2.50	1.34			
Progressiva		-2.58	0.00	2.50	3.84		
Dislivelli		0.00	0.17	0.69	0.00		

Sezione: 52
 Progressiva: 320.000
 Q. Progetto: 551.466

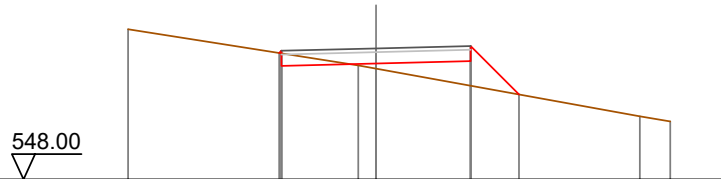

Quote Terreno	-551.97	-551.02	-550.93	-549.67	-549.54
Quote Progetto		551.34 551.00	551.07	551.13	550.25
Parziali		2.50	2.50	1.28	
Progressiva		-2.56 -2.50	0.00	2.50	3.78
Dislivelli		0.00 0.07	0.14	0.65	0.00

Sezione: 53
 Progressiva: 323.411
 Q. Progetto: 551.597

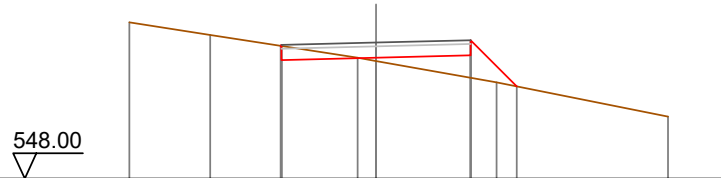

Quote Terreno	-552.13	-551.80	-551.20	-551.11	-550.55	-549.64
Quote Progetto			551.51 551.13	551.20	551.26	550.44
Parziali			2.50	2.50	1.22	
Progressiva			-2.52 -2.50	0.00	2.50	3.72
Dislivelli			0.00 0.03	0.09	0.59	0.00

Sezione: 54
 Progressiva: 340.000
 Q. Progetto: 552.238

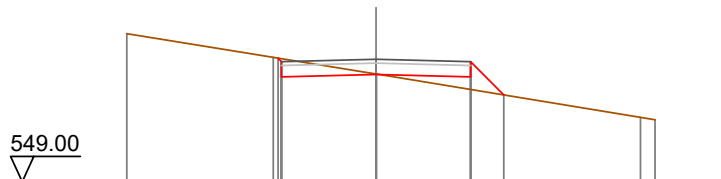

Quote Terreno	-552.92	-552.29	-551.85	-550.70	-550.64
Quote Progetto		552.27 551.78	551.84	551.78	551.30
Parziali		2.50	2.50	0.88	
Progressiva		-2.59 -2.50	0.00	2.50	3.38
Dislivelli		0.00 -0.08	-0.01	0.34	0.00

Sezione: 55
 Progressiva: 360.000
 Q. Progetto: 552.762

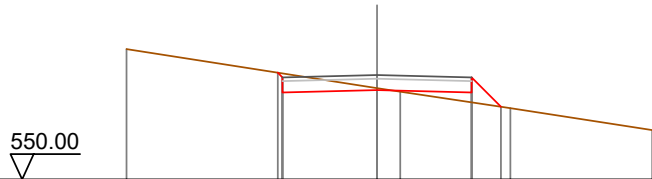

Quote Terreno		-553.46			552.41	552.32		551.89		-551.30
Quote Progetto			552.82	552.30		552.36		552.30	551.92	
Parziali				2.50		2.50		0.78		
Progressiva			-2.62	-2.50		0.00		2.50	3.28	
Dislivelli			0.00	-0.10		-0.05		0.26	0.00	

Sezione: 56
 Progressiva: 380.000
 Q. Progetto: 553.236

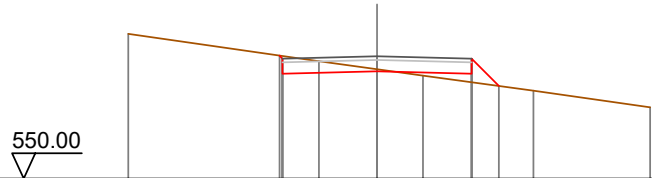

Quote Terreno		-553.83			553.10	552.89		552.72		552.33		-551.89
Quote Progetto			553.25	552.77		552.84		552.77	552.45			
Parziali				2.50		2.50		0.72				
Progressiva			-2.58	-2.50		0.00		2.50	3.22			
Dislivelli			0.00	-0.07		-0.06		0.22	-0.00			

Sezione: 57
 Progressiva: 400.000
 Q. Progetto: 553.646

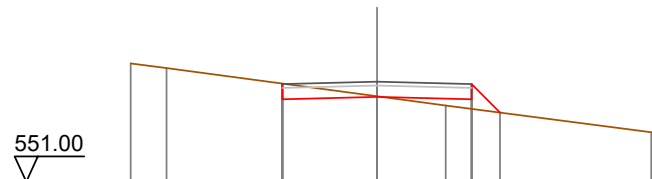

Quote Terreno		-554.13	-554.01			553.26		553.02				-552.31
Quote Progetto				553.18		553.25		553.18	552.83			
Parziali				2.50		2.50		0.75				
Progressiva				-2.51		0.00		2.50	3.25			
Dislivelli				0.00		-0.02		0.25	-0.00			

Sezione: 58
 Progressiva: 410.075
 Q. Progetto: 553.803

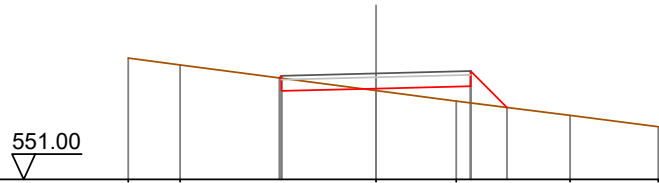

Quote Terreno	554.21	554.03	553.69	553.34	553.40	553.35	553.07	552.89	552.40
Quote Progetto			553.69	553.34	553.40		553.47	552.90	
Parziali			2.50	2.50	0.96				
Progressiva			-2.56	-2.50	0.00		2.50	3.46	
Dislivelli			0.00	0.06	0.05		0.44	0.00	

Sezione: 59
 Progressiva: 416.765
 Q. Progetto: 553.907

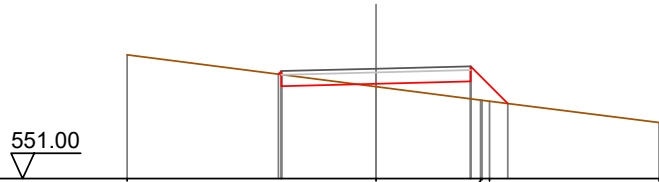

Quote Terreno	554.27		553.76	553.44	553.51	553.43	553.08	553.05	552.48
Quote Progetto			553.76	553.44	553.51		553.57	553.05	
Parziali			2.50	2.50	0.98				
Progressiva			-2.58	-2.50	0.00		2.50	3.48	
Dislivelli			-0.00	0.09	0.08		0.46	0.00	

Sezione: 60
 Progressiva: 420.000
 Q. Progetto: 553.958

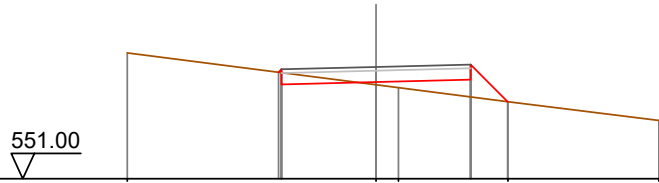

Quote Terreno	554.33		553.82	553.50	553.56	553.48	553.41	553.04	553.04	552.54
Quote Progetto			553.82	553.50	553.56		553.62	553.04	553.04	
Parziali			2.50	2.50	0.98					
Progressiva			-2.58	-2.50	0.00		2.50	3.48		
Dislivelli			-0.00	0.09	0.07		0.46	-0.00		

Sezione: 61
 Progressiva: 423.454
 Q. Progetto: 554.012

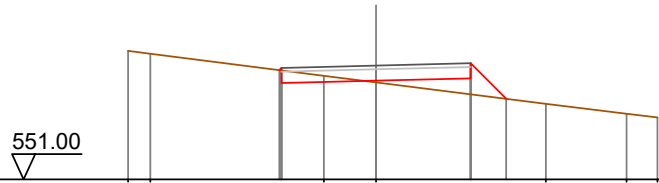

Quote Terreno	554.40	554.32		553.74	553.57		553.00	552.74	552.64
Quote Progetto			553.89	553.55	553.61	553.67	553.13		
Parziali			2.50	2.50	0.94				
Progressiva			-2.56	-2.50	0.00	2.50	3.44		
Dislivelli			0.00	0.07	0.04	0.42	0.00		

Sezione: 62
 Progressiva: 440.000
 Q. Progetto: 554.259

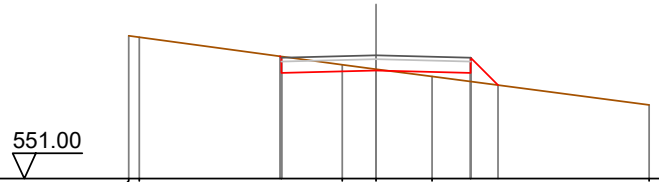

Quote Terreno	554.78	554.74		554.01	553.89	553.70		552.95
Quote Progetto			554.23	553.80	553.86	553.80	553.47	
Parziali			2.50	2.50	0.72			
Progressiva			-2.54	-2.50	0.00	2.50	3.22	
Dislivelli			0.00	-0.03	-0.04	0.23	-0.00	

Sezione: 63
 Progressiva: 460.000
 Q. Progetto: 554.213

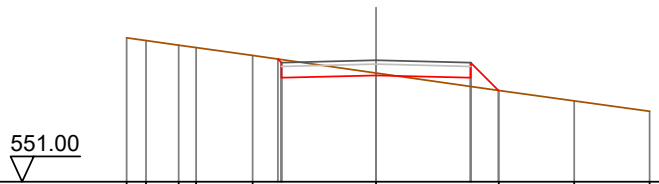

Quote Terreno	554.81	554.73	554.61	554.55	554.34		553.88		553.41	553.14	552.86
Quote Progetto			554.25	553.75	553.81	553.75	553.42				
Parziali			2.50	2.50	0.73						
Progressiva			-2.60	-2.50	0.00	2.50	3.23				
Dislivelli			0.00	-0.08	-0.06	0.23	0.00				

Sezione: 64
 Progressiva: 480.000
 Q. Progetto: 553.677

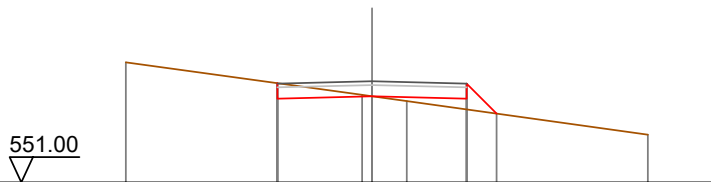

Quote Terreno		-554.18		553.32	553.28		553.15		-552.26
Quote Progetto			553.21		553.28		553.21	552.82	
Parziali				2.50		2.50	0.79		
Progressiva			-2.51		0.00		2.50	3.29	
Dislivelli			0.00		-0.00		0.28	0.00	

Sezione: 65
 Progressiva: 481.460
 Q. Progetto: 553.627

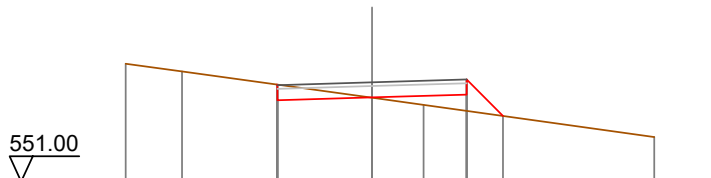

Quote Terreno		-554.12		-553.91		553.22		553.03		-552.18
Quote Progetto				553.15		553.23		553.30	552.74	
Parziali					2.50		2.50	0.96		
Progressiva				-2.51		0.00		2.50	3.46	
Dislivelli				0.00		0.01		0.43	-0.00	

Sezione: 66
 Progressiva: 484.765
 Q. Progetto: 553.513

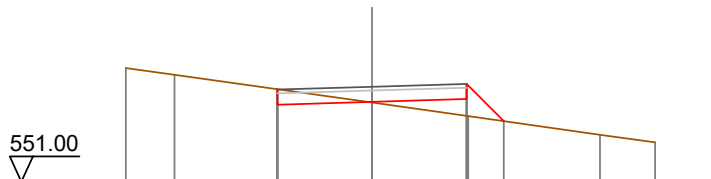

Quote Terreno		-554.01		-553.83		553.10		552.74		552.24	-552.04
Quote Progetto				553.04		553.11		553.19	552.60		
Parziali					2.50		2.50	0.98			
Progressiva				-2.51		0.00		2.50	3.48		
Dislivelli				0.00		0.02		0.44	0.00		

Sezione: 67
 Progressiva: 488.069
 Q. Progetto: 553.399

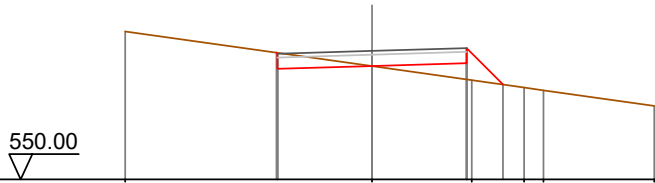

Quote Terreno	553.91		553.00	552.63	552.43	552.36	551.95
Quote Progetto		553.35	553.00	553.07	552.51		
Parziali		2.50	2.50	0.96			
Progressiva		-2.53	0.00	2.50	3.46		
Dislivelli		0.00	0.00	0.43	0.00		

Sezione: 68
 Progressiva: 500.000
 Q. Progetto: 552.989

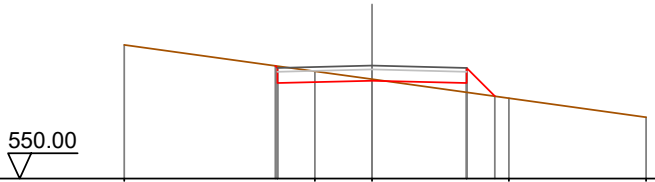

Quote Terreno	553.54	552.84	552.63		552.13	551.62
Quote Progetto		552.98	552.59	552.53	552.18	
Parziali		2.50	2.50	0.75		
Progressiva		-2.56	0.00	2.50	3.25	
Dislivelli		-0.00	-0.04	0.24	0.00	

Sezione: 69
 Progressiva: 520.000
 Q. Progetto: 552.302

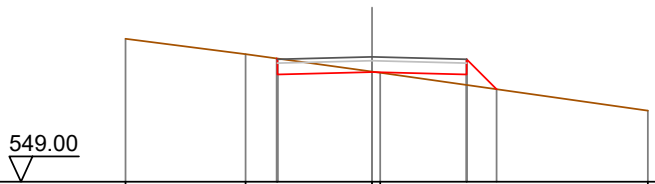

Quote Terreno	552.78	552.37	551.91	551.88		550.88
Quote Progetto		552.26	551.90	551.84	551.45	
Parziali		2.50	2.50	0.79		
Progressiva		-2.52	0.00	2.50	3.29	
Dislivelli		0.00	-0.01	0.28	0.00	

Sezione: 70
 Progressiva: 540.000
 Q. Progetto: 551.614

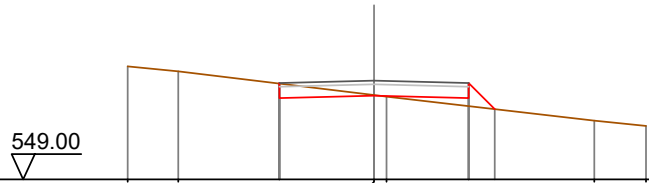

Quote Terreno		-551.99	-551.86		551.23	551.19		-550.56	-550.41
Quote Progetto				551.15	551.21		551.15	550.86	
Parziali				2.50	2.50	0.09			
Progressiva				-2.51	0.00	2.50	3.19		
Dislivelli				-0.00	-0.02	0.21	0.00		

Sezione: 71
 Progressiva: 560.000
 Q. Progetto: 551.033

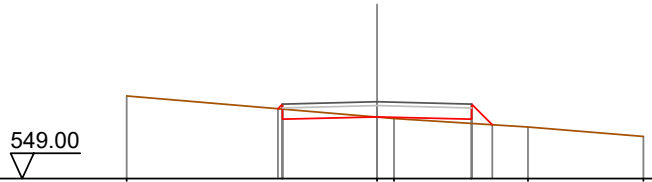

Quote Terreno		-551.19			550.63	550.59		-550.36	-550.11
Quote Progetto				550.85	550.57		550.57	550.42	
Parziali				2.50	2.50	0.55			
Progressiva				-2.62	-2.50	0.00	2.50	3.05	
Dislivelli				-0.00	0.13	0.01	0.11	0.00	

Sezione: 72
 Progressiva: 566.591
 Q. Progetto: 550.851

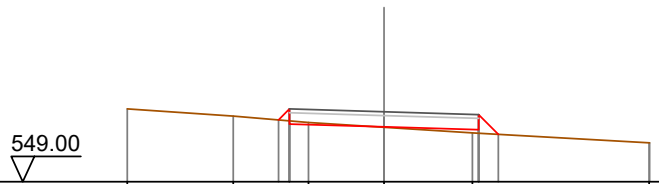

Quote Terreno		-550.93	-550.74		550.44		550.29		-550.03
Quote Progetto				550.64	550.53		550.38	550.25	
Parziali				0.23	2.50	2.50	0.52		
Progressiva				-2.79	-2.50	0.00	2.50	3.02	
Dislivelli				0.00	0.31	0.01	0.09	-0.00	

Sezione: 73
 Progressiva: 567.706
 Q. Progetto: 550.820

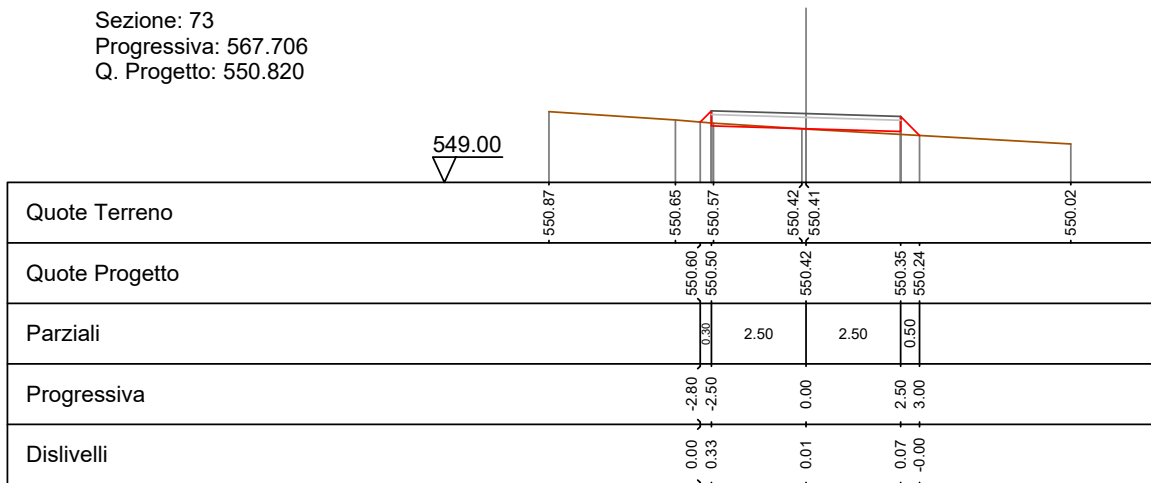

Sezione: 74
 Progressiva: 568.820
 Q. Progetto: 550.790

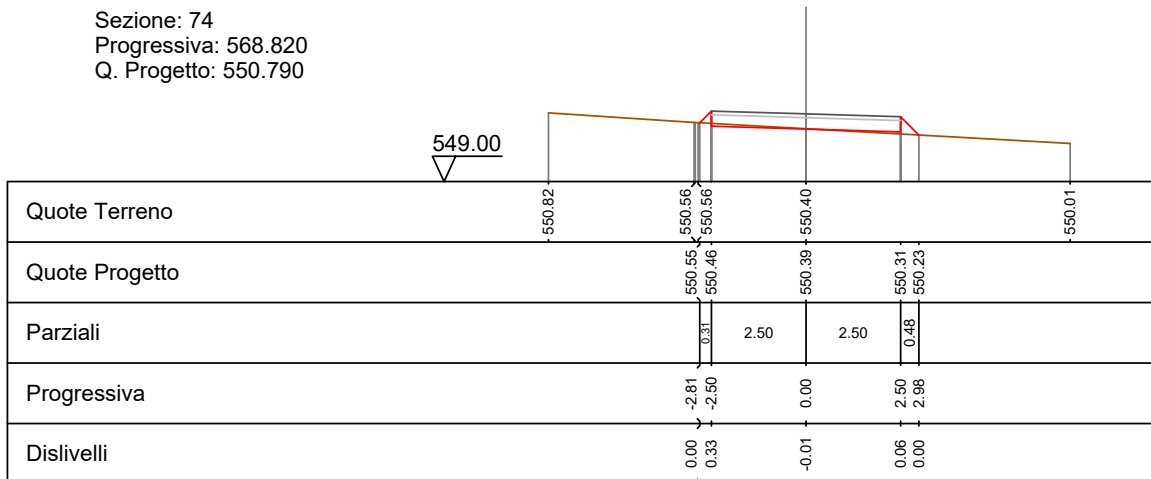

Sezione: 75
 Progressiva: 580.000
 Q. Progetto: 550.487

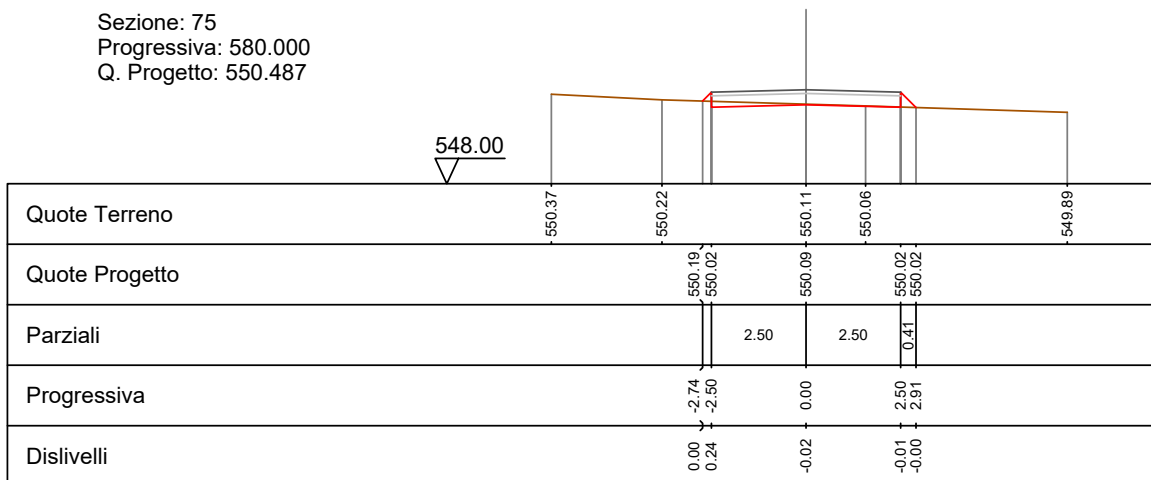

Sezione: 76
 Progressiva: 600.000
 Q. Progetto: 550.061

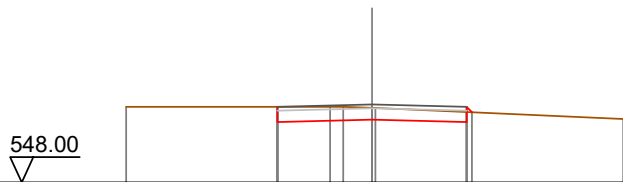

Quote Terreno	550.00	550.00	549.97	549.68
Quote Progetto		549.60	549.66	549.60
Parziali		2.50	2.50	
Progressiva		-2.50	0.00	2.50
Dislivelli		0.00	-0.31	-0.26

Sezione: 77
 Progressiva: 604.660
 Q. Progetto: 549.943

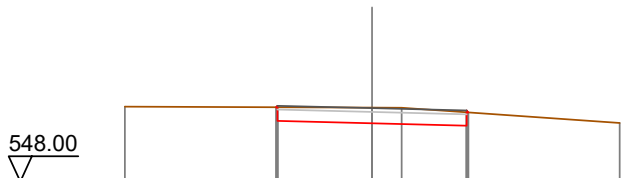

Quote Terreno	549.98	549.96	549.95	549.55
Quote Progetto		549.97	549.81	549.48
Parziali		2.50	2.50	
Progressiva		-2.54	0.00	2.50
Dislivelli		0.00	-0.41	-0.35

Sezione: 78
 Progressiva: 610.000
 Q. Progetto: 549.753

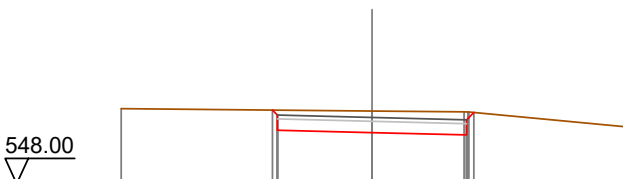

Quote Terreno	549.99	549.92	549.90	549.51
Quote Progetto		549.95	549.42	549.29
Parziali		2.50	2.50	
Progressiva		-2.63	0.00	2.50
Dislivelli		0.00	-0.57	-0.61

Sezione: 79
 Progressiva: 613.431
 Q. Progetto: 549.601

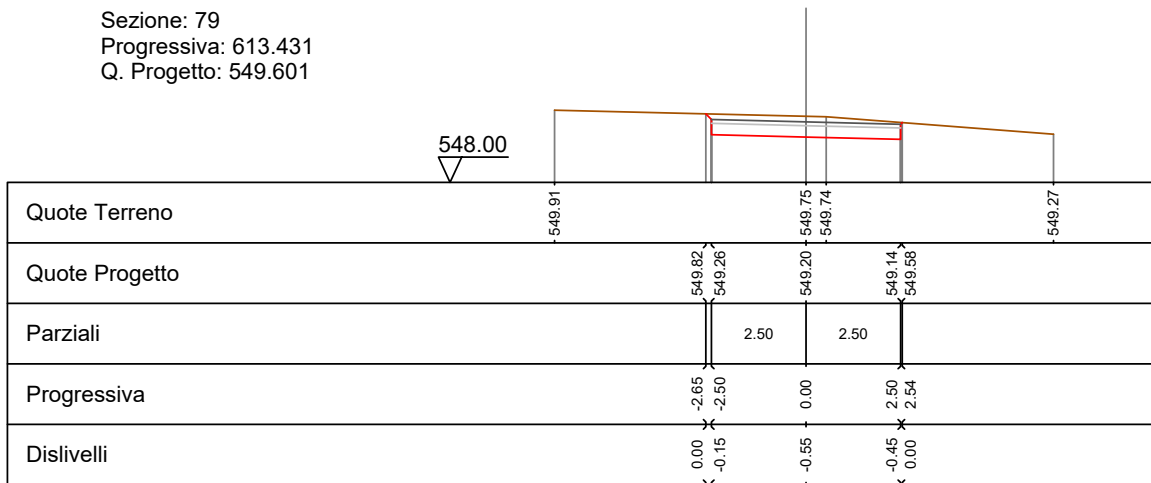

Sezione: 80
 Progressiva: 620.000
 Q. Progetto: 549.244

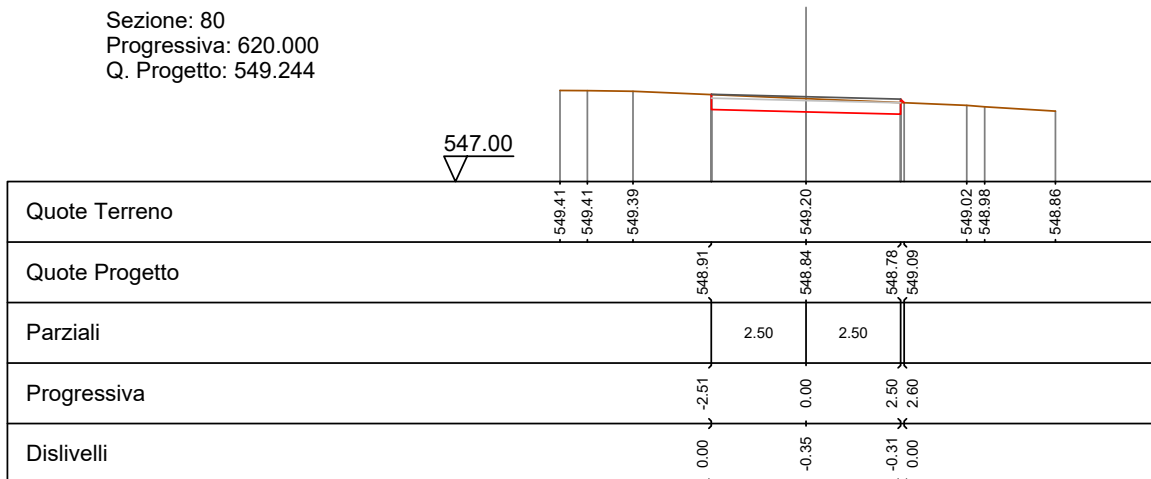

Sezione: 81
 Progressiva: 622.201
 Q. Progetto: 549.105

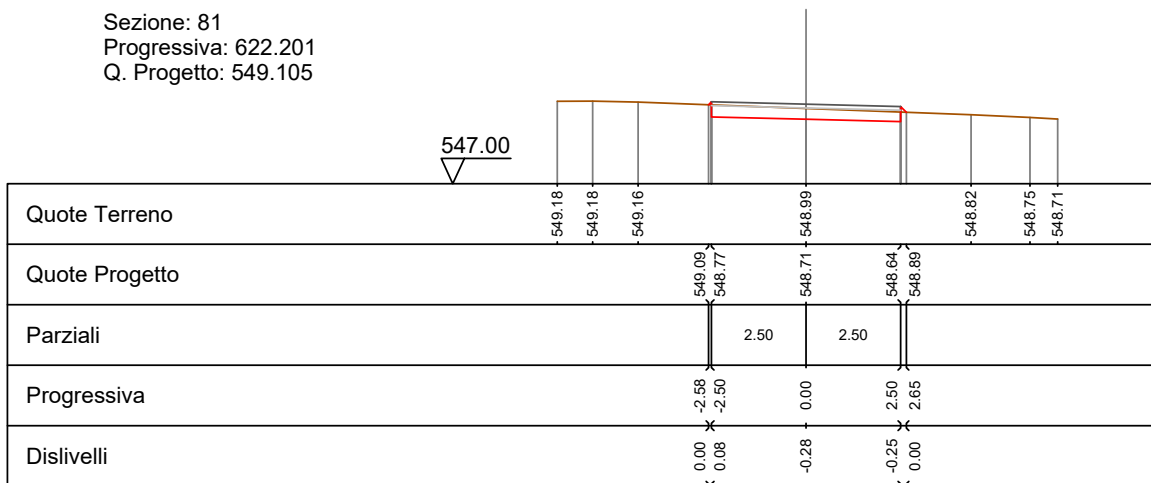

Sezione: 82
 Progressiva: 640.000
 Q. Progetto: 547.622

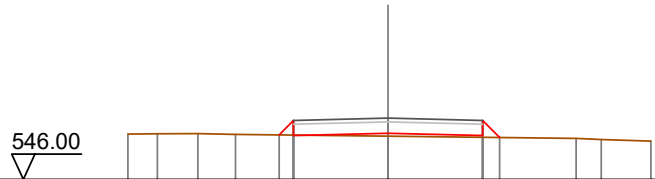

Quote Terreno	547.20	547.21	547.21	547.19	547.15	547.09	547.06	547.01
Quote Progetto				547.18	547.22	547.16	547.11	
Parziali				0.38	2.50	2.50	0.45	
Progressiva				-2.88	0.00	2.50	2.95	
Dislivelli				0.00	0.08	0.04	0.00	

Sezione: 83
 Progressiva: 660.000
 Q. Progetto: 545.592

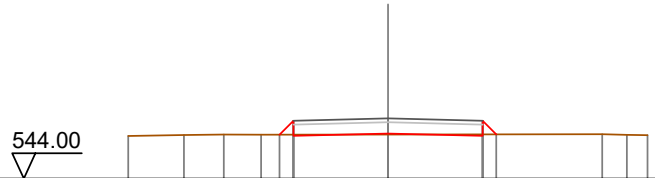

Quote Terreno	545.13	545.15	545.16	545.16	545.16	545.17	545.16	545.15
Quote Progetto				545.16	545.19	545.13	545.17	
Parziali				0.37	2.50	2.50	0.36	
Progressiva				-2.87	0.00	2.50	2.86	
Dislivelli				-0.00	0.03	-0.04	-0.00	

Sezione: 84
 Progressiva: 680.000
 Q. Progetto: 543.562

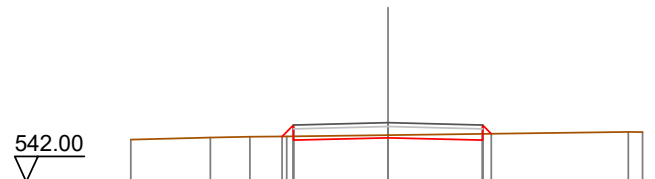

Quote Terreno	543.12	543.17	543.19	543.20	543.23	543.32	543.31
Quote Progetto				543.20	543.16	543.10	543.27
Parziali				0.30	2.50	2.50	
Progressiva				-2.80	0.00	2.50	2.73
Dislivelli				0.00	-0.07	-0.17	0.00

Sezione: 85
 Progressiva: 700.000
 Q. Progetto: 541.587

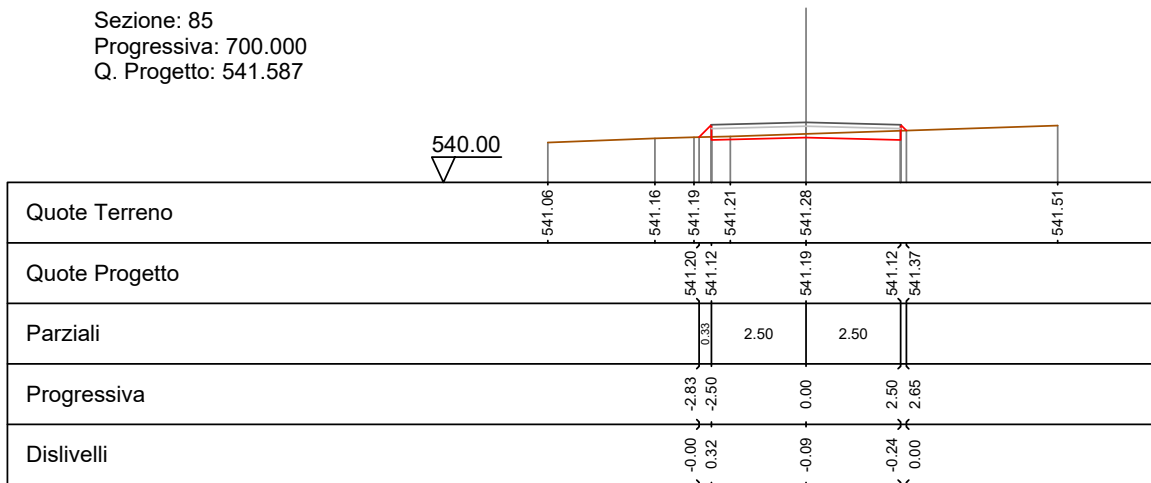

Sezione: 86
 Progressiva: 707.998
 Q. Progetto: 540.959

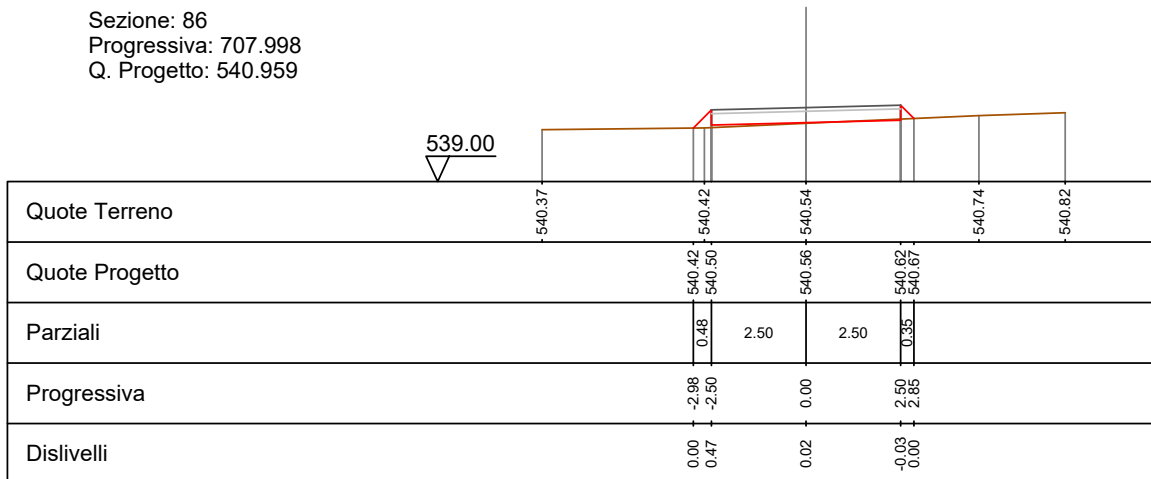

Sezione: 87
 Progressiva: 710.000
 Q. Progetto: 540.822

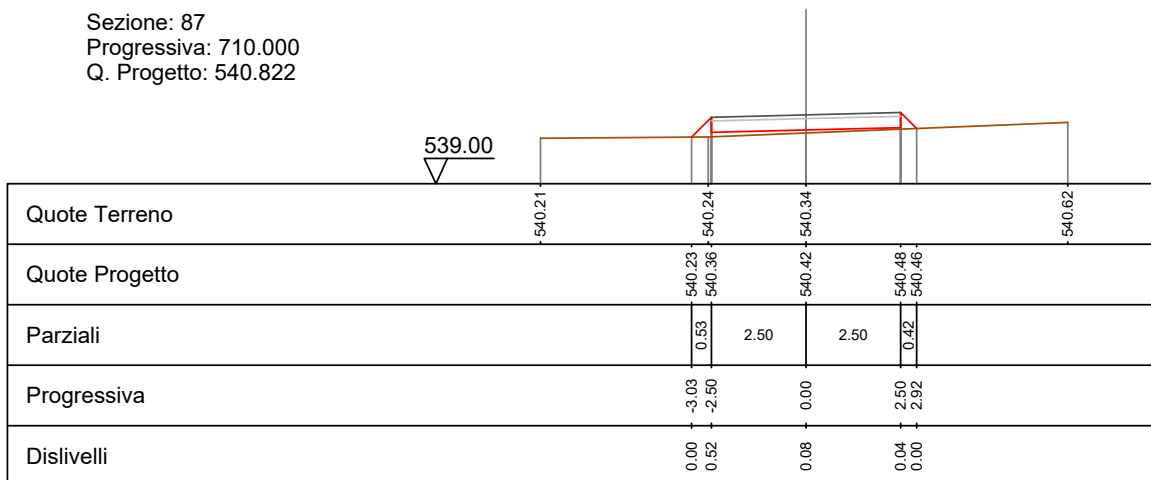

Sezione: 88
 Progressiva: 720.000
 Q. Progetto: 540.258

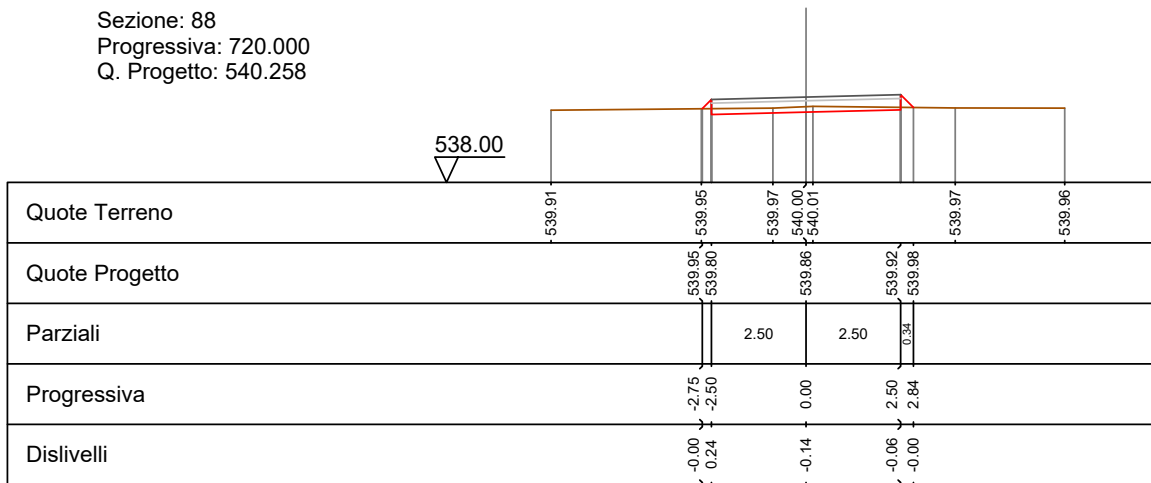

Sezione: 89
 Progressiva: 730.000
 Q. Progetto: 539.870

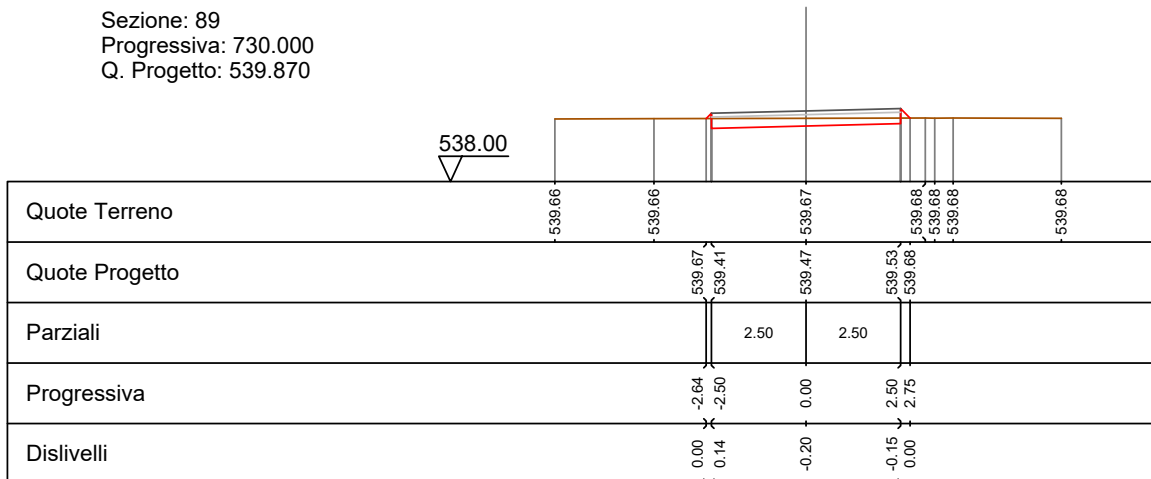

Sezione: 90
 Progressiva: 735.790
 Q. Progetto: 539.659

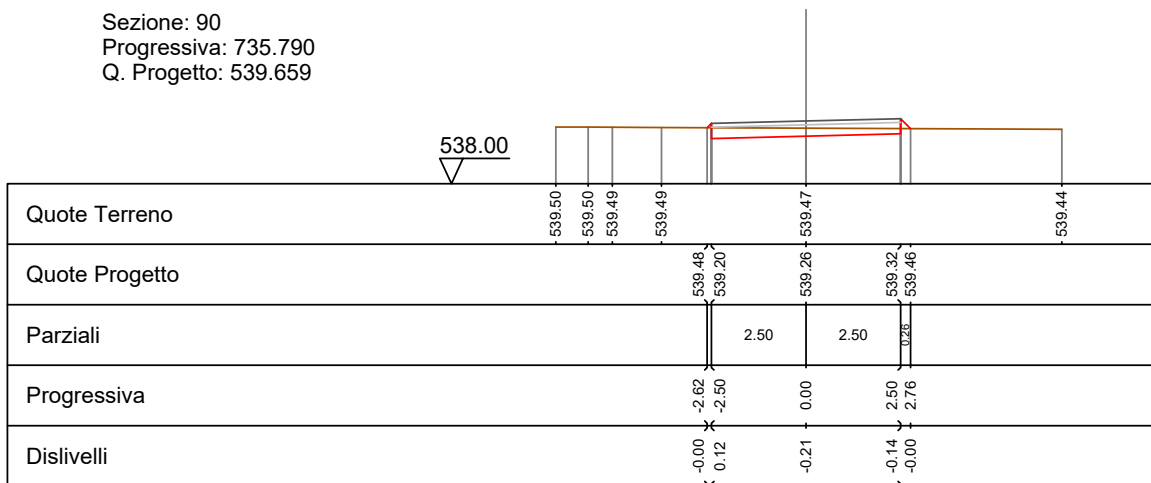

Sezione: 91
 Progressiva: 740.000
 Q. Progetto: 539.506

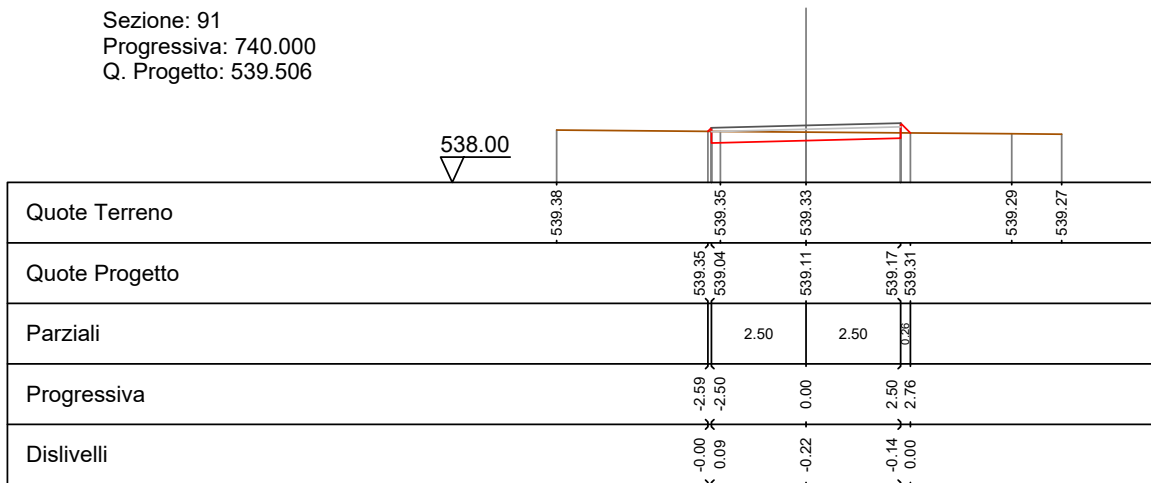

Sezione: 92
 Progressiva: 749.487
 Q. Progetto: 539.162

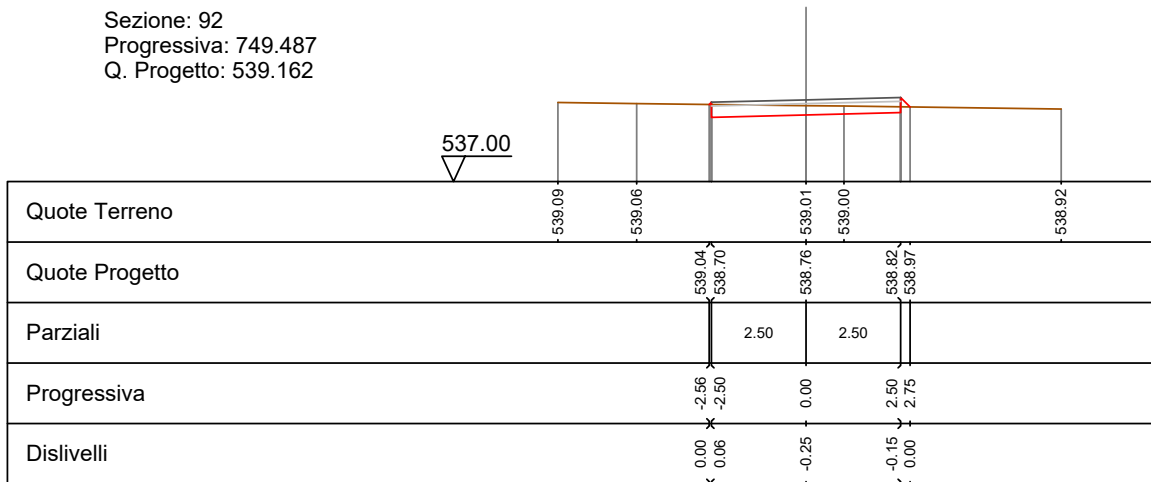

Sezione: 92
 Progressiva: 749.487
 Q. Progetto: 539.162

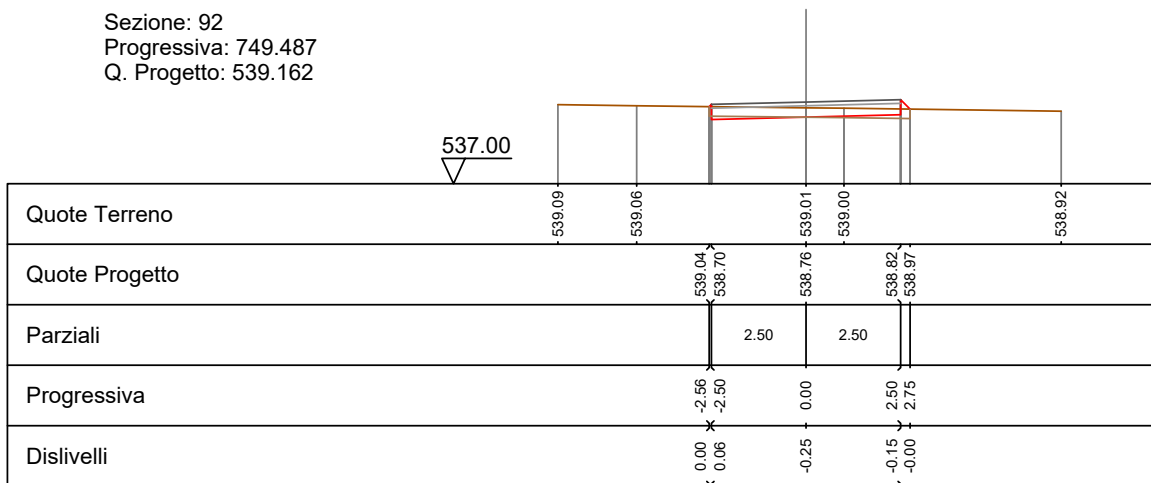

Sezione: 93
 Progressiva: 750.000
 Q. Progetto: 539.143

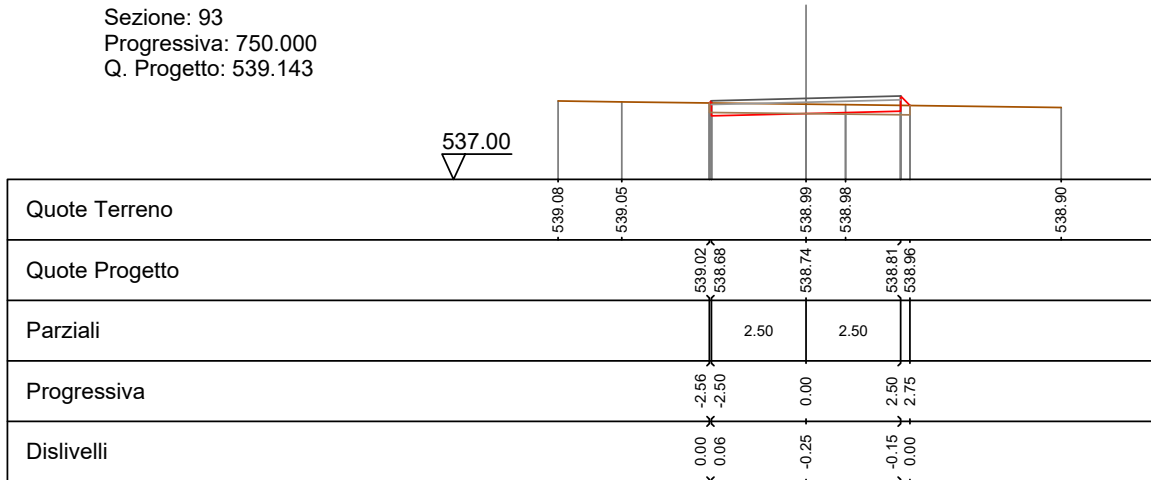

Sezione: 94
 Progressiva: 760.000
 Q. Progetto: 538.779

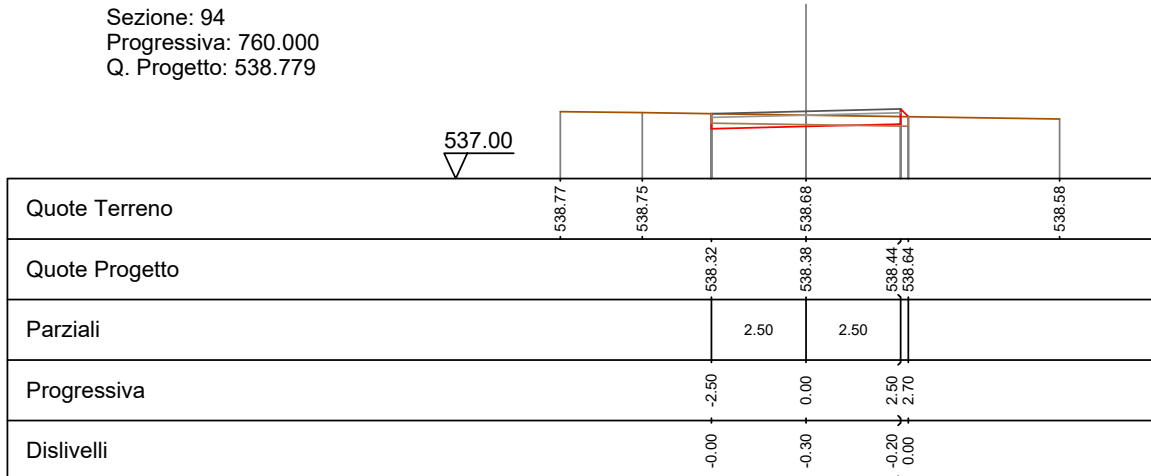

Sezione: 95
 Progressiva: 763.583
 Q. Progetto: 538.649

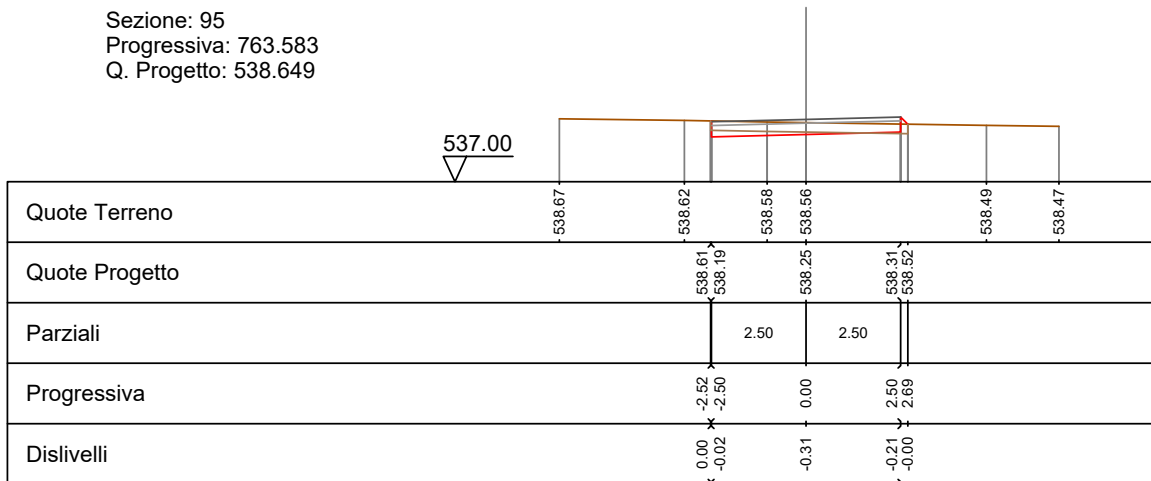

Sezione: 96
 Progressiva: 780.000
 Q. Progetto: 538.053

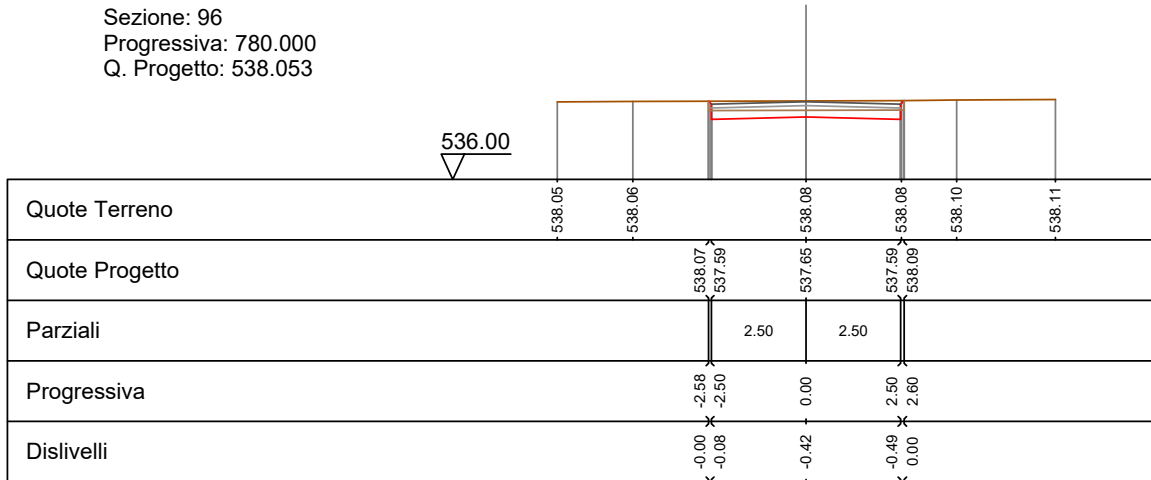

Sezione: 97
 Progressiva: 800.000
 Q. Progetto: 537.272

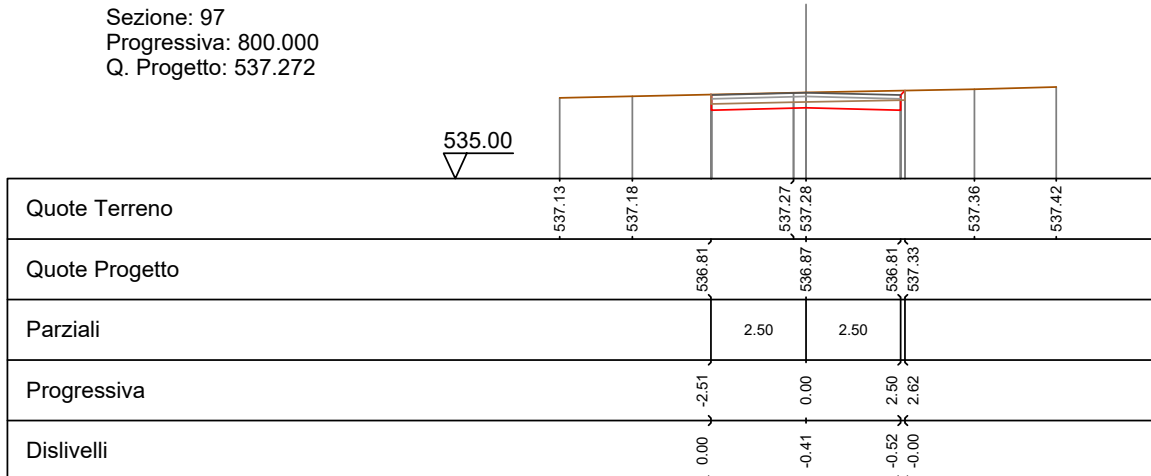

Sezione: 98
 Progressiva: 810.373
 Q. Progetto: 536.746

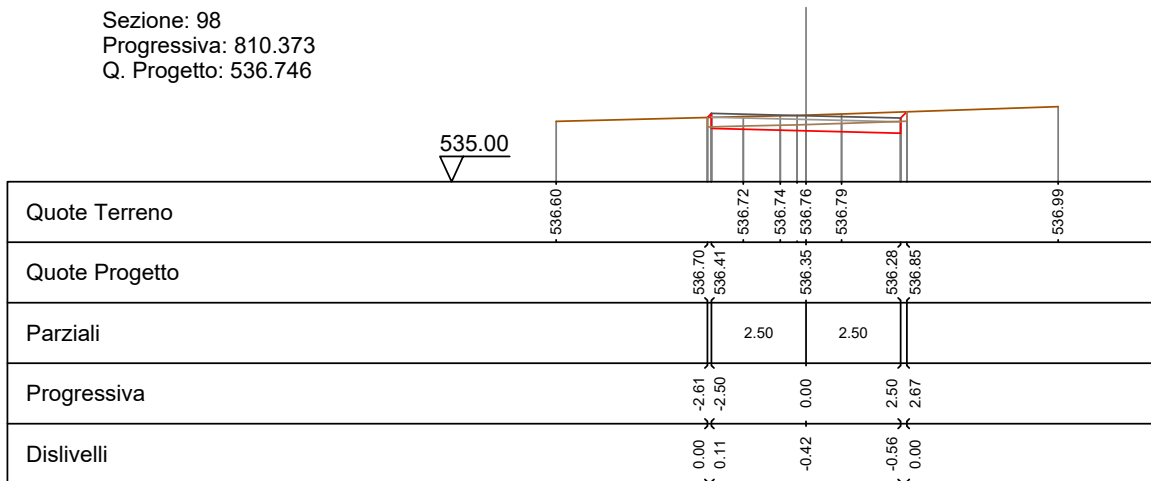

Sezione: 99
 Progressiva: 814.853
 Q. Progetto: 536.520

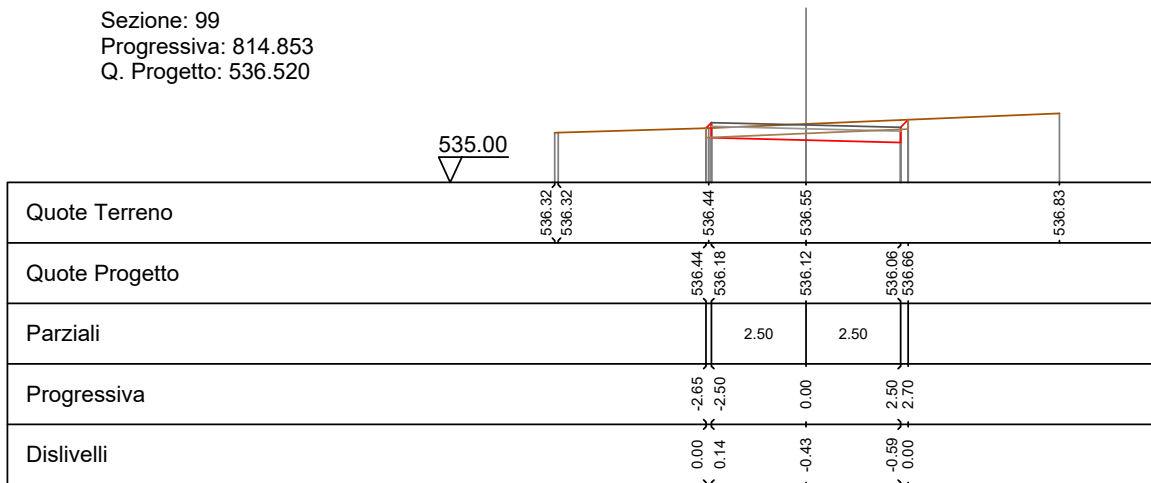

Sezione: 100
 Progressiva: 819.333
 Q. Progetto: 536.293

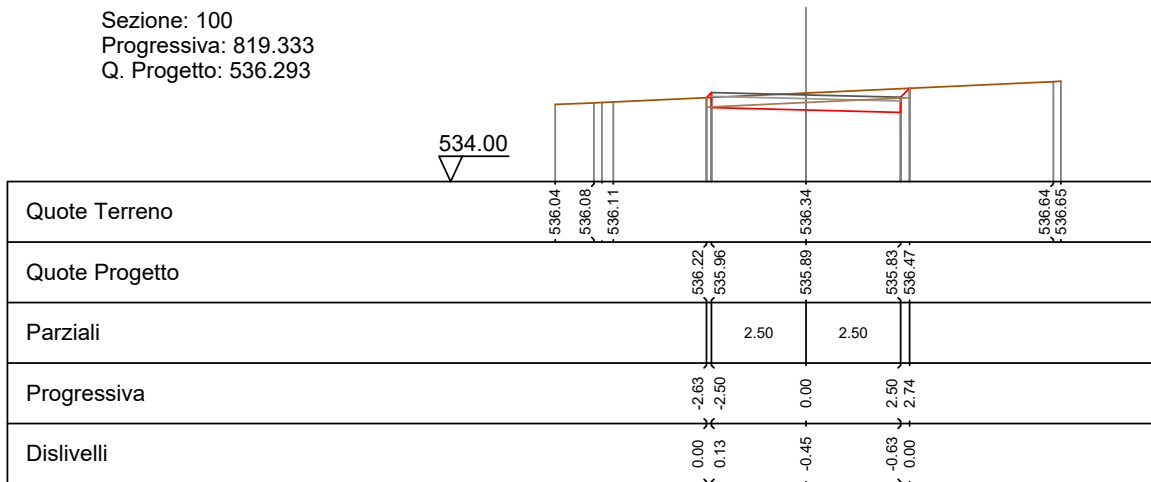

Sezione: 101
 Progressiva: 820.000
 Q. Progetto: 536.259

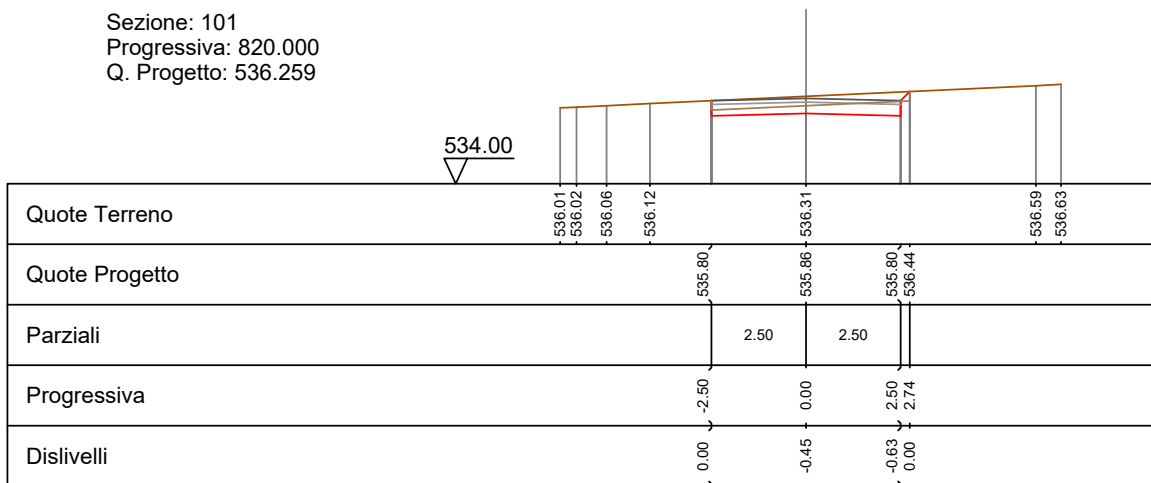

Sezione: 102
 Progressiva: 840.000
 Q. Progetto: 535.314

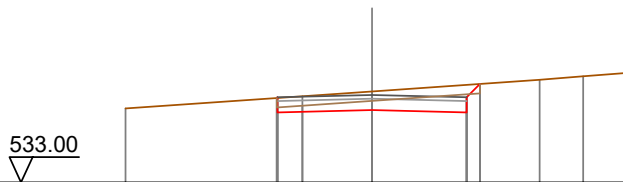

Quote Terreno	534.96		535.28	535.41		535.71	535.81	535.91
Quote Progetto		535.23	534.85	534.91		534.85	535.00	
Parziali			2.50	2.50			0.35	
Progressiva		-2.52	-2.50	0.00		2.50	2.85	
Dislivelli		0.00	0.02	-0.49		-0.73	0.00	

Sezione: 103
 Progressiva: 849.267
 Q. Progetto: 535.084

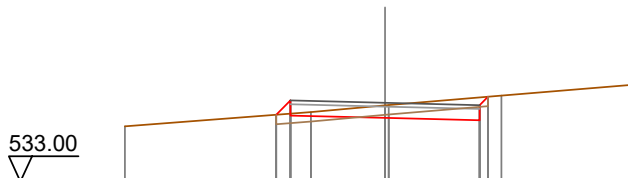

Quote Terreno	534.46		534.84	535.02	535.02		535.27	535.57
Quote Progetto		534.77	534.75	534.88	535.02		534.62	535.24
Parziali		0.38	2.50	2.50				
Progressiva		-2.88	-2.50	0.00		2.50	2.72	
Dislivelli		-0.00	0.35	-0.33		-0.60	0.00	

Sezione: 104
 Progressiva: 850.000
 Q. Progetto: 535.073

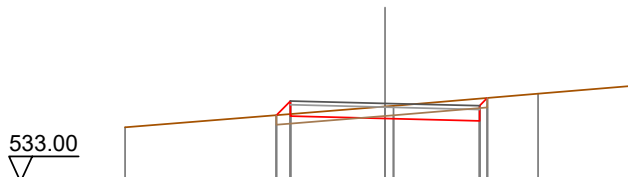

Quote Terreno	534.44			534.99	535.01		535.33	535.55
Quote Progetto		534.76	534.74	534.67	535.01		534.61	535.22
Parziali		0.38	2.50	2.50				
Progressiva		-2.88	-2.50	0.00		2.50	2.71	
Dislivelli		0.00	0.35	-0.32		-0.59	-0.00	

Sezione: 105
 Progressiva: 858.281
 Q. Progetto: 535.025

533.00

Quote Terreno	-534.03	-534.14		-534.65	-534.74	-534.83	-535.07	-535.38
Quote Progetto			534.43	534.69	534.63	534.56		
Parziali			0.66	2.50	2.50			
Progressiva			-3.16	-2.50	0.00	2.50		
Dislivelli			0.00	0.59	-0.11	-0.40		

Sezione: 106
 Progressiva: 860.000
 Q. Progetto: 535.032

532.00

Quote Terreno	-533.99	-534.10		-534.68	-534.70	-534.79	-534.89	-535.35
Quote Progetto			534.39	534.69	534.63	534.57	534.94	
Parziali			0.70	2.50	2.50			
Progressiva			-3.20	-2.50	0.00	2.50	2.53	
Dislivelli			0.00	0.64	-0.07	-0.37	0.00	

Sezione: 107
 Progressiva: 867.296
 Q. Progetto: 535.129

532.00

Quote Terreno	-533.89	-533.96	-534.14		-534.70		-535.29	-535.41
Quote Progetto			534.33	534.79	534.73	534.67	534.98	
Parziali			0.86	2.50	2.50			
Progressiva			-3.36	-2.50	0.00	2.50	2.58	
Dislivelli			0.00	0.77	0.03	-0.31	0.00	

Sezione: 108
 Progressiva: 879.807
 Q. Progetto: 535.542

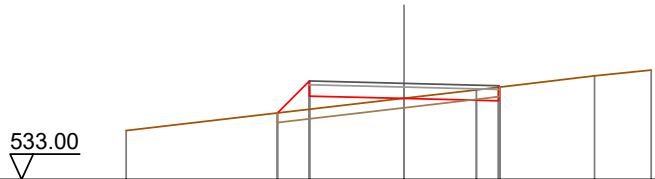

Quote Terreno		534.29			535.15	535.37		535.74	535.89
Quote Progetto				534.76	535.20		535.14	535.08	535.44
Parziali				0.85	2.50		2.50		
Progressiva				-3.35	-2.50		0.00	2.50	2.54
Dislivelli				0.00	0.75		-0.00	-0.36	-0.00

Sezione: 109
 Progressiva: 890.000
 Q. Progetto: 536.110

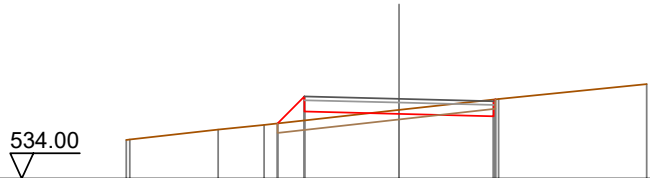

Quote Terreno		535.02	535.03	535.30	535.42		535.82	536.11	536.50
Quote Progetto					535.46	535.77		535.65	536.10
Parziali					0.71	2.50		2.50	
Progressiva					-3.21	-2.50		2.50	2.55
Dislivelli					0.00	0.63		-0.44	0.00

Sezione: 110
 Progressiva: 899.548
 Q. Progetto: 536.833

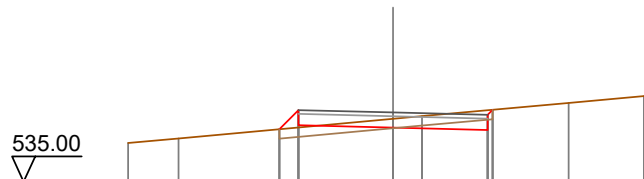

Quote Terreno		536.02	536.14			536.67	536.74		537.08	537.27
Quote Progetto				536.39	536.50		536.43	536.37	536.90	
Parziali				0.51	2.50		2.50			
Progressiva				-3.01	-2.50		0.00	2.50	2.63	
Dislivelli				0.00	0.46		-0.23	-0.52	-0.00	

Sezione: 111
 Progressiva: 900.000
 Q. Progetto: 536.872

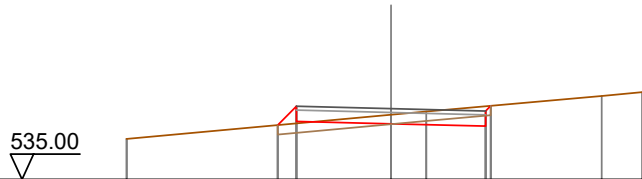

Quote Terreno	536.07			536.71	536.80		537.21	537.31
Quote Progetto		536.44	536.53	536.47	536.41	536.95		
Parziali		0.50	2.50	2.50				
Progressiva		-3.00	-2.50	0.00	2.50	2.64		
Dislivelli		0.00	0.45	-0.24	-0.53	0.00		

Sezione: 112
 Progressiva: 910.000
 Q. Progetto: 537.772

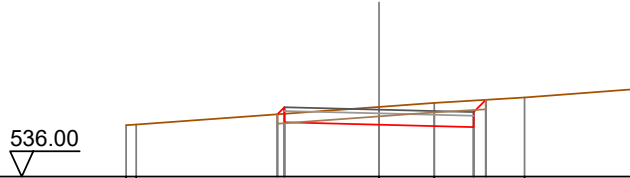

Quote Terreno	537.36	537.38		537.84	537.95		538.09	538.32
Quote Progetto			537.65	537.37	537.31	538.03		
Parziali			2.50	2.50	0.32			
Progressiva			-2.69	-2.50	0.00	2.50	2.82	
Dislivelli			0.00	0.17	-0.47	-0.70	-0.00	

Sezione: 113
 Progressiva: 919.288
 Q. Progetto: 538.589

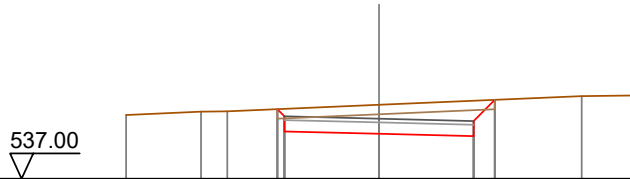

Quote Terreno	538.69	538.77	538.78		538.96		539.19	539.21
Quote Progetto			538.84	538.25	538.19	538.13	539.09	
Parziali			2.50	2.50	0.56			
Progressiva			-2.69	-2.50	0.00	2.50	3.06	
Dislivelli			0.00	-0.20	-0.77	-0.94	-0.00	

Sezione: 114
 Progressiva: 920.000
 Q. Progetto: 538.647

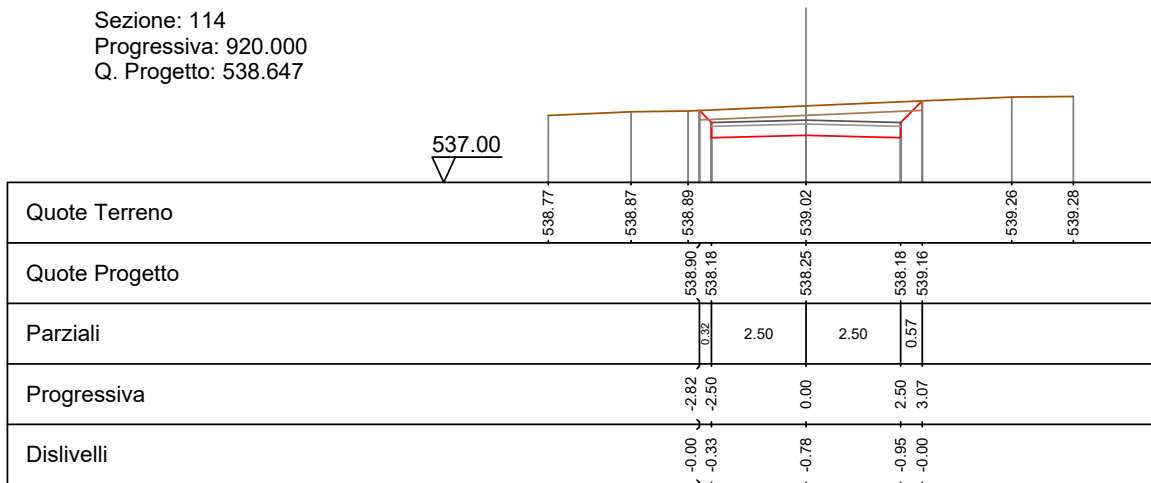

Sezione: 115
 Progressiva: 940.000
 Q. Progetto: 539.834

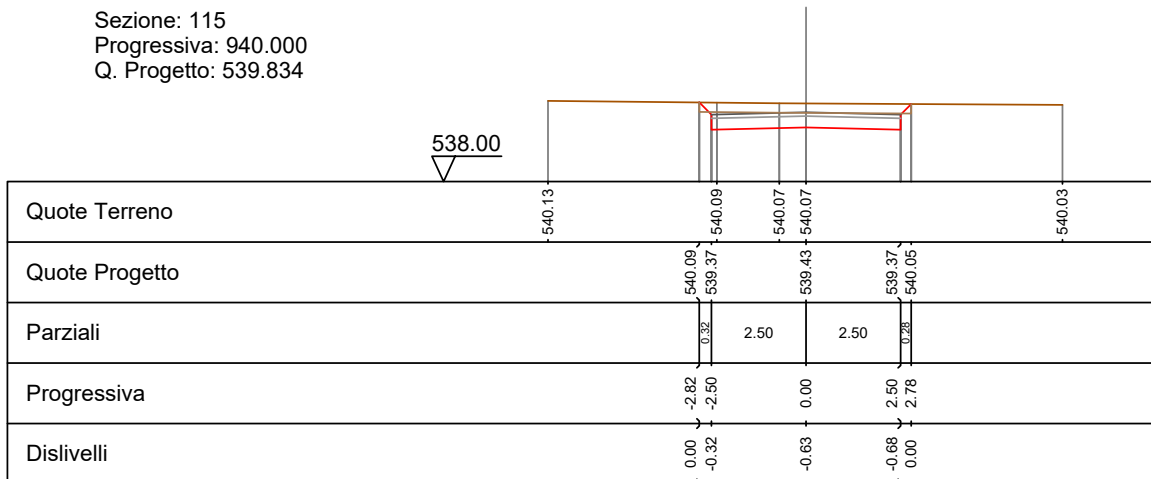

Sezione: 116
 Progressiva: 944.090
 Q. Progetto: 539.978

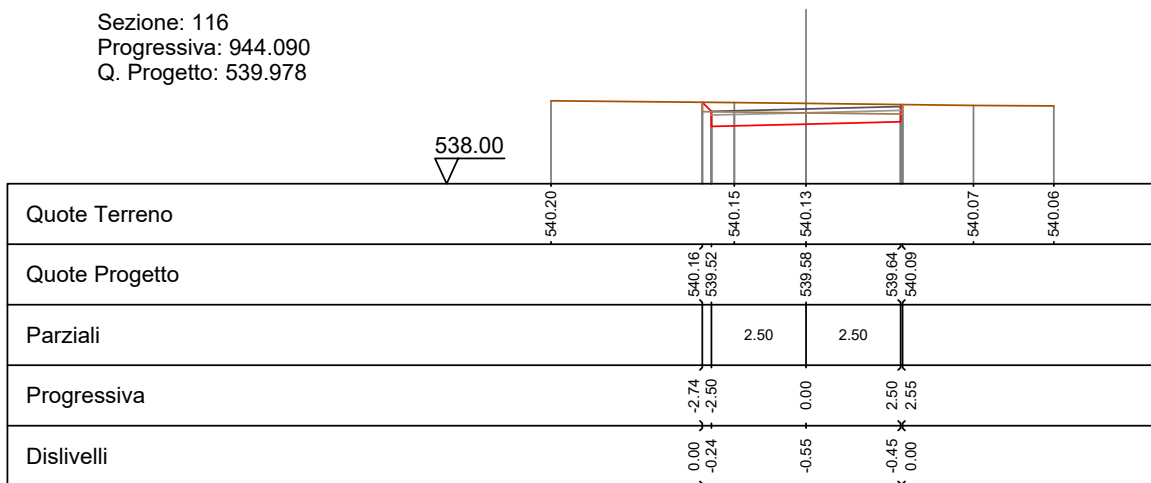

Sezione: 117
 Progressiva: 950.000
 Q. Progetto: 540.138

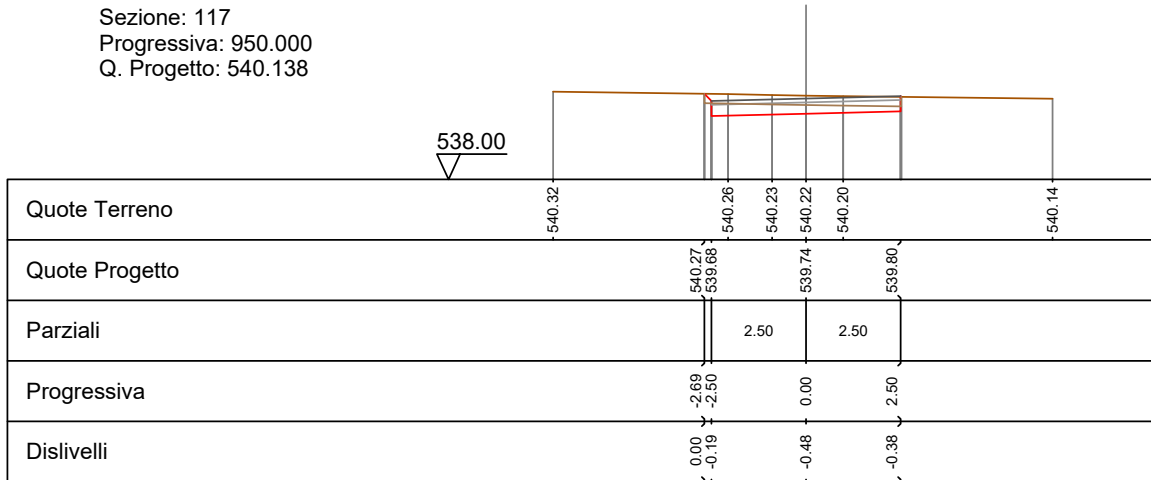

Sezione: 118
 Progressiva: 960.000
 Q. Progetto: 540.399

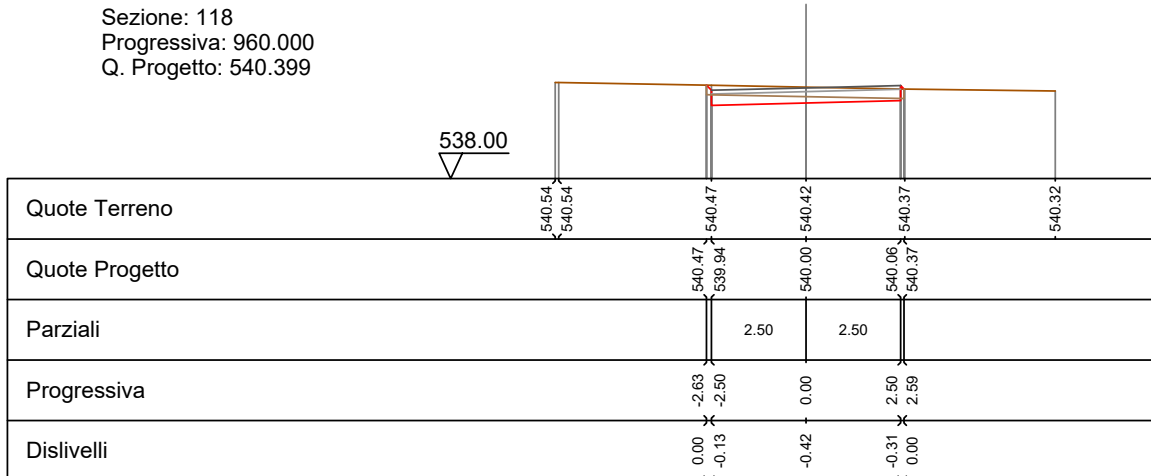

Sezione: 119
 Progressiva: 967.936
 Q. Progetto: 540.634

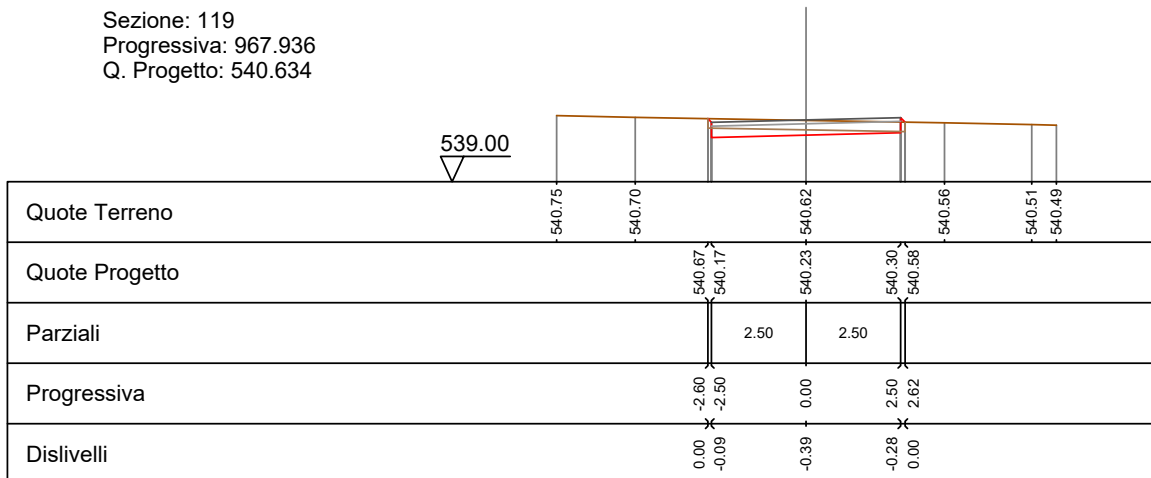

Sezione: 120
 Progressiva: 970.000
 Q. Progetto: 540.714

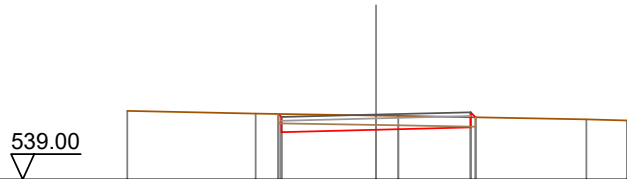

Quote Terreno	-540.81	-540.74	-540.69	-540.68	-540.59	-540.56
Quote Progetto		540.73 540.25	540.31	540.38 540.64		
Parziali		2.50	2.50			
Progressiva		-2.58 -2.50	0.00	2.50 2.63		
Dislivelli		-0.00 -0.08	-0.38	-0.27 0.00		

Sezione: 121
 Progressiva: 980.000
 Q. Progetto: 541.222

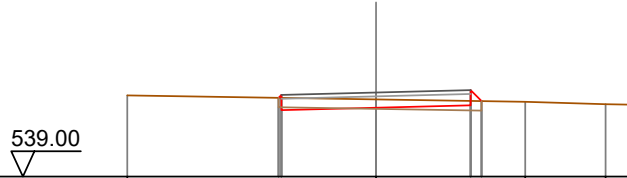

Quote Terreno	-541.15		-541.04		-540.98	-540.92	-540.90
Quote Progetto		541.08 540.76	540.82 541.04	540.88 541.00			
Parziali		2.50	2.50	0.28			
Progressiva		-2.58 -2.50	0.00	2.50 2.79			
Dislivelli		0.00 0.08	-0.22	-0.12 0.00			

Sezione: 122
 Progressiva: 990.000
 Q. Progetto: 541.865

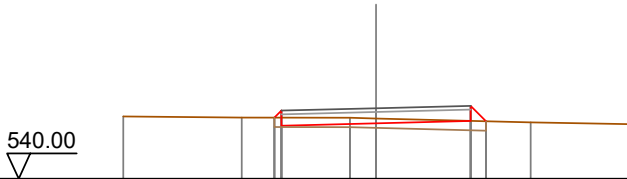

Quote Terreno	-541.65	-541.62	-541.61	-541.59	-541.49	-541.44
Quote Progetto		541.62 541.40	541.47 541.59	541.53 541.52		
Parziali		2.50	2.50	0.41		
Progressiva		-2.69 -2.50	0.00	2.50 2.91		
Dislivelli		0.00 0.19	-0.13	-0.00 0.00		

Sezione: 123
 Progressiva: 991.782
 Q. Progetto: 541.966

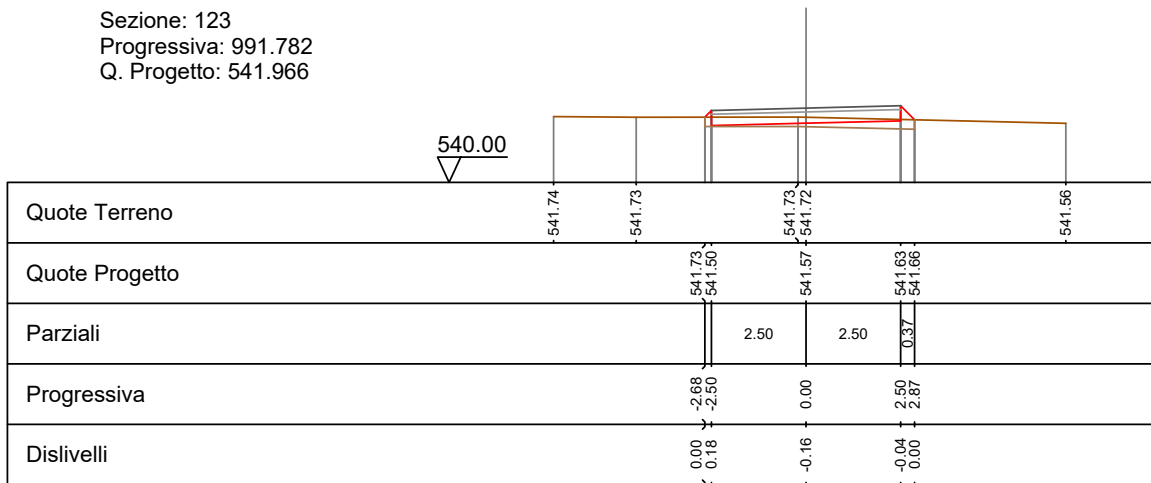

Sezione: 124
 Progressiva: 1000.000
 Q. Progetto: 542.346

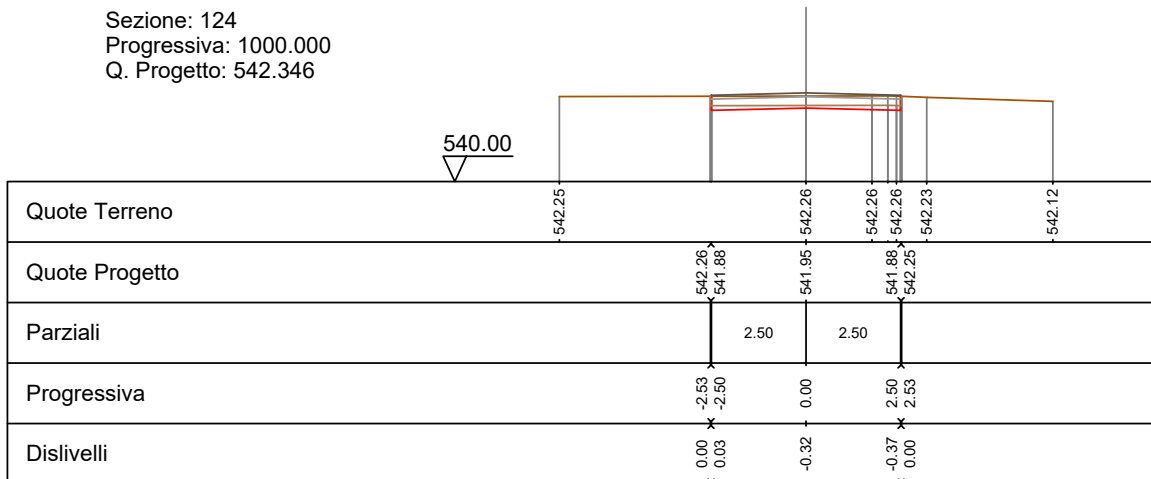

Sezione: 125
 Progressiva: 1009.843
 Q. Progetto: 542.622

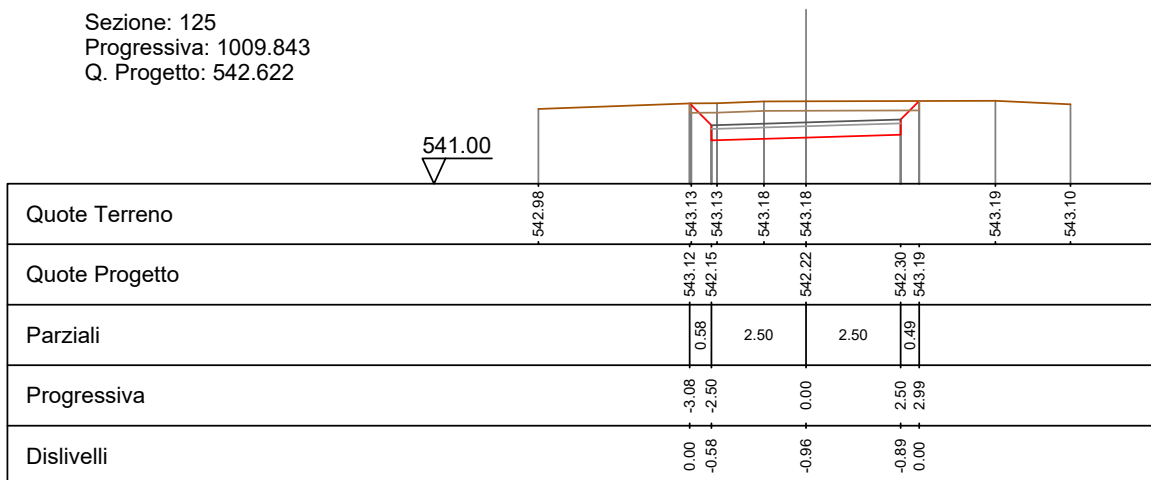

Sezione: 126
 Progressiva: 1016.126
 Q. Progetto: 542.698

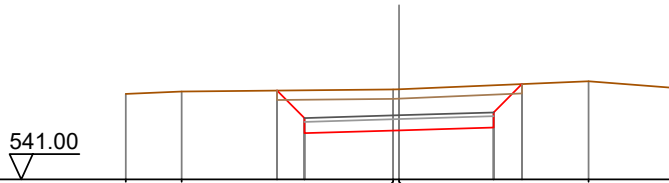

Quote Terreno	-543.26	-543.33		-543.38	-543.39		-543.60	-543.42
Quote Progetto			543.35	542.22	542.30	542.37	543.52	
Parziali			0.73	2.50	2.50	0.75		
Progressiva			-3.23	-2.50	0.00	2.50	3.25	
Dislivelli			0.00	-0.73	-1.09	-1.12	-0.00	

Sezione: 127
 Progressiva: 1020.000
 Q. Progetto: 542.705

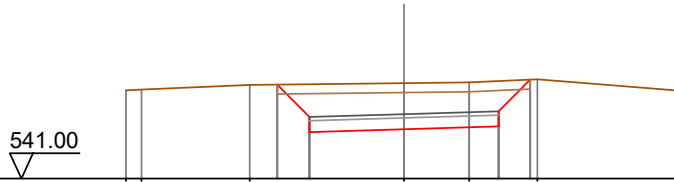

Quote Terreno	-543.34	-543.35		-543.48	-543.52	-543.55	-543.63	-543.32
Quote Progetto			543.48	542.23	542.30	542.38	543.62	
Parziali			0.85	2.50	2.50	0.84		
Progressiva			-3.35	-2.50	0.00	2.50	3.34	
Dislivelli			0.00	-0.87	-1.22	-1.20	0.00	

Sezione: 128
 Progressiva: 1022.409
 Q. Progetto: 542.694

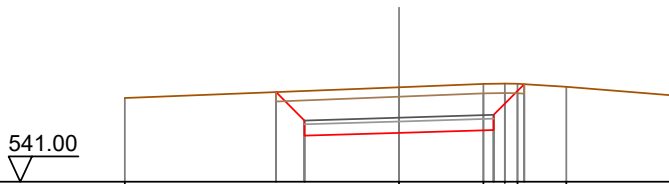

Quote Terreno	-543.21			-543.50		-543.59	-543.59	-543.51	-543.28
Quote Progetto		543.37	542.22	542.29	542.37	543.58			
Parziali		0.75	2.50	2.50	0.81				
Progressiva		-3.25	-2.50	0.00	2.50	3.31			
Dislivelli		-0.00	-0.78	-1.21	-1.22	0.00			

Sezione: 129
 Progressiva: 1040.000
 Q. Progetto: 542.263

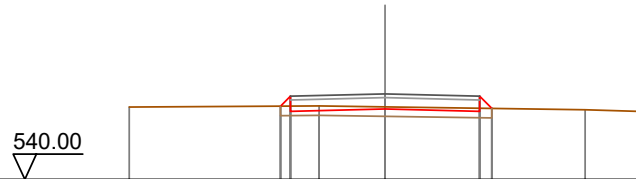

Quote Terreno	-541.91	-541.94	-541.92	-541.84	-541.79
Quote Progetto		541.94 541.80	541.86 541.92	541.80 541.88	
Parziali		0.26 2.50	2.50	0.32 2.50	
Progressiva		-2.76 -2.50	0.00	2.50 2.82	
Dislivelli		0.00 0.26	-0.06	-0.08 0.00	

Sezione: 130
 Progressiva: 1044.207
 Q. Progetto: 542.069

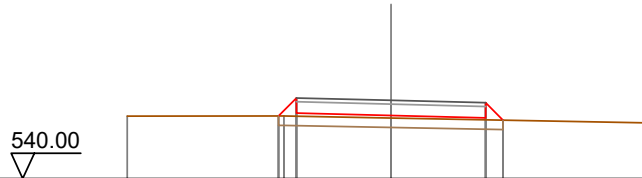

Quote Terreno	-541.65	-541.66	-541.60	-541.47
Quote Progetto		541.66 541.73	541.67 541.60	541.61 541.55
Parziali		0.48 2.50	2.50	0.46 2.50
Progressiva		-2.98 -2.50	0.00	2.50 2.96
Dislivelli		0.00 0.48	0.07	0.05 0.00

Sezione: 131
 Progressiva: 1050.000
 Q. Progetto: 541.788

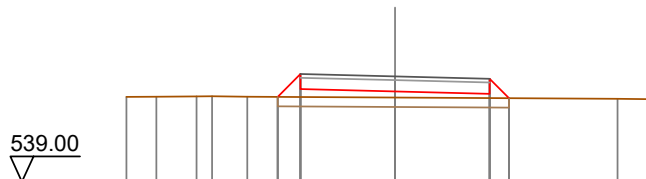

Quote Terreno	-541.24	-541.25	-541.26	-541.25	-541.23	-541.20	-541.18
Quote Progetto				541.25 541.45	541.39 541.23	541.33 541.21	
Parziali				0.60 2.50	2.50	0.51 2.50	
Progressiva				-3.10 -2.50	0.00	2.50 3.01	
Dislivelli				-0.00 0.61	0.16	0.11 -0.00	

Sezione: 132
 Progressiva: 1053.767
 Q. Progetto: 541.604

539.00

Quote Terreno	-540.98			541.00		541.01	541.01	-540.99
Quote Progetto		540.99	541.27	541.20		541.14	541.01	
Parziali		0.68	2.50	2.50		0.53		
Progressiva		-3.18	-2.50	0.00		2.50	3.03	
Dislivelli		0.00	0.67	0.20		0.13	0.00	

Sezione: 132
 Progressiva: 1053.767
 Q. Progetto: 541.604

539.00

Quote Terreno	-540.98			541.00		541.01	541.01	-540.99
Quote Progetto		540.99	541.27	541.20		541.14	541.01	
Parziali		0.68	2.50	2.50		0.53		
Progressiva		-3.18	-2.50	0.00		2.50	3.03	
Dislivelli		-0.00	0.67	0.20		0.13	0.00	

Sezione: 133
 Progressiva: 1055.735
 Q. Progetto: 541.509

539.00

Quote Terreno	-540.92			540.92	540.91	540.92	540.89	540.89
Quote Progetto		540.92	541.17	541.11		541.05	540.92	
Parziali		0.65	2.50	2.50		0.53		
Progressiva		-3.15	-2.50	0.00		2.50	3.03	
Dislivelli		0.00	0.65	0.19		0.13	0.00	

Sezione: 134
 Progressiva: 1060.000
 Q. Progetto: 541.315

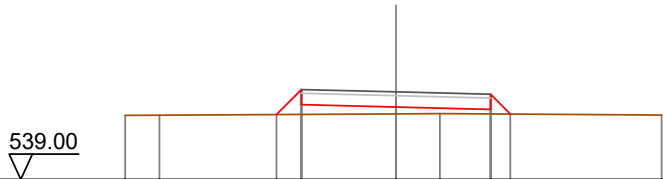

Quote Terreno	-540.69	-540.70		540.73	-540.74		-540.70
Quote Progetto			540.72	540.98	540.92	540.85	540.73
Parziali			0.66	2.50	2.50	0.52	
Progressiva			-3.16	-2.50	0.00	2.50	3.02
Dislivelli			0.00	0.66	0.18	0.12	-0.00

Sezione: 135
 Progressiva: 1067.262
 Q. Progetto: 541.070

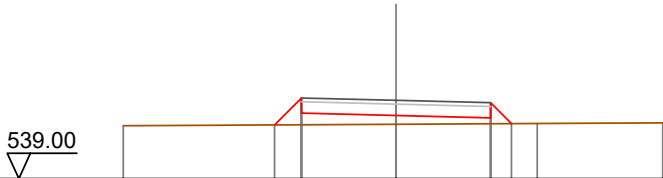

Quote Terreno	-540.40			540.44		540.46	-540.47
Quote Progetto			540.42	540.73	540.67	540.61	540.45
Parziali			0.71	2.50	2.50	0.55	
Progressiva			-3.21	-2.50	0.00	2.50	3.05
Dislivelli			0.00	0.71	0.23	0.16	0.00

Sezione: 136
 Progressiva: 1080.000
 Q. Progetto: 540.894

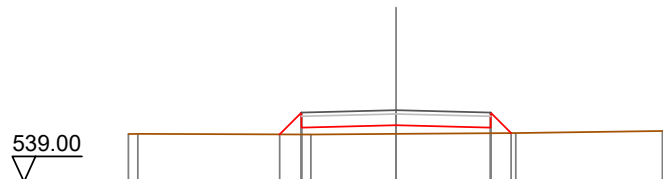

Quote Terreno	540.26	540.27		540.27		540.29	-540.34
Quote Progetto			540.25	540.43	540.49	540.43	540.29
Parziali			0.58	2.50	2.50	0.54	
Progressiva			-3.08	-2.50	0.00	2.50	3.04
Dislivelli			0.00	0.58	0.23	0.15	0.00

Sezione: 137
 Progressiva: 1082.842
 Q. Progetto: 540.899

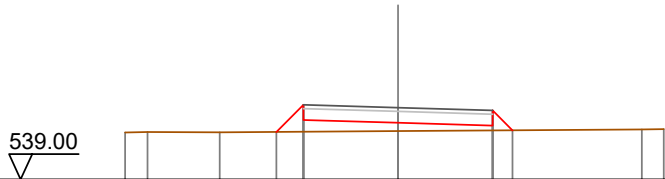

Quote Terreno		540.24	540.25	540.25		540.28		540.32	540.33
Quote Progetto					540.26	540.57		540.42	540.30
Parziali					0.72	2.50	2.50	0.53	
Progressiva					-3.22	-2.50	0.00	2.50	3.03
Dislivelli					0.00	0.71	0.22	0.13	0.00

Sezione: 138
 Progressiva: 1084.275
 Q. Progetto: 540.907

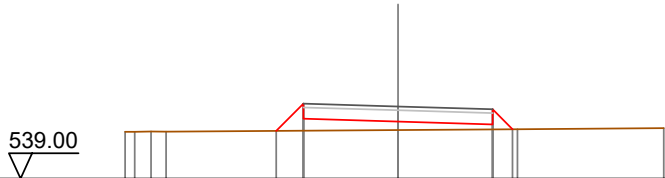

Quote Terreno		540.24	540.24	540.24		540.28		540.30	540.33
Quote Progetto					540.26	540.58		540.43	540.30
Parziali					0.72	2.50	2.50	0.53	
Progressiva					-3.22	-2.50	0.00	2.50	3.03
Dislivelli					0.00	0.72	0.22	0.13	-0.00

Sezione: 139
 Progressiva: 1085.708
 Q. Progetto: 540.920

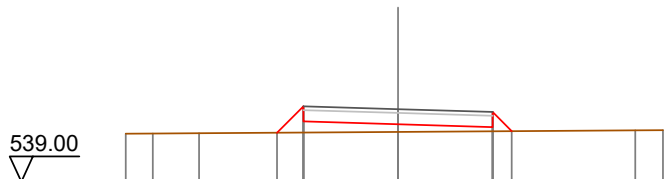

Quote Terreno		540.27	540.28	540.28		540.32		540.36	540.36
Quote Progetto					540.30	540.60		540.45	540.34
Parziali					0.70	2.50	2.50	0.51	
Progressiva					-3.20	-2.50	0.00	2.50	3.01
Dislivelli					0.00	0.69	0.20	0.11	0.00

Sezione: 140
 Progressiva: 1100.000
 Q. Progetto: 541.272

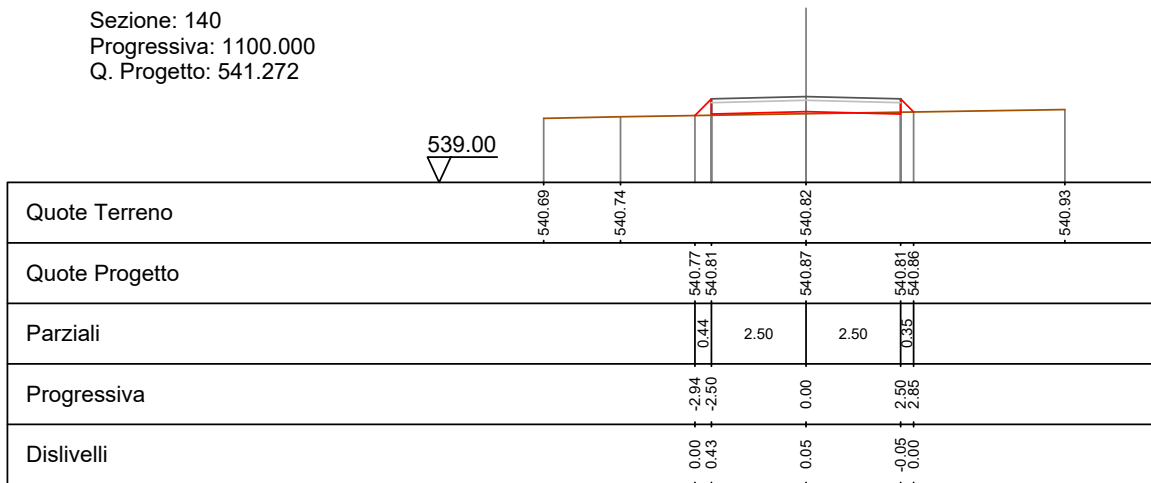

Sezione: 141
 Progressiva: 1120.000
 Q. Progetto: 542.453

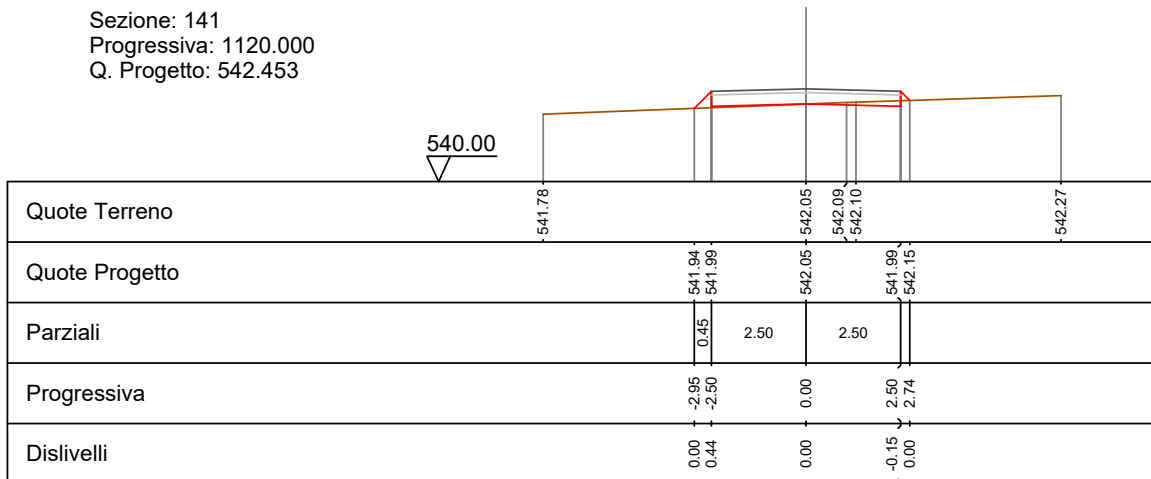

Sezione: 142
 Progressiva: 1140.000
 Q. Progetto: 544.220

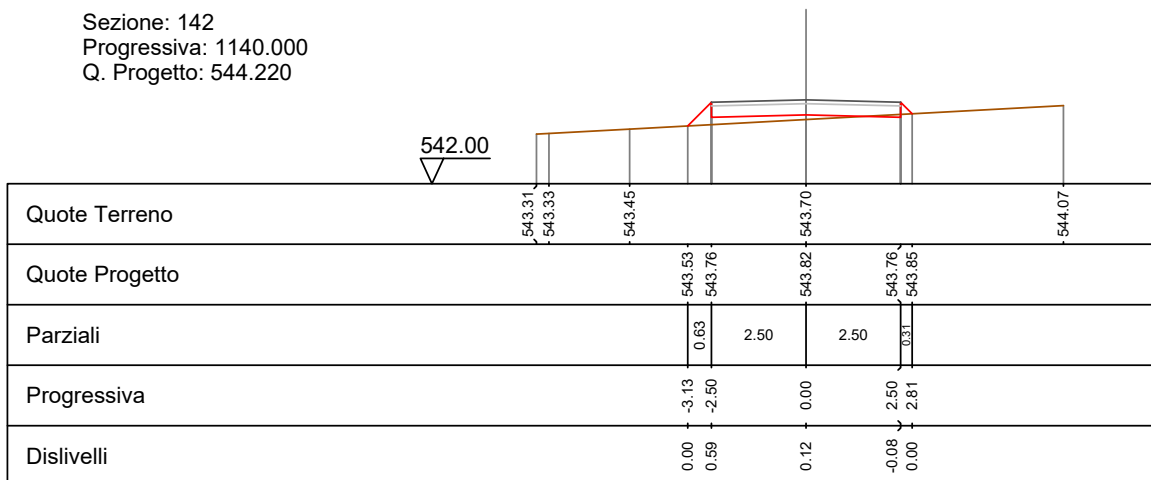

Sezione: 143
 Progressiva: 1160.000
 Q. Progetto: 546.205

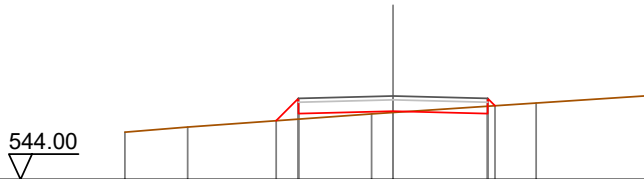

Quote Terreno		-545.25	-545.39		-545.73	-545.77		-546.02	-546.21
Quote Progetto				545.55	545.74	545.80	545.74	545.95	
Parziali				0.59	2.50	2.50			
Progressiva				-3.09	-2.50	0.00	2.50	2.70	
Dislivelli				0.00	0.55	0.04	-0.19	0.00	

Sezione: 144
 Progressiva: 1180.000
 Q. Progetto: 548.681

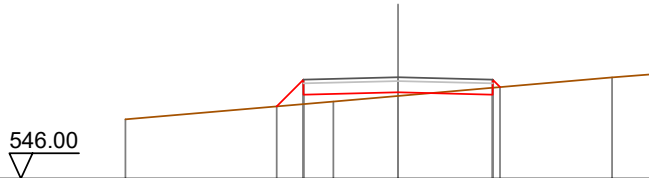

Quote Terreno		-547.57		-548.04	-548.19		-548.68	-548.76
Quote Progetto			547.91	548.22	548.28	548.22	548.42	
Parziali			0.71	2.50	2.50			
Progressiva			-3.21	-2.50	0.00	2.50	2.70	
Dislivelli			0.00	0.65	0.09	-0.18	0.00	

Sezione: 145
 Progressiva: 1200.000
 Q. Progetto: 551.640

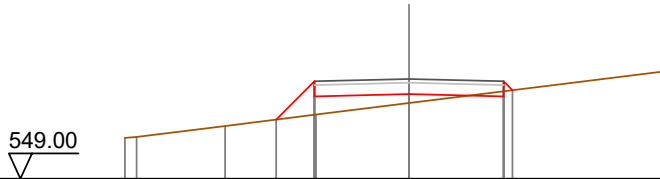

Quote Terreno		-550.08	-550.11	-550.39	-550.70	-551.00		-551.84
Quote Progetto				550.56	551.18	551.24	551.18	551.34
Parziali				1.01	2.50	2.50		
Progressiva				-3.51	-2.50	0.00	2.50	2.74
Dislivelli				0.00	0.89	0.24	-0.13	0.00

Sezione: 146
 Progressiva: 1220.000
 Q. Progetto: 554.738

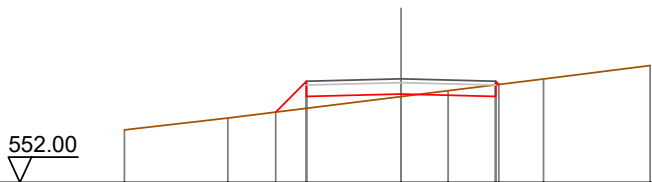

Quote Terreno	-553.39	-553.70				554.27	-554.43		-554.74	-555.09
Quote Progetto			553.86	554.28		554.34		554.28	554.59	
Parziali			0.81	2.50		2.50				
Progressiva			-3.31	-2.50		0.00		2.50	2.56	
Dislivelli			0.00	0.71		0.07		-0.30	0.00	

Sezione: 147
 Progressiva: 1226.902
 Q. Progetto: 555.807

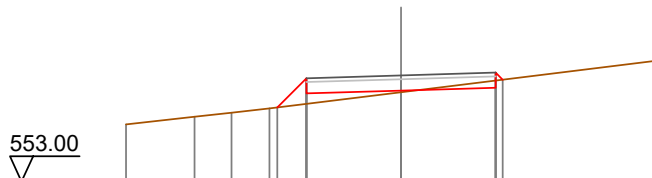

Quote Terreno	-554.51	-554.72	-554.82	-554.93			555.36			-556.19
Quote Progetto				554.96	555.33		555.41		555.48	555.69
Parziali				0.77	2.50		2.50			
Progressiva				-3.27	-2.50		0.00		2.50	2.69
Dislivelli				0.00	0.68		0.04		-0.19	0.00

Sezione: 148
 Progressiva: 1227.916
 Q. Progetto: 555.962

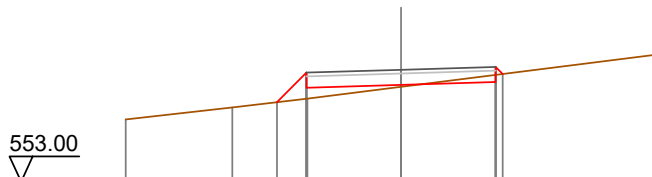

Quote Terreno	-554.65	-554.97					555.51			-556.35
Quote Progetto			555.10	555.49			555.56		555.64	555.85
Parziali			0.78	2.50			2.50			
Progressiva			-3.28	-2.50			0.00		2.50	2.69
Dislivelli			0.00	0.69			0.05		-0.19	0.00

Sezione: 149
 Progressiva: 1228.930
 Q. Progetto: 556.115

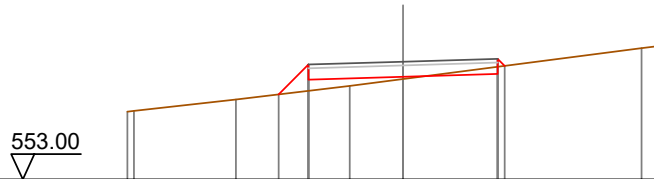

Quote Terreno	554.79	554.81	555.11	555.47	555.66	555.79	556.47	556.52
Quote Progetto			555.25	555.04	555.71	555.79	556.00	
Parziali			0.79	2.50	2.50			
Progressiva			-3.29	-2.50	0.00	2.50	2.69	
Dislivelli			0.00	0.70	0.06	-0.19	-0.00	

Sezione: 150
 Progressiva: 1240.000
 Q. Progetto: 557.643

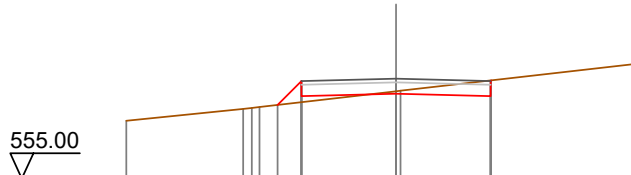

Quote Terreno	556.53	556.84	556.89	557.31	557.32	558.05
Quote Progetto			556.95	557.24	557.18	
Parziali			0.63	2.50	2.50	
Progressiva			-3.13	-2.50	0.00	2.50
Dislivelli			-0.00	0.56	-0.07	-0.41

Sezione: 151
 Progressiva: 1260.000
 Q. Progetto: 559.770

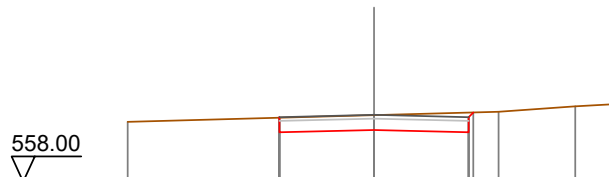

Quote Terreno	559.58	559.31	559.76	559.85	559.99	560.07
Quote Progetto		559.37	559.31	559.83		
Parziali		2.50	2.50			
Progressiva		-2.52	0.00	2.50	2.62	
Dislivelli		0.00	-0.39	-0.52	0.00	

Sezione: 152
 Progressiva: 1264.771
 Q. Progetto: 560.158

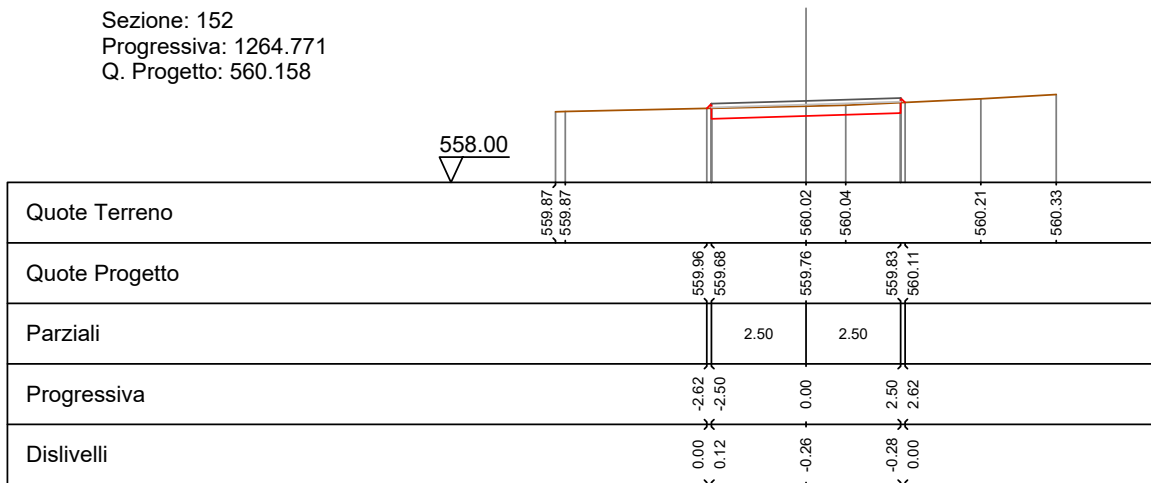

Sezione: 153
 Progressiva: 1267.707
 Q. Progetto: 560.373

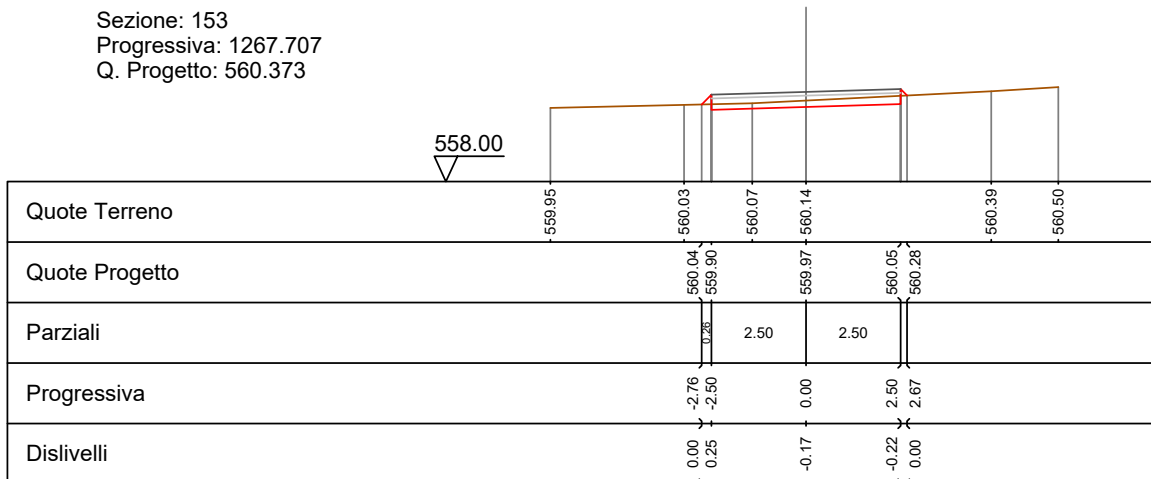

Sezione: 154
 Progressiva: 1270.000
 Q. Progetto: 560.530

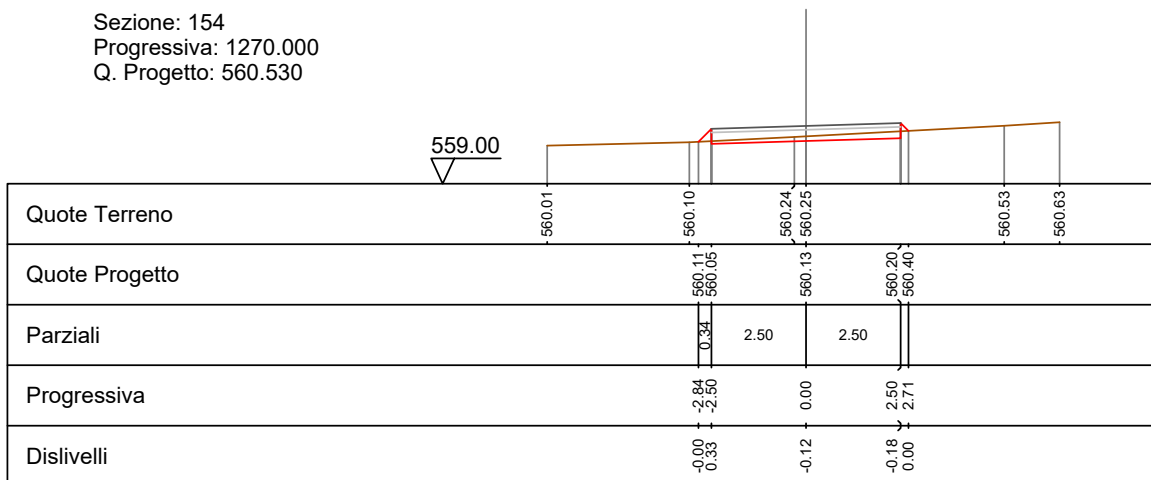

Sezione: 155
 Progressiva: 1270.643
 Q. Progetto: 560.572

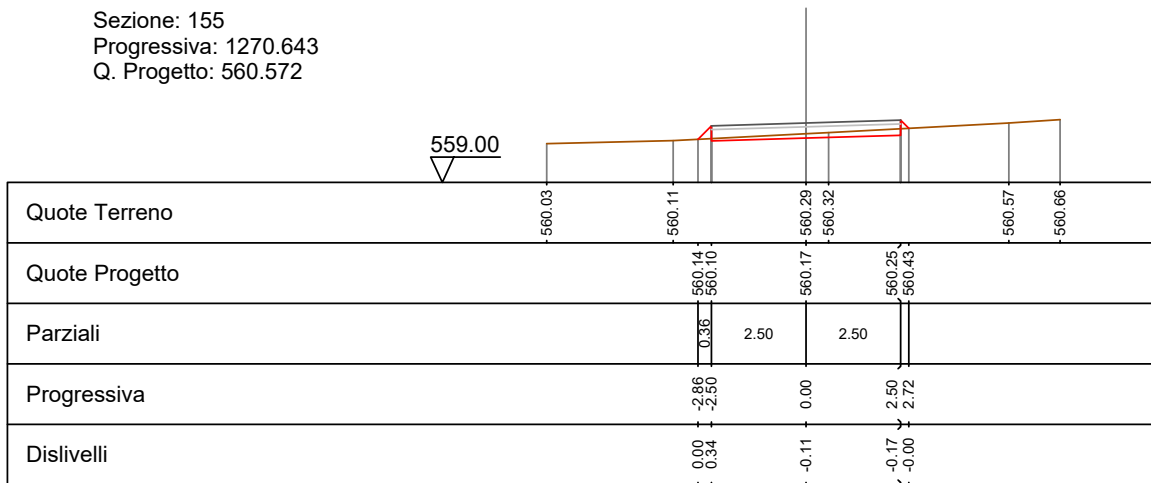

Sezione: 156
 Progressiva: 1280.000
 Q. Progetto: 561.088

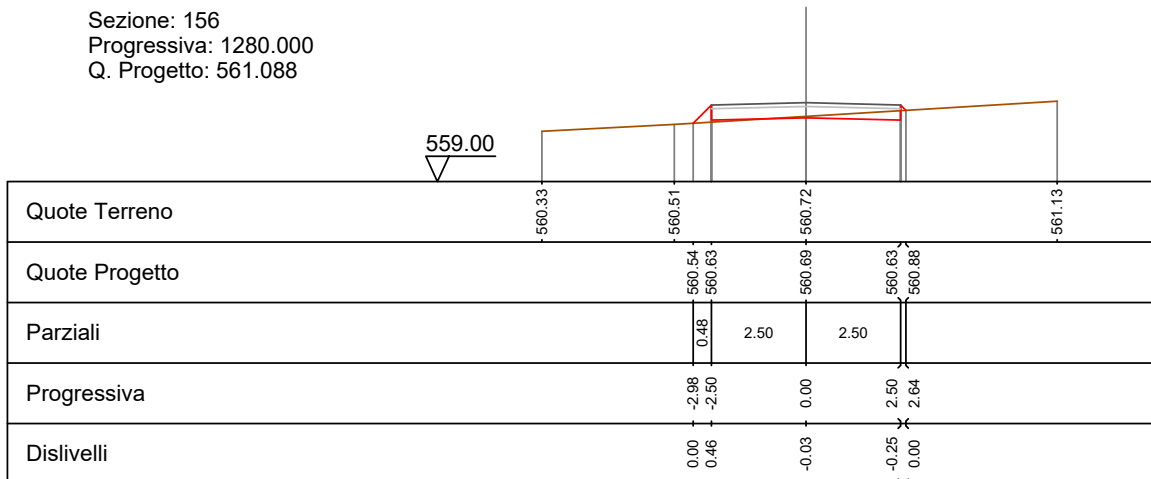

Sezione: 157
 Progressiva: 1288.112
 Q. Progetto: 561.394

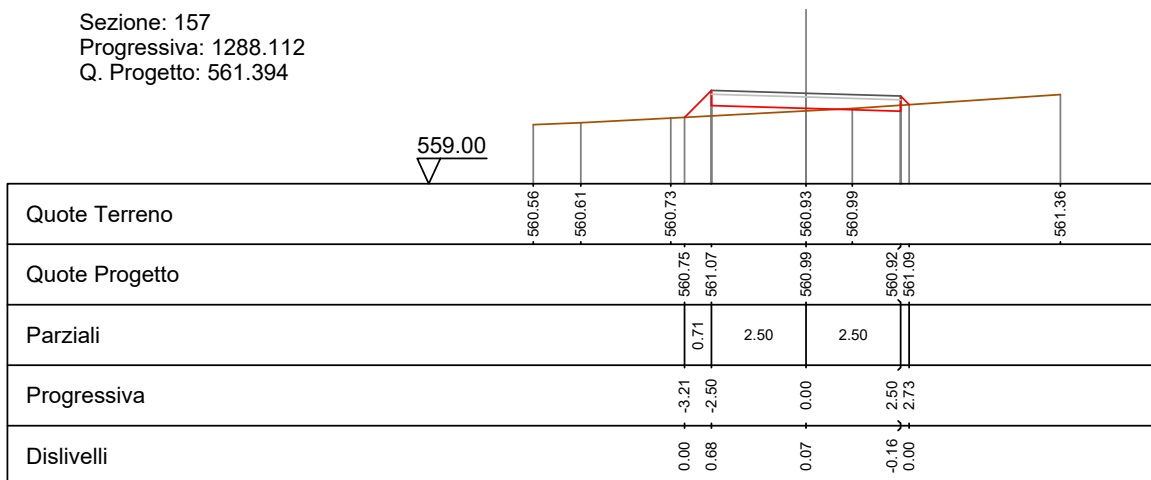

Sezione: 160
 Progressiva: 1303.414
 Q. Progetto: 561.871

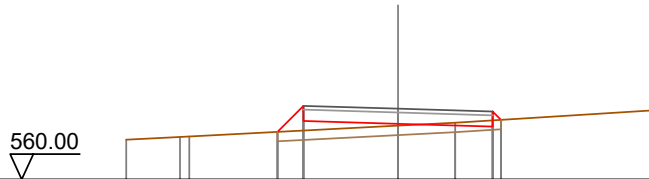

Quote Terreno	-561.05	-561.12	-561.14	-561.26	-561.55	-561.42	-561.50	-561.82
Quote Progetto				561.26	561.55	561.47	561.40	561.58
Parziali				0.69	2.50	2.50		
Progressiva				-3.19	-2.50	0.00	2.50	2.72
Dislivelli				0.00	0.65	0.05	-0.17	0.00

Sezione: 161
 Progressiva: 1310.000
 Q. Progetto: 562.077

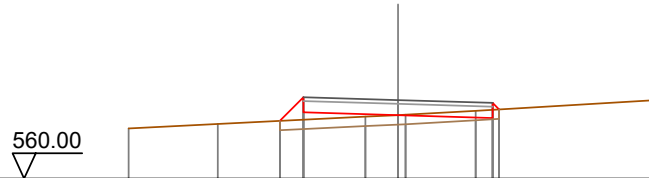

Quote Terreno	-561.32	-561.45	-561.64	-561.68	-561.69	-561.79	-562.06
Quote Progetto			561.53	561.75	561.88	561.60	561.83
Parziali			0.62	2.50	2.50		
Progressiva			-3.12	-2.50	0.00	2.50	2.67
Dislivelli			0.00	0.59	-0.00	-0.22	0.00

Sezione: 162
 Progressiva: 1318.445
 Q. Progetto: 562.372

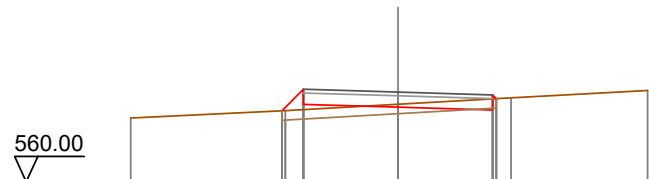

Quote Terreno	-561.69	-561.88	-562.05	-562.05	-562.22	-562.41
Quote Progetto		561.88	562.05	561.97	561.90	562.20
Parziali		0.57	2.50	2.50		
Progressiva		-3.07	-2.50	0.00	2.50	2.60
Dislivelli		0.00	0.54	-0.08	-0.30	0.00

Sezione: 163
 Progressiva: 1320.000
 Q. Progetto: 562.436

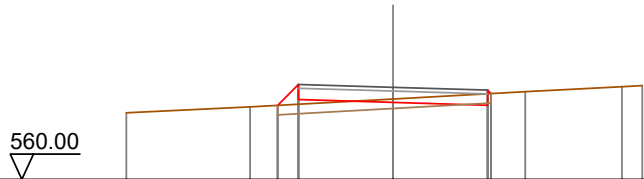

Quote Terreno	561.76	561.92		562.13		562.32	562.45	562.48
Quote Progetto			561.96	562.11	562.04	561.96	562.27	
Parziali			0.55	2.50	2.50			
Progressiva			-3.05	-2.50	0.00	2.50	2.59	
Dislivelli			0.00	0.52	-0.09	-0.30	0.00	

Sezione: 164
 Progressiva: 1330.000
 Q. Progetto: 562.924

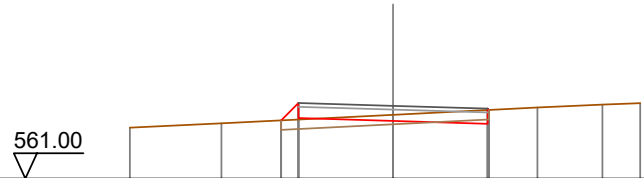

Quote Terreno	562.35	562.46		562.69		562.88	562.96	563.00
Quote Progetto			562.54	562.80	562.52	562.45	562.81	
Parziali			0.46	2.50	2.50			
Progressiva			-2.96	-2.50	0.00	2.50	2.53	
Dislivelli			-0.00	0.44	-0.16	-0.36	-0.00	

Sezione: 165
 Progressiva: 1340.000
 Q. Progetto: 563.542

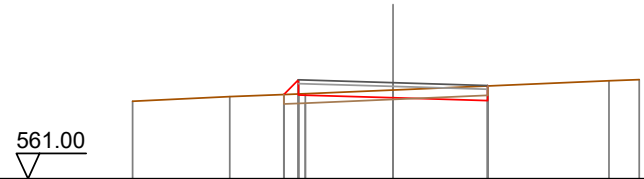

Quote Terreno	563.05	563.17		563.35		563.59	563.62	
Quote Progetto			563.23	563.22	563.14	563.07		
Parziali			0.39	2.50	2.50			
Progressiva			-2.89	-2.50	0.00	2.50		
Dislivelli			0.00	0.37	-0.21	-0.39		

Sezione: 166
 Progressiva: 1348.779
 Q. Progetto: 564.191

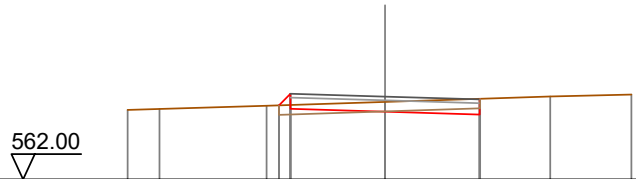

Quote Terreno	-563.84	-563.86	-563.95	-564.05	-564.19	-564.24
Quote Progetto			-563.96 -563.87	-563.79	-563.72	
Parziali			0.31	2.50	2.50	
Progressiva			-2.81 -2.50	0.00	2.50	
Dislivelli			-0.00 -0.30	-0.26	-0.42	

Sezione: 167
 Progressiva: 1360.000
 Q. Progetto: 565.167

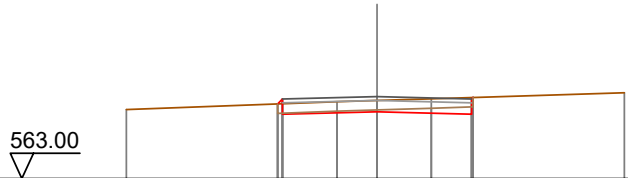

Quote Terreno	-564.83	-565.03	-565.07	-565.11	-565.27
Quote Progetto		-564.97 -564.70	-564.77	-564.70 -565.15	
Parziali		2.50	2.50		
Progressiva		-2.63 -2.50	0.00	2.50 2.54	
Dislivelli		0.00 0.13	-0.30	-0.44 0.00	

Sezione: 168
 Progressiva: 1380.000
 Q. Progetto: 567.209

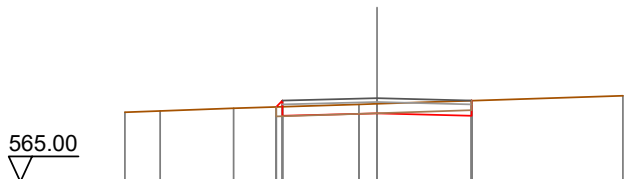

Quote Terreno	-566.84	-566.87	-566.94	-567.05 -567.06	-567.27
Quote Progetto			-566.98 -566.75	-566.81	-566.75
Parziali			2.50	2.50	
Progressiva			-2.67 -2.50	0.00	2.50
Dislivelli			0.00 0.16	-0.25	-0.40

Sezione: 169
 Progressiva: 1400.000
 Q. Progetto: 569.262

567.00

Quote Terreno		-569.19		569.29	568.80	569.29		569.36		569.40		569.43	569.45
Quote Progetto				569.29	568.80	569.29		568.86		568.80	569.40		
Parziali					2.50			2.50					
Progressiva				-2.59	-2.50			0.00		2.50	2.71		
Dislivelli				-0.00	-0.09			-0.50		-0.60	0.00		

Sezione: 170
 Progressiva: 1420.000
 Q. Progetto: 570.950

569.00

Quote Terreno		-570.85		570.93		571.03		571.07				571.15	571.15
Quote Progetto				570.97	570.49	570.55		570.49	571.09				
Parziali					2.50			2.50					
Progressiva				-2.58	-2.50			0.00		2.50	2.70		
Dislivelli				-0.00	-0.08			-0.48		-0.60	-0.00		

Sezione: 171
 Progressiva: 1438.067
 Q. Progetto: 571.817

570.00

Quote Terreno		-571.89		572.05	571.34	572.09		572.17		572.25		572.34	572.41
Quote Progetto				572.05	571.34	572.09		571.42		571.49	572.31		
Parziali				0.31		2.50		2.50		0.42			
Progressiva				-2.81	-2.50			0.00		2.50	2.92		
Dislivelli				0.00	-0.32			-0.76		-0.80	0.00		

Sezione: 172
 Progressiva: 1440.000
 Q. Progetto: 571.871

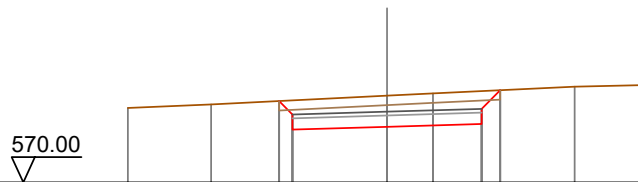

Quote Terreno	-571.97	-572.06			-572.29	-572.35		-572.53	-572.58
Quote Progetto			572.15	571.40	571.47		571.55	572.44	
Parziali			0.38	2.50	2.50		0.49		
Progressiva			-2.86	-2.50	0.00		2.50	2.99	
Dislivelli			0.00	-0.37	-0.82		-0.87	0.00	

Sezione: 173
 Progressiva: 1450.000
 Q. Progetto: 572.031

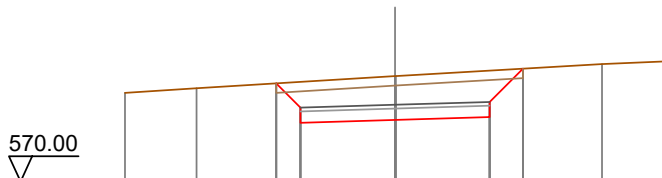

Quote Terreno	-572.35	-572.47			-572.79	-572.79		-573.11	-573.19
Quote Progetto			572.60	571.56	571.63		571.71	572.99	
Parziali			0.64	2.50	2.50		0.88		
Progressiva			-3.14	-2.50	0.00		2.50	3.38	
Dislivelli			0.00	-0.68	-1.16		-1.23	0.00	

Sezione: 174
 Progressiva: 1460.000
 Q. Progetto: 571.992

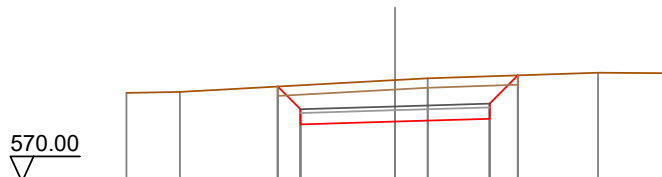

Quote Terreno	-572.35	-572.38			-572.69	-572.74		-572.88	-572.87
Quote Progetto			572.52	571.52	571.59		571.67	572.81	
Parziali			0.60	2.50	2.50		0.75		
Progressiva			-3.10	-2.50	0.00		2.50	3.25	
Dislivelli			-0.00	-0.64	-1.10		-1.12	0.00	

Sezione: 175
 Progressiva: 1465.596
 Q. Progetto: 571.882

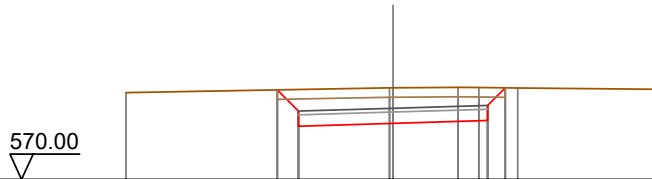

Quote Terreno	-572.30			572.42	572.42	-572.43	572.43	572.42	-572.39
Quote Progetto			572.37	571.41	571.48	571.56	572.42		
Parziali			0.56	2.50	2.50	0.47			
Progressiva			-3.06	-2.50	0.00	2.50	2.97		
Dislivelli			0.00	-0.57	-0.94	-0.87	0.00		

Sezione: 176
 Progressiva: 1470.000
 Q. Progetto: 571.752

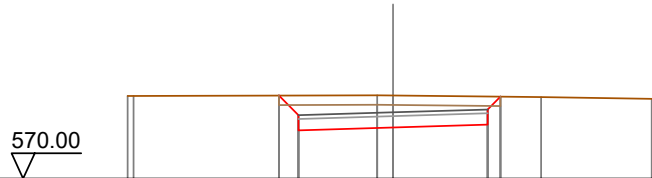

Quote Terreno	572.19	572.19			572.20	572.20		572.16	572.11
Quote Progetto			572.20	571.28	571.35	571.43	572.17		
Parziali			0.52	2.50	2.50	0.34			
Progressiva			-3.02	-2.50	0.00	2.50	2.84		
Dislivelli			-0.00	-0.52	-0.85	-0.75	-0.00		

Sezione: 177
 Progressiva: 1480.000
 Q. Progetto: 571.312

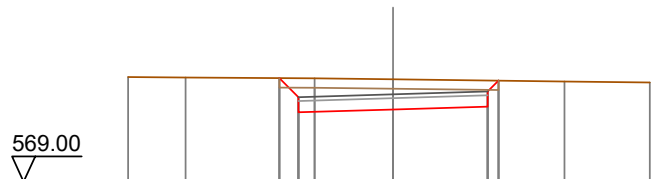

Quote Terreno	571.77	571.75			571.74	571.71		571.65	571.63
Quote Progetto			571.74	570.84	570.91	570.99	571.67		
Parziali			0.51	2.50	2.50	0.23			
Progressiva			-3.01	-2.50	0.00	2.50	2.79		
Dislivelli			-0.00	-0.50	-0.80	-0.69	-0.00		

Sezione: 178
 Progressiva: 1490.000
 Q. Progetto: 570.670

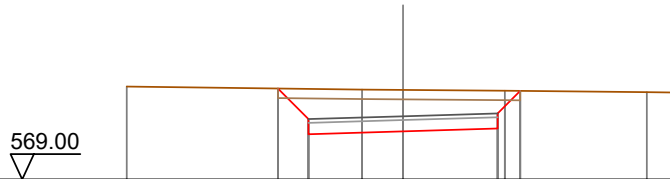

Quote Terreno	-571.46			-571.37	-571.37		-571.35		-571.31	-571.30
Quote Progetto			571.40	570.20		570.27		570.35	571.34	
Parziali			0.81	2.50		2.50		0.80		
Progressiva			-3.31	-2.50		0.00		2.50	3.10	
Dislivelli			0.00	-0.80		-1.10		-1.00	0.00	

Sezione: 179
 Progressiva: 1493.125
 Q. Progetto: 570.432

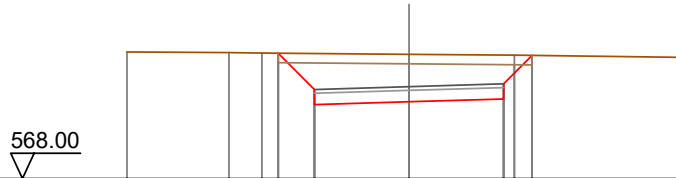

Quote Terreno	-571.35	-571.33	-571.32		-571.29		-571.26		-571.21
Quote Progetto			571.32	569.96		570.03	571.26		
Parziali			0.96	2.50		2.50	0.75		
Progressiva			-3.46	-2.50		0.00	2.50	3.25	
Dislivelli			0.00	-0.95		-1.26	-1.16	0.00	

Sezione: 180
 Progressiva: 1500.000
 Q. Progetto: 569.958

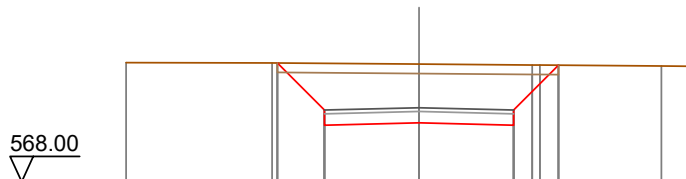

Quote Terreno	-571.15		-571.14		-571.11		-571.09	-571.09	-571.06	-571.05
Quote Progetto			571.14	569.50		569.56	571.08			
Parziali			1.25	2.50		2.50	1.19			
Progressiva			-3.75	-2.50		0.00	2.50	3.69		
Dislivelli			0.00	-1.24		-1.55	-1.60	0.00		

Sezione: 181
 Progressiva: 1509.300
 Q. Progetto: 569.468

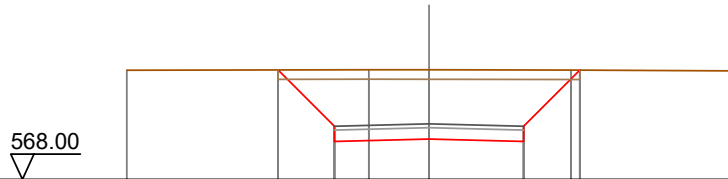

Quote Terreno		570.89		570.90	570.90		570.89		570.87
Quote Progetto			570.90	569.01	569.07	569.01	570.89		
Parziali			1.49	2.50	2.50	1.49			
Progressiva			-3.99	-2.50	0.00	2.50	3.99		
Dislivelli			0.00	-1.49	-1.83	-1.89	0.00		

Sezione: 182
 Progressiva: 1520.000
 Q. Progetto: 569.120

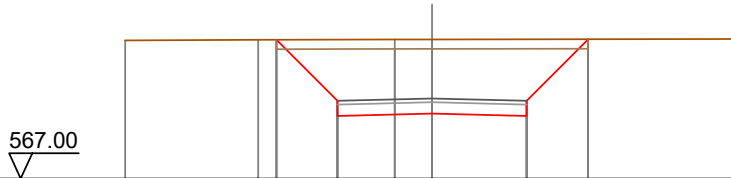

Quote Terreno		570.66		570.67	570.68	570.68			570.69
Quote Progetto			570.67	568.66	568.72	568.66	570.69		
Parziali			1.62	2.50	2.50	1.63			
Progressiva			-4.12	-2.50	0.00	2.50	4.13		
Dislivelli			-0.00	-1.62	-1.96	-2.03	0.00		

Sezione: 183
 Progressiva: 1522.700
 Q. Progetto: 569.068

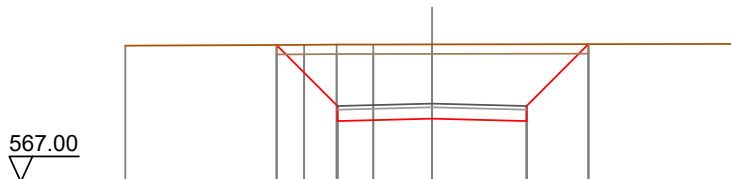

Quote Terreno		570.60		570.62	570.63	570.63			570.65
Quote Progetto			570.62	568.61	568.67	568.61	570.64		
Parziali			1.61	2.50	2.50	1.63			
Progressiva			-4.11	-2.50	0.00	2.50	4.13		
Dislivelli			0.00	-1.62	-1.97	-2.03	0.00		

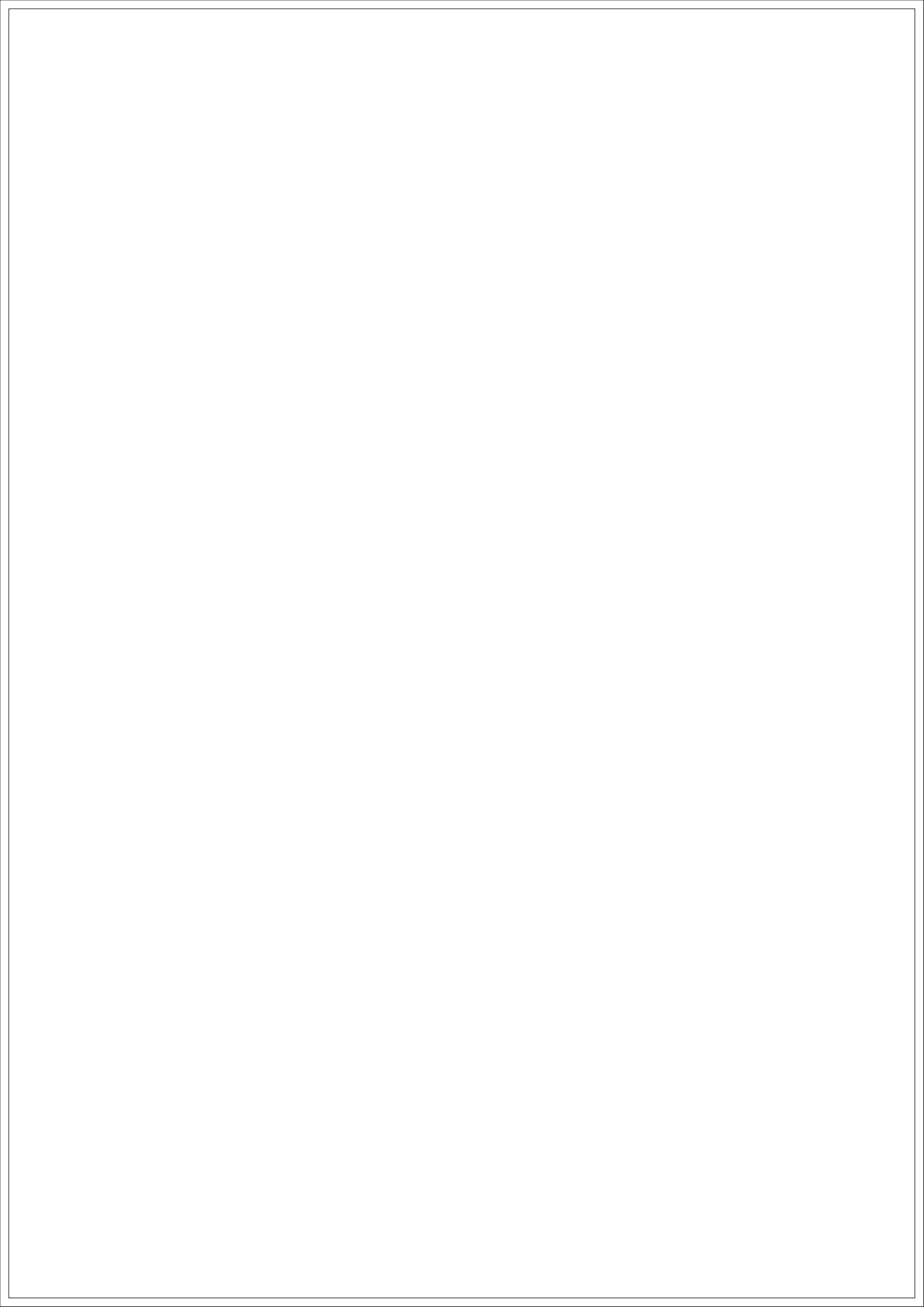

SEZIONI TRASVERSALI
Profilo longitudinale tratto 20-21
Viabilità di impianto postazione aerogeneratore T11

Nota: Le canalette di deflusso delle acque meteoriche, non indicate nel presente elaborato, sono rappresentate graficamente nelle sezioni stradali tipo dell'elaborato "WIND002-TC13_Piazzole aerogeneratori e strade di servizio - Particolari costruttivi", individuate planimetricamente nell'elaborato "WIND002-TC14_Opere di regimazione acque superficiali - Planimetria generale" e quantificate nell'elaborato "WIND002-RC6_Computo Metrico Estimativo".

DISEGNI DI RIFERIMENTO

TAVOLA	DESCRIZIONE
WIND002-TC8	Piazzole e viabilità - Planimetria di progetto - Fase di cantiere
WIND002-TC11	Profili longitudinali viabilità di impianto
WIND002-TC13	Piazzole aerogeneratori e strade di servizio - Particolari costruttivi
WIND002-TC14	Opere di regimazione acque superficiali - Planimetria generale

Sezione: 6
 Progressiva: 30.000
 Q. Progetto: 398.437

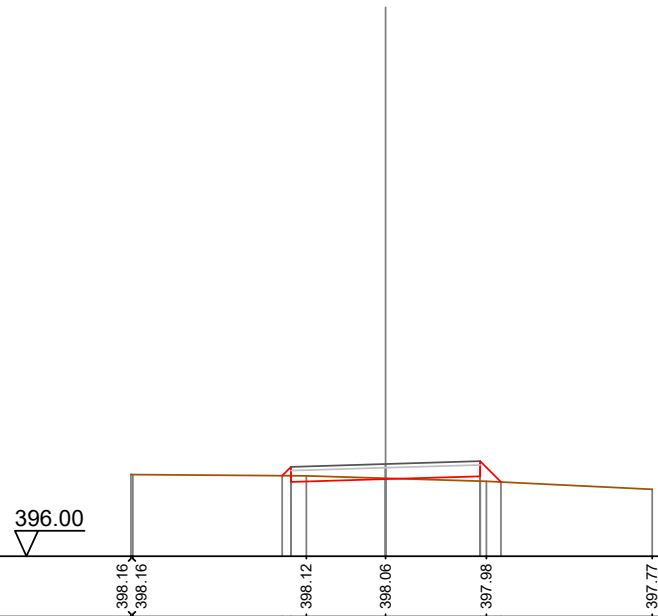

Quote Terreno	398.16	398.16	398.12	398.06	398.11	397.98	397.77
Quote Progetto			398.13	398.04	398.11	397.96	
Parziali			2.50	2.50	0.55		
Progressiva			-2.73	0.00	2.50	3.05	
Dislivelli			0.00	-0.02	0.13	0.00	

Sezione: 7
 Progressiva: 38.787
 Q. Progetto: 398.649

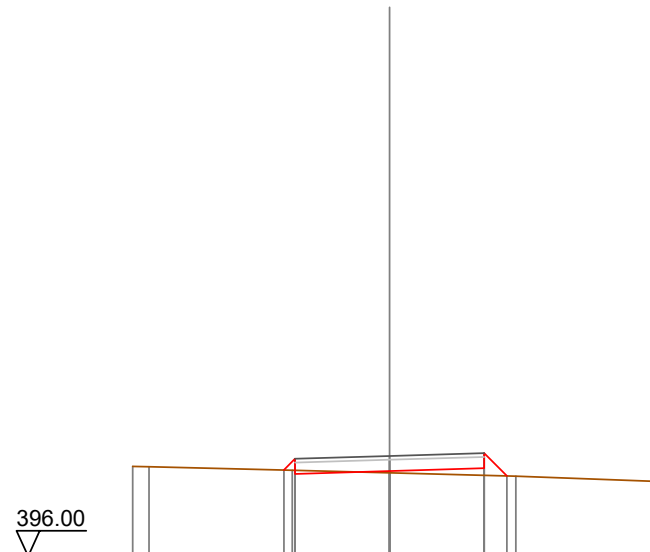

Quote Terreno		-398.37	-398.36		398.27		398.20		398.12		-397.98
Quote Progetto					398.28		398.25		398.32		
Parziali					0.30	2.50	2.50		0.60		
Progressiva					-2.80	-2.50	0.00		2.50	3.10	
Dislivelli					0.00	0.30	0.04		0.19	0.00	

Sezione: 8
 Progressiva: 40.000
 Q. Progetto: 398.678

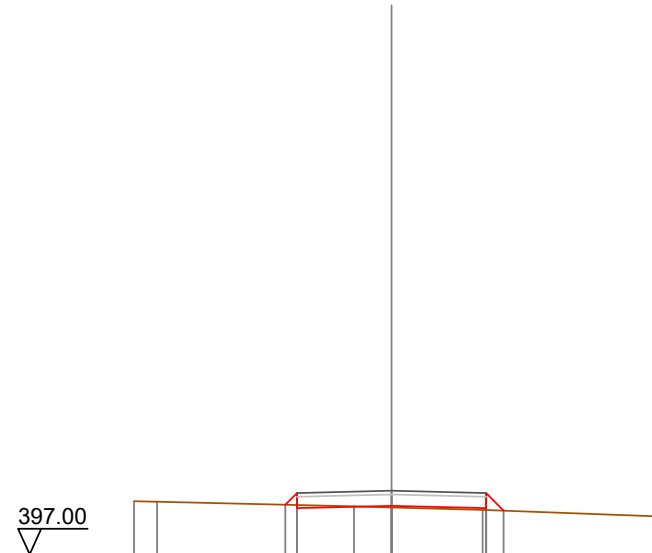

Quote Terreno		398.40	398.39		398.26	398.24	398.17	398.00
Quote Progetto				398.31	398.22	398.28	398.22	398.15
Parziali				0.31	2.50	2.50	0.46	
Progressiva				-2.81	-2.50	0.00	2.50	2.96
Dislivelli				0.00	0.32	0.04	0.05	0.00

Sezione: 9
 Progressiva: 60.000
 Q. Progetto: 399.158

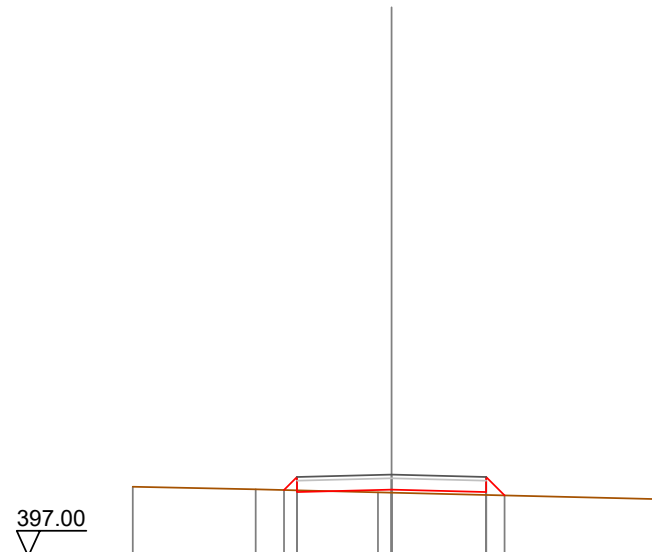

Quote Terreno	-398.83	-398.77	-398.69 -398.68	-398.51
Quote Progetto		398.75 398.70	398.76	398.70 398.61
Parziali		0.35 -2.85	2.50	2.50 0.49
Progressiva		-2.50	0.00	2.50 2.99
Dislivelli		0.00 0.35	0.08	0.08 0.00

Sezione: 10
 Progressiva: 80.000
 Q. Progetto: 399.637

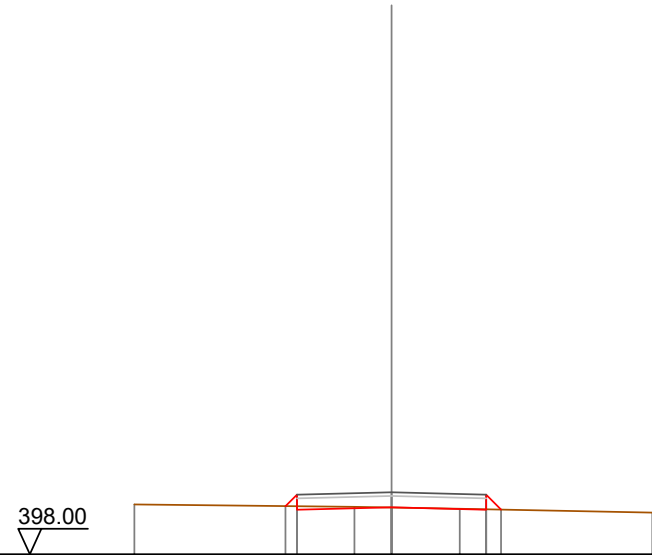

Quote Terreno		-399.31		-399.25	399.23	-399.20		-399.10
Quote Progetto			399.27	399.17	399.24	399.17	399.18	
Parziali			0.30	2.50	2.50	0.39		
Progressiva			-2.80	-2.50	0.00	2.50	2.89	
Dislivelli			0.00	0.31	0.00	-0.01	0.00	

Sezione: 11
 Progressiva: 100.000
 Q. Progetto: 400.155

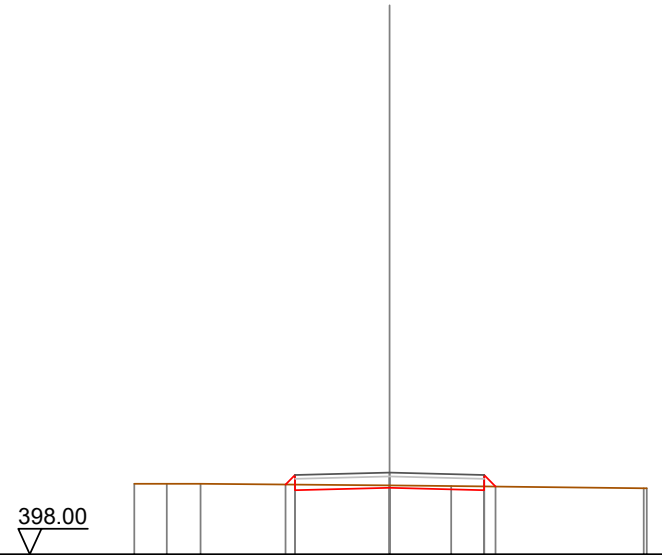

Quote Terreno		399.86	399.86	399.86		399.82	399.80		399.74	399.74
Quote Progetto					399.84	399.76		399.69	399.79	
Parziali					2.50		2.50		0.30	
Progressiva					-2.75	0.00		2.50	2.80	
Dislivelli					0.00	-0.06		-0.10	0.00	

Sezione: 12
 Progressiva: 120.000
 Q. Progetto: 401.286

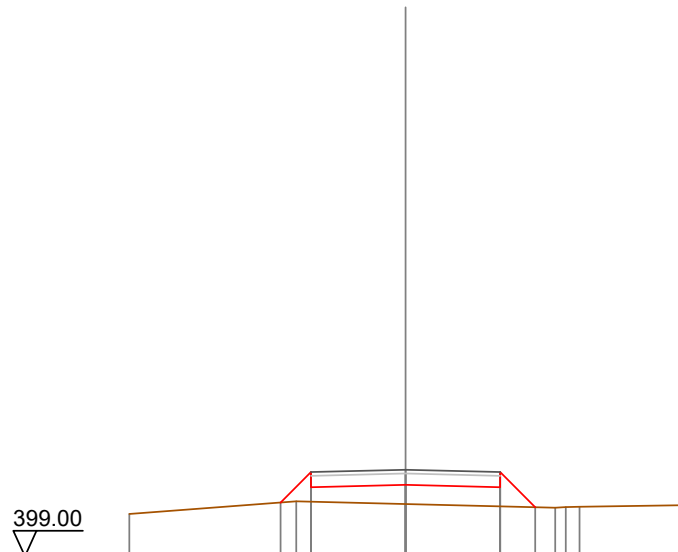

Quote Terreno	-400.11	400.45	400.38	400.28	400.30	400.31	-400.35
Quote Progetto		400.42	400.82	400.89	400.82	400.29	
Parziali		0.81	2.50	2.50	0.93		
Progressiva		-3.31	-2.50	0.00	2.50	3.43	
Dislivelli		-0.00	0.78	0.51	0.51	0.00	

Sezione: 13
 Progressiva: 140.000
 Q. Progetto: 403.224

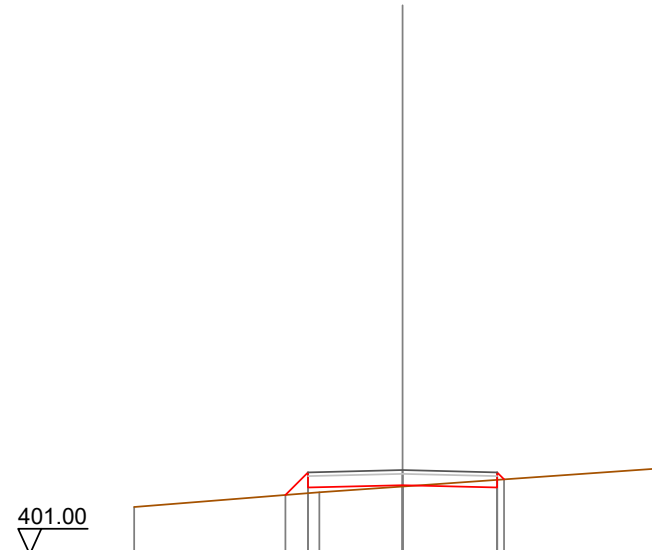

Quote Terreno		402.25		402.64		402.79		403.26
Quote Progetto			402.56	402.76		402.82	402.76	402.98
Parziali			0.60	2.50		2.50		
Progressiva			-3.10	-2.50		0.00	2.50	2.88
Dislivelli			-0.00	0.55		0.03	-0.20	0.00

Sezione: 14
 Progressiva: 160.000
 Q. Progetto: 405.773

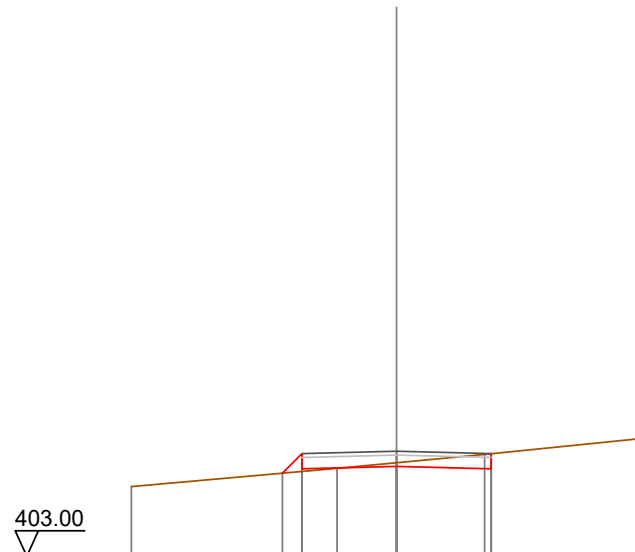

Quote Terreno	-404.84		-405.32	-405.47	-405.69	-406.11
Quote Progetto		405.19	405.31	405.37	405.31	
Parziali		0.52	2.50	2.50		
Progressiva		-3.02	-2.50	0.00	2.50	
Dislivelli		-0.00	0.47	-0.10	-0.40	

Sezione: 15
 Progressiva: 180.000
 Q. Progetto: 408.126

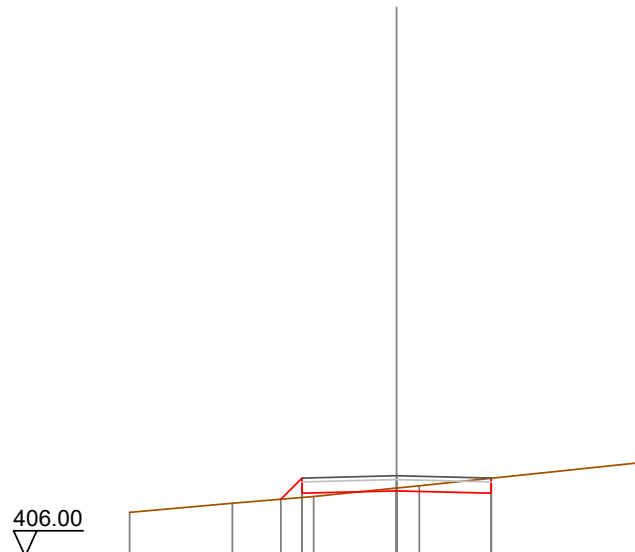

Quote Terreno	-407.16	-407.40	-407.58	-407.80	-407.86	-408.48
Quote Progetto			407.50	407.66	407.73	407.66
Parziali			0.56	2.50	2.50	
Progressiva			-3.06	-2.50	0.00	2.50
Dislivelli			-0.00	0.51	-0.07	-0.40

Sezione: 16
 Progressiva: 189.402
 Q. Progetto: 408.963

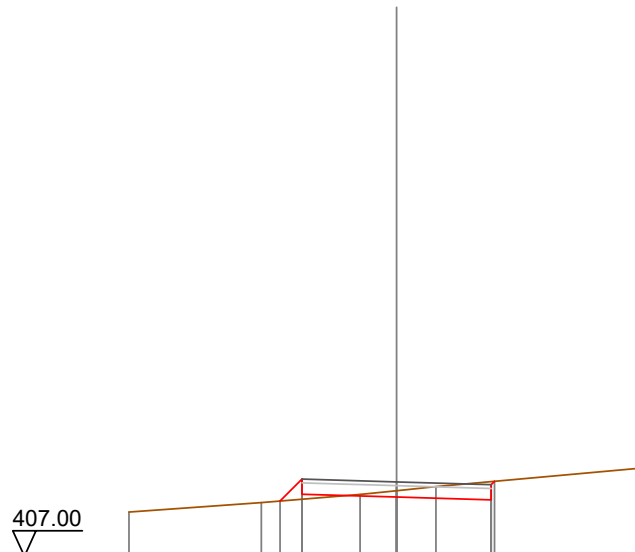

Quote Terreno		-408.16		-408.42		-408.63		-408.73		-408.84		-409.34
Quote Progetto				408.46		408.64		408.56		408.49		408.98
Parziali				0.58		2.50		2.50				
Progressiva				-3.08		-2.50		0.00		2.50		2.59
Dislivelli				0.00		0.53		-0.17		-0.48		0.00

Sezione: 17
 Progressiva: 190.000
 Q. Progetto: 409.011

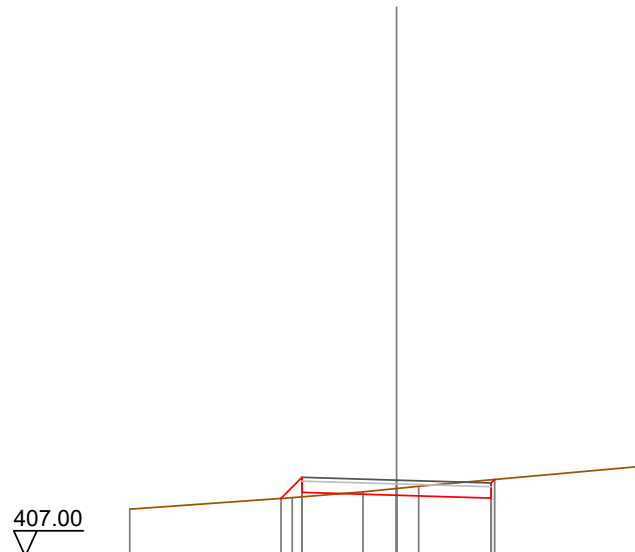

Quote Terreno		-408.24		408.55		408.70		408.79		408.85				-409.39
Quote Progetto				408.53		408.69		408.61				408.54	409.03	
Parziali				0.56		2.50		2.50						
Progressiva				-3.06		-2.50		0.00				2.50	2.89	
Dislivelli				0.00		0.52		-0.18				-0.48	0.00	

Sezione: 18
 Progressiva: 199.428
 Q. Progetto: 409.726

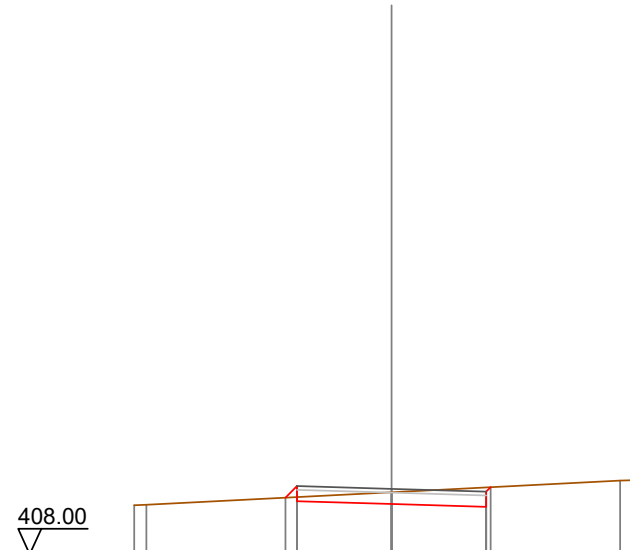

Quote Terreno		409.29	409.31			409.33	409.64			409.94	409.96
Quote Progetto				409.49	409.40	409.33	409.64	409.25	409.77		
Parziali				0.31	2.50		2.50				
Progressiva				-2.81	-2.50	0.00		2.50	2.62		
Dislivelli				0.00	0.29		-0.31	-0.51	0.00		

Sezione: 19
 Progressiva: 200.000
 Q. Progetto: 409.770

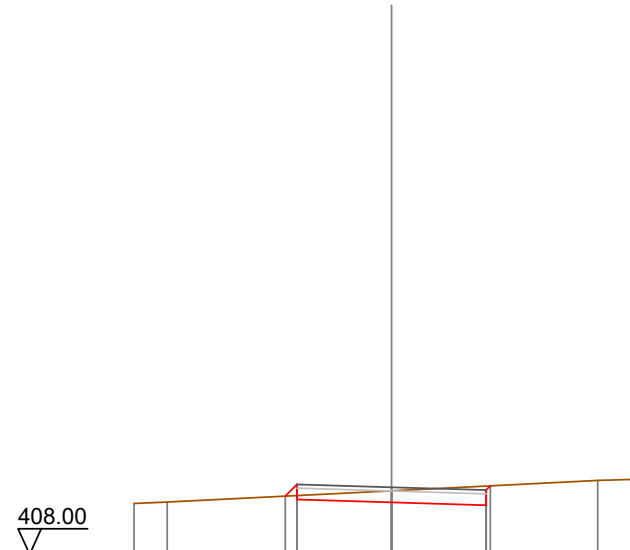

Quote Terreno		409.34	409.38		409.68		409.95	409.98
Quote Progetto				409.53	409.44	409.37	409.29	409.81
Parziali				0.31	2.50	2.50		
Progressiva				-2.81	-2.50	0.00	2.50	2.61
Dislivelli				0.00	0.29	-0.31	-0.51	0.00

Sezione: 20
 Progressiva: 209.453
 Q. Progetto: 410.551

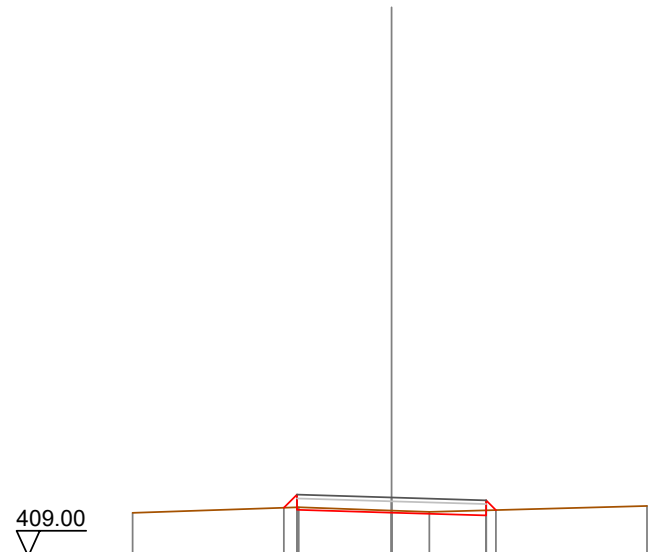

Quote Terreno		410.15		410.29		410.21		410.17		410.33
Quote Progetto			410.28	410.23	410.29	410.15	410.21	410.17	410.08	410.22
Parziali			0.35	2.50		2.50		0.26		
Progressiva			-2.85	-2.50		0.00		2.50	2.76	
Dislivelli			0.00	0.34		-0.05		-0.14	-0.00	

Sezione: 21
 Progressiva: 220.000
 Q. Progetto: 411.635

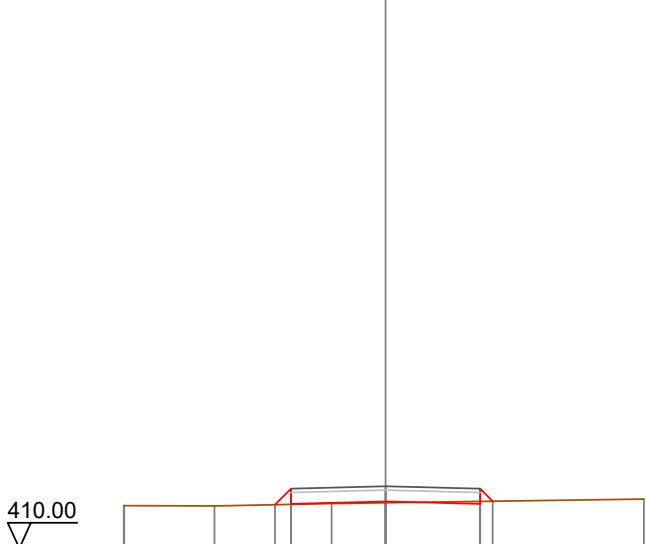

Quote Terreno		411.12		411.11		411.18		411.20		411.30	
Quote Progetto					411.15	411.17		411.24		411.17	411.24
Parziali					0.42	2.50		2.50		0.33	
Progressiva					-2.92	-2.50		0.00		2.50	2.83
Dislivelli					0.00	0.42		0.04		-0.06	-0.00

Sezione: 22
 Progressiva: 240.000
 Q. Progetto: 414.193

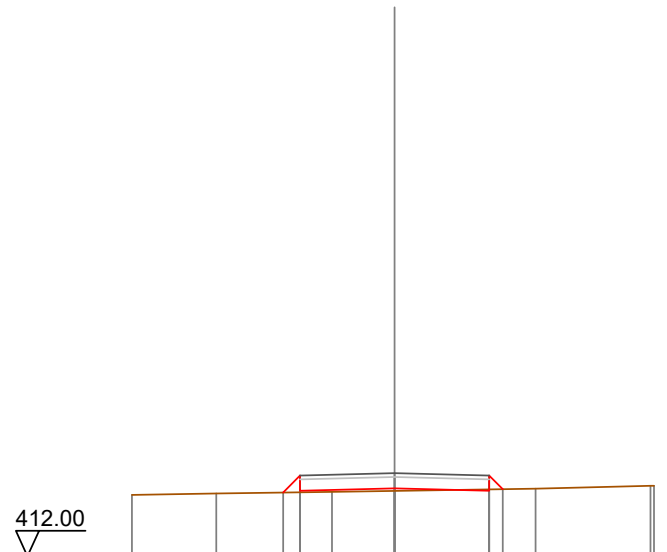

Quote Terreno	-413.62	-413.66	413.68	413.70	413.73	413.78	413.86
Quote Progetto			413.73	413.73	413.79	413.73	413.86
Parziali			0.45	2.50	2.50	0.36	
Progressiva			-2.95	-2.50	0.00	2.50	2.86
Dislivelli			0.00	0.44	0.07	-0.03	-0.00

Sezione: 23
 Progressiva: 241.633
 Q. Progetto: 414.399

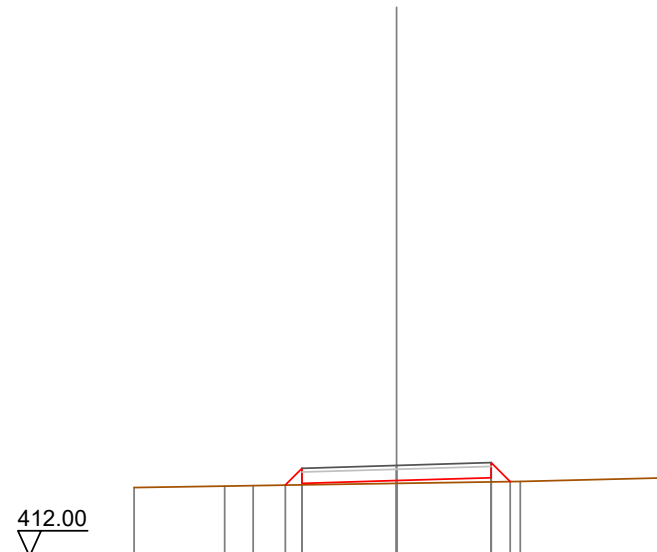

Quote Terreno	-413.81	-413.85	-413.87	-413.88	-413.92	-413.92	-413.97	-414.07
Quote Progetto				413.88	413.92	414.00	414.07	
Parziali				0.44	2.50	2.50	0.50	
Progressiva				-2.94	-2.50	0.00	2.50	3.00
Dislivelli				-0.00	0.44	0.07	0.11	-0.00

Sezione: 24
 Progressiva: 244.918
 Q. Progetto: 414.796

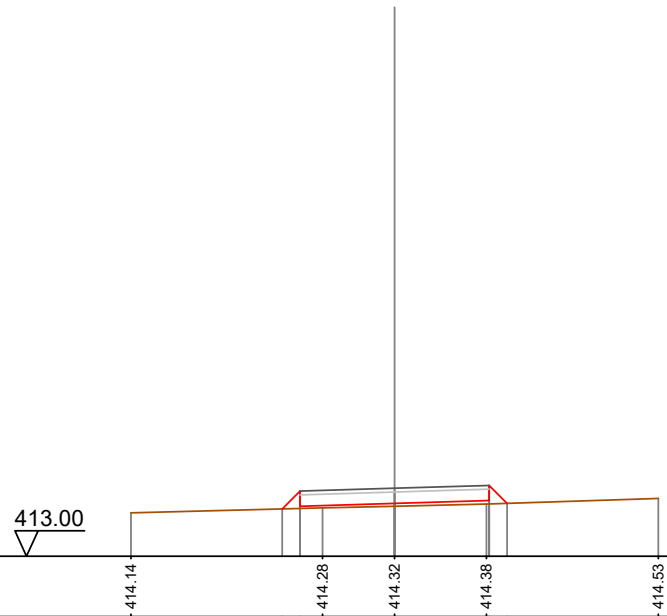

Quote Terreno	414.14	414.25	414.28	414.32	414.40	414.38	414.53
Quote Progetto		414.25	414.32	414.40	414.47	414.39	
Parziali		0.47	2.50	2.50	0.48		
Progressiva		-2.97	-2.50	0.00	2.50	2.98	
Dislivelli		0.00	0.46	0.08	0.09	-0.00	

Sezione: 25
 Progressiva: 248.203
 Q. Progetto: 415.171

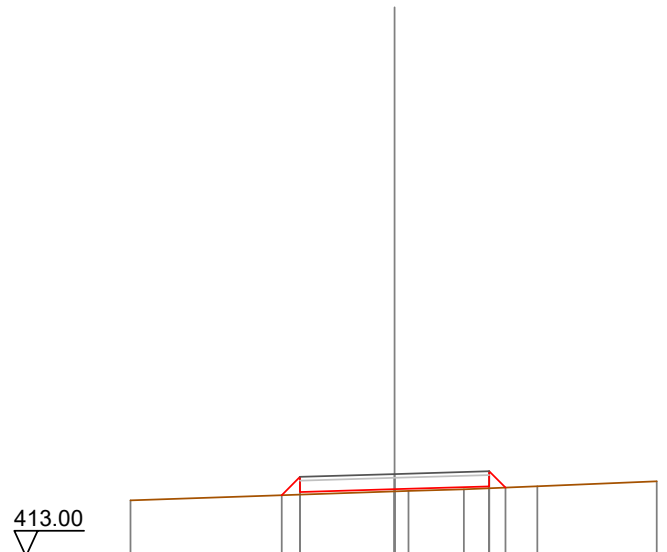

Quote Terreno	-414.47			414.71	414.72	-414.77	-414.85	-414.98
Quote Progetto		414.61	414.70	414.77		414.85	414.81	
Parziali		0.49	2.50	2.50		0.43		
Progressiva		-2.89	-2.50	0.00		2.50	2.93	
Dislivelli		0.00	0.47	0.06		0.05	0.00	

Sezione: 26
 Progressiva: 250.000
 Q. Progetto: 415.367

413.00

Quote Terreno	-414.65			414.92						-415.22
Quote Progetto		414.80	414.89	414.97	415.04	415.04				
Parziali		0.49	2.50	2.50	0.40					
Progressiva		-2.89	-2.50	0.00	2.50	2.90				
Dislivelli		0.00	0.47	0.05	0.02	-0.00				

Sezione: 27
 Progressiva: 260.000
 Q. Progetto: 416.336

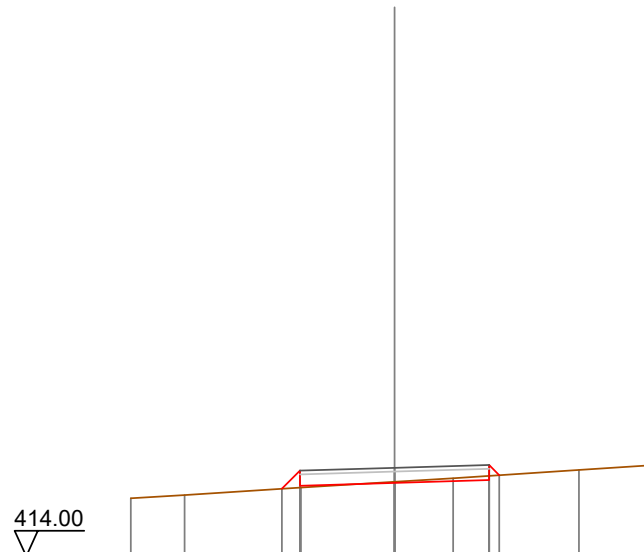

Quote Terreno	-415.53	-415.62	-415.82	-415.97	-416.06	-416.28	-416.40
Quote Progetto			415.78 415.86	415.94	416.01 416.14		
Parziali			0.48 2.50	2.50	0.27 0.27		
Progressiva			-2.88 -2.50	0.00	2.50 2.77		
Dislivelli			-0.00 0.45	-0.03	-0.11 0.00		

Sezione: 27
 Progressiva: 260.000
 Q. Progetto: 416.336

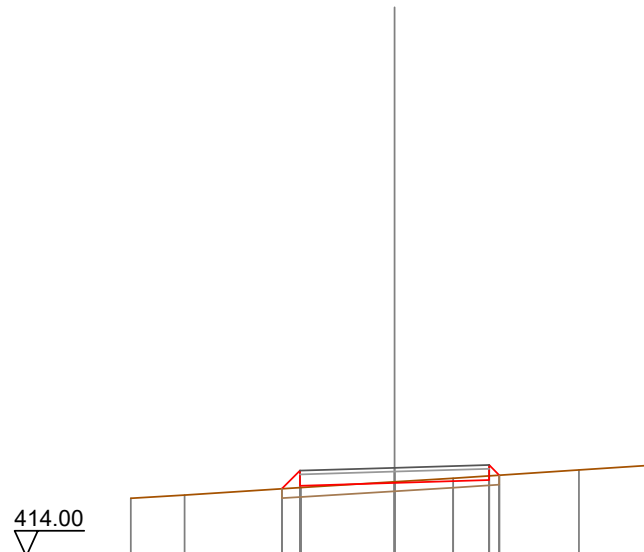

Quote Terreno	-415.53	-415.62	-415.82	-415.97	-416.06	-416.28	-416.40
Quote Progetto			415.78 415.86	415.94	416.01 416.14		
Parziali			0.48 2.50	2.50	0.27 0.27		
Progressiva			-2.88 -2.50	0.00	2.50 2.77		
Dislivelli			0.00 0.45	-0.03	-0.11 0.00		

Sezione: 28
 Progressiva: 270.000
 Q. Progetto: 417.104

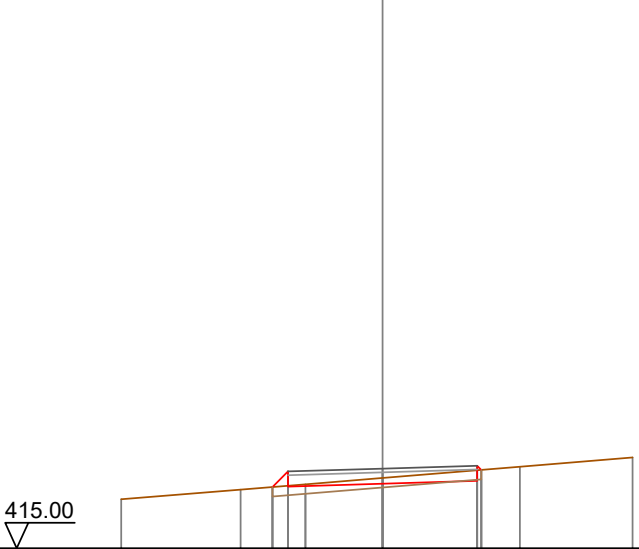

Quote Terreno	-416.30	-416.55	-416.62	-416.63	-416.69	-416.70	-416.85	-417.15	-417.40
Quote Progetto			416.62	416.63		416.70		416.78	417.07
Parziali			0.41	2.50		2.50			
Progressiva			-2.91	-2.50		0.00		2.50	2.61
Dislivelli			0.00	0.38		-0.15		-0.28	0.00

Sezione: 29
 Progressiva: 270.919
 Q. Progetto: 417.164

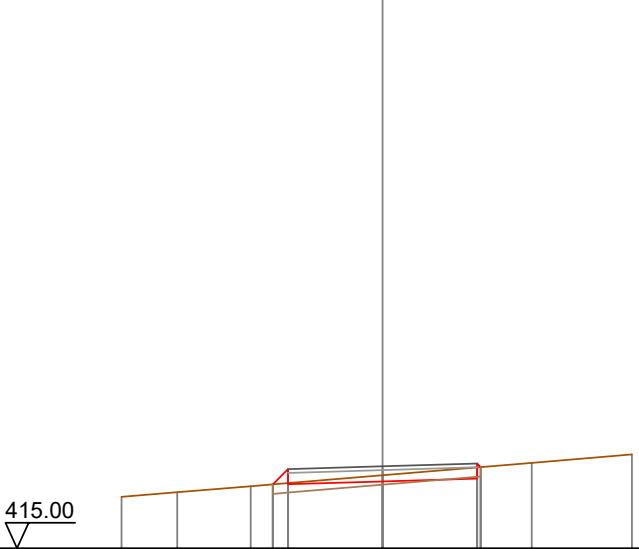

Quote Terreno	-416.36	-416.48	-416.64	-416.72	-416.93	-417.26	-417.48
Quote Progetto			416.68	416.69	416.76	416.84	417.14
Parziali			0.40	2.50	2.50		
Progressiva			-2.90	-2.50	0.00	2.50	2.60
Dislivelli			0.00	0.37	-0.16	-0.30	-0.00

Sezione: 30
 Progressiva: 280.000
 Q. Progetto: 417.670

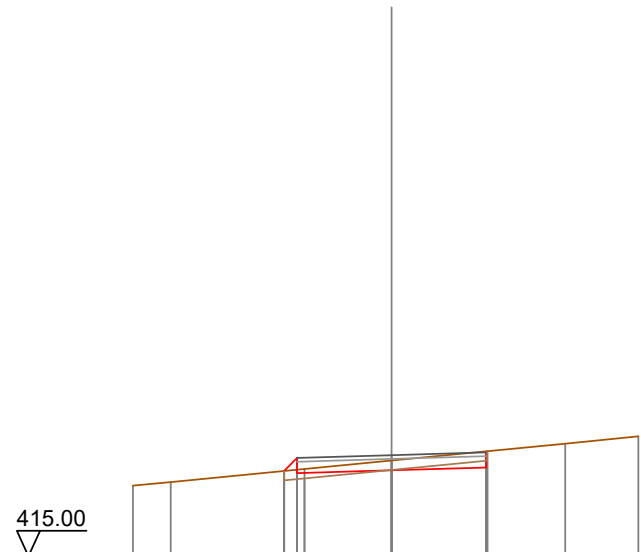

Quote Terreno		416.87	416.96	417.25	417.20	417.31	417.53	417.95	417.78	417.98	418.17
Quote Progetto				417.25	417.20	417.31	417.27	417.35	417.78		
Parziali				0.34	2.50	2.50					
Progressiva				-2.84	-2.50		0.00	2.50	2.53		
Dislivelli				0.00	0.31		-0.26	-0.43	0.00		

Sezione: 32
 Progressiva: 293.577
 Q. Progetto: 418.118

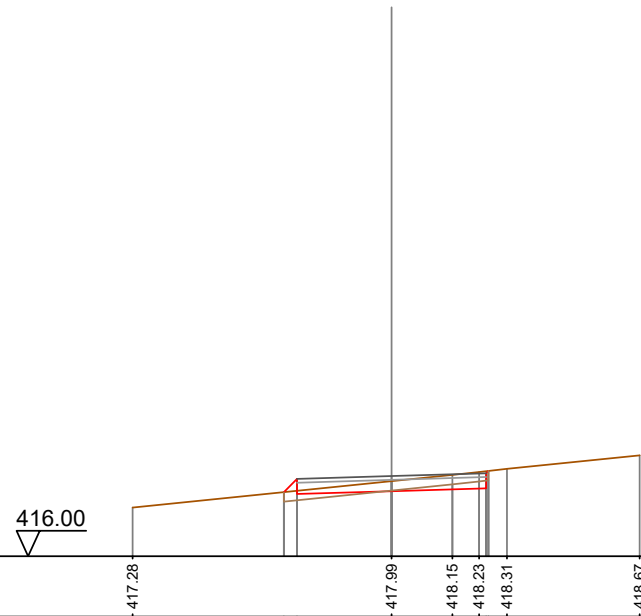

Quote Terreno	-417.28			417.99	-418.15	-418.23	-418.31	-418.67
Quote Progetto		417.69	417.64	417.72	417.79	418.25		
Parziali		0.35	2.50	2.50				
Progressiva		-2.85	-2.50	0.00	2.50	2.56		
Dislivelli		0.00	0.31	-0.27	-0.45	0.00		

Sezione: 33
 Progressiva: 300.000
 Q. Progetto: 418.201

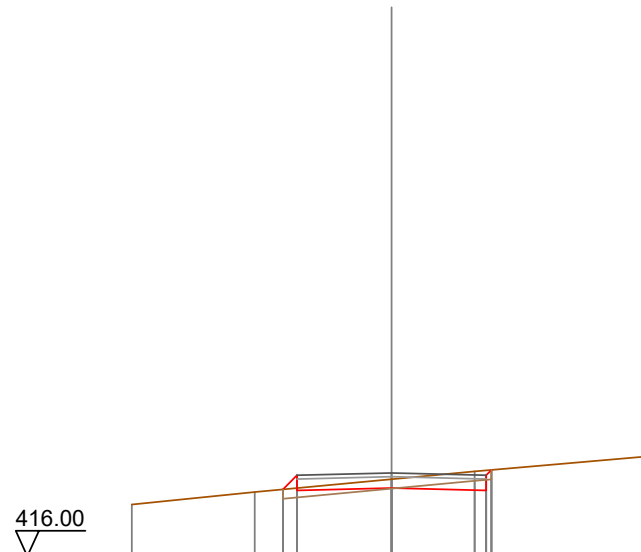

Quote Terreno	-417.36	-417.70	-417.77	-417.74	418.04	-417.74	-418.24	-418.28	-418.63
Quote Progetto			417.77	417.74	417.80	417.74	418.28		
Parziali			0.37	2.50	2.50				
Progressiva			-2.87	-2.50	0.00	2.50	2.64		
Dislivelli			-0.00	0.34	-0.23	-0.53	0.00		

Sezione: 34
 Progressiva: 320.000
 Q. Progetto: 418.118

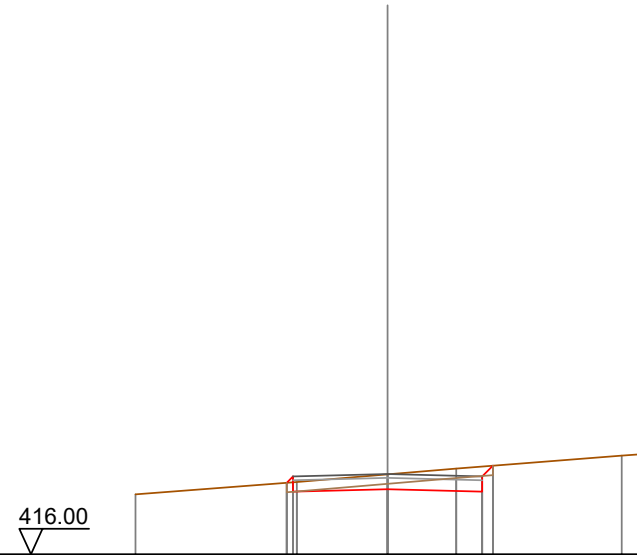

Quote Terreno	-417.58	-417.91	-417.91	-418.11	-418.26	-418.61	-418.65
Quote Progetto		417.89	417.66	417.72	417.66		
Parziali			2.50	2.50	0.28		
Progressiva		-2.67	-2.50	0.00	2.50	2.78	
Dislivelli		0.00	0.16	-0.39	-0.66	0.00	

Sezione: 35
 Progressiva: 340.000
 Q. Progetto: 418.423

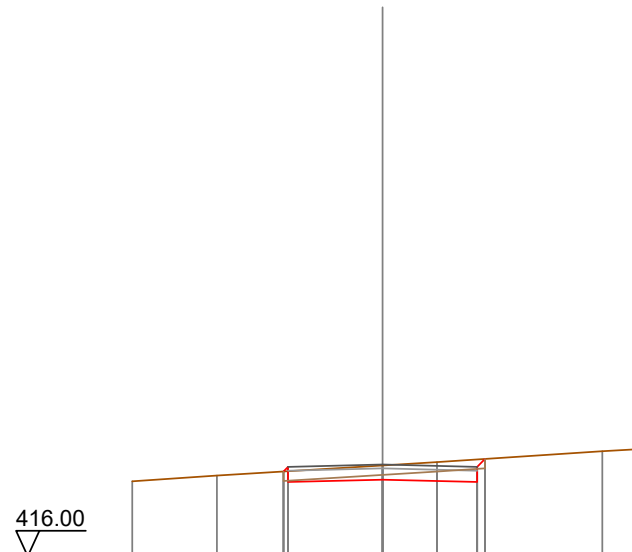

Quote Terreno	-417.98	-418.13		418.02	418.40	-418.49		-418.77	-418.83
Quote Progetto			418.24	417.96		417.96	418.57		
Parziali				2.50		2.50			
Progressiva			-2.62	-2.50	0.00	2.50	2.71		
Dislivelli			0.00	0.11	-0.38	-0.60	0.00		

Sezione: 36
 Progressiva: 360.000
 Q. Progetto: 418.941

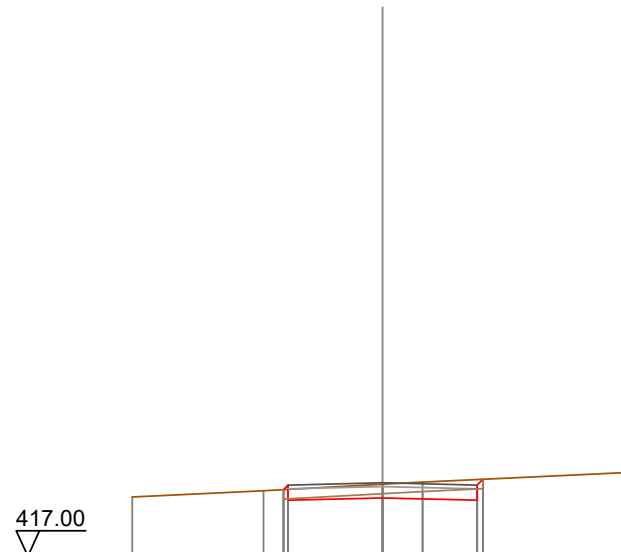

Quote Terreno		-418.57		-418.73		418.90		-418.96		-419.22
Quote Progetto				418.76		418.54		418.48		419.03
Parziali				418.48		2.50		2.50		
Progressiva				-2.62		0.00		2.50		2.66
Dislivelli				0.00		-0.36		-0.55		0.00

Sezione: 37
 Progressiva: 368.003
 Q. Progetto: 419.148

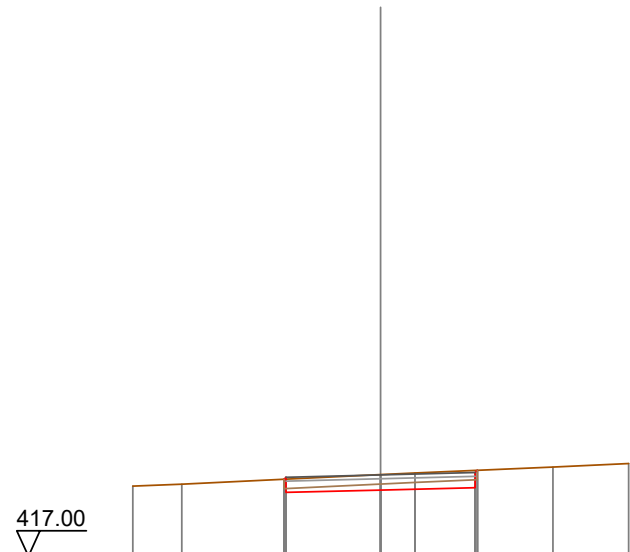

Quote Terreno	-418.85	-418.90			419.16	419.20		-419.36	-419.45
Quote Progetto			419.03	418.69	418.75		418.81	419.27	
Parziali				2.50		2.50			
Progressiva			-2.55	-2.50	0.00		2.50	2.56	
Dislivelli			-0.00	0.05	-0.41		-0.46	-0.00	

Sezione: 38
 Progressiva: 370.000
 Q. Progetto: 419.199

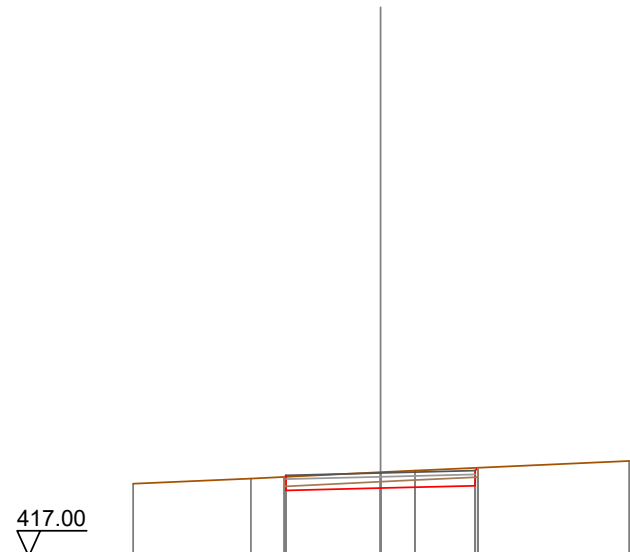

Quote Terreno	-418.92	-419.05	-419.22	-419.26	-419.52
Quote Progetto		419.09 418.74	418.80	418.86 419.34	
Parziali		2.50	2.50		
Progressiva		-2.54 -2.50	0.00	2.50 2.58	
Dislivelli		0.00 0.04	-0.42	-0.47 0.00	

Sezione: 39
 Progressiva: 380.000
 Q. Progetto: 419.549

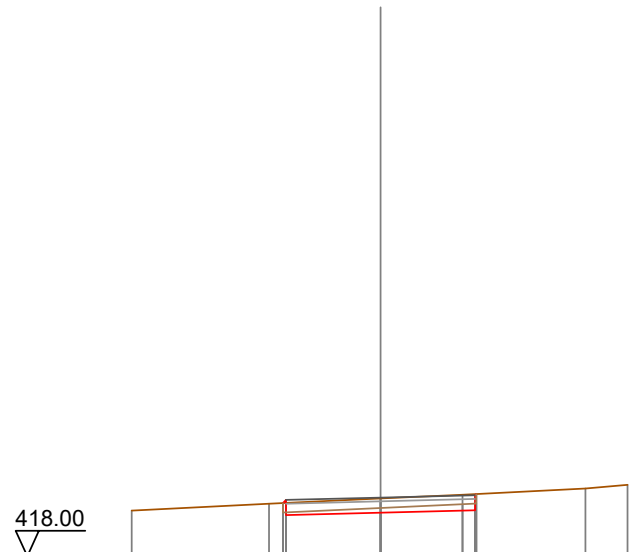

Quote Terreno	-419.21	419.39	419.52	419.62	-419.79	-419.89
Quote Progetto		419.41 419.09	419.15	419.21 419.64		
Parziali			2.50	2.50		
Progressiva		-2.68 -2.50	0.00	2.50 2.53		
Dislivelli		0.00 0.08	-0.38	-0.43 0.00		

Sezione: 40
 Progressiva: 390.000
 Q. Progetto: 420.074

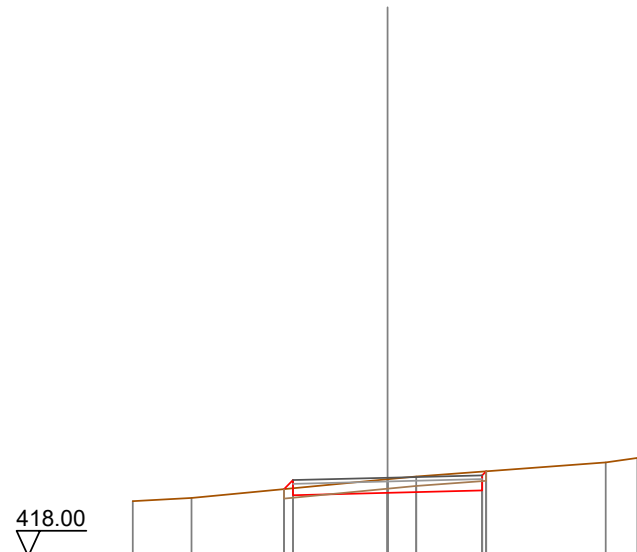

Quote Terreno		419.45	419.54		419.67	420.03	420.11		420.48	420.60
Quote Progetto				419.77	419.61			419.74	420.24	
Parziali					2.50		2.50			
Progressiva				-2.74	-2.50	0.00		2.50	2.61	
Dislivelli				0.00	0.22	-0.36		-0.50	0.00	

Sezione: 41
 Progressiva: 400.000
 Q. Progetto: 420.623

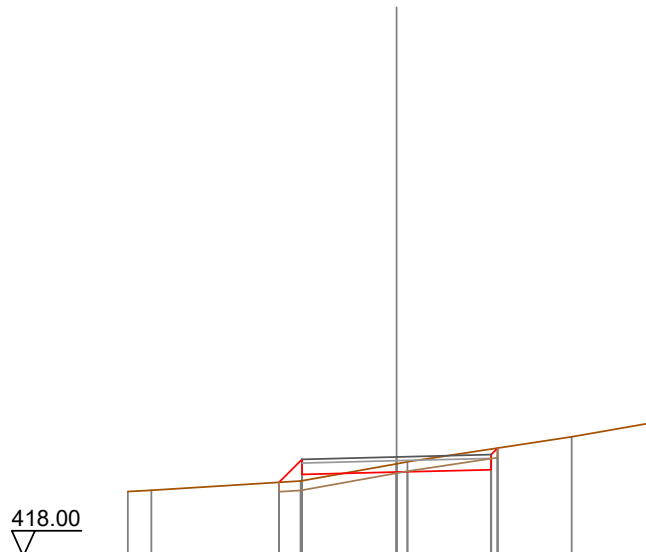

Quote Terreno		-419.71	-419.74		419.99		420.44	420.49			-421.15	-421.51
Quote Progetto					419.95	420.16	420.22		420.29	420.86		
Parziali					0.61	2.50	2.50					
Progressiva					-3.11	-2.50	0.00		2.50	2.67		
Dislivelli					0.00	0.57	-0.22		-0.54	0.00		

Sezione: 42
 Progressiva: 408.122
 Q. Progetto: 421.070

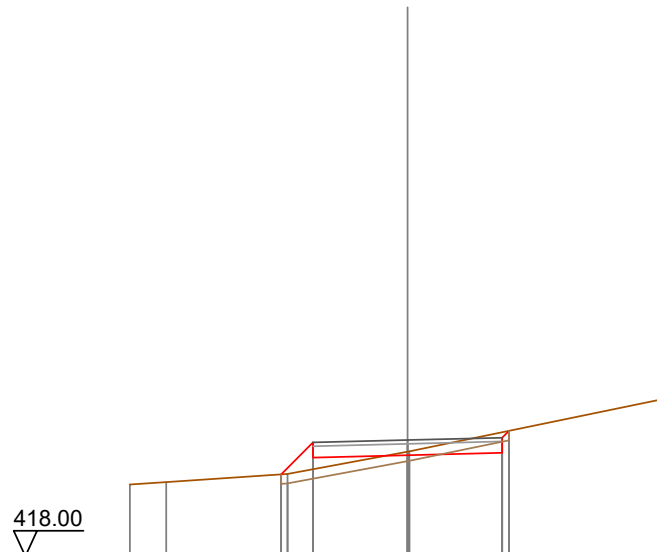

Quote Terreno	-419.90	-419.96	420.17	420.76	420.77	-422.14
Quote Progetto			420.16	420.67	420.73	421.31
Parziali			0.85	2.50	2.50	
Progressiva			-3.35	-2.50	0.00	2.50
Dislivelli			0.00	0.71	-0.09	-0.54
						-0.00

Sezione: 43
 Progressiva: 410.000
 Q. Progetto: 421.173

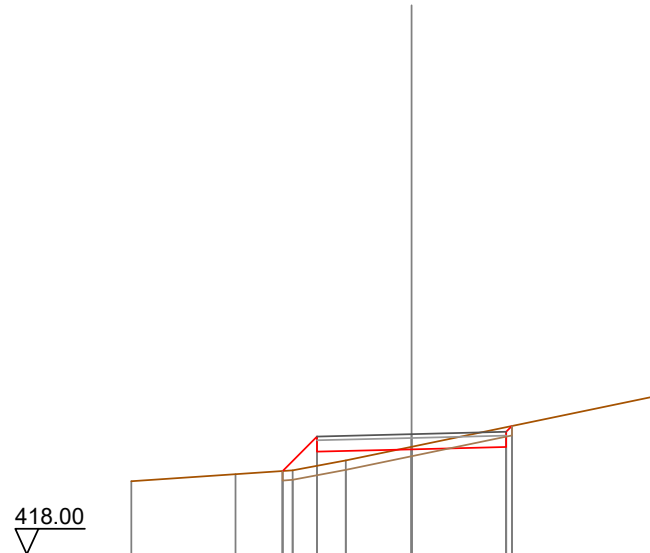

Quote Terreno	419.93	420.11	420.21	420.48	420.84	422.22
Quote Progetto			420.20	420.71	420.77	420.84 421.39
Parziali			0.91	2.50	2.50	
Progressiva			-3.41	-2.50	0.00	2.50 2.65
Dislivelli			0.00	0.78	-0.07	-0.52 0.00

Sezione: 44
 Progressiva: 420.000
 Q. Progetto: 421.722

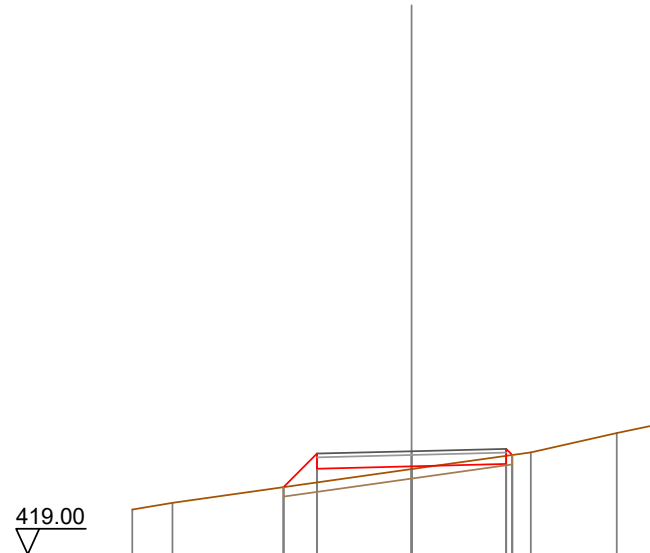

Quote Terreno	-420.18	-420.36			421.25	421.69	-422.20	-422.46
Quote Progetto			420.77	421.26	421.32	421.38	421.62	
Parziali			0.89	2.50	2.50			
Progressiva			-3.39	-2.50	0.00	2.50	2.66	
Dislivelli			0.00	0.76	0.07	-0.22	0.00	

Sezione: 45
 Progressiva: 430.000
 Q. Progetto: 422.272

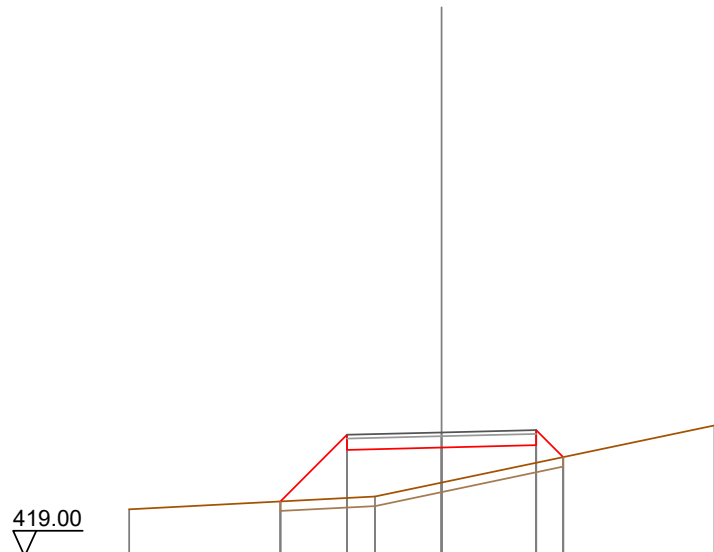

Quote Terreno		420.24							422.46
Quote Progetto			420.45	421.81	420.58	420.94	421.87	421.93	421.62
Parziali				1.76	2.50		2.50	0.72	
Progressiva			-4.26	-2.50		0.00		2.50	3.22
Dislivelli			-0.00	1.67		0.93		0.47	-0.00

Sezione: 46
 Progressiva: 440.000
 Q. Progetto: 422.914

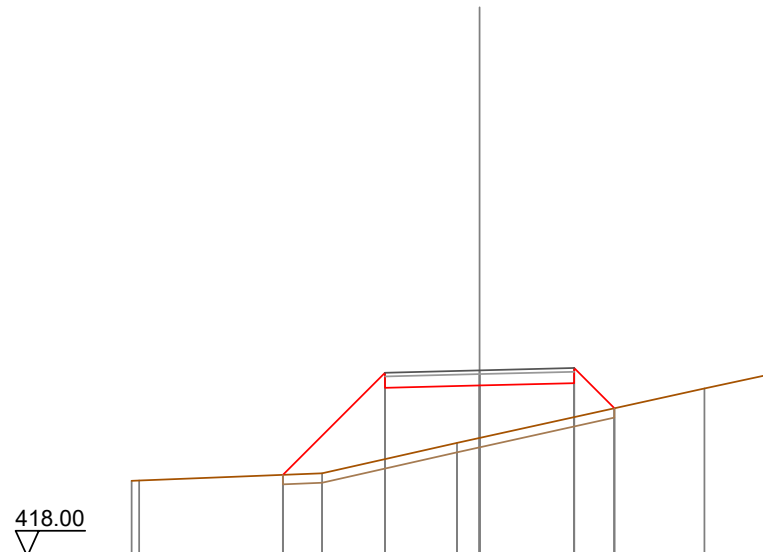

Quote Terreno	419.99	420.00	420.19	421.00	421.13	422.44	422.78
Quote Progetto		420.15	422.45	422.51	422.58	421.91	
Parziali			2.70	2.50	2.50	1.06	
Progressiva		-5.20	-2.50	0.00	2.50	3.56	
Dislivelli		-0.00	2.28	1.39	0.90	0.00	

Sezione: 47
 Progressiva: 448.241
 Q. Progetto: 423.594

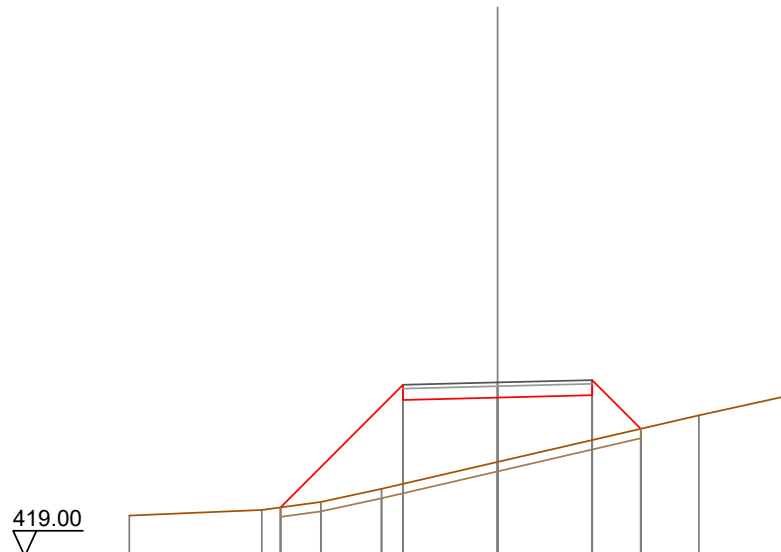

Quote Terreno	420.07	420.22	420.43	420.78	421.49	422.72	423.27
Quote Progetto		420.29		423.13	423.19	423.26	422.37
Parziali			3.24	2.50	2.50	1.29	
Progressiva		-5.74		-2.50	0.00	2.50	3.79
Dislivelli		0.00		2.62	1.70	1.19	-0.00

Sezione: 48
 Progressiva: 451.085
 Q. Progetto: 423.861

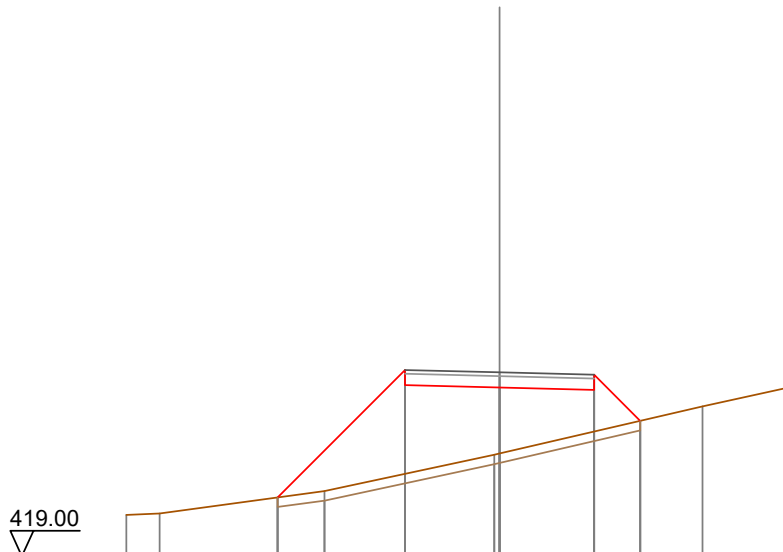

Quote Terreno	-420.09	-420.13	-420.72	-421.68	-421.72	-422.96	-423.48
Quote Progetto			420.55	423.52	423.46	423.40	422.58
Parziali			3.37	2.50	2.50	1.22	
Progressiva			-5.87	-2.50	0.00	2.50	3.72
Dislivelli			0.00	2.75	1.75	1.10	-0.00

Sezione: 49
 Progressiva: 460.000
 Q. Progetto: 424.803

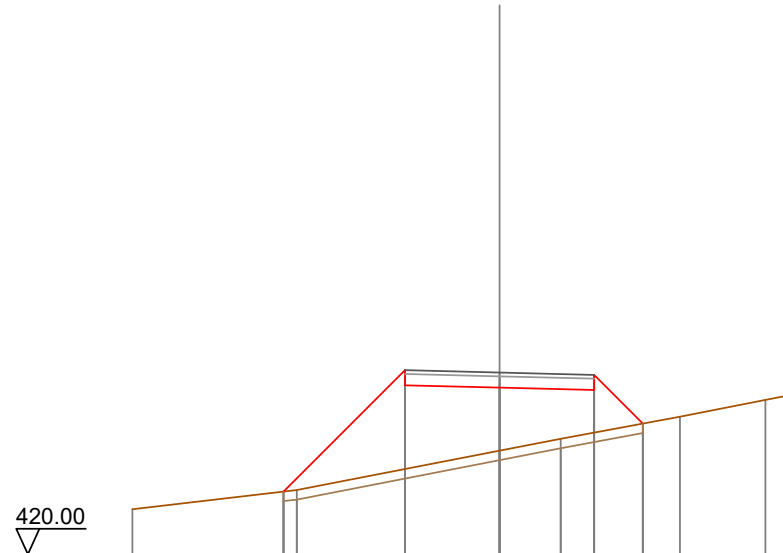

Quote Terreno	421.19	421.69		422.74	423.05	423.64	424.08	424.23
Quote Progetto		421.65	424.47	424.40	424.34	423.45		
Parziali		3.21	2.50	2.50	1.29			
Progressiva		-5.71	-2.50	0.00	2.50	3.79		
Dislivelli		-0.00	2.62	1.67	1.13	0.00		

Sezione: 50
 Progressiva: 470.000
 Q. Progetto: 426.054

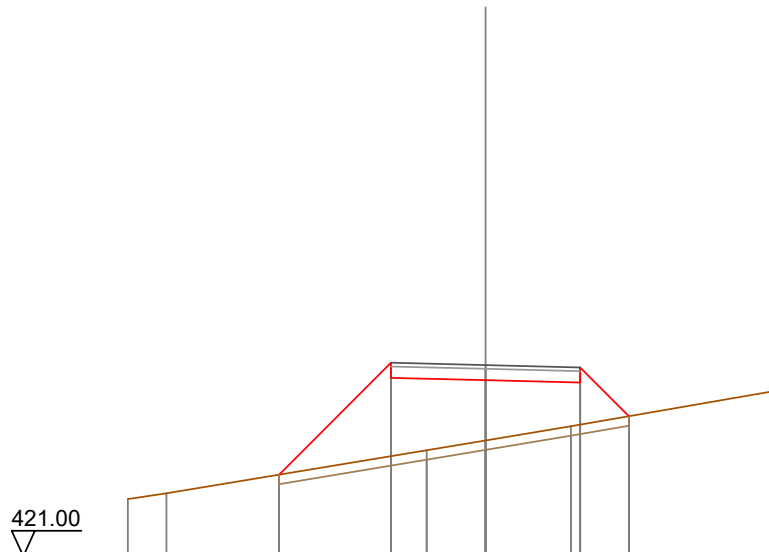

Quote Terreno							
	422.51	422.66			423.80	424.06	424.43
Quote Progetto			423.15	425.72	425.65	425.69	424.70
Parziali				2.96	2.50	2.50	1.29
Progressiva			-5.46	-2.50	0.00	2.50	3.79
Dislivelli			0.00	2.47	1.60	1.11	0.00

Sezione: 51
 Progressiva: 479.291
 Q. Progetto: 427.313

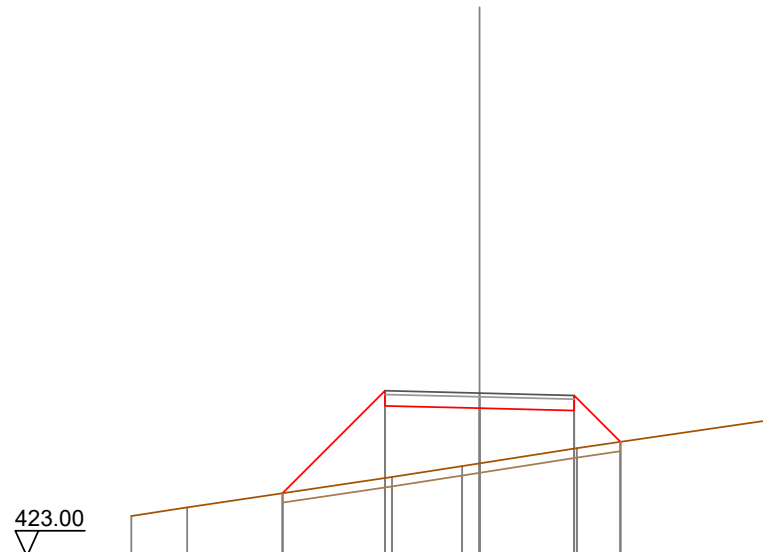

Quote Terreno		424.06		424.29		425.10	425.38	425.45	425.85		426.61
Quote Progetto			424.67		426.98		426.91		426.85	426.02	
Parziali				2.71		2.50		2.50		1.23	
Progressiva			-5.21		-2.50		0.00		2.50	3.73	
Dislivelli			0.00		2.31		1.46		1.01	-0.00	

Sezione: 52
 Progressiva: 480.000
 Q. Progetto: 427.409

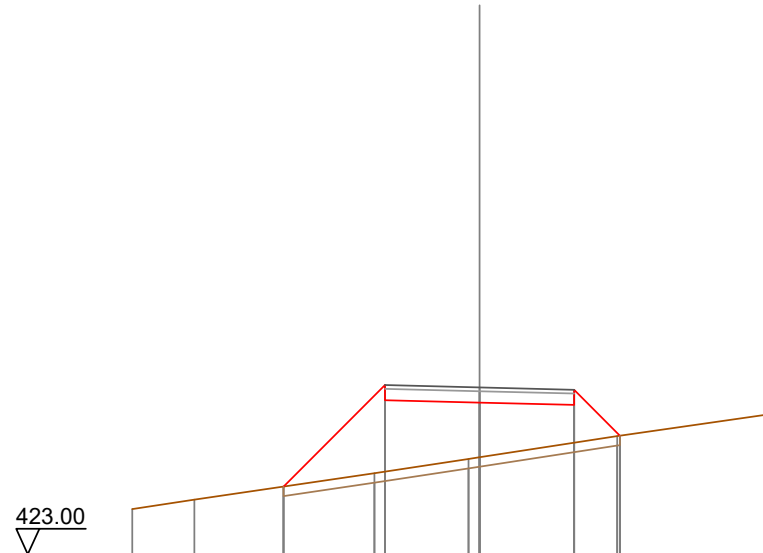

Quote Terreno		424.19	424.44	424.79	425.14	425.52	425.56	426.12	426.71
Quote Progetto				424.79	427.07	427.01	426.95	426.13	
Parziali					2.69	2.50	2.50	1.21	
Progressiva				-5.19	-2.50	0.00	2.50	3.71	
Dislivelli				0.00	2.29	1.45	1.00	0.00	

Sezione: 53
 Progressiva: 490.000
 Q. Progetto: 428.764

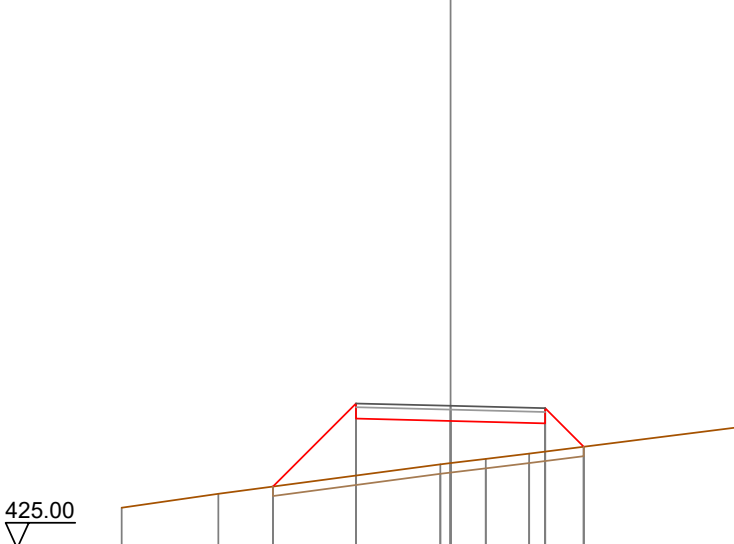

Quote Terreno	426.07	426.44	426.63	428.43	427.22	427.25	427.36	427.50	428.18
Quote Progetto			426.63	428.43	428.36	428.36	428.30	428.30	427.68
Parziali				2.20	2.50	2.50	1.02		
Progressiva			-4.70	-2.50	0.00	2.50	3.52		
Dislivelli			0.00	1.91	1.11	0.75	-0.00		

Sezione: 54
 Progressiva: 500.000
 Q. Progetto: 430.119

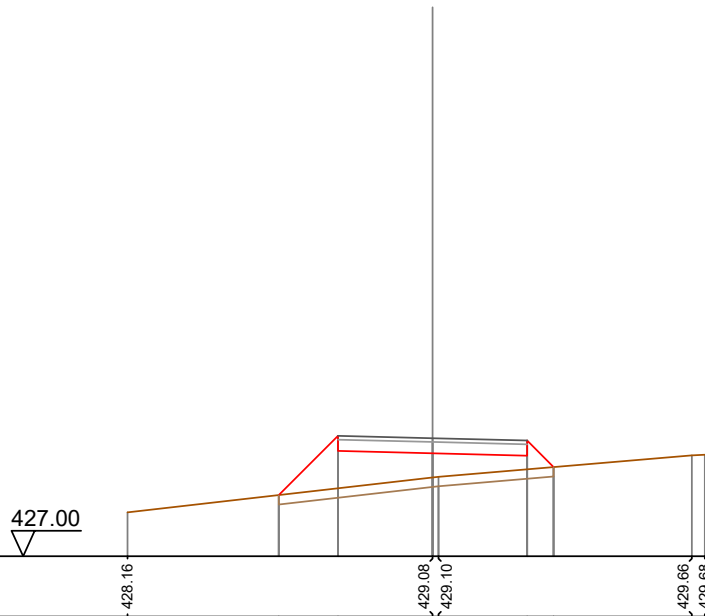

Quote Terreno	428.16			429.08		429.66
Quote Progetto		428.62	429.78	429.72	429.66	429.36
Parziali		1.57	2.50	2.50	0.70	
Progressiva		-4.07	-2.50	0.00	2.50	3.20
Dislivelli		0.00	1.39	0.64	0.36	0.00

Sezione: 55
 Progressiva: 507.496
 Q. Progetto: 431.135

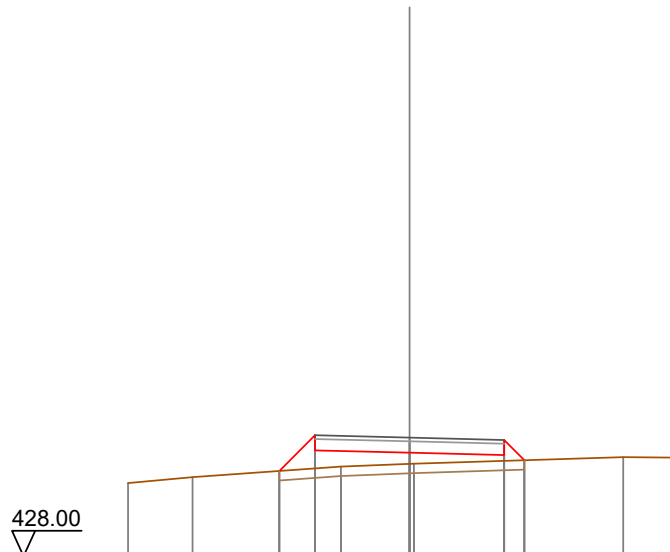

Quote Terreno	-429.93	-430.09		-430.37	430.44	430.44		-430.62	-430.61
Quote Progetto			430.25	430.80	430.74	430.67	430.54		
Parziali			0.95	2.50	2.50	0.54			
Progressiva			-3.45	-2.50	0.00	2.50	3.04		
Dislivelli			0.00	0.88	0.30	0.15	0.00		

Sezione: 56
 Progressiva: 520.000
 Q. Progetto: 432.830

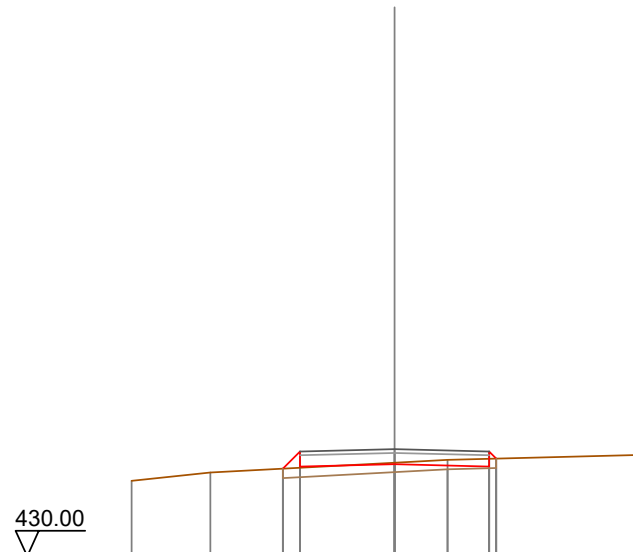

Quote Terreno	-431.99	-432.21		432.47	-432.55		-432.68
Quote Progetto			432.31 432.37	432.43	432.37 432.58		
Parziali			0.45 2.50	2.50			
Progressiva			-2.85 -2.50	0.00	2.50 2.69		
Dislivelli			0.00 0.43	-0.04	-0.21 0.00		

Sezione: 57
 Progressiva: 540.000
 Q. Progetto: 435.315

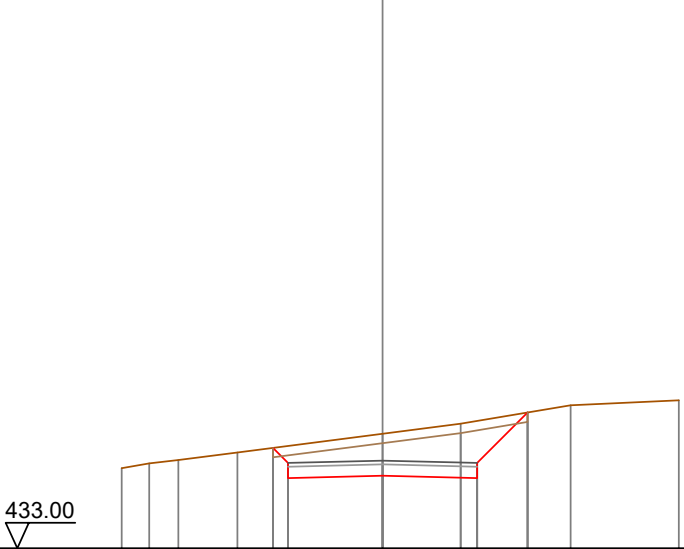

Quote Terreno	-435.11	-435.24	-435.33	-435.53		436.03	-436.29	-436.78	-436.91
Quote Progetto				435.65	434.85	434.92	434.85	436.59	
Parziali				0.40	2.50	2.50	1.34		
Progressiva				-2.90	-2.50	0.00	2.50	3.84	
Dislivelli				-0.00	-0.45	-1.11	-1.51	0.00	

Sezione: 58
 Progressiva: 560.000
 Q. Progetto: 437.232

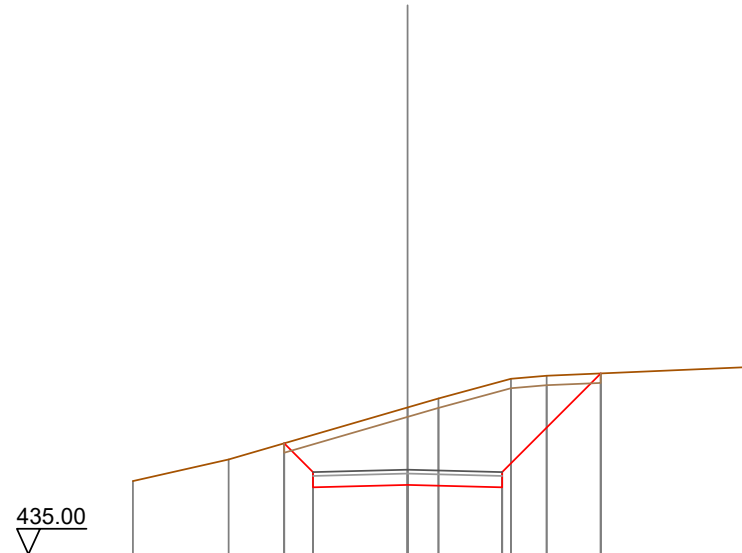

Quote Terreno		-436.93		-437.51			438.88	-439.12		-439.64	-439.72		-439.95
Quote Progetto				437.93	436.77		436.83		436.77		439.78		
Parziali				0.76	2.50		2.50		2.61				
Progressiva				-3.26	-2.50		0.00		2.50		5.11		
Dislivelli				0.00	-0.98		-2.05		-2.80		0.00		

Sezione: 59
 Progressiva: 568.523
 Q. Progetto: 438.036

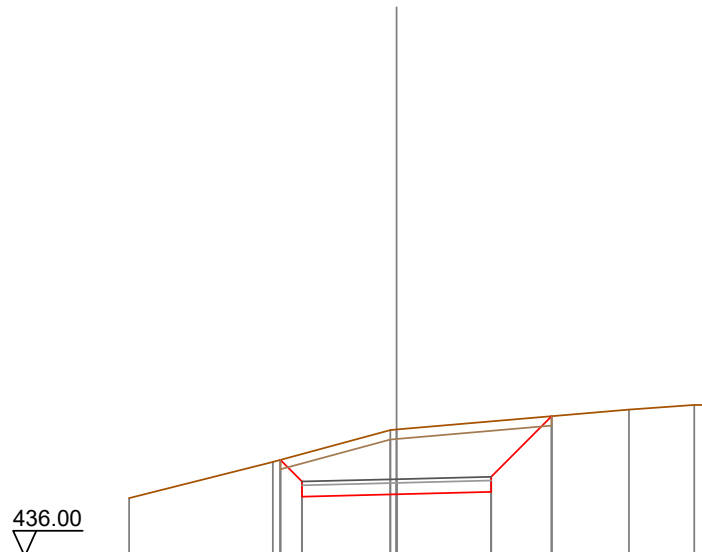

Quote Terreno	437.53	438.49	439.34	439.35	439.88	440.00	440.00
Quote Progetto		438.55	437.57	437.64	437.70	439.70	
Parziali		0.57	2.50	2.50	1.60		
Progressiva		-3.07	-2.50	0.00	2.50	4.10	
Dislivelli		0.00	-0.73	-1.71	-1.86	0.00	

Sezione: 60
 Progressiva: 570.000
 Q. Progetto: 438.176

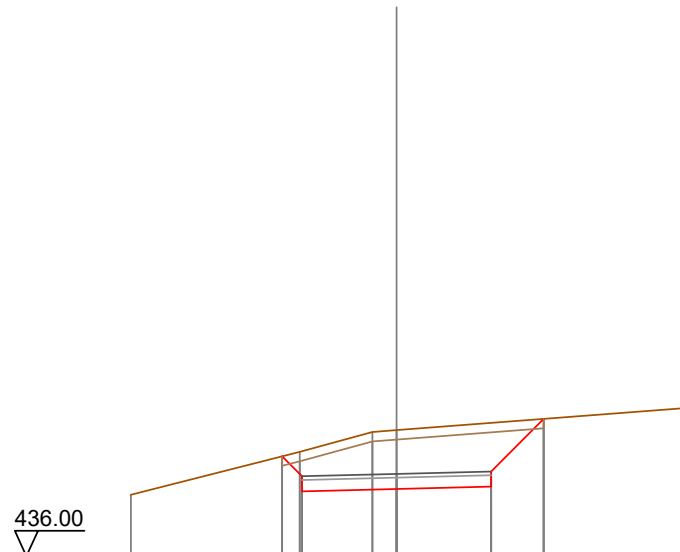

Quote Terreno		437.62		438.64	437.71	438.76	439.28	439.33		437.84	439.63		439.93
Quote Progetto				438.64	437.71	438.76	439.28	439.33		437.84	439.63		
Parziali				0.53	2.50		2.50			1.39			
Progressiva				-3.03	-2.50		0.00			2.50	3.89		
Dislivelli				0.00	-0.66		-1.56			-1.68	-0.00		

Sezione: 61
 Progressiva: 580.000
 Q. Progetto: 439.120

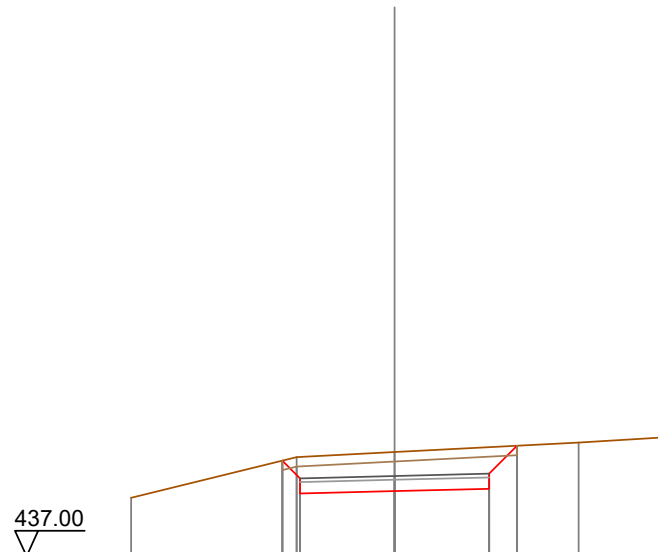

Quote Terreno	-438.54	439.62	439.75	-440.00	-440.15
Quote Progetto		439.63 438.66	438.72 439.75	438.78 439.92	
Parziali		0.47 2.50	2.50	0.74	
Progressiva		-2.97 -2.50	0.00	2.50 3.24	
Dislivelli		0.00 -0.57	-1.03	-1.10 -0.00	

Sezione: 62
 Progressiva: 590.000
 Q. Progetto: 440.063

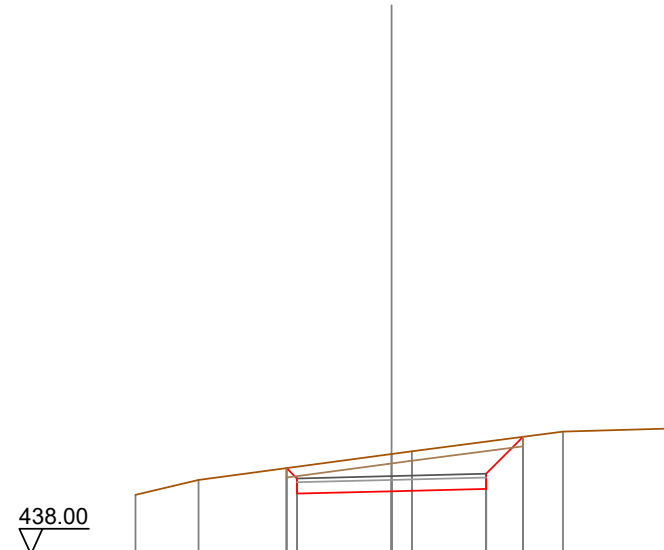

Quote Terreno	439.57	439.96		440.65	440.72		441.24	441.33
Quote Progetto			440.28	439.66	439.73	441.10		
Parziali			0.28	2.50	2.50	0.98		
Progressiva			-2.78	0.00	2.50	3.48		
Dislivelli			-0.00	-0.99	-1.25	-0.00		

Sezione: 63
 Progressiva: 597.322
 Q. Progetto: 440.755

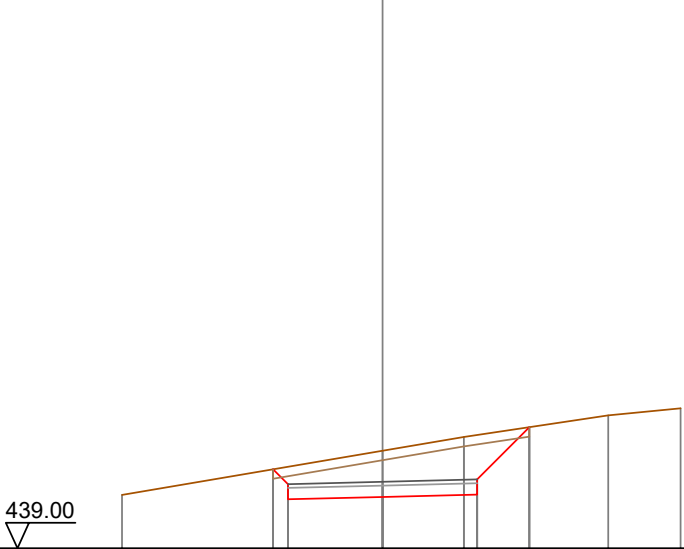

Quote Terreno	-440.41										
Quote Progetto		441.09	440.29	440.35	441.58	441.94	440.42	442.20	442.51	442.70	
Parziali		0.39	2.50		2.50	1.38					
Progressiva		-2.89	-2.50	0.00		2.50	3.88				
Dislivelli		0.00	-0.46		-1.22		-1.57	-0.00			

Sezione: 64
 Progressiva: 600.000
 Q. Progetto: 441.007

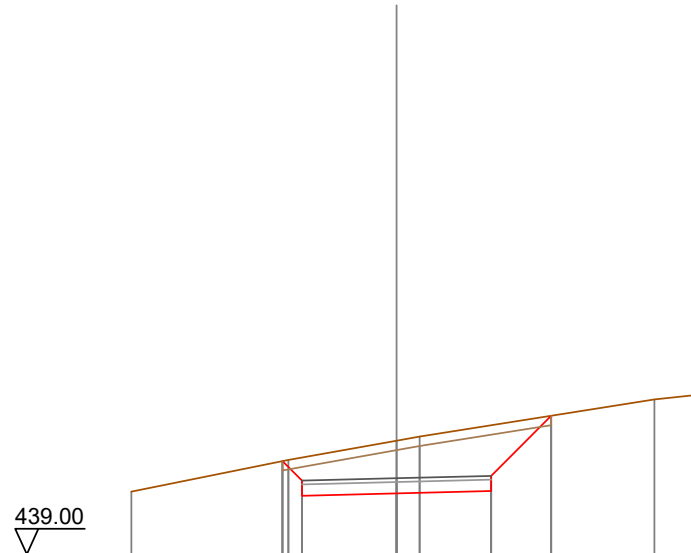

Quote Terreno	-440.65	441.49	442.00	443.09	443.23
Quote Progetto		441.46	440.61	440.67	442.66
Parziali		0.52	2.50	2.50	1.59
Progressiva		-3.02	0.00	2.50	4.09
Dislivelli		0.00	-1.39	-1.74	0.00

Sezione: 65
 Progressiva: 610.000
 Q. Progetto: 442.039

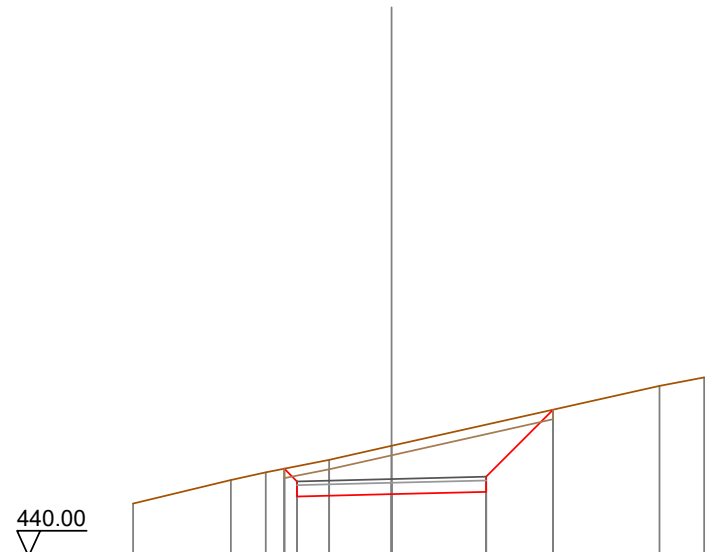

Quote Terreno		441.39		442.01		442.22		442.31		441.58		442.55		442.92				444.50		444.73
Quote Progetto						442.31		441.58				441.64		441.70		443.87				
Parziali						0.34		2.50				2.50		1.77						
Progressiva						-2.84		-2.50				0.00		2.50		4.27				
Dislivelli						0.00		-0.40				-1.28		-1.77		0.00				

Sezione: 66
 Progressiva: 620.000
 Q. Progetto: 443.275

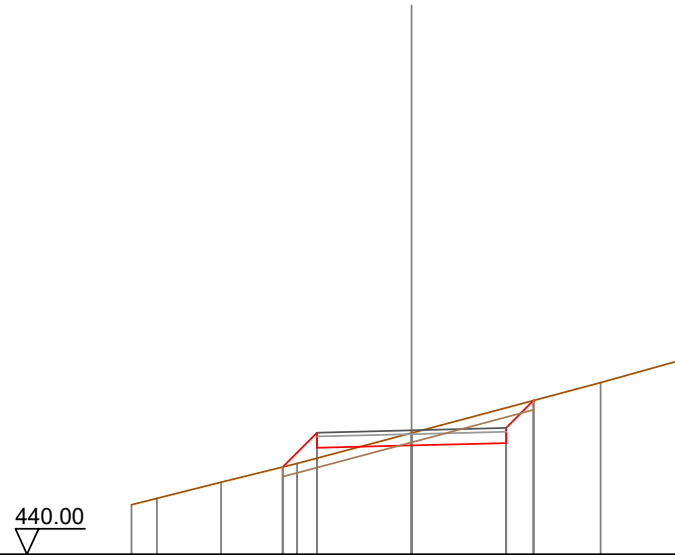

Quote Terreno	441.30	441.48	441.90	442.40	442.87	443.20	443.275	444.54	445.16
Quote Progetto				442.30	442.81	442.87	443.275	442.94	444.06
Parziali				0.91	2.50	2.50	0.00	0.73	
Progressiva				-3.41	-2.50	0.00	0.00	2.50	3.23
Dislivelli				0.00	0.67	-0.33	0.00	-0.93	0.00

Sezione: 67
 Progressiva: 626.121
 Q. Progetto: 444.132

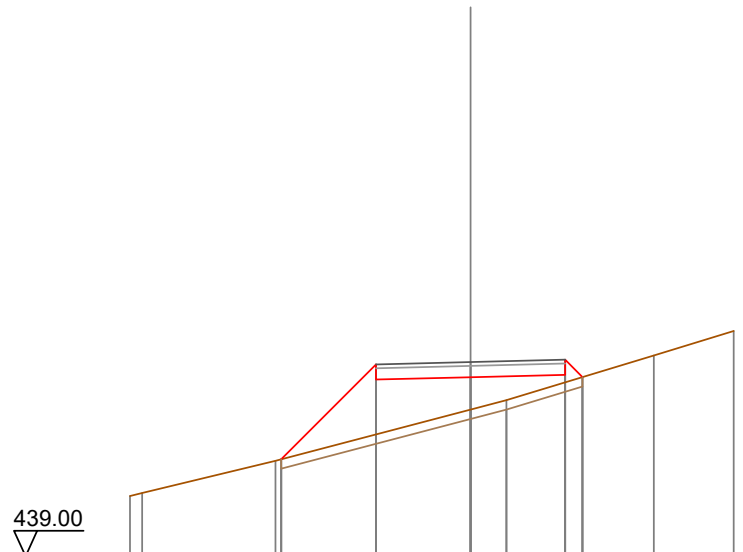

Quote Terreno	440.59	440.67	441.52		442.88	443.13		443.79	443.74	444.31	444.96
Quote Progetto			441.56		443.67		443.73		443.74		
Parziali				2.51		2.50		2.50		0.46	
Progressiva			-5.01		-2.50		0.00		2.50	2.96	
Dislivelli			0.00		1.85		0.85		0.20	0.00	

Sezione: 68
 Progressiva: 640.000
 Q. Progetto: 446.360

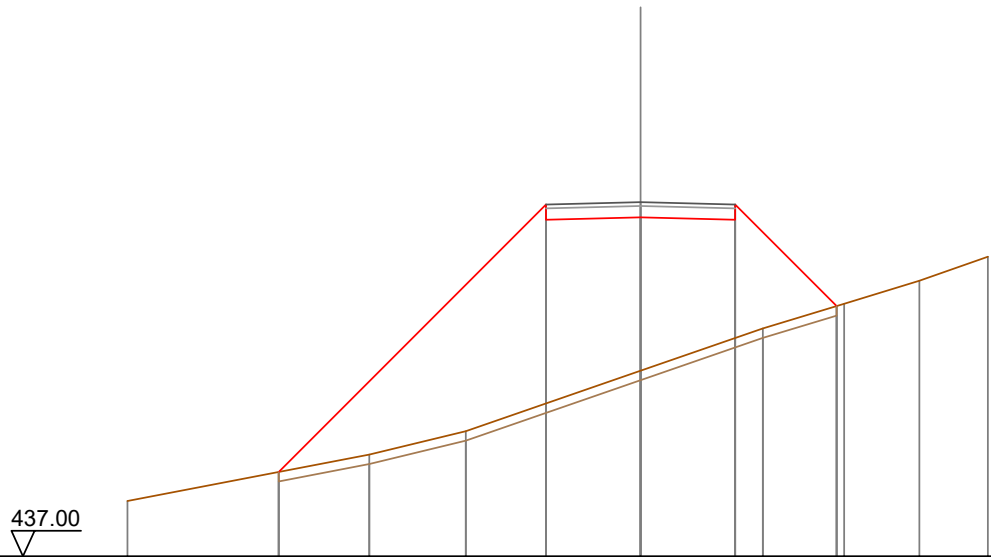

Quote Terreno	438.46	439.69	440.30	445.90	441.90	443.02	443.67	444.28	444.92
Quote Progetto		439.23		445.90	445.96	445.90	443.61		
Parziali			7.07	2.50	2.50	2.69			
Progressiva		-9.57		-2.50	0.00	2.50	5.19		
Dislivelli		0.00		5.26	4.06	3.13	-0.00		

Sezione: 69
 Progressiva: 660.000
 Q. Progetto: 449.788

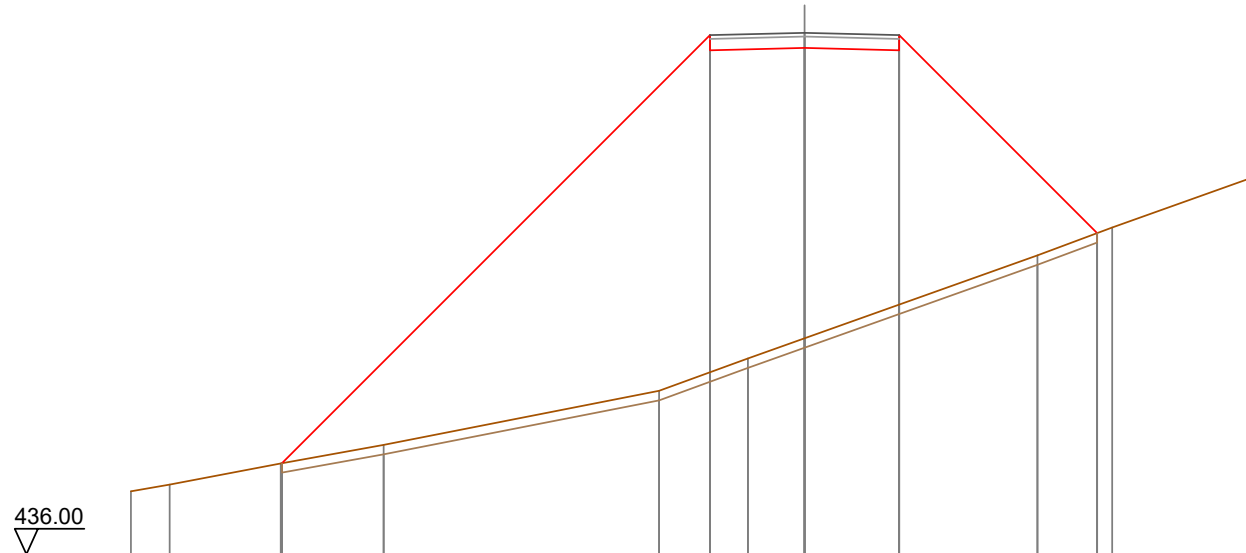

Quote Terreno	437.66	437.84	438.40	438.89	440.32	441.18	441.71	443.90	444.64	445.92
Quote Progetto			438.41		449.33	449.39	449.33		444.49	
Parziali				11.32		2.50	2.50	5.24		
Progressiva			-13.82		-2.50	0.00	2.50		7.74	
Dislivelli			-0.00		8.91	7.68	6.73		-0.00	

Sezione: 70
 Progressiva: 662.835
 Q. Progetto: 450.274

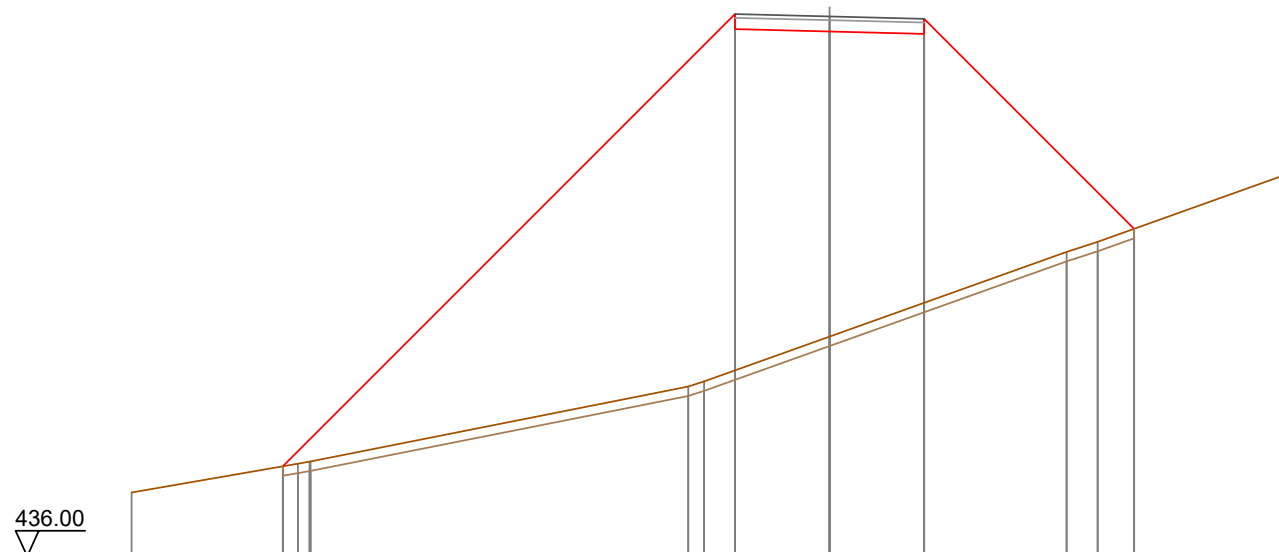

Quote Terreno	-437.68	-438.45	-438.50	-440.49	-440.62	-441.81	-444.04	-444.31	-446.09
Quote Progetto		438.38		449.94		449.87	449.81	444.66	
Parziali		11.96		2.50	2.50	5.55			
Progressiva		-14.46		-2.50	0.00	2.50		8.05	
Dislivelli		0.00		9.42	8.07	7.11		-0.00	

Sezione: 71
 Progressiva: 670.000
 Q. Progetto: 451.452

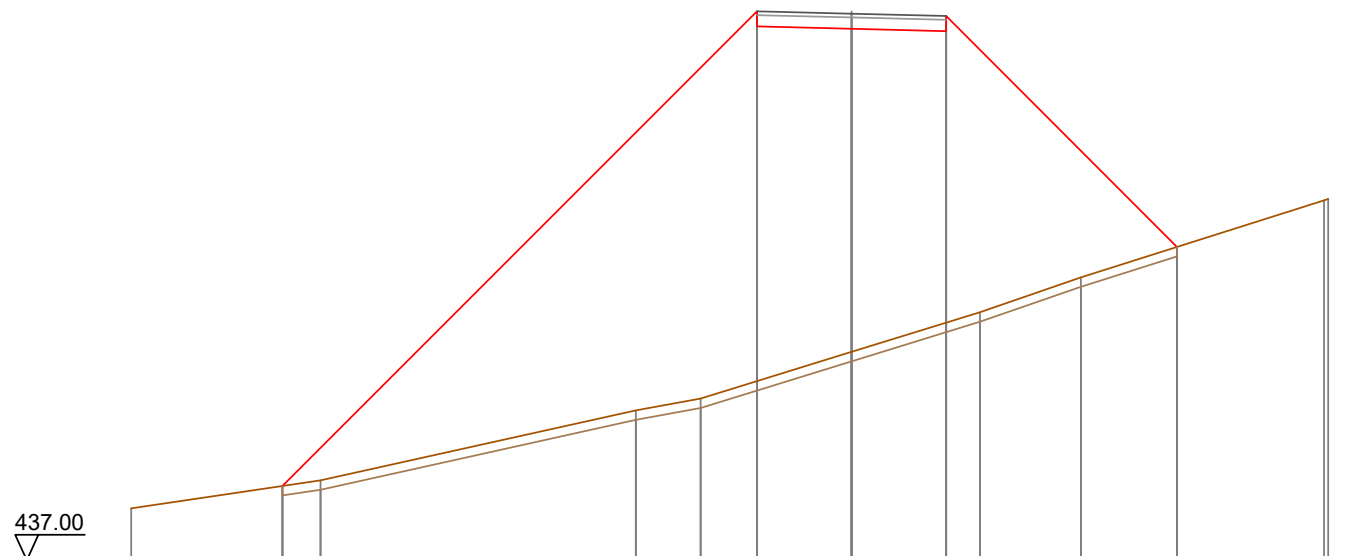

Quote Terreno	438.37	439.11	440.96	441.28	451.11	442.51	443.56	444.48	446.51	446.55
Quote Progetto		438.96			451.11	451.05	450.99		445.28	
Parziali			12.55		2.50	2.50		6.11		
Progressiva		-15.05			-2.50	0.00	2.50		8.61	
Dislivelli		0.00			9.78	8.54	7.71		0.00	

Sezione: 72
 Progressiva: 680.000
 Q. Progetto: 452.918

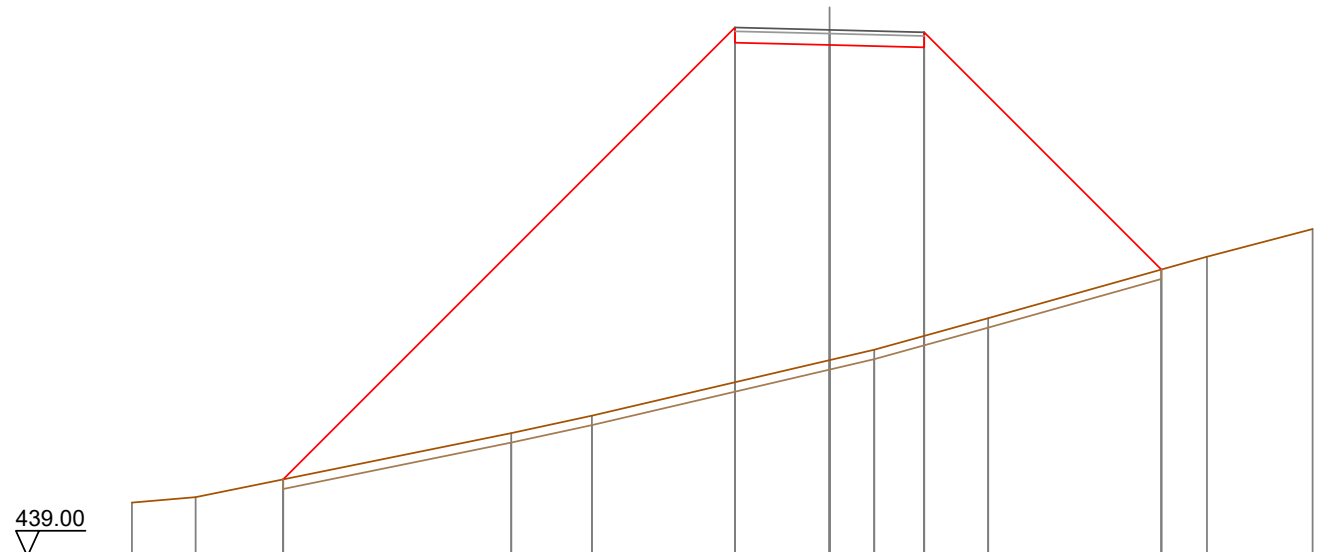

Quote Terreno	-440.42	-440.56	-441.03	-442.25	-442.72	-452.58	-444.18	-444.46	-445.29	-446.92	-447.65
Quote Progetto			441.03			452.58	452.52	452.46		446.58	
Parziali				11.95		2.50	2.50		6.28		
Progressiva			-14.45			-2.50	0.00	2.50		8.78	
Dislivelli			-0.00			9.38	8.34	7.63		0.00	

Sezione: 73
 Progressiva: 690.000
 Q. Progetto: 454.179

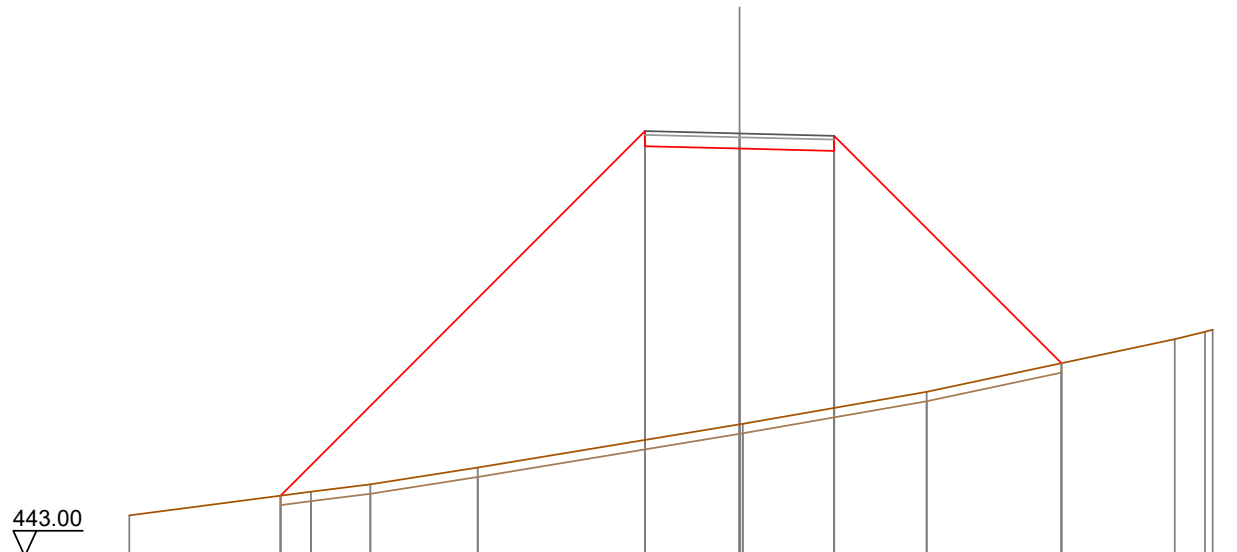

Quote Terreno	444.08	444.70	444.90	445.34	446.49	446.50	447.34	448.74	448.93	448.99
Quote Progetto		444.60			453.84	453.78	453.72		448.10	
Parziali				9.64	2.50	2.50	6.01			
Progressiva		-12.14			-2.50	0.00	2.50		8.51	
Dislivelli		0.00			8.17	7.29	6.80		0.00	

Sezione: 74
 Progressiva: 700.000
 Q. Progetto: 455.235

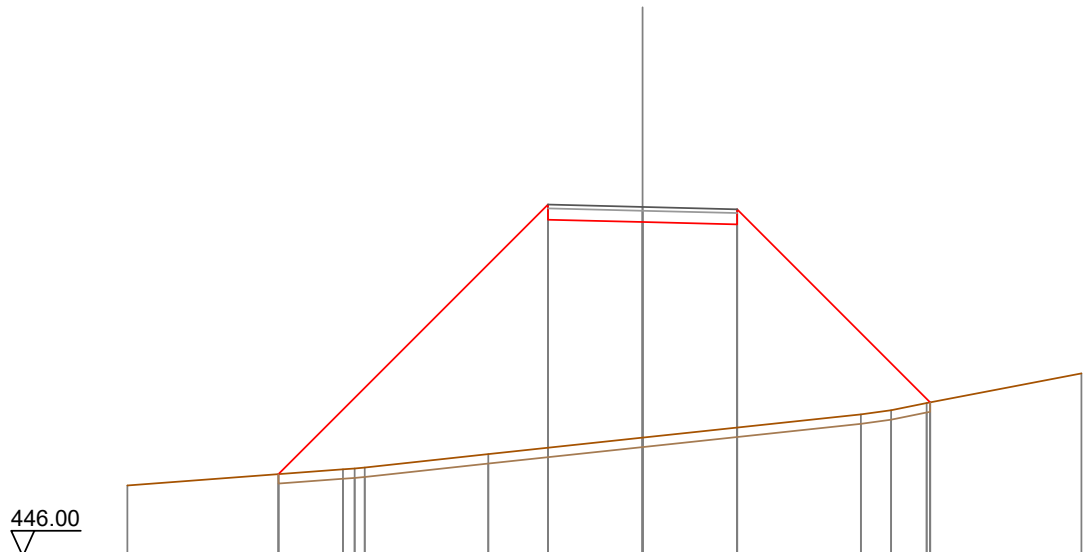

Quote Terreno	-447.87	-448.30	-448.34	-448.70	-449.13	-449.75	-449.86	-450.05	-450.83
Quote Progetto		448.17			454.90	454.84	454.77	450.07	
Parziali			7.13		2.50	2.50	5.11		
Progressiva		-9.63			-2.50	0.00	2.50	7.61	
Dislivelli		0.00			6.43	5.70	5.37	0.00	

Sezione: 75
 Progressiva: 703.999
 Q. Progetto: 455.601

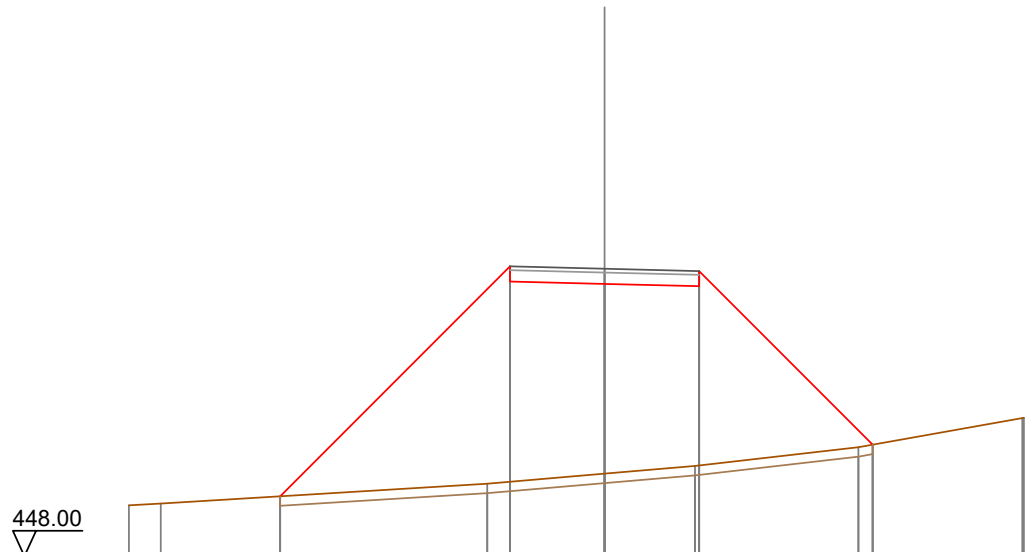

Quote Terreno	-449.35	-449.39	-449.92	-450.18	-450.39	-450.88	-451.65	-451.68
Quote Progetto			449.58	455.26	455.20	455.14	450.95	
Parziali			6.08	2.50	2.50	4.59		
Progressiva			-8.58	-2.50	0.00	2.50	7.09	
Dislivelli			-0.00	5.70	5.02	4.74	0.00	

Sezione: 76
 Progressiva: 710.000
 Q. Progetto: 456.089

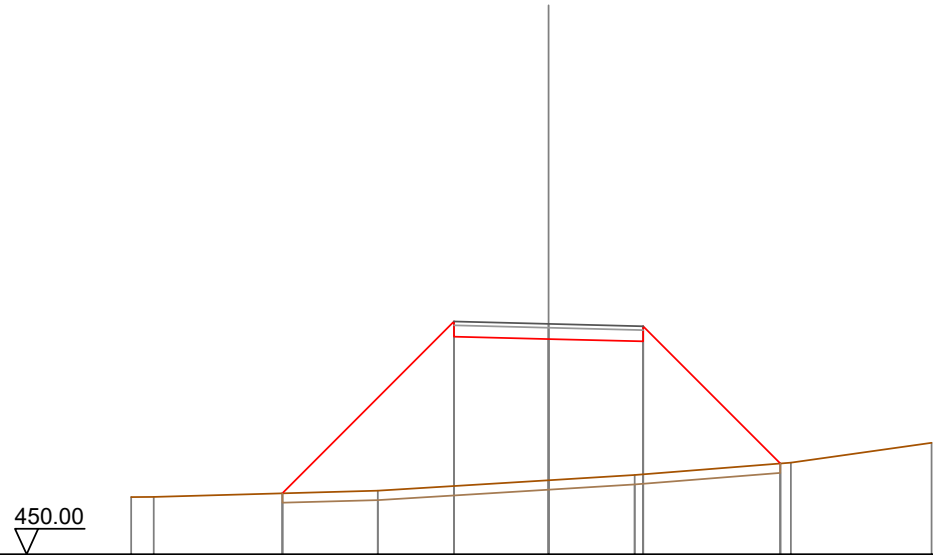

Quote Terreno		451.51	451.52		451.68		451.96	452.09	452.42	452.95
Quote Progetto				451.61		455.75	455.69	455.63	452.40	
Parziali					4.54	2.50	2.50	3.63		
Progressiva				-7.04		-2.50	0.00	2.50	6.13	
Dislivelli				-0.00		4.35	3.73	3.51	-0.00	

Sezione: 77
 Progressiva: 720.000
 Q. Progetto: 456.741

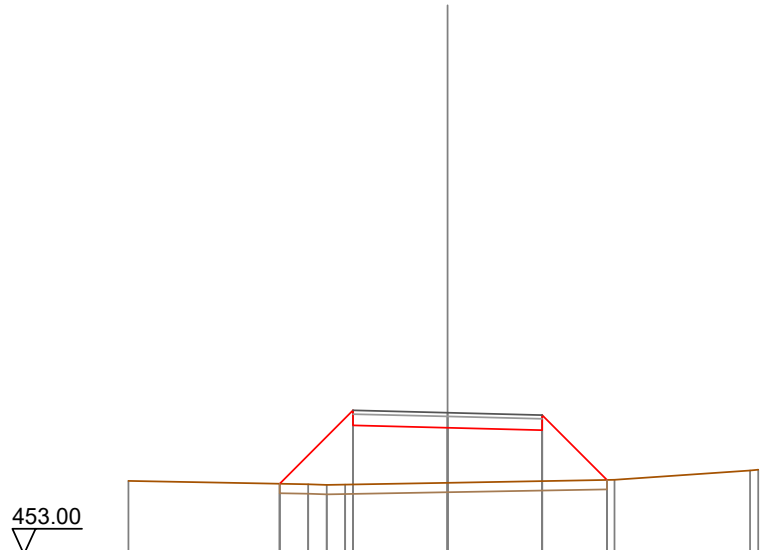

Quote Terreno	454.94	454.85	454.83	454.84	456.40	454.89	454.97	455.21	455.23
Quote Progetto		454.86		456.40		456.34	456.28	454.86	
Parziali			1.94		2.50		2.50	1.72	
Progressiva		-4.44		-2.50		0.00	2.50	4.22	
Dislivelli		0.00		1.96		1.45	1.35	0.00	

Sezione: 78
 Progressiva: 730.000
 Q. Progetto: 457.192

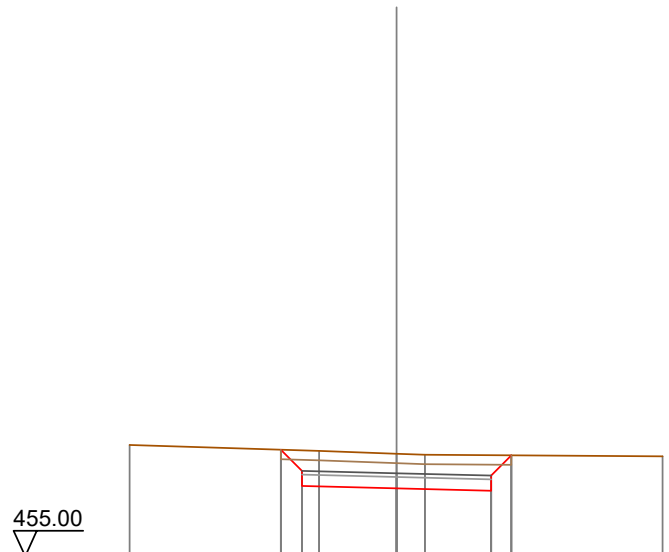

Quote Terreno	-457.94		457.81	456.85	457.78	456.79	457.71	457.68		-457.64
Quote Progetto			457.81	456.85		456.79	457.71		456.73	457.67
Parziali			0.56	2.50		2.50			0.54	
Progressiva			-3.06	-2.50		0.00			2.50	3.04
Dislivelli			0.00	-0.54		-0.92			-0.94	0.00

Sezione: 79
 Progressiva: 740.000
 Q. Progetto: 457.443

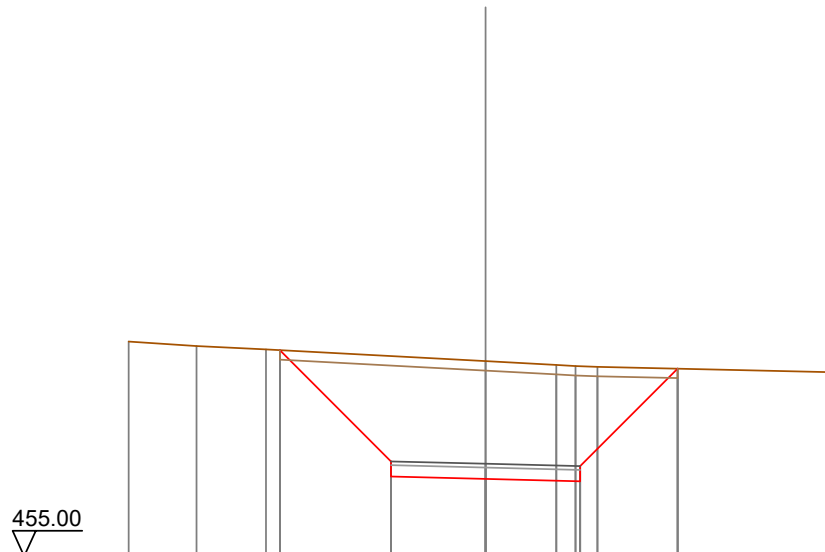

Quote Terreno	-460.67	-460.55	-460.47			460.16	-460.06	-460.03	-460.01		-459.87
Quote Progetto			460.45		457.11	457.04	456.98		459.96		
Parziali				2.94	2.50	2.50	2.58				
Progressiva			-5.44		-2.50	0.00	2.50		5.08		
Dislivelli			0.00		-2.78	-3.11	-3.04		0.00		

SEZIONI TRASVERSALI
Profilo longitudinale tratto 23-24
Viabilità di impianto postazione aerogeneratore T12

Nota: Le canalette di deflusso delle acque meteoriche, non indicate nel presente elaborato, sono rappresentate graficamente nelle sezioni stradali tipo dell'elaborato "WIND002-TC13_Piazzole aerogeneratori e strade di servizio - Particolari costruttivi", individuate planimetricamente nell'elaborato "WIND002-TC14_Opere di regimazione acque superficiali - Planimetria generale" e quantificate nell'elaborato "WIND002-RC6_Computo Metrico Estimativo".

DISEGNI DI RIFERIMENTO

TAVOLA	DESCRIZIONE
WIND002-TC8	Piazzole e viabilità - Planimetria di progetto - Fase di cantiere
WIND002-TC11	Profili longitudinali viabilità di impianto
WIND002-TC13	Piazzole aerogeneratori e strade di servizio - Particolari costruttivi
WIND002-TC14	Opere di regimazione acque superficiali - Planimetria generale

Sezione: 4
 Progressiva: 20.000
 Q. Progetto: 583.624

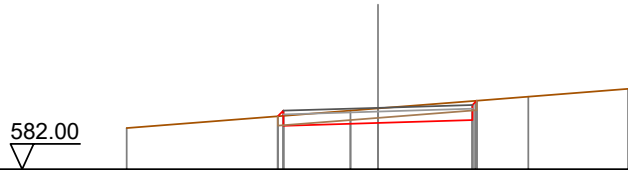

Quote Terreno	583.09		583.55	583.61	583.81	583.92	584.13
Quote Progetto		583.40	583.15	583.22	583.30	583.81	
Parziali			2.50	2.50			
Progressiva		-2.65	-2.50	0.00	2.50	2.61	
Dislivelli		0.00	0.14	-0.38	-0.51	-0.00	

Sezione: 5
 Progressiva: 30.000
 Q. Progetto: 583.510

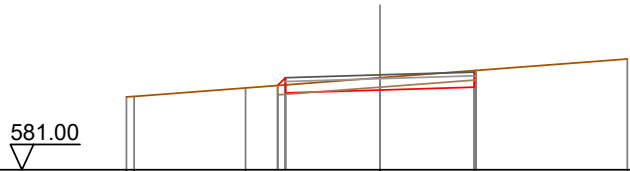

Quote Terreno	582.83	582.94	583.17	583.44		583.83	
Quote Progetto			583.23	583.04	583.11	583.19	583.63
Parziali			2.50	2.50			
Progressiva		-2.70	-2.50	0.00	2.50	2.54	
Dislivelli		0.00	0.19	-0.33	-0.44	0.00	

Sezione: 6
 Progressiva: 40.000
 Q. Progetto: 583.270

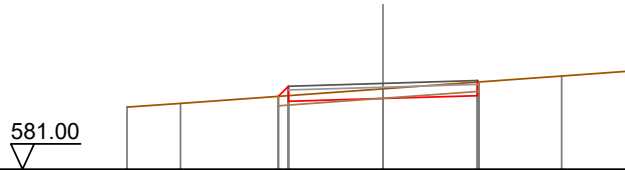

Quote Terreno	582.64	582.74	582.93	582.79	583.13	582.94	583.47	583.60
Quote Progetto			582.93	582.79	582.87	582.94	583.31	
Parziali			0.27	2.50	2.50			
Progressiva			-2.77	-2.50	0.00	2.50	2.54	
Dislivelli			-0.00	0.25	-0.26	-0.36	0.00	

Sezione: 7
 Progressiva: 49.964
 Q. Progetto: 582.904

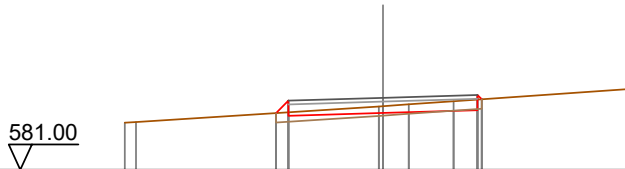

Quote Terreno	582.25	582.26	582.50	582.43	582.68	582.68	582.73	582.82	583.14
Quote Progetto			582.50	582.43	582.50	582.50	582.58	582.87	
Parziali			0.33	2.50	2.50				
Progressiva			-2.83	-2.50	0.00	2.50	2.61		
Dislivelli			0.00	0.31	-0.18	-0.28	0.00		

Sezione: 8
 Progressiva: 60.000
 Q. Progetto: 582.407

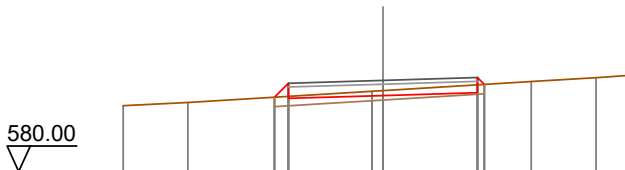

Quote Terreno	581.74	581.82	581.96	581.93	582.12	582.14	582.38	582.48	582.55
Quote Progetto			581.96	581.93	582.01	582.01	582.08	582.30	
Parziali			0.37	2.50	2.50				
Progressiva			-2.87	-2.50	0.00	2.50	2.68		
Dislivelli			-0.00	0.35	-0.13	-0.21	0.00		

Sezione: 9
 Progressiva: 70.000
 Q. Progetto: 581.787

580.00

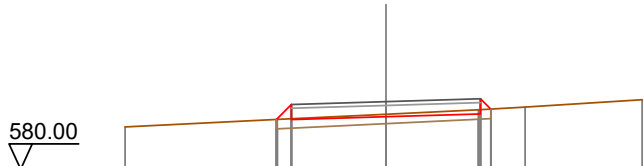

Quote Terreno	-581.12	-581.32	-581.45	-581.57	-581.64	-581.84
Quote Progetto		581.31 581.31	581.39	581.46 581.59		
Parziali		0.40	2.50	2.50	0.27	
Progressiva		-2.90 -2.50	0.00	2.50 2.77		
Dislivelli		0.00 0.38	-0.07	-0.11 0.00		

Sezione: 10
 Progressiva: 80.000
 Q. Progetto: 581.152

579.00

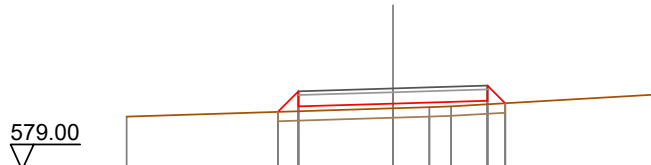

Quote Terreno	-580.41		-580.63	-580.66	-580.68	-580.99
Quote Progetto		580.53 580.68	580.75	580.83 580.76		
Parziali		0.54	2.50	2.50	0.47	
Progressiva		-3.04 -2.50	0.00	2.50 2.97		
Dislivelli		0.00 0.53	0.12	0.09 0.00		

Sezione: 11
 Progressiva: 90.000
 Q. Progetto: 580.694

578.00

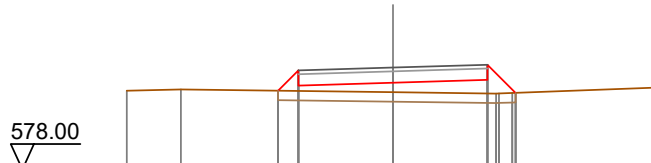

Quote Terreno	-580.08	-580.12	-580.04	-580.01	-580.02	-580.18
Quote Progetto		580.08 580.22	580.29	580.37 580.02		
Parziali		0.54	2.50	2.50	0.75	
Progressiva		-3.04 -2.50	0.00	2.50 3.25		
Dislivelli		0.00 0.54	0.25	0.36 0.00		

Sezione: 11
 Progressiva: 90.000
 Q. Progetto: 580.694

579.00

Quote Terreno	-580.08	-580.12		580.04	580.01	580.02	-580.18
Quote Progetto			580.08	580.29	580.37	580.02	
Parziali			0.54	2.50	2.50	0.75	
Progressiva			-3.04	-2.50	0.00	2.50	3.25
Dislivelli			0.00	0.54	0.25	0.36	0.00

Sezione: 12
 Progressiva: 96.903
 Q. Progetto: 580.495

579.00

Quote Terreno	-580.00	-580.00		580.00	580.00	580.00	-580.00
Quote Progetto			580.00	580.10	580.17	580.00	
Parziali			0.42	2.50	2.50	0.57	
Progressiva			-2.92	-2.50	0.00	2.50	3.07
Dislivelli			0.00	0.42	0.10	0.17	0.00

Sezione: 13
 Progressiva: 100.000
 Q. Progetto: 580.437

578.00

Quote Terreno	-580.00	-580.00		580.00	580.00	580.00	-580.00
Quote Progetto			580.00	580.04	579.97	580.00	
Parziali			0.37	2.50	2.50	0.37	
Progressiva			-2.87	-2.50	0.00	2.50	2.87
Dislivelli			0.00	0.37	0.04	-0.03	0.00

Sezione: 14
 Progressiva: 105.287
 Q. Progetto: 580.382

578.00

Quote Terreno		-579.99	-579.99	-579.99	-579.99	-579.99	-580.00
Quote Progetto				579.99	579.92	579.98	580.04
Parziali				0.33	2.50	2.50	0.46
Progressiva				-2.83	-2.50	0.00	2.50
Dislivelli				0.00	0.33	-0.01	0.06

Sezione: 15
 Progressiva: 110.000
 Q. Progetto: 580.371

578.00

Quote Terreno		579.97	579.97	-579.98	-579.98	-579.98	-579.99	-579.98
Quote Progetto				579.98	579.91	579.97	580.03	579.98
Parziali				0.33	2.50	2.50	0.45	
Progressiva				-2.83	-2.50	0.00	2.50	2.96
Dislivelli				-0.00	0.33	-0.01	0.05	0.00

Sezione: 16
 Progressiva: 110.699
 Q. Progetto: 580.368

578.00

Quote Terreno		-579.97	-579.97	-579.98	-579.98	-579.98	-579.98	-579.98
Quote Progetto				579.97	579.91	579.97	580.03	579.98
Parziali				0.33	2.50	2.50	0.45	
Progressiva				-2.83	-2.50	0.00	2.50	2.95
Dislivelli				0.00	0.33	-0.01	0.05	0.00

Sezione: 17
 Progressiva: 116.110
 Q. Progetto: 580.334

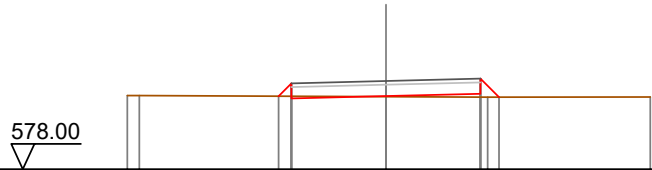

Quote Terreno	579.95	579.95		579.92	579.91	579.91
Quote Progetto			579.93	579.93	580.00	579.91
Parziali			0.34	2.50	2.50	0.49
Progressiva			-2.84	-2.50	0.00	2.50
Dislivelli			0.00	0.34	0.02	0.09

Sezione: 18
 Progressiva: 120.000
 Q. Progetto: 580.290

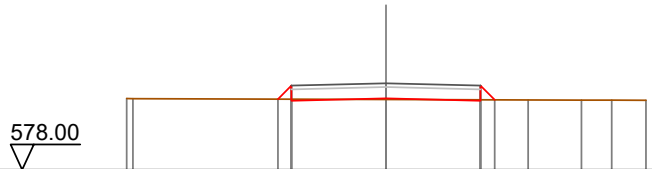

Quote Terreno	579.88	579.88		579.86		579.85	579.84	579.84	579.84
Quote Progetto			579.87	579.89	579.83	579.85			
Parziali			0.36	2.50	2.50	0.38			
Progressiva			-2.86	-2.50	0.00	2.50	2.88		
Dislivelli			0.00	0.36	0.03	-0.03	-0.00		

Sezione: 19
 Progressiva: 140.000
 Q. Progetto: 579.814



Quote Terreno	579.43	579.43	579.41		579.32	579.31		579.26	579.25
Quote Progetto			579.37	579.41	579.35	579.35	579.29		
Parziali			0.39	2.50	2.50	0.46			
Progressiva			-2.89	-2.50	0.00	2.50	2.96		
Dislivelli			0.00	0.39	0.09	0.06	0.00		

Sezione: 20
 Progressiva: 160.000
 Q. Progetto: 578.976



Quote Terreno	-578.71	-578.65		-578.56	-578.54		-578.43	-578.37
Quote Progetto			578.60	578.51	578.58		578.51	578.46
Parziali			0.31	2.50	2.50		0.45	
Progressiva			-2.81	-2.50	0.00		2.50	2.95
Dislivelli			0.00	0.32	0.04		0.04	0.00

Sezione: 21
 Progressiva: 169.211
 Q. Progetto: 578.498

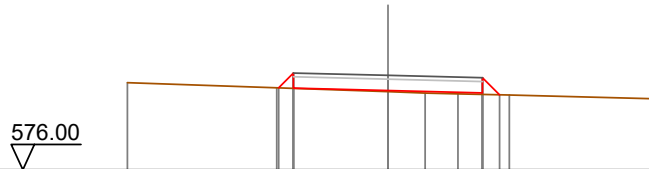

Quote Terreno	-578.31	-578.17		-578.07	-578.03	-578.01	-577.98	-577.88
Quote Progetto		578.17	578.16	578.10		578.04	577.98	
Parziali		0.39	2.50	2.50		0.45		
Progressiva		-2.89	-2.50	0.00		2.50	2.95	
Dislivelli		0.00	0.41	0.03		0.04	0.00	

Sezione: 22
 Progressiva: 170.000
 Q. Progetto: 578.449

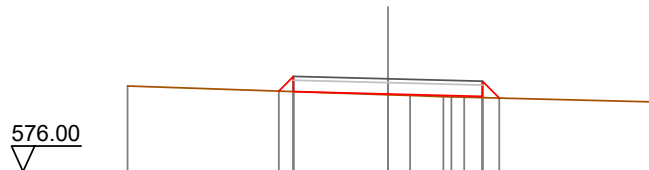

Quote Terreno	-578.26			-578.03	-578.01	-577.98	-577.97	-577.84
Quote Progetto		578.13	578.11	578.05		577.99	577.94	
Parziali		0.39	2.50	2.50		0.44		
Progressiva		-2.89	-2.50	0.00		2.50	2.94	
Dislivelli		-0.00	0.40	0.02		0.03	0.00	

Sezione: 23
 Progressiva: 171.621
 Q. Progetto: 578.345

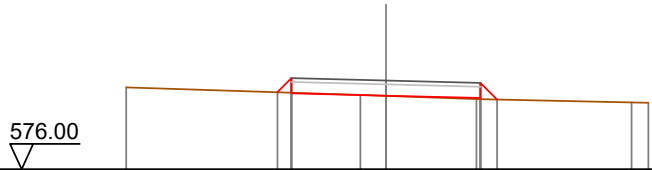

Quote Terreno	-578.17		-577.97	-577.94	-577.85	-577.77	-577.76
Quote Progetto		578.04	578.01	577.94	577.88	577.84	
Parziali		0.37	2.50	2.50	0.44		
Progressiva		-2.87	-2.50	0.00	2.50	2.94	
Dislivelli		0.00	0.38	0.00	0.03	0.00	

Sezione: 24
 Progressiva: 174.031
 Q. Progetto: 578.180

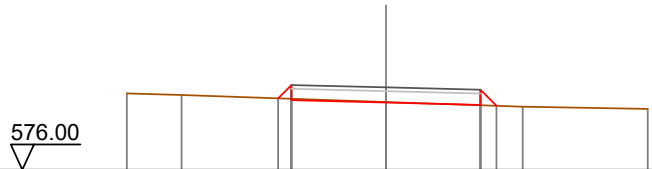

Quote Terreno	-578.02	-577.98		-577.79		-577.67	-577.61
Quote Progetto			577.89	577.78	577.72	577.69	
Parziali			0.35	2.50	2.50	0.42	
Progressiva			-2.85	-2.50	0.00	2.50	2.92
Dislivelli			0.00	0.36	-0.01	0.01	0.00

Sezione: 25
 Progressiva: 180.000
 Q. Progetto: 577.722

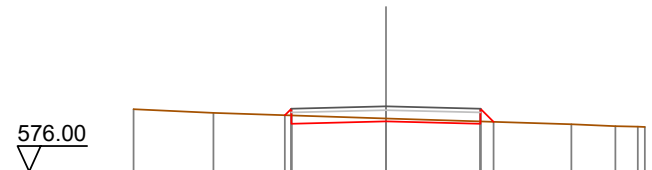

Quote Terreno	-577.65	-577.55		-577.40		-577.25	-577.20	-577.18
Quote Progetto			577.49	577.32	577.26	577.31		
Parziali				2.50	2.50	0.35		
Progressiva			-2.67	-2.50	0.00	2.50	2.85	
Dislivelli			-0.00	0.18	-0.08	-0.06	-0.00	

Sezione: 26
 Progressiva: 200.000
 Q. Progetto: 575.822

574.00

Quote Terreno	-575.99	-575.90		-575.55	-575.53		-575.27	-575.24
Quote Progetto			575.69	575.36	575.42	575.36	575.40	
Parziali			2.50	2.50	0.36			
Progressiva			-2.57	-2.50	0.00	2.50	2.86	
Dislivelli			-0.00	0.07	-0.11	-0.06	0.00	

Sezione: 27
 Progressiva: 216.860
 Q. Progetto: 574.172

571.00

Quote Terreno	-573.55		-573.03	-572.91	-572.64	-572.32
Quote Progetto		573.21	573.83	573.77	573.71	572.57
Parziali		1.02	2.50	2.50	1.54	
Progressiva		-3.52	-2.50	0.00	2.50	4.04
Dislivelli		0.00	1.11	0.86	1.02	0.00

Sezione: 28
 Progressiva: 220.000
 Q. Progetto: 573.865

570.00

Quote Terreno	-572.90	-572.69	-572.61		-572.24		-571.91	-571.72	-571.73
Quote Progetto			572.54	573.53	573.46	573.40	571.91		
Parziali			1.39	2.50	2.50	1.90			
Progressiva			-3.89	-2.50	0.00	2.50	4.40		
Dislivelli			0.00	1.49	1.22	1.35	0.00		

Sezione: 29
 Progressiva: 226.233
 Q. Progetto: 573.290

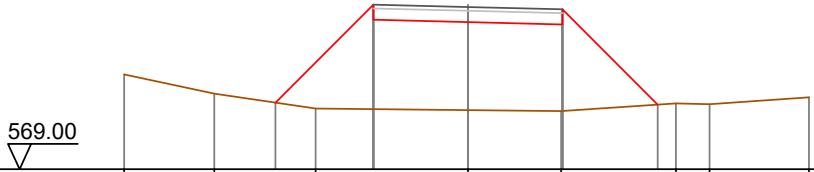

Quote Terreno	-571.50	-571.00	-570.60	-570.56	-570.54	-570.74	-570.72	-570.90
Quote Progetto			570.76	572.95	572.89	572.83	570.71	
Parziali			2.59	2.50	2.50	2.52		
Progressiva			-5.09	-2.50	0.00	2.50	5.02	
Dislivelli			0.00	2.77	2.33	2.29	0.00	

Sezione: 30
 Progressiva: 230.000
 Q. Progetto: 572.981

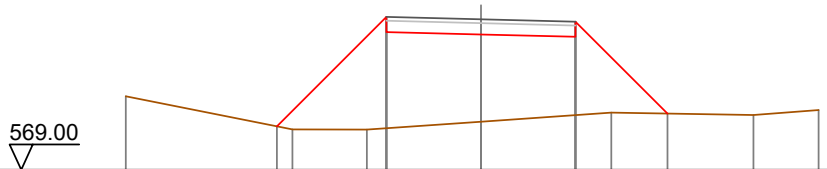

Quote Terreno	-570.95	-570.07	-570.06	-570.27	-570.51	-570.45	-570.58
Quote Progetto		570.15	572.64	572.58	572.52	570.49	
Parziali		2.89	2.50	2.50	2.43		
Progressiva		-5.39	-2.50	0.00	2.50	4.93	
Dislivelli		0.00	2.94	2.31	2.07	0.00	

Sezione: 31
 Progressiva: 235.607
 Q. Progetto: 572.573

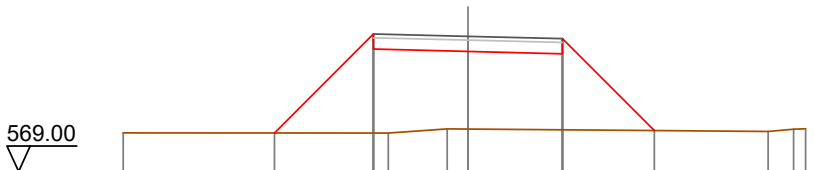

Quote Terreno	-570.02	-570.02	-570.01	-570.13	-570.12	-570.06	-570.12	-570.13
Quote Progetto		570.02	572.24	572.17	572.11	570.08		
Parziali		2.62	2.50	2.50	2.43			
Progressiva		-5.12	-2.50	0.00	2.50	4.93		
Dislivelli		0.00	2.62	2.05	2.01	-0.00		

Sezione: 32
 Progressiva: 240.000
 Q. Progetto: 572.298

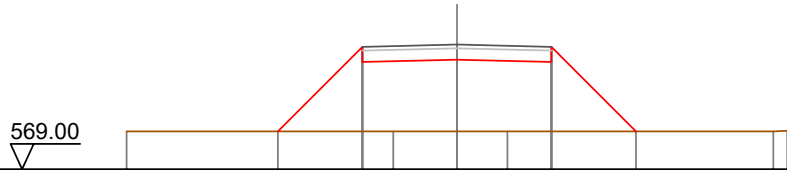

Quote Terreno	570.00	570.00	570.00	570.00	570.00	570.00	570.00
Quote Progetto		570.00	571.84	571.90	571.84	570.00	
Parziali			2.24	2.50	2.50	2.24	
Progressiva			-4.74	-2.50	0.00	2.50	4.74
Dislivelli			0.00	2.24	1.90	1.84	0.00

Sezione: 33
 Progressiva: 260.000
 Q. Progetto: 571.472

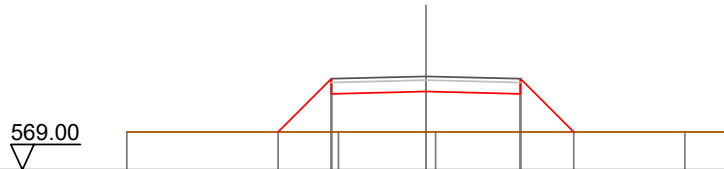

Quote Terreno	570.00	570.00	570.00	570.00	570.00	570.00	570.00
Quote Progetto		570.00	571.01	571.07	571.01	570.00	
Parziali			1.41	2.50	2.50	1.41	
Progressiva			-3.91	-2.50	0.00	2.50	3.91
Dislivelli			0.00	1.41	1.07	1.01	0.00

Sezione: 34
 Progressiva: 271.924
 Q. Progetto: 571.066

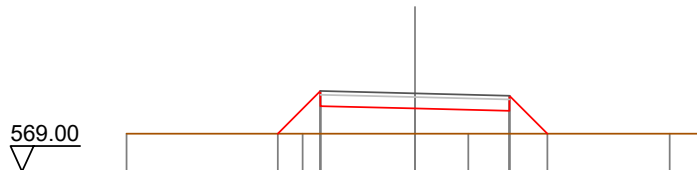

Quote Terreno	570.00	570.00	570.00	570.00	570.00	570.00	570.00
Quote Progetto		570.00	570.73	570.67	570.60	570.00	
Parziali			1.13	2.50	2.50	1.00	
Progressiva			-3.63	-2.50	0.00	2.50	3.50
Dislivelli			0.00	1.13	0.67	0.60	0.00

Sezione: 35
 Progressiva: 276.621
 Q. Progetto: 570.906

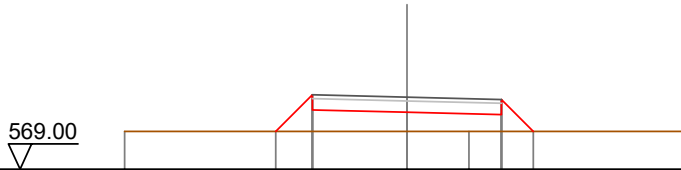

Quote Terreno	570.00			570.00	570.00	570.00
Quote Progetto		570.00	570.57	570.51	570.44	570.00
Parziali		0.97	2.50	2.50	0.84	
Progressiva		-3.47	-2.50	0.00	2.50	3.34
Dislivelli		0.00	0.97	0.51	0.44	0.00

Sezione: 36
 Progressiva: 280.000
 Q. Progetto: 570.791

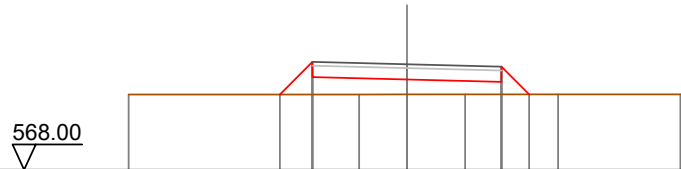

Quote Terreno	569.99			569.99	569.99	570.00	570.00
Quote Progetto		569.99	570.45	570.39	570.33	570.00	
Parziali		0.86	2.50	2.50	0.73		
Progressiva		-3.36	-2.50	0.00	2.50	3.23	
Dislivelli		0.00	0.86	0.40	0.33	-0.00	

Sezione: 37
 Progressiva: 281.317
 Q. Progetto: 570.746

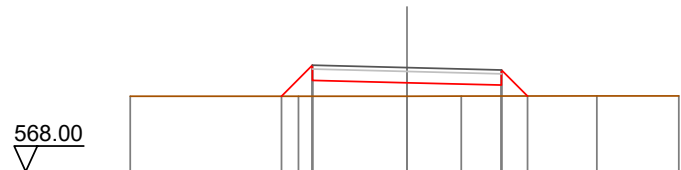

Quote Terreno	569.99			569.99	569.99	570.00	570.00
Quote Progetto		569.99	570.41	570.35	570.28	569.99	
Parziali		0.82	2.50	2.50	0.69		
Progressiva		-3.32	-2.50	0.00	2.50	3.19	
Dislivelli		0.00	0.82	0.35	0.29	0.00	

Sezione: 38
 Progressiva: 300.000
 Q. Progetto: 570.109

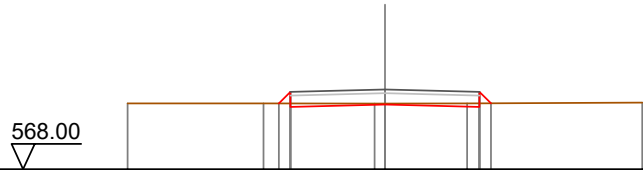

Quote Terreno	569.74	569.74	569.74	569.74	569.74	569.76
Quote Progetto		569.74 569.65	569.71	569.65 569.74		
Parziali		0.31 2.50	2.50	0.30		
Progressiva		-2.81 -2.50	0.00	2.50 2.80		
Dislivelli		-0.00 0.31	-0.03	-0.10 0.00		

Sezione: 39
 Progressiva: 306.818
 Q. Progetto: 569.901

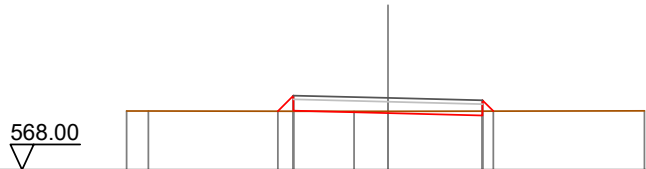

Quote Terreno	569.56	569.56	569.55	569.55	569.56	
Quote Progetto		569.55 569.56	569.50	569.44 569.55		
Parziali		0.41 2.50	2.50	0.28		
Progressiva		-2.91 -2.50	0.00	2.50 2.78		
Dislivelli		-0.00 0.41	-0.05	-0.11 0.00		

Sezione: 40
 Progressiva: 310.000
 Q. Progetto: 569.809

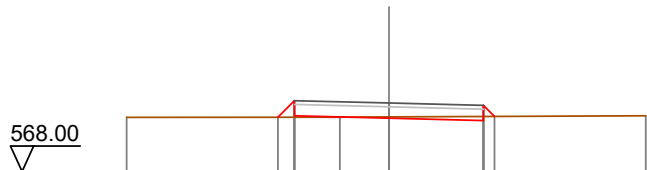

Quote Terreno	569.43	569.43	569.44	569.44	569.47	
Quote Progetto		569.43 569.47	569.41	569.35 569.45		
Parziali		0.44 2.50	2.50	0.28		
Progressiva		-2.94 -2.50	0.00	2.50 2.79		
Dislivelli		0.00 0.44	-0.03	-0.11 0.00		

Sezione: 41
 Progressiva: 317.021
 Q. Progetto: 569.600

568.00

Quote Terreno	-569.15	-569.17	-569.17	-569.18	-569.19	-569.24
Quote Progetto		-569.17	-569.26	-569.18	-569.20	-569.14
Parziali		0.49	2.50	2.50	0.32	
Progressiva		-2.99	-2.50	0.00	2.50	2.82
Dislivelli		-0.00	0.49	0.01	-0.07	0.00

Sezione: 42
 Progressiva: 320.000
 Q. Progetto: 569.501

568.00

Quote Terreno	-569.01	-569.03	-569.05	-569.07	-569.14	-569.15
Quote Progetto		-569.04	-569.16	-569.10	-569.04	-569.10
Parziali		0.53	2.50	2.50	0.34	
Progressiva		-3.03	-2.50	0.00	2.50	2.84
Dislivelli		0.00	0.52	0.04	-0.06	0.00

Sezione: 43
 Progressiva: 327.223
 Q. Progetto: 569.236

567.00

Quote Terreno	-568.66	-568.73	-568.74	-568.77	-568.79	-568.83	-568.89
Quote Progetto		-568.90	-568.74	-568.84	-568.77	-568.81	
Parziali		0.57	2.50	2.50	0.36		
Progressiva		-3.07	-2.50	0.00	2.50	2.86	
Dislivelli		0.00	0.56	0.07	-0.03	0.00	

Sezione: 44
 Progressiva: 340.000
 Q. Progetto: 568.673

567.00

Quote Terreno	-568.06	-568.11	-568.18	-568.18	-568.31
Quote Progetto		568.11 568.21	568.27	568.21 568.23	
Parziali		0.50	2.50	2.50	0.38
Progressiva		-3.00 -2.50	0.00	2.50 2.88	
Dislivelli		0.00 0.49	0.10	-0.02 -0.00	

Sezione: 45
 Progressiva: 360.000
 Q. Progetto: 567.552

565.00

Quote Terreno	-566.89	-566.93	-566.95	-566.97	-567.03	-567.12	-567.20
Quote Progetto			566.96 567.09	567.15	567.09 567.10		
Parziali			0.53	2.50	2.50	0.39	
Progressiva			-3.03 -2.50	0.00	2.50 2.89		
Dislivelli			0.00 0.51	0.12	0.00 0.00		

Sezione: 46
 Progressiva: 364.118
 Q. Progetto: 567.286

565.00

Quote Terreno	-566.61	-566.65	-566.70	-566.78	-566.84	-566.90	-566.93	-566.96
Quote Progetto			566.70 566.82	566.89	566.95 566.85			
Parziali			0.52	2.50	2.50	0.50		
Progressiva			-3.02 -2.50	0.00	2.50 3.00			
Dislivelli			0.00 0.51	0.11	0.11 0.00			

Sezione: 47
 Progressiva: 366.490
 Q. Progetto: 567.126

565.00

Quote Terreno	-566.48	-566.49		566.62	566.68	566.73	566.75	566.79
Quote Progetto			566.56	566.66	566.73	566.79	566.89	
Parziali			0.50	2.50	2.50	0.50		
Progressiva			-3.00	-2.50	0.00	2.50	3.00	
Dislivelli			0.00	0.49	0.10	0.11	0.00	

Sezione: 48
 Progressiva: 368.863
 Q. Progetto: 566.963

565.00

Quote Terreno	-566.34	-566.40		566.46	566.52	566.59	566.60
Quote Progetto			566.41	566.50	566.56	566.63	566.51
Parziali			0.49	2.50	2.50	0.52	
Progressiva			-2.99	-2.50	0.00	2.50	3.02
Dislivelli			0.00	0.48	0.10	0.12	0.00

Sezione: 49
 Progressiva: 380.000
 Q. Progetto: 566.140

564.00

Quote Terreno	-565.53			565.61	565.63	565.71	565.80
Quote Progetto		565.58	565.68	565.74	565.68	565.70	
Parziali		0.50	2.50	2.50	0.38		
Progressiva		-3.00	-2.50	0.00	2.50	2.88	
Dislivelli		0.00	0.49	0.11	-0.01	-0.00	

Sezione: 50
 Progressiva: 400.000
 Q. Progetto: 564.514

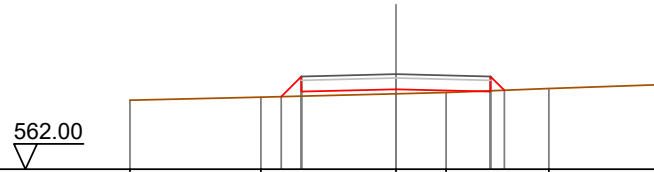

Quote Terreno	-563.82	-563.90	-563.99	-564.03	-564.13	-564.23
Quote Progetto		563.92 564.05	564.11	564.05 564.09		
Parziali		0.53	2.50	2.50	0.37	
Progressiva		-3.03	-2.50	0.00	2.50	2.87
Dislivelli		-0.00	0.52	0.12	-0.02	0.00

Sezione: 51
 Progressiva: 420.000
 Q. Progetto: 563.094

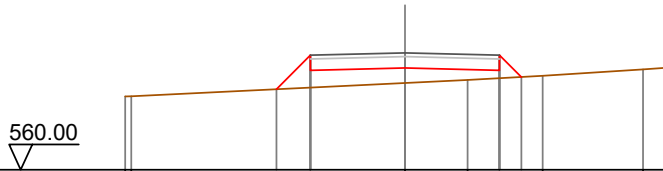

Quote Terreno	-561.94 -561.95		-562.30	-562.37	-562.49	-562.66 -562.71
Quote Progetto		562.13 562.63	562.69	562.63 562.45		
Parziali		0.90	2.50	2.50	0.58	
Progressiva		-3.40	-2.50	0.00	2.50	3.08
Dislivelli		0.00	0.86	0.40	0.21	0.00

Sezione: 52
 Progressiva: 420.963
 Q. Progetto: 563.032

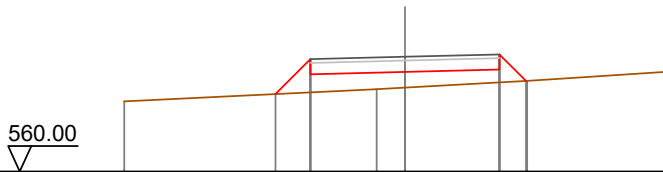

Quote Terreno	-561.85		-562.17 -562.22	-562.40	-562.65	
Quote Progetto		562.05 562.57	562.63	562.69 562.39		
Parziali		0.92	2.50	2.50	0.70	
Progressiva		-3.42	-2.50	0.00	2.50	3.20
Dislivelli		0.00	0.88	0.42	0.34	0.00

Sezione: 53
 Progressiva: 421.775
 Q. Progetto: 562.981

560.00

Quote Terreno	-561.79		562.02	562.16	562.32	562.59
Quote Progetto		561.98	562.52	562.58	562.64	562.34
Parziali			0.94	2.50	2.50	0.71
Progressiva			-3.44	-2.50	0.00	2.50
Dislivelli			0.00	0.89	0.42	0.35
						0.00

Sezione: 54
 Progressiva: 422.587
 Q. Progetto: 562.930

560.00

Quote Terreno	-561.73	-561.87		562.10	562.24	562.53
Quote Progetto			561.92	562.47	562.59	562.28
Parziali			0.95	2.50	2.50	0.71
Progressiva			-3.45	-2.50	0.00	2.50
Dislivelli			0.00	0.90	0.43	0.36
						-0.00

Sezione: 55
 Progressiva: 440.000
 Q. Progetto: 561.954

559.00

Quote Terreno	-560.52	-560.63		560.96	561.18	561.37	561.44	561.49
Quote Progetto			560.67	561.49	561.55	561.49	561.20	
Parziali			1.22	2.50	2.50	0.69		
Progressiva			-3.72	-2.50	0.00	2.50	3.19	
Dislivelli			0.00	1.13	0.60	0.35	0.00	

Sezione: 56
 Progressiva: 460.000
 Q. Progetto: 561.095

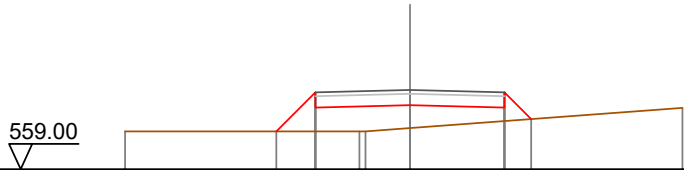

Quote Terreno	-560.00		560.00	560.63	560.00	560.00	560.09		560.62
Quote Progetto			560.00	560.63			560.69		560.63
Parziali			1.03	2.50			2.50		0.71
Progressiva			-3.53	-2.50			0.00		2.50
Dislivelli			0.00	1.03			0.61		0.36

Sezione: 57
 Progressiva: 480.000
 Q. Progetto: 560.515

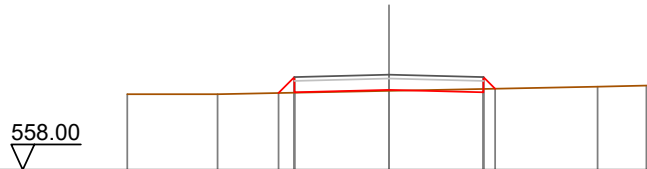

Quote Terreno	-560.00	-560.00			560.09			-560.20	-560.23
Quote Progetto			560.03	560.05	560.11		560.05	560.14	
Parziali			0.42	2.50	2.50		0.31		
Progressiva			-2.92	-2.50	0.00		2.50	2.81	
Dislivelli			0.00	0.41	0.03		-0.09	0.00	

Sezione: 58
 Progressiva: 500.000
 Q. Progetto: 560.071

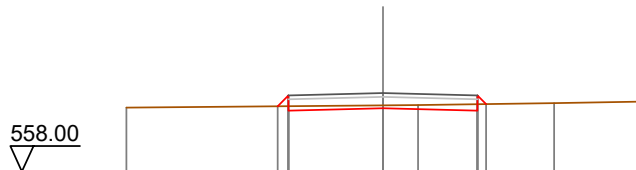

Quote Terreno	-559.69				559.75	559.76		559.81	559.84
Quote Progetto		559.72	559.61		559.67		559.61	559.78	
Parziali		0.28	2.50		2.50				
Progressiva		-2.78	-2.50		0.00		2.50	2.73	
Dislivelli		-0.00	0.28		-0.08		-0.17	0.00	

Sezione: 59
 Progressiva: 508.839
 Q. Progetto: 559.682

558.00

Quote Terreno	-559.27		559.32	-559.33		-559.40	-559.48
Quote Progetto		559.30	559.28	559.22	559.36		
Parziali		0.44	2.50	2.50			
Progressiva		-2.94	-2.50	0.00	2.50	2.76	
Dislivelli		-0.00	0.44	-0.04	-0.14	0.00	

Sezione: 60
 Progressiva: 510.000
 Q. Progetto: 559.620

558.00

Quote Terreno	-559.18		559.25	-559.26		-559.34	-559.41
Quote Progetto		559.22	559.28	559.16	559.29		
Parziali		0.46	2.50	2.50			
Progressiva		-2.96	-2.50	0.00	2.50	2.76	
Dislivelli		0.00	0.46	-0.03	-0.13	0.00	

Sezione: 61
 Progressiva: 520.000
 Q. Progetto: 559.085

557.00

Quote Terreno	-558.42	-558.42	-558.46		558.63	558.72	-558.84
Quote Progetto			558.52	558.75	558.69	558.62	
Parziali			0.62	2.50	2.50	0.30	
Progressiva			-3.12	-2.50	0.00	2.50	2.80
Dislivelli			0.00	0.60	0.06	-0.09	0.00

Sezione: 62
 Progressiva: 529.744
 Q. Progetto: 558.513

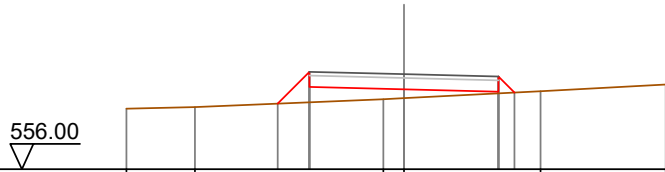

Quote Terreno	-557.60	-557.64		-557.85	-557.88		-558.06	-558.24
Quote Progetto			557.73	558.18	558.11	558.05	558.03	
Parziali			0.84	2.50	2.50	0.42		
Progressiva			-3.34	-2.50	0.00	2.50	2.92	
Dislivelli			0.00	0.81	0.23	0.04	0.00	

Sezione: 63
 Progressiva: 530.000
 Q. Progetto: 558.499

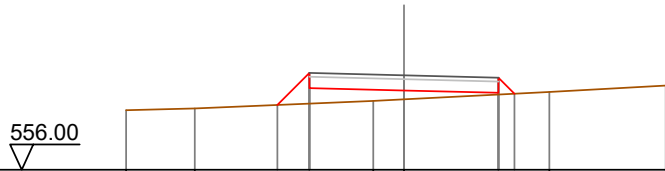

Quote Terreno	-557.58	-557.62		-557.82	-557.86		-558.06	-558.23
Quote Progetto			557.71	558.16	558.10	558.04	558.01	
Parziali			0.85	2.50	2.50	0.42		
Progressiva			-3.35	-2.50	0.00	2.50	2.92	
Dislivelli			0.00	0.81	0.24	0.05	-0.00	

Sezione: 64
 Progressiva: 540.000
 Q. Progetto: 558.017

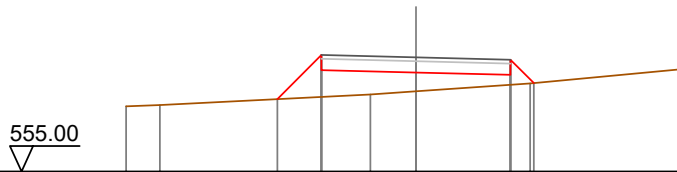

Quote Terreno	-556.72	-556.76		-557.04	-557.12		-557.33	-557.71
Quote Progetto			556.91	557.68	557.62	557.55	557.34	
Parziali			1.17	2.50	2.50	0.62		
Progressiva			-3.67	-2.50	0.00	2.50	3.12	
Dislivelli			0.00	1.11	0.50	0.26	0.00	

Sezione: 65
 Progressiva: 550.000
 Q. Progetto: 557.678

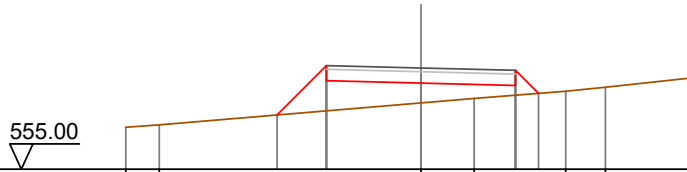

Quote Terreno	-556.11	-556.17				556.75	-556.87		557.06	-557.17	-557.41
Quote Progetto			556.43	557.34		557.28		557.22	557.01		
Parziali			1.31	2.50		2.50		0.61			
Progressiva			-3.81	-2.50		0.00		2.50	3.11		
Dislivelli			-0.00	1.20		0.52		0.26	0.00		

Sezione: 65
 Progressiva: 550.000
 Q. Progetto: 557.678

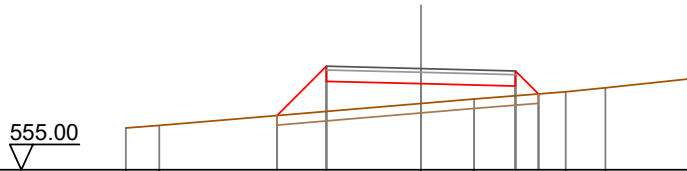

Quote Terreno	-556.11	-556.17				556.75	-556.87		557.06	-557.17	-557.41
Quote Progetto			556.43	557.34		557.28		557.22	557.01		
Parziali			1.31	2.50		2.50		0.61			
Progressiva			-3.81	-2.50		0.00		2.50	3.11		
Dislivelli			0.00	1.20		0.52		0.26	0.00		

Sezione: 66
 Progressiva: 550.649
 Q. Progetto: 557.661

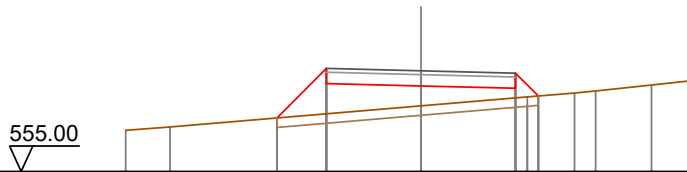

Quote Terreno	-556.09	-556.18				556.74	-556.97	-557.07	-557.13	-557.29	-557.40
Quote Progetto			556.41	557.32		557.26	557.20	557.00			
Parziali			1.31	2.50		2.50	0.60				
Progressiva			-3.81	-2.50		0.00	2.50	3.10			
Dislivelli			-0.00	1.20		0.53	0.25	0.00			

Sezione: 67
 Progressiva: 552.802
 Q. Progetto: 557.609

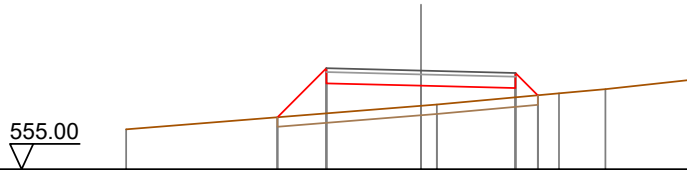

Quote Terreno	-556.06			556.68	556.71		557.01	557.12	557.36
Quote Progetto		556.37	557.27	557.21		557.15	556.95		
Parziali			1.30	2.50	2.50	0.59			
Progressiva		-3.80	-2.50	0.00		2.50	3.09		
Dislivelli		0.00	1.19	0.53		0.25	0.00		

Sezione: 68
 Progressiva: 560.000
 Q. Progetto: 557.482

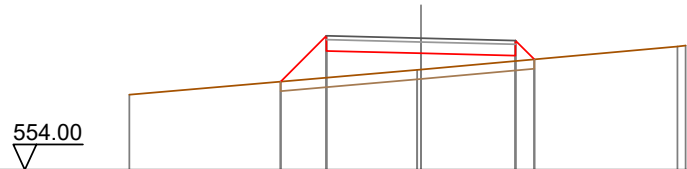

Quote Terreno	-555.99			556.64	556.65			557.26	557.29
Quote Progetto		556.33	557.14	557.08		557.02	556.92		
Parziali			1.21	2.50	2.50	0.50			
Progressiva		-3.71	-2.50	0.00		2.50	3.00		
Dislivelli		0.00	1.11	0.43		0.14	0.00		

Sezione: 69
 Progressiva: 567.074
 Q. Progetto: 557.430

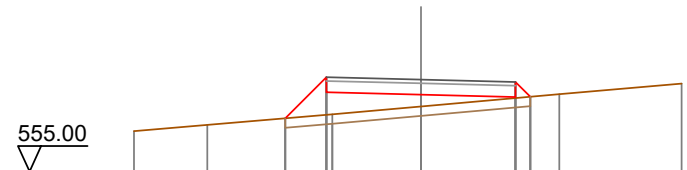

Quote Terreno	-556.06	-556.23		556.51	556.72		557.04	557.32
Quote Progetto			556.41	557.09	557.03		556.97	556.98
Parziali			1.09	2.50	2.50	0.39		
Progressiva			-3.59	-2.50	0.00		2.50	2.89
Dislivelli			-0.00	1.00	0.31		0.03	0.00

Sezione: 70
 Progressiva: 570.000
 Q. Progetto: 557.429

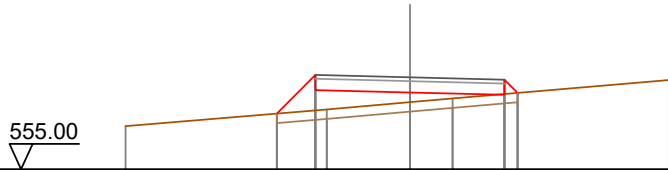

Quote Terreno	556.14		556.58	556.77	556.87	557.36
Quote Progetto		556.47	557.09	557.03	556.97	557.02
Parziali		1.02	2.50	2.50	0.35	
Progressiva		-3.52	-2.50	0.00	2.50	2.85
Dislivelli		0.00	0.94	0.26	-0.02	0.00

Sezione: 71
 Progressiva: 580.000
 Q. Progetto: 557.519

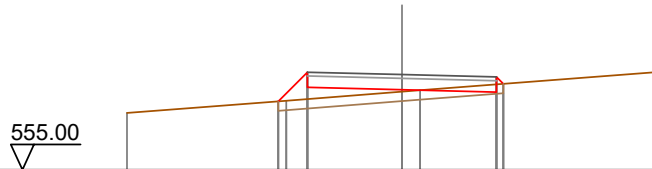

Quote Terreno	556.51		556.82	557.07	557.11	557.58
Quote Progetto		556.81	557.18	557.12	557.06	557.27
Parziali		0.77	2.50	2.50		
Progressiva		-3.27	-2.50	0.00	2.50	2.68
Dislivelli		0.00	0.71	0.05	-0.20	0.00

Sezione: 72
 Progressiva: 581.347
 Q. Progetto: 557.542

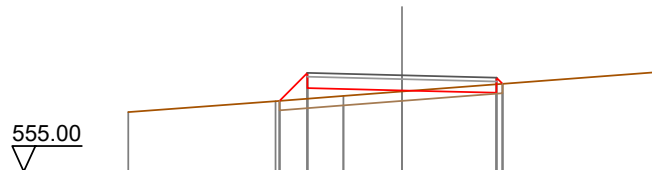

Quote Terreno	556.57		556.86	557.00	557.12	557.62
Quote Progetto		556.87	557.20	557.14	557.08	557.32
Parziali		0.74	2.50	2.50		
Progressiva		-3.24	-2.50	0.00	2.50	2.66
Dislivelli		0.00	0.68	0.03	-0.23	-0.00

Sezione: 73
 Progressiva: 600.000
 Q. Progetto: 558.092

556.00

Quote Terreno	-557.36	-557.54	-557.64	-557.63	-557.84	-558.04	-558.29
Quote Progetto			557.64	557.63	557.69	557.63	
Parziali			0.39	2.50	2.50		
Progressiva			-2.89	-2.50	0.00	2.50	
Dislivelli			-0.00	0.36	-0.15	-0.38	

Sezione: 74
 Progressiva: 620.000
 Q. Progetto: 558.782

557.00

Quote Terreno	-558.20	-558.33	-558.46	-558.32	-558.55	-558.63	-558.88	-559.04
Quote Progetto			558.46	558.32	558.38	558.32	558.80	
Parziali			0.26	2.50	2.50			
Progressiva			-2.76	-2.50	0.00	2.50	2.58	
Dislivelli			-0.00	0.25	-0.25	-0.47	0.00	

Sezione: 75
 Progressiva: 640.000
 Q. Progetto: 559.480

558.00

Quote Terreno	-559.13	-559.19	-559.32	-559.02	-559.44	-559.45	-559.70	-559.77
Quote Progetto			559.32	559.02	559.08	559.02	559.59	
Parziali			0.19	2.50	2.50			
Progressiva			-2.59	-2.50	0.00	2.50	2.67	
Dislivelli			-0.00	0.09	-0.37	-0.56	0.00	

Sezione: 76
 Progressiva: 650.116
 Q. Progetto: 559.980

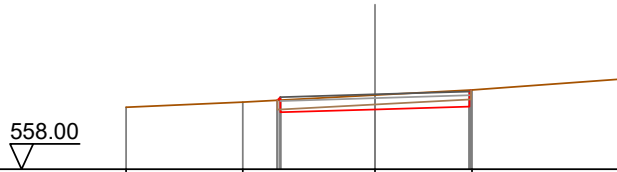

Quote Terreno	-559.64	-559.78	-559.96	-560.10	-560.38	-560.38
Quote Progetto		559.82	559.51	559.58	559.66	560.10
Parziali			2.50	2.50		
Progressiva		-2.58	-2.50	0.00	2.50	2.54
Dislivelli		0.00	0.08	-0.38	-0.44	0.00

Sezione: 77
 Progressiva: 653.610
 Q. Progetto: 560.197

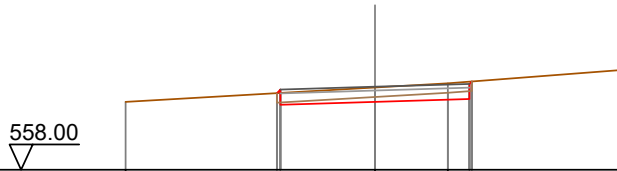

Quote Terreno	-559.80	-560.03	-560.18	-560.29	-560.64	
Quote Progetto		560.03	559.72	559.87	560.34	
Parziali			2.50	2.50		
Progressiva		-2.59	-2.50	0.00	2.50	2.56
Dislivelli		-0.00	0.09	-0.38	-0.46	0.00

Sezione: 78
 Progressiva: 657.104
 Q. Progetto: 560.429

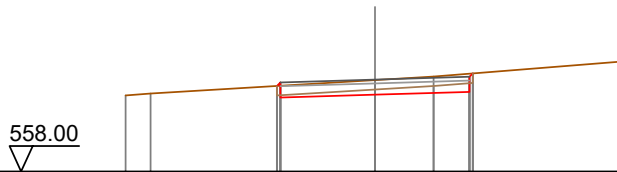

Quote Terreno	-560.01	-560.06	-560.42	-560.51	-560.91	
Quote Progetto		560.26	559.95	560.03	560.10	560.59
Parziali			2.50	2.50		
Progressiva		-2.59	-2.50	0.00	2.50	2.59
Dislivelli		-0.00	0.09	-0.39	-0.48	-0.00

Sezione: 79
 Progressiva: 660.000
 Q. Progetto: 560.622

559.00

Quote Terreno	-560.19	-560.42	-560.63	-560.71	-561.14
Quote Progetto		560.47 560.16	560.22	560.16 560.82	
Parziali			2.50	2.50	0.28
Progressiva		-2.59 -2.50	0.00	2.50 2.76	
Dislivelli		-0.00 0.08	-0.41	-0.64 0.00	

Sezione: 80
 Progressiva: 680.000
 Q. Progetto: 561.953

560.00

Quote Terreno	-561.50	-561.59	-561.95	-562.35	-562.45
Quote Progetto			561.78 561.49	561.49 562.16	
Parziali			2.50	2.50	0.27
Progressiva		-2.61 -2.50	0.00	2.50 2.77	
Dislivelli		-0.00 0.10	-0.40	-0.65 0.00	

Sezione: 81
 Progressiva: 700.000
 Q. Progetto: 563.051

561.00

Quote Terreno	-562.58	-562.62	-562.93	-563.03	-563.31	-563.51
Quote Progetto			562.85 562.59	562.65	562.59 563.23	
Parziali			2.50	2.50		
Progressiva		-2.64 -2.50	0.00	2.50 2.74		
Dislivelli		0.00 0.13	-0.38	-0.62 0.00		

Sezione: 82
 Progressiva: 720.000
 Q. Progetto: 563.829

562.00

Quote Terreno	-563.38	-563.64	-563.83	-564.01	-564.30
Quote Progetto		-563.65 -563.37	-563.43	-563.37 -564.03	
Parziali		2.50	2.50	0.28	
Progressiva		-2.62 -2.50	0.00	2.50 2.76	
Dislivelli		0.00 0.11	-0.40	-0.64 -0.00	

Sezione: 83
 Progressiva: 724.272
 Q. Progetto: 563.936

562.00

Quote Terreno	-563.53	-563.72	-563.76	-563.81	-563.98	-564.44
Quote Progetto		-563.80 -563.47	-563.54	-563.60 -564.16		
Parziali		2.50	2.50	0.00		
Progressiva		-2.58 -2.50	0.00	2.50 2.66		
Dislivelli		0.00 0.07	-0.44	-0.55 0.00		

Sezione: 84
 Progressiva: 730.000
 Q. Progetto: 564.044

562.00

Quote Terreno	-563.65	-563.90	-564.12	-564.26	-564.61
Quote Progetto		-563.94 -563.58	-563.64	-563.71 -564.32	
Parziali		2.50	2.50	0.00	
Progressiva		-2.54 -2.50	0.00	2.50 2.71	
Dislivelli		-0.00 0.04	-0.48	-0.60 -0.00	

Sezione: 85
 Progressiva: 740.000
 Q. Progetto: 564.132

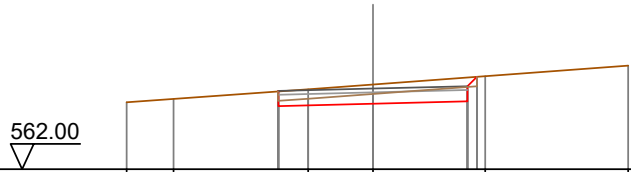

Quote Terreno	-563.77	-563.86	-564.11	-564.24	-564.46	-564.74
Quote Progetto			563.67	563.73	563.79	564.44
Parziali			2.50	2.50		
Progressiva			-2.51	0.00	2.50	2.75
Dislivelli			0.00	-0.51	-0.63	0.00

Sezione: 86
 Progressiva: 748.925
 Q. Progetto: 564.103

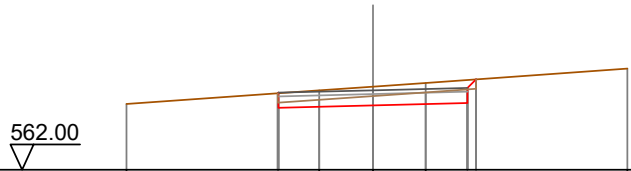

Quote Terreno	-563.74	-564.10	-564.20	-564.30	-564.68
Quote Progetto		563.64	563.70	563.77	564.39
Parziali		2.50	2.50		
Progressiva		-2.52	0.00	2.50	2.73
Dislivelli		0.00	-0.50	-0.61	0.00

Sezione: 87
 Progressiva: 750.000
 Q. Progetto: 564.093

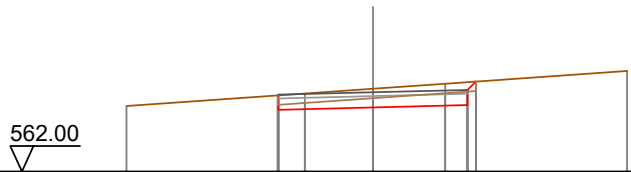

Quote Terreno	-563.73	-564.06	-564.19	-564.32	-564.66
Quote Progetto		563.63	563.69	563.76	564.38
Parziali		2.50	2.50		
Progressiva		-2.52	0.00	2.50	2.72
Dislivelli		0.00	-0.49	-0.61	0.00

Sezione: 88
 Progressiva: 760.000
 Q. Progetto: 563.927

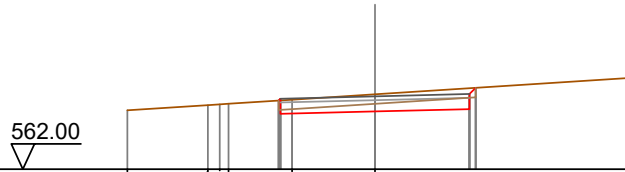

Quote Terreno	-563.56	-563.70	-563.73	-563.84	-563.98	-564.41
Quote Progetto			563.82	563.46	563.53	563.59
Parziali			2.50	2.50		
Progressiva			-2.55	-2.50	0.00	2.50
Dislivelli			0.00	0.05	-0.45	-0.55

Sezione: 89
 Progressiva: 770.000
 Q. Progetto: 563.632

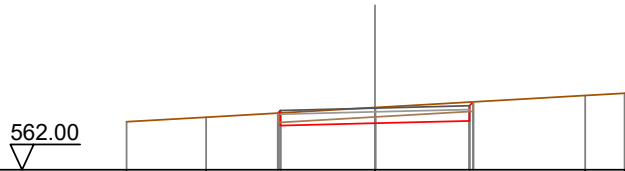

Quote Terreno	-563.27	-563.39	-563.50	-563.65	-563.97	-564.03
Quote Progetto			563.17	563.23	563.29	563.80
Parziali			2.50	2.50		
Progressiva			-2.57	-2.50	0.00	2.50
Dislivelli			0.00	0.07	-0.41	-0.50

Sezione: 90
 Progressiva: 773.578
 Q. Progetto: 563.498

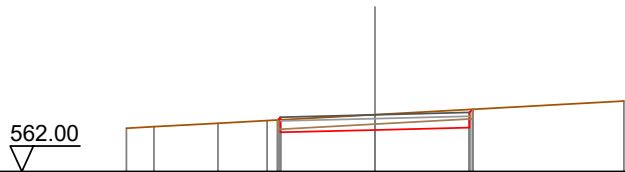

Quote Terreno	-563.14	-563.18	-563.28	-563.35	-563.50	-563.86
Quote Progetto			563.36	563.04	563.10	563.16
Parziali			2.50	2.50		
Progressiva			-2.57	-2.50	0.00	2.50
Dislivelli			0.00	0.07	-0.40	-0.48

Sezione: 91
 Progressiva: 780.000
 Q. Progetto: 563.250

561.00

Quote Terreno	-562.87	-563.06	-563.24	-563.50	-563.61
Quote Progetto		562.79	562.85	563.38	
Parziali		2.50	2.50		
Progressiva		-2.59	0.00	2.50	2.70
Dislivelli		0.00	-0.39	-0.59	-0.00

Sezione: 92
 Progressiva: 800.000
 Q. Progetto: 562.479

561.00

Quote Terreno	-562.08	-562.21	-562.42	-562.46	-562.58	-562.84
Quote Progetto		562.31	562.08	562.02	562.61	
Parziali		2.50	2.50			
Progressiva		-2.61	0.00	2.50	2.70	
Dislivelli		0.00	-0.38	-0.58	-0.00	

Sezione: 93
 Progressiva: 820.000
 Q. Progetto: 561.737

560.00

Quote Terreno	-561.36	-561.46	-561.73	-561.76	-561.90	-562.10	-562.18
Quote Progetto		561.61	561.34	561.27	561.94		
Parziali		2.50	2.50				
Progressiva		-2.57	0.00	2.50	2.77		
Dislivelli		0.00	-0.43	-0.65	-0.00		

Sezione: 94
 Progressiva: 840.000
 Q. Progetto: 561.275

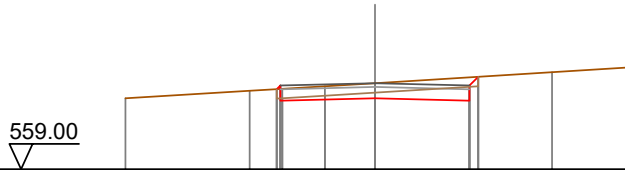

Quote Terreno	-560.88	-561.07	-561.12	-561.19	-561.27	-561.57	-561.69
Quote Progetto		-561.12	-560.81	-560.87	-560.81	-561.44	
Parziali			2.50	2.50			
Progressiva		-2.60	-2.50	0.00	2.50	2.73	
Dislivelli		-0.00	-0.09	-0.40	-0.62	-0.00	

Sezione: 95
 Progressiva: 860.000
 Q. Progetto: 560.438

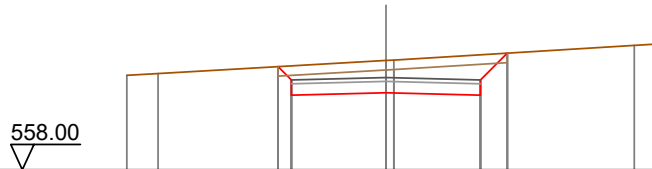

Quote Terreno	-560.50	-560.54	-560.89	-560.90	-561.29	-561.33
Quote Progetto		-560.73	-560.04	-560.98	-561.09	
Parziali		0.35	2.50	2.50	0.71	
Progressiva		-2.85	-2.50	0.00	2.50	3.21
Dislivelli		0.00	-0.37	-0.85	-1.07	0.00

Sezione: 96
 Progressiva: 875.147
 Q. Progetto: 559.429

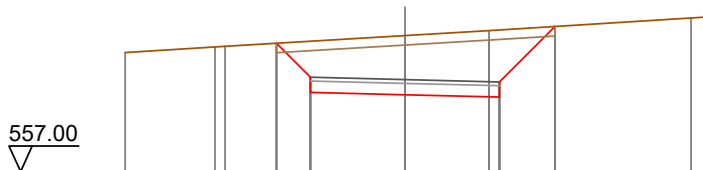

Quote Terreno	-560.15	-560.29	-560.31	-560.59	-560.72	-561.06	-561.08
Quote Progetto		-560.39	-559.09	-559.03	-558.97	-560.83	
Parziali		0.90	2.50	2.50	1.47		
Progressiva		-3.40	-2.50	0.00	2.50	3.97	
Dislivelli		-0.00	-0.95	-1.56	-1.77	-0.00	

Sezione: 97
 Progressiva: 880.000
 Q. Progetto: 559.156

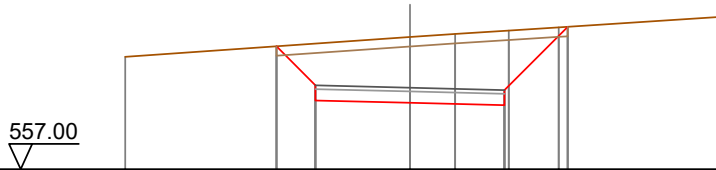

Quote Terreno	-559.97				560.50	560.58	560.66	560.75	-561.02
Quote Progetto			560.25	558.82	558.76		558.69	560.77	
Parziali			1.03	2.50	2.50		1.67		
Progressiva			-3.53	-2.50	0.00		2.50	4.17	
Dislivelli			-0.00	-1.10	-1.74		-1.96	0.00	

Sezione: 98
 Progressiva: 889.232
 Q. Progetto: 558.768

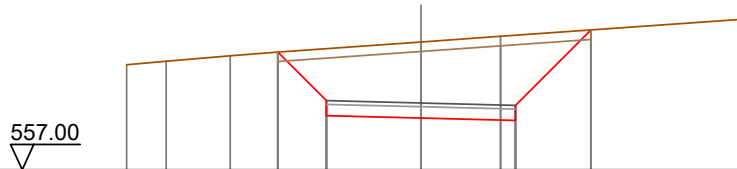

Quote Terreno	-559.78	-559.87	-560.02	560.11		560.38	560.53		-560.98
Quote Progetto				560.11	558.43	558.37	558.31	560.70	
Parziali				1.28	2.50	2.50	1.99		
Progressiva				-3.78	-2.50	0.00	2.50	4.49	
Dislivelli				0.00	-1.37	-2.01	-2.25	-0.00	

Sezione: 99
 Progressiva: 890.000
 Q. Progetto: 558.744

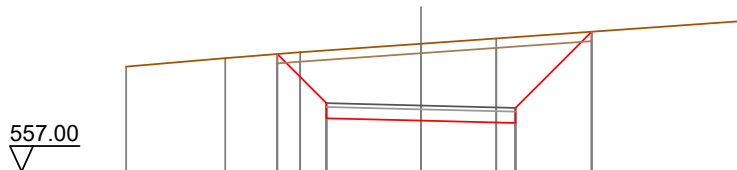

Quote Terreno	-559.77	-560.00	560.15		560.38	560.52			-560.98
Quote Progetto			560.10	558.41	558.34	558.28	560.70		
Parziali			1.30	2.50	2.50	2.02			
Progressiva			-3.80	-2.50	0.00	2.50	4.52		
Dislivelli			0.00	-1.39	-2.03	-2.27	0.00		

Sezione: 100
 Progressiva: 900.000
 Q. Progetto: 558.531

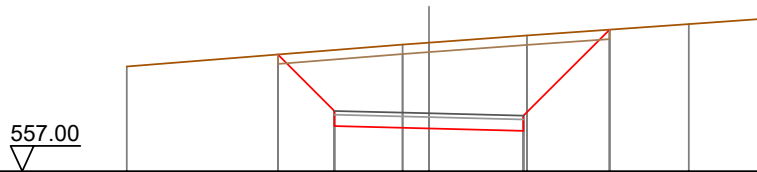

Quote Terreno	559.77			560.35	560.40	560.59		560.89	561.02
Quote Progetto		560.09	558.19	558.13	558.07	560.74			
Parziali		1.49	2.50	2.50	2.28				
Progressiva		-3.99	-2.50	0.00	2.50	4.78			
Dislivelli		0.00	-1.61	-2.27	-2.52	0.00			

Sezione: 101
 Progressiva: 900.500
 Q. Progetto: 558.526

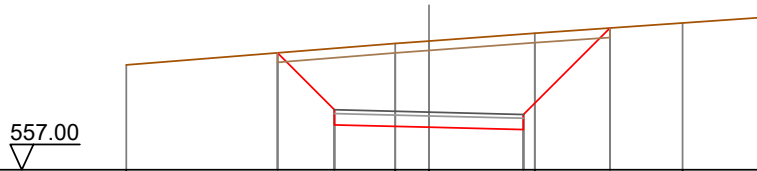

Quote Terreno	559.77			560.34	560.41	560.61		560.88	561.03
Quote Progetto		560.09	558.19	558.13	558.06	560.75			
Parziali		1.50	2.50	2.50	2.29				
Progressiva		-4.00	-2.50	0.00	2.50	4.79			
Dislivelli		0.00	-1.62	-2.28	-2.53	0.00			

SEZIONI TRASVERSALI
Profilo longitudinale tratto 25-26
Viabilità di impianto postazione aerogeneratore T13

Nota: Le canalette di deflusso delle acque meteoriche, non indicate nel presente elaborato, sono rappresentate graficamente nelle sezioni stradali tipo dell'elaborato "WIND002-TC13_Piazzole aerogeneratori e strade di servizio - Particolari costruttivi", individuate planimetricamente nell'elaborato "WIND002-TC14_Opere di regimazione acque superficiali - Planimetria generale" e quantificate nell'elaborato "WIND002-RC6_Computo Metrico Estimativo".

DISEGNI DI RIFERIMENTO

TAVOLA	DESCRIZIONE
WIND002-TC8	Piazzole e viabilità - Planimetria di progetto - Fase di cantiere
WIND002-TC11	Profili longitudinali viabilità di impianto
WIND002-TC13	Piazzole aerogeneratori e strade di servizio - Particolari costruttivi
WIND002-TC14	Opere di regimazione acque superficiali - Planimetria generale

Sezione: 4
 Progressiva: 30.000
 Q. Progetto: 473.552

472.00

Quote Terreno	-473.05			473.20		-473.24		-473.30		-473.41
Quote Progetto		473.13	473.08	473.15		473.23	473.26			
Parziali		0.34	2.50	2.50		0.37				
Progressiva		-2.84	-2.50	0.00		2.50	2.87			
Dislivelli		0.00	0.34	-0.04		-0.02	-0.06			

Sezione: 5
 Progressiva: 34.584
 Q. Progetto: 473.298

471.00

Quote Terreno	-472.81			472.93		-472.96		-473.03		-473.10
Quote Progetto		472.88	472.82	472.90		472.97	472.98			
Parziali		0.34	2.50	2.50		0.39				
Progressiva		-2.84	-2.50	0.00		2.50	2.89			
Dislivelli		0.00	0.34	-0.03		-0.00	-0.00			

Sezione: 6
 Progressiva: 40.000
 Q. Progetto: 472.998

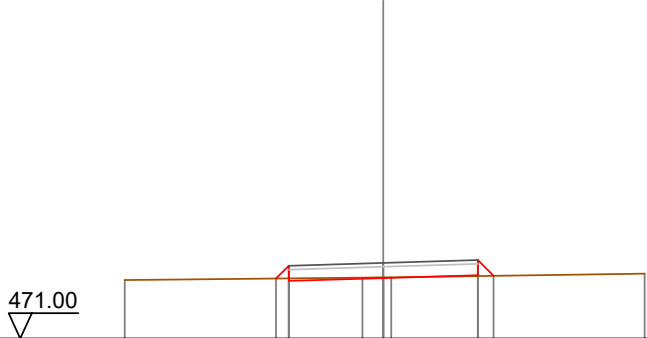

Quote Terreno	472.55		472.61	472.62		472.72
Quote Progetto		472.59	472.52	472.60	472.67	472.66
Parziali		0.34	2.50	2.50	0.41	
Progressiva		-2.84	-2.50	0.00	2.50	2.91
Dislivelli		0.00	0.33	-0.02	0.02	-0.00

Sezione: 7
 Progressiva: 50.000
 Q. Progetto: 472.445

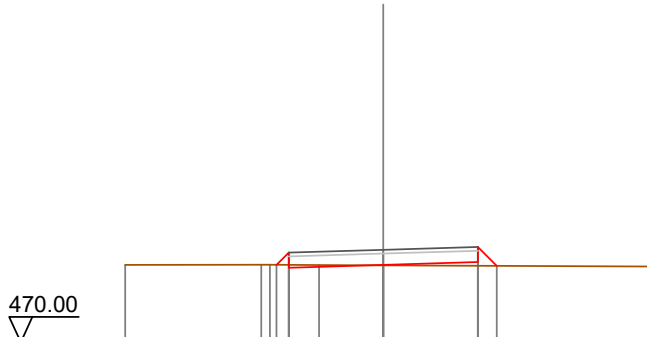

Quote Terreno	472.04	472.05	472.05	472.04	472.03		472.00
Quote Progetto		472.05	471.97		472.05	472.12	472.02
Parziali		0.32	2.50		2.50	0.50	
Progressiva		-2.82	-2.50		0.00	2.50	3.00
Dislivelli		-0.00	0.32		0.01	0.10	0.00

Sezione: 8
 Progressiva: 54.983
 Q. Progetto: 472.170

470.00

Quote Terreno	-471.80	-471.79	-471.75	-471.73	-471.67	-471.68
Quote Progetto		471.78 471.69	471.77	471.84 471.72		
Parziali		0.31 2.50	2.50	0.53		
Progressiva		-2.81 -2.50	0.00	2.50 3.03		
Dislivelli		0.00 0.31	0.02	0.12 0.00		

Sezione: 9
 Progressiva: 55.385
 Q. Progetto: 472.147

470.00

Quote Terreno	-471.78	-471.77	-471.73	-471.71	-471.65	-471.65
Quote Progetto		471.76 471.82	471.75	471.67 471.70		
Parziali		0.46 2.50	2.50	0.38		
Progressiva		-2.96 -2.50	0.00	2.50 2.88		
Dislivelli		0.00 0.46	0.02	-0.03 0.00		

Sezione: 10
 Progressiva: 60.000
 Q. Progetto: 471.892

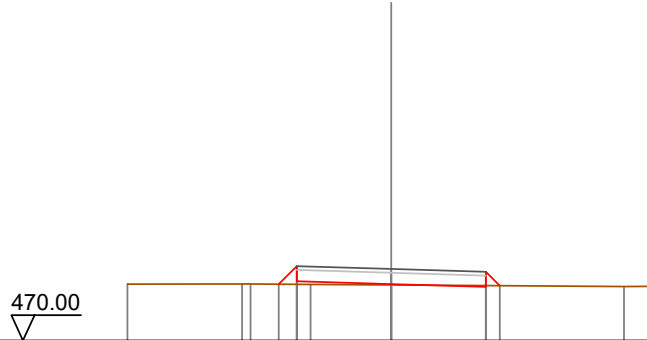

Quote Terreno	-471.49	-471.50	-471.49	-471.48	-471.47	-471.43	-471.43
Quote Progetto			471.49	471.57	471.49	471.42	471.45
Parziali			0.48	2.50	2.50	0.37	
Progressiva			-2.98	-2.50	0.00	2.50	2.87
Dislivelli			0.00	0.48	0.02	-0.03	0.00

Sezione: 11
 Progressiva: 68.963
 Q. Progetto: 471.396

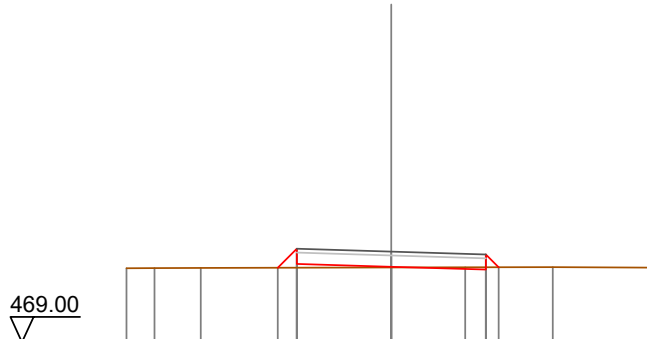

Quote Terreno	-470.96	-470.96	-470.96		-470.96	-470.96	-470.99	-470.97
Quote Progetto				470.97	471.07	471.00	470.92	470.98
Parziali				0.50	2.50	2.50	0.34	
Progressiva				-3.00	-2.50	0.00	2.50	2.84
Dislivelli				-0.00	0.50	0.02	-0.06	0.00

Sezione: 12
 Progressiva: 70.000
 Q. Progetto: 471.339

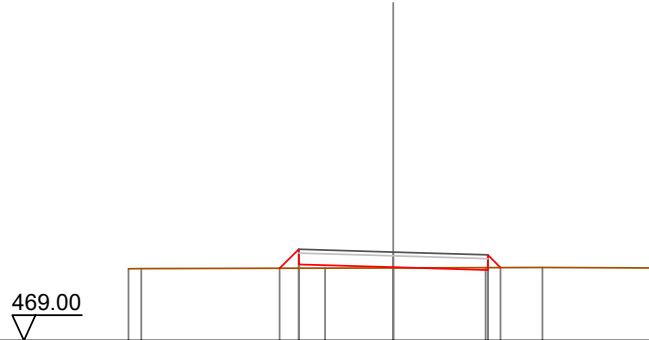

Quote Terreno	470.90	470.90		470.91	470.92	470.93	470.93	470.92
Quote Progetto			470.91	471.01	470.94	470.86	470.93	
Parziali			0.50	2.50	2.50	0.33		
Progressiva			-3.00	-2.50	0.00	2.50	2.83	
Dislivelli			0.00	0.50	0.02	-0.06	0.00	

Sezione: 13
 Progressiva: 80.000
 Q. Progetto: 470.830

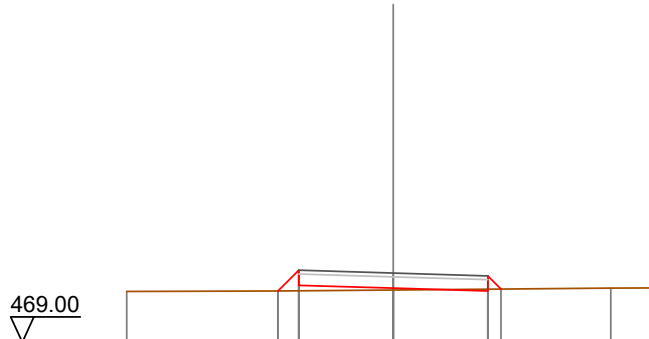

Quote Terreno	470.34		470.36	470.36		470.43	470.44
Quote Progetto		470.36	470.51	470.43	470.36	470.41	
Parziali		0.55	2.50	2.50	0.35		
Progressiva		-3.05	-2.50	0.00	2.50	2.85	
Dislivelli		0.00	0.54	0.05	-0.05	0.00	

Sezione: 14
 Progressiva: 82.541
 Q. Progetto: 470.730

469.00

Quote Terreno	-470.24		470.27	470.26	-470.26		-470.31	-470.32
Quote Progetto			470.26	470.40	470.33		470.25	470.28
Parziali			0.54	2.50	2.50		0.37	
Progressiva			-3.04	-2.50	0.00		2.50	2.87
Dislivelli			0.00	0.54	0.07		-0.02	0.00

Sezione: 15
 Progressiva: 100.000
 Q. Progetto: 470.386

468.00

Quote Terreno	469.95	469.98		469.99		470.00	
Quote Progetto			469.98	469.92	469.99	469.92	469.99
Parziali			0.34	2.50	2.50	0.33	
Progressiva			-2.84	-2.50	0.00	2.50	2.83
Dislivelli			-0.00	0.34	0.00	-0.07	0.00

Sezione: 16
 Progressiva: 120.000
 Q. Progetto: 470.264

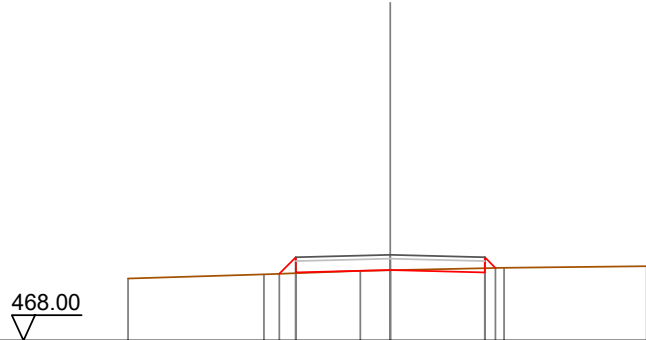

Quote Terreno	469.64	469.75	469.84	469.86	469.93	469.97
Quote Progetto		469.77	469.80	469.86	469.80	469.92
Parziali		0.44	2.50	2.50	0.28	
Progressiva		-2.94	-2.50	0.00	2.50	2.78
Dislivelli		0.00	0.42	0.00	-0.11	0.00

Sezione: 17
 Progressiva: 139.600
 Q. Progetto: 470.061

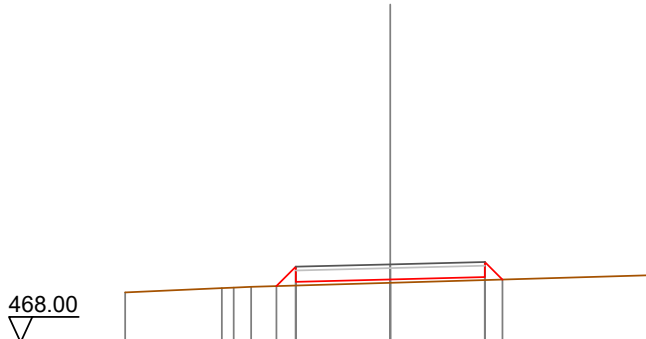

Quote Terreno	469.32	469.43	469.45	469.47	469.49	469.60	469.57	469.72	469.66	469.77
Quote Progetto					469.49	469.60	469.66	469.72	469.66	
Parziali					0.51	2.50	2.50	0.46		
Progressiva					-3.01	-2.50	0.00	2.50	2.96	
Dislivelli					0.00	0.50	0.09	0.08	0.00	

Sezione: 18
 Progressiva: 140.000
 Q. Progetto: 470.054

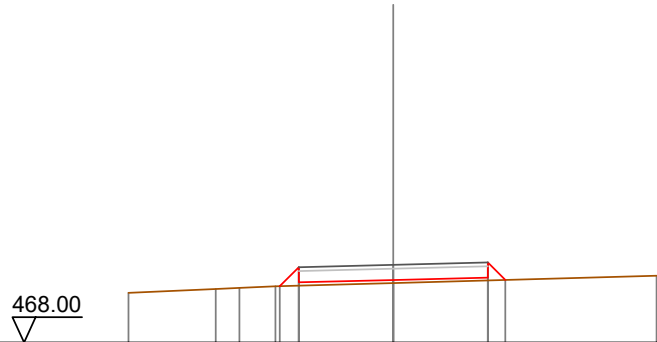

Quote Terreno	-469.31	-469.41	-469.45	-469.49	-469.57	-469.76
Quote Progetto			469.49	469.59	469.65	469.72
Parziali			0.50	2.50	2.50	0.46
Progressiva			-3.00	-2.50	0.00	2.50
Dislivelli			-0.00	0.49	0.08	0.07

Sezione: 19
 Progressiva: 149.387
 Q. Progetto: 469.859

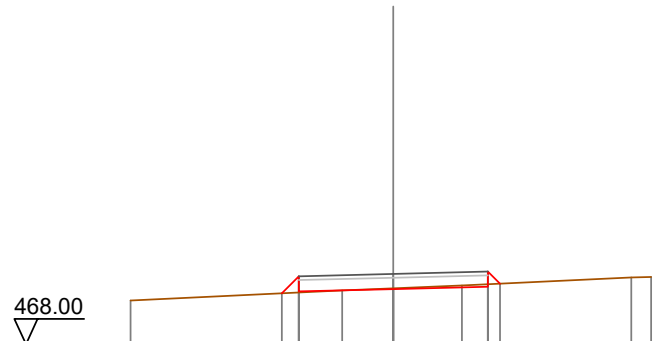

Quote Terreno	-469.16	-469.42	-469.48	-469.55	-469.76
Quote Progetto		469.35	469.46	469.52	469.60
Parziali		0.45	2.50	2.50	0.32
Progressiva		-2.95	-2.50	0.00	2.50
Dislivelli		-0.00	0.43	-0.02	-0.06

Sezione: 20
 Progressiva: 150.000
 Q. Progetto: 469.844

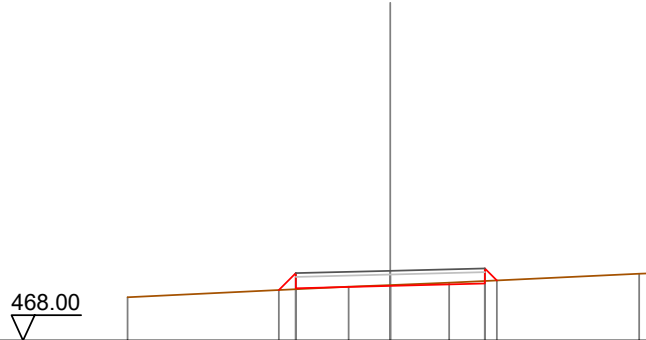

Quote Terreno	469.14		469.42	469.47	469.53		469.77	469.77
Quote Progetto		469.33	469.38	469.44	469.51	469.59		
Parziali		0.45	2.50		2.50	0.32		
Progressiva		-2.95	-2.50	0.00	2.50	2.82		
Dislivelli		0.00	0.43	-0.02	-0.07	0.00		

Sezione: 21
 Progressiva: 159.174
 Q. Progetto: 469.589

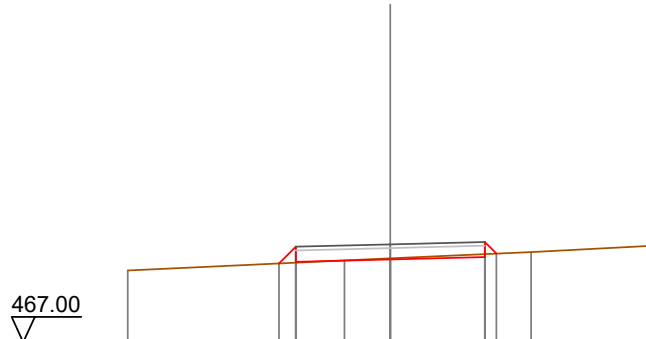

Quote Terreno	468.90		469.16	469.22		469.39		469.54
Quote Progetto		469.08	469.13	469.19	469.25	469.34		
Parziali		0.44	2.50		2.50	0.31		
Progressiva		-2.94	-2.50	0.00	2.50	2.81		
Dislivelli		-0.00	0.42	-0.03	-0.08	0.00		

Sezione: 22
 Progressiva: 160.000
 Q. Progetto: 469.563

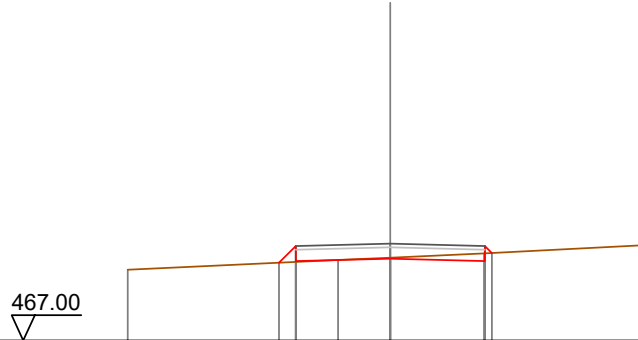

Quote Terreno	468.87		469.13	469.19	469.30	469.52
Quote Progetto		469.06	469.10	469.16	469.10	469.31
Parziali		0.44	2.50	2.50		
Progressiva		-2.94	-2.50	0.00	2.50	2.69
Dislivelli		-0.00	0.42	-0.03	-0.20	-0.00

Sezione: 23
 Progressiva: 180.000
 Q. Progetto: 468.839

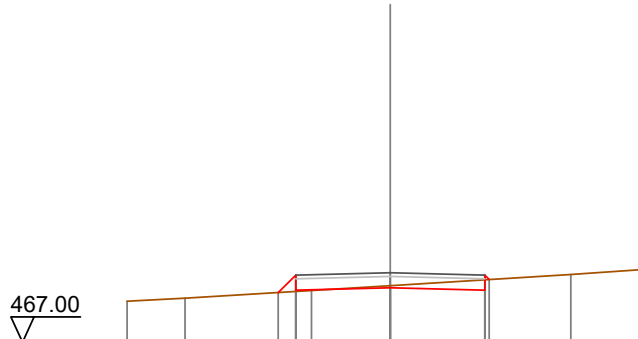

Quote Terreno	468.09	468.17	468.37	468.50	468.79	468.92	
Quote Progetto			468.31	468.44	468.38	468.66	
Parziali			0.46	2.50	2.50		
Progressiva			-2.96	-2.50	0.00	2.50	2.62
Dislivelli			0.00	0.43	-0.06	-0.28	-0.00

Sezione: 24
 Progressiva: 195.360
 Q. Progetto: 468.266

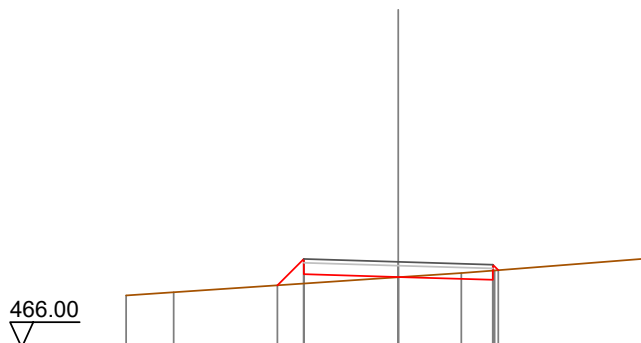

Quote Terreno		467.38	467.46		467.86	467.97	468.04	468.36
Quote Progetto				467.85	467.94	467.87	467.79	468.05
Parziali				0.70	2.50	2.50		
Progressiva				-3.20	-2.50	0.00	2.50	2.64
Dislivelli				0.00	0.65	0.01	-0.24	0.00

Sezione: 25
 Progressiva: 200.000
 Q. Progetto: 468.093

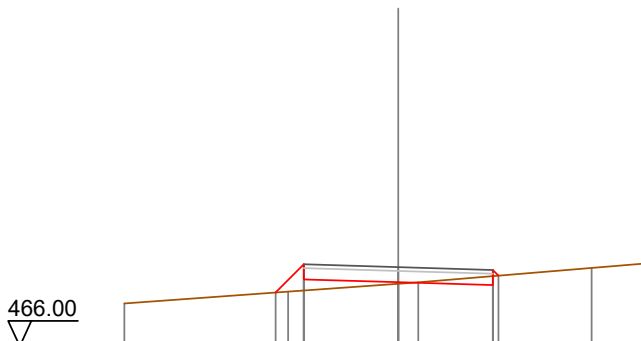

Quote Terreno		467.13	467.45	467.65	467.69	468.07	468.20
Quote Progetto			467.42	467.77	467.69	467.62	467.87
Parziali			0.75	2.50	2.50		
Progressiva			-3.25	-2.50	0.00	2.50	2.65
Dislivelli			0.00	0.69	0.04	-0.24	-0.00

Sezione: 26
 Progressiva: 205.400
 Q. Progetto: 467.894

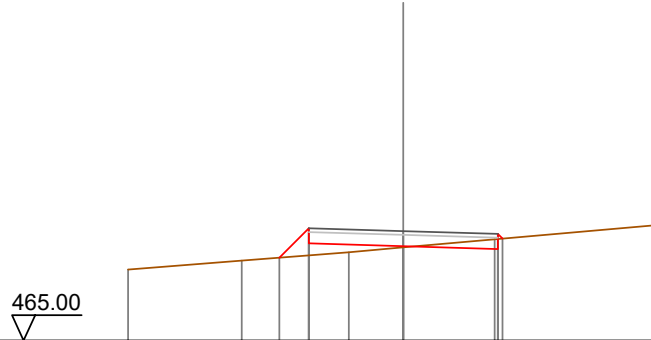

Quote Terreno	466.88	467.11	467.34	467.46	467.68	468.04
Quote Progetto		467.19	467.57	467.49	467.42	467.70
Parziali		0.78	2.50	2.50		
Progressiva		-3.28	-2.50	0.00	2.50	2.62
Dislivelli		0.00	0.72	0.03	-0.27	0.00

Sezione: 27
 Progressiva: 210.000
 Q. Progetto: 467.759

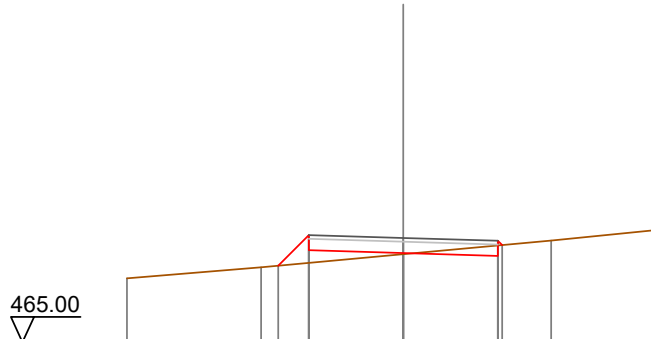

Quote Terreno	466.69	466.98	467.33	467.69	467.96	
Quote Progetto		467.03	467.43	467.36	467.28	467.57
Parziali		0.81	2.50	2.50		
Progressiva		-3.31	-2.50	0.00	2.50	2.61
Dislivelli		0.00	0.73	0.03	-0.27	0.00

Sezione: 28
 Progressiva: 215.439
 Q. Progetto: 467.649

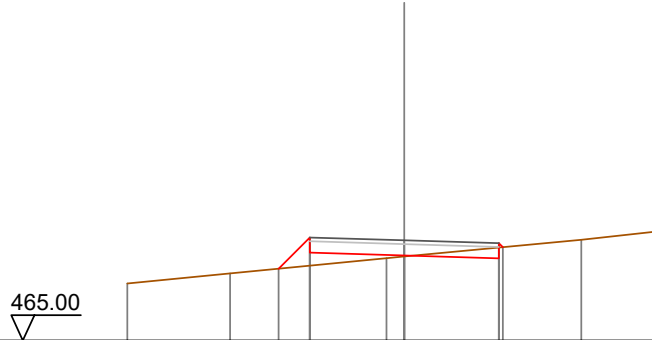

Quote Terreno		466.51	466.77		467.18	467.22		467.66	467.88
Quote Progetto				466.90	467.32	467.25		467.17	467.47
Parziali				0.82	2.50	2.50			
Progressiva				-3.32	-2.50	0.00		2.50	2.61
Dislivelli				0.00	0.74	0.03		-0.28	0.00

Sezione: 29
 Progressiva: 220.000
 Q. Progetto: 467.567

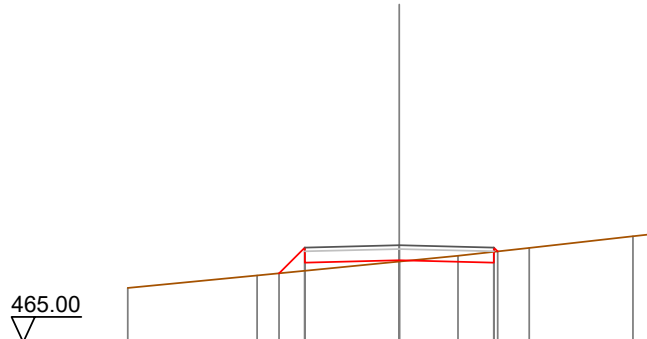

Quote Terreno		466.43	466.77		467.13	467.29		467.50	467.85
Quote Progetto				466.82	467.10	467.17		467.10	467.40
Parziali				0.68	2.50	2.50			
Progressiva				-3.18	-2.50	0.00		2.50	2.60
Dislivelli				0.00	0.61	0.03		-0.29	0.00

Sezione: 30
 Progressiva: 240.000
 Q. Progetto: 467.205

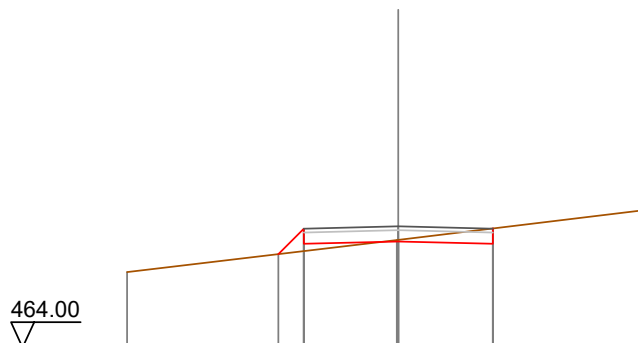

Quote Terreno	465.99		466.84	466.85		467.63
Quote Progetto		466.47	466.74	466.80	466.74	
Parziali		0.67	2.50	2.50		
Progressiva		-3.17	-2.50	0.00	2.50	
Dislivelli		0.00	0.59	-0.04	-0.41	

Sezione: 31
 Progressiva: 260.000
 Q. Progetto: 466.724

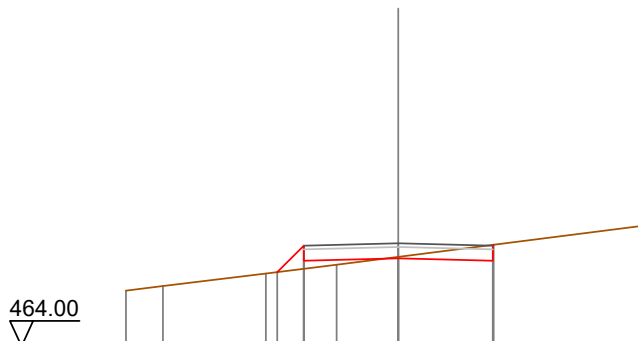

Quote Terreno	465.47	465.59	465.92	466.16	466.36	467.19
Quote Progetto			465.96	466.26	466.32	466.26
Parziali			0.70	2.50	2.50	
Progressiva			-3.20	-2.50	0.00	2.50
Dislivelli			0.00	0.61	-0.04	-0.42
						-0.00

Sezione: 32
 Progressiva: 280.000
 Q. Progetto: 465.971

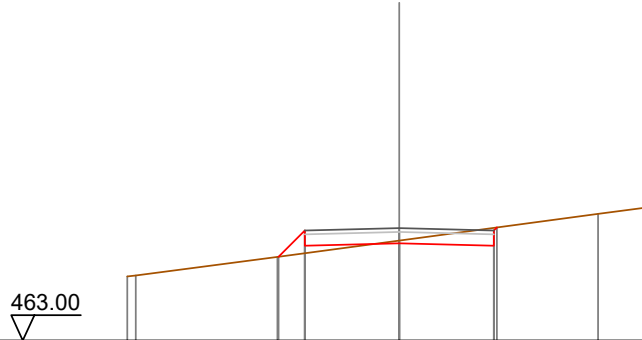

Quote Terreno	464.89	464.72	465.21	465.64	466.35	466.52
Quote Progetto			465.22	465.51	465.51	465.99
Parziali			0.69	2.50	2.50	
Progressiva			-3.19	-2.50	0.00	2.50
Dislivelli			0.60	-0.07	-0.47	0.00

Sezione: 33
 Progressiva: 300.000
 Q. Progetto: 464.995

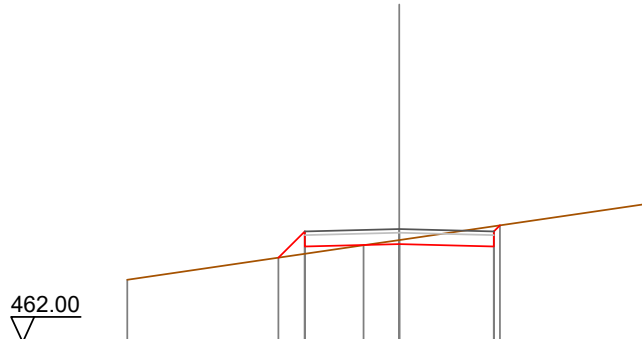

Quote Terreno	463.65		464.57	464.70		465.68
Quote Progetto			464.24	464.53	464.53	465.09
Parziali			0.69	2.50	2.50	
Progressiva			-3.19	-2.50	0.00	2.50
Dislivelli			0.00	0.59	-0.11	-0.54

Sezione: 34
 Progressiva: 301.529
 Q. Progetto: 464.893

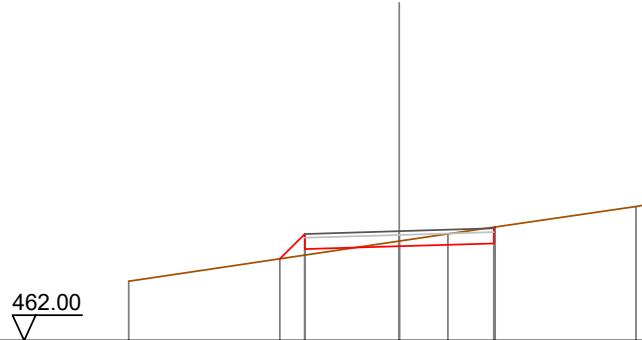

Quote Terreno	463.57			464.63	464.82		465.55	465.59
Quote Progetto			464.16	464.42	464.49		464.57	465.00
Parziali			0.66	2.50	2.50			
Progressiva			-3.16	-2.50	0.00		2.50	2.53
Dislivelli			0.00	0.56	-0.14		-0.43	0.00

Sezione: 35
 Progressiva: 306.408
 Q. Progetto: 464.535

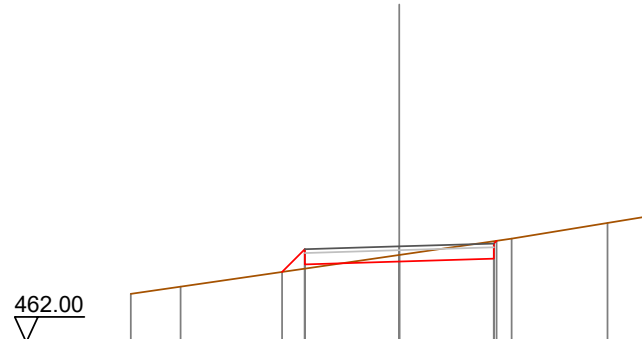

Quote Terreno	463.28	463.47			464.31		464.74	465.16	465.33
Quote Progetto			463.86	464.06	464.13		464.21	464.68	
Parziali			0.60	2.50	2.50				
Progressiva			-3.10	-2.50	0.00		2.50	2.57	
Dislivelli			0.00	0.51	-0.17		-0.46	0.00	

Sezione: 36
 Progressiva: 310.000
 Q. Progetto: 464.241

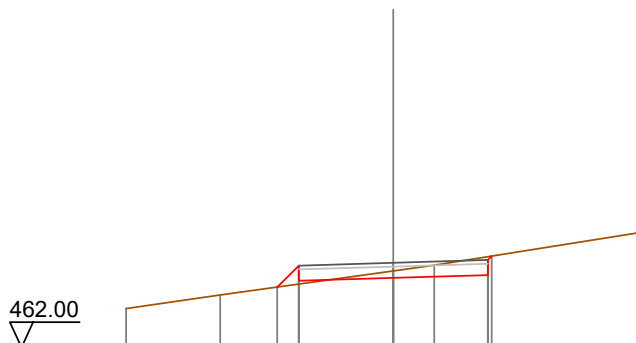

Quote Terreno		463.03	463.39		464.03	464.18		465.05
Quote Progetto				463.60	463.77	463.84	463.92	464.42
Parziali				0.57	2.50	2.50		
Progressiva				-3.07	-2.50	0.00	2.50	2.60
Dislivelli				-0.00	0.49	-0.18	-0.49	0.00

Sezione: 37
 Progressiva: 311.287
 Q. Progetto: 464.129

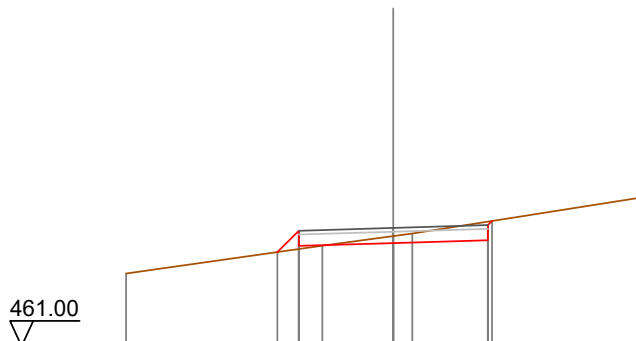

Quote Terreno		462.92		463.66	463.91	463.96		464.94
Quote Progetto				463.49	463.65	463.73	463.80	464.31
Parziali				0.57	2.50	2.50		
Progressiva				-3.07	-2.50	0.00	2.50	2.61
Dislivelli				-0.00	0.49	-0.19	-0.49	0.00

Sezione: 38
 Progressiva: 320.000
 Q. Progetto: 463.296

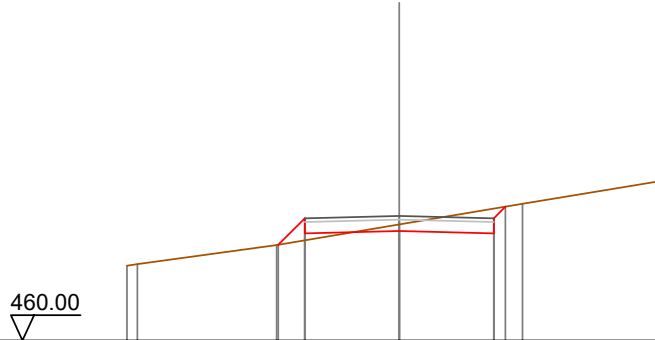

Quote Terreno	461.98	462.02	462.52	462.83	463.07	463.62	464.20
Quote Progetto			462.53	462.83	462.90	462.83	463.54
Parziali			0.70	2.50	2.50	0.31	
Progressiva			-3.20	-2.50	0.00	2.50	2.81
Dislivelli			0.00	0.58	-0.17	-0.65	0.00

Sezione: 39
 Progressiva: 338.063
 Q. Progetto: 461.659

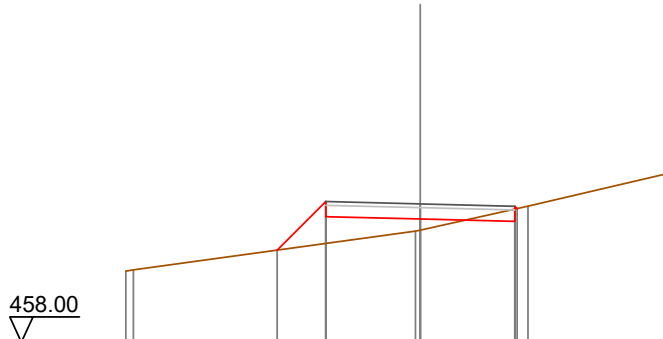

Quote Terreno	459.88	459.92	460.44	461.32	461.26	461.20	461.60	462.47
Quote Progetto			460.44	461.32	461.26	461.20	461.54	
Parziali			1.29	2.50	2.50	0.00		
Progressiva			-3.79	-2.50	0.00	2.50	2.56	
Dislivelli			0.00	1.11	0.29	-0.33	0.00	

Sezione: 40
 Progressiva: 340.000
 Q. Progetto: 461.519

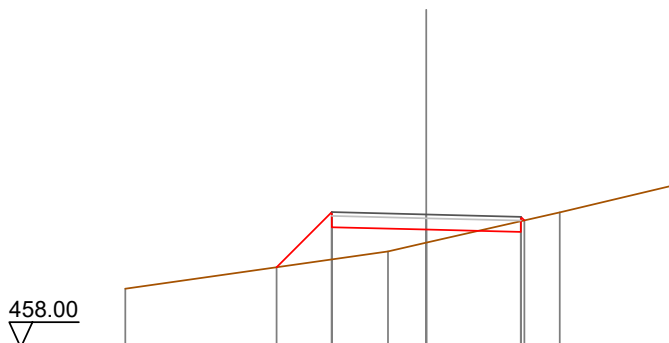

Quote Terreno	-459.55			-460.54	-460.77	-461.57	-462.30
Quote Progetto		460.12	461.18	461.12	461.06	461.36	
Parziali		1.46	2.50	2.50			
Progressiva		-3.96	-2.50	0.00	2.50	2.60	
Dislivelli		0.00	1.25	0.35	-0.28	0.00	

Sezione: 41
 Progressiva: 349.925
 Q. Progetto: 460.921

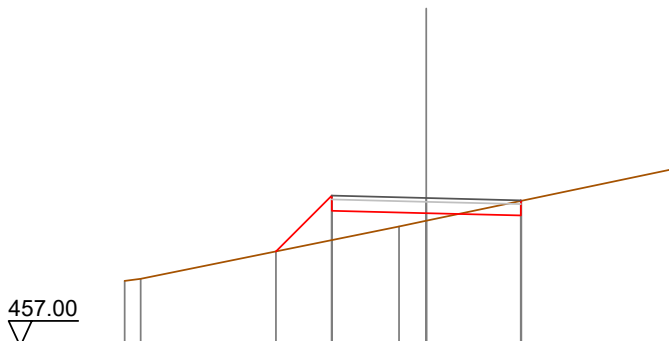

Quote Terreno	-458.73	-458.76		-460.17	-460.32		-461.68
Quote Progetto			459.51	460.58	460.52	460.46	
Parziali			1.47	2.50	2.50		
Progressiva			-3.97	-2.50	0.00	2.50	
Dislivelli			0.00	1.18	0.20	-0.38	

Sezione: 42
 Progressiva: 360.000
 Q. Progetto: 460.516

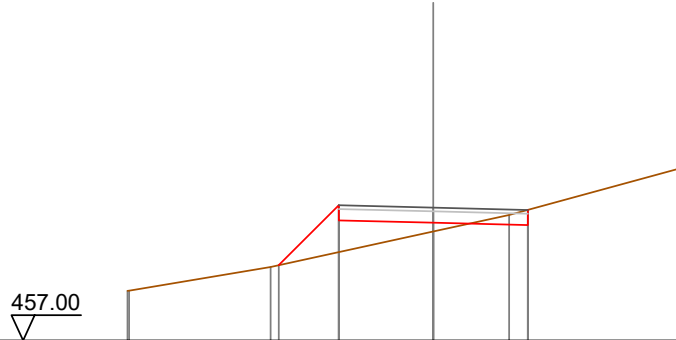

Quote Terreno	458.31	458.32	458.95	460.18	459.88	460.32	461.55
Quote Progetto			458.99	460.18	460.12	460.05	
Parziali			1.59	2.50	2.50		
Progressiva			-4.09	-2.50	0.00	2.50	
Dislivelli			-0.00	1.24	0.23	-0.40	

Sezione: 43
 Progressiva: 361.787
 Q. Progetto: 460.465

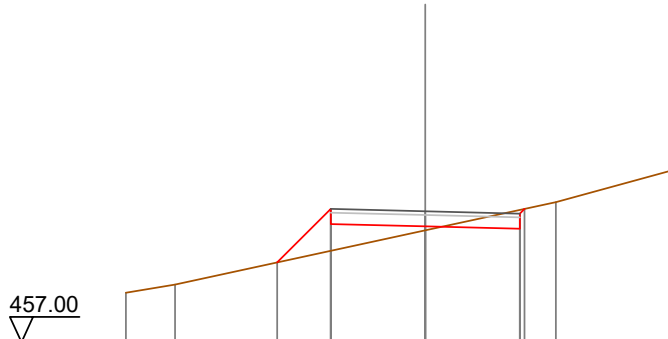

Quote Terreno	458.31	458.53	459.11	460.13	459.96	460.71	461.57
Quote Progetto			459.11	460.13	460.06	460.00	460.53
Parziali			1.41	2.50	2.50		
Progressiva			-3.91	-2.50	0.00	2.50	2.63
Dislivelli			0.00	1.11	0.10	-0.50	0.00

Sezione: 46
 Progressiva: 420.000
 Q. Progetto: 459.353

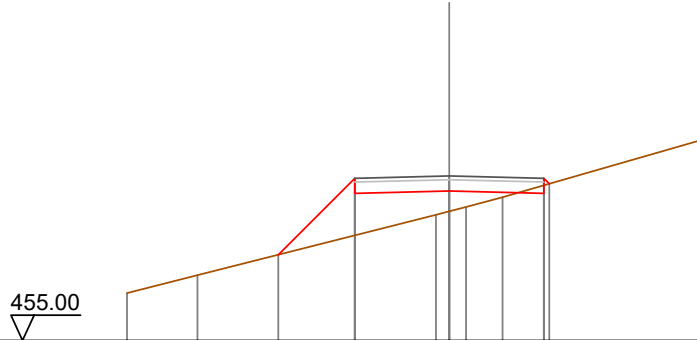

Quote Terreno		456.25	456.73		458.22	458.53	458.79		460.30
Quote Progetto				457.27	458.89	458.95	458.89	459.15	
Parziali				2.02	2.50	2.50			
Progressiva				-4.52	-2.50	0.00	2.50	2.65	
Dislivelli				0.00	1.51	0.54	-0.21	-0.00	

Sezione: 47
 Progressiva: 440.000
 Q. Progetto: 457.757

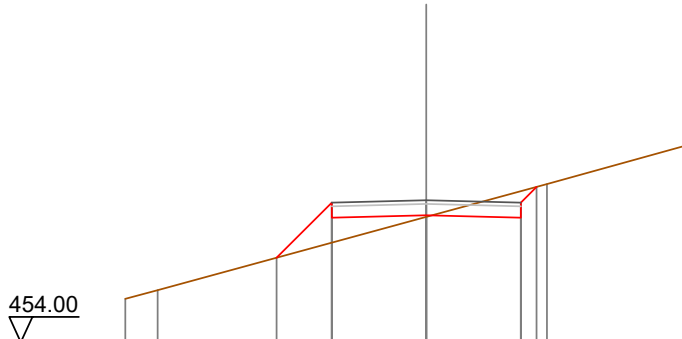

Quote Terreno		455.15	455.38		456.23	457.29	457.36	457.31	458.18	459.22
Quote Progetto				456.23	457.29	457.36	457.29	458.11		
Parziali				1.46	2.50	2.50	0.41			
Progressiva				-3.96	-2.50	0.00	2.50	2.91		
Dislivelli				0.00	1.06	0.04	-0.70	-0.00		

Sezione: 48
 Progressiva: 460.000
 Q. Progetto: 455.348

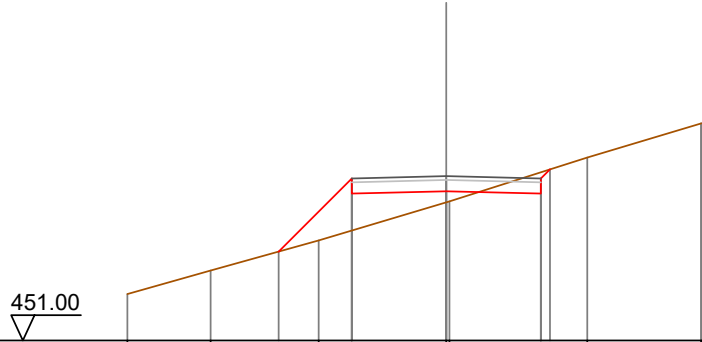

Quote Terreno	452.23	452.85	453.65	454.65	454.68	455.84	456.74
Quote Progetto			453.35	454.89	454.95	454.89	455.53
Parziali			1.93	2.50	2.50		
Progressiva			-4.43	-2.50	0.00	2.50	2.74
Dislivelli			0.00	1.38	0.29	-0.56	-0.00

Sezione: 49
 Progressiva: 469.016
 Q. Progetto: 454.060

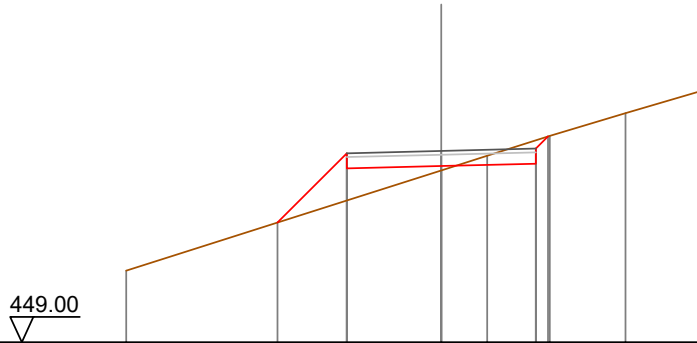

Quote Terreno	450.89			453.55	453.93	454.46	455.06	455.63
Quote Progetto		452.17	453.60	453.66	453.72	454.44		
Parziali		1.83	2.50	2.50	0.32			
Progressiva		-4.33	-2.50	0.00	2.50	2.82		
Dislivelli		0.00	1.25	0.11	-0.62	0.00		

Sezione: 50
 Progressiva: 470.000
 Q. Progetto: 453.920

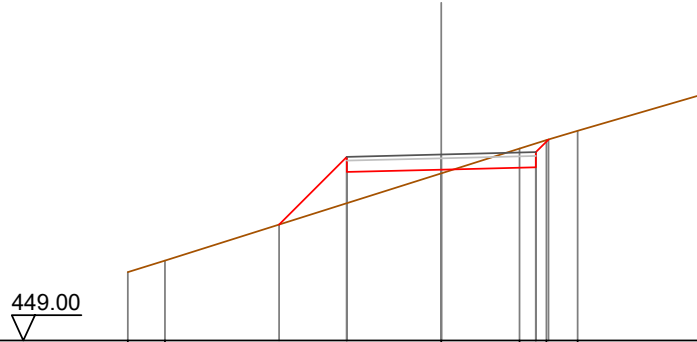

Quote Terreno		-450.81	-451.11				453.42	454.08	454.30	454.55	455.49
Quote Progetto				452.07	453.46		453.52	453.56	454.32		
Parziali					1.79	2.50	2.50	0.33			
Progressiva				-4.29	-2.50	0.00	2.50	2.83			
Dislivelli				0.00	1.22	0.10	-0.63	0.00			

Sezione: 51
 Progressiva: 472.474
 Q. Progetto: 453.566

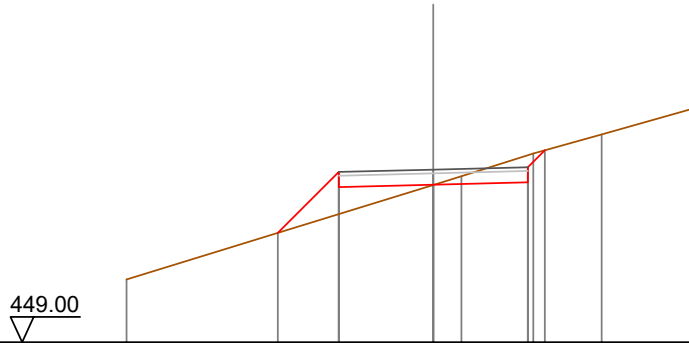

Quote Terreno		-450.66					453.16	453.99	454.50	455.20
Quote Progetto			451.89	453.10		453.17	453.23	454.08		
Parziali			1.61	2.50	2.50	0.45				
Progressiva			-4.11	-2.50	0.00	2.50	2.95			
Dislivelli			0.00	1.11	0.01	-0.72	0.00			

Sezione: 52
 Progressiva: 475.932
 Q. Progetto: 453.072

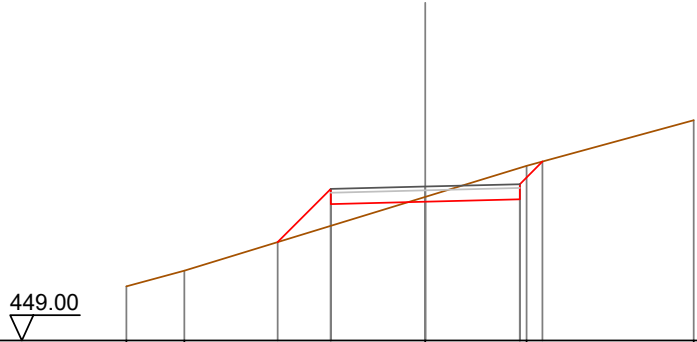

Quote Terreno	450.43	450.85			452.80	453.62	454.82
Quote Progetto			451.60	452.61	452.67	452.73	453.73
Parziali			1.41	2.50	2.50	0.60	
Progressiva			-3.91	-2.50	0.00	2.50	3.10
Dislivelli			0.00	0.98	-0.13	-0.83	0.00

Sezione: 53
 Progressiva: 480.000
 Q. Progetto: 452.491

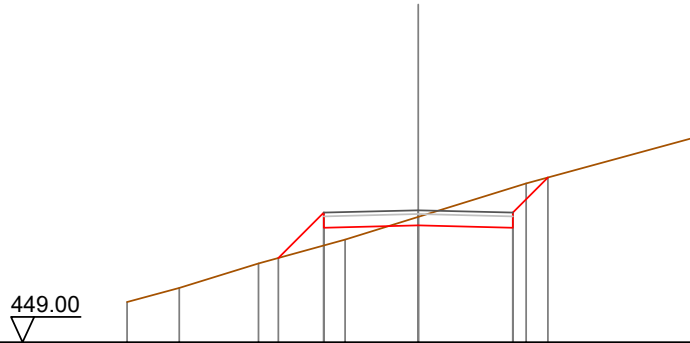

Quote Terreno	450.06	450.43	451.06	451.71	452.32	453.20	454.40	454.45
Quote Progetto			451.23	452.03	452.09	452.03	453.36	
Parziali			1.20	2.50	2.50	0.93		
Progressiva			-3.70	-2.50	0.00	2.50	3.43	
Dislivelli			0.00	0.87	-0.22	-1.06	0.00	

Sezione: 54
 Progressiva: 500.000
 Q. Progetto: 449.633

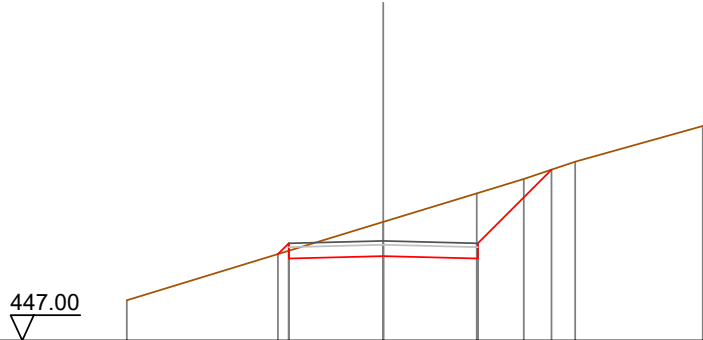

Quote Terreno		448.06			450.14	450.89	451.27	451.73	452.67
Quote Progetto			449.29	449.17	449.23	449.17	451.52		
Parziali			0.23	2.50	2.50	1.95			
Progressiva			-2.78	-2.50	0.00	2.50	4.45		
Dislivelli			0.00	0.20	-0.90	-1.73	0.00		

Sezione: 55
 Progressiva: 520.000
 Q. Progetto: 446.775

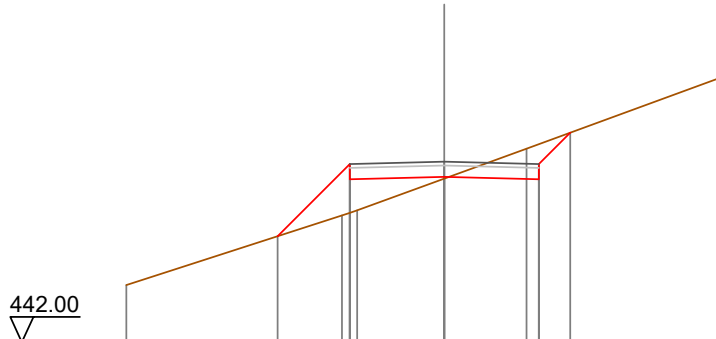

Quote Terreno		443.51		445.35	445.49	446.33	447.12	449.01
Quote Progetto			444.81	446.31	446.37	446.31	447.54	
Parziali			1.91	2.50	2.50	0.83		
Progressiva			-4.41	-2.50	0.00	2.50	3.33	
Dislivelli			0.00	1.29	0.05	-0.93	0.00	

Sezione: 56
 Progressiva: 540.000
 Q. Progetto: 443.931

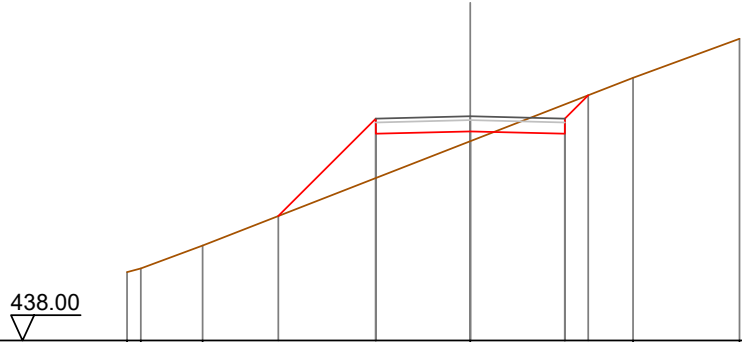

Quote Terreno	-439.81	-439.91	-440.51							
Quote Progetto				441.29	443.47	443.53	443.27	443.47	444.49	445.98
Parziali					2.58	2.50	2.50	0.62		
Progressiva				-5.08	-2.50	0.00	2.50	3.12		
Dislivelli				-0.00	1.57	0.26	-0.78	0.00		

Sezione: 57
 Progressiva: 557.175
 Q. Progetto: 441.872

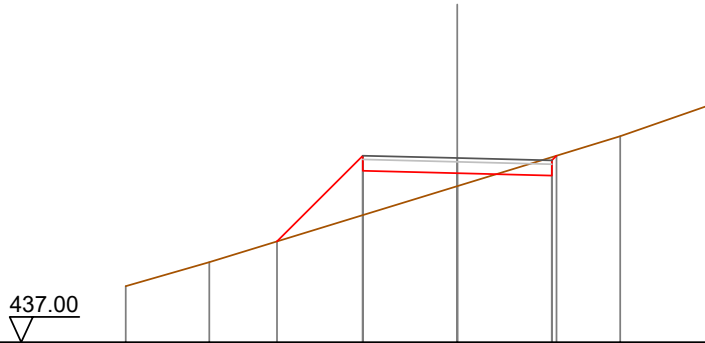

Quote Terreno	-438.48	-439.12								
Quote Progetto			439.67	441.53	441.47	441.13	441.41	441.93	442.45	443.25
Parziali				2.27	2.50	2.50				
Progressiva			-4.77	-2.50	0.00	2.50	2.62			
Dislivelli			-0.00	1.57	0.34	-0.48	-0.00			

Sezione: 58
 Progressiva: 558.030
 Q. Progetto: 441.776

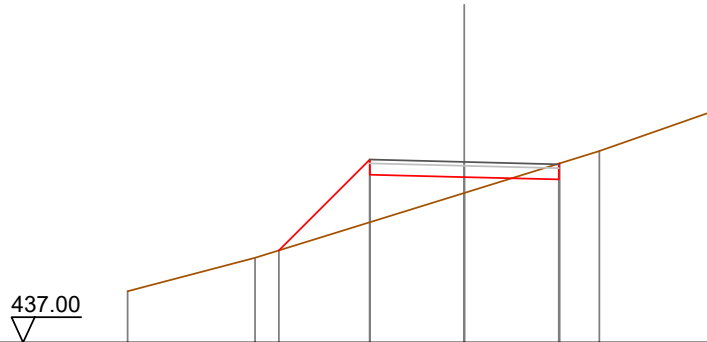

Quote Terreno		438.36	439.24		440.96		442.06	443.10
Quote Progetto			439.44	441.44	441.38	441.31	441.74	
Parziali				2.40	2.50	2.50		
Progressiva			-4.90	-2.50	0.00	2.50	2.52	
Dislivelli			0.00	1.66	0.42	-0.42	0.00	

Sezione: 59
 Progressiva: 558.884
 Q. Progetto: 441.679

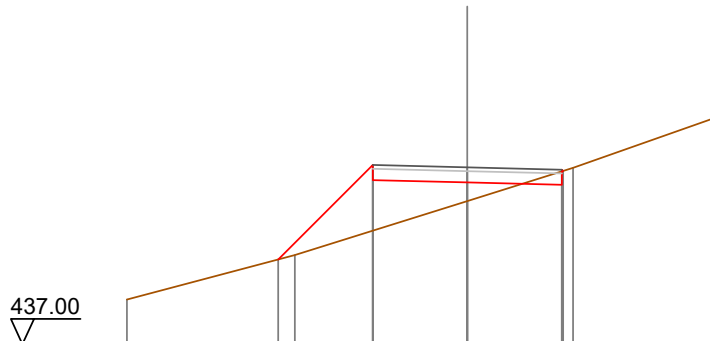

Quote Terreno		438.18	439.36		440.79		441.66	442.98
Quote Progetto			439.24	441.34	441.28	441.22	441.58	
Parziali				2.50	2.50	2.50		
Progressiva			-5.00	-2.50	0.00	2.50	2.54	
Dislivelli			0.00	1.74	0.49	-0.35	0.00	

Sezione: 60
 Progressiva: 560.000
 Q. Progetto: 441.554

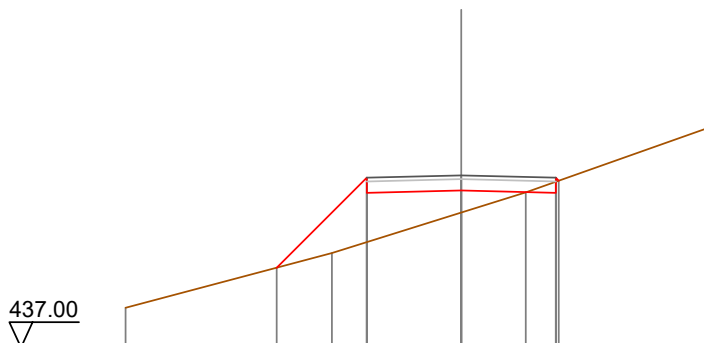

Quote Terreno		438.05		439.50		440.57		441.10		442.82
Quote Progetto			439.11		441.09		441.15		441.09	441.41
Parziali				2.38		2.50		2.50		
Progressiva			-4.88		-2.50		0.00		2.50	2.58
Dislivelli			-0.00		1.70		0.58		-0.29	-0.00

Sezione: 61
 Progressiva: 580.000
 Q. Progetto: 439.301

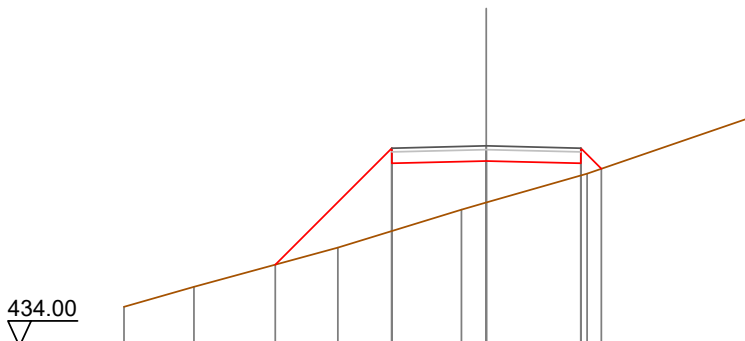

Quote Terreno		435.04		435.57		436.61		437.61		438.56		440.07
Quote Progetto				436.16		438.84		438.90		438.84	438.69	
Parziali					3.08		2.50		2.50	0.54		
Progressiva				-5.58		-2.50		0.00		2.50	3.04	
Dislivelli				0.00		2.19		1.10		0.32	-0.00	

Sezione: 62
 Progressiva: 600.014
 Q. Progetto: 437.047

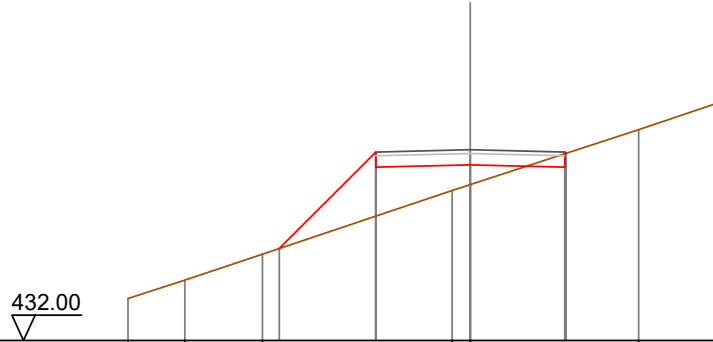

Quote Terreno	-433.11	-433.60	-434.28	-435.97	-436.12	-437.58	-438.28
Quote Progetto			434.43	436.58	436.65	436.58	436.95
Parziali			2.55	2.50	2.50		
Progressiva			-5.05	-2.50	0.00	2.50	2.53
Dislivelli			-0.00	1.70	0.52	-0.35	0.00

Sezione: 62
 Progressiva: 600.015
 Q. Progetto: 437.047

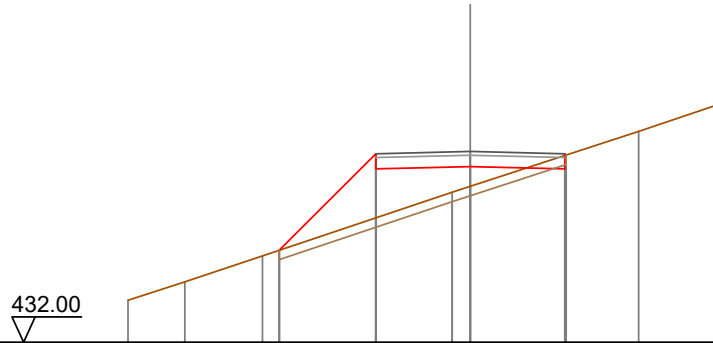

Quote Terreno	-433.11	-433.60	-434.28	-435.97	-436.12	-437.58	-438.28
Quote Progetto			434.43	436.58	436.65	436.58	436.95
Parziali			2.55	2.50	2.50		
Progressiva			-5.05	-2.50	0.00	2.50	2.53
Dislivelli			-0.00	1.70	0.52	-0.35	-0.00

Sezione: 63
 Progressiva: 620.000
 Q. Progetto: 435.067

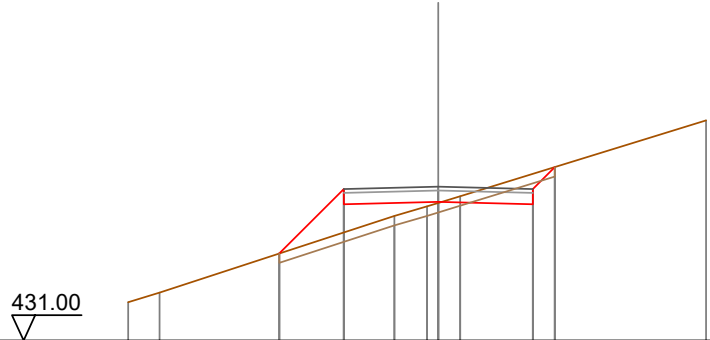

Quote Terreno	-432.01	-432.27			-434.30	-434.55	-434.64	-434.81		-436.82
Quote Progetto				433.30	434.60	434.67	434.67	434.60	435.59	
Parziali					1.70	2.50	2.50	0.58		
Progressiva				-4.20	-2.50	0.00	2.50	3.08		
Dislivelli				0.00	1.15	0.03	-0.80	0.00		

Sezione: 64
 Progressiva: 640.000
 Q. Progetto: 433.880

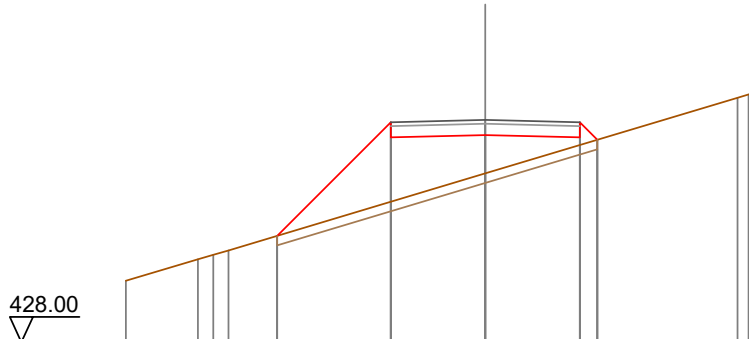

Quote Terreno	-429.63	-430.19	-430.31	-430.43			-432.47		-434.47	-434.55
Quote Progetto					430.81	433.42	433.48	433.42	433.35	
Parziali						3.00	2.50	2.50	0.46	
Progressiva					-5.50	-2.50	0.00	2.50	2.96	
Dislivelli					-0.00	2.10	1.02	0.20	0.00	

Sezione: 65
 Progressiva: 641.318
 Q. Progetto: 433.830

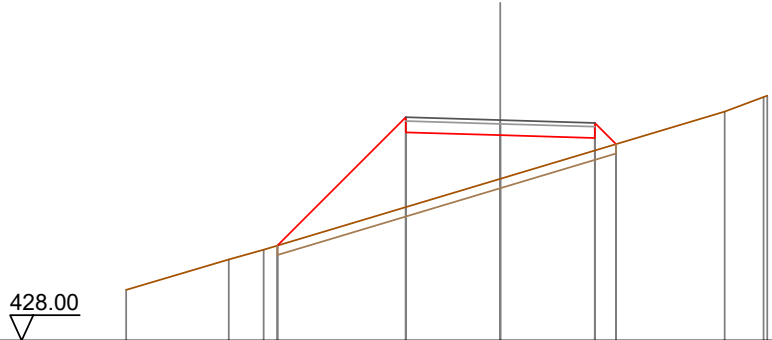

Quote Terreno		429.34	430.15	430.40		432.28		434.05	434.44	434.48
Quote Progetto				430.51		433.51	433.43	433.36	433.19	
Parziali					3.39	2.50	2.50	0.56		
Progressiva				-5.89		-2.50	0.00	2.50	3.06	
Dislivelli				-0.00		2.38	1.15	0.33	0.00	

Sezione: 66
 Progressiva: 645.838
 Q. Progetto: 433.685

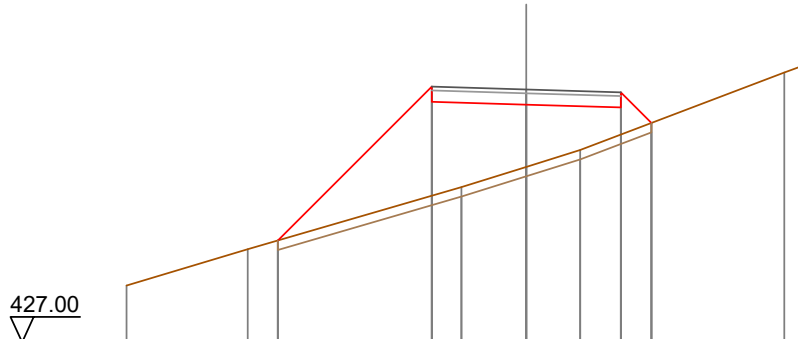

Quote Terreno		428.50	429.46		431.10	431.64	432.08		434.13	434.31
Quote Progetto			429.69		433.36	433.29	433.21	432.80		
Parziali				4.07	2.50	2.50	0.81			
Progressiva			-6.57		-2.50	0.00	2.50	3.31		
Dislivelli			0.00		2.89	1.65	0.72	0.00		

Sezione: 67
 Progressiva: 650.000
 Q. Progetto: 433.588

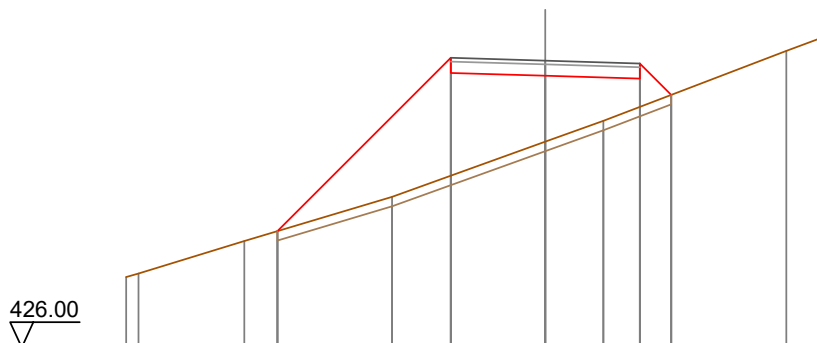

Quote Terreno	427.86	427.96	428.82	429.99	431.44	432.00	433.85	434.20
Quote Progetto			429.08	433.26	433.19	433.11	432.68	
Parziali				4.58	2.50	2.50	0.83	
Progressiva			-7.08		-2.50	0.00	2.50	3.33
Dislivelli			0.00		3.12	1.74	0.75	0.00

Sezione: 68
 Progressiva: 650.359
 Q. Progetto: 433.581

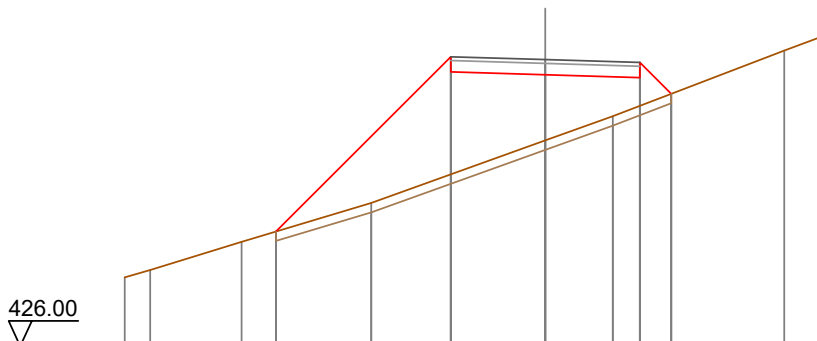

Quote Terreno	427.82	428.02	428.76	429.79	431.44	432.08	433.82	434.20
Quote Progetto			429.03	433.26	433.18	433.11	432.68	
Parziali				4.62	2.50	2.50	0.83	
Progressiva			-7.12		-2.50	0.00	2.50	3.33
Dislivelli			0.00		3.11	1.74	0.75	0.00

Sezione: 69
 Progressiva: 654.127
 Q. Progetto: 433.526

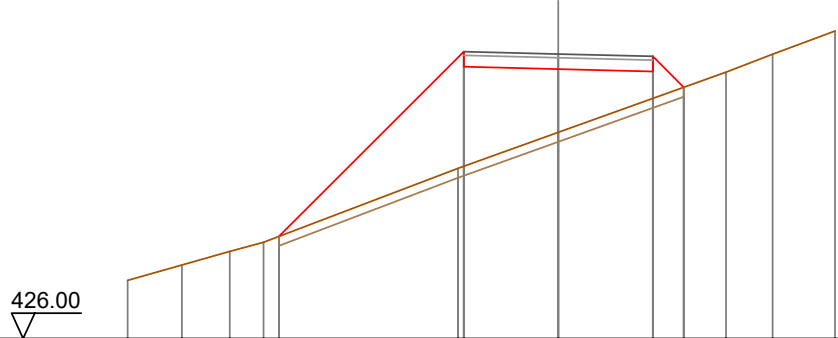

Quote Terreno	-427.54	-427.94	-428.30	-428.55	-430.50	-431.45	-433.05	-433.52	-434.13
Quote Progetto				428.70	433.19	433.13	433.06	432.65	
Parziali					4.89	2.50	2.50	0.82	
Progressiva				-7.39	-2.50	0.00	2.50	3.32	
Dislivelli				-0.00	3.03	1.67	0.71	0.00	

Sezione: 70
 Progressiva: 660.000
 Q. Progetto: 433.496

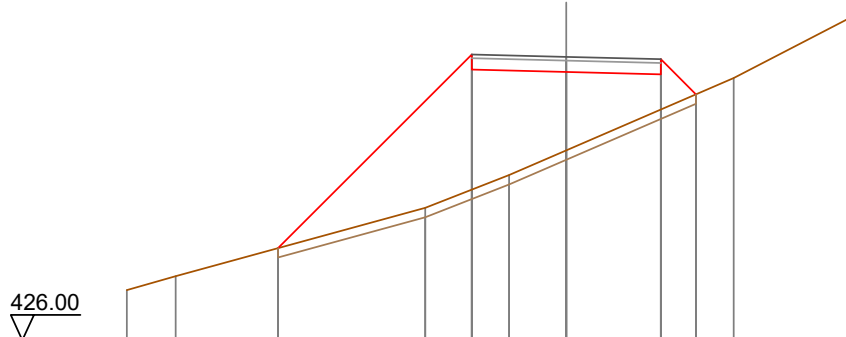

Quote Terreno	-427.33	-427.70	-429.50	-430.37	-431.02	-432.94	-434.49
Quote Progetto			428.44	433.16	433.10	433.03	432.51
Parziali			5.12	2.50	2.50	0.93	
Progressiva			-7.62	-2.50	0.00	2.50	3.43
Dislivelli			0.00	3.57	2.07	0.93	0.00

Sezione: 71
 Progressiva: 670.000
 Q. Progetto: 433.603

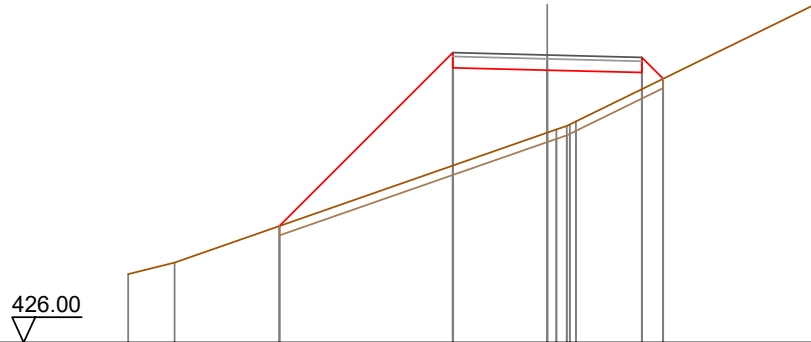

Quote Terreno	-427.81	-428.12					431.55	431.73	431.85		-434.93
Quote Progetto			429.08		433.27		433.20		433.14	432.98	
Parziali				4.58		2.50		2.50		0.56	
Progressiva			-7.08		-2.50		0.00		2.50	3.06	
Dislivelli			0.00		2.99		1.65		0.44	-0.00	

Sezione: 72
 Progressiva: 680.000
 Q. Progetto: 433.911

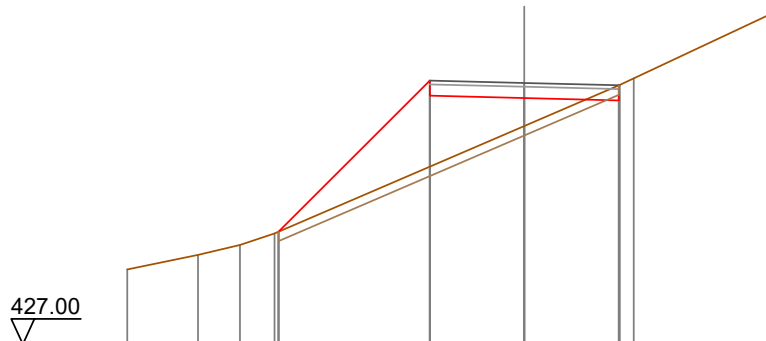

Quote Terreno	-428.98	-429.37	-429.62	-429.93				432.77	433.86	434.03	-435.72
Quote Progetto				429.98		433.57		433.51	433.45		
Parziali					4.00		2.50		2.50		
Progressiva				-6.50		-2.50		0.00	2.50		
Dislivelli				0.00		2.28		0.74	-0.40		

Sezione: 73
 Progressiva: 686.252
 Q. Progetto: 434.206

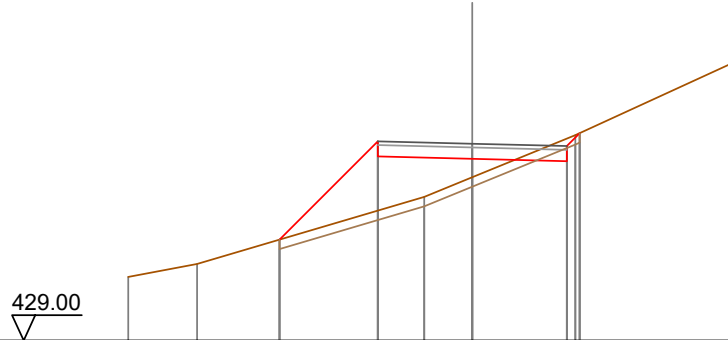

Quote Terreno		-430.68	-431.03			-432.80	-433.32	-434.43	-436.32
Quote Progetto				431.67	433.87		433.81	433.74	434.48
Parziali				2.60	2.50		2.50	0.34	
Progressiva				-5.10	-2.50		0.00	2.50	2.84
Dislivelli				-0.00	1.83		0.49	-0.60	0.00

Sezione: 74
 Progressiva: 690.000
 Q. Progetto: 434.420

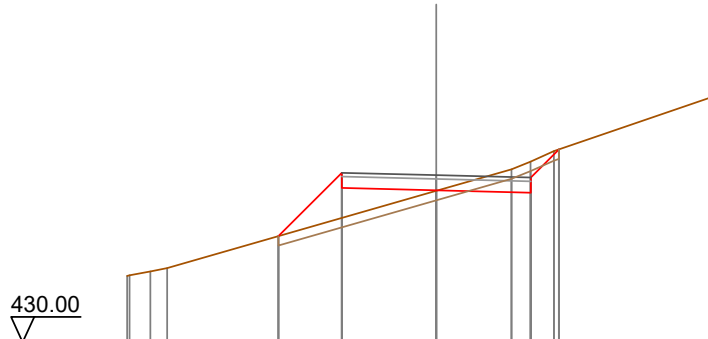

Quote Terreno		431.75	431.77	431.87	431.96		434.00	434.57	434.76	435.05	436.47
Quote Progetto						432.81	434.08	434.02	433.96	435.10	
Parziali						1.68	2.50	2.50	0.74		
Progressiva						-4.18	-2.50	0.00	2.50	3.24	
Dislivelli						0.00	1.20	0.02	-0.82	0.00	

Sezione: 75
 Progressiva: 700.000
 Q. Progetto: 435.129

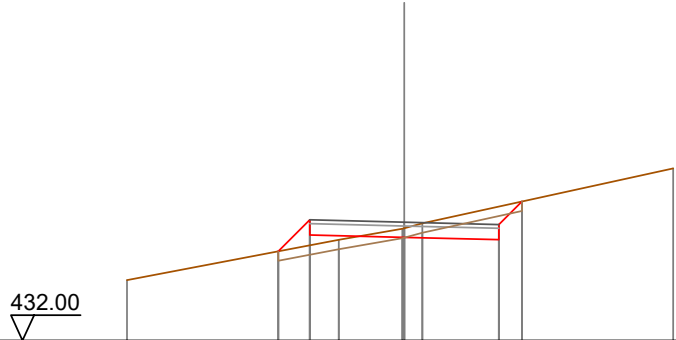

Quote Terreno	433.60			434.66	434.95	434.97	435.10		436.55
Quote Progetto			434.36	434.79	434.73		434.67	435.68	
Parziali			0.83	2.50		2.50	0.61		
Progressiva			-3.33	-2.50	0.00		2.50	3.11	
Dislivelli			0.00	0.68	-0.24		-0.88	0.00	

Sezione: 76
 Progressiva: 710.000
 Q. Progetto: 436.024

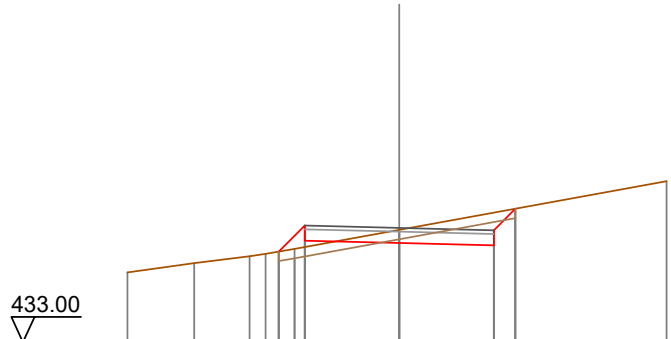

Quote Terreno	434.85	435.09	435.28	435.34	435.47		435.62	435.97		437.26
Quote Progetto				435.40	435.69		435.62		435.56	436.53
Parziali				0.69	2.50		2.50	0.57		
Progressiva				-3.19	-2.50		0.00		2.50	3.07
Dislivelli				0.00	0.57		-0.35		-0.87	0.00

Sezione: 77
 Progressiva: 718.378
 Q. Progetto: 436.751

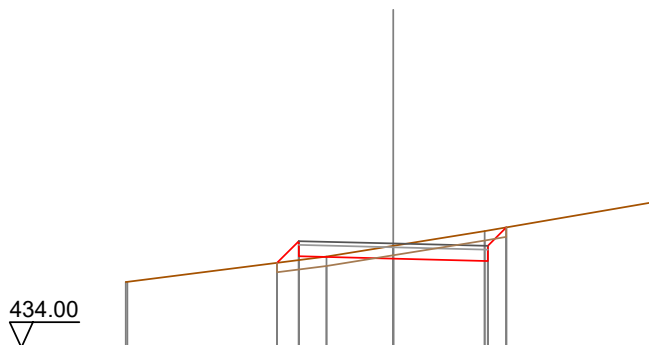

Quote Terreno	435.73	435.74		436.41	436.69	437.08	437.86
Quote Progetto			436.24	436.41	436.35	436.29	437.18
Parziali			0.57	2.50	2.50	0.49	
Progressiva			-3.07	-2.50	0.00	2.50	2.99
Dislivelli			0.00	0.50	-0.34	-0.80	-0.00

Sezione: 78
 Progressiva: 720.000
 Q. Progetto: 436.882

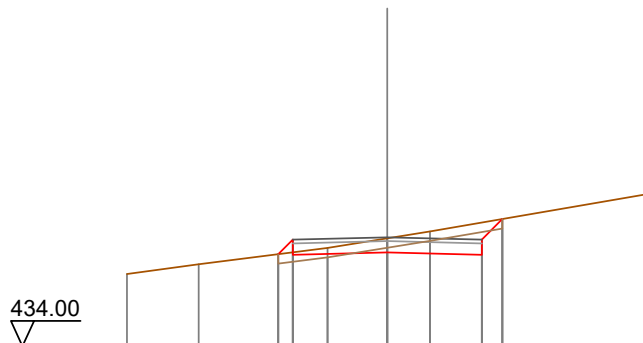

Quote Terreno	435.91	436.17		436.60	436.85	437.04	438.05
Quote Progetto			436.44	436.42	436.48	436.42	437.36
Parziali			0.35	2.50	2.50	0.55	
Progressiva			-2.88	-2.50	0.00	2.50	3.05
Dislivelli			0.00	0.33	-0.37	-0.85	0.00

Sezione: 79
 Progressiva: 740.000
 Q. Progetto: 438.228

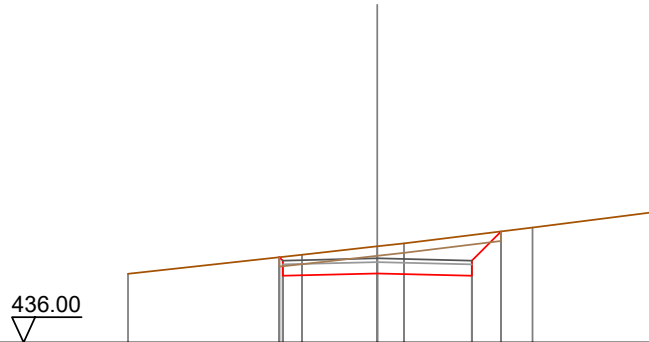

Quote Terreno		-437.82		-438.32		-438.54		-438.62		-439.04		-439.44
Quote Progetto				438.26	437.77	437.83		437.77	438.94			
Parziali					2.50		2.50		0.77			
Progressiva				-2.59	-2.50	0.00		2.50	3.27			
Dislivelli				-0.00	-0.10	-0.72		-1.08	0.00			

Sezione: 80
 Progressiva: 743.189
 Q. Progetto: 438.397

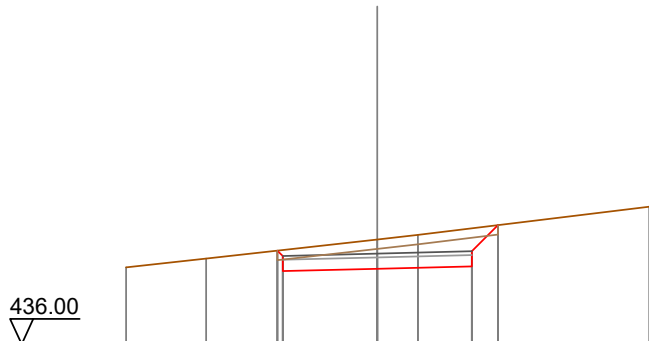

Quote Terreno		-438.03		-438.26		-438.77		-438.89		-439.64
Quote Progetto				438.48	437.93	438.00		438.06	439.15	
Parziali					2.50		2.50	0.69		
Progressiva				-2.64	-2.50	0.00		2.50	3.19	
Dislivelli				0.00	-0.16	-0.77		-1.01	0.00	

Sezione: 81
 Progressiva: 750.000
 Q. Progetto: 438.717

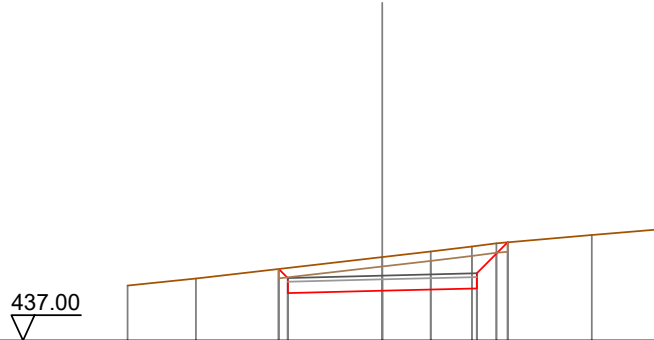

Quote Terreno	438.45	438.64	438.89	438.21	439.36	439.49	439.57	439.79	439.94
Quote Progetto			438.25	438.32		438.38	439.60		
Parziali			2.50		2.50	0.82			
Progressiva			-2.74	0.00		2.50	3.32		
Dislivelli			-0.00	-0.89		-1.13	-0.00		

Sezione: 82
 Progressiva: 753.293
 Q. Progetto: 438.851

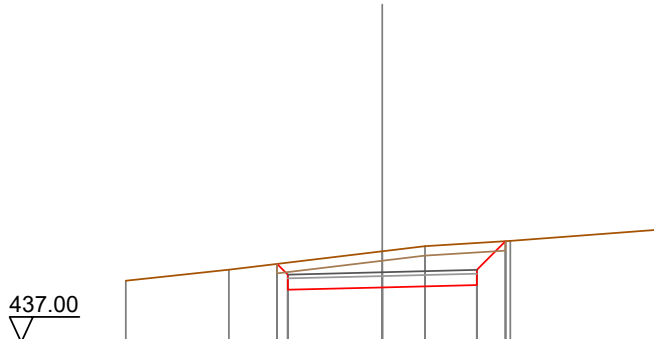

Quote Terreno	438.63	438.92	439.07	439.40	439.54	438.51	439.68	439.97
Quote Progetto			438.39	438.45		438.51	439.67	
Parziali			0.28	2.50		2.50	0.76	
Progressiva			-2.78	0.00		2.50	3.26	
Dislivelli			-0.00	-0.95		-1.11	0.00	

Sezione: 83
 Progressiva: 760.000
 Q. Progetto: 439.083

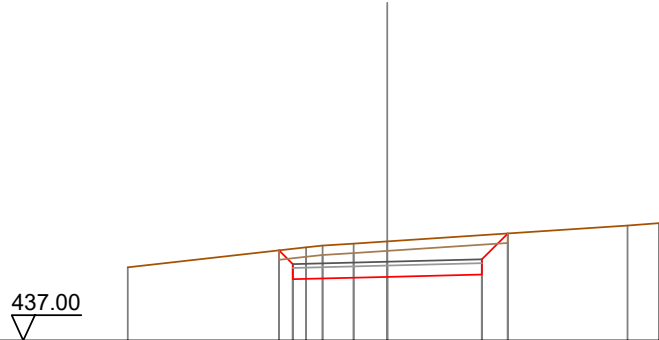

Quote Terreno	438.94	439.46	439.51	439.56	439.62	440.04	440.10
Quote Progetto		438.82	438.82	438.68	438.75	439.83	
Parziali		0.36	2.50	2.50	0.69		
Progressiva		2.96	2.50	0.00	2.50	3.19	
Dislivelli		0.00	-0.40	-0.94	-1.04	-0.00	

Sezione: 84
 Progressiva: 763.397
 Q. Progetto: 439.180

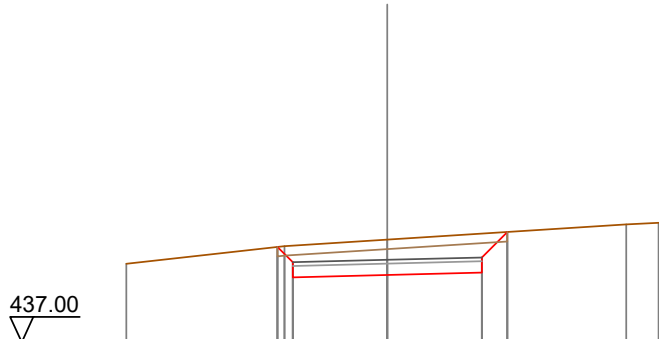

Quote Terreno	439.07	439.54	439.71	440.12	440.16	
Quote Progetto		438.72	438.78	438.84	439.92	
Parziali		0.40	2.50	2.50	0.67	
Progressiva		2.90	2.50	0.00	2.50	3.17
Dislivelli		0.00	-0.44	-0.93	-1.03	0.00

Sezione: 85
 Progressiva: 780.000
 Q. Progetto: 439.450

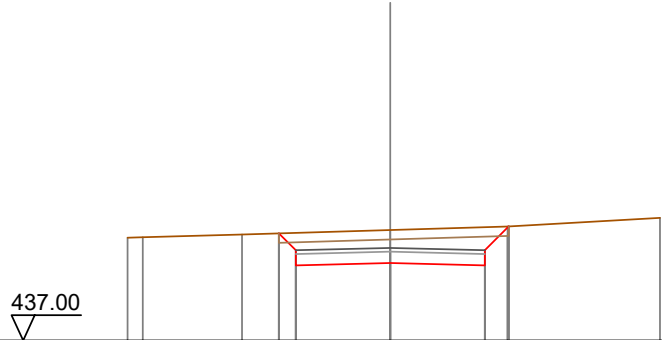

Quote Terreno	439.72	439.73	439.80	439.92	440.02	440.24	
Quote Progetto			439.83	438.99	439.05	438.99	440.02
Parziali			0.45	2.50	2.50	0.63	
Progressiva			-2.95	-2.50	0.00	2.50	3.13
Dislivelli			-0.00	-0.46	-0.87	-1.01	0.00

Sezione: 86
 Progressiva: 787.414
 Q. Progetto: 439.462

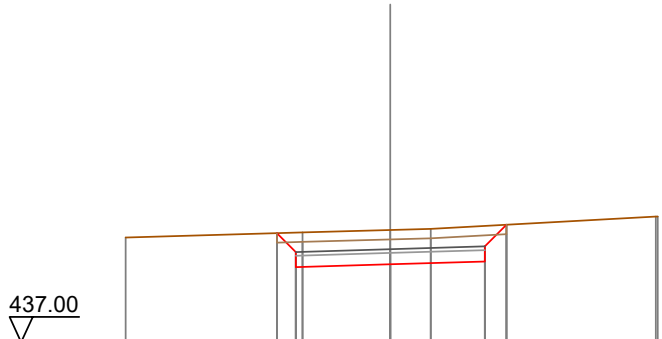

Quote Terreno	439.77	439.89	439.91	439.97	440.00	440.32	440.33
Quote Progetto		439.89	438.99	439.06	439.14	440.11	
Parziali		0.50	2.50	2.50	0.57		
Progressiva		-3.00	-2.50	0.00	2.50	3.07	
Dislivelli		0.00	-0.51	-0.91	-0.94	0.00	

Sezione: 87
 Progressiva: 790.000
 Q. Progetto: 439.450

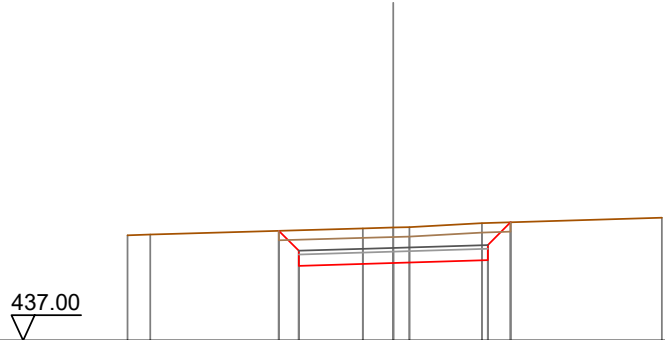

Quote Terreno	-439.78	-439.80		-439.97	-439.99	-440.00	-440.11	-440.25
Quote Progetto			439.90	438.97	439.05	439.05	439.12	440.13
Parziali			0.53	2.50	2.50	0.60		
Progressiva			-3.03	-2.50	0.00	2.50	3.10	
Dislivelli			0.00	-0.54	-0.94	-0.99	0.00	

Sezione: 88
 Progressiva: 797.856
 Q. Progetto: 439.365

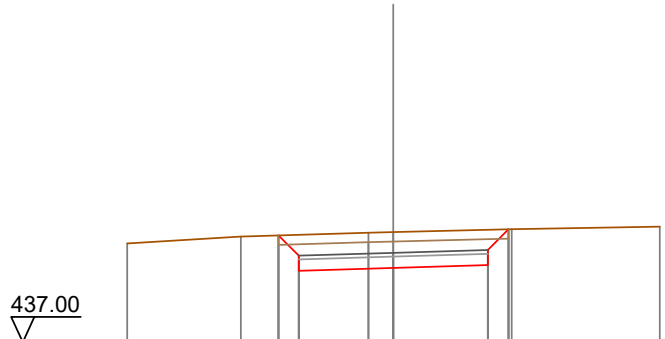

Quote Terreno	-439.61	-439.79		-439.90	-439.91	-439.99	-440.06
Quote Progetto			439.82	438.89	438.96	439.04	439.99
Parziali			0.53	2.50	2.50	0.55	
Progressiva			-3.03	-2.50	0.00	2.50	3.05
Dislivelli			-0.00	-0.55	-0.95	-0.93	0.00

Sezione: 89
 Progressiva: 800.000
 Q. Progetto: 439.328

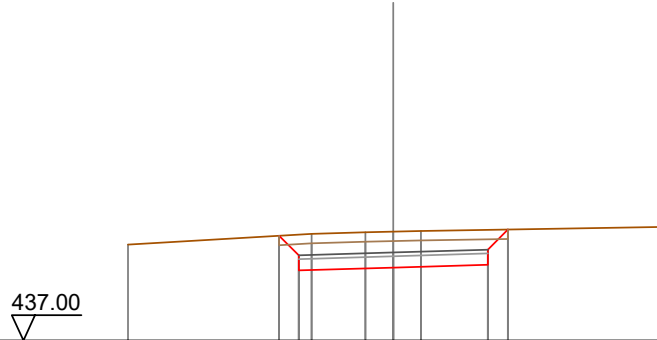

Quote Terreno		439.54							440.00
Quote Progetto				439.77	438.85		438.93	439.00	439.94
Parziali				0.52	2.50		2.50	0.53	
Progressiva				-3.02	-2.50		0.00	2.50	3.03
Dislivelli				0.00	-0.55		-0.95	-0.92	-0.00

Sezione: 90
 Progressiva: 808.298
 Q. Progetto: 439.135

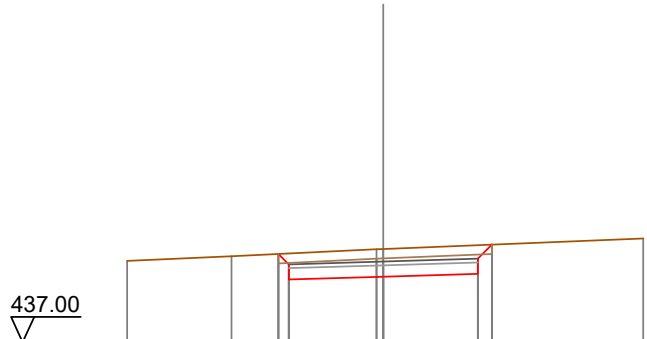

Quote Terreno		439.15		439.27		439.46	439.47		439.75
Quote Progetto				439.33	438.66		438.73	438.81	439.58
Parziali				0.27	2.50		2.50	0.37	
Progressiva				-2.77	-2.50		0.00	2.50	2.87
Dislivelli				0.00	-0.29		-0.73	-0.76	-0.00

Sezione: 91
 Progressiva: 820.000
 Q. Progetto: 438.719

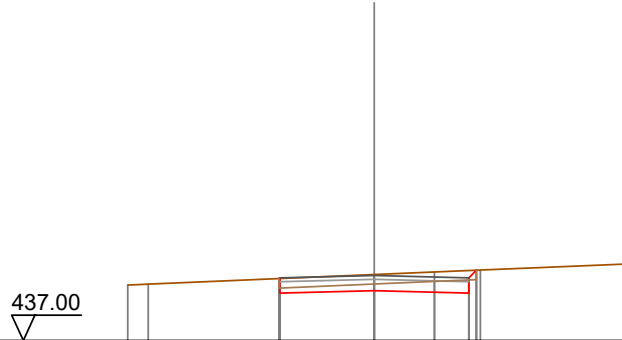

Quote Terreno		438.47	438.49		438.74	438.81	438.86		439.02
Quote Progetto				438.26	438.32	438.26	438.86		
Parziali					2.50	2.50			
Progressiva				-2.52	0.00	2.50	2.70		
Dislivelli				0.00	-0.43	-0.59	0.00		

Sezione: 92
 Progressiva: 831.066
 Q. Progetto: 438.171

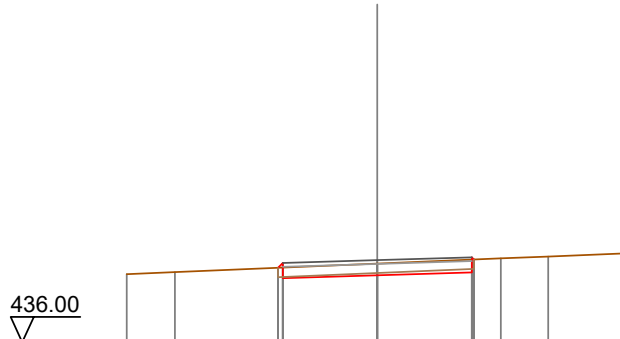

Quote Terreno		437.80	437.86		438.08	438.22	438.27		438.35
Quote Progetto				437.97	437.77	437.85	438.19		
Parziali					2.50	2.50			
Progressiva				-2.63	0.00	2.50	2.56		
Dislivelli				0.00	-0.31	-0.34	0.00		

Sezione: 93
 Progressiva: 840.000
 Q. Progetto: 437.619

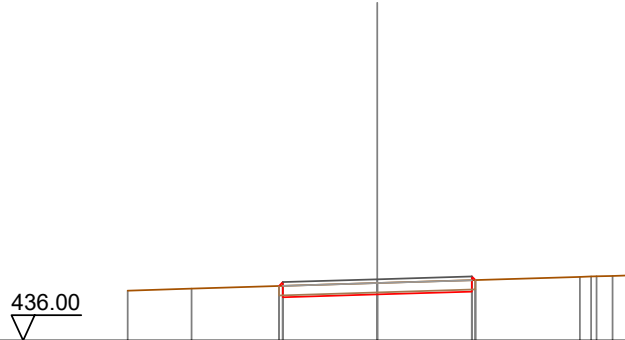

Quote Terreno	437.32	437.37	437.44	437.14	437.22	437.52	437.29	437.60	437.68	437.71	437.72
Quote Progetto			437.44	437.14	437.22		437.29	437.60			
Parziali			2.50		2.50						
Progressiva			-2.60	-2.50	0.00		2.50	2.59			
Dislivelli			0.00	0.10	-0.30		-0.30	0.00			

Sezione: 94
 Progressiva: 843.651
 Q. Progetto: 437.371

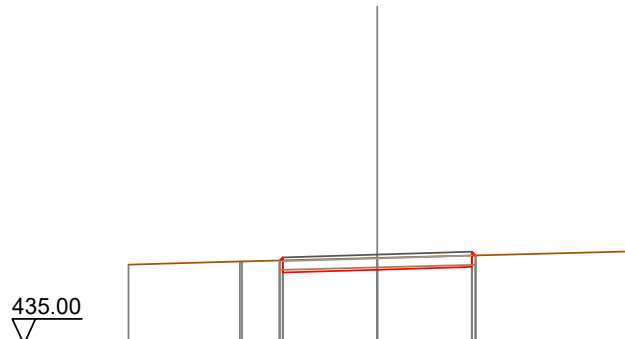

Quote Terreno	437.11	437.19	437.19	437.22	436.90	436.97	437.26	437.05	437.35	437.45
Quote Progetto				437.22	436.90	436.97	437.26	437.05	437.35	
Parziali				2.50		2.50				
Progressiva				-2.58	-2.50	0.00		2.50	2.60	
Dislivelli				0.00	0.08	-0.31		-0.30	0.00	

Sezione: 95
 Progressiva: 850.000
 Q. Progetto: 436.940

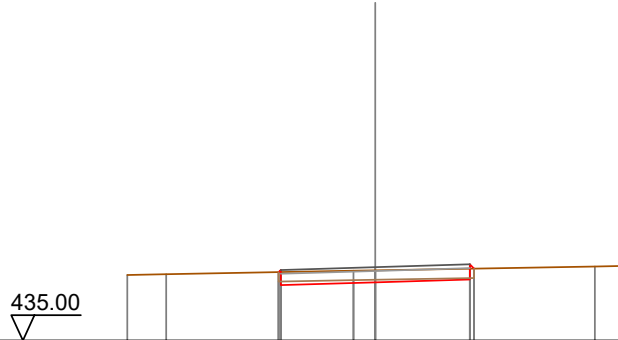

Quote Terreno		436.73	436.75		436.85	436.86		436.96	436.97
Quote Progetto				436.81	436.46	436.54		436.61	436.90
Parziali				2.50		2.50			
Progressiva				-2.56	-2.50	0.00		2.50	2.61
Dislivelli				0.00	0.06	-0.32		-0.29	-0.00

Sezione: 96
 Progressiva: 856.236
 Q. Progetto: 436.516

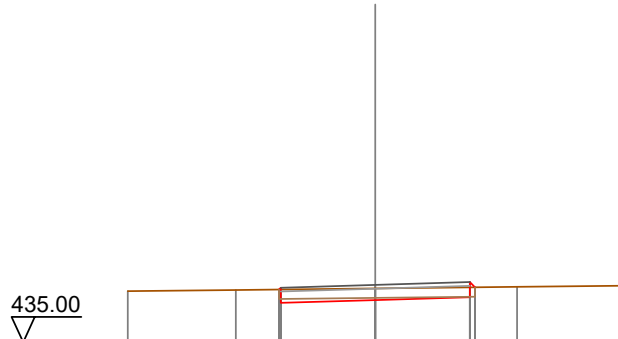

Quote Terreno		436.35	436.38		436.42		436.47	436.49	
Quote Progetto				436.39	436.04	436.12		436.19	436.45
Parziali				2.50		2.50			
Progressiva				-2.55	-2.50	0.00		2.50	2.64
Dislivelli				0.00	0.05	-0.31		-0.26	0.00

Sezione: 97
 Progressiva: 860.000
 Q. Progetto: 436.260

434.00

Quote Terreno	-436.09	-436.09		436.16	436.19	-436.23
Quote Progetto			436.13	435.80	435.86	435.80
Parziali			2.50	2.50		
Progressiva			-2.57	-2.50	0.00	2.50
Dislivelli			0.00	0.07	-0.30	-0.39

Sezione: 98
 Progressiva: 880.000
 Q. Progetto: 434.901

433.00

Quote Terreno	-434.69	-434.73	-434.75	-434.76	-434.84	-434.87
Quote Progetto		434.74	434.44	434.50	434.44	434.81
Parziali		2.50	2.50			
Progressiva		-2.60	-2.50	0.00	2.50	2.53
Dislivelli		0.00	0.10	-0.28	-0.37	0.00

Sezione: 99
 Progressiva: 900.000
 Q. Progetto: 433.542

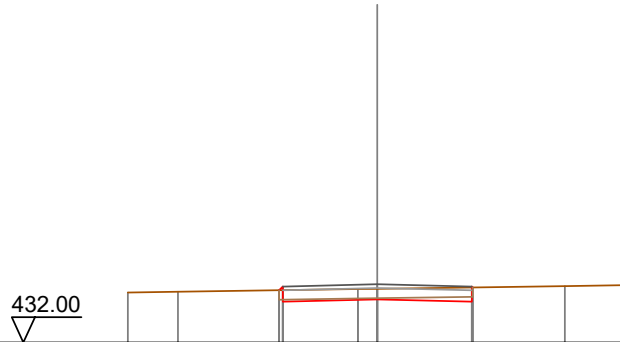

Quote Terreno	433.32	433.34	433.41	433.42	433.49	433.52	
Quote Progetto			433.38	433.08	433.08	433.46	
Parziali			2.50	2.50			
Progressiva			-2.60	-2.50	0.00	2.50	2.52
Dislivelli			0.00	0.09	-0.28	-0.38	-0.00

Sezione: 100
 Progressiva: 911.118
 Q. Progetto: 432.786

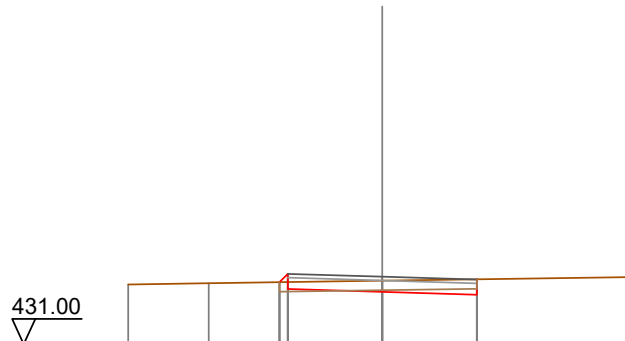

Quote Terreno	432.56	432.61	432.66	432.66	432.76	
Quote Progetto			432.64	432.46	432.31	
Parziali			2.50	2.50		
Progressiva			-2.72	-2.50	0.00	2.50
Dislivelli			0.00	0.22	-0.30	-0.41

Sezione: 101
 Progressiva: 920.000
 Q. Progetto: 432.182

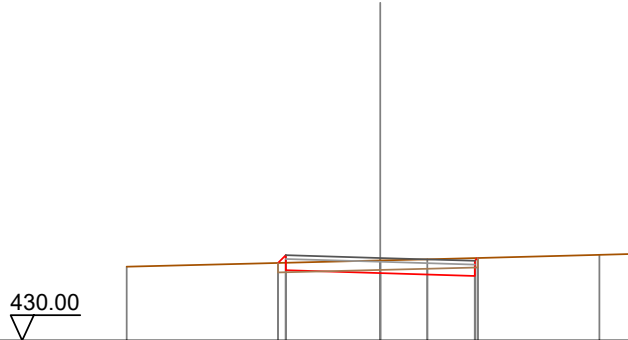

Quote Terreno		431.95		432.12	432.15		432.27	432.29
Quote Progetto			432.05	431.86	431.78	431.71	432.18	
Parziali				2.50		2.50		
Progressiva			-2.71	-2.50	0.00	2.50	2.68	
Dislivelli			0.00	0.20	-0.34	-0.47	0.00	

Sezione: 102
 Progressiva: 930.000
 Q. Progetto: 431.579

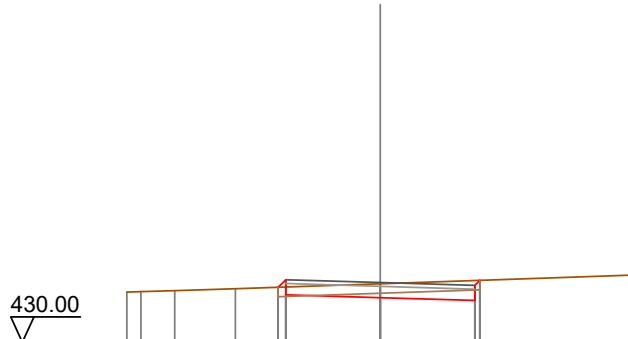

Quote Terreno		431.33	431.34	431.36	431.41		431.55		431.78
Quote Progetto					431.45	431.25	431.18	431.10	431.64
Parziali						2.50		2.50	
Progressiva					-2.70	-2.50	0.00	2.50	2.63
Dislivelli					-0.00	0.19	-0.37	-0.53	0.00

Sezione: 103
 Progressiva: 932.734
 Q. Progetto: 431.449

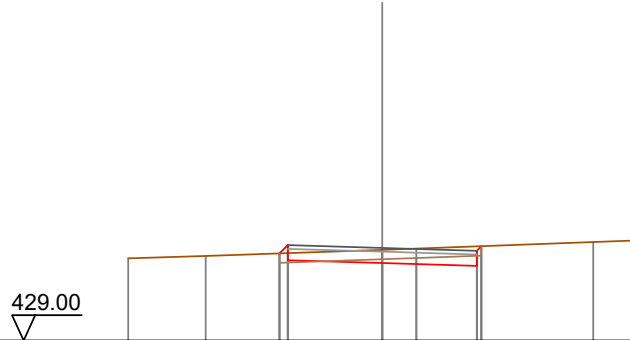

Quote Terreno	-431.17	-431.24			431.05	431.40	431.43			431.60	431.64
Quote Progetto			431.30	431.12						430.97	431.49
Parziali					2.50		2.50				
Progressiva			-2.72	-2.50		0.00		2.50	2.62		
Dislivelli			0.00	0.21		-0.35		-0.52	0.00		

Sezione: 104
 Progressiva: 940.000
 Q. Progetto: 431.175

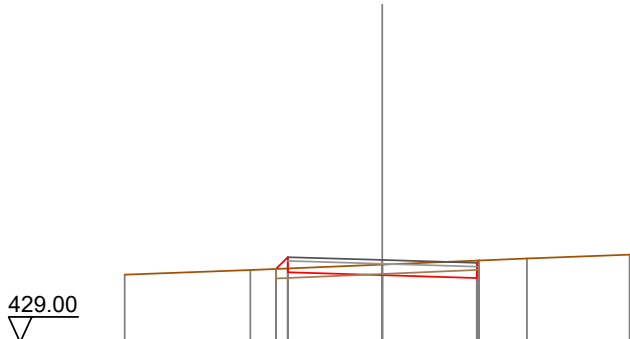

Quote Terreno	430.79	430.91			430.78	431.06			431.22	431.32	431.32
Quote Progetto			430.94	430.85				430.70	431.16		
Parziali			0.31		2.50		2.50				
Progressiva			-2.81	-2.50		0.00		2.50	2.56		
Dislivelli			-0.00	0.30		-0.28		-0.46	-0.00		

Sezione: 105
 Progressiva: 950.014
 Q. Progetto: 430.881

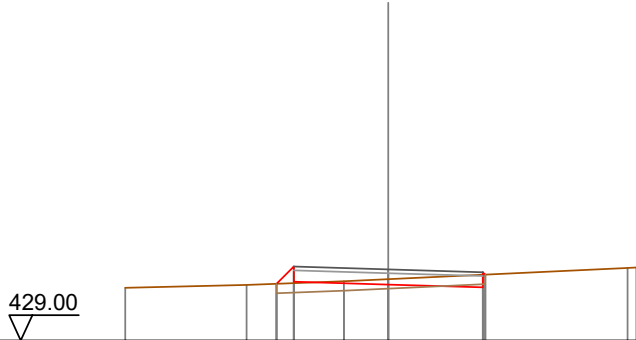

Quote Terreno	430.40	430.47	430.57	430.62	430.92	430.93	
Quote Progetto			430.50	430.56	430.48	430.41	430.74
Parziali			0.46	2.50	2.50		
Progressiva			-2.96	-2.50	0.00	2.50	2.56
Dislivelli			0.00	0.44	-0.14	-0.33	0.00

Sezione: 105
 Progressiva: 950.015
 Q. Progetto: 430.881

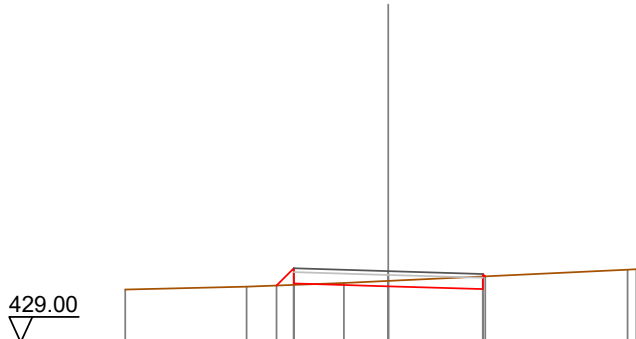

Quote Terreno	430.40	430.47	430.57	430.62	430.92	430.93	
Quote Progetto			430.50	430.56	430.48	430.41	430.74
Parziali			0.46	2.50	2.50		
Progressiva			-2.96	-2.50	0.00	2.50	2.56
Dislivelli			-0.00	0.44	-0.14	-0.33	0.00

Sezione: 106
 Progressiva: 954.351
 Q. Progetto: 430.753

429.00

Quote Terreno	-430.21	-430.28		430.34	430.43	430.47	430.54	430.58	-430.73	-430.79
Quote Progetto				430.34	430.43	430.35	430.28	430.68		
Parziali				0.49	2.50		2.50			
Progressiva				-2.98	-2.50	0.00	2.50	2.60		
Dislivelli				-0.00	0.47	-0.11	-0.30	0.00		

Sezione: 107
 Progressiva: 960.000
 Q. Progetto: 430.589

429.00

Quote Terreno	-430.11	-430.12		430.13	430.13	430.26		430.45	430.52	430.58
Quote Progetto				430.13	430.13	430.19	430.13	430.37		
Parziali				0.39	2.50		2.50			
Progressiva				-2.89	-2.50	0.00	2.50	2.65		
Dislivelli				0.00	0.38	-0.07	-0.24	-0.00		

Sezione: 108
 Progressiva: 968.853
 Q. Progetto: 430.431

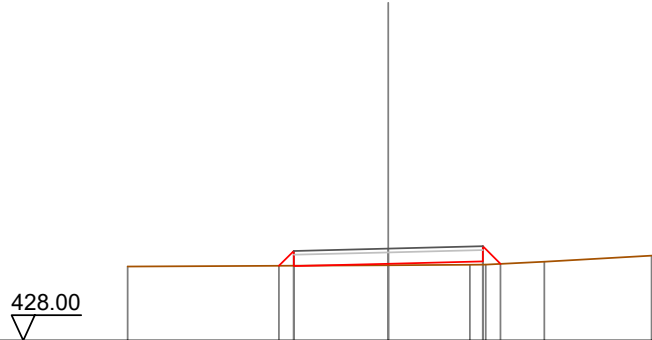

Quote Terreno	-429.96			-429.99		-430.00	-430.01	-430.08	-430.25
Quote Progetto		429.98	429.97	430.03		430.09	430.03		
Parziali		0.39	2.50	2.50		0.47			
Progressiva		-2.98	-2.50	0.00		2.50	2.97		
Dislivelli		0.00	0.39	0.04		0.08	-0.00		

Sezione: 109
 Progressiva: 970.000
 Q. Progetto: 430.419

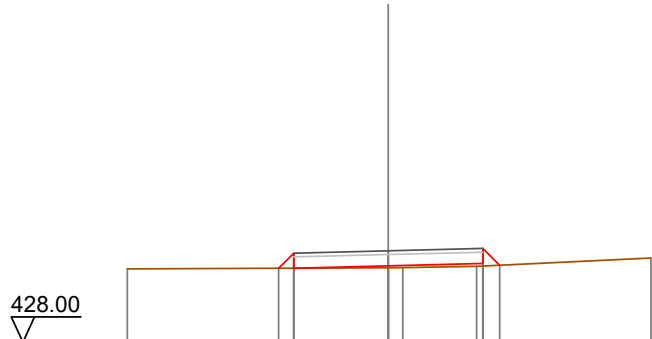

Quote Terreno	-429.94			-429.97		-430.01		-430.23
Quote Progetto		429.96	429.96	430.02		430.08	430.04	
Parziali		0.40	2.50	2.50		0.44		
Progressiva		-2.90	-2.50	0.00		2.50	2.94	
Dislivelli		-0.00	0.40	0.05		0.07	0.00	

Sezione: 110
 Progressiva: 974.576
 Q. Progetto: 430.374

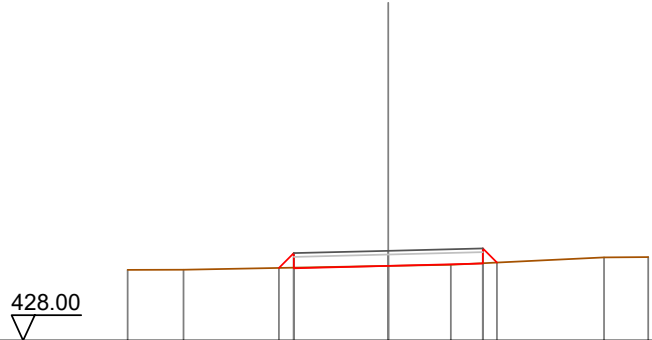

Quote Terreno	-429.87	-429.87			-429.97	-430.00		-430.20	-430.21
Quote Progetto			429.82	429.81	429.97	430.04	430.06		
Parziali			0.39	2.50	2.50	0.37			
Progressiva			-2.89	-2.50	0.00	2.50	2.87		
Dislivelli			0.00	0.38	0.00	-0.01	0.00		

Sezione: 111
 Progressiva: 980.000
 Q. Progetto: 430.302

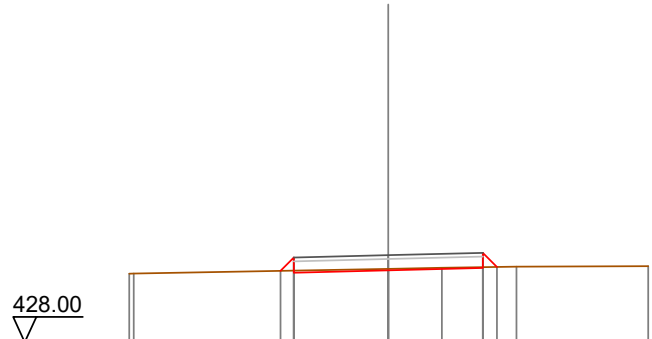

Quote Terreno	-429.81	-429.82			-429.94	-429.97	-430.00		-430.01
Quote Progetto			429.89	429.84	429.90	429.96	429.99		
Parziali			0.35	2.50	2.50	0.37			
Progressiva			-2.85	-2.50	0.00	2.50	2.87		
Dislivelli			0.00	0.34	-0.04	-0.02	-0.00		

Sezione: 112
 Progressiva: 980.299
 Q. Progetto: 430.296

428.00

Quote Terreno	-429.80	-429.82			429.94	-429.96	-430.00	-430.01
Quote Progetto			429.88	429.83	429.90	429.96	429.99	
Parziali			0.35	2.50	2.50	0.37		
Progressiva			2.85	-2.50	0.00	2.50	2.87	
Dislivelli			0.00	0.34	-0.04	-0.02	0.00	

Sezione: 113
 Progressiva: 1000.000
 Q. Progetto: 429.572

427.00

Quote Terreno	-428.80	-428.83			429.22	429.33		429.61
Quote Progetto			429.04	429.11	429.17	429.11	429.38	
Parziali			0.47	2.50	2.50			
Progressiva			-2.97	-2.50	0.00	2.50	2.63	
Dislivelli			0.00	0.44	-0.05	-0.26	0.00	

Sezione: 114
 Progressiva: 1020.000
 Q. Progetto: 428.651

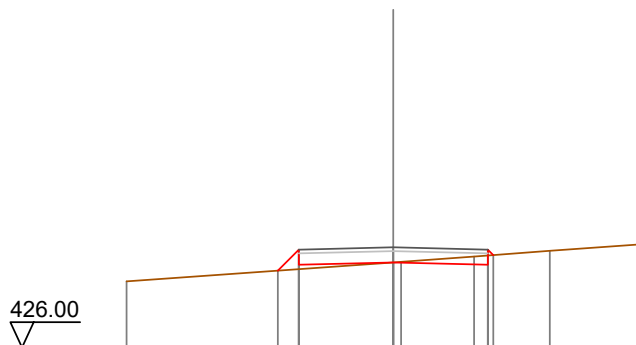

Quote Terreno	427.75		428.25	428.26	428.41	428.56	428.74
Quote Progetto		428.03	428.19	428.25	428.19	428.44	
Parziali		0.55	2.50	2.50			
Progressiva		-3.05	-2.50	0.00	2.50	2.64	
Dislivelli		0.00	0.52	0.00	-0.25	-0.00	

Sezione: 115
 Progressiva: 1027.707
 Q. Progetto: 428.300

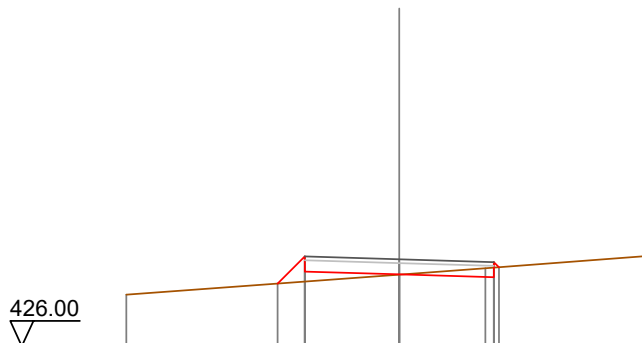

Quote Terreno	427.36		427.89	428.06	428.39	
Quote Progetto		427.66	427.90	427.83	428.09	
Parziali		0.72	2.50	2.50		
Progressiva		-3.22	-2.50	0.00	2.50	2.64
Dislivelli		0.00	0.67	0.01	-0.25	-0.00

Sezione: 116
 Progressiva: 1030.000
 Q. Progetto: 428.210

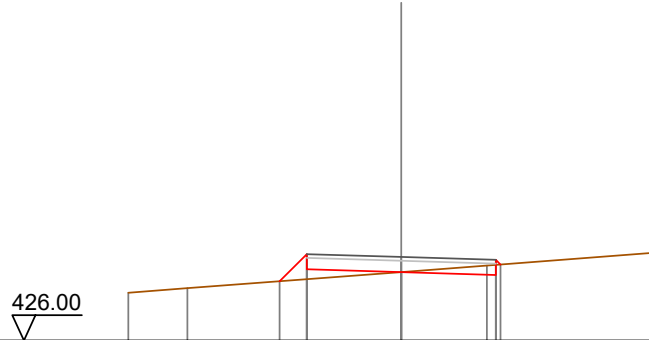

Quote Terreno		427.26	427.38		427.81	427.98	428.32
Quote Progetto				427.57	427.88	427.81	428.01
Parziali				0.72	2.50	2.50	
Progressiva				-3.22	-2.50	0.00	2.63
Dislivelli				-0.00	0.66	-0.00	-0.27
							0.00

Sezione: 117
 Progressiva: 1032.534
 Q. Progetto: 428.122

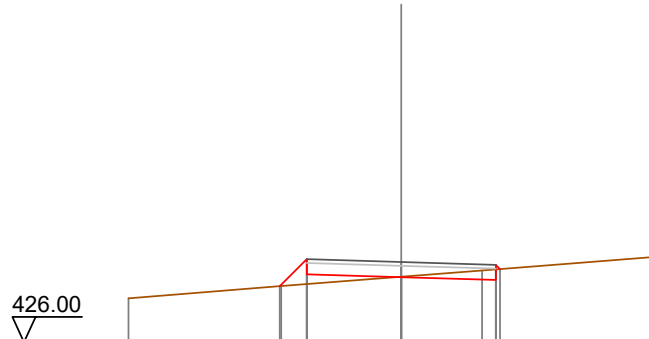

Quote Terreno		427.16		427.48	427.49	427.72	427.73	427.90	428.25
Quote Progetto				427.48	427.80	427.72	427.73	427.93	
Parziali				0.71	2.50	2.50			
Progressiva				-3.21	-2.50	0.00	2.50	2.61	
Dislivelli				0.00	0.66	-0.01	-0.28	-0.00	

Sezione: 118
 Progressiva: 1037.361
 Q. Progetto: 427.990

426.00

Quote Terreno	-427.01	-427.24			-427.60	-427.66	-427.73	-427.83	-428.15
Quote Progetto			427.34	427.66	427.59		427.51	427.82	
Parziali			0.73	2.50		2.50			
Progressiva			-3.23	-2.50	0.00		2.50	2.60	
Dislivelli			0.00	0.67	-0.02		-0.29	0.00	

Sezione: 119
 Progressiva: 1040.000
 Q. Progetto: 427.937

425.00

Quote Terreno	-427.00	-427.08			-427.57	-427.65	-427.77	-428.10
Quote Progetto			427.32	427.47	427.54		427.47	427.78
Parziali			0.55	2.50		2.50		
Progressiva			-3.05	-2.50	0.00		2.50	2.59
Dislivelli			-0.00	0.51	-0.03		-0.30	0.00

Sezione: 120
 Progressiva: 1060.000
 Q. Progetto: 427.919

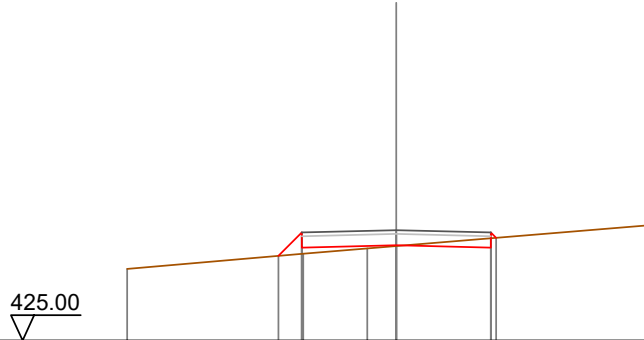

Quote Terreno	426.89		427.30	427.43	427.50		428.04
Quote Progetto			427.24	427.46	427.52	427.46	427.72
Parziali			0.62	2.50	2.50		
Progressiva			-3.12	-2.50	0.00	2.50	2.64
Dislivelli			0.00	0.56	0.02	-0.25	0.00

Sezione: 121
 Progressiva: 1075.205
 Q. Progetto: 428.004

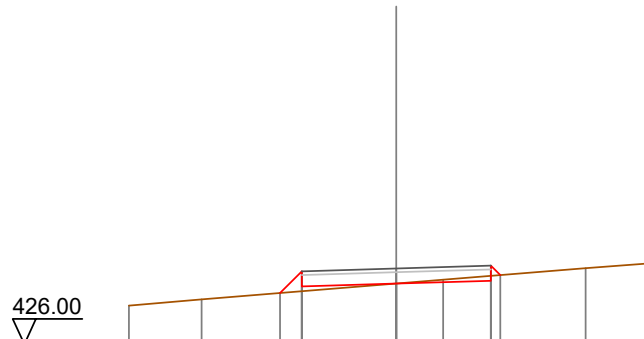

Quote Terreno	427.02	427.19		427.61	427.71		428.01	428.14
Quote Progetto			427.36	427.53	427.60	427.68	427.83	
Parziali			0.57	2.50	2.50			
Progressiva			-3.07	-2.50	0.00	2.50	2.75	
Dislivelli			0.00	0.53	-0.00	-0.13	0.00	

Sezione: 122
 Progressiva: 1080.000
 Q. Progetto: 428.031

426.00

Quote Terreno	-427.06	-427.18			427.64			-427.91	-428.00	-428.06	-428.18
Quote Progetto			427.39	427.56	427.63		427.71	427.87			
Parziali			0.56	2.50		2.50					
Progressiva			-3.06	-2.50	0.00		2.50	2.74			
Dislivelli			0.00	0.52	-0.01		-0.14	0.00			

Sezione: 123
 Progressiva: 1086.849
 Q. Progetto: 428.049

426.00

Quote Terreno	-427.07	-427.18	-427.36		427.66			-428.01	-428.20
Quote Progetto			427.40	427.57	427.65		427.72	427.88	
Parziali			0.57	2.50		2.50			
Progressiva			-3.07	-2.50	0.00		2.50	2.74	
Dislivelli			0.00	0.52	-0.01		-0.14	0.00	

Sezione: 124
 Progressiva: 1090.000
 Q. Progetto: 428.028

426.00

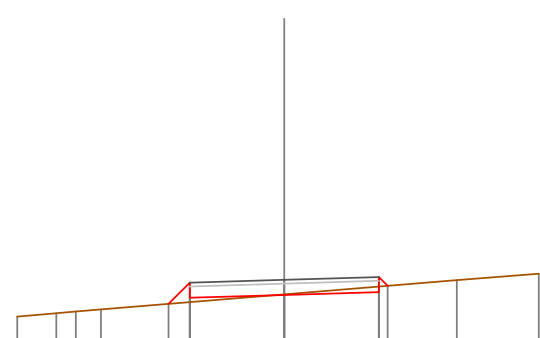

Quote Terreno	427.05	427.14	427.19	427.24		427.64		428.02	428.19
Quote Progetto					427.39	427.55	427.63	427.70	427.87
Parziali					0.56	2.50	2.50		
Progressiva					-3.06	-2.50	0.00	2.50	2.73
Dislivelli					-0.00	0.51	-0.02	-0.15	0.00

Sezione: 125
 Progressiva: 1098.492
 Q. Progetto: 427.924

425.00

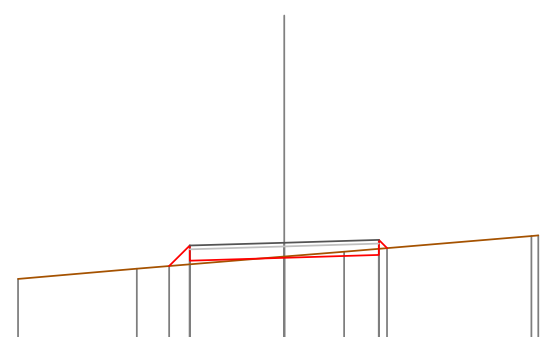

Quote Terreno	426.97	427.24			427.56	427.69		428.10	428.12
Quote Progetto			427.31	427.45	427.52	427.60	427.78		
Parziali			0.54	2.50	2.50				
Progressiva			-3.04	-2.50	0.00	2.50	2.72		
Dislivelli			0.00	0.50	-0.03	-0.16	-0.00		

Sezione: 126
 Progressiva: 1100.000
 Q. Progetto: 427.906

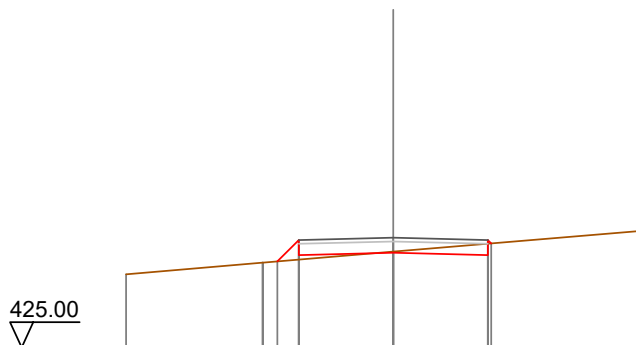

Quote Terreno	426.93	427.25	427.54	428.09
Quote Progetto		427.28 427.44	427.51 427.44	427.75
Parziali		0.56	2.50	2.50
Progressiva		-3.06 -2.50	0.00	2.50 2.59
Dislivelli		0.00 0.52	-0.03	-0.30 0.00

Sezione: 127
 Progressiva: 1109.336
 Q. Progetto: 427.790

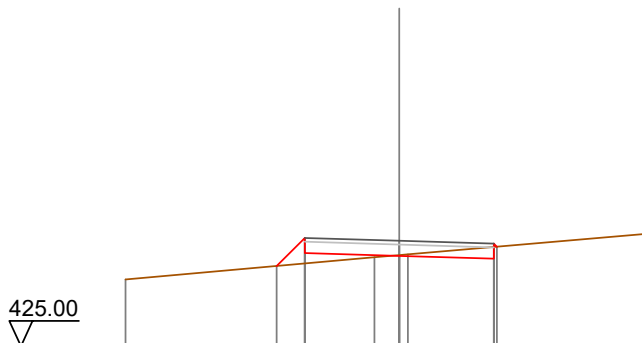

Quote Terreno	426.77	427.12	427.35	427.98
Quote Progetto		427.12 427.46	427.39 427.43	427.63
Parziali		0.74	2.50	2.50
Progressiva		-3.24 -2.50	0.00	2.50 2.58
Dislivelli		-0.00 0.68	-0.02	-0.31 -0.00

Sezione: 128
 Progressiva: 1110.000
 Q. Progetto: 427.782

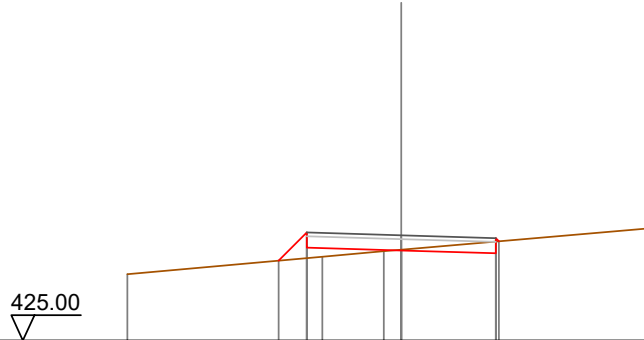

Quote Terreno		426.76		427.22		427.36	427.40				427.97
Quote Progetto			427.11	427.46		427.38		427.31	427.62		
Parziali			0.74	2.50		2.50					
Progressiva			-3.24	-2.50		0.00		2.50	2.58		
Dislivelli			-0.00	0.68		-0.02		-0.31	0.00		

Sezione: 129
 Progressiva: 1116.908
 Q. Progetto: 427.747

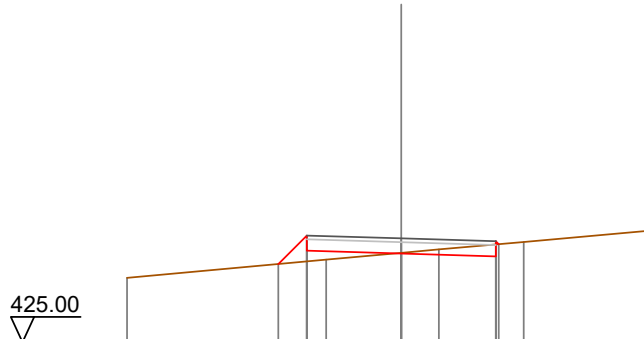

Quote Terreno		426.70		427.18		427.37	427.46				427.95
Quote Progetto			427.07	427.42		427.35		427.27	427.59		
Parziali			0.75	2.50		2.50					
Progressiva			-3.25	-2.50		0.00		2.50	2.58		
Dislivelli			-0.00	0.68		-0.02		-0.31	0.00		

Sezione: 130
 Progressiva: 1120.000
 Q. Progetto: 427.762

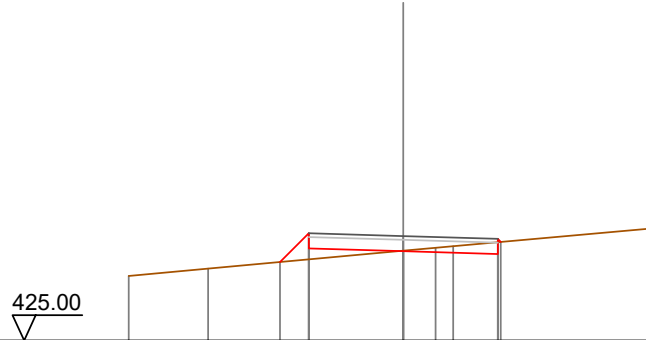

Quote Terreno		426.71		426.90				427.38	427.45	427.50		427.97
Quote Progetto					427.08	427.44		427.36		427.29	427.61	
Parziali					0.76	2.50		2.50				
Progressiva					-3.26	-2.50		0.00		2.50	2.58	
Dislivelli					0.00	0.69		-0.01		-0.31	0.00	

Sezione: 131
 Progressiva: 1124.480
 Q. Progetto: 427.818

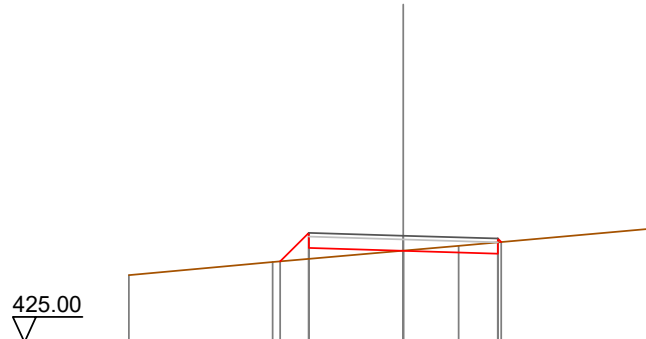

Quote Terreno		426.78		427.12				427.42	427.55		428.01
Quote Progetto				427.14	427.49		427.42		427.34	427.65	
Parziali				0.76	2.50		2.50				
Progressiva				-3.26	-2.50		0.00		2.50	2.59	
Dislivelli				0.00	0.69		-0.00		-0.30	0.00	

Sezione: 132
 Progressiva: 1140.000
 Q. Progetto: 428.070

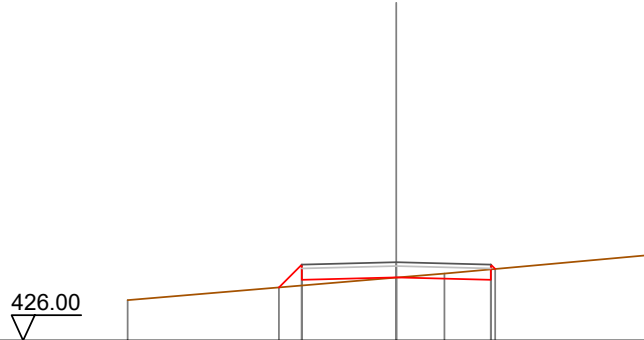

Quote Terreno	427.07		427.66	427.77		428.26
Quote Progetto		427.40	427.61	427.67	427.61	427.89
Parziali		0.60	2.50	2.50		
Progressiva		-3.10	-2.50	0.00	2.50	2.61
Dislivelli		-0.00	0.55	0.00	-0.28	-0.00

Sezione: 133
 Progressiva: 1160.000
 Q. Progetto: 428.394

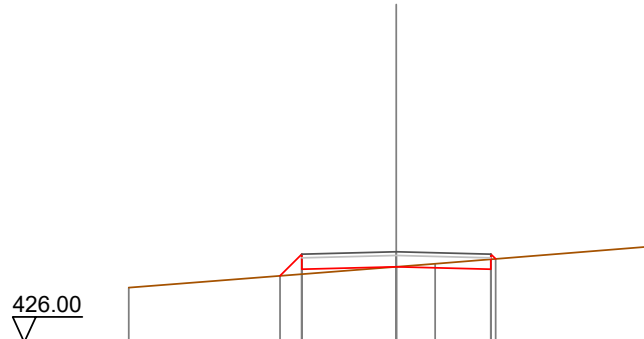

Quote Terreno	427.45		428.00	428.08		428.53
Quote Progetto		427.76	427.93	427.99	427.93	428.21
Parziali		0.57	2.50	2.50		
Progressiva		-3.07	-2.50	0.00	2.50	2.63
Dislivelli		-0.00	0.53	-0.00	-0.26	0.00

Sezione: 134
 Progressiva: 1180.000
 Q. Progetto: 428.718

426.00

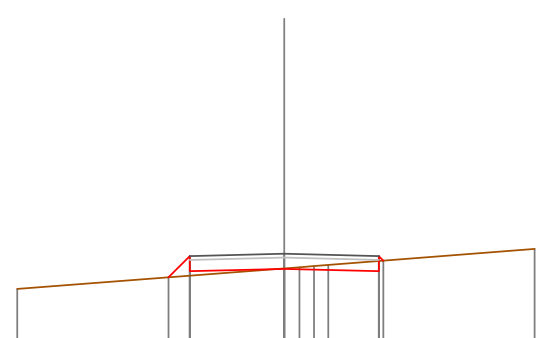

Quote Terreno	427.79			428.33	428.36	428.39	428.42		428.84
Quote Progetto		428.09	428.26	428.32	428.26	428.53			
Parziali		0.56	2.50		2.50				
Progressiva		-3.06	-2.50	0.00	2.50	2.62			
Dislivelli		0.00	0.52	-0.01	-0.27	-0.00			

Sezione: 135
 Progressiva: 1200.000
 Q. Progetto: 429.002

427.00

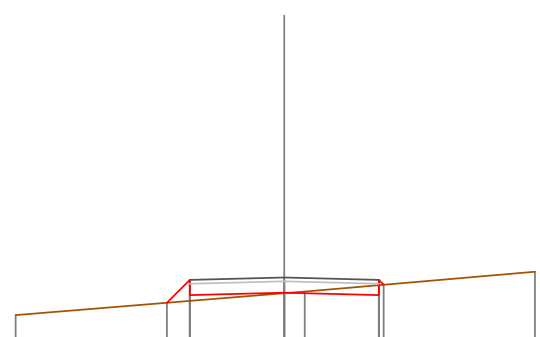

Quote Terreno	428.01			428.59	428.63			429.16
Quote Progetto		428.34	428.54	428.60	428.54	428.81		
Parziali		0.60	2.50		2.50			
Progressiva		-3.10	-2.50	0.00	2.50	2.63		
Dislivelli		0.00	0.55	0.01	-0.26	0.00		

Sezione: 136
 Progressiva: 1219.493
 Q. Progetto: 429.005

427.00

Quote Terreno		428.05		428.62	428.65		429.15
Quote Progetto			428.37	428.67	428.61	428.54	428.83
Parziali			0.70	2.50	2.50		
Progressiva			-3.20	-2.50	0.00	2.50	2.61
Dislivelli			0.00	0.64	-0.02	-0.28	-0.00

Sezione: 137
 Progressiva: 1220.000
 Q. Progetto: 429.005

427.00

Quote Terreno		428.05		428.62	428.64		429.15
Quote Progetto			428.36	428.67	428.61	428.54	428.83
Parziali			0.70	2.50	2.50		
Progressiva			-3.20	-2.50	0.00	2.50	2.62
Dislivelli			0.00	0.65	-0.01	-0.28	0.00

Sezione: 138
 Progressiva: 1230.000
 Q. Progetto: 429.005

427.00

Quote Terreno	428.09									429.12
Quote Progetto		428.40	428.67			428.61		428.54	428.82	
Parziali			0.67	2.50		2.50				
Progressiva		-3.17	-2.50		0.00		2.50	2.62		
Dislivelli		0.00	0.62		-0.03		-0.27	0.00		

Sezione: 139
 Progressiva: 1231.042
 Q. Progetto: 429.006

427.00

Quote Terreno	428.10									429.12
Quote Progetto		428.41	428.67			428.61		428.54	428.83	
Parziali			0.66	2.50		2.50				
Progressiva		-3.16	-2.50		0.00		2.50	2.62		
Dislivelli		0.00	0.61		-0.03		-0.27	0.00		

Sezione: 140
 Progressiva: 1240.000
 Q. Progetto: 429.108

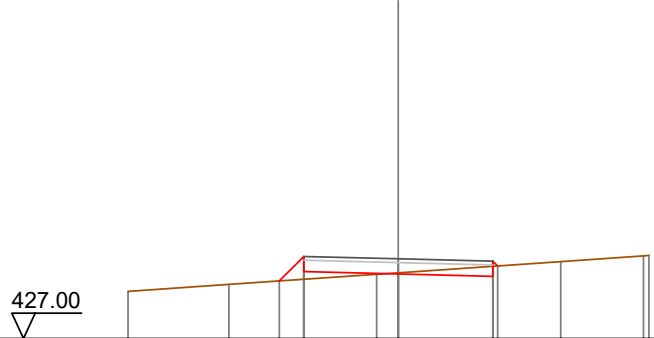

Quote Terreno	428.24	428.43		428.70	428.74		429.03	429.19	429.20
Quote Progetto			428.52	428.77	428.71	428.65	428.92		
Parziali			0.65	2.50	2.50				
Progressiva			-3.15	-2.50	0.00	2.50	2.63		
Dislivelli			0.00	0.60	-0.03	-0.26	0.00		

Sezione: 141
 Progressiva: 1242.591
 Q. Progetto: 429.167

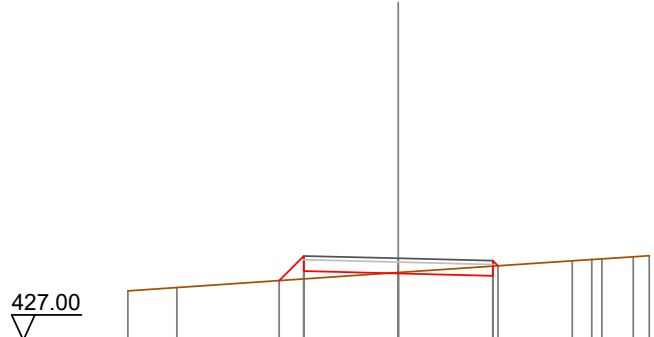

Quote Terreno	428.31	428.40		428.79		429.10	429.15	429.21	429.24
Quote Progetto			428.58	428.83	428.77	428.70	428.97		
Parziali			0.65	2.50	2.50				
Progressiva			-3.15	-2.50	0.00	2.50	2.64		
Dislivelli			0.00	0.61	-0.02	-0.25	-0.00		

Sezione: 142
 Progressiva: 1260.000
 Q. Progetto: 429.596

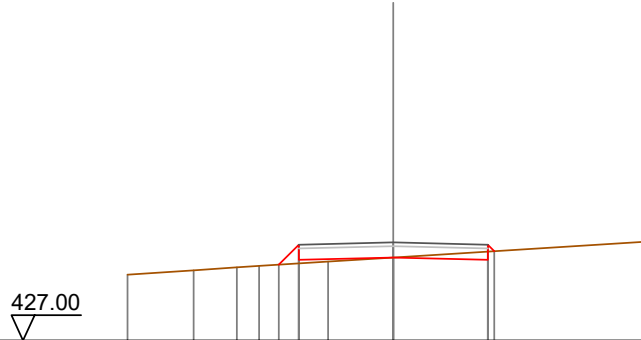

Quote Terreno	-428.74	-428.86	-428.93	-428.97	-429.09	-429.19	-429.61
Quote Progetto			429.01	429.13		429.20	429.13
Parziali			0.53	2.50		2.50	
Progressiva			-3.03	-2.50		0.00	2.50
Dislivelli			0.00	0.49		0.00	-0.22

Sezione: 143
 Progressiva: 1280.000
 Q. Progetto: 430.088

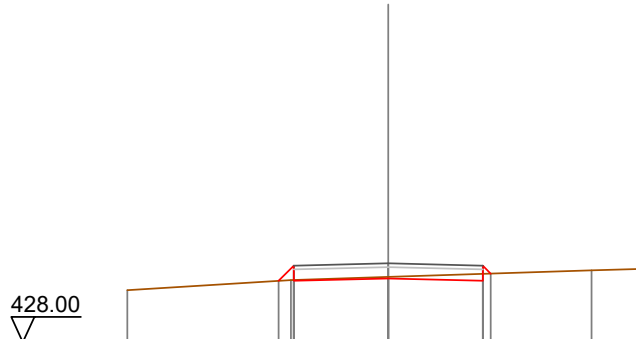

Quote Terreno	-429.38	-429.65	-429.73	-429.90	-429.94
Quote Progetto		429.62	429.69	429.63	429.81
Parziali		0.40	2.50		2.50
Progressiva		-2.90	-2.50		2.50
Dislivelli		0.00	0.38		-0.18

Sezione: 144
 Progressiva: 1299.677
 Q. Progetto: 430.373

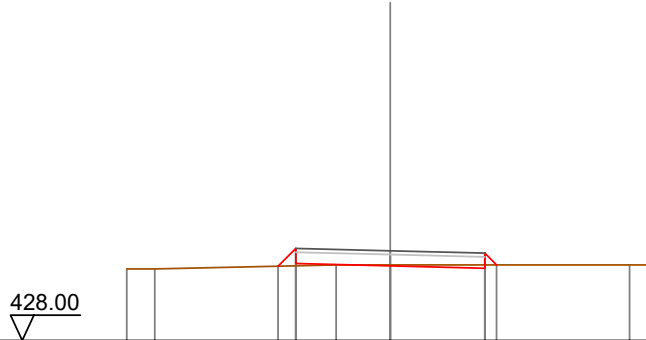

Quote Terreno	-429.89	-429.89		-430.00	-430.00		-430.00	-430.00
Quote Progetto			429.97	430.04		429.97	429.91	430.00
Parziali			0.47	2.50		2.50	0.31	
Progressiva			-2.97	-2.50		0.00	2.50	2.81
Dislivelli			-0.00	0.46		-0.03	-0.09	0.00

Sezione: 145
 Progressiva: 1300.000
 Q. Progetto: 430.372

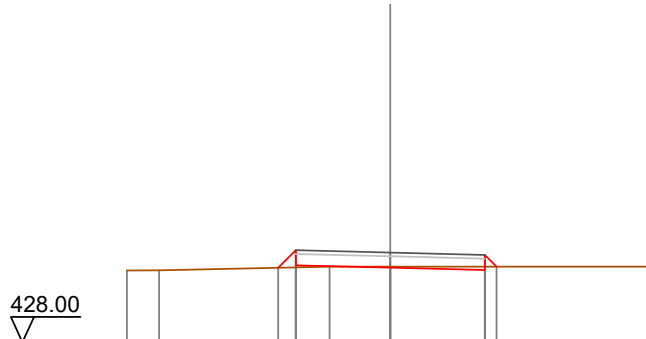

Quote Terreno	-429.90	-429.90		-430.00	-430.00		-430.00	-430.00
Quote Progetto			429.97	430.03		429.97	429.91	430.00
Parziali			0.47	2.50		2.50	0.31	
Progressiva			-2.97	-2.50		0.00	2.50	2.81
Dislivelli			0.00	0.45		-0.03	-0.09	0.00

Sezione: 146
 Progressiva: 1301.347
 Q. Progetto: 430.369

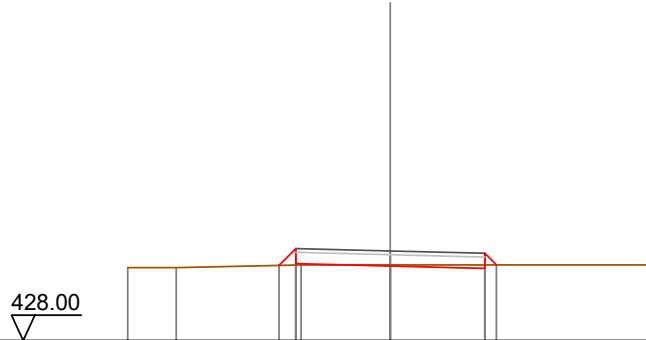

Quote Terreno	-429.93	-429.93	430.00	430.00	430.00
Quote Progetto			429.99	429.97	429.91
Parziali			0.44	2.50	2.50
Progressiva			-2.94	0.00	2.50
Dislivelli			-0.00	-0.03	-0.09

Sezione: 147
 Progressiva: 1303.017
 Q. Progetto: 430.365

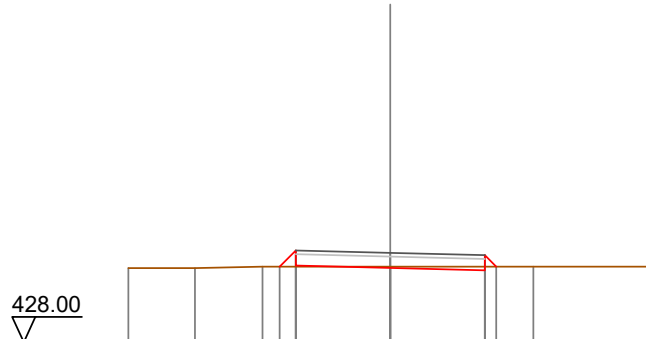

Quote Terreno	-429.96	-429.96	430.00	430.00	430.00
Quote Progetto			430.00	429.97	429.90
Parziali			0.43	2.50	2.50
Progressiva			-2.93	0.00	2.50
Dislivelli			0.00	-0.03	-0.10

Sezione: 148
 Progressiva: 1320.000
 Q. Progetto: 430.324

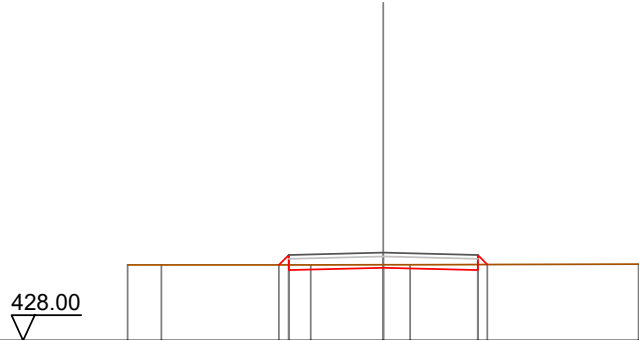

Quote Terreno	430.00	430.00	430.00	430.00	430.00	430.02
Quote Progetto			430.00	429.86	429.92	430.01
Parziali			0.26	2.50	2.50	
Progressiva			-2.76	-2.50	0.00	2.50
Dislivelli			0.00	0.26	-0.08	-0.15

Sezione: 149
 Progressiva: 1338.704
 Q. Progetto: 430.353

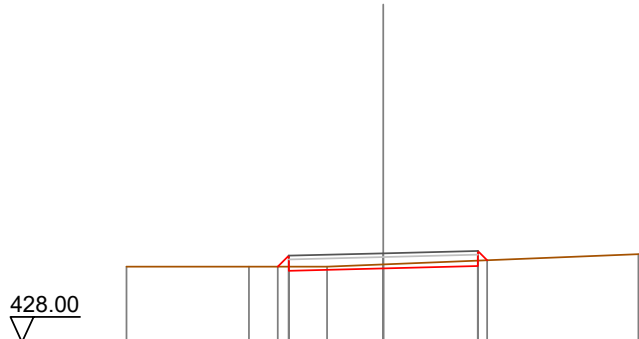

Quote Terreno	430.00	430.00	430.00	430.06	430.06	430.33
Quote Progetto			430.00	429.89	429.95	430.02
Parziali			0.29	2.50	2.50	
Progressiva			-2.79	-2.50	0.00	2.50
Dislivelli			0.00	0.29	-0.11	-0.14

Sezione: 150
 Progressiva: 1340.000
 Q. Progetto: 430.373

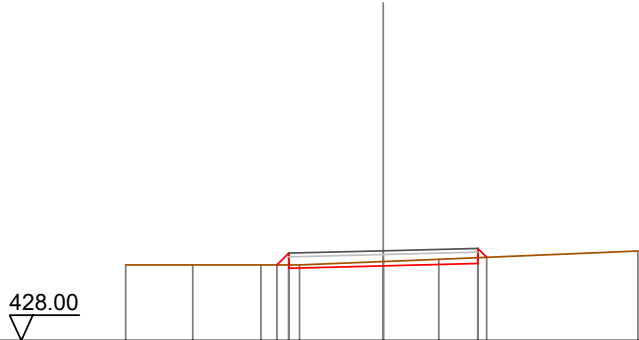

Quote Terreno		-430.00	-430.00	-430.00	-430.00	-430.09	-430.15		-430.37
Quote Progetto				430.00	429.91	429.97	430.04	430.20	
Parziali				0.31	2.50	2.50			
Progressiva				-2.81	-2.50	0.00	2.50	2.73	
Dislivelli				0.00	0.31	-0.12	-0.16	-0.00	

Sezione: 151
 Progressiva: 1350.000
 Q. Progetto: 430.602

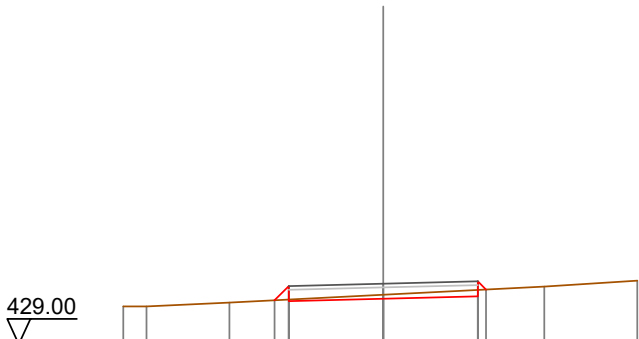

Quote Terreno		-430.00	-430.00	-430.10		-430.31		-430.52	-430.66
Quote Progetto				430.16	430.14	430.20	430.26	430.45	
Parziali				0.38	2.50	2.50			
Progressiva				-2.88	-2.50	0.00	2.50	2.72	
Dislivelli				0.00	0.36	-0.11	-0.17	-0.00	

Sezione: 152
 Progressiva: 1351.409
 Q. Progetto: 430.636

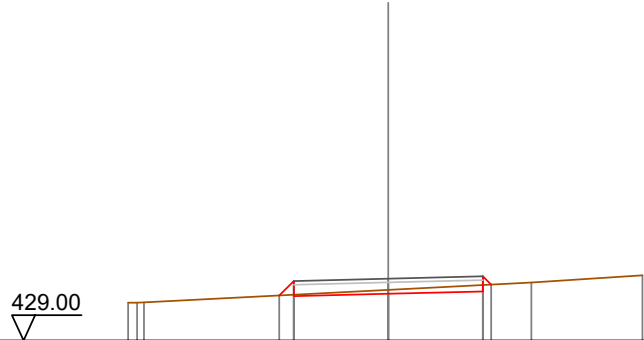

Quote Terreno	430.00	430.01			430.19	430.17	430.24	430.34		430.53	430.72
Quote Progetto					430.19	430.17	430.24	430.30	430.48		
Parziali					0.38	2.50	2.50				
Progressiva					-2.88	-2.50	0.00	2.50	2.72		
Dislivelli					-0.00	0.36	-0.10	-0.17	0.00		

Sezione: 153
 Progressiva: 1360.014
 Q. Progetto: 430.843

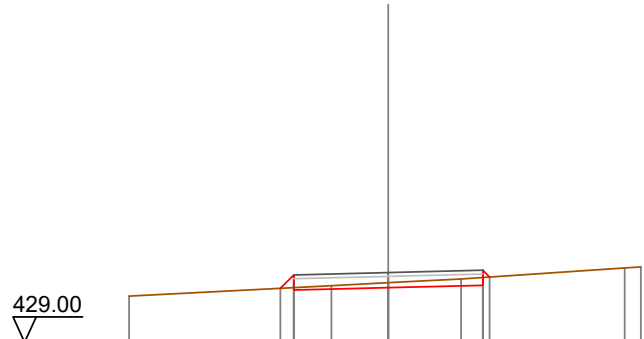

Quote Terreno	430.22				430.43	430.38	430.50	430.57	430.68		430.96	430.99
Quote Progetto					430.43	430.38	430.44	430.51	430.73			
Parziali					0.35	2.50	2.50					
Progressiva					-2.85	-2.50	0.00	2.50	2.68			
Dislivelli					-0.00	0.34	-0.13	-0.21	0.00			

Sezione: 153
 Progressiva: 1360.015
 Q. Progetto: 430.843

429.00

Quote Terreno	-430.22	-430.50	-430.57	-430.68	-430.96	-430.99
Quote Progetto		430.43 430.38	430.44	430.51 430.73		
Parziali		0.35	2.50	2.50		
Progressiva		2.85 2.50	0.00	2.50 2.68		
Dislivelli		0.00 0.34	-0.13	-0.21 0.00		

Sezione: 154
 Progressiva: 1364.113
 Q. Progetto: 430.941

429.00

Quote Terreno	-430.32	-430.66	-430.77	-431.10
Quote Progetto		430.53 430.48	430.54	430.60 430.84
Parziali		0.35	2.50	2.50
Progressiva		2.85 2.50	0.00	2.50 2.67
Dislivelli		-0.00 0.33	-0.14	-0.22 0.00

Sezione: 155
 Progressiva: 1366.602
 Q. Progetto: 431.001

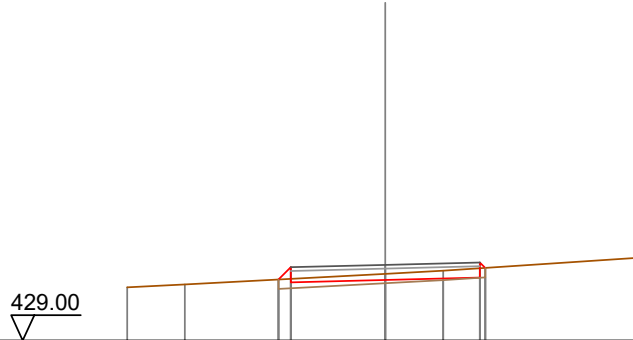

Quote Terreno	-430.41	-430.48			430.76	-430.85		-431.19
Quote Progetto			430.61	430.54	430.60	430.66	430.92	
Parziali			0.32	2.50		2.50		
Progressiva			-2.82	-2.50	0.00	2.50	2.64	
Dislivelli			0.00	0.31	-0.16	-0.25	0.00	

Sezione: 156
 Progressiva: 1370.000
 Q. Progetto: 431.082

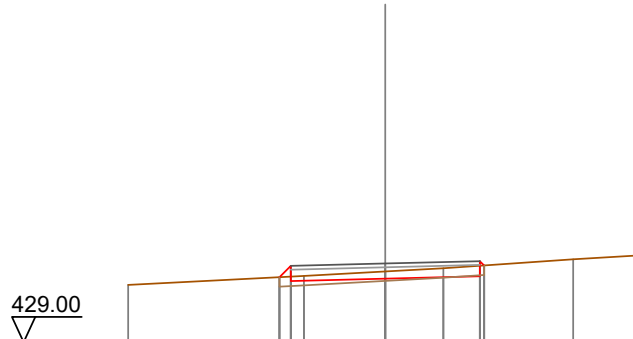

Quote Terreno	-430.52				430.87	-430.96		-431.19	-431.29
Quote Progetto			430.72	430.62	430.68	430.74	431.03		
Parziali			0.30	2.50		2.50			
Progressiva			-2.80	-2.50	0.00	2.50	2.61		
Dislivelli			0.00	0.29	-0.19	-0.28	0.00		

Sezione: 157
 Progressiva: 1380.000
 Q. Progetto: 431.265

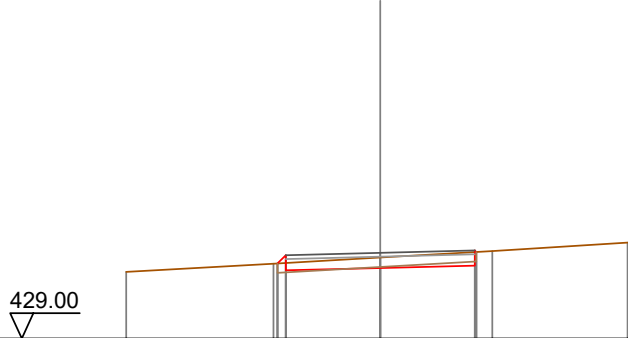

Quote Terreno	430.76	430.98	431.14	431.31	431.54
Quote Progetto		430.99 430.80	430.87	430.93 431.29	
Parziali			2.50	2.50	
Progressiva		-2.72 -2.50	0.00	2.50 2.54	
Dislivelli		-0.00 0.21	-0.28	-0.36 -0.00	

Sezione: 158
 Progressiva: 1390.000
 Q. Progetto: 431.327

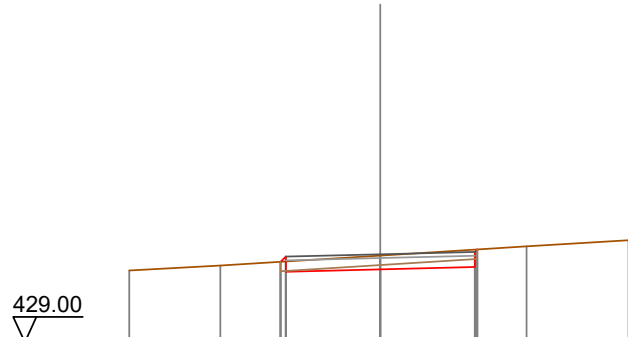

Quote Terreno	430.90	431.03	431.29	431.54	431.70
Quote Progetto			430.93 431.29	430.99 431.45	
Parziali			2.50	2.50	
Progressiva		-2.64 -2.50	0.00	2.50 2.56	
Dislivelli		0.00 0.13	-0.37	-0.46 0.00	

Sezione: 159
 Progressiva: 1400.000
 Q. Progetto: 431.267

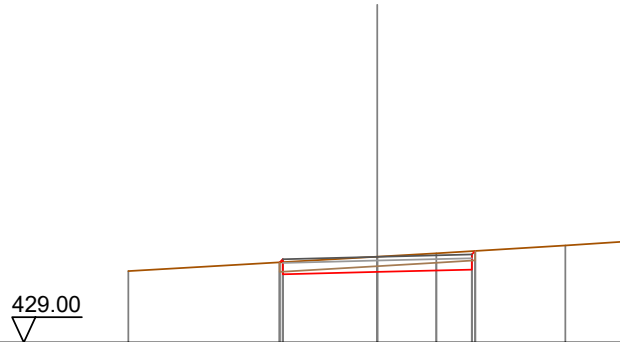

Quote Terreno	-430.89								
Quote Progetto		431.12	430.80	430.87	431.27	431.36	430.93	431.42	
Parziali			2.50		2.50				
Progressiva		-2.58	-2.50	0.00		2.50	2.59		
Dislivelli		0.00	0.08	-0.40		-0.49	-0.00		

Sezione: 160
 Progressiva: 1410.000
 Q. Progetto: 431.085

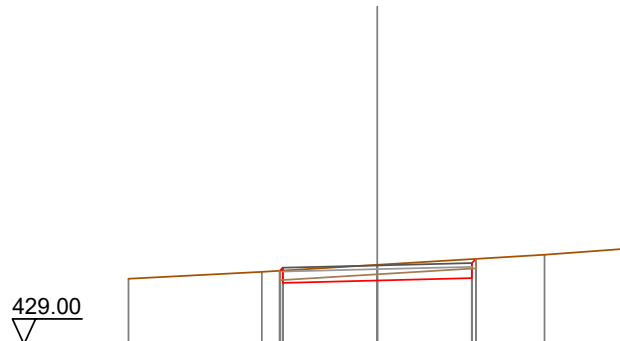

Quote Terreno	-430.73								
Quote Progetto		430.94	430.62	430.69	431.10	431.37	431.53		
Parziali			2.50		2.50				
Progressiva		-2.58	-2.50	0.00		2.50	2.61		
Dislivelli		0.00	0.08	-0.41		-0.50	0.00		

Sezione: 161
 Progressiva: 1415.251
 Q. Progetto: 430.941

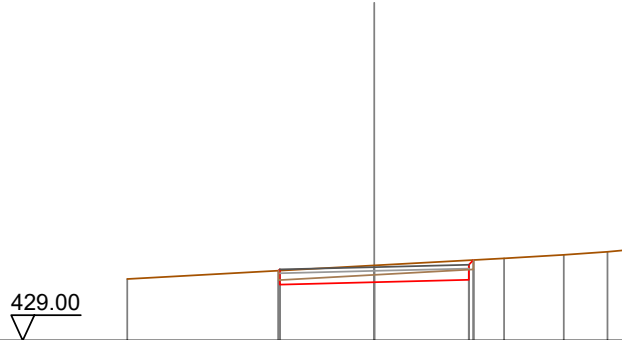

Quote Terreno	-430.63		430.98		-431.17		-431.27		-431.35		-431.39
Quote Progetto		430.85	430.48	430.54	430.60	431.13					
Parziali		2.50		2.50							
Progressiva		-2.53	-2.50	0.00	2.50	2.63					
Dislivelli		0.00	0.03	-0.44	-0.52	0.00					

Sezione: 162
 Progressiva: 1420.000
 Q. Progetto: 430.782

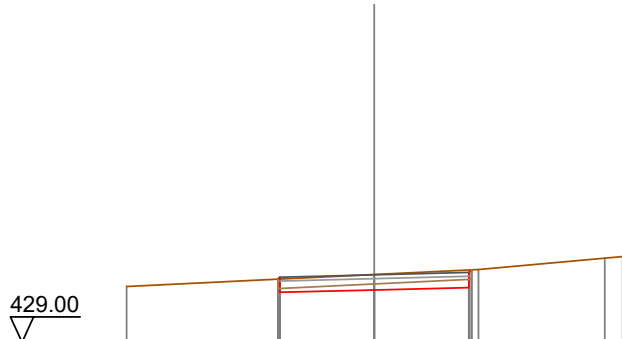

Quote Terreno	-430.48		430.79		430.93		-431.22		-431.27
Quote Progetto		430.67	430.32	430.38	430.44	430.92			
Parziali		2.50		2.50					
Progressiva		-2.55	-2.50	0.00	2.50	2.57			
Dislivelli		-0.00	0.05	-0.41	-0.47	0.00			

Sezione: 163
 Progressiva: 1430.000
 Q. Progetto: 430.383

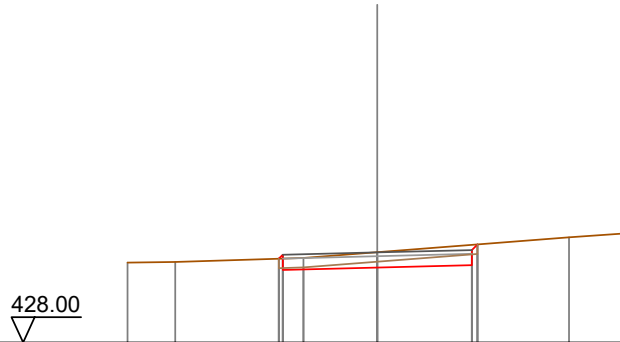

Quote Terreno	-430.11	-430.13	-430.24	-430.39	-430.78	-430.89
Quote Progetto			430.22 429.92	429.98	430.05 430.59	
Parziali			2.50	2.50		
Progressiva			-2.60 -2.50	0.00	2.50 2.65	
Dislivelli			-0.00 0.10	-0.41	-0.54 0.00	

Sezione: 164
 Progressiva: 1440.000
 Q. Progetto: 430.066

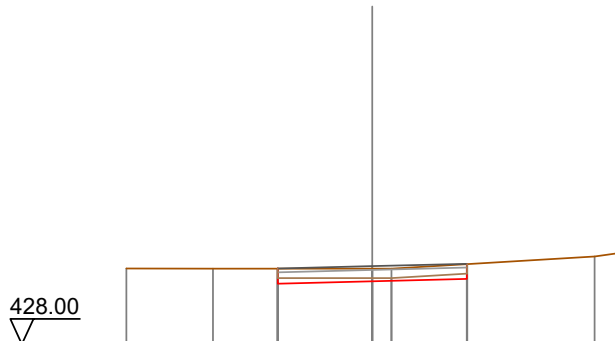

Quote Terreno	-430.00	-430.00	-430.00	-430.00	-430.32	-430.41
Quote Progetto			429.60	429.67	429.73	
Parziali			2.50	2.50		
Progressiva			-2.50	0.00	2.50	
Dislivelli			0.00	-0.34	-0.39	

Sezione: 165
 Progressiva: 1450.000
 Q. Progetto: 429.929

428.00

Quote Terreno	429.99	430.00	430.00	430.00	430.00	430.00	430.08
Quote Progetto			430.00	429.47	429.53	429.59	
Parziali			2.50		2.50		
Progressiva			-2.63	-2.50	0.00	2.50	
Dislivelli			0.00	-0.13	-0.47	-0.41	

Sezione: 166
 Progressiva: 1460.000
 Q. Progetto: 429.771

428.00

Quote Terreno	429.89	429.87	429.92	429.95	429.94
Quote Progetto		429.88	429.37	429.43	
Parziali		429.31	2.50	2.50	429.95
Progressiva		-2.67	-2.50	0.00	2.50
Dislivelli		0.00	-0.17	-0.54	-0.51
					0.00

Sezione: 167
 Progressiva: 1463.901
 Q. Progetto: 429.659

428.00

Quote Terreno	429.77	429.77	429.74	429.76	429.82	429.83
Quote Progetto			429.75	429.26	429.32	429.79
Parziali			2.50	2.50		
Progressiva			-2.65	0.00	2.50	2.57
Dislivelli			0.00	-0.50	-0.47	0.00

Sezione: 168
 Progressiva: 1477.862
 Q. Progetto: 429.005

427.00

Quote Terreno	428.90	428.91	428.94	428.95	428.97	429.01
Quote Progetto			428.61	428.61	428.54	428.96
Parziali			2.50	2.50		
Progressiva			-2.64	0.00	2.50	2.52
Dislivelli			-0.00	-0.34	-0.42	-0.00

Sezione: 169
 Progressiva: 1479.721
 Q. Progetto: 428.889

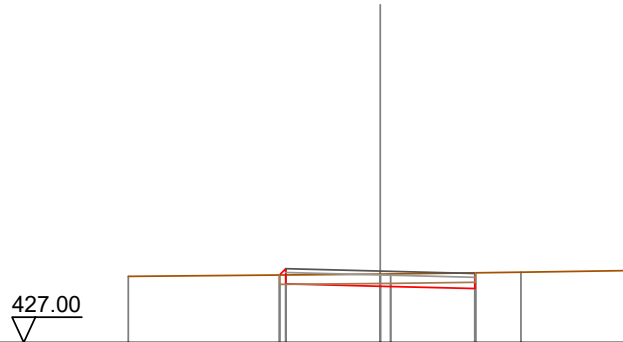

Quote Terreno		428.75		428.81	428.81		428.86		428.90
Quote Progetto			428.79	428.55	428.49		428.43		
Parziali				2.50		2.50			
Progressiva			-2.67	-2.50	0.00		2.50		
Dislivelli			0.00	0.16	-0.32		-0.42		

Sezione: 170
 Progressiva: 1480.000
 Q. Progetto: 428.871

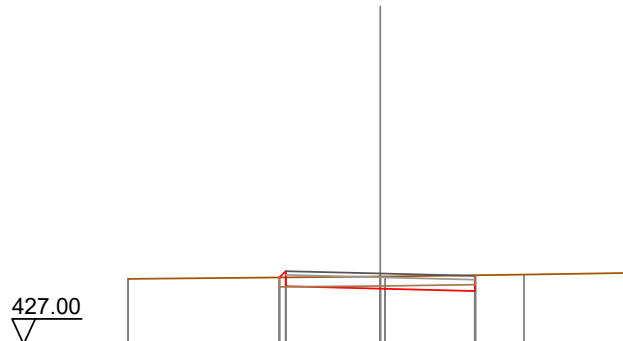

Quote Terreno		428.73		428.79	428.79		428.84		428.88
Quote Progetto			428.77	428.53	428.47		428.41		
Parziali				2.50		2.50			
Progressiva			-2.67	-2.50	0.00		2.50		
Dislivelli			0.00	0.17	-0.32		-0.42		

Sezione: 171
 Progressiva: 1481.579
 Q. Progetto: 428.765

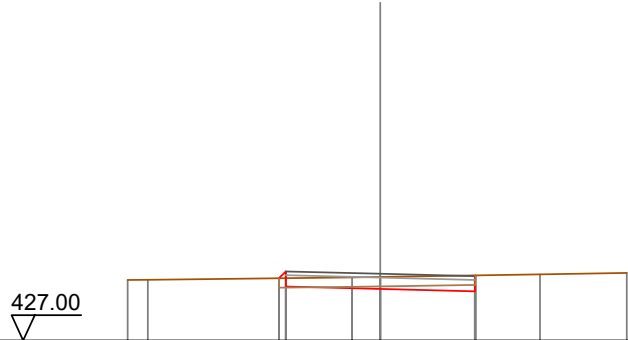

Quote Terreno		428.60	428.61		428.67	428.68		428.75	428.79
Quote Progetto				428.65	428.43	428.37		428.30	
Parziali					2.50		2.50		
Progressiva				-2.68	-2.50	0.00		2.50	
Dislivelli				-0.00	0.18	-0.32		-0.42	

Sezione: 172
 Progressiva: 1500.000
 Q. Progetto: 427.378

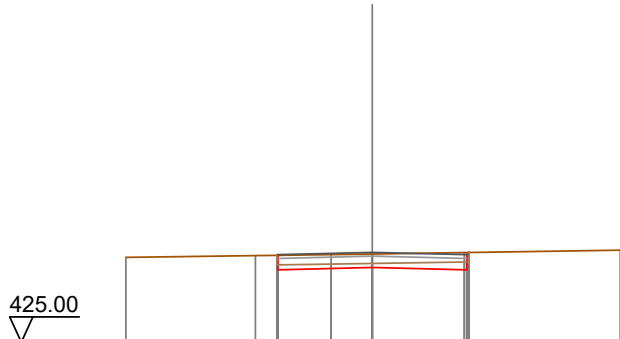

Quote Terreno		427.24		427.29		427.32	427.33		427.37	427.43
Quote Progetto				426.92		426.98	426.92		427.37	
Parziali					2.50		2.50			
Progressiva				-2.52		0.00		2.50	2.56	
Dislivelli				-0.00		-0.36		-0.46	0.00	

Sezione: 173
 Progressiva: 1501.750
 Q. Progetto: 427.245

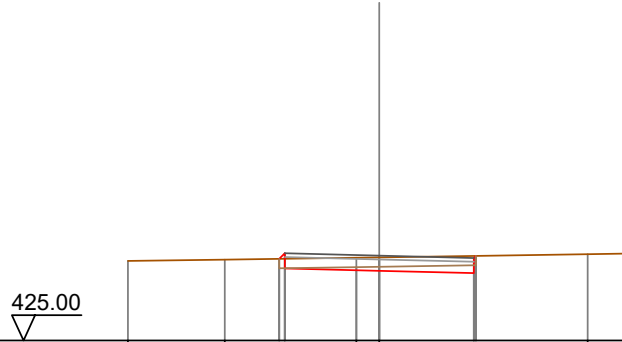

Quote Terreno	-427.11	-427.14	-427.16	-427.19	-427.20	-427.28	-427.30
Quote Progetto			427.16	426.91	426.84	426.78	427.24
Parziali			2.50	2.50			
Progressiva			-2.65	-2.50	0.00	2.50	2.56
Dislivelli			0.00	0.14	-0.35	-0.46	0.00

Sezione: 174
 Progressiva: 1504.653
 Q. Progetto: 427.024

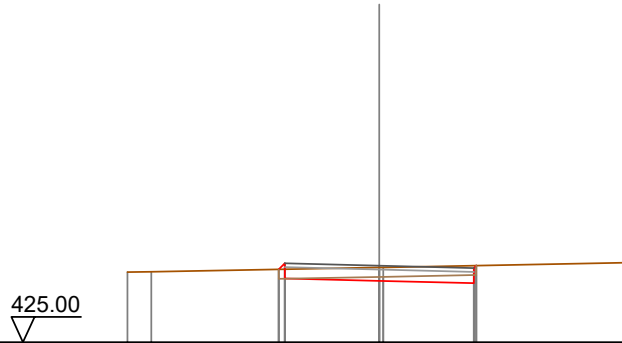

Quote Terreno	-426.85	-426.86	-426.93	-426.96	-426.98	-427.11	
Quote Progetto			426.93	426.69	426.62	426.56	427.03
Parziali			2.50	2.50			
Progressiva			-2.66	-2.50	0.00	2.50	2.57
Dislivelli			0.00	0.16	-0.35	-0.47	0.00

Sezione: 175
 Progressiva: 1507.556
 Q. Progetto: 426.803

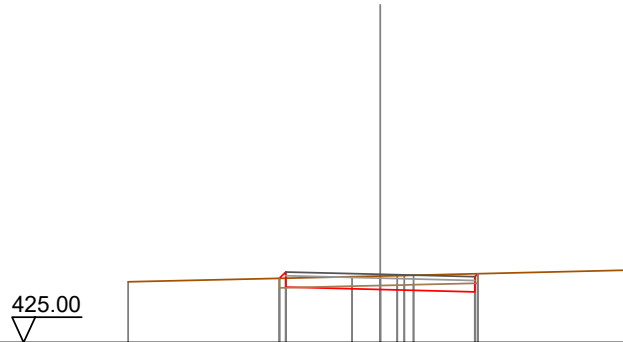

Quote Terreno	-426.61	-426.74	-426.76	-426.78	-426.91	
Quote Progetto		-426.70	-426.47	-426.40	-426.34	-426.82
Parziali		2.50	2.50			
Progressiva		-2.67	-2.50	0.00	2.50	2.58
Dislivelli		0.00	0.16	-0.36	-0.48	-0.00

Sezione: 176
 Progressiva: 1520.000
 Q. Progetto: 425.855

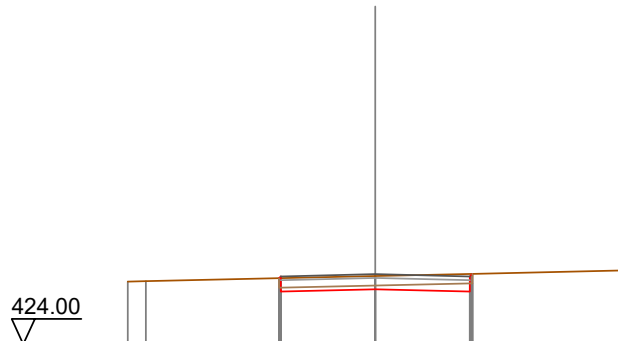

Quote Terreno	-425.66	-425.67	-425.80	-425.86	-425.95	
Quote Progetto		-425.75	-425.39	-425.46	-425.39	-425.86
Parziali		2.50	2.50			
Progressiva		-2.55	-2.50	0.00	2.50	2.57
Dislivelli		0.00	0.04	-0.35	-0.47	0.00

Sezione: 177
 Progressiva: 1540.000
 Q. Progetto: 424.332

422.00

Quote Terreno	-424.12	-424.13	-424.16	424.19	424.19	424.24	424.24	424.36	424.37
Quote Progetto				424.19	423.87	423.93	423.87	424.29	
Parziali				2.50		2.50			
Progressiva				-2.58	-2.50	0.00	2.50	2.52	
Dislivelli				0.00	0.07	-0.31	-0.42	-0.00	

Sezione: 178
 Progressiva: 1560.000
 Q. Progetto: 422.810

421.00

Quote Terreno	-422.60	-422.69	-422.71	-422.81	-422.81
Quote Progetto		422.67	422.35	422.41	422.35
Parziali		2.50		2.50	
Progressiva		-2.58	-2.50	0.00	2.50
Dislivelli		0.00	0.07	-0.30	-0.41

Sezione: 179
 Progressiva: 1580.000
 Q. Progetto: 421.296

419.00

Quote Terreno	-421.20		421.28	-421.30	-421.31	-421.33
Quote Progetto		420.83	420.90	420.83	421.30	
Parziali		2.50	2.50			
Progressiva		-2.52	0.00	2.50	2.57	
Dislivelli		0.00	-0.38	-0.47	0.00	

Sezione: 180
 Progressiva: 1584.512
 Q. Progetto: 421.001

419.00

Quote Terreno	-420.92		420.95	420.98	421.00	-421.02
Quote Progetto		420.95	420.66	420.60	420.54	421.00
Parziali		2.50	2.50			
Progressiva		-2.62	-2.50	0.00	2.50	2.57
Dislivelli		0.00	0.11	-0.37	-0.47	-0.00

Sezione: 181
 Progressiva: 1590.000
 Q. Progetto: 420.698

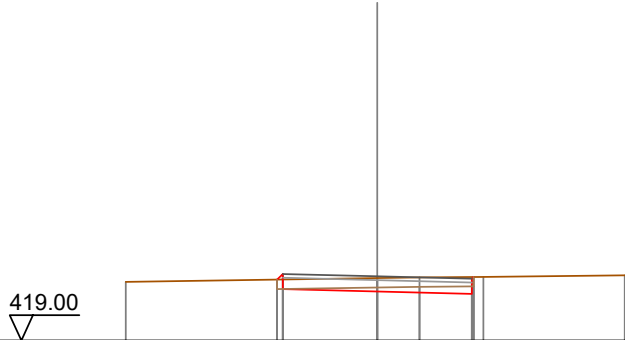

Quote Terreno	420.55			420.65	420.67	420.68	420.73
Quote Progetto		420.61	420.36	420.30		420.24	420.68
Parziali			2.50		2.50		
Progressiva		-2.65	-2.50	0.00		2.50	2.55
Dislivelli		0.00	0.15	-0.35		-0.45	0.00

Sezione: 182
 Progressiva: 1590.534
 Q. Progetto: 420.671

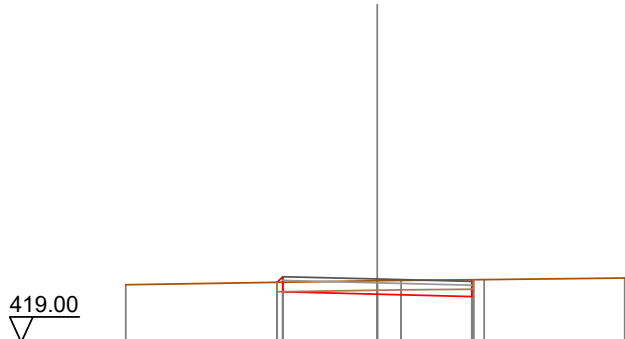

Quote Terreno	420.52			420.63	420.64	420.66	420.70
Quote Progetto		420.58	420.33	420.27		420.21	420.65
Parziali			2.50		2.50		
Progressiva		-2.65	-2.50	0.00		2.50	2.54
Dislivelli		-0.00	0.15	-0.35		-0.44	0.00

Sezione: 183
 Progressiva: 1596.555
 Q. Progetto: 420.414

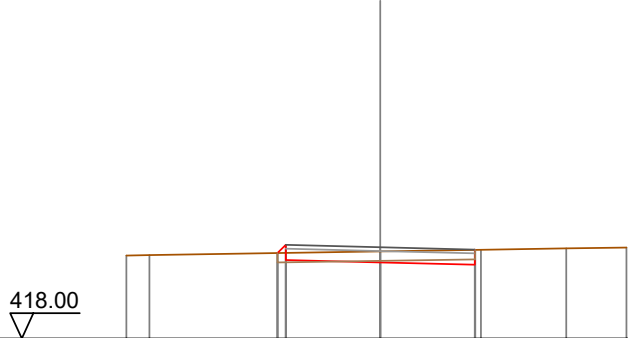

Quote Terreno	-420.19	-420.21			420.30		-420.34		-420.39	-420.41
Quote Progetto			420.26	420.08	420.01		419.95			
Parziali				2.50		2.50				
Progressiva			-2.72	-2.50	0.00		2.50			
Dislivelli			0.00	0.21		-0.29		-0.39		

Sezione: 184
 Progressiva: 1600.000
 Q. Progetto: 420.299

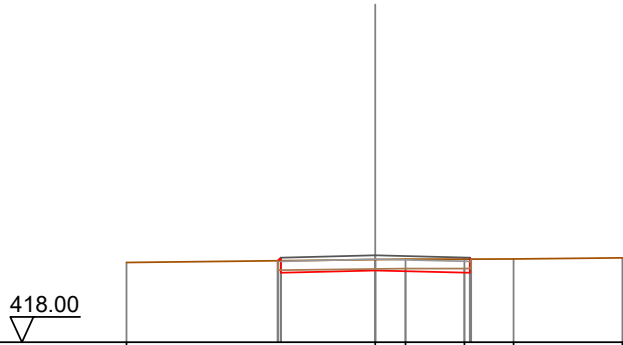

Quote Terreno	-420.11				420.19		-420.20		-420.20	-420.23
Quote Progetto		420.16	419.84		419.90		419.84	420.20		
Parziali			2.50		2.50					
Progressiva		-2.58	-2.50		0.00		2.50	2.54		
Dislivelli		-0.00	0.08		-0.29		-0.36	0.00		

Sezione: 185
 Progressiva: 1620.000
 Q. Progetto: 419.895

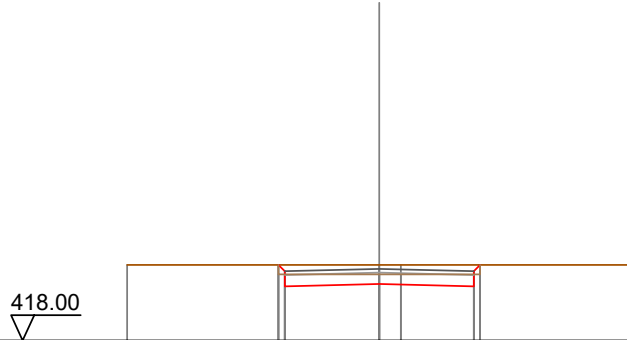

Quote Terreno	-420.00	-420.00	-420.00	-420.00
Quote Progetto	420.00	419.43	419.50	419.43
Parziali		2.50	2.50	
Progressiva	-2.67	-2.50	0.00	2.50
Dislivelli	0.00	-0.17	-0.50	-0.57

Sezione: 186
 Progressiva: 1640.000
 Q. Progetto: 418.985

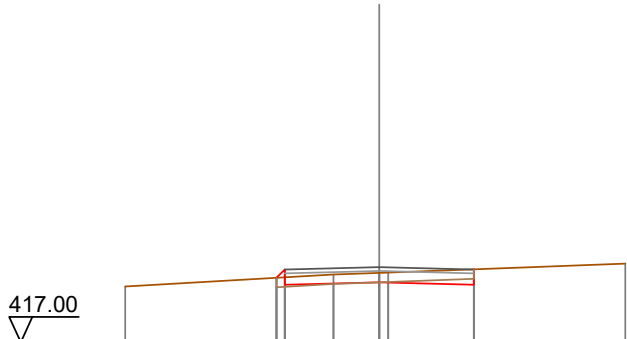

Quote Terreno	-418.47	-418.79	-418.83	-418.84
Quote Progetto	418.71	418.52	418.59	418.52
Parziali		2.50	2.50	
Progressiva	-2.72	-2.50	0.00	2.50
Dislivelli	0.00	0.21	-0.25	-0.40

Sezione: 187
 Progressiva: 1640.508
 Q. Progetto: 418.952

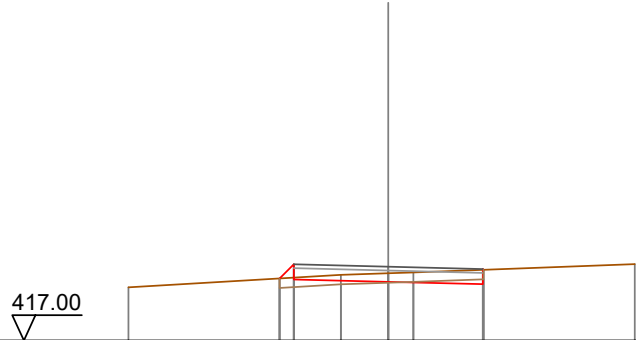

Quote Terreno	-418.41	-418.74	-418.78	-418.80	-419.02
Quote Progetto		418.64 418.61	418.55	418.49	
Parziali		0.37	2.50	2.50	
Progressiva		-2.87 -2.50	0.00	2.50	
Dislivelli		-0.00 0.35	-0.23	-0.38	

Sezione: 188
 Progressiva: 1650.000
 Q. Progetto: 418.229

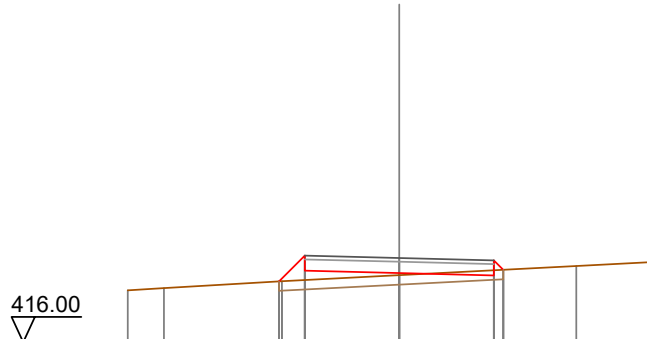

Quote Terreno	-417.37	-417.43	-417.61	-417.77	-418.01	-418.12 -418.13
Quote Progetto			417.61 417.89	417.83 417.77	417.92	
Parziali			0.68	2.50	2.50	
Progressiva			-3.18 -2.50	0.00	2.50 2.75	
Dislivelli			0.00 0.65	0.06	-0.14 0.00	

Sezione: 189
 Progressiva: 1654.858
 Q. Progetto: 417.804

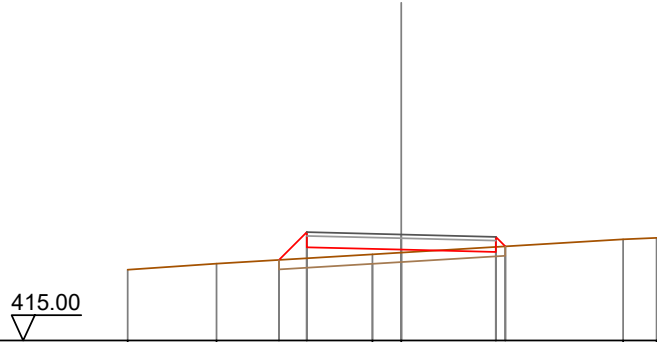

Quote Terreno		416.87	417.03		417.28	417.33		417.67	417.71
Quote Progetto				417.13	417.47		417.40	417.34	417.49
Parziali				0.74	2.50		2.50		
Progressiva				-3.24	-2.50		0.00	2.50	2.75
Dislivelli				0.00	0.69		0.08	-0.13	-0.00

Sezione: 190
 Progressiva: 1660.000
 Q. Progetto: 417.355

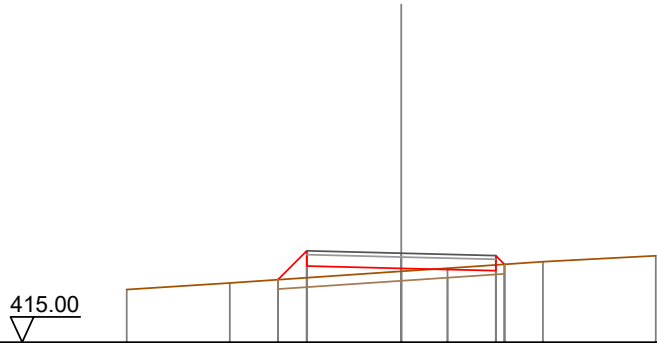

Quote Terreno		416.39	416.57		416.87	416.96		417.13	417.29
Quote Progetto				416.66	417.02		416.95	416.89	417.06
Parziali				0.76	2.50		2.50		
Progressiva				-3.26	-2.50		0.00	2.50	2.73
Dislivelli				0.00	0.71		0.08	-0.15	0.00

Sezione: 191
 Progressiva: 1669.209
 Q. Progetto: 416.549

414.00

Quote Terreno	-415.61	-415.95	-416.01	-416.15	-416.17	-416.60
Quote Progetto		415.92	416.21	416.15	416.09	416.33
Parziali		0.69	2.50	2.50		
Progressiva		-3.19	-2.50	0.00	2.50	2.66
Dislivelli		-0.00	0.64	0.00	-0.23	0.00

Sezione: 192
 Progressiva: 1680.000
 Q. Progetto: 415.605

413.00

Quote Terreno	-414.88	-414.99	-415.28	-415.36	-415.50	-415.76
Quote Progetto			415.15	415.20	415.14	415.52
Parziali			0.39	2.50	2.50	
Progressiva			-2.89	-2.50	0.00	2.50
Dislivelli			0.00	0.36	-0.15	-0.38
						0.00

Sezione: 193
 Progressiva: 1692.148
 Q. Progetto: 414.542

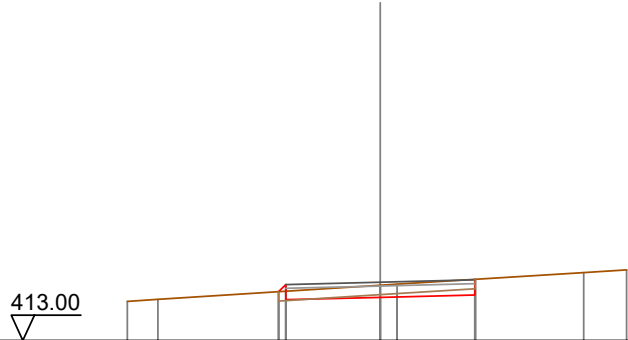

Quote Terreno	-414.03	-414.09		414.46	414.49		-414.80	-414.87
Quote Progetto			414.29	414.08	414.14		414.20	
Parziali				2.50		2.50		
Progressiva			-2.69	-2.50	0.00		2.50	
Dislivelli			-0.00	0.18	-0.32		-0.41	

Sezione: 194
 Progressiva: 1700.000
 Q. Progetto: 413.855

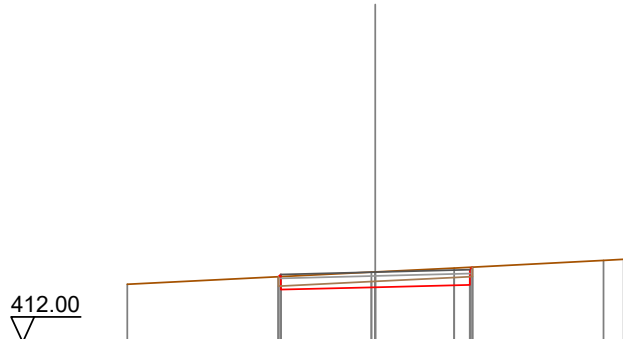

Quote Terreno	-413.63			413.85	413.86		413.96	-414.17	-414.19
Quote Progetto			413.73	413.39	413.45		413.52	413.99	
Parziali				2.50		2.50			
Progressiva			-2.56	-2.50	0.00		2.50	2.57	
Dislivelli			0.00	0.06	-0.40		-0.47	0.00	

Sezione: 195
 Progressiva: 1706.167
 Q. Progetto: 413.315

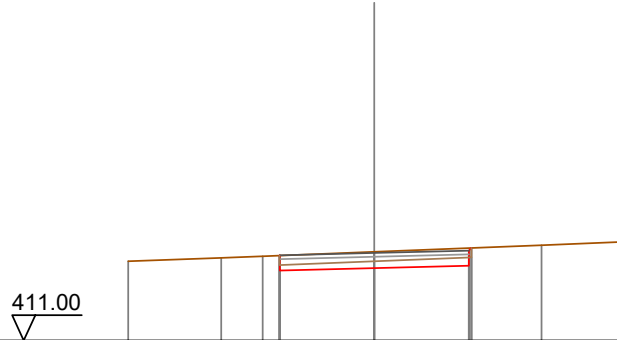

Quote Terreno	-413.10	-413.18	-413.23	-413.34	-413.52	-413.61
Quote Progetto			412.85	412.92	412.98	413.45
Parziali			2.50	2.50		
Progressiva			-2.51	0.00	2.50	2.57
Dislivelli			-0.00	-0.43	-0.47	0.00

Sezione: 196
 Progressiva: 1710.000
 Q. Progetto: 412.980

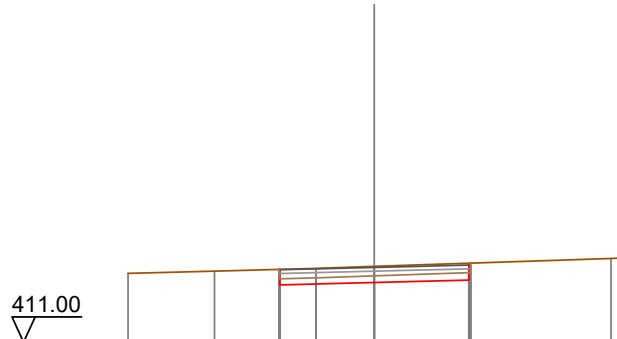

Quote Terreno	-412.82	-412.88	-412.95	-413.01	-413.22	-413.23
Quote Progetto			412.52	412.58	412.64	413.09
Parziali			2.50	2.50		
Progressiva			-2.51	0.00	2.50	2.55
Dislivelli			0.00	-0.43	-0.45	0.00

Sezione: 197
 Progressiva: 1720.186
 Q. Progetto: 412.088

410.00

Quote Terreno	-412.06	-412.06		412.11	412.12	412.12	412.16
Quote Progetto			412.09	411.63	411.69	411.75	412.12
Parziali			2.50		2.50		
Progressiva		-2.56	-2.50	0.00		2.50	2.63
Dislivelli		0.00	-0.06	-0.42		-0.37	-0.00

Sezione: 198
 Progressiva: 1740.000
 Q. Progetto: 410.695

409.00

Quote Terreno	-410.63			410.53	410.53	410.51	410.50	410.41
Quote Progetto			410.57	410.23	410.29	410.23	410.51	
Parziali			2.50		2.50			
Progressiva		-2.56	-2.50	0.00		2.50	2.63	
Dislivelli		0.00	0.06	-0.24		-0.27	0.00	

Sezione: 199
 Progressiva: 1760.000
 Q. Progetto: 410.086

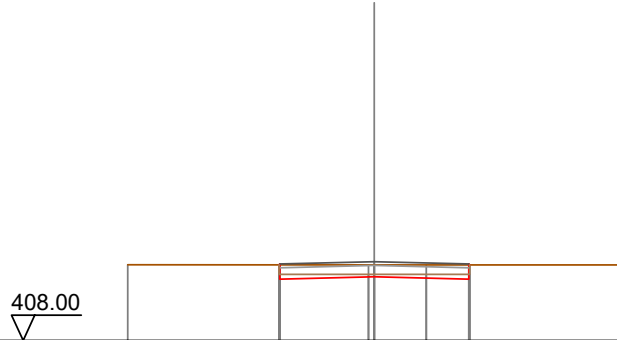

Quote Terreno	-410.00	410.00	410.00	-410.00	-410.00
Quote Progetto		410.00	409.69	409.62	410.00
Parziali		2.50	2.50		
Progressiva		-2.52	0.00	2.50	2.52
Dislivelli		-0.00	-0.31	-0.38	-0.00

Sezione: 200
 Progressiva: 1780.000
 Q. Progetto: 409.859

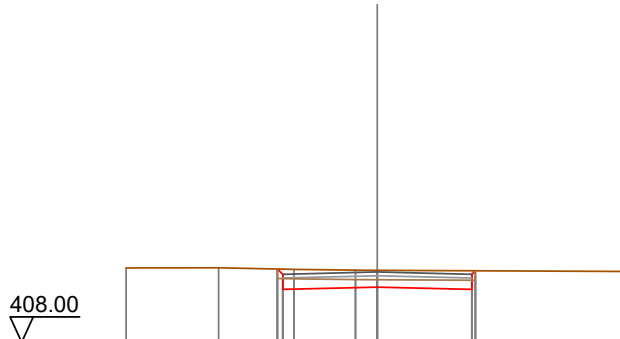

Quote Terreno	-409.97	409.97	409.93	409.91	409.90	-409.87
Quote Progetto		409.94	409.40	409.46	409.40	409.89
Parziali		2.50	2.50			
Progressiva		-2.64	0.00	2.50	2.59	
Dislivelli		0.00	-0.44	-0.49	0.00	

Sezione: 201
 Progressiva: 1800.000
 Q. Progetto: 408.894

407.00

Quote Terreno	408.96	408.96	408.92	408.90	408.87	408.79	408.78
Quote Progetto				408.90	408.49	408.43	
Parziali				2.50	2.50		
Progressiva				-2.57	0.00	2.50	
Dislivelli				0.00	-0.37	-0.40	

Sezione: 202
 Progressiva: 1809.552
 Q. Progetto: 408.163

406.00

Quote Terreno	408.28	408.26		408.19		408.13	408.12	408.11
Quote Progetto				407.83	407.76	407.70	408.15	
Parziali				2.50	2.50			
Progressiva				-2.50	0.00	2.50	2.55	
Dislivelli				0.00	-0.42	-0.45	0.00	

Sezione: 203
 Progressiva: 1810.000
 Q. Progetto: 408.127

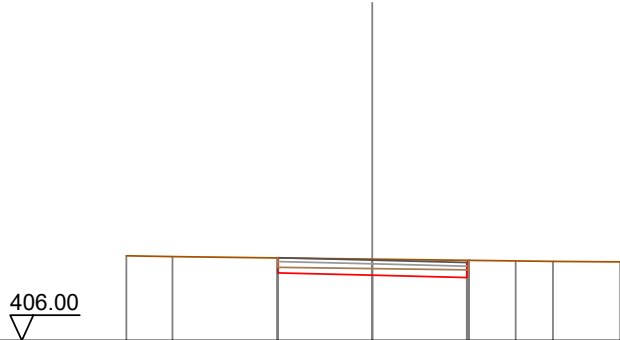

Quote Terreno	-408.24	-408.22		407.79	408.15		-408.10	-408.09	-408.08
Quote Progetto				407.79	407.73	407.86	408.12		
Parziali				2.50	2.50				
Progressiva				-2.50	0.00	2.50	2.55		
Dislivelli				0.00	-0.43	-0.46	0.00		

Sezione: 204
 Progressiva: 1811.267
 Q. Progetto: 408.025

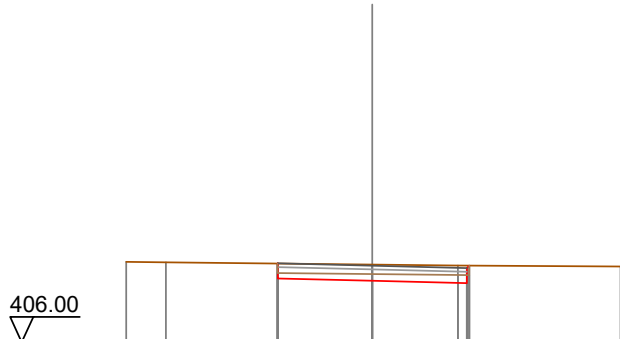

Quote Terreno	-408.13	-408.11		407.69	408.05		407.56	408.03	-408.00
Quote Progetto				407.69	407.63	407.56	408.03		
Parziali				2.50	2.50				
Progressiva				-2.51	0.00	2.50	2.56		
Dislivelli				0.00	-0.43	-0.46	0.00		

Sezione: 205
 Progressiva: 1812.981
 Q. Progetto: 407.888

406.00

Quote Terreno	-407.97	-407.97		407.92	407.92		-407.89	-407.88
Quote Progetto			407.55	407.49	407.43	407.90		
Parziali			2.50	2.50				
Progressiva			-2.51	0.00	2.50	2.58		
Dislivelli			-0.00	-0.43	-0.48	0.00		

Sezione: 206
 Progressiva: 1820.000
 Q. Progetto: 407.326

405.00

Quote Terreno	-407.42	-407.41		407.36	407.36		-407.35	-407.35
Quote Progetto			407.39	406.86	406.93	407.36	406.86	407.36
Parziali			2.50	2.50				
Progressiva			-2.63	-2.50	0.00	2.50	2.60	
Dislivelli			-0.00	-0.13	-0.45	-0.50	-0.00	

Sezione: 207
 Progressiva: 1840.000
 Q. Progetto: 405.724

404.00

Quote Terreno	-405.78		405.75	405.75		405.73	405.73
Quote Progetto		405.77	405.26	405.32	405.26	405.74	
Parziali			2.50		2.50		
Progressiva		-2.60	-2.50	0.00	2.50	2.58	
Dislivelli		0.00	-0.10	-0.43	-0.48	0.00	

Sezione: 208
 Progressiva: 1860.000
 Q. Progetto: 404.121

402.00

Quote Terreno	-404.15	-404.13	404.12	404.10		404.07	404.05	404.05
Quote Progetto			404.12	403.66	403.72	403.66	404.08	
Parziali			2.50		2.50			
Progressiva		-2.56	-2.50	0.00	2.50	2.52		
Dislivelli		0.00	-0.06	-0.38	-0.42	0.00		

Sezione: 209
 Progressiva: 1871.780
 Q. Progetto: 403.178

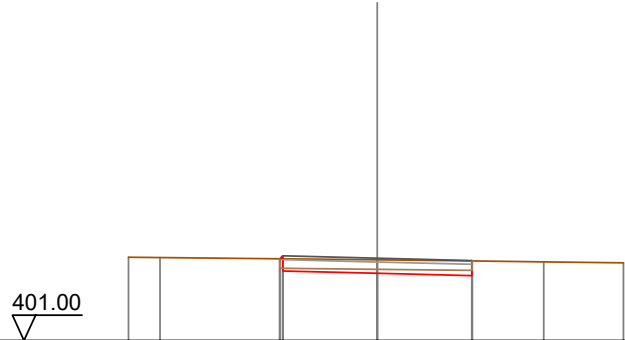

Quote Terreno	-403.20	-403.20		403.16	403.13	403.11	-403.08	-403.06
Quote Progetto				403.16	402.84	402.78	402.72	
Parziali				2.50		2.50		
Progressiva				-2.58	-2.50	0.00	2.50	
Dislivelli				0.00	0.08	-0.36	-0.39	

Sezione: 210
 Progressiva: 1874.643
 Q. Progetto: 402.948

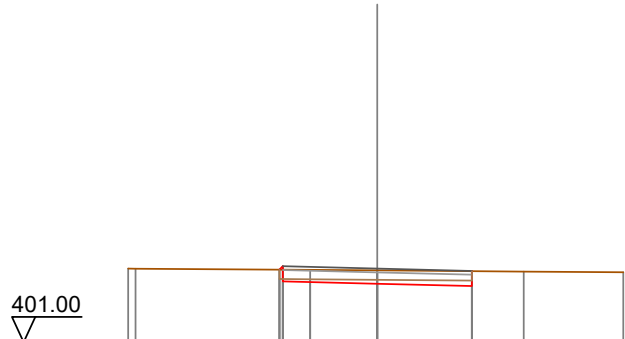

Quote Terreno	402.95	402.95		402.92	402.90		402.87	402.85
Quote Progetto				402.92	402.61	402.55	402.49	
Parziali				2.50		2.50		
Progressiva				-2.59	-2.50	0.00	2.50	
Dislivelli				-0.00	0.09	-0.35	-0.39	

Sezione: 211
 Progressiva: 1877.507
 Q. Progetto: 402.719

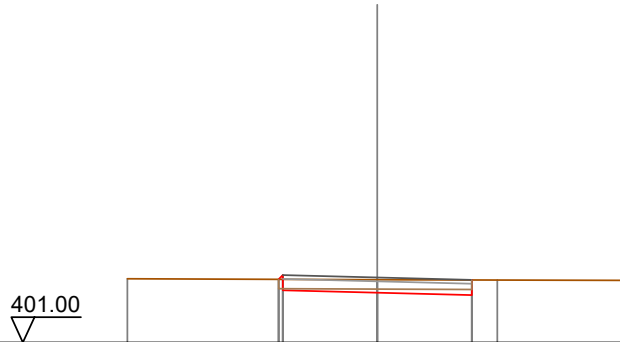

Quote Terreno	-402.69		402.66		-402.65	-402.64
Quote Progetto		402.67	402.38	402.32	402.26	
Parziali			2.50		2.50	
Progressiva		-2.61	-2.50	0.00	2.50	
Dislivelli		-0.00	0.11	-0.34	-0.40	

Sezione: 212
 Progressiva: 1880.000
 Q. Progetto: 402.519

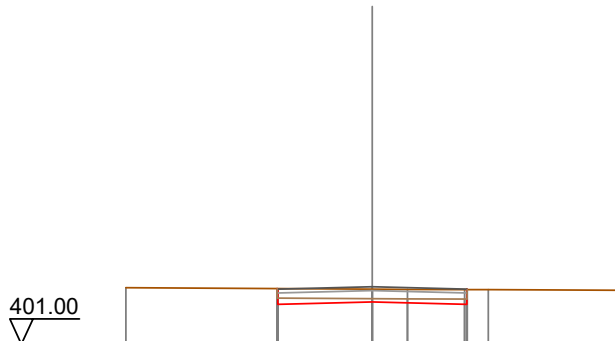

Quote Terreno	-402.50		402.46	402.45	402.44	402.44	-402.43
Quote Progetto		402.06	402.12	402.06	402.06		
Parziali			2.50		2.50		
Progressiva		-2.51	0.00	2.50			
Dislivelli		-0.00	-0.34	-0.39			

Sezione: 213
 Progressiva: 1900.000
 Q. Progetto: 400.962

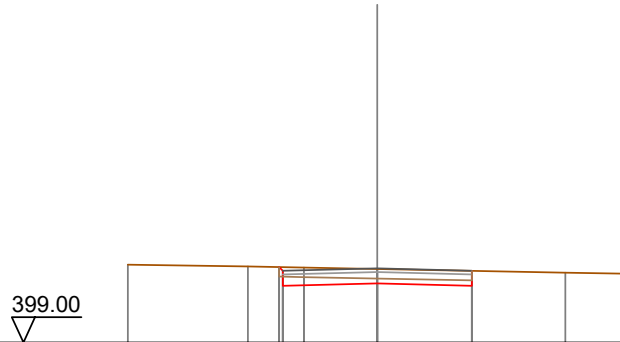

Quote Terreno	-401.06	-401.01	-400.98	-400.94	-400.85	-400.82
Quote Progetto		400.99	400.50	400.56	400.50	
Parziali			2.50	2.50		
Progressiva		-2.60	-2.50	0.00	2.50	
Dislivelli		0.00	-0.09	-0.38	-0.39	

Sezione: 214
 Progressiva: 1920.000
 Q. Progetto: 399.992

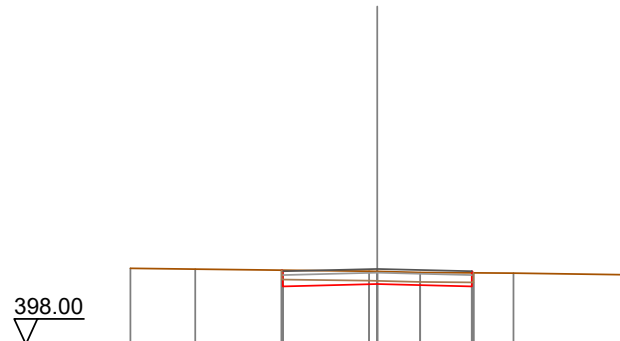

Quote Terreno	-400.01	-399.99	-399.93	-399.90	-399.88	-399.84
Quote Progetto			399.96	399.59	399.53	
Parziali			2.50	2.50		
Progressiva		-2.53	-2.50	0.00	2.50	2.54
Dislivelli		-0.00	-0.03	-0.33	-0.36	-0.00

Sezione: 215
 Progressiva: 1940.000
 Q. Progetto: 398.859

397.00

Quote Terreno	-398.86	-398.81		398.70	398.65	-398.60	-398.59
Quote Progetto			398.76 398.40	398.46	398.40 398.65		
Parziali			2.50	2.50			
Progressiva			-2.54 -2.50	0.00	2.50 2.65		
Dislivelli			0.00 0.04	-0.24	-0.25 0.00		

Sezione: 216
 Progressiva: 1945.516
 Q. Progetto: 398.407

396.00

Quote Terreno	398.44 398.43			398.30	398.28	398.21	398.18
Quote Progetto		398.36 398.07		398.01	397.94 398.25		
Parziali		2.50	2.50				
Progressiva		-2.61 -2.50	0.00	2.50 2.60			
Dislivelli		0.00 0.12	-0.30	-0.30 0.00			

Sezione: 217
 Progressiva: 1950.000
 Q. Progetto: 398.025

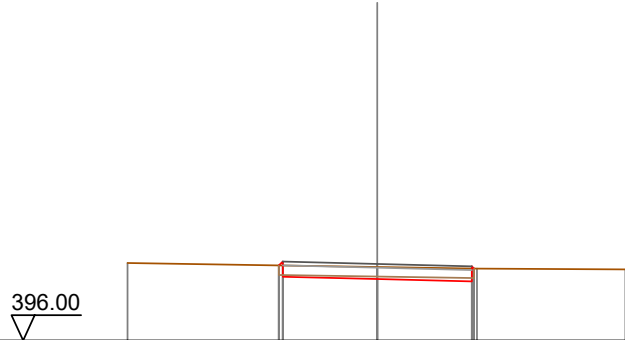

Quote Terreno		396.05		397.94		397.90		397.88
Quote Progetto			397.98	397.63		397.90		
Parziali			2.50		2.50			
Progressiva			-2.60	0.00		2.50	2.56	
Dislivelli			0.00	-0.32		-0.34	0.00	

Sezione: 218
 Progressiva: 1960.000
 Q. Progetto: 397.175

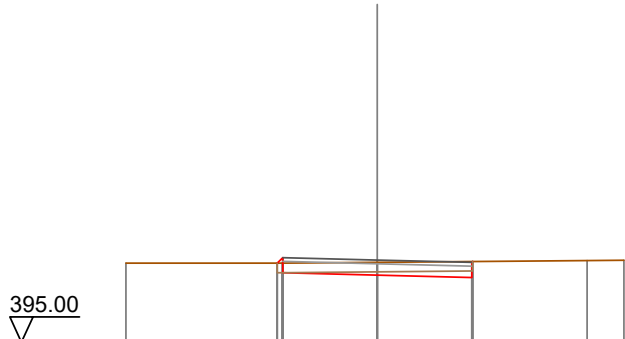

Quote Terreno		397.09		397.11		397.16		397.17
Quote Progetto			397.09	396.77		397.13		
Parziali			2.50		2.50			
Progressiva			-2.65	0.00		2.50	2.52	
Dislivelli			0.00	-0.34		-0.42	-0.00	

Sezione: 219
 Progressiva: 1970.000
 Q. Progetto: 396.324

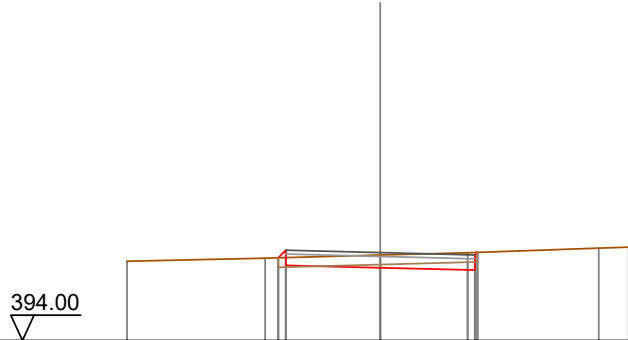

Quote Terreno	396.10	396.18	396.26	396.32	396.44	396.47
Quote Progetto		396.19 395.99	395.92	395.86 396.33		
Parziali			2.50	2.50		
Progressiva		-2.70 -2.50	0.00	2.50 2.57		
Dislivelli		0.00 0.19	-0.34	-0.47 0.00		

Sezione: 220
 Progressiva: 1972.705
 Q. Progetto: 396.094

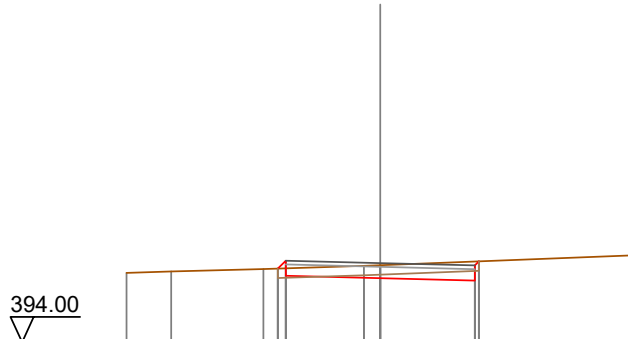

Quote Terreno	395.83	395.87	395.94	396.02	396.04	396.30
Quote Progetto			395.95 395.76	395.69	395.63 396.14	
Parziali			2.50	2.50		
Progressiva			-2.71 -2.50	0.00	2.50 2.61	
Dislivelli			0.00 0.20	-0.34	-0.50 0.00	

Sezione: 221
 Progressiva: 1980.000
 Q. Progetto: 395.507

394.00

Quote Terreno	395.16		395.50	395.53		395.84
Quote Progetto		395.36	395.17	395.11	395.04	395.63
Parziali			2.50		2.50	
Progressiva		-2.71	-2.50	0.00	2.50	2.69
Dislivelli		0.00	0.20	-0.39	-0.58	-0.00

Sezione: 222
 Progressiva: 1990.000
 Q. Progetto: 394.874

393.00

Quote Terreno	394.36	394.50		394.87	394.90		395.29	395.37
Quote Progetto			394.67	394.54	394.47		394.41	395.08
Parziali			0.28		2.50		2.50	0.27
Progressiva			-2.76	-2.50	0.00		2.50	2.77
Dislivelli			0.00	0.24	-0.40		-0.65	0.00

Sezione: 223
 Progressiva: 1999.894
 Q. Progetto: 394.444

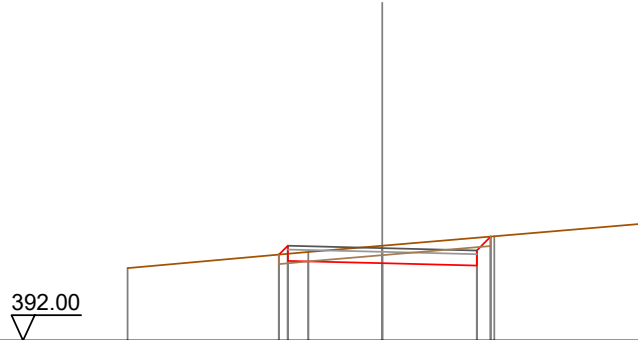

Quote Terreno	393.92		394.34	394.51	394.76	395.09
Quote Progetto		394.27	394.11	394.04	393.98	394.75
Parziali			2.50	2.50	0.37	
Progressiva		-2.74	-2.50	0.00	2.50	2.87
Dislivelli		0.00	0.21	-0.46	-0.74	0.00

Sezione: 224
 Progressiva: 2020.000
 Q. Progetto: 394.176

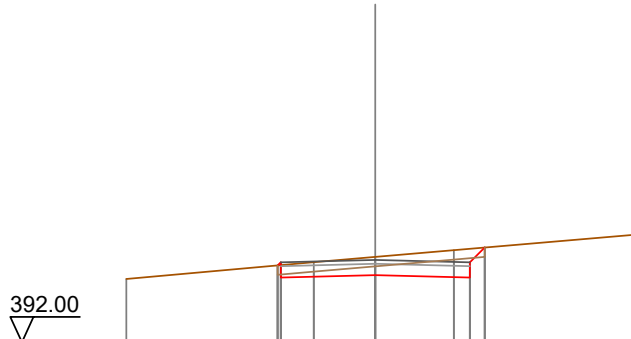

Quote Terreno	393.67		394.12	394.26	394.44	394.85
Quote Progetto		394.03	393.71	393.78	393.71	394.51
Parziali			2.50	2.50	0.39	
Progressiva		-2.58	-2.50	0.00	2.50	2.89
Dislivelli		0.00	0.07	-0.48	-0.76	-0.00

Sezione: 225
 Progressiva: 2040.000
 Q. Progetto: 394.290

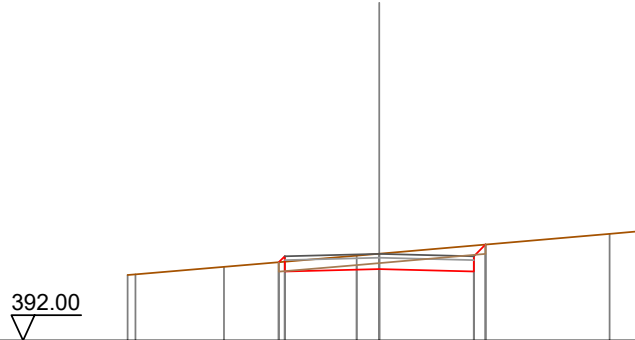

Quote Terreno		393.73	393.75		393.95		394.07	393.83		394.25	394.30		394.82	394.88
Quote Progetto							394.07	393.83		393.89		393.83	394.54	
Parziali							2.50			2.50			0.31	
Progressiva							-2.66	-2.50		0.00		2.50	2.81	
Dislivelli							0.00	0.14		-0.41		-0.68	0.00	

Sezione: 226
 Progressiva: 2060.000
 Q. Progetto: 394.405

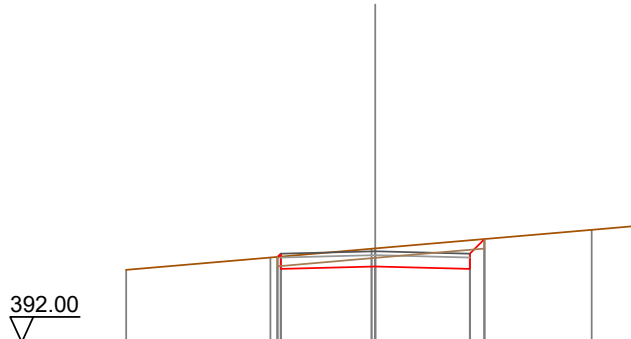

Quote Terreno		393.92		394.24		394.47	394.48		394.97	395.07
Quote Progetto				394.26	393.94	394.00		393.94	394.73	
Parziali				2.50		2.50		0.39		
Progressiva				-2.59	-2.50	0.00		2.50	2.89	
Dislivelli				0.00	0.08	-0.48		-0.75	0.00	

Sezione: 227
 Progressiva: 2080.000
 Q. Progetto: 394.519

393.00

Quote Terreno	394.03	394.06	394.23	394.39	394.06	394.96	395.22
Quote Progetto				394.06	394.12	394.06	394.87
Parziali				2.50	2.50	0.41	
Progressiva				-2.57	-2.50	0.00	2.50
Dislivelli				0.00	0.06	-0.49	-0.78
							0.00

Sezione: 228
 Progressiva: 2100.000
 Q. Progetto: 394.633

393.00

Quote Terreno	394.06	394.43	394.17	394.46	394.67	394.69	395.28
Quote Progetto				394.23	394.17	394.92	
Parziali				2.50	2.50	0.35	
Progressiva		-2.64	-2.50	0.00	0.00	2.50	2.85
Dislivelli		0.00	0.13	-0.43	-0.72	0.00	

Sezione: 229
 Progressiva: 2120.000
 Q. Progetto: 394.748

393.00

Quote Terreno		394.11			394.74			394.90			394.29			395.00			395.37
Quote Progetto					394.49			394.29			394.35			394.29			395.00
Parziali							2.50				2.50			0.32			
Progressiva					-2.70		-2.50			0.00				2.50			2.82
Dislivelli					0.00		0.18			-0.39				-0.69			0.00

Sezione: 230
 Progressiva: 2140.000
 Q. Progetto: 394.899

393.00

Quote Terreno		394.26			394.49			394.93			394.44			395.26			395.50			395.61
Quote Progetto								394.66			394.44			394.50			394.44			395.21
Parziali										2.50				2.50			0.37			
Progressiva								-2.67		-2.50				0.00			2.50			2.87
Dislivelli								0.00		0.16				-0.43			-0.73			0.00

Sezione: 231
 Progressiva: 2160.000
 Q. Progetto: 395.220

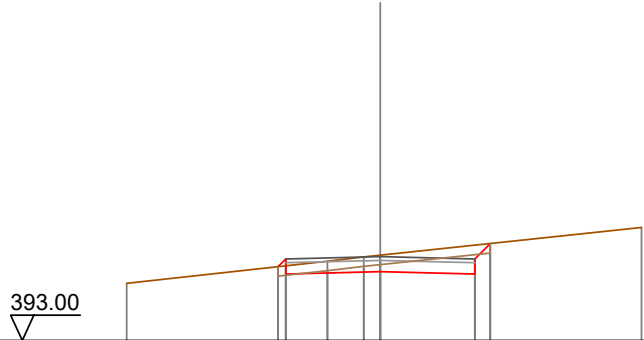

Quote Terreno		394.51		395.10	395.21	395.26				395.99
Quote Progetto			394.95	394.76		394.82		394.76	395.56	
Parziali				2.50		2.50		0.41		
Progressiva			-2.71	-2.50		0.00		2.50	2.91	
Dislivelli			0.00	0.18		-0.44		-0.76	0.00	

Sezione: 232
 Progressiva: 2180.000
 Q. Progetto: 395.547

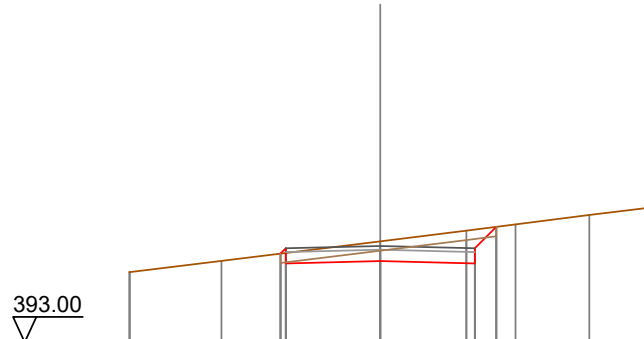

Quote Terreno		394.85		395.15		395.67		395.95		396.12		396.37	396.55
Quote Progetto				395.35	395.08		395.15		395.08	396.05			
Parziali					2.50		2.50		0.57				
Progressiva				-2.64	-2.50		0.00		2.50	3.07			
Dislivelli				0.00	0.12		-0.52		-0.89	0.00			

Sezione: 233
 Progressiva: 2200.000
 Q. Progetto: 395.875

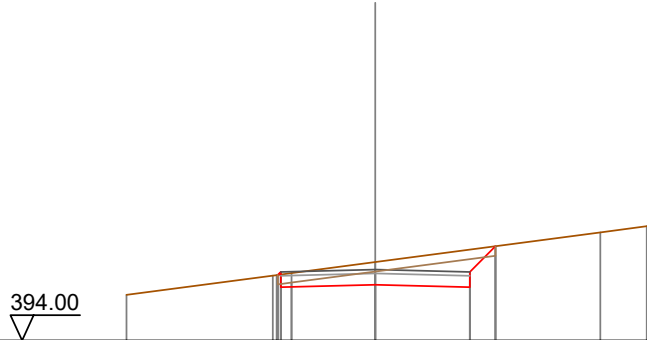

Quote Terreno		395.21	395.72	395.78	396.07		396.86	397.02
Quote Progetto			395.73	395.41	395.47		395.41	396.49
Parziali				2.50	2.50		0.68	
Progressiva			-2.58	-2.50	0.00		2.50	3.18
Dislivelli			0.00	0.07	-0.60		-0.99	0.00

Sezione: 234
 Progressiva: 2220.000
 Q. Progetto: 396.468

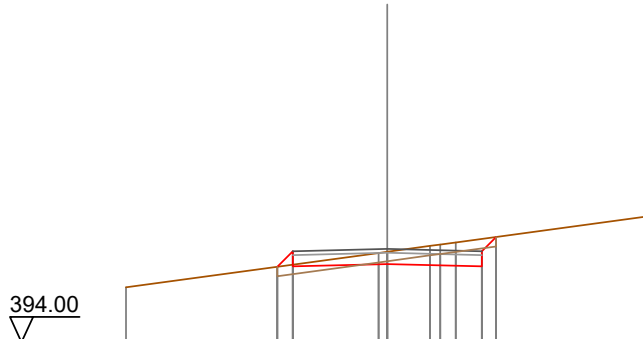

Quote Terreno		395.45	396.36	396.39	396.55	396.56	396.64	397.33
Quote Progetto			396.00	396.01	396.07		396.01	396.78
Parziali			0.41	2.50	2.50		0.38	
Progressiva			-2.91	-2.50	0.00		2.50	2.88
Dislivelli			-0.00	0.35	-0.32		-0.73	0.00

Sezione: 235
 Progressiva: 2240.000
 Q. Progetto: 397.507

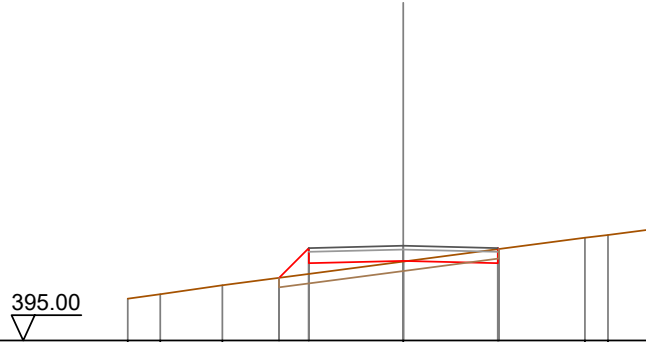

Quote Terreno		396.11	396.22	396.46			397.09			397.72	397.79	397.93
Quote Progetto					396.66	397.04	397.11		397.04			
Parziali					0.79	2.50		2.50				
Progressiva					-3.29	-2.50	0.00		2.50	2.52		
Dislivelli					0.00	0.68		0.02		-0.37	0.00	

Sezione: 236
 Progressiva: 2260.000
 Q. Progetto: 398.288

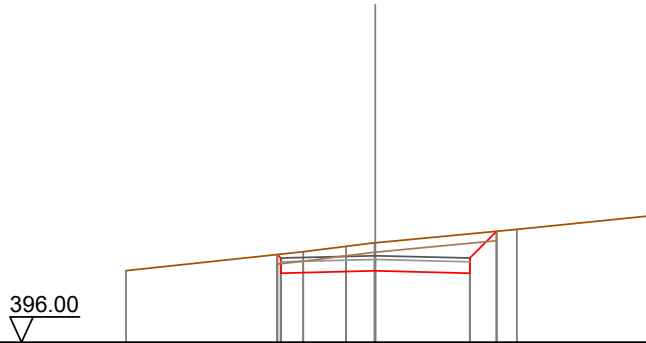

Quote Terreno		397.89			398.39	398.54	398.63			398.99		399.34
Quote Progetto					398.32	397.83	397.89		397.83			
Parziali						2.50		2.50		0.71		
Progressiva					-2.59	-2.50	0.00		2.50	3.21		
Dislivelli					0.00	-0.10		-0.74		-1.04	0.00	

Sezione: 237
 Progressiva: 2273.361
 Q. Progetto: 398.375

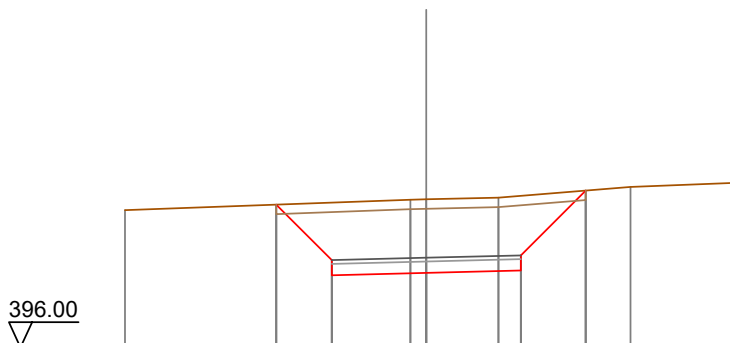

Quote Terreno		399.63			399.91	399.92		399.96		400.25	400.36
Quote Progetto				399.78	397.91		397.97	398.04		400.15	
Parziali				1.47	2.50		2.50	1.71			
Progressiva				-3.97	-2.50		0.00	2.50		4.21	
Dislivelli				0.00	-1.52		-1.94	-1.98		0.00	

Sezione: 238
 Progressiva: 2280.000
 Q. Progetto: 398.284

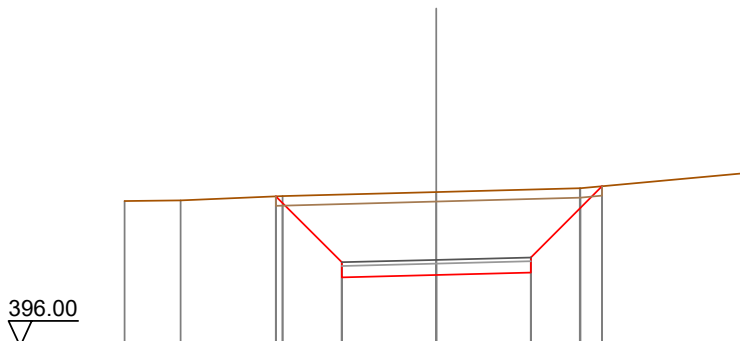

Quote Terreno		399.84	399.86	399.97		400.08		400.18		400.60
Quote Progetto				399.96	397.82		397.88	397.95		400.23
Parziali				1.74	2.50		2.50	1.89		
Progressiva				-4.24	-2.50		0.00	2.50		4.39
Dislivelli				0.00	-1.79		-2.19	-2.20		0.00

Sezione: 239
 Progressiva: 2282.372
 Q. Progetto: 398.231

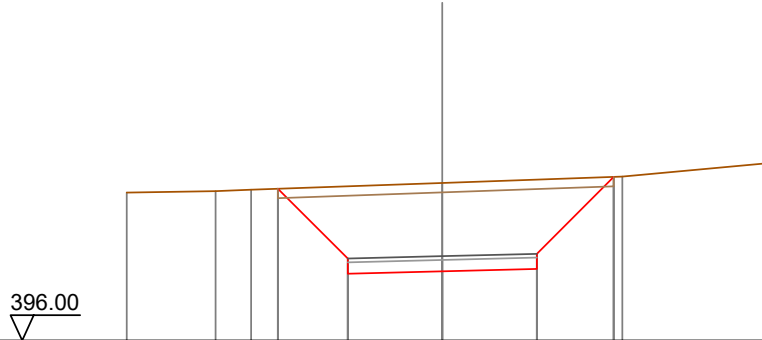

Quote Terreno	-399.91	-399.95	-399.99		400.17		-400.34	-400.68
Quote Progetto			400.01	397.77	397.83	397.89	400.33	
Parziali				1.85	2.50	2.50	2.03	
Progressiva			-4.35	-2.50	0.00	2.50	4.53	
Dislivelli			0.00	-1.91	-2.34	-2.36	0.00	

Sezione: 240
 Progressiva: 2290.000
 Q. Progetto: 397.982

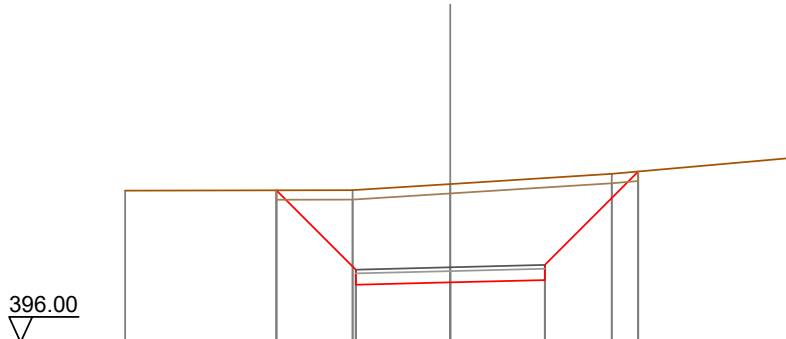

Quote Terreno	-400.01		400.02	400.18		400.45	-400.87
Quote Progetto		400.02	397.52	397.58	397.64	400.52	
Parziali			2.10	2.50	2.50	2.47	
Progressiva		-4.60	-2.50	0.00	2.50	4.97	
Dislivelli		-0.00	-2.11	-2.60	-2.70	0.00	

Sezione: 241
 Progressiva: 2291.383
 Q. Progetto: 397.925

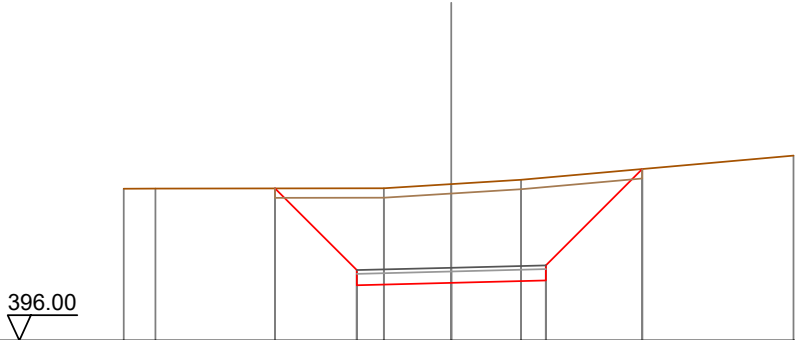

Quote Terreno	-400.01	-400.02		-400.03	400.14	-400.25		-400.89
Quote Progetto			400.02	397.46	400.03	397.52	397.59	400.54
Parziali				2.16	2.50	2.50	2.55	
Progressiva			-4.66	-2.50	0.00	2.50	5.05	
Dislivelli			-0.00	-2.16	-2.61	-2.72	-0.00	

Sezione: 242
 Progressiva: 2300.000
 Q. Progetto: 397.480

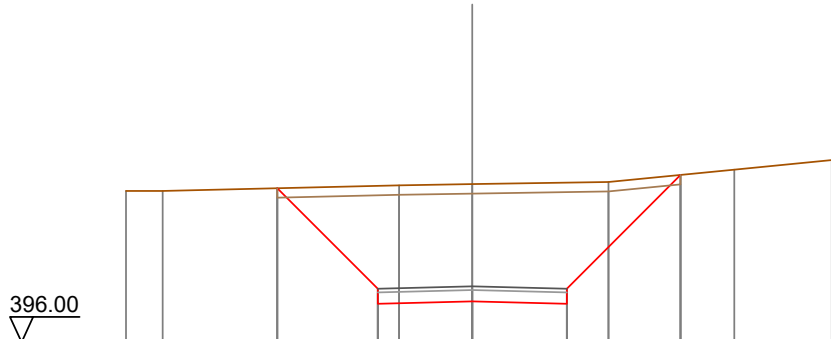

Quote Terreno	-400.00	-400.00		-400.15	400.18	-400.24		-400.56	-400.82
Quote Progetto			400.07	397.02	400.08	397.02	400.43		
Parziali				2.66	2.50	2.50	3.01		
Progressiva			-5.16	-2.50	0.00	2.50	5.51		
Dislivelli			0.00	-2.72	-3.10	-3.21	0.00		

Sezione: 243
 Progressiva: 2320.000
 Q. Progetto: 396.315

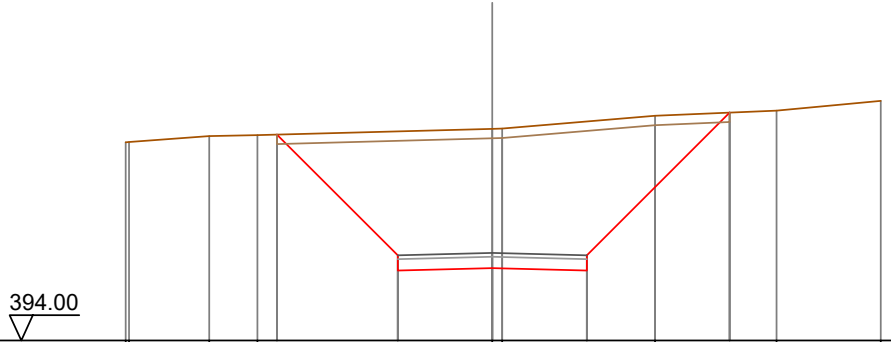

Quote Terreno	399.24	399.25	399.41	399.43	399.45	399.60	399.60	399.85	399.94	400.08	400.34
Quote Progetto					399.45	395.85	395.92	395.85		400.03	
Parziali					3.19	2.50	2.50	3.78			
Progressiva				-5.69		-2.50	0.00	2.50		6.28	
Dislivelli				0.00		-3.28	-3.68	-3.94		0.00	

Sezione: 244
 Progressiva: 2321.372
 Q. Progetto: 396.261

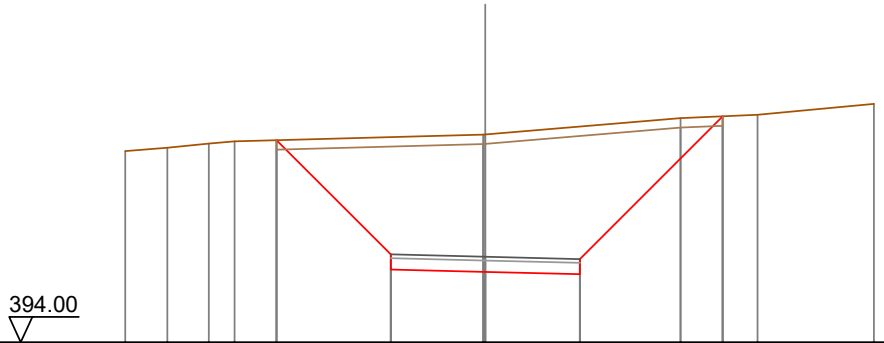

Quote Terreno	399.05	399.14	399.25	399.32	399.34	399.49	399.49	399.80	399.93	400.02	400.30
Quote Progetto					399.34	395.92	395.86	395.80		399.98	
Parziali					3.02	2.50	2.50	3.78			
Progressiva				-5.52		-2.50	0.00	2.50		6.28	
Dislivelli				0.00		-3.10	-3.63	-3.91		0.00	

Sezione: 245
 Progressiva: 2330.000
 Q. Progetto: 396.008

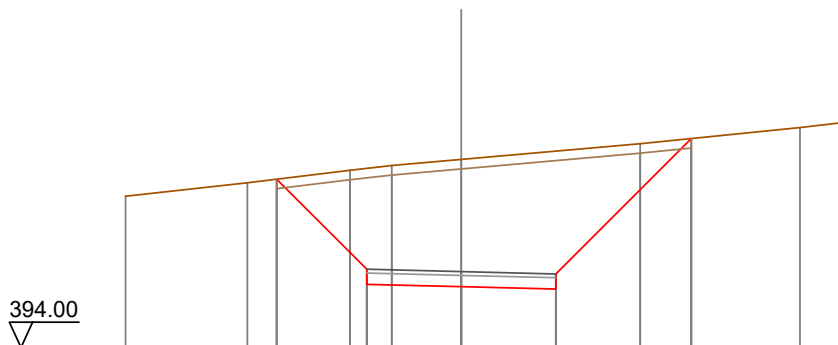

Quote Terreno	398.00	398.36	398.69	398.81	398.97	399.39	399.82	399.95
Quote Progetto		398.45	395.67	395.61	395.55	399.53		
Parziali			2.38	2.50	2.50	3.58		
Progressiva		-4.88	-2.50	0.00	2.50	6.08		
Dislivelli		-0.00	-2.67	-3.37	-3.65	-0.00		

Sezione: 246
 Progressiva: 2332.887
 Q. Progetto: 395.956

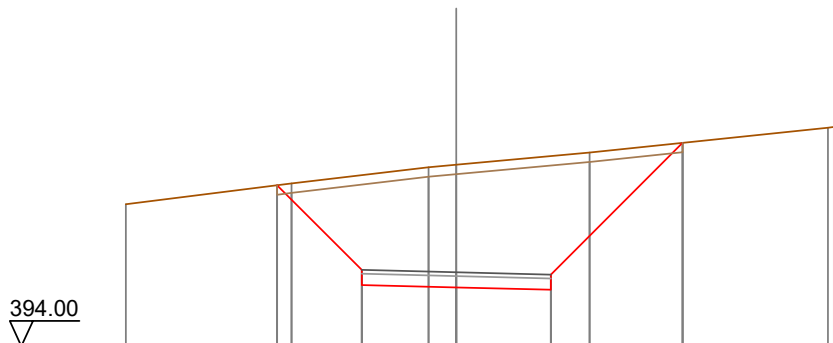

Quote Terreno	397.75	398.30	398.73	398.80	399.12	399.78	399.80
Quote Progetto		398.26	395.62	395.56	395.49	399.38	
Parziali		2.24	2.50	2.50	3.49		
Progressiva		-4.74	-2.50	0.00	2.50	5.99	
Dislivelli		0.00	-2.51	-3.24	-3.54	0.00	

Sezione: 247
 Progressiva: 2340.000
 Q. Progetto: 395.900

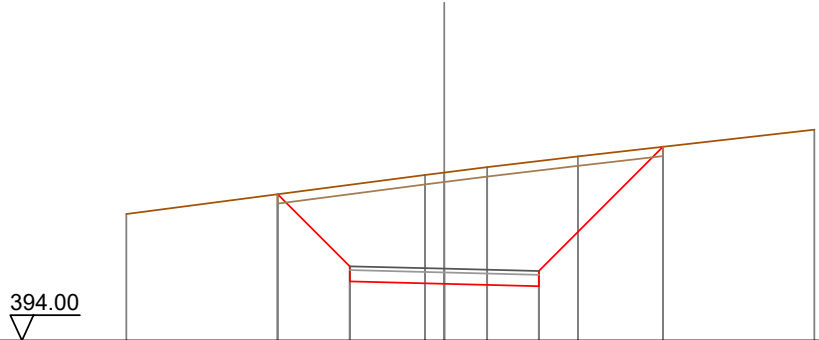

Quote Terreno		397.35		398.38	398.44	398.59	398.87	399.58
Quote Progetto			397.87	395.56	395.50	395.44	399.13	
Parziali			1.91	2.50	2.50	3.29		
Progressiva			-4.41	-2.50	0.00	2.50	5.79	
Dislivelli			0.00	-2.15	-2.94	-3.31	-0.00	

Sezione: 248
 Progressiva: 2343.000
 Q. Progetto: 395.900

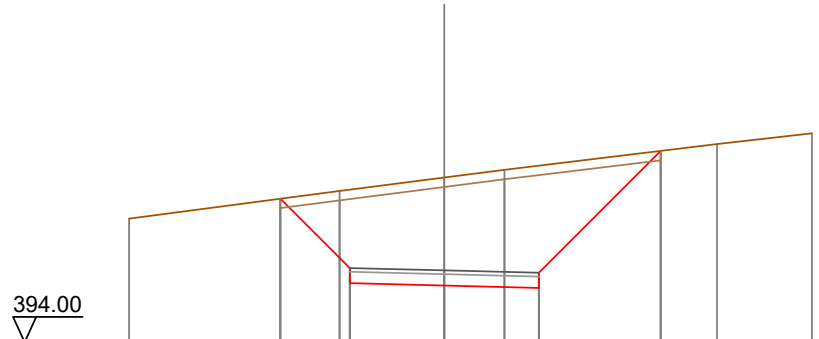

Quote Terreno		397.27		398.00	398.36	398.56	399.24	399.53
Quote Progetto			397.80	395.56	395.50	395.44	399.06	
Parziali			1.83	2.50	2.50	3.22		
Progressiva			-4.33	-2.50	0.00	2.50	5.72	
Dislivelli			-0.00	-2.08	-2.86	-3.23	0.00	

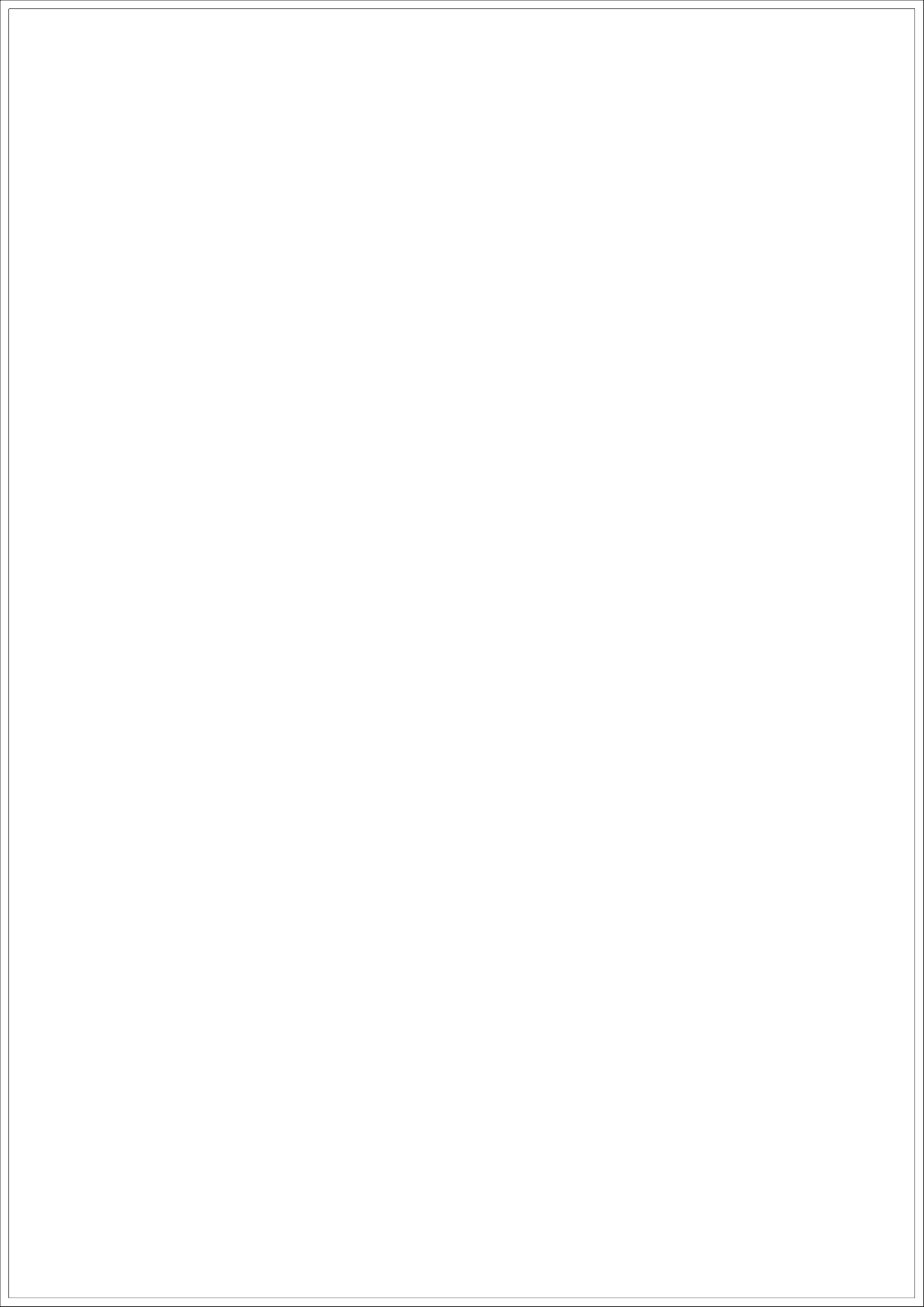

SEZIONI TRASVERSALI
Profilo longitudinale tratto 27-28
Viabilità di impianto postazione aerogeneratore T14

Nota: Le canalette di deflusso delle acque meteoriche, non indicate nel presente elaborato, sono rappresentate graficamente nelle sezioni stradali tipo dell'elaborato "WIND002-TC13_Piazzole aerogeneratori e strade di servizio - Particolari costruttivi", individuate planimetricamente nell'elaborato "WIND002-TC14_Opere di regimazione acque superficiali - Planimetria generale" e quantificate nell'elaborato "WIND002-RC6_Computo Metrico Estimativo".

DISEGNI DI RIFERIMENTO

TAVOLA	DESCRIZIONE
WIND002-TC8	Piazzole e viabilità - Planimetria di progetto - Fase di cantiere
WIND002-TC11	Profili longitudinali viabilità di impianto
WIND002-TC13	Piazzole aerogeneratori e strade di servizio - Particolari costruttivi
WIND002-TC14	Opere di regimazione acque superficiali - Planimetria generale

Sezione: 4
 Progressiva: 20.000
 Q. Progetto: 390.087

388.00

Quote Terreno	-390.00	-390.00	-390.00	-390.00	-390.00	-390.00
Quote Progetto		390.00	389.75	389.69	389.62	390.00
Parziali			2.50	2.50		
Progressiva		-2.65	-2.50	0.00	2.50	2.52
Dislivelli		-0.00	0.15	-0.31	-0.38	-0.00

Sezione: 5
 Progressiva: 30.000
 Q. Progetto: 390.130

388.00

Quote Terreno	-390.00	-390.00	-390.00	-390.00	-390.00	-390.00
Quote Progetto		390.00	389.79	389.73	389.67	390.00
Parziali			2.50	2.50		
Progressiva		-2.69	-2.50	0.00	2.50	2.57
Dislivelli		-0.00	0.19	-0.27	-0.33	-0.00

Sezione: 6
 Progressiva: 36.700
 Q. Progetto: 390.159

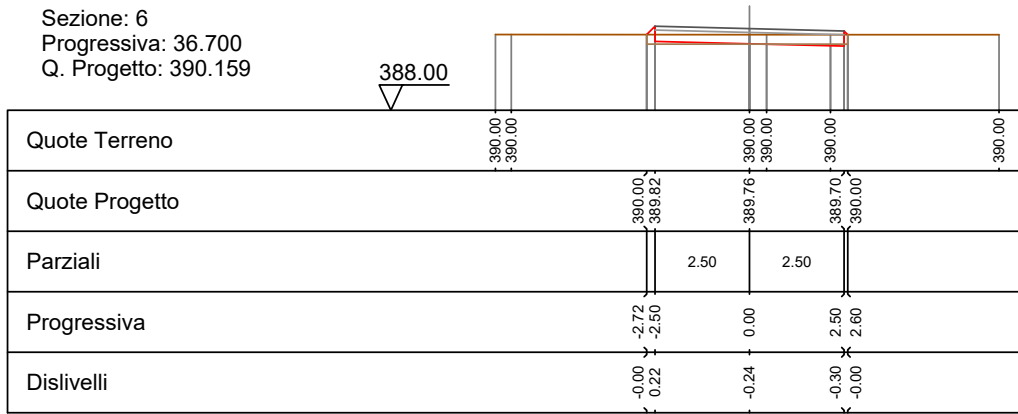

Sezione: 7
 Progressiva: 40.000
 Q. Progetto: 390.173

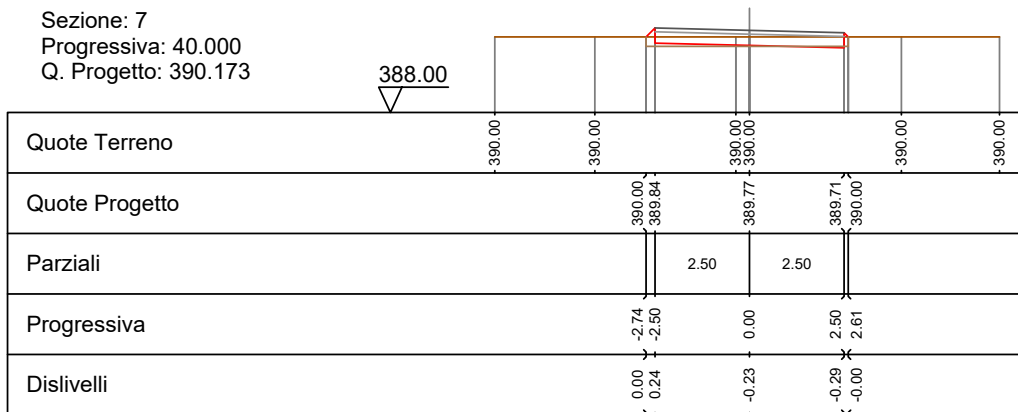

Sezione: 8
 Progressiva: 50.000
 Q. Progetto: 390.216

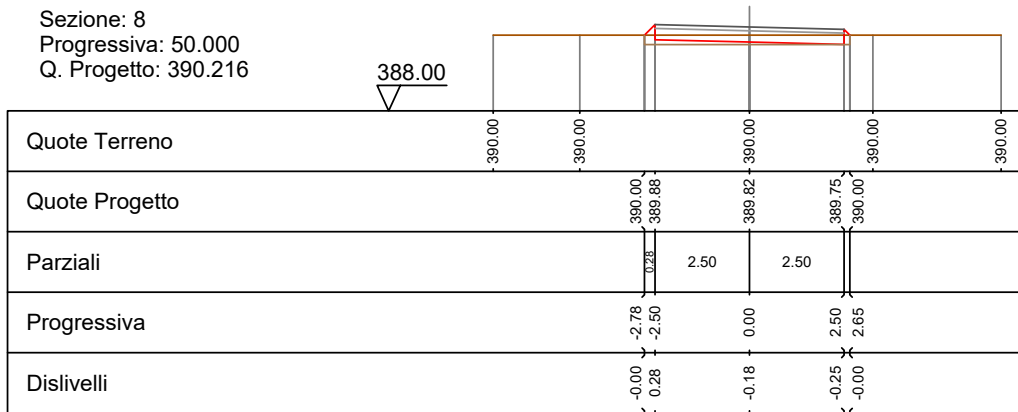

Sezione: 8
 Progressiva: 50.000
 Q. Progetto: 390.216

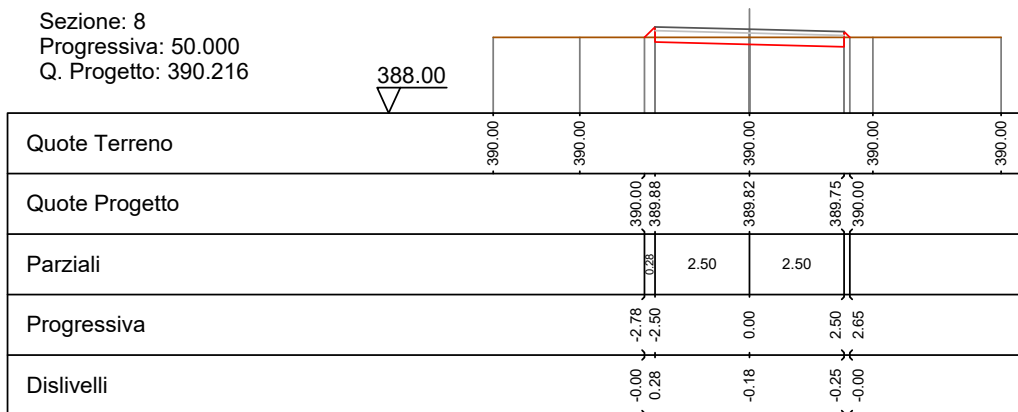

Sezione: 9
 Progressiva: 60.000
 Q. Progetto: 390.260

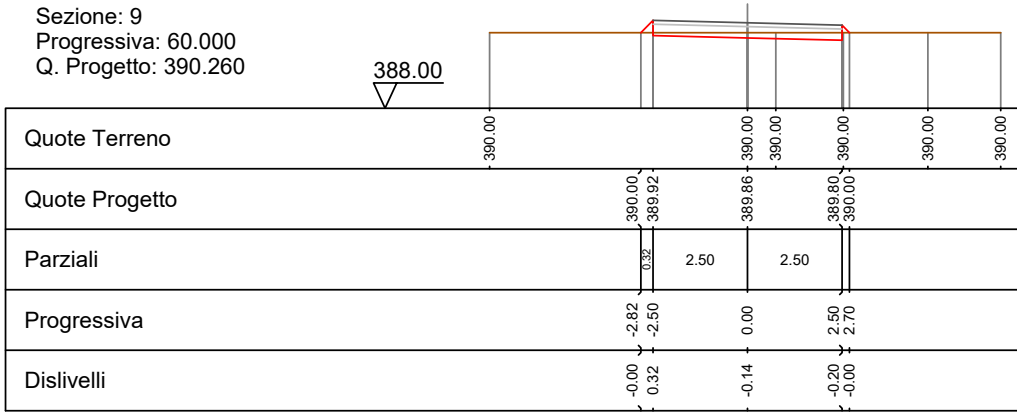

Sezione: 10
 Progressiva: 70.000
 Q. Progetto: 390.303

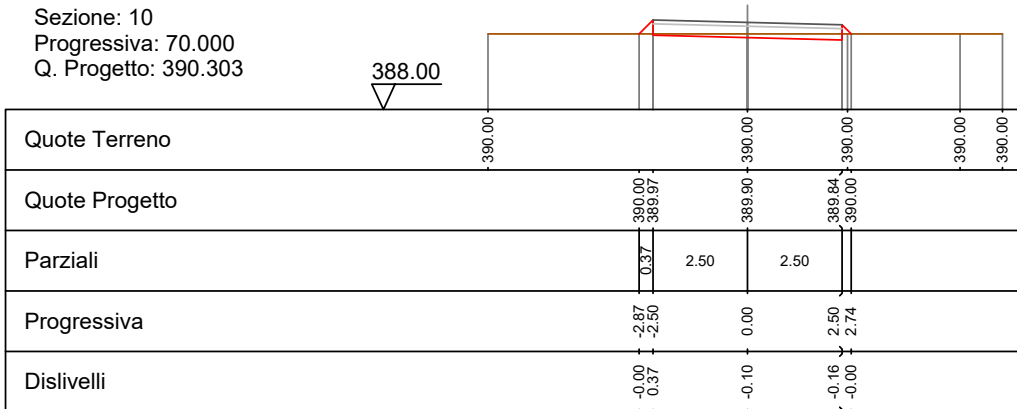

Sezione: 11
 Progressiva: 72.377
 Q. Progetto: 390.313

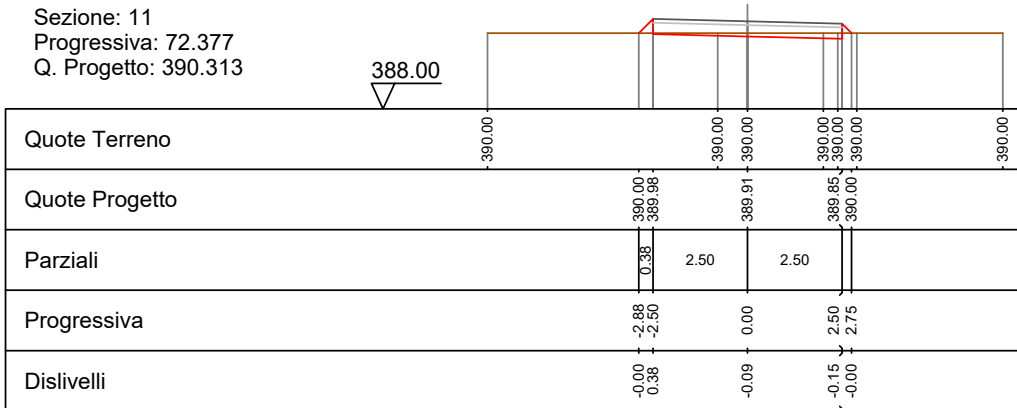

Sezione: 12
 Progressiva: 80.000
 Q. Progetto: 390.346

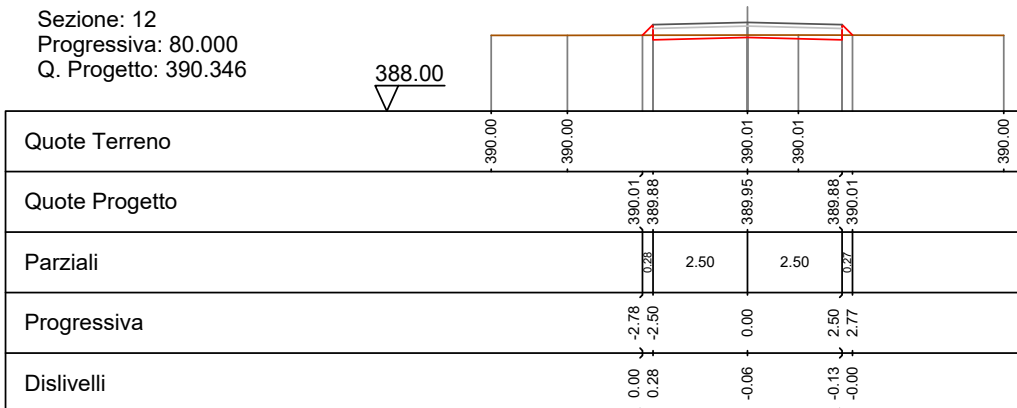

Sezione: 13
 Progressiva: 100.000
 Q. Progetto: 390.658

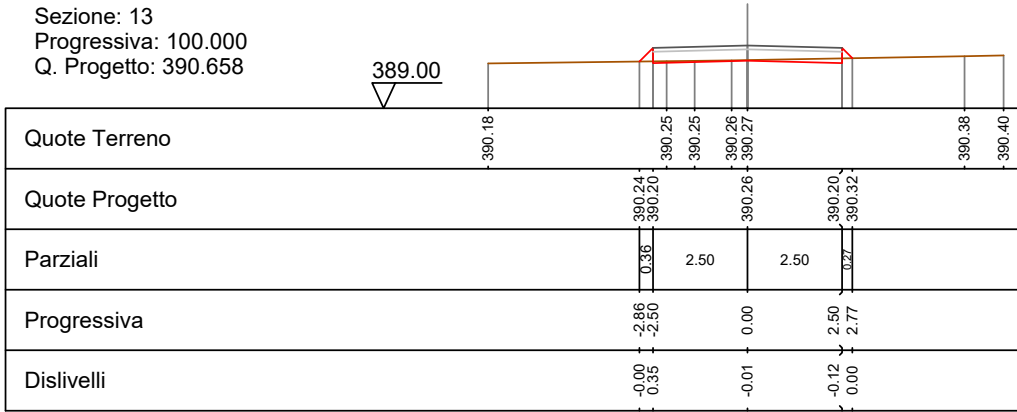

Sezione: 14
 Progressiva: 120.000
 Q. Progetto: 391.272

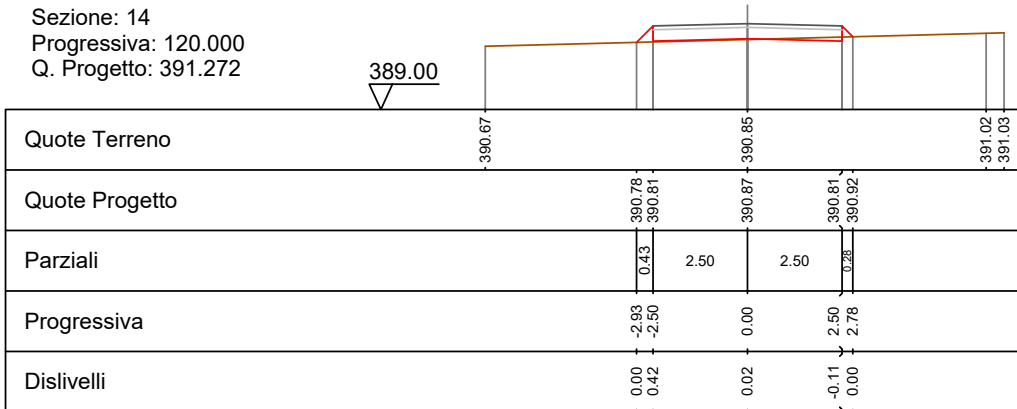

Sezione: 15
 Progressiva: 136.592
 Q. Progetto: 391.785

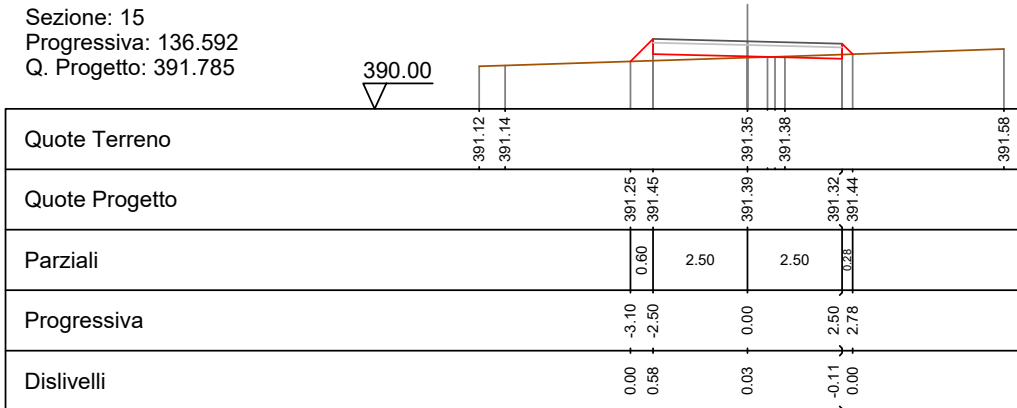

Sezione: 16
 Progressiva: 140.000
 Q. Progetto: 391.891

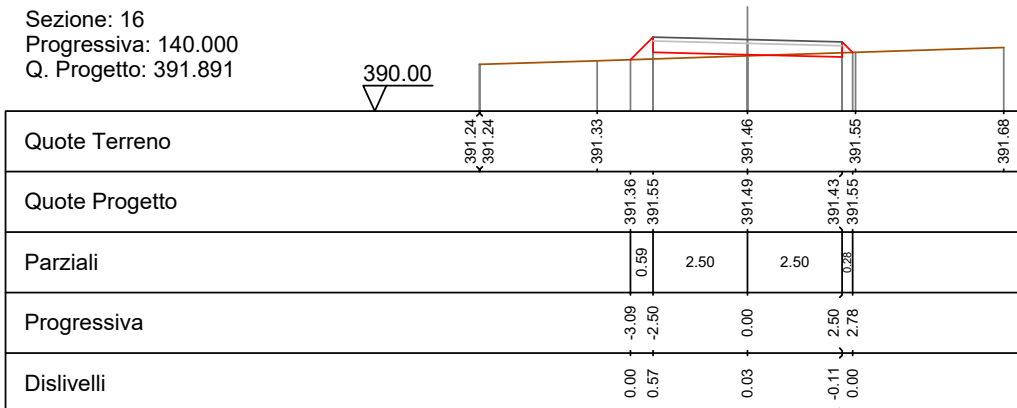

Sezione: 17
 Progressiva: 150.000
 Q. Progetto: 392.207

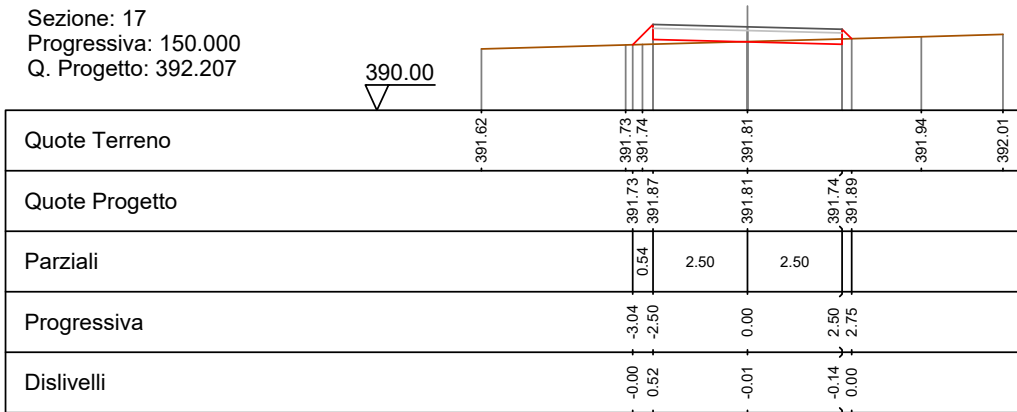

Sezione: 17
 Progressiva: 150.000
 Q. Progetto: 392.207

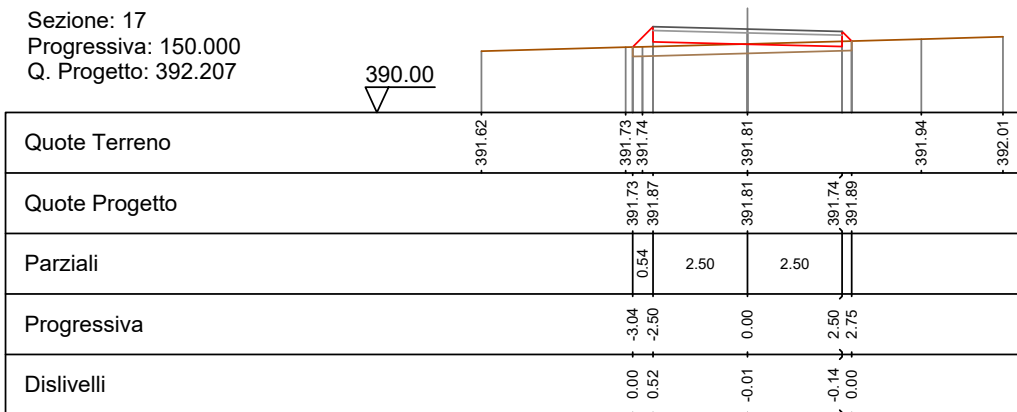

Sezione: 18
 Progressiva: 160.000
 Q. Progetto: 392.583

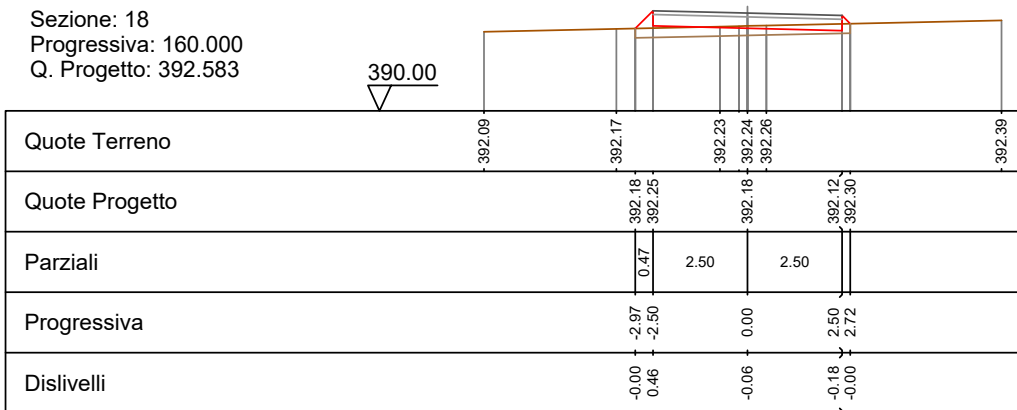

Sezione: 19
 Progressiva: 170.000
 Q. Progetto: 393.035

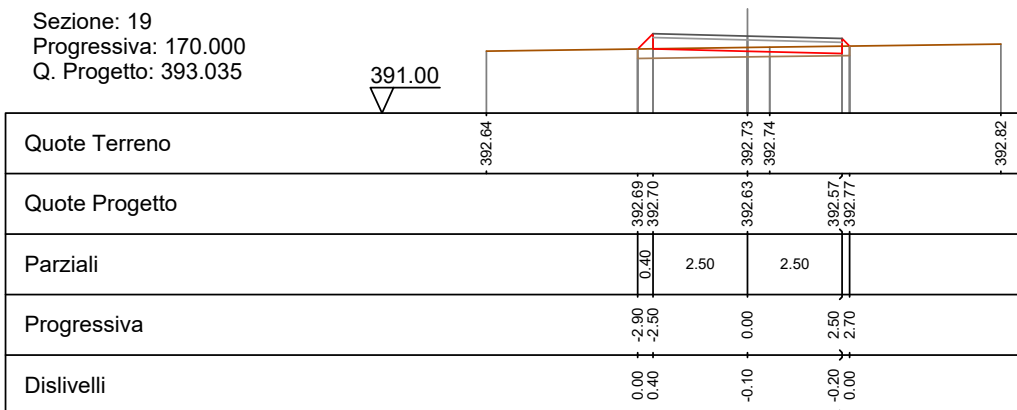

Sezione: 20
 Progressiva: 172.858
 Q. Progetto: 393.177

391.00

Quote Terreno	-392.81	-392.82	-392.85	-392.89	-392.89	-392.96
Quote Progetto			392.85	392.78	392.71	392.92
Parziali			0.39	2.50	2.50	
Progressiva			-2.89	0.00	2.50	2.70
Dislivelli			0.00	-0.11	-0.20	-0.00

Sezione: 21
 Progressiva: 180.000
 Q. Progetto: 393.549

392.00

Quote Terreno	-393.24	-393.27	-393.28	-393.28	-393.30
Quote Progetto		393.26	393.15	393.09	393.29
Parziali		0.35	2.50	2.50	
Progressiva		-2.85	0.00	2.50	2.70
Dislivelli		0.00	-0.13	-0.20	0.00

Sezione: 22
 Progressiva: 190.000
 Q. Progetto: 394.069

392.00

Quote Terreno	-393.89	-393.88	-393.85	-393.85	-393.80
Quote Progetto		393.87	393.67	393.61	393.83
Parziali		0.28	2.50	2.50	
Progressiva		-2.76	0.00	2.50	2.68
Dislivelli		-0.00	-0.18	-0.22	0.00

Sezione: 23
 Progressiva: 200.000
 Q. Progetto: 394.590

393.00

Quote Terreno	-394.55	-394.47	-394.43	-394.40	-394.30
Quote Progetto		394.48	394.19	394.13	394.38
Parziali		0.18	2.50	2.50	
Progressiva		-2.67	0.00	2.50	2.64
Dislivelli		0.00	-0.24	-0.26	-0.00

Sezione: 24
 Progressiva: 209.124
 Q. Progetto: 395.065

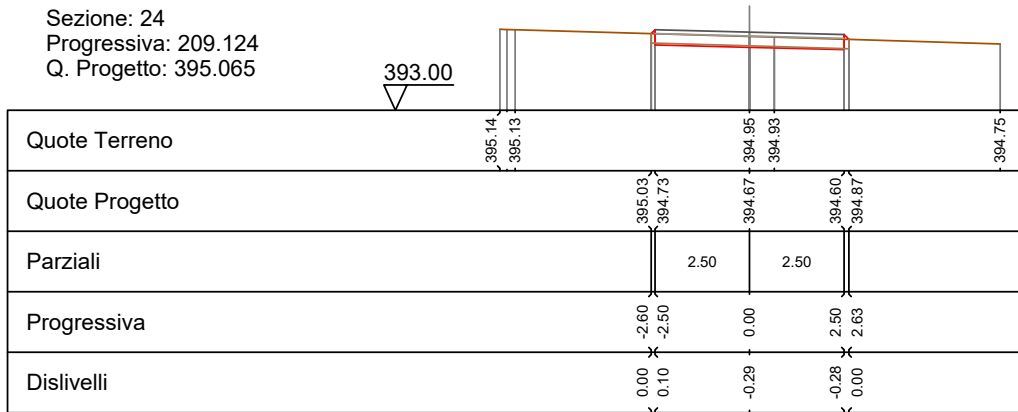

Sezione: 25
 Progressiva: 216.372
 Q. Progetto: 395.443

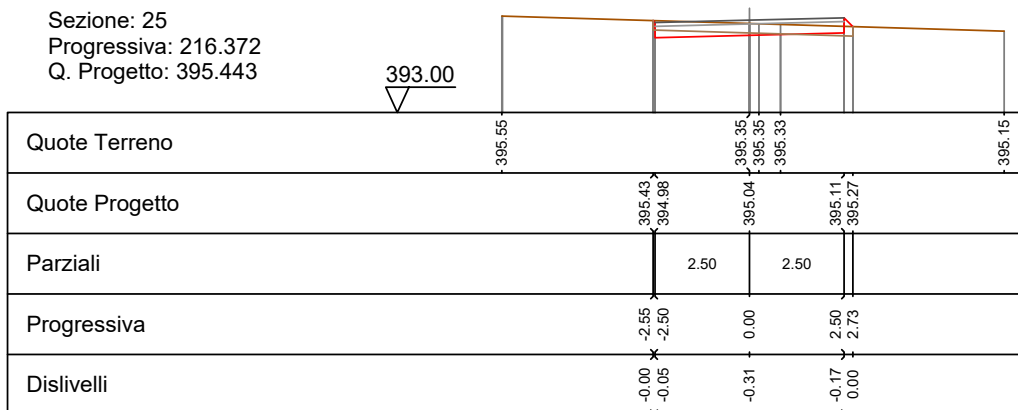

Sezione: 26
 Progressiva: 220.000
 Q. Progetto: 395.647

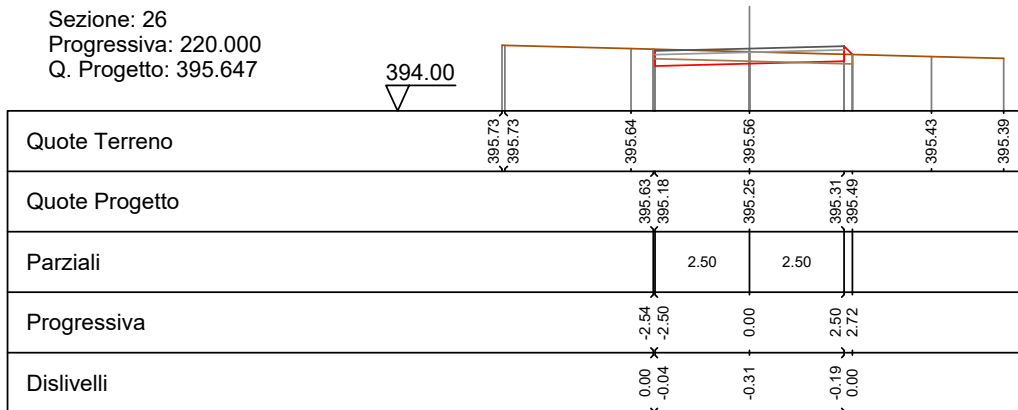

Sezione: 27
 Progressiva: 230.000
 Q. Progetto: 396.331

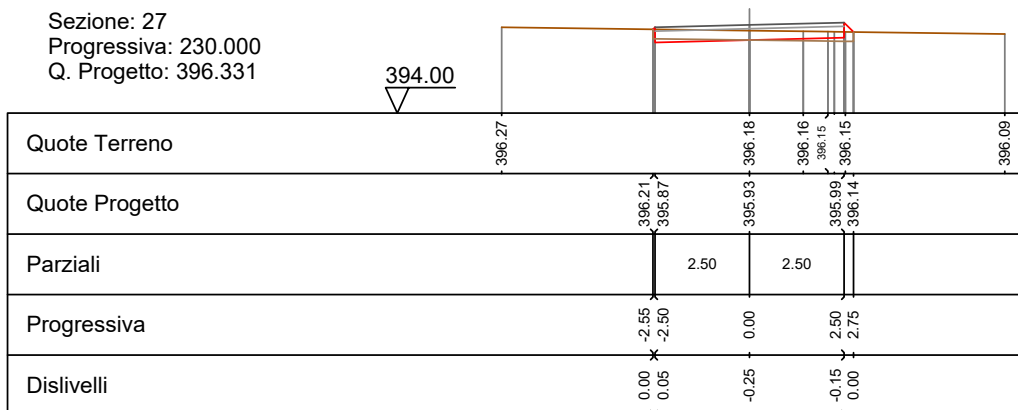

Sezione: 28
 Progressiva: 240.000
 Q. Progetto: 397.050

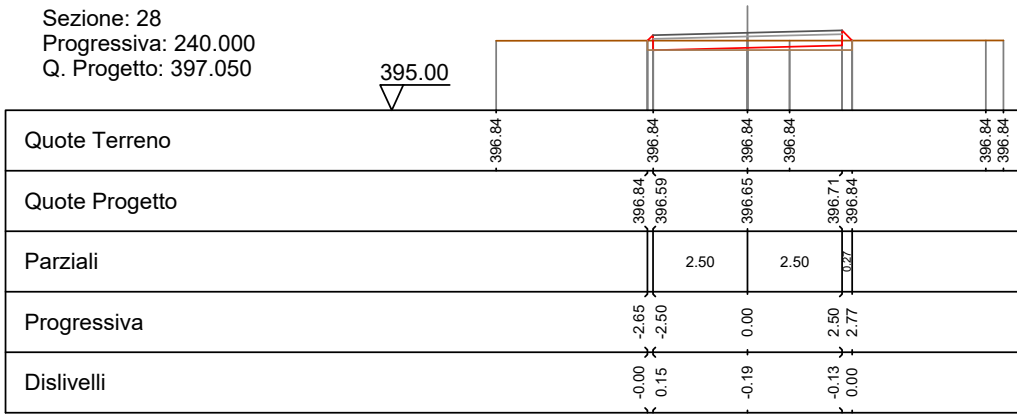

Sezione: 29
 Progressiva: 248.673
 Q. Progetto: 397.674

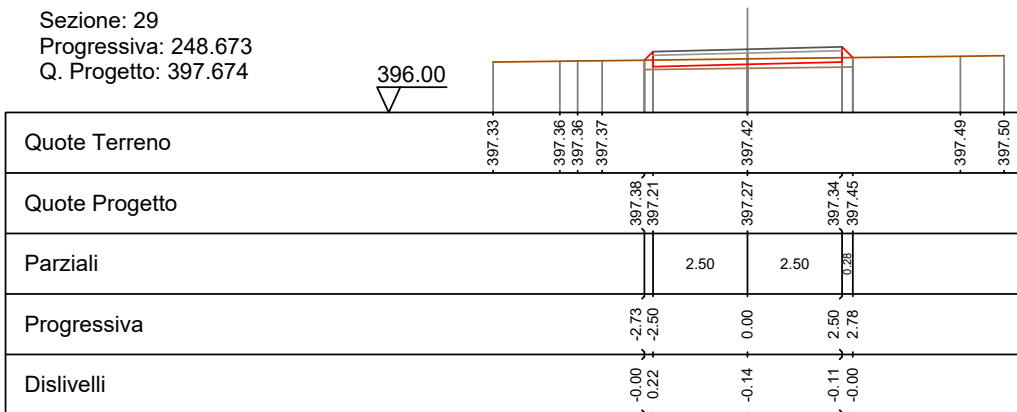

Sezione: 30
 Progressiva: 250.000
 Q. Progetto: 397.769

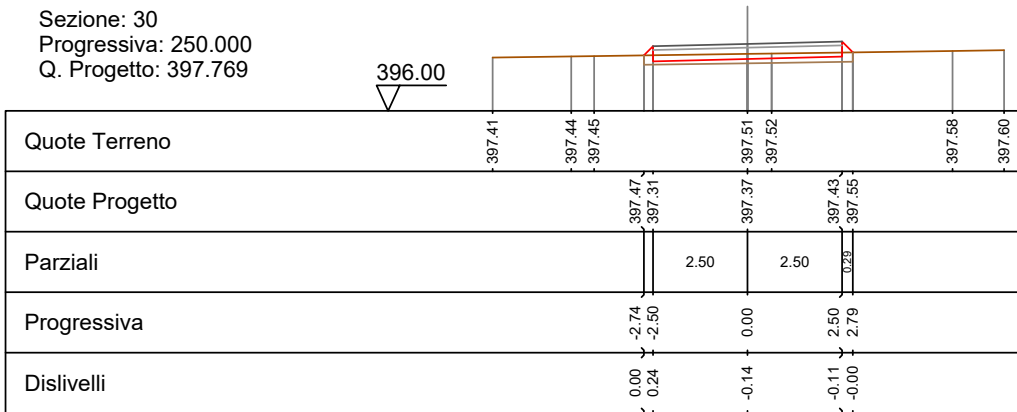

Sezione: 31
 Progressiva: 260.000
 Q. Progetto: 398.488

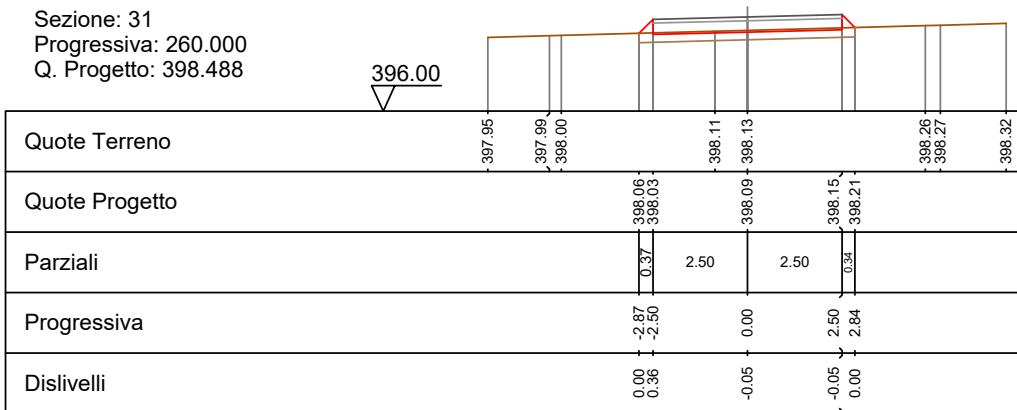

Sezione: 32
 Progressiva: 270.000
 Q. Progetto: 399.167

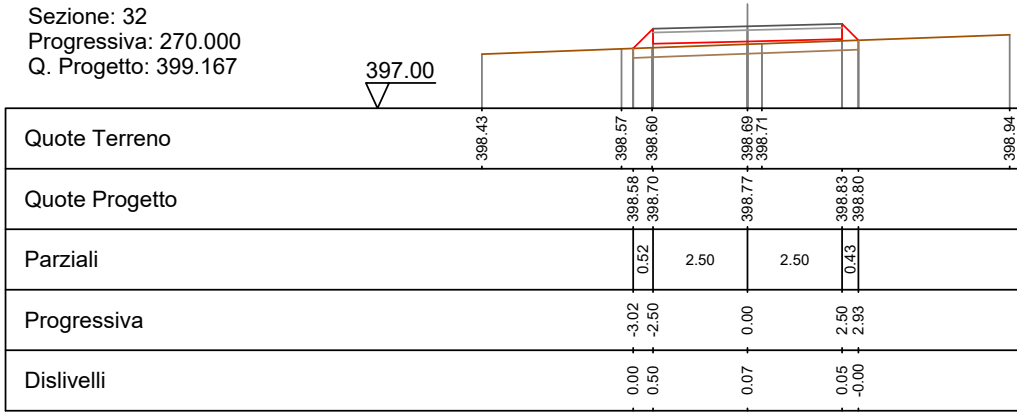

Sezione: 32
 Progressiva: 270.000
 Q. Progetto: 399.167

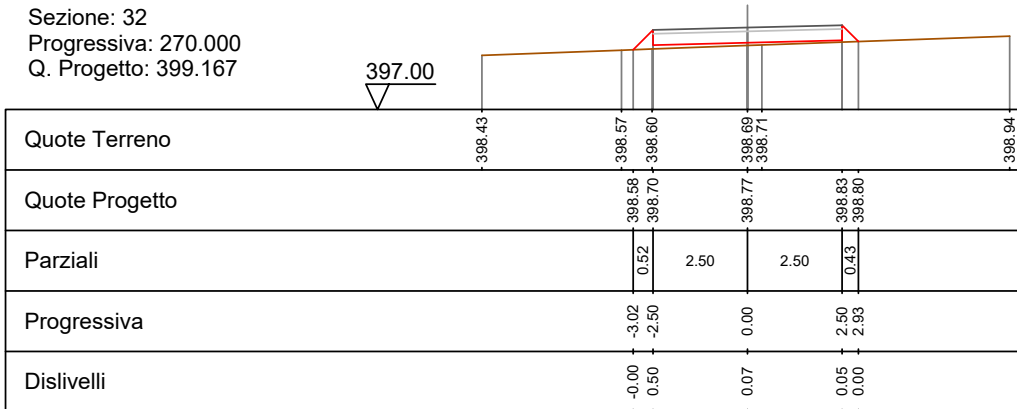

Sezione: 33
 Progressiva: 280.000
 Q. Progetto: 399.657

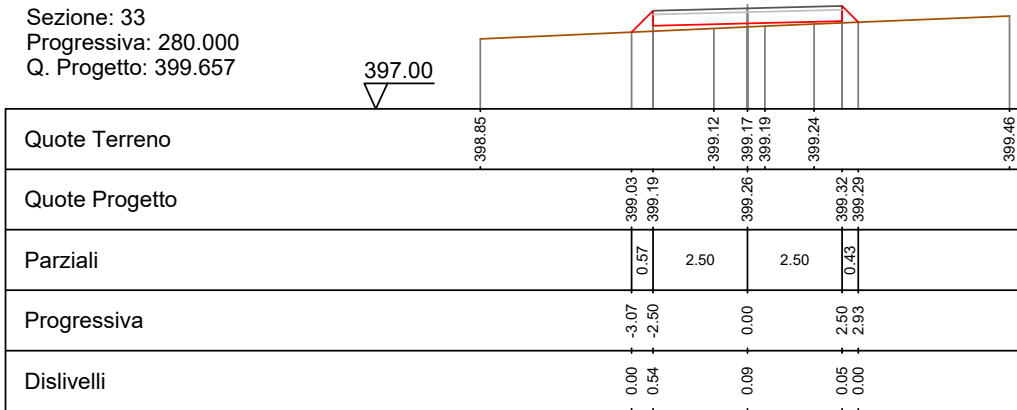

Sezione: 34
 Progressiva: 280.974
 Q. Progetto: 399.694

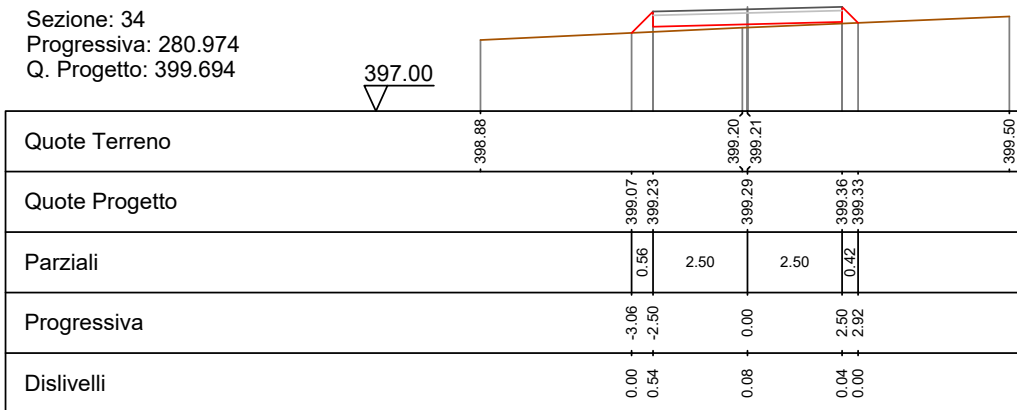

Sezione: 35
 Progressiva: 287.616
 Q. Progetto: 399.908

398.00

Quote Terreno	399.19	399.20		399.46	399.47		399.66	399.72	399.74
Quote Progetto			399.35	399.57	399.51	399.45			
Parziali			0.62	2.50	2.50	0.28			
Progressiva			-3.12	-2.50	0.00	2.50	2.76		
Dislivelli			0.00	0.60	0.04	-0.13	-0.00		

Sezione: 36
 Progressiva: 290.000
 Q. Progetto: 399.982

398.00

Quote Terreno	399.32	399.38		399.59		399.75	399.78	399.79	399.79
Quote Progetto			399.47	399.64	399.68	399.62	399.68		
Parziali			0.57	2.50	2.50				
Progressiva			-3.07	-2.50	0.00	2.50	2.73		
Dislivelli			0.00	0.55	-0.01	-0.16	0.00		

Sezione: 37
 Progressiva: 291.824
 Q. Progetto: 400.038

398.00

Quote Terreno	399.43	399.52		399.68	399.71		399.82	399.82	
Quote Progetto			399.57	399.70	399.64	399.68	399.75		
Parziali			0.53	2.50	2.50				
Progressiva			-3.03	-2.50	0.00	2.50	2.73		
Dislivelli			0.00	0.51	-0.04	-0.17	0.00		

Sezione: 38
 Progressiva: 296.031
 Q. Progetto: 400.168

398.00

Quote Terreno	399.66	399.72	399.74	399.78	399.79		399.89		
Quote Progetto			399.74	399.83	399.77	399.71	399.82		
Parziali			0.49	2.50	2.50	0.28			
Progressiva			-2.99	-2.50	0.00	2.50	2.79		
Dislivelli			0.00	0.48	-0.01	-0.11	0.00		

Sezione: 39
 Progressiva: 300.000
 Q. Progetto: 400.287

398.00

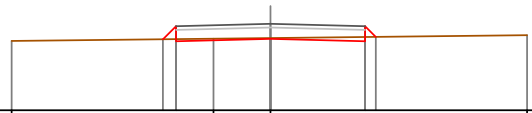

Quote Terreno	-399.83		-399.89	399.91		-399.98
Quote Progetto		399.88 399.82		399.89		399.82 399.94
Parziali		0.35 2.50	2.50		2.50	0.78 0.00
Progressiva		-2.85 -2.50		0.00		2.50 2.78
Dislivelli		-0.00 0.34		-0.02		-0.11 0.00

Sezione: 39
 Progressiva: 300.000
 Q. Progetto: 400.287

398.00

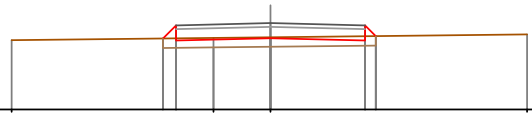

Quote Terreno	-399.83		-399.89	399.91		-399.98
Quote Progetto		399.88 399.82		399.89		399.82 399.94
Parziali		0.35 2.50	2.50		2.50	0.78 0.00
Progressiva		-2.85 -2.50		0.00		2.50 2.78
Dislivelli		-0.00 0.34		-0.02		-0.11 0.00

Sezione: 40
 Progressiva: 307.709
 Q. Progetto: 400.438

398.00

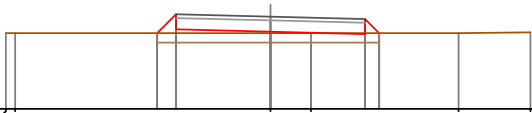

Quote Terreno	400.00 400.00			400.00	400.00	400.00 400.02
Quote Progetto		400.00 400.10		400.04		399.98 400.00
Parziali		0.50 2.50	2.50		2.50	0.38 0.00
Progressiva		-3.00 -2.50		0.00		2.50 2.88
Dislivelli		-0.00 0.50		0.04		-0.02 -0.00

Sezione: 41
 Progressiva: 310.000
 Q. Progetto: 400.459

398.00

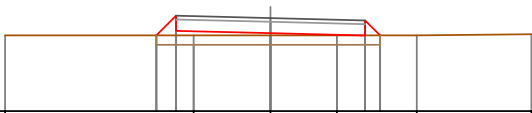

Quote Terreno	400.00		400.00	400.00	400.00	400.00 400.03
Quote Progetto		400.00 400.12		400.06		400.00 400.00
Parziali		0.52 2.50	2.50		2.50	0.40 0.00
Progressiva		-3.02 -2.50		0.00		2.50 2.90
Dislivelli		-0.00 0.52		0.06		-0.00 -0.00

Sezione: 42
 Progressiva: 320.000
 Q. Progetto: 400.453

398.00

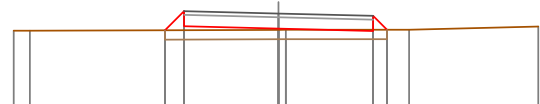

Quote Terreno	-400.00	-400.00		400.02	400.02		400.02	-400.11
Quote Progetto			400.01	400.12	400.05		399.99	400.02
Parziali			0.50	2.50	2.50		0.37	
Progressiva			-3.00	-2.50	0.00		2.50	2.87
Dislivelli			0.00	0.50	0.03		-0.03	0.00

Sezione: 43
 Progressiva: 320.799
 Q. Progetto: 400.450

398.00

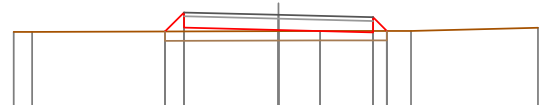

Quote Terreno	-400.00	-400.00		400.02	400.02		400.03	-400.11
Quote Progetto			400.01	400.11	400.05		399.99	400.02
Parziali			0.50	2.50	2.50		0.36	
Progressiva			-3.00	-2.50	0.00		2.50	2.86
Dislivelli			0.00	0.50	0.03		-0.04	0.00

Sezione: 44
 Progressiva: 324.000
 Q. Progetto: 400.439

398.00

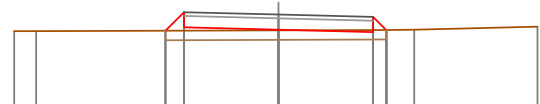

Quote Terreno	-400.00	-400.00		400.02	400.02		400.03	400.04	-400.12
Quote Progetto			400.01	400.10	400.04		399.98	400.03	
Parziali			0.49	2.50	2.50		0.35		
Progressiva			-2.99	-2.50	0.00		2.50	2.85	
Dislivelli			-0.00	0.49	0.02		-0.05	-0.00	

SEZIONI TRASVERSALI
Profilo longitudinale tratto 29-30
Viabilità di impianto postazione aerogeneratore T15

Nota: Le canalette di deflusso delle acque meteoriche, non indicate nel presente elaborato, sono rappresentate graficamente nelle sezioni stradali tipo dell'elaborato "WIND002-TC13_Piazzole aerogeneratori e strade di servizio - Particolari costruttivi", individuate planimetricamente nell'elaborato "WIND002-TC14_Opere di regimazione acque superficiali - Planimetria generale" e quantificate nell'elaborato "WIND002-RC6_Computo Metrico Estimativo".

DISEGNI DI RIFERIMENTO

TAVOLA	DESCRIZIONE
WIND002-TC8	Piazzole e viabilità - Planimetria di progetto - Fase di cantiere
WIND002-TC11	Profili longitudinali viabilità di impianto
WIND002-TC13	Piazzole aerogeneratori e strade di servizio - Particolari costruttivi
WIND002-TC14	Opere di regimazione acque superficiali - Planimetria generale

Sezione: 2
 Progressiva: 20.000
 Q. Progetto: 440.166

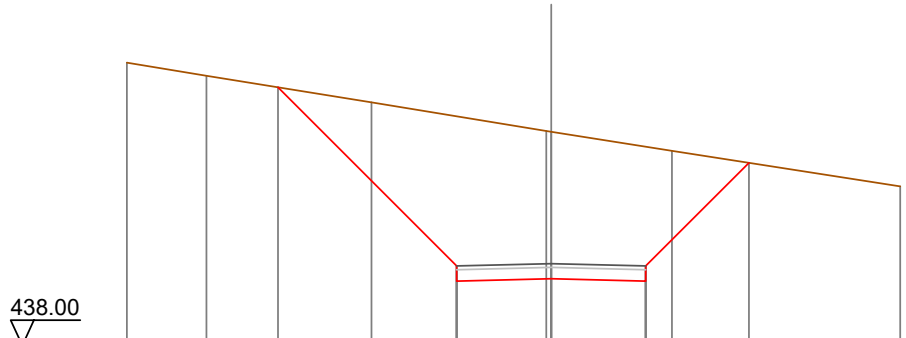

Quote Terreno	-445.48	-445.13	-444.43	-443.67	-443.65	-443.15	-442.21
Quote Progetto		444.83	439.70	439.77	439.70	442.83	
Parziali			4.72	2.50	2.50	2.73	
Progressiva		-7.22	-2.50	0.00	2.50	5.23	
Dislivelli		0.00	-3.96	-3.89	-3.55	-0.00	

Sezione: 3
 Progressiva: 40.000
 Q. Progetto: 440.590

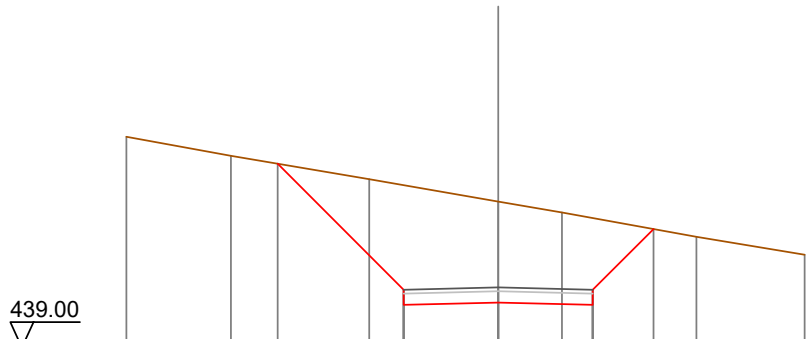

Quote Terreno	-444.57	-444.07	-443.45	-442.86	-442.57	-441.93	-441.45
Quote Progetto		443.86	440.13	440.19	440.13	442.13	
Parziali			3.33	2.50	2.50	1.61	
Progressiva		-5.83	-2.50	0.00	2.50	4.11	
Dislivelli		0.00	-2.77	-2.67	-2.30	0.00	

Sezione: 4
 Progressiva: 60.000
 Q. Progetto: 441.771

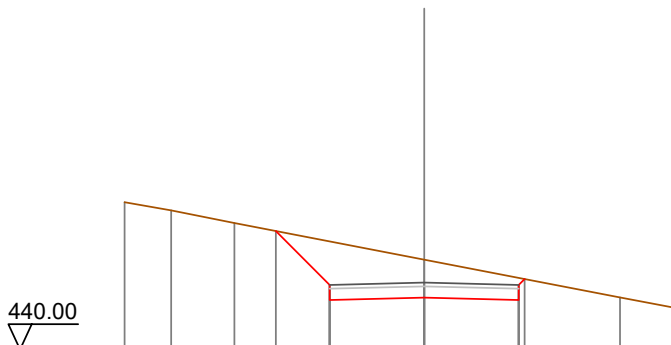

Quote Terreno		443.90	443.68	443.35		443.13		441.37	442.38		441.38	441.10
Quote Progetto						443.13	441.31		441.37	441.31	441.86	
Parziali						1.43	2.50		2.50			
Progressiva						-3.93	-2.50		0.00	2.50	2.65	
Dislivelli						-0.00	-1.15		-1.00	-0.58	-0.00	

Sezione: 5
 Progressiva: 80.000
 Q. Progetto: 443.192

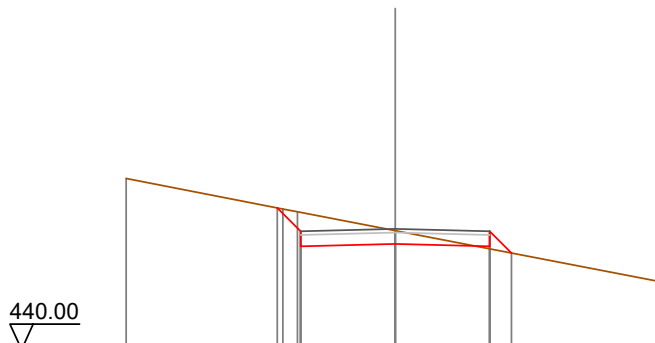

Quote Terreno		444.53		443.75	443.72	443.64		442.79	443.15		441.78
Quote Progetto				443.75	442.73	443.64		442.79	443.15	442.73	442.55
Parziali				0.62	2.50		2.50		0.58		
Progressiva				-3.12	-2.50		0.00	2.50	3.08		
Dislivelli				0.00	-0.50		-0.35	0.07	0.00		

Sezione: 6
 Progressiva: 100.000
 Q. Progetto: 444.510

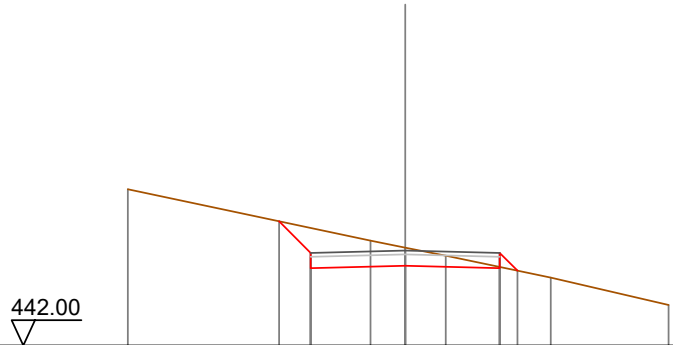

Quote Terreno	-446.13			-444.77	-444.59	-444.37		-443.80		-443.07
Quote Progetto		445.28	444.05		444.11		444.05	443.98		
Parziali		0.84	2.50		2.50		0.37			
Progressiva		-3.34	-2.50		0.00		2.50	2.97		
Dislivelli		-0.00	-0.66		-0.48		-0.03	0.00		

Sezione: 7
 Progressiva: 114.695
 Q. Progetto: 445.038

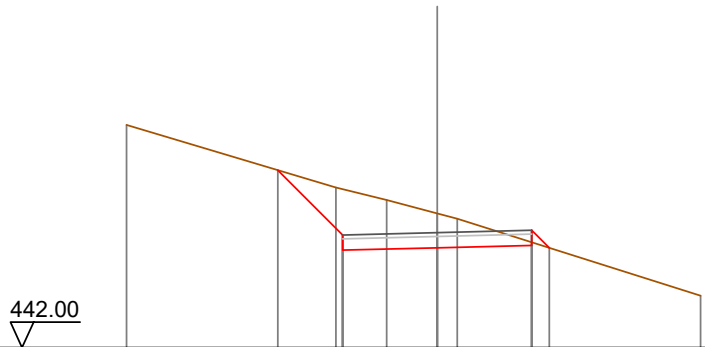

Quote Terreno	-447.89			-446.23	-445.90	-445.55	-445.41			-443.37
Quote Progetto		446.69	444.58		444.64	444.70	444.64			
Parziali		1.72	2.50		2.50		0.46			
Progressiva		-4.22	-2.50		0.00	2.50	2.96			
Dislivelli		0.00	-1.21		-0.91	-0.08	0.00			

Sezione: 8
 Progressiva: 120.000
 Q. Progetto: 445.122

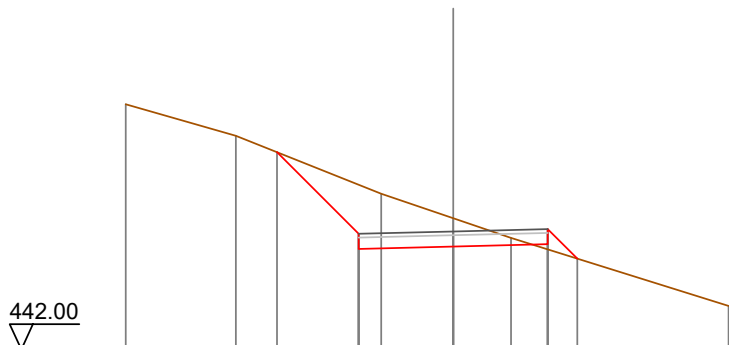

Quote Terreno	-448.49	-447.65	-446.12	-445.47	-444.95	-443.15
Quote Progetto		447.22	444.66	444.72	444.78	444.40
Parziali			2.16	2.50	2.50	0.78
Progressiva		-4.66	-2.50	0.00	2.50	3.28
Dislivelli		0.00	-1.30	-0.75	0.14	0.00

Sezione: 9
 Progressiva: 123.494
 Q. Progetto: 445.147

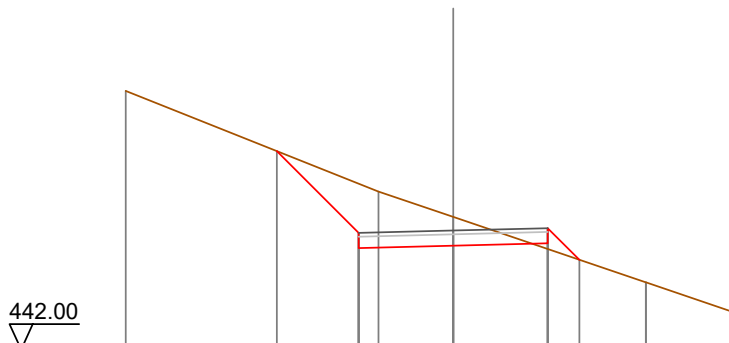

Quote Terreno	-448.84	-447.25	-446.18	-445.51	-444.78	-443.01
Quote Progetto		447.25	444.68	444.75	444.81	444.38
Parziali			2.16	2.50	2.50	0.83
Progressiva		-4.66	-2.50	0.00	2.50	3.33
Dislivelli		-0.00	-1.30	-0.76	0.15	0.00

Sezione: 10
 Progressiva: 130.000
 Q. Progetto: 445.129

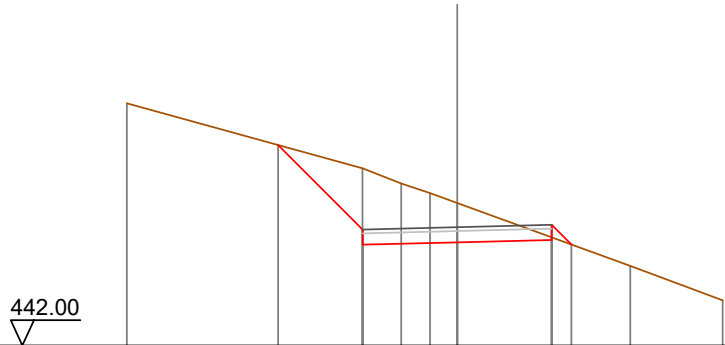

Quote Terreno	-448.41		446.69	446.29	446.03	445.77		444.10	443.19
Quote Progetto		447.30	444.67			444.73		444.79	444.67
Parziali			2.24	2.50		2.50		0.52	
Progressiva		-4.74	-2.50		0.00		2.50	3.02	
Dislivelli		0.00	-1.62		-1.04		-0.07	0.00	

Sezione: 11
 Progressiva: 132.293
 Q. Progetto: 445.102

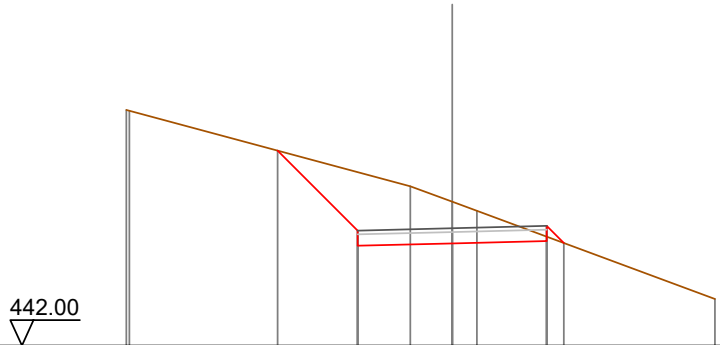

Quote Terreno	448.23	448.21		446.21	445.81	445.57			443.23
Quote Progetto			447.16	444.64		444.70		444.76	444.71
Parziali			2.12	2.50		2.50		0.45	
Progressiva			-4.62	-2.50		0.00		2.50	2.95
Dislivelli			-0.00	-1.55		-1.10		-0.12	0.00

Sezione: 12
 Progressiva: 140.000
 Q. Progetto: 444.935

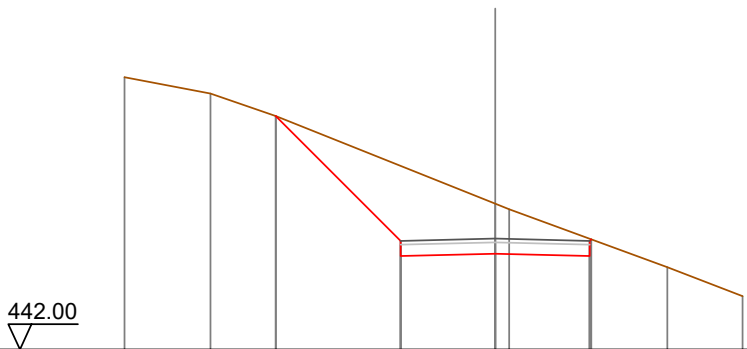

Quote Terreno	-449.20	-448.77	-448.17		-445.86 -445.71		-444.18	-443.41
Quote Progetto			448.18	444.47	444.53	444.47	444.91	
Parziali			3.31	2.50	2.50			
Progressiva			-5.81	-2.50	0.00	2.50	2.54	
Dislivelli			0.00	-1.99	-1.32	-0.46	0.00	

Sezione: 13
 Progressiva: 160.000
 Q. Progetto: 443.945

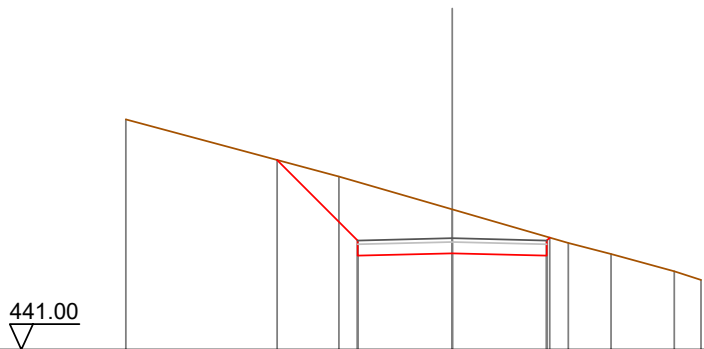

Quote Terreno	-447.09		-445.58		-444.71		-443.82	-443.53	-443.07	-442.84
Quote Progetto		446.01	443.48	443.55	443.96	443.82				
Parziali		2.13	2.50	2.50						
Progressiva		-4.63	-2.50	0.00	2.50	2.58				
Dislivelli		0.00	-1.55	-1.16	-0.50	-0.00				

Sezione: 14
 Progressiva: 180.000
 Q. Progetto: 442.070

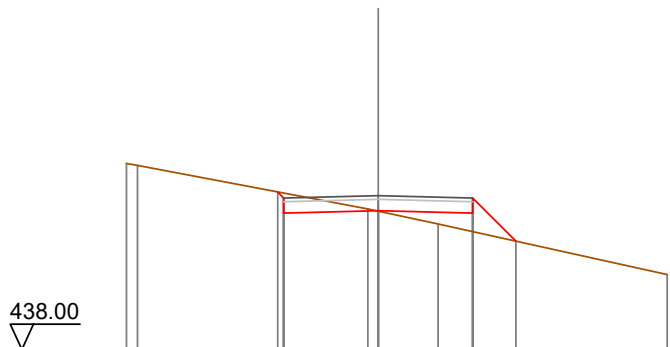

Quote Terreno		442.92	442.87		441.72	441.66	441.32		439.98
Quote Progetto				442.17	441.61	441.67	441.61	440.87	
Parziali					2.50	2.50	1.14		
Progressiva				-2.66	-2.50	0.00	2.50	3.64	
Dislivelli				0.00	-0.13	0.01	0.49	-0.00	

Sezione: 15
 Progressiva: 184.459
 Q. Progetto: 441.538

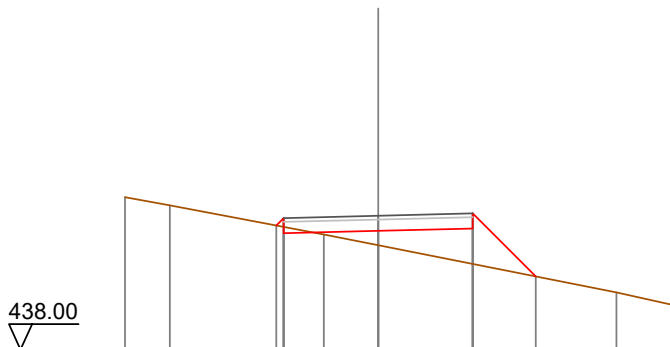

Quote Terreno		442.03	441.81		441.04	440.76		439.51	439.10
Quote Progetto				441.28	441.08	441.14	441.20	439.93	
Parziali					2.50	2.50	1.67		
Progressiva				-2.70	-2.50	0.00	2.50	4.17	
Dislivelli				0.00	0.23	0.38	0.94	0.00	

Sezione: 16
 Progressiva: 190.000
 Q. Progetto: 440.821

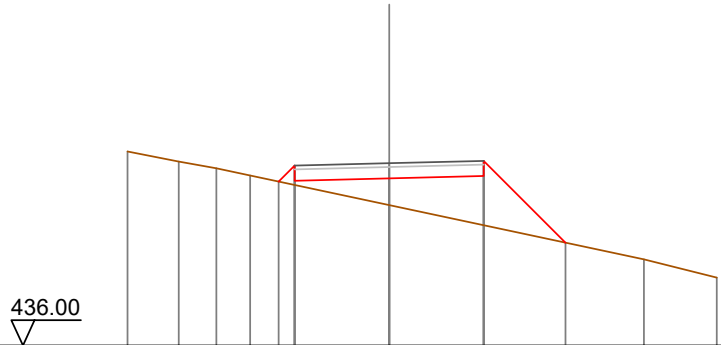

Quote Terreno	-441.13	-440.87	-440.69	-440.50			440.34	440.36	440.42	439.71				-438.28	-437.80
Quote Progetto							440.34	440.36	440.42	440.48			438.72		
Parziali							0.42	2.50	2.50	2.16					
Progressiva							-2.92	-2.50	0.00	2.50			4.66		
Dislivelli							0.00	0.51	0.71	1.30			0.00		

Sezione: 17
 Progressiva: 194.450
 Q. Progetto: 440.210

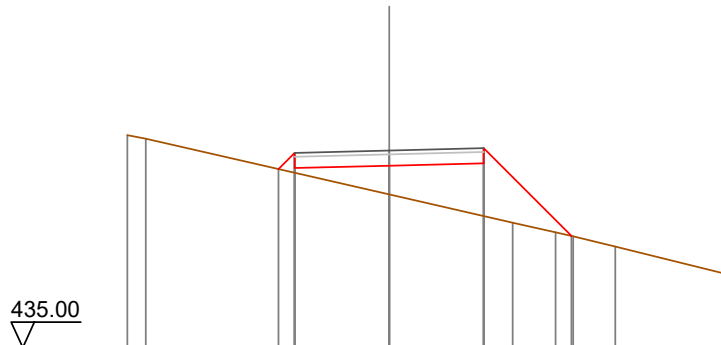

Quote Terreno	-440.62	-440.52							439.05					-438.30	-438.05	-437.94	-437.67	-436.97
Quote Progetto									439.81	439.87			437.95					
Parziali									0.43	2.50	2.50		2.32					
Progressiva									-2.93	-2.50	0.00	2.50	4.82					
Dislivelli									0.00	0.52	0.76	1.39	0.00					

Sezione: 18
 Progressiva: 200.000
 Q. Progetto: 439.445

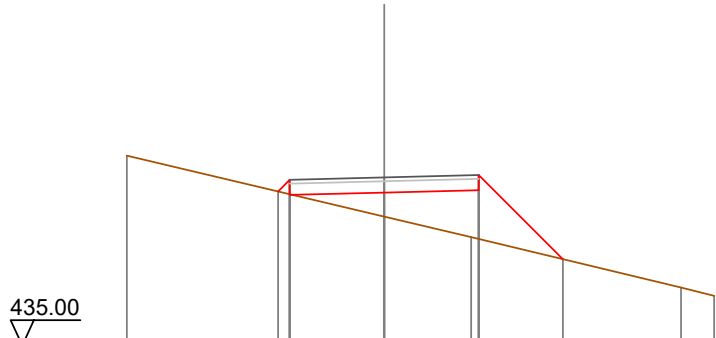

Quote Terreno		440.02		438.41	437.87		436.54	436.31
Quote Progetto			439.08	438.98	439.05	439.11	437.28	
Parziali			0.31	2.50	2.50	2.22		
Progressiva			-2.81	-2.50	0.00	2.50	4.72	
Dislivelli			0.00	0.38	0.64	1.29	-0.00	

Sezione: 19
 Progressiva: 204.441
 Q. Progetto: 438.834

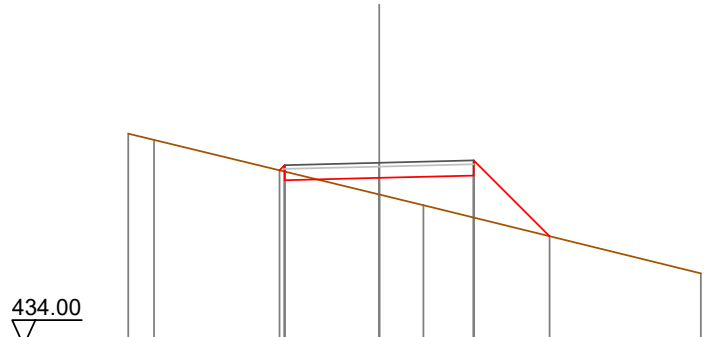

Quote Terreno		439.60	439.44		437.99	437.71		435.91
Quote Progetto				438.63	438.37	438.43	438.50	436.89
Parziali					2.50	2.50	2.00	
Progressiva				-2.64	-2.50	0.00	2.50	4.50
Dislivelli				-0.00	0.17	0.44	1.11	0.00

Sezione: 20
 Progressiva: 220.000
 Q. Progetto: 436.692

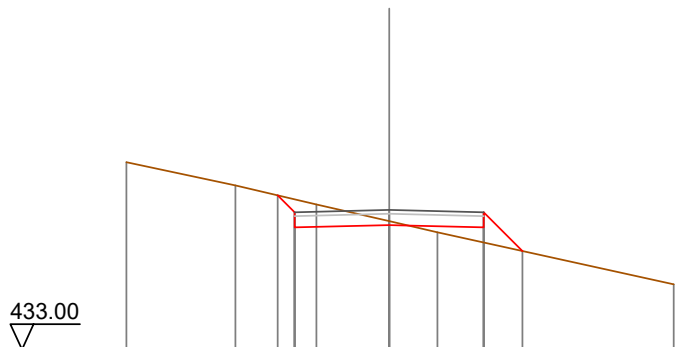

Quote Terreno		437.95		437.34		436.84		436.39		436.10		434.72
Quote Progetto						437.08		436.23		436.23		435.60
Parziali						0.45		2.50		2.50		1.02
Progressiva						-2.95		-2.50		0.00		2.50
Dislivelli						0.00		-0.34		-0.10		0.40

Sezione: 21
 Progressiva: 240.000
 Q. Progetto: 434.229

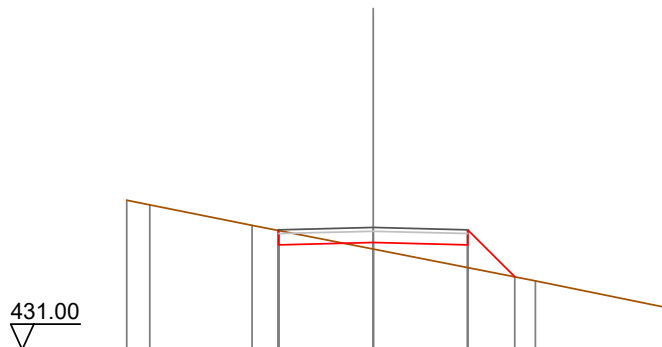

Quote Terreno		434.95		434.83		434.28		433.66		432.82		432.11
Quote Progetto						433.77		433.83		433.77		432.92
Parziali								2.50		2.50		1.24
Progressiva						-2.52		0.00		2.50		3.74
Dislivelli						0.00		0.17		0.60		0.00

Sezione: 22
 Progressiva: 260.000
 Q. Progetto: 432.570

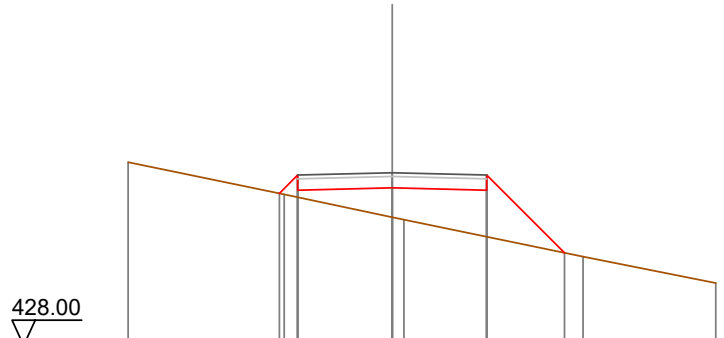

Quote Terreno	-432.85	-432.00	-431.39	-431.33	-430.35	-429.65
Quote Progetto		432.02	432.17	432.11	430.45	
Parziali		0.48	2.50	2.50	2.06	
Progressiva		-2.98	-2.50	0.00	2.50	4.56
Dislivelli		0.00	0.59	0.78	1.23	-0.00

Sezione: 23
 Progressiva: 280.000
 Q. Progetto: 431.716

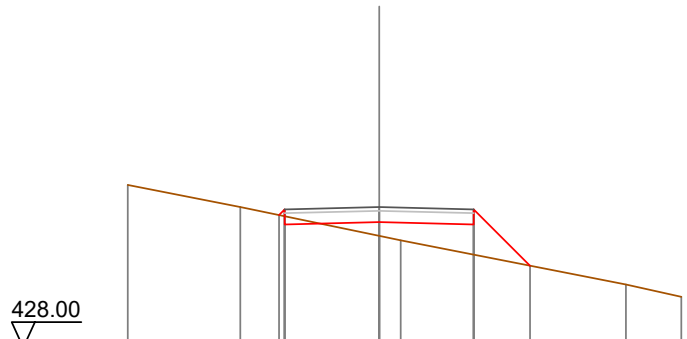

Quote Terreno	-432.30	-431.72	-430.95	-430.84	-429.67	-429.34
Quote Progetto		431.50	431.25	431.25	430.16	
Parziali			2.50	2.50	1.49	
Progressiva		-2.65	-2.50	0.00	2.50	3.99
Dislivelli		0.00	0.18	0.36	0.80	0.00

Sezione: 24
 Progressiva: 296.356
 Q. Progetto: 431.613

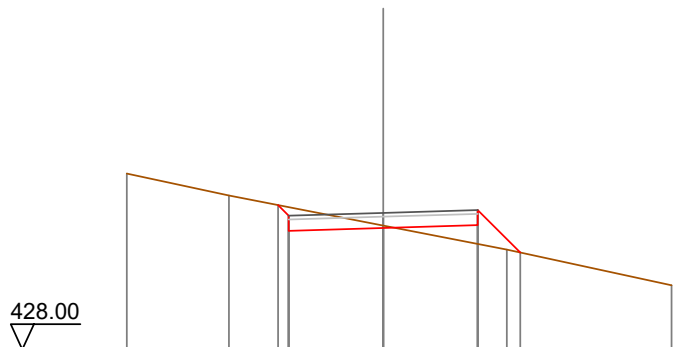

Quote Terreno	-432.65	-432.07	431.82	431.14	431.28	431.29	430.64	-429.70
Quote Progetto			431.82	431.14	431.21	431.29	430.57	
Parziali			0.28	2.50	2.50	1.12		
Progressiva			-2.78	-2.50	0.00	2.50	3.62	
Dislivelli			0.00	-0.23	-0.07	0.50	-0.00	

Sezione: 25
 Progressiva: 299.108
 Q. Progetto: 431.645

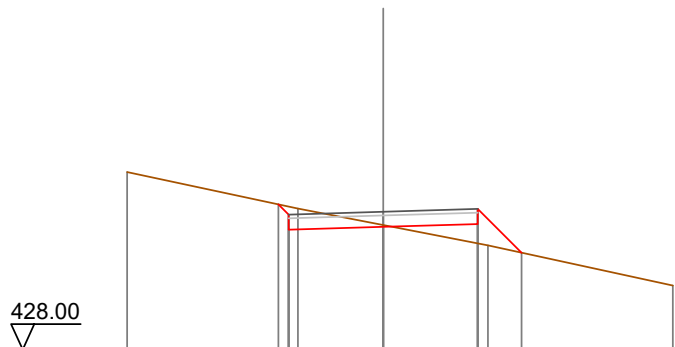

Quote Terreno	-432.69	-431.73	431.24	431.29	430.75	-429.69
Quote Progetto		431.84	431.17	431.24	431.32	430.56
Parziali		0.27	2.50	2.50	1.16	
Progressiva		-2.77	-2.50	0.00	2.50	3.66
Dislivelli		0.00	-0.21	-0.05	0.51	0.00

Sezione: 26
 Progressiva: 300.000
 Q. Progetto: 431.653

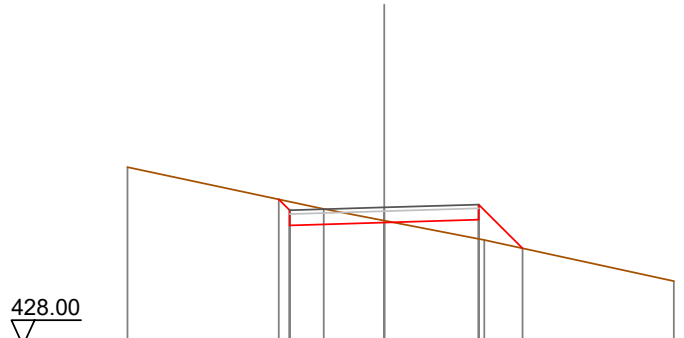

Quote Terreno	-432.72	-431.61	-431.30	-430.79	-429.70
Quote Progetto		431.87 431.18	431.25 431.30	431.33 430.79	430.57
Parziali		0.28 2.50	2.50	1.16	
Progressiva		-2.79 -2.50	0.00	2.50 3.66	
Dislivelli		-0.00 -0.23	-0.05	0.51 0.00	

Sezione: 27
 Progressiva: 301.860
 Q. Progetto: 431.665

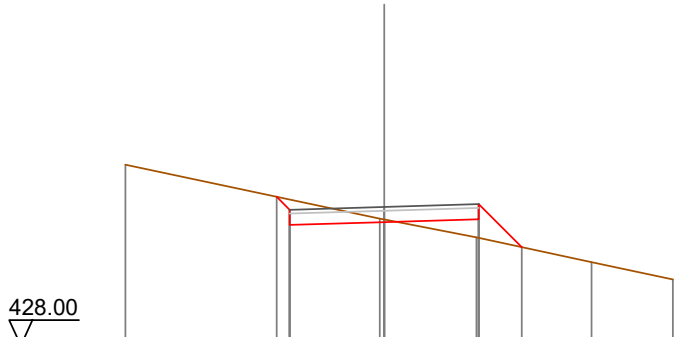

Quote Terreno	-432.78	-431.36	-431.34	-430.86	-430.21	-429.75
Quote Progetto		431.94 431.19	431.26 431.34	431.34 430.86	430.60	
Parziali		0.35 2.50	2.50	1.14		
Progressiva		-2.85 -2.50	0.00	2.50 3.64		
Dislivelli		0.00 -0.27	-0.07	0.49 -0.00		

Sezione: 28
 Progressiva: 320.000
 Q. Progetto: 431.417

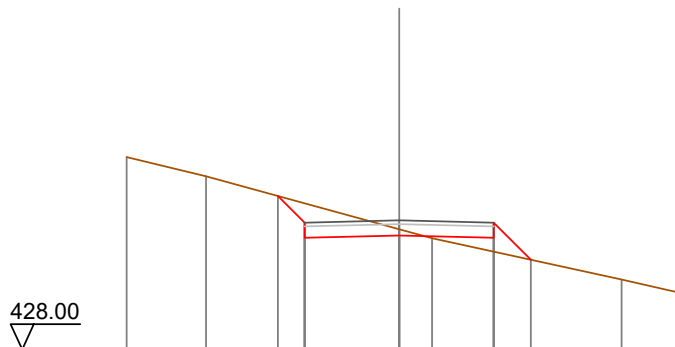

Quote Terreno	-433.09	-432.58			431.18	-430.94			-429.85	-429.49
Quote Progetto			432.06	430.95	431.02		430.95	430.38		
Parziali			0.71	2.50	2.50		0.98			
Progressiva			-3.21	-2.50	0.00		2.50	3.48		
Dislivelli			0.00	-0.51	-0.16		0.37	0.00		

Sezione: 29
 Progressiva: 340.000
 Q. Progetto: 430.394

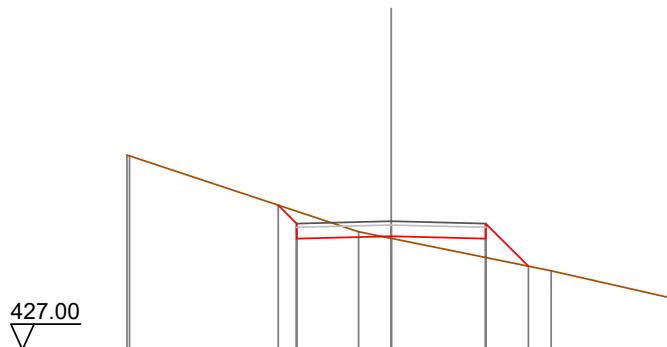

Quote Terreno	432.14	432.12			-430.12	-429.94			-429.08	-428.31
Quote Progetto			430.82	429.93	429.99		429.93	429.20		
Parziali			0.49	2.50	2.50		1.13			
Progressiva			-2.99	-2.50	0.00		2.50	3.63		
Dislivelli			0.00	-0.33	0.05		0.50	-0.00		

Sezione: 30
 Progressiva: 360.000
 Q. Progetto: 429.256

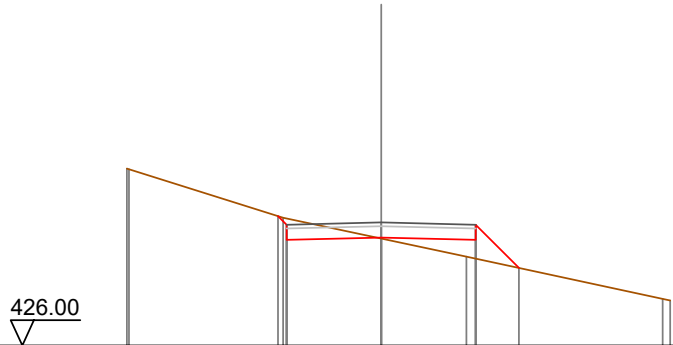

Quote Terreno	430.66	430.66	429.38	428.83	428.35	427.23	427.19
Quote Progetto			428.79	428.86	428.79	428.05	
Parziali			2.50	2.50	1.14		
Progressiva			-2.73	0.00	2.50	3.64	
Dislivelli			-0.00	0.03	0.50	0.00	

Sezione: 31
 Progressiva: 380.000
 Q. Progetto: 428.858

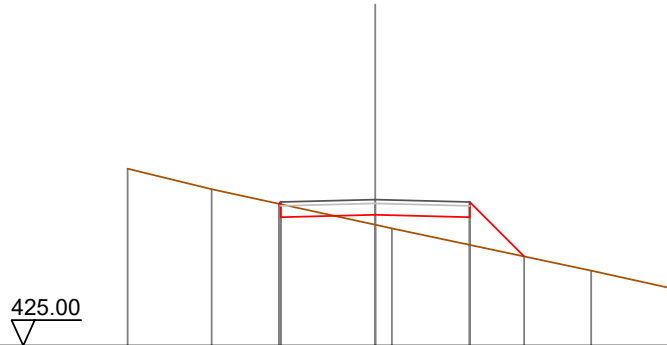

Quote Terreno	429.68	429.14	428.20	428.10	426.98	426.49
Quote Progetto			428.46	428.40	427.36	
Parziali			2.50	2.50	1.44	
Progressiva			-2.55	0.00	2.50	3.94
Dislivelli			0.00	0.26	0.73	0.00

Sezione: 32
 Progressiva: 393.663
 Q. Progetto: 429.046

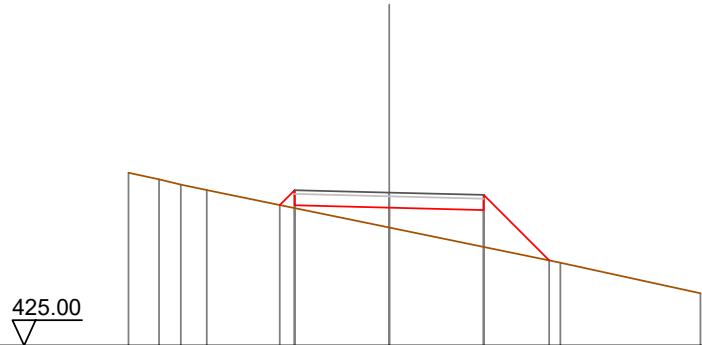

Quote Terreno	-429.57	-429.40	-429.26	-429.11				428.12			427.19		-426.38
Quote Progetto					428.71	428.71		428.65	428.12	428.68	427.25		
Parziali					0.39	2.50		2.50		1.73			
Progressiva					-2.89	-2.50		0.00		2.50	4.23		
Dislivelli					-0.00	0.48		0.53		0.98	-0.00		

Sezione: 33
 Progressiva: 400.000
 Q. Progetto: 429.260

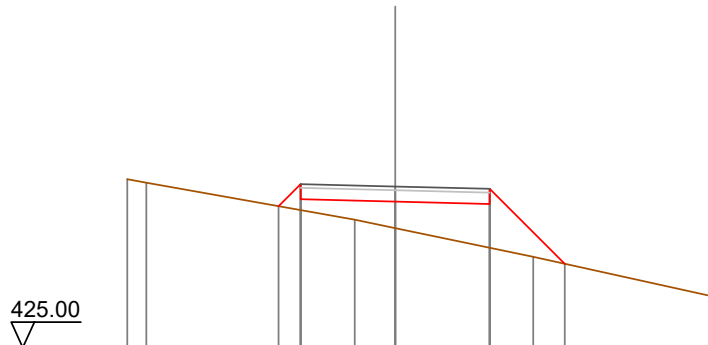

Quote Terreno	-429.45	-429.36						-428.38	-428.16		-427.40		-426.33
Quote Progetto					428.74	428.92		428.86	428.16	428.80	427.21		
Parziali					0.58	2.50		2.50		1.98			
Progressiva					-3.08	-2.50		0.00		2.50	4.48		
Dislivelli					-0.00	0.69		0.70		1.16	-0.00		

Sezione: 34
 Progressiva: 410.000
 Q. Progetto: 429.664

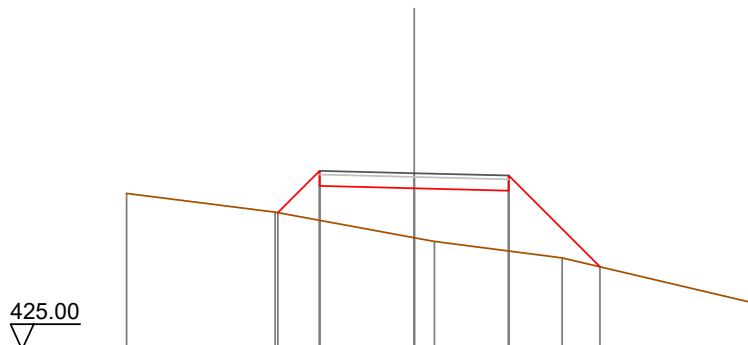

Quote Terreno	-429.13	-428.63	-427.96	-427.86	-427.42	-426.25
Quote Progetto		428.62	429.33	429.26	429.20	427.19
Parziali		1.11	2.50	2.50	2.41	
Progressiva		-3.61	-2.50	0.00	2.50	4.91
Dislivelli		0.00	1.31	1.31	1.60	0.00

Sezione: 35
 Progressiva: 418.422
 Q. Progetto: 429.993

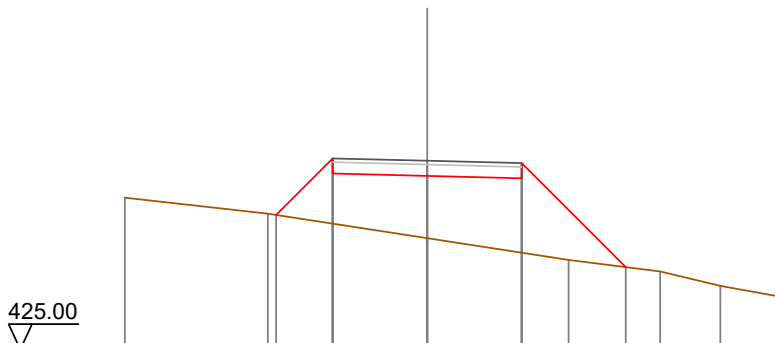

Quote Terreno	-429.02	-428.59	-427.95	-427.37	-427.07	-426.68	-426.41
Quote Progetto		428.56	429.66	429.59	429.53	427.18	
Parziali		1.50	2.50	2.50	2.75		
Progressiva		-4.00	-2.50	0.00	2.50	5.25	
Dislivelli		-0.00	1.73	1.65	1.97	0.00	

Sezione: 36
 Progressiva: 420.000
 Q. Progetto: 430.044

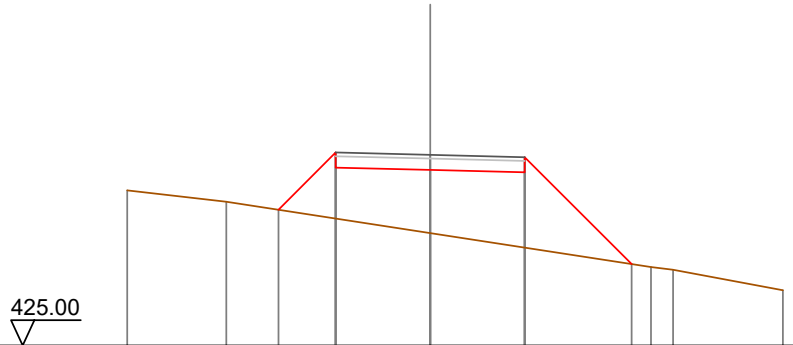

Quote Terreno		429.10		428.80		428.59		429.71		429.64		429.68		427.15		427.08		427.00		426.46
Quote Progetto						428.59		429.71		429.64		429.68		427.15						
Parziali							1.51	2.50		2.50		2.83								
Progressiva						-4.01	-2.50	0.00		2.50		5.33								
Dislivelli						-0.00	1.75	1.67		1.99		0.00								

Sezione: 37
 Progressiva: 430.000
 Q. Progetto: 430.261

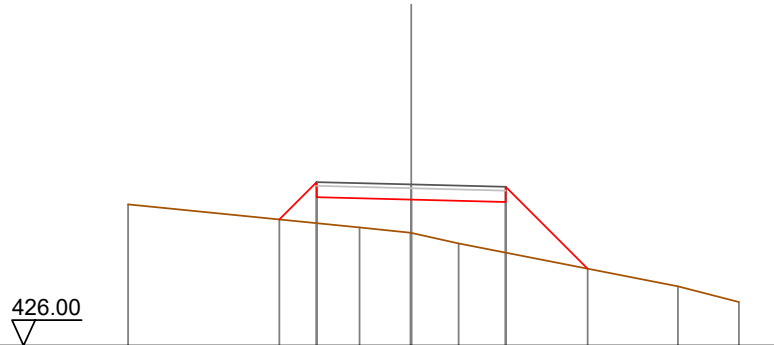

Quote Terreno				429.73				429.12		428.89		428.98		428.70				427.56		427.15
Quote Progetto								429.33		429.92		429.86		429.80		428.03				
Parziali								0.99		2.50		2.50		2.17						
Progressiva								-3.49		-2.50		0.00		2.50		4.67				
Dislivelli								-0.00		1.09		0.88		1.34		0.00				

Sezione: 38
 Progressiva: 440.000
 Q. Progetto: 430.433

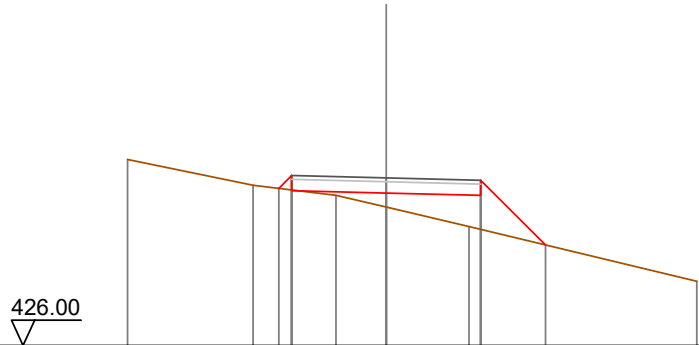

Quote Terreno	-430.92	-430.24	-429.97	-429.66	-429.14	-427.70
Quote Progetto		430.16	430.10	430.03	429.97	428.66
Parziali		0.34	2.50	2.50	1.71	
Progressiva		-2.84	-2.50	0.00	2.50	4.21
Dislivelli		0.00	0.38	0.37	0.90	-0.00

Sezione: 39
 Progressiva: 443.181
 Q. Progetto: 430.488

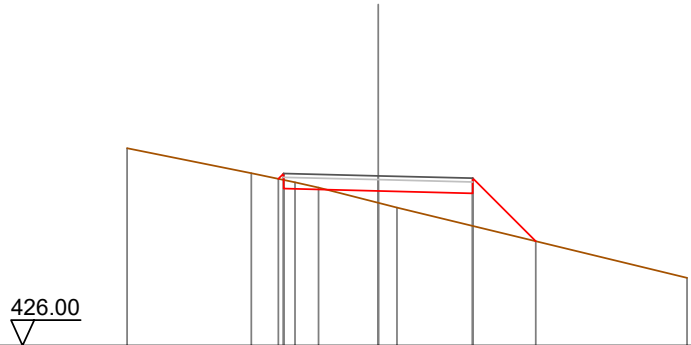

Quote Terreno	-431.22	-430.56	-430.32	-430.18	-429.77	-429.65	-427.79
Quote Progetto		430.41	430.15	430.09	430.03	428.76	
Parziali			2.50	2.50	1.67		
Progressiva		-2.64	-2.50	0.00	2.50	4.17	
Dislivelli		-0.00	0.17	0.31	0.86	0.00	

Sezione: 40
 Progressiva: 460.000
 Q. Progetto: 430.981

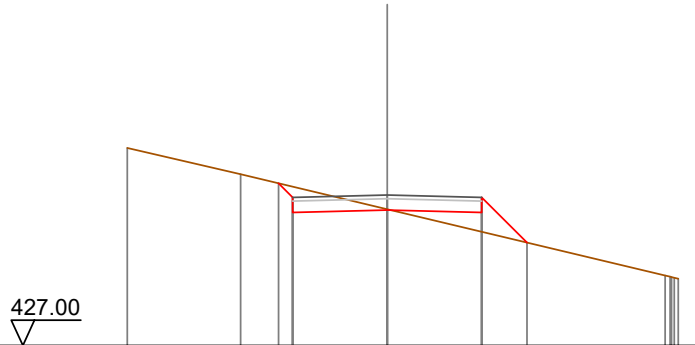

Quote Terreno	-432.22	-431.53	430.61	428.85	428.77
Quote Progetto			430.58	430.52	429.72
Parziali			2.50	2.50	1.20
Progressiva			0.00	2.50	3.70
Dislivelli			-0.02	0.51	-0.00

Sezione: 41
 Progressiva: 480.000
 Q. Progetto: 432.293

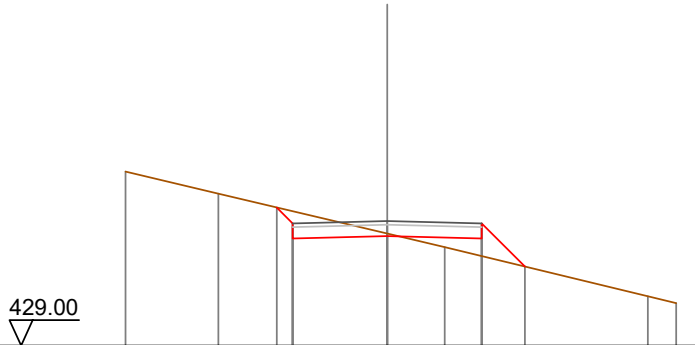

Quote Terreno	-433.60	-433.01	431.96	431.60	430.30	430.12
Quote Progetto			431.89	431.83	431.09	
Parziali			2.50	2.50	1.14	
Progressiva			0.00	2.50	3.64	
Dislivelli			-0.07	0.47	0.00	

Sezione: 42
 Progressiva: 500.000
 Q. Progetto: 433.915

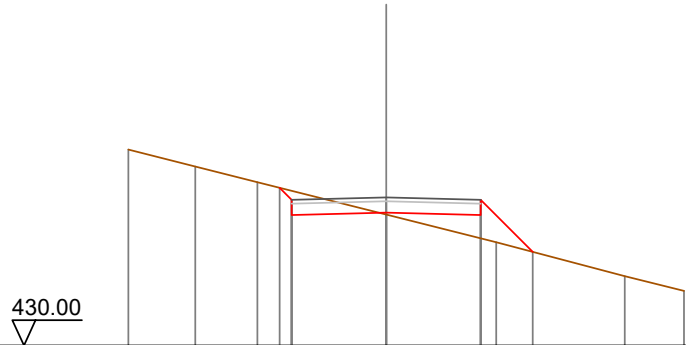

Quote Terreno	-435.18	-434.73	-434.32	-433.46	-432.73	-431.84	-431.44
Quote Progetto			434.17 433.45	433.52	433.45	432.48	
Parziali			0.32 2.50	2.50	1.38		
Progressiva			-2.82 -2.50	0.00	2.50	3.88	
Dislivelli			0.00 -0.24	0.05	0.62	0.00	

Sezione: 43
 Progressiva: 520.000
 Q. Progetto: 435.478

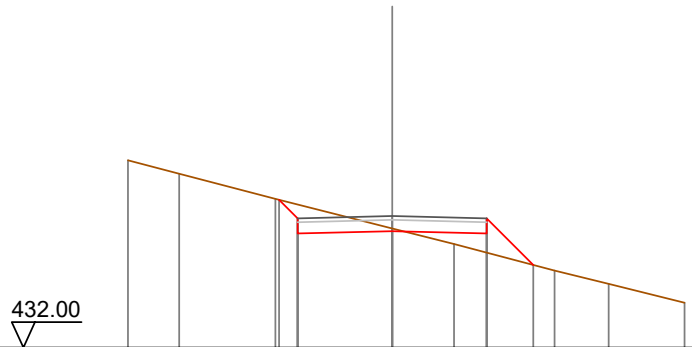

Quote Terreno	-436.95	-436.60	-435.93	-435.15	-434.74	-434.04	-433.68	-433.18
Quote Progetto			435.91 435.02	435.08	435.02	434.18		
Parziali			0.49 2.50	2.50	1.23			
Progressiva			-2.99 -2.50	0.00	2.50	3.73		
Dislivelli			0.00 -0.37	-0.07	0.51	-0.00		

Sezione: 44
 Progressiva: 540.000
 Q. Progetto: 436.669

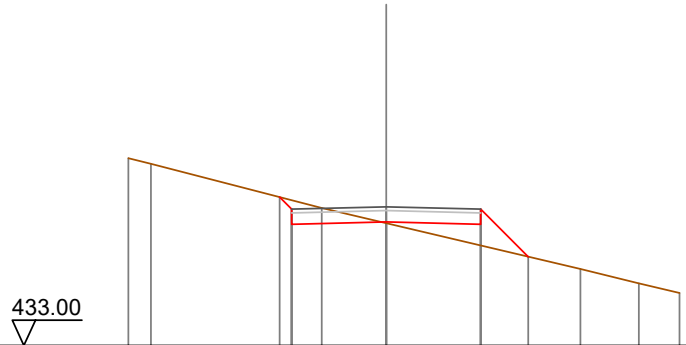

Quote Terreno	-437.95	-437.80		-436.64	-436.23		-435.02	-434.65	-434.39
Quote Progetto			436.92	436.21	436.27	436.21	435.35		
Parziali			0.32	2.50	2.50	1.26			
Progressiva			-2.82	-2.50	0.00	2.50	3.76		
Dislivelli			0.00	-0.24	0.03	0.56	0.00		

Sezione: 45
 Progressiva: 550.284
 Q. Progetto: 437.156

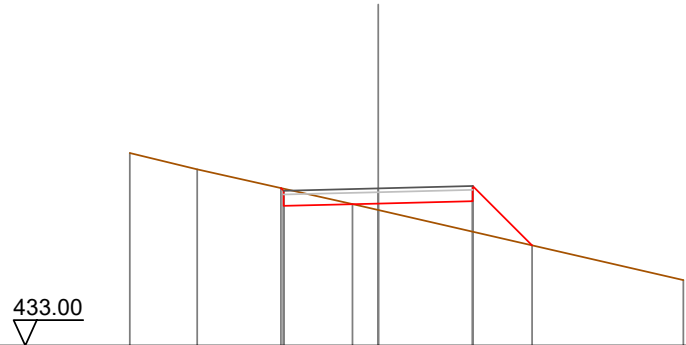

Quote Terreno	-438.09	-437.66		-436.74	-436.59			-434.73
Quote Progetto			437.16	436.69	436.76	436.82	435.65	
Parziali				2.50	2.50	1.57		
Progressiva			-2.57	-2.50	0.00	2.50	4.07	
Dislivelli			0.00	-0.06	0.17	0.81	0.00	

Sezione: 46
 Progressiva: 553.519
 Q. Progetto: 437.265

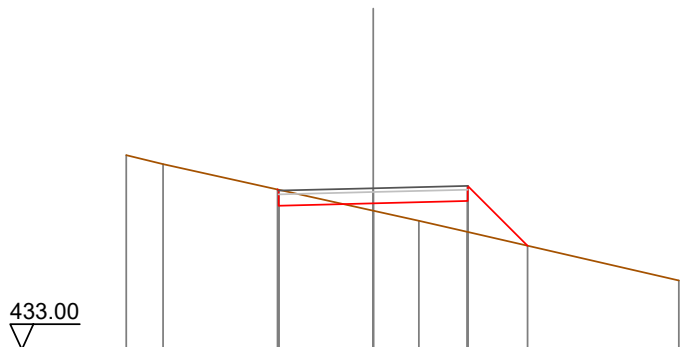

Quote Terreno		-438.14	-437.90			436.67	-436.40	436.11		-434.83
Quote Progetto				437.23	436.90	436.87		436.83	435.75	
Parziali					2.50		2.50	1.58		
Progressiva				-2.53	-2.50	0.00		2.50	4.08	
Dislivelli				0.00	-0.02	0.19		0.82	0.00	

Sezione: 47
 Progressiva: 556.754
 Q. Progetto: 437.354

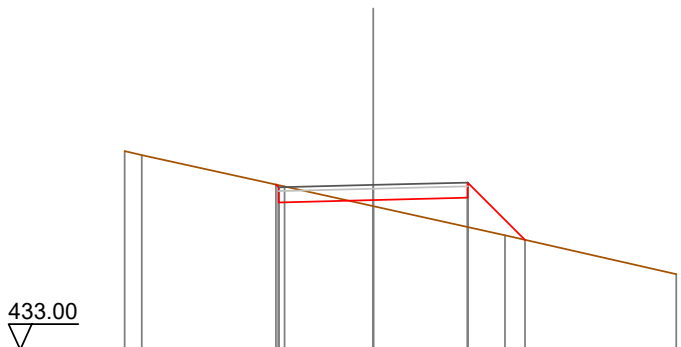

Quote Terreno		-438.25	-438.14			436.79		436.02		-434.99
Quote Progetto				437.36	436.89	436.95		437.02	435.90	
Parziali					2.50		2.50	1.52		
Progressiva				-2.57	-2.50	0.00		2.50	4.02	
Dislivelli				0.00	-0.06	0.16		0.78	0.00	

Sezione: 48
 Progressiva: 560.000
 Q. Progetto: 437.422

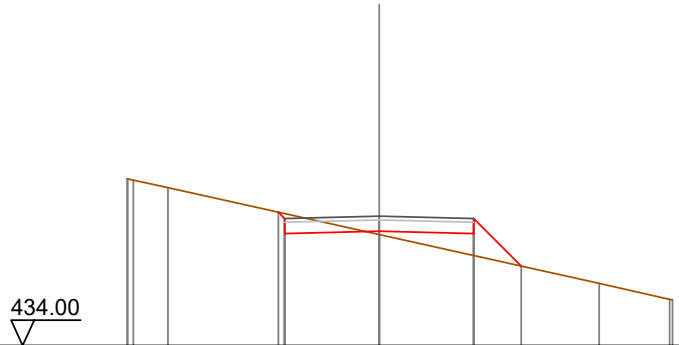

Quote Terreno	438.40	438.37	438.17	436.94	436.96	436.85	435.22	435.21
Quote Progetto			437.53	437.02	436.96	436.10		
Parziali			2.50	2.50	1.26			
Progressiva			-2.67	0.00	2.50	3.76		
Dislivelli			0.00	0.09	0.58	-0.00		

Sezione: 49
 Progressiva: 580.000
 Q. Progetto: 437.616

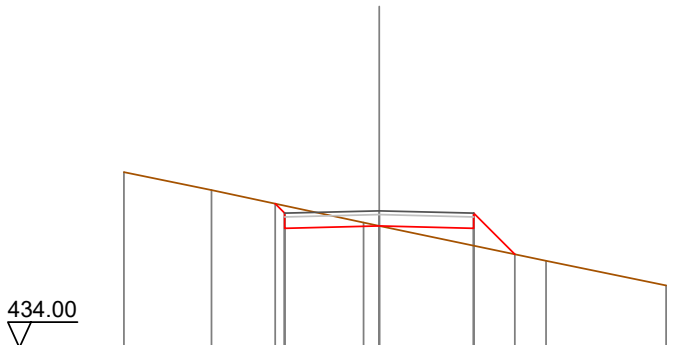

Quote Terreno	438.64	438.16	437.30	437.22	436.29	435.64
Quote Progetto			437.80	437.22	437.15	436.47
Parziali			2.50	2.50	1.09	
Progressiva			-2.75	0.00	2.50	3.59
Dislivelli			0.00	-0.00	0.46	-0.00

Sezione: 50
 Progressiva: 600.000
 Q. Progetto: 437.790

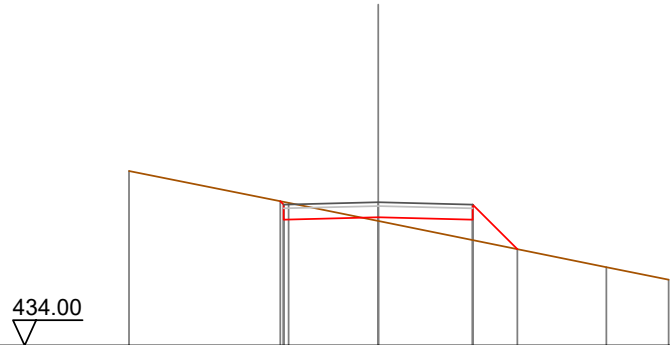

Quote Terreno		-438.62		437.77		437.29			-436.07	-435.74
Quote Progetto			437.82	437.33		437.39		437.33	436.55	
Parziali					2.50		2.50		1.18	
Progressiva			-2.59	-2.50		0.00		2.50	3.68	
Dislivelli			-0.00	-0.07		0.10		0.54	0.00	

Sezione: 51
 Progressiva: 620.000
 Q. Progetto: 437.965

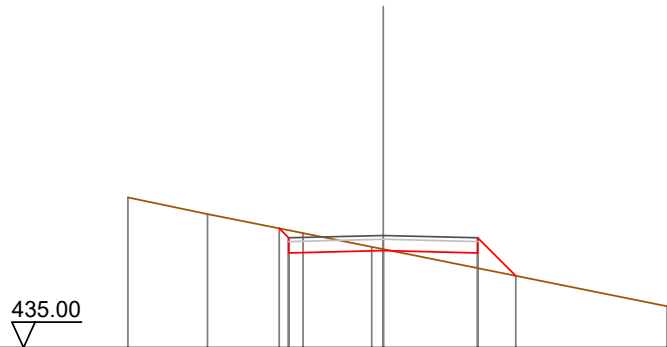

Quote Terreno		-438.97		-438.53		-438.03		437.66		437.60				-436.09
Quote Progetto					438.15	437.50		437.56		437.50		436.90		
Parziali							2.50		2.50		1.01			
Progressiva					-2.75	-2.50		0.00		2.50		3.51		
Dislivelli					0.00	-0.20		-0.04		0.40		0.00		

Sezione: 52
 Progressiva: 640.000
 Q. Progetto: 438.140

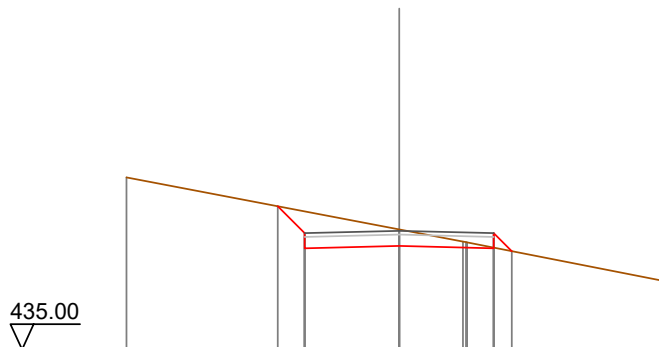

Quote Terreno	439.55		438.18	437.86	437.83		436.82
Quote Progetto		438.79	437.68	437.74	437.68	437.60	
Parziali		0.71	2.50	2.50	0.47		
Progressiva		-3.21	-2.50	0.00	2.50	2.97	
Dislivelli		0.00	-0.58	-0.44	-0.02	-0.00	

Sezione: 53
 Progressiva: 660.000
 Q. Progetto: 438.747

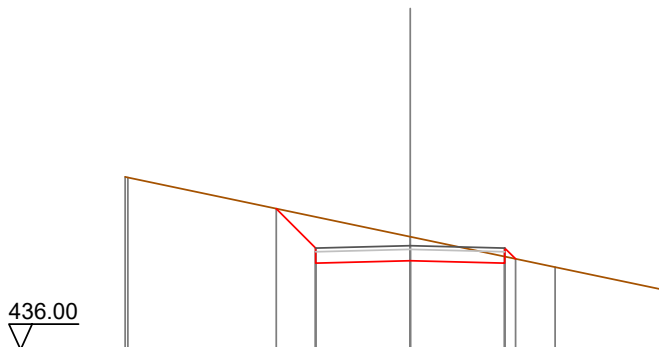

Quote Terreno	440.56	440.55		438.98		438.18	437.56
Quote Progetto			439.73	438.28	438.35	438.28	438.40
Parziali			1.04	2.50	2.50	0.28	
Progressiva			-3.54	-2.50	0.00	2.50	2.79
Dislivelli			0.00	-0.82	-0.64	-0.17	0.00

Sezione: 54
 Progressiva: 663.433
 Q. Progetto: 438.932

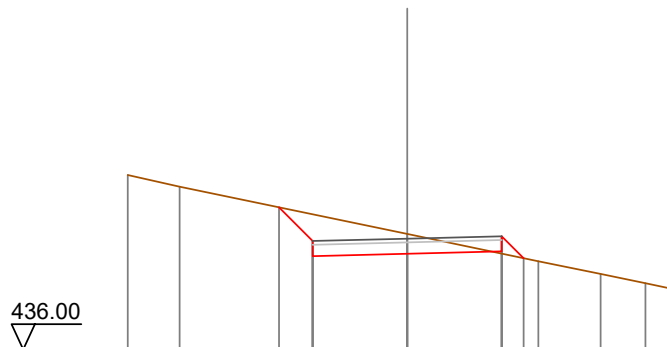

Quote Terreno	-440.62	-440.31			439.06		438.34	-438.00	-437.75	-437.59
Quote Progetto			439.76	438.47	438.53		438.59	438.42		
Parziali			0.89	2.50	2.50		0.58			
Progressiva			-3.39	-2.50	0.00		2.50	3.08		
Dislivelli			0.00	-0.71	-0.52		0.06	0.00		

Sezione: 55
 Progressiva: 667.586
 Q. Progetto: 439.188

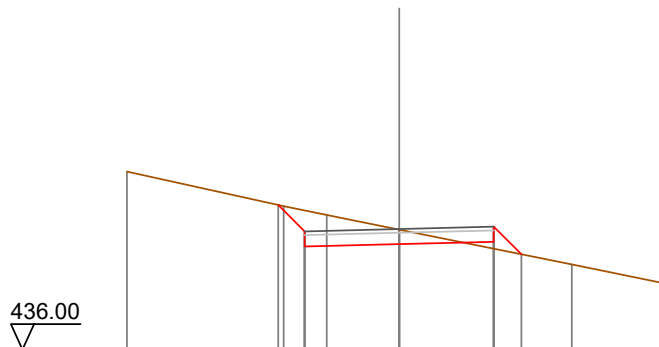

Quote Terreno	-440.71		439.79	439.56	439.17			438.25	-437.70
Quote Progetto			439.82	438.73	438.79		438.85	438.52	
Parziali			0.70	2.50	2.50		0.73		
Progressiva			-3.20	-2.50	0.00		2.50	3.23	
Dislivelli			0.00	-0.55	-0.38		0.18	0.00	

Sezione: 56
 Progressiva: 670.000
 Q. Progetto: 439.352

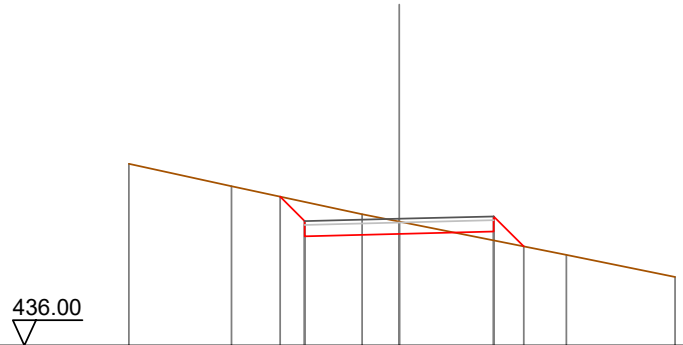

Quote Terreno		-440.81		-440.21		-439.47	-439.28		-438.40	-437.81
Quote Progetto				439.94	438.89		438.95		439.01	438.62
Parziali				0.65	2.50		2.50		0.79	
Progressiva				-3.15	-2.50		0.00		2.50	3.29
Dislivelli				-0.00	-0.51		-0.33		0.23	0.00

Sezione: 57
 Progressiva: 671.740
 Q. Progetto: 439.478

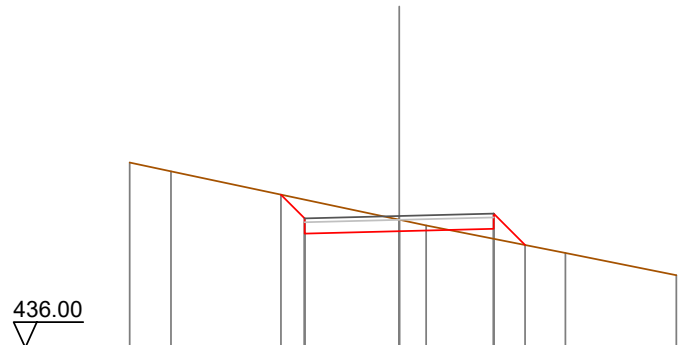

Quote Terreno		-440.89		-440.66		-439.38	-439.23		-438.50	-437.91
Quote Progetto				440.04	439.02		439.08		439.14	438.71
Parziali				0.63	2.50		2.50		0.83	
Progressiva				-3.13	-2.50		0.00		2.50	3.33
Dislivelli				-0.00	-0.49		-0.30		0.26	0.00

Sezione: 58
 Progressiva: 680.000
 Q. Progetto: 440.158

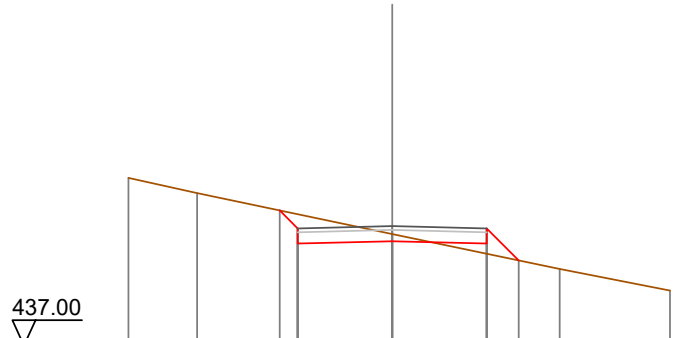

Quote Terreno	-441.43	-441.03			439.95			-439.02	-438.45
Quote Progetto			440.57	439.70	439.76	439.70	439.25		
Parziali			0.48	2.50	2.50	0.85			
Progressiva			-2.98	-2.50	0.00	2.50	3.35		
Dislivelli			0.00	-0.38	-0.19	0.27	0.00		

Sezione: 59
 Progressiva: 700.000
 Q. Progetto: 442.227

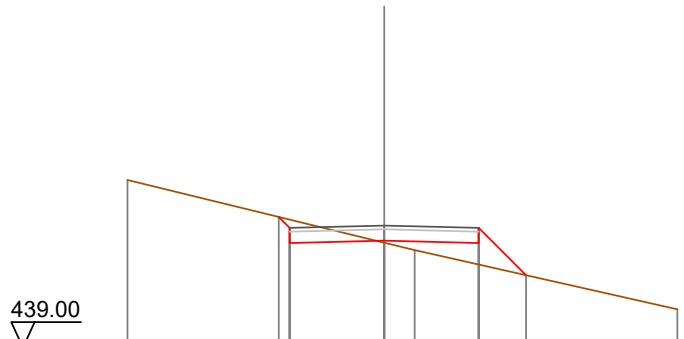

Quote Terreno	-443.43				441.77	-441.58			-440.01
Quote Progetto			442.46	441.76	441.83	441.76	440.91		
Parziali			0.29	2.50	2.50	1.25			
Progressiva			-2.79	-2.50	0.00	2.50	3.75		
Dislivelli			0.00	-0.22	0.05	0.57	0.00		

Sezione: 60
 Progressiva: 720.000
 Q. Progetto: 444.459

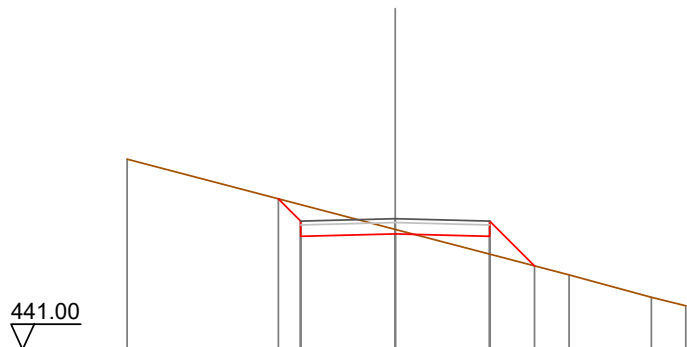

Quote Terreno	-446.03			444.18						
Quote Progetto		444.99	444.00	444.06	444.00	443.21				
Parziali		0.59	2.50	2.50	1.18					
Progressiva		-3.09	-2.50	0.00	2.50	3.68				
Dislivelli		0.00	-0.44	-0.12	0.47	0.00				

Sezione: 61
 Progressiva: 740.000
 Q. Progetto: 447.335

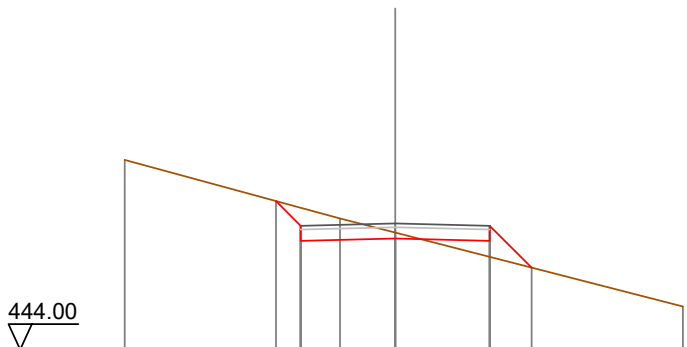

Quote Terreno	-449.01			447.09						
Quote Progetto		447.93	446.87	446.94	446.87	446.16				
Parziali		0.65	2.50	2.50	1.11					
Progressiva		-3.15	-2.50	0.00	2.50	3.61				
Dislivelli		0.00	-0.48	-0.16	0.42	0.00				

Sezione: 62
 Progressiva: 746.211
 Q. Progetto: 448.272

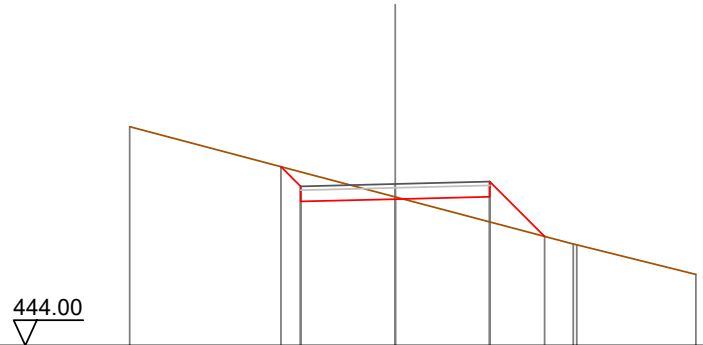

Quote Terreno	-449.79			447.93					
Quote Progetto		448.73	447.81	447.87	447.93	446.88	446.66		445.88
Parziali		0.52	2.50	2.50	1.45				
Progressiva		-3.02	-2.50	0.00	2.50	3.95			
Dislivelli		0.00	-0.38	-0.06	0.67	-0.00			

Sezione: 63
 Progressiva: 750.000
 Q. Progetto: 448.843

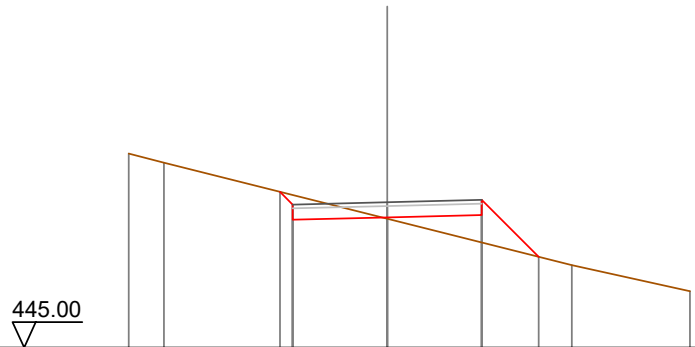

Quote Terreno	-450.13			448.41					
Quote Progetto		449.12	448.38	448.44	448.51	447.40			446.49
Parziali		0.34	2.50	2.50	1.51				
Progressiva		-2.84	-2.50	0.00	2.50	4.01			
Dislivelli		0.00	-0.25	0.04	0.73	0.00			

Sezione: 64
 Progressiva: 752.377
 Q. Progetto: 449.201

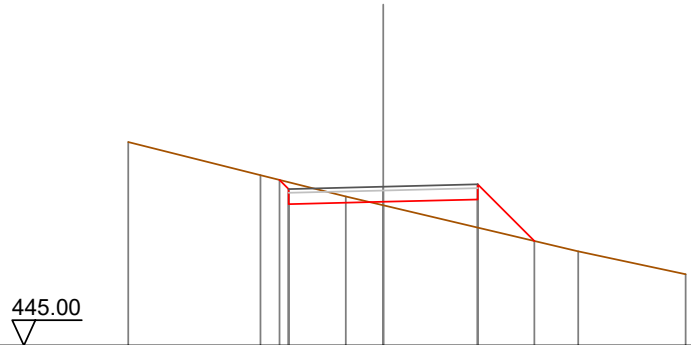

Quote Terreno	-450.38	-449.51	-448.94	-448.71	-448.86	-447.49	-446.89
Quote Progetto		449.38 448.74		448.80	448.86	447.77	
Parziali			2.50	2.50	1.50		
Progressiva		-2.74 -2.50		0.00	2.50	4.00	
Dislivelli		0.00 -0.18		0.09	0.74	0.00	

Sezione: 65
 Progressiva: 758.543
 Q. Progetto: 450.130

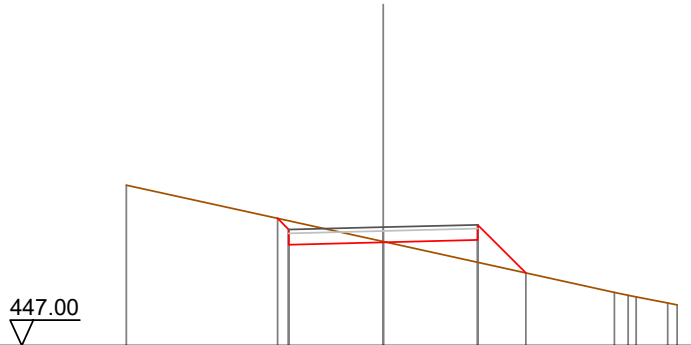

Quote Terreno	-451.24			-449.75			-448.40 -448.29 -448.13 -448.08
Quote Progetto		450.36 449.67		449.73	449.79	448.92	
Parziali		0.30	2.50	2.50	1.27		
Progressiva		-2.80 -2.50		0.00	2.50	3.77	
Dislivelli		0.00 -0.23		-0.02	0.59	0.00	

Sezione: 66
 Progressiva: 760.000
 Q. Progetto: 450.350

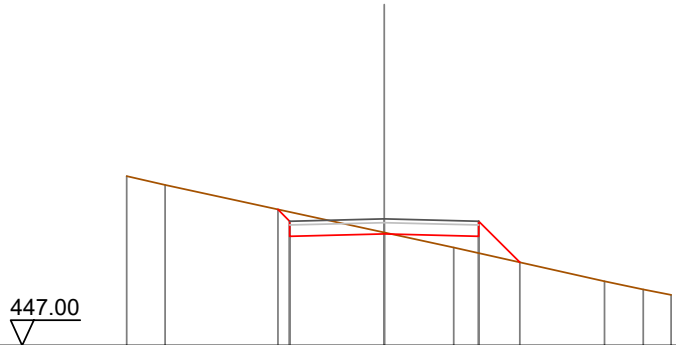

Quote Terreno	-451.48	-451.25			449.99	-449.59		-448.70	-448.48	-448.34
Quote Progetto			450.60	449.89	449.95	449.89	449.20			
Parziali			0.31	2.50	2.50	1.09				
Progressiva			-2.81	-2.50	0.00	2.50	3.59			
Dislivelli			0.00	-0.24	-0.04	0.44	0.00			

Sezione: 67
 Progressiva: 780.000
 Q. Progetto: 452.965

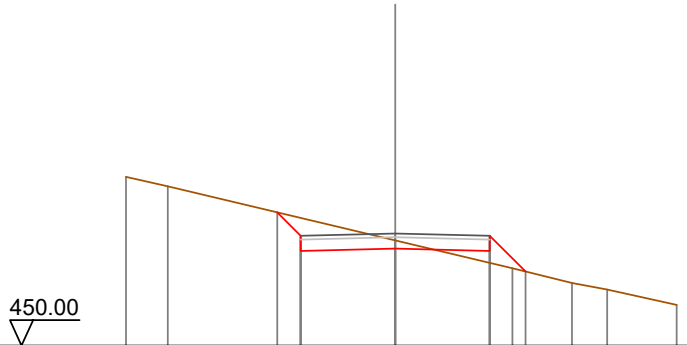

Quote Terreno	-454.46	-454.21			452.78	-452.04	-451.65	-451.48	-451.08
Quote Progetto			453.52	452.50	452.56	452.50	451.96		
Parziali			0.62	2.50	2.50	0.94			
Progressiva			-3.12	-2.50	0.00	2.50	3.44		
Dislivelli			0.00	-0.47	-0.21	0.32	0.00		

Sezione: 68
 Progressiva: 800.000
 Q. Progetto: 454.764

451.00

Quote Terreno	-456.22	-456.04								
Quote Progetto			455.13	454.30	454.36	454.30	453.63	453.24		
Parziali			0.42	2.50	2.50	1.46				
Progressiva			-2.92	-2.50	0.00	2.50	3.96			
Dislivelli			-0.00	-0.31	0.05	0.68	-0.00			

Sezione: 69
 Progressiva: 820.000
 Q. Progetto: 456.071

452.00

Quote Terreno	-457.58	-457.43								
Quote Progetto			456.51	455.61	455.67	455.61	454.68			
Parziali			0.50	2.50	2.50	1.33				
Progressiva			-3.00	-2.50	0.00	2.50	3.83			
Dislivelli			0.00	-0.37	-0.04	0.57	-0.00			

Sezione: 70
 Progressiva: 840.000
 Q. Progetto: 457.371

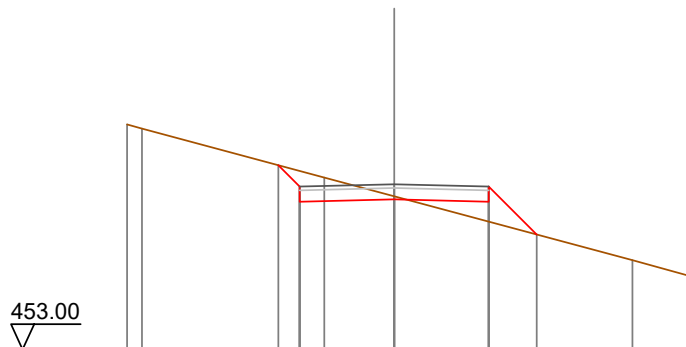

Quote Terreno		-458.95	-458.84		-457.55	-457.05			-455.36	-454.96
Quote Progetto				457.87	456.91	456.97		456.91	456.04	
Parziali				0.56	2.50	2.50		1.27		
Progressiva				-3.06	-2.50	0.00		2.50	3.77	
Dislivelli				0.00	-0.41	-0.08		0.53	0.00	

Sezione: 71
 Progressiva: 860.000
 Q. Progetto: 458.672

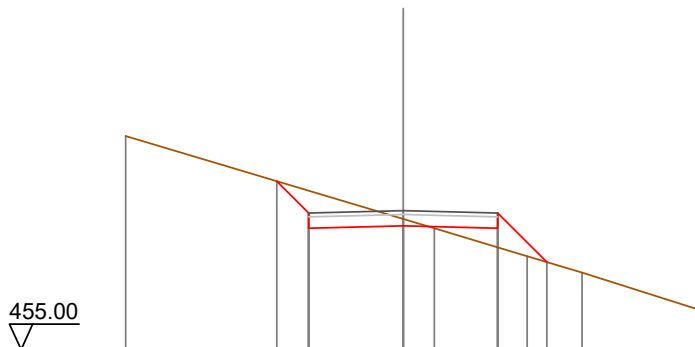

Quote Terreno		-460.65			-458.45	-458.21		-457.47	-457.03	-456.06
Quote Progetto			459.45	458.21	458.27	458.21		457.31		
Parziali			0.84	2.50	2.50		1.30			
Progressiva			-3.34	-2.50	0.00		2.50	3.80		
Dislivelli			0.00	-0.59	-0.18		0.51	0.00		

Sezione: 72
 Progressiva: 880.000
 Q. Progetto: 459.973

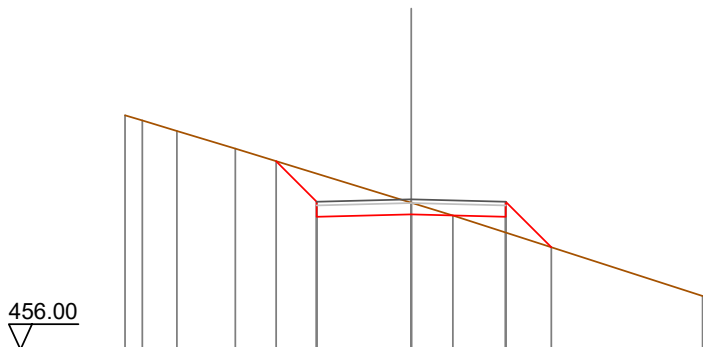

Quote Terreno	-462.19	-462.06	-461.78	-461.31	-459.88	-459.55	-459.51	-458.71	-457.41
Quote Progetto				460.98	459.51	459.57	459.51	458.71	
Parziali				1.07	2.50	2.50	1.20		
Progressiva				-3.57	-2.50	0.00	2.50	3.70	
Dislivelli				0.00	-0.74	-0.31	0.42	0.00	

Sezione: 73
 Progressiva: 896.173
 Q. Progetto: 461.025

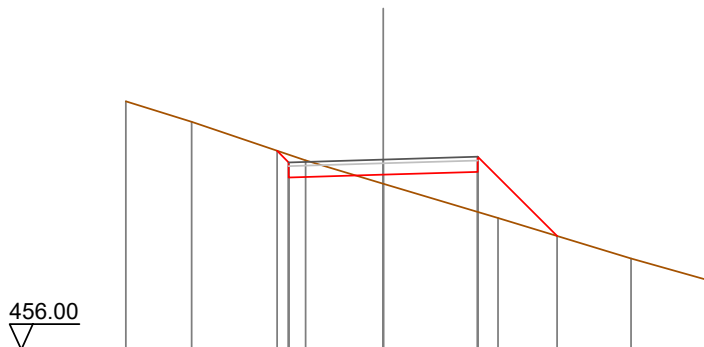

Quote Terreno	-462.56	-462.02	-461.00	-460.39	-459.48	-458.41	-457.83
Quote Progetto			461.26	460.55	460.62	460.70	459.00
Parziali			0.31	2.50	2.50	2.10	
Progressiva			-2.81	-2.50	0.00	2.50	4.60
Dislivelli			-0.00	-0.20	0.24	1.06	0.00

Sezione: 74
 Progressiva: 898.003
 Q. Progetto: 461.144

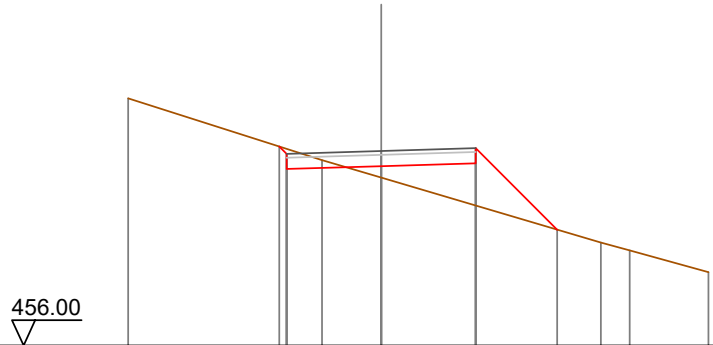

Quote Terreno	-462.54	-460.90	-460.44	-458.72	-458.52	-457.94
Quote Progetto		461.26 460.67	460.74	460.82	459.06	
Parziali		2.50	2.50	2.16		
Progressiva		-2.69 -2.50	0.00	2.50	4.66	
Dislivelli		0.00 -0.13	0.30	1.12	-0.00	

Sezione: 75
 Progressiva: 899.833
 Q. Progetto: 461.263

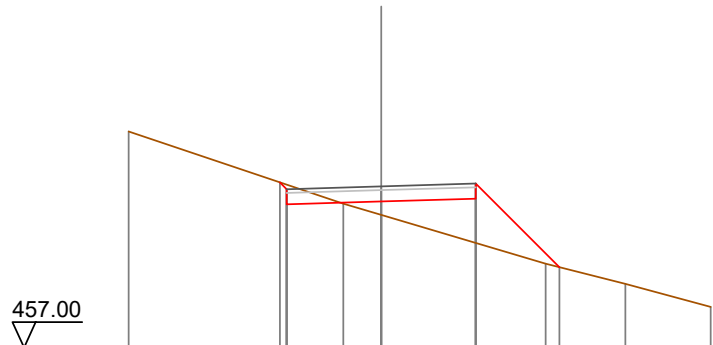

Quote Terreno	-462.71	-460.90	-460.51	-459.22	-458.68	-458.08
Quote Progetto		461.37 460.79	460.86	460.94	459.12	
Parziali		2.50	2.50	2.21		
Progressiva		-2.68 -2.50	0.00	2.50	4.71	
Dislivelli		-0.00 -0.12	0.36	1.17	0.00	

Sezione: 76
 Progressiva: 920.000
 Q. Progetto: 462.574

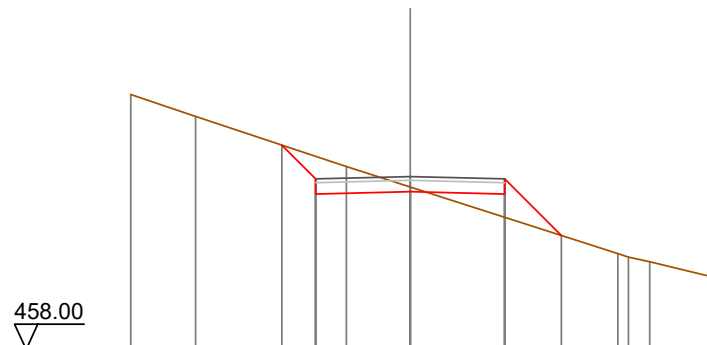

Quote Terreno	-464.74	-464.16		-462.84	-462.30		-460.54	-460.45	-460.32	-459.92
Quote Progetto			463.40	462.11	462.17	462.11	461.02			
Parziali			0.89	2.50	2.50	1.50				
Progressiva			-3.39	-2.50	0.00	2.50	4.00			
Dislivelli			-0.00	-0.60	-0.12	0.62	0.00			

Sezione: 77
 Progressiva: 940.000
 Q. Progetto: 463.794

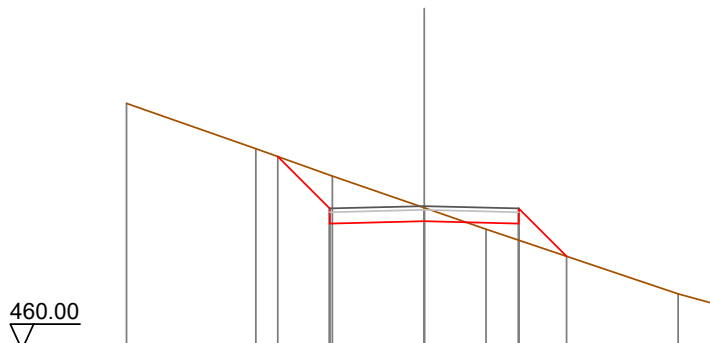

Quote Terreno	-466.51	-465.31	-464.59	-463.75	-463.18		-461.47	-461.18
Quote Progetto		465.11	463.33	463.39	463.33	462.47		
Parziali			1.37	2.50	2.50	1.26		
Progressiva		-3.87	-2.50	0.00	2.50	3.76		
Dislivelli		-0.00	-0.88	-0.35	0.44	0.00		

Sezione: 78
 Progressiva: 960.000
 Q. Progetto: 464.792

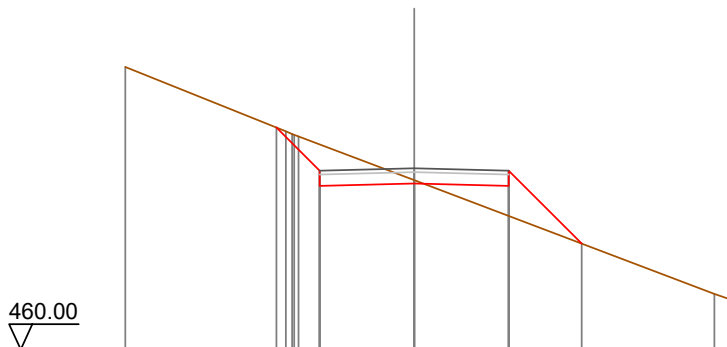

Quote Terreno		467.47	465.77	465.64	464.48		461.47	461.30
Quote Progetto			465.87	464.33	464.39	464.33	462.80	
Parziali			1.14	2.50	2.50	1.93		
Progressiva			-3.64	-2.50	0.00	2.50	4.43	
Dislivelli			-0.00	-0.70	-0.09	0.80	0.00	

Sezione: 79
 Progressiva: 980.000
 Q. Progetto: 465.790

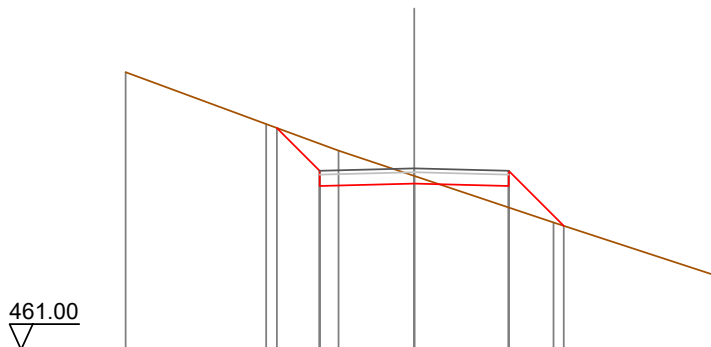

Quote Terreno		468.33	466.96	466.26	465.59		464.36	462.97
Quote Progetto			466.86	465.33	465.39	465.33	464.27	
Parziali			1.13	2.50	2.50	1.46		
Progressiva			-3.63	-2.50	0.00	2.50	3.96	
Dislivelli			0.00	-0.72	-0.20	0.57	0.00	

Sezione: 80
 Progressiva: 1000.000
 Q. Progetto: 466.796

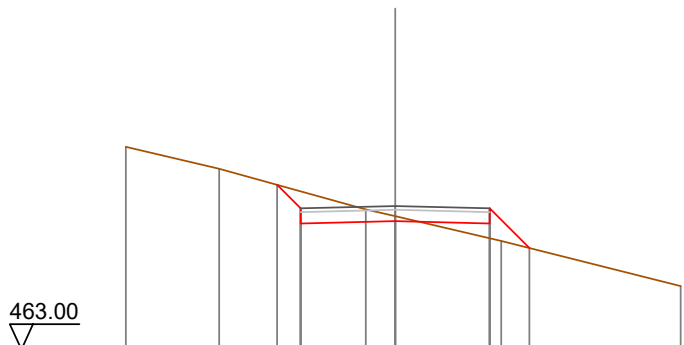

Quote Terreno	-468.36	-467.78		-466.71	-466.53	-465.87	-464.68
Quote Progetto			467.36	466.33	466.40	466.33	465.68
Parziali			0.62	2.50	2.50	1.05	
Progressiva			-3.12	-2.50	0.00	2.50	3.55
Dislivelli			-0.00	-0.45	-0.13	0.39	-0.00

Sezione: 81
 Progressiva: 1020.000
 Q. Progetto: 468.314

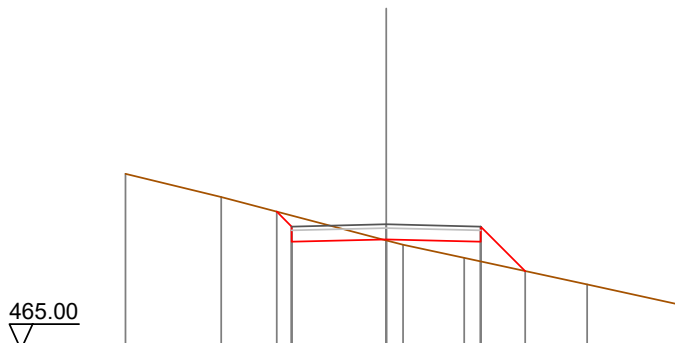

Quote Terreno	-469.65	-469.03		-467.89	-467.77	-467.42	-466.72	-466.21
Quote Progetto			468.65	467.85	467.91	467.85	467.07	
Parziali			0.40	2.50	2.50	1.18		
Progressiva			-2.90	-2.50	0.00	2.50	3.68	
Dislivelli			0.00	-0.29	0.03	0.52	-0.00	

Sezione: 82
 Progressiva: 1040.000
 Q. Progetto: 470.318

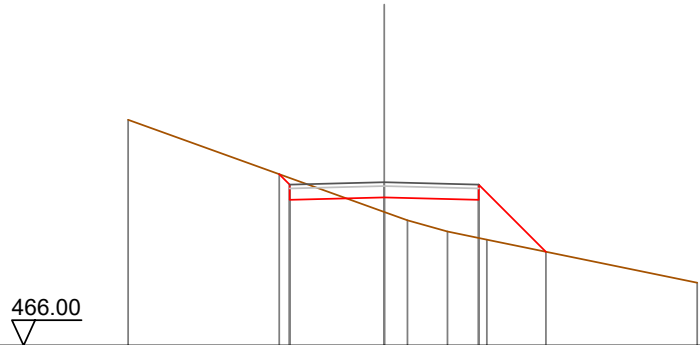

Quote Terreno		-471.97		469.53	-469.31	-469.01	-468.80		-467.66
Quote Progetto			470.53	469.86	469.92	469.86	468.48		
Parziali			0.27	2.50	2.50	1.78			
Progressiva			-2.77	-2.50	0.00	2.50	4.28		
Dislivelli			0.00	-0.18	0.39	1.01	0.00		

Sezione: 83
 Progressiva: 1058.289
 Q. Progetto: 472.154

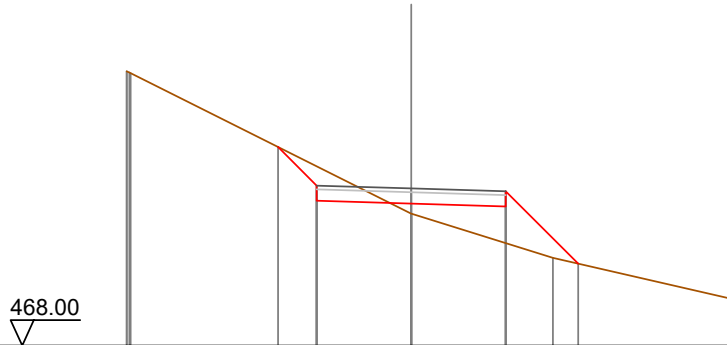

Quote Terreno		-475.25	-475.20		471.49		-470.32		-469.25
Quote Progetto				473.25	471.83	471.75	471.68	470.17	
Parziali				1.02	2.50	2.50	1.91		
Progressiva				-3.52	-2.50	0.00	2.50	4.41	
Dislivelli				-0.00	-0.51	0.27	0.97	0.00	

Sezione: 84
 Progressiva: 1060.000
 Q. Progetto: 472.320

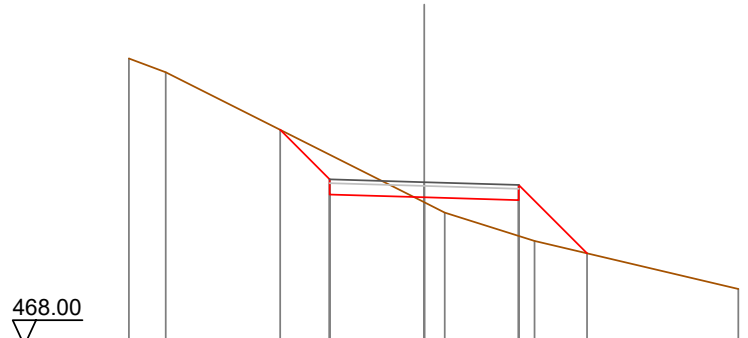

Quote Terreno	-475.59	-475.23				471.79	471.51		470.76		-469.50
Quote Progetto			473.71	472.00		471.92		471.85	470.44		
Parziali				1.31	2.50	2.50		1.81			
Progressiva			-3.81	-2.50		0.00		2.50	4.31		
Dislivelli			-0.00	-0.65		0.13		0.95	0.00		

Sezione: 85
 Progressiva: 1062.028
 Q. Progetto: 472.509

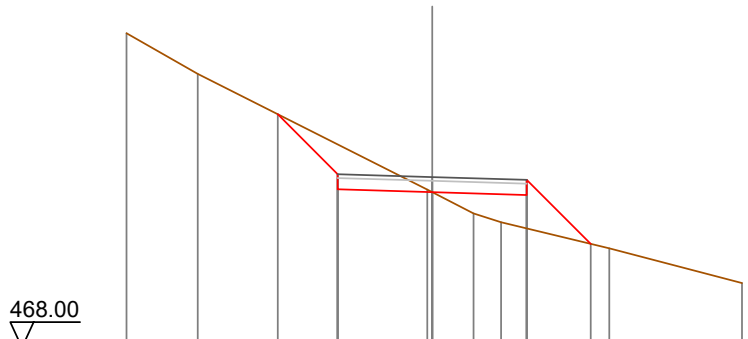

Quote Terreno	-476.31	-475.24				472.18	472.11		470.63		-469.71
Quote Progetto			474.17	472.18		472.11		472.03	470.74		
Parziali				1.59	2.50	2.50		1.69			
Progressiva			-4.09	-2.50		0.00		2.50	4.19		
Dislivelli			-0.00	-0.79		-0.00		0.88	-0.00		

Sezione: 86
 Progressiva: 1065.768
 Q. Progetto: 472.835

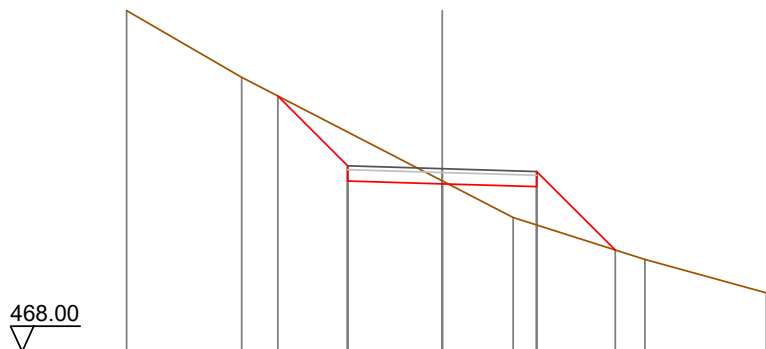

Quote Terreno	-477.02	-475.25	-474.76	-472.51	-471.54	-470.44	-469.55
Quote Progetto			474.76	472.51	472.44	472.36	470.69
Parziali			1.85	2.50	2.50	2.08	
Progressiva		-4.35	-2.50	0.00	2.50	4.58	
Dislivelli		0.00	-0.89	-0.08	1.02	0.00	

Sezione: 87
 Progressiva: 1080.000
 Q. Progetto: 473.830

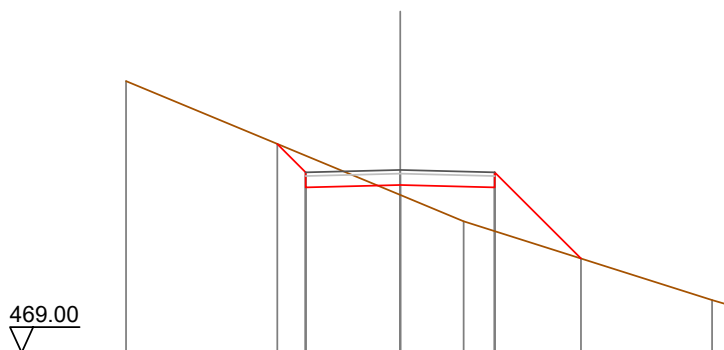

Quote Terreno	-476.18	-474.52	-473.37	-473.17	-472.47	-471.49	-470.39	-470.23
Quote Progetto		474.52	473.37	473.43	473.37	471.49		
Parziali		0.75	2.50	2.50	2.28			
Progressiva		-3.25	-2.50	0.00	2.50	4.76		
Dislivelli		0.00	-0.44	0.26	1.16	0.00		

Sezione: 88
 Progressiva: 1100.000
 Q. Progetto: 475.057



Quote Terreno	-475.79	-475.70		473.96	473.93	-473.75	-473.44		-471.73	-471.45
Quote Progetto			474.89	474.66	474.66	474.59	474.59	472.60		
Parziali			0.30	2.50	2.50	2.40				
Progressiva			-2.80	-2.50	0.00	2.50	4.90			
Dislivelli			0.00	0.38	0.73	1.31	0.00			

Sezione: 89
 Progressiva: 1120.000
 Q. Progetto: 476.284

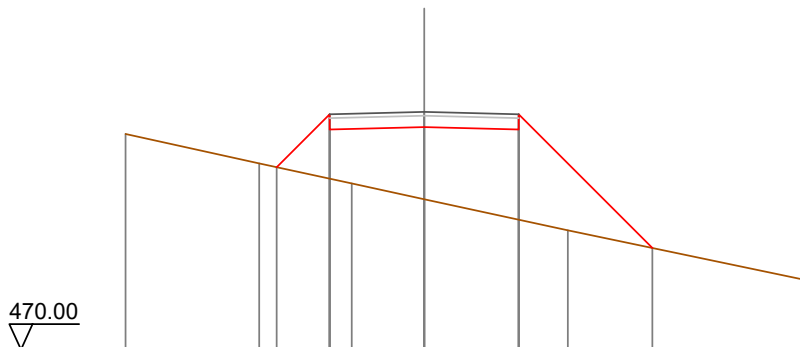

Quote Terreno	-475.70	-474.92	-474.39	-473.98	-473.15	-471.85
Quote Progetto		474.82	475.82	475.88	475.82	472.69
Parziali		1.40	2.50	2.50	3.54	
Progressiva		-3.90	-2.50	0.00	2.50	6.04
Dislivelli		0.00	1.70	1.91	2.39	0.00

Sezione: 90
 Progressiva: 1132.336
 Q. Progetto: 477.017

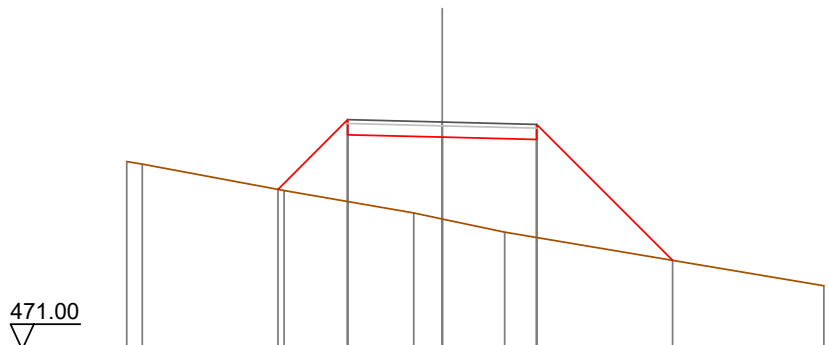

Quote Terreno	-475.97	-475.90	475.20	474.61	474.45	474.11	-472.69
Quote Progetto			475.23	476.68	476.62	476.55	473.36
Parziali			1.84	2.50	2.50	3.59	
Progressiva			-4.34	-2.50	0.00	2.50	6.09
Dislivelli			0.00	2.17	2.16	2.59	-0.00

Sezione: 91
 Progressiva: 1134.427
 Q. Progetto: 477.122

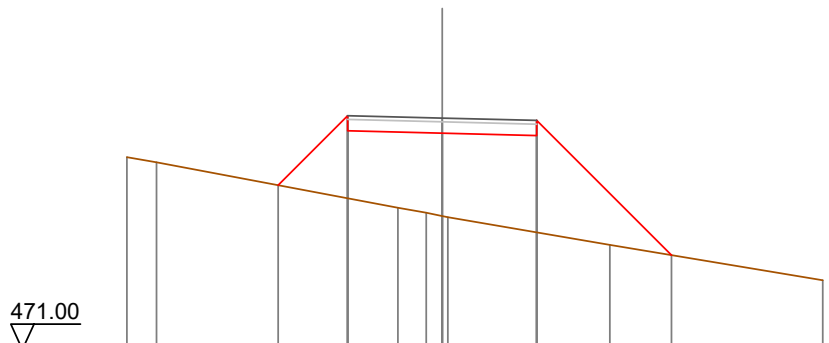

Quote Terreno	-476.09	-475.95		-474.75	-474.62	-474.50	-473.77	-472.83
Quote Progetto			475.35	476.78	476.72	476.66	473.50	
Parziali			1.84	2.50	2.50	3.56		
Progressiva			-4.34	-2.50	0.00	2.50	6.06	
Dislivelli			0.00	2.18	2.19	2.56	-0.00	

Sezione: 92
 Progressiva: 1136.519
 Q. Progetto: 477.227

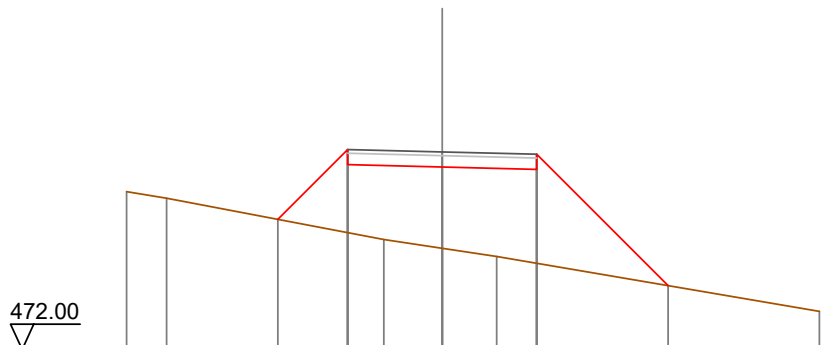

Quote Terreno	-476.18	-476.00			-474.91	-474.68	-474.46		-473.01
Quote Progetto			475.44	476.89	476.83	476.76	473.69		
Parziali			1.85	2.50	2.50	3.47			
Progressiva			-4.35	-2.50	0.00	2.50	5.97		
Dislivelli			0.00	2.20	2.15	2.48	0.00		

Sezione: 93
 Progressiva: 1140.000
 Q. Progetto: 477.402

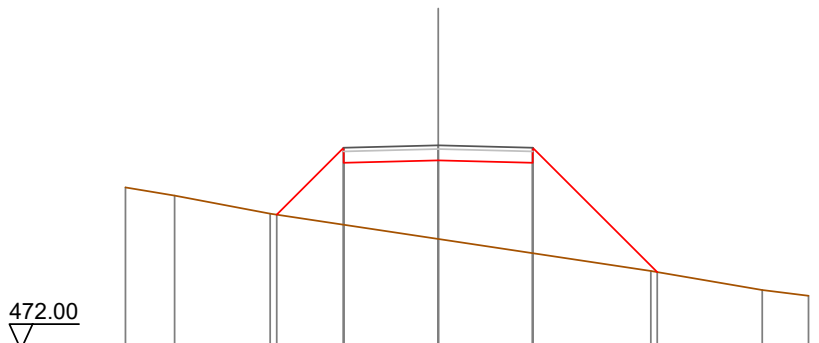

Quote Terreno	-476.29	-476.07	-475.59		-474.92		-474.08	-473.58	-473.42
Quote Progetto			475.57	476.94	477.00	476.94	474.05		
Parziali			1.77	2.50	2.50	3.29			
Progressiva			-4.27	-2.50	0.00	2.50	5.79		
Dislivelli			-0.00	2.04	2.08	2.39	-0.00		

Sezione: 94
 Progressiva: 1160.000
 Q. Progetto: 478.405

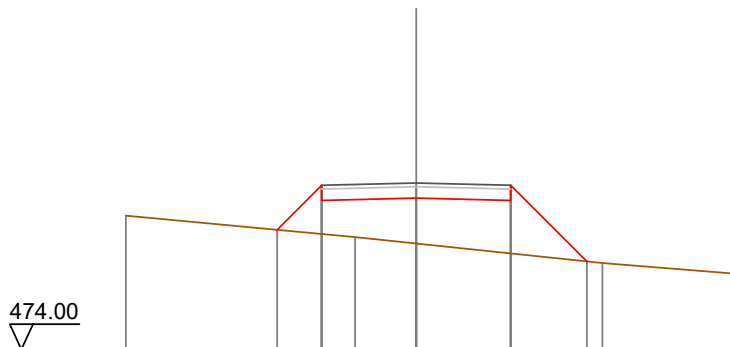

Quote Terreno		477.54		477.16	477.94	476.97	476.80	477.94	476.29	476.00
Quote Progetto				477.16	477.94		478.01	477.94	476.33	
Parziali				1.18	2.50		2.50	2.01		
Progressiva				-3.68	-2.50		0.00	2.50	4.51	
Dislivelli				0.00	1.29		1.20	1.40	-0.00	

Sezione: 95
 Progressiva: 1168.392
 Q. Progetto: 478.827

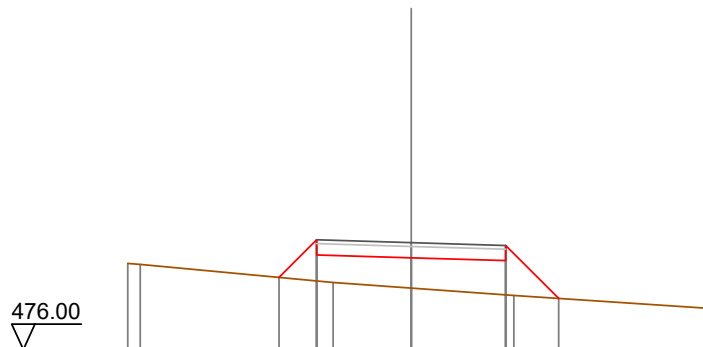

Quote Terreno		478.28	478.25		477.77	477.63	477.43		477.09
Quote Progetto				477.91	478.50	478.43	478.35	477.35	
Parziali				0.99	2.50	2.50	1.40		
Progressiva				-3.49	-2.50	0.00	2.50	3.90	
Dislivelli				0.00	1.09	0.80	0.91	-0.00	

Sezione: 96
 Progressiva: 1170.000
 Q. Progetto: 478.907

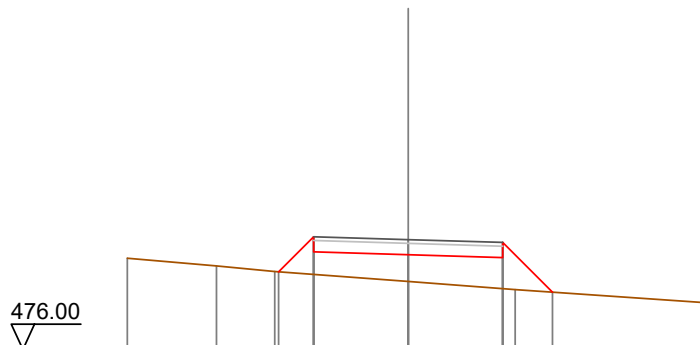

Quote Terreno	-478.41	-478.21	-478.06	-478.06	-477.80	-477.59	-477.24
Quote Progetto			478.06	478.68	478.51	478.43	477.52
Parziali			0.93	2.50	2.50	1.31	
Progressiva			-3.43	-2.50	0.00	2.50	3.81
Dislivelli			0.00	1.00	0.71	0.82	-0.00

Sezione: 97
 Progressiva: 1174.863
 Q. Progetto: 479.151

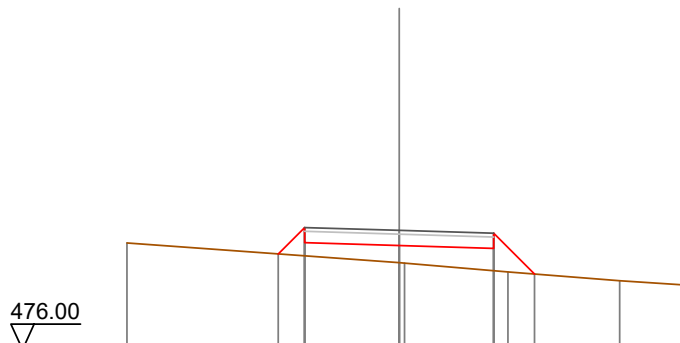

Quote Terreno	-478.82			-478.30	-478.05	-477.82	-477.71
Quote Progetto			478.53	478.75	478.66	478.00	
Parziali			0.70	2.50	2.50	1.08	
Progressiva			-3.20	-2.50	0.00	2.50	3.58
Dislivelli			0.00	0.75	0.45	0.59	0.00

Sezione: 98
 Progressiva: 1180.000
 Q. Progetto: 479.409

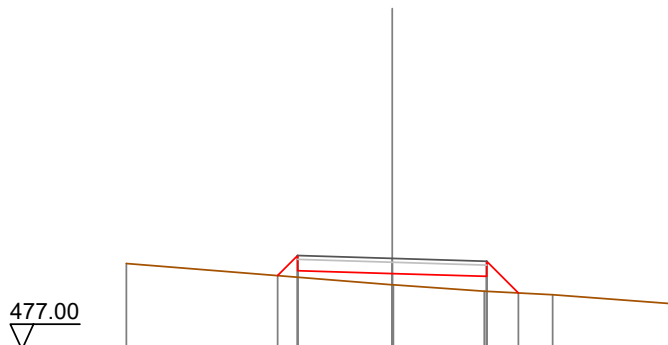

Quote Terreno		479.28		478.71	478.71	478.54		478.45		478.21
Quote Progetto			478.96	479.08	479.01	478.93	478.50			
Parziali			0.53	2.50	2.50	0.84				
Progressiva			-3.03	-2.50	0.00	2.50	3.34			
Dislivelli			0.00	0.57	0.30	0.39	-0.00			

Sezione: 99
 Progressiva: 1181.333
 Q. Progetto: 479.476

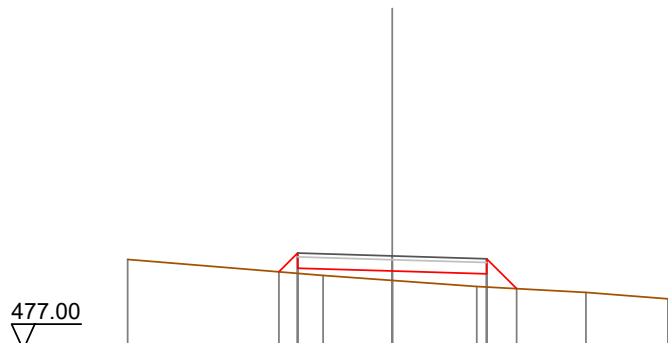

Quote Terreno		479.38		478.83	478.83	478.67		478.51		478.34
Quote Progetto			479.06	479.15	479.08	479.00	478.61			
Parziali			0.50	2.50	2.50	0.79				
Progressiva			-3.00	-2.50	0.00	2.50	3.29			
Dislivelli			0.00	0.54	0.25	0.35	0.00			

Sezione: 100
 Progressiva: 1200.000
 Q. Progetto: 480.581

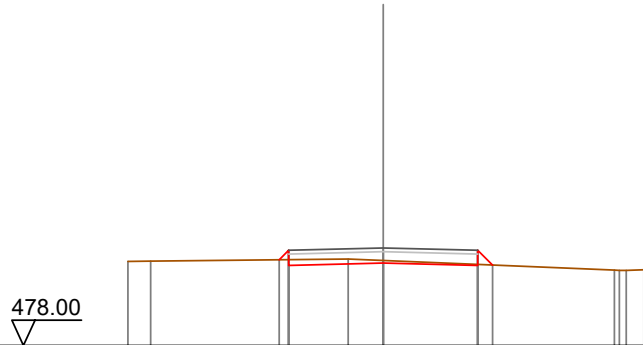

Quote Terreno	-480.22	-480.23		-480.29	-480.25		-479.99	-479.98	-480.00
Quote Progetto			480.27	480.12	480.18	480.12	480.13		
Parziali				2.50	2.50	0.39			
Progressiva			-2.75	-2.50	0.00	2.50	2.89		
Dislivelli			0.00	0.25	-0.07	-0.03	0.00		

Sezione: 101
 Progressiva: 1206.477
 Q. Progetto: 480.989

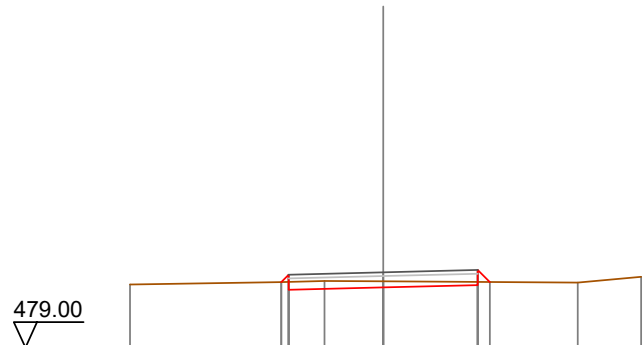

Quote Terreno	-480.67	-480.73	-480.76	-480.75		-480.72	-480.87
Quote Progetto		480.73	480.53	480.59	480.65	480.73	
Parziali			2.50	2.50	0.32		
Progressiva		-2.70	-2.50	0.00	2.50	2.82	
Dislivelli		-0.00	0.19	-0.16	-0.08	0.00	

Sezione: 102
 Progressiva: 1210.000
 Q. Progetto: 481.207

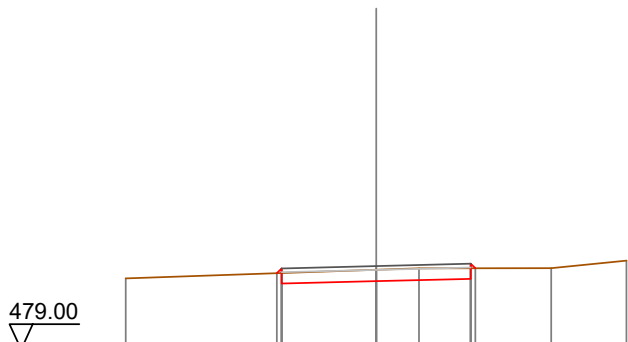

Quote Terreno		-480.88			481.11	-481.15		-481.15	-481.35
Quote Progetto			481.02	480.74	480.81		480.87	481.15	
Parziali				2.50		2.50			
Progressiva			-2.63	-2.50	0.00		2.50	2.62	
Dislivelli			-0.00	0.12	-0.30		-0.28	0.00	

Sezione: 103
 Progressiva: 1219.958
 Q. Progetto: 481.693

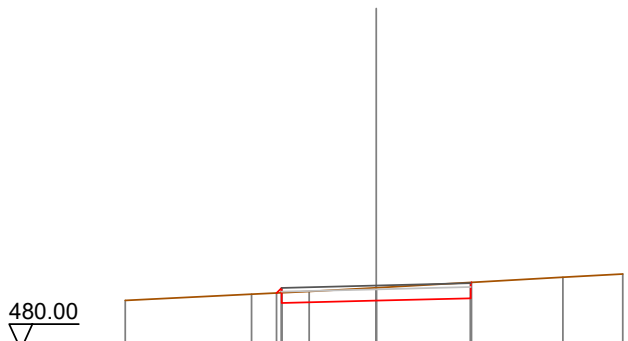

Quote Terreno		-481.30	-481.46	-481.53	481.63		-481.91	-482.00
Quote Progetto			481.49	481.23	481.29		481.36	
Parziali				2.50		2.50		
Progressiva			-2.64	-2.50	0.00		2.50	2.52
Dislivelli			-0.00	0.13	-0.34		-0.42	-0.00

Sezione: 104
 Progressiva: 1230.000
 Q. Progetto: 481.981

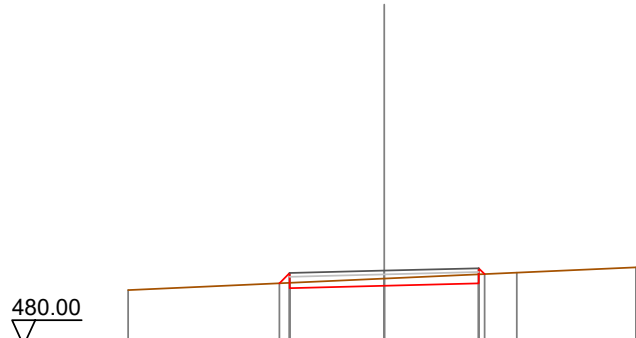

Quote Terreno	481.47		481.77	481.93	482.07
Quote Progetto		481.65	481.52	481.64	481.89
Parziali		0.27	2.50	2.50	
Progressiva		-2.77	-2.50	0.00	2.50
Dislivelli		0.00	0.26	-0.19	-0.24

Sezione: 105
 Progressiva: 1233.439
 Q. Progetto: 482.033

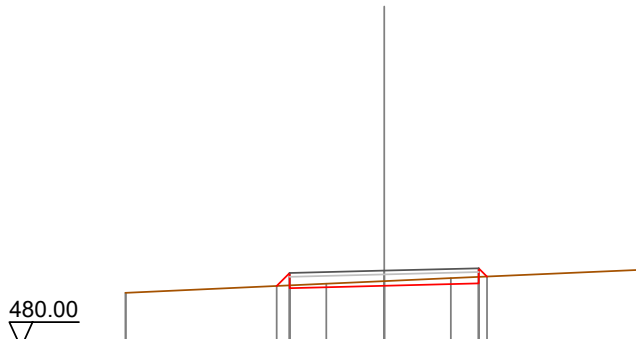

Quote Terreno	481.45		481.76	481.83	482.05
Quote Progetto		481.63	481.57	481.70	481.86
Parziali		0.34	2.50	2.50	
Progressiva		-2.84	-2.50	0.00	2.50
Dislivelli		0.00	0.33	-0.12	-0.17

Sezione: 106
 Progressiva: 1240.000
 Q. Progetto: 482.068

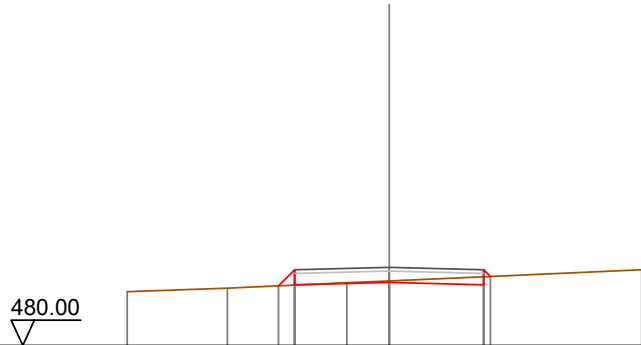

Quote Terreno	-481.42	-481.52	-481.66	-481.71	-482.00
Quote Progetto			481.58 481.61	481.67	481.61 481.59
Parziali			0.43 2.50	2.50	
Progressiva			-2.93 -2.50	0.00	2.50 2.68
Dislivelli			0.00 0.41	-0.04	-0.21 0.00

Sezione: 107
 Progressiva: 1260.000
 Q. Progetto: 481.799

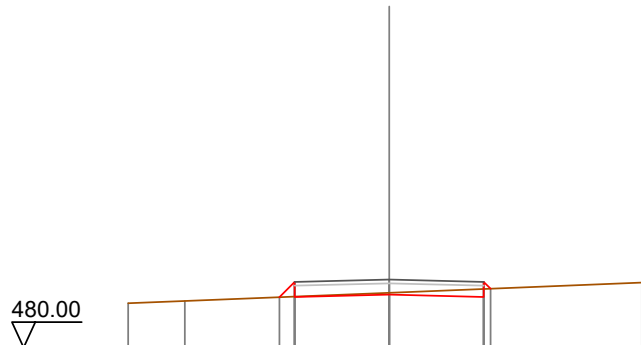

Quote Terreno	-481.17	-481.23	-481.34	-481.45	-481.72
Quote Progetto			481.33 481.34	481.40	481.34 481.56
Parziali			0.40 2.50	2.50	
Progressiva			-2.90 -2.50	0.00	2.50 2.68
Dislivelli			0.00 0.39	-0.05	-0.21 -0.00

Sezione: 108
 Progressiva: 1280.000
 Q. Progetto: 481.475

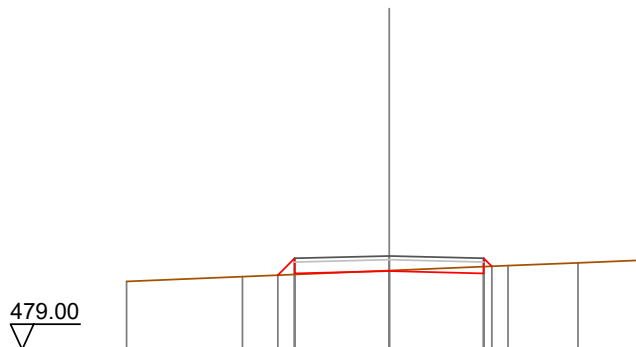

Quote Terreno	-480.80	-480.93	-481.09	-481.22	-481.29	-481.36
Quote Progetto			-480.97 -481.01	-481.07 -481.01	-481.20	
Parziali			0.45 2.50	2.50		
Progressiva			-2.95 -2.50	0.00	2.50 2.71	
Dislivelli			0.00 0.43	-0.01	-0.18 0.00	

Sezione: 109
 Progressiva: 1283.998
 Q. Progetto: 481.410

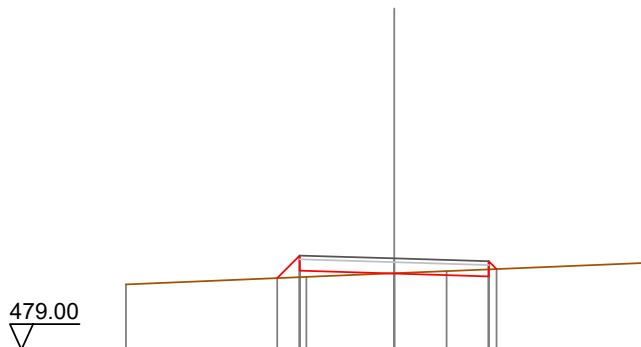

Quote Terreno	-480.72	-480.92	-481.02	-481.07	-481.29
Quote Progetto		-480.89 -481.09	-481.01	-480.94 -481.13	
Parziali		0.60 2.50	2.50		
Progressiva		-3.10 -2.50	0.00	2.50 2.71	
Dislivelli		-0.00 0.57	-0.01	-0.19 0.00	

Sezione: 110
 Progressiva: 1286.340
 Q. Progetto: 481.372

479.00

Quote Terreno	-480.68	-480.77		-480.92	-480.98	-480.99		-481.21	-481.26
Quote Progetto			480.85	481.05		480.97		480.90	481.09
Parziali			0.60	2.50		2.50			
Progressiva			-3.10	-2.50		0.00		2.50	2.70
Dislivelli			0.00	0.57		-0.01		-0.19	0.00

Sezione: 111
 Progressiva: 1288.682
 Q. Progetto: 481.334

479.00

Quote Terreno	-480.64		-480.87	-480.90	-480.91	-480.94		-481.23	
Quote Progetto		480.81	481.01			480.93		480.86	481.06
Parziali		0.60	2.50			2.50			
Progressiva		-3.10	-2.50			0.00		2.50	2.70
Dislivelli		0.00	0.57			-0.01		-0.19	0.00

Sezione: 112
 Progressiva: 1300.000
 Q. Progetto: 481.151

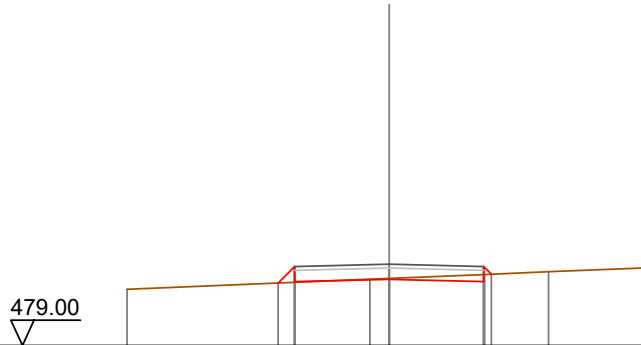

Quote Terreno	-480.49			-480.75	-480.77	-480.88	-480.95	-481.05
Quote Progetto			480.65	480.69	480.75	480.69	480.69	
Parziali			0.44	2.50	2.50			
Progressiva			-2.94	-2.50	0.00	2.50	2.70	
Dislivelli			0.00	0.42	-0.02	-0.19	0.00	

Sezione: 113
 Progressiva: 1320.000
 Q. Progetto: 480.827

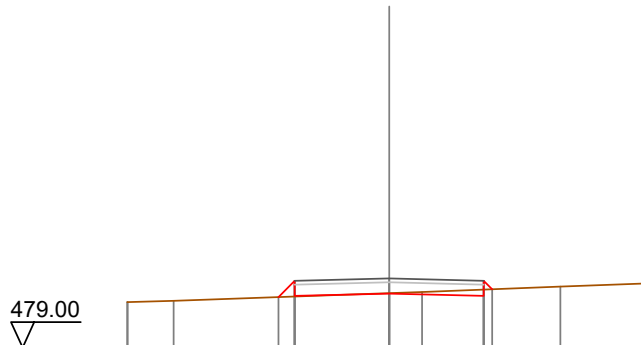

Quote Terreno	-480.20	-480.24			-480.44	-480.47	-480.61	-480.69
Quote Progetto			480.33	480.36	480.43	480.36	480.54	
Parziali			0.43	2.50	2.50			
Progressiva			-2.93	-2.50	0.00	2.50	2.72	
Dislivelli			0.00	0.42	-0.01	-0.17	0.00	

Sezione: 114
 Progressiva: 1340.000
 Q. Progetto: 480.538

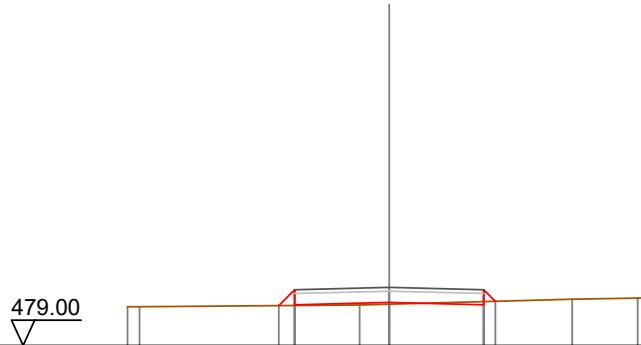

Quote Terreno	480.03	480.03		480.07	480.09		480.22	480.25	480.26
Quote Progetto			480.06	480.08	480.14		480.08	480.17	
Parziali			0.42	2.50		2.50	0.31		
Progressiva			-2.92	-2.50	0.00		2.50	2.81	
Dislivelli			-0.00	0.42		0.04	-0.08	-0.00	

Sezione: 115
 Progressiva: 1360.000
 Q. Progetto: 480.221

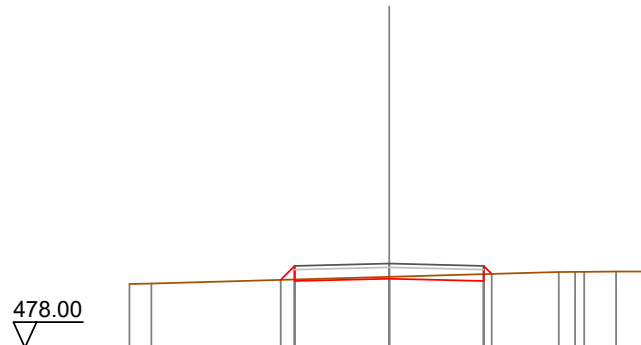

Quote Terreno	479.68	479.69		479.87		480.00	480.00	480.01	480.01
Quote Progetto			479.79	479.76	479.82		479.76	479.95	
Parziali			0.37	2.50		2.50			
Progressiva			-2.87	-2.50	0.00		2.50	2.71	
Dislivelli			-0.00	0.36		-0.05	-0.18	-0.00	

Sezione: 116
 Progressiva: 1380.000
 Q. Progetto: 479.207

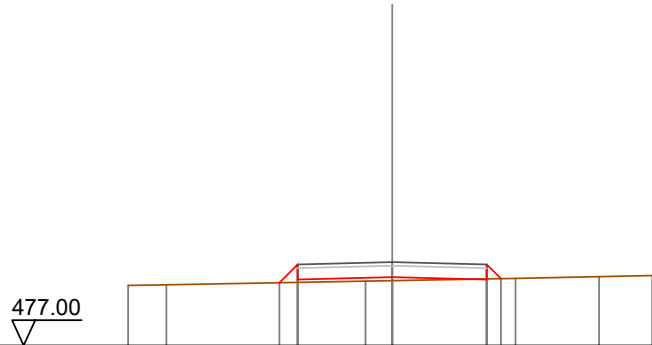

Quote Terreno	-478.59	-478.61		-478.70	-478.72		-478.78	-478.82	-478.85
Quote Progetto			478.66	478.74	478.81	478.74	478.77		
Parziali			0.48	2.50	2.50	0.38			
Progressiva			-2.98	-2.50	0.00	2.50	2.88		
Dislivelli			-0.00	0.48	0.09	-0.02	0.00		

Sezione: 117
 Progressiva: 1391.969
 Q. Progetto: 478.519

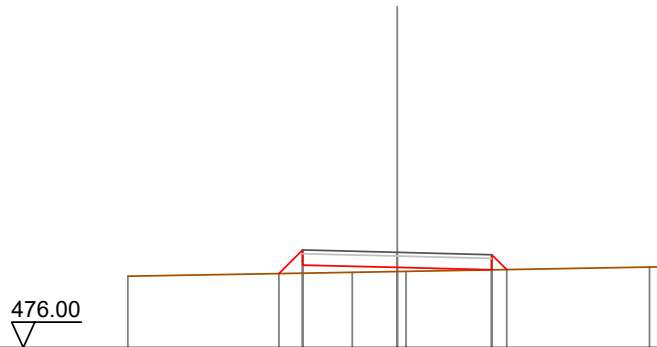

Quote Terreno	-477.89		-477.99	-478.01	-478.01		-478.13	-478.13
Quote Progetto		477.96	478.18	478.12	478.06	478.06		
Parziali		0.63	2.50	2.50	0.39			
Progressiva		-3.13	-2.50	0.00	2.50	2.89		
Dislivelli		0.00	0.61	0.11	0.00	0.00		

Sezione: 118
 Progressiva: 1400.000
 Q. Progetto: 478.057

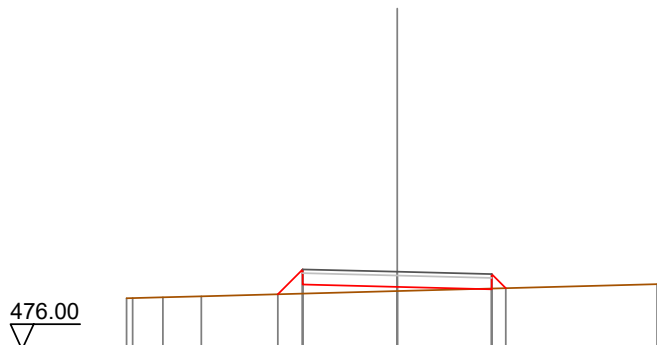

Quote Terreno		477.36	477.36	477.38	477.41		477.55		477.73	
Quote Progetto						477.46	477.72	477.66	477.59	477.62
Parziali						0.66	2.50	2.50	0.37	
Progressiva						-3.16	-2.50	0.00	2.50	2.87
Dislivelli						-0.00	0.64	0.11	-0.02	-0.00

Sezione: 119
 Progressiva: 1405.414
 Q. Progetto: 477.745

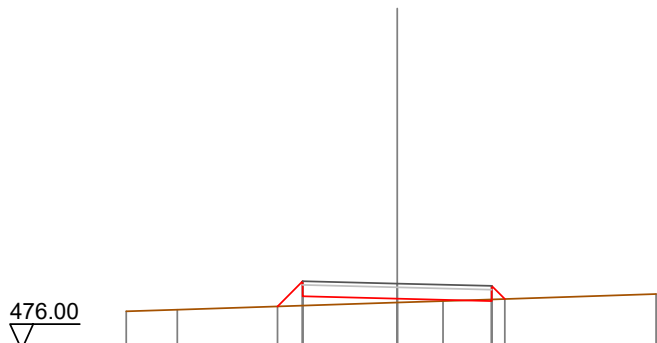

Quote Terreno		477.01	477.05			477.14	477.41	477.24	477.28	477.47
Quote Progetto						477.14	477.41	477.34	477.28	477.34
Parziali						0.67	2.50	2.50	0.35	
Progressiva						-3.17	-2.50	0.00	2.50	2.85
Dislivelli						0.00	0.65	0.10	-0.04	0.00

Sezione: 120
 Progressiva: 1410.000
 Q. Progetto: 477.481

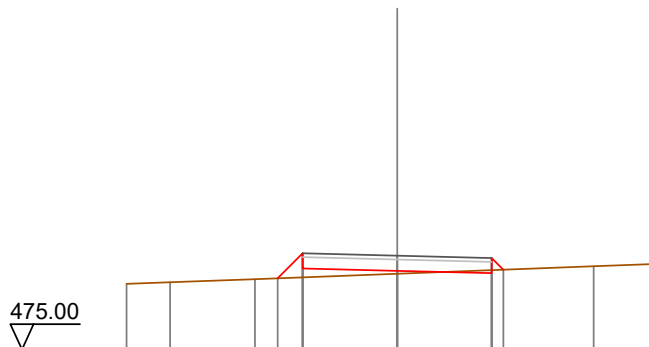

Quote Terreno		476.74	476.78	476.86	477.00	477.00	477.20	477.26
Quote Progetto				476.88	477.14	477.08	477.02	477.11
Parziali				0.66	2.50	2.50	0.31	
Progressiva				-3.16	-2.50	0.00	2.50	2.81
Dislivelli				-0.00	0.63	0.08	-0.08	0.00

Sezione: 121
 Progressiva: 1418.860
 Q. Progetto: 476.991

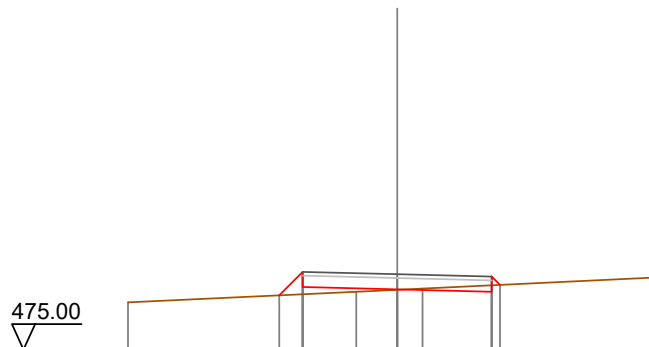

Quote Terreno		476.25		476.53	476.58	476.61		476.90
Quote Progetto				476.43	476.65	476.59	476.53	476.71
Parziali				0.62	2.50	2.50		
Progressiva				-3.12	-2.50	0.00	2.50	2.72
Dislivelli				-0.00	0.59	0.01	-0.17	-0.00

Sezione: 122
 Progressiva: 1420.000
 Q. Progetto: 476.937

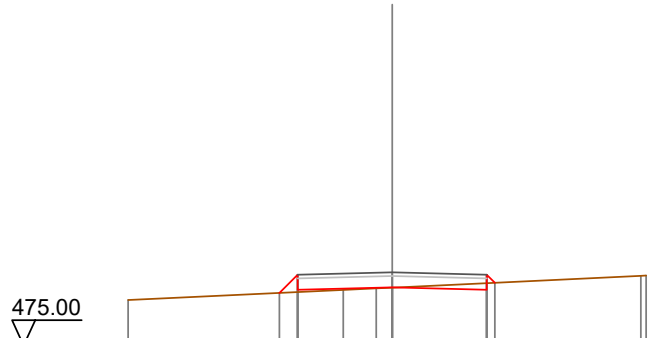

Quote Terreno	476.20		476.47	476.51	476.53		476.84	476.85
Quote Progetto		476.39	476.47		476.54		476.47	476.86
Parziali		0.48	2.50		2.50			
Progressiva		-2.98	-2.50		0.00		2.50	2.71
Dislivelli		0.00	0.46		0.01		-0.18	0.00

Sezione: 123
 Progressiva: 1440.000
 Q. Progetto: 476.033

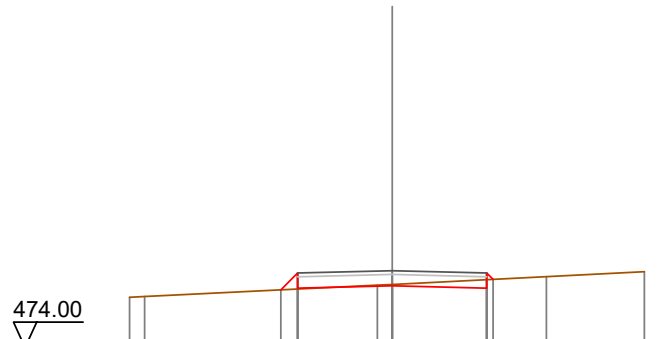

Quote Terreno	475.93	475.95		475.65	475.67		475.87	476.01
Quote Progetto			475.52	475.57		475.63	475.57	475.80
Parziali			0.45	2.50		2.50		
Progressiva			-2.95	-2.50		0.00	2.50	2.67
Dislivelli			0.00	0.42		-0.04	-0.22	0.00

Sezione: 124
 Progressiva: 1455.338
 Q. Progetto: 475.340

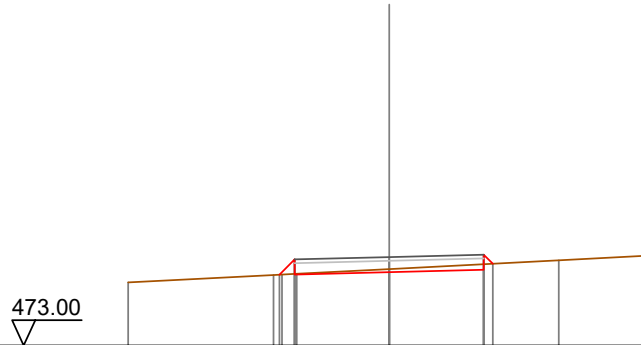

Quote Terreno	-474.67	474.86 474.88 474.90	474.94 475.02	475.00 475.16	-475.25	-475.37
Quote Progetto		474.87 474.88 474.90	474.94 475.02	475.00 475.16		
Parziali		0.40 2.50	2.50			
Progressiva		-2.90 -2.50	0.00	2.50 2.74		
Dislivelli		0.00 0.38	-0.08	-0.15 0.00		

Sezione: 125
 Progressiva: 1460.000
 Q. Progetto: 475.129

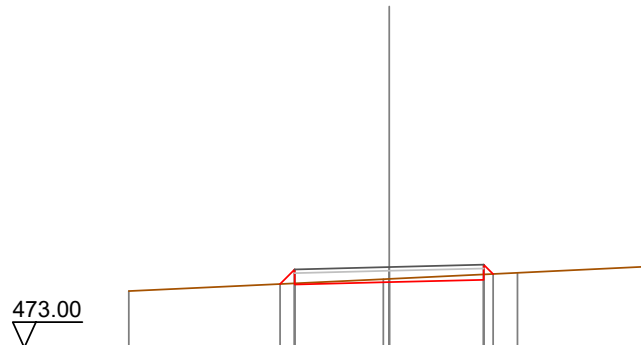

Quote Terreno	-474.49	474.68 474.67	474.81 474.81	474.79 474.94	474.97	475.14
Quote Progetto		474.68 474.67	474.73 474.81	474.79 474.94		
Parziali		0.39 2.50	2.50			
Progressiva		-2.89 -2.50	0.00	2.50 2.75		
Dislivelli		0.00 0.37	-0.09	-0.14 0.00		

Sezione: 126
 Progressiva: 1460.236
 Q. Progetto: 475.118

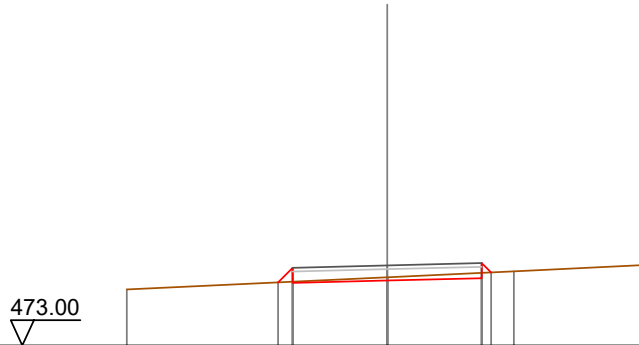

Quote Terreno	-474.48			474.80						
Quote Progetto		474.67	474.66	474.72	474.78	474.93				
Parziali		0.39	2.50	2.50						
Progressiva		-2.89	-2.50	0.00	2.50	2.75				
Dislivelli		0.00	0.37	-0.08	-0.14	0.00				

Sezione: 127
 Progressiva: 1465.135
 Q. Progetto: 474.897

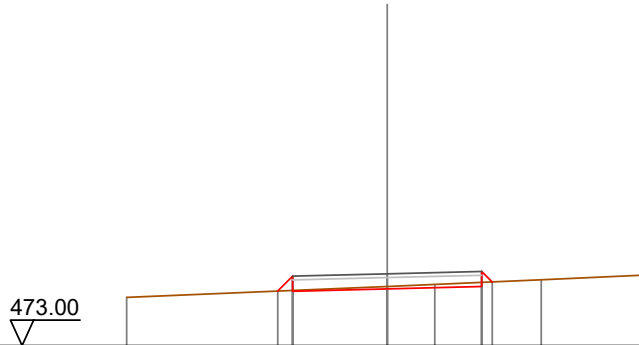

Quote Terreno	-474.27			474.56						
Quote Progetto		474.44	474.43	474.50	474.56	474.68				
Parziali		0.39	2.50	2.50	0.38					
Progressiva		-2.89	-2.50	0.00	2.50	2.78				
Dislivelli		0.00	0.38	-0.07	-0.11	0.00				

Sezione: 128
 Progressiva: 1480.000
 Q. Progetto: 474.226

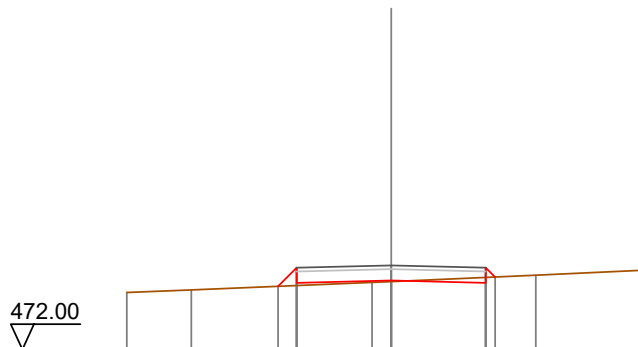

Quote Terreno		-473.51	-473.58			-473.77	-473.80			-473.96	-474.10
Quote Progetto						473.67	473.76			473.76	473.92
Parziali						0.49	2.50			2.50	
Progressiva						-2.99	-2.50			0.00	2.50
Dislivelli						0.00	0.47			0.03	-0.14

Sezione: 129
 Progressiva: 1482.486
 Q. Progetto: 474.113

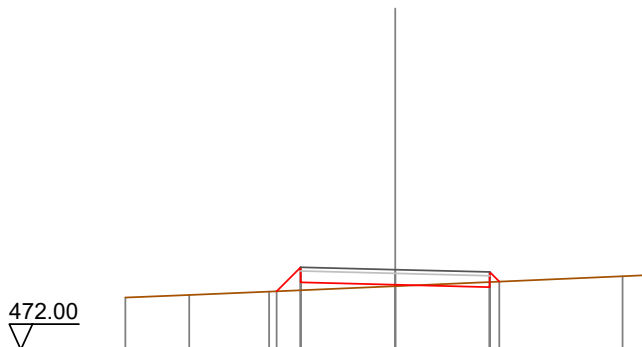

Quote Terreno		-473.37	-473.44			-473.53				-473.68	-473.94
Quote Progetto						473.54	473.78			473.71	473.80
Parziali						0.64	2.50			2.50	
Progressiva						-3.14	-2.50			0.00	2.50
Dislivelli						0.00	0.61			0.04	-0.14

Sezione: 130
 Progressiva: 1490.000
 Q. Progetto: 473.774

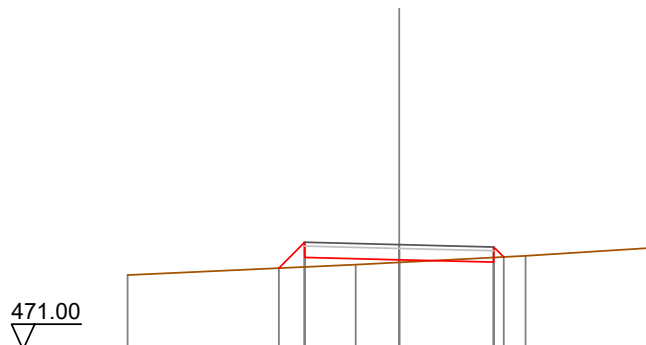

Quote Terreno		472.97		473.24	473.30		473.48	473.70
Quote Progetto			473.15	473.44	473.37	473.31	473.45	
Parziali			0.68	2.50	2.50	0.26		
Progressiva			-3.18	-2.50	0.00	2.50	2.76	
Dislivelli			0.00	0.65	0.07	-0.12	0.00	

Sezione: 131
 Progressiva: 1497.923
 Q. Progetto: 473.475

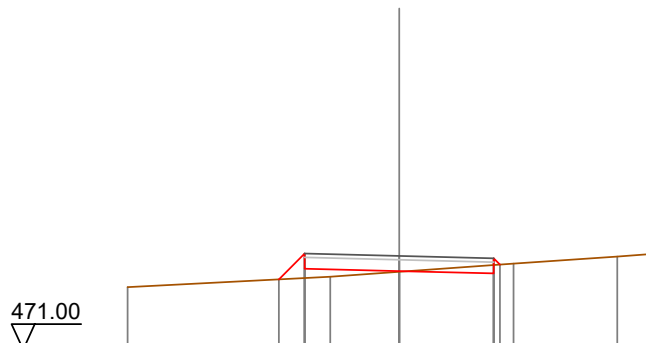

Quote Terreno		472.65		472.93	473.06		473.27	473.46	473.53
Quote Progetto			472.86	473.14	473.07	473.01	473.25		
Parziali			0.68	2.50	2.50				
Progressiva			-3.18	-2.50	0.00	2.50	2.67		
Dislivelli			0.00	0.65	0.02	-0.22	0.00		

Sezione: 132
 Progressiva: 1500.000
 Q. Progetto: 473.417

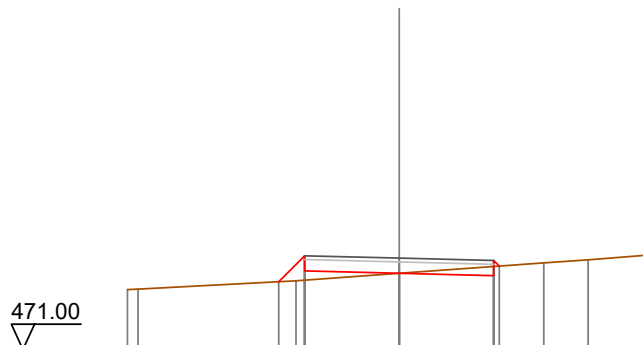

Quote Terreno	472.58	472.60	472.82	473.01	473.29	473.37	473.50
Quote Progetto			472.79	473.08	473.02	472.95	473.21
Parziali			0.69	2.50	2.50		
Progressiva			-3.19	-2.50	0.00	2.50	2.65
Dislivelli			0.00	0.65	0.00	-0.24	-0.00

Sezione: 133
 Progressiva: 1510.000
 Q. Progetto: 473.261

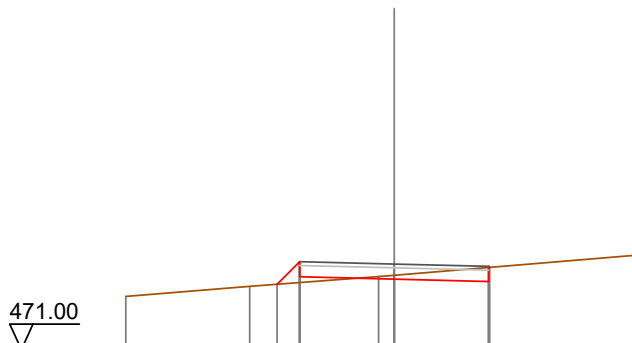

Quote Terreno	472.41	472.67	472.93	472.96	473.49	473.51	
Quote Progetto			472.73	472.92	472.86	472.80	473.17
Parziali			0.60	2.50	2.50		
Progressiva			-3.10	-2.50	0.00	2.50	2.52
Dislivelli			0.00	0.55	-0.10	-0.37	-0.00

Sezione: 133
 Progressiva: 1510.000
 Q. Progetto: 473.261

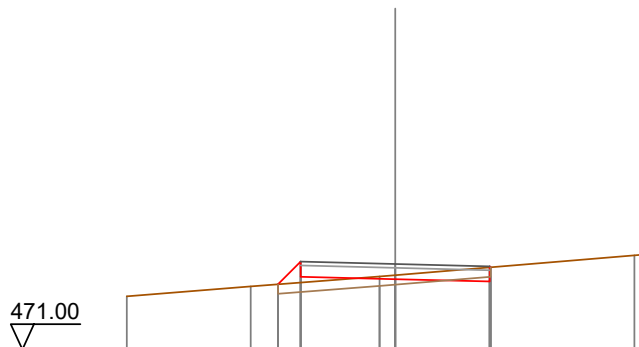

Quote Terreno		472.41		472.67		472.93		472.96		473.49		473.51
Quote Progetto				472.73		472.92		472.86		472.80		473.17
Parziali				0.60		2.50		2.50				
Progressiva				-3.10		-2.50		0.00		2.50		2.52
Dislivelli				0.00		0.55		-0.10		-0.37		0.00

Sezione: 134
 Progressiva: 1513.361
 Q. Progetto: 473.253

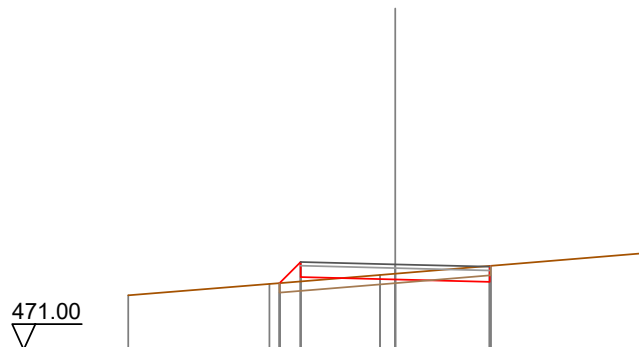

Quote Terreno		472.44		472.74		472.97		473.01		473.55		
Quote Progetto				472.76		472.92		472.85		472.79		473.22
Parziali				0.56		2.50		2.50				
Progressiva				-3.06		-2.50		0.00		2.50		2.52
Dislivelli				0.00		0.51		-0.15		-0.42		0.00

Sezione: 135
 Progressiva: 1520.000
 Q. Progetto: 473.304

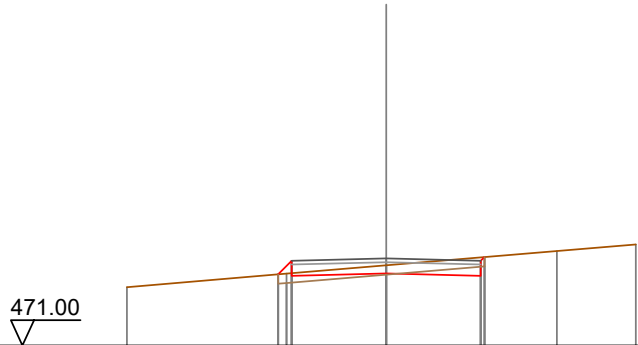

Quote Terreno	-472.54	472.90	473.12	-473.50	-473.67
Quote Progetto		472.88 472.84	472.90 473.12	472.84 473.34	
Parziali		0.36 2.50	2.50		
Progressiva		-2.66 -2.50	0.00	2.50 2.60	
Dislivelli		0.00 0.33	-0.22	-0.49 -0.00	

Sezione: 136
 Progressiva: 1540.000
 Q. Progetto: 473.575

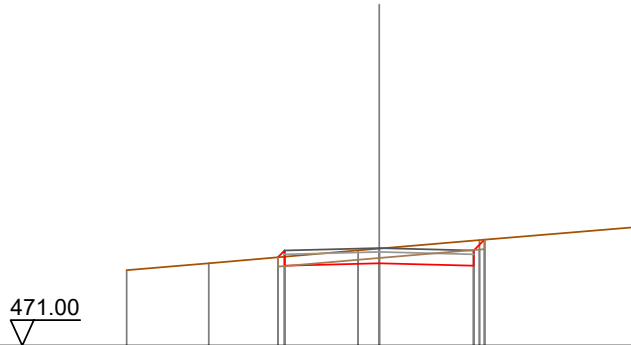

Quote Terreno	-472.99	-473.18	-473.52	-473.79	-474.13
Quote Progetto			473.18 473.57	473.11 473.80	
Parziali			2.50	2.50 0.23	
Progressiva		-2.68 -2.50	0.00	2.50 2.79	
Dislivelli		0.00 0.16	-0.39	-0.66 0.00	

Sezione: 137
 Progressiva: 1560.000
 Q. Progetto: 474.166

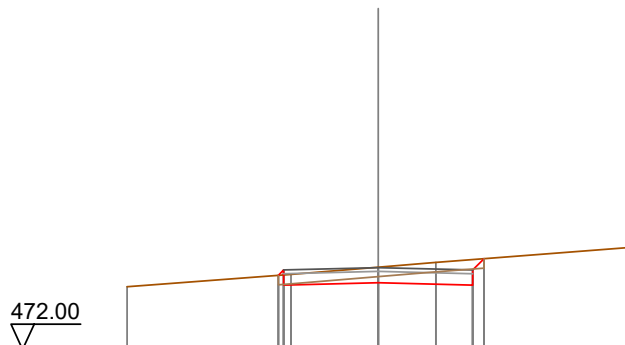

Quote Terreno		473.66		473.99		474.18		474.30		474.71
Quote Progetto			473.96	473.70	473.99	473.77	474.18	473.70	474.40	
Parziali				2.50		2.50		0.30		
Progressiva			-2.64	-2.50		0.00		2.50	2.80	
Dislivelli			0.00	0.13		-0.41		-0.67	0.00	

Sezione: 138
 Progressiva: 1568.639
 Q. Progetto: 474.476

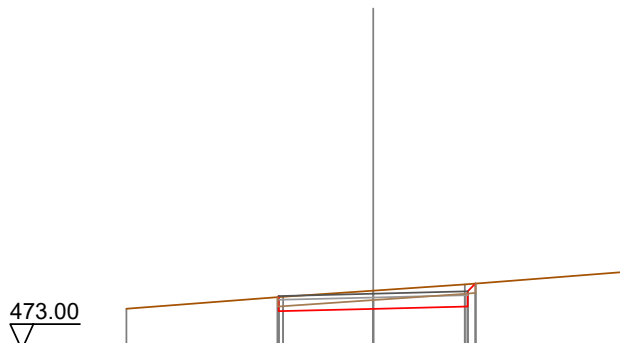

Quote Terreno		474.08		474.40		474.56		474.72		475.06
Quote Progetto			474.39	474.01	474.40	474.08	474.56	474.14	474.75	
Parziali				2.50		2.50				
Progressiva			-2.53	-2.50		0.00		2.50	2.71	
Dislivelli			0.00	0.03		-0.48		-0.59	0.00	

Sezione: 139
 Progressiva: 1570.000
 Q. Progetto: 474.515

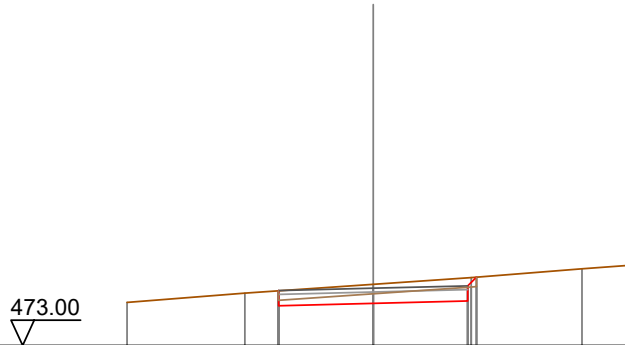

Quote Terreno	-474.14	-474.38	-474.62	-474.80	-475.03	-475.12
Quote Progetto		474.05	474.12	474.18	474.81	
Parziali			2.50	2.50		
Progressiva		-2.51	0.00	2.50	2.73	
Dislivelli		0.00	-0.50	-0.61	0.00	

Sezione: 140
 Progressiva: 1580.000
 Q. Progetto: 474.689

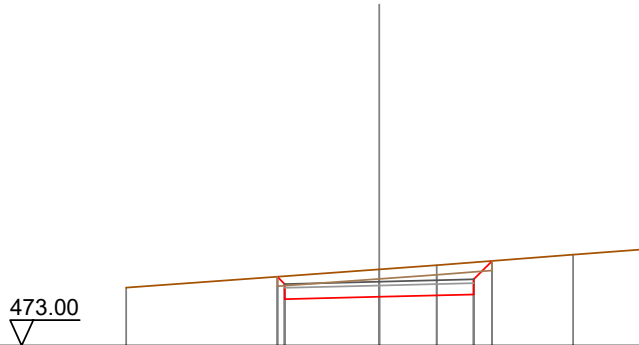

Quote Terreno	-474.53	-474.82	-475.01	-475.12	-475.40	-475.54
Quote Progetto		474.82	474.29	474.35	475.24	
Parziali			2.50	2.50	0.49	
Progressiva		-2.69	0.00	2.50	2.99	
Dislivelli		0.00	-0.72	-0.85	0.00	

Sezione: 141
 Progressiva: 1584.146
 Q. Progetto: 474.702

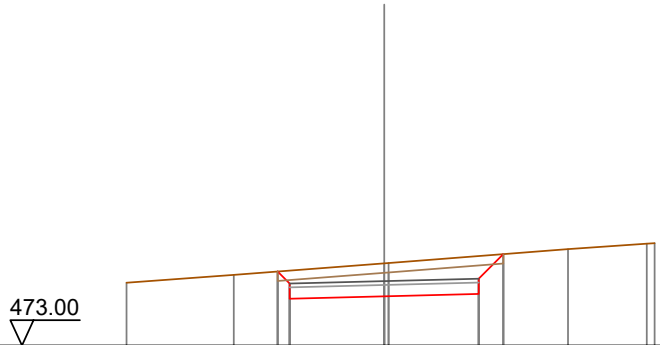

Quote Terreno	-474.66	-474.87		474.96	474.24		474.30	475.17	475.18		475.55	475.69	475.71
Quote Progetto													
Parziali				0.32	2.50		2.50			0.65			
Progressiva				-2.82	-2.50		0.00			2.50	3.15		
Dislivelli				-0.00	-0.34		-0.87			-1.00	-0.00		

Sezione: 142
 Progressiva: 1590.000
 Q. Progetto: 474.662

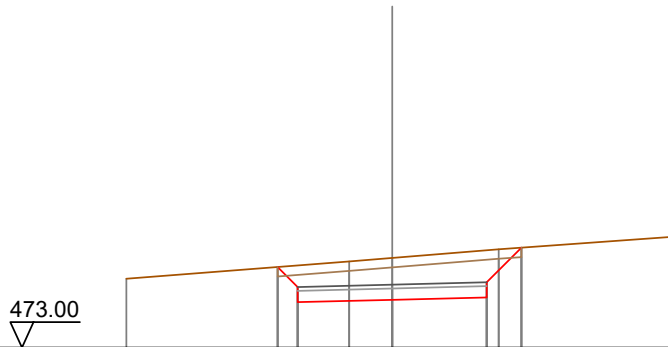

Quote Terreno	-474.82			-475.28	475.37		475.60			-475.93
Quote Progetto				475.13	474.20		474.32	475.64		
Parziali				0.53	2.50		2.50	0.92		
Progressiva				-3.03	-2.50		0.00		2.50	3.42
Dislivelli				0.00	-0.57		-1.11		-1.25	0.00

Sezione: 143
 Progressiva: 1599.653
 Q. Progetto: 474.446

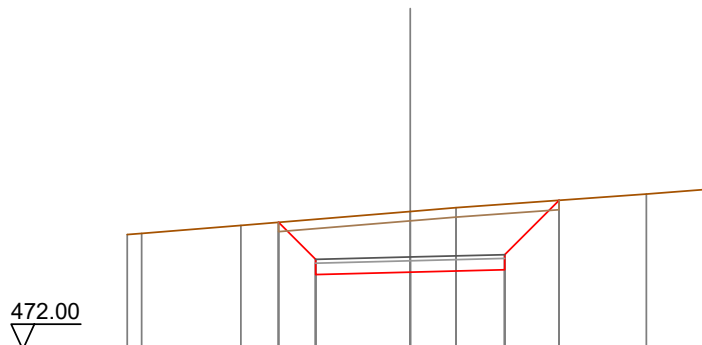

Quote Terreno	-475.04	-475.07	-475.28	-475.65	-475.75	-476.11	-476.24
Quote Progetto			475.37	473.98	474.05	474.11	475.95
Parziali			0.98	2.50	2.50	1.44	
Progressiva			-3.48	-2.50	0.00	2.50	3.94
Dislivelli			0.00	-1.06	-1.60	-1.73	0.00

Sezione: 144
 Progressiva: 1600.000
 Q. Progetto: 474.435

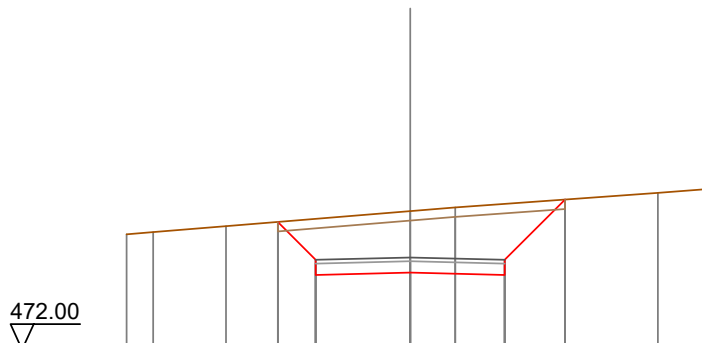

Quote Terreno	-475.05	-475.10	-475.26	-475.66	-475.76	-476.14	-476.26
Quote Progetto			475.37	473.97	474.03	473.97	475.97
Parziali			1.00	2.50	2.50	1.59	
Progressiva			-3.50	-2.50	0.00	2.50	4.09
Dislivelli			0.00	-1.08	-1.63	-1.88	0.00

Sezione: 145
 Progressiva: 1601.082
 Q. Progetto: 474.398

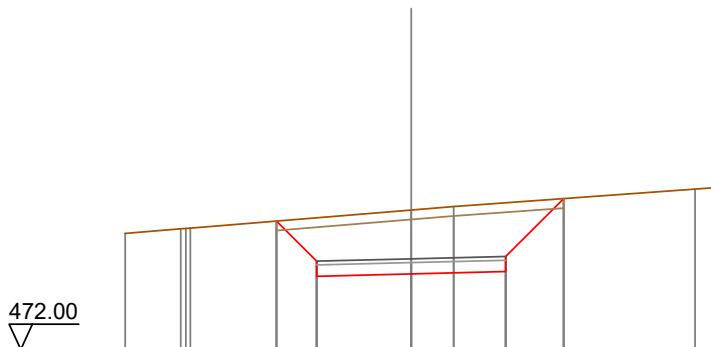

Quote Terreno		475.07	475.19	475.21			475.40	473.94	474.00	475.69	475.78		474.06	475.99	476.24	476.28
Quote Progetto							475.40	473.94	474.00	474.00			474.06	475.99		
Parziali							1.06	2.50		2.50			1.53			
Progressiva							-3.56	-2.50		0.00			2.50	4.03		
Dislivelli							-0.00	-1.15		-1.69			-1.82	-0.00		

Sezione: 146
 Progressiva: 1610.000
 Q. Progetto: 474.089

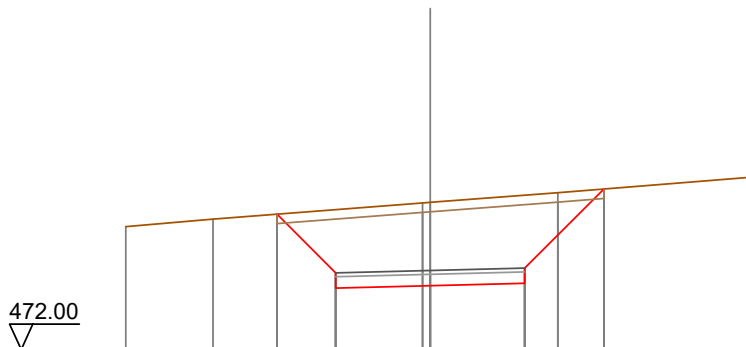

Quote Terreno		475.25	475.45				475.88	475.89		473.69	473.75		476.15	476.25	476.56	476.56
Quote Progetto							475.56	473.63		473.69	473.75		476.15	476.25		
Parziali							1.55	2.50		2.50			2.09			
Progressiva							-4.05	-2.50		0.00	2.50		4.59			
Dislivelli							-0.00	-1.67		-2.20	-2.33		-0.00			

Sezione: 147
 Progressiva: 1620.000
 Q. Progetto: 473.914

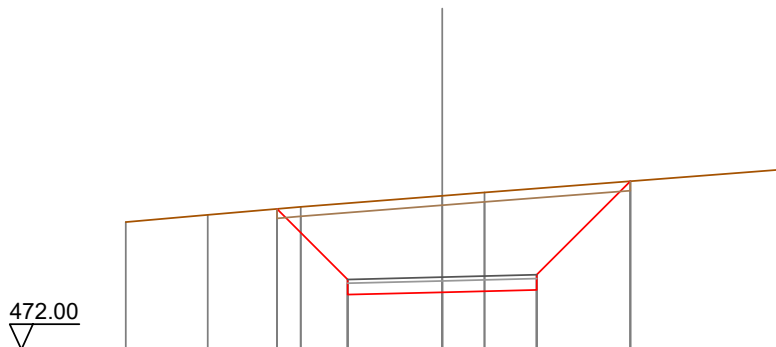

Quote Terreno	-475.37	-475.56	-475.77	-476.06	-476.15	-476.76	
Quote Progetto			475.72	473.51	473.58	476.45	
Parziali			1.87	2.50	2.50	2.47	
Progressiva			-4.37	-2.50	0.00	2.50	4.97
Dislivelli			-0.00	-2.02	-2.55	-2.68	-0.00

Sezione: 148
 Progressiva: 1624.891
 Q. Progetto: 473.900

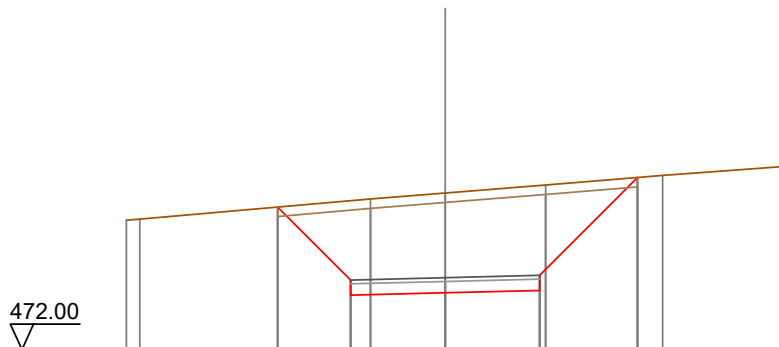

Quote Terreno	-475.42	-475.45	-475.98	-476.14	-476.35	-476.60	-476.85
Quote Progetto			475.77	473.44	473.50	473.56	476.55
Parziali			1.93	2.50	2.50	2.59	
Progressiva			-4.43	-2.50	0.00	2.50	5.09
Dislivelli			-0.00	-2.10	-2.64	-2.78	0.00

Sezione: 149
 Progressiva: 1626.000
 Q. Progetto: 473.900

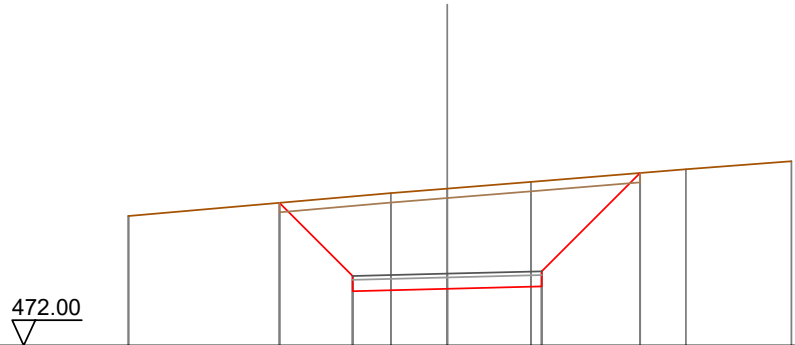

Quote Terreno		475.43		476.03	476.15	476.33		476.66	476.87
Quote Progetto			475.77	473.44	473.50	473.66		476.66	
Parziali			1.94	2.50	2.50	2.60			
Progressiva			-4.44	-2.50	0.00	2.50		5.10	
Dislivelli			0.00	-2.11	-2.65	-2.79		0.00	

SEZIONI TRASVERSALI
Profilo longitudinale tratto 31-32
Viabilità di impianto postazione aerogeneratore T16

Nota: Le canalette di deflusso delle acque meteoriche, non indicate nel presente elaborato, sono rappresentate graficamente nelle sezioni stradali tipo dell'elaborato "WIND002-TC13_Piazzole aerogeneratori e strade di servizio - Particolari costruttivi", individuate planimetricamente nell'elaborato "WIND002-TC14_Opere di regimazione acque superficiali - Planimetria generale" e quantificate nell'elaborato "WIND002-RC6_Computo Metrico Estimativo".

DISEGNI DI RIFERIMENTO

TAVOLA	DESCRIZIONE
WIND002-TC8	Piazzole e viabilità - Planimetria di progetto - Fase di cantiere
WIND002-TC11	Profili longitudinali viabilità di impianto
WIND002-TC13	Piazzole aerogeneratori e strade di servizio - Particolari costruttivi
WIND002-TC14	Opere di regimazione acque superficiali - Planimetria generale

Sezione: 1
 Progressiva: 0.000
 Q. Progetto: 496.000

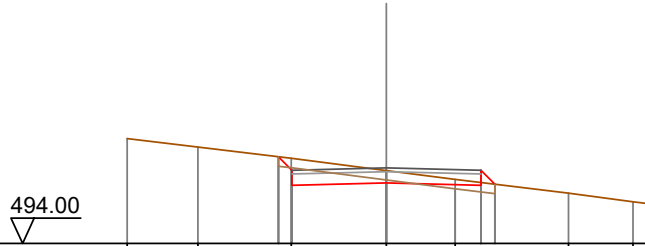

Quote Terreno	496.78	496.55	496.25	495.93	495.69	495.33	495.10	495.06
Quote Progetto			496.25	495.60	495.54			
Parziali			0.38	2.50	2.50	0.37		
Progressiva			-2.86	-2.50	0.00	2.50	2.87	
Dislivelli			0.00	-0.33		-0.07	0.00	

Sezione: 2
 Progressiva: 20.000
 Q. Progetto: 497.086

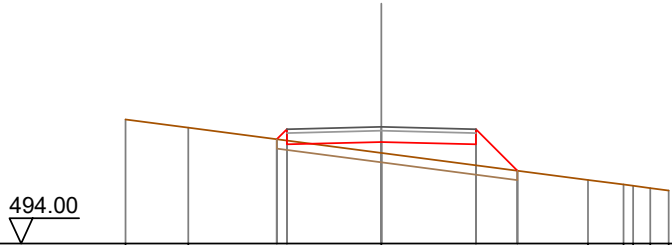

Quote Terreno	497.28	497.07	496.40	495.68	495.56	495.53	495.47	495.40
Quote Progetto			496.76	496.62	496.62	495.93		
Parziali			0.26	2.50	2.50	1.10		
Progressiva			-2.76	-2.50	0.00	2.50	3.60	
Dislivelli			-0.00	-0.30	0.29	0.55	-0.00	

Sezione: 3
 Progressiva: 30.863
 Q. Progetto: 497.718

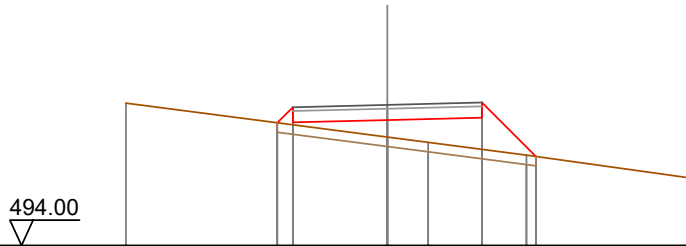

Quote Terreno	-497.76				496.87	496.73		496.39		-495.80
Quote Progetto			497.24	497.26	497.32		497.38	496.35		
Parziali			0.41	2.50	2.50		1.43			
Progressiva			-2.91	-2.50	0.00		2.50	3.93		
Dislivelli			0.00	0.46	0.45		0.84	-0.00		

Sezione: 4
 Progressiva: 40.000
 Q. Progetto: 498.355

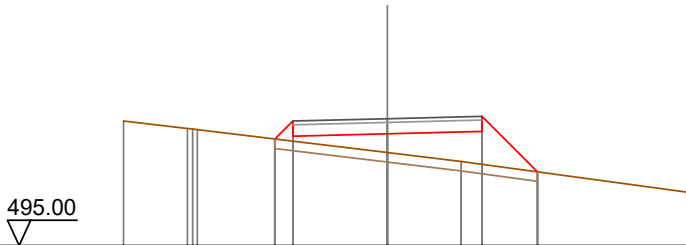

Quote Terreno	-498.29	-498.10	-498.06			497.46		497.22		-496.40
Quote Progetto				497.82	497.89	497.96		498.02	496.95	
Parziali				0.48	2.50	2.50		1.47		
Progressiva				-2.98	-2.50	0.00		2.50	3.97	
Dislivelli				-0.00	0.53	0.50		0.87	0.00	

Sezione: 5
 Progressiva: 50.000
 Q. Progetto: 499.166

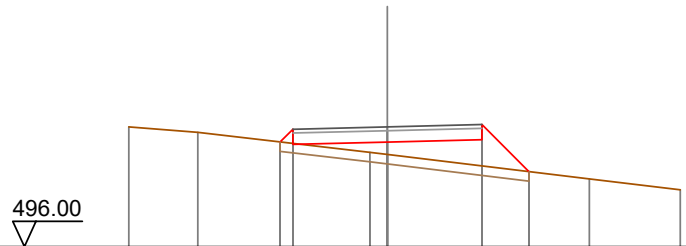

Quote Terreno	-499.17	-499.02			498.49	498.44			-497.79	-497.50
Quote Progetto			498.77	498.70	498.77		498.83	497.98		
Parziali			0.34	2.50	2.50		1.25			
Progressiva			-2.84	-2.50	0.00		2.50	3.75		
Dislivelli			0.00	0.37	0.33		0.70	-0.00		

Sezione: 6
 Progressiva: 53.022
 Q. Progetto: 499.434

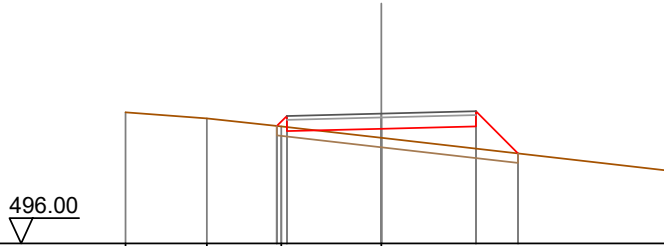

Quote Terreno	-499.47	-499.31	-499.10	-498.79	-498.38	-497.92
Quote Progetto			499.11 498.97	499.03	499.10	498.38
Parziali			0.25 2.50	2.50	1.12	
Progressiva			-2.76 -2.50	0.00	2.50	3.62
Dislivelli			0.00 0.29	0.24	0.59	0.00

Sezione: 7
 Progressiva: 60.000
 Q. Progetto: 500.095

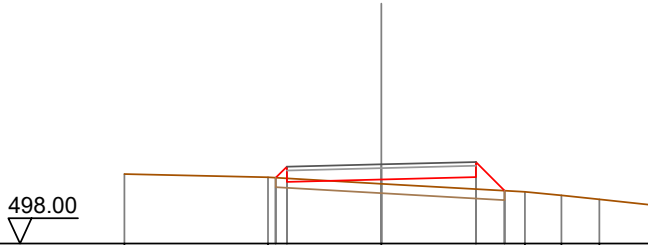

Quote Terreno	-499.84	-499.75	-499.58	-499.37	-499.28	-499.17	-499.01
Quote Progetto		499.74 499.63	499.69	499.76 499.40			
Parziali		0.25 2.50	2.50	0.76			
Progressiva		-2.79 -2.50	0.00	2.50	3.26		
Dislivelli		0.00 0.31	0.11	0.32	0.00		

Sezione: 7
 Progressiva: 60.000
 Q. Progetto: 500.095

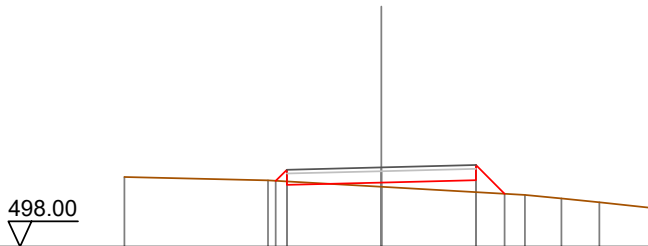

Quote Terreno	-499.84	-499.75	-499.58	-499.37	-499.28	-499.17	-499.01
Quote Progetto		499.74 499.63	499.69	499.76 499.40			
Parziali		0.25 2.50	2.50	0.76			
Progressiva		-2.79 -2.50	0.00	2.50	3.26		
Dislivelli		0.00 0.31	0.11	0.32	-0.00		

Sezione: 8
 Progressiva: 70.000
 Q. Progetto: 501.143

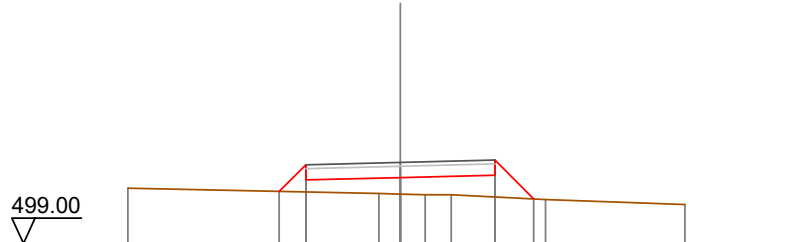

Quote Terreno	-500.46			500.32	500.31	500.29	500.29		500.16		-500.03
Quote Progetto			500.38	500.68	500.74			500.81	500.18		
Parziali			0.70	2.50		2.50		1.03			
Progressiva			-3.20	-2.50	0.00		2.50	3.53			
Dislivelli			-0.00	0.72	0.44		0.57	0.00			

Sezione: 9
 Progressiva: 75.181
 Q. Progetto: 501.733

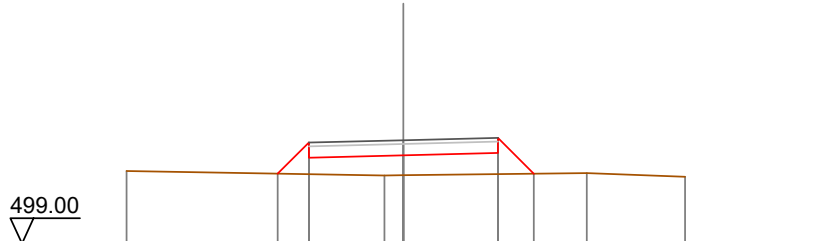

Quote Terreno	-500.92			500.80	500.81			500.86		-500.77
Quote Progetto			500.85	501.27	501.33			501.40	500.85	
Parziali			0.82	2.50		2.50		0.95		
Progressiva			-3.32	-2.50	0.00		2.50	3.45		
Dislivelli			-0.00	0.84	0.53		0.56	0.00		

Sezione: 10
 Progressiva: 80.000
 Q. Progetto: 502.311

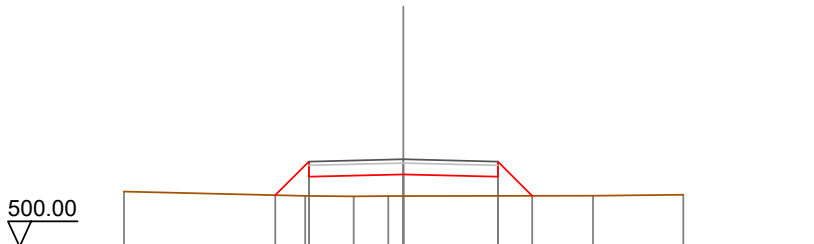

Quote Terreno	-501.45			501.34	501.33	501.34	501.34		501.34		-501.37
Quote Progetto			501.36	501.85	501.91			501.85	501.34		
Parziali			0.89	2.50		2.50		0.91			
Progressiva			-3.39	-2.50	0.00		2.50	3.41			
Dislivelli			-0.00	0.91	0.57		0.51	-0.00			

Sezione: 11
 Progressiva: 100.000
 Q. Progetto: 504.820

503.00

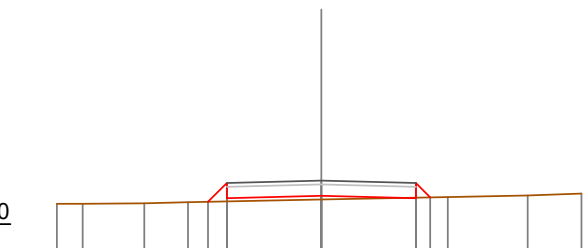

Quote Terreno	-504.21	-504.21	-504.22	-504.25	-504.32	-504.39	-504.43	-504.48
Quote Progetto				504.26	504.42	504.36	504.38	
Parziali				0.50	2.50	2.50	0.38	
Progressiva				-3.00	-2.50	0.00	2.50	2.88
Dislivelli				-0.00	0.49	0.10	-0.01	0.00

Sezione: 12
 Progressiva: 102.609
 Q. Progetto: 505.148

503.00

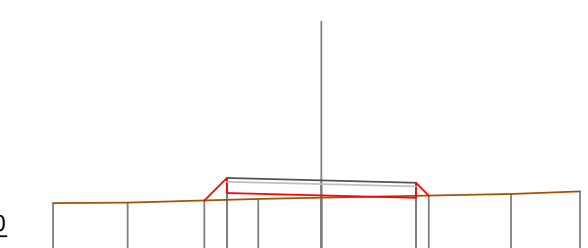

Quote Terreno	-504.55	-504.56	-504.65	-504.69	-504.79	-504.86
Quote Progetto			504.82	504.81	504.75	504.69
Parziali			0.59	2.50	2.50	0.34
Progressiva			-3.09	-2.50	0.00	2.50
Dislivelli			-0.00	0.68	0.06	-0.05

Sezione: 13
 Progressiva: 106.758
 Q. Progetto: 505.669

504.00

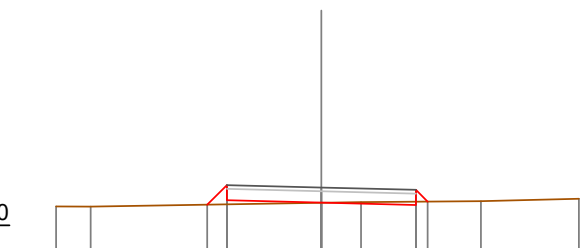

Quote Terreno	-505.17	-505.16	-505.22	-505.28	-505.31	-505.37
Quote Progetto			505.22	505.27	505.21	505.30
Parziali			0.52	2.50	2.50	0.31
Progressiva			-3.02	-2.50	0.00	2.50
Dislivelli			0.00	0.51	0.00	-0.09

Sezione: 14
 Progressiva: 110.000
 Q. Progetto: 506.077

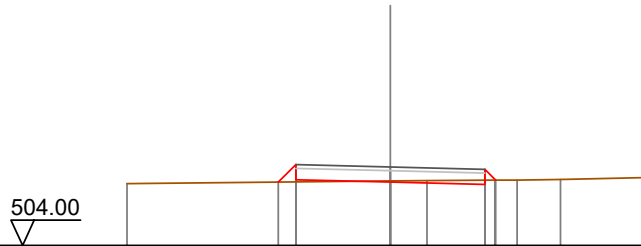

Quote Terreno	-505.64			505.71	505.72	505.73	505.73	505.75	505.80
Quote Progetto		505.68	505.74	505.68		505.61	505.73		
Parziali		0.46	2.50		2.50	0.28			
Progressiva		-2.96	-2.50	0.00		2.50	2.78		
Dislivelli		-0.00	0.46	-0.03		-0.11	0.00		

Sezione: 15
 Progressiva: 110.908
 Q. Progetto: 506.191

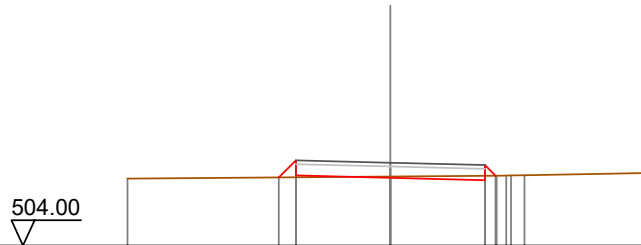

Quote Terreno	-505.77			505.82		505.85	505.86		505.92
Quote Progetto		505.80	505.85	505.79		505.73	505.85		
Parziali		0.45	2.50		2.50	0.28			
Progressiva		-2.95	-2.50	0.00		2.50	2.78		
Dislivelli		0.00	0.45	-0.03		-0.12	-0.00		

Sezione: 16
 Progressiva: 120.000
 Q. Progetto: 507.277

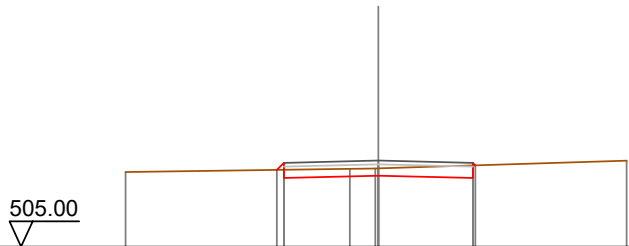

Quote Terreno	-506.97			507.06	507.07				507.27
Quote Progetto		507.03	506.81	506.88		506.81	507.15		
Parziali			2.50		2.50				
Progressiva		-2.68	-2.50	0.00		2.50	2.57		
Dislivelli		0.00	0.18	-0.19		-0.33	0.00		

Sezione: 17
 Progressiva: 140.000
 Q. Progetto: 509.081

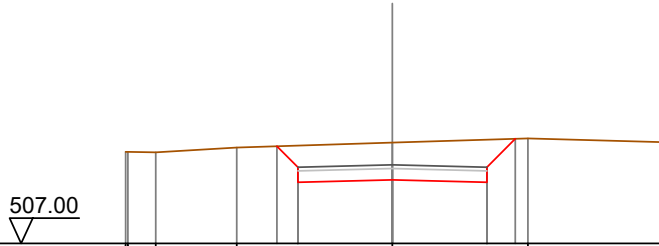

Quote Terreno	509.42	509.42	509.41	509.54	509.67	509.78	509.68
Quote Progetto				509.57	508.62	508.62	509.77
Parziali				0.55	2.50	2.50	0.75
Progressiva				-3.05	-2.50	0.00	2.50
Dislivelli				0.00	-0.57	-0.99	-1.13
							0.00

Sezione: 18
 Progressiva: 149.294
 Q. Progetto: 509.645

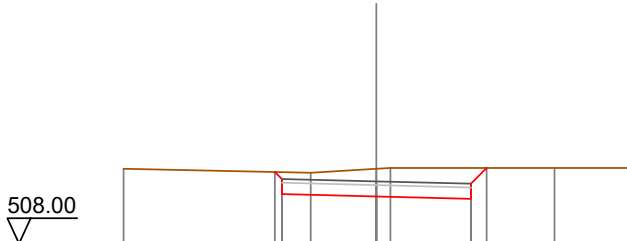

Quote Terreno	509.98			509.87	509.98	510.00	510.00	510.00
Quote Progetto				509.89	509.31	509.24	509.18	510.00
Parziali				2.50	2.50	0.42		
Progressiva				-2.69	-2.50	0.00	2.50	2.92
Dislivelli				0.00	-0.18	-0.73	-0.82	0.00

Sezione: 19
 Progressiva: 150.000
 Q. Progetto: 509.680

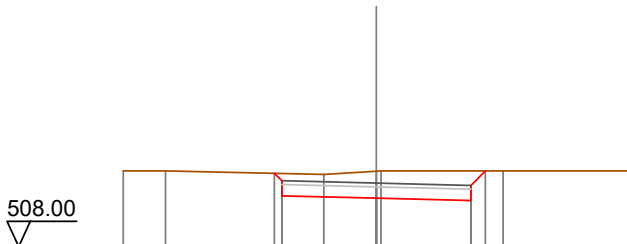

Quote Terreno	510.00	510.00		509.91	509.99	510.00	510.00	510.00
Quote Progetto				509.94	509.34	509.28	509.22	510.00
Parziali				2.50	2.50	0.33		
Progressiva				-2.69	-2.50	0.00	2.50	2.88
Dislivelli				-0.00	-0.19	-0.71	-0.78	0.00

Sezione: 20
 Progressiva: 153.802
 Q. Progetto: 509.856

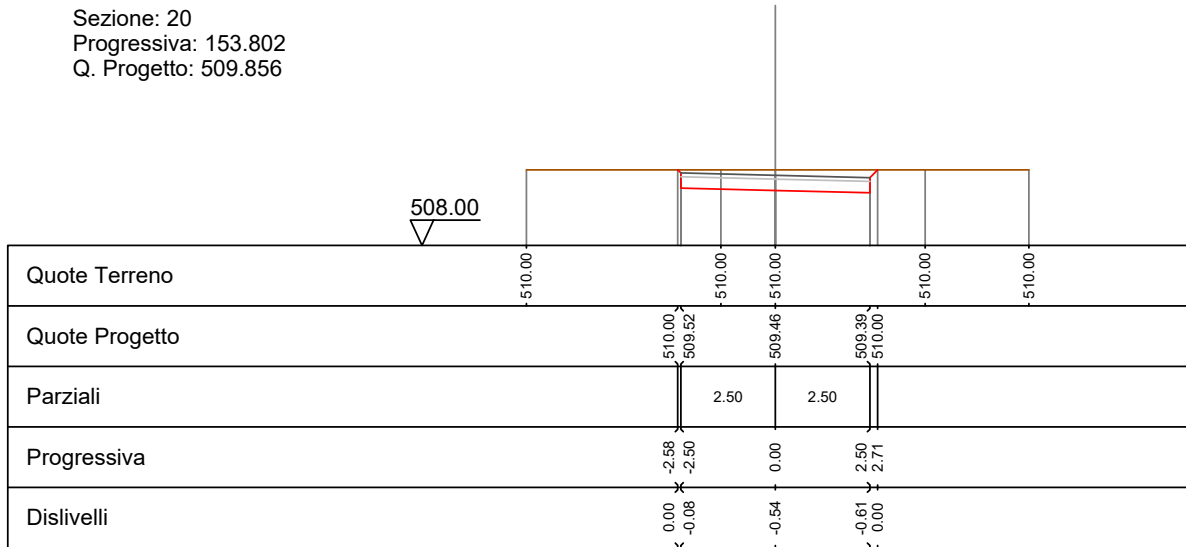

Sezione: 21
 Progressiva: 158.309
 Q. Progetto: 510.026

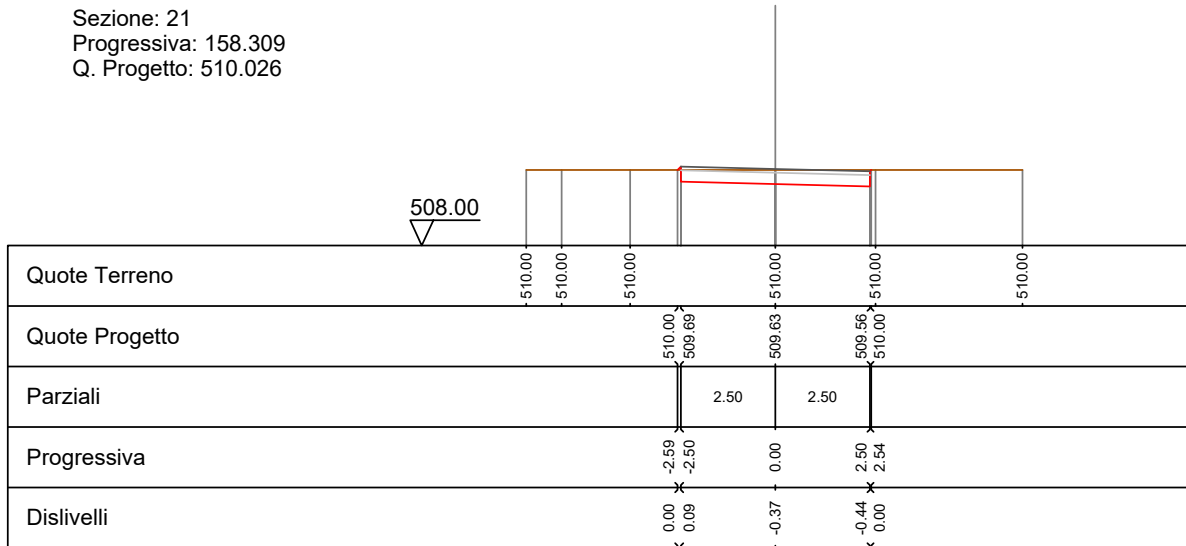

Sezione: 22
 Progressiva: 160.000
 Q. Progetto: 510.079

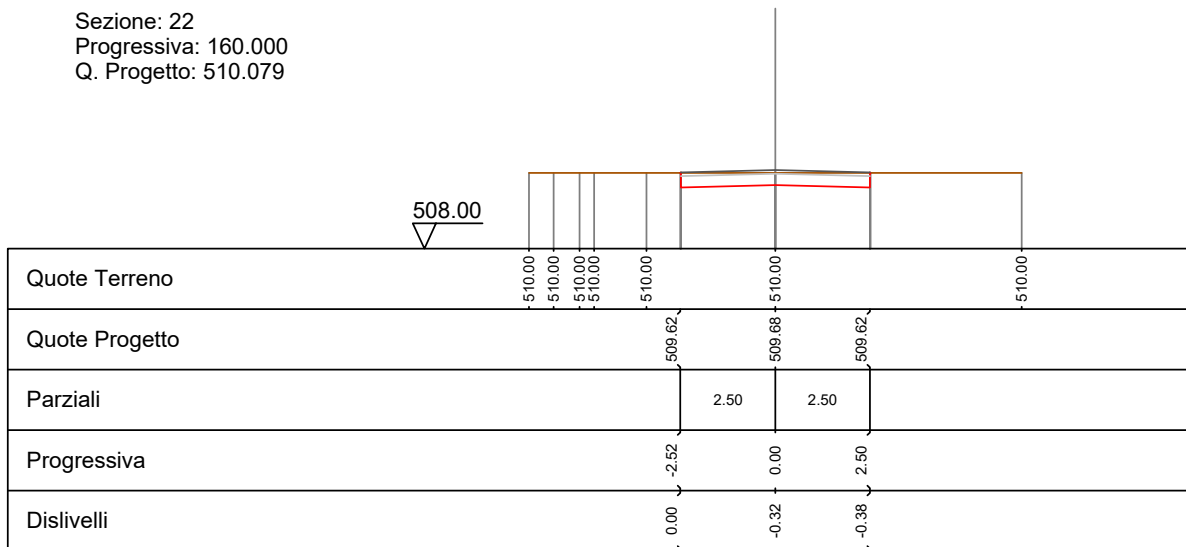

Sezione: 23
 Progressiva: 180.000
 Q. Progetto: 510.316

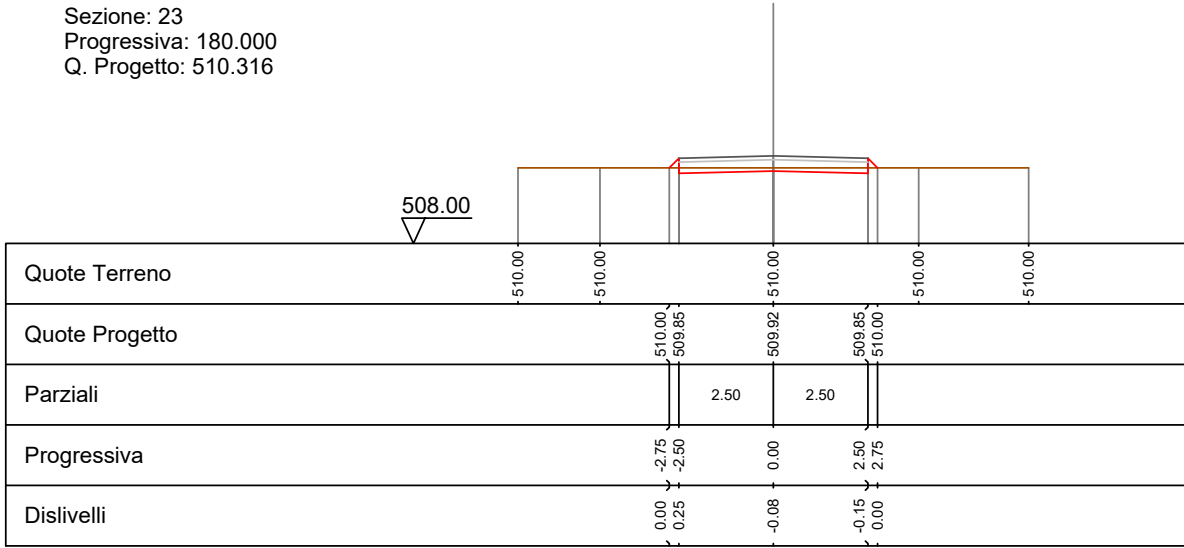

Sezione: 24
 Progressiva: 184.982
 Q. Progetto: 510.329

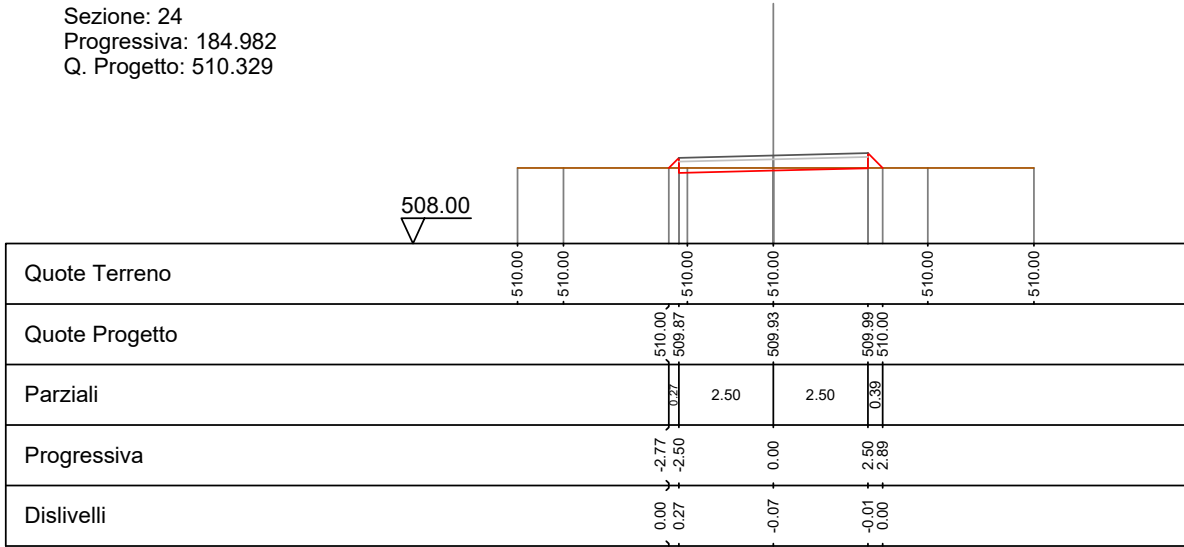

Sezione: 25
 Progressiva: 190.000
 Q. Progetto: 510.342

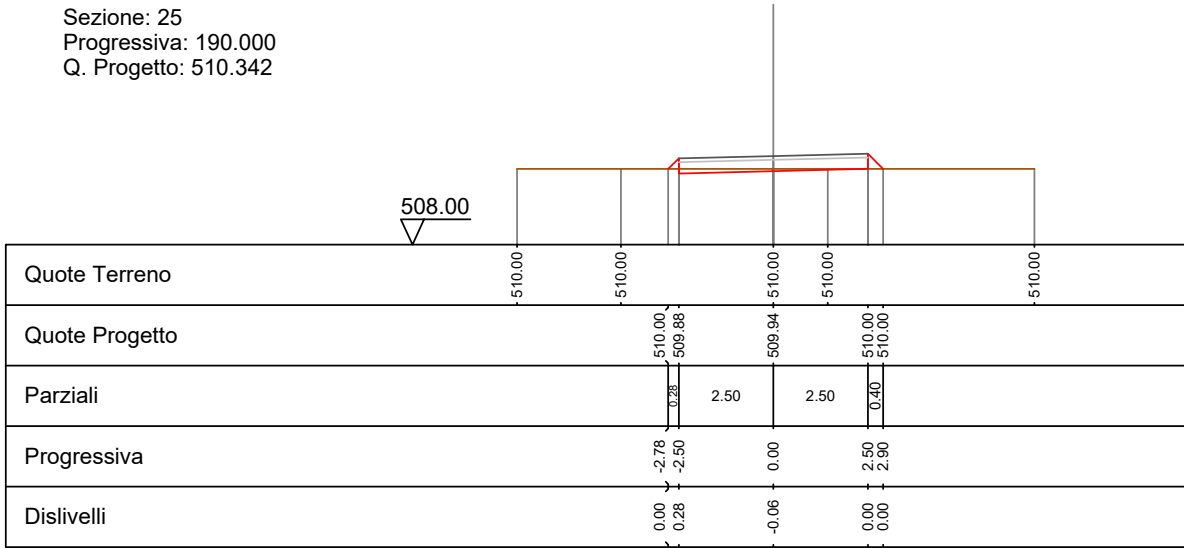

Sezione: 26
 Progressiva: 197.137
 Q. Progetto: 510.360

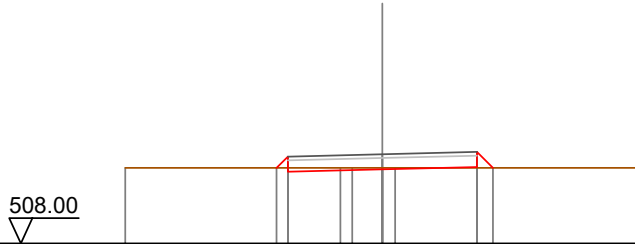

Quote Terreno	-510.00	-510.00	-510.00	-510.00	-510.00
Quote Progetto		510.00	509.90	509.96	510.02
Parziali		0.30	2.50	2.50	0.42
Progressiva		-2.80	-2.50	0.00	2.50
Dislivelli		0.00	0.30	-0.04	0.02

Sezione: 27
 Progressiva: 200.000
 Q. Progetto: 510.368

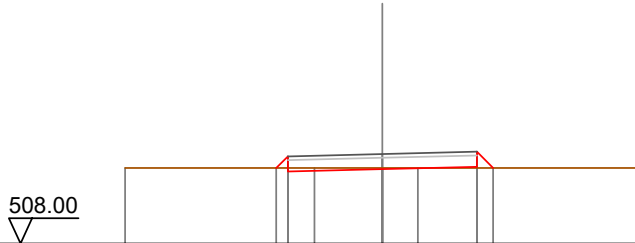

Quote Terreno	-510.00	-510.00	-510.00	-510.00	-510.00
Quote Progetto		510.00	509.91	509.97	510.03
Parziali		0.31	2.50	2.50	0.43
Progressiva		-2.81	-2.50	0.00	2.50
Dislivelli		0.00	0.31	-0.03	0.03

Sezione: 28
 Progressiva: 209.293
 Q. Progetto: 510.392

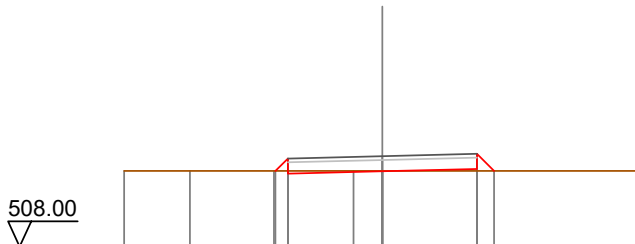

Quote Terreno	-510.00	-510.00	-510.00	-510.00	-510.00
Quote Progetto		510.00	509.93	509.98	510.05
Parziali		0.33	2.50	2.50	0.45
Progressiva		-2.83	-2.50	0.00	2.50
Dislivelli		0.00	0.33	-0.01	0.05

Sezione: 29
 Progressiva: 209.893
 Q. Progetto: 510.393

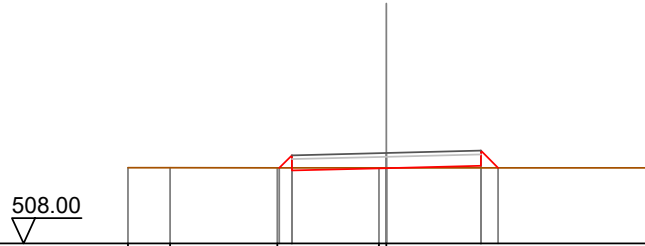

Quote Terreno	510.00	510.00	510.00	510.00	510.00	510.00	
Quote Progetto			510.00	509.93	509.98	510.06	510.00
Parziali			0.33	2.50	2.50	0.46	
Progressiva			-2.83	-2.50	0.00	2.50	2.96
Dislivelli			0.00	0.33	-0.01	0.06	0.00

Sezione: 30
 Progressiva: 220.017
 Q. Progetto: 510.423

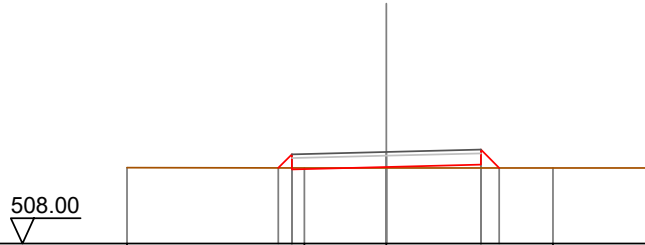

Quote Terreno	510.01	510.00	510.00	510.00	510.00	510.00	
Quote Progetto			510.00	509.96	510.02	510.09	510.00
Parziali			0.36	2.50	2.50	0.49	
Progressiva			-2.86	-2.50	0.00	2.50	2.99
Dislivelli			-0.00	0.36	0.02	0.09	0.00

Sezione: 31
 Progressiva: 230.141
 Q. Progetto: 510.460

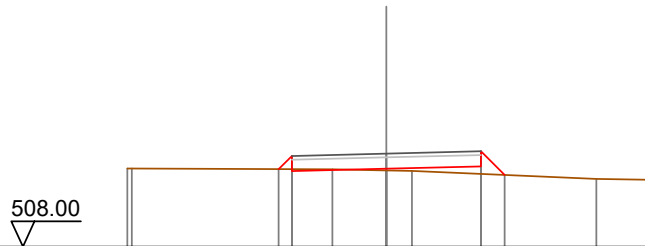

Quote Terreno	510.07	510.07	510.04	510.01	510.00	509.79	509.77
Quote Progetto			510.05	510.00	510.06	510.12	509.90
Parziali			0.35	2.50	2.50	0.63	
Progressiva			-2.85	-2.50	0.00	2.50	3.13
Dislivelli			-0.00	0.35	0.05	0.20	-0.00

Sezione: 32
 Progressiva: 240.000
 Q. Progetto: 510.495

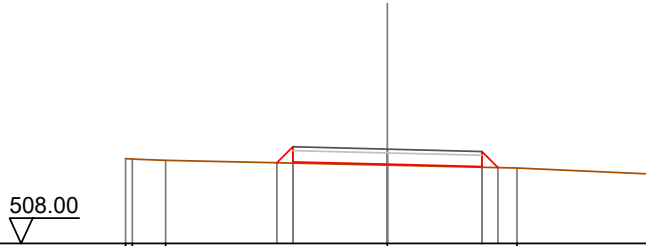

Quote Terreno	510.25	510.23	510.20		510.14	510.16	510.10	510.07	510.03	510.01	510.00	509.84
Quote Progetto					510.14	510.16	510.10		510.03	510.01		
Parziali					0.42	2.50	2.50		0.43			
Progressiva					-2.92	-2.50	0.00		2.50	2.93		
Dislivelli					-0.00	0.43	0.02		0.02	-0.00		

Sezione: 33
 Progressiva: 250.000
 Q. Progetto: 510.532

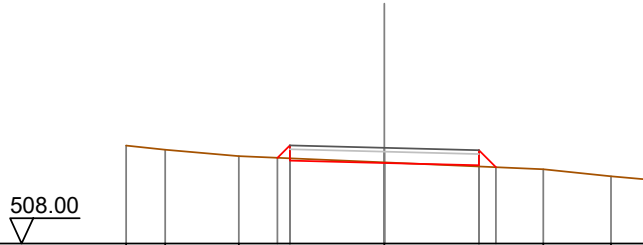

Quote Terreno	510.59	510.48	510.31		510.15	510.15		509.96	509.78	509.69
Quote Progetto					510.13	510.13		510.07	510.02	
Parziali					0.33	2.50	2.50	0.45		
Progressiva					-2.83	-2.50	0.00	2.50	2.95	
Dislivelli					0.00	0.34	-0.01	0.03	0.00	

Sezione: 34
 Progressiva: 255.404
 Q. Progetto: 510.548

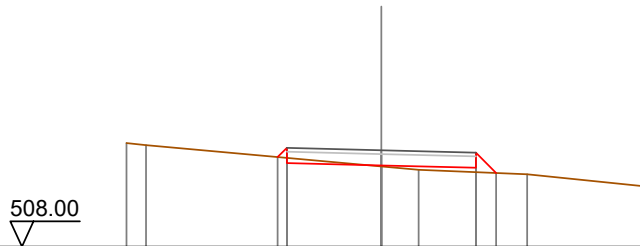

Quote Terreno	510.74	510.68			510.12	510.12		510.03	509.91	509.59
Quote Progetto					510.15	510.15		510.09	509.95	
Parziali					2.50	2.50		0.54		
Progressiva					-2.74	-2.50	0.00	2.50	3.04	
Dislivelli					0.00	0.26	0.03	0.11	0.00	

Sezione: 35
 Progressiva: 260.000
 Q. Progetto: 510.526

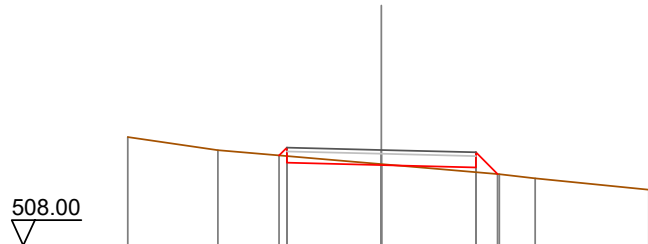

Quote Terreno	-510.87	-510.52		510.15		509.89	-509.78	-509.47
Quote Progetto			510.38	510.19	510.13	510.06	509.89	
Parziali			2.50	2.50		0.57		
Progressiva			-2.71	-2.50	0.00	2.50	3.07	
Dislivelli			0.00	0.22	-0.03	0.13	0.00	

Sezione: 36
 Progressiva: 270.000
 Q. Progetto: 510.334

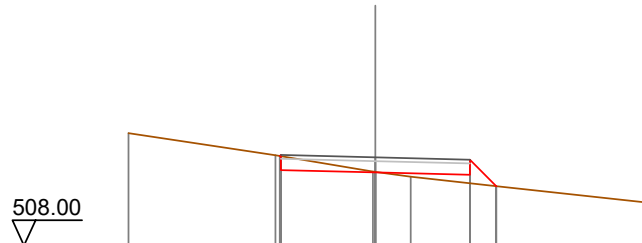

Quote Terreno	-510.97	-510.39		509.96	509.95	509.82	509.57	-509.14
Quote Progetto		510.37	510.00	509.93	509.95	509.87	509.57	
Parziali			2.50	2.50		0.70		
Progressiva			-2.53	-2.50	0.00	2.50	3.20	
Dislivelli			-0.00	0.03	-0.02	0.22	-0.00	

Sezione: 37
 Progressiva: 280.000
 Q. Progetto: 509.941

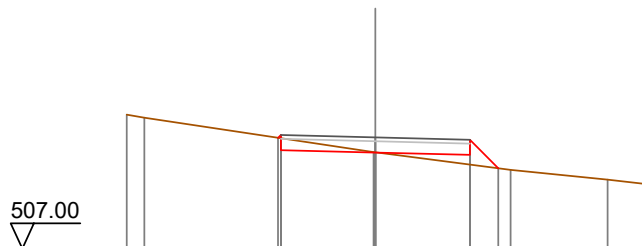

Quote Terreno	-510.54	-510.46		509.55	509.55		509.08	-508.82	-508.70
Quote Progetto			509.93	509.60	509.54	509.48	509.13		
Parziali			2.50	2.50		0.75			
Progressiva			-2.57	-2.50	0.00	2.50	3.25		
Dislivelli			-0.00	0.08	-0.01	0.26	0.00		

Sezione: 38
 Progressiva: 280.519
 Q. Progetto: 509.916

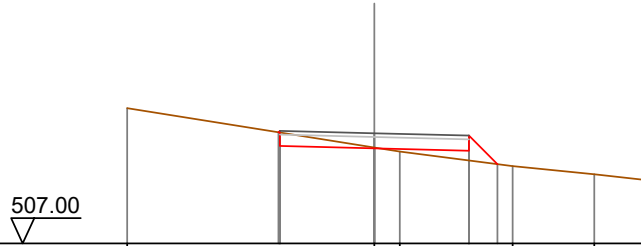

Quote Terreno	-510.58		509.54	509.43	509.05	508.83	508.67
Quote Progetto		509.94 509.58	509.52		509.45 509.10		
Parziali			2.50	2.50	0.75		
Progressiva		-2.54 -2.50	0.00		2.50 3.25		
Dislivelli		-0.00 0.04	-0.02		0.26 0.00		

Sezione: 39
 Progressiva: 288.679
 Q. Progetto: 509.525

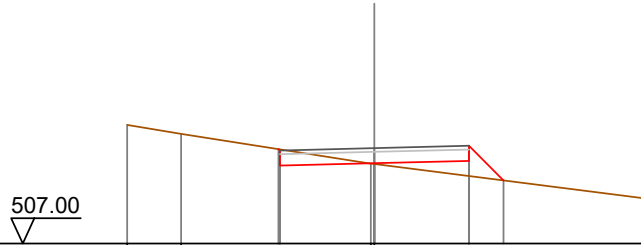

Quote Terreno	-510.14	509.90	509.12 509.10		508.16
Quote Progetto		509.50 509.06	509.12	509.19 508.67	
Parziali			2.50	2.50	0.92
Progressiva		-2.53 -2.50	0.00	2.50 3.42	
Dislivelli		0.00 -0.03	0.02	0.40 0.00	

Sezione: 40
 Progressiva: 289.098
 Q. Progetto: 509.505

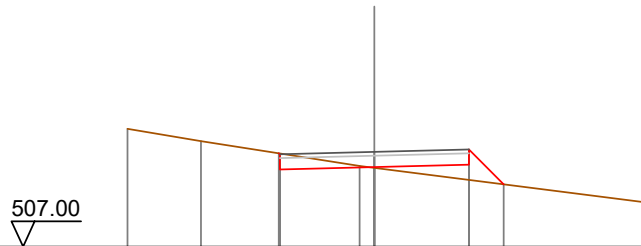

Quote Terreno	-510.12	509.79	509.13 509.08		508.14
Quote Progetto		509.47 509.04	509.10	509.17 508.65	
Parziali			2.50	2.50	0.92
Progressiva		-2.53 -2.50	0.00	2.50 3.42	
Dislivelli		0.00 -0.02	0.02	0.40 0.00	

Sezione: 41
 Progressiva: 289.516
 Q. Progetto: 509.485

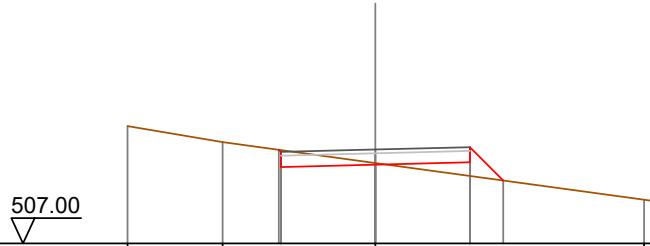

Quote Terreno	510.10	509.88	509.13	508.16	508.12	
Quote Progetto		509.48	509.02	509.09	509.15	508.67
Parziali			2.50	2.50	0.88	
Progressiva		-2.55	-2.50	0.00	2.50	3.38
Dislivelli		-0.00	-0.05	-0.04	0.36	-0.00

Sezione: 42
 Progressiva: 300.000
 Q. Progetto: 509.109

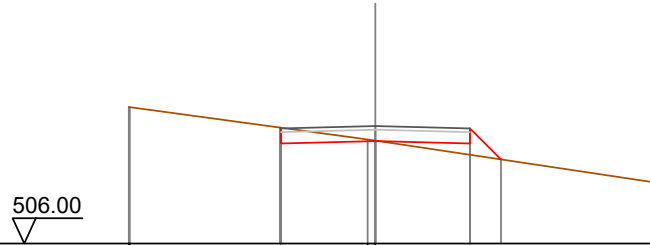

Quote Terreno	509.61	509.61	508.75	508.72	507.63	
Quote Progetto		509.07	508.65	508.71	508.65	508.22
Parziali			2.50	2.50	0.82	
Progressiva		-2.52	-2.50	0.00	2.50	3.32
Dislivelli		0.00	-0.02	-0.01	0.30	0.00

Sezione: 43
 Progressiva: 320.000
 Q. Progetto: 508.830

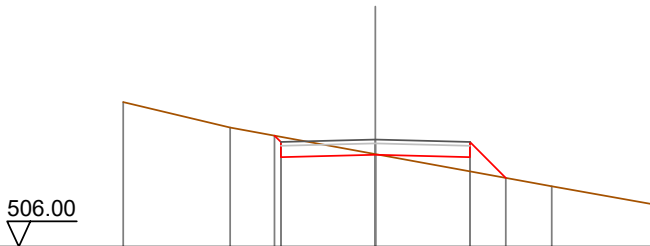

Quote Terreno	509.82	509.15	508.45	507.59	507.10	
Quote Progetto		508.93	508.37	508.43	508.37	507.82
Parziali			2.50	2.50	0.95	
Progressiva		-2.67	-2.50	0.00	2.50	3.45
Dislivelli		-0.00	-0.14	-0.02	0.38	-0.00

Sezione: 44
 Progressiva: 321.718
 Q. Progetto: 508.811

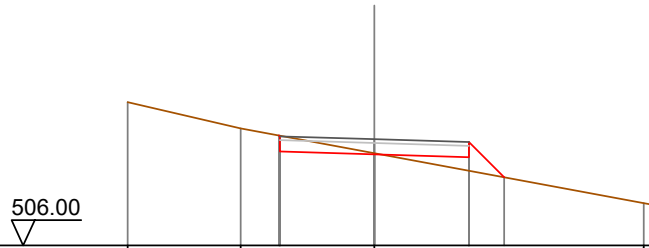

Quote Terreno	509.79	509.10	508.44	507.12	507.06
Quote Progetto		508.91 508.48	508.41	508.34	507.80
Parziali			2.50	2.50	0.93
Progressiva		-2.52 -2.50	0.00	2.50	3.43
Dislivelli		-0.00 -0.02	-0.03	0.36	0.00

Sezione: 45
 Progressiva: 323.255
 Q. Progetto: 508.793

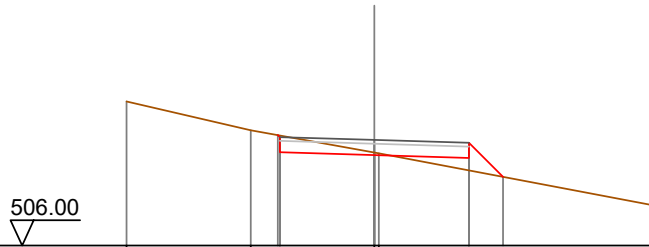

Quote Terreno	509.81	509.05	508.46 508.44	507.06	
Quote Progetto		508.92 508.47	508.39	508.32	507.82
Parziali			2.50	2.50	0.90
Progressiva		-2.55 -2.50	0.00	2.50	3.40
Dislivelli		-0.00 -0.04	-0.07	0.33	0.00

Sezione: 46
 Progressiva: 324.793
 Q. Progetto: 508.775

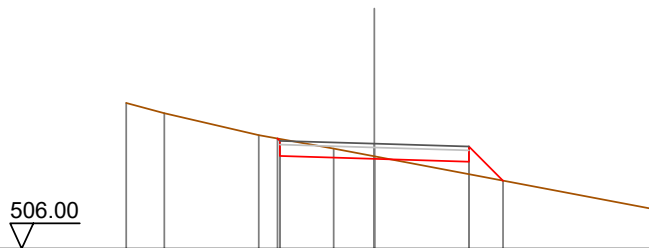

Quote Terreno	509.85	509.58	509.00	508.64	508.44	507.04
Quote Progetto			508.91 508.45	508.38	508.30	507.80
Parziali				2.50	2.50	0.90
Progressiva			-2.56 -2.50	0.00	2.50	3.40
Dislivelli			0.00 -0.05	-0.07	0.33	0.00

Sezione: 47
 Progressiva: 340.000
 Q. Progetto: 508.592

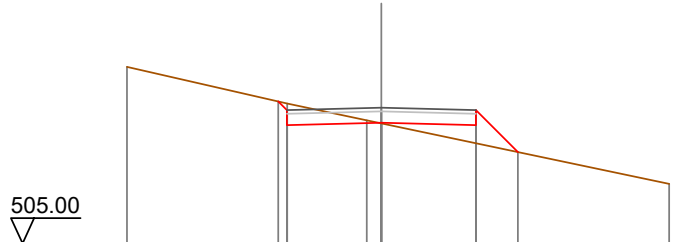

Quote Terreno	-509.67	-508.70	-508.26	-508.18	-507.42	-506.58
Quote Progetto		508.76	508.13	508.19	508.13	507.42
Parziali			2.50	2.50	1.11	
Progressiva		-2.73	-2.50	0.00	2.50	3.61
Dislivelli		-0.00	-0.17	0.01	0.48	-0.00

Sezione: 48
 Progressiva: 360.000
 Q. Progetto: 508.235

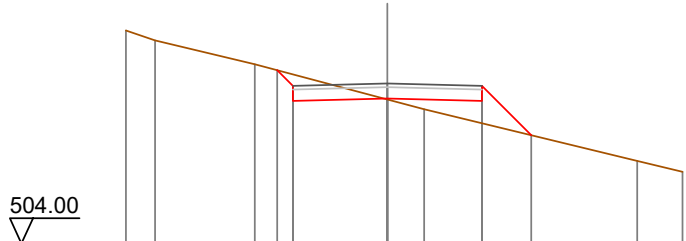

Quote Terreno	-509.64	-509.37	-508.74	-507.81	-507.55	-506.19	-505.90
Quote Progetto			508.59	507.77	507.83	507.77	506.87
Parziali			0.41	2.50	2.50	1.31	
Progressiva			-2.91	-2.50	0.00	2.50	3.81
Dislivelli			0.00	-0.30	0.02	0.59	-0.00

Sezione: 49
 Progressiva: 361.039
 Q. Progetto: 508.203

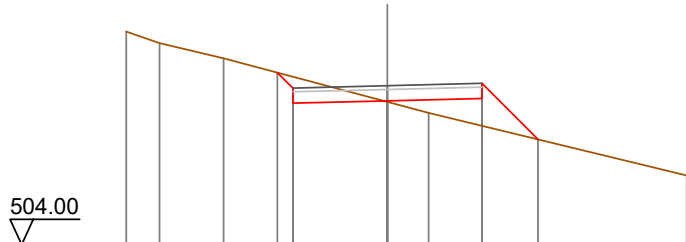

Quote Terreno	-509.63	-509.33	-508.93	-507.78	-507.49	-506.83	-505.81
Quote Progetto			508.55	507.80	507.87	506.78	
Parziali			0.41	2.50	2.50	1.48	
Progressiva			-2.91	-2.50	0.00	2.50	3.98
Dislivelli			0.00	-0.30	0.03	0.72	-0.00

Sezione: 50
 Progressiva: 367.354
 Q. Progetto: 508.044

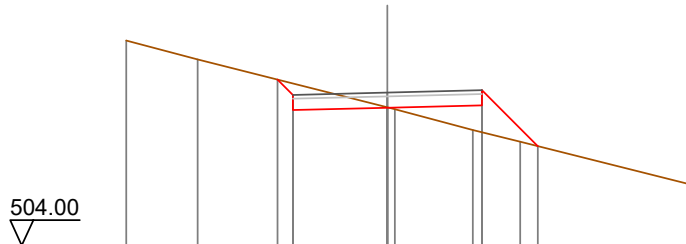

Quote Terreno	509.42	508.92		507.66	507.60	507.05	506.75	505.62
Quote Progetto			508.39	507.58	507.64	507.71	506.63	
Parziali			0.41	2.50	2.50	1.48		
Progressiva			-2.91	-2.50	0.00	2.50	3.98	
Dislivelli			0.00	-0.30	-0.01	0.71	-0.00	

Sezione: 51
 Progressiva: 370.000
 Q. Progetto: 508.001

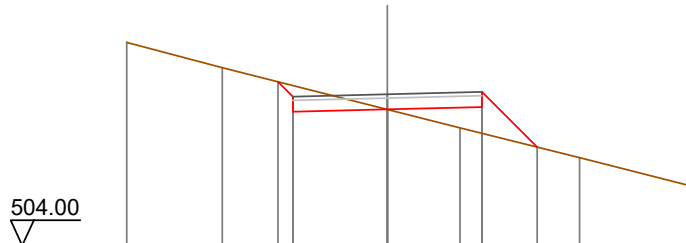

Quote Terreno	509.37	508.70		507.60	507.11	506.32	505.59
Quote Progetto			508.33	507.54	507.60	507.66	506.60
Parziali			0.39	2.50	2.50	1.46	
Progressiva			-2.89	-2.50	0.00	2.50	3.96
Dislivelli			0.00	-0.29	0.00	0.70	-0.00

Sezione: 52
 Progressiva: 373.668
 Q. Progetto: 507.964

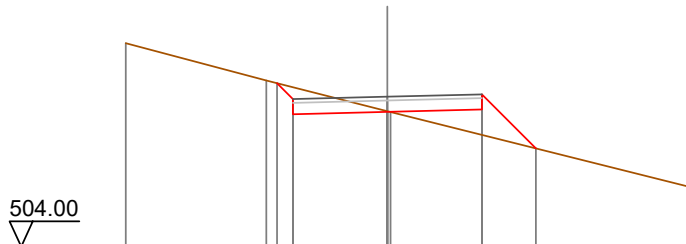

Quote Terreno	509.38	508.39		507.58	507.56		505.60
Quote Progetto		508.32	507.50	507.56	507.63	506.60	
Parziali		0.42	2.50	2.50	1.43		
Progressiva		-2.92	-2.50	0.00	2.50	3.93	
Dislivelli		-0.00	-0.31	-0.02	0.67	-0.00	

Sezione: 53
 Progressiva: 380.000
 Q. Progetto: 507.914

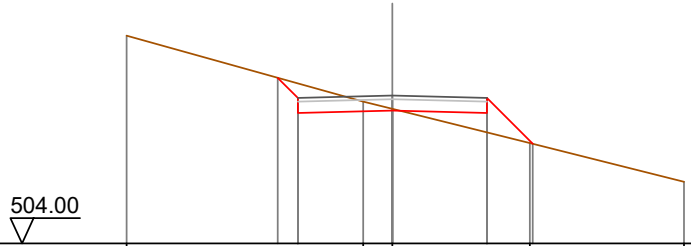

Quote Terreno	-509.50		-507.75	-507.56		-506.66	-505.63
Quote Progetto		508.38	507.45	507.51	507.45	506.64	
Parziali		0.63	2.50	2.50	1.21		
Progressiva		-3.03	-2.50	0.00	2.50	3.71	
Dislivelli		-0.00	-0.38	-0.05	0.51	-0.00	

Sezione: 54
 Progressiva: 399.013
 Q. Progetto: 507.523

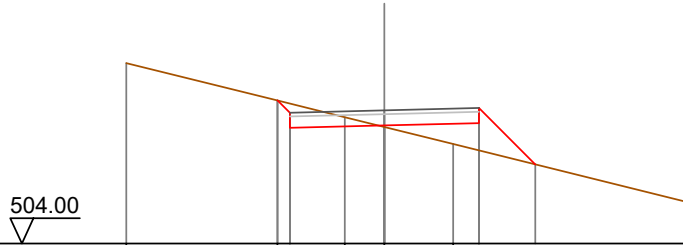

Quote Terreno	-508.77		-507.34	-507.08		-506.63	-505.10
Quote Progetto		507.78	507.06	507.12	507.19	506.09	
Parziali		0.32	2.50	2.50	1.49		
Progressiva		-2.82	-2.50	0.00	2.50	3.99	
Dislivelli		0.00	-0.24	0.04	0.72	-0.00	

Sezione: 55
 Progressiva: 400.000
 Q. Progetto: 507.505

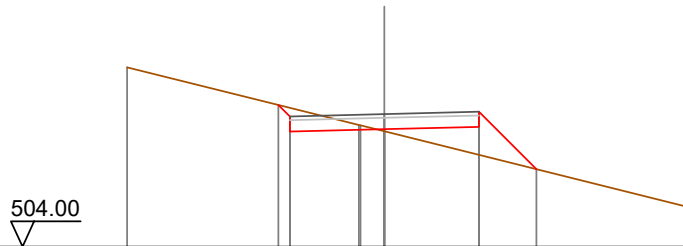

Quote Terreno	-508.74		-507.22	-507.05		-506.05	-505.05
Quote Progetto		507.75	507.04	507.11	507.17	506.05	
Parziali		0.30	2.50	2.50	1.52		
Progressiva		-2.80	-2.50	0.00	2.50	4.02	
Dislivelli		-0.00	-0.23	0.05	0.74	0.00	

Sezione: 56
 Progressiva: 407.508
 Q. Progetto: 507.438

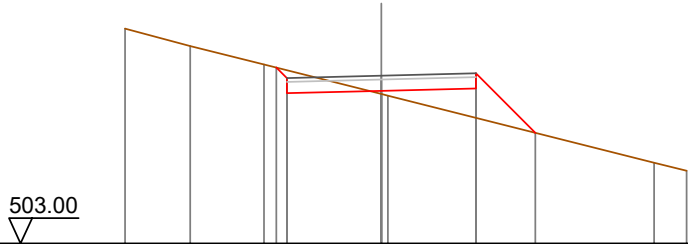

Quote Terreno	-508.68	-508.22	-507.74	-506.95	-506.91	-505.14	-504.92
Quote Progetto			-507.65	-507.04	-507.10	-505.93	
Parziali			0.28	2.50	2.50	1.57	
Progressiva			-2.78	-2.50	0.00	2.50	4.07
Dislivelli			0.00	-0.21	0.08	0.78	0.00

Sezione: 57
 Progressiva: 410.000
 Q. Progetto: 507.440

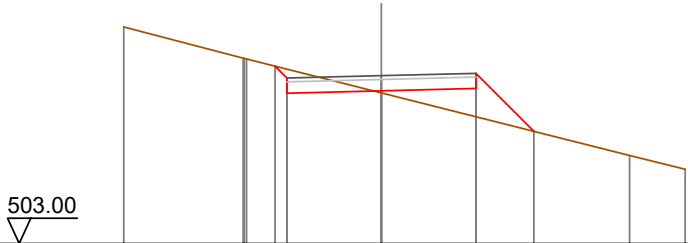

Quote Terreno	-508.73	-507.89	-507.88	-506.98	-505.33	-504.97
Quote Progetto		-507.69	-506.98	-507.04	-507.10	-505.97
Parziali		0.33	2.50	2.50	1.54	
Progressiva		-2.81	-2.50	0.00	2.50	4.04
Dislivelli		0.00	-0.23	0.06	0.75	0.00

Sezione: 58
 Progressiva: 416.003
 Q. Progetto: 507.497

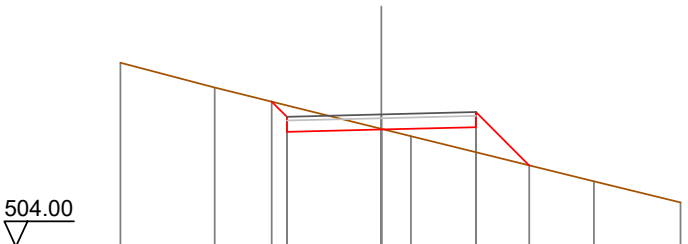

Quote Terreno	-508.86	-508.21	-507.11	-506.92	-505.73	-505.17
Quote Progetto		-507.83	-507.10	-507.16	-506.15	
Parziali		0.40	2.50	2.50	1.41	
Progressiva		-2.90	-2.50	0.00	2.50	3.91
Dislivelli		-0.00	-0.30	-0.02	0.66	0.00

Sezione: 59
 Progressiva: 420.000
 Q. Progetto: 507.574

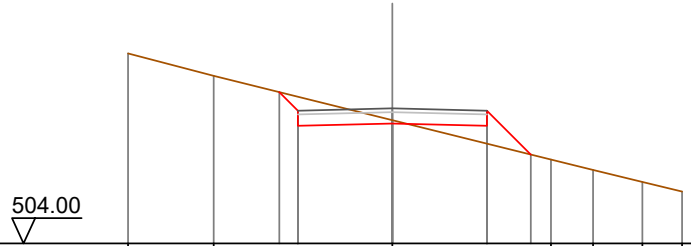

Quote Terreno	509.03	508.43		507.26		506.22	505.94	505.63	505.37
Quote Progetto			508.00	507.11	507.17	507.11	506.35		
Parziali			0.49	2.50	2.50	1.16			
Progressiva			-2.99	-2.50	0.00	2.50	3.66		
Dislivelli			0.00	-0.37	-0.09	0.47	-0.00		

Sezione: 60
 Progressiva: 426.756
 Q. Progetto: 507.769

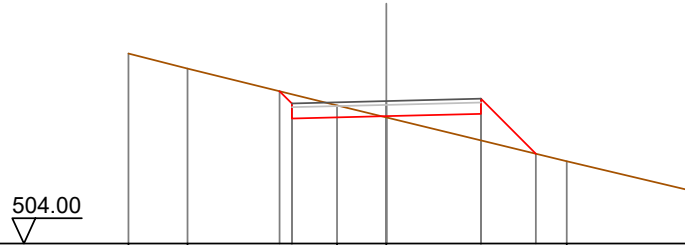

Quote Terreno	509.03	508.63		507.66	507.34		506.18	505.42
Quote Progetto			508.03	507.31	507.37	507.43	506.38	
Parziali			0.32	2.50	2.50	1.45		
Progressiva			-2.82	-2.50	0.00	2.50	3.95	
Dislivelli			-0.00	-0.24	0.03	0.70	-0.00	

Sezione: 61
 Progressiva: 430.000
 Q. Progetto: 507.868

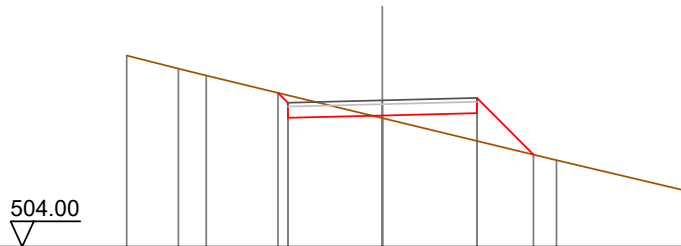

Quote Terreno	509.05	508.71	508.53		507.40		506.29	505.49
Quote Progetto			508.07	507.41	507.47	507.53	506.43	
Parziali			0.26	2.50	2.50	1.50		
Progressiva			-2.76	-2.50	0.00	2.50	4.00	
Dislivelli			0.00	-0.20	0.07	0.74	-0.00	

Sezione: 62
 Progressiva: 440.000
 Q. Progetto: 508.269

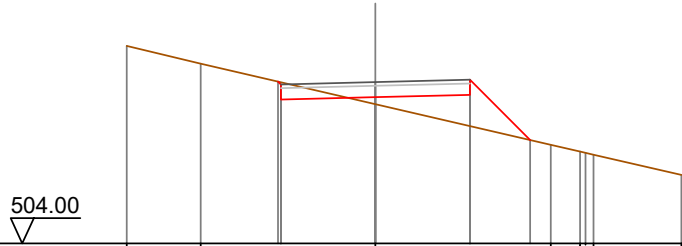

Quote Terreno	509.23	508.75	508.28	507.87	507.93	506.74	506.61	506.43	506.35	505.81
Quote Progetto			508.28	507.87	507.93	506.74				
Parziali			2.50	2.50	1.60					
Progressiva			-2.57	-2.50	0.00	2.50	4.10			
Dislivelli			0.00	-0.06	0.18	0.83	0.00			

Sezione: 62
 Progressiva: 440.000
 Q. Progetto: 508.269

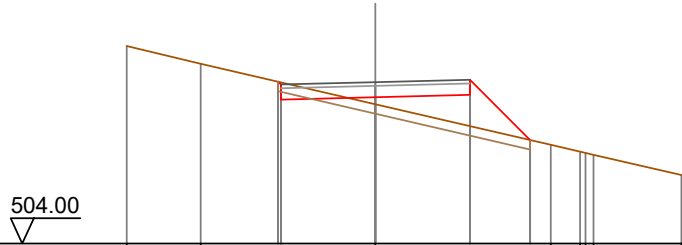

Quote Terreno	509.23	508.75	508.28	507.87	507.93	506.74	506.61	506.43	506.35	505.81
Quote Progetto			508.28	507.87	507.93	506.74				
Parziali			2.50	2.50	1.60					
Progressiva			-2.57	-2.50	0.00	2.50	4.10			
Dislivelli			-0.00	-0.06	0.18	0.83	0.00			

Sezione: 63
 Progressiva: 450.000
 Q. Progetto: 508.871

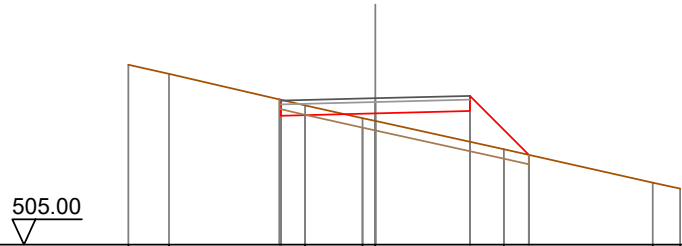

Quote Terreno	509.76	509.52	508.84	508.35	508.27	507.52	506.64	506.48
Quote Progetto			508.41	508.47	508.53	507.37		
Parziali			2.50	2.50	1.56			
Progressiva			-2.53	-2.50	0.00	2.50	4.06	
Dislivelli			0.00	-0.02	0.20	0.81	0.00	

Sezione: 64
 Progressiva: 453.294
 Q. Progetto: 509.114

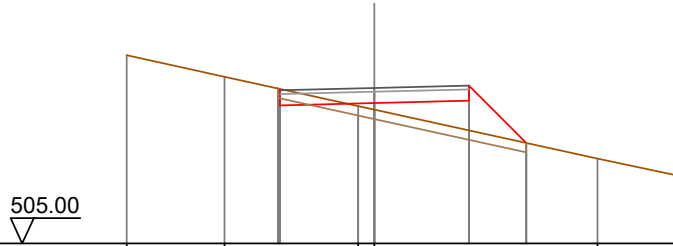

Quote Terreno	509.98	509.41	509.10	508.64	508.54	508.78	507.25	506.79
Quote Progetto			509.10	508.65	508.71	508.78	507.66	
Parziali			2.50	2.50	1.52			
Progressiva			-2.55	-2.50	0.00	2.50	4.02	
Dislivelli			0.00	-0.04	0.17	0.78	0.00	

Sezione: 65
 Progressiva: 460.000
 Q. Progetto: 509.675

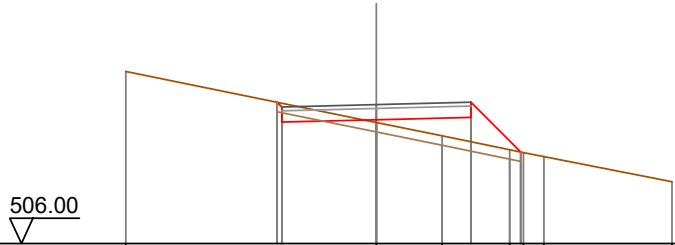

Quote Terreno	510.55		509.74	509.20	508.85	508.48	508.30	507.63
Quote Progetto			509.21	509.27	509.34	508.42		
Parziali			2.50	2.50	1.32			
Progressiva			-2.62	-2.50	0.00	2.50	3.82	
Dislivelli			0.00	-0.10	0.07	0.65	0.00	

Sezione: 66
 Progressiva: 470.000
 Q. Progetto: 510.627

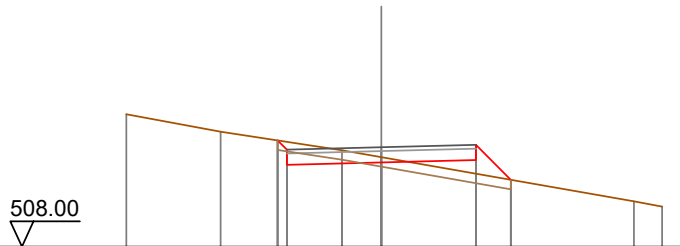

Quote Terreno	511.50	511.04	510.55	510.36		509.20	508.06
Quote Progetto			510.81	510.16	510.23	510.29	509.77
Parziali			2.50	2.50	0.92		
Progressiva			-2.74	-2.50	0.00	2.50	3.42
Dislivelli			-0.00	-0.20	-0.14	0.36	-0.00

Sezione: 67
 Progressiva: 479.831
 Q. Progetto: 511.572

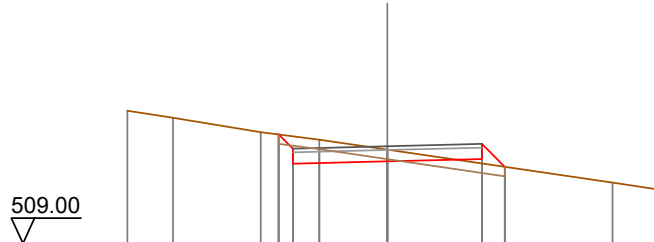

Quote Terreno	-512.51	-512.33	-511.95	-511.74	-511.48	-510.61	-510.43
Quote Progetto			511.88 511.11	511.17	511.23 511.03		
Parziali			0.37	2.50	2.50	0.61	
Progressiva			-2.87 -2.50	0.00	2.50 3.11		
Dislivelli			0.00 -0.33	-0.31	0.12 0.00		

Sezione: 68
 Progressiva: 500.000
 Q. Progetto: 513.302

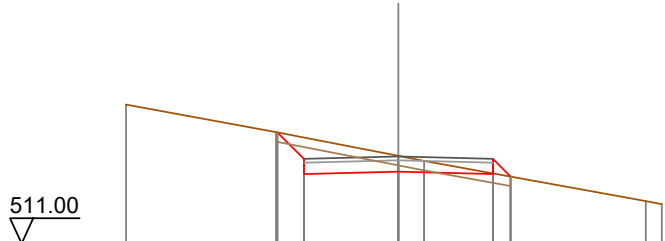

Quote Terreno	-514.67	-513.95	-513.32	-512.12	-512.04
Quote Progetto		513.94 512.84	512.90 513.19	512.84 512.77	
Parziali		0.70	2.50	2.50	0.47
Progressiva		-3.20 -2.50	0.00	2.50 2.97	
Dislivelli		-0.00 -0.56	-0.42	-0.02 -0.00	

Sezione: 69
 Progressiva: 520.000
 Q. Progetto: 514.614

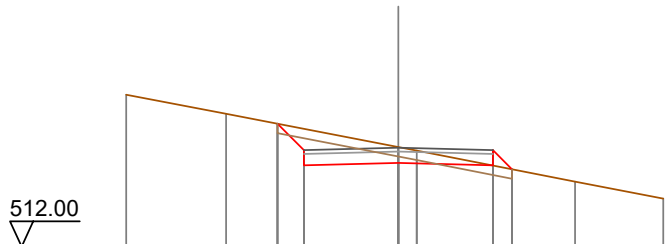

Quote Terreno	-516.02	-515.51	-514.63	-513.72	-513.27
Quote Progetto		515.25 514.15	514.21 514.54	514.15 514.04	
Parziali		0.70	2.50	2.50	0.51
Progressiva		-3.20 -2.50	0.00	2.50 3.01	
Dislivelli		0.00 -0.56	-0.42	0.01 0.00	

Sezione: 70
 Progressiva: 540.000
 Q. Progetto: 515.533

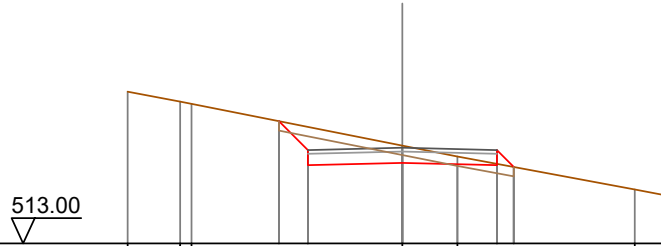

Quote Terreno	517.01	516.75	516.69		516.24	515.07	515.13	515.59	515.30		514.43	514.28
Quote Progetto					516.24	515.07	515.13	515.59	515.07	515.02		
Parziali					0.77	2.50		2.50	0.45			
Progressiva					-3.27	-2.50	0.00		2.50	2.95		
Dislivelli					0.00	-0.61	-0.46		-0.04	0.00		

Sezione: 71
 Progressiva: 560.000
 Q. Progetto: 516.006

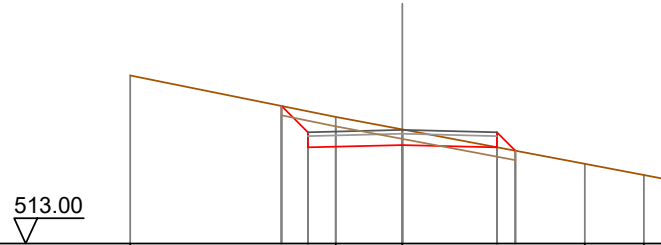

Quote Terreno	517.45				516.35	516.02				515.11	514.81	514.70
Quote Progetto					516.64	515.54	515.61		515.54	515.46		
Parziali					0.70	2.50		2.50	0.49			
Progressiva					-3.20	-2.50	0.00		2.50	2.99		
Dislivelli					0.00	-0.96	-0.41		-0.00	0.00		

Sezione: 72
 Progressiva: 574.636
 Q. Progetto: 515.954

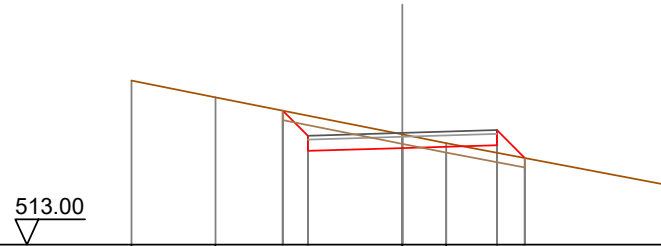

Quote Terreno	517.34	516.90				515.91	515.68				514.56	514.53
Quote Progetto					516.54	515.48	515.55		515.63	515.29		
Parziali					0.66	2.50		2.50	0.74			
Progressiva					-3.16	-2.50	0.00		2.50	3.24		
Dislivelli					0.00	-0.53	-0.36		0.20	0.00		

Sezione: 73
 Progressiva: 580.000
 Q. Progetto: 515.901

513.00

Quote Terreno	-517.28			515.88	515.74	515.37	515.18	514.59	514.48
Quote Progetto		516.50	515.43	515.50		515.58	515.25		
Parziali		0.67	2.50	2.50		0.73			
Progressiva		-3.17	-2.50	0.00		2.50	3.23		
Dislivelli		0.00	-0.54	-0.38		0.19	0.00		

Sezione: 74
 Progressiva: 581.154
 Q. Progetto: 515.893

513.00

Quote Terreno	-517.28			515.88		515.33	515.30		514.47
Quote Progetto		516.50	515.42	515.49		515.57	515.25		
Parziali		0.68	2.50	2.50		0.71			
Progressiva		-3.18	-2.50	0.00		2.50	3.21		
Dislivelli		0.00	-0.55	-0.39		0.17	-0.00		

Sezione: 75
 Progressiva: 587.672
 Q. Progetto: 515.897

513.00

Quote Terreno	-517.36			515.93	515.90			514.77	514.54
Quote Progetto		516.57	515.42	515.50		515.57	515.31		
Parziali		0.75	2.50	2.50		0.66			
Progressiva		-3.25	-2.50	0.00		2.50	3.16		
Dislivelli		0.00	-0.60	-0.44		0.13	0.00		

Sezione: 76
 Progressiva: 600.000
 Q. Progetto: 516.078

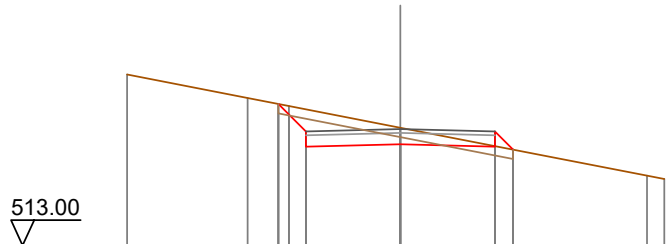

Quote Terreno	517.52	516.90	516.69	516.11	514.85	514.76	
Quote Progetto			516.74	515.62	515.62	515.54	
Parziali			0.73	2.50	2.50	0.48	
Progressiva			-3.23	-2.50	0.00	2.50	2.98
Dislivelli			0.00	-0.59	-0.44	-0.01	0.00

Sezione: 77
 Progressiva: 620.000
 Q. Progetto: 516.407

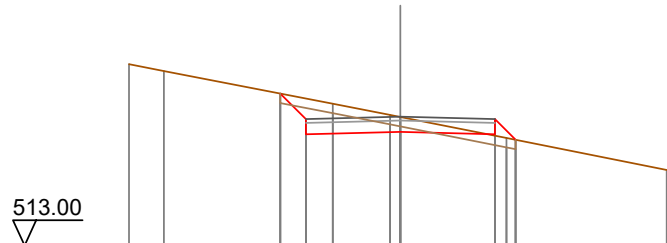

Quote Terreno	517.80	517.62	516.75	516.46	516.40	515.85	515.00
Quote Progetto			517.02	515.94	516.01	515.94	515.80
Parziali			0.67	2.50	2.50	0.55	
Progressiva			-3.17	-2.50	0.00	2.50	3.05
Dislivelli			0.00	-0.54	-0.39	0.04	0.00

Sezione: 78
 Progressiva: 639.585
 Q. Progetto: 516.677

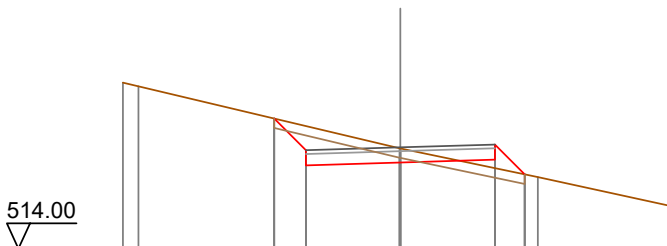

Quote Terreno	518.39	518.29	516.65	516.65	515.89	515.10	
Quote Progetto			517.44	516.20	516.35	515.96	
Parziali			0.84	2.50	2.50	0.79	
Progressiva			-3.34	-2.50	0.00	2.50	3.29
Dislivelli			-0.00	-0.64	-0.37	0.23	0.00

Sezione: 79
 Progressiva: 640.000
 Q. Progetto: 516.681

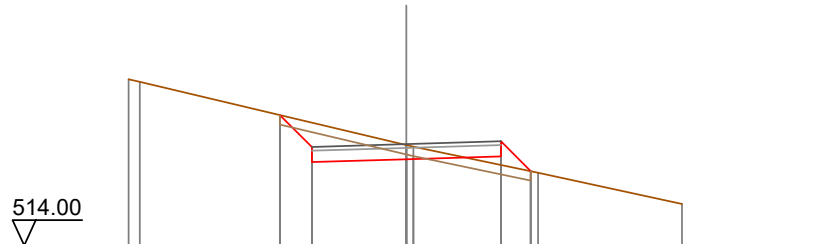

Quote Terreno	-518.40	-518.33			516.66	516.61			515.92	-515.10
Quote Progetto			517.45	516.21	516.28	516.36	515.97			
Parziali			0.84	2.50	2.50	0.79				
Progressiva			-3.34	-2.50	0.00	2.50	3.29			
Dislivelli			0.00	-0.64	-0.38	0.23	-0.00			

Sezione: 80
 Progressiva: 641.925
 Q. Progetto: 516.698

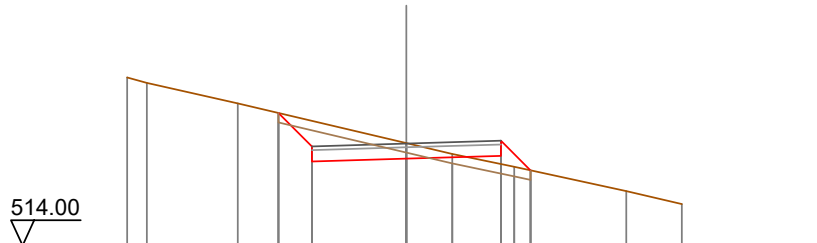

Quote Terreno	-518.44	-518.30		-517.76		516.71	516.42	516.08		515.44	-515.10
Quote Progetto				517.51	516.22	516.30	516.37	515.99			
Parziali				0.88	2.50	2.50	0.79				
Progressiva				-3.38	-2.50	0.00	2.50	3.29			
Dislivelli				-0.00	-0.68	-0.41	0.22	-0.00			

Sezione: 81
 Progressiva: 644.265
 Q. Progetto: 516.719

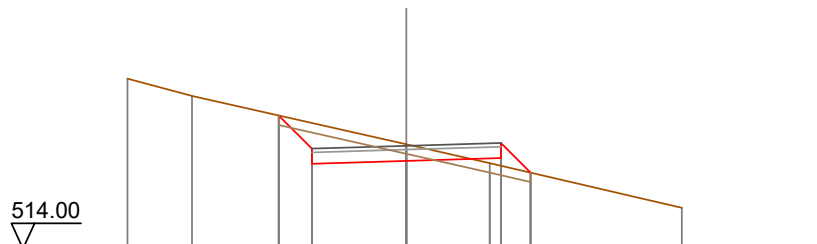

Quote Terreno	-518.49	-518.04			516.76	516.26				-515.08
Quote Progetto				517.52	516.24	516.32	516.39	516.01		
Parziali				0.88	2.50	2.50	0.78			
Progressiva				-3.38	-2.50	0.00	2.50	3.28		
Dislivelli				0.00	-0.68	-0.44	0.20	0.00		

Sezione: 82
 Progressiva: 660.000
 Q. Progetto: 516.634

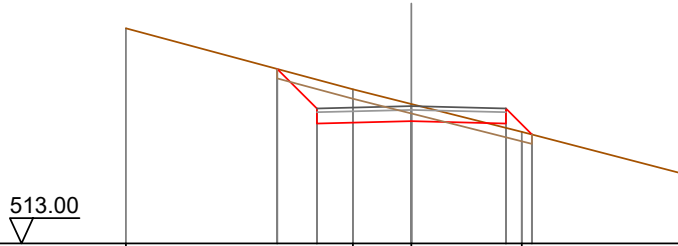

Quote Terreno	-518.69			-517.08	-516.69		-515.95		-514.84
Quote Progetto			517.62	516.17	516.23		516.17	515.88	
Parziali			1.05	2.50	2.50		0.69		
Progressiva			-3.55	-2.50	0.00		2.50	3.19	
Dislivelli			-0.00	-0.77	-0.46		0.11	0.00	

Sezione: 83
 Progressiva: 680.000
 Q. Progetto: 516.139

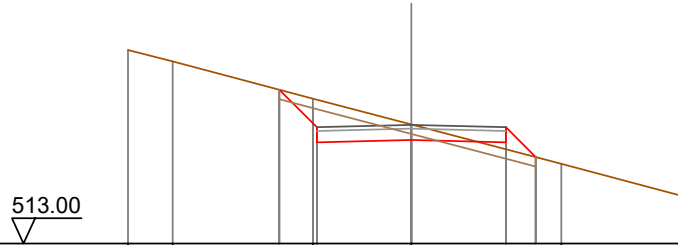

Quote Terreno	-518.12	-517.82		-516.83	-516.15		-515.11		-514.22
Quote Progetto				517.07	515.68	515.74	515.68	515.29	
Parziali				0.99	2.50	2.50	0.79		
Progressiva				-3.49	-2.50	0.00	2.50	3.29	
Dislivelli				0.00	-0.73	-0.41	0.18	0.00	

Sezione: 84
 Progressiva: 700.000
 Q. Progetto: 516.033

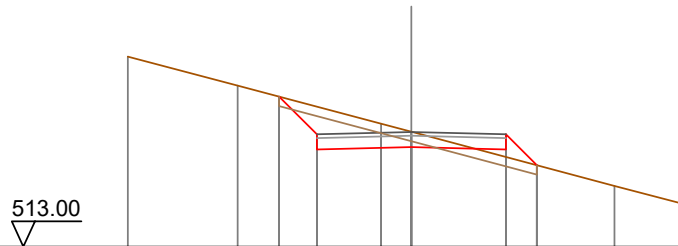

Quote Terreno	-518.03		-517.26		-516.25	-516.04		-514.60	-514.10
Quote Progetto			516.97	515.57	515.63		515.57	515.15	
Parziali			1.00	2.50	2.50		0.82		
Progressiva			-3.50	-2.50	0.00		2.50	3.32	
Dislivelli			0.00	-0.73	-0.41		0.20	0.00	

Sezione: 85
 Progressiva: 720.000
 Q. Progetto: 516.534

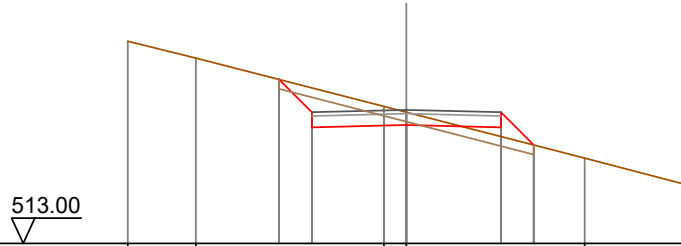

Quote Terreno	518.35	517.91			516.62	516.47		515.26	514.56
Quote Progetto			517.34	516.07	516.13	516.07	515.60		
Parziali			0.87	2.50	2.50	0.87			
Progressiva			-3.37	-2.50	0.00	2.50	3.37		
Dislivelli			0.00	-0.64	-0.34	0.24	-0.00		

Sezione: 86
 Progressiva: 729.673
 Q. Progetto: 516.838

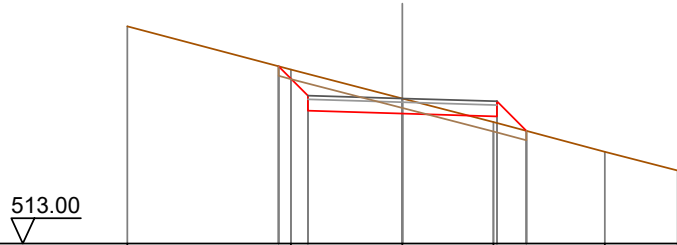

Quote Terreno	518.74	517.60			516.84	516.21		515.43	514.93
Quote Progetto			517.69	516.51	516.44	516.36	515.98		
Parziali			0.77	2.50	2.50	0.78			
Progressiva			-3.27	-2.50	0.00	2.50	3.28		
Dislivelli			-0.00	-0.57	-0.40	0.17	-0.00		

Sezione: 87
 Progressiva: 730.000
 Q. Progetto: 516.847

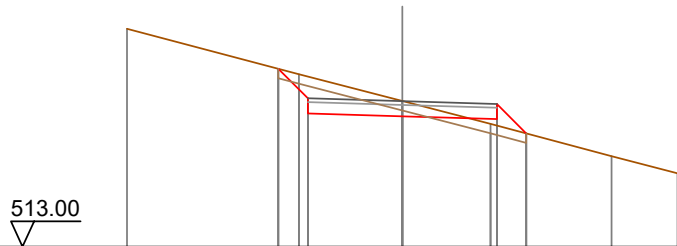

Quote Terreno	518.76	517.56			516.85	516.25		515.39	514.84
Quote Progetto			517.70	516.52	516.45	516.37	515.99		
Parziali			0.78	2.50	2.50	0.78			
Progressiva			-3.28	-2.50	0.00	2.50	3.28		
Dislivelli			0.00	-0.58	-0.40	0.17	-0.00		

Sezione: 88
 Progressiva: 736.475
 Q. Progetto: 516.990

514.00

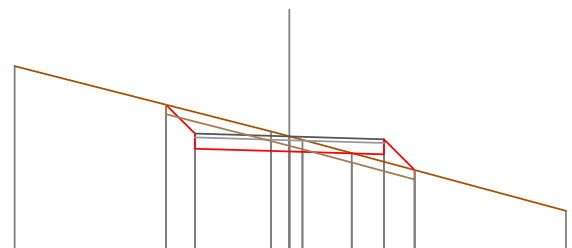

Quote Terreno	-518.85			-517.12	-516.99	-516.90	-516.55		-515.02
Quote Progetto			517.83	516.67	516.58		516.52	516.10	
Parziali			0.76	2.50	2.50		0.81		
Progressiva			-3.26	-2.50	0.00		2.50	3.31	
Dislivelli			0.00	-0.57	-0.40		0.19	0.00	

Sezione: 89
 Progressiva: 740.000
 Q. Progetto: 517.033

513.00

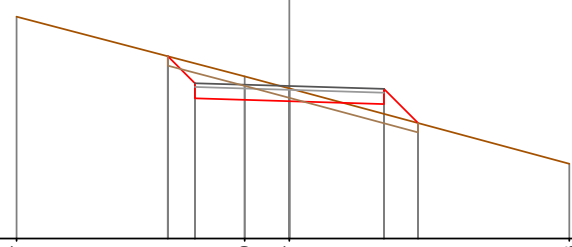

Quote Terreno	-518.87			-517.29	-516.97				-514.98
Quote Progetto			517.82	516.71	516.63		516.56	516.06	
Parziali			0.71	2.50	2.50		0.90		
Progressiva			-3.21	-2.50	0.00		2.50	3.40	
Dislivelli			-0.00	-0.53	-0.34		0.26	0.00	

Sezione: 90
 Progressiva: 743.278
 Q. Progetto: 517.061

513.00

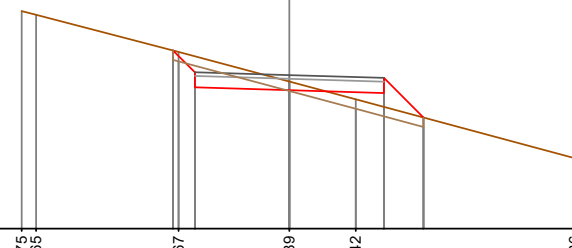

Quote Terreno	-518.75	-518.65	-517.67	-516.89	-516.42				-514.86
Quote Progetto			517.71	516.74	516.66	516.59	515.94		
Parziali			0.58	2.50	2.50	1.05			
Progressiva			-3.08	-2.50	0.00	2.50	3.55		
Dislivelli			0.00	-0.42	-0.23	0.37	-0.00		

Sezione: 91
 Progressiva: 760.000
 Q. Progetto: 517.527

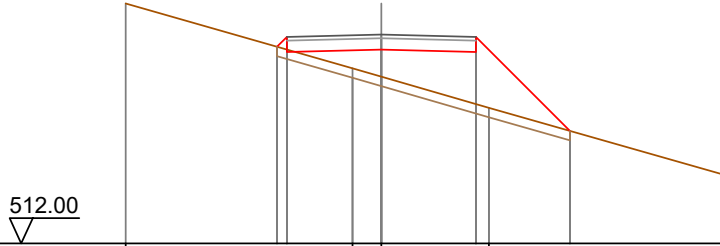

Quote Terreno	-518.95		-516.63	-516.41	-515.59		-513.84
Quote Progetto		-517.20	-517.06	-517.13	-517.06	-514.98	
Parziali		0.26	2.50	2.50	2.49		
Progressiva		-2.76	-2.50	0.00	2.50	4.99	
Dislivelli		-0.00	0.34	0.72	1.38	-0.00	

Sezione: 92
 Progressiva: 780.000
 Q. Progetto: 518.158

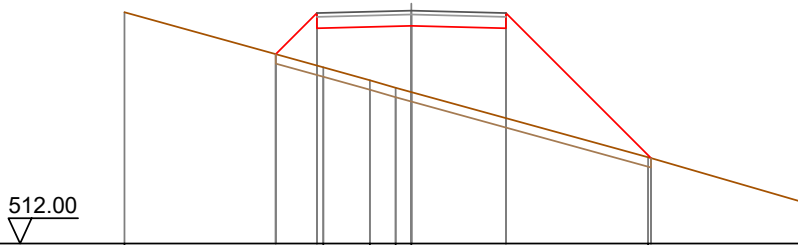

Quote Terreno	-518.12		-516.66	-516.32	-516.12	-516.00	-514.28	-513.10
Quote Progetto		-517.01	-517.70	-517.76	-517.70	-514.26	-514.28	
Parziali		1.09	2.50	2.50	3.83			
Progressiva		-3.59	-2.50	0.00	2.50	6.33		
Dislivelli		0.00	1.39	1.75	2.38	0.00		

Sezione: 93
 Progressiva: 792.445
 Q. Progetto: 518.200

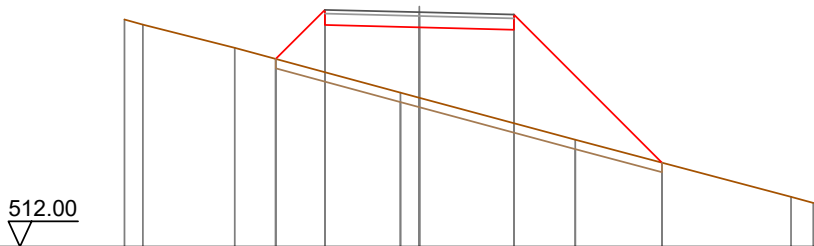

Quote Terreno	-518.01	-517.87	-517.26	-516.07	-515.94	-514.83	-513.32	-513.15
Quote Progetto		-516.96	-517.86	-517.80	-517.74	-514.22	-514.22	
Parziali		1.30	2.50	2.50	3.92			
Progressiva		-3.80	-2.50	0.00	2.50	6.42		
Dislivelli		0.00	1.65	1.86	2.47	0.00		

Sezione: 94
 Progressiva: 795.500
 Q. Progetto: 518.200

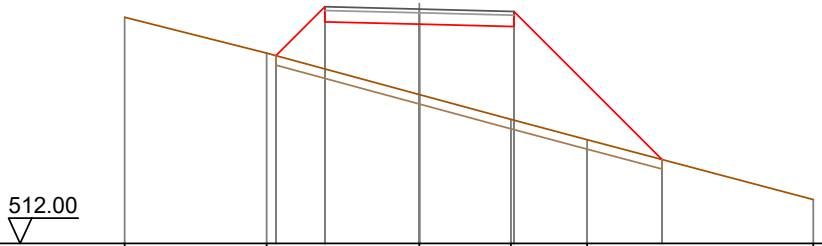

Quote Terreno	517.98	517.03		515.94	515.28	514.75	513.16
Quote Progetto		516.97	517.86	517.80	517.74	514.22	
Parziali		1.29	2.50	2.50	3.92		
Progressiva		-3.79	-2.50	0.00	2.50	6.42	
Dislivelli		0.00	1.64	1.86	2.47	0.00	

SEZIONI TRASVERSALI

Profilo longitudinale tratto 33-34

Viabilità - raccordo sud

Nota: Le canalette di deflusso delle acque meteoriche, non indicate nel presente elaborato, sono rappresentate graficamente nelle sezioni stradali tipo dell'elaborato "WIND002-TC13_Piazzole aerogeneratori e strade di servizio - Particolari costruttivi", individuate planimetricamente nell'elaborato "WIND002-TC14_Opere di regimazione acque superficiali - Planimetria generale" e quantificate nell'elaborato "WIND002-RC6_Computo Metrico Estimativo".

DISEGNI DI RIFERIMENTO

TAVOLA	DESCRIZIONE
WIND002-TC8	Piazzole e viabilità - Planimetria di progetto - Fase di cantiere
WIND002-TC11	Profili longitudinali viabilità di impianto
WIND002-TC13	Piazzole aerogeneratori e strade di servizio - Particolari costruttivi
WIND002-TC14	Opere di regimazione acque superficiali - Planimetria generale

Sezione: 3
 Progressiva: 10.000
 Q. Progetto: 442.866

440.00

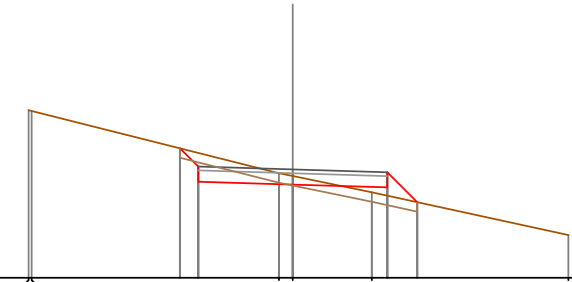

Quote Terreno	444.43	444.41		442.77	442.69	442.26	441.13
Quote Progetto			443.43	442.54	442.47	442.39	442.00
Parziali			0.99	2.50	2.50	0.79	
Progressiva			-2.99	-2.50	0.00	2.50	3.29
Dislivelli			0.00	-0.36	-0.23	0.22	0.00

Sezione: 4
 Progressiva: 11.044
 Q. Progetto: 442.786

439.00

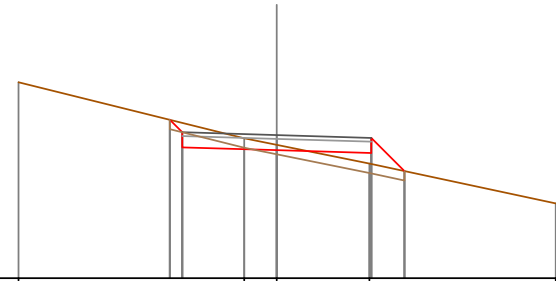

Quote Terreno	444.18		442.70	442.53	442.03	440.98
Quote Progetto		443.19	442.46	442.39	442.31	441.83
Parziali		0.33	2.50	2.50	0.88	
Progressiva		-2.83	-2.50	0.00	2.50	3.38
Dislivelli		-0.00	-0.25	-0.14	0.29	0.00

Sezione: 5
 Progressiva: 20.000
 Q. Progetto: 442.191

438.00

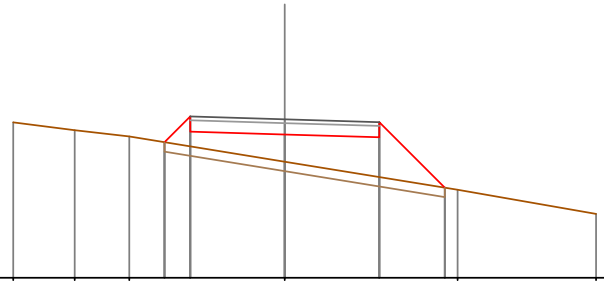

Quote Terreno	442.11	441.91	441.74		441.07		440.33	439.69
Quote Progetto			441.59	441.87	441.79	441.72	440.39	
Parziali			0.68	2.50	2.50	1.73		
Progressiva			-3.18	-2.50	0.00	2.50	4.23	
Dislivelli			0.00	0.79	0.72	1.05	0.00	

Sezione: 6
 Progressiva: 20.525
 Q. Progetto: 442.162

438.00

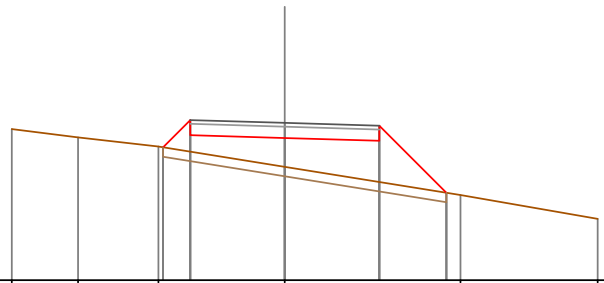

Quote Terreno	442.00	441.78	441.54		441.00		440.25	439.62
Quote Progetto			441.52	441.84	441.76	441.69	440.31	
Parziali			0.72	2.50	2.50	1.77		
Progressiva			-3.22	-2.50	0.00	2.50	4.27	
Dislivelli			0.00	0.84	0.76	1.09	0.00	

Sezione: 7
 Progressiva: 40.000
 Q. Progetto: 441.068

436.00

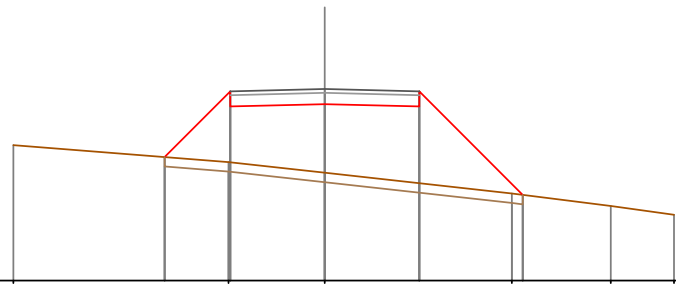

Quote Terreno	439.58		439.14	438.85		438.31	437.98	437.74
Quote Progetto		439.27	440.61	440.67	440.61	438.27		
Parziali			1.74	2.50	2.50	2.74		
Progressiva		-4.24	-2.50	0.00	2.50	5.24		
Dislivelli		0.00	1.87	1.81	2.03	-0.00		

Sezione: 8
 Progressiva: 60.000
 Q. Progetto: 439.703

435.00

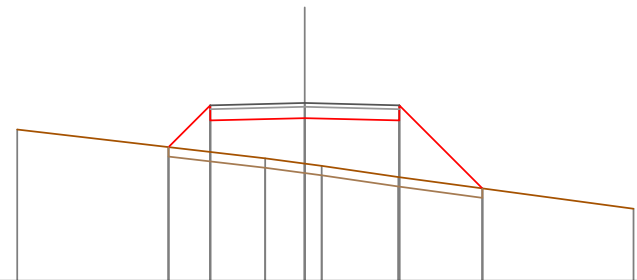

Quote Terreno		439.00		438.24	438.10	438.04	437.74		436.91
Quote Progetto			438.54	439.24	439.30	439.24	437.44		
Parziali			1.10	2.50	2.50	2.20			
Progressiva			-3.60	-2.50	0.00	2.50	4.70		
Dislivelli			0.00	1.23	1.20	1.50	-0.00		

Sezione: 9
 Progressiva: 80.000
 Q. Progetto: 438.216

435.00

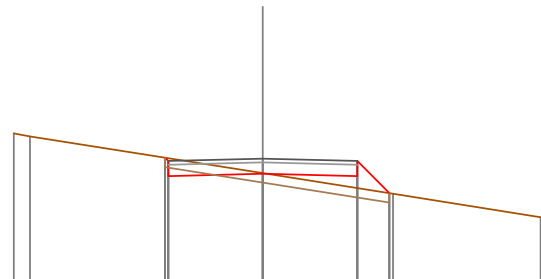

Quote Terreno		438.88	438.80		437.83		437.29		436.66
Quote Progetto			438.24	437.75	437.82	437.75	437.30		
Parziali			2.50	2.50	0.85				
Progressiva			-2.59	-2.50	0.00	2.50	3.35		
Dislivelli			0.00	-0.07	-0.02	0.32	0.00		

Sezione: 10
 Progressiva: 95.659
 Q. Progetto: 437.575

435.00

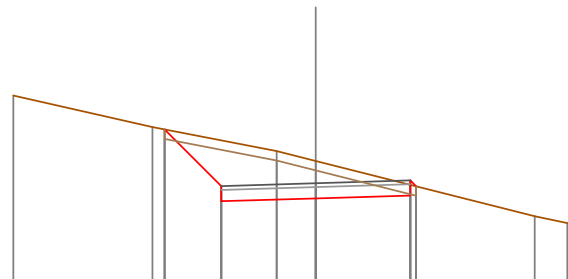

Quote Terreno		439.89	439.06	438.43	438.17		436.70	436.52
Quote Progetto			439.00	437.10	437.17	437.25	437.50	
Parziali			1.50	2.50	2.50			
Progressiva			-4.00	-2.50	0.00	2.50	2.65	
Dislivelli			0.00	-1.21	-0.99	-0.28	0.00	

Sezione: 11
 Progressiva: 96.000
 Q. Progetto: 437.565

435.00

Quote Terreno	439.91	439.06	438.49	438.16	437.24	437.50	436.69	436.52
Quote Progetto		439.02	437.09	437.16	437.24	437.50		
Parziali		1.53	2.50	2.50				
Progressiva		-4.03	-2.50	0.00	2.50	2.64		
Dislivelli		0.00	-1.23	-1.00	-0.29	0.00		

Sezione: 11
 Progressiva: 96.000
 Q. Progetto: 437.565

435.00

Quote Terreno	439.91	439.06	438.49	438.16	437.24	437.50	436.69	436.52
Quote Progetto		439.02	437.09	437.16	437.24	437.50		
Parziali		1.53	2.50	2.50				
Progressiva		-4.03	-2.50	0.00	2.50	2.64		
Dislivelli		-0.00	-1.23	-1.00	-0.29	-0.00		

Sezione: 12
 Progressiva: 96.560
 Q. Progetto: 437.548

435.00

Quote Terreno	439.94	439.87	439.07	438.59	438.16	437.22	437.50	436.66	436.52
Quote Progetto			439.05	437.07	437.15	437.22	437.50		
Parziali			1.57	2.50	2.50				
Progressiva			-4.07	-2.50	0.00	2.50	2.62		
Dislivelli			-0.00	-1.27	-1.02	-0.31	0.00		

Sezione: 13
 Progressiva: 97.461
 Q. Progetto: 437.522

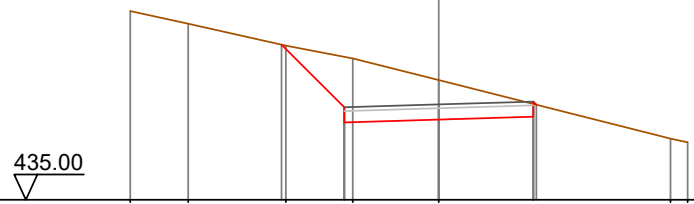

Quote Terreno	439.99	439.66	439.08	438.74	438.17	436.62	436.52
Quote Progetto			439.10	437.05	437.12	437.20	437.51
Parziali			1.66	2.50	2.50		
Progressiva			-4.16	-2.50	0.00	2.50	2.58
Dislivelli			0.00	-1.34	-1.04	-0.34	-0.00

Sezione: 14
 Progressiva: 100.000
 Q. Progetto: 437.448

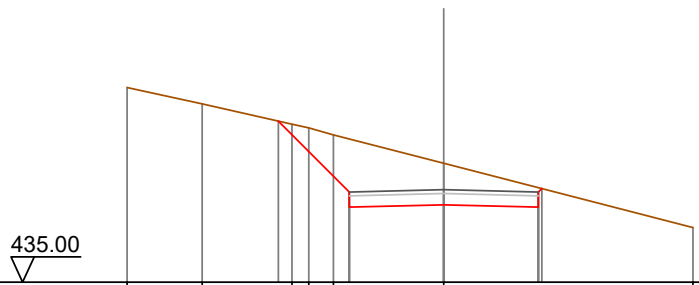

Quote Terreno	440.15	438.72	439.18	439.08	438.90	438.15	436.45
Quote Progetto			439.26	436.99	437.05	436.99	437.48
Parziali			1.87	2.50	2.50		
Progressiva			-4.37	-2.50	0.00	2.50	2.59
Dislivelli			0.00	-1.40	-1.10	-0.52	-0.00

Sezione: 15
 Progressiva: 120.000
 Q. Progetto: 436.630

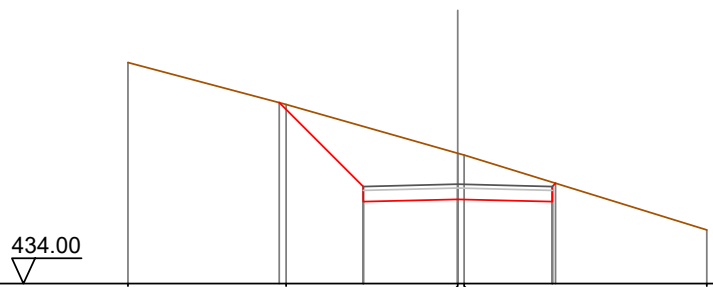

Quote Terreno	439.85	438.74	437.45	437.40	435.42	
Quote Progetto		438.79	436.17	436.23	436.17	436.65
Parziali		2.22	2.50	2.50		
Progressiva		-4.72	-2.50	0.00	2.50	2.59
Dislivelli		0.00	-1.59	-1.22	-0.51	0.00

Sezione: 16
 Progressiva: 140.000
 Q. Progetto: 435.031

431.00

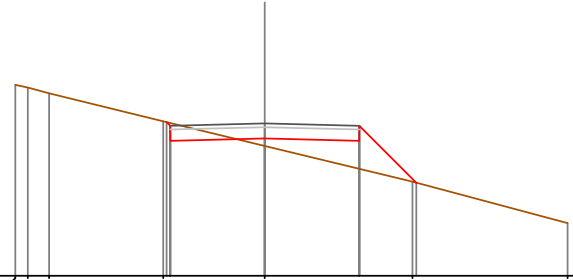

Quote Terreno	436.05	435.98	435.83	435.09	434.44	433.49	432.39
Quote Progetto			435.06	434.57	434.63	434.57	433.46
Parziali			2.50	2.50	1.51		
Progressiva			-2.60	-2.50	0.00	2.50	4.01
Dislivelli			-0.00	-0.07	0.20	0.74	0.00

Sezione: 17
 Progressiva: 145.706
 Q. Progetto: 434.427

430.00

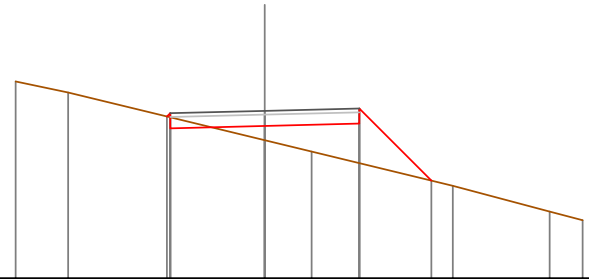

Quote Terreno	435.20	434.91	434.28	433.96	434.03	433.65	433.35	432.44	431.76	431.53
Quote Progetto			434.28	433.96	434.03	433.65	433.35	432.58		
Parziali			2.50	2.50	1.91					
Progressiva			-2.59	-2.50	0.00	2.50	4.41			
Dislivelli			0.00	0.11	0.38	1.05	-0.00			

Sezione: 18
 Progressiva: 150.088
 Q. Progetto: 433.917

430.00

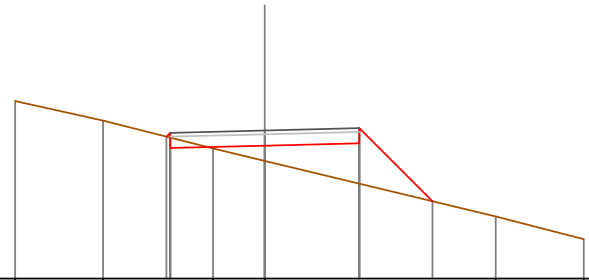

Quote Terreno	434.70	434.18	433.44	433.11	433.58	432.05	431.64	431.04
Quote Progetto			433.75	433.45	433.52	433.58	432.05	
Parziali			2.50	2.50	1.93			
Progressiva			-2.60	-2.50	0.00	2.50	4.43	
Dislivelli			-0.00	0.13	0.40	1.07	-0.00	

Sezione: 19
 Progressiva: 154.470
 Q. Progetto: 433.388

429.00

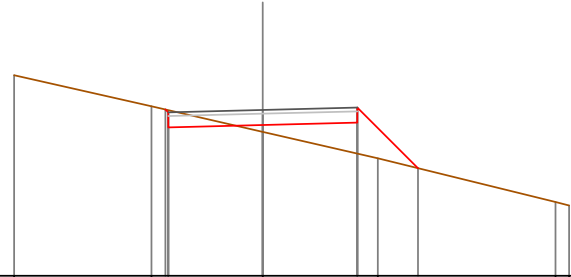

Quote Terreno	434.30	433.48	432.81	432.11	430.95	430.86
Quote Progetto		433.40 432.93	432.99	433.05	431.85	
Parziali			2.50	2.50	1.60	
Progressiva		-2.57 -2.50	0.00	2.50	4.10	
Dislivelli		-0.00 -0.06	0.18	0.82	0.00	

Sezione: 20
 Progressiva: 160.000
 Q. Progetto: 432.719

429.00

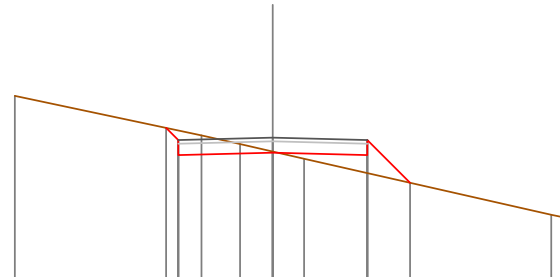

Quote Terreno	433.82	432.78	432.55	432.35	432.16	430.68	430.62
Quote Progetto		432.98 432.26	432.32	432.26	431.52		
Parziali		0.32	2.50	2.50	1.13		
Progressiva		-2.82 -2.50	0.00	2.50	3.63		
Dislivelli		0.00 -0.25	-0.03	0.48	0.00		

Sezione: 21
 Progressiva: 170.000
 Q. Progetto: 431.447

429.00

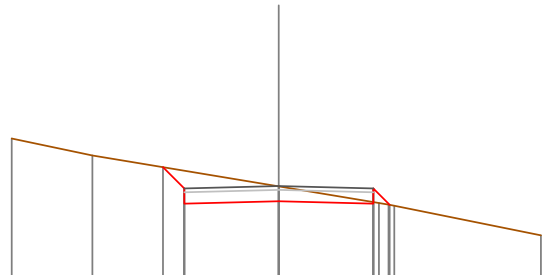

Quote Terreno	432.71	432.26	431.44	431.00	430.93	430.14
Quote Progetto			431.05	430.98 430.95	430.95	
Parziali			2.50	2.50	0.43	
Progressiva		-3.06 -2.50	0.00	2.50	2.93	
Dislivelli		0.00 -0.47	-0.39	-0.04	0.00	

Sezione: 21
 Progressiva: 170.000
 Q. Progetto: 431.447

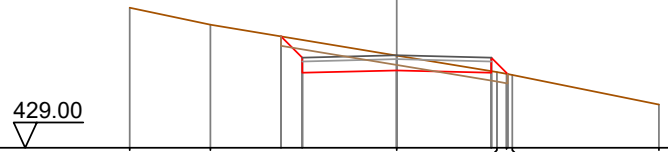

Quote Terreno	432.71	432.26		431.44	431.00	430.93	430.14
Quote Progetto			431.95	431.05	430.98	430.95	
Parziali			0.56	2.50	2.50	0.43	
Progressiva			-3.06	-2.50	0.00	2.50	2.93
Dislivelli			0.00	-0.47	-0.39	-0.04	0.00

Sezione: 22
 Progressiva: 180.000
 Q. Progetto: 429.974

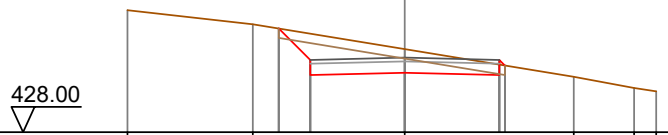

Quote Terreno	431.23	430.86		430.20		429.47	429.17	429.08
Quote Progetto			430.74	429.51	429.57	429.51	429.76	
Parziali			0.83	2.50	2.50			
Progressiva			-3.33	-2.50	0.00	2.50	2.65	
Dislivelli			-0.00	-0.70	-0.62	-0.28	0.00	

Sezione: 23
 Progressiva: 200.000
 Q. Progetto: 426.402

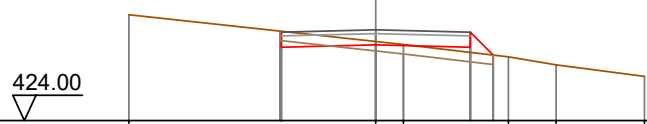

Quote Terreno	426.80		426.09	426.01	425.68	425.48	425.17
Quote Progetto		426.37	426.00	425.94	425.73		
Parziali			2.50	2.50	0.61		
Progressiva		-2.53	-2.50	0.00	2.50	3.11	
Dislivelli		0.00	-0.03	-0.09	0.14	0.00	

Sezione: 24
 Progressiva: 220.000
 Q. Progetto: 422.417

419.00

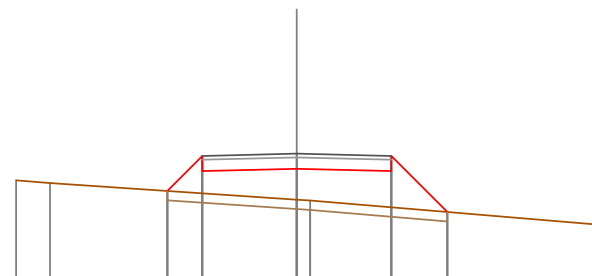

Quote Terreno		421.71	421.64		421.20	421.18		420.54
Quote Progetto				421.43	421.95	422.02	421.95	420.87
Parziali				0.92	2.50	2.50	1.48	
Progressiva				-3.42	-2.50	0.00	2.50	3.98
Dislivelli				-0.00	0.99	0.82	0.96	-0.00

Sezione: 25
 Progressiva: 240.000
 Q. Progetto: 419.201

415.00

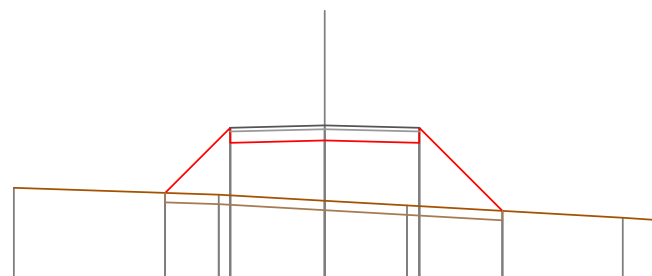

Quote Terreno		417.55		417.37	417.21	417.09		416.76	416.70
Quote Progetto			417.42	418.74	418.80	418.74	416.94		
Parziali			1.72	2.50	2.50	2.20			
Progressiva			-4.22	-2.50	0.00	2.50	4.70		
Dislivelli			0.00	1.79	1.59	1.67	-0.00		

Sezione: 26
 Progressiva: 260.000
 Q. Progetto: 416.810

412.00

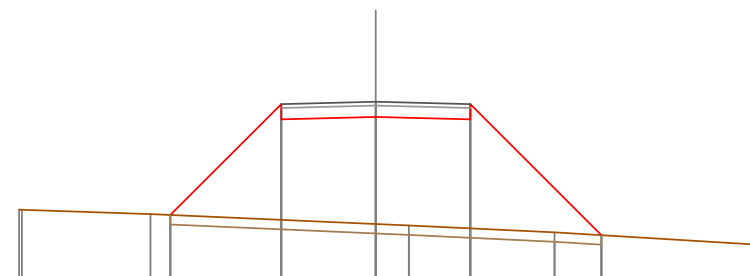

Quote Terreno		413.96	413.95	413.84		413.58	413.54	413.36	413.04
Quote Progetto				413.82	416.35	416.41	416.35	413.28	
Parziali				2.93	2.50	2.50	3.47		
Progressiva				-5.43	-2.50	0.00	2.50	5.97	
Dislivelli				0.00	3.06	2.83	2.89	-0.00	

Sezione: 27
 Progressiva: 280.000
 Q. Progetto: 415.230

408.00

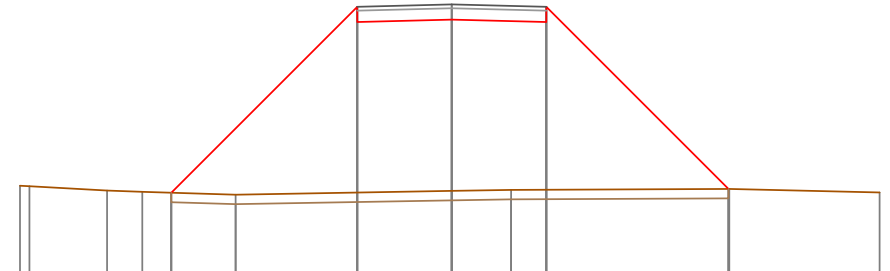

Quote Terreno	410.44	410.42	410.31	410.27	410.20	414.77	414.83	410.30	410.33	410.35	410.26
Quote Progetto				410.25		414.77	414.83	414.83	414.77	410.35	
Parziali					4.92	2.50	2.50		4.82		
Progressiva				-7.42		-2.50	0.00	2.50		7.32	
Dislivelli				0.00		4.91	4.53	4.44		-0.00	

Sezione: 28
 Progressiva: 300.000
 Q. Progetto: 414.455

408.00

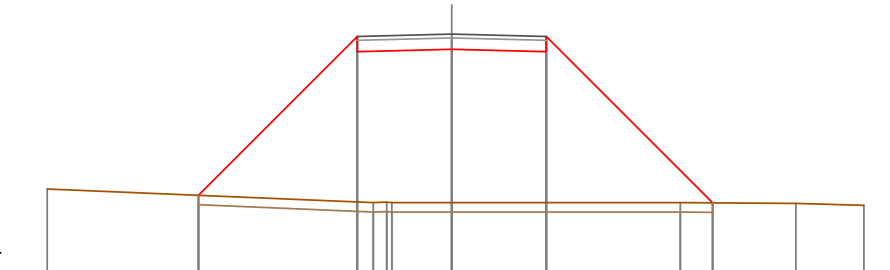

Quote Terreno	410.36			410.00	410.00	410.00		410.00		409.98	409.93
Quote Progetto		410.19		413.99		414.06		413.99		409.99	
Parziali			4.20	2.50	2.50		4.40				
Progressiva		-6.70		-2.50	0.00	2.50		6.90			
Dislivelli		-0.00		4.37	4.06	3.99		-0.00			

Sezione: 29
 Progressiva: 320.000
 Q. Progetto: 414.481

408.00

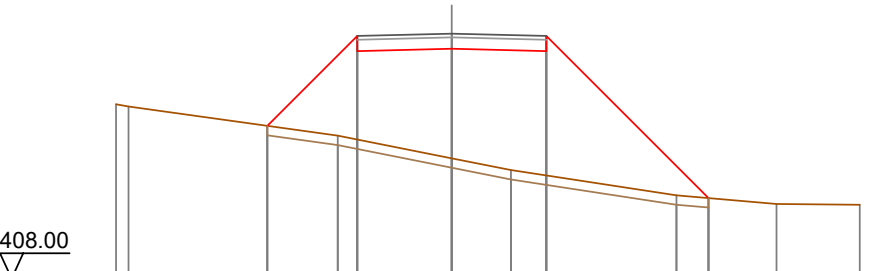

Quote Terreno	412.61	412.55		411.78	411.18	410.87		410.20	409.98	409.95
Quote Progetto			412.04	414.02	414.08	414.02		410.13		
Parziali				2.38	2.50	2.50		4.29		
Progressiva			-4.88	-2.50	0.00	2.50		6.79		
Dislivelli			0.00	2.74	2.90	3.29		-0.00		

Sezione: 30
 Progressiva: 325.860
 Q. Progetto: 414.640

409.00

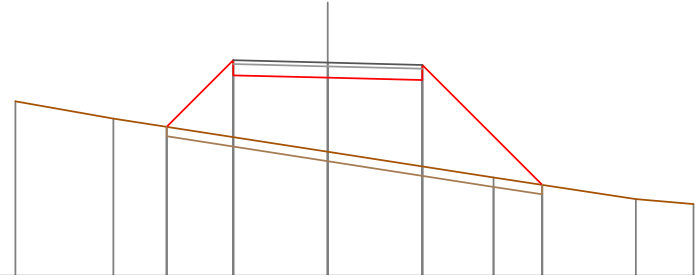

Quote Terreno	-413.62	-413.16								
Quote Progetto			412.94	414.30	414.24	414.18	411.41			
Parziali			1.76	2.50	2.50	3.17				
Progressiva		-4.26	-2.50	0.00	2.50	5.67				
Dislivelli		0.00	2.03	1.96	2.28	-0.00				

Sezione: 31
 Progressiva: 330.000
 Q. Progetto: 414.794

410.00

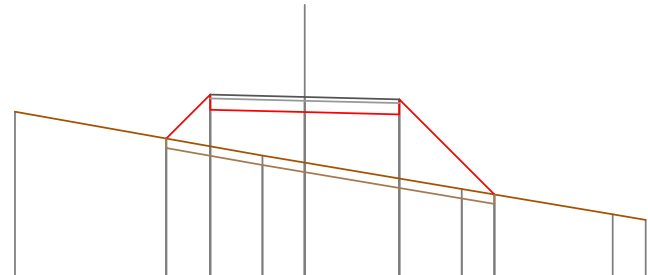

Quote Terreno	-414.40			-413.24	-413.06		-412.36	-411.69	-411.54
Quote Progetto		413.69	414.46	414.39	414.33	412.22			
Parziali		1.16	2.50	2.50	2.52				
Progressiva		-3.66	-2.50	0.00	2.50	5.02			
Dislivelli		-0.00	1.37	1.34	1.69	0.00			

Sezione: 32
 Progressiva: 340.000
 Q. Progetto: 415.249

412.00

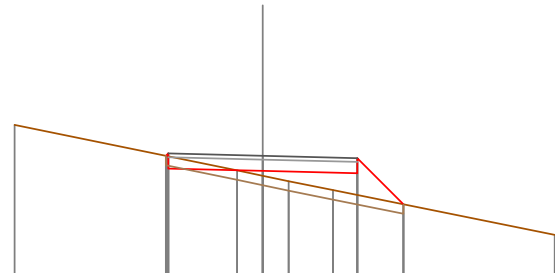

Quote Terreno	-416.06			-414.86	-414.72	-414.58	-414.34		-413.16
Quote Progetto		415.25	414.91	414.85	414.79	413.96			
Parziali		2.50	2.50	1.22					
Progressiva		-2.56	-2.50	0.00	2.50	3.72			
Dislivelli		-0.00	0.08	0.13	0.58	-0.00			

Sezione: 33
 Progressiva: 350.000
 Q. Progetto: 415.566

413.00

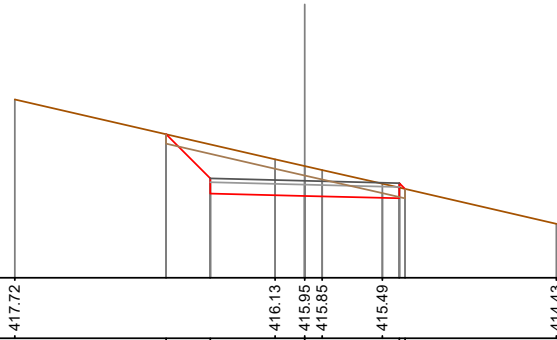

Quote Terreno	417.72	416.80	415.23	416.13	415.95	415.85	415.49	414.43
Quote Progetto		416.80	415.23	415.17	415.10	415.35		
Parziali		1.17	2.50	2.50				
Progressiva		-3.67	-2.50	0.00	2.50	2.65		
Dislivelli		-0.00	-0.90	-0.79	-0.28	0.00		