

PIANTA

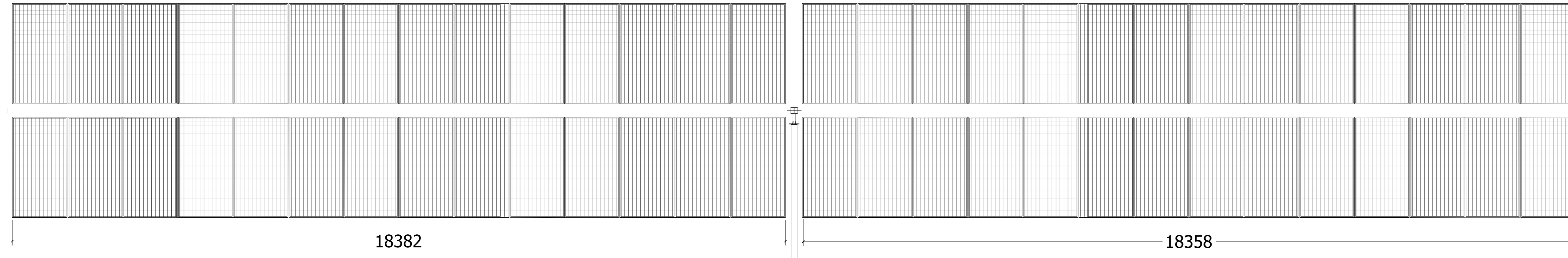

PROSPETTO LONGITUDINALE A RIPOSO + 0°

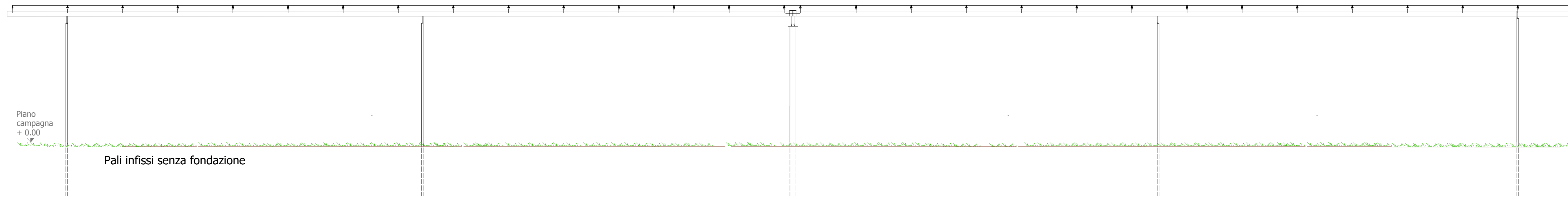

PROSPETTO LONGITUDINALE A INCLINAZIONE MASSIMA + 55°

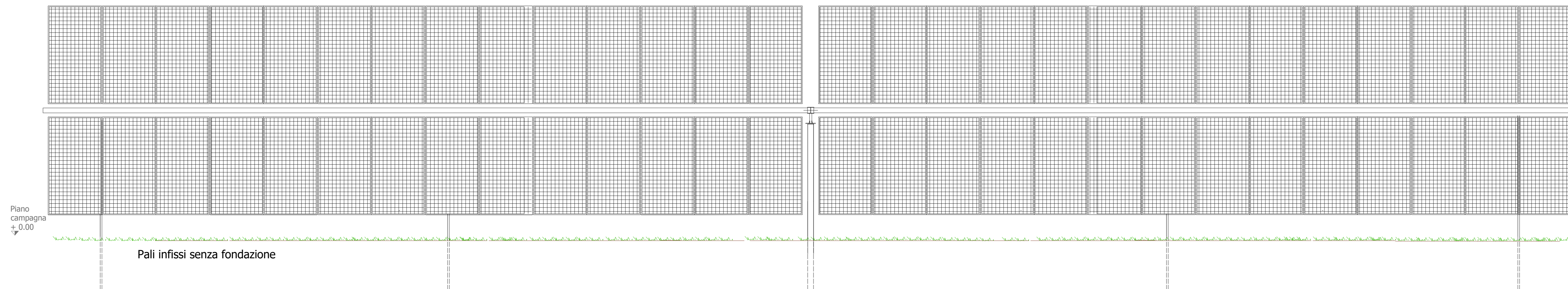

VISTA TRASVERSALE IN CAMPO E POSIZIONI TRACKER

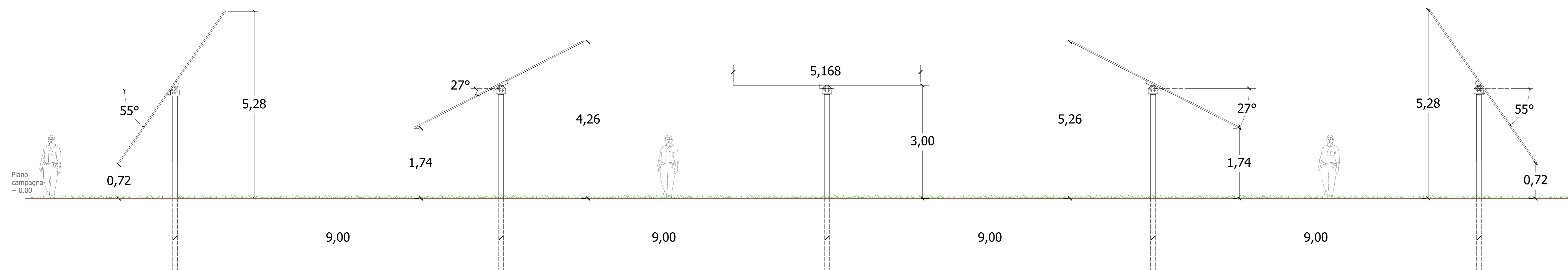

MODULO

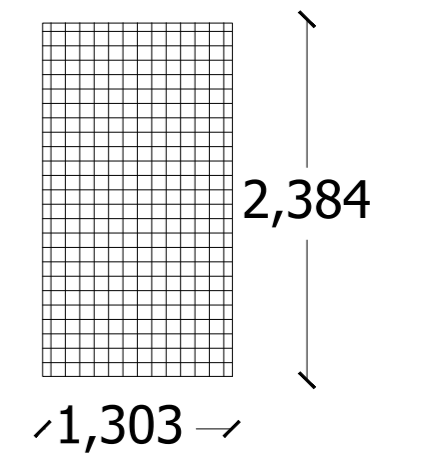

POSIZIONE + 0°

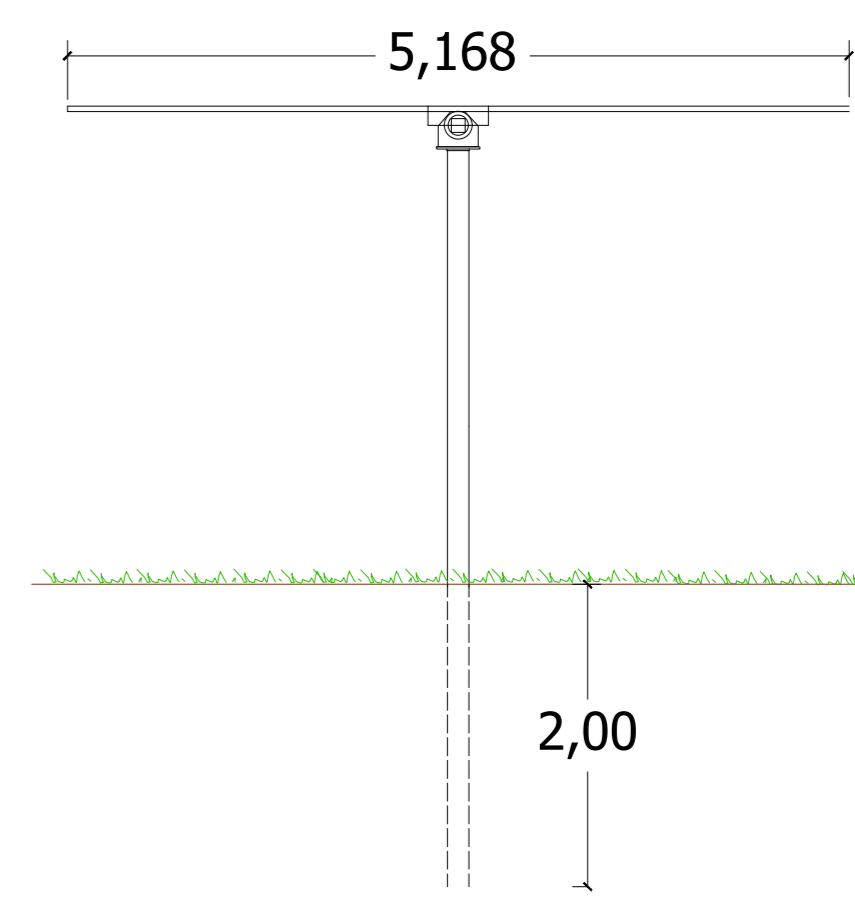

POSIZIONE + 55° (inclinazione massima)

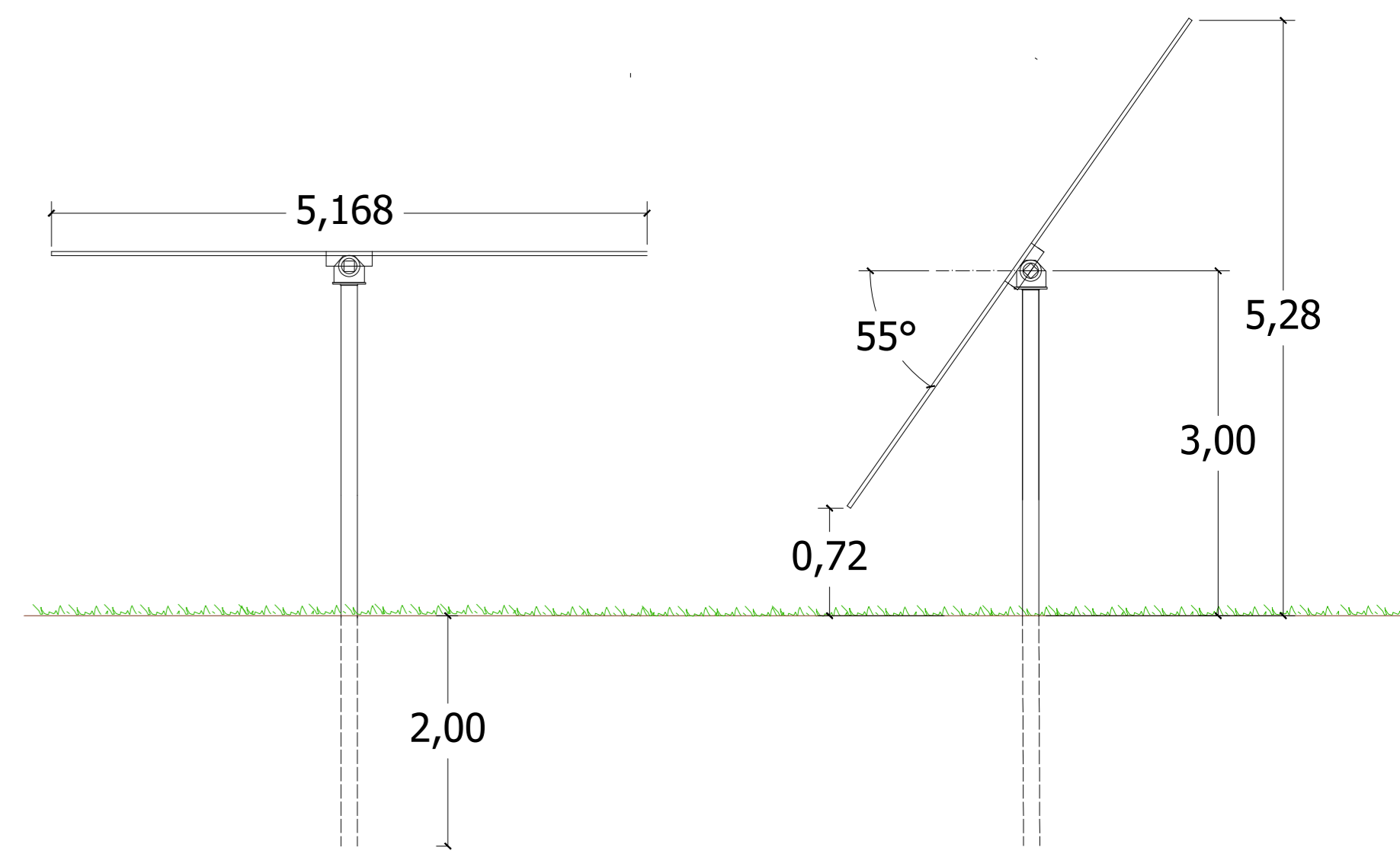

REGIONE PIEMONTE

Provincia di Vercelli
Comune di Formigiana

PARCO FOTOVOLTAICO DELLA BENNA
Valutazione di Impatto Ambientale
ai sensi
del d.lgs 152/2006, art.23, Titolo III, parte seconda

COORDINAMENTO GENERALE



PROGETTISTA

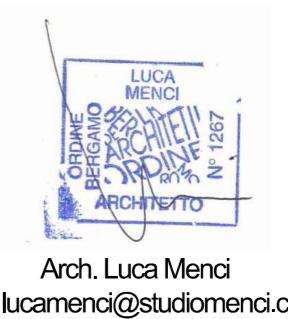

PROPONENTE



OGGETTO

6. Dettagli e particolari

TITOLO

6.1 Particolari costruttivi tracker

CODICE ELABORATO

FOR_6.1_DP_0

DATA

Luglio 2023

SCALA

1:50

FORMATO

A0

REDATTO DA

Kariman Diab

APPROVATO DA

Luca Menci

TIMBRI E FIRME

