

PLANIMETRIA DI TRACCIAMENTO
SCALA 1:2000



TABELLE TRACCIAMENTO NV46, NV46-A

NV46				NV46-A			
Az: 333	V1: 552360.7	V2: 552272.3	V3: 552196.7	V4: 551919.1	V5: 551822.3	V6: 551719.9	V7: 551608.2
L: 333	V1: 4466914.8	V2: 4466914.8	V3: 4466914.8	V4: 4466914.8	V5: 4466914.8	V6: 4466914.8	V7: 4466914.8
N: 333	A: 333.0	A: 333.0	A: 333.0	A: 333.0	A: 333.0	A: 333.0	A: 333.0
Sv: 333.0	Sv: 333.0	Sv: 333.0	Sv: 333.0	Sv: 333.0	Sv: 333.0	Sv: 333.0	Sv: 333.0
Ts: 333.0	Ts: 333.0	Ts: 333.0	Ts: 333.0	Ts: 333.0	Ts: 333.0	Ts: 333.0	Ts: 333.0
D: 333.0	D: 333.0	D: 333.0	D: 333.0	D: 333.0	D: 333.0	D: 333.0	D: 333.0
Tl: 333.0	Tl: 333.0	Tl: 333.0	Tl: 333.0	Tl: 333.0	Tl: 333.0	Tl: 333.0	Tl: 333.0
Tc: 333.0	Tc: 333.0	Tc: 333.0	Tc: 333.0	Tc: 333.0	Tc: 333.0	Tc: 333.0	Tc: 333.0

PLANIMETRIA DI PROGETTO
SCALA 1:2000

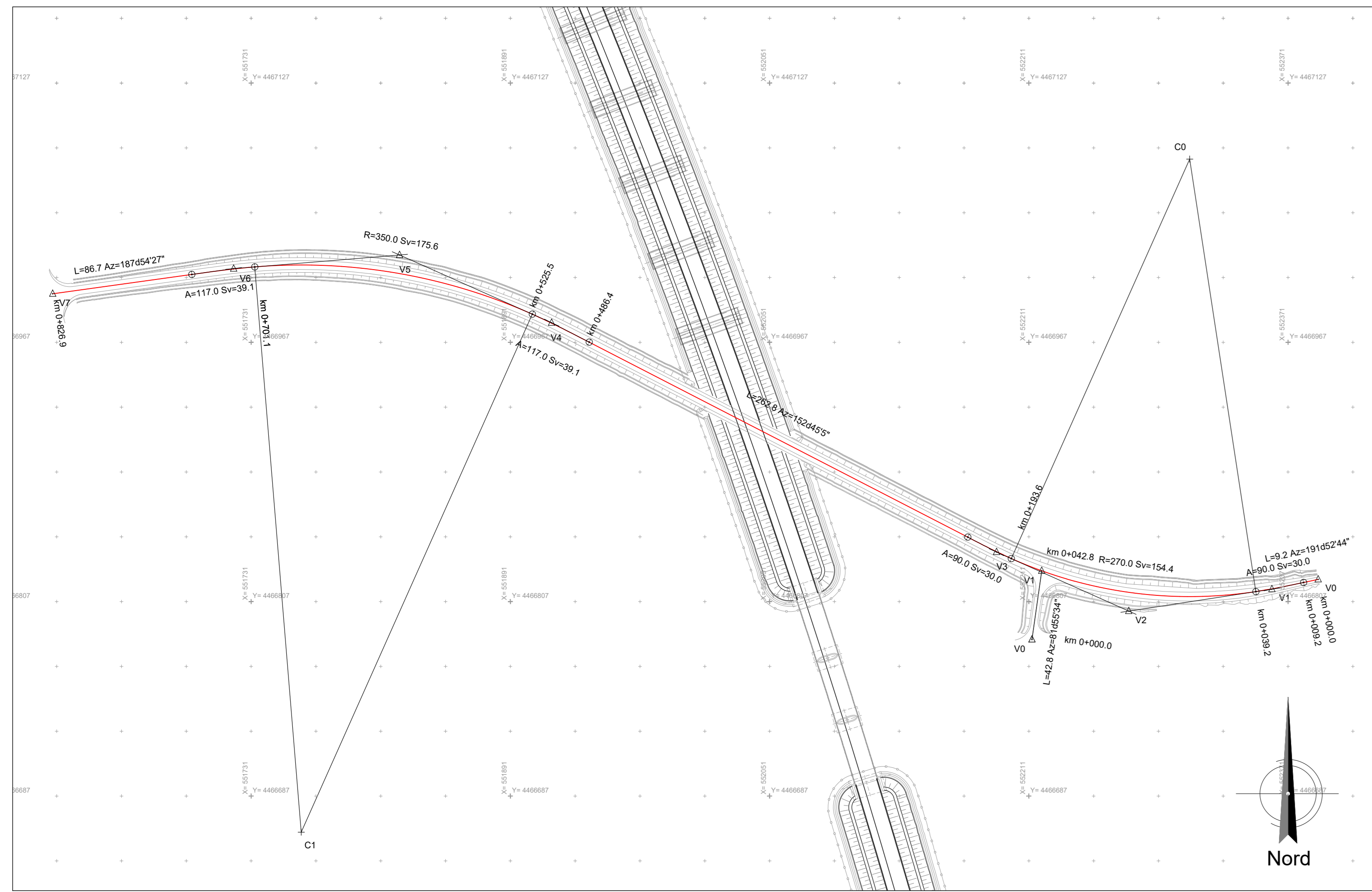
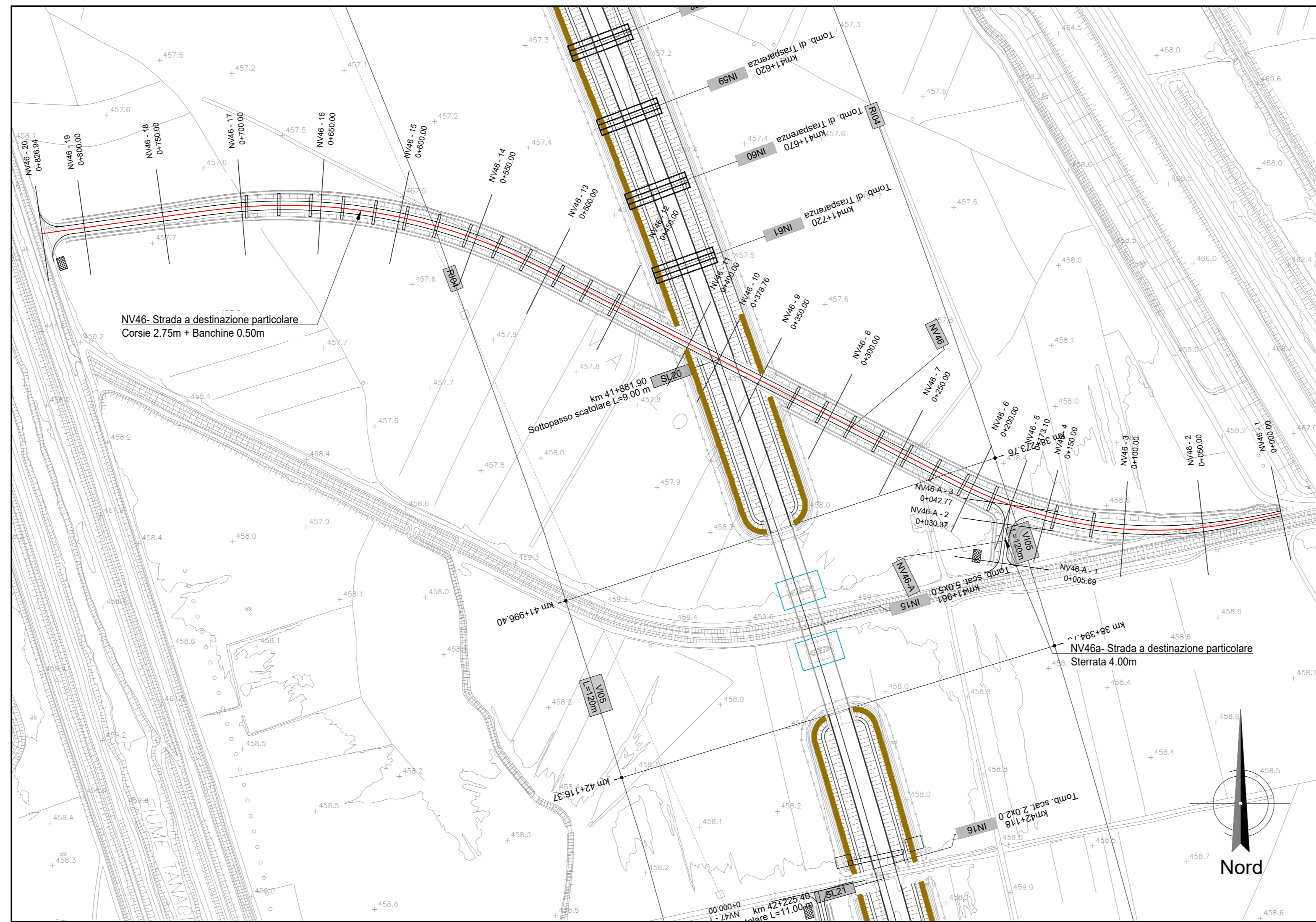

PROFILO DI PROGETTO
SCALA 1:2000000

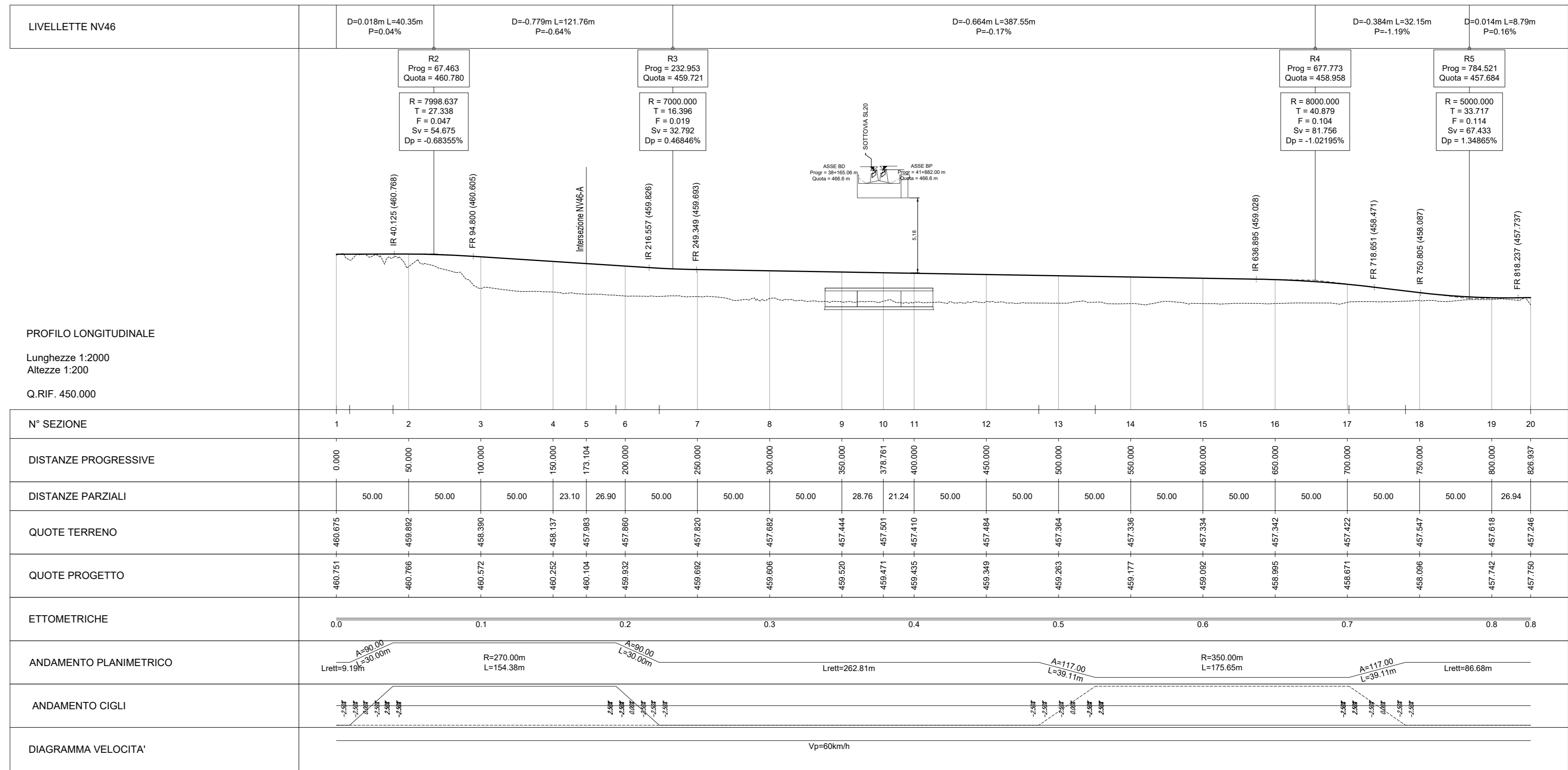

NV46A
STRADA A DESTINAZIONE PARTICOLARE
(L=4.00m - STERRATA)
SEZIONE TIPO IN RILEVATO H_{RI} < 1.00 m
SCALA 1:50

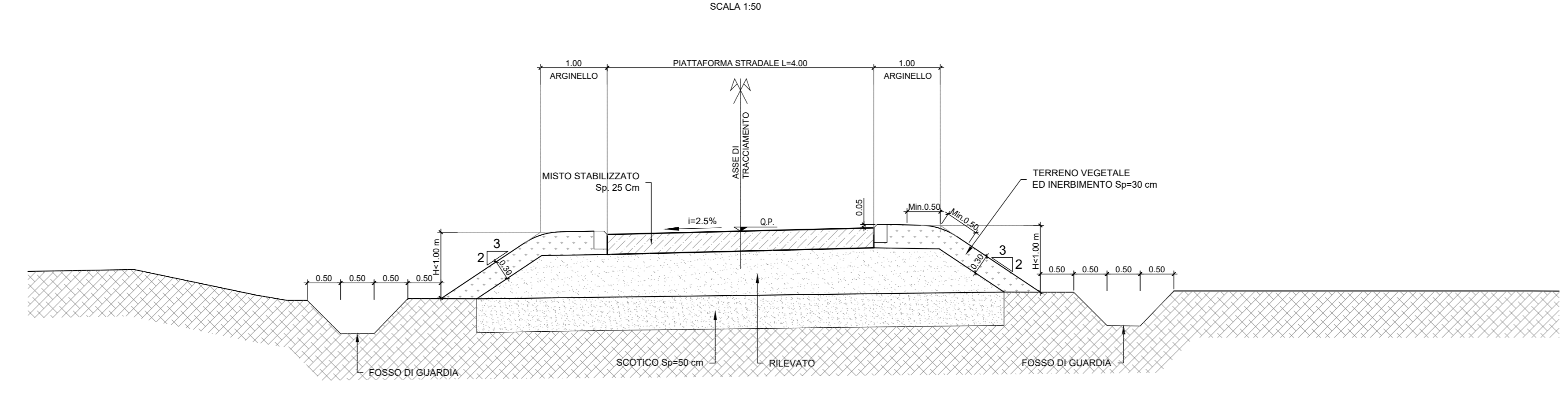

DETTAGLIO PAVIMENTAZIONE STRADALE TIPO 1
SCALA 1:20

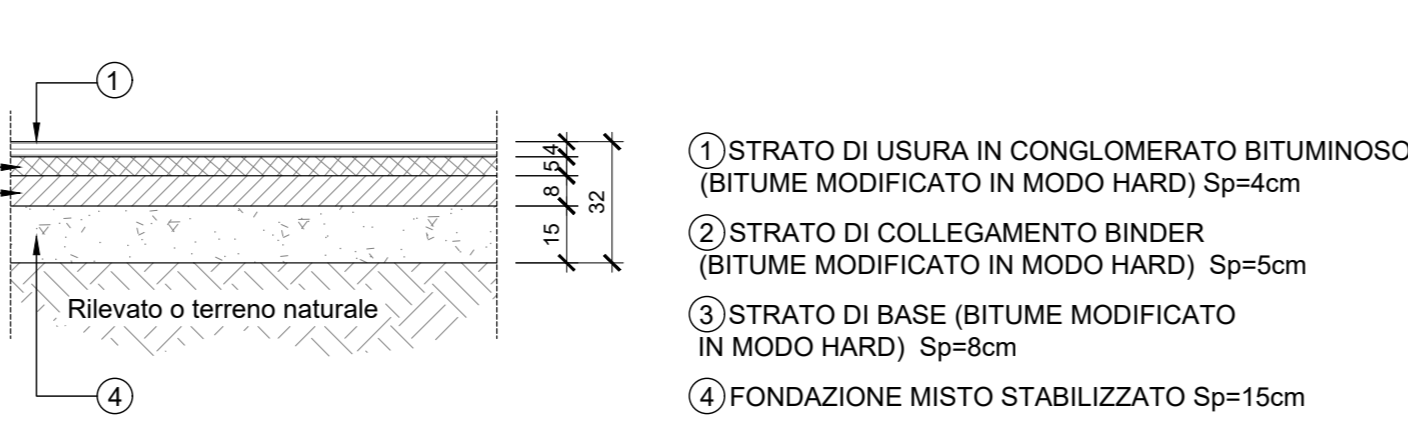

NV46
STRADA A DESTINAZIONE PARTICOLARE
(L=6.50m - PAVIMENTATA)
SEZIONE TIPO IN TRINCEA
SCALA 1:50

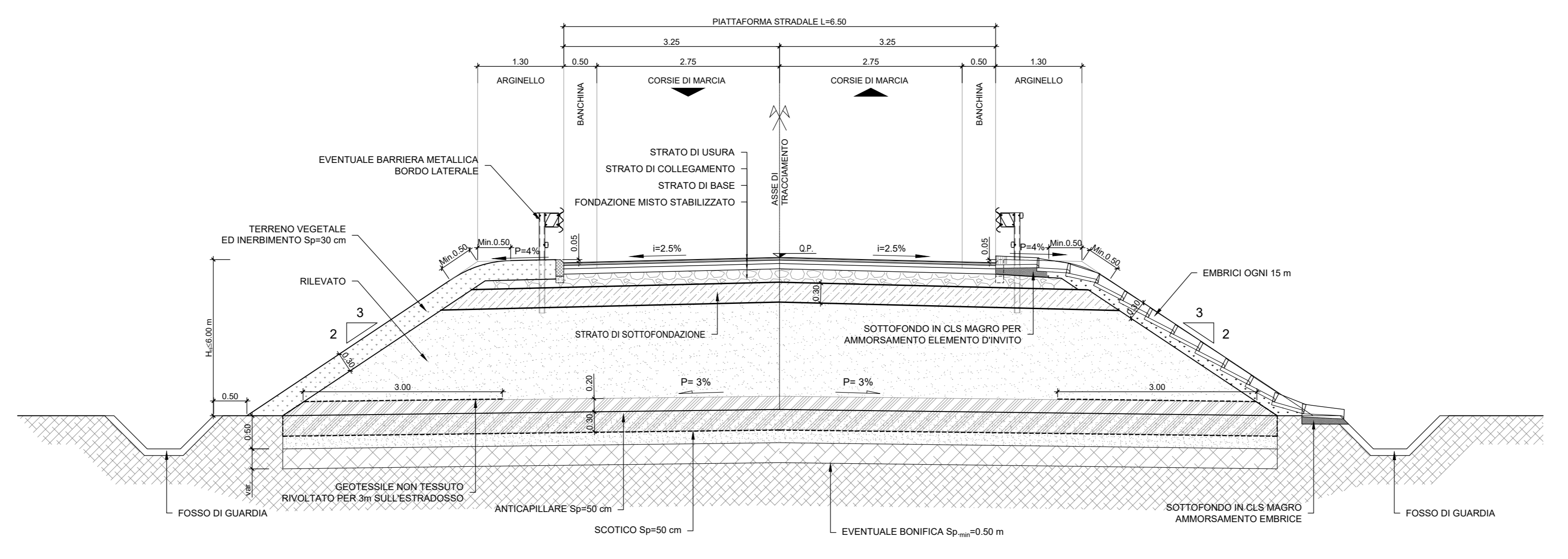

PROFILO DI PROGETTO
SCALA 1:2000000

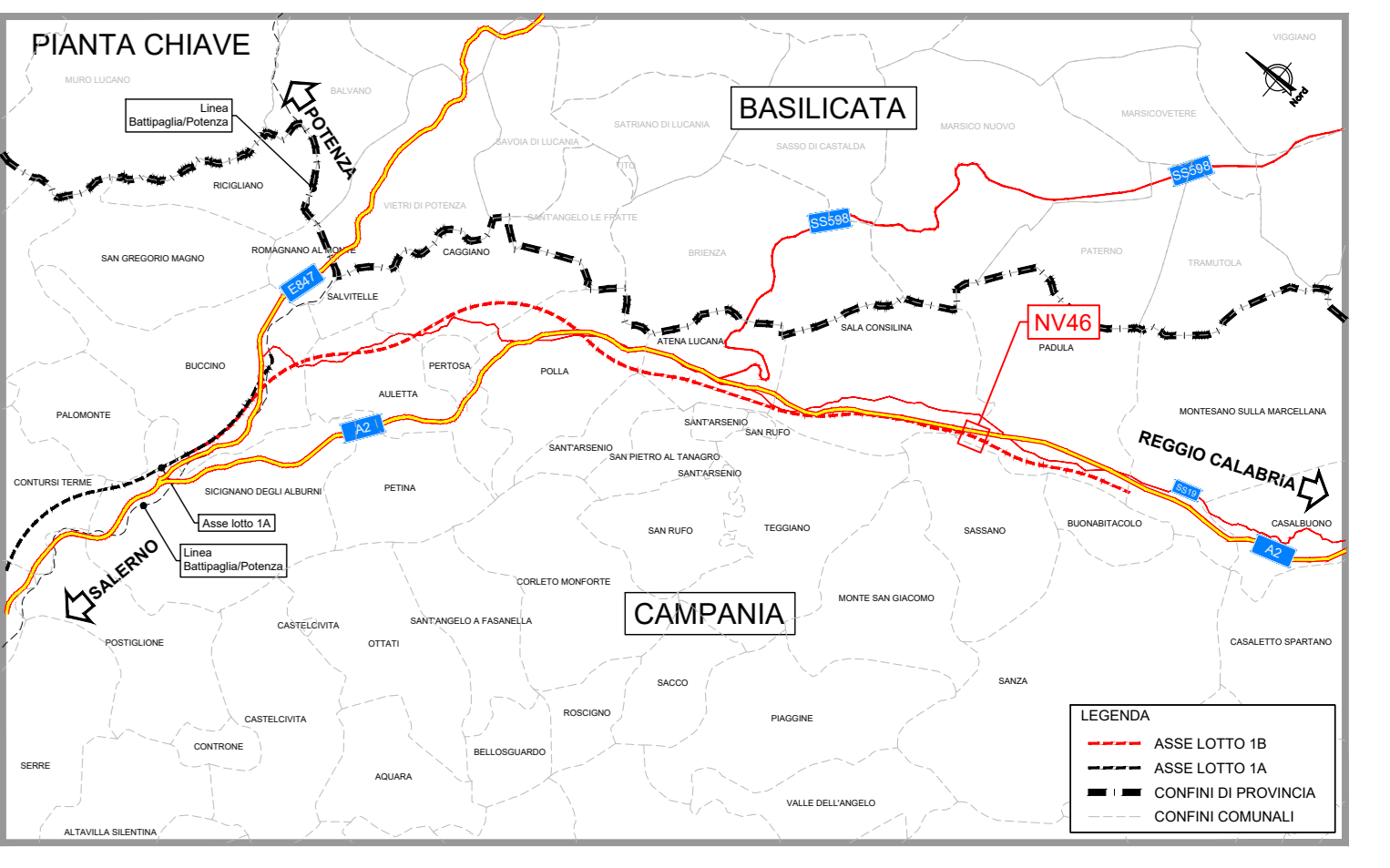
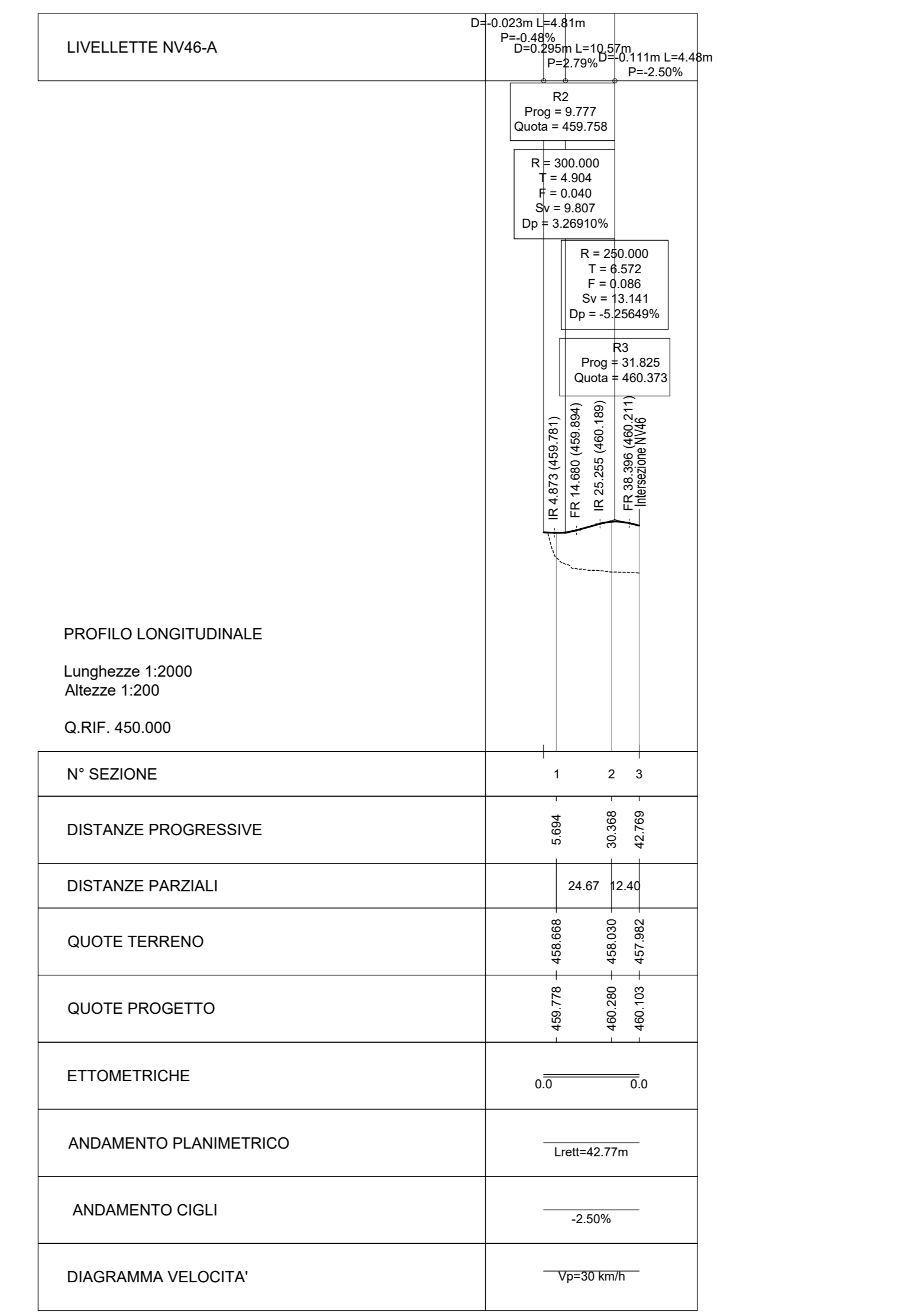

COMMITTENTE: **RFI** RETE FERROVIARIA ITALIANA GRUPPO FERROVIE DELLO STATO ITALIANO

PROGETTAZIONE: **ITALFERR** www.italferr.it

U.O. PROGETTAZIONE LINEE, NODI E ARMAMENTO
 PROGETTO DI FATTIBILITA' TECNICA ED ECONOMICA
 LINEA SALERNO - REGGIO CALABRIA
 NUOVA LINEA AV SALERNO - REGGIO CALABRIA
 LOTTO 1 BATTIPAGLIA - PRAIA
 LOTTO 1B ROMAGNANO - BUONABITACOLO
 VIABILITA'
 NV46 - Viabilità al km 41+885
 Planoprofilo, tracciamento e sezione tipo

SCALA: varie

Rev.	Descrizione	Redatto	Data	Verificato	Data	Approvato	Data	Autore	Data
A	Criterio tecnica	[Firma]	11/03/2010	[Firma]	11/03/2010	[Firma]	11/03/2010	V. Conza	11/03/2010

File: RC2A.B.1.R.13.LZ.NV46.0.001.A n. Esb.