

- Profilo Piazzola
- Profilo terreno

TR_S1T27
Sezione 9
Progressiva: 0+180
Scala: 1:200
Quota di Riferimento: 355

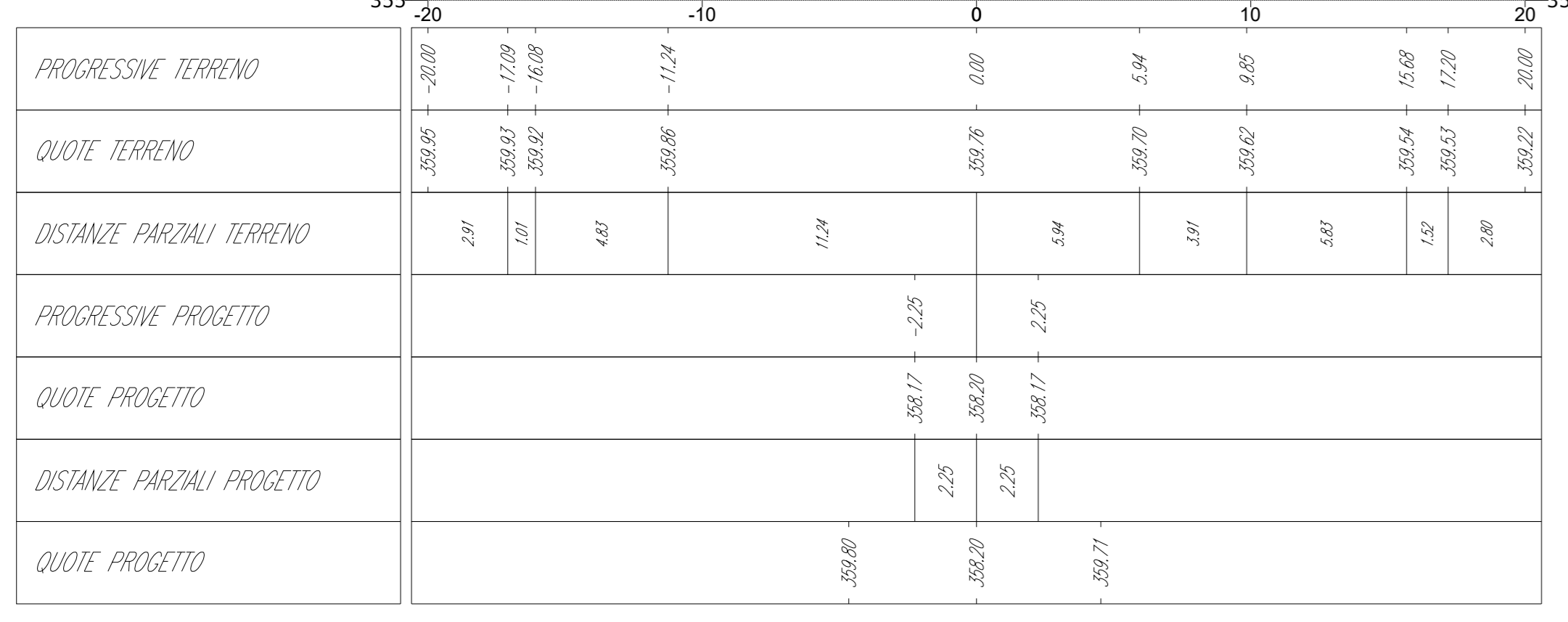

TR_S1T27
Sezione 13
Progressiva: 0+260
Scala: 1:200
Quota di Riferimento: 350

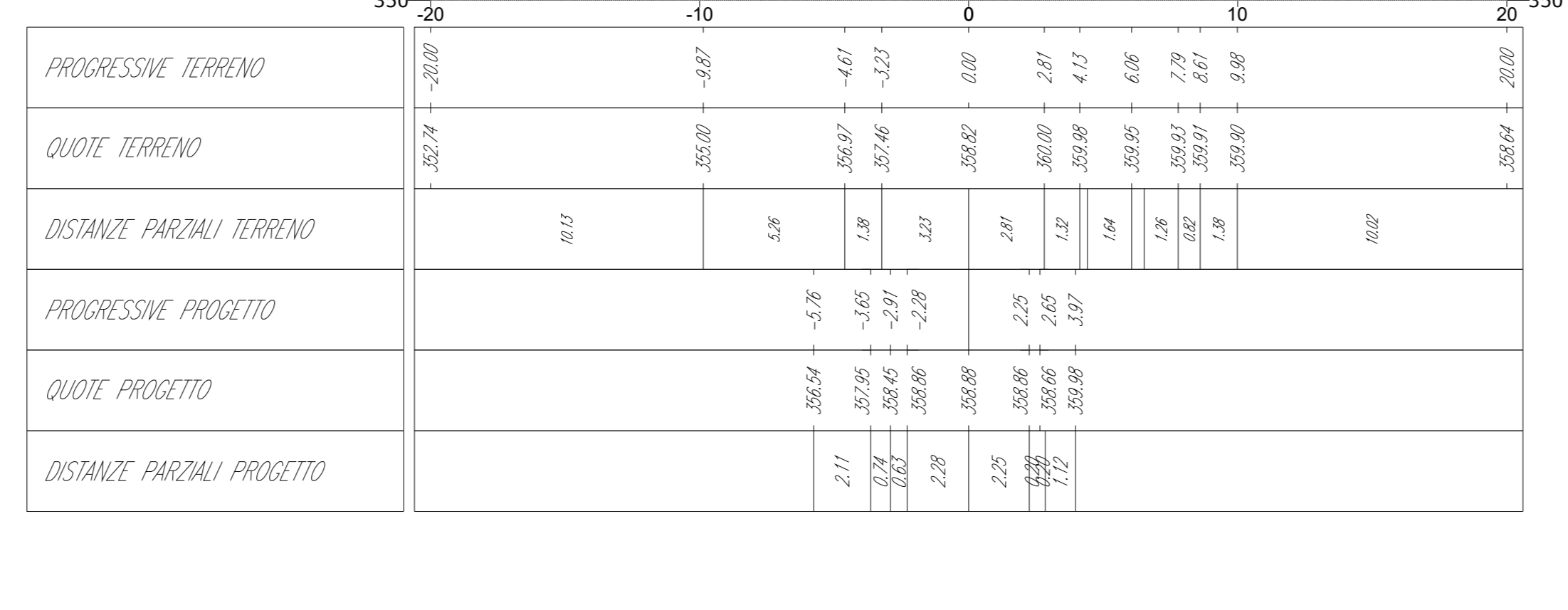

TR_S1T27
Sezione 17
Progressiva: 0+340
Scala: 1:200
Quota di Riferimento: 345

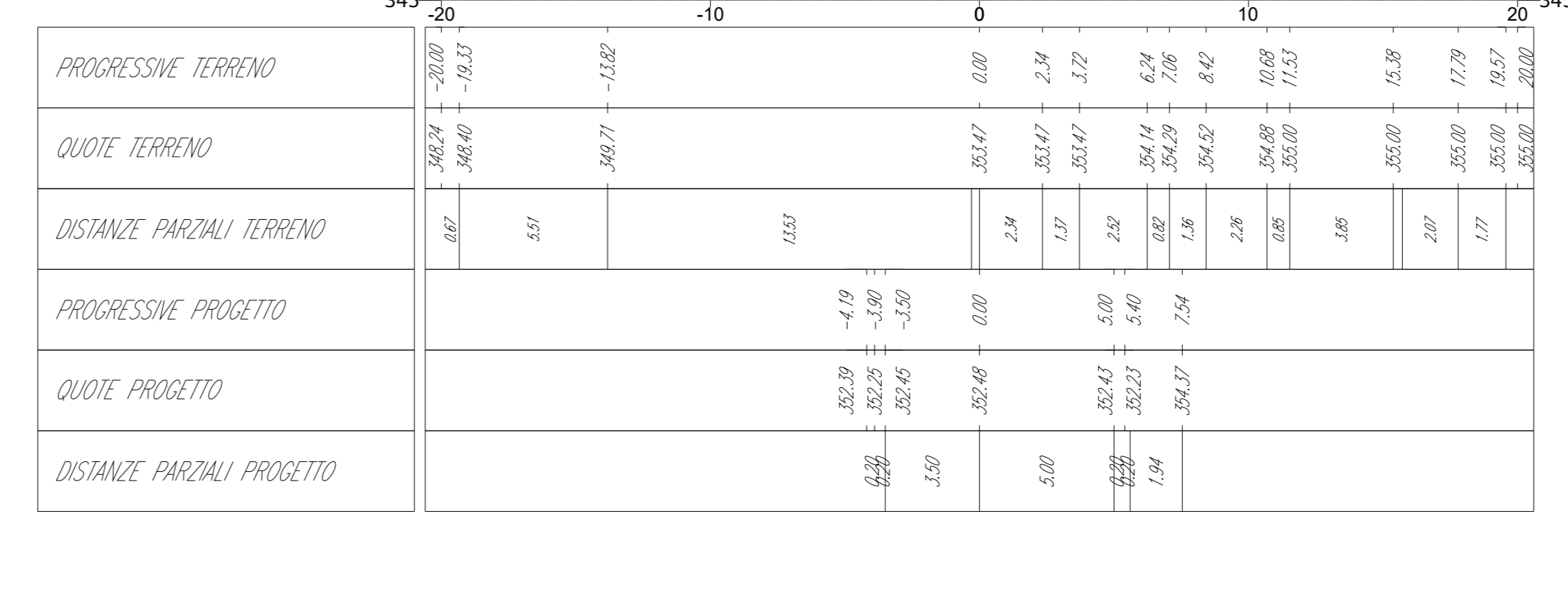

TR_S1T27
Sezione 10
Progressiva: 0+200
Scala: 1:200
Quota di Riferimento: 355

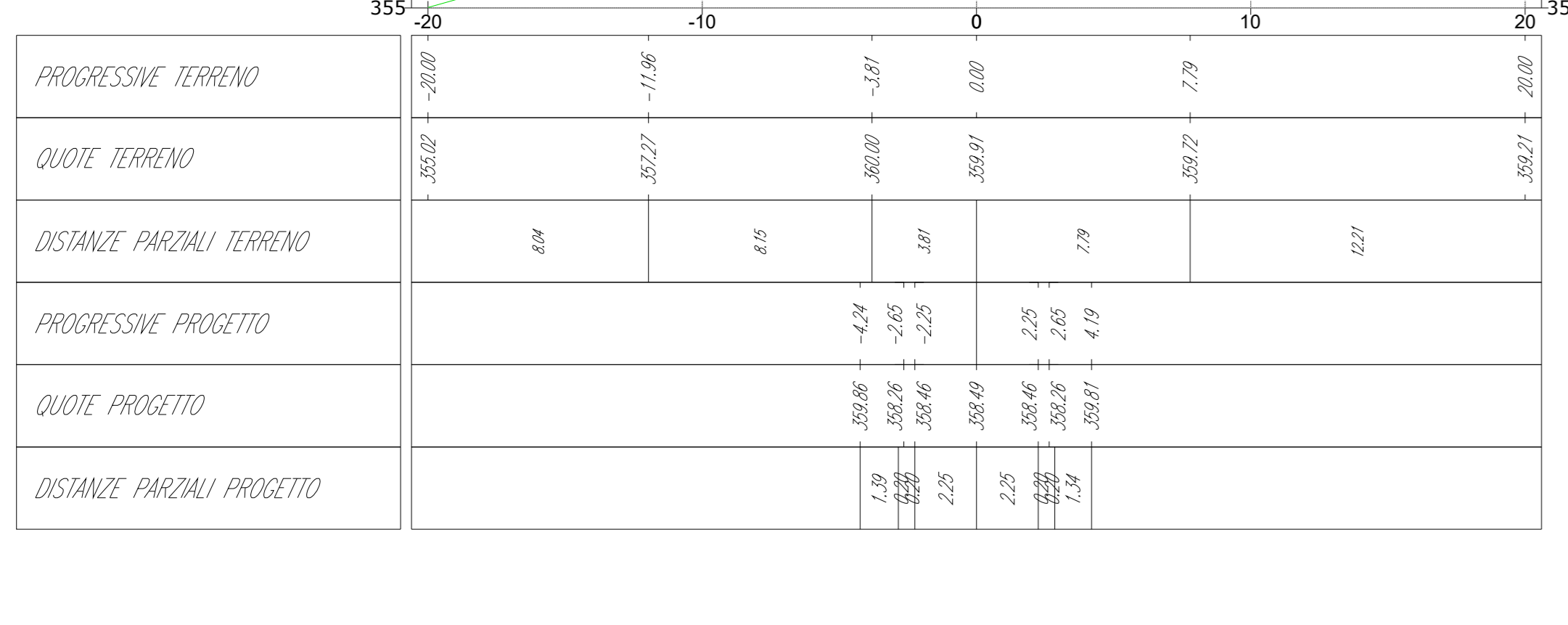

TR_S1T27
Sezione 14
Progressiva: 0+279
Scala: 1:200
Quota di Riferimento: 350

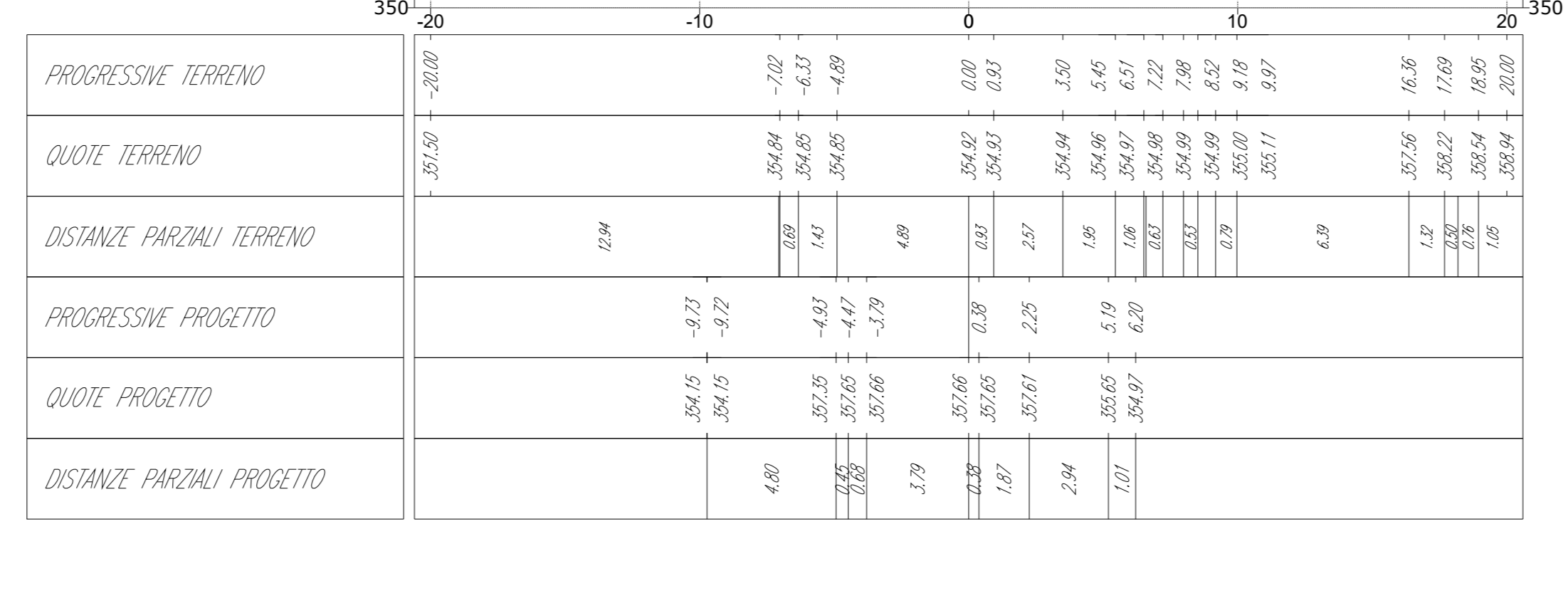

TR_S1T27
Sezione 18
Progressiva: 0+360
Scala: 1:200
Quota di Riferimento: 350

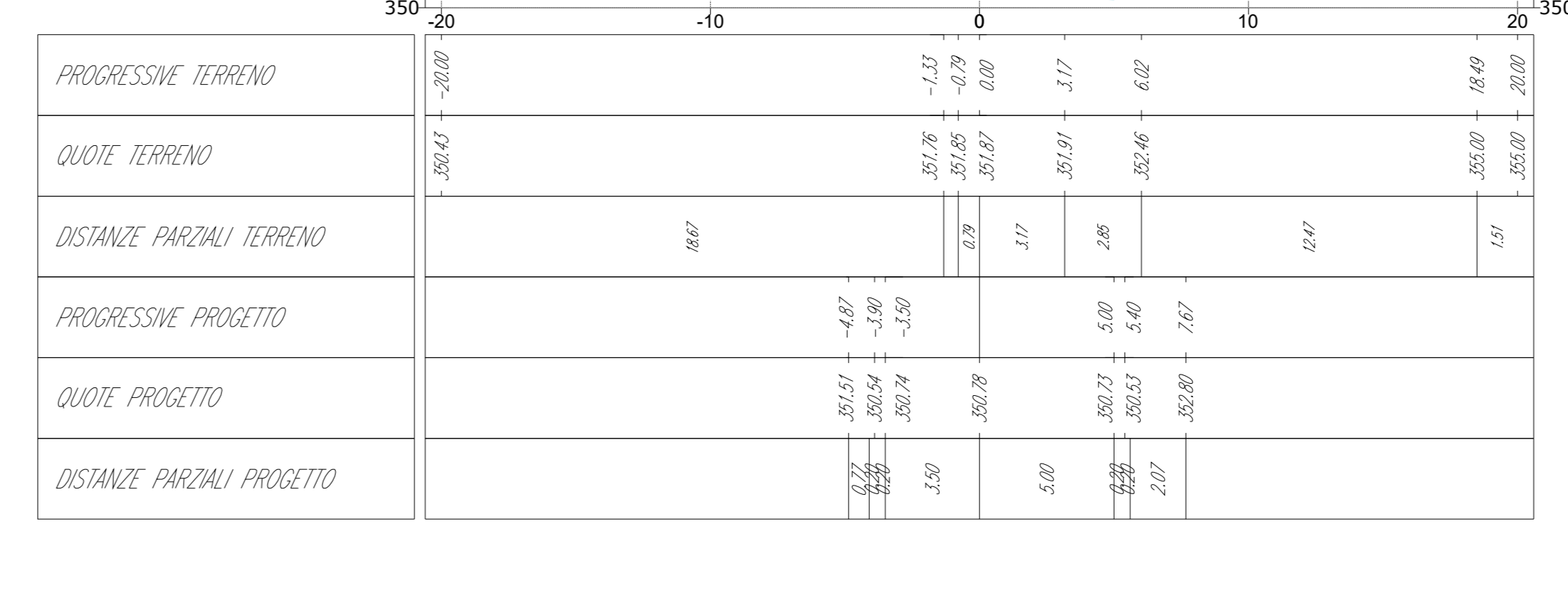

TR_S1T27
Sezione 11
Progressiva: 0+220
Scala: 1:200
Quota di Riferimento: 350

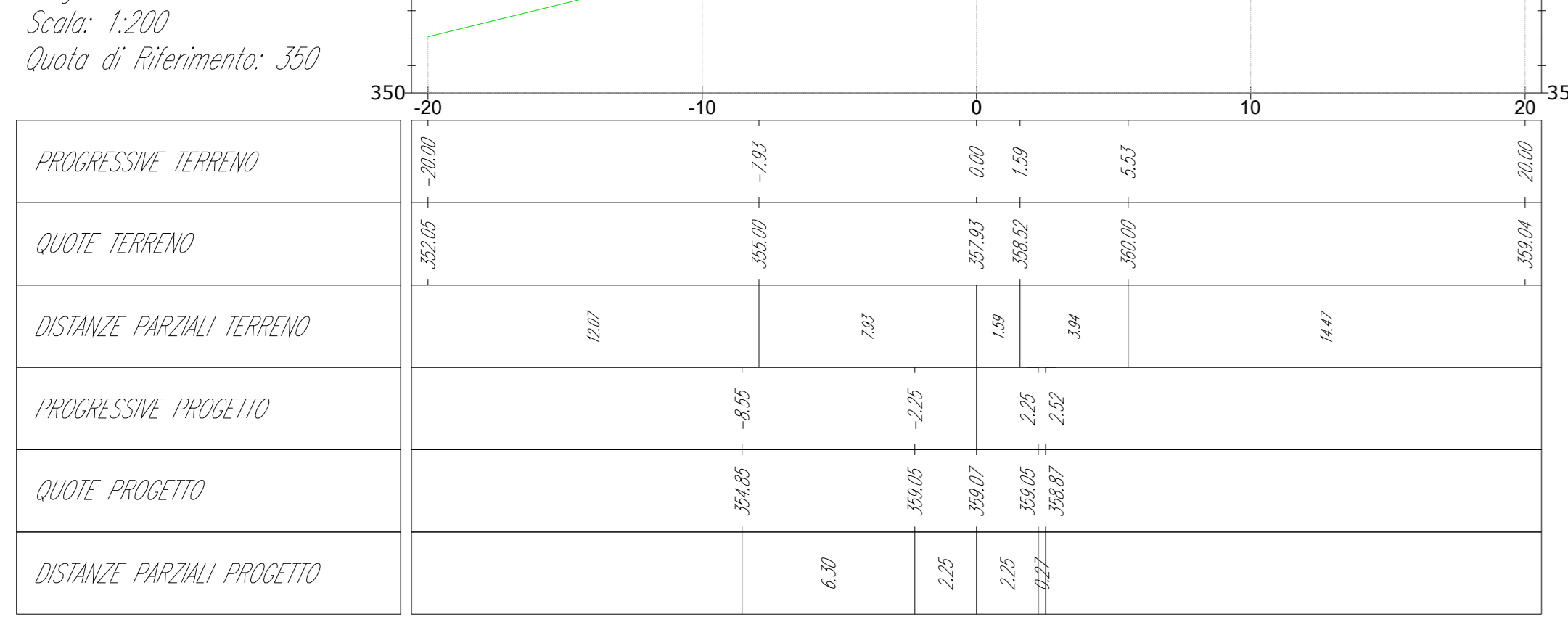

TR_S1T27
Sezione 15
Progressiva: 0+300
Scala: 1:200
Quota di Riferimento: 350

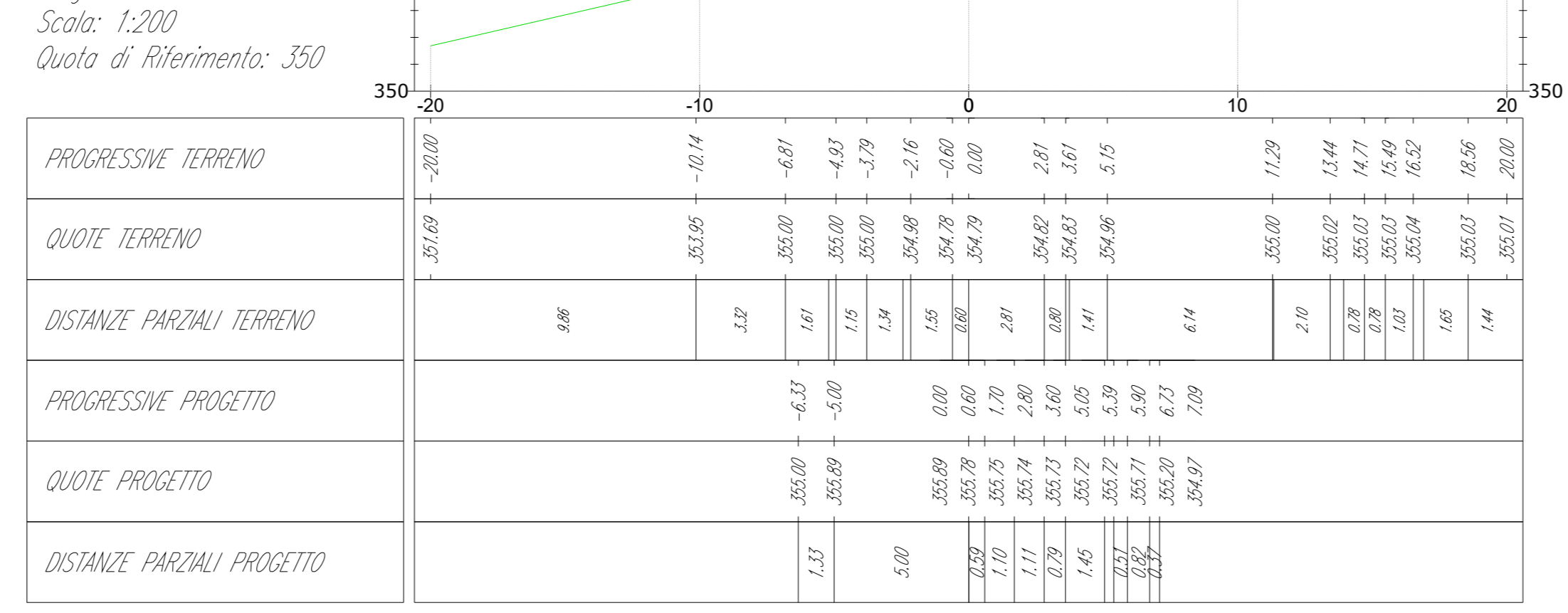

TR_S1T27
Sezione 19
Progressiva: 0+380
Scala: 1:200
Quota di Riferimento: 345

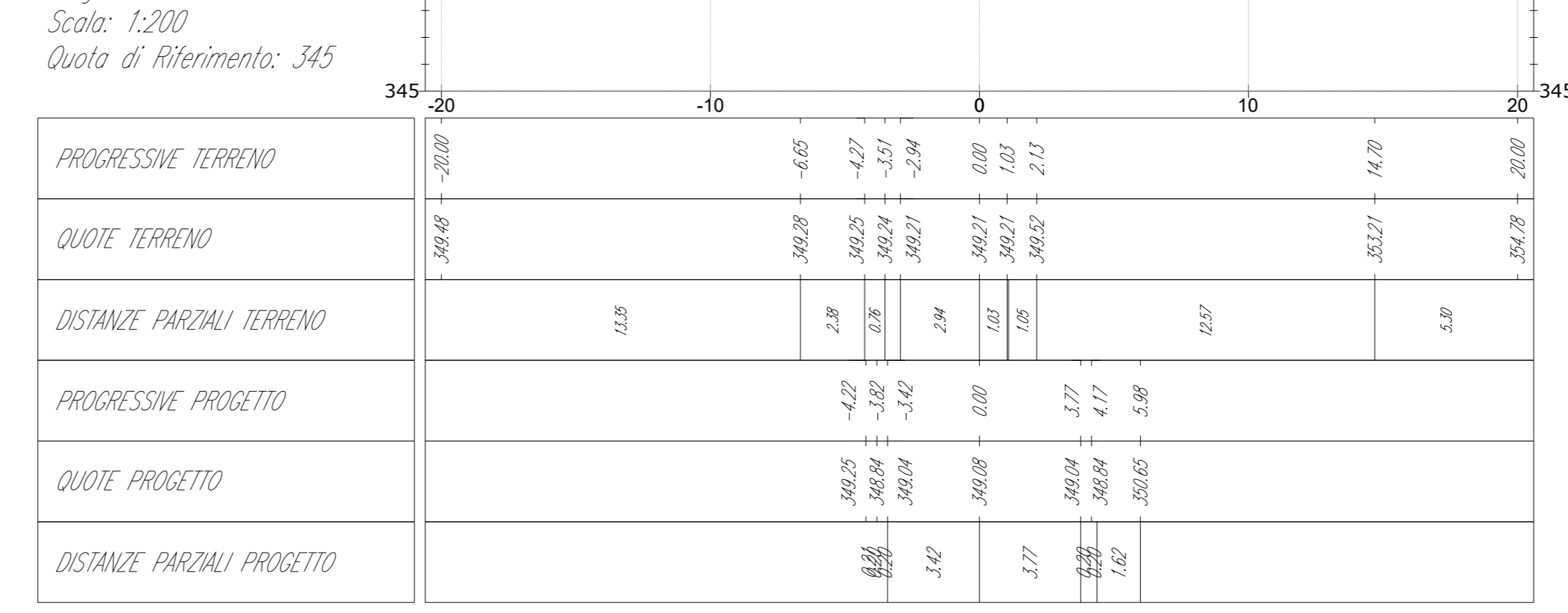

TR_S1T27
Sezione 12
Progressiva: 0+240
Scala: 1:200
Quota di Riferimento: 350

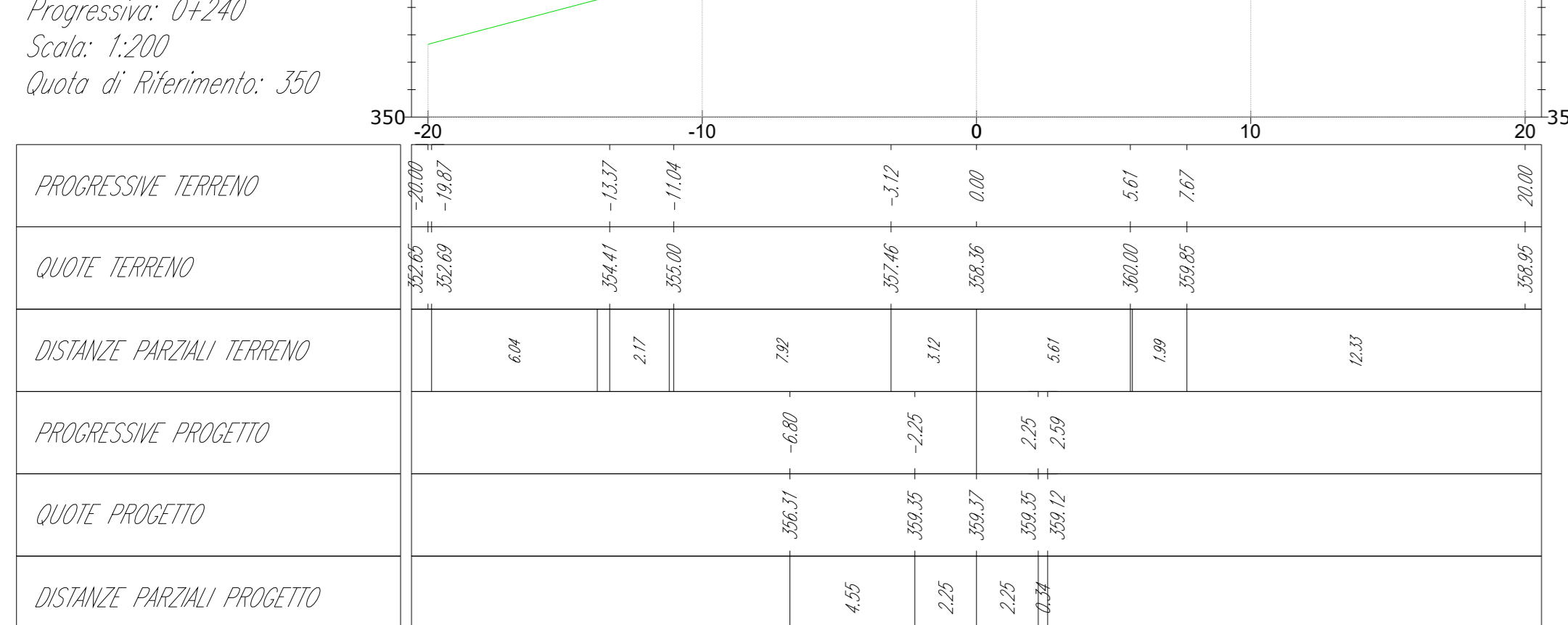

TR_S1T27
Sezione 16
Progressiva: 0+320
Scala: 1:200
Quota di Riferimento: 345

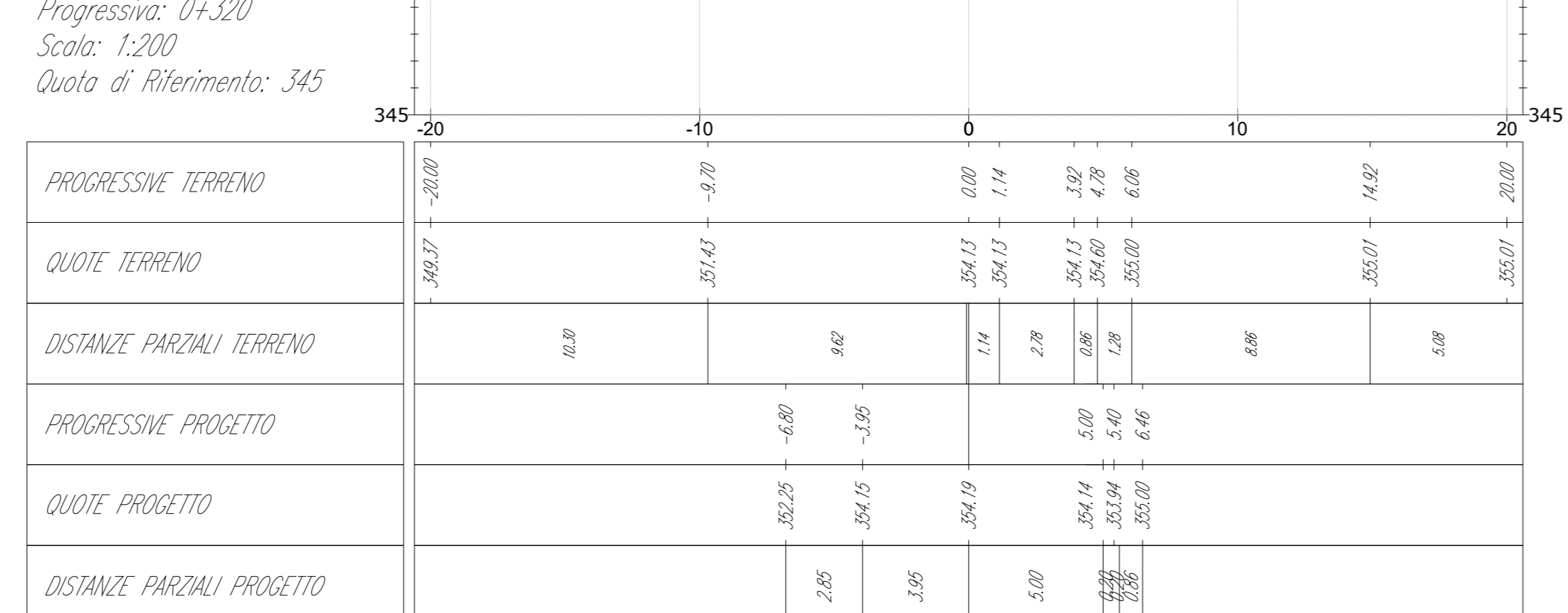

TR_S1T27
Sezione 20
Progressiva: 0+400
Scala: 1:200
Quota di Riferimento: 345

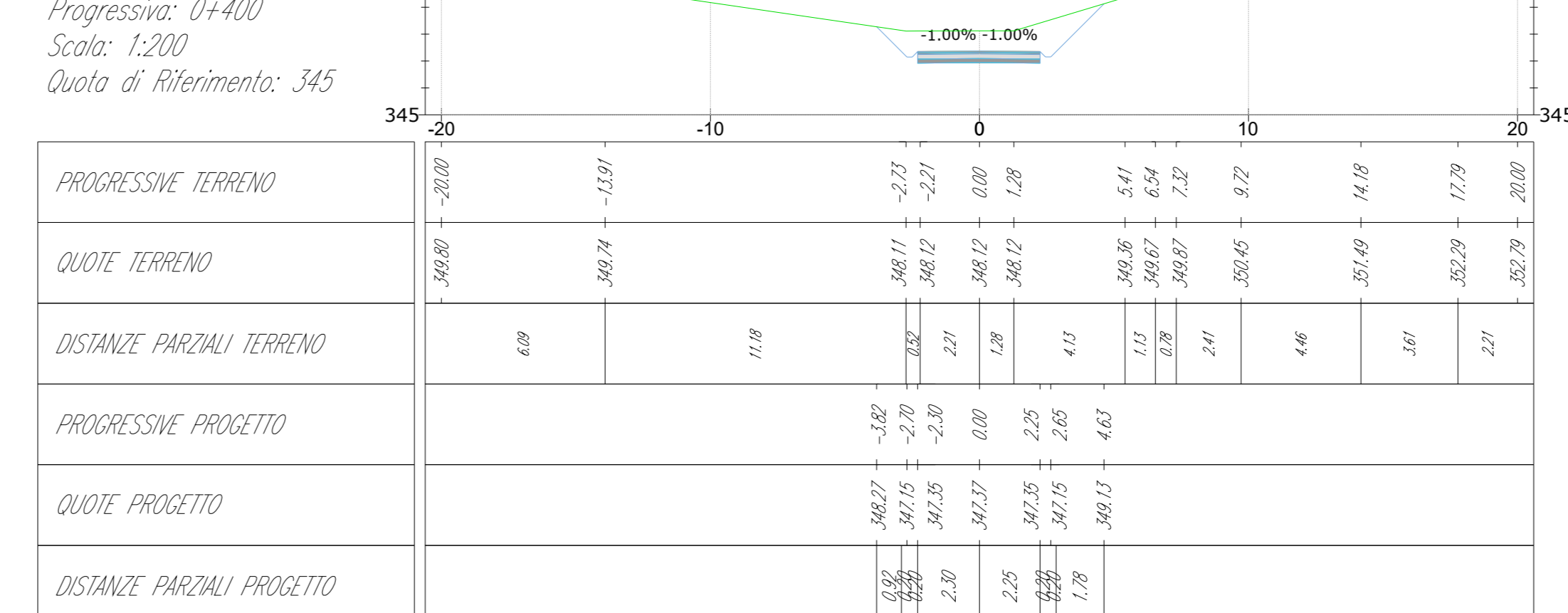

green & green
WE ENGINEERING

Green & Green S.r.l.
Via Edmondo de Amicis n.64
37036 Ronde (CS) - Italy
P.IVA 0290010782
Ph. (+39) 0984 846295
Fax (+39) 0984 1214470
info@greengreen.it
www.greengreen.it

Il tecnico
Ing. Leonardo Sblendido

| | | | | | |
|------|------------|-----------------|-------------|-------------|--------------|
| 00 | 22/12/2023 | PRIMA EMISSIONE | R. De Fiore | P.E. | L. Sblendido |
| REV. | DATA | DESCRIZIONE | PREPARATO | CONTROLLATO | APPROVATO |

"IMPIANTO EOLICO TERRANOVA DA SIBARI"
(COMUNI DI TERRANOVA DA SIBARI, SAN DEMETRIO CORONE, SPEZZANO ALBANESE, CORIGLIANO-ROSSANO, SANTA SOFIA D'EPSIRO E TARSIA (CS))

hergo

PROGETTO
DEFINITIVO

FORMATO: C:\ZFSTR001\WD01000_STUDIO_PLANOALTIMETRICO.pdf

SCALA: 1:200

FOGLIO: 3 di 39

TITOLO:
STUDIO PLANOALTIMETRICO

CODICE ELABORATO
C23F3STR002WD01000

TR_ST127
Sezione 21
Progressiva: 0+420
Scala: 1:200
Quota di Riferimento: 345

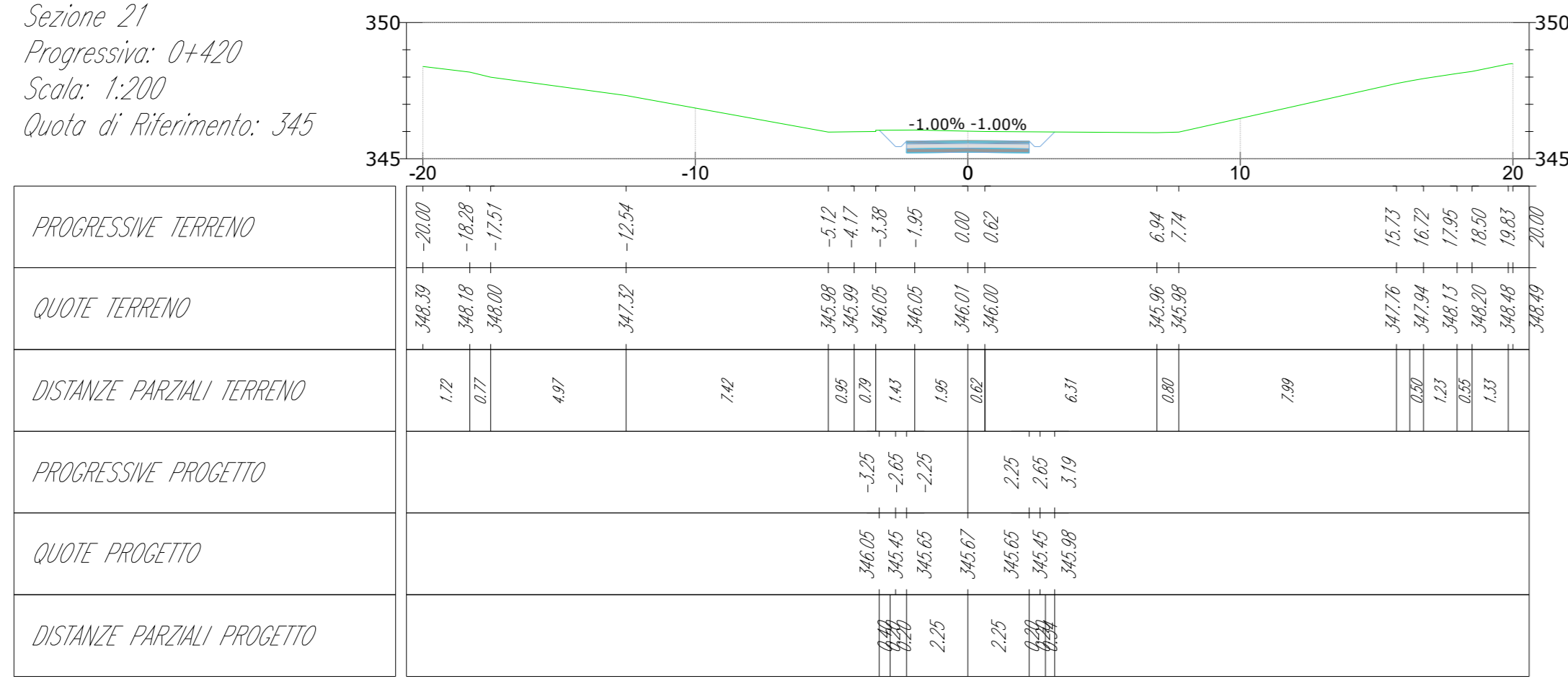

TR_ST127
Sezione 22
Progressiva: 0+440
Scala: 1:200
Quota di Riferimento: 340

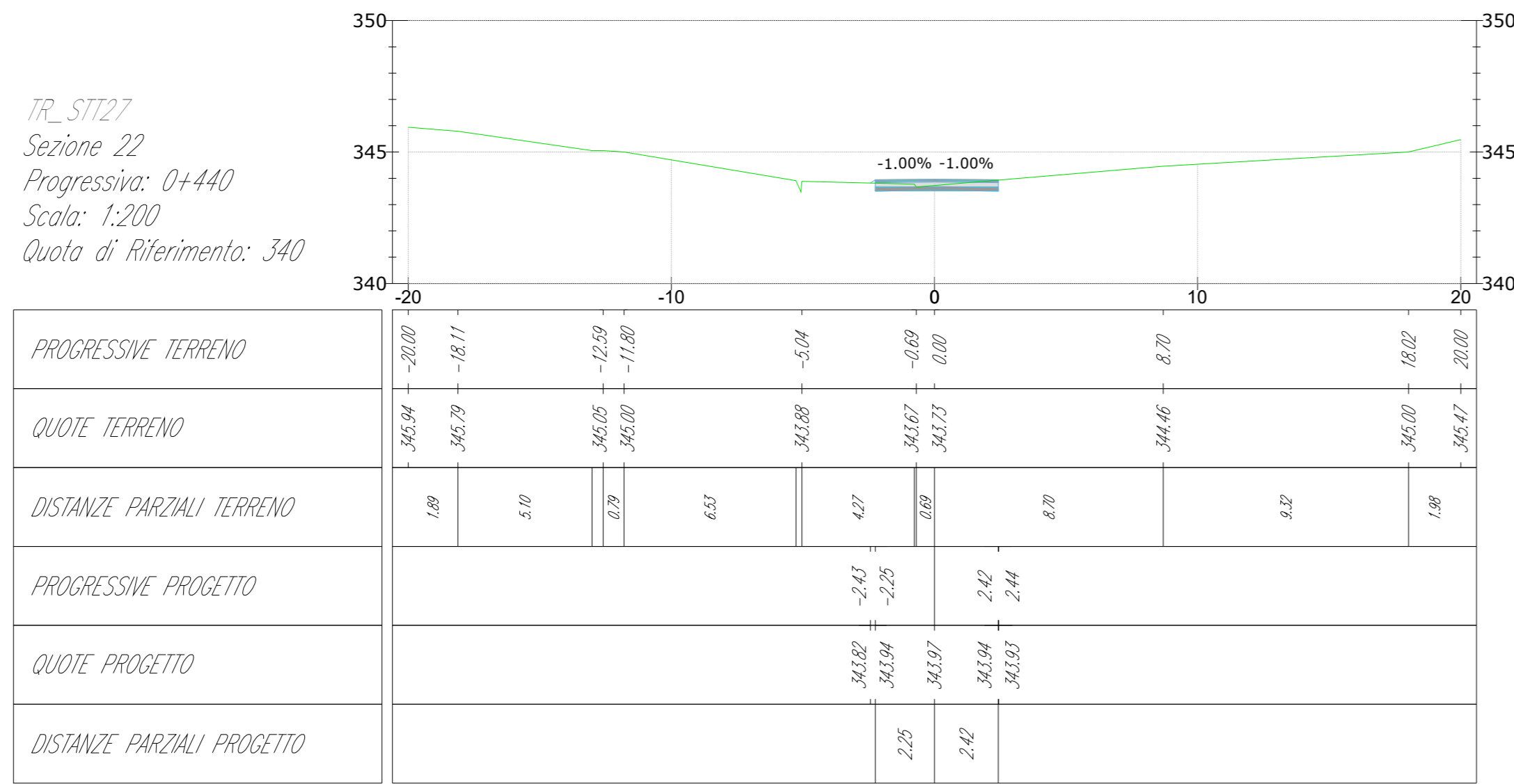

TR_ST127
Sezione 23
Progressiva: 0+460
Scala: 1:200
Quota di Riferimento: 340

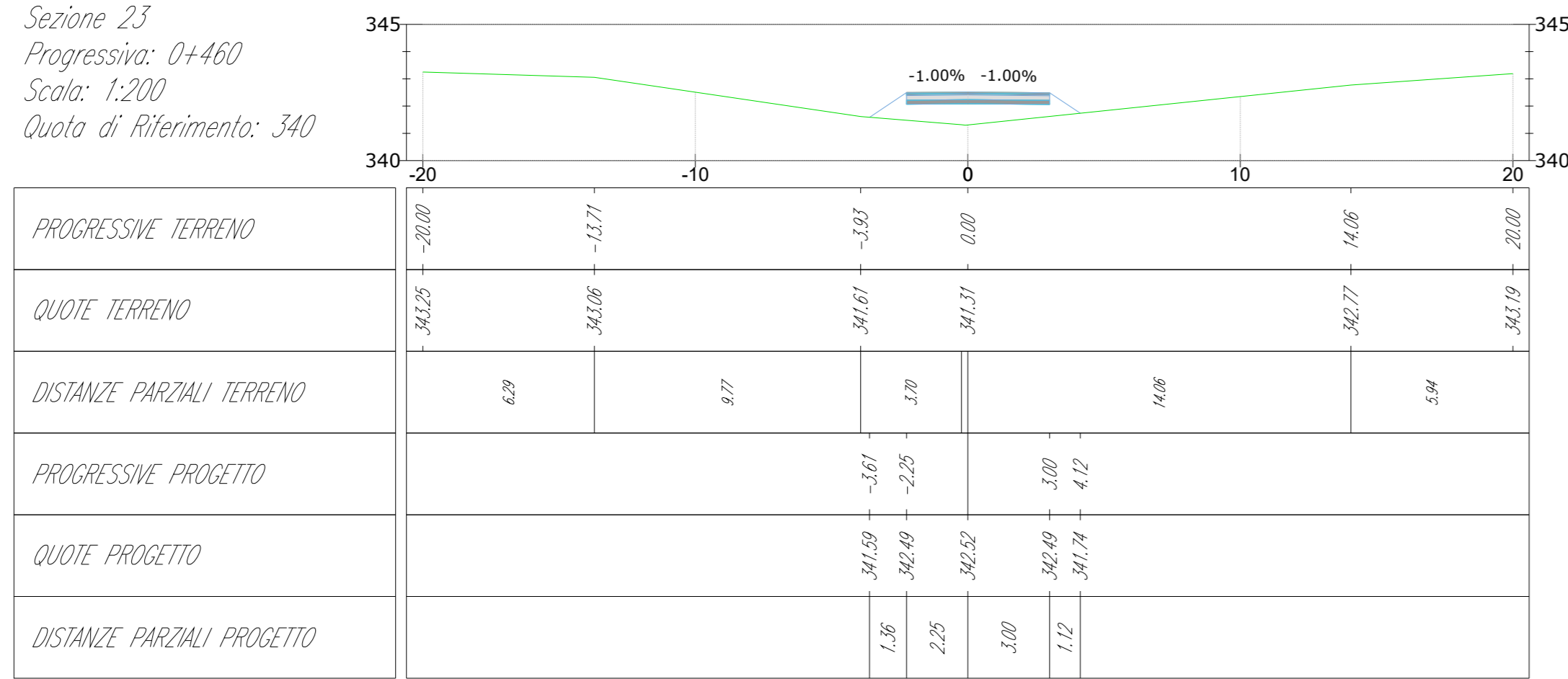

TR_ST127
Sezione 24
Progressiva: 0+480
Scala: 1:200
Quota di Riferimento: 340

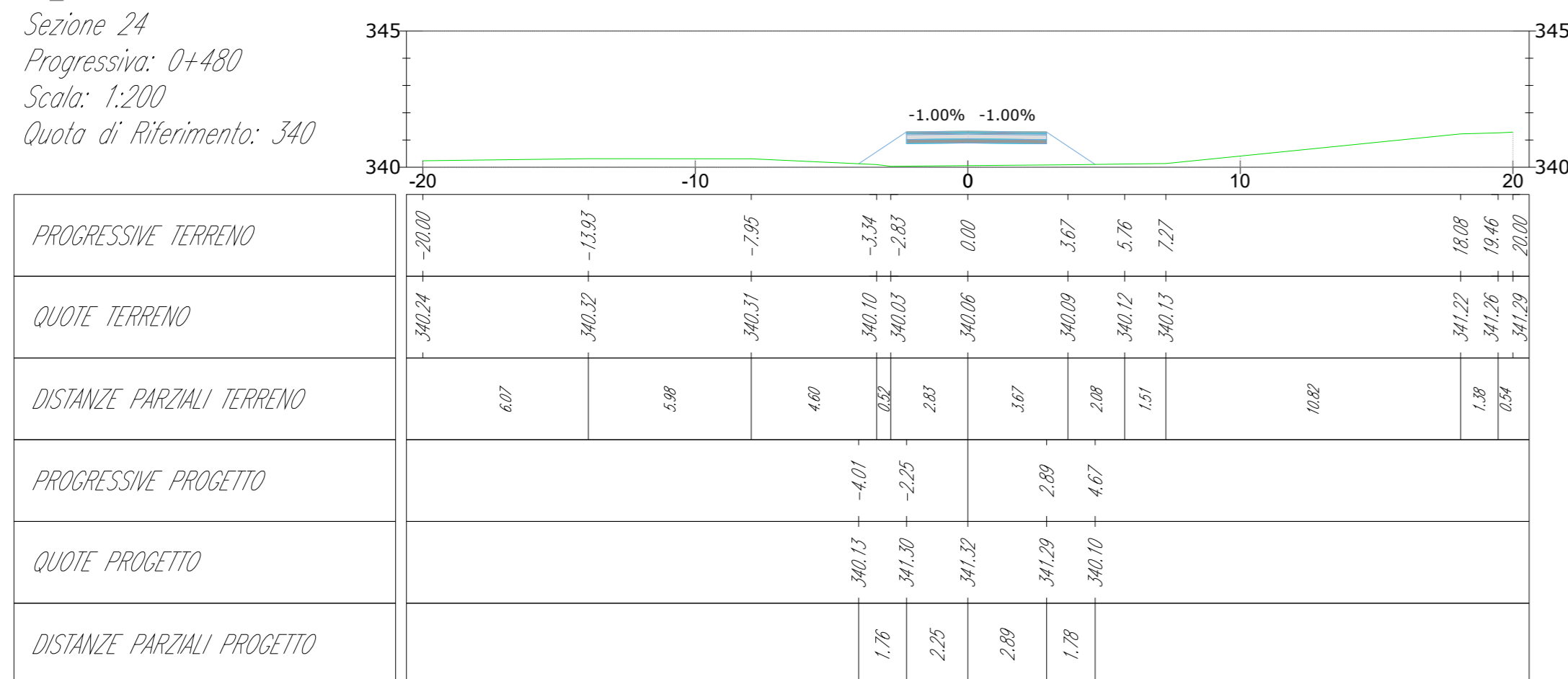

TR_ST127
Sezione 25
Progressiva: 0+500
Scala: 1:200
Quota di Riferimento: 335

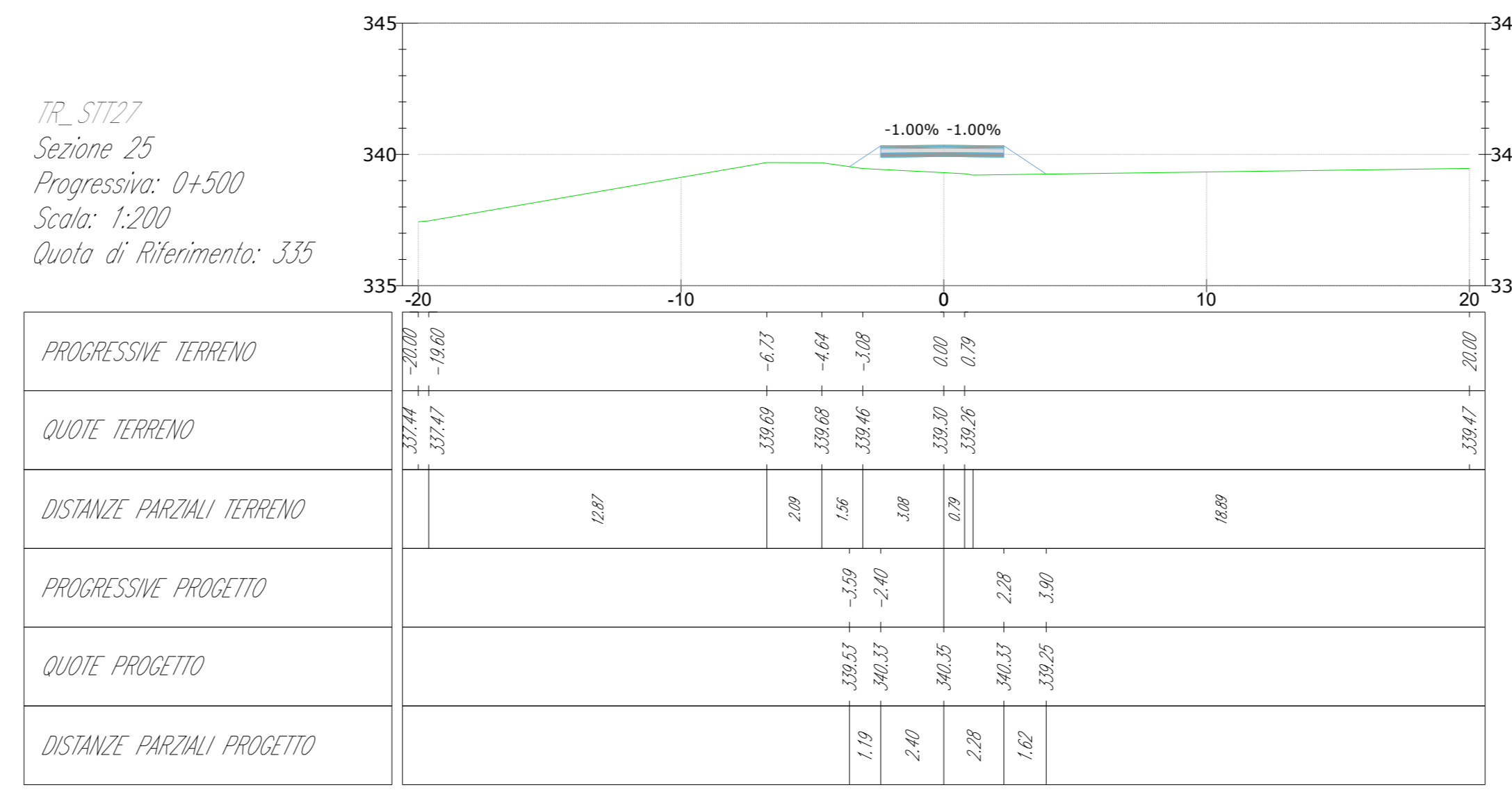

TR_ST127
Sezione 26
Progressiva: 0+520
Scala: 1:200
Quota di Riferimento: 330

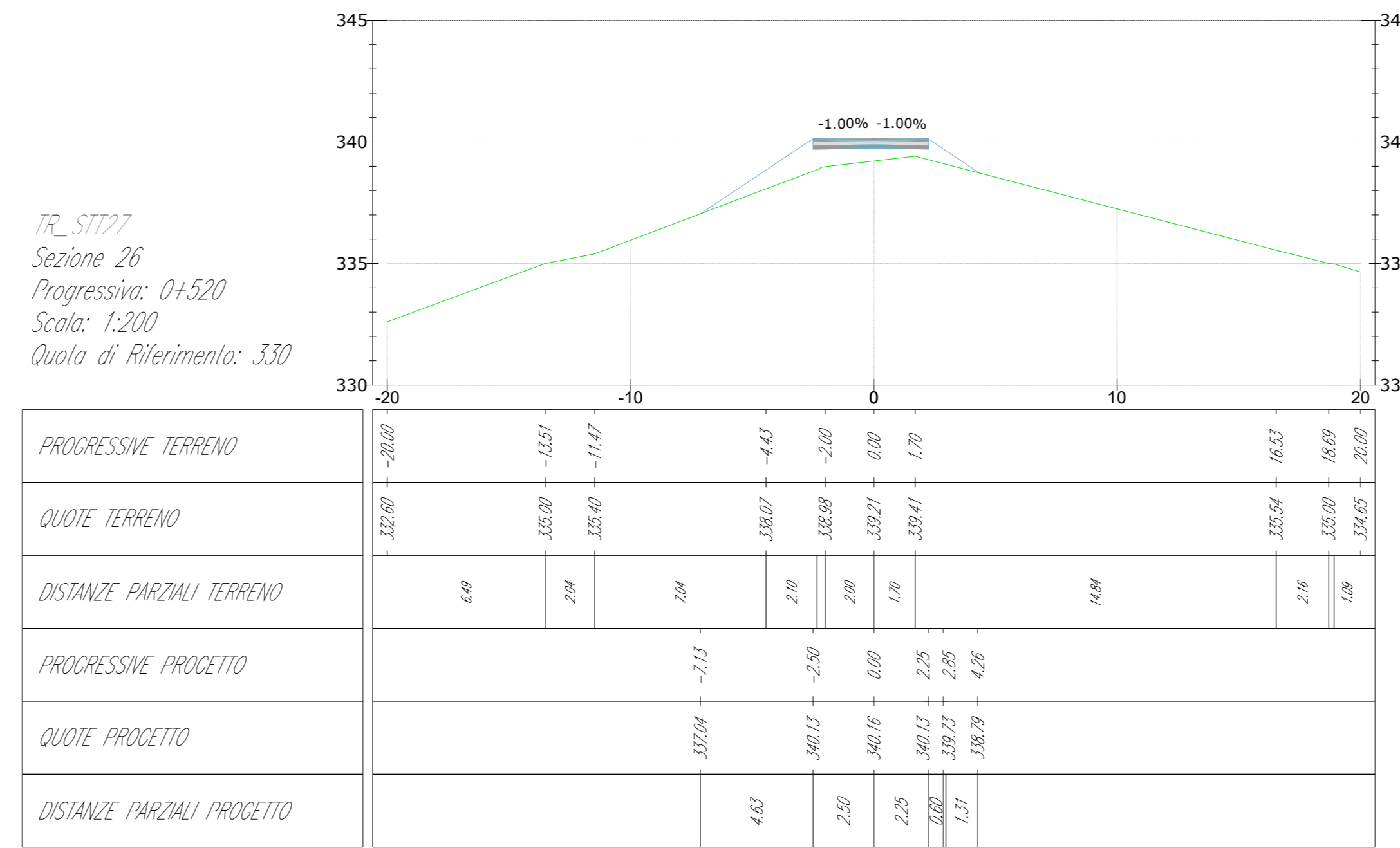

TR_ST127
Sezione 27
Progressiva: 0+540
Scala: 1:200
Quota di Riferimento: 330

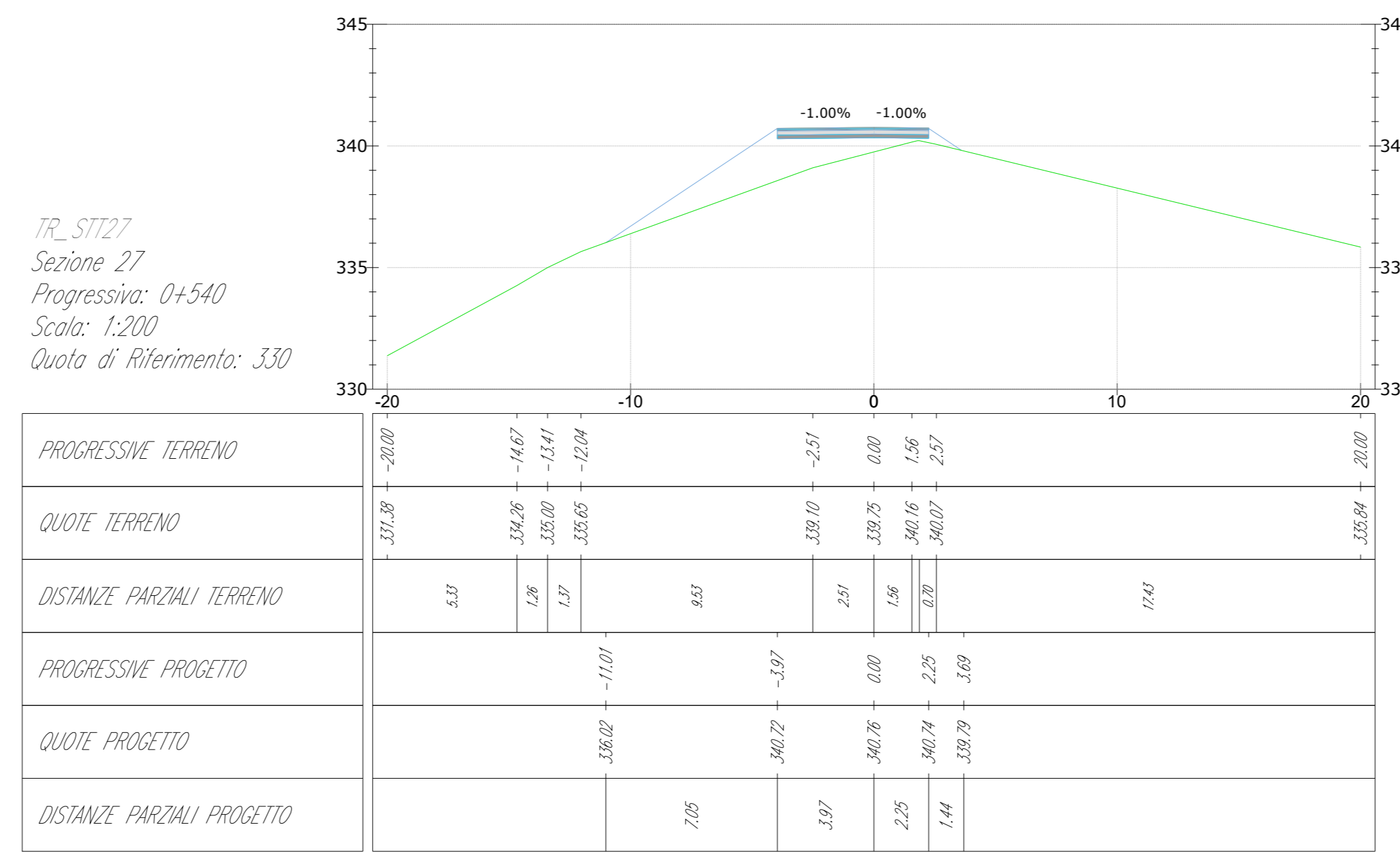

TR_ST127
Sezione 28
Progressiva: 0+555
Scala: 1:200
Quota di Riferimento: 330

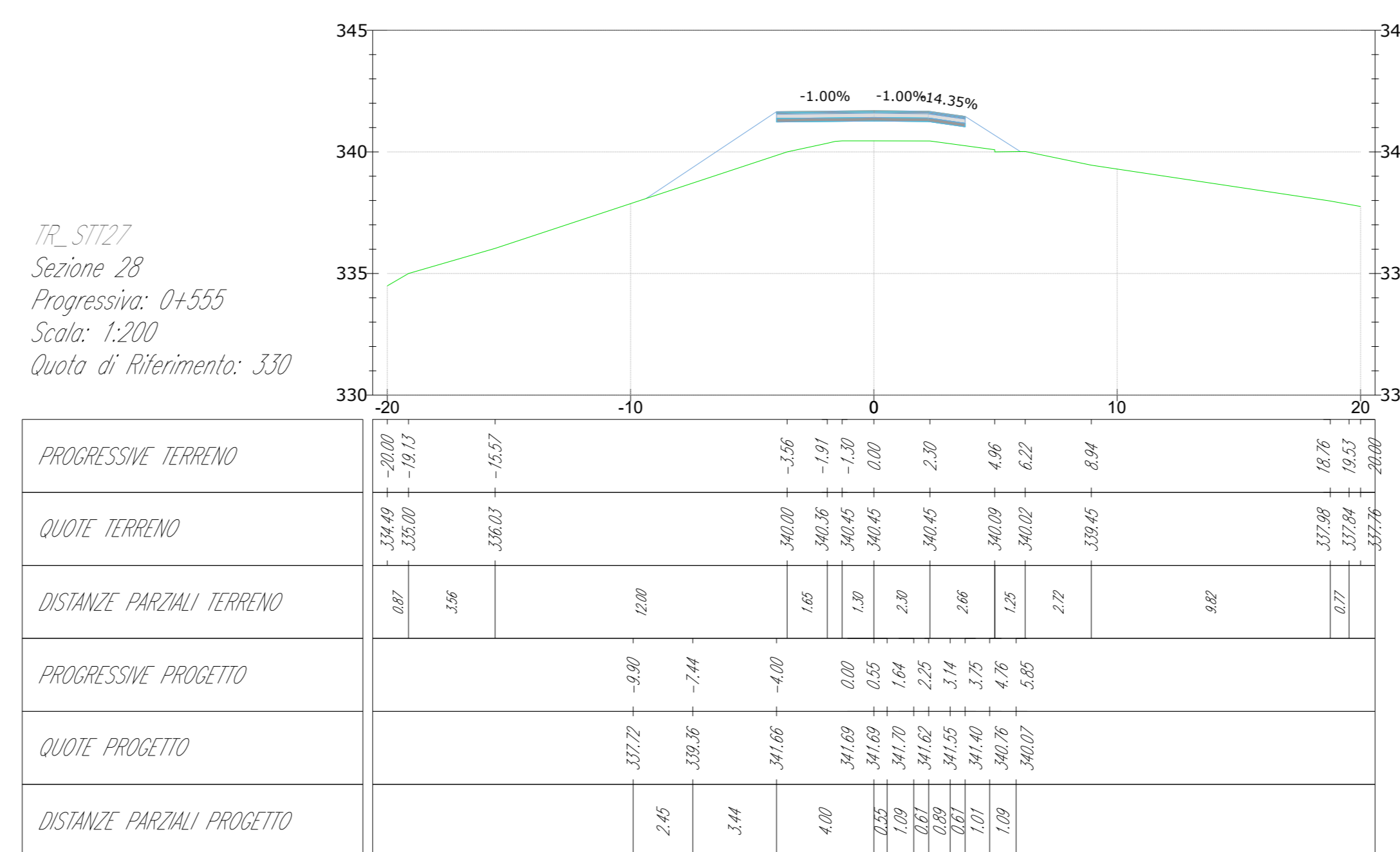

LEGENDA DEI COLORI E SIMBOLI IN CARTA

Profilo terreno



Green & Green S.r.l.
Via Edmondo de Amicis n.64
37036 Ronde (CS) - Italy
P.IVA 0290010782
Ph. (+39) 0984 846295
Fax (+39) 0984 1214470
info@greengreen.it
www.greengreen.it

Il tecnico
Ing. Leonardo Sblendido

| | | | | | |
|------|------------|-----------------|-------------|-------------|--------------|
| 00 | 22/12/2023 | PRIMA EMISSIONE | R. De Fiore | P. E. | L. Sblendido |
| REV. | DATA | DESCRIZIONE | PREPARATO | CONTROLLATO | APPROVATO |

"IMPIANTO EOLICO TERRANOVA DA SIBARI"
(COMUNI DI TERRANOVA DA SIBARI, SAN DEMETRIO CORONE, SPEZZANO ALBANESE, CORIGLIANO-ROSSANO, SANTA SOFIA D'EPSIRO E TARSIA (CS))

hergo

PROGETTO: DEFINITIVO

FORMATO: A0 | SCALA: 1:200 | SCALA PLOT: 1:1 | FOGLIO: 4 di 39

TITOLO: STUDIO PLANOALTIMETRICO

CODICE ELABORATO: C23FSTR002WD01000

Profilo terreno

TR_ST127
Sezione 29
Progressiva: 0+580
Scala: 1:200
Quota di Riferimento: 335

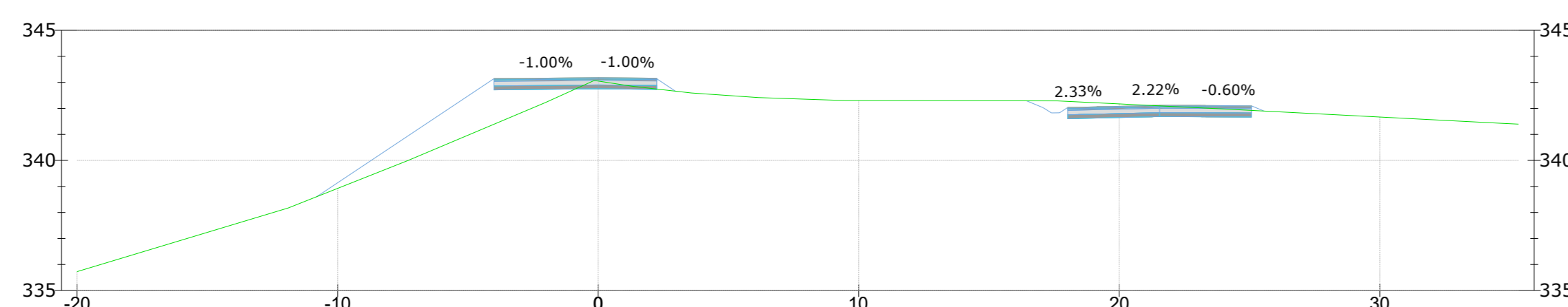

| | | | | | | | |
|----------------------------|--------|--------|--------|--------|--------|--------|--------|
| PROGRESSIVE TERRENO | -20.00 | -10.00 | 0.00 | 10.00 | 20.00 | 30.00 | 35.00 |
| QUOTE TERRENO | 335.00 | 336.17 | 337.00 | 337.00 | 337.00 | 337.00 | 337.00 |
| DISTANZE PARZIALI TERRENO | 0.00 | 10.00 | 10.00 | 10.00 | 10.00 | 10.00 | 10.00 |
| PROGRESSIVE PROGETTO | -20.00 | -10.00 | 0.00 | 10.00 | 20.00 | 30.00 | 35.00 |
| QUOTE PROGETTO | 335.00 | 336.17 | 337.00 | 337.00 | 337.00 | 337.00 | 337.00 |
| DISTANZE PARZIALI PROGETTO | 0.00 | 10.00 | 10.00 | 10.00 | 10.00 | 10.00 | 10.00 |

TR_ST127
Sezione 32
Progressiva: 0+636
Scala: 1:200
Quota di Riferimento: 330

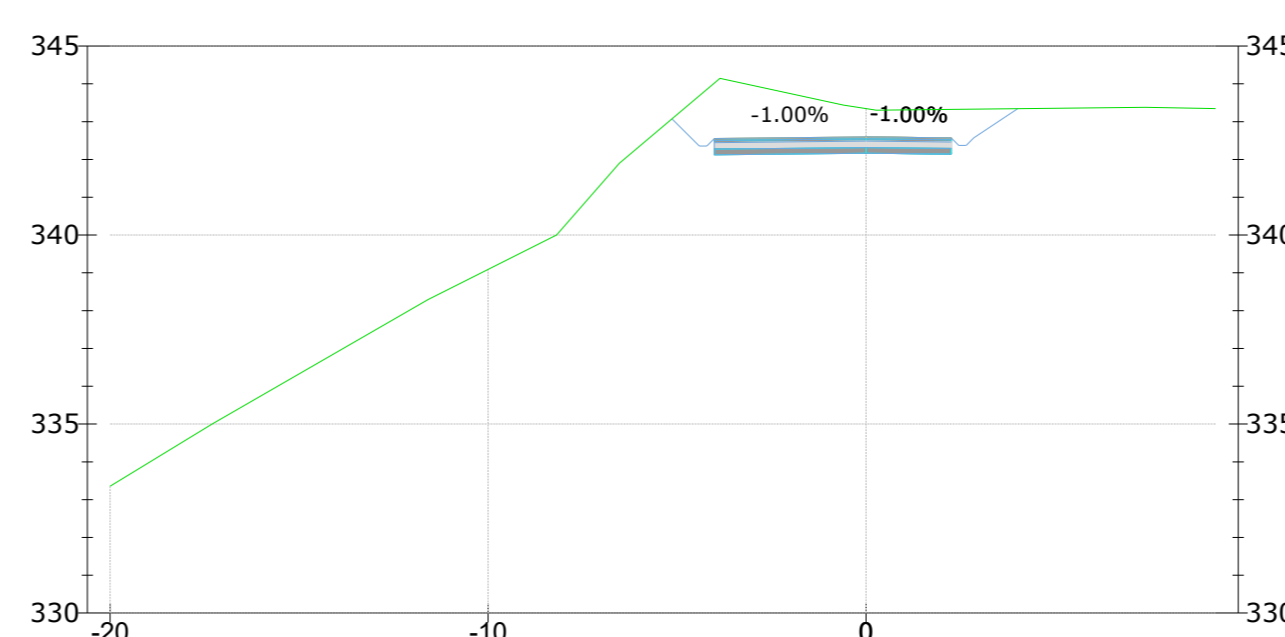

| | | | | | | | |
|----------------------------|--------|--------|--------|--------|--------|--------|--------|
| PROGRESSIVE TERRENO | -20.00 | -10.00 | 0.00 | 10.00 | 20.00 | 30.00 | 35.00 |
| QUOTE TERRENO | 330.00 | 331.00 | 332.00 | 333.00 | 334.00 | 335.00 | 336.00 |
| DISTANZE PARZIALI TERRENO | 0.00 | 10.00 | 10.00 | 10.00 | 10.00 | 10.00 | 10.00 |
| PROGRESSIVE PROGETTO | -20.00 | -10.00 | 0.00 | 10.00 | 20.00 | 30.00 | 35.00 |
| QUOTE PROGETTO | 330.00 | 331.00 | 332.00 | 333.00 | 334.00 | 335.00 | 336.00 |
| DISTANZE PARZIALI PROGETTO | 0.00 | 10.00 | 10.00 | 10.00 | 10.00 | 10.00 | 10.00 |

TR_ST127
Sezione 30
Progressiva: 0+600
Scala: 1:200
Quota di Riferimento: 330

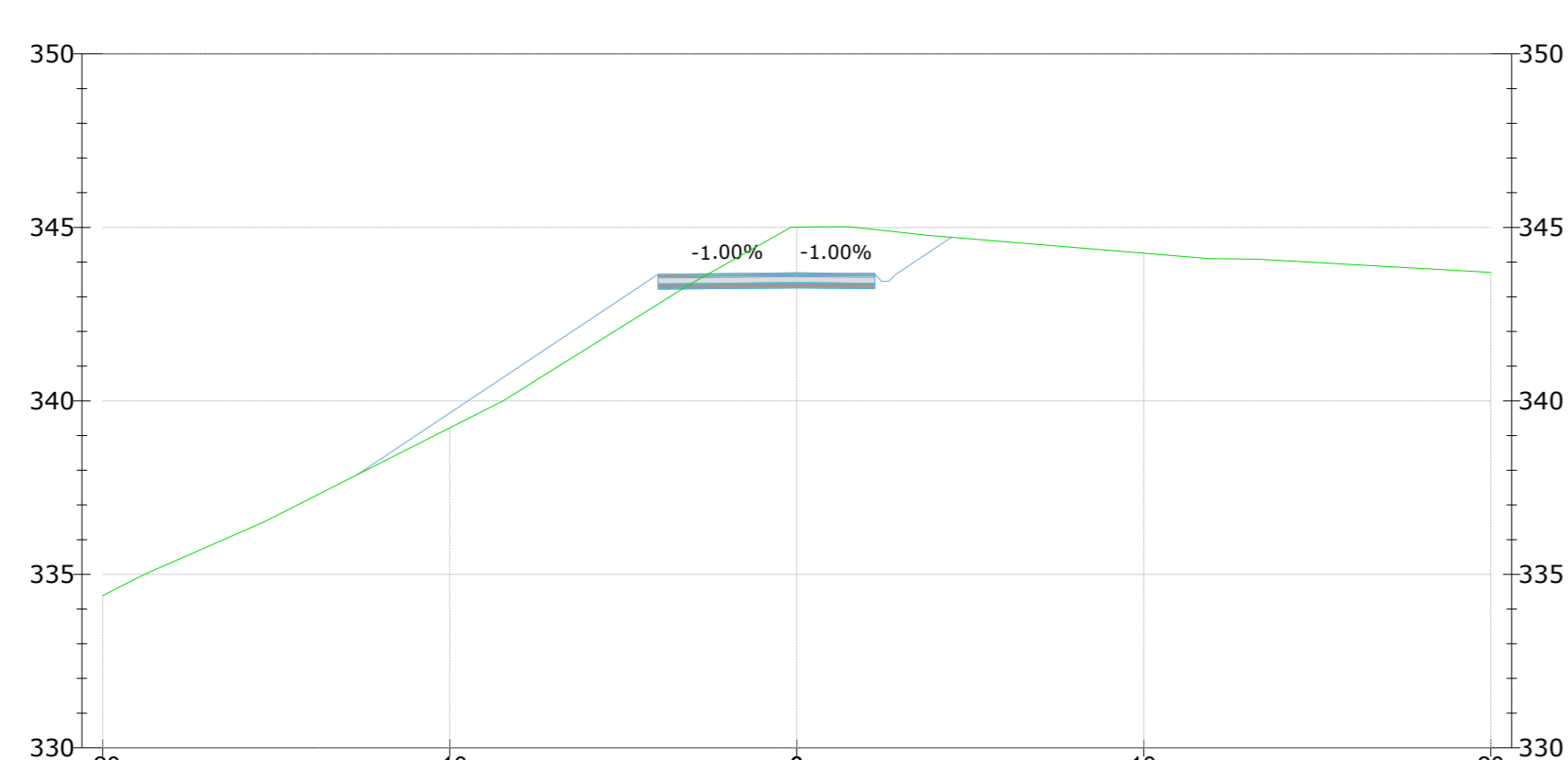

| | | | | | |
|----------------------------|--------|--------|--------|--------|--------|
| PROGRESSIVE TERRENO | -20.00 | -10.00 | 0.00 | 10.00 | 20.00 |
| QUOTE TERRENO | 330.00 | 331.00 | 332.00 | 333.00 | 334.00 |
| DISTANZE PARZIALI TERRENO | 0.00 | 10.00 | 10.00 | 10.00 | 10.00 |
| PROGRESSIVE PROGETTO | -20.00 | -10.00 | 0.00 | 10.00 | 20.00 |
| QUOTE PROGETTO | 330.00 | 331.00 | 332.00 | 333.00 | 334.00 |
| DISTANZE PARZIALI PROGETTO | 0.00 | 10.00 | 10.00 | 10.00 | 10.00 |

TR_ST127
Sezione 33
Progressiva: 0+660
Scala: 1:200
Quota di Riferimento: 330

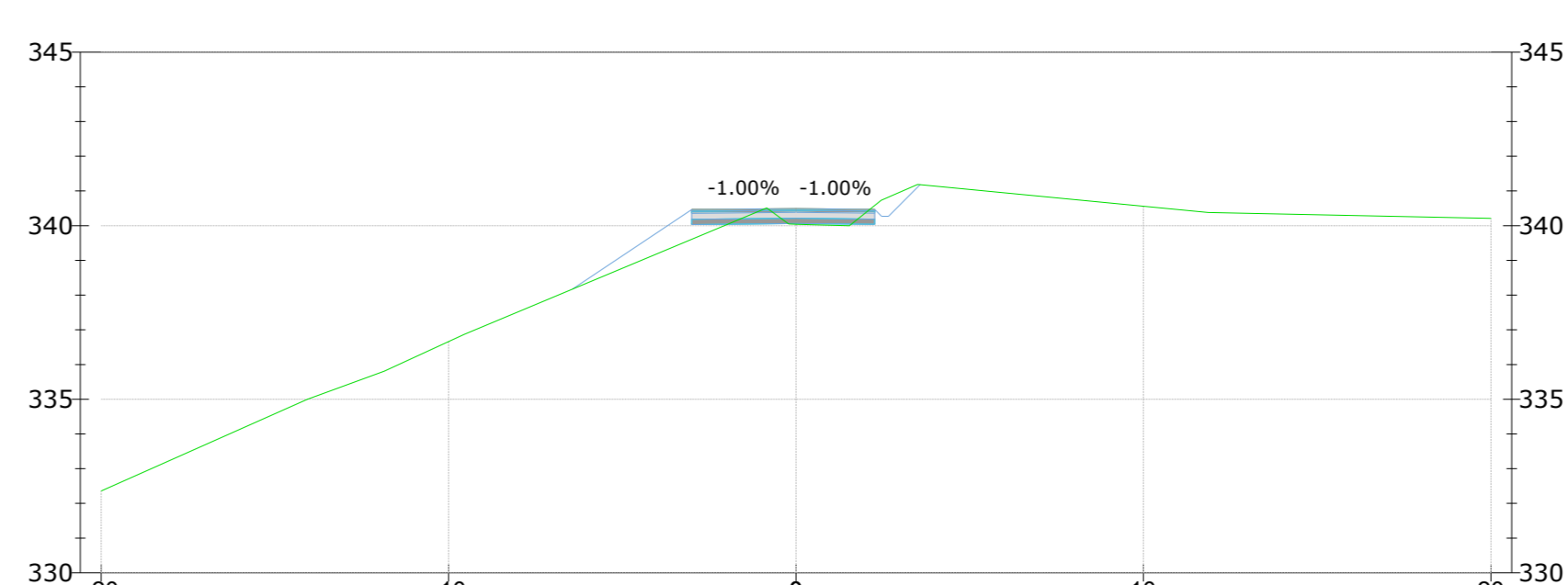

| | | | | | |
|----------------------------|--------|--------|--------|--------|--------|
| PROGRESSIVE TERRENO | -20.00 | -10.00 | 0.00 | 10.00 | 20.00 |
| QUOTE TERRENO | 330.00 | 331.00 | 332.00 | 333.00 | 334.00 |
| DISTANZE PARZIALI TERRENO | 0.00 | 10.00 | 10.00 | 10.00 | 10.00 |
| PROGRESSIVE PROGETTO | -20.00 | -10.00 | 0.00 | 10.00 | 20.00 |
| QUOTE PROGETTO | 330.00 | 331.00 | 332.00 | 333.00 | 334.00 |
| DISTANZE PARZIALI PROGETTO | 0.00 | 10.00 | 10.00 | 10.00 | 10.00 |

TR_ST127
Sezione 31
Progressiva: 0+620
Scala: 1:200
Quota di Riferimento: 330

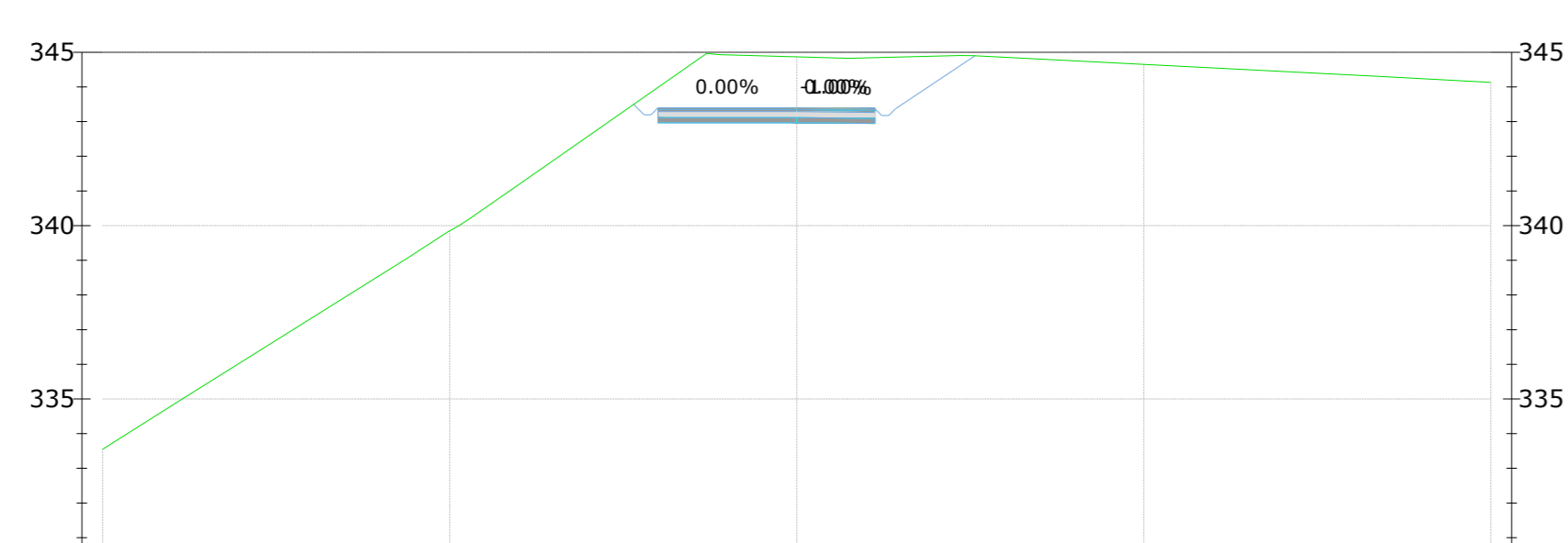

| | | | | | |
|----------------------------|--------|--------|--------|--------|--------|
| PROGRESSIVE TERRENO | -20.00 | -10.00 | 0.00 | 10.00 | 20.00 |
| QUOTE TERRENO | 330.00 | 331.00 | 332.00 | 333.00 | 334.00 |
| DISTANZE PARZIALI TERRENO | 0.00 | 10.00 | 10.00 | 10.00 | 10.00 |
| PROGRESSIVE PROGETTO | -20.00 | -10.00 | 0.00 | 10.00 | 20.00 |
| QUOTE PROGETTO | 330.00 | 331.00 | 332.00 | 333.00 | 334.00 |
| DISTANZE PARZIALI PROGETTO | 0.00 | 10.00 | 10.00 | 10.00 | 10.00 |

TR_ST127
Sezione 34
Progressiva: 0+680
Scala: 1:200
Quota di Riferimento: 330

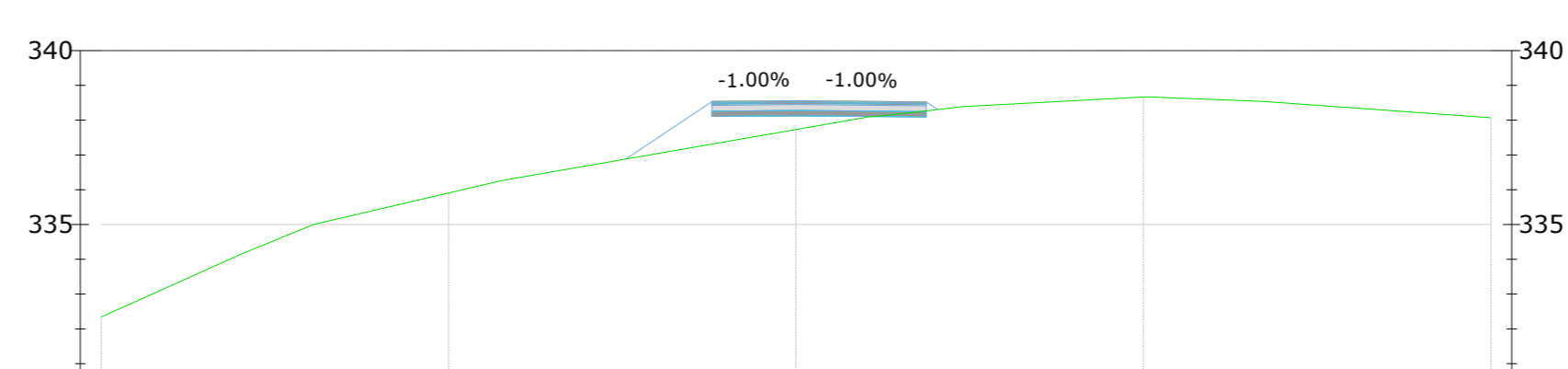

| | | | | | |
|----------------------------|--------|--------|--------|--------|--------|
| PROGRESSIVE TERRENO | -20.00 | -10.00 | 0.00 | 10.00 | 20.00 |
| QUOTE TERRENO | 330.00 | 331.00 | 332.00 | 333.00 | 334.00 |
| DISTANZE PARZIALI TERRENO | 0.00 | 10.00 | 10.00 | 10.00 | 10.00 |
| PROGRESSIVE PROGETTO | -20.00 | -10.00 | 0.00 | 10.00 | 20.00 |
| QUOTE PROGETTO | 330.00 | 331.00 | 332.00 | 333.00 | 334.00 |
| DISTANZE PARZIALI PROGETTO | 0.00 | 10.00 | 10.00 | 10.00 | 10.00 |

green & green
WE ENGINEERING

Green & Green S.r.l.
Via Edmondo de Amicis n.64
87036 Rende (CS) - Italy
P.IVA 02900010782
Ph. (+39) 0984 846295
Fax (+39) 0984 121440
info@greengreen.it
www.greengreen.it

Il tecnico
Ing. Leonardo Sblendido

| | | | | | |
|------|------------|-----------------|-------------|-------------|--------------|
| 00 | 22/12/2023 | PRIMA EMISSIONE | R. De Fiore | P. E. | L. Sblendido |
| REV. | DATA | DESCRIZIONE | PREPARIATO | CONTROLLATO | APPROVATO |

"IMPIANTO EOLICO TERRANOVA DA SIBARI"
(COMUNI DI TERRANOVA DA SIBARI, SAN DEMETRIO CORONE, SPEZZANO ALBANESE, CORIGLIANO-ROSSANO, SANTA SOFIA D'EPSIRO E TARSIA (CS))

hergo

PROGETTO: DEFINITIVO

NOTE FILE: C23FSTR0011WD01000_STUDIO_PLANOALTIMETRICO.pdf

FORMATO: A0 | SCALA: 1:200 | SCALA PLOT: 1:1 | FOGLIO: 5 di 39

TITOLO: STUDIO PLANOALTIMETRICO

CODICE ELABORATO: C23FSTR002WD01000

green & green
WE ENGINEERING

TR_ST127
Sezione 35
Progressiva: 0+700
Scala: 1:200
Quota di Riferimento: 335

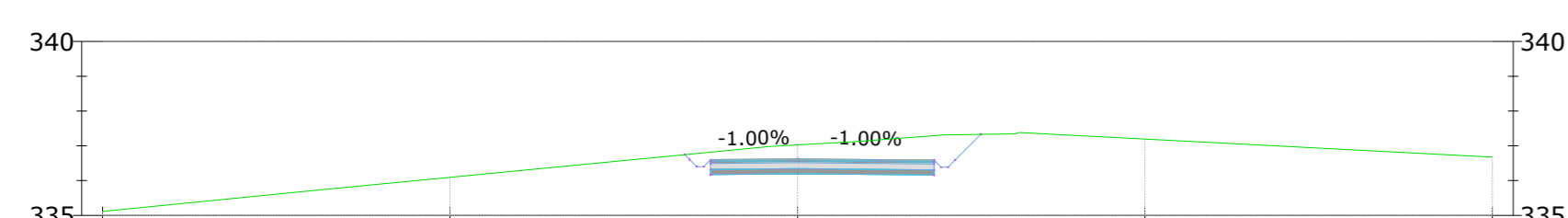

| | | | | | |
|----------------------------|--------|--------|--------|--------|--------|
| PROGRESSIVE TERRENO | -20.00 | -10.00 | 0.00 | 10.00 | 20.00 |
| QUOTE TERRENO | 335.17 | 335.66 | 336.15 | 336.64 | 337.13 |
| DISTANZE PARZIALI TERRENO | 5.94 | 10.00 | 10.00 | 10.00 | 10.00 |
| PROGRESSIVE PROGETTO | -20.00 | -10.00 | 0.00 | 10.00 | 20.00 |
| QUOTE PROGETTO | 335.17 | 335.66 | 336.15 | 336.64 | 337.13 |
| DISTANZE PARZIALI PROGETTO | 5.94 | 10.00 | 10.00 | 10.00 | 10.00 |

TR_ST127
Sezione 39
Progressiva: 0+780
Scala: 1:200
Quota di Riferimento: 325

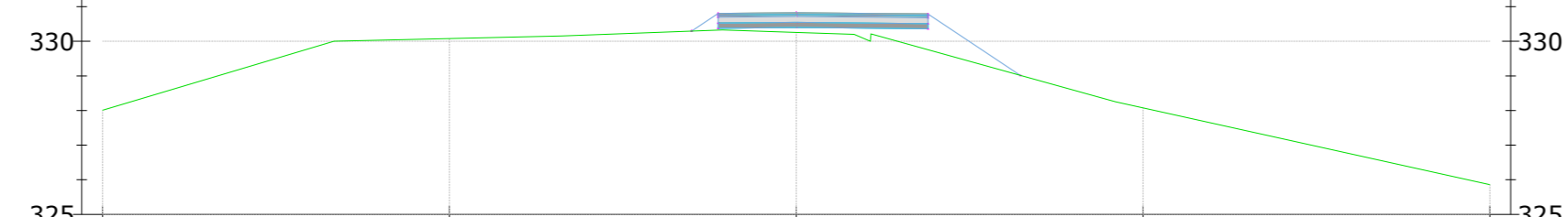

| | | | | | |
|----------------------------|--------|--------|--------|--------|--------|
| PROGRESSIVE TERRENO | -20.00 | -10.00 | 0.00 | 10.00 | 20.00 |
| QUOTE TERRENO | 325.07 | 325.56 | 326.05 | 326.54 | 327.03 |
| DISTANZE PARZIALI TERRENO | 6.67 | 10.00 | 10.00 | 10.00 | 10.00 |
| PROGRESSIVE PROGETTO | -20.00 | -10.00 | 0.00 | 10.00 | 20.00 |
| QUOTE PROGETTO | 325.07 | 325.56 | 326.05 | 326.54 | 327.03 |
| DISTANZE PARZIALI PROGETTO | 6.67 | 10.00 | 10.00 | 10.00 | 10.00 |

TR_ST127
Sezione 43
Progressiva: 0+860
Scala: 1:200
Quota di Riferimento: 320

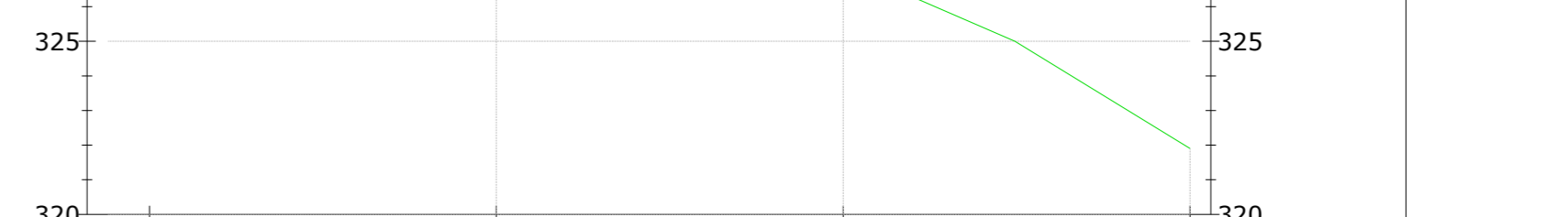

| | | | | | |
|----------------------------|--------|--------|--------|--------|--------|
| PROGRESSIVE TERRENO | -20.00 | -10.00 | 0.00 | 10.00 | 20.00 |
| QUOTE TERRENO | 320.17 | 320.66 | 321.15 | 321.64 | 322.13 |
| DISTANZE PARZIALI TERRENO | 5.94 | 10.00 | 10.00 | 10.00 | 10.00 |
| PROGRESSIVE PROGETTO | -20.00 | -10.00 | 0.00 | 10.00 | 20.00 |
| QUOTE PROGETTO | 320.17 | 320.66 | 321.15 | 321.64 | 322.13 |
| DISTANZE PARZIALI PROGETTO | 5.94 | 10.00 | 10.00 | 10.00 | 10.00 |

TR_ST127
Sezione 36
Progressiva: 0+720
Scala: 1:200
Quota di Riferimento: 330

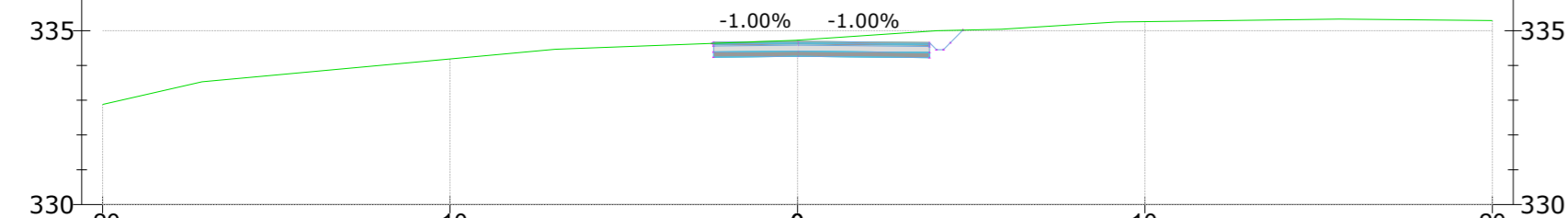

| | | | | | |
|----------------------------|--------|--------|--------|--------|--------|
| PROGRESSIVE TERRENO | -20.00 | -10.00 | 0.00 | 10.00 | 20.00 |
| QUOTE TERRENO | 330.08 | 330.57 | 331.06 | 331.55 | 332.04 |
| DISTANZE PARZIALI TERRENO | 2.98 | 10.00 | 10.00 | 10.00 | 10.00 |
| PROGRESSIVE PROGETTO | -20.00 | -10.00 | 0.00 | 10.00 | 20.00 |
| QUOTE PROGETTO | 330.08 | 330.57 | 331.06 | 331.55 | 332.04 |
| DISTANZE PARZIALI PROGETTO | 2.98 | 10.00 | 10.00 | 10.00 | 10.00 |

TR_ST127
Sezione 40
Progressiva: 0+800
Scala: 1:200
Quota di Riferimento: 325

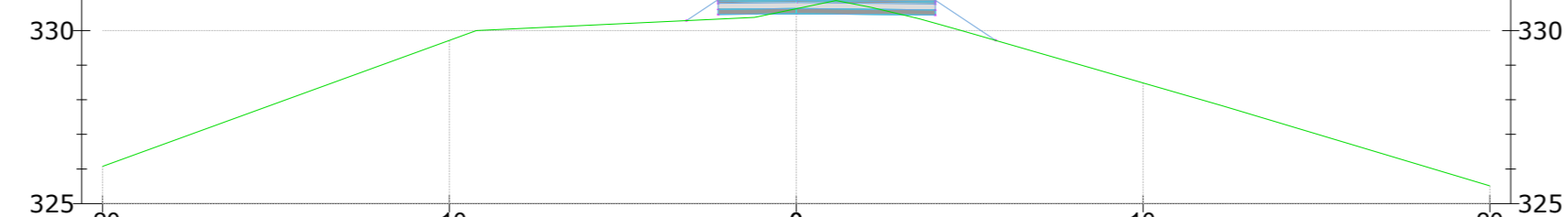

| | | | | | |
|----------------------------|--------|--------|--------|--------|--------|
| PROGRESSIVE TERRENO | -20.00 | -10.00 | 0.00 | 10.00 | 20.00 |
| QUOTE TERRENO | 325.07 | 325.56 | 326.05 | 326.54 | 327.03 |
| DISTANZE PARZIALI TERRENO | 6.67 | 10.00 | 10.00 | 10.00 | 10.00 |
| PROGRESSIVE PROGETTO | -20.00 | -10.00 | 0.00 | 10.00 | 20.00 |
| QUOTE PROGETTO | 325.07 | 325.56 | 326.05 | 326.54 | 327.03 |
| DISTANZE PARZIALI PROGETTO | 6.67 | 10.00 | 10.00 | 10.00 | 10.00 |

TR_ST127
Sezione 44
Progressiva: 0+880
Scala: 1:200
Quota di Riferimento: 320



| | | | | | |
|----------------------------|--------|--------|--------|--------|--------|
| PROGRESSIVE TERRENO | -20.00 | -10.00 | 0.00 | 10.00 | 20.00 |
| QUOTE TERRENO | 320.17 | 320.66 | 321.15 | 321.64 | 322.13 |
| DISTANZE PARZIALI TERRENO | 5.94 | 10.00 | 10.00 | 10.00 | 10.00 |
| PROGRESSIVE PROGETTO | -20.00 | -10.00 | 0.00 | 10.00 | 20.00 |
| QUOTE PROGETTO | 320.17 | 320.66 | 321.15 | 321.64 | 322.13 |
| DISTANZE PARZIALI PROGETTO | 5.94 | 10.00 | 10.00 | 10.00 | 10.00 |

TR_ST127
Sezione 37
Progressiva: 0+740
Scala: 1:200
Quota di Riferimento: 330

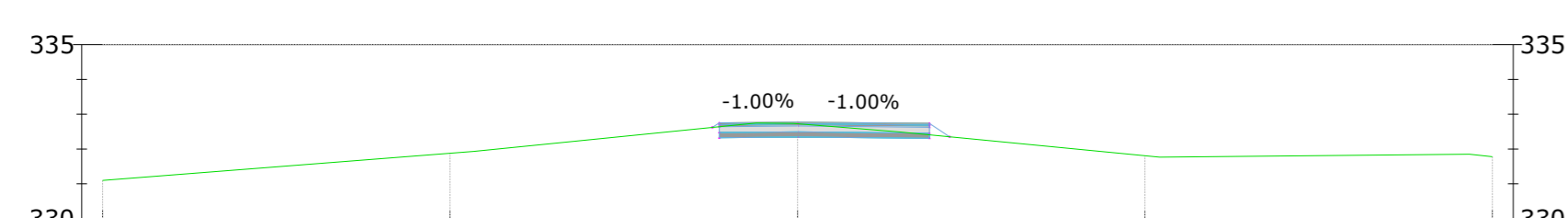

| | | | | | |
|----------------------------|--------|--------|--------|--------|--------|
| PROGRESSIVE TERRENO | -20.00 | -10.00 | 0.00 | 10.00 | 20.00 |
| QUOTE TERRENO | 330.16 | 330.65 | 331.14 | 331.63 | 332.12 |
| DISTANZE PARZIALI TERRENO | 6.67 | 10.00 | 10.00 | 10.00 | 10.00 |
| PROGRESSIVE PROGETTO | -20.00 | -10.00 | 0.00 | 10.00 | 20.00 |
| QUOTE PROGETTO | 330.16 | 330.65 | 331.14 | 331.63 | 332.12 |
| DISTANZE PARZIALI PROGETTO | 6.67 | 10.00 | 10.00 | 10.00 | 10.00 |

TR_ST127
Sezione 41
Progressiva: 0+820
Scala: 1:200
Quota di Riferimento: 320

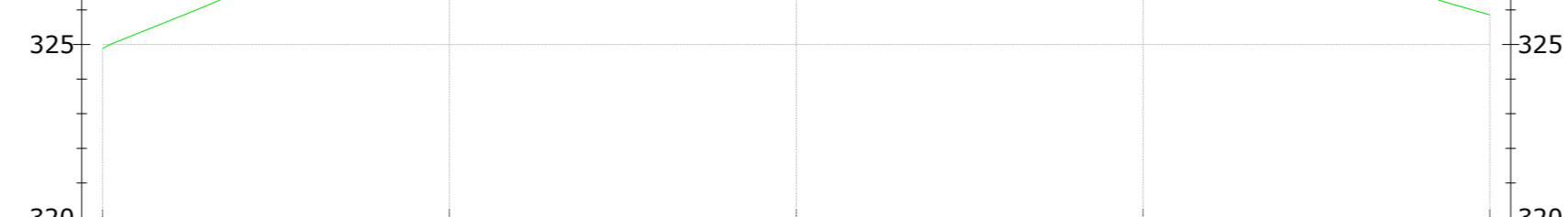

| | | | | | |
|----------------------------|--------|--------|--------|--------|--------|
| PROGRESSIVE TERRENO | -20.00 | -10.00 | 0.00 | 10.00 | 20.00 |
| QUOTE TERRENO | 320.16 | 320.65 | 321.14 | 321.63 | 322.12 |
| DISTANZE PARZIALI TERRENO | 2.47 | 10.00 | 10.00 | 10.00 | 10.00 |
| PROGRESSIVE PROGETTO | -20.00 | -10.00 | 0.00 | 10.00 | 20.00 |
| QUOTE PROGETTO | 320.16 | 320.65 | 321.14 | 321.63 | 322.12 |
| DISTANZE PARZIALI PROGETTO | 2.47 | 10.00 | 10.00 | 10.00 | 10.00 |

TR_ST127
Sezione 45
Progressiva: 0+900
Scala: 1:200
Quota di Riferimento: 320



| | | | | | |
|----------------------------|--------|--------|--------|--------|--------|
| PROGRESSIVE TERRENO | -20.00 | -10.00 | 0.00 | 10.00 | 20.00 |
| QUOTE TERRENO | 320.16 | 320.65 | 321.14 | 321.63 | 322.12 |
| DISTANZE PARZIALI TERRENO | 2.47 | 10.00 | 10.00 | 10.00 | 10.00 |
| PROGRESSIVE PROGETTO | -20.00 | -10.00 | 0.00 | 10.00 | 20.00 |
| QUOTE PROGETTO | 320.16 | 320.65 | 321.14 | 321.63 | 322.12 |
| DISTANZE PARZIALI PROGETTO | 2.47 | 10.00 | 10.00 | 10.00 | 10.00 |

TR_ST127
Sezione 38
Progressiva: 0+760
Scala: 1:200
Quota di Riferimento: 325

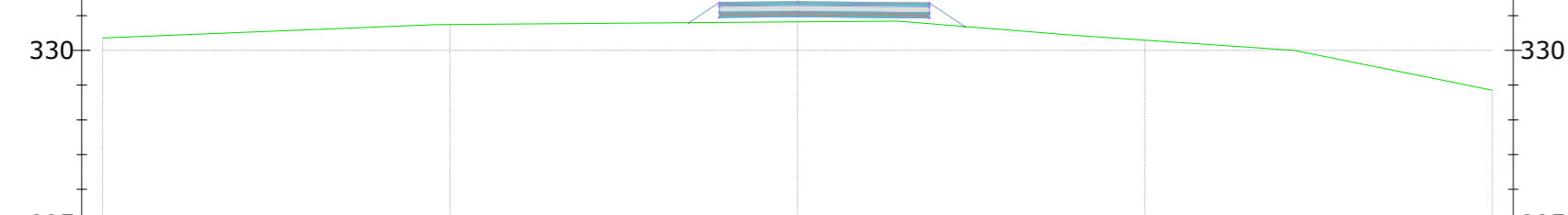

| | | | | | |
|----------------------------|--------|--------|--------|--------|--------|
| PROGRESSIVE TERRENO | -20.00 | -10.00 | 0.00 | 10.00 | 20.00 |
| QUOTE TERRENO | 325.15 | 325.64 | 326.13 | 326.62 | 327.11 |
| DISTANZE PARZIALI TERRENO | 6.67 | 10.00 | 10.00 | 10.00 | 10.00 |
| PROGRESSIVE PROGETTO | -20.00 | -10.00 | 0.00 | 10.00 | 20.00 |
| QUOTE PROGETTO | 325.15 | 325.64 | 326.13 | 326.62 | 327.11 |
| DISTANZE PARZIALI PROGETTO | 6.67 | 10.00 | 10.00 | 10.00 | 10.00 |

TR_ST127
Sezione 42
Progressiva: 0+840
Scala: 1:200
Quota di Riferimento: 320



| | | | | | |
|----------------------------|--------|--------|--------|--------|--------|
| PROGRESSIVE TERRENO | -20.00 | -10.00 | 0.00 | 10.00 | 20.00 |
| QUOTE TERRENO | 320.16 | 320.65 | 321.14 | 321.63 | 322.12 |
| DISTANZE PARZIALI TERRENO | 2.47 | 10.00 | 10.00 | 10.00 | 10.00 |
| PROGRESSIVE PROGETTO | -20.00 | -10.00 | 0.00 | 10.00 | 20.00 |
| QUOTE PROGETTO | 320.16 | 320.65 | 321.14 | 321.63 | 322.12 |
| DISTANZE PARZIALI PROGETTO | 2.47 | 10.00 | 10.00 | 10.00 | 10.00 |

TR_ST127
Sezione 46
Progressiva: 0+920
Scala: 1:200
Quota di Riferimento: 325

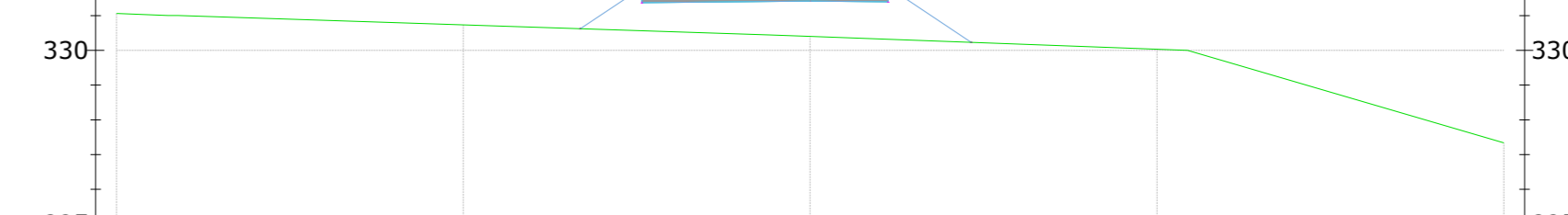

| | | | | | |
|----------------------------|--------|--------|--------|--------|--------|
| PROGRESSIVE TERRENO | -20.00 | -10.00 | 0.00 | 10.00 | 20.00 |
| QUOTE TERRENO | 325.15 | 325.64 | 326.13 | 326.62 | 327.11 |
| DISTANZE PARZIALI TERRENO | 6.67 | 10.00 | 10.00 | 10.00 | 10.00 |
| PROGRESSIVE PROGETTO | -20.00 | -10.00 | 0.00 | 10.00 | 20.00 |
| QUOTE PROGETTO | 325.15 | 325.64 | 326.13 | 326.62 | 327.11 |
| DISTANZE PARZIALI PROGETTO | 6.67 | 10.00 | 10.00 | 10.00 | 10.00 |

LEGENDA DEI COLORI E SIMBOLI IN CARTA



Green & Green S.r.l.
Via Edmondo de Amicis n.64
37036 Ronde (CS) - Italy
P.IVA 02900010782
Ph. (+39) 0984 846295
E-mail (+39) 0984 1214470
info@greengreen.it
www.greengreen.it

Il tecnico
Ing. Leonardo Sblendido



| | | | | | |
|-----|------------|-----------------|-------------|-------------|--------------|
| 00 | 22/12/2023 | PRIMA EMISSIONE | R. De Fiore | P. E. | L. Sblendido |
| REV | DATA | DESCRIZIONE | PREPARATO | CONTROLLATO | APPROVATO |

"IMPIANTO EOLICO TERRANOVA DA SIBARI"
(COMUNI DI TERRANOVA DA SIBARI, SAN DEMETRIO CORONE, SPEZZANO ALBANESE, CORIGLIANO-ROSSANO, SANTA SOFIA D'EPSIRO E TARSIA (CS))

| | | | | | | | | | |
|--------------------|---|--------|-------|-------------|-----|--------|---|----|----|
| PROGETTO | DEFINITIVO | | | | | | | | |
| WORK FILE | CZ3FSTR0011WD01000_STUDIO PLANALTIMETRICO.pdf | | | | | | | | |
| FORMATO | A0 | SCALA: | 1:200 | SCALA PLOT: | 1:1 | FOGLIO | 6 | di | 39 |
| TITOLO: | STUDIO PLANALTIMETRICO | | | | | | | | |
| CODICE ELABORATO | | | | | | | | | |
| C23FSTR0012WD01000 | | | | | | | | | |

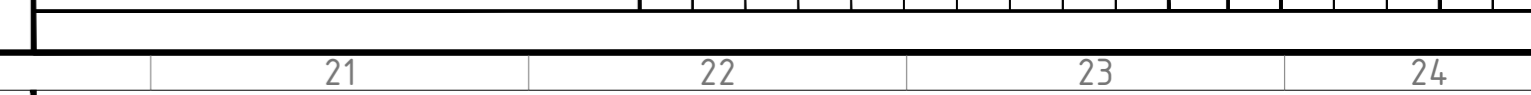



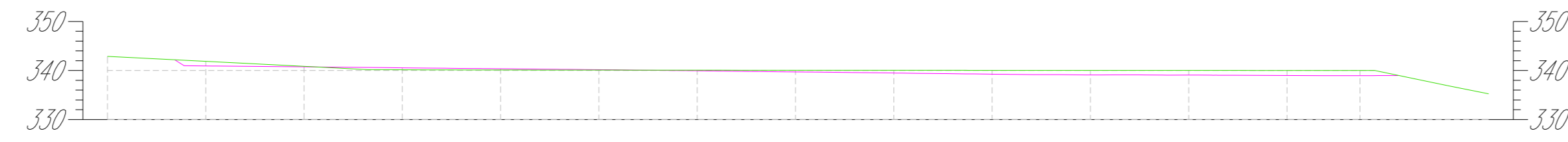



Profilo: TrArea10
 Scala: 1000:1000
 Q. Alt.: 330 mslm

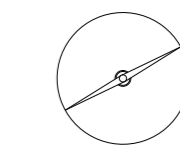

| NUMERO SEZIONE | 1 | 2 | 3 | 4 | 5 | 6 | 7 | 8 | 9 | 10 | 11 | 12 | 13 | 14 |
|----------------------|-------|-------|-------|-------|-------|-------|-------|-------|-------|-------|-------|-------|-------|-------|
| DISTANZE PROGRESSIVE | 0+000 | 0+020 | 0+040 | 0+060 | 0+080 | 0+100 | 0+120 | 0+140 | 0+160 | 0+180 | 0+200 | 0+220 | 0+240 | 0+255 |
| QUOTE TERRENO | 340,9 | 341,9 | 340,9 | 340,2 | 340,1 | 340,1 | 340,1 | 340,1 | 340,1 | 340,0 | 340,0 | 340,0 | 340,0 | 340,0 |
| QUOTE PROGETTO | | 340,9 | 340,1 | 340,6 | 340,4 | 340,2 | 339,9 | 339,7 | 339,5 | 339,1 | 339,1 | 339,1 | 339,0 | 339,0 |
| DIFFERENZA QUOTE | | -0,9 | -0,1 | 0,4 | 0,3 | 0,1 | -0,1 | -0,2 | -0,6 | -0,9 | -0,9 | -1,0 | -1,0 | -1,0 |

LEGENDA DEI COLORI E SIMBOLI IN CARTA

-  Aerogeneratore (Diametro = 163 m, Hhub = 125 m)
-  Piazzaola
-  Profilo Piazzaola
-  Profilo terreno
-  Strade esistenti da adeguare
-  Strade di nuova realizzazione
-  Livellotta
-  Cavdotto 36 kV
-  Scavi
-  Riporti
-  Curva di livello principale (intervalli di 10 m)
- Quota terreno
-  Curva di livello secondaria (intervalli di 2 m)
- Quota terreno

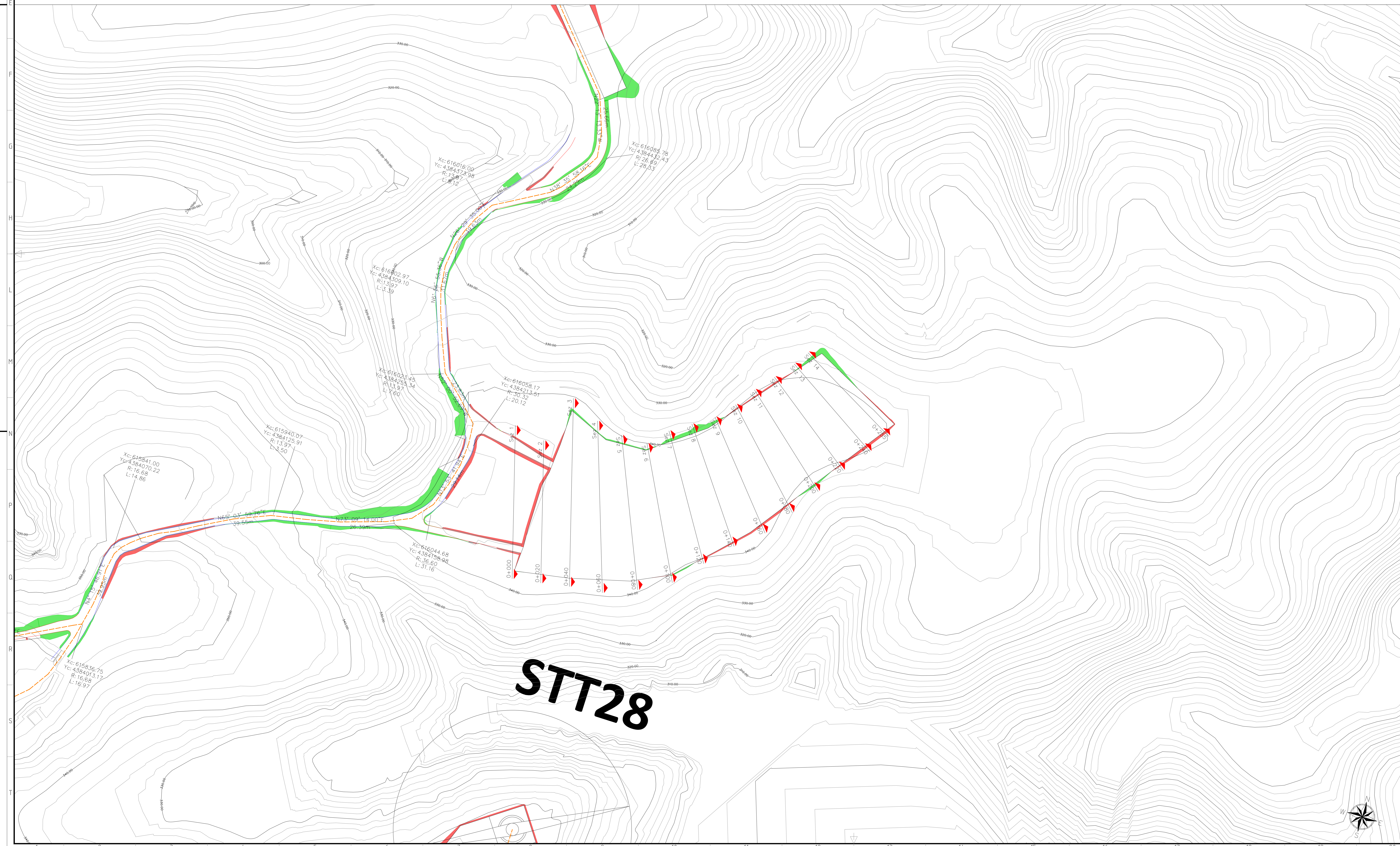

green & green
 WE ENGINEERING
 Green & Green S.r.l.
 Via Edmondo de Amicis n.64
 37026 Ronde (CS) - Italy
 P.IVA 0290010782
 Ph. (+39) 0984 846295
 Fax (+39) 0984 121470
 info@greengreen.it
 www.greengreen.it

Il tecnico
Ing. Leonardo Sblendido

| REV. | DATA | DESCRIZIONE | PREPARATO | CONTROLLATO | APPROVATO |
|------|------------|-----------------|-------------|-------------|--------------|
| 00 | 22/12/2023 | PRIMA EMISSIONE | R. De Fiore | P. E. | L. Sblendido |

"IMPIANTO EOLICO TERRANOVA DA SIBARI"
 (COMUNI DI TERRANOVA DA SIBARI, SAN DEMETRIO CORONE, SPEZZANO ALBANESE, CORIGLIANO-ROSSANO, SANTA SOFIA D'EPSIRO E TARSIA (CS))

| | | | | |
|---|---|--------------------|----------------------|------------------------|
|  | PROGETTO: DEFINITIVO | | | |
| | NOTE FILE: CZ3FSTR001\WD01000_STUDIO PLANOALTIMETRICO.pdf | FORMATO: A0 | SCALA: 1:1000 | SCALA PLOT: 1:1 |
|  | TITOLO: STUDIO PLANOALTIMETRICO | | | |
| | CODICE ELABORATO: C23FSTR002WD01000 | | | |

TRAREA10
Sezione 1
Progressiva: 0+000
Scala: 1:200
Quota di Riferimento: 340

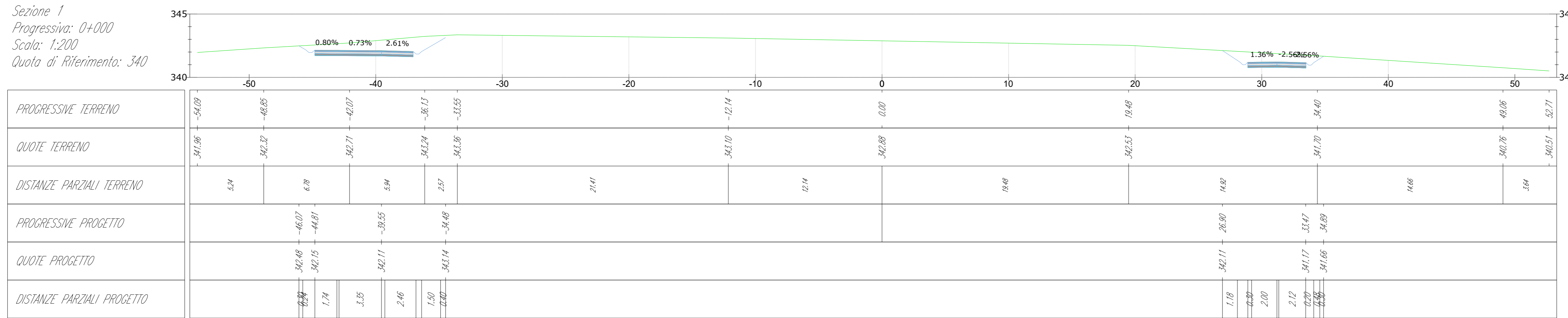

TRAREA10
Sezione 2
Progressiva: 0+020
Scala: 1:200
Quota di Riferimento: 340

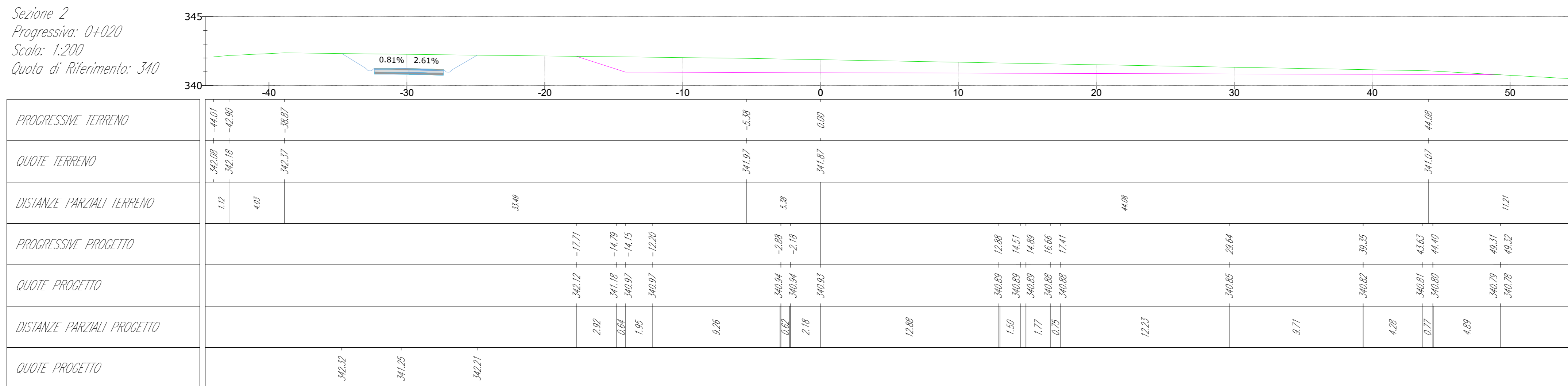

TRAREA10
Sezione 3
Progressiva: 0+040
Scala: 1:200
Quota di Riferimento: 340

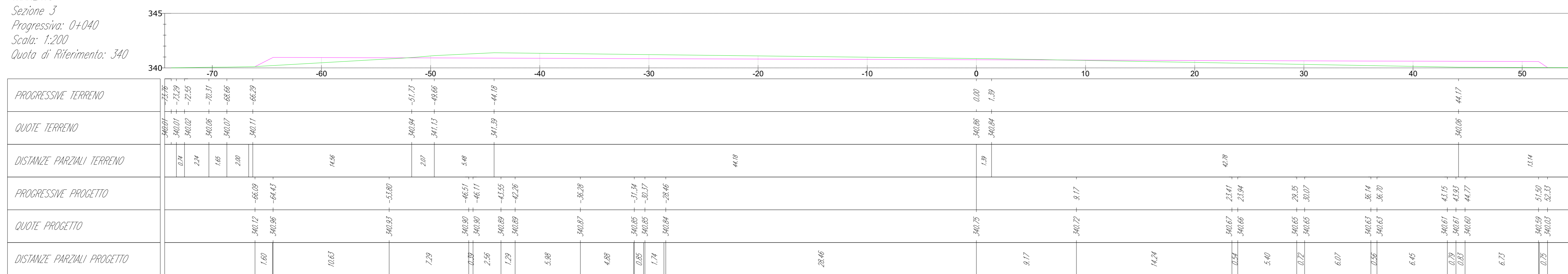

TRAREA10
Sezione 4
Progressiva: 0+060
Scala: 1:200
Quota di Riferimento: 340

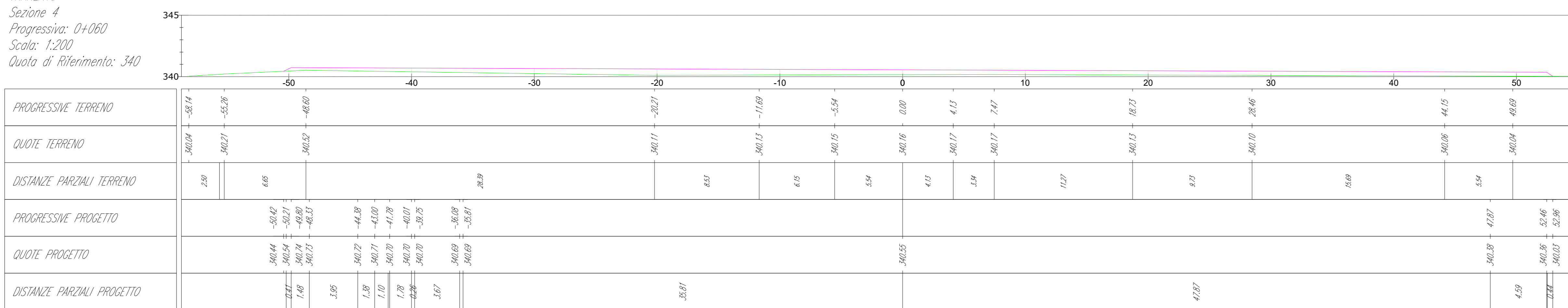

TRAREA10
Sezione 5
Progressiva: 0+080
Scala: 1:200
Quota di Riferimento: 335

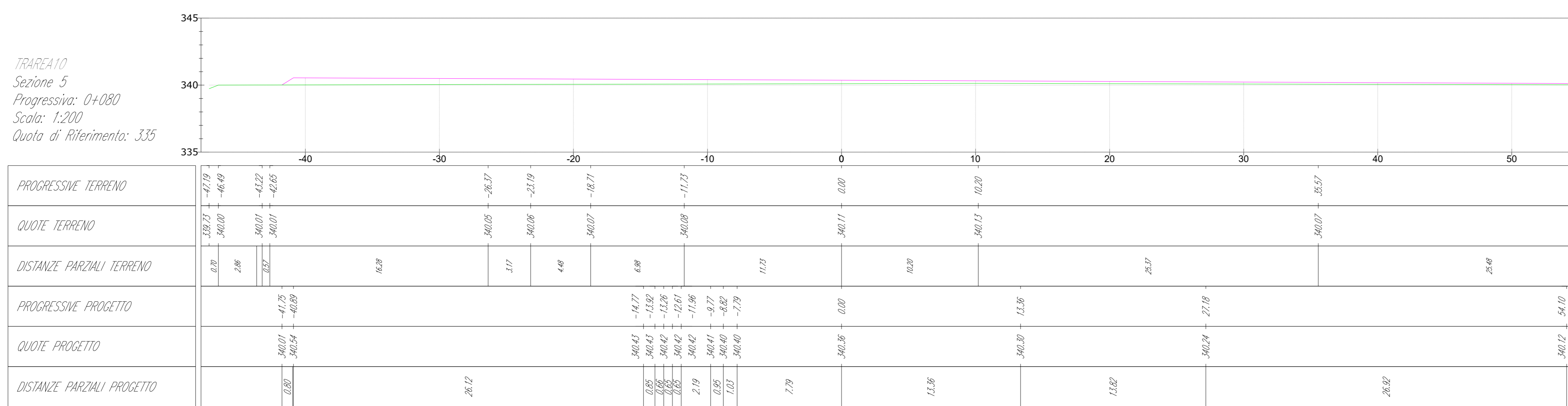

LEGGENDA DEI COLORI E SIMBOLI IN CARTA

- Profilo terreno
- Profilo Piazzola

green & green
WE ENGINEERING

Green & Green S.r.l.
Via Edmondo de Amicis n.64
37036 Ronde (CS) - Italy
P.IVA 02900010782
Ph. (+39) 0984 846295
Fax (+39) 0984 121440
info@greeneng.it
www.greeneng.it

Il tecnico
Ing. Leonardo Sblendido

| | | | | | |
|------|------------|-----------------|-------------|-------------|--------------|
| 00 | 22/12/2023 | PRIMA EMISSIONE | R. De Fiore | P. E. | L. Sblendido |
| REV. | DATA | DESCRIZIONE | PREPARATO | CONTROLLATO | APPROVATO |

"IMPIANTO EOLICO TERRANOVA DA SIBARI"
(COMUNI DI TERRANOVA DA SIBARI, SAN DEMETRIO CORONE, SPEZZANO ALBANESE, CORIGLIANO-ROSSANO, SANTA SOFIA D'EPSIRO E TARSIA (CS))

hergo

PROGETTO: DEFINITIVO

FILE: CZ3FSTR0011WD01000_STUDIO PLANOALTIMETRICO.pdf

| | | | |
|-------------|--------------|-----------------|-----------------|
| FORMATO: A0 | SCALA: 1:200 | SCALA PLOT: 1:1 | FOGLIO: 9 di 39 |
|-------------|--------------|-----------------|-----------------|

TITOLO: STUDIO PLANOALTIMETRICO

green & green
WE ENGINEERING

| | | | | | | | | | | | | | | | |
|---------|-----|-----|-------------|-----------|---|---|---|---|---|---|---|---|---|---|---|
| C | 2 | 3 | F | S | T | R | 0 | 0 | 2 | W | D | 0 | 1 | 0 | 0 |
| IMPVITO | TRC | TRG | PROGRESSIVO | REVISIONE | | | | | | | | | | | |

- Profilo terreno
- Profilo Piazzola

TRARCA10
Sezione 6
Progressiva: 0+100
Scala: 1:200
Quota di Riferimento: 335

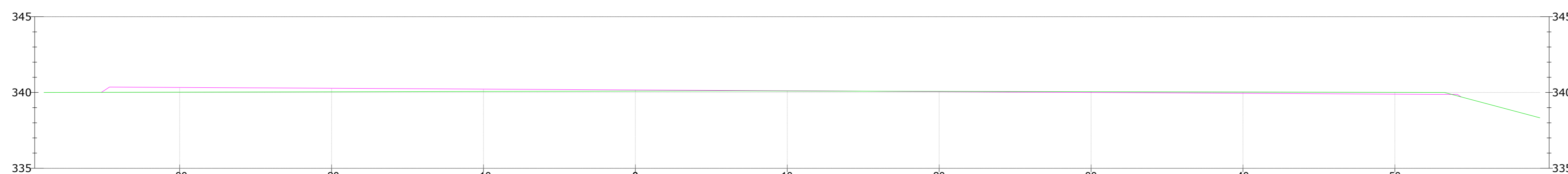

| | | | | | | | |
|----------------------------|--------|--------|--------|--------|--------|--------|--------|
| PROGRESSIVE TERRENO | 0+00 | 0+10 | 0+20 | 0+30 | 0+40 | 0+50 | 0+55 |
| QUOTE TERRENO | 340.00 | 340.02 | 340.00 | 340.00 | 340.11 | 340.00 | 339.57 |
| DISTANZE PARZIALI TERRENO | | 8.01 | 8.01 | 8.01 | 8.01 | 8.01 | 4.95 |
| PROGRESSIVE PROGETTO | 0+00 | 0+10 | 0+20 | 0+30 | 0+40 | 0+50 | 0+55 |
| QUOTE PROGETTO | 340.00 | 340.00 | 340.00 | 340.00 | 340.00 | 340.00 | 339.57 |
| DISTANZE PARZIALI PROGETTO | | 8.01 | 8.01 | 8.01 | 8.01 | 8.01 | 4.95 |

TRARCA10
Sezione 7
Progressiva: 0+120
Scala: 1:200
Quota di Riferimento: 335

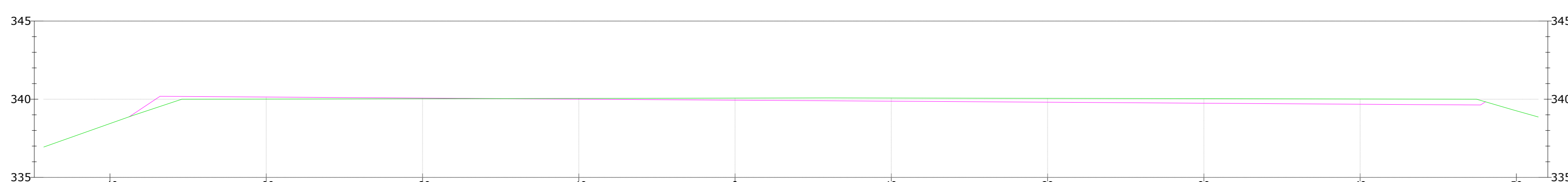

| | | | | | | | |
|----------------------------|--------|--------|--------|--------|--------|--------|--------|
| PROGRESSIVE TERRENO | 0+00 | 0+10 | 0+20 | 0+30 | 0+40 | 0+50 | 0+55 |
| QUOTE TERRENO | 339.84 | 339.84 | 340.00 | 340.00 | 340.00 | 340.00 | 339.88 |
| DISTANZE PARZIALI TERRENO | 5.67 | 5.17 | 8.01 | 8.01 | 8.01 | 8.01 | 4.95 |
| PROGRESSIVE PROGETTO | 0+00 | 0+10 | 0+20 | 0+30 | 0+40 | 0+50 | 0+55 |
| QUOTE PROGETTO | 339.87 | 339.87 | 340.00 | 340.00 | 340.00 | 340.00 | 339.88 |
| DISTANZE PARZIALI PROGETTO | 5.67 | 5.17 | 8.01 | 8.01 | 8.01 | 8.01 | 4.95 |

TRARCA10
Sezione 8
Progressiva: 0+140
Scala: 1:200
Quota di Riferimento: 335

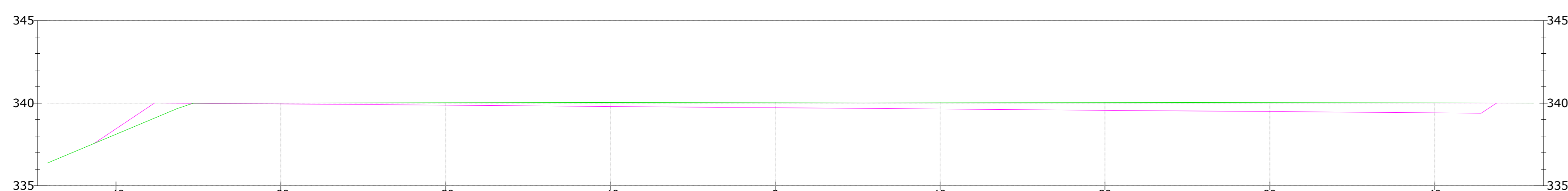

| | | | | | | | |
|----------------------------|--------|--------|--------|--------|--------|--------|--------|
| PROGRESSIVE TERRENO | 0+00 | 0+10 | 0+20 | 0+30 | 0+40 | 0+50 | 0+55 |
| QUOTE TERRENO | 339.88 | 339.87 | 340.00 | 340.00 | 340.00 | 340.00 | 339.88 |
| DISTANZE PARZIALI TERRENO | 5.67 | 5.17 | 8.01 | 8.01 | 8.01 | 8.01 | 4.95 |
| PROGRESSIVE PROGETTO | 0+00 | 0+10 | 0+20 | 0+30 | 0+40 | 0+50 | 0+55 |
| QUOTE PROGETTO | 339.88 | 339.87 | 340.00 | 340.00 | 340.00 | 340.00 | 339.88 |
| DISTANZE PARZIALI PROGETTO | 5.67 | 5.17 | 8.01 | 8.01 | 8.01 | 8.01 | 4.95 |

TRARCA10
Sezione 9
Progressiva: 0+160
Scala: 1:200
Quota di Riferimento: 335

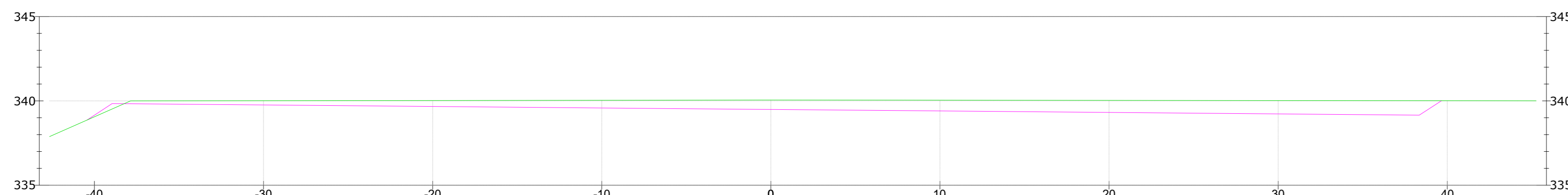

| | | | | | | | |
|----------------------------|--------|--------|--------|--------|--------|--------|--------|
| PROGRESSIVE TERRENO | 0+00 | 0+10 | 0+20 | 0+30 | 0+40 | 0+50 | 0+55 |
| QUOTE TERRENO | 339.88 | 339.87 | 340.00 | 340.00 | 340.00 | 340.00 | 339.88 |
| DISTANZE PARZIALI TERRENO | 5.67 | 5.17 | 8.01 | 8.01 | 8.01 | 8.01 | 4.95 |
| PROGRESSIVE PROGETTO | 0+00 | 0+10 | 0+20 | 0+30 | 0+40 | 0+50 | 0+55 |
| QUOTE PROGETTO | 339.88 | 339.87 | 340.00 | 340.00 | 340.00 | 340.00 | 339.88 |
| DISTANZE PARZIALI PROGETTO | 5.67 | 5.17 | 8.01 | 8.01 | 8.01 | 8.01 | 4.95 |

green & green
WE ENGINEERING
Green & Green S.r.l.
Via Edmondo de Amicis n.64
37036 Ronde (CS) - Italy
P.IVA 02900010782
Ph. (+39) 0984 846295
Fax (+39) 0984 1214470
info@greengreen.it
www.greengreen.it

Il tecnico
Ing. Leonardo Sblendido

| | | | | | |
|----|------------|-----------------|-------------|------|--------------|
| 00 | 22/12/2023 | PRIMA EMISSIONE | R. De Fiore | P.E. | L. Sblendido |
|----|------------|-----------------|-------------|------|--------------|

"IMPIANTO EOLICO TERRANOVA DA SIBARI"
(COMUNI DI TERRANOVA DA SIBARI, SAN DEMETRIO CORONE, SPEZZANO ALBANESE, CORIGLIANO-ROSSANO, SANTA SOFIA D'EPSIRO E TARSIA (CS))



| | | | |
|---|--------|-------------|----------|
| PROGETTO | | | |
| DEFINITIVO | | | |
| NOME FILE: C23FSTR0011WD01000_STUDIO PLANOALTIMETRICO.pdf | | | |
| FORMATO: | SCALA: | SCALA PLOT: | FOGLIO |
| A0 | 1:200 | 1:1 | 10 di 39 |



| | | | |
|-------------------------|------|-------------|-----------|
| TITOLO: | | | |
| STUDIO PLANOALTIMETRICO | | | |
| CODICE ELABORATO | | | |
| IMPUNTO | TRC | PROGRESSIVO | REVISIONE |
| C23FSTR0011 | WD01 | 000 | 00 |

TERRASIAO
Sezione 14
Progressiva: 0+255
Scala: 1:200
Quota di Riferimento: 3,35

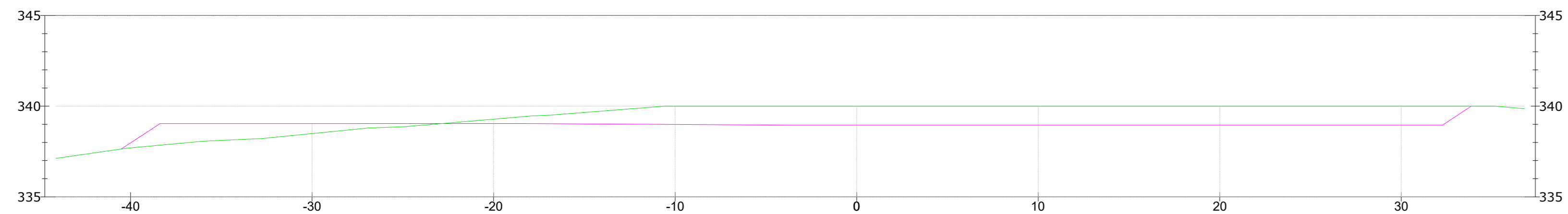

| PROGRESSIVE TERRENO | QUOTE TERRENO | DISTANZE PARZIALI TERRENO | PROGRESSIVE PROGETTO | QUOTE PROGETTO | DISTANZE PARZIALI PROGETTO |
|---------------------|---------------|---------------------------|----------------------|----------------|----------------------------|
| -44.12 | 337.12 | 0.00 | -44.12 | 337.12 | 1.31 |
| -40.13 | 337.08 | 4.99 | -40.13 | 337.06 | 1.61 |
| -36.10 | 338.07 | 4.93 | -36.10 | 338.04 | 2.02 |
| -32.06 | 338.27 | 4.94 | -32.06 | 338.04 | 2.71 |
| -27.96 | 338.27 | 5.95 | -27.96 | 338.04 | 2.67 |
| -23.86 | 338.27 | 6.96 | -23.86 | 338.04 | 3.00 |
| -19.76 | 338.27 | 7.97 | -19.76 | 338.04 | 3.78 |
| -15.66 | 338.27 | 8.98 | -15.66 | 338.04 | 4.56 |
| -11.56 | 338.27 | 9.99 | -11.56 | 338.04 | 5.34 |
| -7.46 | 338.27 | 10.99 | -7.46 | 338.04 | 6.12 |
| -3.36 | 338.27 | 11.99 | -3.36 | 338.04 | 6.90 |
| 0.74 | 338.27 | 12.99 | 0.74 | 338.04 | 7.68 |
| 4.84 | 338.27 | 13.99 | 4.84 | 338.04 | 8.46 |
| 8.94 | 338.27 | 14.99 | 8.94 | 338.04 | 9.24 |
| 13.04 | 338.27 | 15.99 | 13.04 | 338.04 | 10.02 |
| 17.14 | 338.27 | 16.99 | 17.14 | 338.04 | 10.80 |
| 21.24 | 338.27 | 17.99 | 21.24 | 338.04 | 11.58 |
| 25.34 | 338.27 | 18.99 | 25.34 | 338.04 | 12.36 |
| 29.44 | 338.27 | 19.99 | 29.44 | 338.04 | 13.14 |
| 33.54 | 338.27 | 20.99 | 33.54 | 338.04 | 13.92 |
| 37.64 | 338.27 | 21.99 | 37.64 | 338.04 | 14.70 |
| 41.74 | 338.27 | 22.99 | 41.74 | 338.04 | 15.48 |
| 45.84 | 338.27 | 23.99 | 45.84 | 338.04 | 16.26 |
| 49.94 | 338.27 | 24.99 | 49.94 | 338.04 | 17.04 |
| 54.04 | 338.27 | 25.99 | 54.04 | 338.04 | 17.82 |
| 58.14 | 338.27 | 26.99 | 58.14 | 338.04 | 18.60 |
| 62.24 | 338.27 | 27.99 | 62.24 | 338.04 | 19.38 |
| 66.34 | 338.27 | 28.99 | 66.34 | 338.04 | 20.16 |
| 70.44 | 338.27 | 29.99 | 70.44 | 338.04 | 20.94 |
| 74.54 | 338.27 | 30.99 | 74.54 | 338.04 | 21.72 |
| 78.64 | 338.27 | 31.99 | 78.64 | 338.04 | 22.50 |
| 82.74 | 338.27 | 32.99 | 82.74 | 338.04 | 23.28 |
| 86.84 | 338.27 | 33.99 | 86.84 | 338.04 | 24.06 |
| 90.94 | 338.27 | 34.99 | 90.94 | 338.04 | 24.84 |
| 95.04 | 338.27 | 35.99 | 95.04 | 338.04 | 25.62 |
| 99.14 | 338.27 | 36.99 | 99.14 | 338.04 | 26.40 |
| 103.24 | 338.27 | 37.99 | 103.24 | 338.04 | 27.18 |
| 107.34 | 338.27 | 38.99 | 107.34 | 338.04 | 27.96 |
| 111.44 | 338.27 | 39.99 | 111.44 | 338.04 | 28.74 |
| 115.54 | 338.27 | 40.99 | 115.54 | 338.04 | 29.52 |
| 119.64 | 338.27 | 41.99 | 119.64 | 338.04 | 30.30 |
| 123.74 | 338.27 | 42.99 | 123.74 | 338.04 | 31.08 |
| 127.84 | 338.27 | 43.99 | 127.84 | 338.04 | 31.86 |
| 131.94 | 338.27 | 44.99 | 131.94 | 338.04 | 32.64 |
| 136.04 | 338.27 | 45.99 | 136.04 | 338.04 | 33.42 |
| 140.14 | 338.27 | 46.99 | 140.14 | 338.04 | 34.20 |
| 144.24 | 338.27 | 47.99 | 144.24 | 338.04 | 34.98 |
| 148.34 | 338.27 | 48.99 | 148.34 | 338.04 | 35.76 |
| 152.44 | 338.27 | 49.99 | 152.44 | 338.04 | 36.54 |
| 156.54 | 338.27 | 50.99 | 156.54 | 338.04 | 37.32 |
| 160.64 | 338.27 | 51.99 | 160.64 | 338.04 | 38.10 |
| 164.74 | 338.27 | 52.99 | 164.74 | 338.04 | 38.88 |
| 168.84 | 338.27 | 53.99 | 168.84 | 338.04 | 39.66 |
| 172.94 | 338.27 | 54.99 | 172.94 | 338.04 | 40.44 |
| 177.04 | 338.27 | 55.99 | 177.04 | 338.04 | 41.22 |
| 181.14 | 338.27 | 56.99 | 181.14 | 338.04 | 42.00 |
| 185.24 | 338.27 | 57.99 | 185.24 | 338.04 | 42.78 |
| 189.34 | 338.27 | 58.99 | 189.34 | 338.04 | 43.56 |
| 193.44 | 338.27 | 59.99 | 193.44 | 338.04 | 44.34 |
| 197.54 | 338.27 | 60.99 | 197.54 | 338.04 | 45.12 |
| 201.64 | 338.27 | 61.99 | 201.64 | 338.04 | 45.90 |
| 205.74 | 338.27 | 62.99 | 205.74 | 338.04 | 46.68 |
| 209.84 | 338.27 | 63.99 | 209.84 | 338.04 | 47.46 |
| 213.94 | 338.27 | 64.99 | 213.94 | 338.04 | 48.24 |
| 218.04 | 338.27 | 65.99 | 218.04 | 338.04 | 49.02 |
| 222.14 | 338.27 | 66.99 | 222.14 | 338.04 | 49.80 |
| 226.24 | 338.27 | 67.99 | 226.24 | 338.04 | 50.58 |
| 230.34 | 338.27 | 68.99 | 230.34 | 338.04 | 51.36 |
| 234.44 | 338.27 | 69.99 | 234.44 | 338.04 | 52.14 |
| 238.54 | 338.27 | 70.99 | 238.54 | 338.04 | 52.92 |
| 242.64 | 338.27 | 71.99 | 242.64 | 338.04 | 53.70 |
| 246.74 | 338.27 | 72.99 | 246.74 | 338.04 | 54.48 |
| 250.84 | 338.27 | 73.99 | 250.84 | 338.04 | 55.26 |
| 254.94 | 338.27 | 74.99 | 254.94 | 338.04 | 56.04 |
| 259.04 | 338.27 | 75.99 | 259.04 | 338.04 | 56.82 |
| 263.14 | 338.27 | 76.99 | 263.14 | 338.04 | 57.60 |
| 267.24 | 338.27 | 77.99 | 267.24 | 338.04 | 58.38 |
| 271.34 | 338.27 | 78.99 | 271.34 | 338.04 | 59.16 |
| 275.44 | 338.27 | 79.99 | 275.44 | 338.04 | 59.94 |
| 279.54 | 338.27 | 80.99 | 279.54 | 338.04 | 60.72 |
| 283.64 | 338.27 | 81.99 | 283.64 | 338.04 | 61.50 |
| 287.74 | 338.27 | 82.99 | 287.74 | 338.04 | 62.28 |
| 291.84 | 338.27 | 83.99 | 291.84 | 338.04 | 63.06 |
| 295.94 | 338.27 | 84.99 | 295.94 | 338.04 | 63.84 |
| 300.04 | 338.27 | 85.99 | 300.04 | 338.04 | 64.62 |
| 304.14 | 338.27 | 86.99 | 304.14 | 338.04 | 65.40 |
| 308.24 | 338.27 | 87.99 | 308.24 | 338.04 | 66.18 |
| 312.34 | 338.27 | 88.99 | 312.34 | 338.04 | 66.96 |
| 316.44 | 338.27 | 89.99 | 316.44 | 338.04 | 67.74 |
| 320.54 | 338.27 | 90.99 | 320.54 | 338.04 | 68.52 |
| 324.64 | 338.27 | 91.99 | 324.64 | 338.04 | 69.30 |
| 328.74 | 338.27 | 92.99 | 328.74 | 338.04 | 70.08 |
| 332.84 | 338.27 | 93.99 | 332.84 | 338.04 | 70.86 |
| 336.94 | 338.27 | 94.99 | 336.94 | 338.04 | 71.64 |
| 341.04 | 338.27 | 95.99 | 341.04 | 338.04 | 72.42 |
| 345.14 | 338.27 | 96.99 | 345.14 | 338.04 | 73.20 |

LEGENDA DEI COLORI E SIMBOLI IN CARTA

- Profilo terreno
- Profilo Piazzola

green & green
WE ENGINEERING

Green & Green S.r.l.
Via Edmondo de Amicis n.64
87036 Rende (CS) - Italy
P.IVA 0290010782
Ph. (+39) 0984 846295
Fax (+39) 0984 1214470
info@greengreen.it
www.greengreen.it

Il tecnico
Ing. Leonardo Sblendido



| | | | | | |
|------|------------|-----------------|-------------|-------------|--------------|
| 00 | 22/12/2023 | PRIMA EMISSIONE | R. De Fiore | P. E. | L. Sblendido |
| REV. | DATA | DESCRIZIONE | PREPARATO | CONTROLLATO | APPROVATO |

"IMPIANTO EOLICO TERRANOVA DA SIBARI"
(COMUNI DI TERRANOVA DA SIBARI, SAN DEMETRIO CORONE, SPEZZANO ALBANESE, CORIGLIANO-ROSSANO, SANTA SOFIA D'EPSIRO E TARSIA (CS))

| | | | | |
|---|---|--------------------|--------------------|-----------|
| | PROGETTO DEFINITIVO | | | |
| | WORK FILE: CZ3FSTR0011WD01000_STUDIO PLANOALTIMETRICO.pdf | | | |
| FORMATO: A0 | SCALA: 1:200 | SCALA PLOT: 1:1 | FOGLIO 12 di 39 | |
| TITOLO: STUDIO PLANOALTIMETRICO | | | | |
| CODICE ELABORATO | | | | |
| IMPIANTO | TRC | TRM | PROGRESSIVO | REVISIONE |
| C23FSTR001 | 02 | WD01 | 10 | 00 |

LIVELLETTA

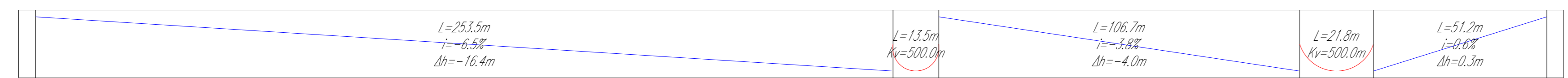

Profilo: TR_STT31
Scala: 1000:1000
Q.Ref.: 320 mslm

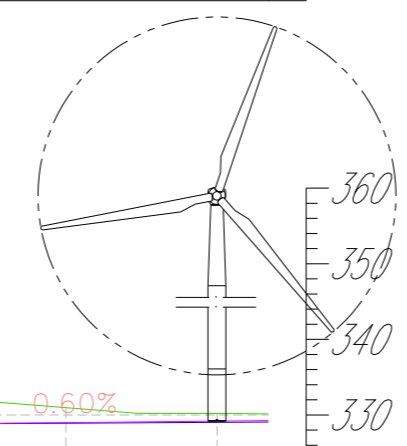
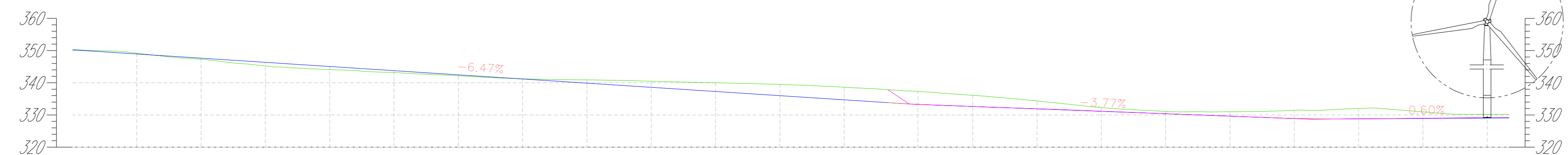

| NUMERO SEZIONE | 1 | 2 | 3 | 4 | 5 | 6 | 7 | 8 | 9 | 10 | 11 | 12 | 13 | 14 | 15 | 16 | 17 | 18 | 19 | 20 | 21 | 22 |
|----------------------|-------|-------|-------|-------|-------|-------|-------|-------|-------|-------|-------|-------|-------|-------|-------|-------|-------|-------|-------|-------|-------|-------|
| DISTANZE PROGRESSIVE | 0+000 | 0+040 | 0+080 | 0+120 | 0+160 | 0+200 | 0+240 | 0+280 | 0+320 | 0+360 | 0+400 | 0+440 | 0+480 | 0+520 | 0+560 | 0+600 | 0+640 | 0+680 | 0+720 | 0+760 | 0+800 | 0+840 |
| QUOTE TERRENO | 342 | 341 | 342 | 341 | 342 | 342 | 342 | 340 | 340 | 340 | 338 | 338 | 337 | 336 | 334 | 333 | 331 | 330 | 329 | 328 | 327 | 327 |
| QUOTE PROGETTO | 342 | 341 | 341 | 340 | 341 | 341 | 341 | 339 | 339 | 339 | 337 | 337 | 336 | 335 | 333 | 332 | 331 | 330 | 329 | 328 | 327 | 327 |
| DIFFERENZA QUOTE | 0 | 0 | 0 | 0 | 0 | 0 | 0 | -2 | -2 | -2 | -2 | -2 | -2 | -2 | -2 | -2 | -2 | -2 | -2 | -2 | -2 | -2 |

LEGENDA DEI COLORI E SIMBOLI IN CARTA

- Aerogeneratore (Diametro = 163 m, Hhub = 125 m)
- Piazzaola
- Profilo Piazzaola
- Profilo terreno
- Strade esistenti da adeguare
- Strade di nuova realizzazione
- Livellatta
- Cavidotto 36 kv
- Scavi
- Riparti
- Curva di livello principale (intervalli di 10 m) - Quota terreno
- Curva di livello secondaria (intervalli di 2 m) - Quota terreno

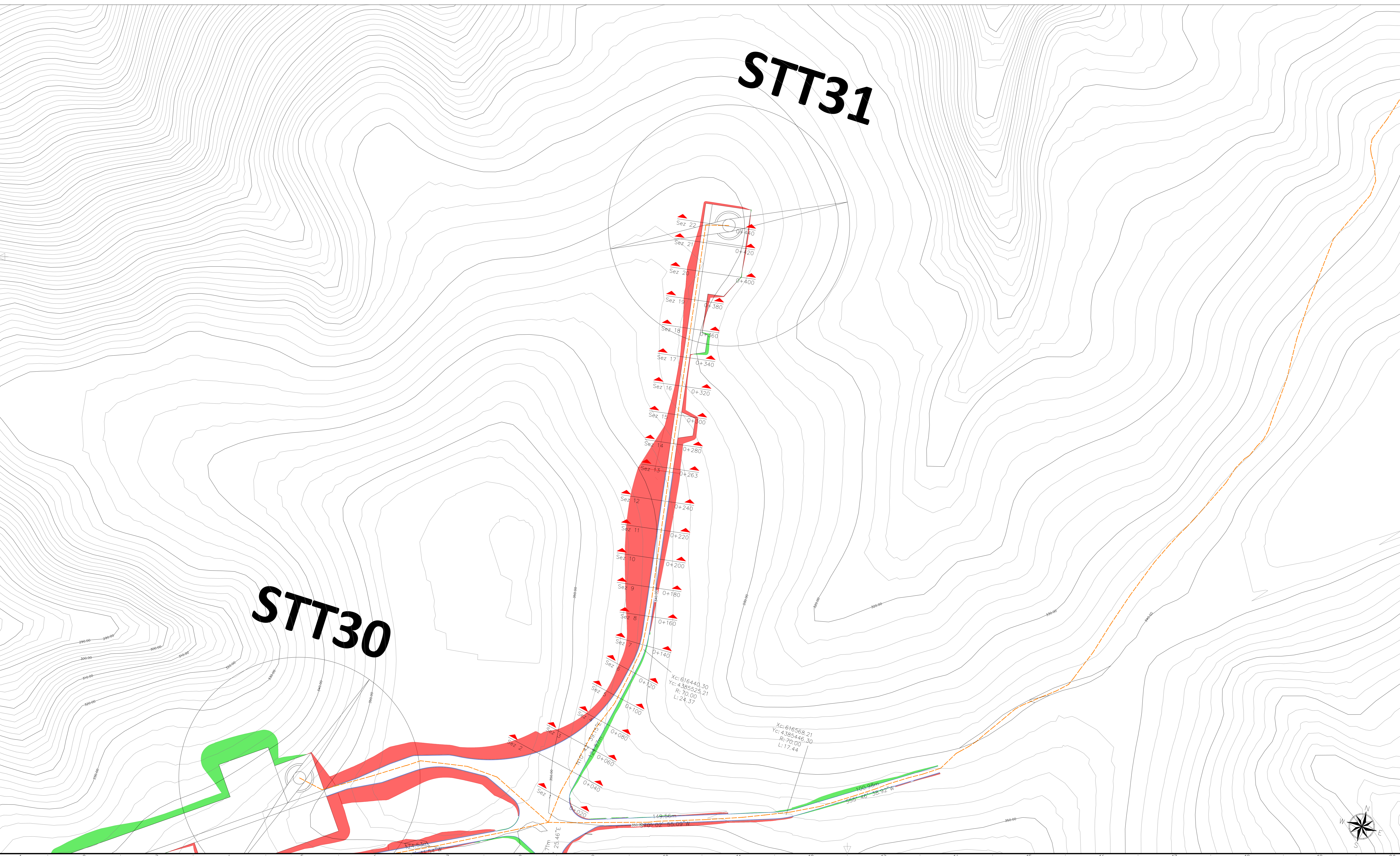

green & green
WE ENGINEERING

Green & Green S.r.l.
Via Edmondo de Amicis n.64
37036 Ronde (CS) - Italy
P.IVA 0290010782
Ph. (+39) 0984 846295
Fax (+39) 0984 121470
info@greengreen.it
www.greengreen.it

Il tecnico
Ing. Leonardo Sblendoro

| | | | | | |
|------|------------|-----------------|-------------|-------------|--------------|
| 00 | 22/12/2023 | PRIMA EMISSIONE | R. De Fiore | P.E. | L. Sblendoro |
| REV. | DATA | DESCRIZIONE | PREPARATO | CONTROLLATO | APPROVATO |

"IMPIANTO EOLICO TERRANOVA DA SIBARI"
(COMUNI DI TERRANOVA DA SIBARI, SAN DEMETRIO CORONE, SPEZZANO ALBANESE, CORIGLIANO-ROSSANO, SANTA SOFIA D'EPSIRO E TARSIA (CS))

| | | | | |
|--|----------------------|---------------|-----------------|------------------|
| | PROGETTO: DEFINITIVO | | | |
| | FORMATO: A0 | SCALA: 1:1000 | SCALA PLOT: 1:1 | FOGLIO: 13 di 39 |

| | | | | |
|--|-------------------------|-----|------|-----------|
| | STUDIO PLANOALTIMETRICO | | | |
| | CODICE ELABORATO | | | |
| | IMPVTO | TRC | TRNO | PROGRESSO |
| | C23 | F5 | T00 | 02 |
| | WD | 01 | 00 | 00 |

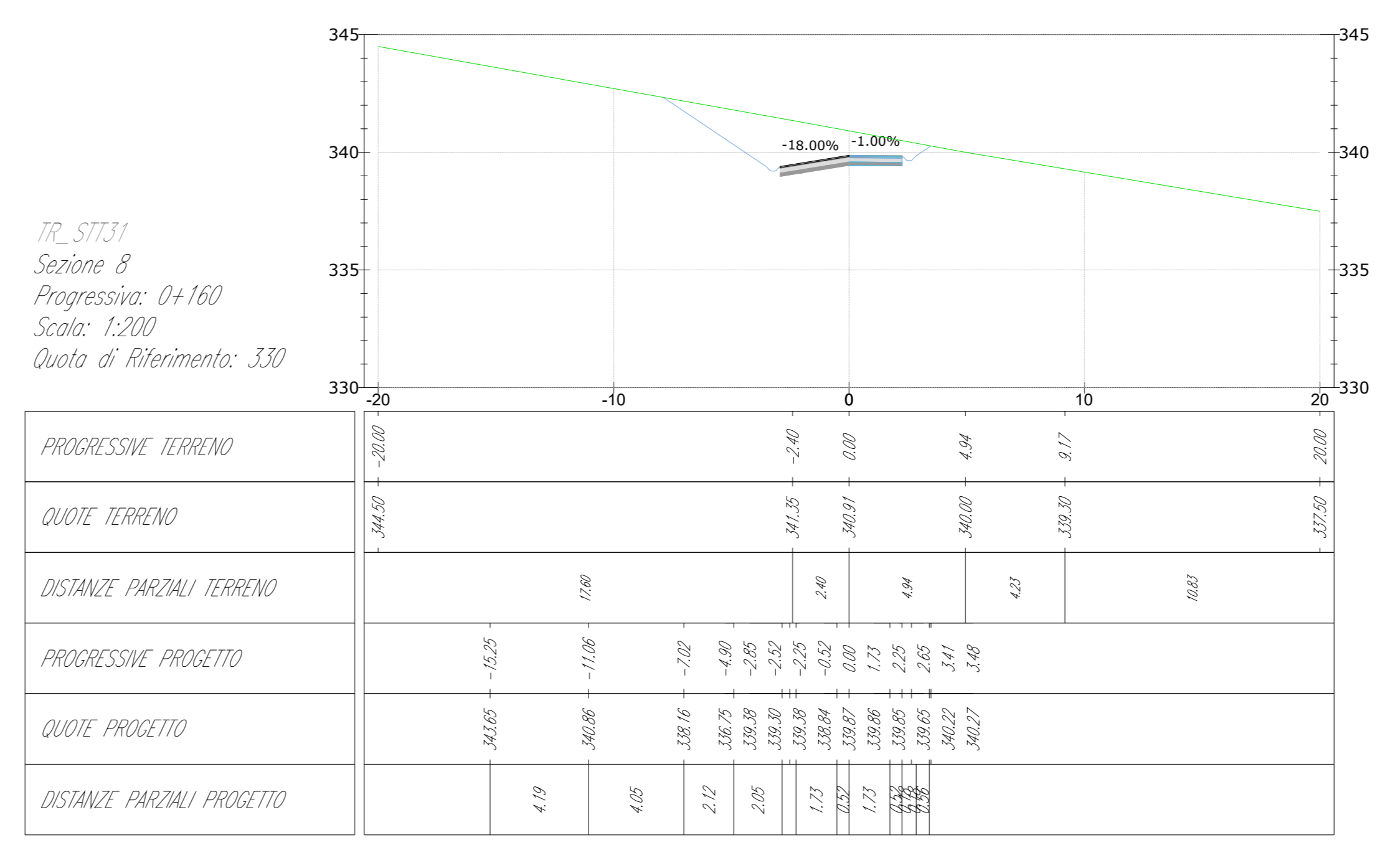
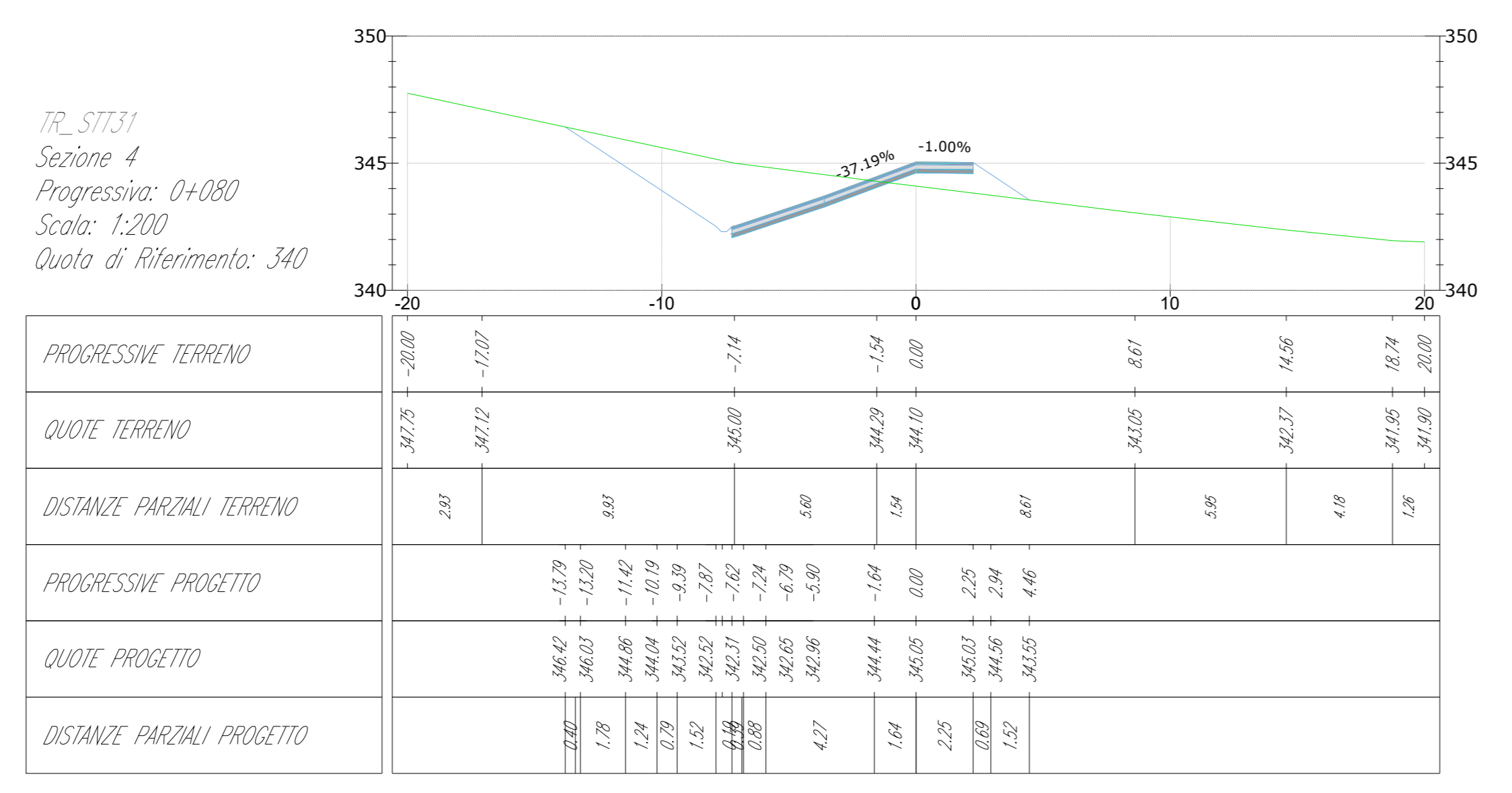
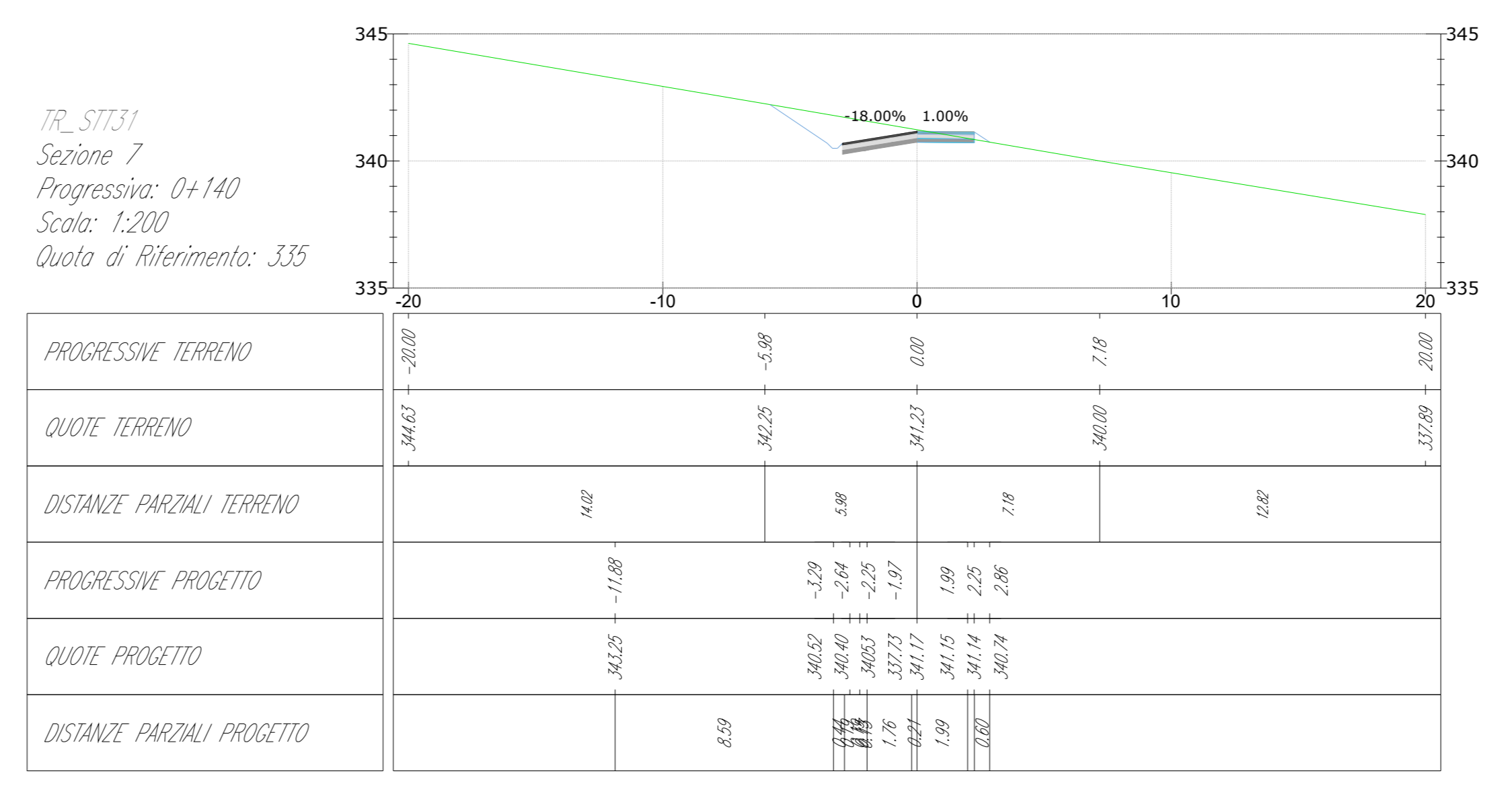
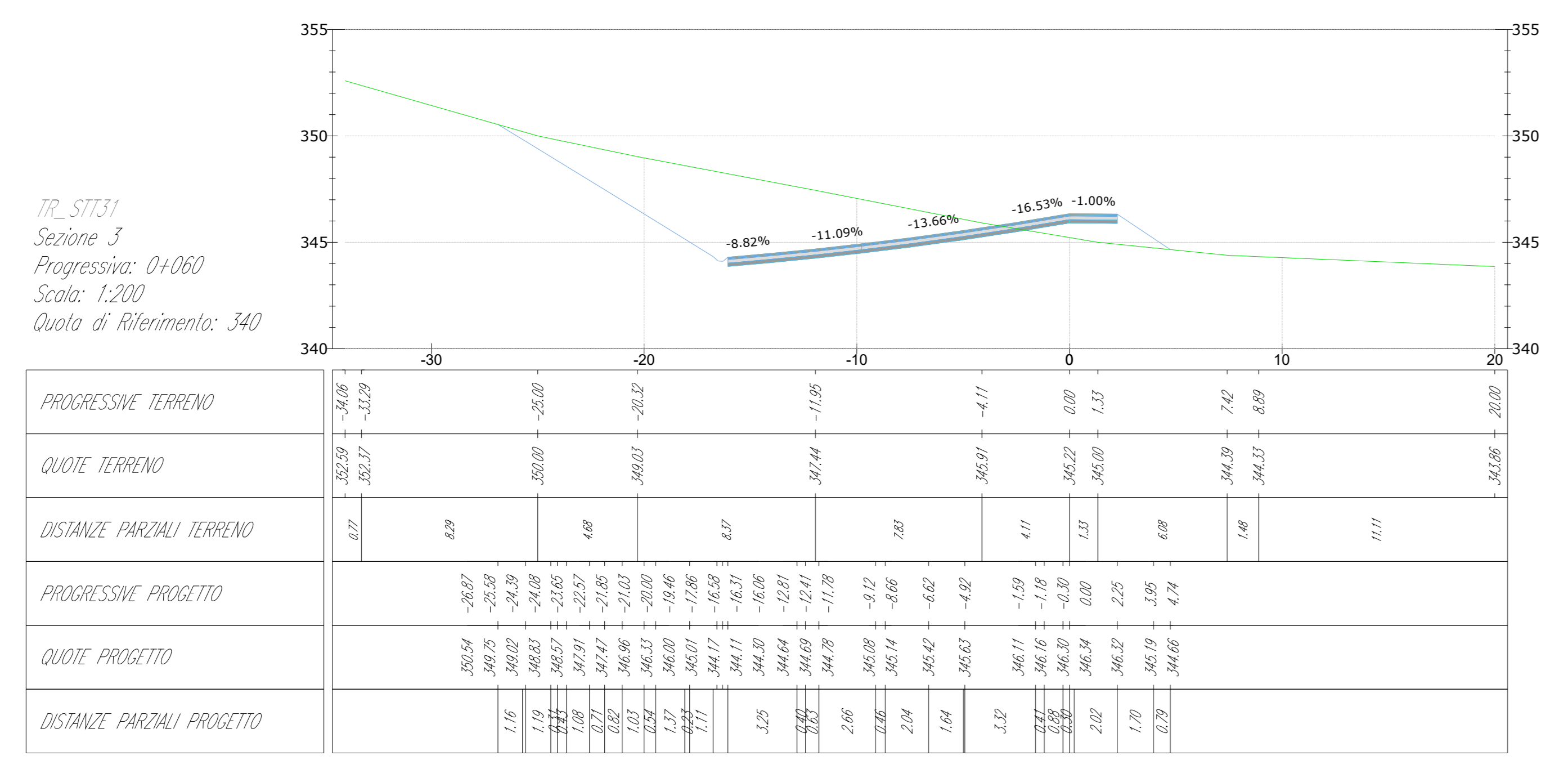
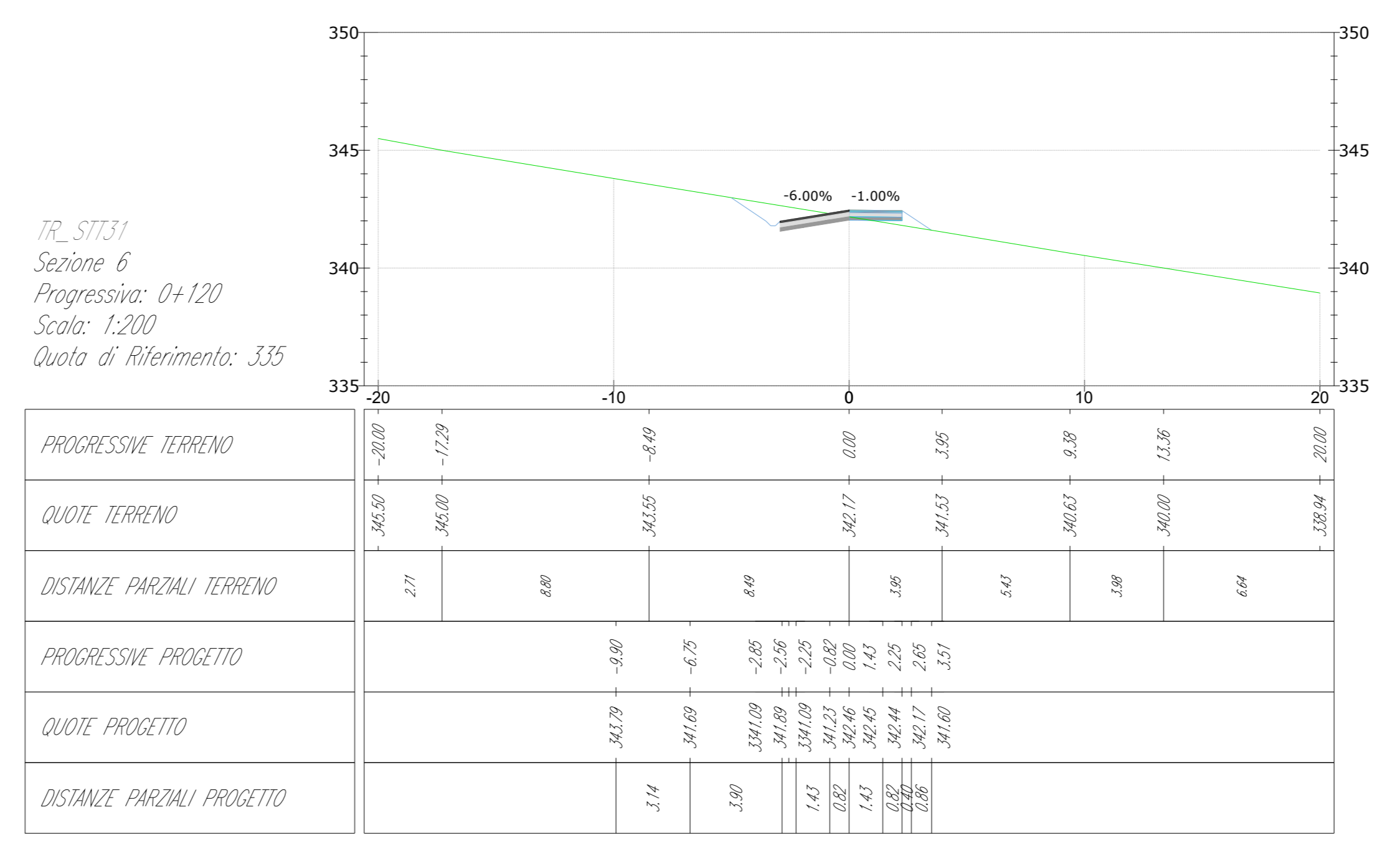
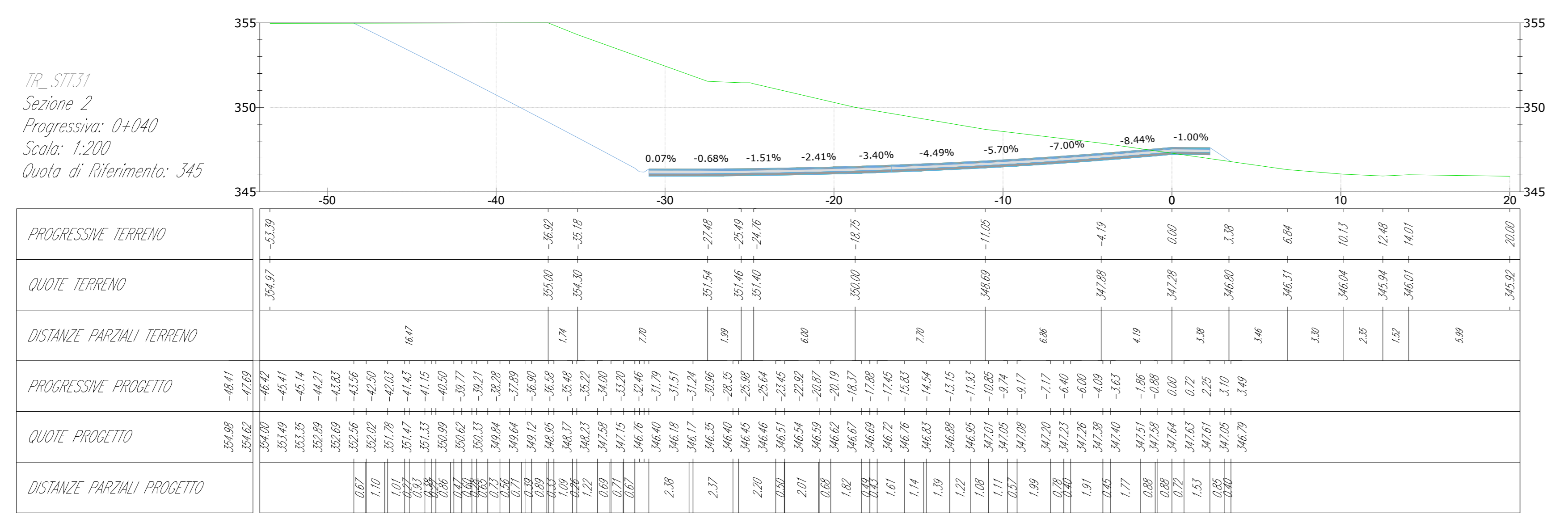
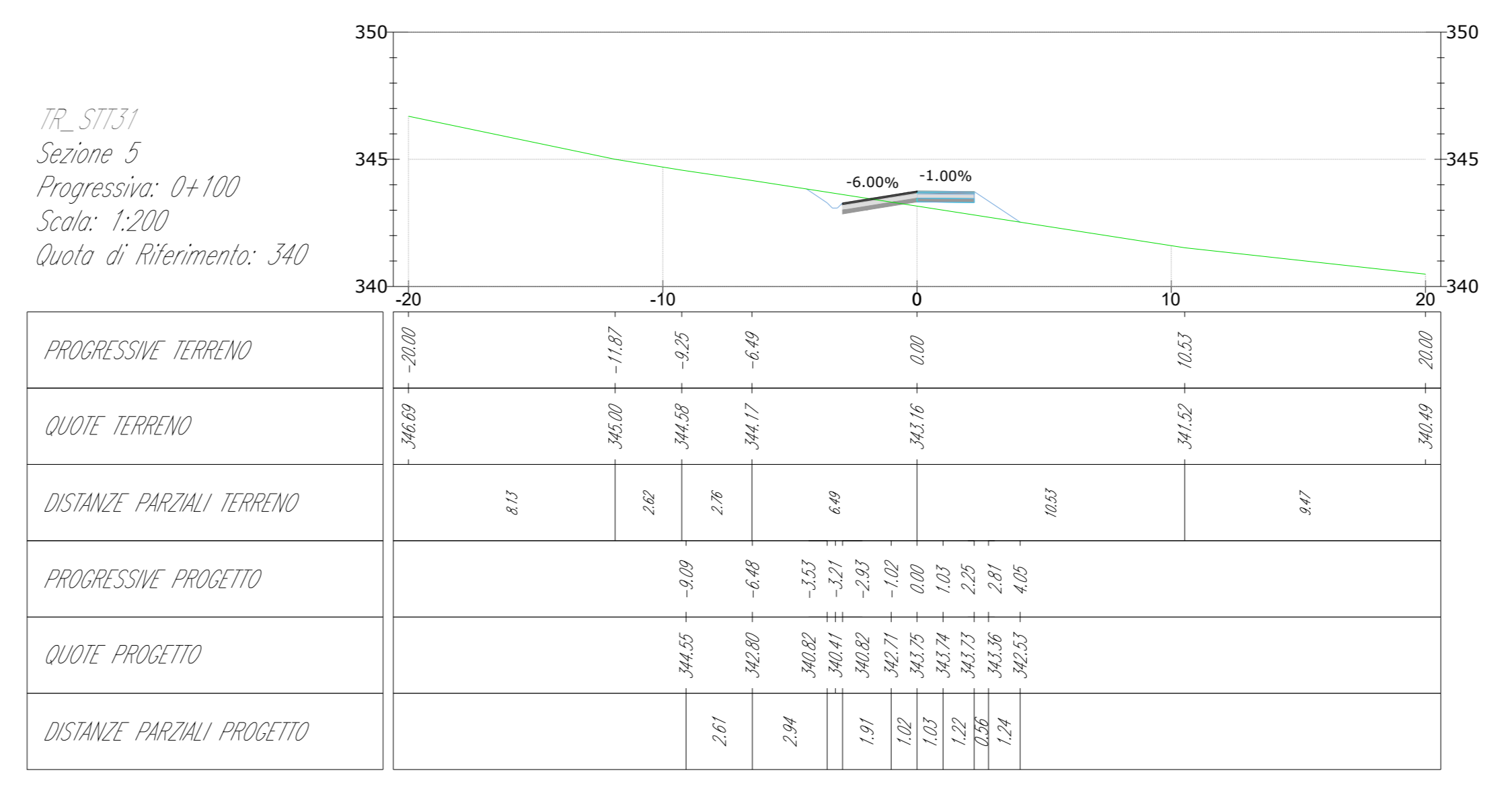
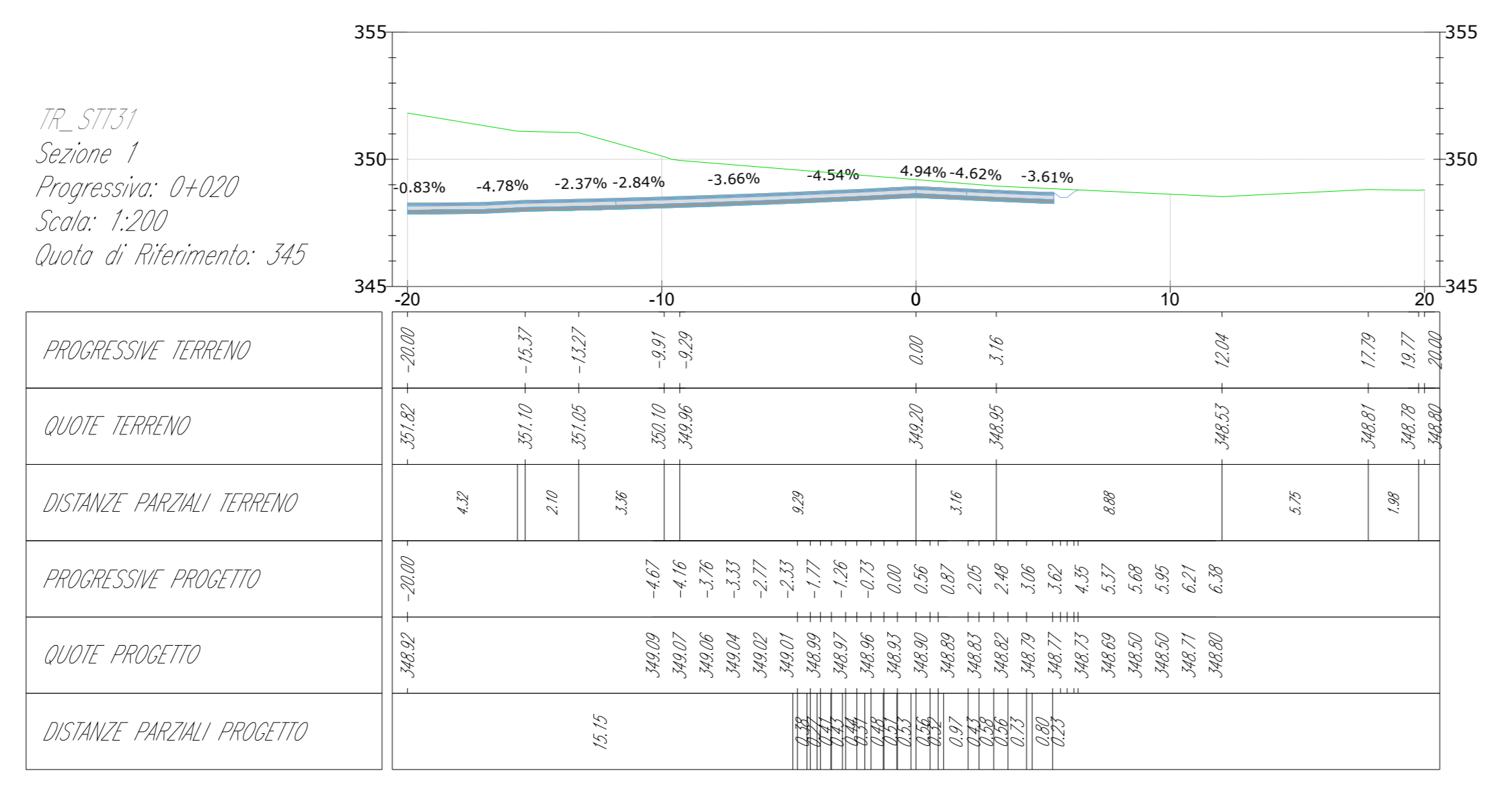

green & green
WE ENGINEERING

Il tecnico
Ing. Leonardo Sblendido

Green & Green S.r.l.
Via Edmondo de Amicis n.64
37036 Ronde (CS) - Italy
P.IVA 02900010782
Ph. (+39) 0984 846295
Fax (+39) 0984 1214470
info@greengreen.it
www.greengreen.it

| 00 | 22/12/2023 | PRIMA EMISSIONE | R. De Fiore | P. E. | L. Sblendido |
|------|------------|-----------------|-------------|-------------|--------------|
| REV. | DATA | DESCRIZIONE | PREPARATO | CONTROLLATO | APPROVATO |

"IMPIANTO EOLICO TERRANOVA DA SIBARI"
(COMUNI DI TERRANOVA DA SIBARI, SAN DEMETRIO CORONE, SPEZZANO ALBANESE, CORIGLIANO-ROSSANO, SANTA SOFIA D'EPSIRO E TARSIA (CS))

hergo

green & green
WE ENGINEERING

PROGETTO: **DEFINITIVO**

NOTE FILE: CZ3FST0011WD01000_STUDIO_PLANOALTIMETRICO.pdf

| FORMATO: | SCALA: | SCALA PLOT: | FOGLIO: |
|----------|--------|-------------|----------|
| A0 | 1:200 | 1:1 | 14 di 39 |

TITOLO: **STUDIO PLANOALTIMETRICO**

CODICE ELABORATO

| IMPVTO | TRC | TRQ | PROGRESSO | REVISIONE |
|--------|------|------|-----------|-----------|
| C23FST | R002 | WD01 | 000 | 00 |

- Profilo terreno
- Profilo Piazzola

TR_ST31
Sezione 9
Progressiva: 0+180
Scala: 1:200
Quota di Riferimento: 330

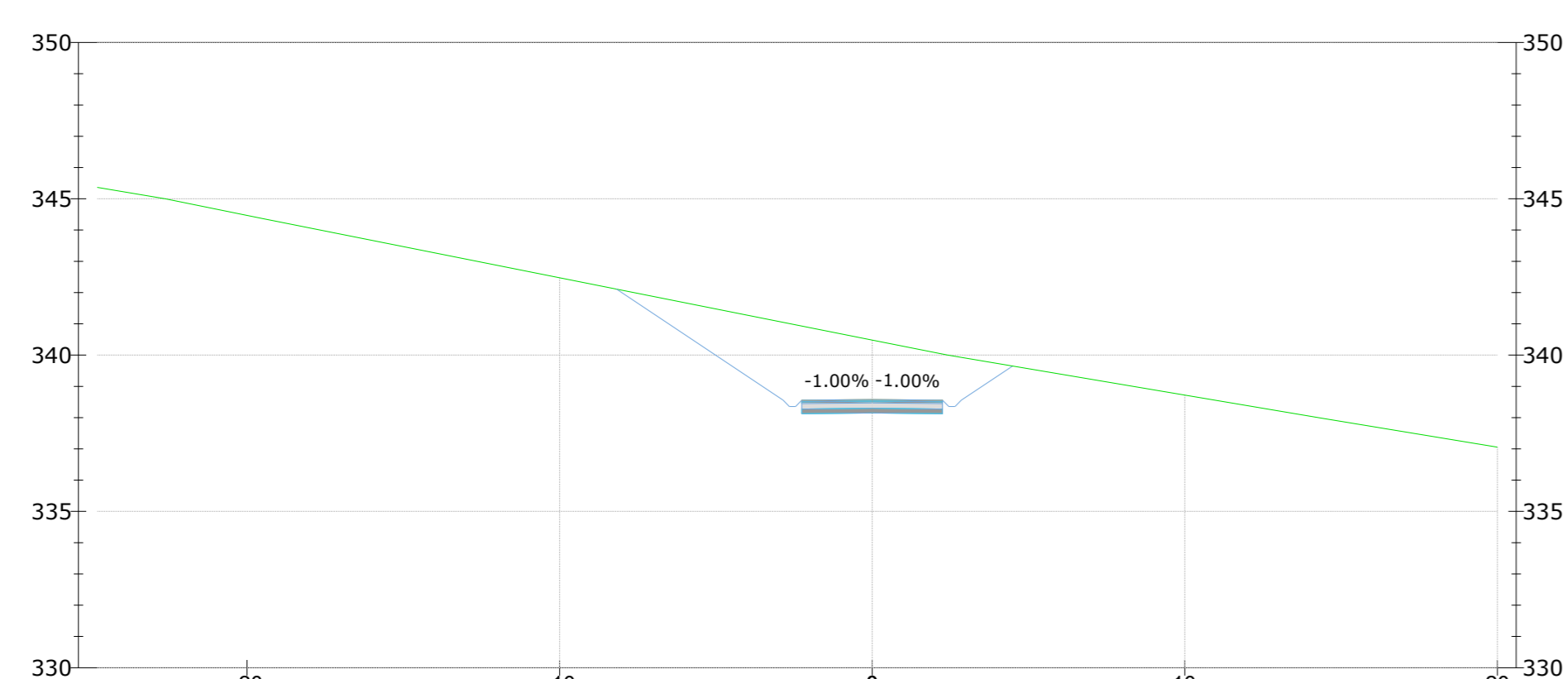

| | | | | | | | | | | | | | | | | | | | | | | | | | | | | | | | | | | | | | | | | | | | | | | | | | | | | | | | | | | | | | | | | | | | | | | | | | | | | | | | | | | | | | | | | | | | | | | | | | | | | | | | | | | | | | | | | | | | | | | | | | | | | | | | | | | | | | | | | | | | | | | | | | | | | | | | | | | | | | | | | | | | | | | | | | | | | | | | | | | | | | | | | | | | | | | | | | | | | | | | | | | | | | | | | | | | | | | | | | | | | | | | | | | | | | | | | | | | | | | | | | | | | | | | | | | | | | | | | | | | | | | | | | | | | | | | | | | | | | | | | | | | | | | | | | | | | | | | | | | | | | | | | | | | | | | | | | | | | | | | | | | | | | | | | | | | | | | | | | | | | | | | | | | | | | | | | | | | | | | | | | | | | | | | | | | | | | | | | | | | | | | | | | | | | | | | | | | | | | | | | | | | | | | | | | | | | | | | | | | | | | | | | | | | | | | | | | | | | | | | | | | | | | | | | | | | | | | | | | | | | | | | | | | | | | | | | | | | | | | | | | | | | | | | | | | | | | | | | | | | | | | | | | | | | | | | | | | | | | | | | | | | | | | | | | | | | | | | | | | | | | | | | | | | | | | | | | | | | | | | | | | | | | | | | | | | | | | | | | | | | | | | | | | | | | | | | | | | | | | | | | | | | | | | | | | | | | | | | | | | | | | | | | | | | | | | | | | | | | | | | | | | | | | | | | | | | | | | | | | | | | | | | | | | | | | | | | | | | | | | | | | | | | | | | | | | | | | | | | | | | | | | | | | | | | | | | | | | | | | | | | | | | | | | | | | | | | | | | | | | | | | | | | | | | | | | | | | | | | | | | | | | | | | | | | | | | | | | | | | | | | | | | | | | | | | | | | | | | | | | | | | | | | | | | | | | | | | | | | | | | | | | | | | | | | | | | | | | | | | | | | | | | | | | | | | | | | | | | | | | | | | | | | | | | | | | | | | | | | | | | | | | | | | | | | | | | | | | | | | | | | | | | | | | | | | | | | | | | | | | | | | | | | | | | | | | | | | | | | | | | | | | | | | | | | | | | | | | | | | | | | | | | | | | | | | | | | | | | | | | | | | | | | | | | | | | | | | | | | | | | | | | | | | | | | | | | | | | | | | | | | | | | | | | | | | | | | | | | | | | | | | | | | |
|---------------------|--------|--------|--------|------|------|------|------|------|-------|-------|-------|-------|-------|-------|-------|-------|-------|-------|-------|-------|-------|-------|-------|-------|-------|-------|-------|-------|-------|-------|-------|-------|-------|-------|-------|-------|-------|-------|-------|-------|-------|-------|-------|-------|--------|--------|--------|--------|--------|--------|--------|--------|--------|--------|--------|--------|--------|--------|--------|--------|--------|--------|--------|--------|--------|--------|--------|--------|--------|--------|--------|--------|--------|--------|--------|--------|--------|--------|--------|--------|--------|--------|--------|--------|--------|--------|--------|--------|--------|--------|--------|--------|--------|--------|--------|--------|--------|--------|--------|--------|--------|--------|--------|--------|--------|--------|--------|--------|--------|--------|--------|--------|--------|--------|--------|--------|--------|--------|--------|--------|--------|--------|--------|--------|--------|--------|--------|--------|--------|--------|--------|--------|--------|--------|--------|--------|--------|--------|--------|--------|--------|--------|--------|--------|--------|--------|--------|--------|--------|--------|--------|--------|--------|--------|--------|--------|--------|--------|--------|--------|--------|--------|--------|--------|--------|--------|--------|--------|--------|--------|--------|--------|--------|--------|--------|--------|--------|--------|--------|--------|--------|--------|--------|--------|--------|--------|--------|--------|--------|--------|--------|--------|--------|--------|--------|--------|--------|--------|--------|--------|--------|--------|--------|--------|--------|--------|--------|--------|--------|--------|--------|--------|--------|--------|--------|--------|--------|--------|--------|--------|--------|--------|--------|--------|--------|--------|--------|--------|--------|--------|--------|--------|--------|--------|--------|--------|--------|--------|--------|--------|--------|--------|--------|--------|--------|--------|--------|--------|--------|--------|--------|--------|--------|--------|--------|--------|--------|--------|--------|--------|--------|--------|--------|--------|--------|--------|--------|--------|--------|--------|--------|--------|--------|--------|--------|--------|--------|--------|--------|--------|--------|--------|--------|--------|--------|--------|--------|--------|--------|--------|--------|--------|--------|--------|--------|--------|--------|--------|--------|--------|--------|--------|--------|--------|--------|--------|--------|--------|--------|--------|--------|--------|--------|--------|--------|--------|--------|--------|--------|--------|--------|--------|--------|--------|--------|--------|--------|--------|--------|--------|--------|--------|--------|--------|--------|--------|--------|--------|--------|--------|--------|--------|--------|--------|--------|--------|--------|--------|--------|--------|--------|--------|--------|--------|--------|--------|--------|--------|--------|--------|--------|--------|--------|--------|--------|--------|--------|--------|--------|--------|--------|--------|--------|--------|--------|--------|--------|--------|--------|--------|--------|--------|--------|--------|--------|--------|--------|--------|--------|--------|--------|--------|--------|--------|--------|--------|--------|--------|--------|--------|--------|--------|--------|--------|--------|--------|--------|---------|---------|---------|---------|---------|---------|---------|---------|---------|---------|---------|---------|---------|---------|---------|---------|---------|---------|---------|---------|---------|---------|---------|---------|---------|---------|---------|---------|---------|---------|---------|---------|---------|---------|---------|---------|---------|---------|---------|---------|---------|---------|---------|---------|---------|---------|---------|---------|---------|---------|---------|---------|---------|---------|---------|---------|---------|---------|---------|---------|---------|---------|---------|---------|---------|---------|---------|---------|---------|---------|---------|---------|---------|---------|---------|---------|---------|---------|---------|---------|---------|---------|---------|---------|---------|---------|---------|---------|---------|---------|---------|---------|---------|---------|---------|---------|---------|---------|---------|---------|---------|---------|---------|---------|---------|---------|---------|---------|---------|---------|---------|---------|---------|---------|---------|---------|---------|---------|---------|---------|---------|---------|---------|---------|---------|---------|---------|---------|---------|---------|---------|---------|---------|---------|---------|---------|---------|---------|---------|---------|---------|---------|---------|---------|---------|---------|---------|---------|---------|---------|---------|---------|---------|---------|---------|---------|---------|---------|---------|---------|---------|---------|---------|---------|---------|---------|---------|---------|---------|---------|---------|---------|---------|---------|---------|---------|---------|---------|---------|---------|---------|---------|---------|---------|---------|---------|---------|---------|---------|---------|---------|---------|---------|---------|---------|---------|---------|---------|---------|---------|---------|---------|---------|---------|---------|---------|---------|---------|---------|---------|---------|---------|---------|---------|---------|---------|---------|---------|---------|---------|---------|---------|---------|---------|---------|---------|---------|---------|---------|---------|---------|---------|---------|---------|---------|---------|---------|---------|---------|---------|---------|---------|---------|---------|---------|---------|---------|---------|---------|---------|---------|---------|---------|---------|---------|---------|---------|---------|---------|---------|---------|---------|---------|---------|---------|---------|---------|---------|---------|---------|---------|---------|---------|---------|---------|---------|---------|---------|---------|---------|---------|---------|---------|---------|---------|---------|---------|---------|---------|---------|---------|---------|---------|---------|---------|---------|---------|---------|---------|---------|---------|---------|---------|---------|---------|---------|---------|---------|---------|---------|---------|---------|---------|---------|---------|---------|---------|---------|---------|---------|---------|---------|---------|---------|---------|---------|---------|---------|---------|---------|---------|---------|---------|---------|---------|---------|---------|---------|---------|---------|---------|---------|---------|---------|---------|---------|---------|---------|---------|---------|---------|---------|---------|---------|---------|---------|---------|---------|---------|---------|---------|---------|---------|---------|---------|---------|---------|---------|---------|---------|---------|---------|---------|---------|---------|---------|---------|---------|---------|---------|---------|---------|---------|---------|---------|---------|---------|---------|---------|---------|---------|---------|---------|---------|---------|---------|---------|---------|---------|---------|---------|---------|---------|---------|---------|---------|---------|---------|---------|---------|---------|---------|---------|---------|---------|---------|---------|---------|---------|---------|---------|---------|---------|---------|---------|---------|---------|---------|---------|---------|---------|---------|---------|---------|---------|---------|---------|---------|---------|---------|---------|---------|---------|---------|---------|---------|---------|---------|---------|---------|---------|---------|---------|---------|---------|---------|---------|---------|---------|---------|---------|---------|---------|---------|---------|---------|---------|---------|---------|---------|---------|---------|---------|---------|---------|---------|---------|---------|---------|---------|---------|---------|---------|---------|---------|---------|---------|---------|---------|---------|---------|---------|---------|---------|---------|---------|---------|---------|---------|---------|---------|---------|---------|---------|---------|---------|---------|---------|---------|---------|---------|---------|---------|---------|---------|---------|---------|---------|---------|---------|---------|---------|---------|---------|---------|---------|---------|---------|---------|---------|---------|---------|---------|---------|---------|---------|---------|---------|---------|---------|---------|---------|---------|---------|---------|---------|---------|---------|---------|---------|---------|---------|---------|---------|---------|---------|---------|---------|---------|---------|---------|---------|---------|---------|---------|---------|---------|---------|---------|---------|---------|---------|---------|---------|---------|---------|---------|---------|---------|---------|---------|---------|---------|---------|---------|---------|---------|---------|---------|---------|---------|---------|---------|---------|---------|---------|---------|---------|---------|---------|---------|---------|---------|---------|---------|---------|---------|---------|---------|---------|---------|---------|---------|---------|---------|---------|---------|---------|---------|---------|---------|---------|---------|---------|---------|---------|---------|---------|---------|---------|---------|---------|---------|---------|---------|---------|---------|---------|
| PROGRESSIVE TERRENO | -24.78 | -21.82 | -18.88 | 0.00 | 2.41 | 4.89 | 7.37 | 9.85 | 12.33 | 14.81 | 17.29 | 19.77 | 22.25 | 24.73 | 27.21 | 29.69 | 32.17 | 34.65 | 37.13 | 39.61 | 42.09 | 44.57 | 47.05 | 49.53 | 52.01 | 54.49 | 56.97 | 59.45 | 61.93 | 64.41 | 66.89 | 69.37 | 71.85 | 74.33 | 76.81 | 79.29 | 81.77 | 84.25 | 86.73 | 89.21 | 91.69 | 94.17 | 96.65 | 99.13 | 101.61 | 104.09 | 106.57 | 109.05 | 111.53 | 114.01 | 116.49 | 118.97 | 121.45 | 123.93 | 126.41 | 128.89 | 131.37 | 133.85 | 136.33 | 138.81 | 141.29 | 143.77 | 146.25 | 148.73 | 151.21 | 153.69 | 156.17 | 158.65 | 161.13 | 163.61 | 166.09 | 168.57 | 171.05 | 173.53 | 176.01 | 178.49 | 180.97 | 183.45 | 185.93 | 188.41 | 190.89 | 193.37 | 195.85 | 198.33 | 200.81 | 203.29 | 205.77 | 208.25 | 210.73 | 213.21 | 215.69 | 218.17 | 220.65 | 223.13 | 225.61 | 228.09 | 230.57 | 233.05 | 235.53 | 238.01 | 240.49 | 242.97 | 245.45 | 247.93 | 250.41 | 252.89 | 255.37 | 257.85 | 260.33 | 262.81 | 265.29 | 267.77 | 270.25 | 272.73 | 275.21 | 277.69 | 280.17 | 282.65 | 285.13 | 287.61 | 290.09 | 292.57 | 295.05 | 297.53 | 300.01 | 302.49 | 304.97 | 307.45 | 309.93 | 312.41 | 314.89 | 317.37 | 319.85 | 322.33 | 324.81 | 327.29 | 329.77 | 332.25 | 334.73 | 337.21 | 339.69 | 342.17 | 344.65 | 347.13 | 349.61 | 352.09 | 354.57 | 357.05 | 359.53 | 362.01 | 364.49 | 366.97 | 369.45 | 371.93 | 374.41 | 376.89 | 379.37 | 381.85 | 384.33 | 386.81 | 389.29 | 391.77 | 394.25 | 396.73 | 399.21 | 401.69 | 404.17 | 406.65 | 409.13 | 411.61 | 414.09 | 416.57 | 419.05 | 421.53 | 424.01 | 426.49 | 428.97 | 431.45 | 433.93 | 436.41 | 438.89 | 441.37 | 443.85 | 446.33 | 448.81 | 451.29 | 453.77 | 456.25 | 458.73 | 461.21 | 463.69 | 466.17 | 468.65 | 471.13 | 473.61 | 476.09 | 478.57 | 481.05 | 483.53 | 486.01 | 488.49 | 490.97 | 493.45 | 495.93 | 498.41 | 500.89 | 503.37 | 505.85 | 508.33 | 510.81 | 513.29 | 515.77 | 518.25 | 520.73 | 523.21 | 525.69 | 528.17 | 530.65 | 533.13 | 535.61 | 538.09 | 540.57 | 543.05 | 545.53 | 548.01 | 550.49 | 552.97 | 555.45 | 557.93 | 560.41 | 562.89 | 565.37 | 567.85 | 570.33 | 572.81 | 575.29 | 577.77 | 580.25 | 582.73 | 585.21 | 587.69 | 590.17 | 592.65 | 595.13 | 597.61 | 600.09 | 602.57 | 605.05 | 607.53 | 610.01 | 612.49 | 614.97 | 617.45 | 619.93 | 622.41 | 624.89 | 627.37 | 629.85 | 632.33 | 634.81 | 637.29 | 639.77 | 642.25 | 644.73 | 647.21 | 649.69 | 652.17 | 654.65 | 657.13 | 659.61 | 662.09 | 664.57 | 667.05 | 669.53 | 672.01 | 674.49 | 676.97 | 679.45 | 681.93 | 684.41 | 686.89 | 689.37 | 691.85 | 694.33 | 696.81 | 699.29 | 701.77 | 704.25 | 706.73 | 709.21 | 711.69 | 714.17 | 716.65 | 719.13 | 721.61 | 724.09 | 726.57 | 729.05 | 731.53 | 734.01 | 736.49 | 738.97 | 741.45 | 743.93 | 746.41 | 748.89 | 751.37 | 753.85 | 756.33 | 758.81 | 761.29 | 763.77 | 766.25 | 768.73 | 771.21 | 773.69 | 776.17 | 778.65 | 781.13 | 783.61 | 786.09 | 788.57 | 791.05 | 793.53 | 796.01 | 798.49 | 800.97 | 803.45 | 805.93 | 808.41 | 810.89 | 813.37 | 815.85 | 818.33 | 820.81 | 823.29 | 825.77 | 828.25 | 830.73 | 833.21 | 835.69 | 838.17 | 840.65 | 843.13 | 845.61 | 848.09 | 850.57 | 853.05 | 855.53 | 858.01 | 860.49 | 862.97 | 865.45 | 867.93 | 870.41 | 872.89 | 875.37 | 877.85 | 880.33 | 882.81 | 885.29 | 887.77 | 890.25 | 892.73 | 895.21 | 897.69 | 900.17 | 902.65 | 905.13 | 907.61 | 910.09 | 912.57 | 915.05 | 917.53 | 920.01 | 922.49 | 924.97 | 927.45 | 929.93 | 932.41 | 934.89 | 937.37 | 939.85 | 942.33 | 944.81 | 947.29 | 949.77 | 952.25 | 954.73 | 957.21 | 959.69 | 962.17 | 964.65 | 967.13 | 969.61 | 972.09 | 974.57 | 977.05 | 979.53 | 982.01 | 984.49 | 986.97 | 989.45 | 991.93 | 994.41 | 996.89 | 999.37 | 1001.85 | 1004.33 | 1006.81 | 1009.29 | 1011.77 | 1014.25 | 1016.73 | 1019.21 | 1021.69 | 1024.17 | 1026.65 | 1029.13 | 1031.61 | 1034.09 | 1036.57 | 1039.05 | 1041.53 | 1044.01 | 1046.49 | 1048.97 | 1051.45 | 1053.93 | 1056.41 | 1058.89 | 1061.37 | 1063.85 | 1066.33 | 1068.81 | 1071.29 | 1073.77 | 1076.25 | 1078.73 | 1081.21 | 1083.69 | 1086.17 | 1088.65 | 1091.13 | 1093.61 | 1096.09 | 1098.57 | 1101.05 | 1103.53 | 1106.01 | 1108.49 | 1110.97 | 1113.45 | 1115.93 | 1118.41 | 1120.89 | 1123.37 | 1125.85 | 1128.33 | 1130.81 | 1133.29 | 1135.77 | 1138.25 | 1140.73 | 1143.21 | 1145.69 | 1148.17 | 1150.65 | 1153.13 | 1155.61 | 1158.09 | 1160.57 | 1163.05 | 1165.53 | 1168.01 | 1170.49 | 1172.97 | 1175.45 | 1177.93 | 1180.41 | 1182.89 | 1185.37 | 1187.85 | 1190.33 | 1192.81 | 1195.29 | 1197.77 | 1200.25 | 1202.73 | 1205.21 | 1207.69 | 1210.17 | 1212.65 | 1215.13 | 1217.61 | 1220.09 | 1222.57 | 1225.05 | 1227.53 | 1230.01 | 1232.49 | 1234.97 | 1237.45 | 1239.93 | 1242.41 | 1244.89 | 1247.37 | 1249.85 | 1252.33 | 1254.81 | 1257.29 | 1259.77 | 1262.25 | 1264.73 | 1267.21 | 1269.69 | 1272.17 | 1274.65 | 1277.13 | 1279.61 | 1282.09 | 1284.57 | 1287.05 | 1289.53 | 1292.01 | 1294.49 | 1296.97 | 1299.45 | 1301.93 | 1304.41 | 1306.89 | 1309.37 | 1311.85 | 1314.33 | 1316.81 | 1319.29 | 1321.77 | 1324.25 | 1326.73 | 1329.21 | 1331.69 | 1334.17 | 1336.65 | 1339.13 | 1341.61 | 1344.09 | 1346.57 | 1349.05 | 1351.53 | 1354.01 | 1356.49 | 1358.97 | 1361.45 | 1363.93 | 1366.41 | 1368.89 | 1371.37 | 1373.85 | 1376.33 | 1378.81 | 1381.29 | 1383.77 | 1386.25 | 1388.73 | 1391.21 | 1393.69 | 1396.17 | 1398.65 | 1401.13 | 1403.61 | 1406.09 | 1408.57 | 1411.05 | 1413.53 | 1416.01 | 1418.49 | 1420.97 | 1423.45 | 1425.93 | 1428.41 | 1430.89 | 1433.37 | 1435.85 | 1438.33 | 1440.81 | 1443.29 | 1445.77 | 1448.25 | 1450.73 | 1453.21 | 1455.69 | 1458.17 | 1460.65 | 1463.13 | 1465.61 | 1468.09 | 1470.57 | 1473.05 | 1475.53 | 1478.01 | 1480.49 | 1482.97 | 1485.45 | 1487.93 | 1490.41 | 1492.89 | 1495.37 | 1497.85 | 1500.33 | 1502.81 | 1505.29 | 1507.77 | 1510.25 | 1512.73 | 1515.21 | 1517.69 | 1520.17 | 1522.65 | 1525.13 | 1527.61 | 1530.09 | 1532.57 | 1535.05 | 1537.53 | 1540.01 | 1542.49 | 1544.97 | 1547.45 | 1549.93 | 1552.41 | 1554.89 | 1557.37 | 1559.85 | 1562.33 | 1564.81 | 1567.29 | 1569.77 | 1572.25 | 1574.73 | 1577.21 | 1579.69 | 1582.17 | 1584.65 | 1587.13 | 1589.61 | 1592.09 | 1594.57 | 1597.05 | 1599.53 | 1602.01 | 1604.49 | 1606.97 | 1609.45 | 1611.93 | 1614.41 | 1616.89 | 1619.37 | 1621.85 | 1624.33 | 1626.81 | 1629.29 | 1631.77 | 1634.25 | 1636.73 | 1639.21 | 1641.69 | 1644.17 | 1646.65 | 1649.13 | 1651.61 | 1654.09 | 1656.57 | 1659.05 | 1661.53 | 1664.01 | 1666.49 | 1668.97 | 1671.45 | 1673.93 | 1676.41 | 1678.89 | 1681.37 | 1683.85 | 1686.33 | 1688.81 | 1691.29 | 1693.77 | 1696.25 | 1698.73 | 1701.21 | 1703.69 | 1706.17 | 1708.65 | 1711.13 | 1713.61 | 1716.09 | 1718.57 | 1721.05 | 1723.53 | 1726.01 | 1728.49 | 1730.97 | 1733.45 | 1735.93 | 1738.41 | 1740.89 | 1743.37 | 1745.85 | 1748.33 | 1750.81 | 1753.29 | 1755.77 | 1758.25 | 1760.73 | 1763.21 | 1765.69 | 1768.17 | 1770.65 | 1773.13 | 1775.61 | 1778.09 | 1780.57 | 1783.05 | 1785.53 | 1788.01 | 1790.49 | 1792.97 | 1795.45 | 1797.93 | 1800.41 | 1802.89 | 1805.37 | 1807.85 | 1810.33 | 1812.81 | 1815.29 | 1817.77 | 1820.25 | 1822.73 | 1825.21 | 1827.69 | 1830.17 | 1832.65 | 1835.13 | 1837.61 | 1840.09 | 1842.57 | 1845.05 | 1847.53 | 1850.01 | 1852.49 | 1854.97 | 1857.45 | 1859.93 | 1862.41 | 1864.89 | 1867.37 | 1869.85 | 1872.33 | 1874.81 | 1877.29 | 1879.77 | 1882.25 | 1884.73 | 1887.21 | 1889.69 | 1892.17 | 1894.65 | 1897.13 | 1899.61 | 1902.09 | 1904.57 | 1907.05 | 1909.53 | 1912.01 | 1914.49 | 1916.97 | 1919.45 | 1921.93 | 1924.41 | 1926.89 | 1929.37 | 1931.85 | 1934.33 | 1936.81 | 1939.29 | 1941.77 | 1944.25 | 1946.73 | 1949.21 | 1951.69 | 1954.17 | 1956.65 | 1959.13 | 1961.61 | 1964.09 | 1966.57 | 1969.05 | 1971.53 | 1974.01 | 1976.49 | 1978.97 | 1981.45 | 1983.93 | 1986.41 | 1988.89 | 1991.37 | 1993.85 | 1996.33 | 1998.81 | 2001.29 | 2003.77 | 2006.25 | 2008.73 | 2011.21 | 2013.69 | 2016.17 | 2018.65 | 2021.13 | 2023.61 | 2026.09 | 2028.57 | 2031.05 | 2033.53 | 2036.01 | 2038.49 | 2040.97 | 2043.45 | 2045.93 | 2048.41 | 2050.89 | 2053.37 | 2055.85 | 2058.33 | 2060.81 | 2063.29 | 2065.77 | 2068.25 | 2070.73 | 2073.21 | 2075.69 | 2078.17 | 2080.65 | 2083.13 | 2085.61 | 2088.09 | 2090.57 | 2093.05 | 2095.53 | 2098.01 | 2100.49 | 2102.97 | 2105.45 | 2107.93 | 2110.41 | 2112.89 | 2115.37 | 2117.85 | 2120.33 | 2122.81 | 2125.29 | 2127.77 | 2130.25 | 2132.73 | 2135.21 | 2137.69 | 2140.17 | 2142.65 | 2145.13 | 2147.61 | 2150.09 | 2152.57 | 2155.05 | 2157.53 | 2160.01 | 2162.49 | 2164.97 | 2167.45 | 2169.93 | 2172.41 | 2174.89 | 2177.37 | 2179.85 | 2182.33 | 2184.81 | 2187.29 | 2189.77 | 2192.25 | 2194.73 | 2197.21 | 2199.69 | 2202.17 | 2204.65 | 2207.13 | 2209.61 | 2212.09 | 2214.57 | 2217.05 | 2219.53 | 2222.01 | 2224.49 | 2226.97 | 2229.45 | 2231.93 | 2234.41 | 2236.89 | 2239.37 | 2241.85 | 2244.33 | 2246.81 | 2249.29 | 2251.77 | 2254.25 | 2256.73 | 2259.21 | 2261.69 | 2264.17 | 2266.65 | 2269.13 | 2271.61 | 2274.09 | 2276.57 | 2279.05 | 2281.53 | 2284.01 | 2286.49 | 2288.97 | 2291.45 | 2293.93 | 2296.41 | 2298.89 | 2301.37 | 2303.85 | 2306.33 | 2308.81 | 2311.29 | 2313.77 | 2316.25 | 2318.73 | 2321.21 | 2323.69 | 2326.17 | 2328.65 | 2331.13 | 2333.61 | 2336.09 | 2338.57 | 2341.05 | 2343.53 | 2346.01 | 2348.49 | 2350.97 | 2353.45 | 2355.93 | 2358.41 | 2360.89 | 2363.37 | 2365.85 | 2368.33 | 2370.81 | 2373.29 | 2375.77 | 2378.25 | 2380.73 | 2383.21 | 2385.69 | 2388.17 | 2390.65 | 2393.13 | 2395.61 | 2398.09 | 2400.57 | 2403.05 | 2405.53 | 2408.01 | 2410.49 | 2412.97 | 2415.45 | 2417.93 | 2420.41 | 2422.89 | 2425.37 | 2427.85 | 2430.33 | 2432.81 | 2435.29 | 2437.77 | 2440.25 | 2442.73 | 2445.21 | 2447.69 | 2450.17 | 2452.65 | 2455.13 | 2457.61 | 2460.09 | 2462.57 | 2465.05 | 2467.53 | 2470.01 | 2472.49 | 2474.97 | 2477.45 | 2479.93 | 2482.41 | 2484.89 | 2487.37 | 2489.85 | 2492.33 | 2494.81 | 2497.29 | 2499.77 | 2502.25 | 2504.73 | 2507.21 | 2509.69 | 2512.17 | 2514.65 | 2517.13 | 2519.61 | 2522.09 | 2524.57 | 2527.05 | 2529.53 | 2532.01 | 2534.49 | 2536.97 | 2539.45 | 2541.93 | 2544.41 | 2546.89 | 2549.37 | 2551.85 | 2554.33 | 2556.81 | 2559.29 | 2561.77 | 2564.25 | 2566.73 | 2569.21 | 2571.69 | 2574.17 | 2576.65 | 2579.13 | 2581.61 |
|---------------------|--------|--------|--------|------|------|------|------|------|-------|-------|-------|-------|-------|-------|-------|-------|-------|-------|-------|-------|-------|-------|-------|-------|-------|-------|-------|-------|-------|-------|-------|-------|-------|-------|-------|-------|-------|-------|-------|-------|-------|-------|-------|-------|--------|--------|--------|--------|--------|--------|--------|--------|--------|--------|--------|--------|--------|--------|--------|--------|--------|--------|--------|--------|--------|--------|--------|--------|--------|--------|--------|--------|--------|--------|--------|--------|--------|--------|--------|--------|--------|--------|--------|--------|--------|--------|--------|--------|--------|--------|--------|--------|--------|--------|--------|--------|--------|--------|--------|--------|--------|--------|--------|--------|--------|--------|--------|--------|--------|--------|--------|--------|--------|--------|--------|--------|--------|--------|--------|--------|--------|--------|--------|--------|--------|--------|--------|--------|--------|--------|--------|--------|--------|--------|--------|--------|--------|--------|--------|--------|--------|--------|--------|--------|--------|--------|--------|--------|--------|--------|--------|--------|--------|--------|--------|--------|--------|--------|--------|--------|--------|--------|--------|--------|--------|--------|--------|--------|--------|--------|--------|--------|--------|--------|--------|--------|--------|--------|--------|--------|--------|--------|--------|--------|--------|--------|--------|--------|--------|--------|--------|--------|--------|--------|--------|--------|--------|--------|--------|--------|--------|--------|--------|--------|--------|--------|--------|--------|--------|--------|--------|--------|--------|--------|--------|--------|--------|--------|--------|--------|--------|--------|--------|--------|--------|--------|--------|--------|--------|--------|--------|--------|--------|--------|--------|--------|--------|--------|--------|--------|--------|--------|--------|--------|--------|--------|--------|--------|--------|--------|--------|--------|--------|--------|--------|--------|--------|--------|--------|--------|--------|--------|--------|--------|--------|--------|--------|--------|--------|--------|--------|--------|--------|--------|--------|--------|--------|--------|--------|--------|--------|--------|--------|--------|--------|--------|--------|--------|--------|--------|--------|--------|--------|--------|--------|--------|--------|--------|--------|--------|--------|--------|--------|--------|--------|--------|--------|--------|--------|--------|--------|--------|--------|--------|--------|--------|--------|--------|--------|--------|--------|--------|--------|--------|--------|--------|--------|--------|--------|--------|--------|--------|--------|--------|--------|--------|--------|--------|--------|--------|--------|--------|--------|--------|--------|--------|--------|--------|--------|--------|--------|--------|--------|--------|--------|--------|--------|--------|--------|--------|--------|--------|--------|--------|--------|--------|--------|--------|--------|--------|--------|--------|--------|--------|--------|--------|--------|--------|--------|--------|--------|--------|--------|--------|--------|--------|--------|--------|--------|--------|--------|--------|--------|--------|--------|--------|--------|--------|--------|--------|--------|--------|--------|--------|--------|--------|--------|---------|---------|---------|---------|---------|---------|---------|---------|---------|---------|---------|---------|---------|---------|---------|---------|---------|---------|---------|---------|---------|---------|---------|---------|---------|---------|---------|---------|---------|---------|---------|---------|---------|---------|---------|---------|---------|---------|---------|---------|---------|---------|---------|---------|---------|---------|---------|---------|---------|---------|---------|---------|---------|---------|---------|---------|---------|---------|---------|---------|---------|---------|---------|---------|---------|---------|---------|---------|---------|---------|---------|---------|---------|---------|---------|---------|---------|---------|---------|---------|---------|---------|---------|---------|---------|---------|---------|---------|---------|---------|---------|---------|---------|---------|---------|---------|---------|---------|---------|---------|---------|---------|---------|---------|---------|---------|---------|---------|---------|---------|---------|---------|---------|---------|---------|---------|---------|---------|---------|---------|---------|---------|---------|---------|---------|---------|---------|---------|---------|---------|---------|---------|---------|---------|---------|---------|---------|---------|---------|---------|---------|---------|---------|---------|---------|---------|---------|---------|---------|---------|---------|---------|---------|---------|---------|---------|---------|---------|---------|---------|---------|---------|---------|---------|---------|---------|---------|---------|---------|---------|---------|---------|---------|---------|---------|---------|---------|---------|---------|---------|---------|---------|---------|---------|---------|---------|---------|---------|---------|---------|---------|---------|---------|---------|---------|---------|---------|---------|---------|---------|---------|---------|---------|---------|---------|---------|---------|---------|---------|---------|---------|---------|---------|---------|---------|---------|---------|---------|---------|---------|---------|---------|---------|---------|---------|---------|---------|---------|---------|---------|---------|---------|---------|---------|---------|---------|---------|---------|---------|---------|---------|---------|---------|---------|---------|---------|---------|---------|---------|---------|---------|---------|---------|---------|---------|---------|---------|---------|---------|---------|---------|---------|---------|---------|---------|---------|---------|---------|---------|---------|---------|---------|---------|---------|---------|---------|---------|---------|---------|---------|---------|---------|---------|---------|---------|---------|---------|---------|---------|---------|---------|---------|---------|---------|---------|---------|---------|---------|---------|---------|---------|---------|---------|---------|---------|---------|---------|---------|---------|---------|---------|---------|---------|---------|---------|---------|---------|---------|---------|---------|---------|---------|---------|---------|---------|---------|---------|---------|---------|---------|---------|---------|---------|---------|---------|---------|---------|---------|---------|---------|---------|---------|---------|---------|---------|---------|---------|---------|---------|---------|---------|---------|---------|---------|---------|---------|---------|---------|---------|---------|---------|---------|---------|---------|---------|---------|---------|---------|---------|---------|---------|---------|---------|---------|---------|---------|---------|---------|---------|---------|---------|---------|---------|---------|---------|---------|---------|---------|---------|---------|---------|---------|---------|---------|---------|---------|---------|---------|---------|---------|---------|---------|---------|---------|---------|---------|---------|---------|---------|---------|---------|---------|---------|---------|---------|---------|---------|---------|---------|---------|---------|---------|---------|---------|---------|---------|---------|---------|---------|---------|---------|---------|---------|---------|---------|---------|---------|---------|---------|---------|---------|---------|---------|---------|---------|---------|---------|---------|---------|---------|---------|---------|---------|---------|---------|---------|---------|---------|---------|---------|---------|---------|---------|---------|---------|---------|---------|---------|---------|---------|---------|---------|---------|---------|---------|---------|---------|---------|---------|---------|---------|---------|---------|---------|---------|---------|---------|---------|---------|---------|---------|---------|---------|---------|---------|---------|---------|---------|---------|---------|---------|---------|---------|---------|---------|---------|---------|---------|---------|---------|---------|---------|---------|---------|---------|---------|---------|---------|---------|---------|---------|---------|---------|---------|---------|---------|---------|---------|---------|---------|---------|---------|---------|---------|---------|---------|---------|---------|---------|---------|---------|---------|---------|---------|---------|---------|---------|---------|---------|---------|---------|---------|---------|---------|---------|---------|---------|---------|---------|---------|---------|---------|---------|---------|---------|---------|---------|---------|---------|---------|---------|---------|---------|---------|---------|---------|---------|---------|---------|---------|---------|---------|---------|---------|---------|---------|---------|---------|---------|---------|---------|---------|---------|---------|---------|---------|---------|---------|---------|---------|---------|---------|---------|---------|---------|---------|---------|---------|---------|---------|---------|---------|---------|---------|---------|---------|---------|---------|---------|---------|---------|---------|---------|---------|---------|---------|---------|---------|---------|---------|---------|---------|---------|---------|---------|---------|---------|---------|

TR_SIT31
Sezione 15
Progressiva: 0+300
Scala: 1:200
Quota di Riferimento: 330

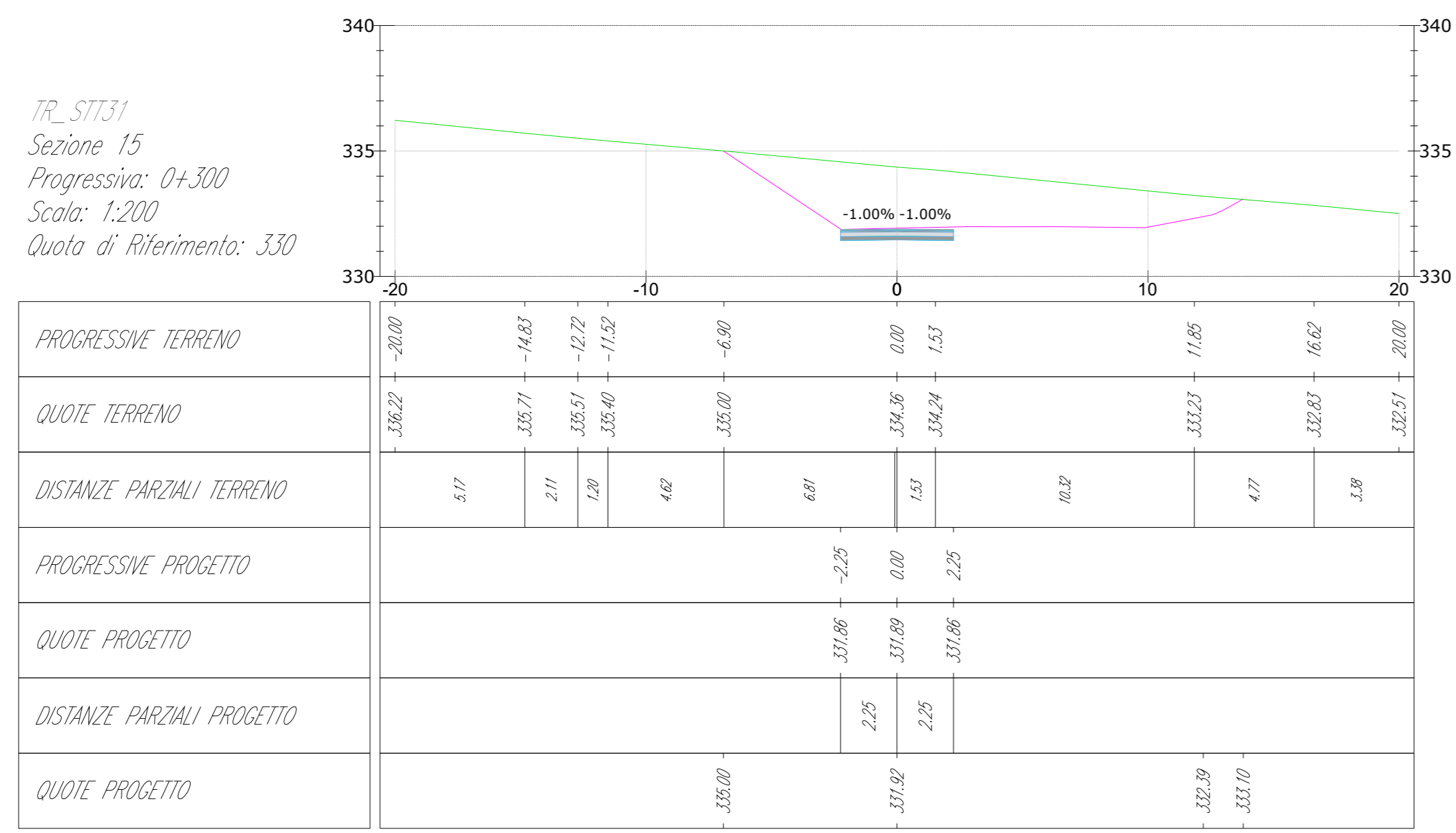

TR_SIT31
Sezione 19
Progressiva: 0+380
Scala: 1:200
Quota di Riferimento: 325

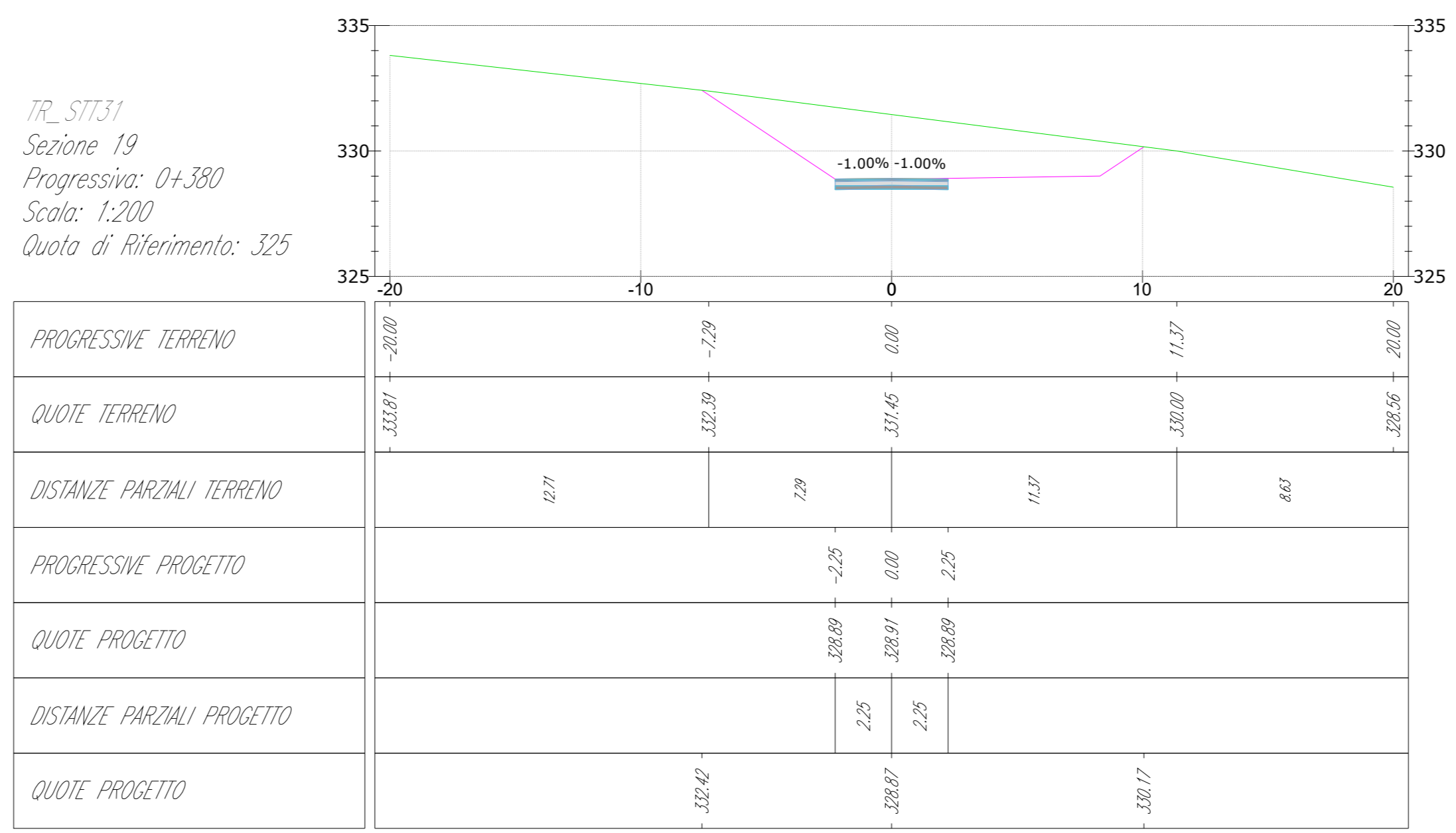

TR_SIT31
Sezione 16
Progressiva: 0+320
Scala: 1:200
Quota di Riferimento: 330

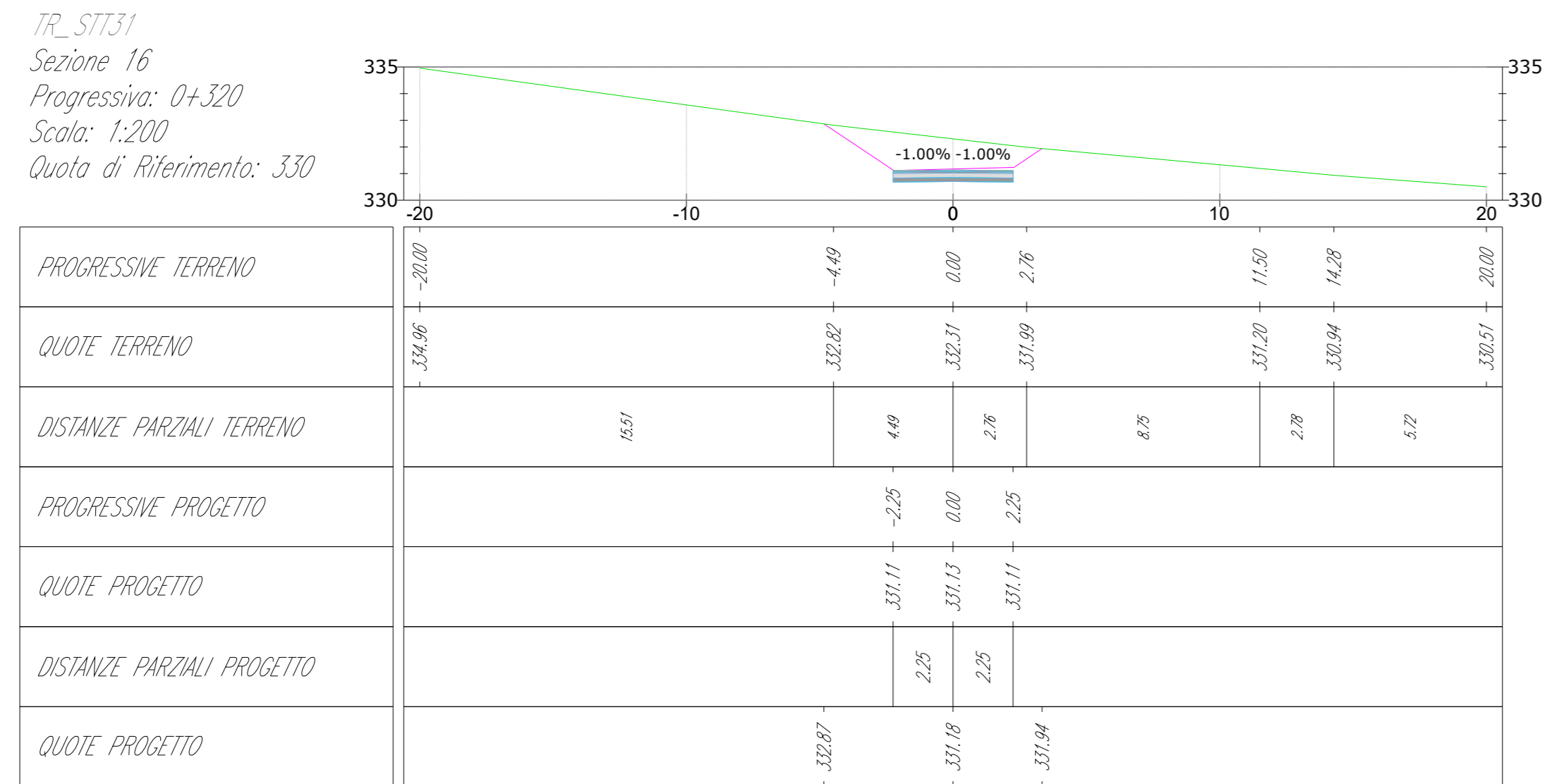

TR_SIT31
Sezione 20
Progressiva: 0+400
Scala: 1:200
Quota di Riferimento: 325

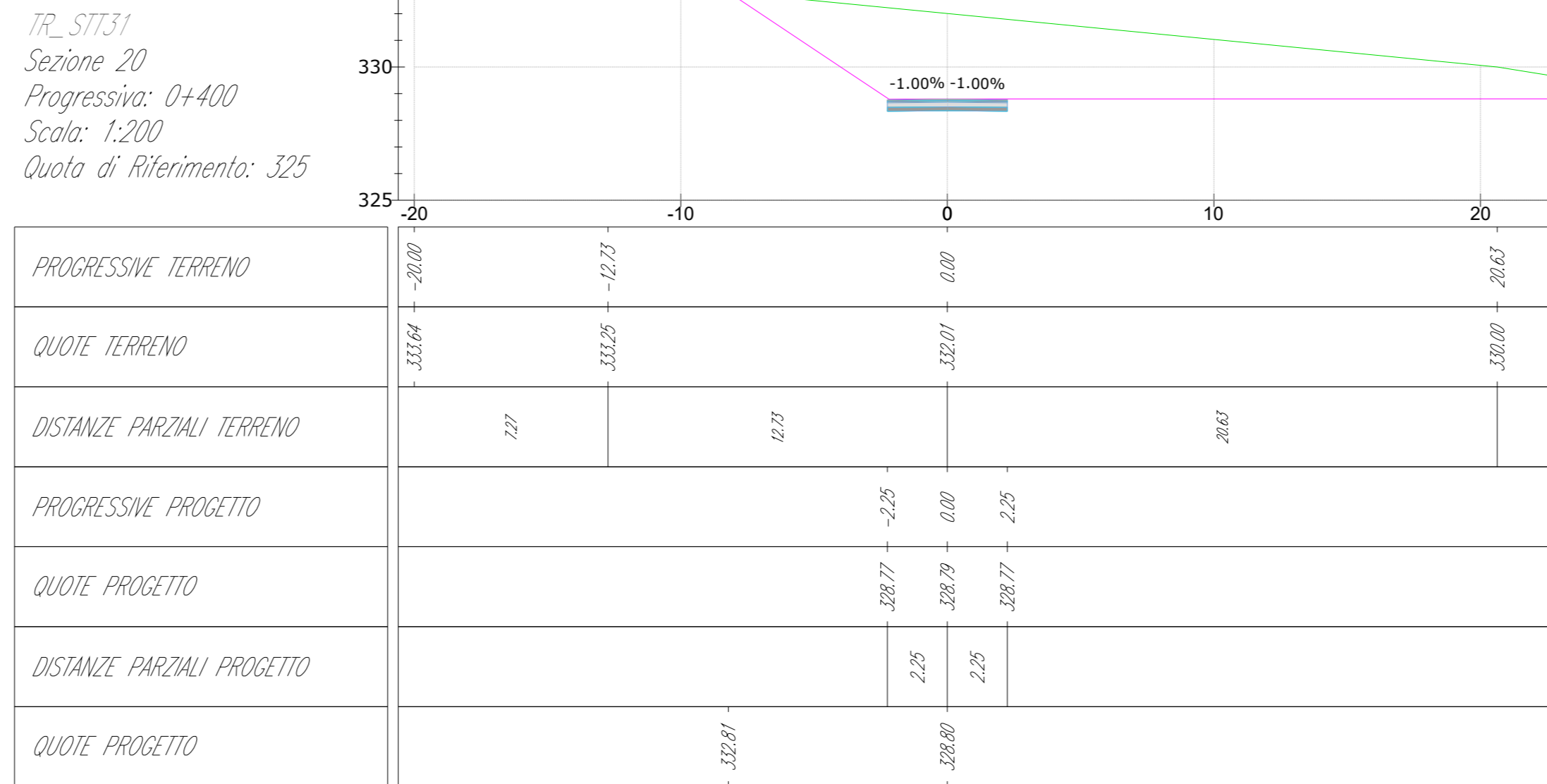

TR_SIT31
Sezione 17
Progressiva: 0+340
Scala: 1:200
Quota di Riferimento: 325

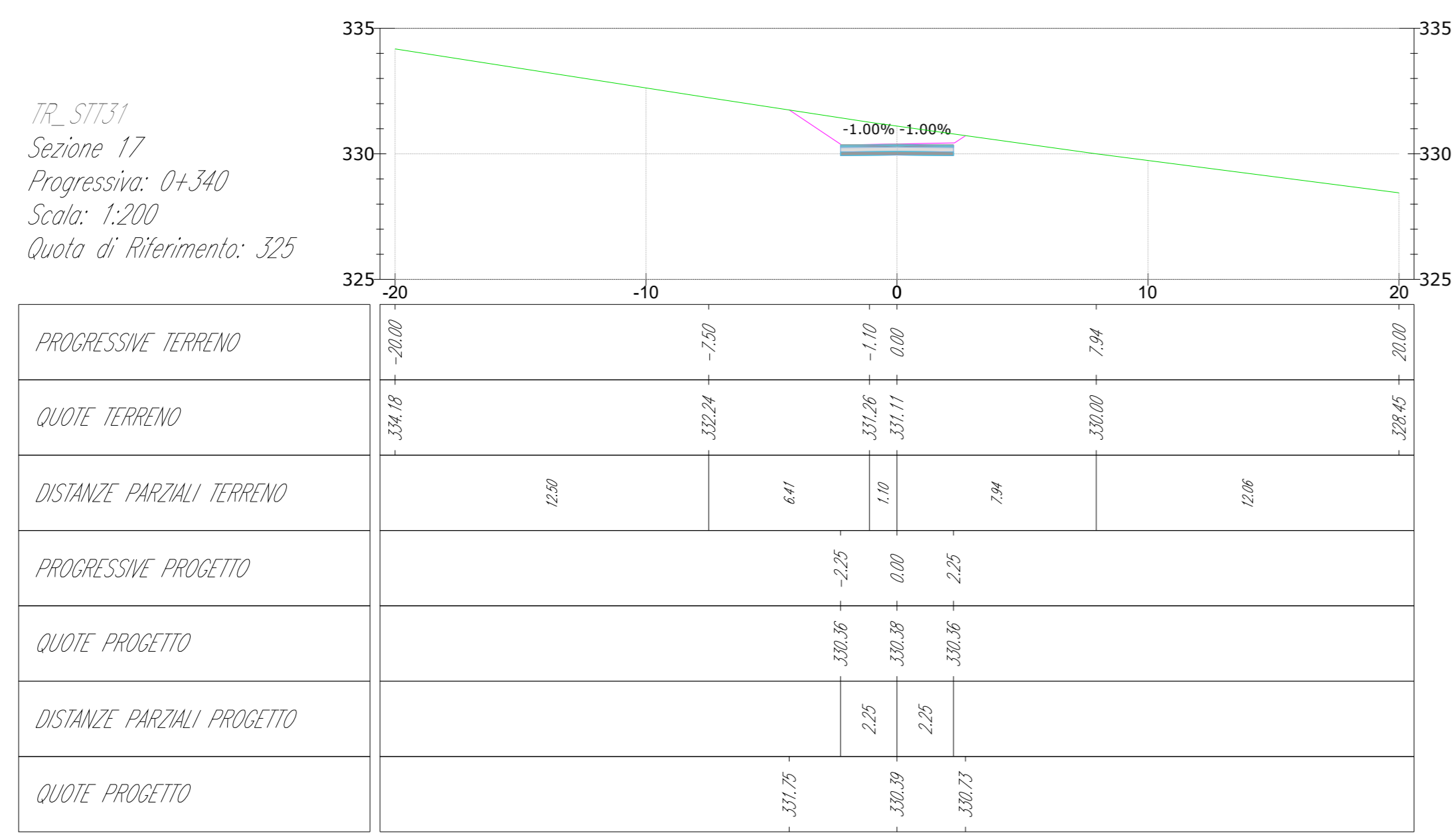

TR_SIT31
Sezione 21
Progressiva: 0+420
Scala: 1:200
Quota di Riferimento: 325

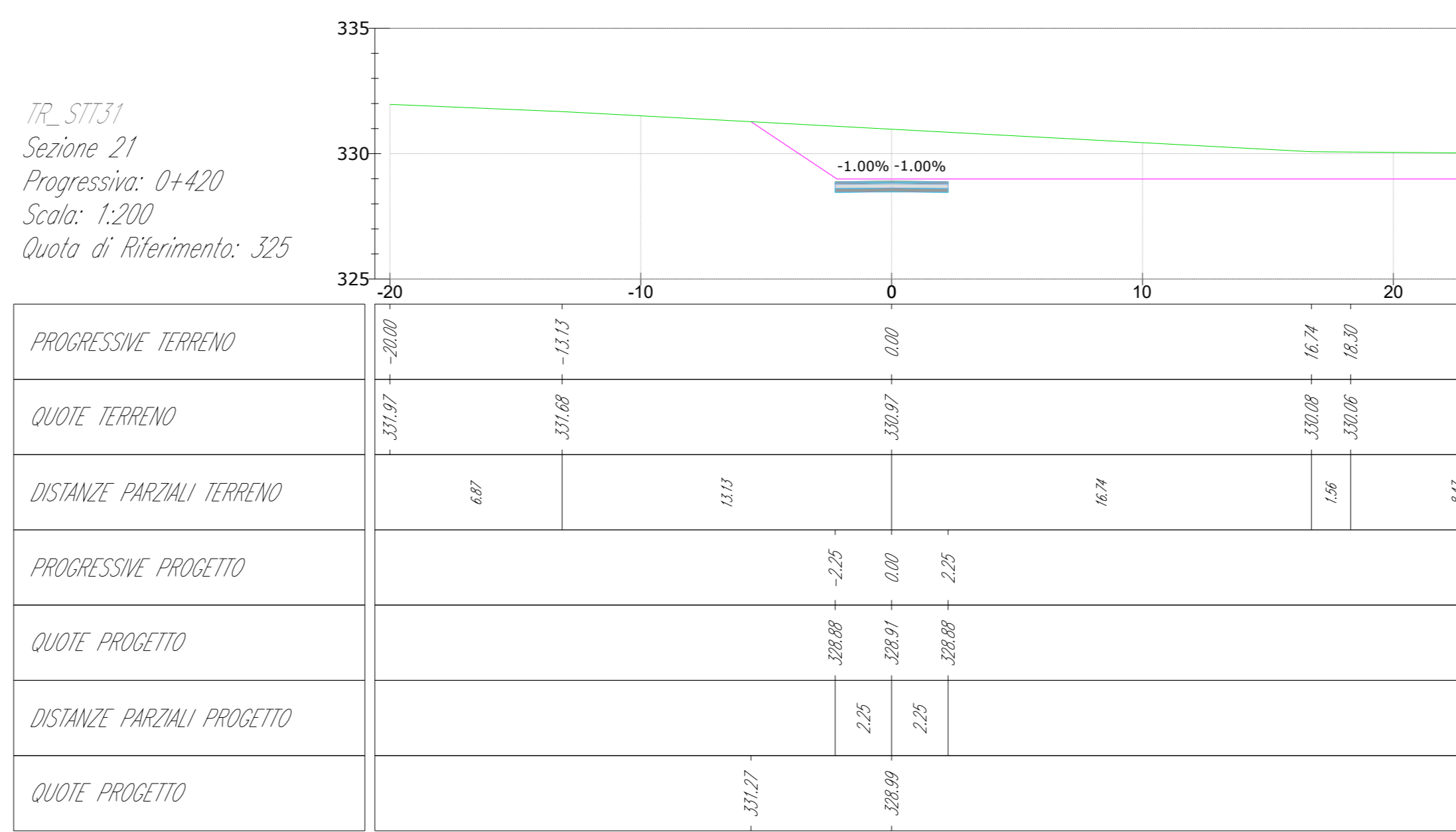

TR_SIT31
Sezione 18
Progressiva: 0+360
Scala: 1:200
Quota di Riferimento: 325

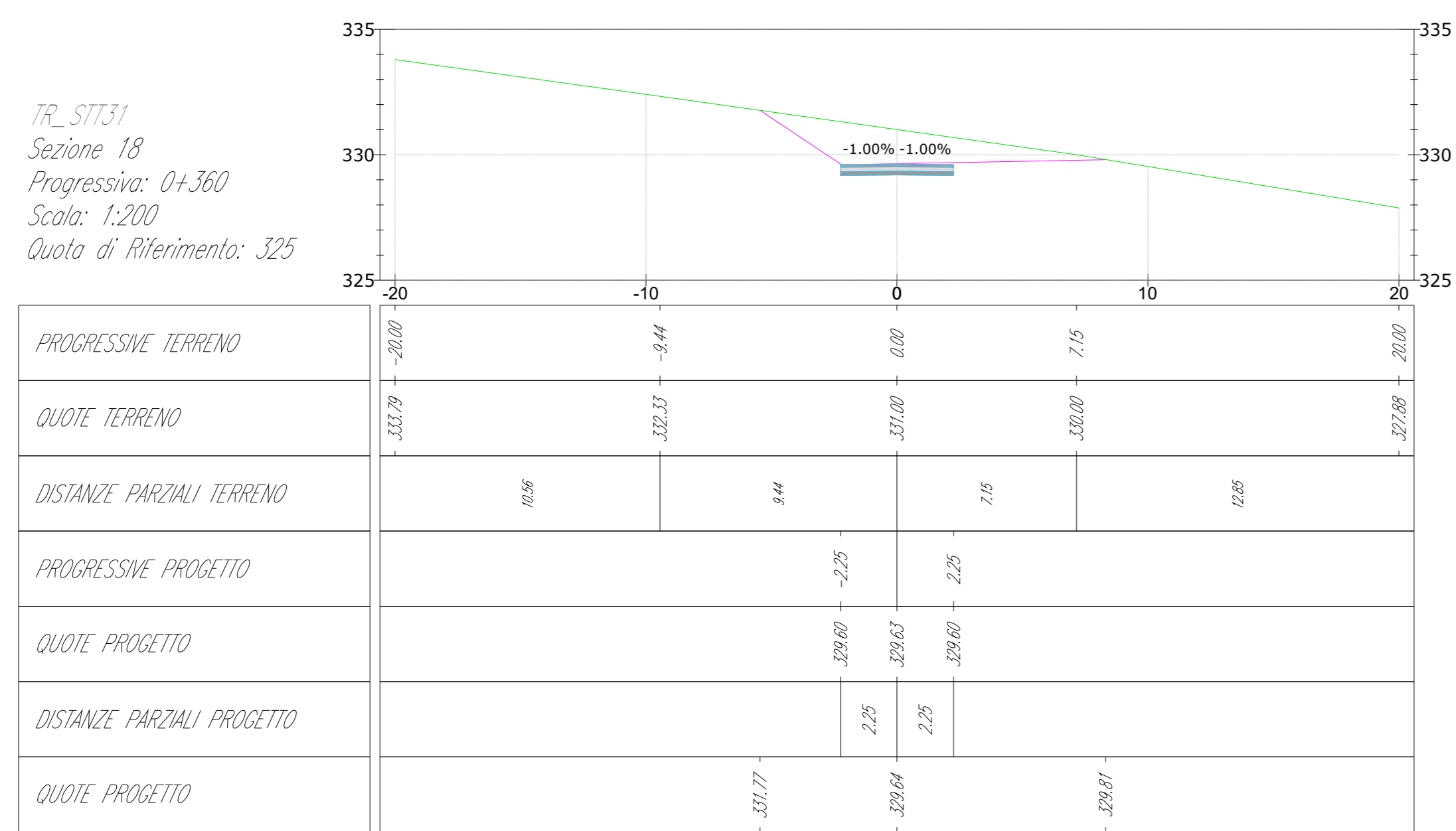

TR_SIT31
Sezione 22
Progressiva: 0+440
Scala: 1:200
Quota di Riferimento: 325

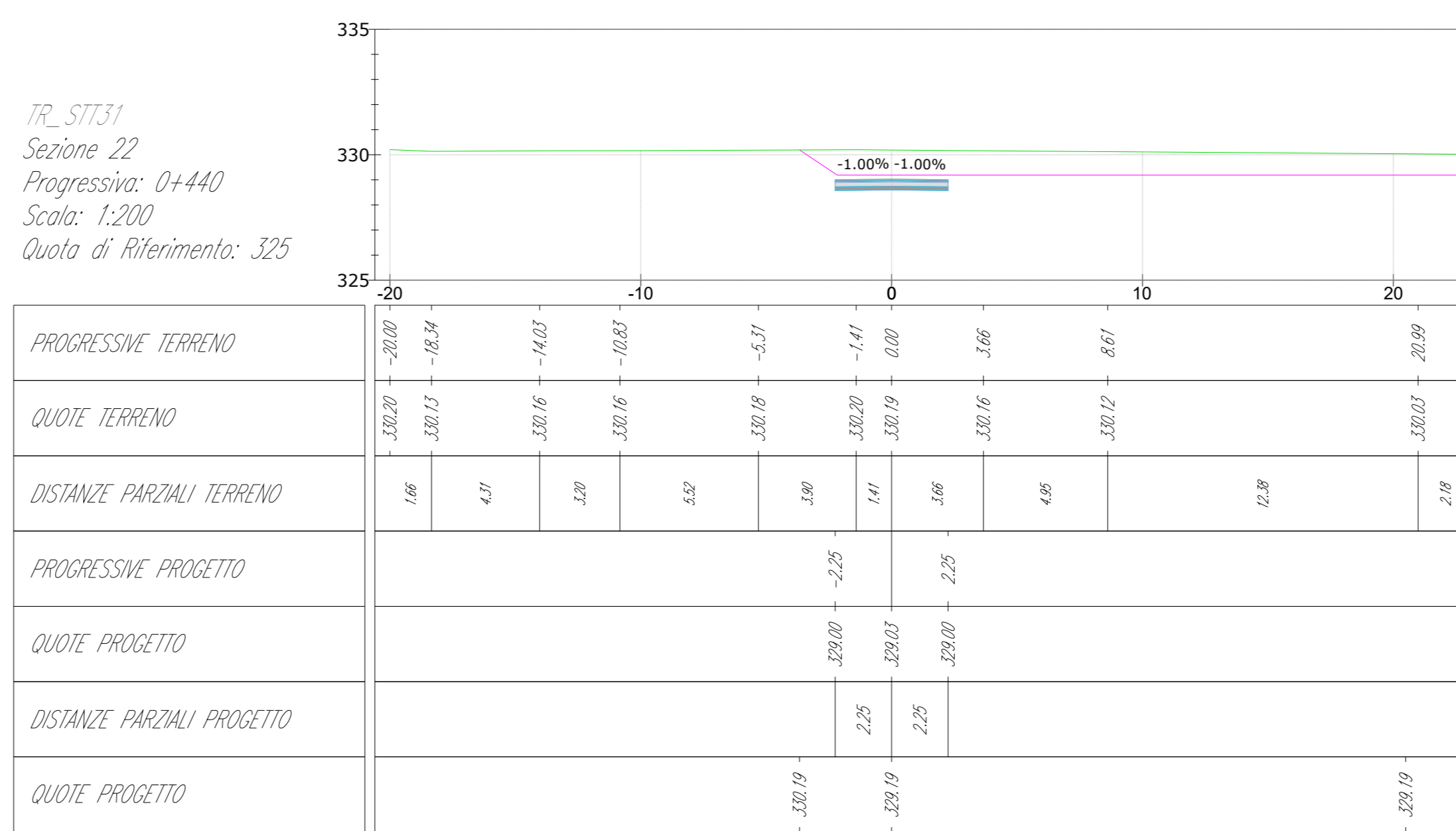

LIVELLETTA

Profilo: Tr_area9_1_ent
Scala : 1000:1000
Q.Rif. : 340 mslm

| | | | | | | | | | | | | | | | | |
|----------------------|-------|-------|-------|-------|-------|-------|-------|-------|-------|-------|-------|-------|-------|-------|-------|-------|
| NUMERO SEZIONE | 1 | 2 | 3 | 4 | 5 | 6 | 7 | 8 | 9 | 10 | 11 | 12 | 13 | 14 | 15 | 16 |
| DISTANZE PROGRESSIVE | 0+000 | 0+040 | 0+080 | 0+080 | 0+100 | 0+120 | 0+140 | 0+160 | 0+180 | 0+200 | 0+220 | 0+240 | 0+280 | 0+280 | 0+310 | 0+334 |
| QUOTE TERRENO | 351,0 | 355,6 | 358,1 | 360,5 | 362,7 | 364,8 | 367,0 | 368,1 | 368,4 | 366,9 | 364,8 | 362,3 | 361,0 | 359,5 | 356,1 | 352,1 |
| QUOTE PROGETTO | 352,6 | 355,1 | 357,9 | 360,2 | 362,4 | 364,6 | 366,8 | 367,9 | 367,5 | 365,9 | 364,0 | 361,5 | 360,3 | 358,1 | 350,2 | 347,3 |
| DIFFERENZA QUOTE | -0,3 | -0,2 | -0,2 | -0,4 | -0,3 | -0,2 | -0,2 | -1,1 | -0,8 | -1,0 | -0,8 | -0,8 | -0,8 | -2,7 | -4,4 | -4,8 |

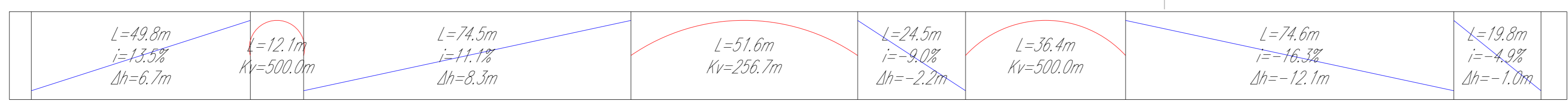

LEGENDA DEI COLORI E SIMBOLI IN CARTA

- Aerogeneratore (Diametro = 163 m, Hhub = 125 m)
- Piazzaola
- Profilo Piazzaola
- Profilo terreno
- Strade esistenti da adeguare
- Strade di nuova realizzazione
- Livelletta
- Cavidotto 36 kV
- Scavi
- Riporti
- Curva di livello principale (intervalli di 10 m) - Quota terreno
- Curva di livello secondaria (intervalli di 2 m) - Quota terreno

STT30

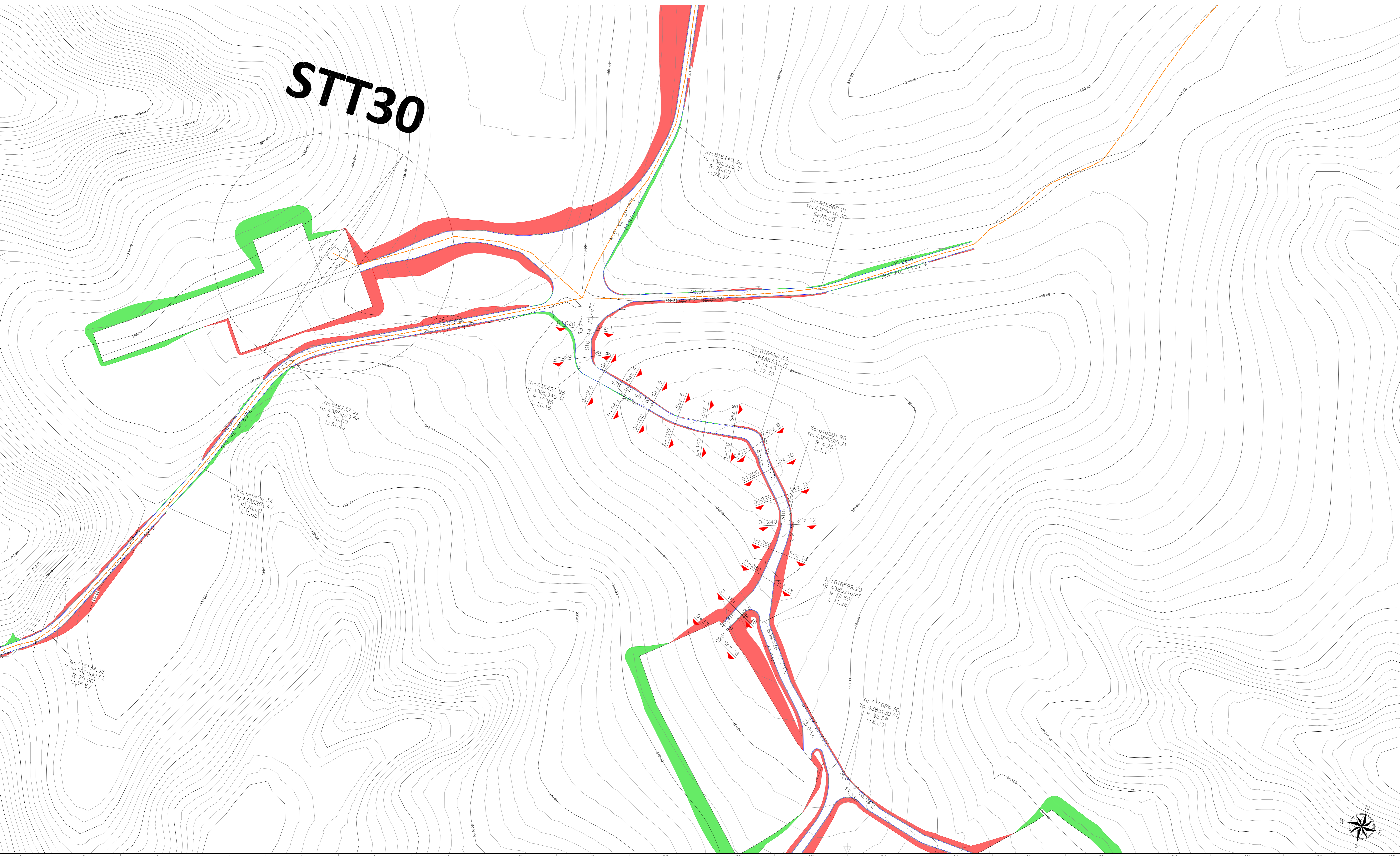

green & green
WE ENGINEERING

Green & Green S.r.l.
Via Edmondo de Amicis n.64
37036 Ronde (CS) - Italy
P.IVA 0290010782
Ph. (+39) 0984 846295
Fax (+39) 0984 121440
info@greengreen.it
www.greengreen.it

Il tecnico
Ing. Leonardo Sblendoro

| | | | | | |
|-----|------------|-----------------|-------------|-------------|--------------|
| 00 | 22/12/2023 | PRIMA EMISSIONE | R. De Fiore | P.E. | L. Sblendoro |
| REV | DATA | DESCRIZIONE | PREPARATO | CONTROLLATO | APPROVATO |

"IMPIANTO EOLICO TERRANOVA DA SIBARI"
(COMUNI DI TERRANOVA DA SIBARI, SAN DEMETRIO CORONE, SPEZZANO ALBANESE, CORIGLIANO-ROSSANO, SANTA SOFIA DE'PIRO E TARSIA (CS))

| | | | | |
|---------------------------------|---|---------------|-----------------|------------------|
| | PROGETTO | | | |
| | DEFINITIVO | | | |
| | NOME FILE: C23FSTR0011WD01000_STUDIO PLANOALTIMETRICO.pdf | | | |
| | FORMATO: A0 | SCALA: 1:1000 | SCALA PLOT: 1:1 | FOGLIO: 17 di 39 |
| TITOLO: STUDIO PLANOALTIMETRICO | | | | |
| CODICE ELABORATO | | | | |
| C23FSTR0011WD01000 | | | | |

LIVELLETTA

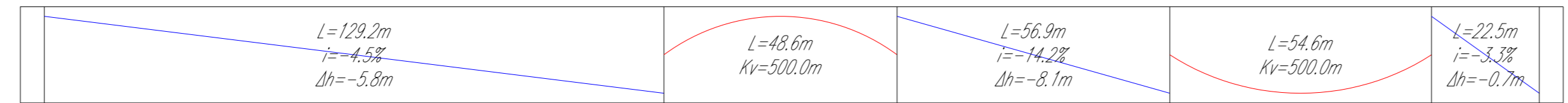

Profilo: Tr_area9_ent
 Scala: 1000/1000
 Q.Rif.: 325 mslm

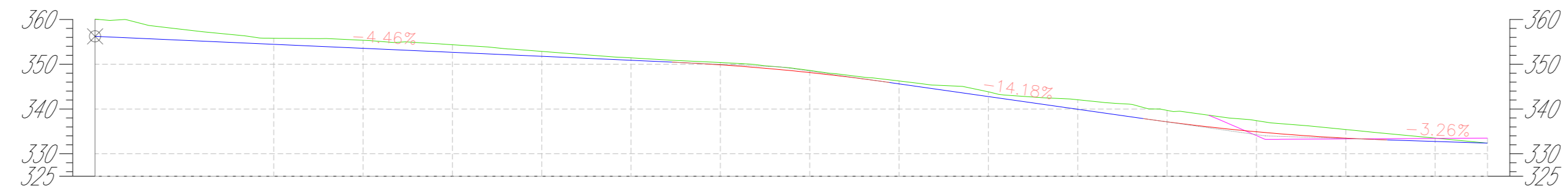

| NUMERO SEZIONE | 1 | 2 | 3 | 4 | 5 | 6 | 7 | 8 | 9 | 10 | 11 | 12 | 13 | 14 | 15 |
|----------------------|-------|-------|-------|-------|-------|-------|-------|-------|-------|-------|-------|-------|-------|--------|--------|
| DISTANZE PROGRESSIVE | 0+000 | 0+080 | 0+160 | 0+240 | 0+320 | 0+400 | 0+480 | 0+560 | 0+640 | 0+720 | 0+800 | 0+880 | 0+960 | 0+1040 | 0+1120 |
| QUOTE TERRENO | 358.8 | 358.4 | 358.4 | 359.9 | 361.4 | 362.4 | 364.6 | 366.1 | 365.9 | 362.1 | 359.7 | 357.4 | 355.4 | 353.1 | 352.4 |
| QUOTE PROGETTO | 364.4 | 363.6 | 362.7 | 361.9 | 360.9 | 360.9 | 361.1 | 361.6 | 362.9 | 360.0 | 357.1 | 354.9 | 353.5 | 352.9 | 352.4 |
| DIFFERENZA QUOTE | -1.4 | -1.8 | -1.7 | -1.1 | -0.5 | -0.5 | -0.5 | -0.6 | -0.6 | -1.1 | -1.1 | -0.6 | -0.9 | -0.8 | 0.0 |

LEGENDA DEI COLORI E SIMBOLI IN CARTA

- Aerogeneratore (Diametro = 163 m, Hhub = 125 m)
- Piazza
- Profilo Piazza
- Profilo terreno
- Strade esistenti da adeguare
- Strade di nuova realizzazione
- Livellatta
- Cavidotto 36 kV
- Scavi
- Riparti
- Curva di livello principale (intervalli di 10 m) - Quota terreno
- Curva di livello secondaria (intervalli di 2 m) - Quota terreno

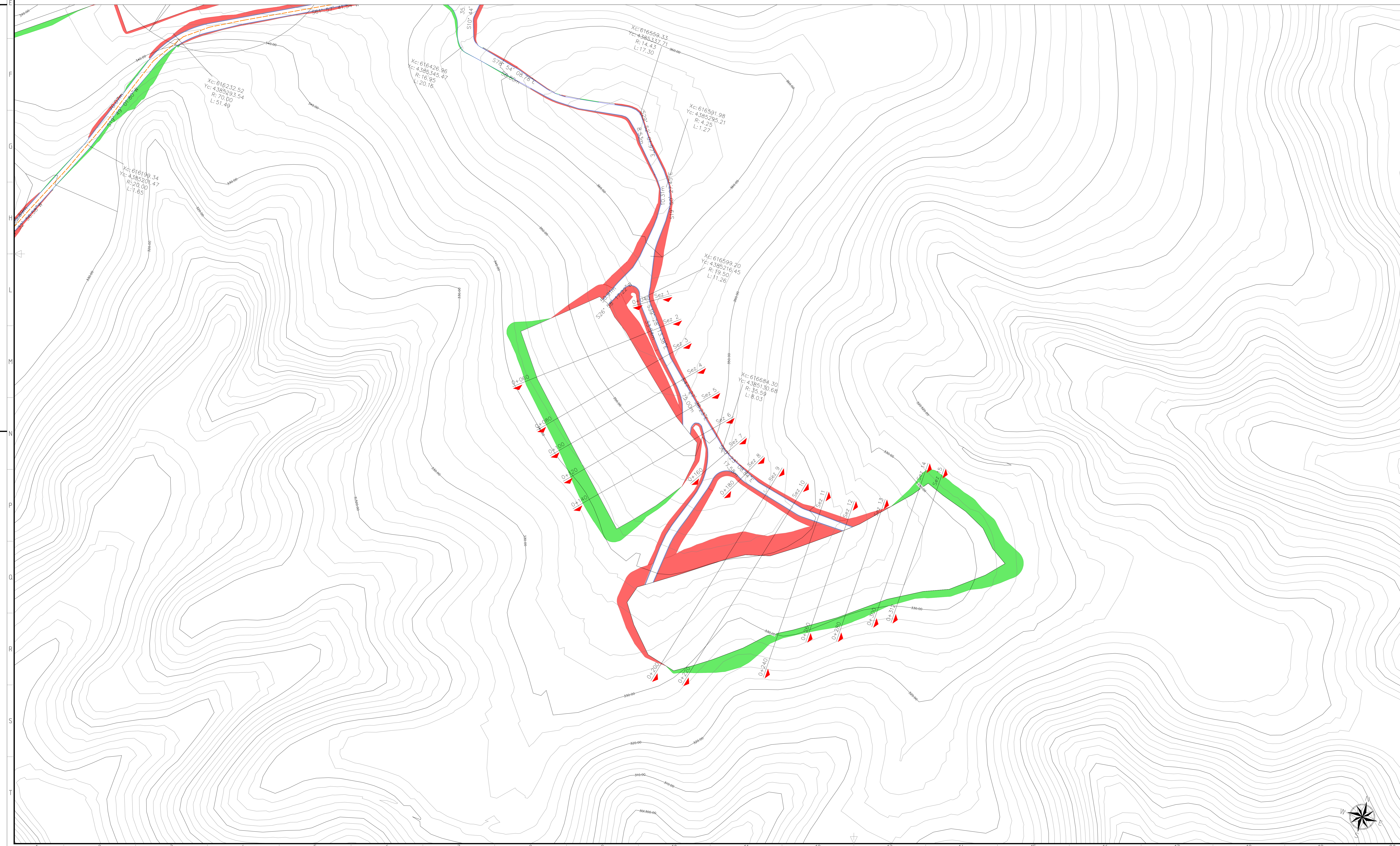

green & green
 WE ENGINEERING
 Green & Green S.r.l.
 Via Edmondo de Amicis n.64
 37036 Ronde (CS) - Italy
 P.IVA 02900010782
 Ph. (+39) 0984 846295
 Fax (+39) 0984 121470
 info@greengreen.it
 www.greengreen.it

Il tecnico
Ing. Leonardo Sblendoro

| | | | | | |
|------|------------|-----------------|-------------|-------------|--------------|
| 00 | 22/12/2023 | PRIMA EMISSIONE | R. De Fiore | P.E. | L. Sblendoro |
| REV. | DATA | DESCRIZIONE | PREPARIATO | CONTROLLATO | APPROVATO |

"IMPIANTO EOLICO TERRANOVA DA SIBARI"
 (COMUNI DI TERRANOVA DA SIBARI, SAN DEMETRIO CORONE, SPEZZANO ALBANESE, CORIGLIANO-ROSSANO, SANTA SOFIA D'EPSIRO E TARSIA (CS))

| | | | | | |
|---------------------------|--|--------------------|----------------------|------------------------|--------------------------------|
| | PROGETTO: DEFINITIVO | | | | |
| | MODEL FILE: C23FSTR0011WD01000_STUDIO PLANOALTIMETRICO.pdf | FORMATO: A0 | SCALA: 1:1000 | SCALA PLOT: 1:1 | FOGLIO: 20 di 39 |
| | STUDIO PLANOALTIMETRICO | | | | |
| | CODICE ELABORATO: | | | | |
| C23FSTR0011WD01000 | | 02 | | WD01000 | |

TR_AREA_ENT
Sezione 1
Progressiva: 0+040
Scala: 1:200
Quota di Riferimento: 350

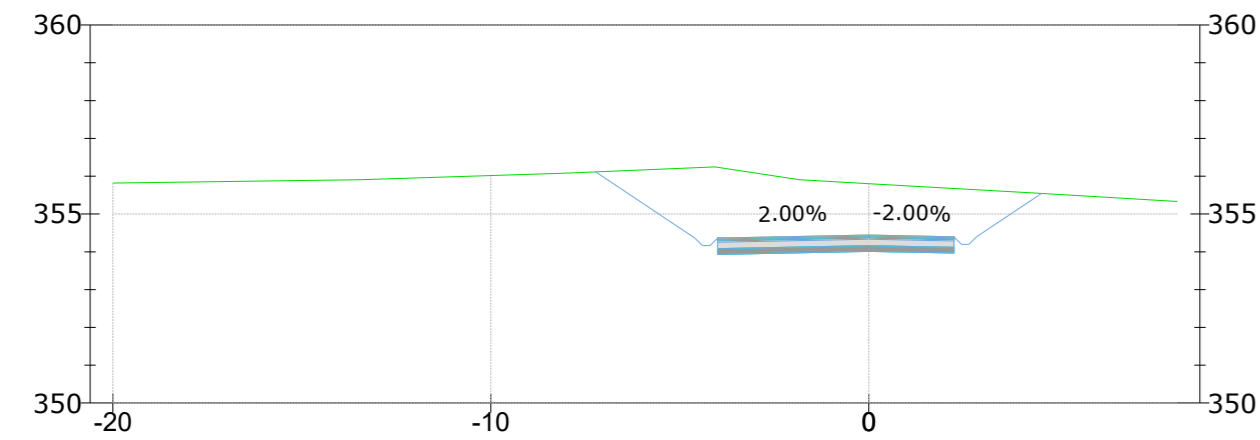

| | | | | | | | | | | | | | |
|----------------------------|--------|--------|--------|--------|--------|--------|--------|--------|--------|--------|--------|--------|--------|
| PROGRESSIVE TERRENO | -20.00 | -10.00 | 0.00 | 10.00 | 20.00 | 30.00 | 40.00 | 50.00 | 60.00 | 70.00 | 80.00 | 90.00 | 100.00 |
| QUOTE TERRENO | 350.00 | 350.00 | 350.00 | 350.00 | 350.00 | 350.00 | 350.00 | 350.00 | 350.00 | 350.00 | 350.00 | 350.00 | 350.00 |
| DISTANZE PARZIALI TERRENO | 6.58 | 5.40 | | | | | | | | | | | |
| PROGRESSIVE PROGETTO | | | | | | | | | | | | | |
| QUOTE PROGETTO | | | | | | | | | | | | | |
| DISTANZE PARZIALI PROGETTO | | | | | | | | | | | | | |

TR_AREA_ENT
Sezione 2
Progressiva: 0+060
Scala: 1:200
Quota di Riferimento: 335

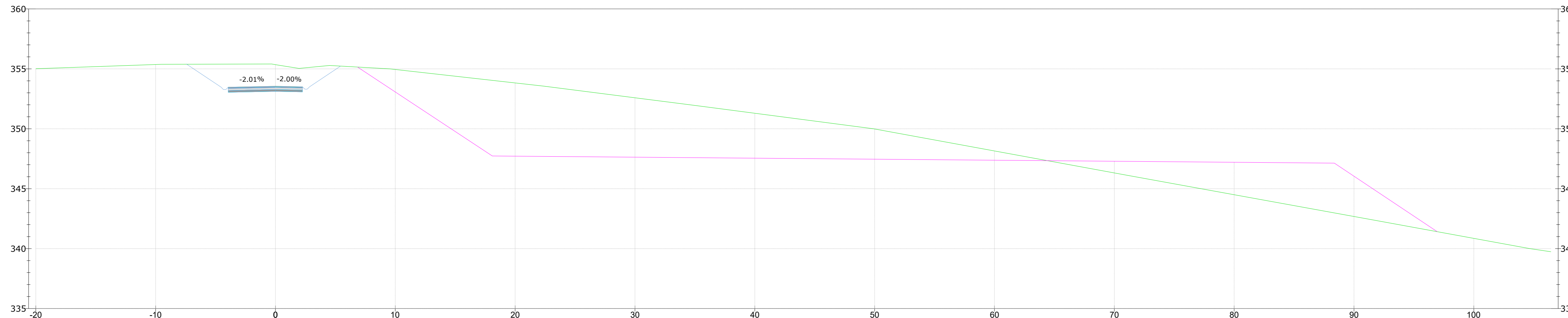

| | | | | | | | | | | | | | |
|----------------------------|--------|--------|--------|--------|--------|--------|--------|--------|--------|--------|--------|--------|--------|
| PROGRESSIVE TERRENO | -20.00 | -10.00 | 0.00 | 10.00 | 20.00 | 30.00 | 40.00 | 50.00 | 60.00 | 70.00 | 80.00 | 90.00 | 100.00 |
| QUOTE TERRENO | 350.00 | 350.00 | 350.00 | 350.00 | 350.00 | 350.00 | 350.00 | 350.00 | 350.00 | 350.00 | 350.00 | 350.00 | 350.00 |
| DISTANZE PARZIALI TERRENO | 6.58 | 5.40 | | | | | | | | | | | |
| PROGRESSIVE PROGETTO | | | | | | | | | | | | | |
| QUOTE PROGETTO | | | | | | | | | | | | | |
| DISTANZE PARZIALI PROGETTO | | | | | | | | | | | | | |
| QUOTE PROGETTO | | | | | | | | | | | | | |

TR_AREA_ENT
Sezione 3
Progressiva: 0+080
Scala: 1:200
Quota di Riferimento: 335

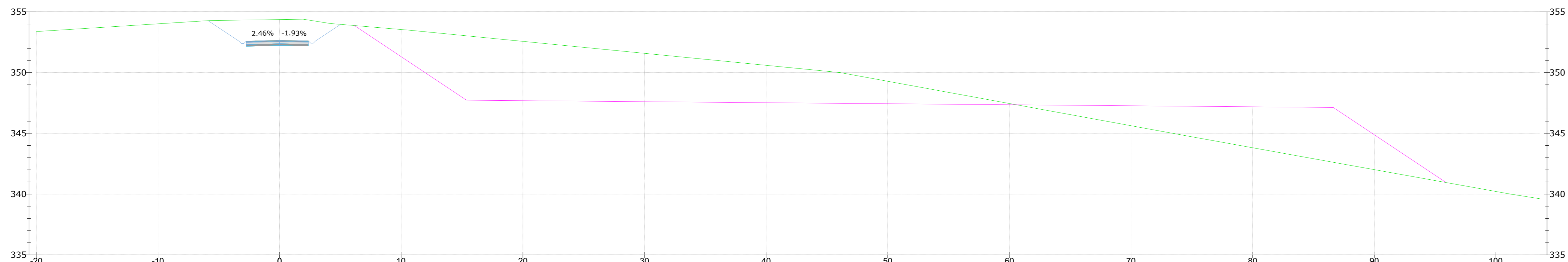

| | | | | | | | | | | | | | |
|----------------------------|--------|--------|--------|--------|--------|--------|--------|--------|--------|--------|--------|--------|--------|
| PROGRESSIVE TERRENO | -20.00 | -10.00 | 0.00 | 10.00 | 20.00 | 30.00 | 40.00 | 50.00 | 60.00 | 70.00 | 80.00 | 90.00 | 100.00 |
| QUOTE TERRENO | 350.00 | 350.00 | 350.00 | 350.00 | 350.00 | 350.00 | 350.00 | 350.00 | 350.00 | 350.00 | 350.00 | 350.00 | 350.00 |
| DISTANZE PARZIALI TERRENO | 6.58 | 5.40 | | | | | | | | | | | |
| PROGRESSIVE PROGETTO | | | | | | | | | | | | | |
| QUOTE PROGETTO | | | | | | | | | | | | | |
| DISTANZE PARZIALI PROGETTO | | | | | | | | | | | | | |
| QUOTE PROGETTO | | | | | | | | | | | | | |

LEGENDA DEI COLORI E SIMBOLI IN CARTA

- Profilo terreno
- Profilo Piazzola



Green & Green S.r.l.
Via Edmondo de Amicis n.64
37036 Ronde (CS) - Italy
P.IVA 02900010782
Ph. (+39) 0984 846295
Fax (+39) 0984 121470
info@greengreen.it
www.greengreen.it

Il tecnico
Ing. Leonardo Sblendido



| | | | | | |
|----|------------|-----------------|-------------|------|--------------|
| 00 | 22/12/2023 | PRIMA EMISSIONE | R. De Fiore | P.E. | L. Sblendido |
|----|------------|-----------------|-------------|------|--------------|

"IMPIANTO EOLICO TERRANOVA DA SIBARI"
(COMUNI DI TERRANOVA DA SIBARI, SAN DEMETRIO CORONE, SPEZZANO ALBANESE, CORIGLIANO-ROSSANO, SANTA SOFIA D'EPSIRO E TARSIA (CS))



| | | | |
|------------|--|-------------|----------|
| PROGETTO | DEFINITIVO | | |
| WORK FILE: | CZ3FSTR0011WD01000_STUDIO PLANOALTIMETRICO.pdf | | |
| FORMATO: | SCALA: | SCALA PLOT: | FOGLIO: |
| A0 | 1:200 | 1:1 | 21 di 39 |



| | | | |
|-------------------------|-----|---------|-----------|
| STUDIO PLANOALTIMETRICO | | | |
| CODICE ELABORATO | | | |
| IMPIANTO | TIC | TR0 | REVISIONE |
| C23FSTR001 | 02 | WD01000 | 00 |

- Profilo terreno
- Profilo Piazzola

TR_AREAS_ENT
Sezione 4
Progressiva: 0+100
Scala: 1:200
Quota di Riferimento: 335

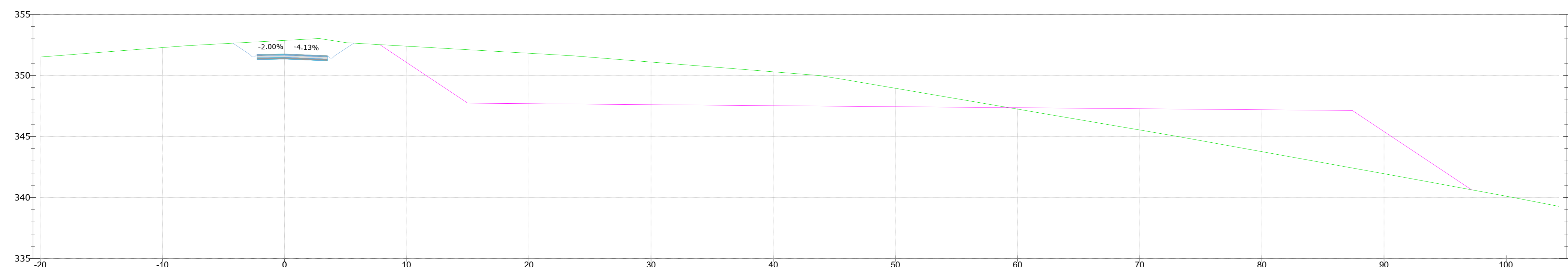

| | | | | | | | | | | | | | | | | | | | | | | | | | | |
|----------------------------|--------|--------|--------|--------|--------|--------|--------|--------|--------|--------|--------|--------|--------|--------|--------|--------|--------|--------|--------|--------|--------|--------|--------|--------|--------|--------|
| PROGRESSIVE TERRENO | 20.00 | 15.00 | 10.00 | 5.00 | 0.00 | 5.00 | 10.00 | 15.00 | 20.00 | 25.00 | 30.00 | 35.00 | 40.00 | 45.00 | 50.00 | 55.00 | 60.00 | 65.00 | 70.00 | 75.00 | 80.00 | 85.00 | 90.00 | 95.00 | 100.00 | 105.00 |
| QUOTE TERRENO | 351.51 | 351.58 | 351.65 | 351.72 | 351.79 | 351.86 | 351.93 | 352.00 | 352.07 | 352.14 | 352.21 | 352.28 | 352.35 | 352.42 | 352.49 | 352.56 | 352.63 | 352.70 | 352.77 | 352.84 | 352.91 | 352.98 | 353.05 | 353.12 | 353.19 | 353.26 |
| DISTANZE PARZIALI TERRENO | 6.99 | 6.99 | 6.99 | 6.99 | 6.99 | 6.99 | 6.99 | 6.99 | 6.99 | 6.99 | 6.99 | 6.99 | 6.99 | 6.99 | 6.99 | 6.99 | 6.99 | 6.99 | 6.99 | 6.99 | 6.99 | 6.99 | 6.99 | 6.99 | 6.99 | 6.99 |
| PROGRESSIVE PROGETTO | | | | 4.15 | -1.12 | | | | | | | | | | | | | | | | | | | | | |
| QUOTE PROGETTO | | | | 352.59 | 352.06 | | | | | | | | | | | | | | | | | | | | | |
| DISTANZE PARZIALI PROGETTO | | | | 2.74 | 1.37 | | | | | | | | | | | | | | | | | | | | | |
| QUOTE PROGETTO | | | | | | | | | | | | | | | | | | | | | | | | | | |

TR_AREAS_ENT
Sezione 5
Progressiva: 0+120
Scala: 1:200
Quota di Riferimento: 335

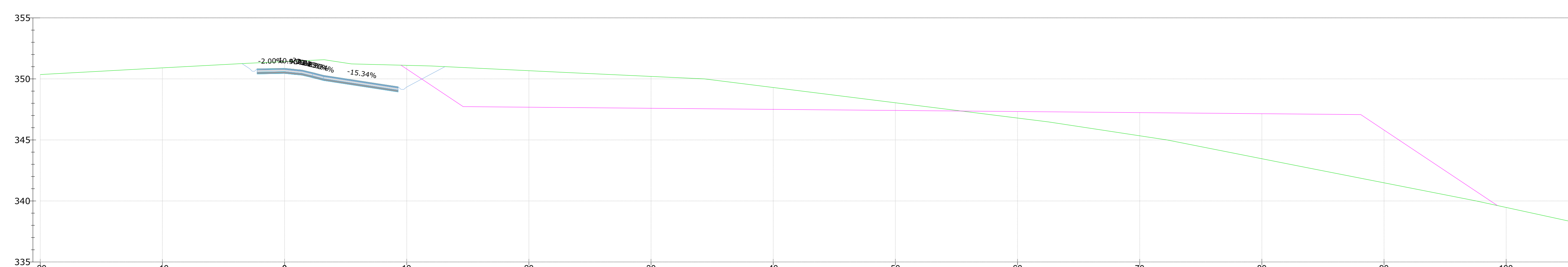

| | | | | | | | | | | | | | | | | | | | | | | | | | | |
|----------------------------|--------|--------|--------|--------|--------|--------|--------|--------|--------|--------|--------|--------|--------|--------|--------|--------|--------|--------|--------|--------|--------|--------|--------|--------|--------|--------|
| PROGRESSIVE TERRENO | 20.00 | 15.00 | 10.00 | 5.00 | 0.00 | 5.00 | 10.00 | 15.00 | 20.00 | 25.00 | 30.00 | 35.00 | 40.00 | 45.00 | 50.00 | 55.00 | 60.00 | 65.00 | 70.00 | 75.00 | 80.00 | 85.00 | 90.00 | 95.00 | 100.00 | 105.00 |
| QUOTE TERRENO | 351.51 | 351.58 | 351.65 | 351.72 | 351.79 | 351.86 | 351.93 | 352.00 | 352.07 | 352.14 | 352.21 | 352.28 | 352.35 | 352.42 | 352.49 | 352.56 | 352.63 | 352.70 | 352.77 | 352.84 | 352.91 | 352.98 | 353.05 | 353.12 | 353.19 | 353.26 |
| DISTANZE PARZIALI TERRENO | 6.99 | 6.99 | 6.99 | 6.99 | 6.99 | 6.99 | 6.99 | 6.99 | 6.99 | 6.99 | 6.99 | 6.99 | 6.99 | 6.99 | 6.99 | 6.99 | 6.99 | 6.99 | 6.99 | 6.99 | 6.99 | 6.99 | 6.99 | 6.99 | 6.99 | 6.99 |
| PROGRESSIVE PROGETTO | | | | -3.49 | -3.49 | | | | | | | | | | | | | | | | | | | | | |
| QUOTE PROGETTO | | | | 351.29 | 351.29 | | | | | | | | | | | | | | | | | | | | | |
| DISTANZE PARZIALI PROGETTO | | | | 0.97 | 0.97 | | | | | | | | | | | | | | | | | | | | | |
| QUOTE PROGETTO | | | | | | | | | | | | | | | | | | | | | | | | | | |

TR_AREAS_ENT
Sezione 6
Progressiva: 0+140
Scala: 1:200
Quota di Riferimento: 335

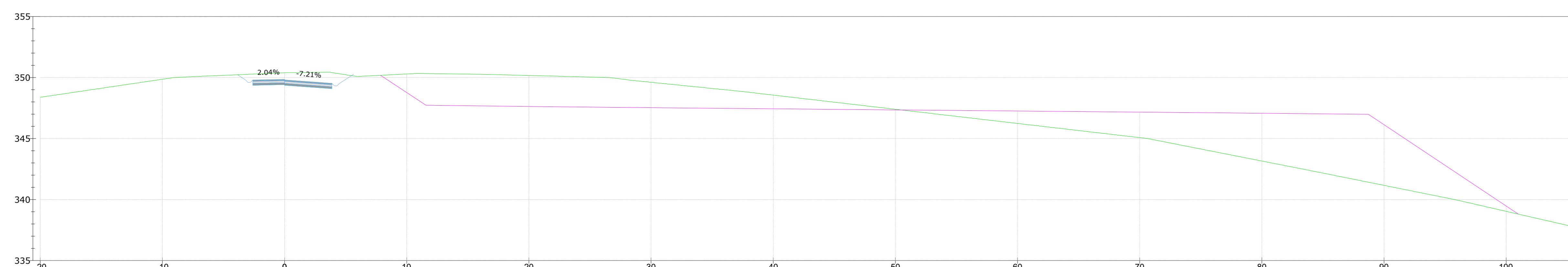

| | | | | | | | | | | | | | | | | | | | | | | | | | | |
|----------------------------|--------|--------|--------|--------|--------|--------|--------|--------|--------|--------|--------|--------|--------|--------|--------|--------|--------|--------|--------|--------|--------|--------|--------|--------|--------|--------|
| PROGRESSIVE TERRENO | 20.00 | 15.00 | 10.00 | 5.00 | 0.00 | 5.00 | 10.00 | 15.00 | 20.00 | 25.00 | 30.00 | 35.00 | 40.00 | 45.00 | 50.00 | 55.00 | 60.00 | 65.00 | 70.00 | 75.00 | 80.00 | 85.00 | 90.00 | 95.00 | 100.00 | 105.00 |
| QUOTE TERRENO | 351.51 | 351.58 | 351.65 | 351.72 | 351.79 | 351.86 | 351.93 | 352.00 | 352.07 | 352.14 | 352.21 | 352.28 | 352.35 | 352.42 | 352.49 | 352.56 | 352.63 | 352.70 | 352.77 | 352.84 | 352.91 | 352.98 | 353.05 | 353.12 | 353.19 | 353.26 |
| DISTANZE PARZIALI TERRENO | 6.99 | 6.99 | 6.99 | 6.99 | 6.99 | 6.99 | 6.99 | 6.99 | 6.99 | 6.99 | 6.99 | 6.99 | 6.99 | 6.99 | 6.99 | 6.99 | 6.99 | 6.99 | 6.99 | 6.99 | 6.99 | 6.99 | 6.99 | 6.99 | 6.99 | 6.99 |
| PROGRESSIVE PROGETTO | | | | -1.84 | -1.84 | | | | | | | | | | | | | | | | | | | | | |
| QUOTE PROGETTO | | | | 351.95 | 351.95 | | | | | | | | | | | | | | | | | | | | | |
| DISTANZE PARZIALI PROGETTO | | | | 1.15 | 1.15 | | | | | | | | | | | | | | | | | | | | | |
| QUOTE PROGETTO | | | | | | | | | | | | | | | | | | | | | | | | | | |

green & green
WE ENGINEERING

Green & Green S.r.l.
Via Edmondo de Amicis n.64
87036 Rende (CS) - Italy
P.IVA 02900010782
Ph. (+39) 0984 846295
Fax (+39) 0984 121470
info@greengreen.it
www.greengreen.it

Il tecnico
Ing. Leonardo Sblendido

| | | | | | |
|------|------------|-----------------|-------------|-------------|--------------|
| 00 | 22/12/2023 | PRIMA EMISSIONE | R. De Fiore | P. E. | L. Sblendido |
| REV. | DATA | DESCRIZIONE | PREPARATO | CONTROLLATO | APPROVATO |

"IMPIANTO EOLICO TERRANOVA DA SIBARI"
(COMUNI DI TERRANOVA DA SIBARI, SAN DEMETRIO CORONE, SPEZZANO ALBANESE, CORIGLIANO-ROSSANO, SANTA SOFIA D'EPSIRO E TARSIA (CS))

hergo

PROGETTO: DEFINITIVO

WORK FILE: C23FSTR0011WD01000_STUDIO PLANALTIMETRICO.pdf

| | | | |
|-------------|--------------|-----------------|------------------|
| FORMATO: A0 | SCALA: 1:200 | SCALA PLOT: 1:1 | FOGLIO: 21 di 39 |
|-------------|--------------|-----------------|------------------|

TITOLO: STUDIO PLANALTIMETRICO

CODICE ELABORATO

| | | | | |
|--------------------|-----|-----|-----------|-----------|
| IMPVTO | TRC | TRD | PROGRESSO | REVISIONE |
| C23FSTR0011WD01000 | | | | |

green & green
WE ENGINEERING

TR_AREA2_ENT
Sezione 7
Progressiva: 0+160
Scala: 1:200
Quota di riferimento: 345

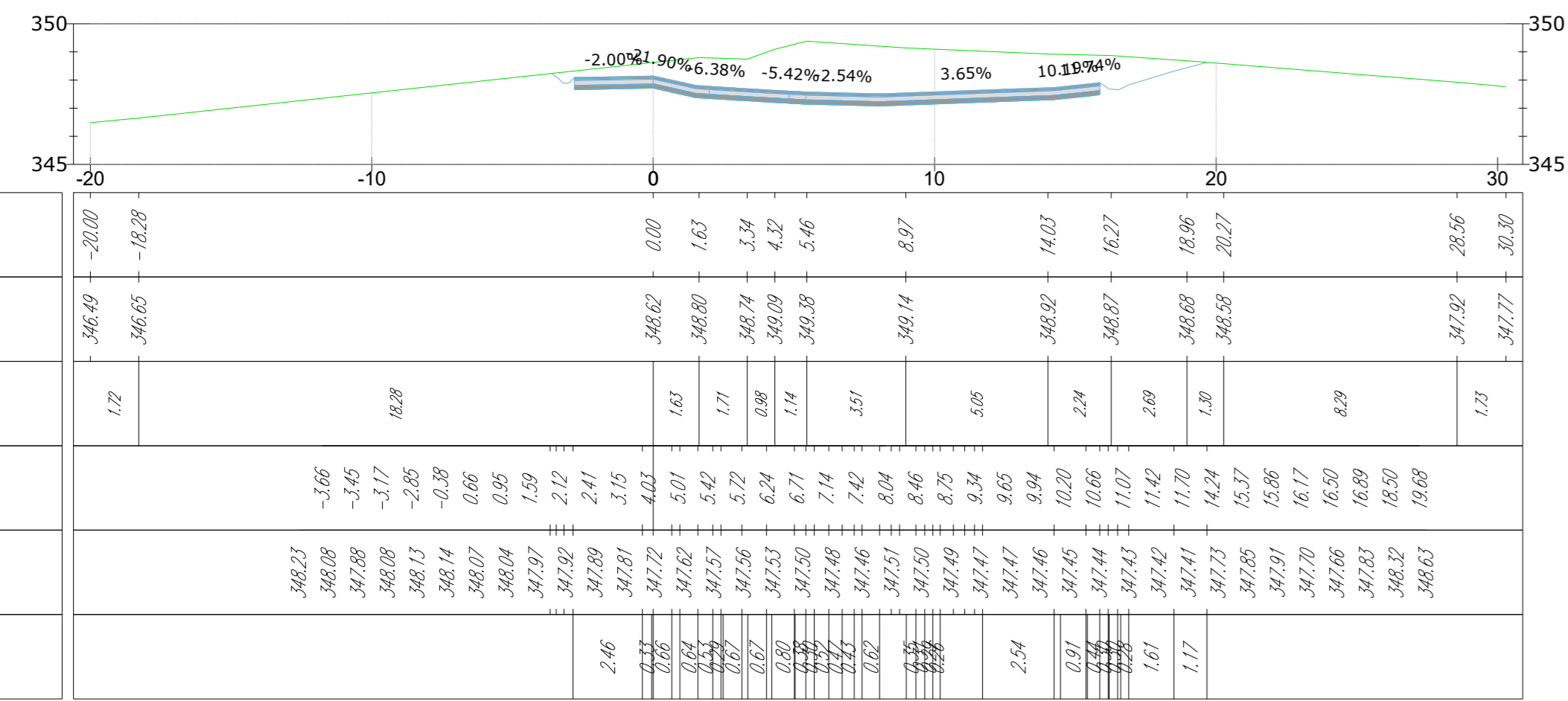

TR_AREA2_ENT
Sezione 8
Progressiva: 0+180
Scala: 1:200
Quota di riferimento: 340

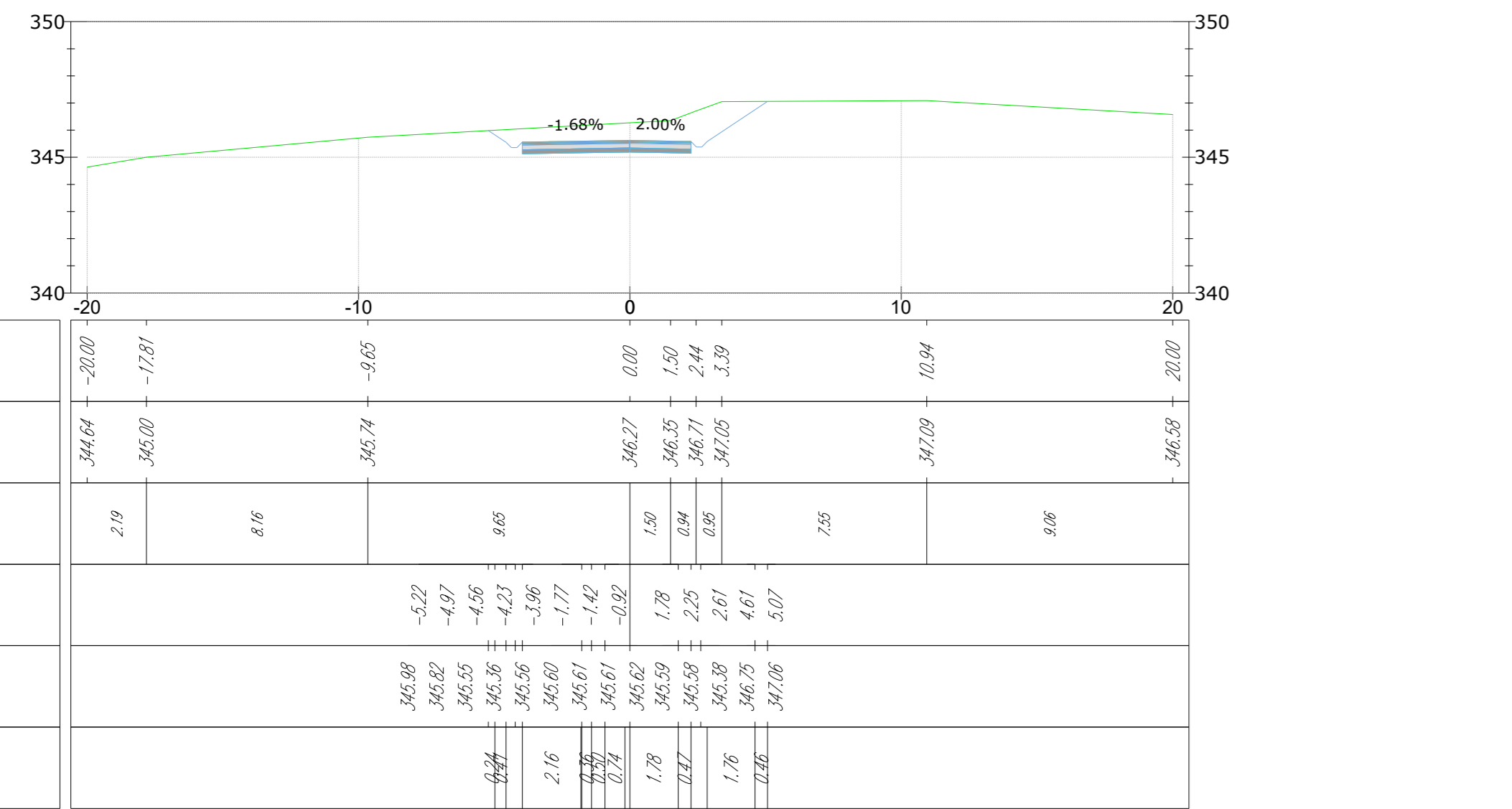

TR_AREA2_ENT
Sezione 9
Progressiva: 0+200
Scala: 1:200
Quota di riferimento: 330

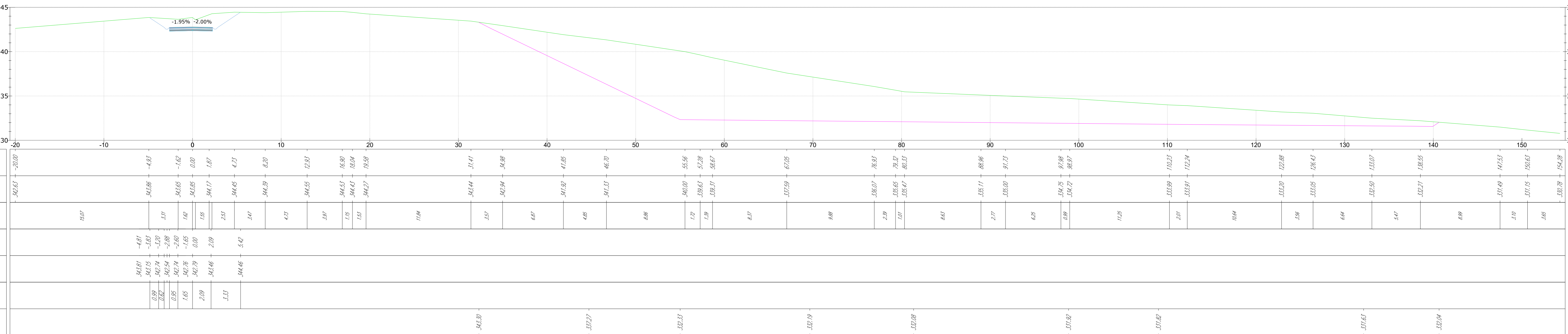

LEGENDA DEI COLORI E SIMBOLI IN CARTA

- Profilo terreno
- Profilo Piazzola

green & green
WE ENGINEERING
Green & Green S.r.l.
Via Edmondo de Amicis n.64
87036 Rende (CS) - Italy
P.IVA 02900010782
Ph. (+39) 0984 846295
Fax (+39) 0984 1214470
info@greengreen.it
www.greengreen.it

Il tecnico
Ing. Leonardo Sblendido

| | | | | | |
|------|------------|-----------------|-------------|-------------|--------------|
| 00 | 22/12/2023 | PRIMA EMISSIONE | R. De Fiore | P. E. | L. Sblendido |
| REV. | DATA | DESCRIZIONE | PREPARATO | CONTROLLATO | APPROVATO |

"IMPIANTO EOLICO TERRANOVA DA SIBARI"
(COMUNI DI TERRANOVA DA SIBARI, SAN DEMETRIO CORONE, SPEZZANO ALBANESE, CORIGLIANO-ROSSANO, SANTA SOFIA D'EPSIRO E TARSIA (CS))

hergo

PROGETTO: DEFINITIVO
NOTE FILE: C23FSTR0011WD01000_STUDIO PLANOALTIMETRICO.pdf
FORMATO: A0 | SCALA: 1:200 | SCALA PLOT: 1:1 | FOGLIO: 21 di 39

green & green
WE ENGINEERING

CODICE ELABORATO
C23FSTR002WD01000

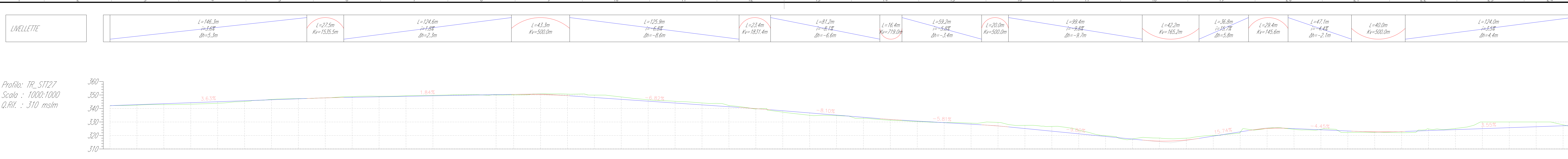

TR_IMPIANTO
Sezione 1
Progressiva: 0+000
Scala: 1:200
Quota di Riferimento: 335

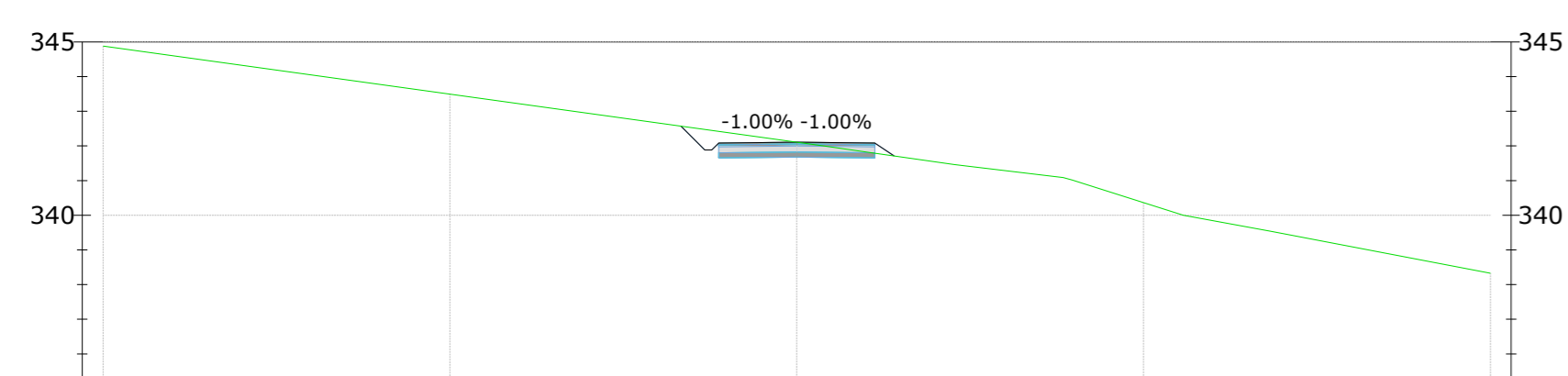

| | | | | | |
|----------------------------|--------|--------|--------|--------|--------|
| PROGRESSIVE TERRENO | -20.00 | -10.00 | 0.00 | 10.00 | 20.00 |
| QUOTE TERRENO | 344.80 | 344.80 | 343.11 | 342.00 | 340.00 |
| DISTANZE PARZIALI TERRENO | | 20.00 | | | |
| PROGRESSIVE PROGETTO | | | 342.57 | 341.57 | 340.57 |
| QUOTE PROGETTO | | | 342.57 | 341.57 | 340.57 |
| DISTANZE PARZIALI PROGETTO | | | 0.57 | 1.00 | 1.00 |

TR_IMPIANTO
Sezione 5
Progressiva: 0+080
Scala: 1:200
Quota di Riferimento: 340

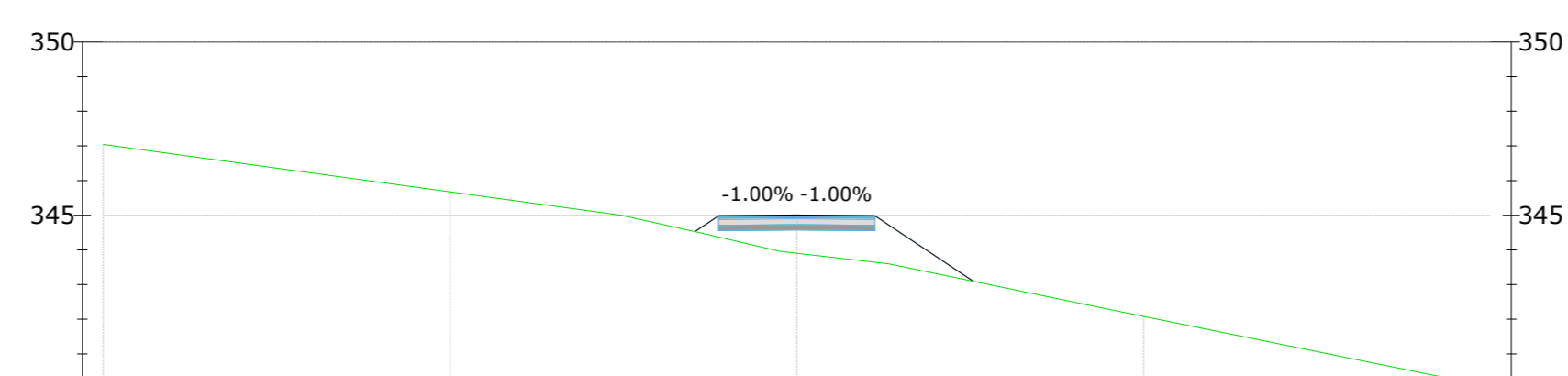

| | | | | | |
|----------------------------|--------|--------|--------|--------|--------|
| PROGRESSIVE TERRENO | -20.00 | -10.00 | 0.00 | 10.00 | 20.00 |
| QUOTE TERRENO | 345.00 | 345.00 | 344.00 | 343.00 | 342.00 |
| DISTANZE PARZIALI TERRENO | | 10.00 | 10.00 | 10.00 | 10.00 |
| PROGRESSIVE PROGETTO | | | 344.50 | 343.50 | 342.50 |
| QUOTE PROGETTO | | | 344.50 | 343.50 | 342.50 |
| DISTANZE PARZIALI PROGETTO | | | 0.50 | 1.00 | 1.00 |

TR_IMPIANTO
Sezione 9
Progressiva: 0+160
Scala: 1:200
Quota di Riferimento: 340

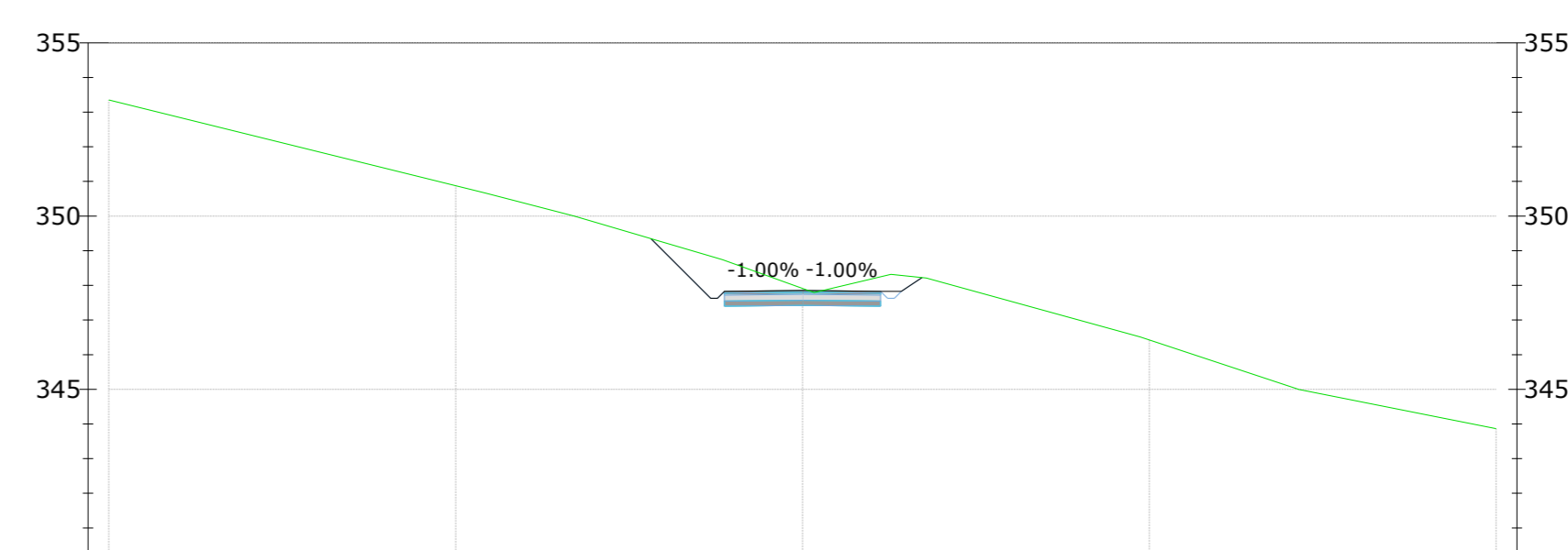

| | | | | | |
|----------------------------|--------|--------|--------|--------|--------|
| PROGRESSIVE TERRENO | -20.00 | -10.00 | 0.00 | 10.00 | 20.00 |
| QUOTE TERRENO | 345.00 | 345.00 | 344.00 | 343.00 | 342.00 |
| DISTANZE PARZIALI TERRENO | | 10.00 | 10.00 | 10.00 | 10.00 |
| PROGRESSIVE PROGETTO | | | 344.50 | 343.50 | 342.50 |
| QUOTE PROGETTO | | | 344.50 | 343.50 | 342.50 |
| DISTANZE PARZIALI PROGETTO | | | 0.50 | 1.00 | 1.00 |

TR_IMPIANTO
Sezione 2
Progressiva: 0+020
Scala: 1:200
Quota di Riferimento: 335

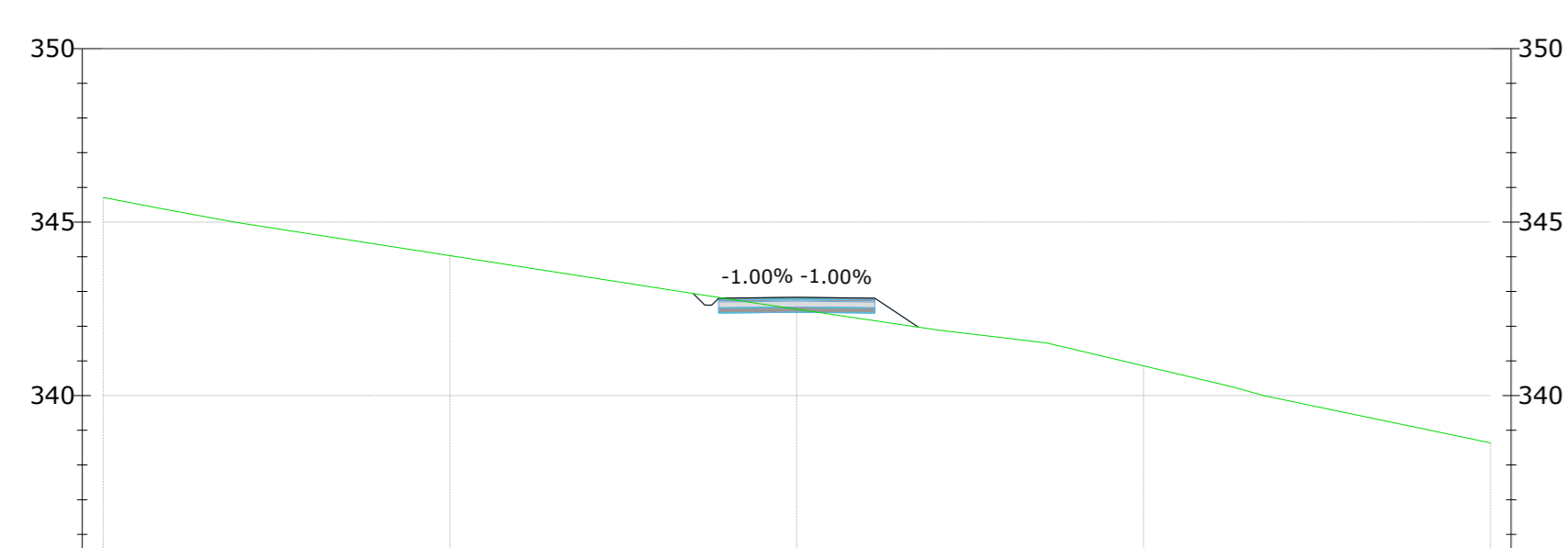

| | | | | | |
|----------------------------|--------|--------|--------|--------|--------|
| PROGRESSIVE TERRENO | -20.00 | -10.00 | 0.00 | 10.00 | 20.00 |
| QUOTE TERRENO | 345.00 | 345.00 | 344.00 | 343.00 | 342.00 |
| DISTANZE PARZIALI TERRENO | | 10.00 | 10.00 | 10.00 | 10.00 |
| PROGRESSIVE PROGETTO | | | 344.50 | 343.50 | 342.50 |
| QUOTE PROGETTO | | | 344.50 | 343.50 | 342.50 |
| DISTANZE PARZIALI PROGETTO | | | 0.50 | 1.00 | 1.00 |

TR_IMPIANTO
Sezione 6
Progressiva: 0+100
Scala: 1:200
Quota di Riferimento: 340

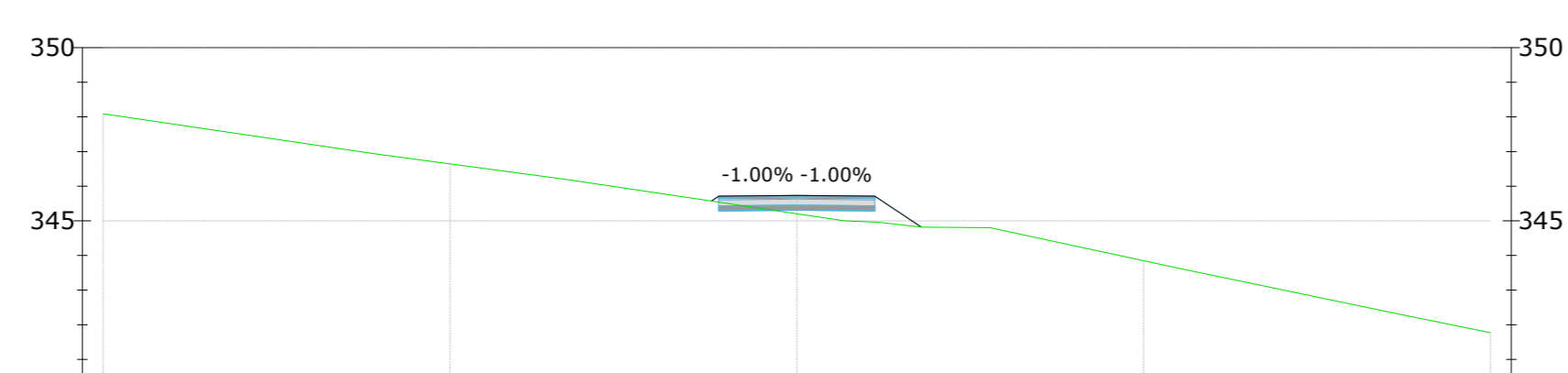

| | | | | | |
|----------------------------|--------|--------|--------|--------|--------|
| PROGRESSIVE TERRENO | -20.00 | -10.00 | 0.00 | 10.00 | 20.00 |
| QUOTE TERRENO | 345.00 | 345.00 | 344.00 | 343.00 | 342.00 |
| DISTANZE PARZIALI TERRENO | | 10.00 | 10.00 | 10.00 | 10.00 |
| PROGRESSIVE PROGETTO | | | 344.50 | 343.50 | 342.50 |
| QUOTE PROGETTO | | | 344.50 | 343.50 | 342.50 |
| DISTANZE PARZIALI PROGETTO | | | 0.50 | 1.00 | 1.00 |

TR_IMPIANTO
Sezione 10
Progressiva: 0+180
Scala: 1:200
Quota di Riferimento: 340

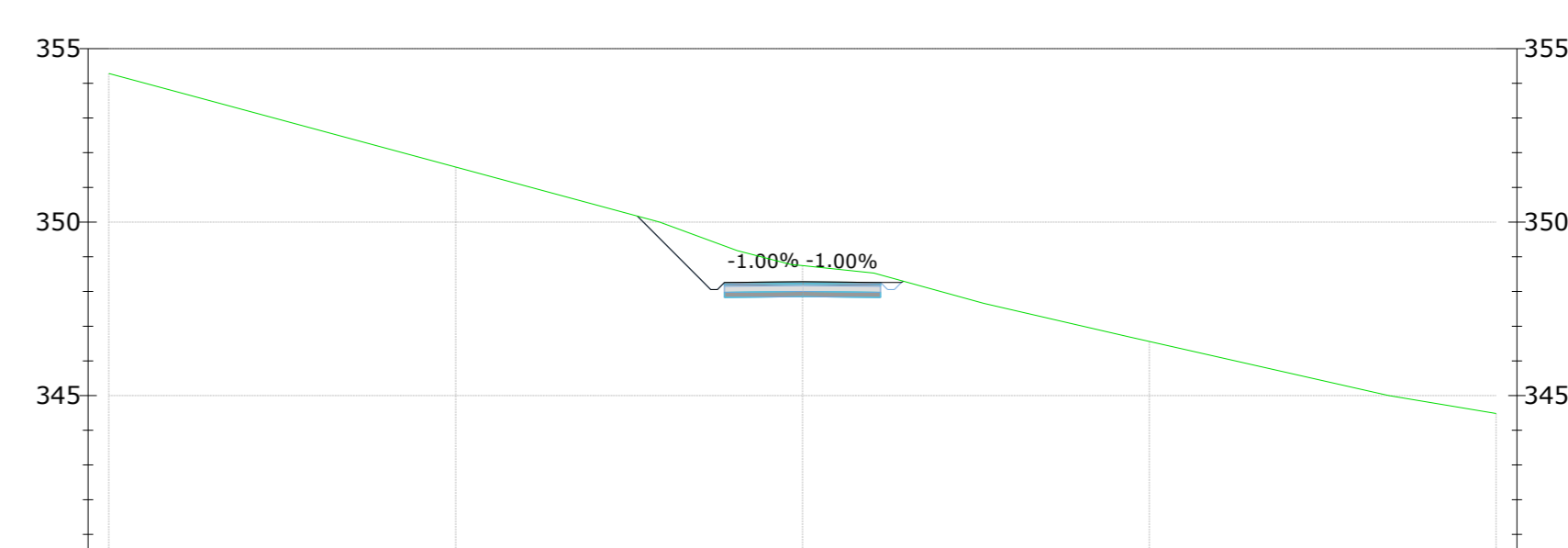

| | | | | | |
|----------------------------|--------|--------|--------|--------|--------|
| PROGRESSIVE TERRENO | -20.00 | -10.00 | 0.00 | 10.00 | 20.00 |
| QUOTE TERRENO | 345.00 | 345.00 | 344.00 | 343.00 | 342.00 |
| DISTANZE PARZIALI TERRENO | | 10.00 | 10.00 | 10.00 | 10.00 |
| PROGRESSIVE PROGETTO | | | 344.50 | 343.50 | 342.50 |
| QUOTE PROGETTO | | | 344.50 | 343.50 | 342.50 |
| DISTANZE PARZIALI PROGETTO | | | 0.50 | 1.00 | 1.00 |

TR_IMPIANTO
Sezione 3
Progressiva: 0+040
Scala: 1:200
Quota di Riferimento: 335

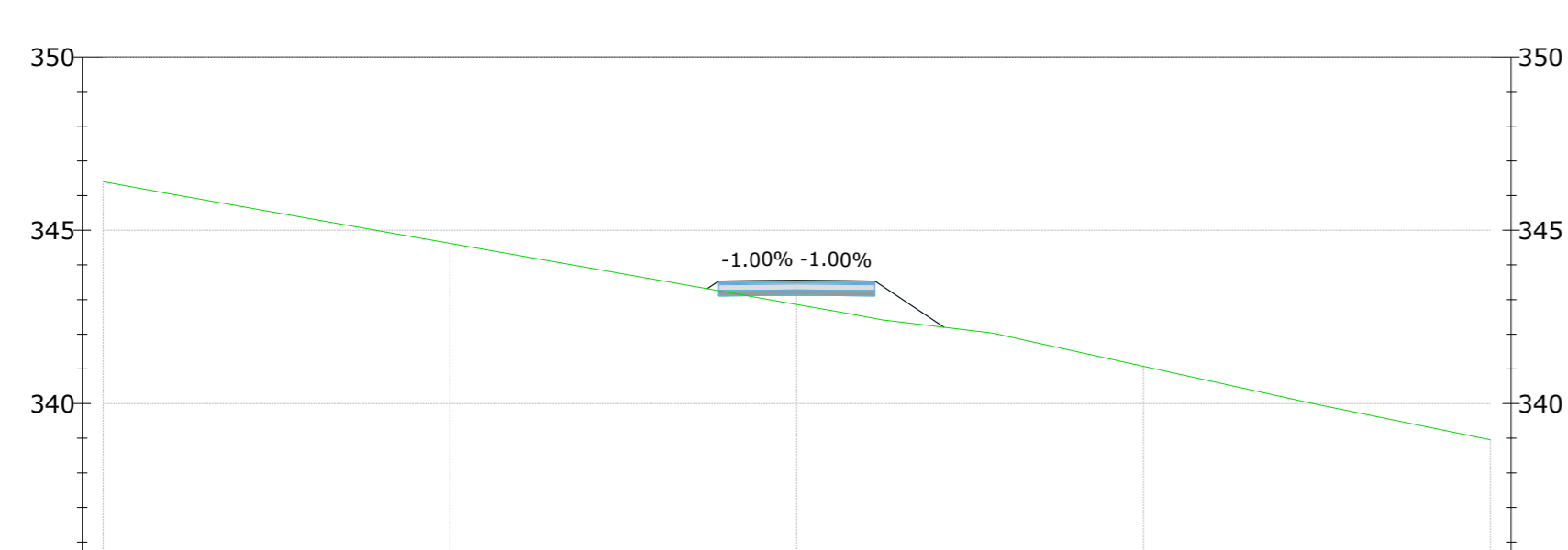

| | | | | | |
|----------------------------|--------|--------|--------|--------|--------|
| PROGRESSIVE TERRENO | -20.00 | -10.00 | 0.00 | 10.00 | 20.00 |
| QUOTE TERRENO | 345.00 | 345.00 | 344.00 | 343.00 | 342.00 |
| DISTANZE PARZIALI TERRENO | | 10.00 | 10.00 | 10.00 | 10.00 |
| PROGRESSIVE PROGETTO | | | 344.50 | 343.50 | 342.50 |
| QUOTE PROGETTO | | | 344.50 | 343.50 | 342.50 |
| DISTANZE PARZIALI PROGETTO | | | 0.50 | 1.00 | 1.00 |

TR_IMPIANTO
Sezione 7
Progressiva: 0+120
Scala: 1:200
Quota di Riferimento: 340

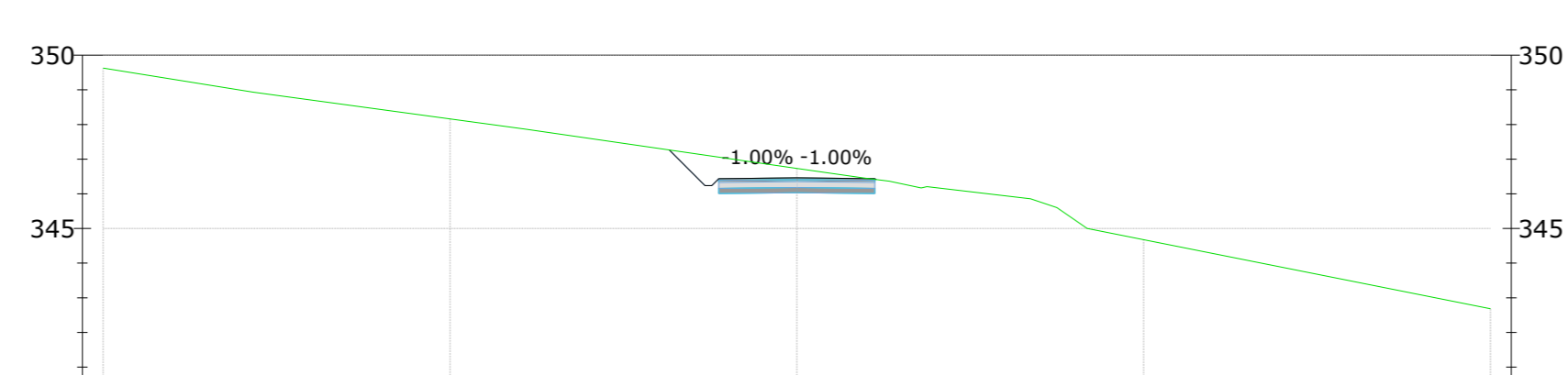

| | | | | | |
|----------------------------|--------|--------|--------|--------|--------|
| PROGRESSIVE TERRENO | -20.00 | -10.00 | 0.00 | 10.00 | 20.00 |
| QUOTE TERRENO | 345.00 | 345.00 | 344.00 | 343.00 | 342.00 |
| DISTANZE PARZIALI TERRENO | | 10.00 | 10.00 | 10.00 | 10.00 |
| PROGRESSIVE PROGETTO | | | 344.50 | 343.50 | 342.50 |
| QUOTE PROGETTO | | | 344.50 | 343.50 | 342.50 |
| DISTANZE PARZIALI PROGETTO | | | 0.50 | 1.00 | 1.00 |

TR_IMPIANTO
Sezione 11
Progressiva: 0+200
Scala: 1:200
Quota di Riferimento: 345

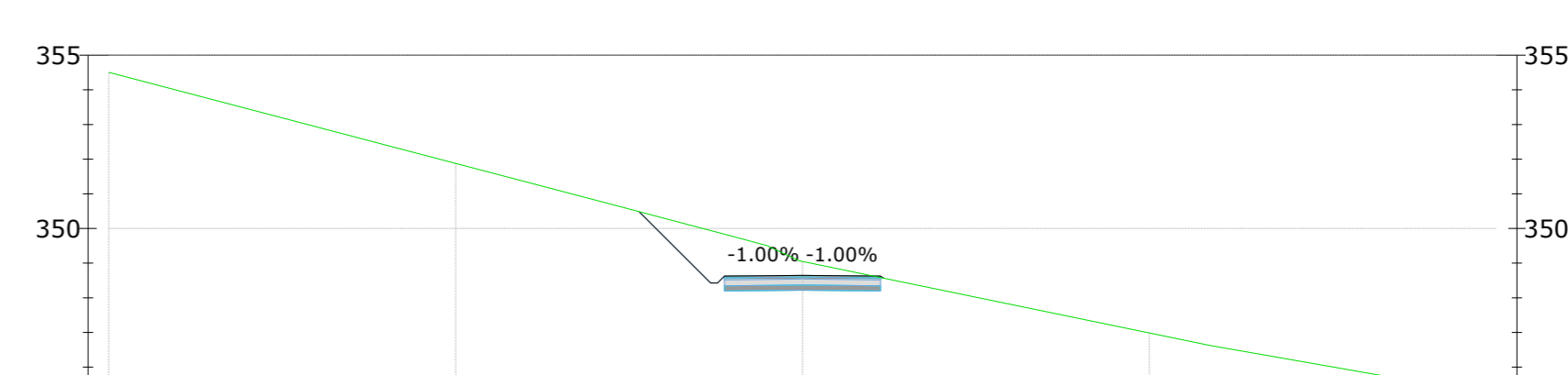

| | | | | | |
|----------------------------|--------|--------|--------|--------|--------|
| PROGRESSIVE TERRENO | -20.00 | -10.00 | 0.00 | 10.00 | 20.00 |
| QUOTE TERRENO | 345.00 | 345.00 | 344.00 | 343.00 | 342.00 |
| DISTANZE PARZIALI TERRENO | | 10.00 | 10.00 | 10.00 | 10.00 |
| PROGRESSIVE PROGETTO | | | 344.50 | 343.50 | 342.50 |
| QUOTE PROGETTO | | | 344.50 | 343.50 | 342.50 |
| DISTANZE PARZIALI PROGETTO | | | 0.50 | 1.00 | 1.00 |

TR_IMPIANTO
Sezione 4
Progressiva: 0+060
Scala: 1:200
Quota di Riferimento: 335

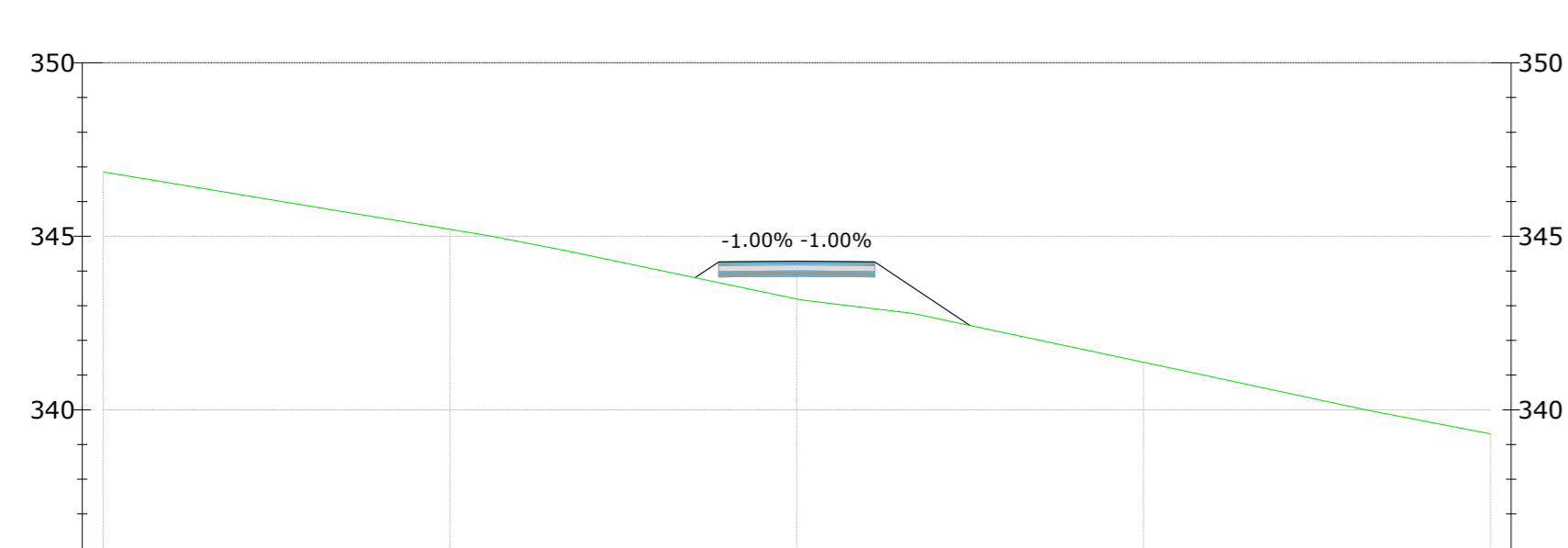

| | | | | | |
|----------------------------|--------|--------|--------|--------|--------|
| PROGRESSIVE TERRENO | -20.00 | -10.00 | 0.00 | 10.00 | 20.00 |
| QUOTE TERRENO | 345.00 | 345.00 | 344.00 | 343.00 | 342.00 |
| DISTANZE PARZIALI TERRENO | | 10.00 | 10.00 | 10.00 | 10.00 |
| PROGRESSIVE PROGETTO | | | 344.50 | 343.50 | 342.50 |
| QUOTE PROGETTO | | | 344.50 | 343.50 | 342.50 |
| DISTANZE PARZIALI PROGETTO | | | 0.50 | 1.00 | 1.00 |

TR_IMPIANTO
Sezione 8
Progressiva: 0+140
Scala: 1:200
Quota di Riferimento: 340

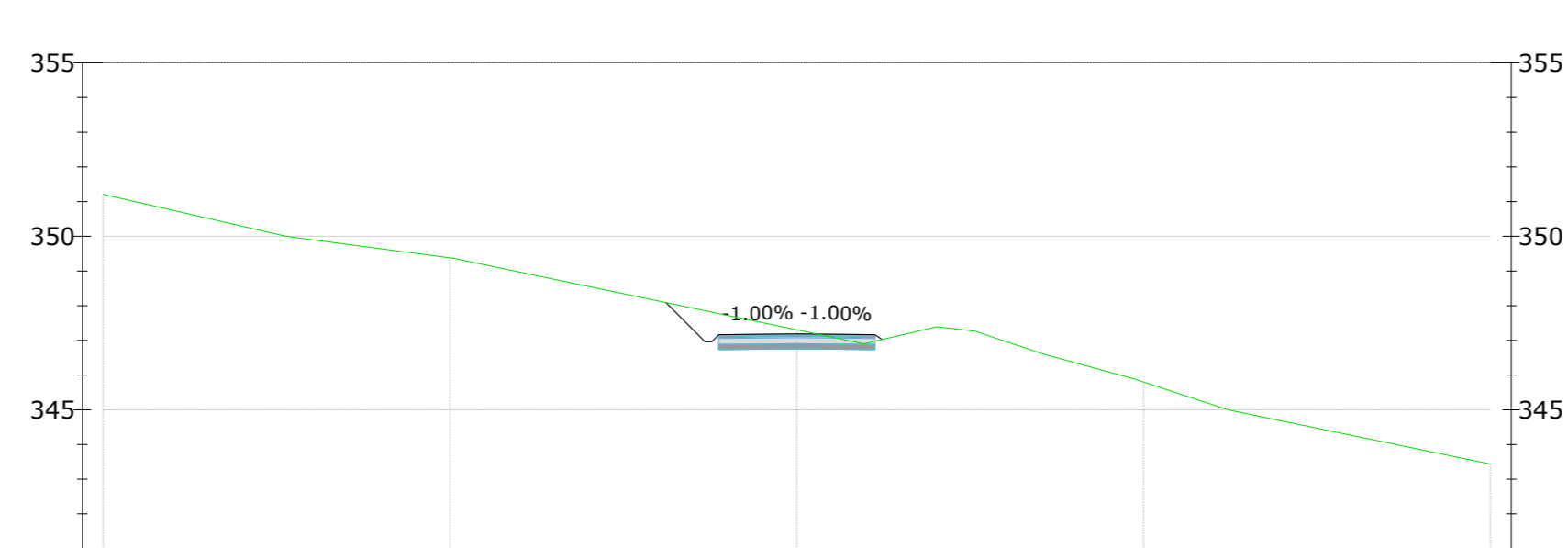

| | | | | | |
|----------------------------|--------|--------|--------|--------|--------|
| PROGRESSIVE TERRENO | -20.00 | -10.00 | 0.00 | 10.00 | 20.00 |
| QUOTE TERRENO | 345.00 | 345.00 | 344.00 | 343.00 | 342.00 |
| DISTANZE PARZIALI TERRENO | | 10.00 | 10.00 | 10.00 | 10.00 |
| PROGRESSIVE PROGETTO | | | 344.50 | 343.50 | 342.50 |
| QUOTE PROGETTO | | | 344.50 | 343.50 | 342.50 |
| DISTANZE PARZIALI PROGETTO | | | 0.50 | 1.00 | 1.00 |

TR_IMPIANTO
Sezione 12
Progressiva: 0+220
Scala: 1:200
Quota di Riferimento: 345

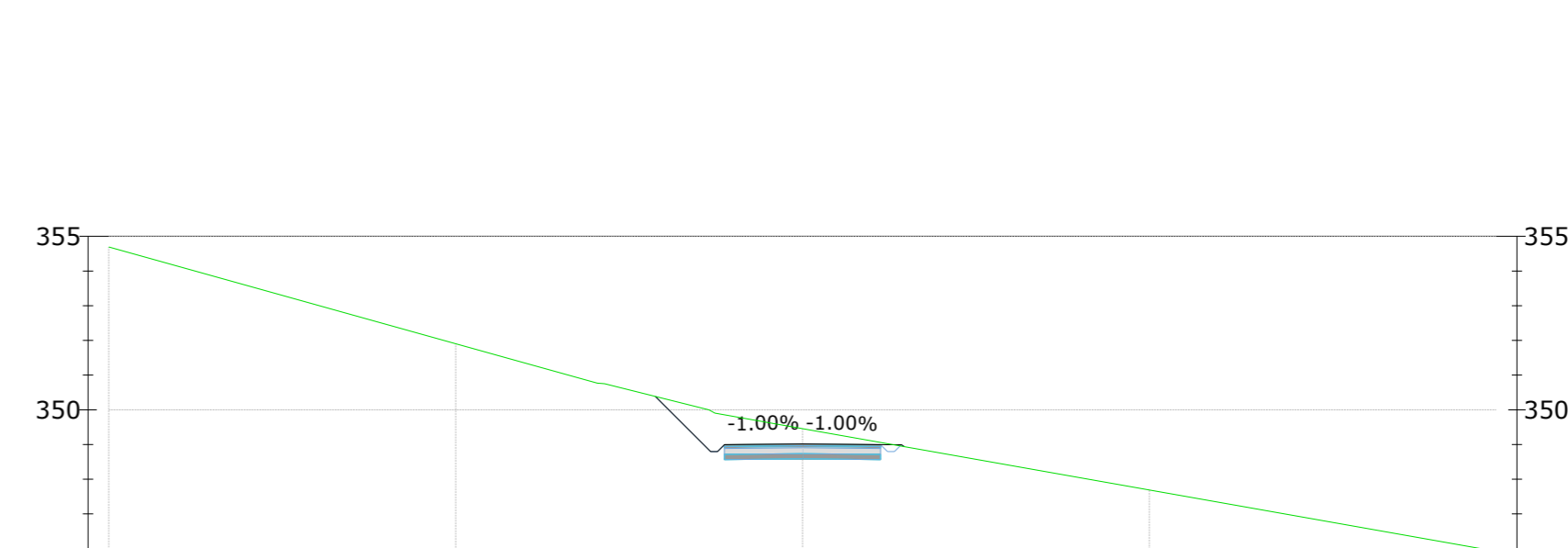

| | | | | | |
|----------------------------|--------|--------|--------|--------|--------|
| PROGRESSIVE TERRENO | -20.00 | -10.00 | 0.00 | 10.00 | 20.00 |
| QUOTE TERRENO | 345.00 | 345.00 | 344.00 | 343.00 | 342.00 |
| DISTANZE PARZIALI TERRENO | | 10.00 | 10.00 | 10.00 | 10.00 |
| PROGRESSIVE PROGETTO | | | 344.50 | 343.50 | 342.50 |
| QUOTE PROGETTO | | | 344.50 | 343.50 | 342.50 |
| DISTANZE PARZIALI PROGETTO | | | 0.50 | 1.00 | 1.00 |

LEGENDA DEI COLORI E SIMBOLI IN CARTA

Profilo terreno



Green & Green S.r.l.
Via Edmondo de Amicis n.64
37036 Ronde (CS) - Italy
P.IVA 02900010782
Ph. (+39) 0984 846295
Fax (+39) 0984 1214470
info@greengreen.it
www.greengreen.it

Il tecnico
Ing. Leonardo Sblendido



| | | | | | |
|-----|------------|-----------------|-------------|-------------|--------------|
| 00 | 22/12/2023 | PRIMA EMISSIONE | R. De Fiore | P.E. | L. Sblendido |
| REV | DATA | DESCRIZIONE | PREPARATO | CONTROLLATO | APPROVATO |

"IMPIANTO EOLICO TERRANOVA DA SIBARI"
(COMUNI DI TERRANOVA DA SIBARI, SAN DEMETRIO CORONE, SPEZZANO ALBANESE, CORIGLIANO-ROSSANO, SANTA SOFIA D'EPSIRO E TARSIA (CS))

| | | | |
|---|--------------|-----------------|------------------|
| PROGETTO | | DEFINITIVO | |
| NOME FILE: CZ3FSTR0011WD01000_STUDIO_PLANOALTIMETRICO.pdf | | | |
| FORMATO: A0 | SCALA: 1:200 | SCALA PLOT: 1:1 | FOGLIO: 26 di 39 |
| TITOLO: STUDIO PLANOALTIMETRICO | | | |
| CODICE ELABORATO | | | |
| C23FSTR002WD01000 | | | |

Profilo terreno

TR_IMPIANTO
Sezione 17
Progressiva: 0+340
Scala: 1:200
Quota di Riferimento: 345

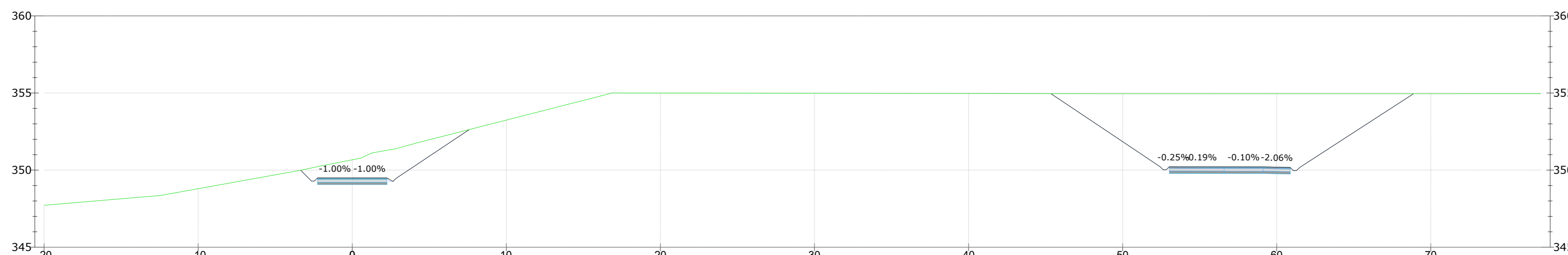

| | | | | | | | | | | | |
|----------------------------|--------|--------|--------|--------|--------|--------|--------|--------|--------|--------|--------|
| PROGRESSIVE TERRENO | -20.00 | -10.00 | 0.00 | 10.00 | 20.00 | 30.00 | 40.00 | 50.00 | 60.00 | 70.00 | 80.00 |
| QUOTE TERRENO | 347.72 | 348.26 | 349.00 | 349.25 | 349.25 | 349.25 | 349.25 | 349.25 | 349.25 | 349.25 | 349.25 |
| DISTANZE PARZIALI TERRENO | 2.00 | 8.00 | 1.00 | 1.00 | 1.00 | 1.00 | 1.00 | 1.00 | 1.00 | 1.00 | 1.00 |
| PROGRESSIVE PROGETTO | | | 0.00 | 1.00 | 2.00 | 3.00 | 4.00 | 5.00 | 6.00 | 7.00 | 8.00 |
| QUOTE PROGETTO | | | 349.00 | 349.25 | 349.50 | 349.75 | 350.00 | 350.25 | 350.50 | 350.75 | 351.00 |
| DISTANZE PARZIALI PROGETTO | | | 1.00 | 1.00 | 1.00 | 1.00 | 1.00 | 1.00 | 1.00 | 1.00 | 1.00 |

TR_IMPIANTO
Sezione 18
Progressiva: 0+360
Scala: 1:200
Quota di Riferimento: 345

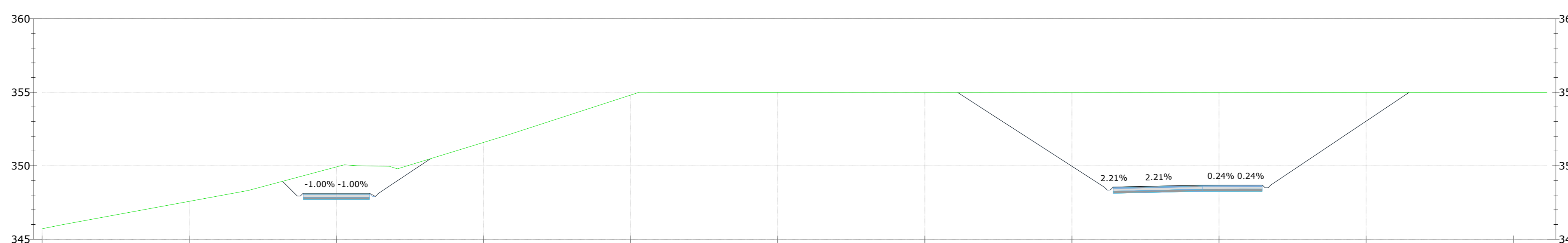

| | | | | | | | | | | | |
|----------------------------|--------|--------|--------|--------|--------|--------|--------|--------|--------|--------|--------|
| PROGRESSIVE TERRENO | -20.00 | -10.00 | 0.00 | 10.00 | 20.00 | 30.00 | 40.00 | 50.00 | 60.00 | 70.00 | 80.00 |
| QUOTE TERRENO | 345.71 | 346.25 | 347.00 | 347.25 | 347.25 | 347.25 | 347.25 | 347.25 | 347.25 | 347.25 | 347.25 |
| DISTANZE PARZIALI TERRENO | 1.00 | 1.00 | 1.00 | 1.00 | 1.00 | 1.00 | 1.00 | 1.00 | 1.00 | 1.00 | 1.00 |
| PROGRESSIVE PROGETTO | | | 0.00 | 1.00 | 2.00 | 3.00 | 4.00 | 5.00 | 6.00 | 7.00 | 8.00 |
| QUOTE PROGETTO | | | 346.50 | 346.75 | 347.00 | 347.25 | 347.50 | 347.75 | 348.00 | 348.25 | 348.50 |
| DISTANZE PARZIALI PROGETTO | | | 1.00 | 1.00 | 1.00 | 1.00 | 1.00 | 1.00 | 1.00 | 1.00 | 1.00 |

TR_IMPIANTO
Sezione 19
Progressiva: 0+380
Scala: 1:200
Quota di Riferimento: 340

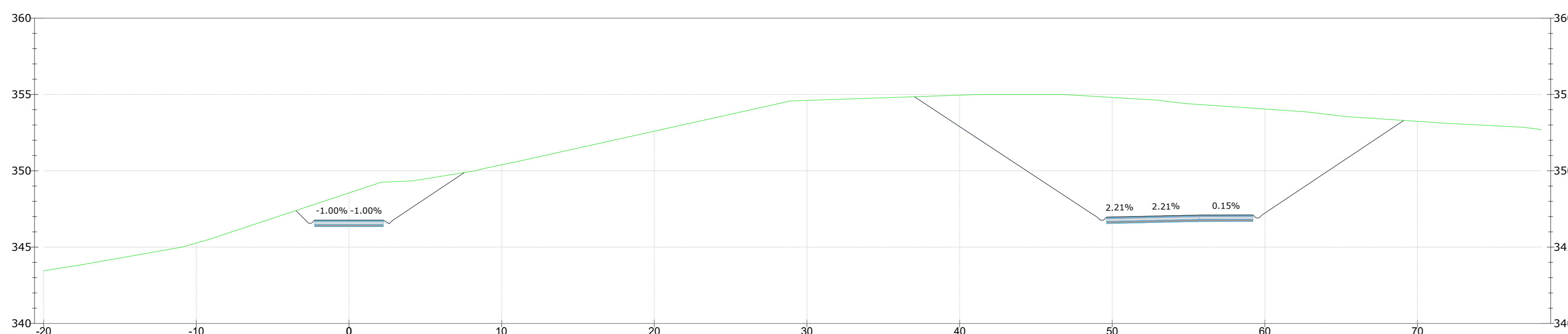

| | | | | | | | | | | |
|----------------------------|--------|--------|--------|--------|--------|--------|--------|--------|--------|--------|
| PROGRESSIVE TERRENO | -20.00 | -10.00 | 0.00 | 10.00 | 20.00 | 30.00 | 40.00 | 50.00 | 60.00 | 70.00 |
| QUOTE TERRENO | 342.44 | 342.97 | 343.50 | 343.50 | 343.50 | 343.50 | 343.50 | 343.50 | 343.50 | 343.50 |
| DISTANZE PARZIALI TERRENO | 2.00 | 4.00 | 1.00 | 1.00 | 1.00 | 1.00 | 1.00 | 1.00 | 1.00 | 1.00 |
| PROGRESSIVE PROGETTO | | | 0.00 | 1.00 | 2.00 | 3.00 | 4.00 | 5.00 | 6.00 | 7.00 |
| QUOTE PROGETTO | | | 343.00 | 343.25 | 343.50 | 343.75 | 344.00 | 344.25 | 344.50 | 344.75 |
| DISTANZE PARZIALI PROGETTO | | | 1.00 | 1.00 | 1.00 | 1.00 | 1.00 | 1.00 | 1.00 | 1.00 |

Green & Green
WE ENGINEERING
Via Edmondo de Amicis n.64
37036 Ronde (CS) - Italy
P.IVA 02900010782
Ph. (+39) 0984 846295
Fax (+39) 0984 121440
info@greengreen.it
www.greengreen.it

Il tecnico
Ing. Leonardo Sblendido

| | | | | | |
|----|------------|-----------------|-------------|-------|--------------|
| 00 | 22/12/2023 | PRIMA EMISSIONE | R. De Fiore | P. E. | L. Sblendido |
|----|------------|-----------------|-------------|-------|--------------|

"IMPIANTO EOLICO TERRANOVA DA SIBARI"
(COMUNI DI TERRANOVA DA SIBARI, SAN DEMETRIO CORONE, SPEZZANO ALBANESE, CORIGLIANO-ROSSANO, SANTA SOFIA D'EPSIRO E TARSIA (CS))



| | | | |
|-----------|--|------------|----------|
| PROGETTO | DEFINITIVO | | |
| NOTE FILE | C23FSTR0011WD01000_STUDIO PLANOALTIMETRICO.pdf | | |
| FORMATO | SCALE | SCALA PLOT | FOGLIO |
| A0 | 1:200 | 1:1 | 28 di 39 |

Green & Green
WE ENGINEERING

| | | | |
|-------------------------|-----|-----------|-----------|
| STUDIO PLANOALTIMETRICO | | | |
| CODICE ELABORATO | | | |
| IMPIANTO | TRC | PROGRESSO | REVISIONE |
| C23FSTR001 | 02 | WD01000 | 00 |

- Profilo terreno
- Profilo Piazzola

TR_IMPIANTO
Sezione 20
Progressiva: 0+400
Scala: 1:200
Quota di Riferimento: 340

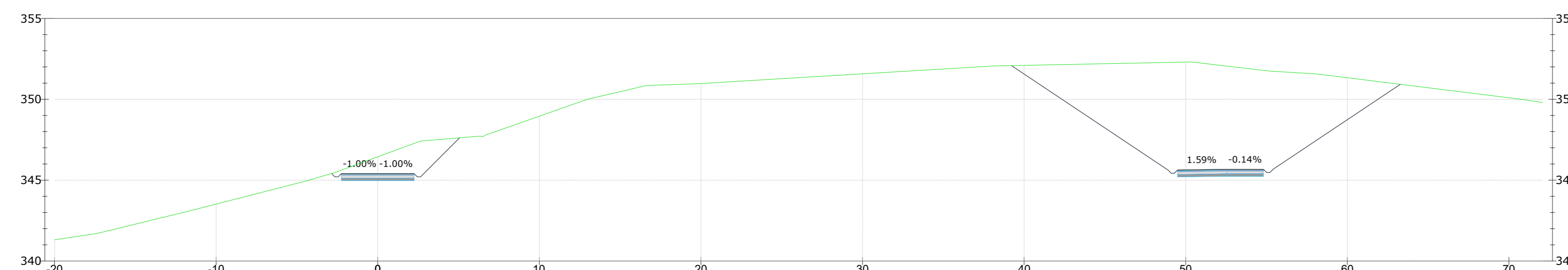

| | | | | | | | | |
|----------------------------|--------|--------|--------|--------|--------|--------|--------|--------|
| PROGRESSIVE TERRENO | 0+00 | 0+10 | 0+20 | 0+30 | 0+40 | 0+50 | 0+60 | 0+70 |
| QUOTE TERRENO | 342.51 | 343.20 | 344.12 | 345.09 | 345.51 | 346.45 | 347.42 | 348.33 |
| DISTANZE PARZIALI TERRENO | 1.00 | 1.00 | 1.00 | 1.00 | 1.00 | 1.00 | 1.00 | 1.00 |
| PROGRESSIVE PROGETTO | | | | | | | | |
| QUOTE PROGETTO | | | | | | | | |
| DISTANZE PARZIALI PROGETTO | | | | | | | | |

TR_IMPIANTO
Sezione 21
Progressiva: 0+420
Scala: 1:200
Quota di Riferimento: 335

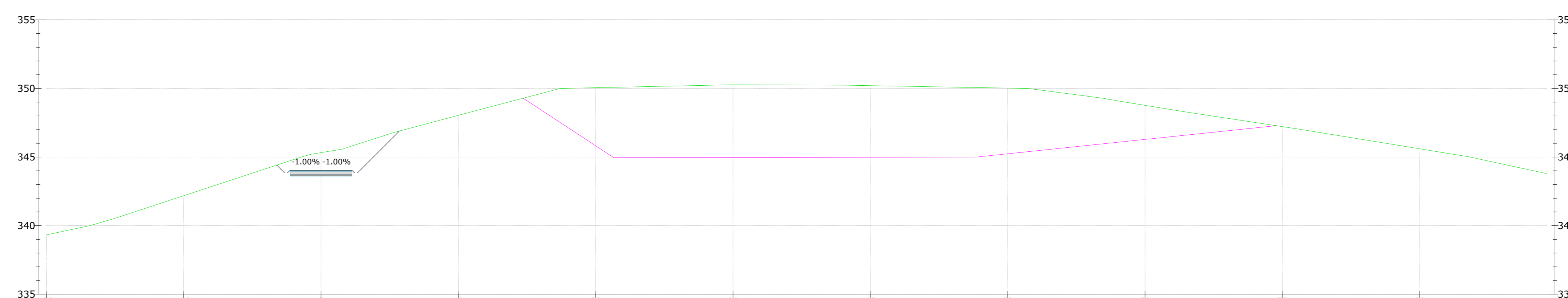

| | | | | | | | | | |
|----------------------------|--------|--------|--------|--------|--------|--------|--------|--------|--------|
| PROGRESSIVE TERRENO | 0+00 | 0+10 | 0+20 | 0+30 | 0+40 | 0+50 | 0+60 | 0+70 | 0+80 |
| QUOTE TERRENO | 338.25 | 339.00 | 340.00 | 341.00 | 342.00 | 343.00 | 344.00 | 345.00 | 346.00 |
| DISTANZE PARZIALI TERRENO | 1.00 | 1.00 | 1.00 | 1.00 | 1.00 | 1.00 | 1.00 | 1.00 | 1.00 |
| PROGRESSIVE PROGETTO | | | | | | | | | |
| QUOTE PROGETTO | | | | | | | | | |
| DISTANZE PARZIALI PROGETTO | | | | | | | | | |

TR_IMPIANTO
Sezione 22
Progressiva: 0+440
Scala: 1:200
Quota di Riferimento: 335

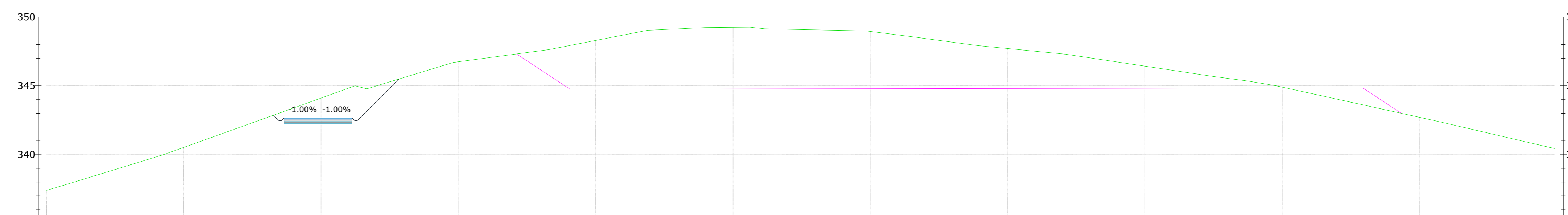

| | | | | | | | | | |
|----------------------------|--------|--------|--------|--------|--------|--------|--------|--------|--------|
| PROGRESSIVE TERRENO | 0+00 | 0+10 | 0+20 | 0+30 | 0+40 | 0+50 | 0+60 | 0+70 | 0+80 |
| QUOTE TERRENO | 338.25 | 339.00 | 340.00 | 341.00 | 342.00 | 343.00 | 344.00 | 345.00 | 346.00 |
| DISTANZE PARZIALI TERRENO | 1.00 | 1.00 | 1.00 | 1.00 | 1.00 | 1.00 | 1.00 | 1.00 | 1.00 |
| PROGRESSIVE PROGETTO | | | | | | | | | |
| QUOTE PROGETTO | | | | | | | | | |
| DISTANZE PARZIALI PROGETTO | | | | | | | | | |

green & green
WE ENGINEERING
Green & Green S.r.l.
Via Edmondo de Amicis n.64
87036 Rende (CS) - Italy
P.IVA 02900010782
Ph. (+39) 0984 846295
Fax (+39) 0984 1214470
info@greengreen.it
www.greengreen.it

Il tecnico
Ing. Leonardo Sblendido

| | | | | | |
|------|------------|-----------------|-------------|-------------|--------------|
| 00 | 22/12/2023 | PRIMA EMISSIONE | R. De Fiore | P. E. | L. Sblendido |
| REV. | DATA | DESCRIZIONE | PREPARATO | CONTROLLATO | APPROVATO |

"IMPIANTO EOLICO TERRANOVA DA SIBARI"
(COMUNI DI TERRANOVA DA SIBARI, SAN DEMETRIO CORONE, SPEZZANO ALBANESE, CORIGLIANO-ROSSANO, SANTA SOFIA D'EPSIRO E TARSIA (CS))

| | | | | |
|---|---|--------------------|---------------------|--|
| | PROGETTO DEFINITIVO | | | |
| | NOME FILE: C23FSTR0011WD01000_STUDIO_PLANOALTIMETRICO.pdf | | | |
| FORMATO: A0 | SCALA: 1:200 | SCALA PLOT: 1:1 | FOGLIO: 29 di 39 | |
| TITOLO: STUDIO PLANOALTIMETRICO | | | | |
| CODICE ELABORATO | | | | |
| C23FSTR0011WD01000 | | | | |

green & green
WE ENGINEERING

- Profilo terreno
- Profilo Piazzola

TR_IMPIANTO
Sezione 23
Progressiva: 0+400
Scala: 1:200
Quota di Riferimento: 330

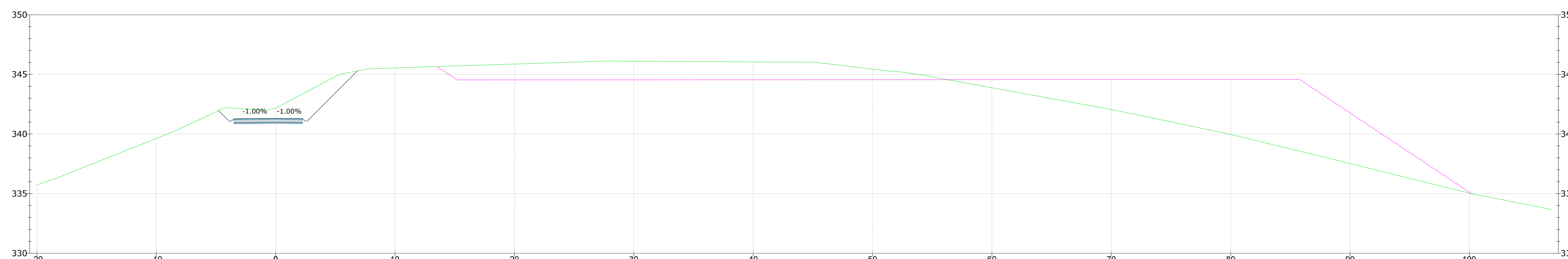

| | | | | | | | | | | | | | | | | | | | | | |
|----------------------------|--------|--------|--------|--------|--------|--------|--------|--------|--------|--------|--------|--------|--------|--------|--------|--------|--------|--------|--------|--------|--|
| PROGRESSIVE TERRENO | -20.00 | -18.00 | -9.05 | -6.21 | -4.29 | -0.63 | 0.00 | 5.51 | 7.88 | 27.08 | 45.16 | 51.51 | 52.04 | 53.05 | 70.35 | 79.06 | 87.16 | 100.18 | 108.41 | 108.85 | |
| QUOTE TERRENO | 337.24 | 338.40 | 340.00 | 341.04 | 342.00 | 343.00 | 343.00 | 343.50 | 343.50 | 343.50 | 343.50 | 343.50 | 343.50 | 343.50 | 343.50 | 343.50 | 343.50 | 343.50 | 343.50 | 343.50 | |
| DISTANZE PARZIALI TERRENO | 1.96 | 1.96 | 2.15 | 2.45 | 1.96 | 0.00 | 0.00 | 2.97 | 0.00 | 0.00 | 4.8 | 0.00 | 0.00 | 0.00 | 0.00 | 0.00 | 0.00 | 0.00 | 0.00 | 0.00 | |
| PROGRESSIVE PROGETTO | | | | | | | | | | | | | | | | | | | | | |
| QUOTE PROGETTO | | | | | | | | | | | | | | | | | | | | | |
| DISTANZE PARZIALI PROGETTO | | | | | | | | | | | | | | | | | | | | | |
| QUOTE PROGETTO | | | | | | | | | | | | | | | | | | | | | |

TR_IMPIANTO
Sezione 24
Progressiva: 0+480
Scala: 1:200
Quota di Riferimento: 330

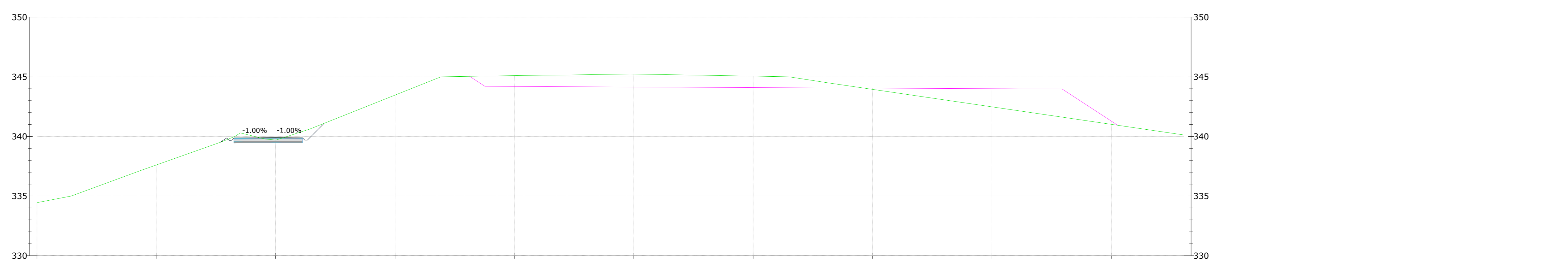

| | | | | | | | | | | | | | | | | | |
|----------------------------|--------|--------|--------|-------|-------|-------|------|-------|-------|-------|-------|-------|-------|-------|-------|-------|--|
| PROGRESSIVE TERRENO | -20.00 | -17.17 | -11.29 | -4.50 | -2.96 | -0.67 | 0.00 | 3.63 | 11.84 | 20.76 | 24.67 | 28.79 | 40.41 | 43.00 | 46.17 | 76.09 | |
| QUOTE TERRENO | | | | | | | | | | | | | | | | | |
| DISTANZE PARZIALI TERRENO | 2.96 | 2.96 | 6.79 | 1.00 | 1.54 | 0.00 | 0.00 | 11.00 | 8.91 | 8.91 | 4.12 | 4.12 | 12.71 | 2.59 | 3.17 | 21.80 | |
| PROGRESSIVE PROGETTO | | | | | | | | | | | | | | | | | |
| QUOTE PROGETTO | | | | | | | | | | | | | | | | | |
| DISTANZE PARZIALI PROGETTO | | | | | | | | | | | | | | | | | |
| QUOTE PROGETTO | | | | | | | | | | | | | | | | | |

TR_IMPIANTO
Sezione 25
Progressiva: 0+500
Scala: 1:200
Quota di Riferimento: 330

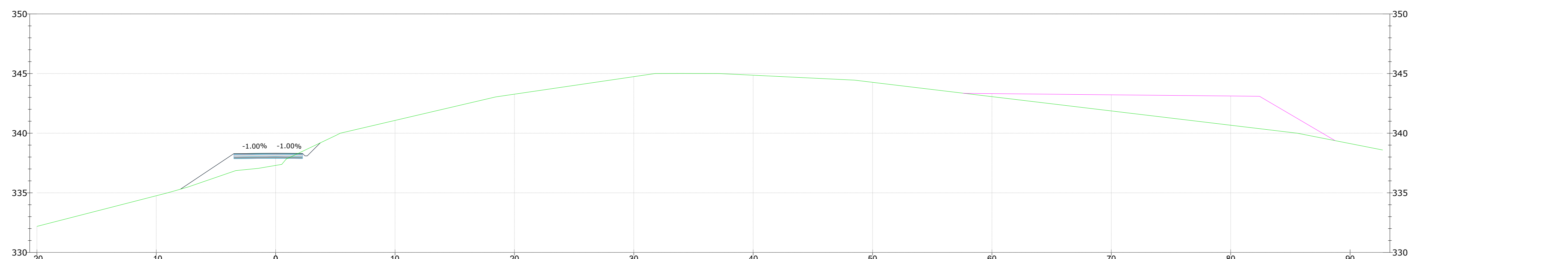

| | | | | | | | | | | | | | | | | | | | | | | |
|----------------------------|--------|--------|--------|--------|--------|--------|--------|--------|--------|--------|--------|--------|--------|--------|--------|--------|--------|--------|--------|--------|--------|--|
| PROGRESSIVE TERRENO | -20.00 | -9.05 | -7.27 | -2.25 | -1.44 | 0.00 | 0.51 | 5.07 | 16.44 | 17.79 | 18.21 | 18.21 | 18.21 | 18.21 | 18.21 | 18.21 | 18.21 | 18.21 | 18.21 | 18.21 | 18.21 | |
| QUOTE TERRENO | 337.24 | 338.40 | 339.40 | 340.00 | 340.50 | 340.50 | 340.50 | 340.50 | 340.50 | 340.50 | 340.50 | 340.50 | 340.50 | 340.50 | 340.50 | 340.50 | 340.50 | 340.50 | 340.50 | 340.50 | 340.50 | |
| DISTANZE PARZIALI TERRENO | 1.96 | 1.96 | 1.00 | 1.00 | 1.00 | 0.00 | 0.00 | 0.00 | 0.00 | 0.00 | 0.00 | 0.00 | 0.00 | 0.00 | 0.00 | 0.00 | 0.00 | 0.00 | 0.00 | 0.00 | 0.00 | |
| PROGRESSIVE PROGETTO | | | | | | | | | | | | | | | | | | | | | | |
| QUOTE PROGETTO | | | | | | | | | | | | | | | | | | | | | | |
| DISTANZE PARZIALI PROGETTO | | | | | | | | | | | | | | | | | | | | | | |
| QUOTE PROGETTO | | | | | | | | | | | | | | | | | | | | | | |

green & green
WE ENGINEERING

Green & Green S.r.l.
Via Edmondo de Amicis n.64
37036 Ronde (CS) - Italy
P.IVA 0290010782
Ph. (+39) 0984 846295
Fax (+39) 0984 121470
info@greengreen.it
www.greengreen.it

Il tecnico
Ing. Leonardo Sblendido

| | | | | | |
|------|------------|-----------------|-------------|-------------|--------------|
| 00 | 22/12/2023 | PRIMA EMISSIONE | R. De Fiore | P. E. | L. Sblendido |
| REV. | DATA | DESCRIZIONE | PREPARATO | CONTROLLATO | APPROVATO |

"IMPIANTO EOLICO TERRANOVA DA SIBARI"
(COMUNI DI TERRANOVA DA SIBARI, SAN DEMETRIO CORONE, SPEZZANO ALBANESE, CORIGLIANO-ROSSANO, SANTA SOFIA D'EPSIRO E TARSIA (CS))

hergo

PROGETTO: **DEFINITIVO**

FILE: C23FSTR0011WD01000_STUDIO_PLANOALTIMETRICO.pdf

| | | | |
|--------------------|--------------|-----------------|------------------|
| FORMATO: A0 | SCALA: 1:200 | SCALA PLOT: 1:1 | FOGLIO: 30 di 39 |
|--------------------|--------------|-----------------|------------------|

TITOLO: **STUDIO PLANOALTIMETRICO**

CODICE ELABORATO

| | | | | |
|---------------------------|-----|-----|-------------|-----------|
| IMPIANTO | TRC | TR0 | PROGRESSIVO | REVISIONE |
| C23FSTR0011WD01000 | | | | |

green & green
WE ENGINEERING

- Profilo terreno
- Profilo Piazzola

TR_ IMPIANTO
Sezione 26
Progressiva: 0+520
Scala: 1:200
Quota di Riferimento: 325

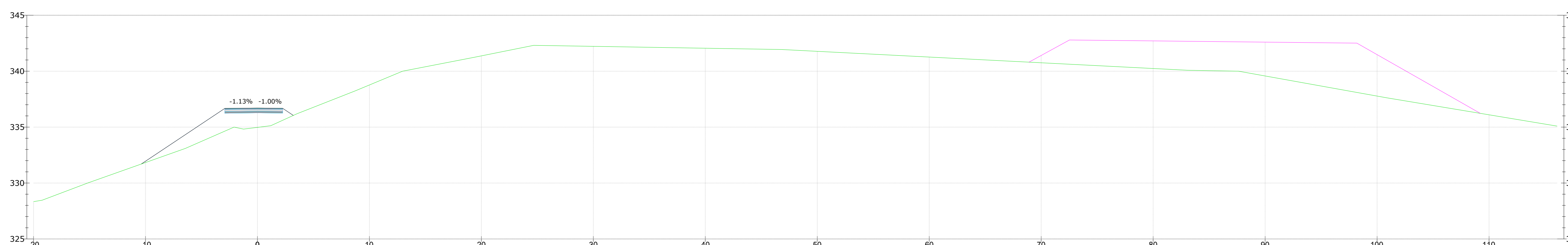

| | | | | | | | | | | | | | | | | | | | | |
|----------------------------|--------|--------|---------|--------|---------|--------|--------|--------|--------|--------|--------|--------|--------|--------|--------|--------|--------|--------|--------|--------|
| PROGRESSIVE TERRENO | 20.00 | 19.23 | 15.17 | 6.44 | 2.09 | 1.74 | 0.00 | 1.79 | 1.55 | 0.71 | 12.86 | 19.40 | 24.68 | 46.81 | 83.05 | 84.80 | 87.61 | 102.06 | 116.08 | |
| QUOTE TERRENO | 328.25 | 328.46 | 328.00 | 327.00 | 326.00 | 325.26 | 325.00 | 325.79 | 326.20 | 326.91 | 327.62 | 328.33 | 329.04 | 329.75 | 330.46 | 330.55 | 330.64 | 330.73 | 330.82 | 330.91 |
| DISTANZE PARZIALI TERRENO | 0.27 | 4.87 | 8.21 | 4.15 | 0.85 | 1.24 | 1.19 | 1.94 | 2.28 | 5.19 | 4.21 | 6.44 | 5.28 | 27.14 | 8.14 | 1.65 | 2.77 | 11.07 | 14.01 | |
| PROGRESSIVE PROGETTO | | | 0+10.00 | | 0+20.00 | | | | | | | | | | | | | | | |
| QUOTE PROGETTO | | | 325.00 | | 325.00 | | | | | | | | | | | | | | | |
| DISTANZE PARZIALI PROGETTO | | | 7.46 | | 2.92 | | | | | | | | | | | | | | | |
| QUOTE PROGETTO | | | | | | | | | | | | | | | | | | | | |

TR_ IMPIANTO
Sezione 27
Progressiva: 0+540
Scala: 1:200
Quota di Riferimento: 320

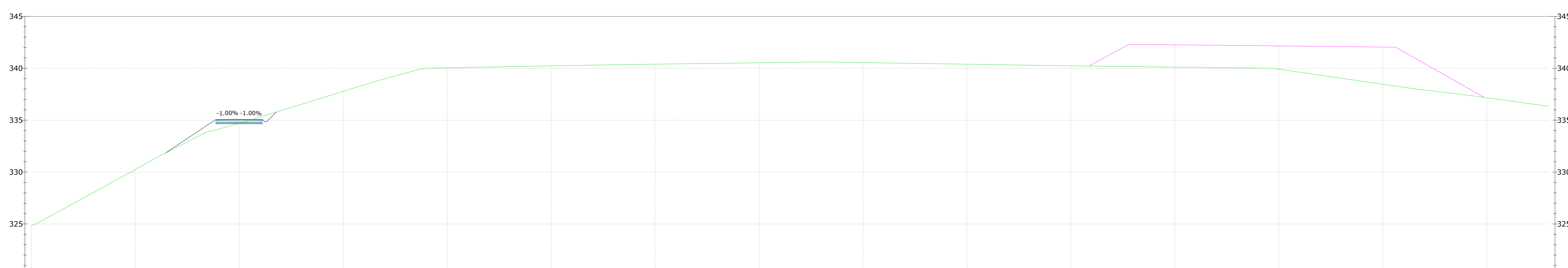

| | | | | | | | | | | | | | | | | | | | | | | | |
|----------------------------|--------|--------|---------|--------|---------|--------|--------|--------|--------|--------|--------|--------|--------|--------|--------|--------|--------|--------|--------|--------|--------|--------|--------|
| PROGRESSIVE TERRENO | 20.00 | 19.41 | 16.67 | 8.20 | 3.74 | 0.00 | 1.02 | 11.17 | 11.71 | 25.58 | 42.97 | 54.77 | 55.53 | 56.29 | 79.81 | 82.17 | 84.45 | 94.42 | 102.10 | 112.97 | 116.65 | 125.94 | |
| QUOTE TERRENO | 324.08 | 325.07 | 326.00 | 327.00 | 327.74 | 328.00 | 328.00 | 328.76 | 329.00 | 329.75 | 330.44 | 331.13 | 331.82 | 332.51 | 333.20 | 333.89 | 334.58 | 335.27 | 335.96 | 336.65 | 337.34 | 338.03 | 338.72 |
| DISTANZE PARZIALI TERRENO | | 8.99 | 1.27 | 4.86 | 1.54 | 0.26 | 0.77 | 20.96 | 4.51 | 10.69 | 12.98 | 15.27 | 0.75 | 0.76 | 23.77 | 2.36 | 2.27 | 10.88 | 7.67 | 10.87 | 3.68 | 7.18 | |
| PROGRESSIVE PROGETTO | | | 0+10.00 | | 0+20.00 | | | | | | | | | | | | | | | | | | |
| QUOTE PROGETTO | | | 320.00 | | 320.00 | | | | | | | | | | | | | | | | | | |
| DISTANZE PARZIALI PROGETTO | | | 4.86 | | 2.25 | | | | | | | | | | | | | | | | | | |
| QUOTE PROGETTO | | | | | | | | | | | | | | | | | | | | | | | |

TR_ IMPIANTO
Sezione 28
Progressiva: 0+560
Scala: 1:200
Quota di Riferimento: 325

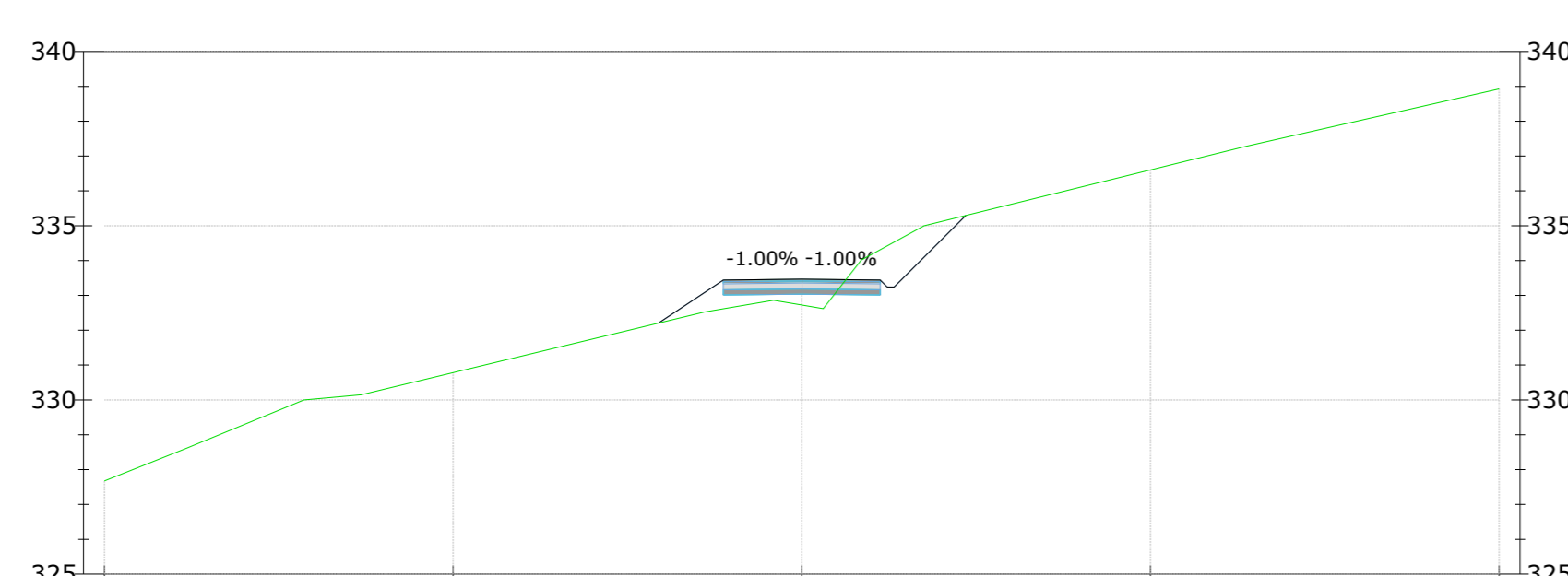

| | | | | | | | | | |
|----------------------------|--------|--------|---------|--------|---------|--------|--------|--------|--------|
| PROGRESSIVE TERRENO | 20.00 | 17.04 | 14.28 | 12.64 | 2.78 | 0.00 | 1.71 | 12.74 | 20.00 |
| QUOTE TERRENO | 325.00 | 324.02 | 323.00 | 322.00 | 321.22 | 321.00 | 321.71 | 322.40 | 323.10 |
| DISTANZE PARZIALI TERRENO | 2.18 | 2.18 | 1.64 | 9.86 | 1.97 | 0.80 | 0.99 | 9.14 | 7.18 |
| PROGRESSIVE PROGETTO | | | 0+10.00 | | 0+20.00 | | | | |
| QUOTE PROGETTO | | | 325.00 | | 325.00 | | | | |
| DISTANZE PARZIALI PROGETTO | | | 1.85 | | 2.25 | | | | |

green & green
WE ENGINEERING

Il tecnico
Ing. Leonardo Sblendido

Green & Green S.r.l.
Via Edmondo de Amicis n.64
37036 Ronde (CS) - Italy
P.IVA 02900010782
Ph. (+39) 0984 846295
Fax (+39) 0984 121470
info@greengreen.it
www.greengreen.it

| | | | | | |
|-----|------------|-----------------|-------------|-------------|--------------|
| 00 | 22/12/2023 | PRIMA EMISSIONE | R. De Fiore | P.E. | L. Sblendido |
| REV | DATA | DESCRIZIONE | PREPARATO | CONTROLLATO | APPROVATO |

"IMPIANTO EOLICO TERRANOVA DA SIBARI"
(COMUNI DI TERRANOVA DA SIBARI, SAN DEMETRIO CORONE, SPEZZANO ALBANESE, CORIGLIANO-ROSSANO, SANTA SOFIA D'EPSIRO E TARSIA (CS))

hergo

PROGETTO: **DEFINITIVO**

NOTE FILE: C23FSTR0011WD01000_STUDIO PLANOALTIMETRICO.pdf

FORMATO: **A0** | SCALA: **1:200** | SCALA PLOT: **1:1** | FOGLIO: **31** di **39**

TITOLO: **STUDIO PLANOALTIMETRICO**

CODICE ELABORATO: **C23FSTR002WD01000**

green & green
WE ENGINEERING

TR_IMPIANTO
Sezione 38
Progressiva: 0+760
Scala: 1:200
Quota di Riferimento: 305

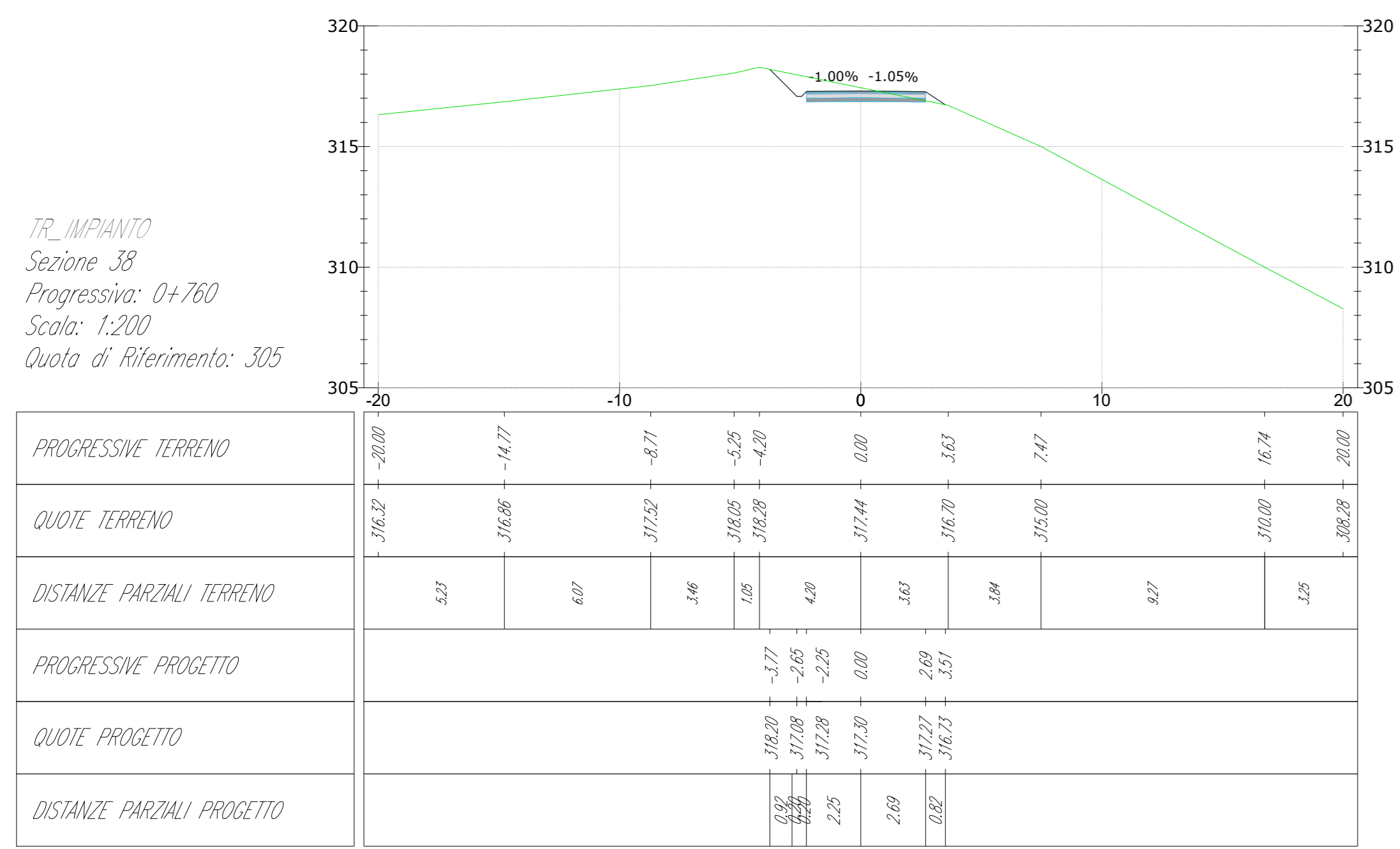

TR_IMPIANTO
Sezione 42
Progressiva: 0+840
Scala: 1:200
Quota di Riferimento: 315

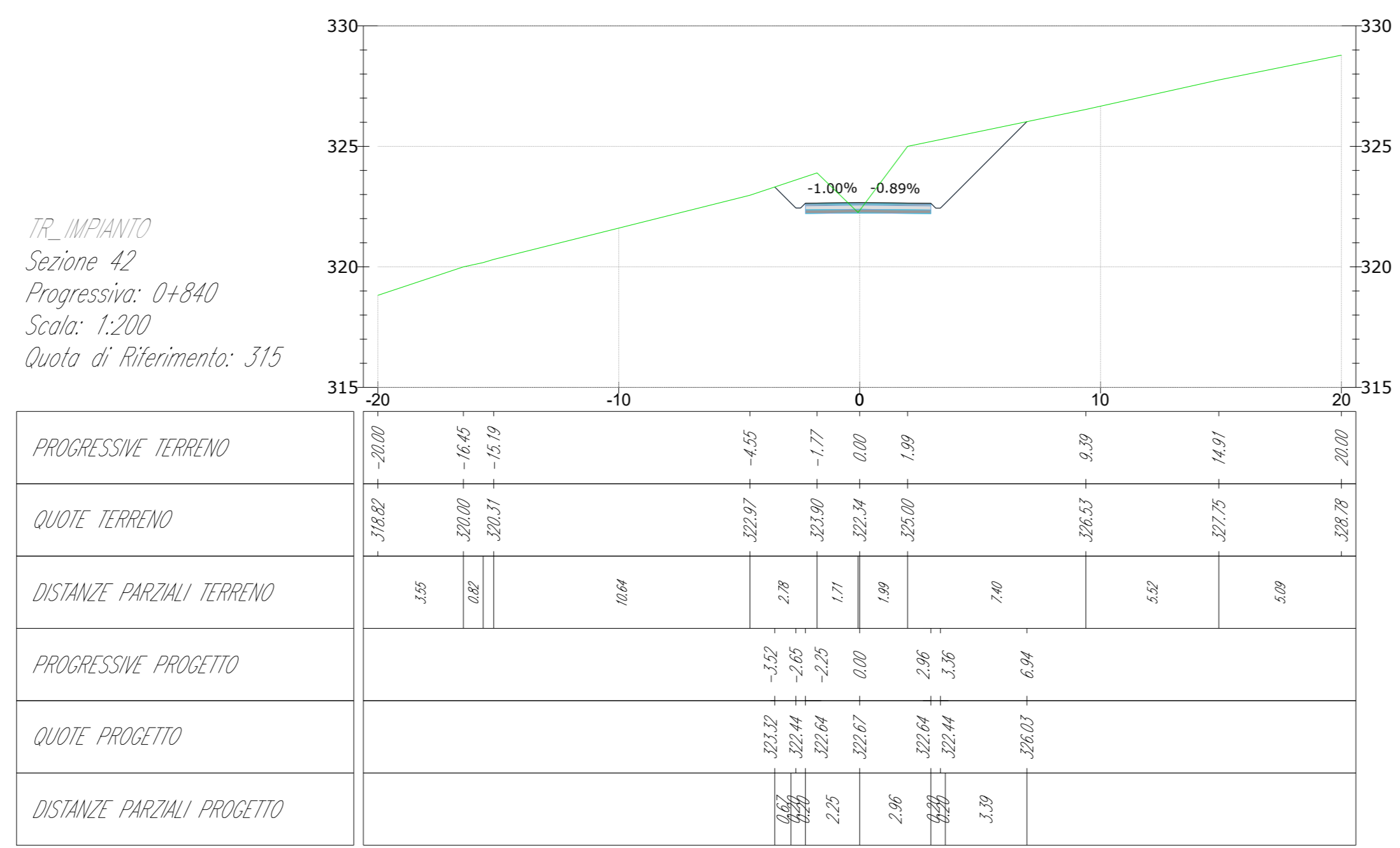

TR_IMPIANTO
Sezione 46
Progressiva: 0+920
Scala: 1:200
Quota di Riferimento: 315

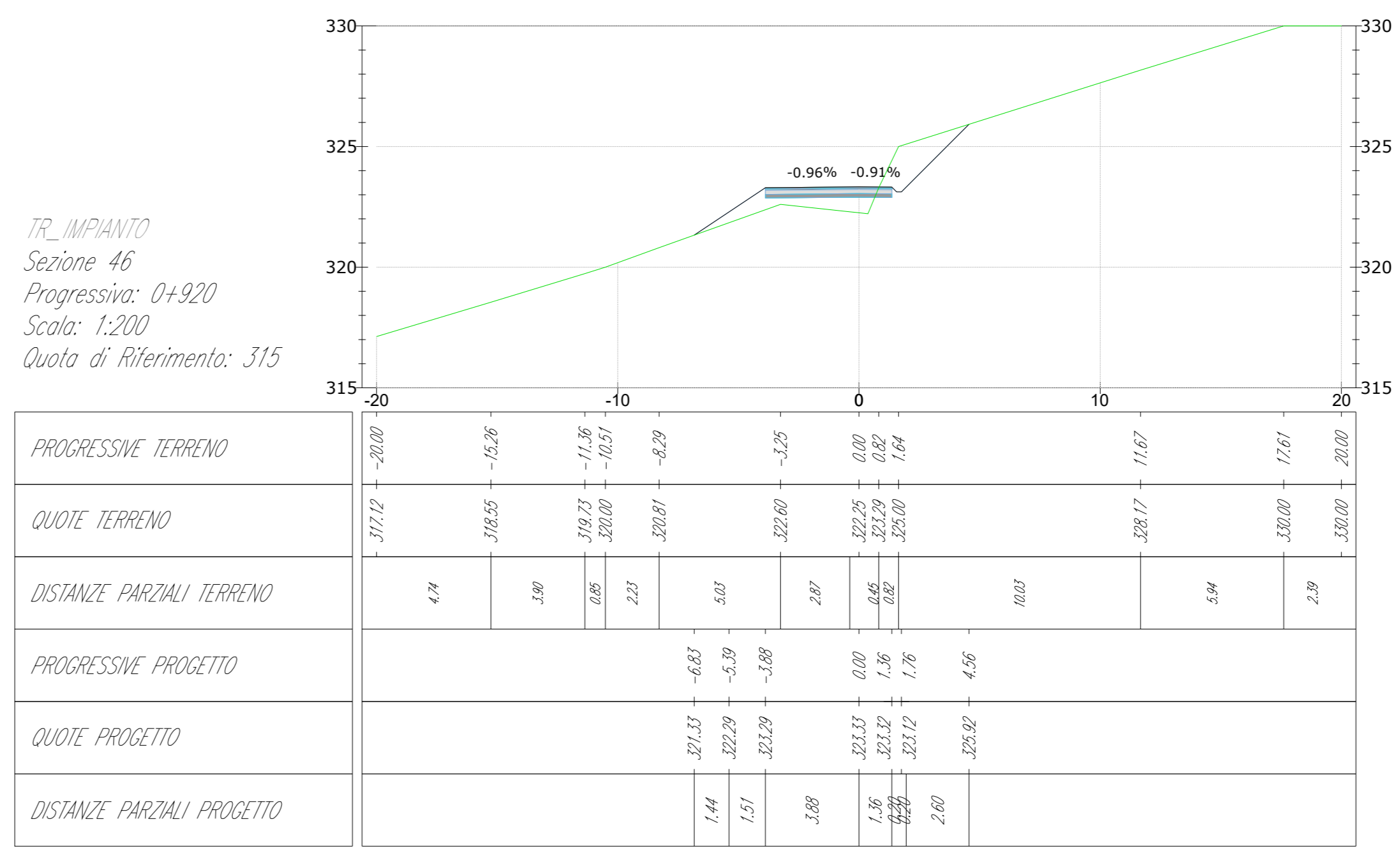

TR_IMPIANTO
Sezione 39
Progressiva: 0+780
Scala: 1:200
Quota di Riferimento: 310

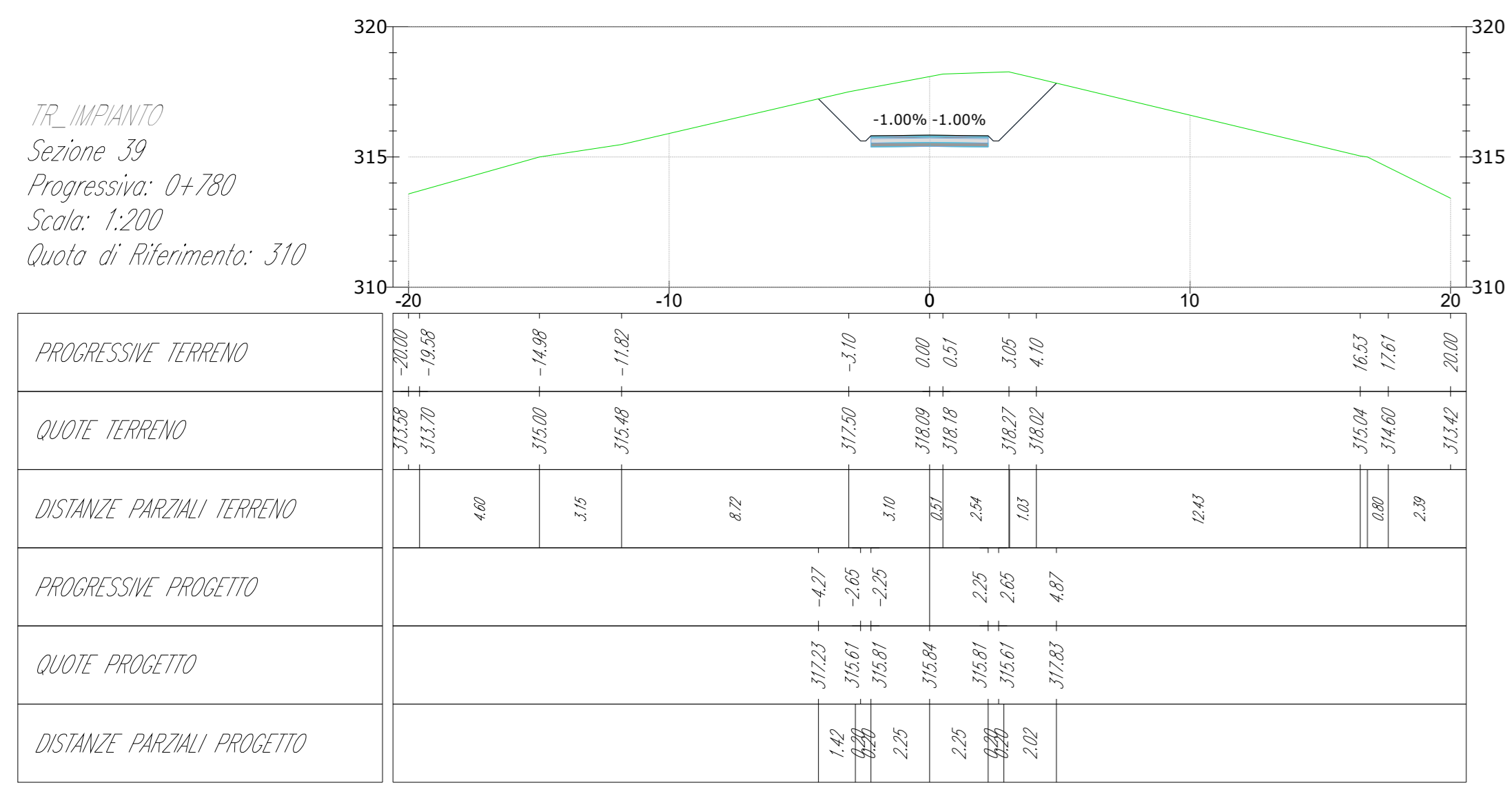

TR_IMPIANTO
Sezione 43
Progressiva: 0+860
Scala: 1:200
Quota di Riferimento: 320

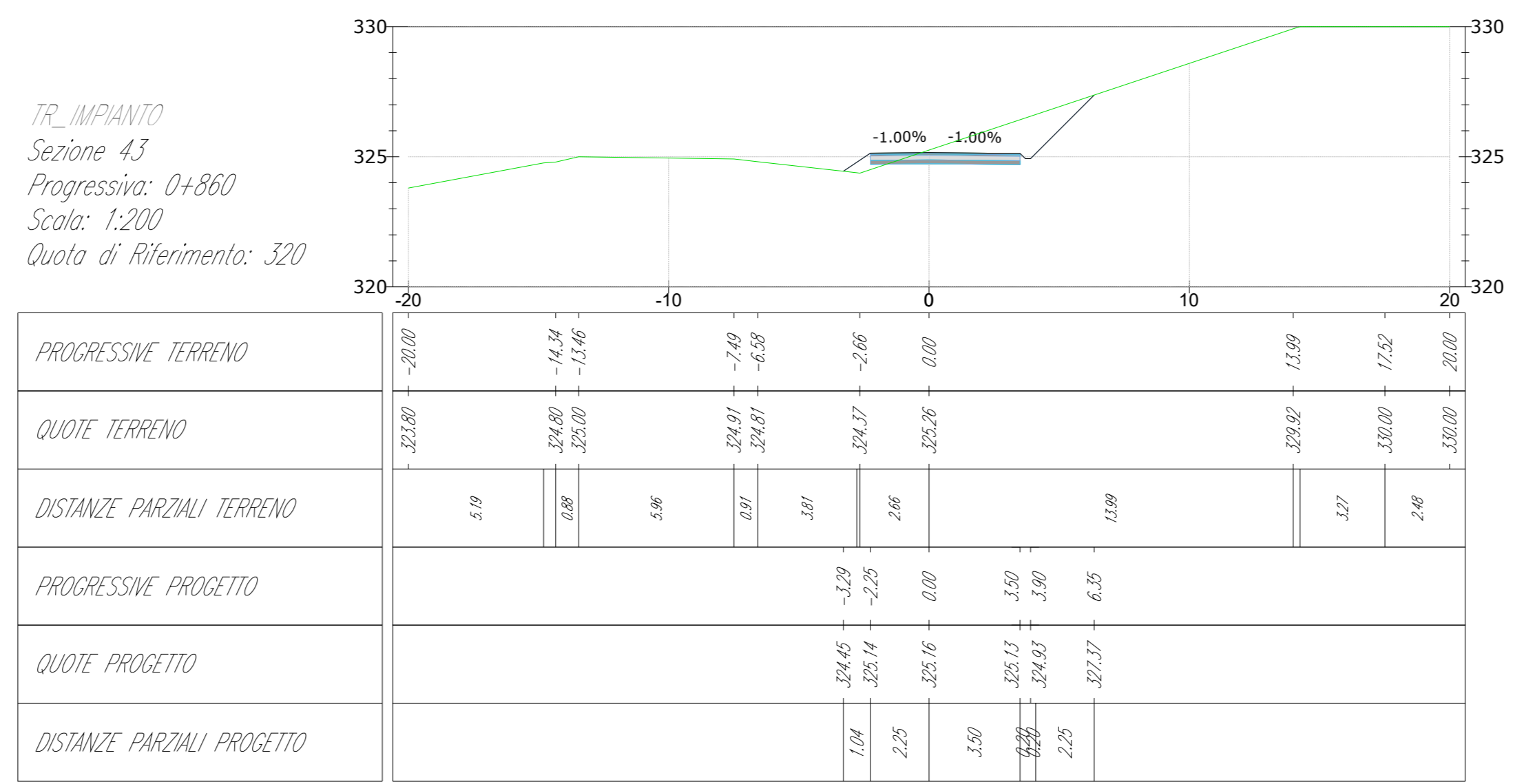

TR_IMPIANTO
Sezione 47
Progressiva: 0+940
Scala: 1:200
Quota di Riferimento: 315

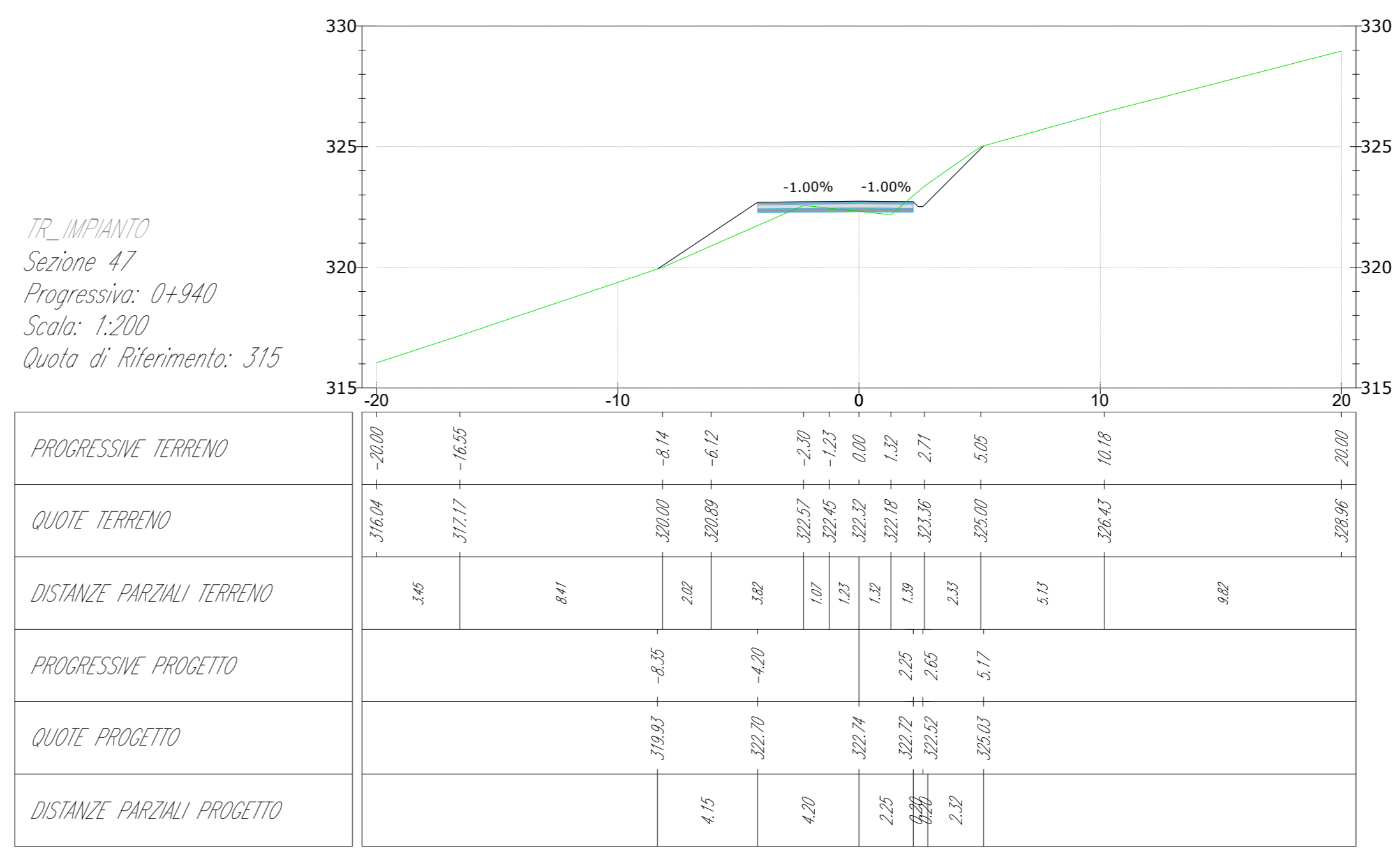

TR_IMPIANTO
Sezione 40
Progressiva: 0+800
Scala: 1:200
Quota di Riferimento: 310

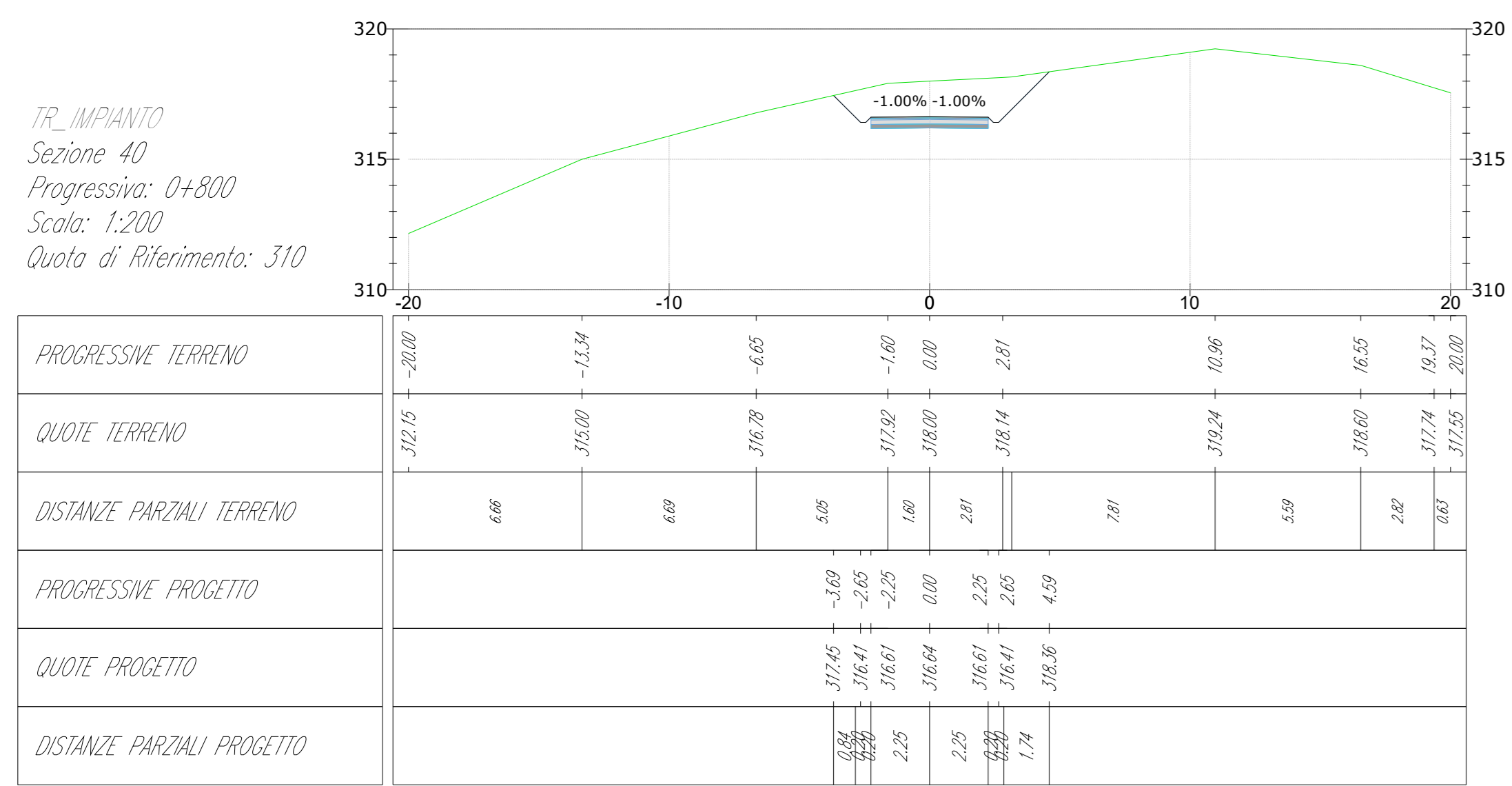

TR_IMPIANTO
Sezione 44
Progressiva: 0+880
Scala: 1:200
Quota di Riferimento: 320

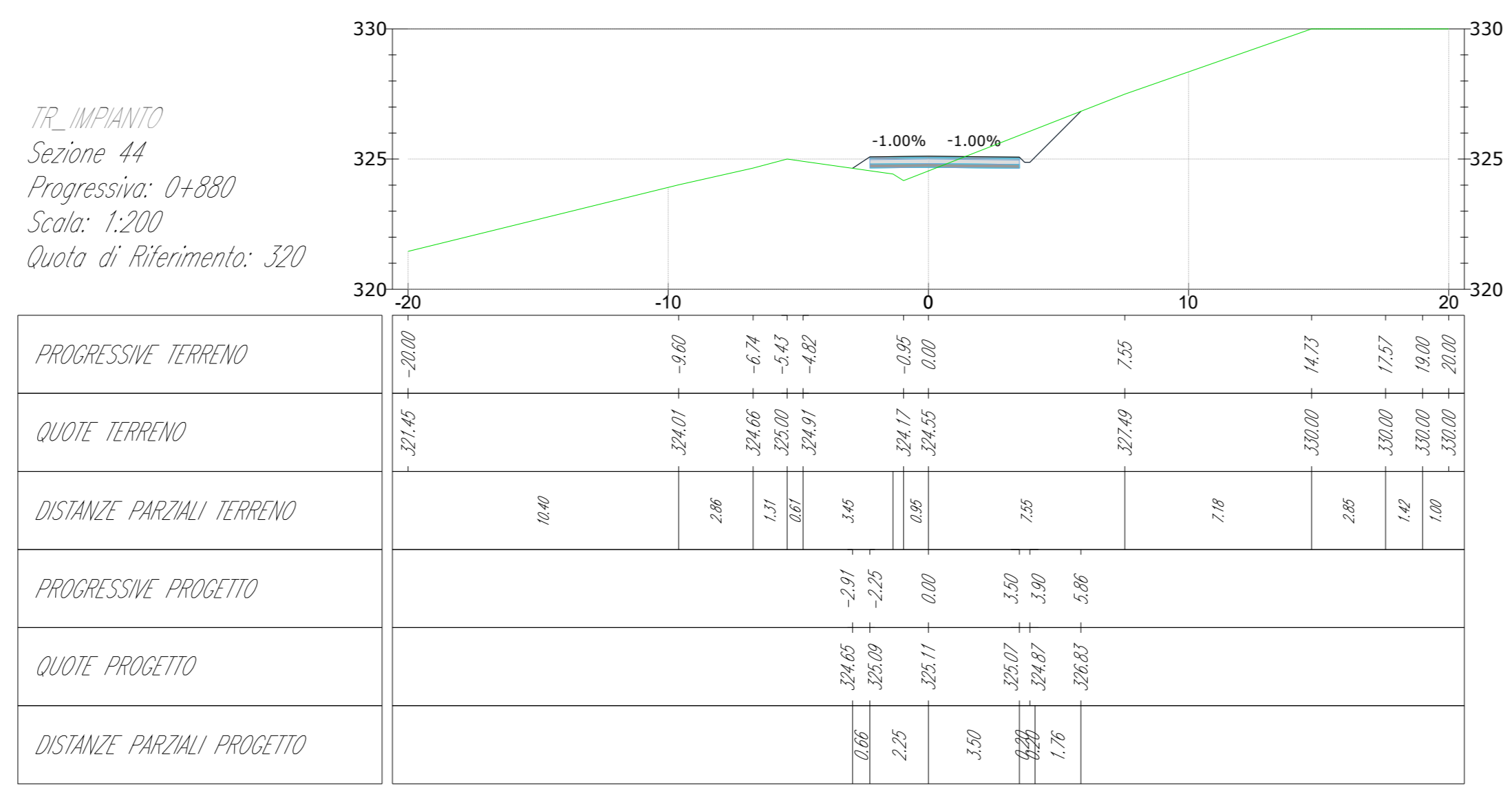

TR_IMPIANTO
Sezione 48
Progressiva: 0+960
Scala: 1:200
Quota di Riferimento: 315

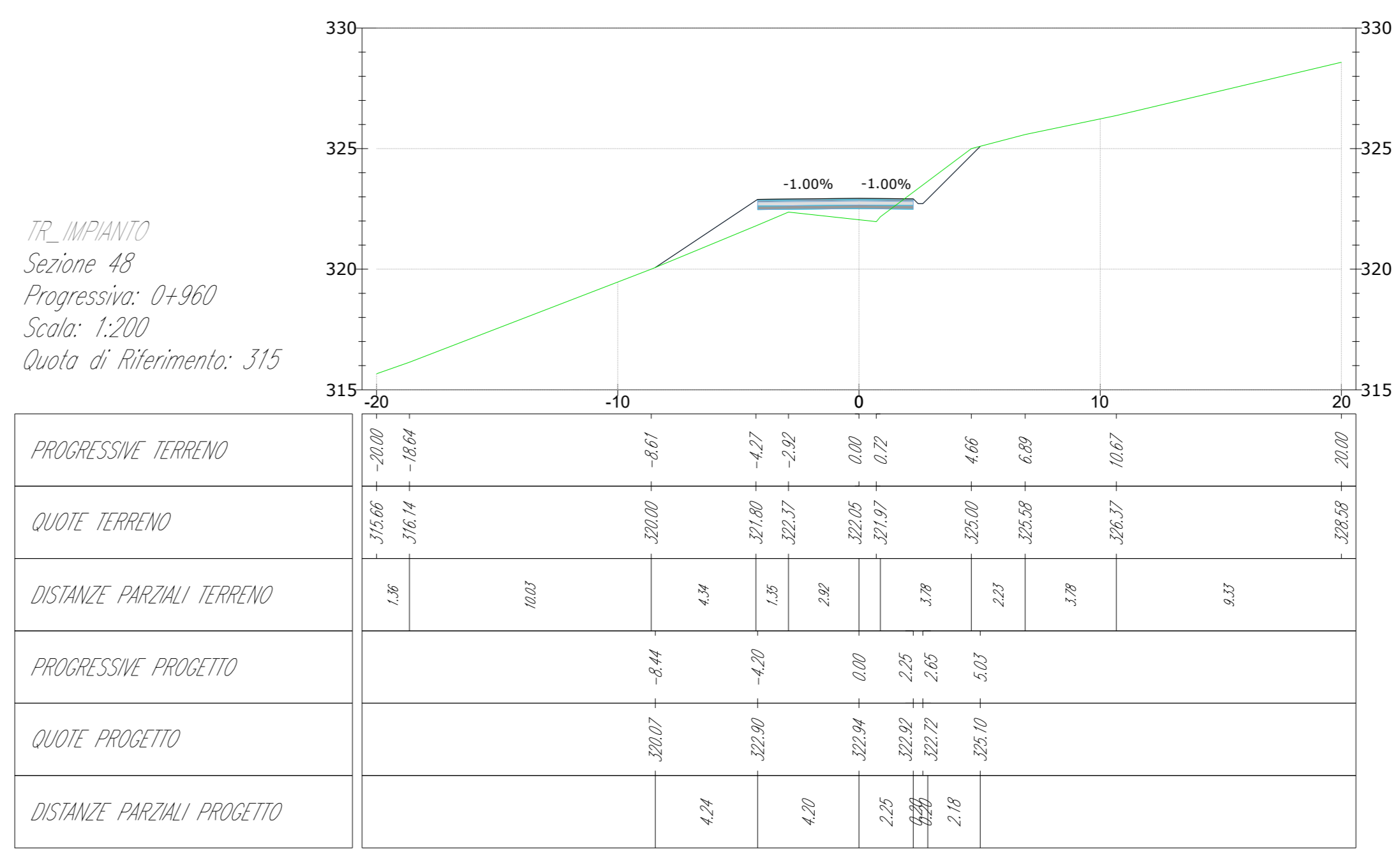

TR_IMPIANTO
Sezione 41
Progressiva: 0+820
Scala: 1:200
Quota di Riferimento: 310

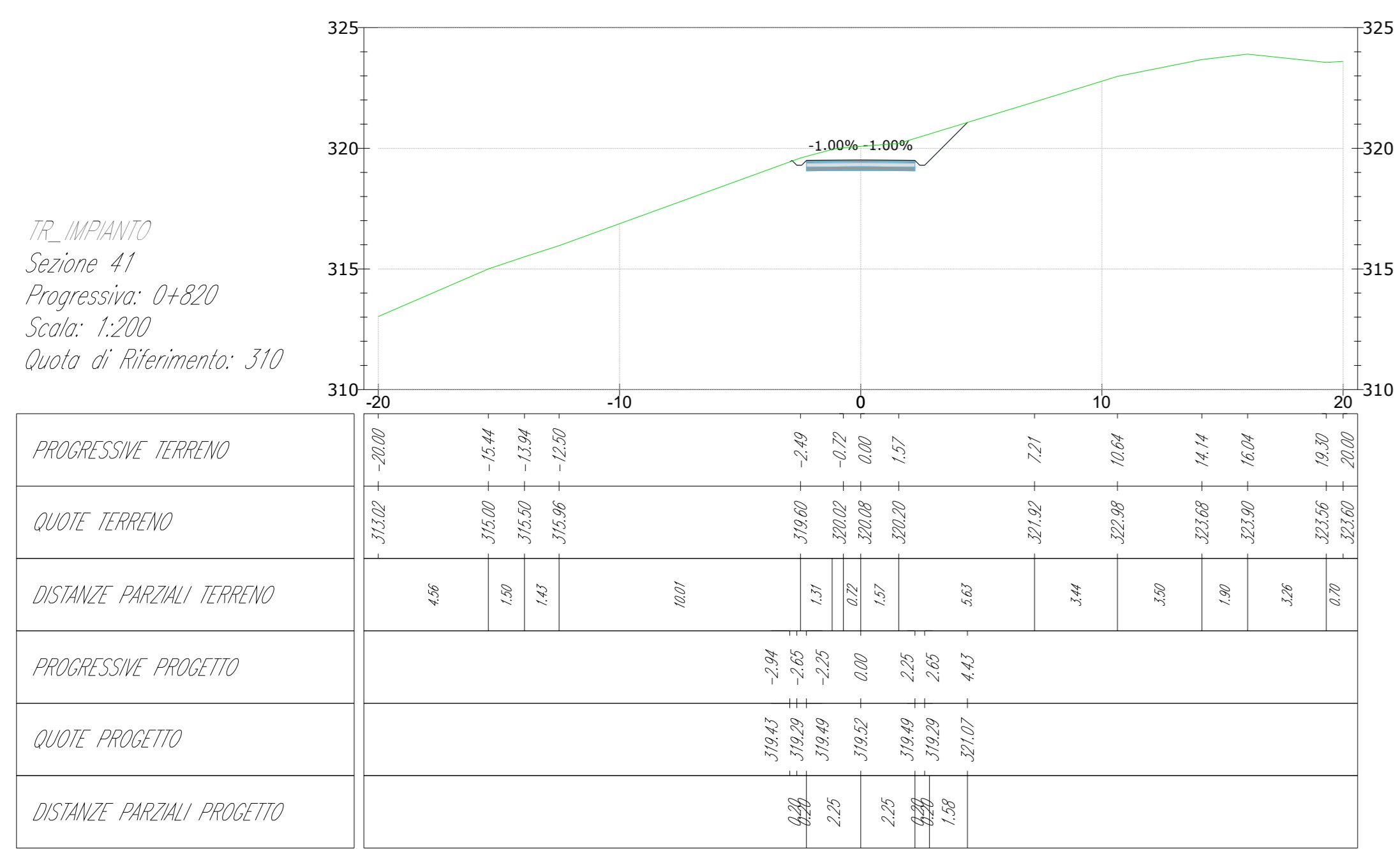

TR_IMPIANTO
Sezione 45
Progressiva: 0+900
Scala: 1:200
Quota di Riferimento: 315

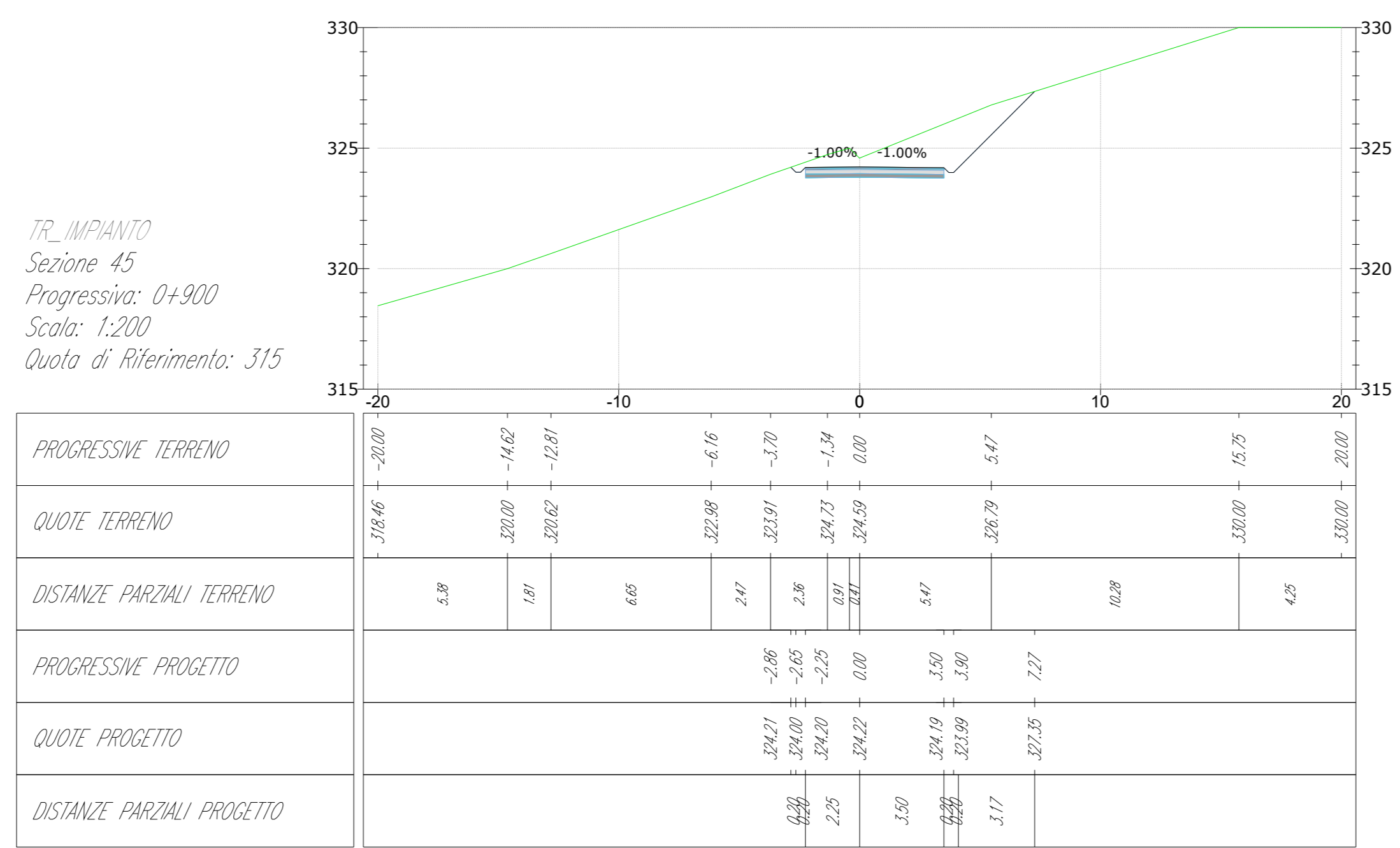

TR_IMPIANTO
Sezione 49
Progressiva: 0+980
Scala: 1:200
Quota di Riferimento: 315

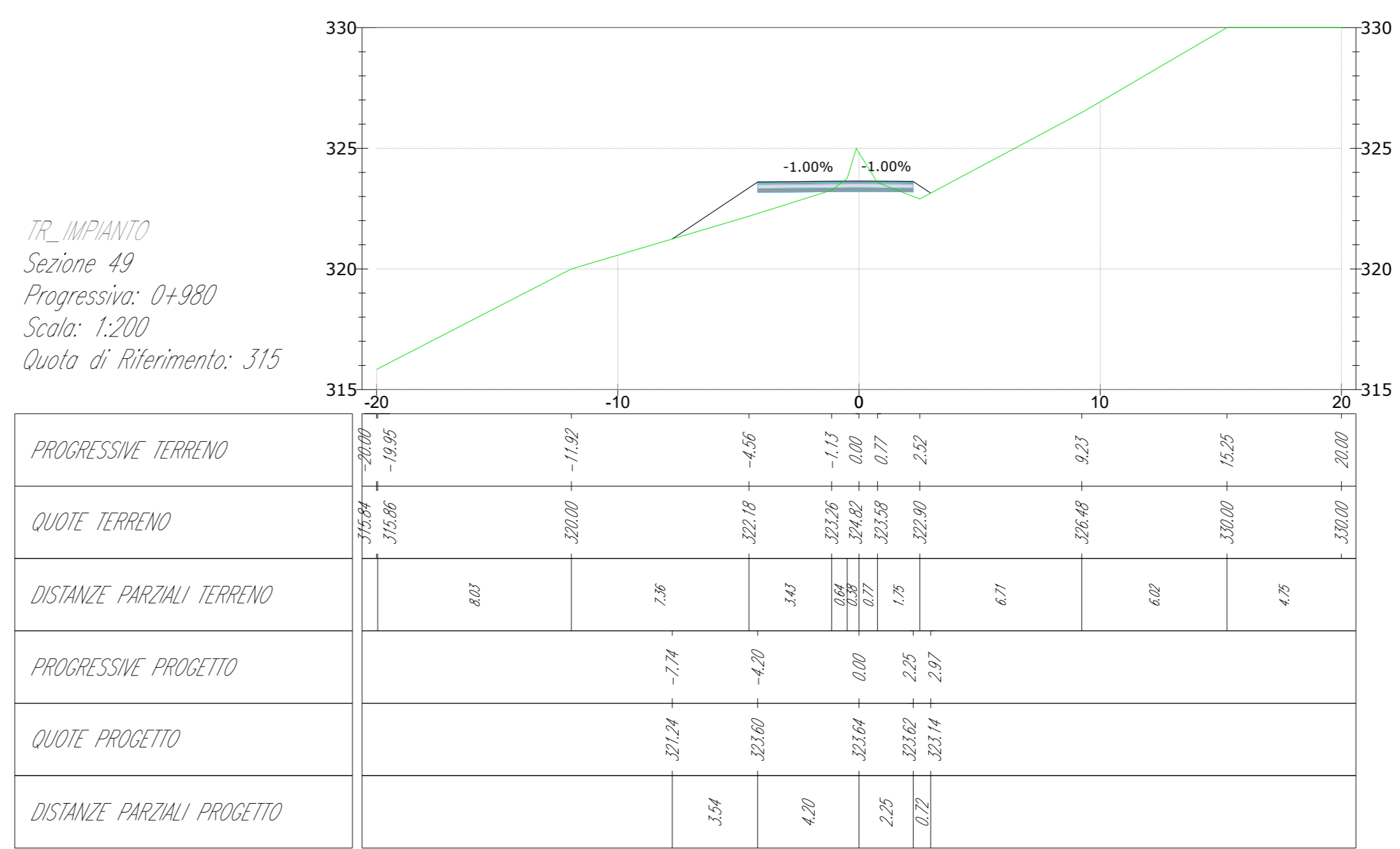

LEGENDA DEI COLORI E SIMBOLI IN CARTA

Profilo terreno



Green & Green S.r.l.
Via Edmondo de Amicis n.64
37036 Ronde (CS) - Italy
P.IVA 02900010782
Ph. (+39) 0984 846295
Fax (+39) 0984 1214470
info@greengreen.it
www.greengreen.it

Il tecnico
Ing. Leonardo Sblendido



| | | | | | |
|-----|------------|-----------------|-------------|-------------|--------------|
| 00 | 22/12/2023 | PRIMA EMISSIONE | R. De Fiore | P.E. | L. Sblendido |
| REV | DATA | DESCRIZIONE | PREPARATO | CONTROLLATO | APPROVATO |

"IMPIANTO EOLICO TERRANOVA DA SIBARI"
(COMUNI DI TERRANOVA DA SIBARI, SAN DEMETRIO CORONE, SPEZZANO ALBANESE, CORIGLIANO-ROSSANO, SANTA SOFIA D'EPSIRO E TARSIA (CS))

| | | | | | | | | | |
|------------------|---|--------|-------------|-------------|-----|--------|----|----|----|
| PROGETTO | DEFINITIVO | | | | | | | | |
| NUMERO FILE | C23FST0011WD01000_STUDIO_PLANOALTIMETRICO.pdf | | | | | | | | |
| FORMATO | A0 | SCALA: | 1:200 | SCALA PLOT: | 1:1 | FOGLIO | 33 | di | 39 |
| TITOLO: | STUDIO PLANOALTIMETRICO | | | | | | | | |
| CODICE ELABORATO | | | | | | | | | |
| IMPIANTO | TRC | TRF | PROGRESSIVO | REVISIONE | | | | | |
| C23FST | R002 | WD01 | 00 | 00 | | | | | |



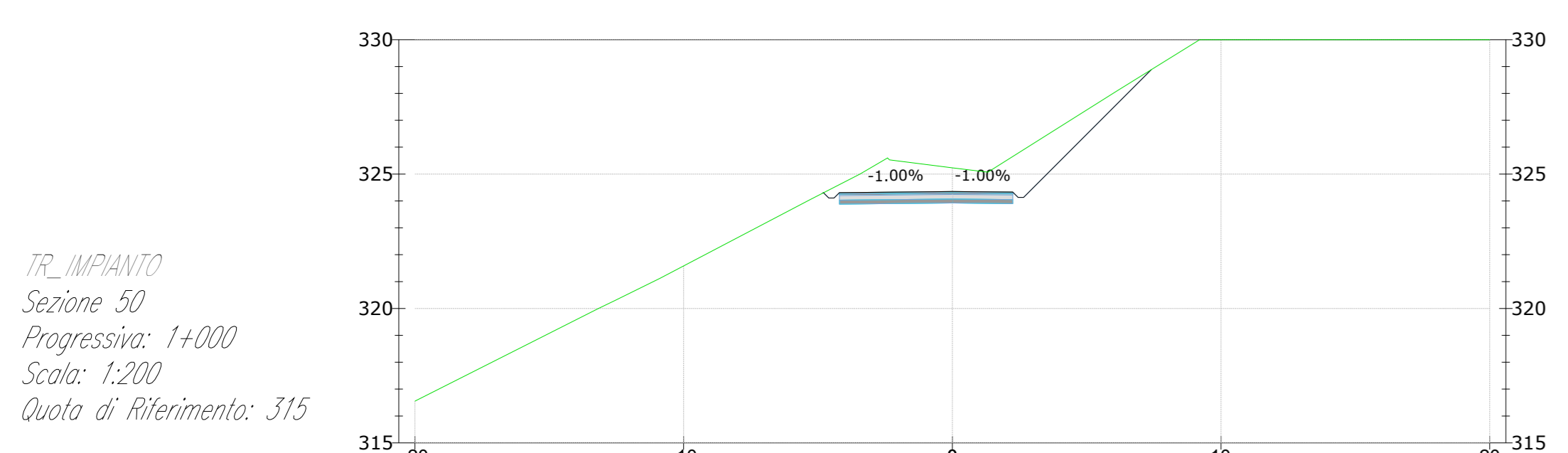

| | | | | | |
|----------------------------|--------|--------|--------|--------|--------|
| PROGRESSIVE TERRENO | 20.00 | 10.00 | 0.00 | 10.00 | 20.00 |
| QUOTE TERRENO | 315.00 | 316.00 | 317.00 | 318.00 | 319.00 |
| DISTANZE PARZIALI TERRENO | 0.00 | 10.00 | 10.00 | 10.00 | 10.00 |
| PROGRESSIVE PROGETTO | | | | | |
| QUOTE PROGETTO | | | | | |
| DISTANZE PARZIALI PROGETTO | | | | | |



| | | | | | |
|----------------------------|--------|--------|--------|--------|--------|
| PROGRESSIVE TERRENO | 20.00 | 10.00 | 0.00 | 10.00 | 20.00 |
| QUOTE TERRENO | 320.00 | 321.00 | 322.00 | 323.00 | 324.00 |
| DISTANZE PARZIALI TERRENO | 0.00 | 10.00 | 10.00 | 10.00 | 10.00 |
| PROGRESSIVE PROGETTO | | | | | |
| QUOTE PROGETTO | | | | | |
| DISTANZE PARZIALI PROGETTO | | | | | |



| | | | | | |
|----------------------------|--------|--------|--------|--------|--------|
| PROGRESSIVE TERRENO | 20.00 | 10.00 | 0.00 | 10.00 | 20.00 |
| QUOTE TERRENO | 320.00 | 321.00 | 322.00 | 323.00 | 324.00 |
| DISTANZE PARZIALI TERRENO | 0.00 | 10.00 | 10.00 | 10.00 | 10.00 |
| PROGRESSIVE PROGETTO | | | | | |
| QUOTE PROGETTO | | | | | |
| DISTANZE PARZIALI PROGETTO | | | | | |

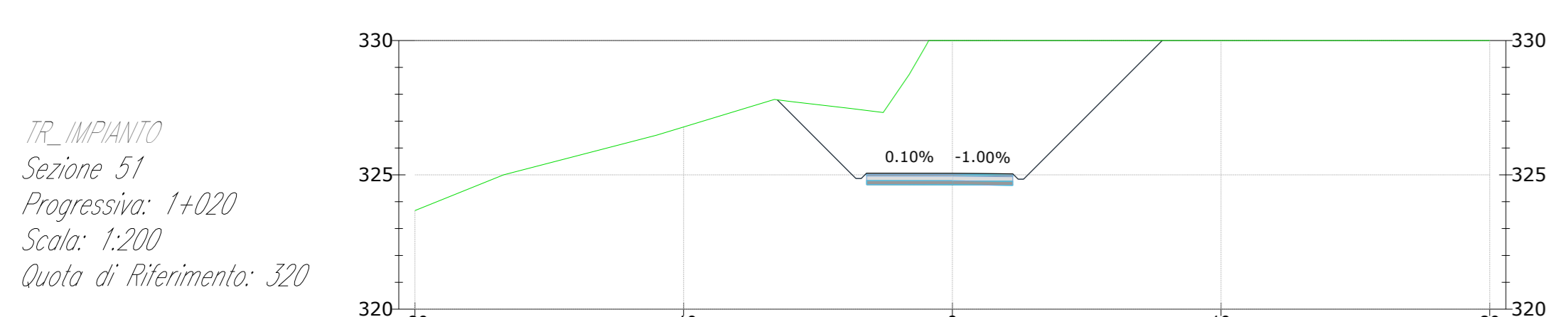

| | | | | | |
|----------------------------|--------|--------|--------|--------|--------|
| PROGRESSIVE TERRENO | 20.00 | 10.00 | 0.00 | 10.00 | 20.00 |
| QUOTE TERRENO | 320.00 | 321.00 | 322.00 | 323.00 | 324.00 |
| DISTANZE PARZIALI TERRENO | 0.00 | 10.00 | 10.00 | 10.00 | 10.00 |
| PROGRESSIVE PROGETTO | | | | | |
| QUOTE PROGETTO | | | | | |
| DISTANZE PARZIALI PROGETTO | | | | | |

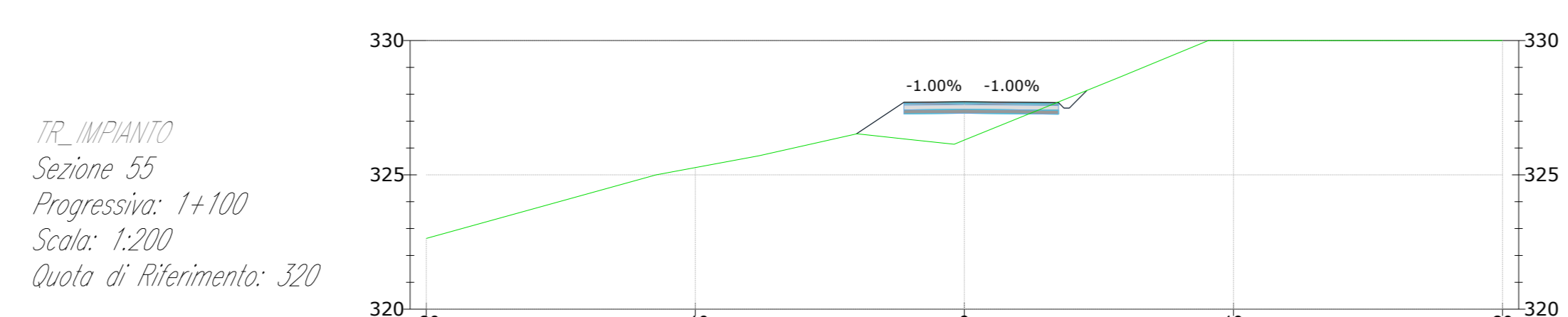

| | | | | | |
|----------------------------|--------|--------|--------|--------|--------|
| PROGRESSIVE TERRENO | 20.00 | 10.00 | 0.00 | 10.00 | 20.00 |
| QUOTE TERRENO | 320.00 | 321.00 | 322.00 | 323.00 | 324.00 |
| DISTANZE PARZIALI TERRENO | 0.00 | 10.00 | 10.00 | 10.00 | 10.00 |
| PROGRESSIVE PROGETTO | | | | | |
| QUOTE PROGETTO | | | | | |
| DISTANZE PARZIALI PROGETTO | | | | | |

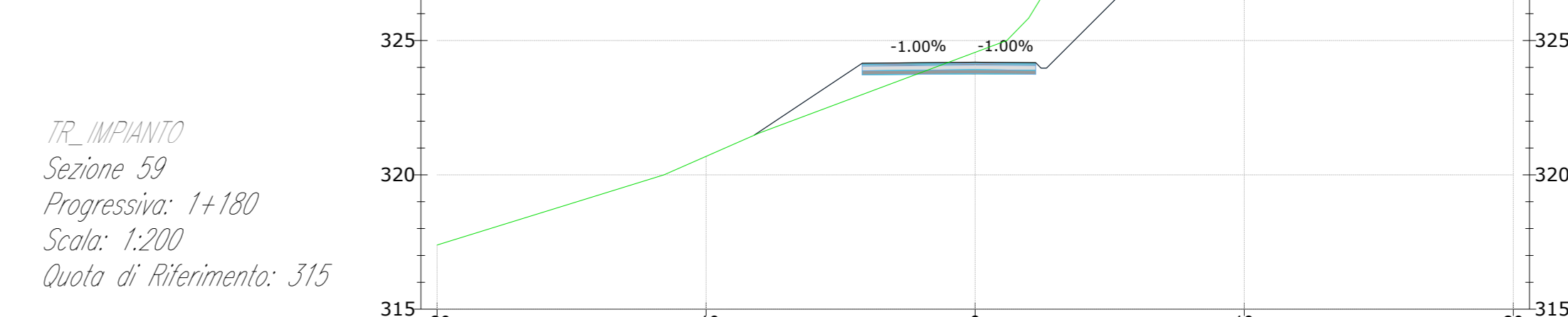

| | | | | | |
|----------------------------|--------|--------|--------|--------|--------|
| PROGRESSIVE TERRENO | 20.00 | 10.00 | 0.00 | 10.00 | 20.00 |
| QUOTE TERRENO | 315.00 | 316.00 | 317.00 | 318.00 | 319.00 |
| DISTANZE PARZIALI TERRENO | 0.00 | 10.00 | 10.00 | 10.00 | 10.00 |
| PROGRESSIVE PROGETTO | | | | | |
| QUOTE PROGETTO | | | | | |
| DISTANZE PARZIALI PROGETTO | | | | | |

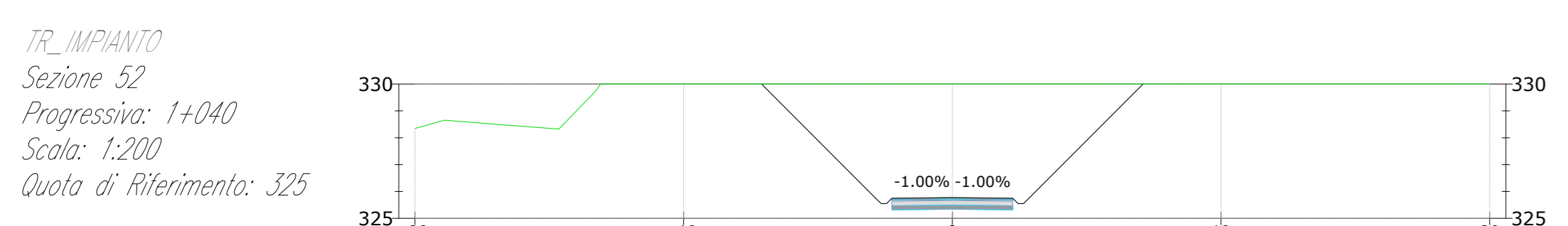

| | | | | | |
|----------------------------|--------|--------|--------|--------|--------|
| PROGRESSIVE TERRENO | 20.00 | 10.00 | 0.00 | 10.00 | 20.00 |
| QUOTE TERRENO | 325.00 | 326.00 | 327.00 | 328.00 | 329.00 |
| DISTANZE PARZIALI TERRENO | 0.00 | 10.00 | 10.00 | 10.00 | 10.00 |
| PROGRESSIVE PROGETTO | | | | | |
| QUOTE PROGETTO | | | | | |
| DISTANZE PARZIALI PROGETTO | | | | | |

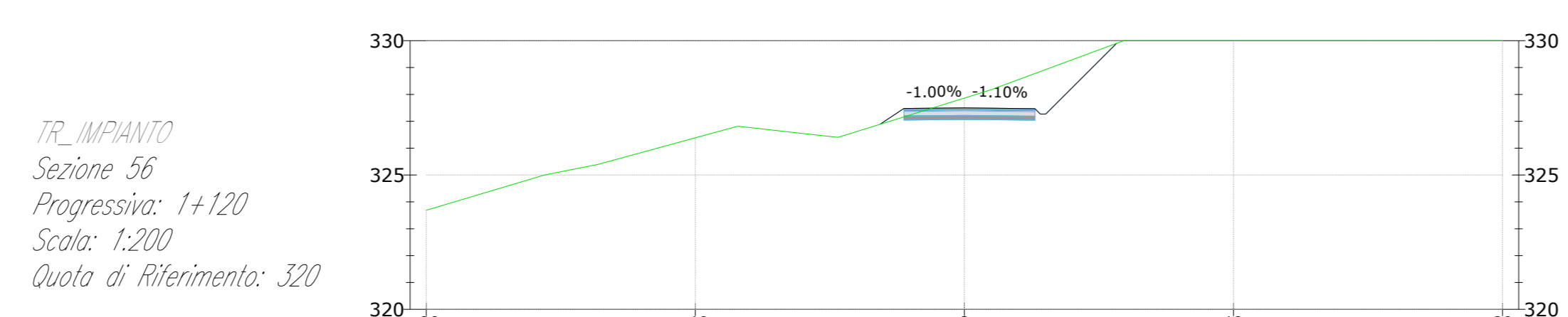

| | | | | | |
|----------------------------|--------|--------|--------|--------|--------|
| PROGRESSIVE TERRENO | 20.00 | 10.00 | 0.00 | 10.00 | 20.00 |
| QUOTE TERRENO | 320.00 | 321.00 | 322.00 | 323.00 | 324.00 |
| DISTANZE PARZIALI TERRENO | 0.00 | 10.00 | 10.00 | 10.00 | 10.00 |
| PROGRESSIVE PROGETTO | | | | | |
| QUOTE PROGETTO | | | | | |
| DISTANZE PARZIALI PROGETTO | | | | | |

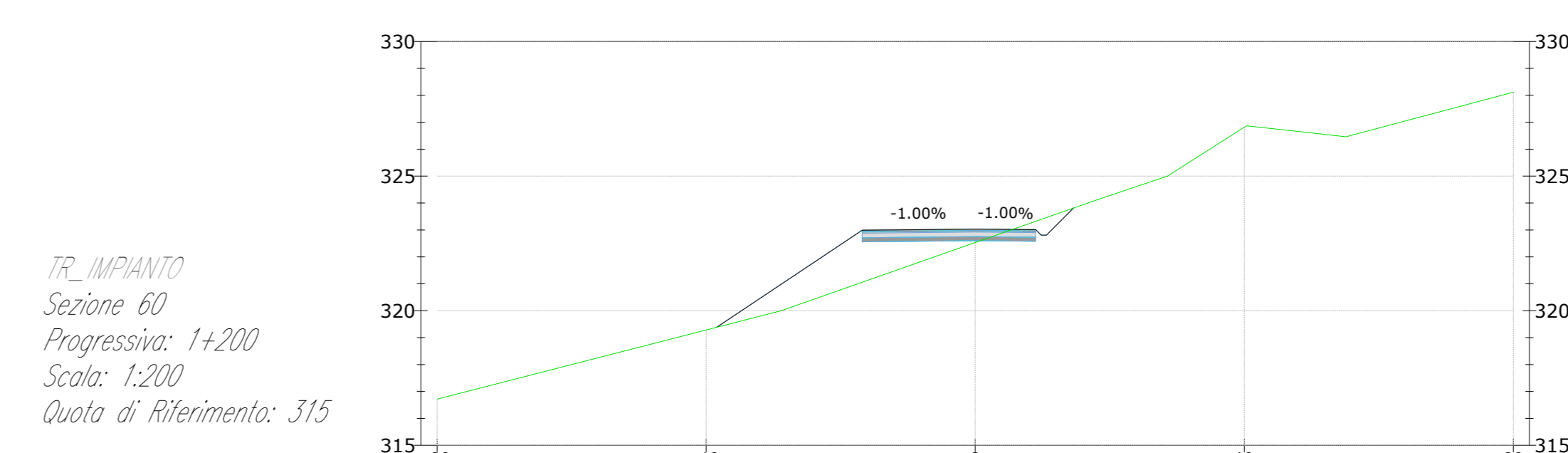

| | | | | | |
|----------------------------|--------|--------|--------|--------|--------|
| PROGRESSIVE TERRENO | 20.00 | 10.00 | 0.00 | 10.00 | 20.00 |
| QUOTE TERRENO | 315.00 | 316.00 | 317.00 | 318.00 | 319.00 |
| DISTANZE PARZIALI TERRENO | 0.00 | 10.00 | 10.00 | 10.00 | 10.00 |
| PROGRESSIVE PROGETTO | | | | | |
| QUOTE PROGETTO | | | | | |
| DISTANZE PARZIALI PROGETTO | | | | | |

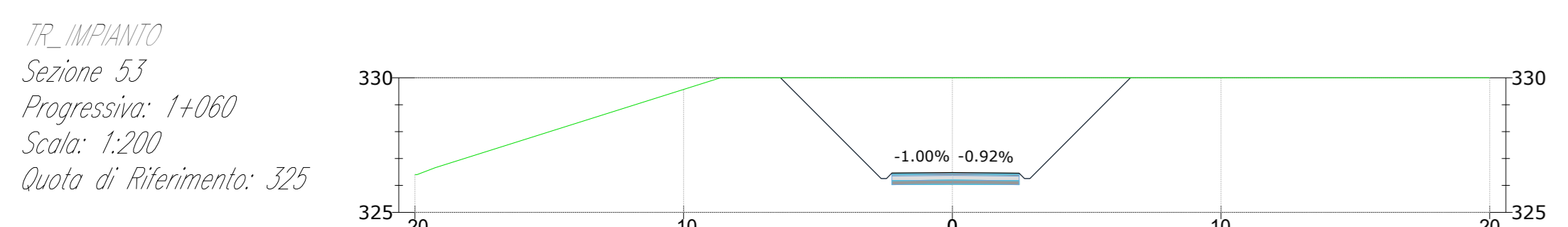

| | | | | | |
|----------------------------|--------|--------|--------|--------|--------|
| PROGRESSIVE TERRENO | 20.00 | 10.00 | 0.00 | 10.00 | 20.00 |
| QUOTE TERRENO | 325.00 | 326.00 | 327.00 | 328.00 | 329.00 |
| DISTANZE PARZIALI TERRENO | 0.00 | 10.00 | 10.00 | 10.00 | 10.00 |
| PROGRESSIVE PROGETTO | | | | | |
| QUOTE PROGETTO | | | | | |
| DISTANZE PARZIALI PROGETTO | | | | | |

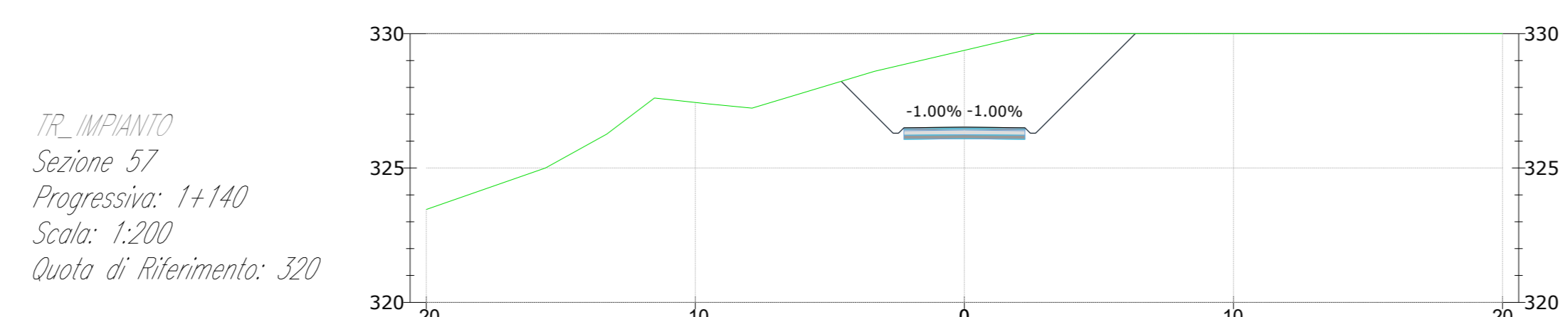

| | | | | | |
|----------------------------|--------|--------|--------|--------|--------|
| PROGRESSIVE TERRENO | 20.00 | 10.00 | 0.00 | 10.00 | 20.00 |
| QUOTE TERRENO | 320.00 | 321.00 | 322.00 | 323.00 | 324.00 |
| DISTANZE PARZIALI TERRENO | 0.00 | 10.00 | 10.00 | 10.00 | 10.00 |
| PROGRESSIVE PROGETTO | | | | | |
| QUOTE PROGETTO | | | | | |
| DISTANZE PARZIALI PROGETTO | | | | | |

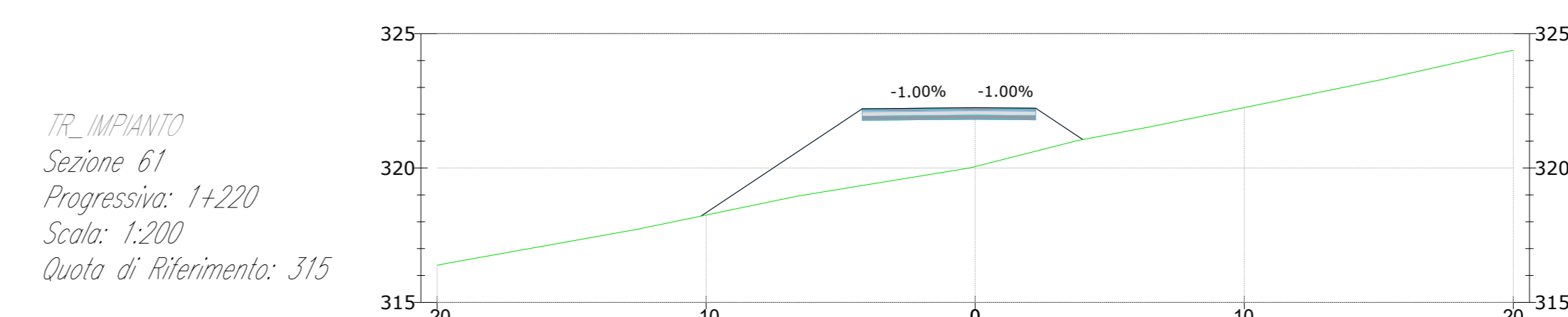

| | | | | | |
|----------------------------|--------|--------|--------|--------|--------|
| PROGRESSIVE TERRENO | 20.00 | 10.00 | 0.00 | 10.00 | 20.00 |
| QUOTE TERRENO | 315.00 | 316.00 | 317.00 | 318.00 | 319.00 |
| DISTANZE PARZIALI TERRENO | 0.00 | 10.00 | 10.00 | 10.00 | 10.00 |
| PROGRESSIVE PROGETTO | | | | | |
| QUOTE PROGETTO | | | | | |
| DISTANZE PARZIALI PROGETTO | | | | | |

green & green
WE ENGINEERING
Green & Green S.r.l.
Via Edmondo de Amicis n.64
37036 Ronde (CS) - Italy
P.IVA 02900010782
Ph. (+39) 0984 846295
E-mail (+39) 0984 1214470
info@greengreen.it
www.greengreen.it

Il tecnico
Ing. Leonardo Sblendido

| | | | | | |
|------|------------|-----------------|-------------|-------------|--------------|
| 00 | 22/12/2023 | PRIMA EMISSIONE | R. De Fiore | P.E. | L. Sblendido |
| REV. | DATA | DESCRIZIONE | PREPARATO | CONTROLLATO | APPROVATO |

"IMPIANTO EOLICO TERRANOVA DA SIBARI"
(COMUNI DI TERRANOVA DA SIBARI, SAN DEMETRIO CORONE, SPEZZANO ALBANESE, CORIGLIANO-ROSSANO, SANTA SOFIA D'EPSIRO E TARSIA (CS))

hergo

PROGETTO: **DEFINITIVO**

NOVE FILE: CZ3FSTR0011WD01000_STUDIO_PLANOALTIMETRICO.pdf

FORMATO: **A0** | SCALA: **1:200** | SCALA PLOT: **1:1** | FOGLIO: **34** di **39**

TITOLO: **STUDIO PLANOALTIMETRICO**

CODICE ELABORATO: **C23FSTR0012WD01000**

green & green
WE ENGINEERING



TR_IMPIANTO
Sezione 62
Progressiva: 1+240
Scala: 1:200
Quota di Riferimento: 315

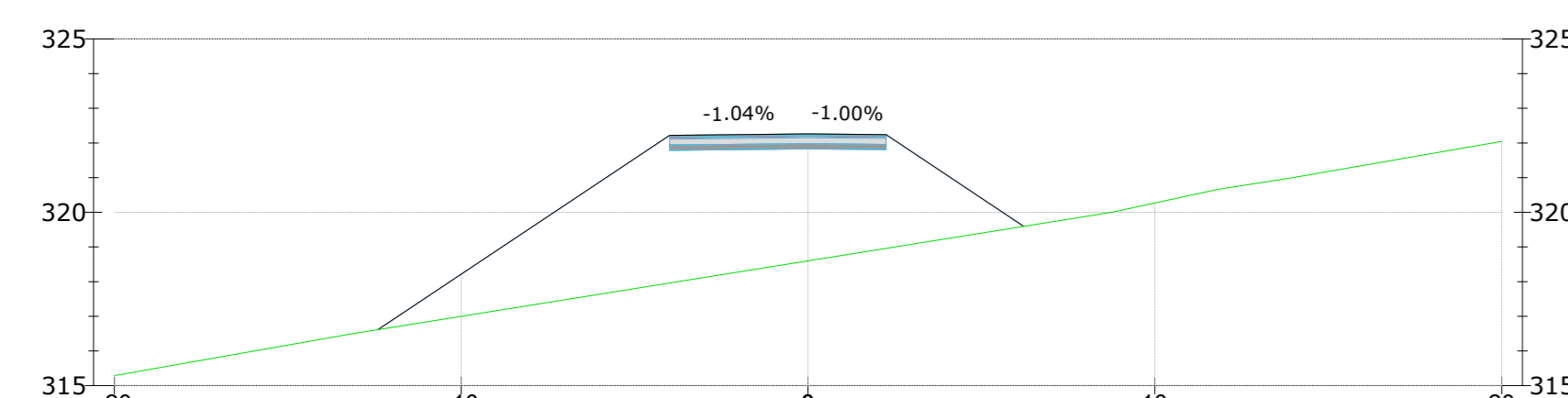

| | | | | | |
|----------------------------|--------|--------|--------|--------|--------|
| PROGRESSIVE TERRENO | 20 | 10 | 0 | 10 | 20 |
| QUOTE TERRENO | 315.29 | 316.49 | 316.60 | 318.00 | 319.84 |
| DISTANZE PARZIALI TERRENO | 6.87 | 11.17 | 6.78 | 5.88 | 6.19 |
| PROGRESSIVE PROGETTO | | | | | |
| QUOTE PROGETTO | | 316.62 | 317.22 | 317.28 | 317.99 |
| DISTANZE PARZIALI PROGETTO | | 8.40 | 3.09 | 2.25 | 1.97 |

TR_IMPIANTO
Sezione 66
Progressiva: 1+320
Scala: 1:200
Quota di Riferimento: 325

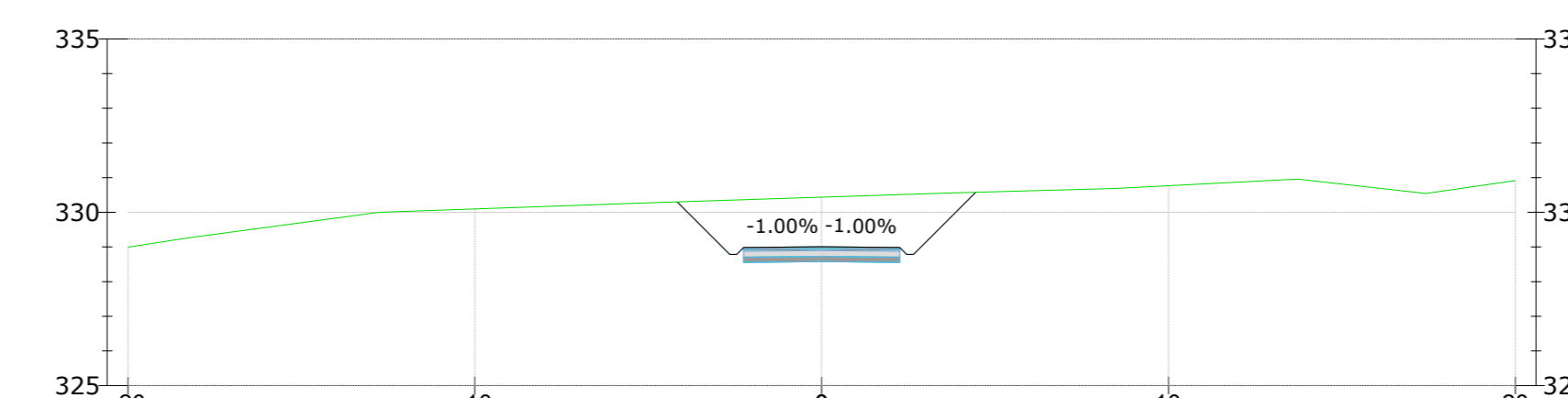

| | | | | | |
|----------------------------|--------|--------|--------|--------|--------|
| PROGRESSIVE TERRENO | 20 | 10 | 0 | 10 | 20 |
| QUOTE TERRENO | 328.89 | 329.38 | 330.00 | 330.28 | 330.60 |
| DISTANZE PARZIALI TERRENO | 7.71 | 5.54 | 7.88 | 4.90 | 5.61 |
| PROGRESSIVE PROGETTO | | | | | |
| QUOTE PROGETTO | | | 330.39 | 330.39 | 330.60 |
| DISTANZE PARZIALI PROGETTO | | | 1.27 | 2.25 | 1.59 |

TR_IMPIANTO
Sezione 63
Progressiva: 1+260
Scala: 1:200
Quota di Riferimento: 315

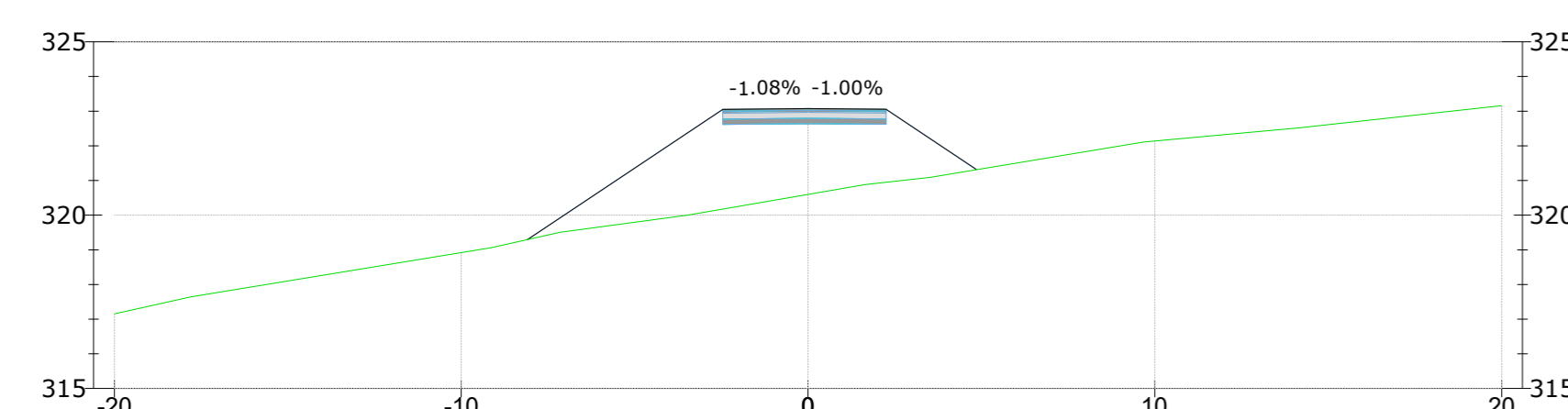

| | | | | | |
|----------------------------|--------|--------|--------|--------|--------|
| PROGRESSIVE TERRENO | 20 | 10 | 0 | 10 | 20 |
| QUOTE TERRENO | 317.25 | 317.64 | 318.06 | 319.51 | 320.00 |
| DISTANZE PARZIALI TERRENO | 5.27 | 6.69 | 1.89 | 1.68 | 4.47 |
| PROGRESSIVE PROGETTO | | | | | |
| QUOTE PROGETTO | | 318.40 | 319.05 | 319.07 | 319.68 |
| DISTANZE PARZIALI PROGETTO | | 5.63 | 2.46 | 2.25 | 2.61 |

TR_IMPIANTO
Sezione 67
Progressiva: 1+340
Scala: 1:200
Quota di Riferimento: 330

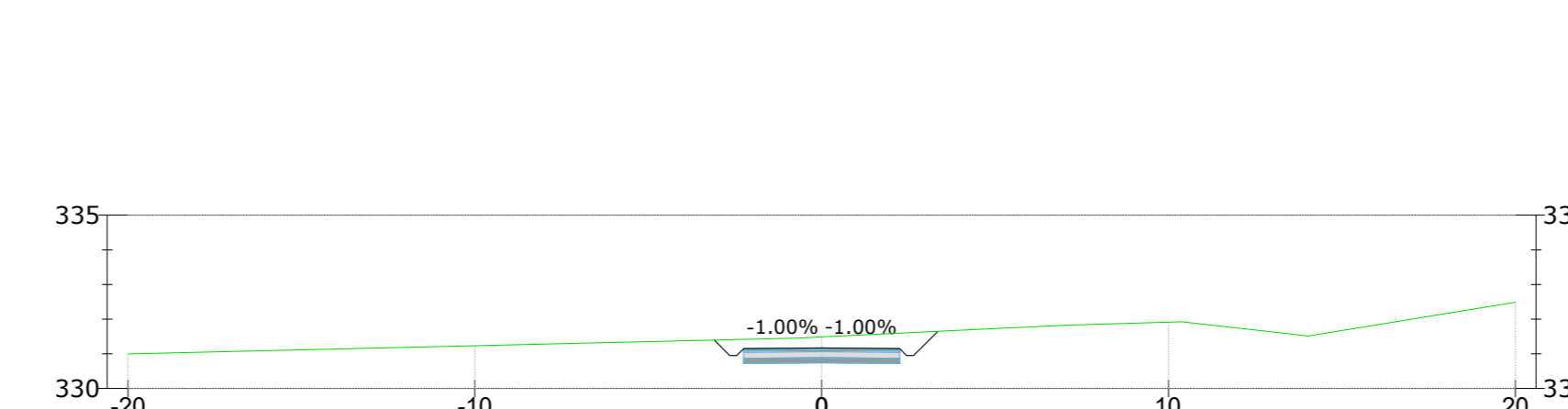

| | | | | | |
|----------------------------|--------|--------|--------|--------|--------|
| PROGRESSIVE TERRENO | 20 | 10 | 0 | 10 | 20 |
| QUOTE TERRENO | 332.00 | 332.00 | 332.00 | 332.00 | 332.00 |
| DISTANZE PARZIALI TERRENO | 9.87 | | | | |
| PROGRESSIVE PROGETTO | | | | | |
| QUOTE PROGETTO | | | 332.00 | 332.00 | 332.00 |
| DISTANZE PARZIALI PROGETTO | | | 1.00 | 1.00 | 1.00 |

TR_IMPIANTO
Sezione 64
Progressiva: 1+280
Scala: 1:200
Quota di Riferimento: 320

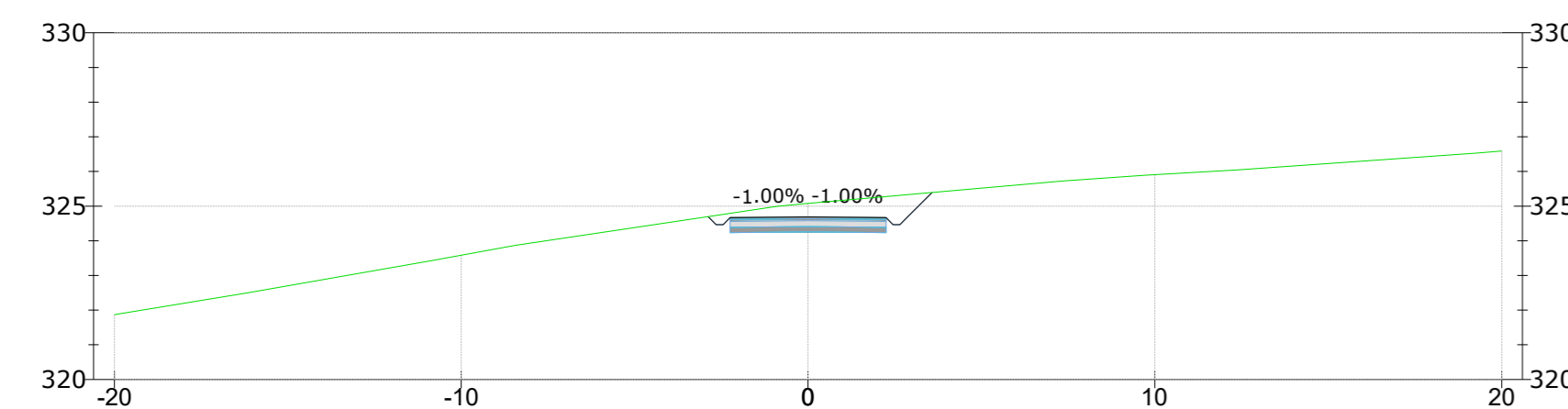

| | | | | | |
|----------------------------|--------|--------|--------|--------|--------|
| PROGRESSIVE TERRENO | 20 | 10 | 0 | 10 | 20 |
| QUOTE TERRENO | 321.87 | 322.20 | 322.67 | 323.00 | 323.51 |
| DISTANZE PARZIALI TERRENO | 6.81 | 5.29 | 2.47 | 2.58 | 6.07 |
| PROGRESSIVE PROGETTO | | | | | |
| QUOTE PROGETTO | | | 323.20 | 323.20 | 323.50 |
| DISTANZE PARZIALI PROGETTO | | | 2.25 | 2.25 | 2.65 |

TR_IMPIANTO
Sezione 68
Progressiva: 1+360
Scala: 1:200
Quota di Riferimento: 330

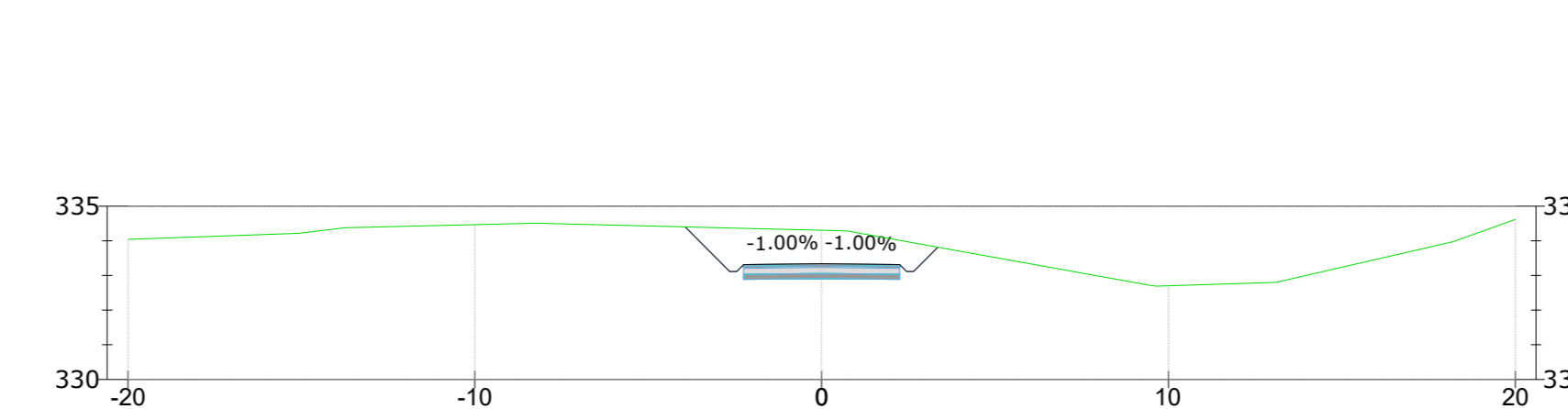

| | | | | | |
|----------------------------|--------|--------|--------|--------|--------|
| PROGRESSIVE TERRENO | 20 | 10 | 0 | 10 | 20 |
| QUOTE TERRENO | 334.04 | 334.27 | 334.38 | 334.51 | 334.60 |
| DISTANZE PARZIALI TERRENO | 6.67 | 1.37 | 1.23 | 6.74 | 1.10 |
| PROGRESSIVE PROGETTO | | | | | |
| QUOTE PROGETTO | | | 334.30 | 334.30 | 334.50 |
| DISTANZE PARZIALI PROGETTO | | | 1.00 | 1.00 | 1.00 |

TR_IMPIANTO
Sezione 65
Progressiva: 1+300
Scala: 1:200
Quota di Riferimento: 325

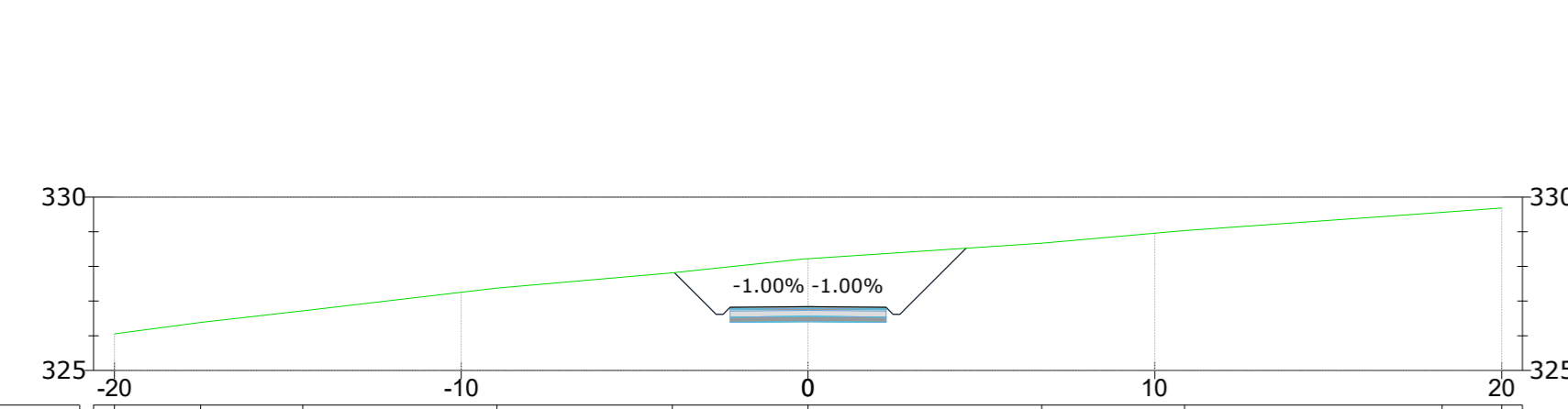

| | | | | | |
|----------------------------|--------|--------|--------|--------|--------|
| PROGRESSIVE TERRENO | 20 | 10 | 0 | 10 | 20 |
| QUOTE TERRENO | 326.26 | 326.28 | 326.72 | 327.17 | 327.81 |
| DISTANZE PARZIALI TERRENO | 2.40 | 2.98 | 5.89 | 6.08 | 1.72 |
| PROGRESSIVE PROGETTO | | | | | |
| QUOTE PROGETTO | | | 327.02 | 327.02 | 327.02 |
| DISTANZE PARZIALI PROGETTO | | | 1.75 | 2.25 | 1.77 |

TR_IMPIANTO
Sezione 69
Progressiva: 1+389
Scala: 1:200
Quota di Riferimento: 330

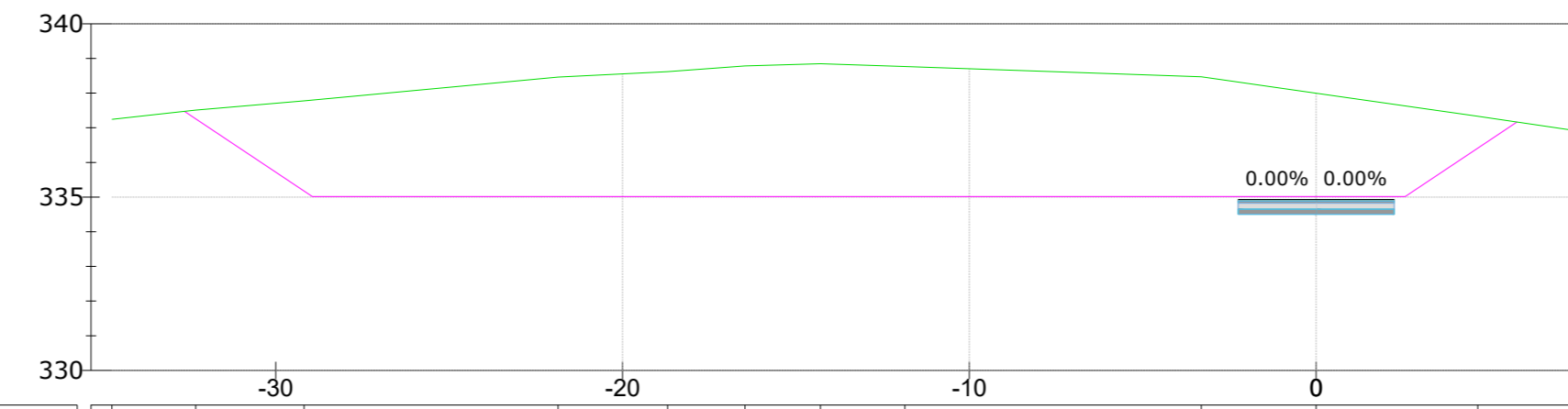

| | | | | | |
|----------------------------|--------|--------|--------|--------|--------|
| PROGRESSIVE TERRENO | 20 | 10 | 0 | 10 | 20 |
| QUOTE TERRENO | 332.24 | 332.51 | 332.78 | 333.06 | 333.27 |
| DISTANZE PARZIALI TERRENO | 2.40 | 3.02 | 2.29 | 1.19 | 1.27 |
| PROGRESSIVE PROGETTO | | | | | |
| QUOTE PROGETTO | | | 332.81 | 332.81 | 332.81 |
| DISTANZE PARZIALI PROGETTO | | | 1.00 | 1.00 | 1.00 |



Il tecnico
Ing. Leonardo Sblendido

| | | | | | |
|------|------------|-----------------|-------------|-------------|--------------|
| 00 | 22/12/2023 | PRIMA EMISSIONE | R. De Fiore | P. E. | L. Sblendido |
| REV. | DATA | DESCRIZIONE | PREPARATO | CONTROLLATO | APPROVATO |

"IMPIANTO EOLICO TERRANOVA DA SIBARI"
(COMUNI DI TERRANOVA DA SIBARI, SAN DEMETRIO CORONE, SPEZZANO ALBANESE, CORIGLIANO-ROSSANO, SANTA SOFIA D'EPSIRO E TARSIA (CS))

hergo

PROGETTO: DEFINITIVO

FORMATO: A0 | SCALA: 1:200 | SCALA PLOT: 1:1 | FOGLIO: 35 di 39

TITOLO: STUDIO PLANOALTIMETRICO

CODICE ELABORATO: C23FSTR002WD01000

