









**LEGENDA**  
FOGNATURA ACQUE BIANCHE

-  CANALETTE PREFABBRICATE AD EMBRICI POSIZIONATE OGNI 25.00m
-  CANALETTE IN TERRA A SEZ. TRAPEZOIDALE (base mag. 90cm, base min. 30cm, pendenza 1:1)
-  TUBAZIONE IN PVC Ø250 SN8 PER RACCOLTA ACQUE DI PIATTAFORMA
-  TUBAZIONE IN PVC Ø400 SN8 PER RACCOLTA ACQUE DI PIATTAFORMA
-  POZZETTO PREFABBRICATO IN CLS dim. interne 100x100cm, CON CHIUSINO IN GHISA SFEROIDALE CLASSE C250
-  POZZETTO STRADALE IN CLS dim. interne 50x50CM, CON CADITOIA IN GHISA SFEROIDALE CLASSE C250, l=25.00m
-  POZZETTO STRADALE IN CLS dim. interne 80x80CM, CON CADITOIA IN GHISA SFEROIDALE CLASSE C250, l=25.00m
-  DIREZIONE DEL FLUSSO NEI TRONCHI DELLA RETE DI DRENAGGIO
-  RUSCELLAMENTO ACQUE DI PIATTAFORMA

PARTICOLARE FOSSO DI GUARDIA  
scala 1:25

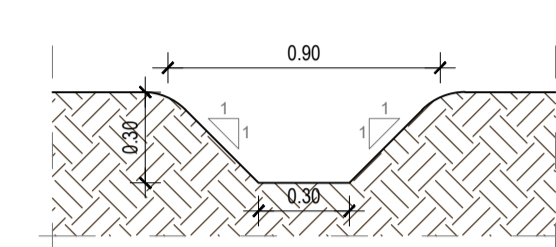

PARTICOLARE POZZETTO E CHIUSINO  
scala 1:25

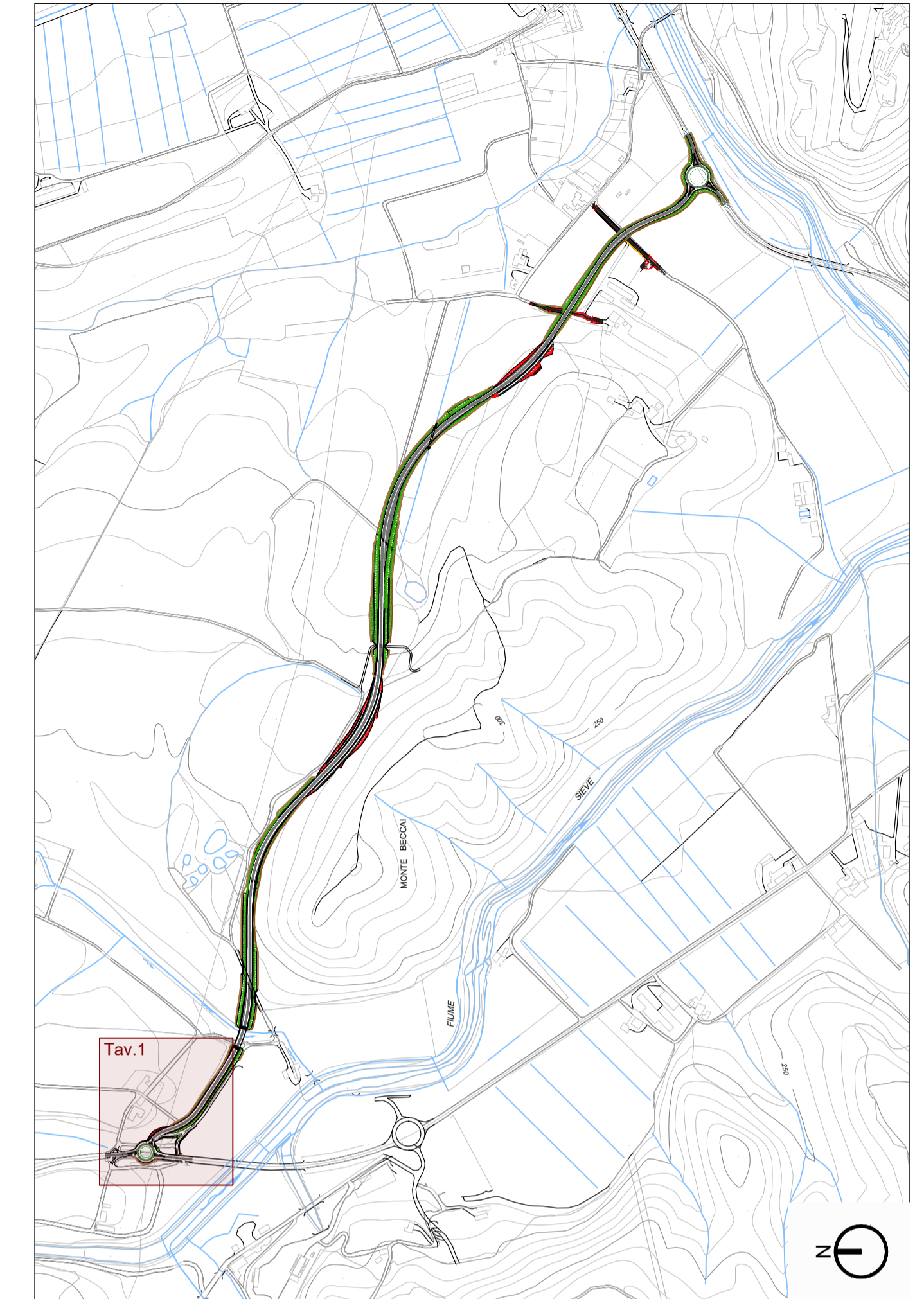
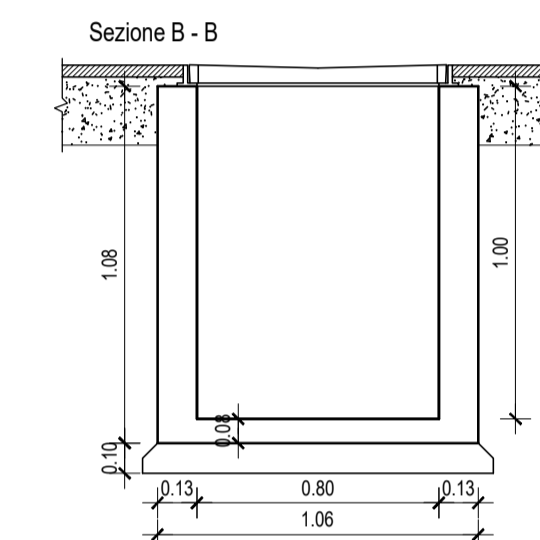
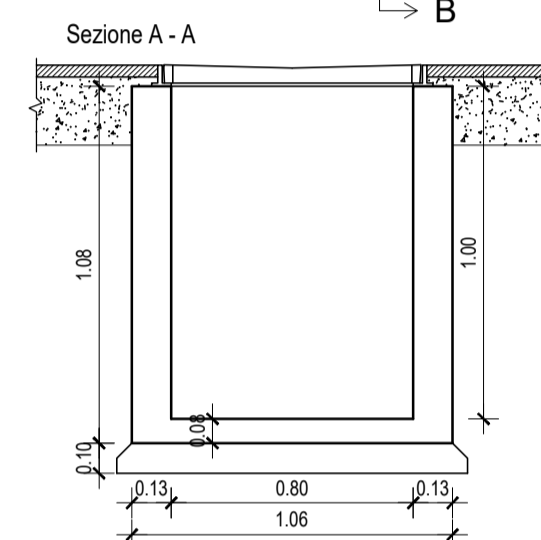
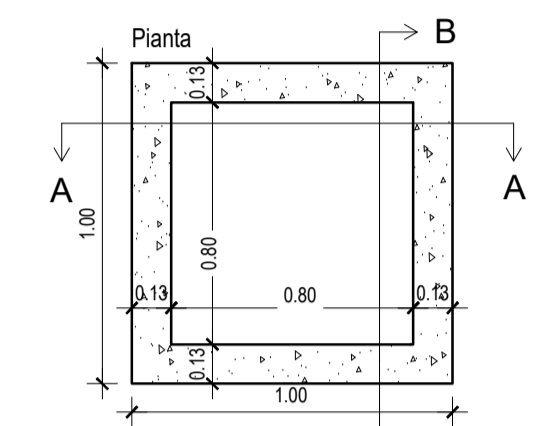

Scala 1:10.000

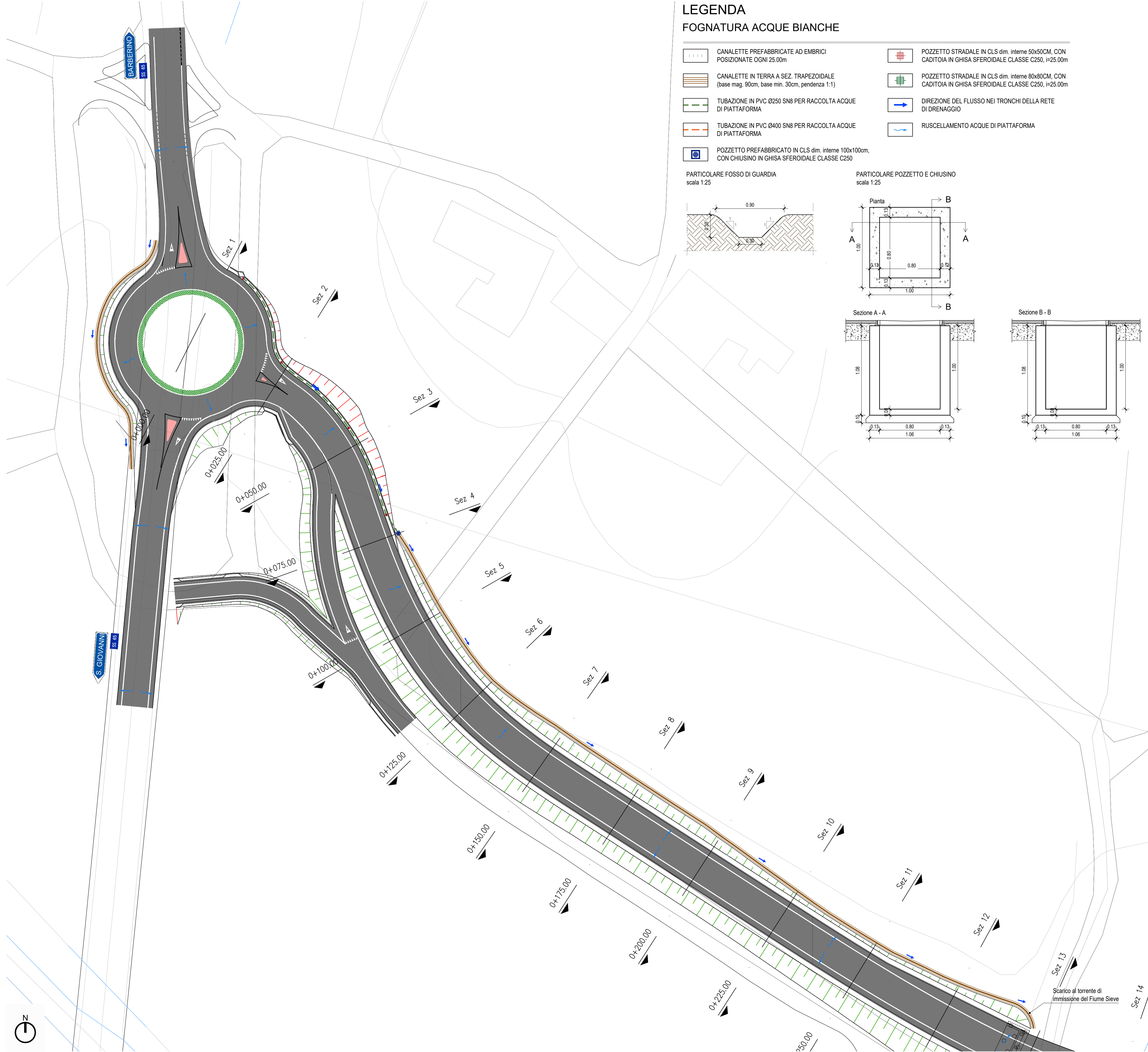

Scala 1:500

			
<b>SOGGETTO PROPONENTE</b>		<b>SOGGETTO ATTUATORE</b>	
			
Struttura Territoriale Toscana Viale dei Milia 36 - Firenze FI Stefano Liani, Ingegnere		Viale Nazionale 8 - Barberino di Mugello FI Alfredo Mauricio Lowenstein, Legale Rappresentante	
<b>Lavori per la realizzazione della Variante alla S.S. 65 della Futa da parte di soggetto privato ai sensi dell'art. 20 D.lgs 50/2016</b>			
<b>Valorizzazione della villa medicea di Cafaggiolo</b>			
<b>PROGETTO DI FATTIBILITA' TECNICO ECONOMICO/DEFINITIVO</b>			
<b>VERIFICA DI ASSOGGETTABILITA' A V.I.A.</b>			
Arch. Fabrizio Romozzi - Project Manager Attività tecnico amministrativa e di coordinamento			
<p><b>Cafaggiolo Srl</b> Via Nazionale 16 50031 Barberino di Mugello (FI) P.IVA 01998740979 info@castellodicafaggiolo.com castellodicafaggiolo@legalmail.it www.castellodicafaggiolo.com</p> <p><b>Advisor</b>  Dott. ssa Antonella Scotese</p> <p><b>Attività di assistenza e consulenza legale</b>  Avv. Giuseppe Giuffrè</p>	<p> Via Campo di Marte 8/A - 06124 Perugia (PG) tel/fax 075 830563 - 8309014 info@abacusprogetti.it www.abacusprogetti.it</p> <p><b>PROGETTISTA RESPONSABILE</b> Ing. Maurizio Serafini</p> <p>Ing. Arch. Chiara Pimpinelli Ing. Adrian Martin Torres Ing. Roberto Pedicini Ing. Sara Berretta Geom. Stefania Pifferi</p>	<p> Viale G. Savonarola 15 - 54033 Carrara (MS) tel. 0585 87687 info@tecnocreo.it www.tecnocreo.it</p> <p><b>DIRETTORE TECNICO</b> Ing. Matteo Bertoneri</p>	<p>PROTOCOLLO DATA</p>

**OPERE DI URBANIZZAZIONE**  
Planimetria di sistemazione idraulica e particolari - Tav. 1/9

NOME FILE		05D_UR0101_A		REVISIONE	SCALA
CODICE ELAB	05DUR0101			A	1:500
D					
C					
B					
A	Consegna progetto definitivo	Ottobre 2022	E. Gradassi	M. Serafini	M. Serafini
REV.	DESCRIZIONE	DATA	REDATTO	VERIFICATO	APPROVATO