

SEZIONI TRASVERSALI CON INDICAZIONE DEI LIVELLI DI PIENA

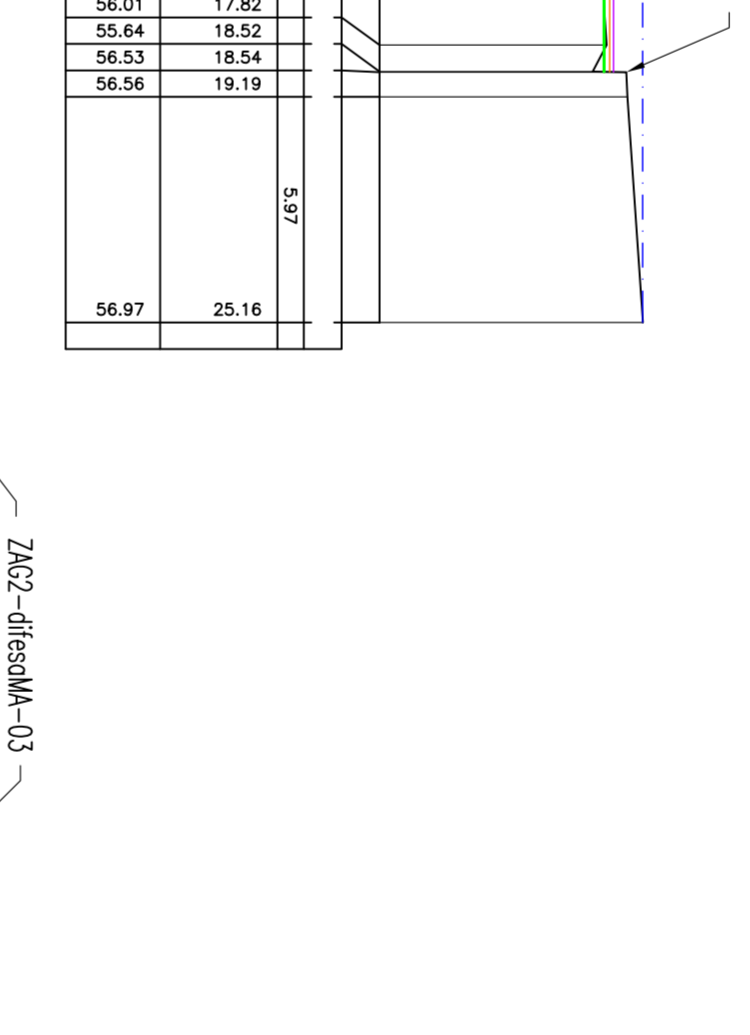

PROFILI DI RIGURITO PER TR 200 ANNI

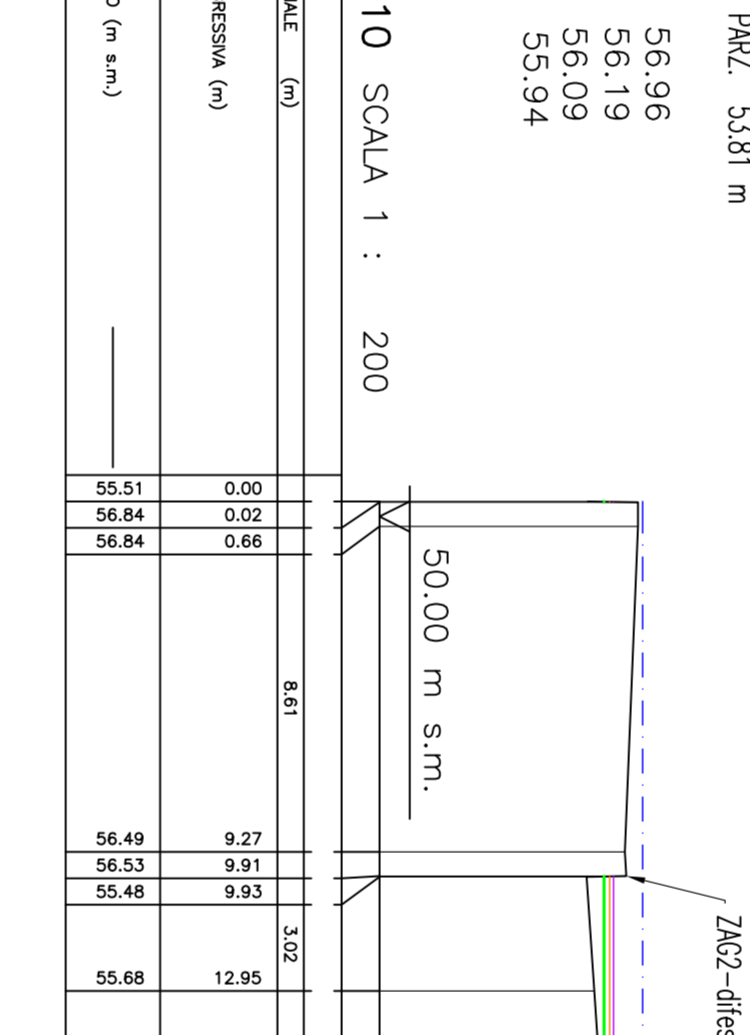
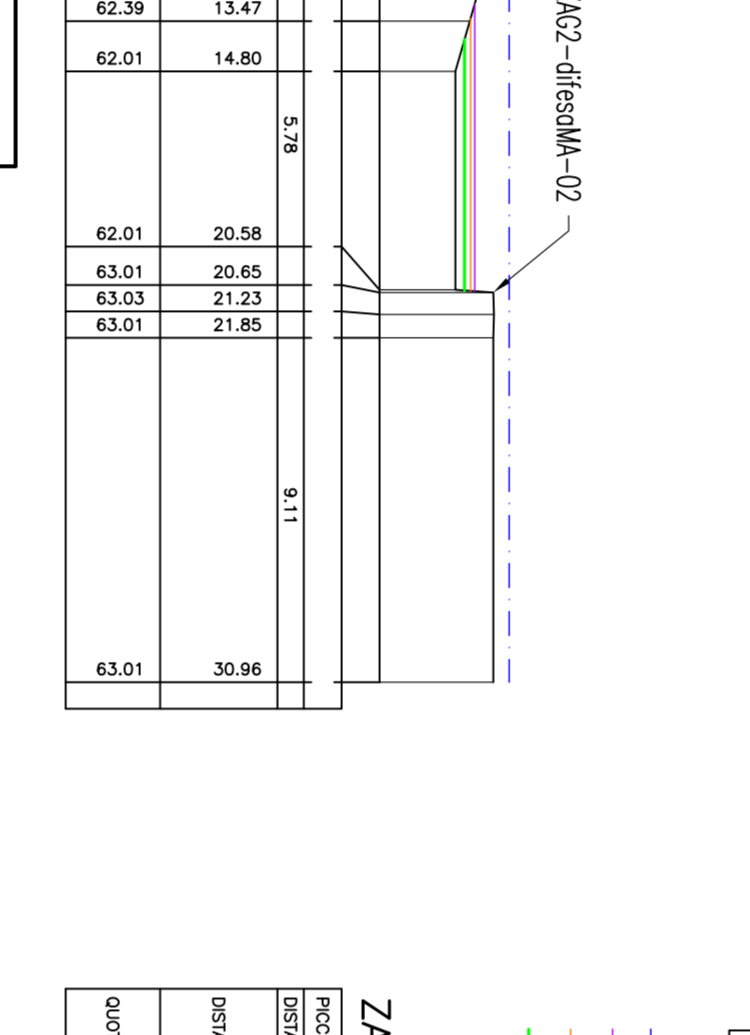
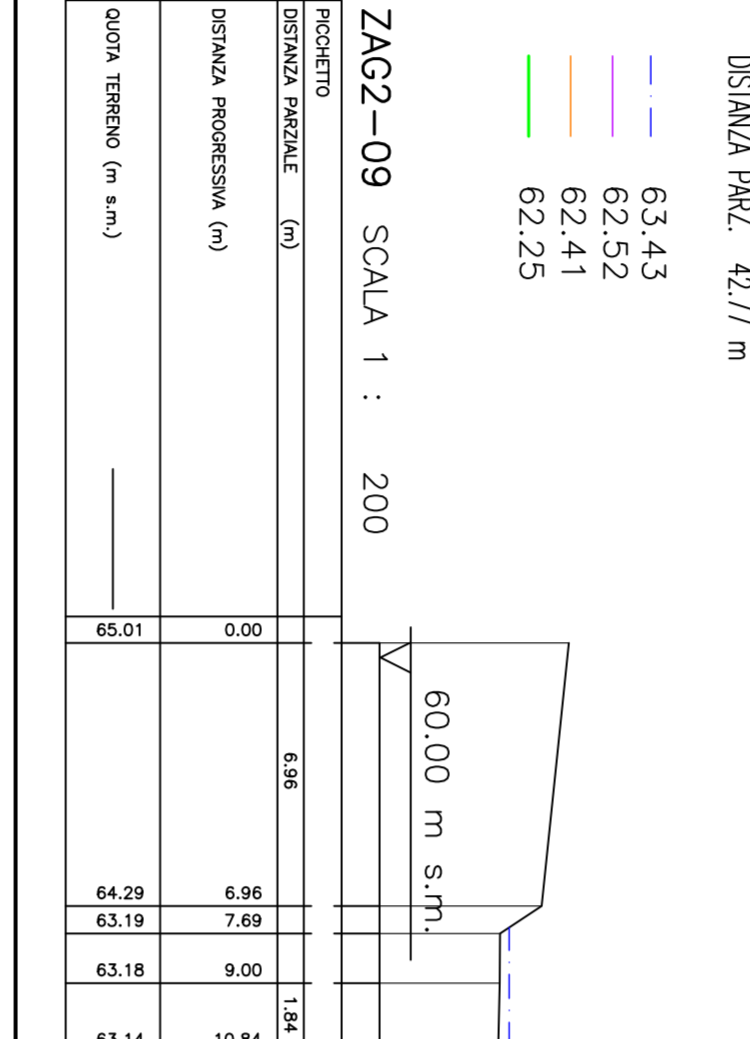
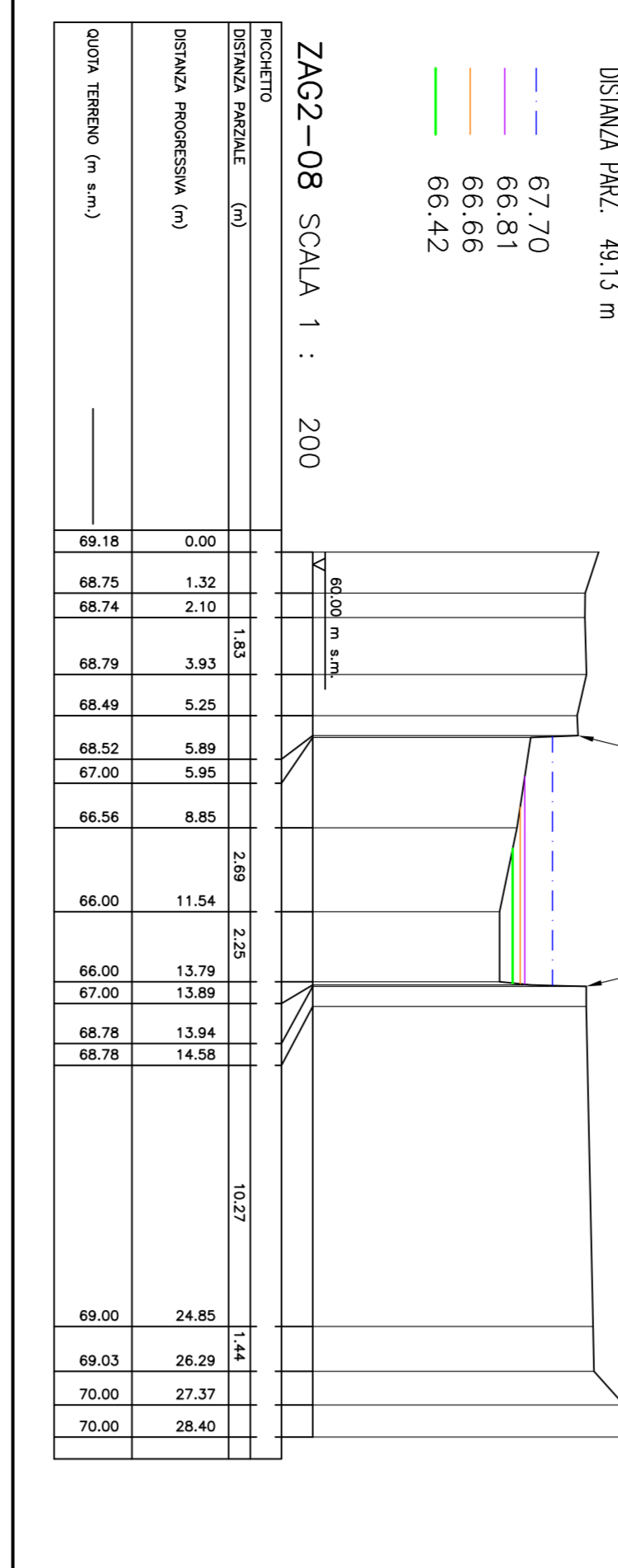
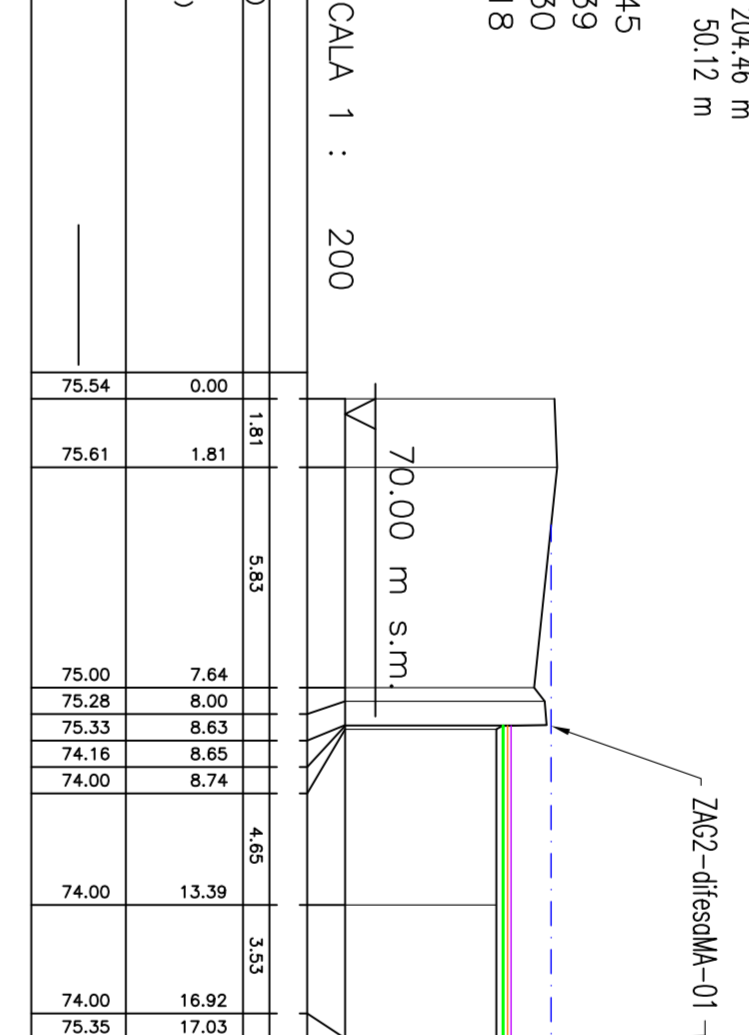
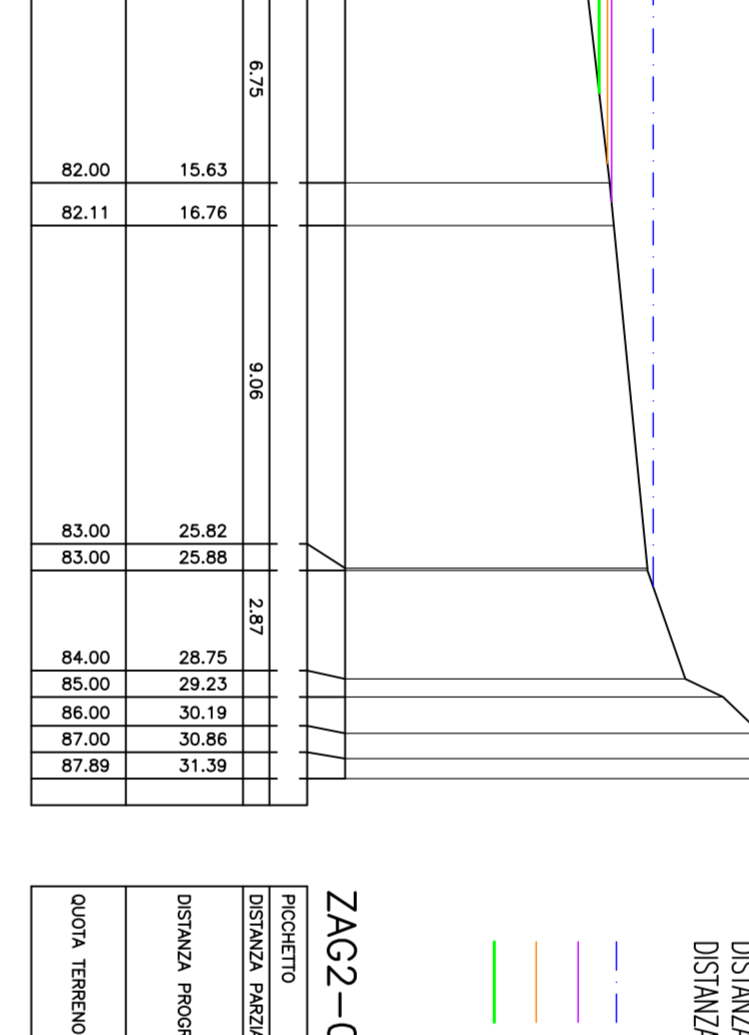
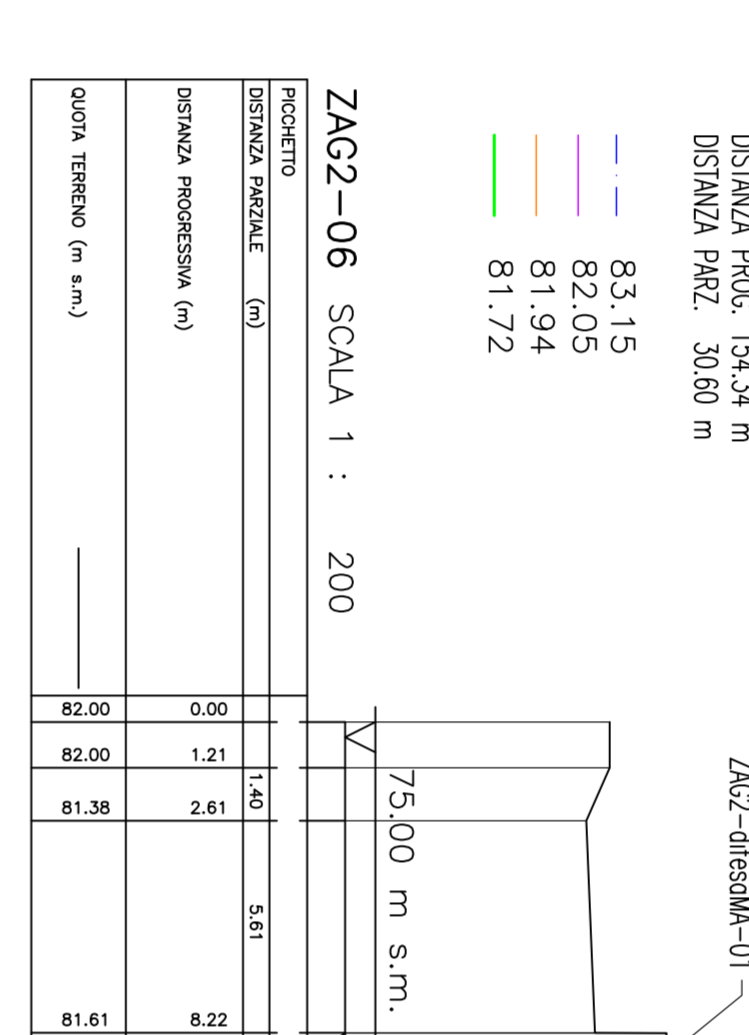
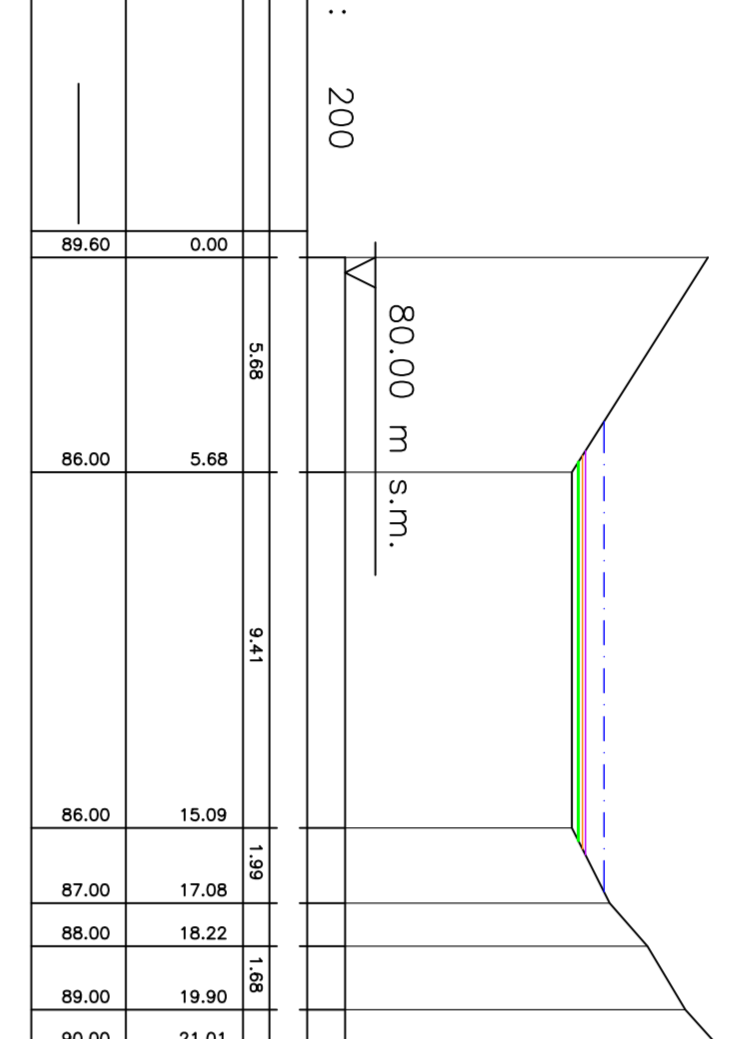
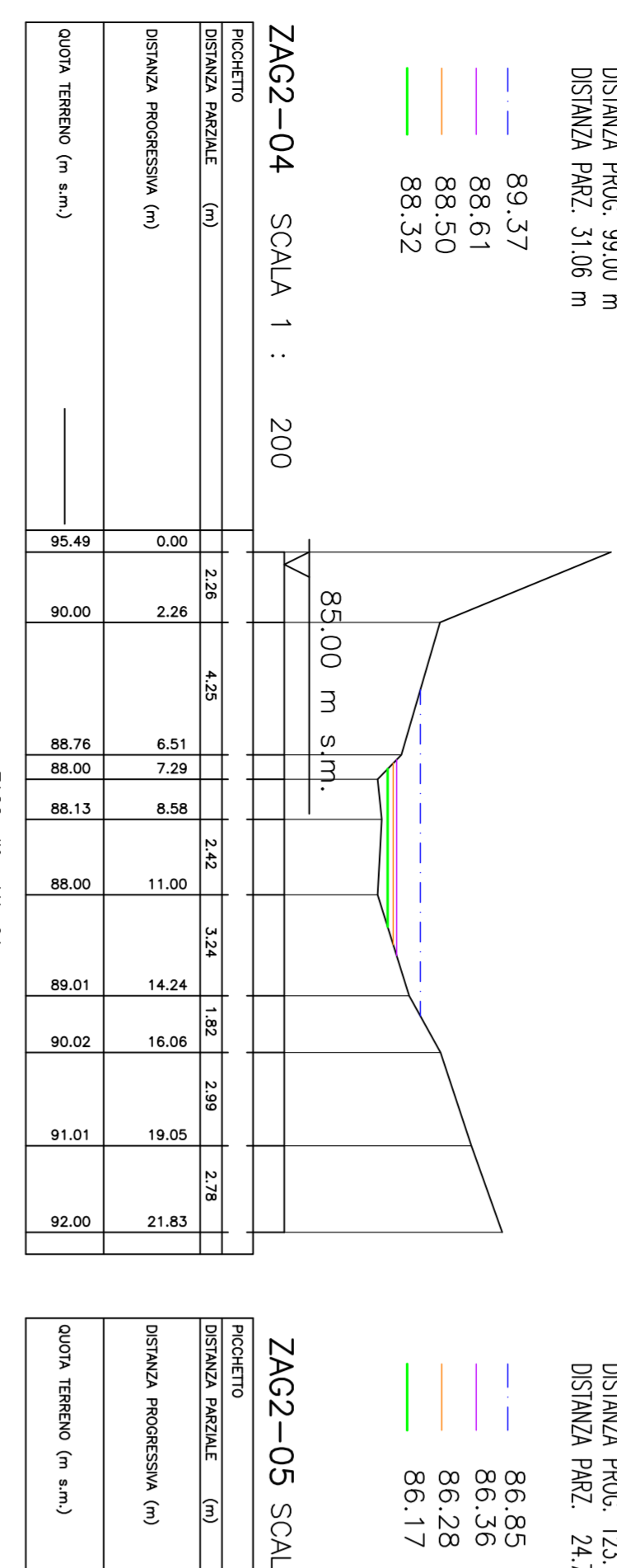
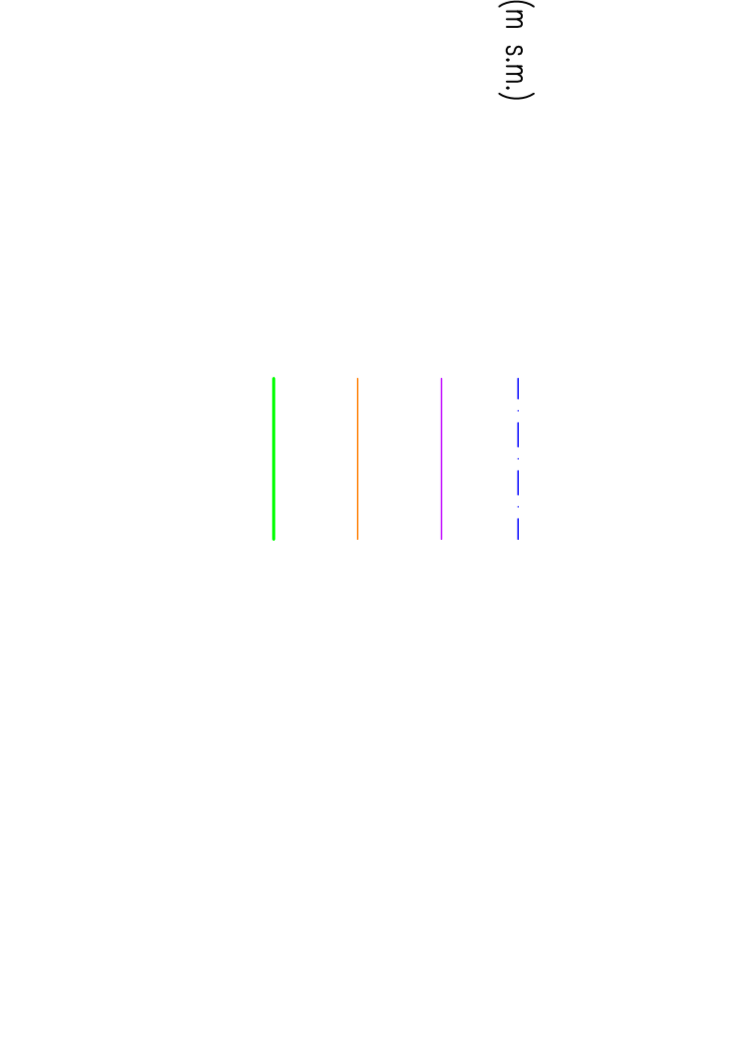
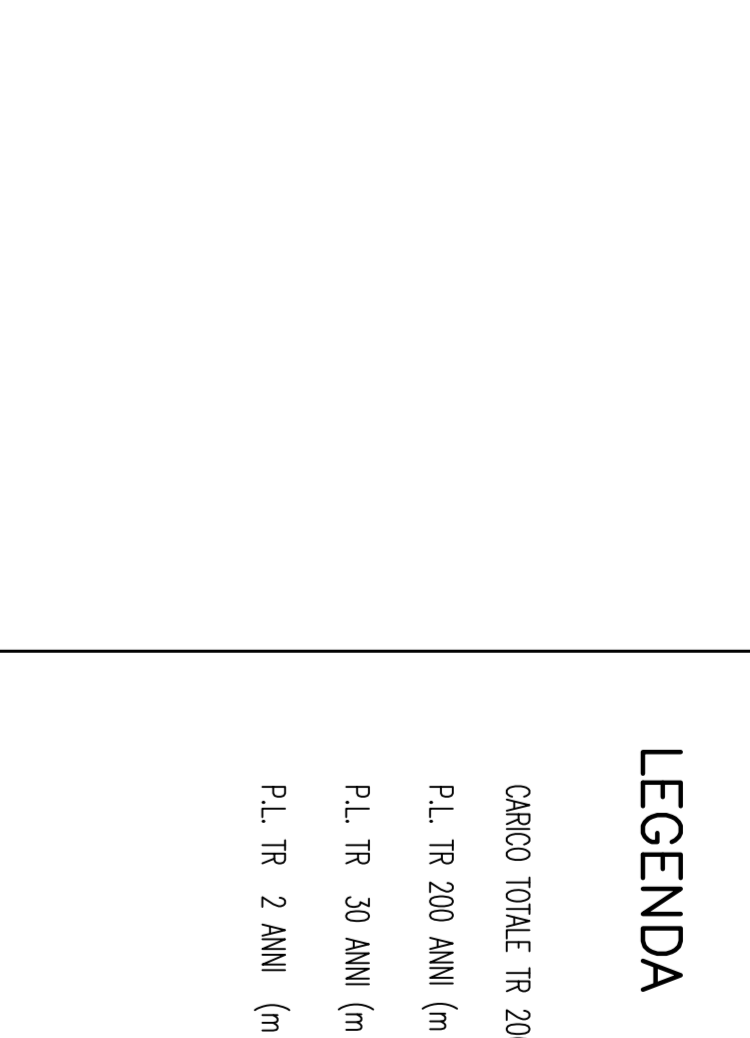
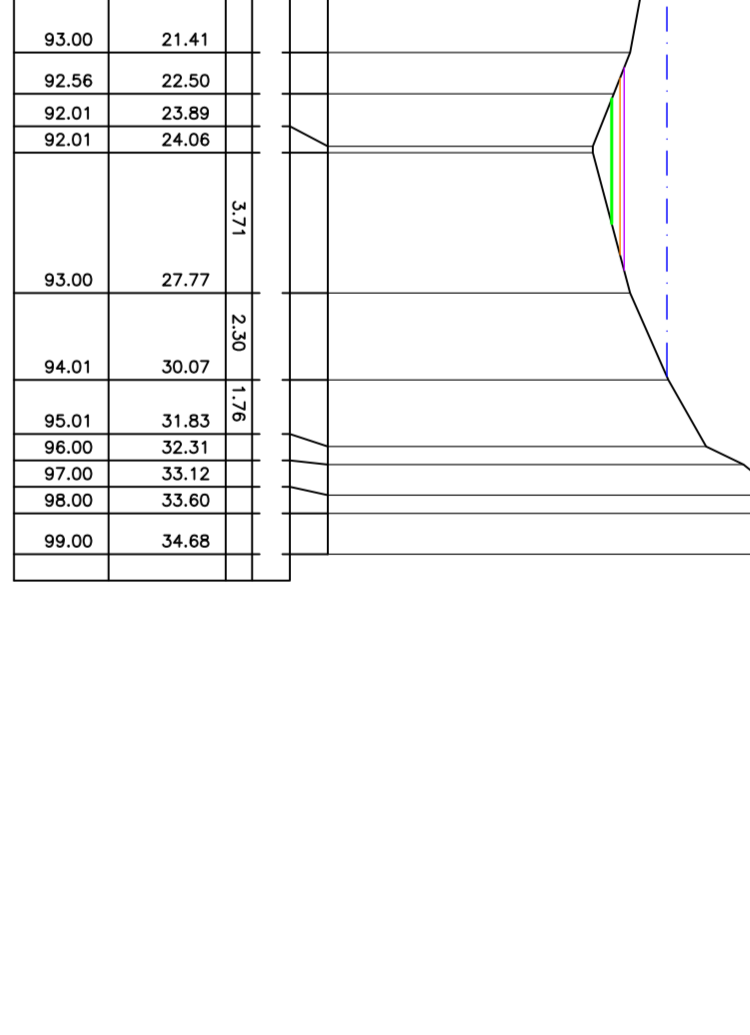
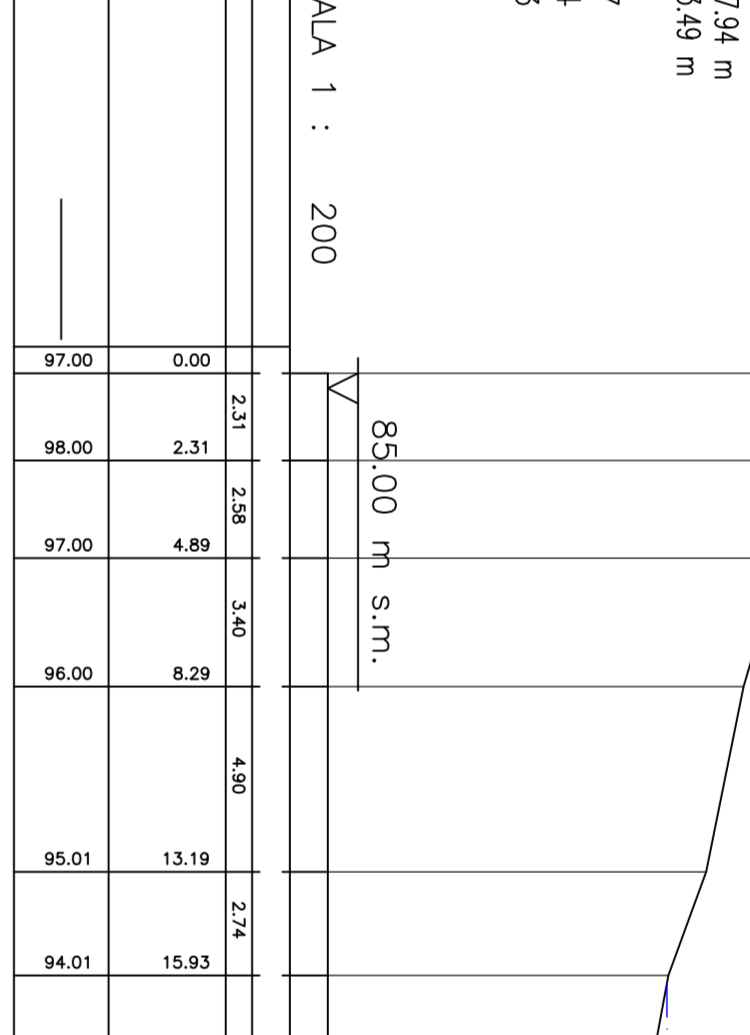
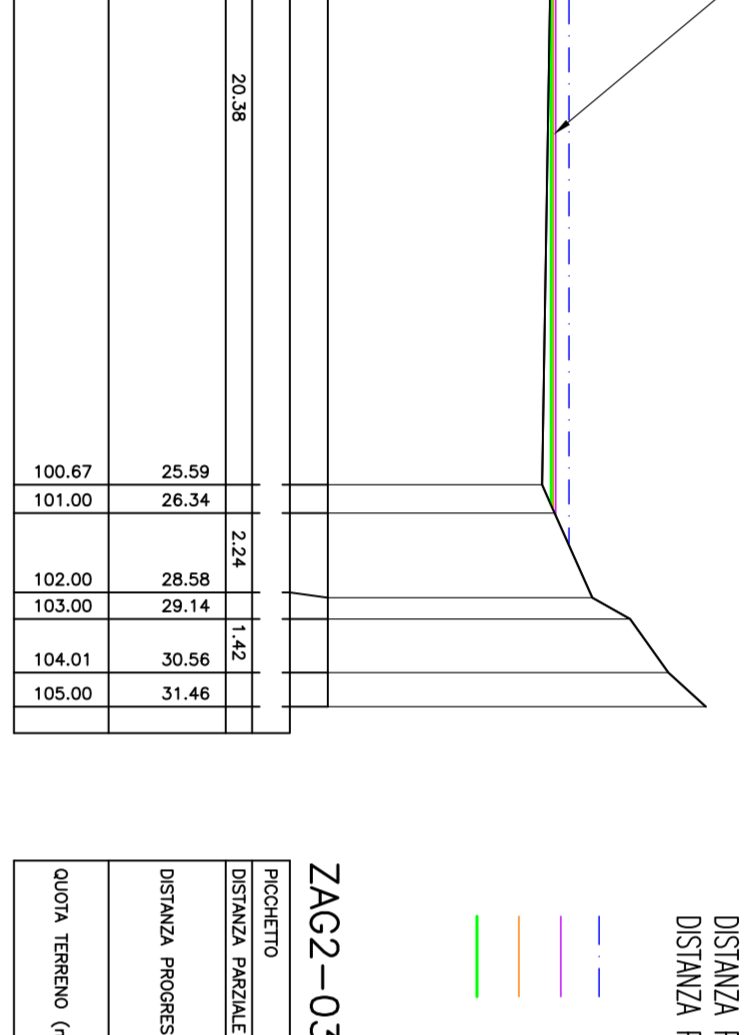
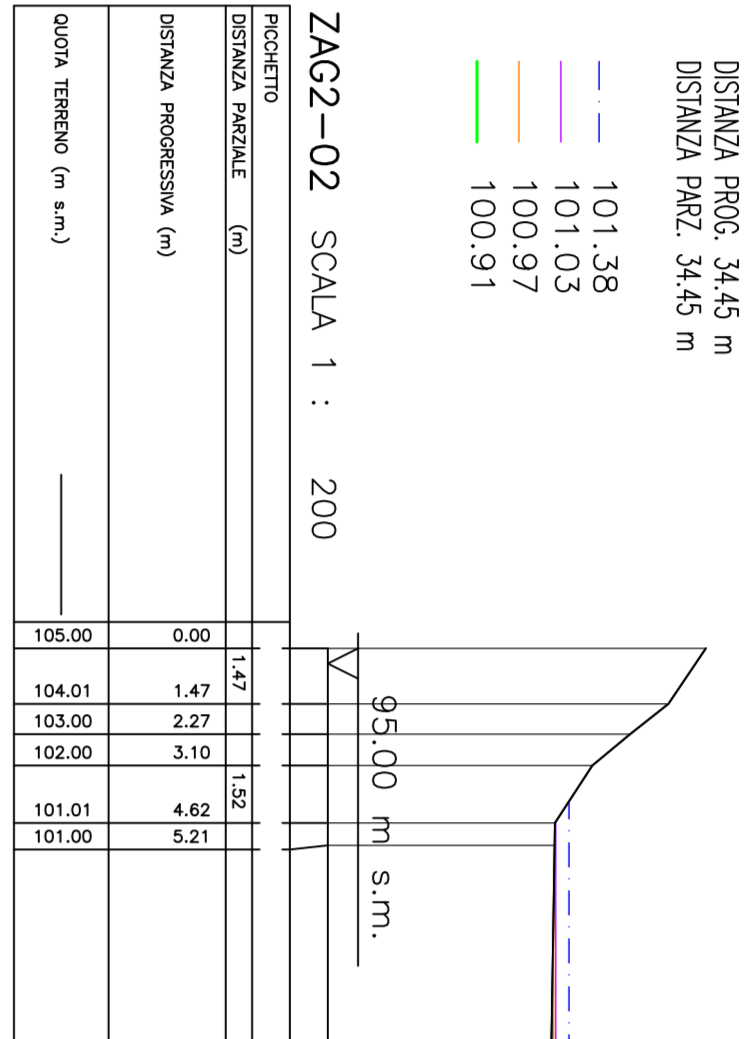
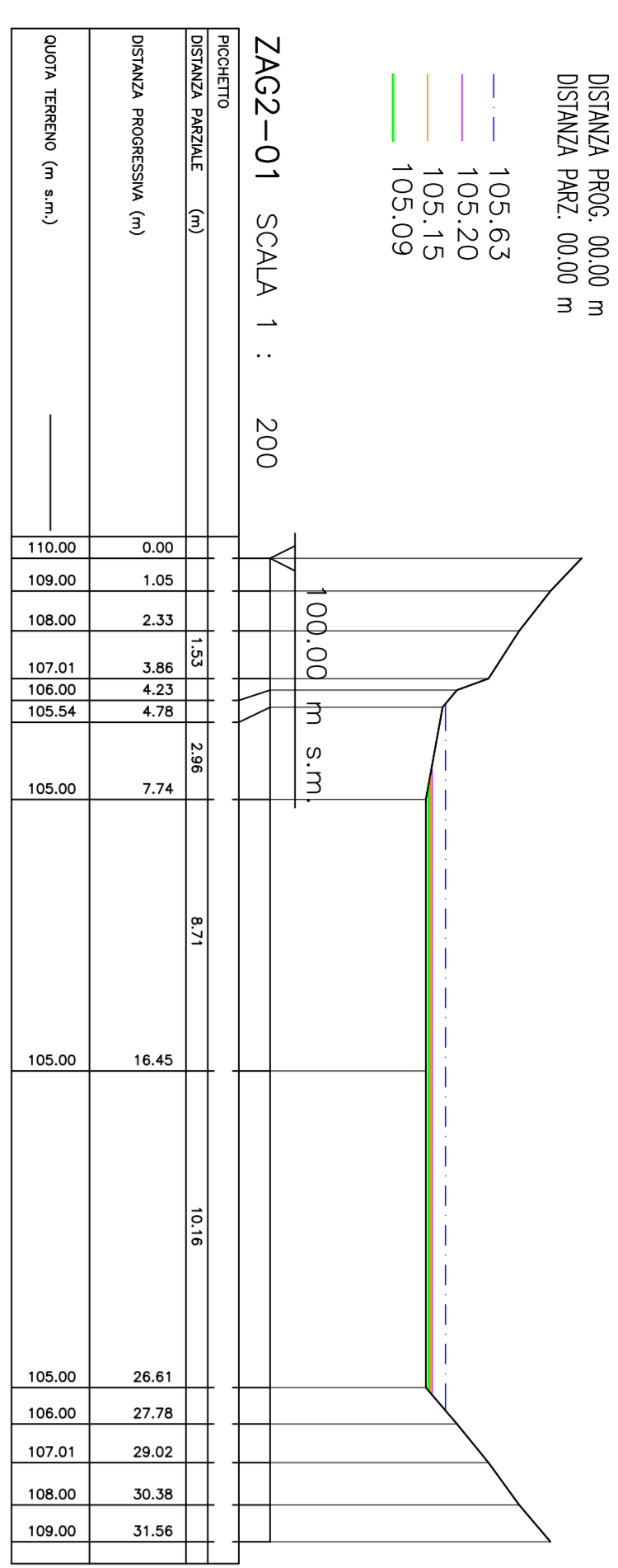
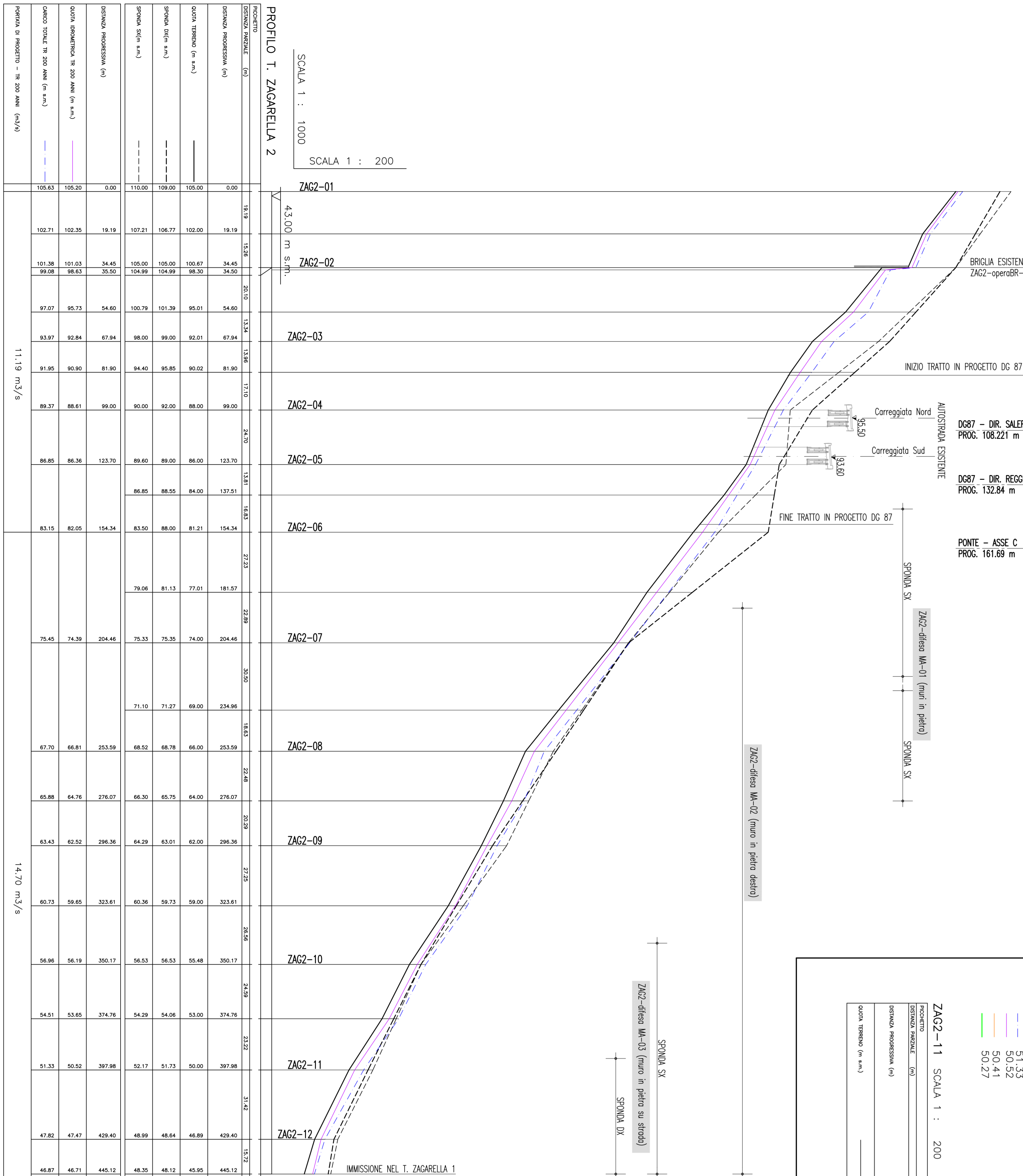

Table with 4 columns: DISTANZA PNEZ (m), DISTANZA PNEZ (m), DISTANZA PNEZ (m), DISTANZA PNEZ (m). Rows correspond to sections ZAG2-01 through ZAG2-18. Includes a legend for 'PROFILO T. ZAGARELLA 2' and 'PROFILO T. ZAGARELLA 1'.

NOTE GENERALI

- LEGENDA
CARGO TOTALE TR 200 ANNI (m s.m.)
P.L. TR 200 ANNI (m s.m.)
P.L. TR 50 ANNI (m s.m.)
P.L. TR 2 ANNI (m s.m.)

Stretto di Messina
EUROINK S.C.A.
PROGETTO DEFINITIVO

EUROINK S.C.A.
SOCIETA' ITALIANA PER CONDOTTE ENCOGOLA S.p.A. (Mauritano)
CORPORATIVA MANUTENZIONE E OPERAZIONI (Mauritano)
SHERKAWALIA - HEAVY HEAVY INDUSTRIES CO. LTD. (Mauritano)
A.C.I. S.C.P.A. - CONSORCIO STABILE (Mauritano)

COLLEGAMENTI CALABRIA
STUDI DI BASE
SISTEMAZIONI IDRAULICHE
GENERALE
CBOB040_F0