

PONTE SULLO STRETTO DI MESSINA



PROGETTO DEFINITIVO

EUROLINK S.C.p.A.

IMPREGILO S.p.A. (MANDATARIA)
 SOCIETÀ ITALIANA PER CONDOTTE D'ACQUA S.p.A. (MANDANTE)
 COOPERATIVA MURATORI E CEMENTISTI - C.M.C. DI RAVENNA SOC. COOP. A.R.L. (MANDANTE)
 SACYR S.A.U. (MANDANTE)
 ISHIKAWAJIMA - HARIMA HEAVY INDUSTRIES CO. LTD (MANDANTE)
 A.C.I. S.C.P.A. - CONSORZIO STABILE (MANDANTE)

| | | | |
|---|--|---|--|
| <p>IL PROGETTISTA Dott. Ing. E. Pagani Ordine Ingegneri Milano n° 15408</p>  | <p>IL CONTRAENTE GENERALE Project Manager (Ing. P.P. Marcheselli)</p> | <p>STRETTO DI MESSINA Direttore Generale e RUP Validazione (Ing. G. Fiammenghi)</p> | <p>STRETTO DI MESSINA Amministratore Delegato (Dott. P. Ciucci)</p> |
|---|--|---|--|

| | |
|--|--|
| <p><i>Unità Funzionale</i> OPERA DI ATTRAVERSAMENTO <i>Tipo di sistema</i> CANTIERI <i>Raggruppamento di opere/attività</i> ITINERARI <i>Opera - tratto d'opera - parte d'opera</i> NUOVI ITINERARI – NI.83. <i>Titolo del documento</i> P-CN1 – QUADERNO DELLE SEZIONI PSN1.A</p> | <div style="border: 1px solid black; padding: 5px; display: inline-block;">CZ0469_F0</div> |
|--|--|

| | | | | | | | | | | | | | |
|--------|-------------|---|-----|---|---|-----|-----|-----|-----|-----|-----|-----|----|
| CODICE | C G 0 0 0 0 | P | W A | D | P | C Z | C 2 | N I | 8 3 | 0 0 | 0 0 | 0 1 | F0 |
|--------|-------------|---|-----|---|---|-----|-----|-----|-----|-----|-----|-----|----|

| REV | DATA | DESCRIZIONE | REDATTO | VERIFICATO | APPROVATO |
|-----|------------|------------------|----------|------------|-----------|
| F0 | 20/06/2011 | EMISSIONE FINALE | PUGLIESE | FARINA | PAGANI |
| | | | | | |
| | | | | | |

PROFILO P-SN1A

SEZIONE 1.PSN1A

PROGRESSIVA 0.00

| | |
|------------|-----------|
| Rilevato | |
| B1 | 0.25 mq. |
| B2 | 2.40 mq. |
| Totale: | 2.65 mq. |
| Sterro | |
| C1 | 0.09 mq. |
| Vegetale | |
| D1 | 0.72 mq. |
| D2 | 0.44 mq. |
| Totale: | 1.16 mq. |
| Fondazione | |
| E1 | 4.80 mq. |
| Usura | |
| a1 | 12.00 ml. |

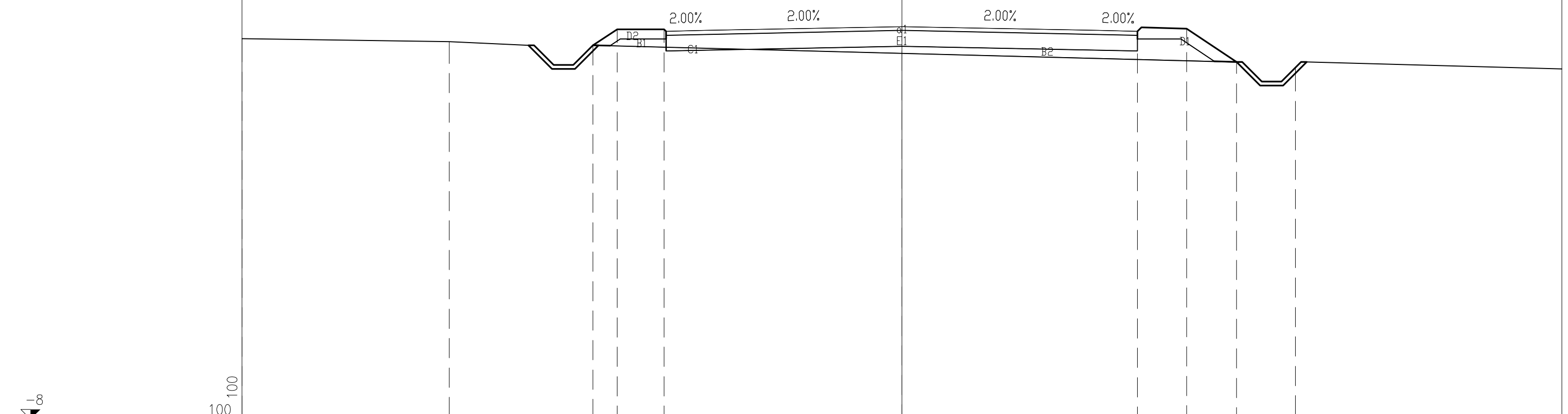

| | | | | | | | | | | |
|----------------------|-------|-------|------|-------|------|------|------|------|------|-------|
| PROGRESSIVE TERRENO | 16.80 | 11.52 | | | | | | | | 10.02 |
| PARZIALI TERRENO | 5.28 | | | 21.54 | | | | | | 6.78 |
| QUOTE TERRENO | 1.69 | 1.62 | | | | | | | | 1.06 |
| PROGRESSIVE PROGETTO | | | 7.86 | 7.25 | 6.05 | 0.00 | | 6.00 | 7.25 | 8.52 |
| PARZIALI PROGETTO | | | 0.61 | 1.20 | 6.05 | | 6.00 | 1.25 | 1.27 | |
| QUOTE PROGETTO | | | 1.52 | 1.93 | 1.93 | 2.00 | | 1.88 | 1.95 | 1.10 |

PROFILO P-SN1A

SEZIONE 2.PSN1A

PROGRESSIVA 20.00

Rilevato
 B1 0.72 mq.
 Sterro
 C1 1.19 mq.
 Vegetale
 D1 0.63 mq.
 D2 0.32 mq.
 Totale: 0.95 mq.
 Fondazione
 E1 4.80 mq.
 Usura
 a1 12.00 ml.

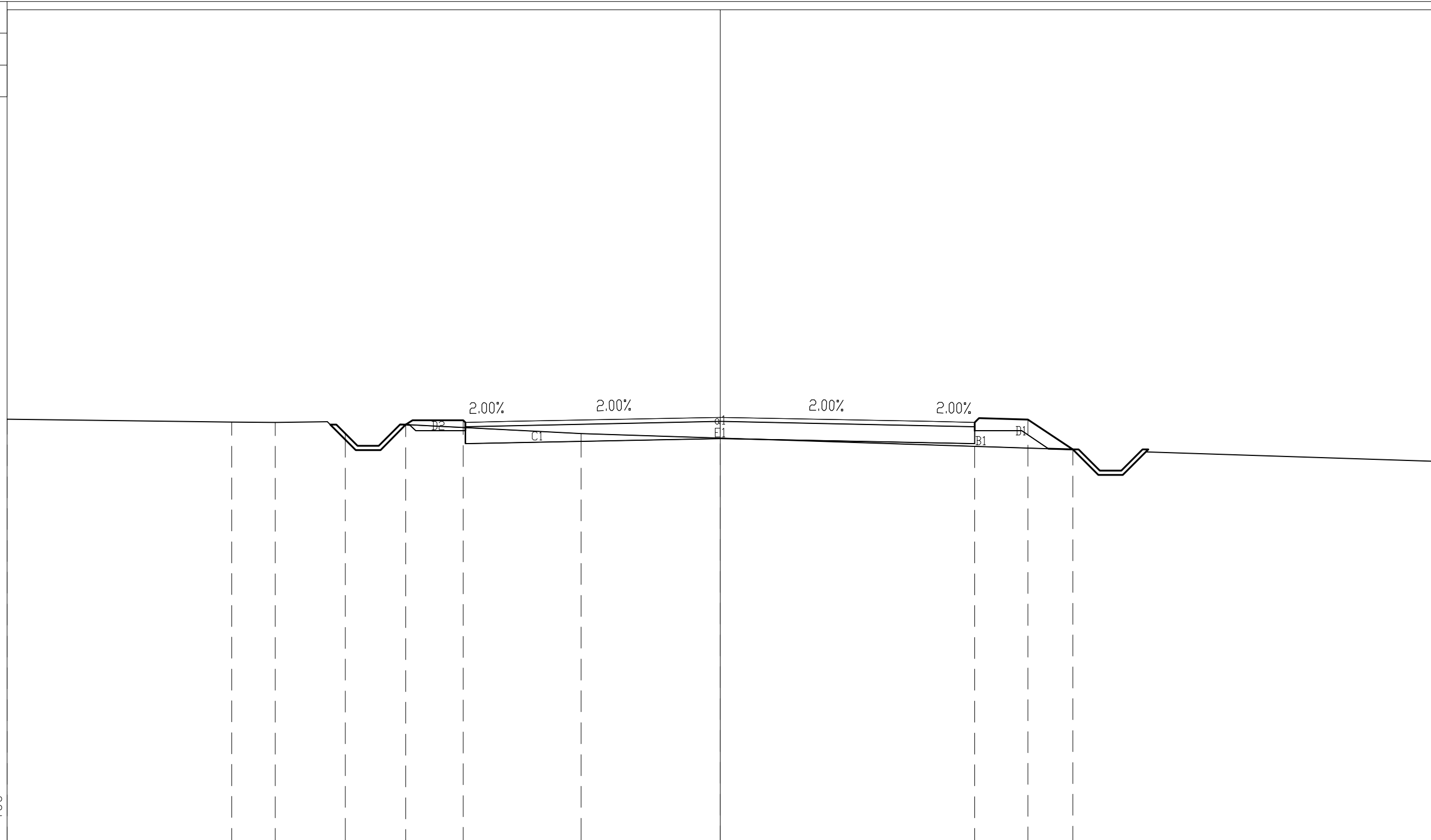

| | | | | | | | | | | | | | |
|----------------------|-------|-------|-------|------|------|------|------|------|-------|------|------|------|--|
| PROGRESSIVE TERRENO | 16.80 | 11.51 | 10.48 | 8.83 | | 3.27 | | | | | | | |
| PARZIALI TERRENO | 5.29 | 1.03 | 1.65 | | 5.56 | | | | 20.07 | | | | |
| QUOTE TERRENO | 1.95 | 1.89 | 1.88 | 1.90 | | 1.61 | | | | | | | |
| PROGRESSIVE PROGETTO | | | | | 7.40 | 6.05 | | 0.00 | | 6.00 | 7.25 | 8.31 | |
| PARZIALI PROGETTO | | | | | 1.35 | | 6.05 | | 6.00 | | 1.25 | 1.06 | |
| QUOTE PROGETTO | | | | | 1.83 | 1.93 | | 2.00 | | 1.88 | 1.95 | 1.24 | |

PROFILO P-SN1A

SEZIONE 4.PSN1A

PROGRESSIVA 60.00

Sterro C1 10.22 mq.
 Vegetale D1 0.39 mq.
 Fondazione E1 4.80 mq.
 Usura a1 12.00 ml.

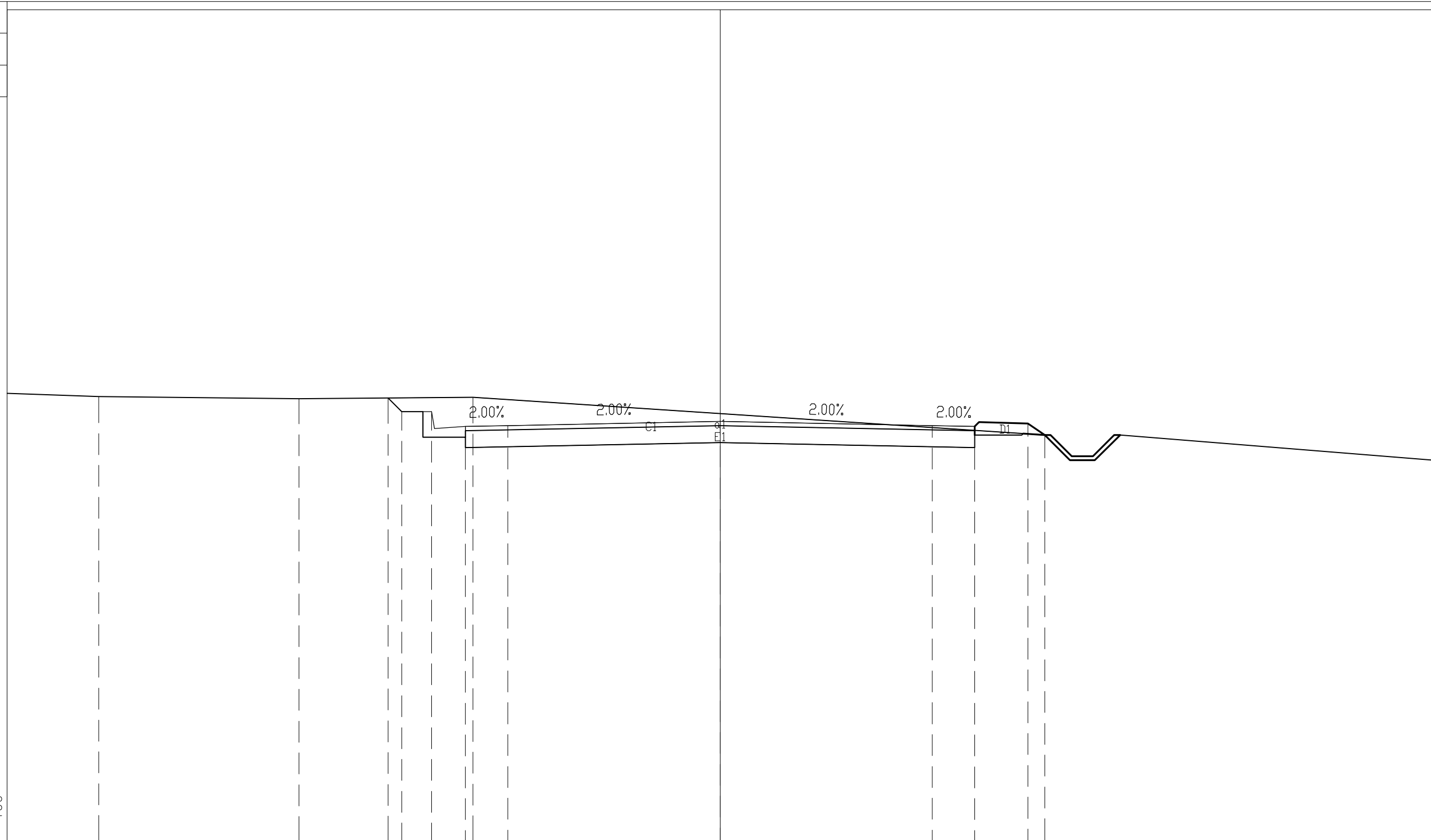

| | | | | | | | | | | | | | | | | |
|----------------------|------|-------|------|------|------|------|------|------|------|------|------|------|-------|------|------|------|
| PROGRESSIVE TERRENO | | 14.64 | 9.92 | 5.83 | | | | | | | | | | | | |
| PARZIALI TERRENO | 5.36 | | 4.72 | | 4.09 | | | | | | | | 24.93 | | | |
| QUOTE TERRENO | | 2.49 | | 2.43 | | 2.47 | | | | | | | | | | |
| PROGRESSIVE PROGETTO | | | | | 7.82 | 7.50 | 6.80 | 6.00 | 5.00 | | 0.00 | | 5.00 | 6.00 | 7.25 | 7.64 |
| PARZIALI PROGETTO | | | | | 0.32 | 0.70 | 0.80 | 1.00 | | 5.00 | | 5.00 | | 1.00 | 1.25 | |
| QUOTE PROGETTO | | | | | 2.45 | 2.13 | 2.13 | 1.78 | 1.80 | | 1.90 | | 1.80 | 1.78 | 1.85 | 1.59 |

PROFILO P-SN1A

SEZIONE 6.PSN1A

PROGRESSIVA 100.00

Rilevato
 B1 4.81 mq.
 Vegetale
 D1 0.74 mq.
 D2 0.56 mq.
 Totale:
 Fondazione 1.30 mq.
 E1 4.80 mq.
 Usura
 a1 12.00 ml.

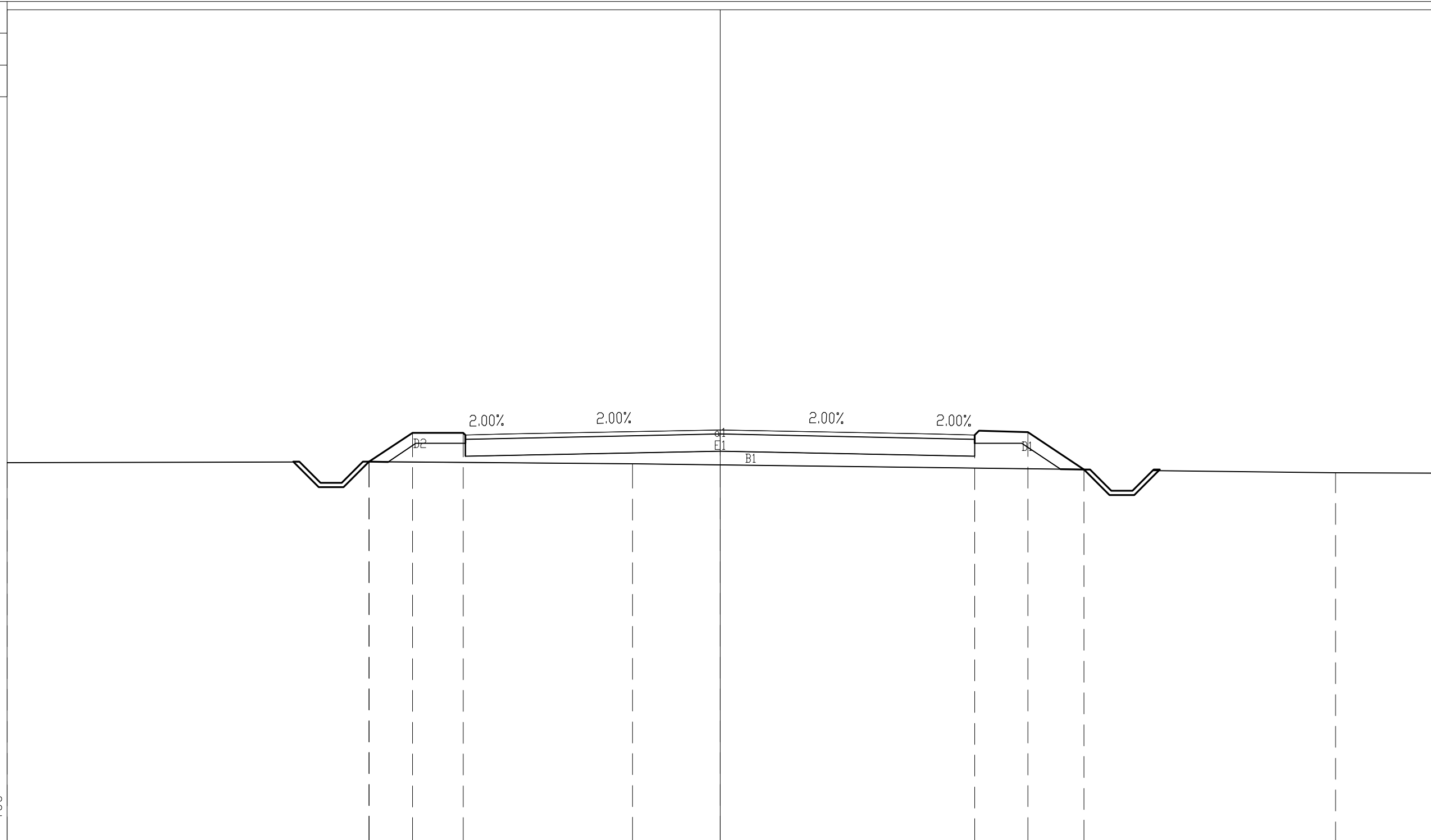

-8

100
100

| | | | | | | | | | |
|----------------------|--------|------|------|------|-------|------|------|------|-------|
| PROGRESSIVE TERRENO | -16.80 | 8.27 | 6.05 | 2.06 | 0.00 | 6.00 | 7.25 | 8.57 | 14.50 |
| PARZIALI TERRENO | 8.53 | 6.21 | | | 16.56 | | | 2.30 | |
| QUOTE TERRENO | 0.93 | 0.95 | 1.20 | 0.90 | | | | 0.69 | |
| PROGRESSIVE PROGETTO | | 8.27 | 7.25 | 6.05 | 0.00 | 6.00 | 7.25 | 8.57 | |
| PARZIALI PROGETTO | | 1.02 | 1.20 | 6.05 | 6.00 | 1.25 | 1.32 | | |
| QUOTE PROGETTO | | 0.95 | 1.63 | 1.63 | 1.70 | 1.58 | 1.65 | 0.77 | |

PROFILO P-SN1A

SEZIONE 7.PSN1A

PROGRESSIVA 120.00

Rilevato
 B1 5.54 mq.
 Vegetale
 D1 0.71 mq.
 D2 0.60 mq.
 Totale:
 Fondazione 1.31 mq.
 E1 4.80 mq.
 Usura
 a1 12.00 ml.

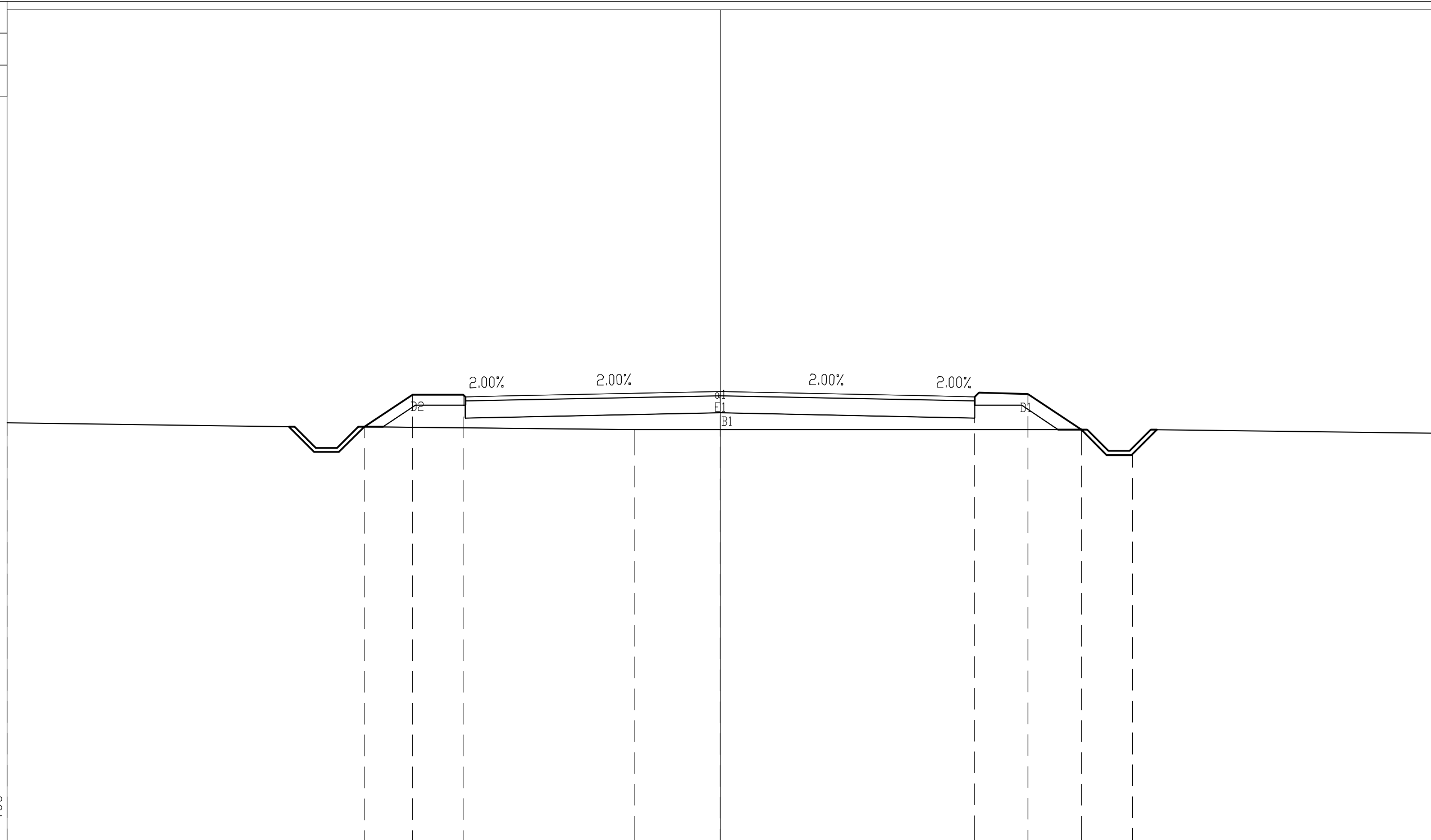

| | | | | | | | | | | | |
|----------------------|-------|------|------|------|-------|------|--|--|------|------|------|
| PROGRESSIVE TERRENO | 16.80 | | | | 2.02 | | | | | 9.71 | |
| PARZIALI TERRENO | 14.78 | | | | 11.73 | | | | | 7.09 | |
| QUOTE TERRENO | 0.87 | | | | 0.71 | | | | | 0.71 | |
| PROGRESSIVE PROGETTO | | 8.38 | 7.25 | 6.05 | | 0.00 | | | 6.00 | 7.25 | 8.51 |
| PARZIALI PROGETTO | | 1.13 | 1.20 | 6.05 | | 6.00 | | | 1.25 | 1.26 | |
| QUOTE PROGETTO | | 0.78 | 1.53 | 1.53 | | 1.60 | | | 1.48 | 1.55 | 0.71 |

PROFILO P-SN1A

SEZIONE 8.PSN1A

PROGRESSIVA 140.00

Rilevato
 B1 8.34 mq.
 Vegetale
 D1 0.81 mq.
 D2 0.66 mq.
 Totale:
 Fondazione 1.47 mq.
 E1 4.80 mq.
 Usura
 a1 12.00 ml.

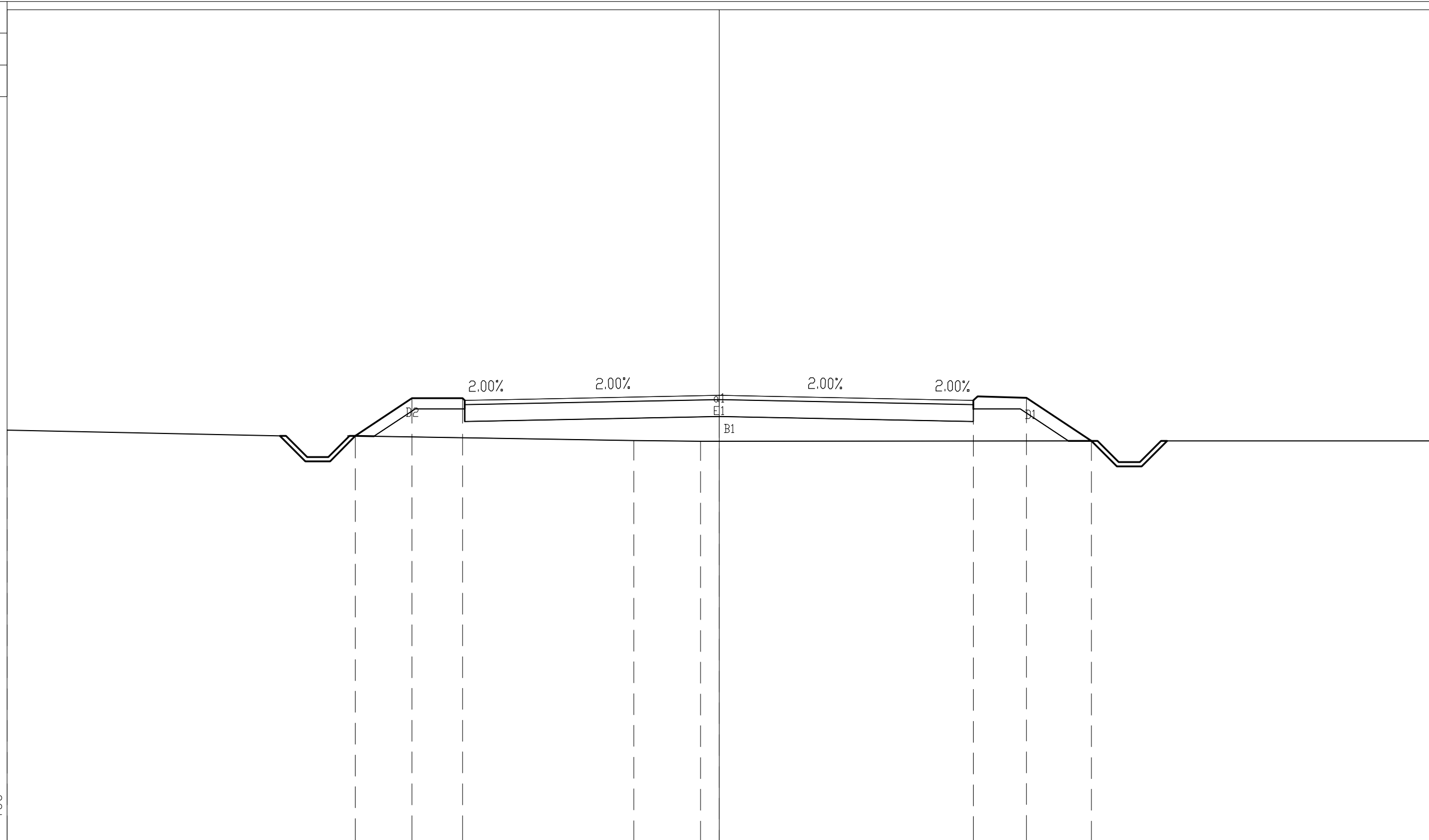

| | | | | | | | | | | | | | | | | | | | | |
|----------------------|--------|-------|------|------|------|------|--|------|------|------|--|--|--|------|------|------|--|--|--|-------|
| PROGRESSIVE TERRENO | -16.80 | | | | | | | | | | | | | | | | | | | |
| PARZIALI TERRENO | | 14.78 | | | | | | 1.58 | | | | | | | | | | | | 17.24 |
| QUOTE TERRENO | 0.68 | | | | | | | 0.44 | | | | | | | | | | | | 0.42 |
| PROGRESSIVE PROGETTO | | | 8.58 | 7.25 | 6.05 | | | | 0.00 | | | | | 6.00 | 7.25 | 8.78 | | | | |
| PARZIALI PROGETTO | | | 1.33 | 1.20 | | 6.05 | | | | 6.00 | | | | 1.25 | 1.53 | | | | | |
| QUOTE PROGETTO | | | 0.55 | 1.43 | 1.43 | | | | 1.50 | | | | | 1.38 | 1.45 | 0.43 | | | | |

PROFILO P-SN1A

SEZIONE 9.PSN1A

PROGRESSIVA 160.00

Rilevato
 B1 4.91 mq.
 Vegetale
 D1 0.69 mq.
 D2 0.62 mq.
 Totale:
 Fondazione 1.31 mq.
 E1 4.80 mq.
 Usura
 a1 12.00 ml.

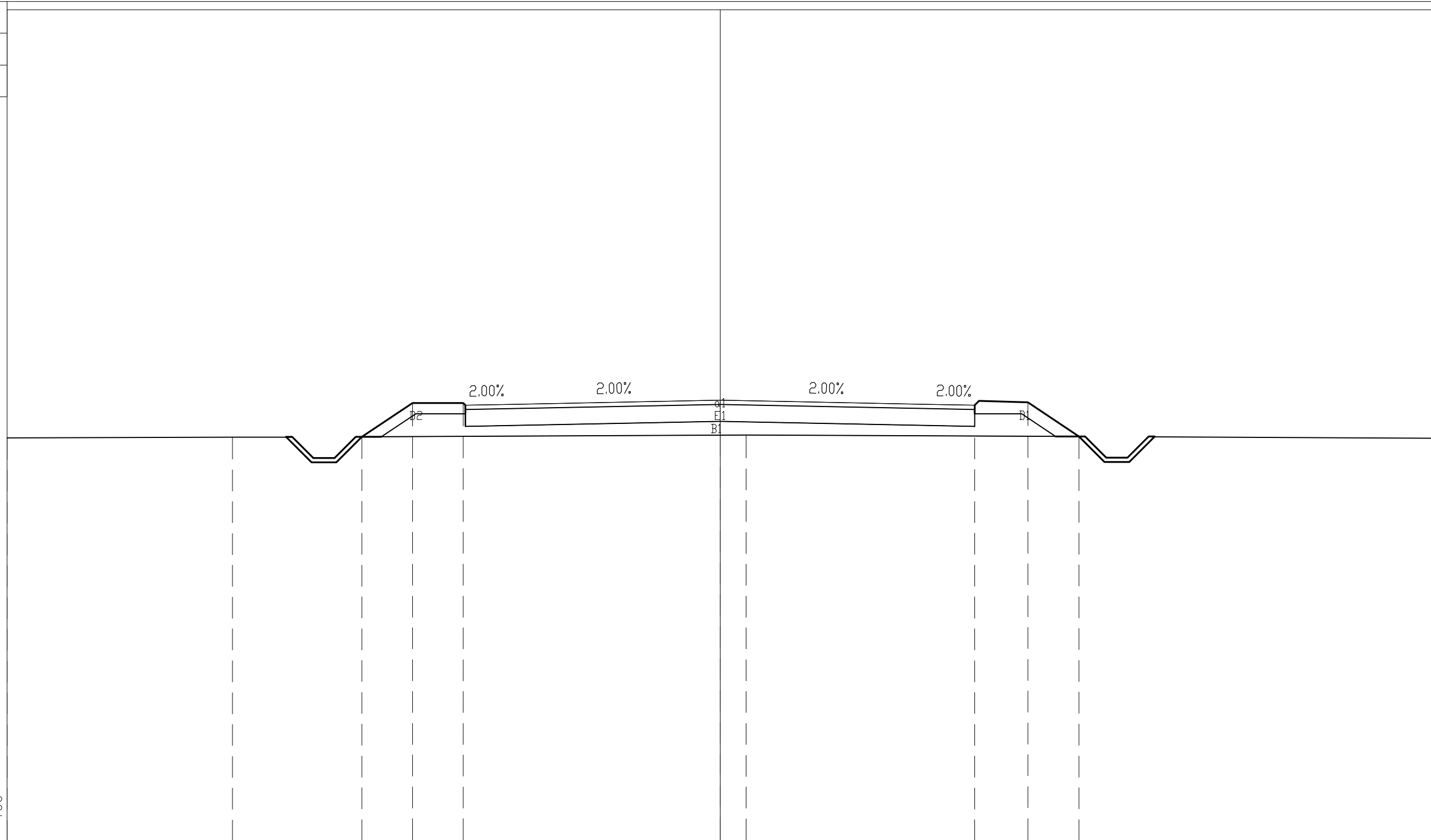

| | | | | | | | | |
|----------------------|-------|-------|------|-------|-------|------|------|------|
| PROGRESSIVE TERRENO | 16.80 | 11.49 | | 0.61 | 16.80 | | | |
| PARZIALI TERRENO | 5.31 | 12.10 | | 16.19 | | | | |
| QUOTE TERRENO | 0.51 | 0.53 | | 0.58 | 0.51 | | | |
| PROGRESSIVE PROGETTO | | 8.44 | 7.25 | 6.05 | 0.00 | 6.00 | 7.25 | 8.45 |
| PARZIALI PROGETTO | | 1.19 | 1.20 | 6.05 | 6.00 | 1.25 | 1.20 | |
| QUOTE PROGETTO | | 0.54 | 1.33 | 1.33 | 1.40 | 1.28 | 1.35 | 0.55 |

PROFILO P-SN1A
 SEZIONE 10.PSN1A
 PROGRESSIVA 180.00

Rilevato
 B1 0.41 mq.
 B2 0.45 mq.
 B3 0.32 mq.
 Totale: 1.18 mq.
 Sterro
 C1 0.05 mq.
 Vegetale
 D1 0.49 mq.
 D2 0.54 mq.
 Totale: 1.03 mq.
 Fondazione
 E1 4.80 mq.
 Usura
 a1 12.00 ml.

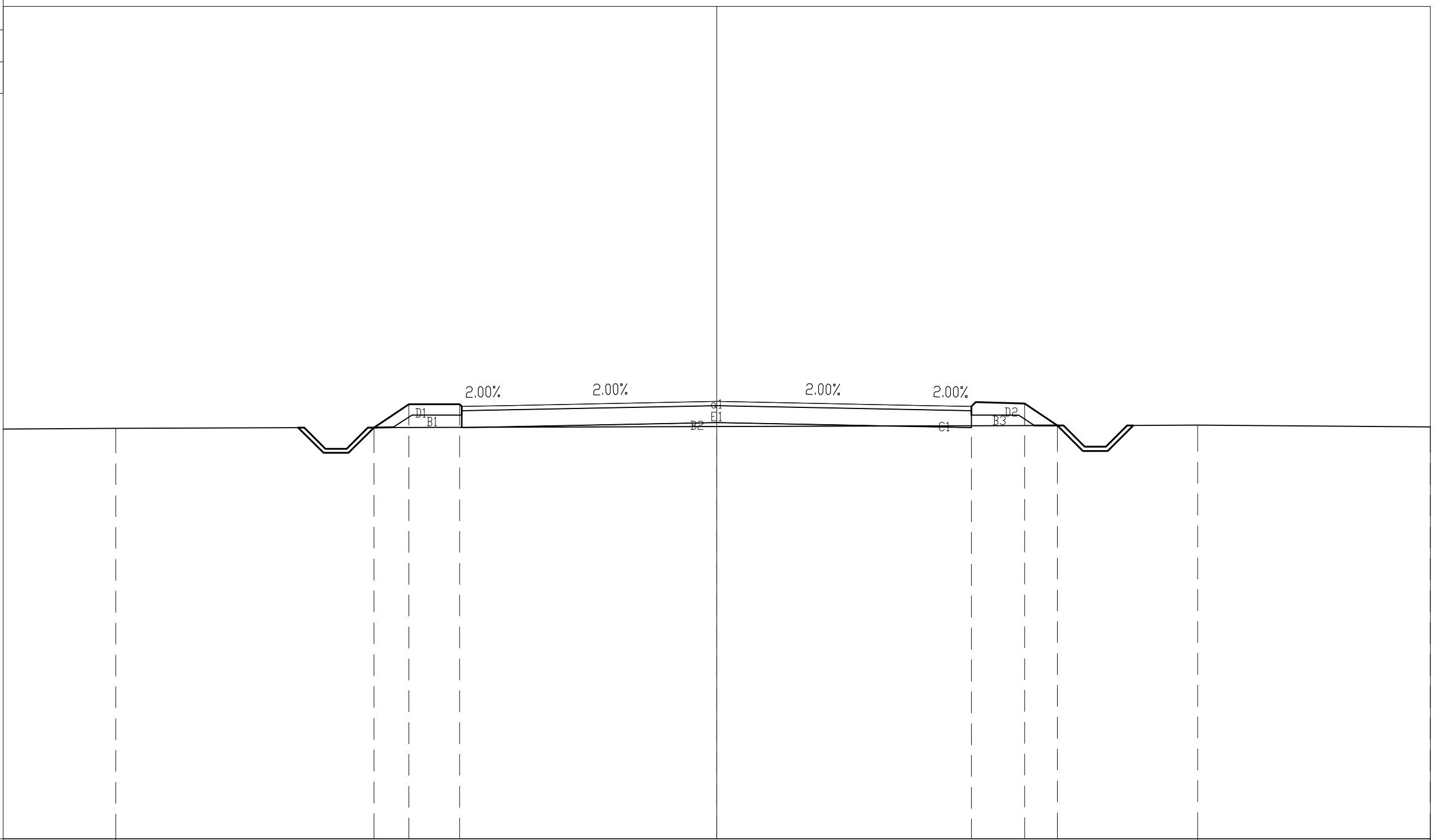

| | | | | | | | | | | | |
|----------------------|------|-------|------|------|-------|------|------|------|------|-------|-------|
| PROGRESSIVE TERRENO | | 14.14 | | | | | | | | 11.32 | 16.80 |
| PARZIALI TERRENO | 2.66 | | | | 25.46 | | | | | | 5.48 |
| QUOTE TERRENO | | 0.67 | | | | | | | | 0.74 | 0.70 |
| PROGRESSIVE PROGETTO | | | 8.07 | 7.25 | 6.05 | | 0.00 | | 6.00 | 7.25 | 8.02 |
| PARZIALI PROGETTO | | | 0.82 | 1.20 | | 6.05 | | 6.00 | | 1.25 | 0.77 |
| QUOTE PROGETTO | | | 0.69 | 1.23 | 1.23 | | 1.30 | | 1.18 | 1.25 | 0.73 |

PROFILO P-SN1A
 SEZIONE 11.PSN1A
 PROGRESSIVA 200.00

Rilevato
 B1 0.28 mq.
 B2 0.15 mq.
 B3 0.32 mq.
 Totale: 0.75 mq.
 Sterro
 C1 0.14 mq.
 C2 0.07 mq.
 Totale: 0.21 mq.
 Vegetale
 D1 0.54 mq.
 D2 0.46 mq.
 Totale: 1.00 mq.
 Fondazione
 E1 4.80 mq.
 Usura
 a1 12.00 ml.

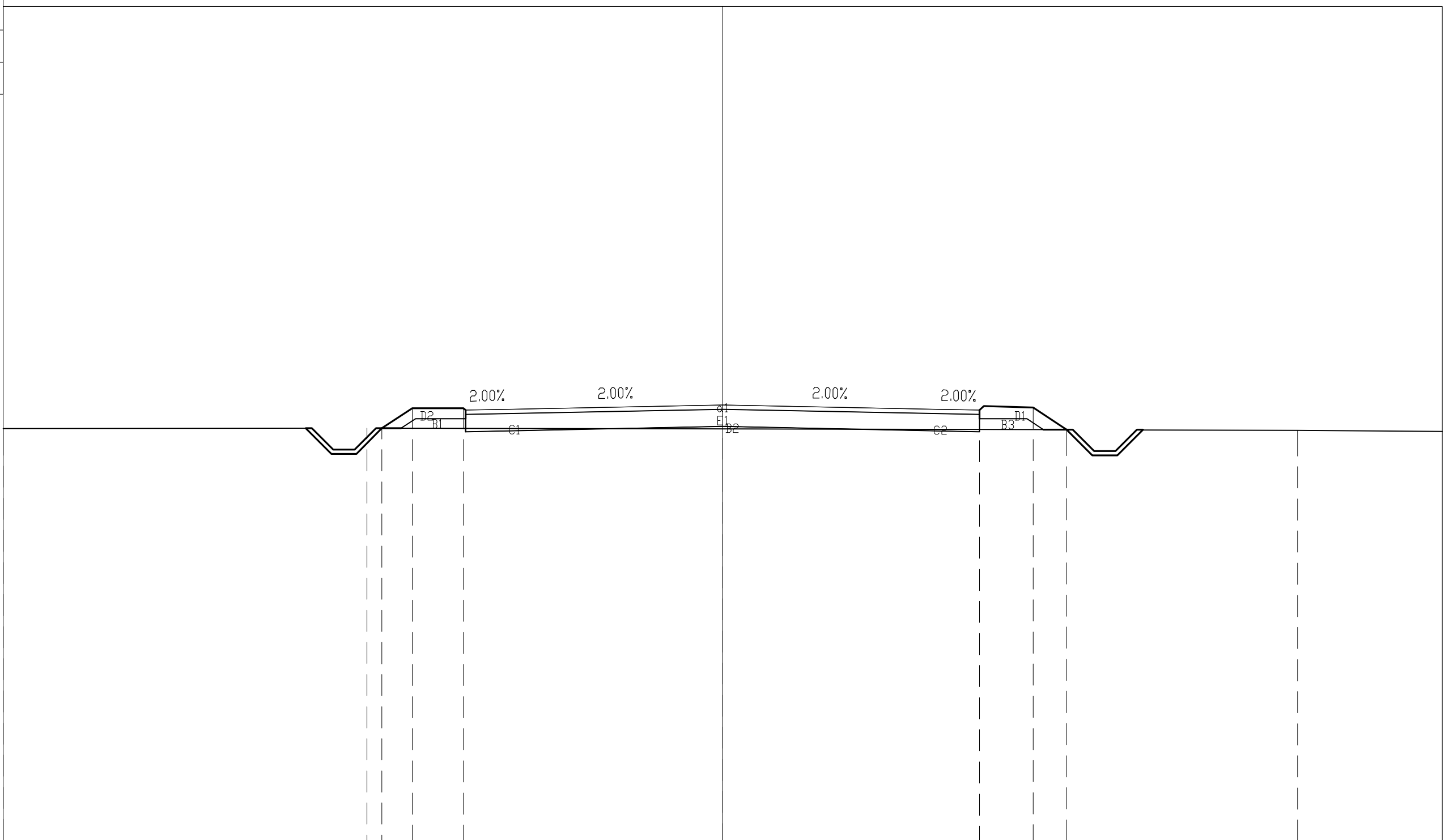

| | | | | | | | |
|----------------------|-------|------|------|-------|------|------|-------|
| PROGRESSIVE TERRENO | 16.80 | 8.31 | | 0.00 | | 6.00 | 13.42 |
| PARZIALI TERRENO | 8.49 | | | 21.73 | | 3.38 | |
| QUOTE TERRENO | 0.74 | 0.75 | | | | 0.70 | |
| PROGRESSIVE PROGETTO | | 7.95 | 7.25 | 6.05 | 0.00 | 6.00 | 7.25 |
| PARZIALI PROGETTO | | 0.70 | 1.20 | 6.05 | 6.00 | 1.25 | 0.78 |
| QUOTE PROGETTO | | 0.75 | 1.22 | 1.22 | 1.29 | 1.17 | 1.24 |
| | | | | | | | 0.71 |

PROFILO P-SN1A
 SEZIONE 12.PSN1A
 PROGRESSIVA 220.00

Rilevato
 B1 14.69 mq.
 Vegetale
 D1 1.03 mq.
 D2 0.83 mq.
 Totale:
 Fondazione 1.86 mq.
 E1 4.80 mq.
 Usura
 a1 12.00 ml.

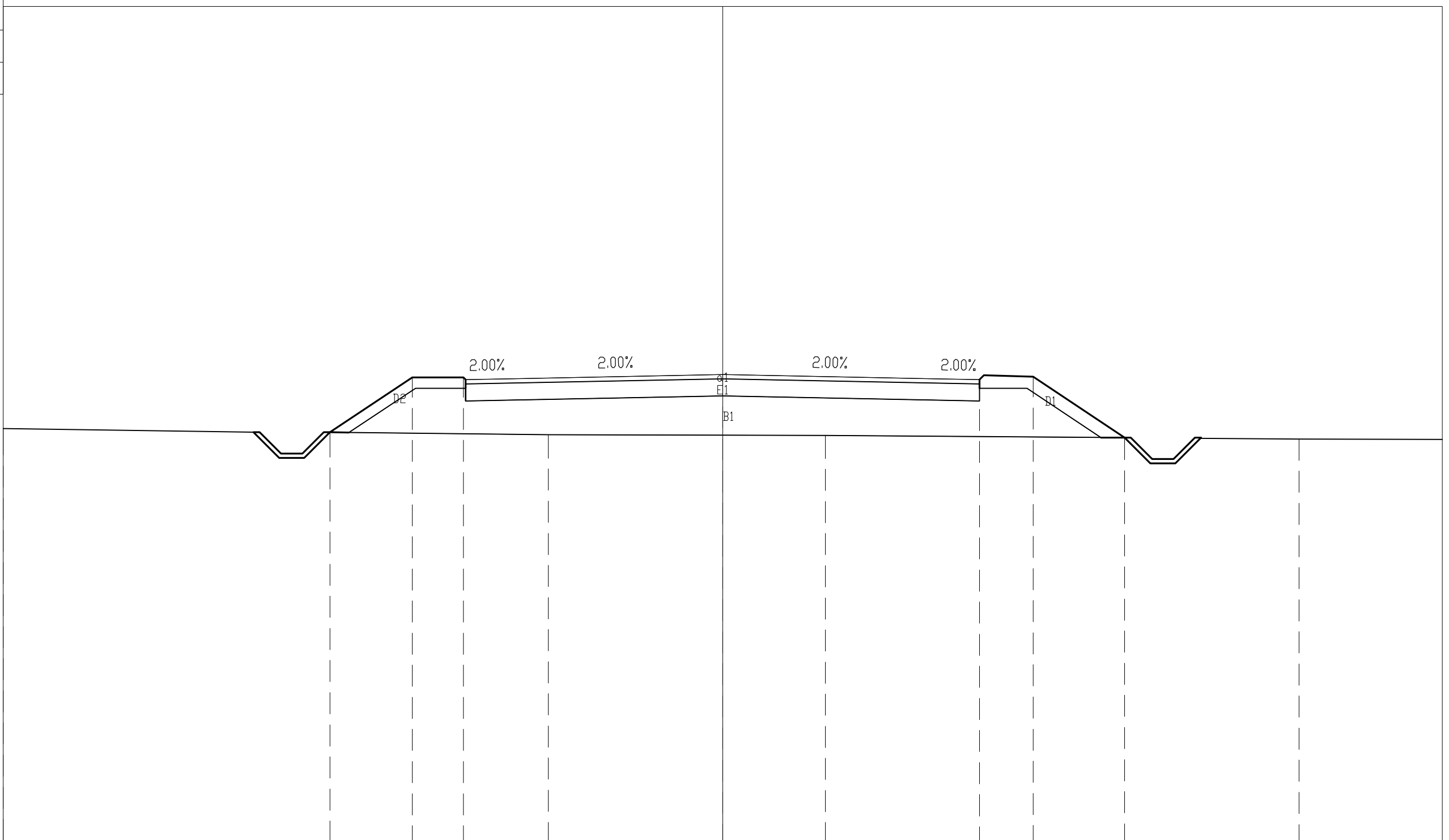

| | | | | | | | | | |
|----------------------|--------|------|------|------|------|-------|------|------|-------|
| PROGRESSIVE TERRENO | -16.80 | | | 4.07 | | 2.40 | | | 13.46 |
| PARZIALI TERRENO | 12.73 | | | 6.47 | | 11.06 | | | 3.34 |
| QUOTE TERRENO | 0.74 | | | 0.60 | | 0.58 | | | 0.50 |
| PROGRESSIVE PROGETTO | | 9.17 | 7.25 | 6.05 | 0.00 | 6.00 | 7.25 | 9.38 | |
| PARZIALI PROGETTO | | 1.92 | 1.20 | 6.05 | | 6.00 | 1.25 | 2.13 | |
| QUOTE PROGETTO | | 0.66 | 1.94 | 1.94 | 2.01 | | 1.89 | 1.95 | 0.53 |

PROFILO P-SN1A
 SEZIONE 13.PSN1A
 PROGRESSIVA 240.00

Rilevato
 B1 39.41 mq.
 Vegetale
 D1 1.86 mq.
 Fondazione
 E1 4.80 mq.
 Usura
 a1 12.00 ml.

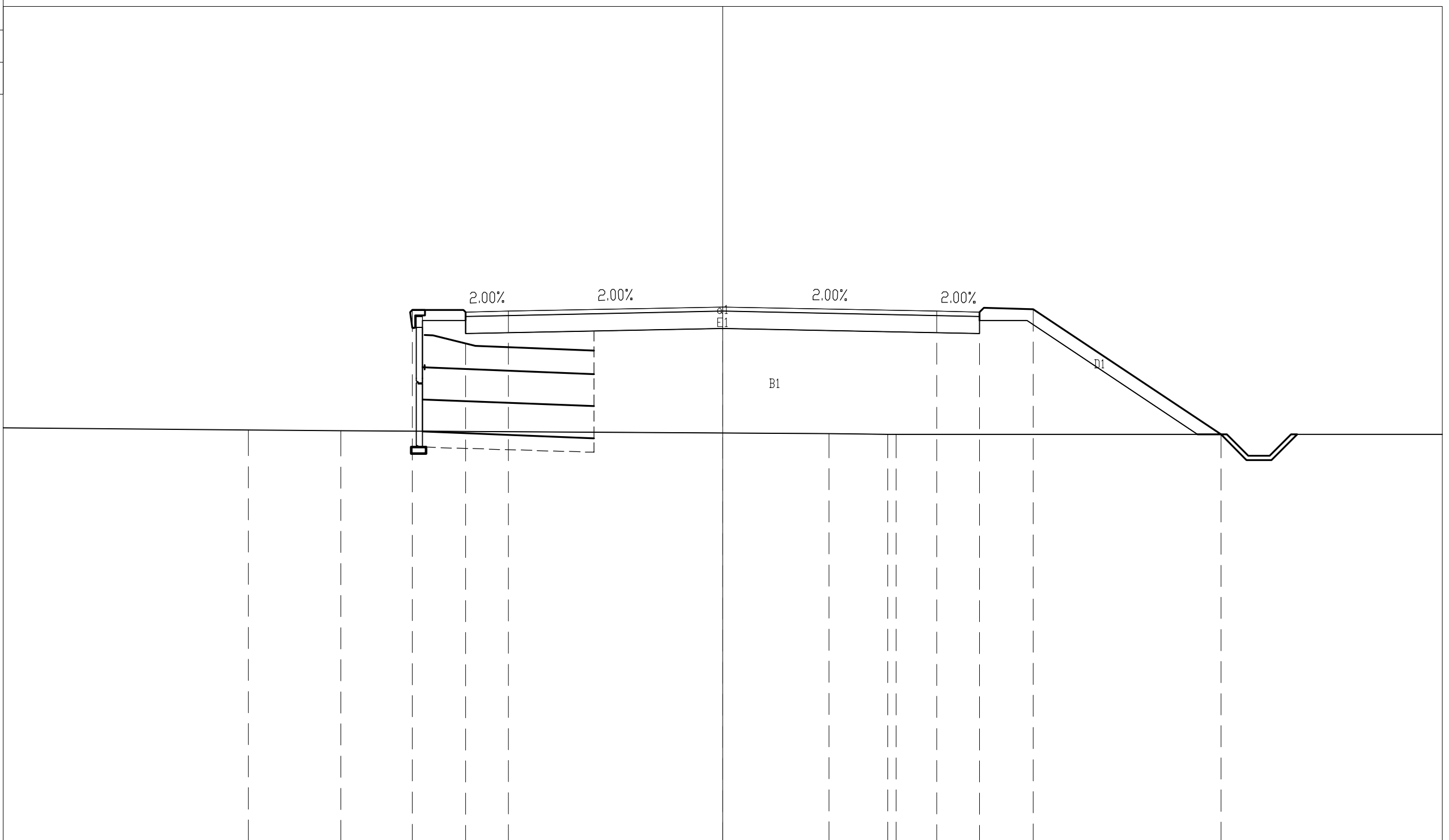

| | | | | | | | | | | | | | |
|----------------------|------|-------|------|-------|------|------|------|------|------|------|-------|------|------|
| PROGRESSIVE TERRENO | | 11.07 | 8.91 | | 2.48 | 3.86 | 4.05 | | | | | | |
| PARZIALI TERRENO | 8.93 | 2.16 | | 11.39 | | 1.38 | | | | | 16.14 | | |
| QUOTE TERRENO | | 0.71 | 0.69 | | 0.62 | 0.61 | 0.61 | | | | | | |
| PROGRESSIVE PROGETTO | | | | 7.25 | 6.00 | 5.00 | | 0.00 | | 5.00 | 6.00 | 7.25 | |
| PARZIALI PROGETTO | | | | 1.25 | 1.00 | | 5.00 | | 5.00 | 1.00 | 1.25 | 4.38 | |
| QUOTE PROGETTO | | | | 3.51 | 3.46 | 3.48 | | 3.58 | | 3.48 | 3.46 | 3.53 | 0.61 |

PROFILO P-SN1A
 SEZIONE 14.PSN1A
 PROGRESSIVA 260.00

Rilevato
 B1 62.23 mq.
 Fondazione E1 4.80 mq.
 Usura al 12.00 ml.

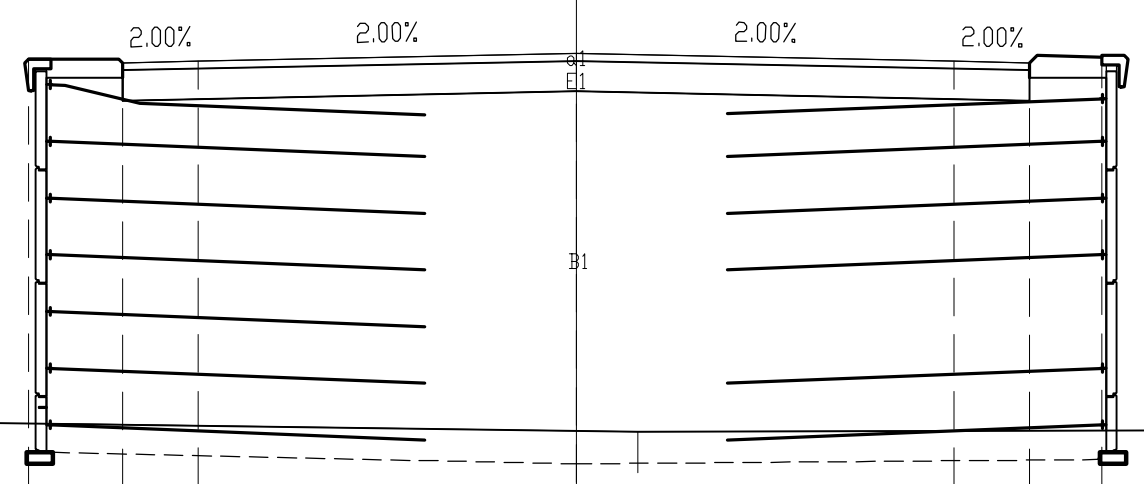

-9

100
 100

| | | | | | | | | |
|----------------------|------|------|------|------|-------|-------|------|------|
| PROGRESSIVE TERRENO | | 8.56 | | 0.81 | | 10.83 | | |
| PARZIALI TERRENO | 9.84 | | 9.37 | | 10.02 | | 9.17 | |
| QUOTE TERRENO | | 0.71 | | 0.58 | | 0.61 | | |
| PROGRESSIVE PROGETTO | | 7.25 | 6.00 | 5.00 | 0.00 | 5.00 | 6.00 | 6.95 |
| PARZIALI PROGETTO | | 1.25 | 1.00 | 5.00 | | 5.00 | 1.00 | 0.95 |
| QUOTE PROGETTO | | 5.51 | 5.46 | 5.48 | 5.58 | 5.48 | 5.46 | 5.51 |

PROFILO P-SN1A

SEZIONE 16.PSN1A

PROGRESSIVA 300.00

Usura
a1 12.00 ml.

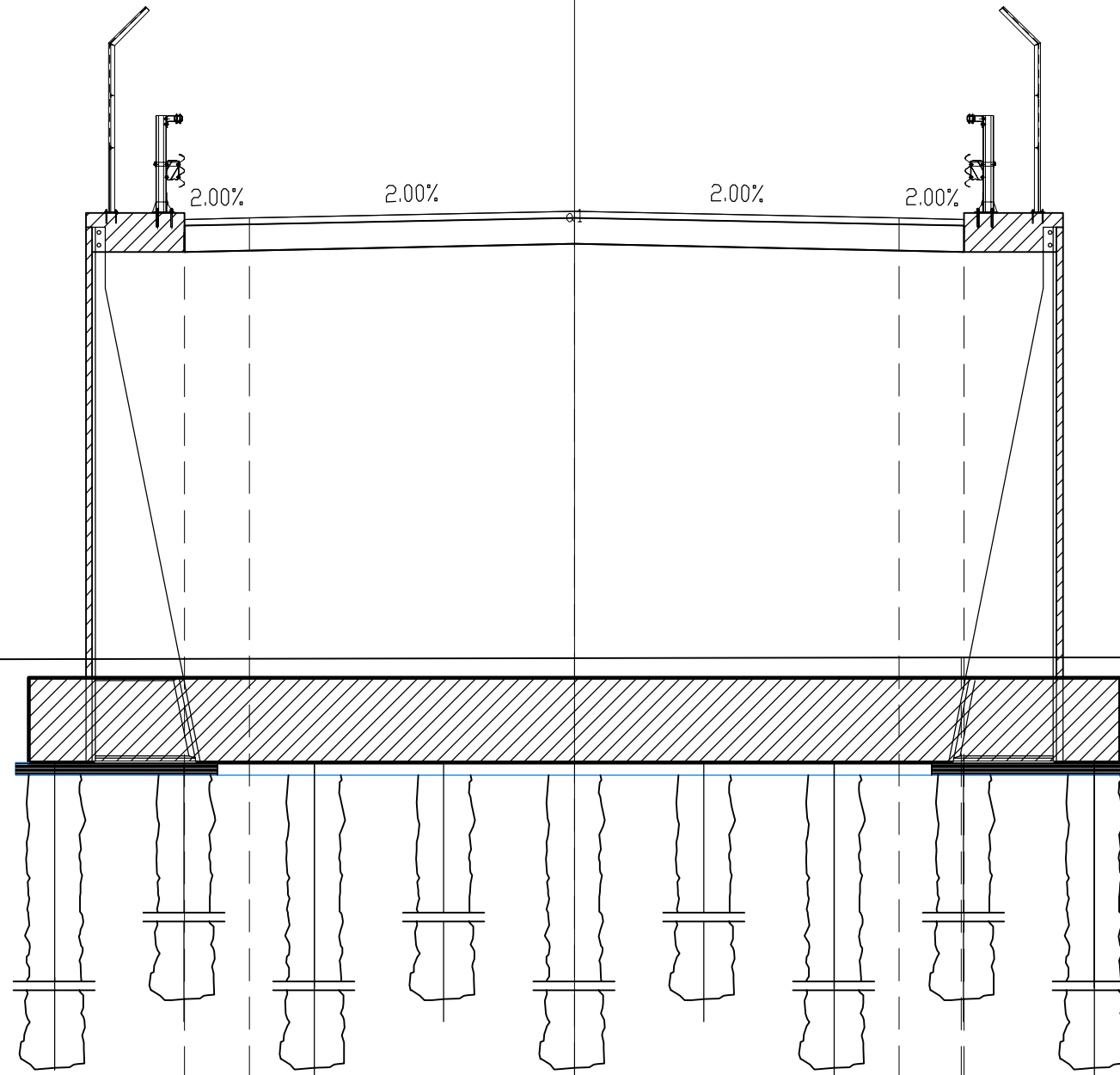

-9

100
100

| | | | | | | | | | | |
|----------------------|--|-------|------|--|------|--|------|------|------|-------|
| PROGRESSIVE TERRENO | | | | | | | | 5.95 | | 15.59 |
| PARZIALI TERRENO | | 24.11 | | | | | | 9.64 | | 4.41 |
| QUOTE TERRENO | | | | | | | | 0.47 | | 0.47 |
| PROGRESSIVE PROGETTO | | 6.00 | 5.00 | | 0.00 | | 5.00 | 6.00 | 0.47 | |
| PARZIALI PROGETTO | | 1.00 | 5.00 | | 5.00 | | 1.00 | | | |
| QUOTE PROGETTO | | 7.22 | 7.24 | | 7.34 | | 7.24 | 7.22 | | |

PROFILO P-SN1A
 SEZIONE 17.PSN1A
 PROGRESSIVA 320.00

Rilevato B1 88.37 mq.
 Usura a1 12.00 ml.

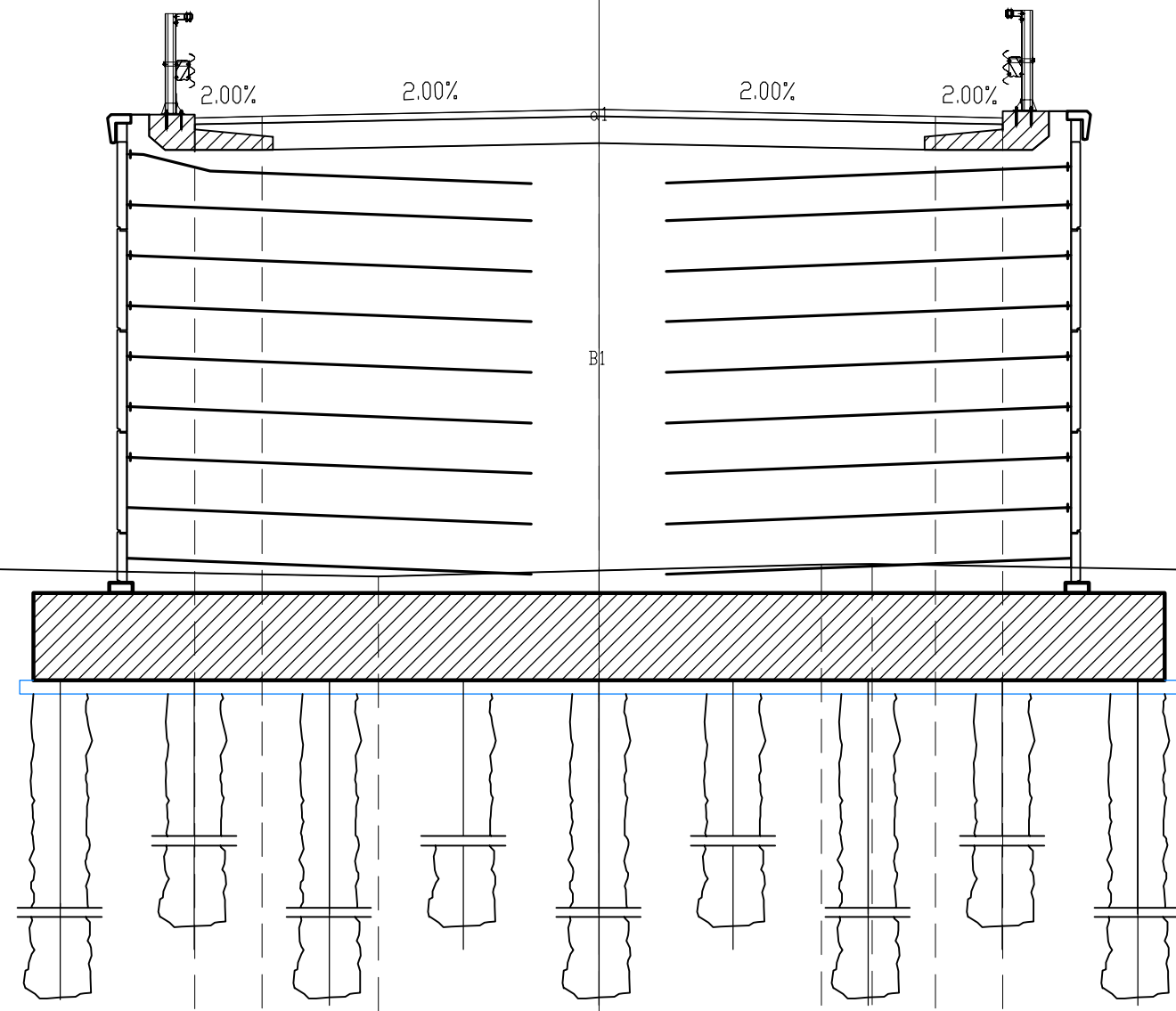

-9

100
 100

| | | | | | | | | | | | | | |
|----------------------|------|-------|------|------|------|------|------|------|------|------|------|--|------|
| PROGRESSIVE TERRENO | | 13.32 | 9.98 | 3.28 | | 3.30 | 4.06 | 9.12 | 1.23 | | | | |
| PARZIALI TERRENO | 3.79 | | 3.34 | | 6.70 | | 6.58 | | 0.76 | 5.06 | 2.11 | | 5.72 |
| QUOTE TERRENO | | 0.70 | | 0.53 | | 0.41 | | 0.58 | 0.59 | | 0.50 | | 0.49 |
| PROGRESSIVE PROGETTO | | | | | 6.00 | | 5.00 | | 0.00 | | 5.00 | | 6.00 |
| PARZIALI PROGETTO | | | | | 1.00 | | 5.00 | | 5.00 | | 1.00 | | |
| QUOTE PROGETTO | | | | | 7.22 | | 7.24 | | 7.34 | | 7.24 | | 7.22 |

PROFILO P-SN1A
 SEZIONE 18.PSN1A
 PROGRESSIVA 340.00

Rilevato
 B1 85.78 mq.
 Fondazione E1 4.80 mq.
 Usura al 12.00 ml.

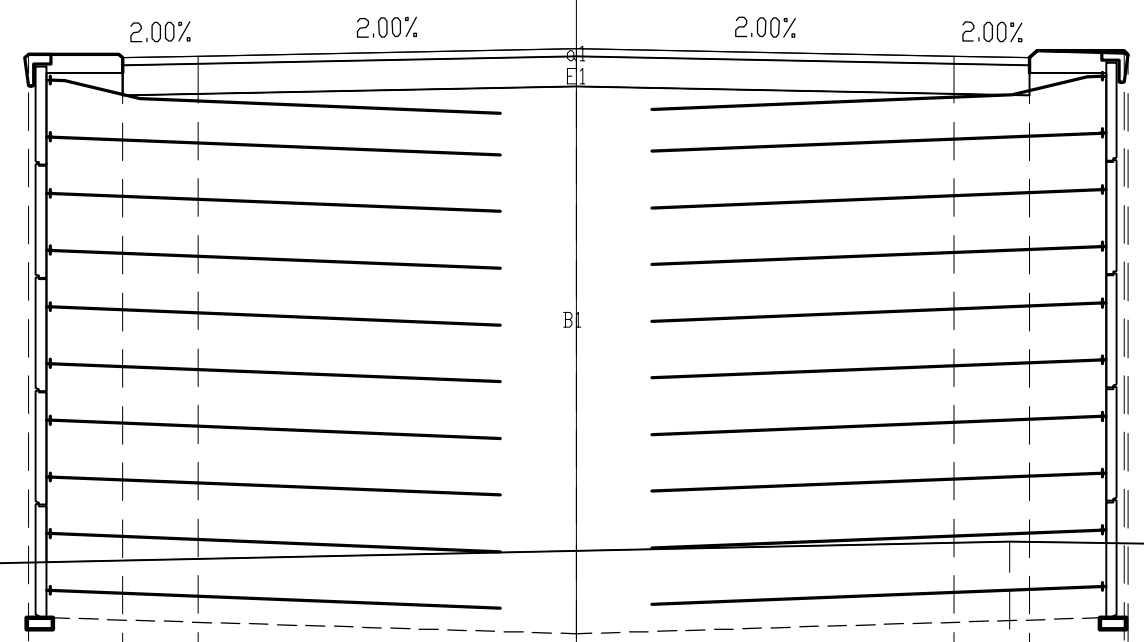

-8

100
 100

| | | | | | | | | | | | |
|----------------------|------|-------|-------|-------|------|------|------|------|------|-------|------|
| PROGRESSIVE TERRENO | | 16.08 | 14.25 | 12.50 | | | | 5.73 | 8.00 | 11.41 | |
| PARZIALI TERRENO | 0.92 | 1.83 | 1.75 | 18.23 | | | | 2.27 | 3.41 | 6.00 | |
| QUOTE TERRENO | 0.91 | 0.88 | 0.93 | | | | | 1.32 | 1.28 | 1.27 | |
| PROGRESSIVE PROGETTO | | | | 7.25 | 6.00 | 5.00 | 0.00 | 5.00 | 6.00 | 7.25 | 7.30 |
| PARZIALI PROGETTO | | | | 0.95 | 1.00 | 5.00 | 5.00 | 1.00 | 1.25 | 0.05 | |
| QUOTE PROGETTO | | | | 7.77 | 7.72 | 7.74 | 7.84 | 7.74 | 7.72 | 7.78 | 7.75 |

PROFILO P-SN1A

SEZIONE 19.PSN1A

PROGRESSIVA 360.00

| | |
|---------|-----------|
| Usura | |
| a1 | 12.00 ml. |
| a2 | 12.00 ml. |
| Totale: | 24.00 ml. |

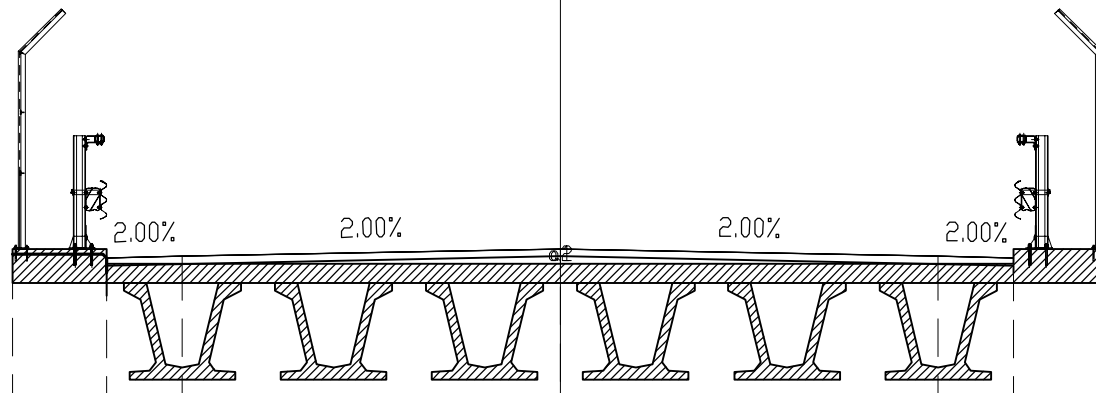

-7

100
100

| | | | | | | | | | | |
|----------------------|-------|------|------|--|------|--|------|------|------|------|
| PROGRESSIVE TERRENO | | | | | | | | | | 6.52 |
| PARZIALI TERRENO | 17.73 | | | | | | | | | |
| QUOTE TERRENO | | | | | | | | | | 1.89 |
| PROGRESSIVE PROGETTO | 7.25 | 6.00 | 5.00 | | 0.00 | | | 5.00 | 6.00 | 7.25 |
| PARZIALI PROGETTO | 1.25 | 1.00 | 5.00 | | 5.00 | | 1.00 | 1.25 | | |
| QUOTE PROGETTO | 8.69 | 8.64 | 8.66 | | 8.76 | | 8.66 | 8.64 | 8.70 | |

PROFILO P-SN1A
 SEZIONE 20.PSN1A
 PROGRESSIVA 380.00

Rilevato
 B1 85.87 mq.
 Sterro C1 0.29 mq.
 Fondazione E1 4.80 mq.
 Usura a1 12.00 ml.

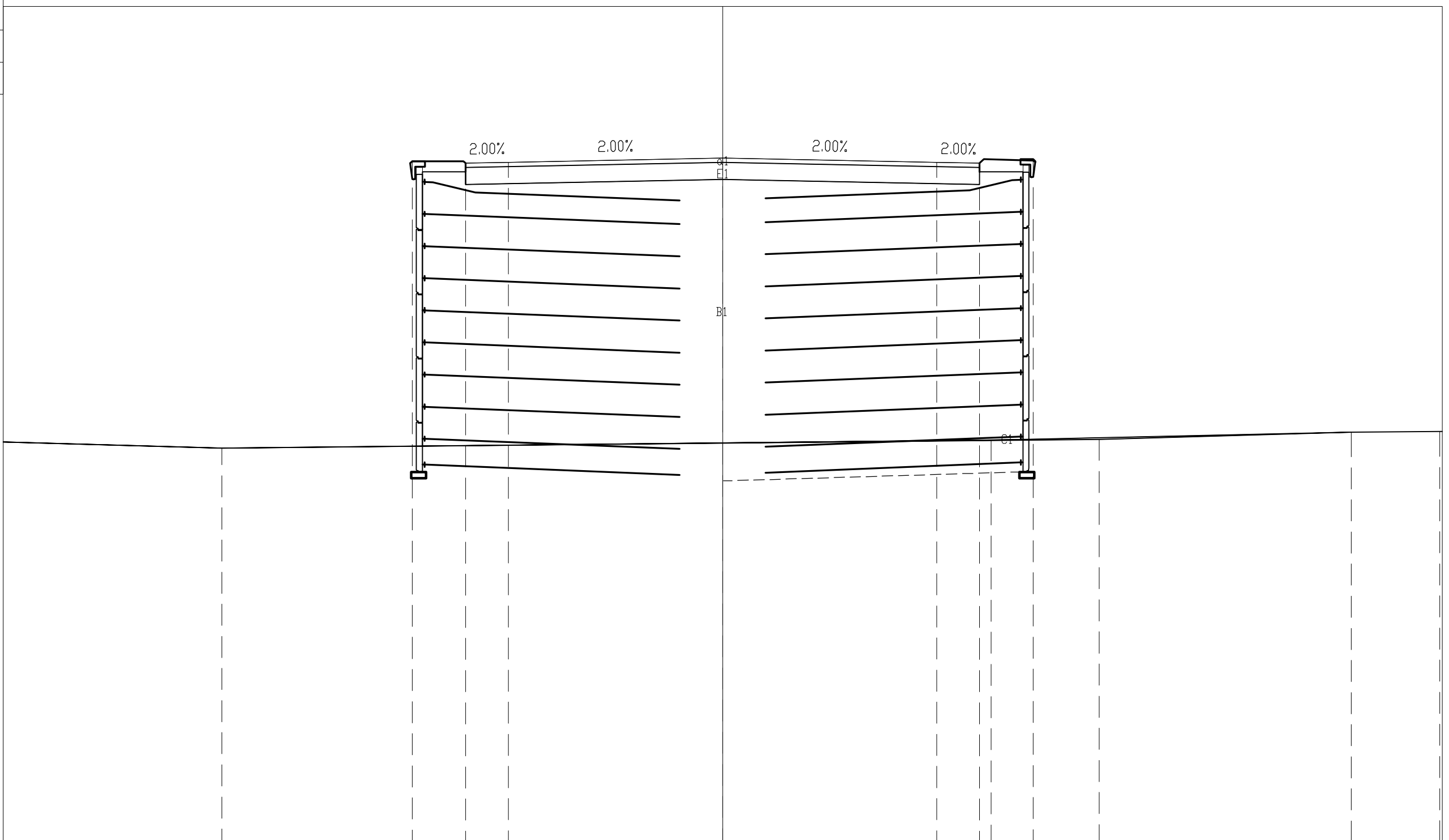

| | | | | | | | | | | | |
|----------------------|-------|-------|------|-------|------|------|------|------|------|-------|-------|
| PROGRESSIVE TERRENO | | 11.69 | | | | | | 6.26 | 8.79 | 14.68 | |
| PARZIALI TERRENO | 8.31 | | | 17.95 | | | | 2.53 | 5.89 | 5.32 | |
| QUOTE TERRENO | | 2.29 | | | | | | 2.48 | 2.49 | 2.66 | |
| PROGRESSIVE PROGETTO | | | 7.25 | 6.00 | 5.00 | 0.00 | 5.00 | 6.00 | 7.25 | | 16.74 |
| PARZIALI PROGETTO | 10.72 | | 1.25 | 1.00 | 5.00 | 5.00 | 1.00 | 1.25 | 9.49 | | |
| QUOTE PROGETTO | | | 8.99 | 8.94 | 8.96 | 9.06 | 8.96 | 8.94 | 9.00 | | 2.67 |

PROFILO P-SN1A
 SEZIONE 21.PSN1A
 PROGRESSIVA 400.00

Rilevato
 B1 171.77 mq.
 Vegetale
 D1 4.30 mq.
 D2 3.39 mq.
 Totale: 7.69 mq.
 Fondazione
 E1 4.80 mq.
 Usura
 a1 12.00 ml.

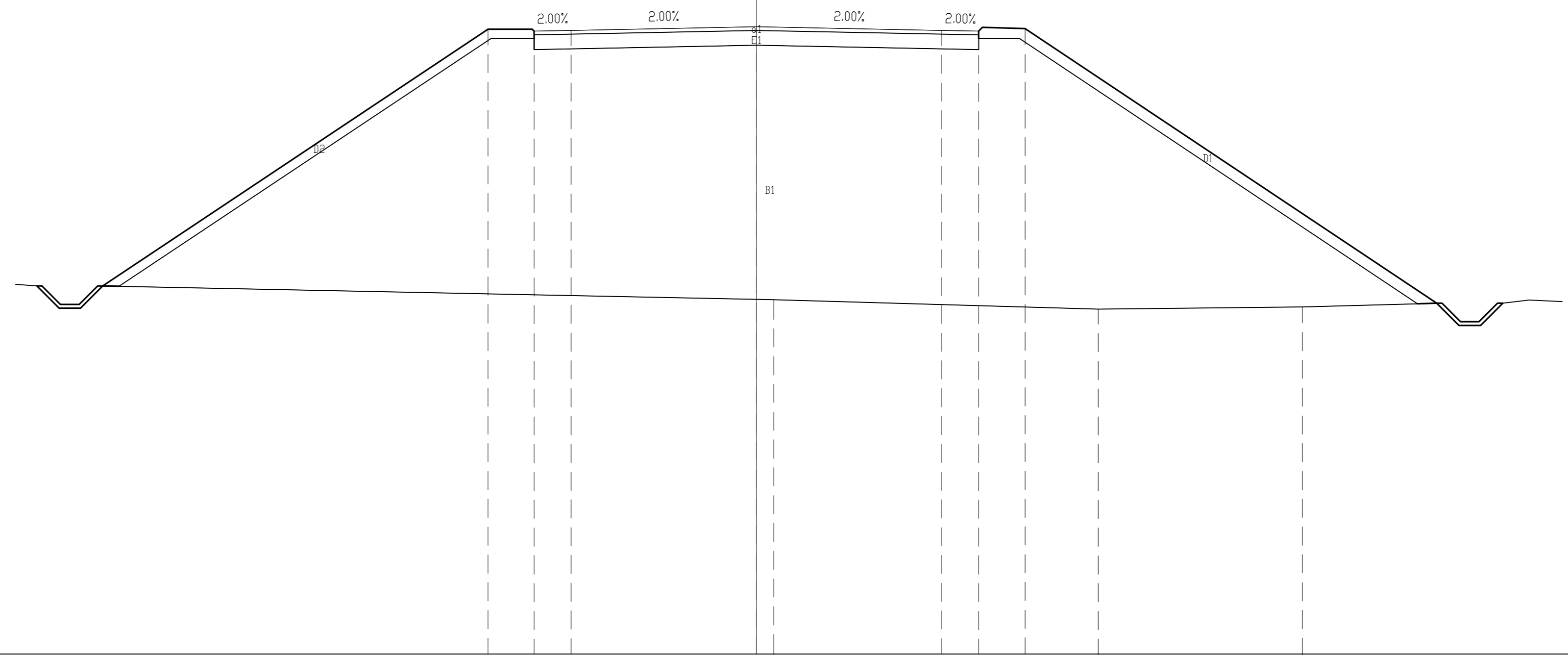

▼ -6
 100 100

| | | | | | | | | | | | | | | | |
|----------------------|--|-------|-------|-------|-------|-------|-------|-------|--|-------|--|--|--|--|--|
| PROGRESSIVE TERRENO | | | | | 0.47 | | | | | | | | | | |
| PARZIALI TERRENO | | 20.47 | | | | 8.75 | | 5.51 | | 5.27 | | | | | |
| QUOTE TERRENO | | | | | 3.56 | | | 3.31 | | 3.36 | | | | | |
| PROGRESSIVE PROGETTO | | | 7.25 | 6.00 | 5.00 | 0.00 | | | | | | | | | |
| PARZIALI PROGETTO | | 11.29 | 1.25 | 1.00 | 5.00 | 5.00 | 1.00 | 1.25 | | 11.01 | | | | | |
| QUOTE PROGETTO | | 10.86 | 10.81 | 10.83 | 10.93 | 10.83 | 10.81 | 10.87 | | | | | | | |

PROFILO P-SN1A
 SEZIONE 22.PSN1A
 PROGRESSIVA 420.00

Vegetale
 D1 5.08 mq.
 D2 3.80 mq.
 Totale: 8.88 mq.
 Fondazione E1 4.80 mq.
 Usura al 12.00 ml.

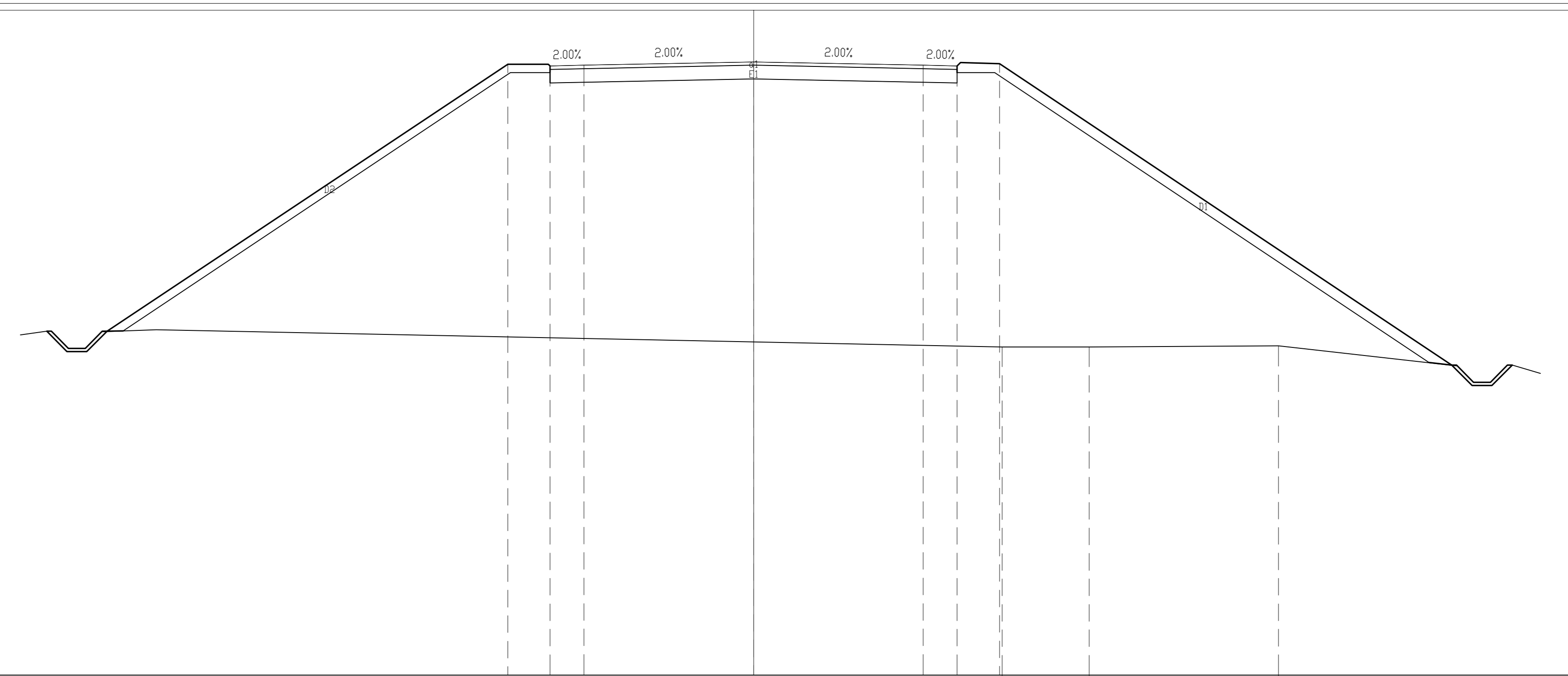

| | | | | | | | | | | | | | |
|----------------------|--|-------|--|-------|-------|-------|-------|------|--|-------|-------|-------|-------|
| PROGRESSIVE TERRENO | | | | | | | | | | | | | |
| PARZIALI TERRENO | | | | 24.93 | | | | 2.57 | | | 5.58 | | 7.38 |
| QUOTE TERRENO | | | | | | | | | | | | | |
| PROGRESSIVE PROGETTO | | | | 7.25 | 6.00 | 5.00 | 0.00 | | | 5.00 | 6.00 | 7.25 | 4.67 |
| PARZIALI PROGETTO | | 12.71 | | 1.25 | 1.00 | | 5.00 | | | 1.00 | 1.25 | | 13.23 |
| QUOTE PROGETTO | | | | 13.00 | 12.95 | 12.97 | 13.07 | | | 12.97 | 12.95 | 13.02 | |

PROFILO P-SN1A
 SEZIONE 23.PSN1A
 PROGRESSIVA 440.00

Vegetale
 D1 5.08 mq.
 D2 4.40 mq.
 Totale: 9.48 mq.
 Fondazione
 E1 4.80 mq.
 Usura
 al 12.00 ml.

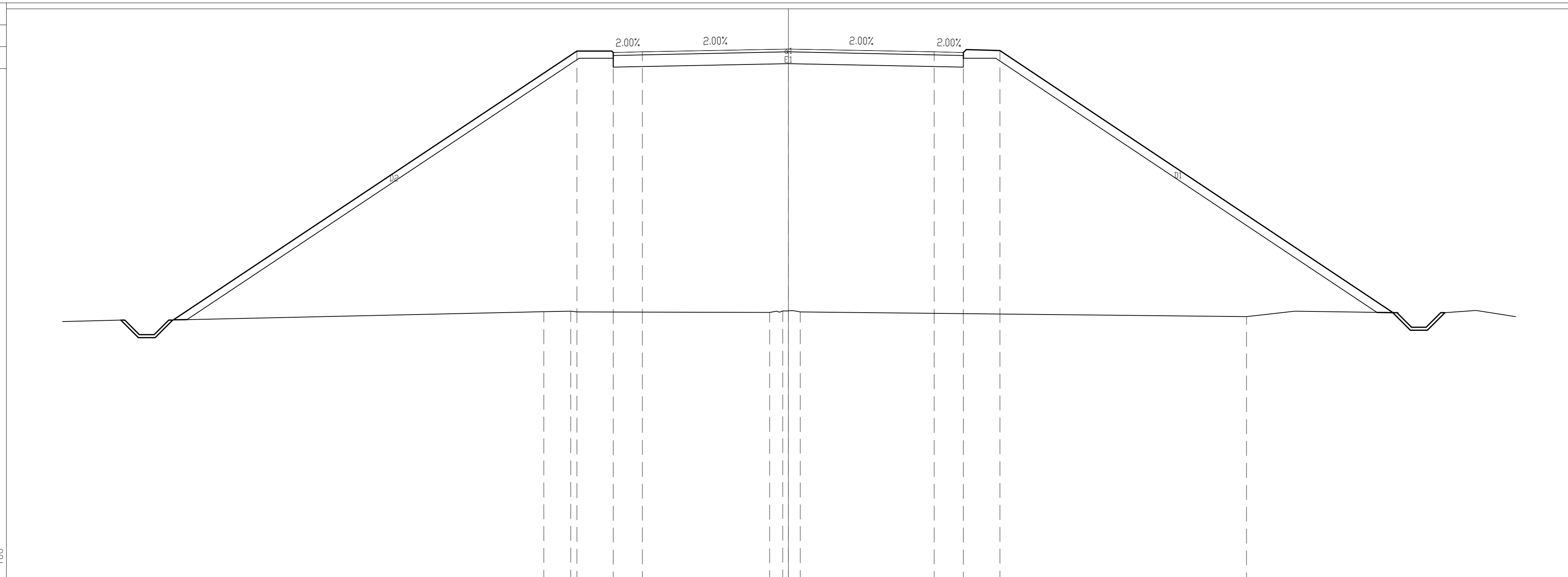

| | | | | | | | | | | |
|----------------------|-------|------|-------|-------|-------|------|-------|-------|-------|-------|
| PROGRESSIVE TERRENO | | 8.38 | 7.46 | | 0.65 | 0.19 | | | 15.70 | |
| PARZIALI TERRENO | 14.00 | 0.92 | | 6.81 | 0.46 | 0.59 | | 15.30 | 1.65 | |
| QUOTE TERRENO | | 6.21 | 6.23 | | 6.19 | 6.24 | 6.20 | | 6.04 | |
| PROGRESSIVE PROGETTO | | | 7.25 | 6.00 | 5.00 | | | 5.00 | 6.00 | 7.25 |
| PARZIALI PROGETTO | 14.72 | | 1.25 | 1.00 | 5.00 | | 5.00 | 1.00 | 1.25 | 13.53 |
| QUOTE PROGETTO | | | 15.15 | 15.10 | 15.12 | | 15.22 | 15.12 | 15.10 | 15.16 |

| | | | | | | | | | | |
|----------------------|-------|------|-------|-------|-------|------|-------|-------|-------|-------|
| PROGRESSIVE TERRENO | | 8.38 | 7.46 | | 0.65 | 0.19 | | | 15.70 | |
| PARZIALI TERRENO | 14.00 | 0.92 | | 6.81 | 0.46 | 0.59 | | 15.30 | 1.65 | |
| QUOTE TERRENO | | 6.21 | 6.23 | | 6.19 | 6.24 | 6.20 | | 6.04 | |
| PROGRESSIVE PROGETTO | | | 7.25 | 6.00 | 5.00 | | | 5.00 | 6.00 | 7.25 |
| PARZIALI PROGETTO | 14.72 | | 1.25 | 1.00 | 5.00 | | 5.00 | 1.00 | 1.25 | 13.53 |
| QUOTE PROGETTO | | | 15.15 | 15.10 | 15.12 | | 15.22 | 15.12 | 15.10 | 15.16 |

PROFILO P-SN1A
 SEZIONE 25.PSN1A
 PROGRESSIVA 480.00

Usura
 a1 12.00 ml.

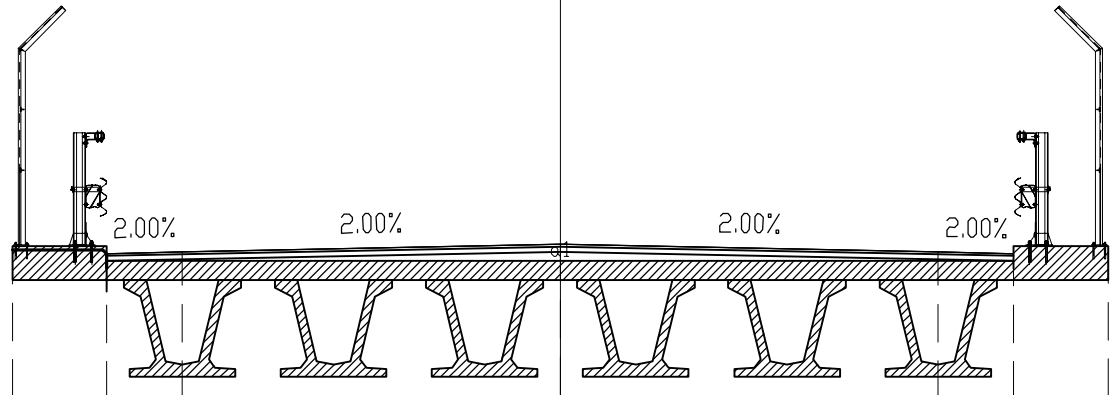

2

100
 100

| | | | | | | | | | | | | | | | | | | | | | | | | | | | | |
|----------------------|-------|-------|-------|-------|------|------|-------|-------|-------|-------|-------|-------|-------|-------|-------|-------|-------|-------|-------|-------|-------|-------|-------|-------|-------|-------|-------|-------|
| PROGRESSIVE TERRENO | 15.57 | 13.43 | 11.96 | 10.75 | 9.88 | 8.44 | 8.11 | 7.16 | 6.11 | 5.69 | 4.54 | 3.22 | 1.83 | 1.36 | 0.46 | 0.03 | 0.75 | 1.23 | 1.93 | 2.44 | 2.97 | 3.49 | 3.96 | 4.65 | 5.11 | 5.67 | 6.16 | |
| PARZIALI TERRENO | 1.73 | 2.14 | 1.47 | 1.21 | 0.87 | 1.44 | 0.33 | 0.95 | 1.05 | 0.42 | 1.15 | 1.32 | 1.39 | 0.47 | 0.90 | 0.43 | 0.78 | 0.48 | 0.70 | 0.51 | 0.53 | 0.52 | 0.47 | 0.6 | 0.46 | 0.56 | 0.49 | 11.71 |
| QUOTE TERRENO | 8.92 | 8.99 | 9.22 | 9.47 | 9.66 | 9.98 | 10.80 | 11.06 | 11.12 | 11.13 | 11.20 | 11.26 | 11.33 | 11.34 | 11.39 | 11.40 | 11.44 | 11.44 | 11.49 | 11.49 | 11.51 | 11.54 | 11.56 | 11.56 | 11.58 | 11.57 | 11.59 | |
| PROGRESSIVE PROGETTO | | | | | | | | 7.25 | 6.00 | 5.00 | | | | | 0.00 | | | | | | | | | 5.00 | 6.00 | 7.25 | | |
| PARZIALI PROGETTO | | | 15.03 | | | | | 1.25 | 1.00 | | 5.00 | | | | | | | | 5.00 | | | | | 1.00 | 1.25 | | 10.04 | |
| QUOTE PROGETTO | | | | | | | | 18.16 | 18.11 | 18.13 | | | | | 18.23 | | | | | | | | | 18.13 | 18.11 | 18.17 | | |

PROFILO P-SN1A
 SEZIONE 26.PSN1A
 PROGRESSIVA 500.00

Rilevato
 B1 69.39 mq.
 Vegetale
 D1 1.84 mq.
 D2 2.67 mq.
 Totale: 4.51 mq.
 Fondazione
 E1 4.80 mq.
 Usura
 a1 12.00 ml.

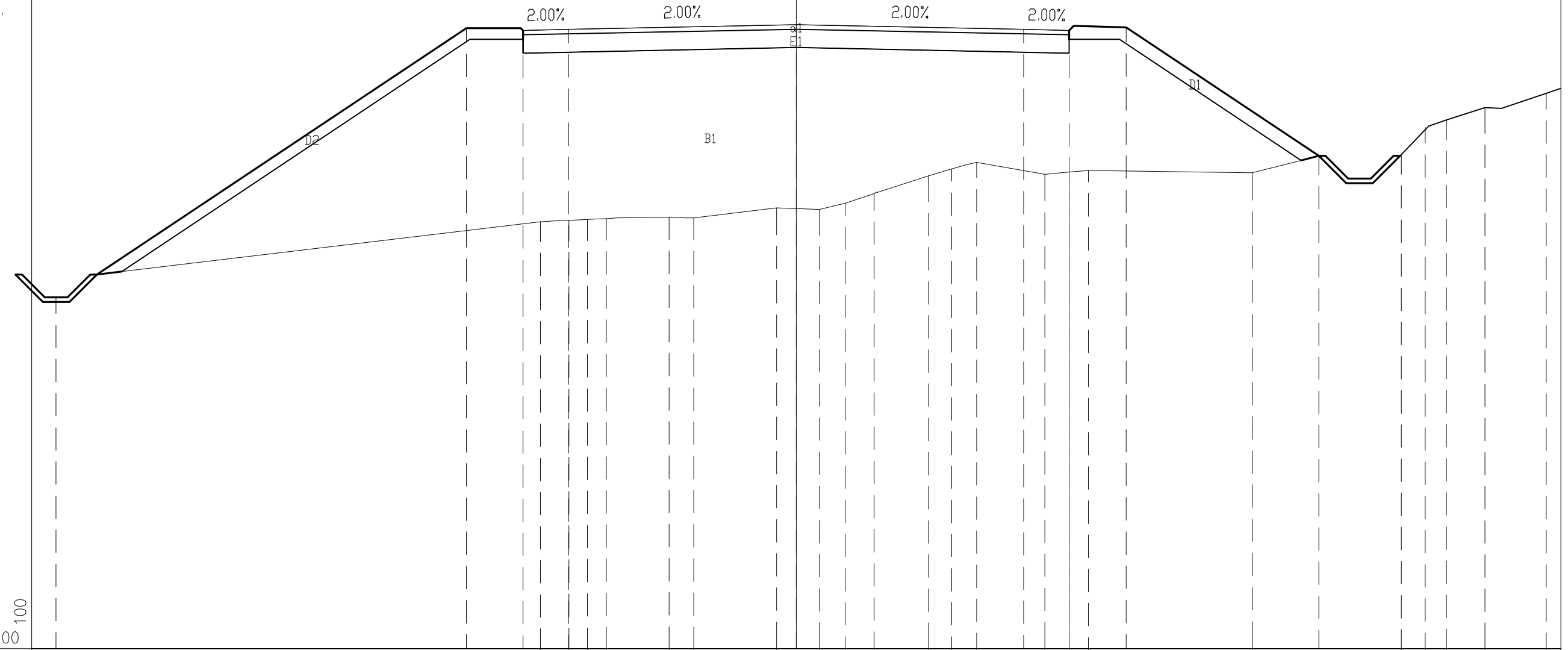

| | | | | | | | | | | | | | | | | | | | | | | | | | | | | | | | |
|----------------------|-------|-------|--|-------|-------|-------|-------|------|-------|-------|--|-------|-------|-------|-------|--|-------|-------|-------|------|-------|-------|-------|--|-------|--|-------|-------|-------|-------|-------|
| PROGRESSIVE TERRENO | | | | 5.62 | 4.99 | 4.59 | 4.17 | | 2.79 | 2.25 | | 0.43 | 0.51 | 1.08 | 1.71 | | 2.91 | 3.42 | 3.96 | | 5.47 | 6.00 | 6.42 | | 10.02 | | 13.29 | 13.82 | 14.28 | 15.13 | 16.48 |
| PARZIALI TERRENO | | 15.30 | | 0.63 | 0.40 | 0.42 | 1.38 | | 0.54 | 1.82 | | 0.94 | 0.57 | 0.63 | 1.20 | | 0.51 | 0.54 | 1.51 | | 0.53 | 0.42 | 3.60 | | 3.27 | | 0.53 | 0.46 | 0.85 | 1.35 | 1.22 |
| QUOTE TERRENO | | | | 14.38 | 14.41 | 14.43 | 14.45 | | 14.48 | 14.46 | | 14.68 | 14.65 | 14.79 | 15.00 | | 15.39 | 15.54 | 15.69 | | 15.42 | 15.47 | 15.50 | | 15.45 | | 16.28 | 16.46 | 16.61 | 16.88 | 17.20 |
| PROGRESSIVE PROGETTO | | 16.27 | | 7.25 | 6.00 | 5.00 | | | | | | 0.00 | | | | | 5.00 | | | 5.00 | 6.00 | 7.25 | | | 11.49 | | | | | | |
| PARZIALI PROGETTO | 0.60 | 9.02 | | 1.25 | 1.00 | | | 5.00 | | | | | 5.00 | | | | 1.00 | 1.25 | | | 4.24 | | | | | | | | | | |
| QUOTE PROGETTO | 12.62 | | | 18.63 | 18.58 | 18.60 | | | | | | 18.70 | | | | | 18.60 | 18.58 | 18.65 | | | | | | 15.82 | | | | | | |

PROFILO P-SN1A
 SEZIONE 27.PSN1A
 PROGRESSIVA 520.00

Rilevato
 B1 24.88 mq.
 Sterro C1 1.23 mq.
 Vegetale D1 2.22 mq.
 Usura a1 12.00 ml.

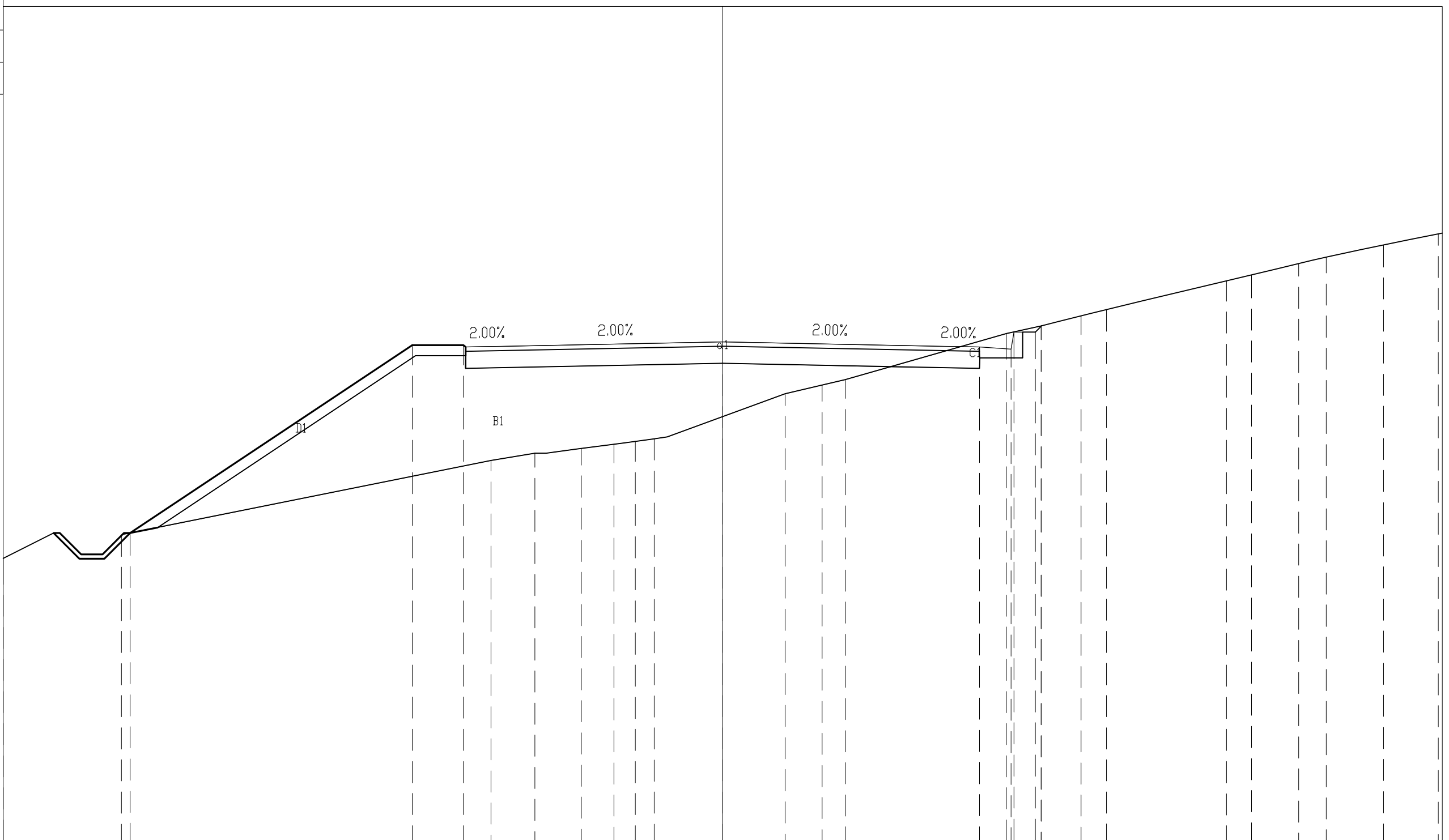

| | | | | | | | | | | | | | | | | | | | | | | | | | |
|----------------------|-------|-------|-------|-------|-------|-------|-------|-------|-------|-------|-------|-------|-------|-------|-------|-------|-------|-------|-------|-------|-------|-------|-------|-------|-------|
| PROGRESSIVE TERRENO | 16.80 | 14.04 | | 5.41 | 4.39 | 3.30 | 2.54 | 2.04 | 1.60 | | 1.46 | 2.32 | 2.87 | | 6.62 | 7.44 | 8.37 | 8.96 | | 11.76 | 12.35 | 13.45 | 14.09 | 15.43 | 16.70 |
| PARZIALI TERRENO | 2.76 | 8.63 | 1.02 | 1.09 | 0.76 | 0.50 | 0.44 | 3.06 | 0.86 | 0.55 | 3.75 | 0.82 | 0.93 | 0.59 | 2.80 | 0.59 | 1.10 | 0.64 | 1.34 | 1.27 | 0.10 | 16.70 | | | |
| QUOTE TERRENO | 15.71 | 16.26 | 18.00 | 18.17 | 18.28 | 18.38 | 18.44 | 18.51 | 19.56 | 19.76 | 19.88 | 20.96 | 21.14 | 21.38 | 21.52 | 22.19 | 22.33 | 22.60 | 22.75 | 23.03 | 23.29 | | | | |
| PROGRESSIVE PROGETTO | | 13.83 | 7.25 | 6.05 | | 0.00 | | | | | | 6.00 | 6.74 | 6.80 | 7.30 | 7.44 | | | | | | | | | |
| PARZIALI PROGETTO | | 6.58 | 1.20 | 6.05 | | 6.00 | | | 0.74 | | | | | | | | | | | | | | | | |
| QUOTE PROGETTO | | 16.31 | 20.69 | 20.69 | | 20.76 | | | 20.64 | 20.60 | 20.99 | 20.99 | 21.14 | 21.14 | 21.38 | 21.52 | 22.19 | 22.33 | 22.60 | 22.75 | 23.03 | 23.29 | | | |

PROFILO P-SN1A
 SEZIONE 28.PSN1A
 PROGRESSIVA 540.00

Sterro
 C1 84.39 mq.
 Fondazione
 E1 4.80 mq.
 Usura
 al 12.00 ml.

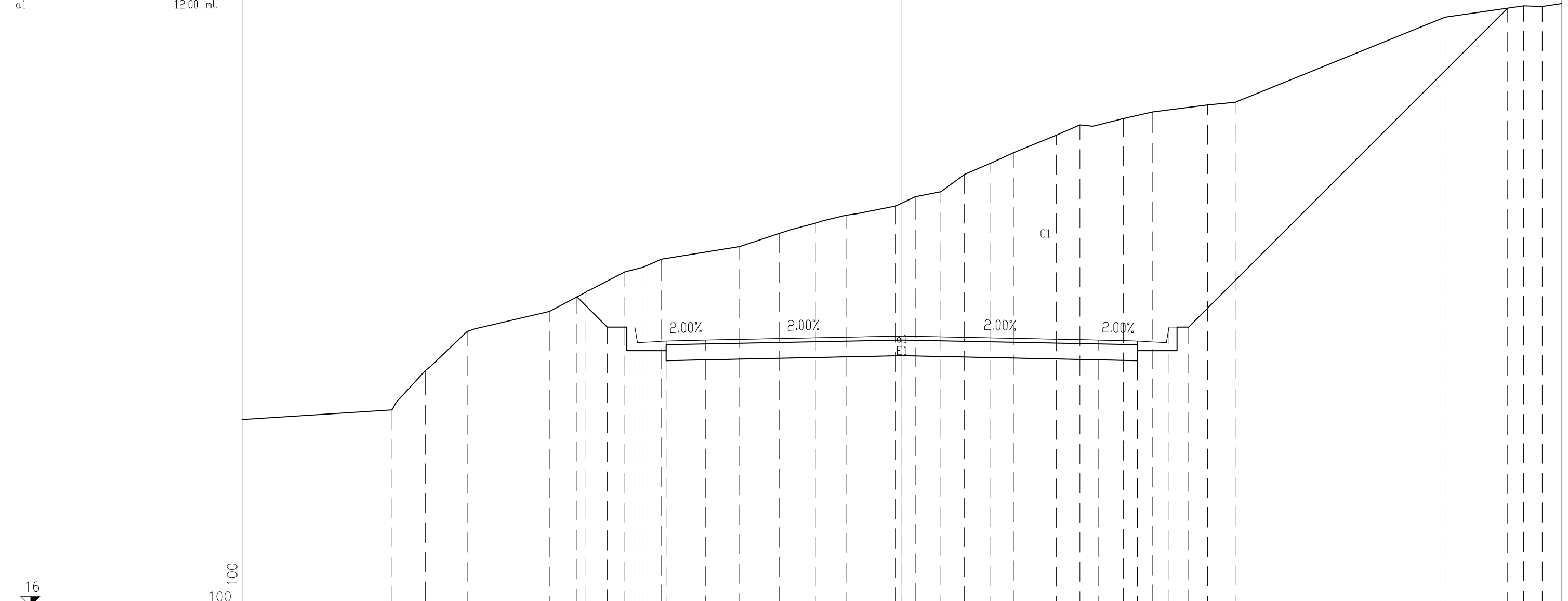

| | | | | | | | | | | | | | | | | | | | | | | | | | | | | | | | | | | | | |
|----------------------|------|-------|-------|-------|-------|-------|-------|-------|-------|-------|-------|-------|-------|-------|-------|-------|-------|-------|-------|-------|-------|-------|-------|-------|-------|-------|-------|------|-------|------|-------|-------|-------|-------|------|-------|
| PROGRESSIVE TERRENO | | 21.00 | 22.00 | 23.00 | 23.51 | 24.00 | 24.51 | 24.64 | 24.84 | | 25.16 | 25.50 | 25.76 | 25.96 | 26.20 | 26.43 | 26.56 | 27.00 | 27.29 | 27.56 | 28.00 | 28.26 | 28.42 | 28.59 | | 28.77 | 28.84 | | 31.00 | | 31.29 | 31.28 | 31.28 | | | |
| PARZIALI TERRENO | 5.40 | 0.85 | 1.06 | 2.09 | 0.94 | 0.99 | 0.47 | 0.45 | | 2.00 | 1.02 | 0.93 | 0.78 | 1.24 | 0.50 | 0.65 | 0.61 | 1.60 | 2.26 | 0.60 | 2.86 | 1.07 | 3.93 | 4.53 | 5.64 | 6.39 | | 7.78 | 8.49 | | 5.34 | | 2.00 | 15.83 | 0.47 | 16.30 |
| QUOTE TERRENO | | 21.00 | 22.00 | 23.00 | 23.51 | 24.00 | 24.51 | 24.64 | 24.84 | | 25.16 | 25.50 | 25.76 | 25.96 | 26.20 | 26.43 | 26.56 | 27.00 | 27.29 | 27.56 | 28.00 | 28.26 | 28.42 | 28.59 | | 28.77 | 28.84 | | 31.00 | | 31.29 | 31.28 | 31.28 | | | |
| PROGRESSIVE PROGETTO | | | | | | 8.27 | 7.50 | 6.80 | 6.00 | 5.00 | | | | | 0.00 | | | | | | | | 5.00 | 6.00 | 6.80 | 7.30 | | | | | | 15.42 | | | | |
| PARZIALI PROGETTO | | | | | | 0.77 | 0.70 | 0.80 | 1.00 | | | 5.00 | | | | | | | | | | | 1.00 | 0.80 | 0.50 | | | | | 8.12 | | | | | | |
| QUOTE PROGETTO | | | | | | 23.88 | 23.11 | 23.11 | 22.76 | 22.78 | | | | | 22.88 | | | | | | | | 22.78 | 22.76 | 23.11 | 23.11 | | | | | 31.23 | | | | | |

PROFILO P-SN1A
 SEZIONE 29.PSN1A
 PROGRESSIVA 560.00

Rilevato
 B1 0.74 mq.
 Sterro
 C1 84.24 mq.
 Fondazione
 E1 4.80 mq.
 Usura
 a1 12.00 ml.

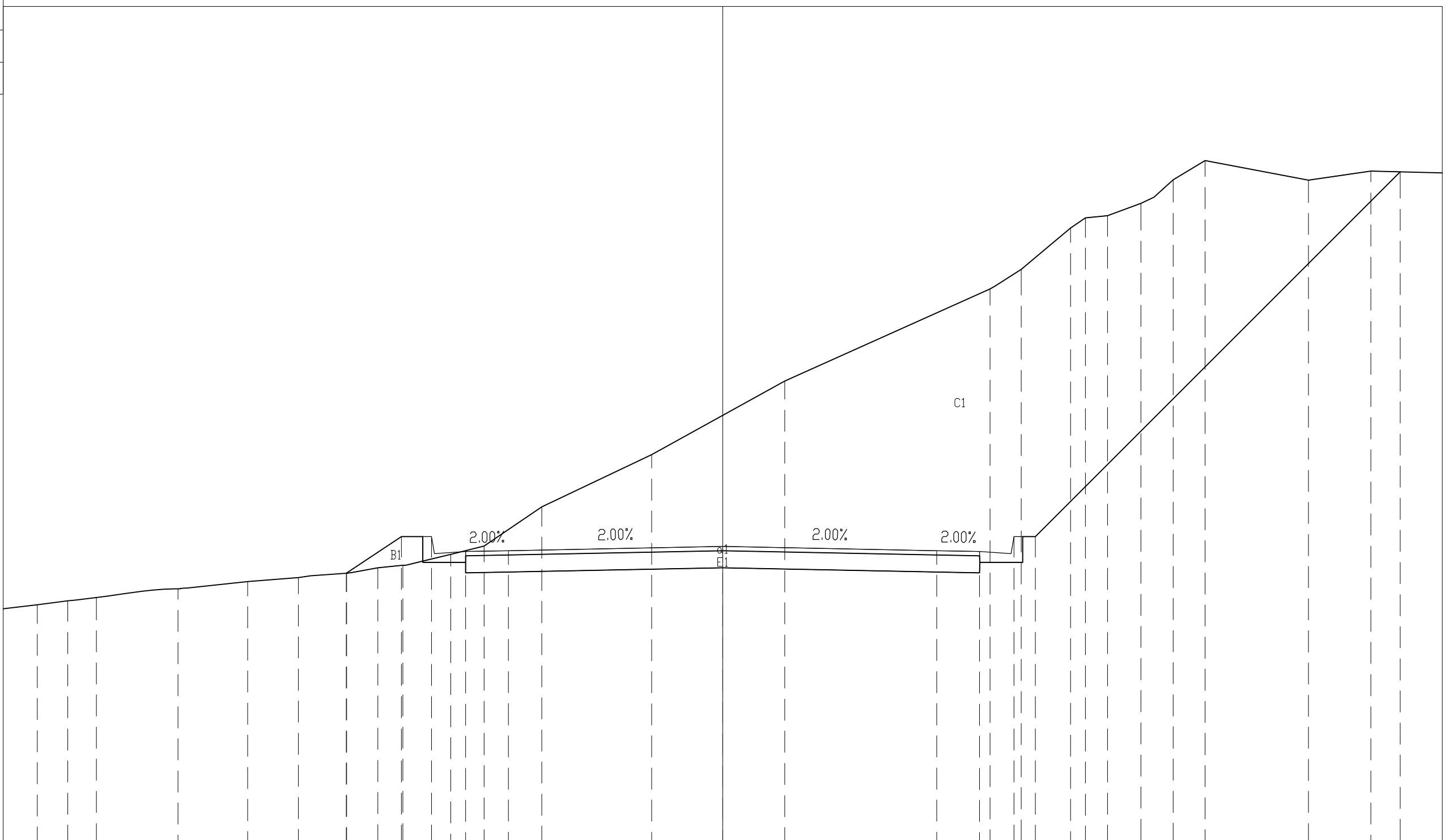

| | | | | | | | | | | | | | | | | | | | | | | | | | |
|----------------------|-------|-------|-------|-------|-------|-------|-------|-------|-------|-------|-------|-------|-------|-------|-------|-------|-------|-------|-------|-------|-------|-------|-------|-------|------|
| PROGRESSIVE TERRENO | 16.00 | 15.29 | 14.63 | 12.72 | 11.09 | 9.91 | 8.78 | 8.05 | 7.47 | 6.35 | 5.57 | 4.22 | 1.65 | 1.45 | 6.25 | 6.97 | 8.12 | 8.47 | 8.99 | 9.77 | 10.52 | 11.26 | 13.68 | 15.13 | |
| PARZIALI TERRENO | 2.30 | 0.71 | 0.66 | 1.91 | 1.63 | 1.18 | 1.13 | 0.73 | 0.58 | 1.12 | 0.78 | 1.35 | 2.57 | 3.10 | 4.80 | 0.72 | 1.15 | 0.35 | 0.47 | 0.78 | 0.75 | 0.74 | 2.42 | 1.45 | 4.55 |
| QUOTE TERRENO | 23.63 | 23.72 | 23.80 | 24.00 | 24.17 | 24.26 | 24.36 | 24.49 | 24.55 | 24.80 | 25.00 | 25.92 | 27.13 | 28.85 | 31.00 | 31.46 | 32.42 | 32.66 | 32.72 | 33.00 | 33.55 | 34.00 | 33.54 | 33.75 | |
| PROGRESSIVE PROGETTO | | | | | | | 8.79 | 7.50 | 6.80 | 6.00 | 5.00 | | 0.00 | | 5.00 | 6.00 | 6.80 | 7.30 | | | | | | 15.82 | |
| PARZIALI PROGETTO | | | | | | | 1.29 | 0.70 | 0.80 | 1.00 | | 5.00 | | 5.00 | 1.00 | 0.80 | | | | | | 8.52 | | | |
| QUOTE PROGETTO | | | | | | | 24.36 | 25.22 | 25.22 | 24.87 | 24.89 | | 24.99 | | 24.89 | 24.87 | 25.22 | 25.22 | | | | | | 33.74 | |

PROFILO P-SN1A
 SEZIONE 30.PSN1A
 PROGRESSIVA 580.00

Rilevato
 B1 5.81 mq.
 Sterro
 C1 13.57 mq.
 Vegetale
 D1 1.22 mq.
 Fondazione
 E1 4.80 mq.
 Usura
 al 12.00 ml.

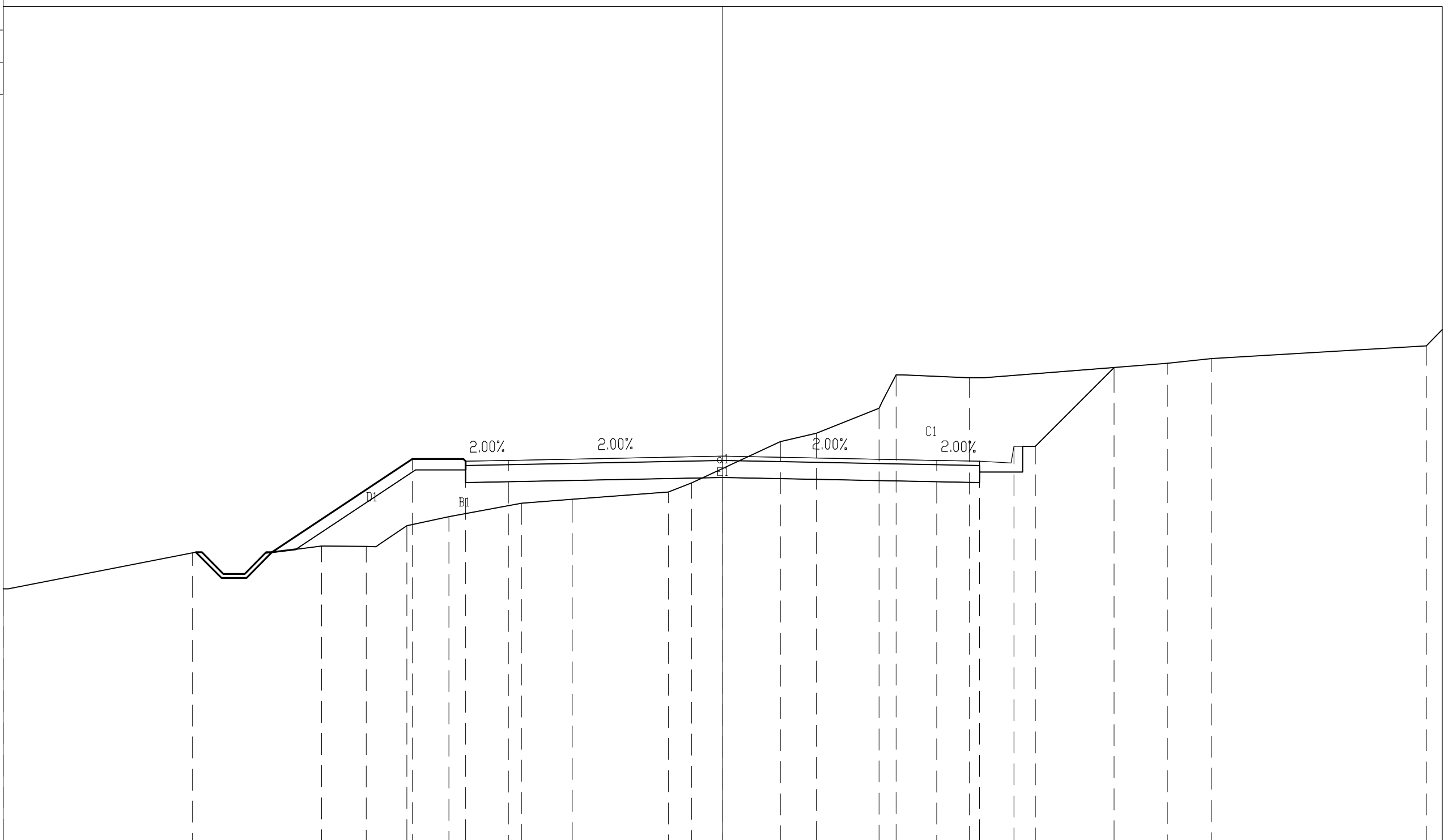

| | | | | | | | | | | | | | | | | | | |
|----------------------|-------|-------|-------|-------|-------|-------|-------|-------|-------|-------|-------|-------|-------|-------|-------|-------|-------|-------|
| PROGRESSIVE TERRENO | 16.80 | 11.86 | 9.37 | 8.32 | 7.38 | 6.39 | 4.70 | 3.51 | 1.27 | 0.72 | 1.34 | 2.19 | 3.65 | 4.05 | 5.76 | 10.38 | 11.42 | 16.43 |
| PARZIALI TERRENO | 4.94 | 2.49 | 1.05 | 0.94 | 0.99 | 1.69 | 1.19 | 2.24 | 0.55 | 2.06 | 0.85 | 1.46 | 0.40 | 1.71 | 4.62 | 1.04 | 5.01 | 0.37 |
| QUOTE TERRENO | 24.00 | 24.68 | 25.00 | 24.99 | 25.48 | 25.68 | 26.00 | 26.09 | 26.26 | 26.47 | 27.44 | 27.64 | 28.22 | 29.00 | 28.93 | 29.27 | 29.37 | 29.68 |
| PROGRESSIVE PROGETTO | | 12.37 | 12.02 | 11.42 | 7.25 | 6.00 | 5.00 | 0.00 | 5.00 | 0.00 | 5.00 | 6.00 | 6.80 | 7.30 | 9.14 | | | |
| PARZIALI PROGETTO | | 0.35 | 0.60 | 4.17 | 1.25 | 1.00 | 5.00 | 5.00 | 0.50 | 2.06 | 5.00 | 5.00 | 1.00 | 0.80 | 1.84 | | | |
| QUOTE PROGETTO | | 24.61 | 24.25 | 24.25 | 27.03 | 26.98 | 27.00 | 27.10 | 27.10 | 27.10 | 27.10 | 27.10 | 27.10 | 27.33 | 27.33 | 29.17 | | |

PROFILO P-SN1A

SEZIONE 31.PSN1A

PROGRESSIVA 600.00

- Rilevato
- B1 50.26 mq.
- Vegetale
- D1 1.17 mq.
- D2 2.32 mq.
- Totale: 3.49 mq.
- Fondazione
- E1 4.80 mq.
- Usura
- a1 12.00 ml.

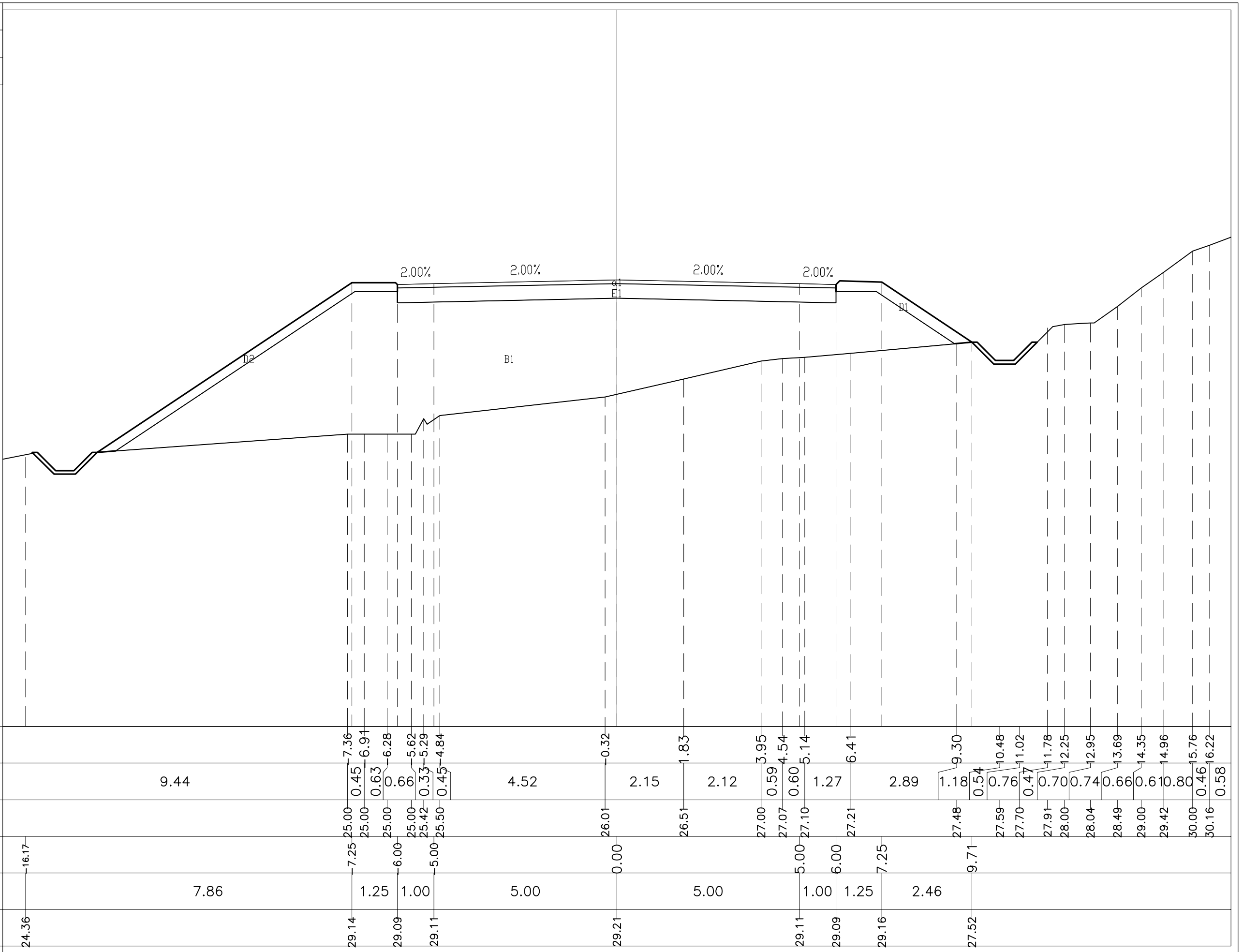

PROFILO P-SN1A
 SEZIONE 33.PSN1A
 PROGRESSIVA 640.00

Rilevato
 B1 62.76 mq.
 Vegetale
 D1 1.99 mq.
 D2 2.03 mq.
 Totale:
 Fondazione 4.02 mq.
 E1 4.80 mq.
 Usura
 a1 12.00 ml.

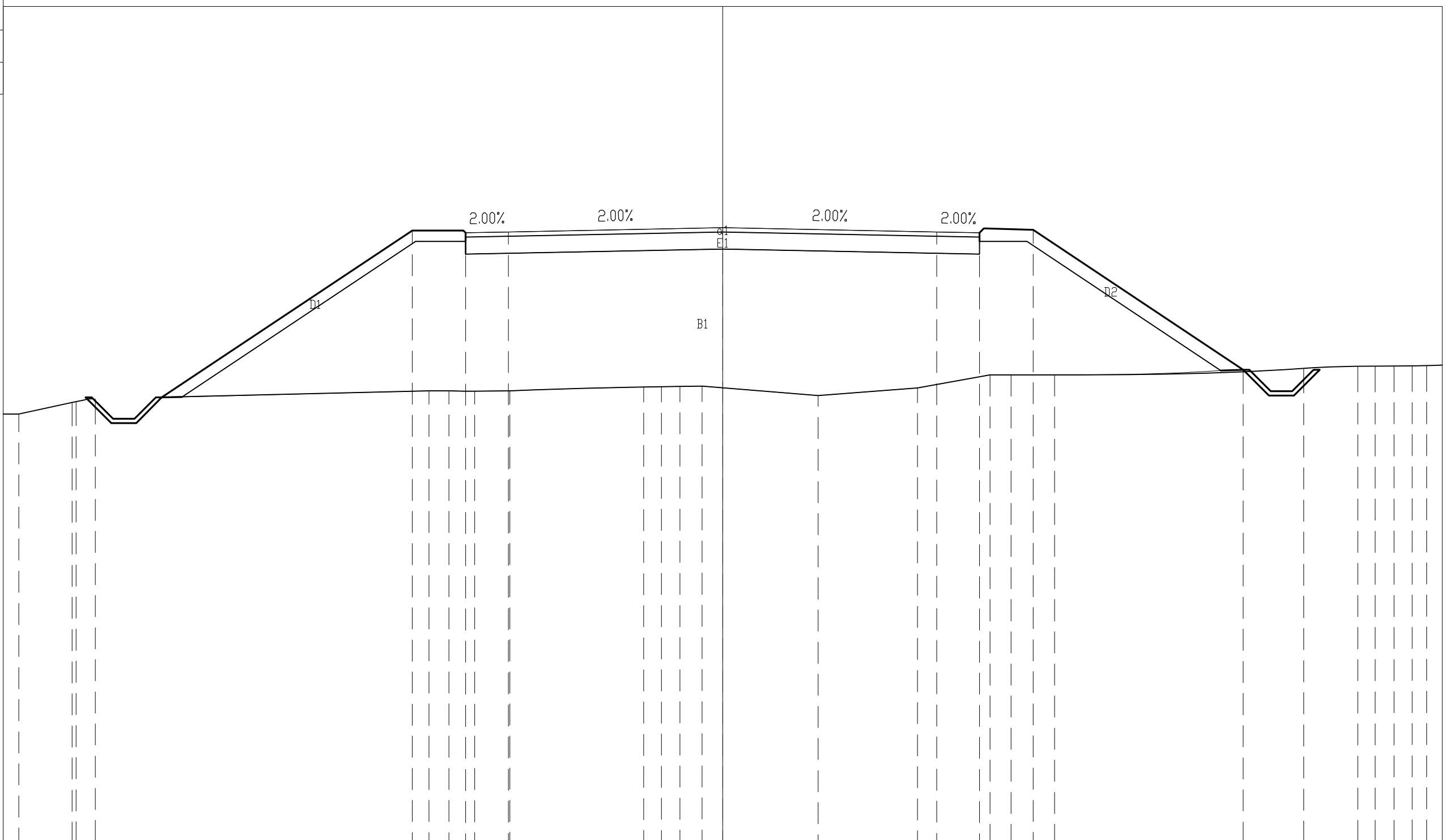

| | | | | | | | | | | | | | | | | | | | | | | |
|----------------------|-------|-------|-------|-------|-------|-------|-------|-------|-------|-------|-------|-------|-------|-------|-------|-------|-------|-------|-------|-------|-------|-------|
| PROGRESSIVE TERRENO | 16.43 | 15.19 | 14.65 | 6.86 | 6.39 | 5.79 | 4.97 | 1.84 | 1.43 | 0.99 | 0.48 | 2.23 | 4.55 | 6.24 | 6.73 | 7.75 | 13.57 | 14.83 | 15.24 | 15.67 | 16.10 | 16.43 |
| PARZIALI TERRENO | 1.19 | 1.24 | 0.54 | 7.21 | 0.47 | 0.60 | 0.82 | 3.13 | 0.41 | 0.44 | 0.51 | 2.71 | 2.32 | 1.69 | 0.49 | 1.02 | 5.82 | 1.26 | 0.41 | 0.43 | 0.43 | 0.98 |
| QUOTE TERRENO | 29.08 | 29.35 | 29.44 | 29.62 | 29.62 | 29.61 | 29.63 | 29.71 | 29.72 | 29.73 | 29.74 | 29.52 | 29.69 | 30.00 | 30.00 | 30.00 | 30.15 | 30.20 | 30.20 | 30.20 | 30.21 | 30.21 |
| PROGRESSIVE PROGETTO | | 15.09 | 14.59 | 7.25 | 6.00 | 5.00 | 0.00 | | | | | | 5.00 | 6.00 | 7.25 | | 12.15 | | | | | |
| PARZIALI PROGETTO | | 0.50 | 0.60 | 6.74 | 1.25 | 1.00 | 5.00 | | | | | 5.00 | 1.00 | 1.25 | 4.90 | | | | | | | |
| QUOTE PROGETTO | | 29.37 | 28.87 | 33.37 | 33.32 | 33.34 | 33.44 | | | | | | 33.34 | 33.32 | 33.38 | | 30.11 | | | | | |

PROFILO P-SN1A
 SEZIONE 36.PSN1A
 PROGRESSIVA 700.00

Rilevato
 B1 39.03 mq.
 Vegetale
 D1 1.76 mq.
 D2 1.59 mq.
 Totale:
 Fondazione 3.35 mq.
 E1 4.80 mq.
 Usura
 al 12.00 ml.

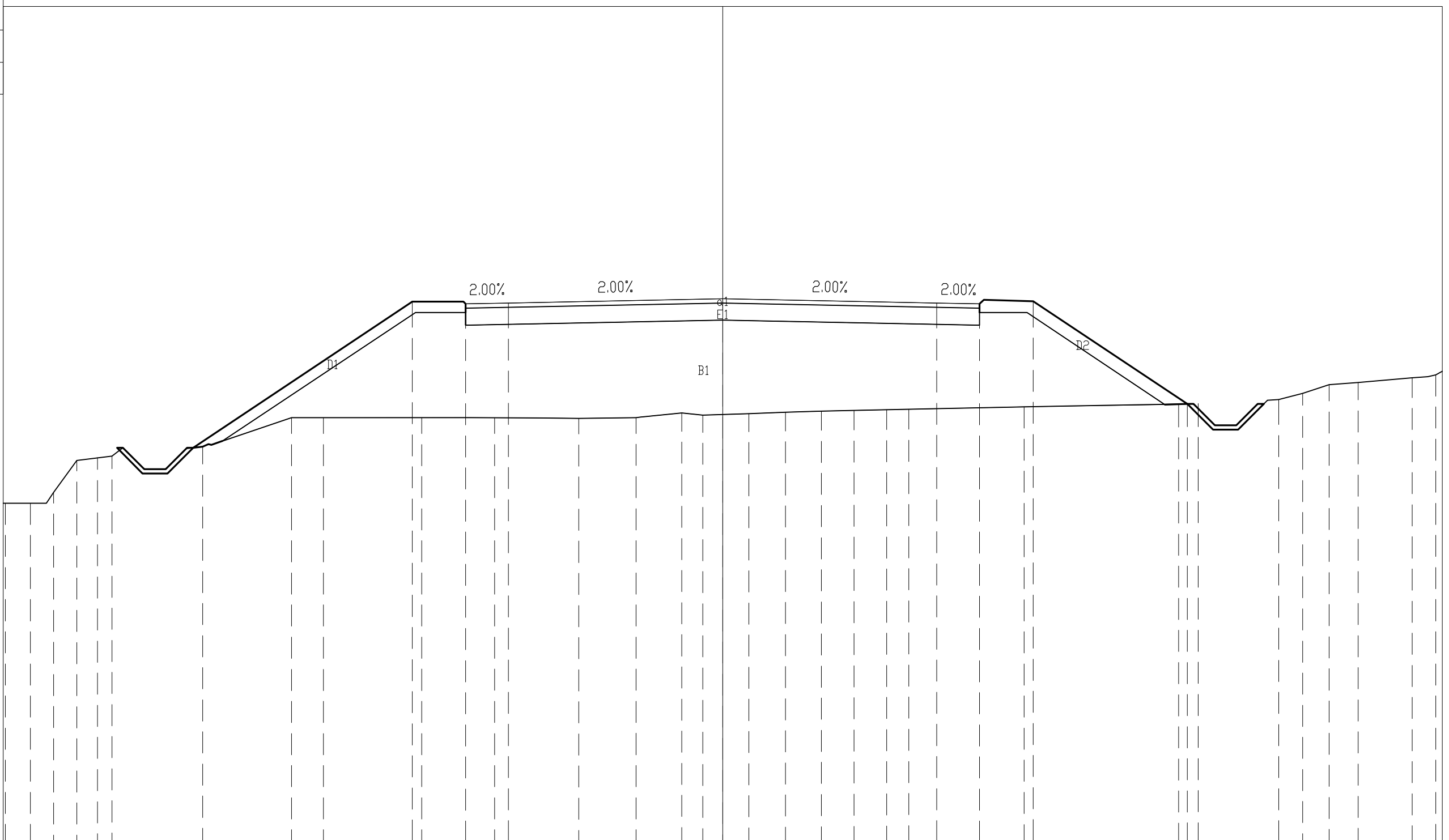

| | | | | | | | | | | | | | | | | | | | | | | | | | | | | | | |
|----------------------|-------|-------|-------|-------|-------|-------|-------|-------|-------|-------|-------|-------|-------|-------|-------|-------|-------|-------|-------|-------|-------|-------|-------|-------|-------|-------|-------|-------|-------|------|
| PROGRESSIVE TERRENO | 16.75 | 16.16 | 15.62 | 15.08 | 14.60 | 12.14 | 10.06 | 9.32 | 7.03 | 5.33 | 3.36 | 2.02 | 0.95 | 0.46 | 0.61 | 1.47 | 2.31 | 3.07 | 3.83 | 4.35 | 7.04 | 10.65 | 11.10 | 12.98 | 13.54 | 14.16 | 14.84 | 16.10 | 16.65 | |
| PARZIALI TERRENO | 1.70 | 0.59 | 0.54 | 0.54 | 0.48 | 2.46 | 2.08 | 0.74 | 2.29 | 1.70 | 1.97 | 1.34 | 1.07 | 0.49 | 1.07 | 0.86 | 0.84 | 0.76 | 0.76 | 0.52 | 2.69 | 3.61 | 0.45 | 1.88 | 0.56 | 0.62 | 0.68 | 1.26 | 0.55 | 0.77 |
| QUOTE TERRENO | 35.00 | 35.00 | 35.25 | 36.00 | 36.06 | 36.32 | 37.00 | 37.00 | 37.00 | 37.00 | 36.98 | 37.00 | 37.11 | 37.06 | 37.09 | 37.12 | 37.15 | 37.16 | 37.18 | 37.19 | 37.25 | 37.31 | 37.32 | 37.42 | 37.57 | 37.76 | 37.82 | 37.93 | 38.00 | |
| PROGRESSIVE PROGETTO | | | | 14.26 | 13.86 | 13.26 | 7.25 | 6.00 | 5.00 | 0.00 | | | | | | | | | | 5.00 | 6.00 | 7.25 | 10.85 | | | | | | | |
| PARZIALI PROGETTO | | | | 0.40 | 0.60 | 6.01 | 1.25 | 1.00 | 5.00 | 5.00 | | | | | | | | | | 1.00 | 1.25 | 3.60 | | | | | | | | |
| QUOTE PROGETTO | | | | 36.10 | 35.70 | 35.70 | 39.70 | 39.65 | 39.67 | 39.77 | | | | | | | | | | 39.67 | 39.65 | 39.72 | 37.32 | | | | | | | |

PROFILO P-SN1A
 SEZIONE 37.PSN1A
 PROGRESSIVA 720.00

Rilevato
 B1 35.12 mq.
 Vegetale
 D1 1.66 mq.
 D2 1.13 mq.
 Totale:
 Fondazione 2.79 mq.
 E1 4.80 mq.
 Usura
 al 12.00 ml.

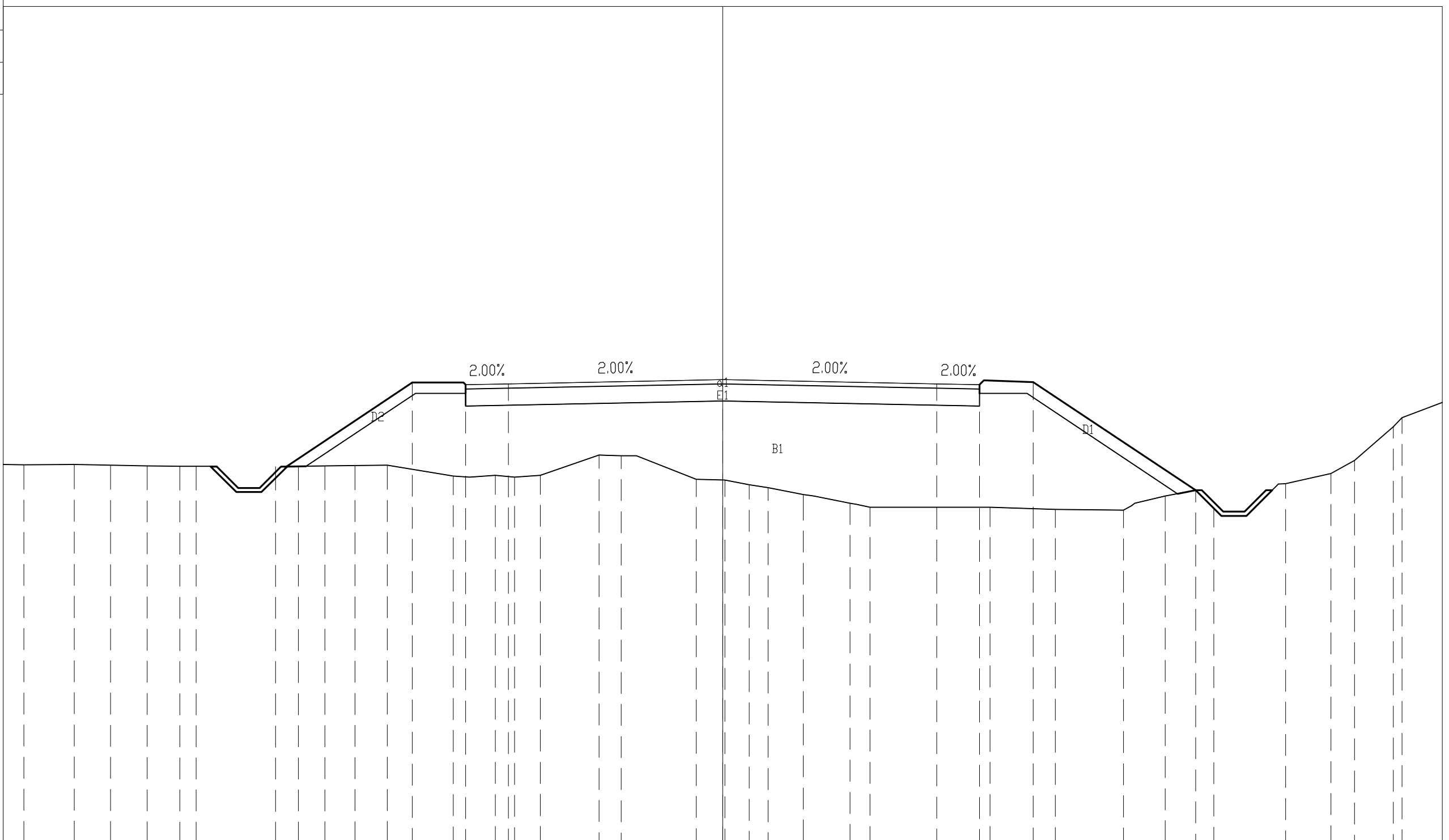

| | | | | | | | | | | | | | | | | | | | | | | | | | | | | | | | | | | | |
|----------------------|-------|-------|-------|-------|-------|-------|-------|-------|-------|-------|-------|-------|-------|-------|-------|-------|-------|-------|-------|-------|-------|-------|-------|-------|-------|-------|-------|-------|-------|-------|-------|-------|-------|------|------|
| PROGRESSIVE TERRENO | 16.32 | 15.14 | 14.29 | 13.44 | 12.67 | 10.44 | 9.90 | 9.29 | 8.59 | 7.83 | 6.29 | 5.30 | 4.86 | 4.25 | 2.89 | 2.37 | 0.62 | 0.05 | 0.62 | 1.06 | 1.88 | 2.97 | 3.44 | 6.24 | 7.77 | 9.36 | 10.34 | 11.47 | 13.14 | 14.20 | 14.75 | 15.66 | 15.86 | | |
| PARZIALI TERRENO | 1.21 | 1.18 | 0.85 | 0.85 | 0.77 | 2.23 | 0.54 | 0.61 | 0.70 | 0.76 | 1.54 | 0.99 | 0.44 | 0.61 | 1.36 | 0.52 | 1.75 | 0.67 | 0.57 | 0.44 | 0.82 | 1.09 | 0.47 | 3.44 | 2.80 | 1.53 | 1.59 | 0.98 | 1.13 | 1.67 | 1.06 | 0.55 | 0.91 | 0.20 | 1.20 |
| QUOTE TERRENO | 39.90 | 39.90 | 39.89 | 39.87 | 39.86 | 39.85 | 39.86 | 39.87 | 39.88 | 39.89 | 39.64 | 39.65 | 39.61 | 39.65 | 40.12 | 40.11 | 39.56 | 39.54 | 39.43 | 39.37 | 39.20 | 39.00 | 38.91 | 38.90 | 38.85 | 38.84 | 39.17 | 39.38 | 39.46 | 39.69 | 40.00 | 40.79 | 41.00 | | |
| PROGRESSIVE PROGETTO | | | | | 12.29 | | | | | 7.25 | 6.00 | 5.00 | | | 0.00 | | | | | | 5.00 | | | 5.00 | 6.00 | 7.25 | | 11.05 | | | | | | | |
| PARZIALI PROGETTO | | | | | 0.60 | | | 3.84 | | 1.25 | 1.00 | | | | 5.00 | | | | | | 5.00 | | | 1.00 | 1.25 | | 3.80 | | | | | | | | |
| QUOTE PROGETTO | | | | | 39.86 | | | | | 41.82 | 41.77 | 41.79 | | | 41.89 | | | | | | 41.79 | | | 41.77 | 41.83 | | 39.30 | | | | | | | | |

PROFILO P-SN1A
 SEZIONE 38.PSN1A
 PROGRESSIVA 740.00

Rilevato
 B1 24.00 mq.
 Vegetale
 D1 0.47 mq.
 D2 1.12 mq.
 Totale:
 Fondazione 1.59 mq.
 E1 4.80 mq.
 Usura
 a1 12.00 ml.

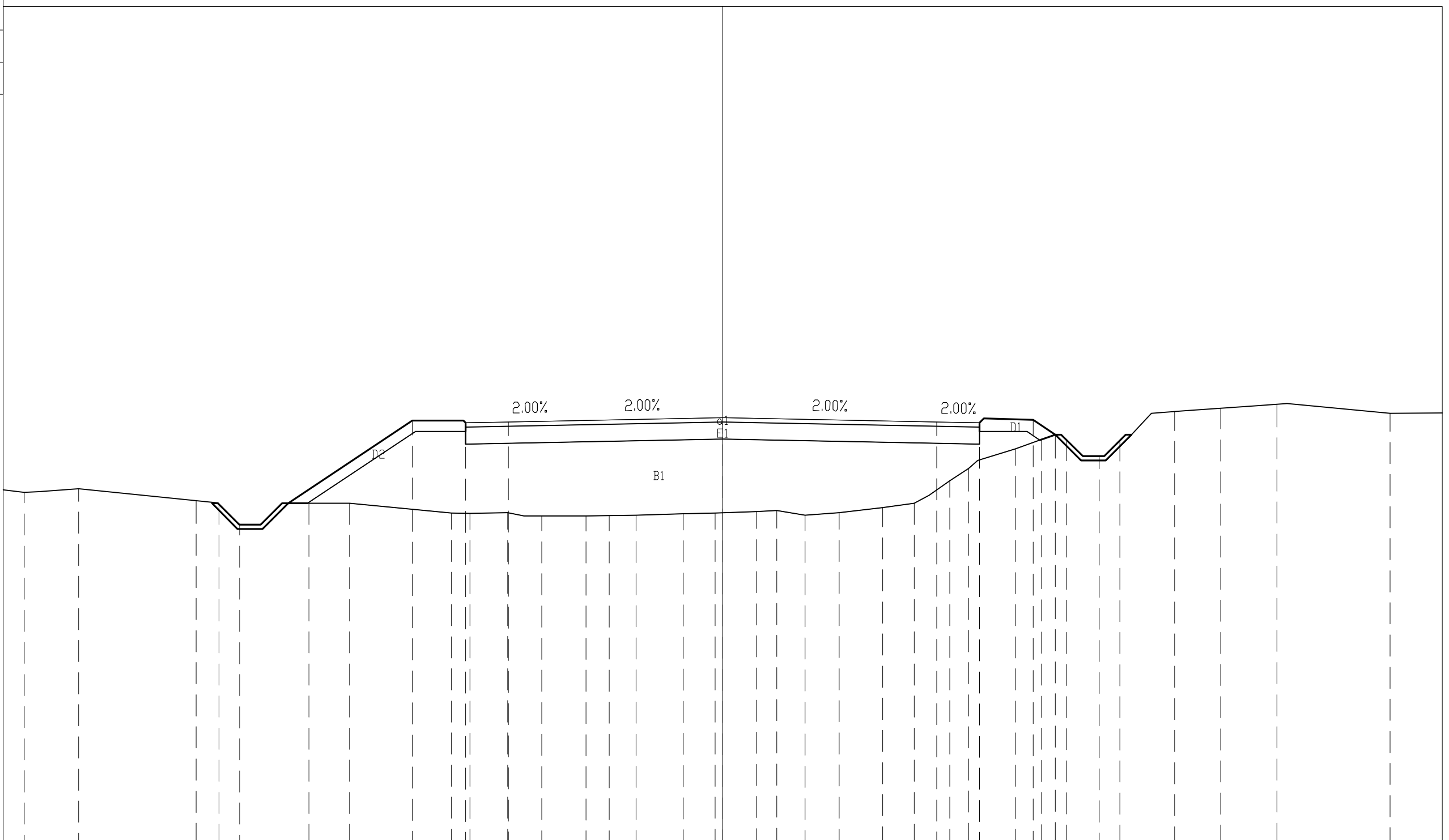

34

100
 100

| | | | | | | | | | | | | | | | | | | | | | | | | | | | | | | | | | | |
|----------------------|-------|-------|-------|-------|-------|-------|-------|-------|-------|-------|-------|-------|-------|-------|-------|-------|-------|-------|-------|-------|-------|-------|-------|-------|-------|-------|-------|-------|-------|-------|-------|-------|------|------|
| PROGRESSIVE TERRENO | 16.30 | 15.04 | 11.76 | 11.27 | 9.66 | 8.71 | 6.34 | 5.90 | 5.02 | 4.22 | 3.19 | 2.65 | 2.03 | 0.92 | 0.18 | 0.79 | 1.27 | 1.93 | 2.72 | 3.74 | 4.47 | 5.30 | 5.74 | 6.84 | 7.45 | 8.03 | 8.79 | 9.27 | 10.55 | 11.63 | 12.94 | 15.58 | | |
| PARZIALI TERRENO | 1.12 | 1.26 | 3.28 | 0.49 | 1.61 | 0.95 | 2.37 | 0.44 | 0.88 | 0.80 | 1.03 | 0.54 | 0.62 | 1.11 | 0.74 | 0.97 | 0.48 | 0.66 | 0.79 | 1.02 | 0.73 | 0.83 | 0.44 | 5.74 | 1.10 | 0.61 | 0.58 | 0.76 | 0.48 | 1.28 | 1.08 | 1.31 | 2.64 | 1.89 |
| QUOTE TERRENO | 42.26 | 42.34 | 42.00 | 42.00 | 42.00 | 42.00 | 41.77 | 41.76 | 41.77 | 41.70 | 41.70 | 41.71 | 41.72 | 41.75 | 41.77 | 41.81 | 41.83 | 41.72 | 41.78 | 41.89 | 42.00 | 42.52 | 42.81 | 43.27 | 43.49 | 43.69 | 44.00 | 44.04 | 44.14 | 44.22 | 44.31 | 44.10 | | |
| PROGRESSIVE PROGETTO | | | 12.30 | 11.64 | 11.04 | | 7.25 | 6.00 | 5.00 | | | | | | 0.00 | | | | | | 5.00 | 6.00 | | | 7.25 | 7.76 | | | | | | | | |
| PARZIALI PROGETTO | | | 0.60 | 0.60 | | 3.79 | 1.25 | 1.00 | | | 5.00 | | | | | | | | 5.00 | | 1.00 | 1.25 | | | 0.51 | | | | | | | | | |
| QUOTE PROGETTO | | | 42.06 | 41.40 | 41.40 | | 43.93 | 43.88 | 43.90 | | | | | | 44.00 | | | | | | 43.90 | 43.88 | | | 43.94 | 43.60 | | | | | | | | |

PROFILO P-SN1A
 SEZIONE 40.PSN1A
 PROGRESSIVA 780.00

Sterro C1 129.28 mq.
 Fondazione E1 4.80 mq.
 Usura al 12.00 ml.

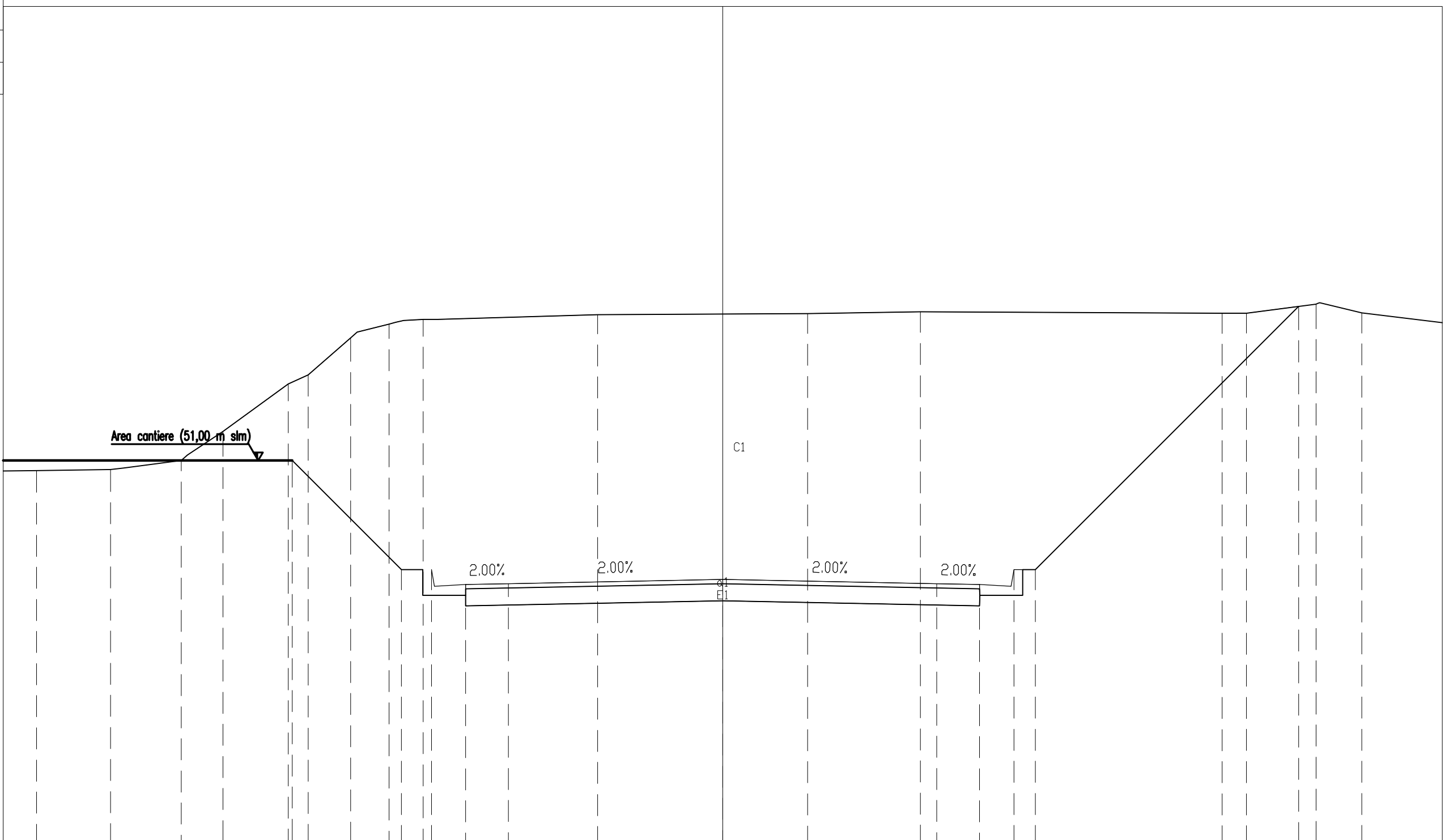

| | | | | | | | | | | | | | | | | | | | | |
|----------------------|-------|-------|-------|-------|-------|-------|-------|-------|-------|-------|-------|------|-------|-------|-------|-------|-------|-------|-------|-------|
| PROGRESSIVE TERRENO | 16.02 | 14.29 | 12.64 | 11.67 | 10.14 | 9.68 | 8.68 | 7.79 | 7.00 | | 2.92 | | 1.98 | 4.62 | | | 1.66 | 12.23 | 3.85 | 14.92 |
| PARZIALI TERRENO | 1.25 | 1.73 | 1.65 | 0.97 | 1.53 | 0.46 | 1.00 | 0.89 | 0.79 | 4.08 | | 4.90 | 2.64 | 4.62 | 7.04 | | 0.57 | 1.62 | 1.07 | 2.36 |
| QUOTE TERRENO | 50.76 | 50.78 | 51.00 | 51.68 | 52.78 | 53.00 | 53.86 | 54.19 | 54.29 | | 54.40 | | 54.43 | 54.47 | | | 54.43 | 54.44 | 54.65 | 54.45 |
| PROGRESSIVE PROGETTO | | | | | 10.05 | | | 7.50 | 6.80 | 6.00 | 5.00 | | 0.00 | | 5.00 | 6.00 | 6.80 | 7.30 | | |
| PARZIALI PROGETTO | | | | | | 2.55 | | 0.70 | 0.80 | 1.00 | | 5.00 | | 5.00 | 1.00 | 0.80 | 0.50 | | 6.14 | |
| QUOTE PROGETTO | | | | | 51.00 | | | 48.45 | 48.45 | 48.10 | 48.12 | | 48.22 | | 48.12 | 48.10 | 48.45 | 48.45 | | 54.59 |

PROFILO P-SN1A

SEZIONE 41.PSN1A

PROGRESSIVA 800.00

Sbancamento
A1 96.68 mq.
Fondazione
E1 4.80 mq.
Usura
a1 12.00 ml.

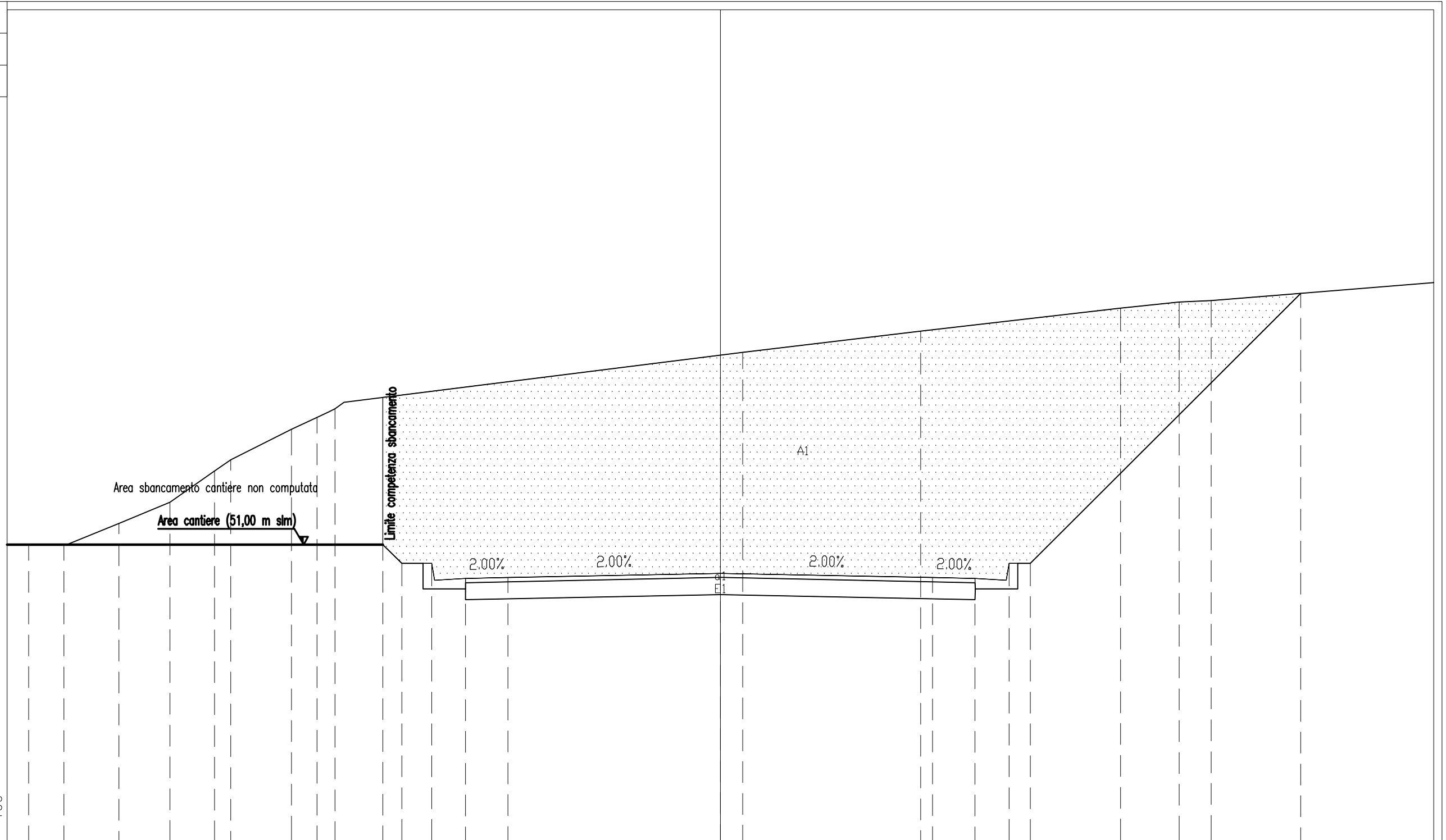

44

100
100

| | | | | | | | | | | | | | | | | | |
|----------------------|-------|-------|-------|-------|-------|-------|-------|-------|-------|-------|-------|-------|-------|-------|-------|-------|-------|
| PROGRESSIVE TERRENO | 16.29 | 15.46 | 14.16 | 12.96 | 11.92 | 11.53 | 10.10 | 9.50 | 9.08 | 0.53 | 4.72 | 9.42 | 10.80 | 11.56 | | | |
| PARZIALI TERRENO | 1.17 | 0.83 | 1.30 | 1.20 | 1.04 | 0.39 | 1.43 | 0.60 | 0.42 | 9.61 | 4.19 | 4.70 | 1.38 | 0.76 | 8.44 | | |
| QUOTE TERRENO | 51.00 | 51.00 | 51.50 | 52.00 | 52.74 | 53.00 | 53.71 | 54.00 | 54.20 | 55.53 | 56.03 | 56.57 | 56.71 | 56.75 | | | |
| PROGRESSIVE PROGETTO | | | | | | | 7.95 | 7.50 | 6.80 | 6.00 | 5.00 | 0.00 | 5.00 | 6.00 | 6.80 | 7.30 | 13.66 |
| PARZIALI PROGETTO | | | | | | | 0.45 | 0.70 | 0.80 | 1.00 | 5.00 | 5.00 | 1.00 | 0.80 | 0.50 | 6.36 | |
| QUOTE PROGETTO | | | | | | | 51.00 | 50.55 | 50.55 | 50.20 | 50.22 | 50.32 | 50.22 | 50.20 | 50.55 | 50.55 | 56.92 |

PROFILO P-SN1A
 SEZIONE 42.PSN1A
 PROGRESSIVA 820.00

Sbancamento
 A1 58.63 mq.
 Fondazione
 E1 4.80 mq.
 Usura
 a1 12.00 ml.

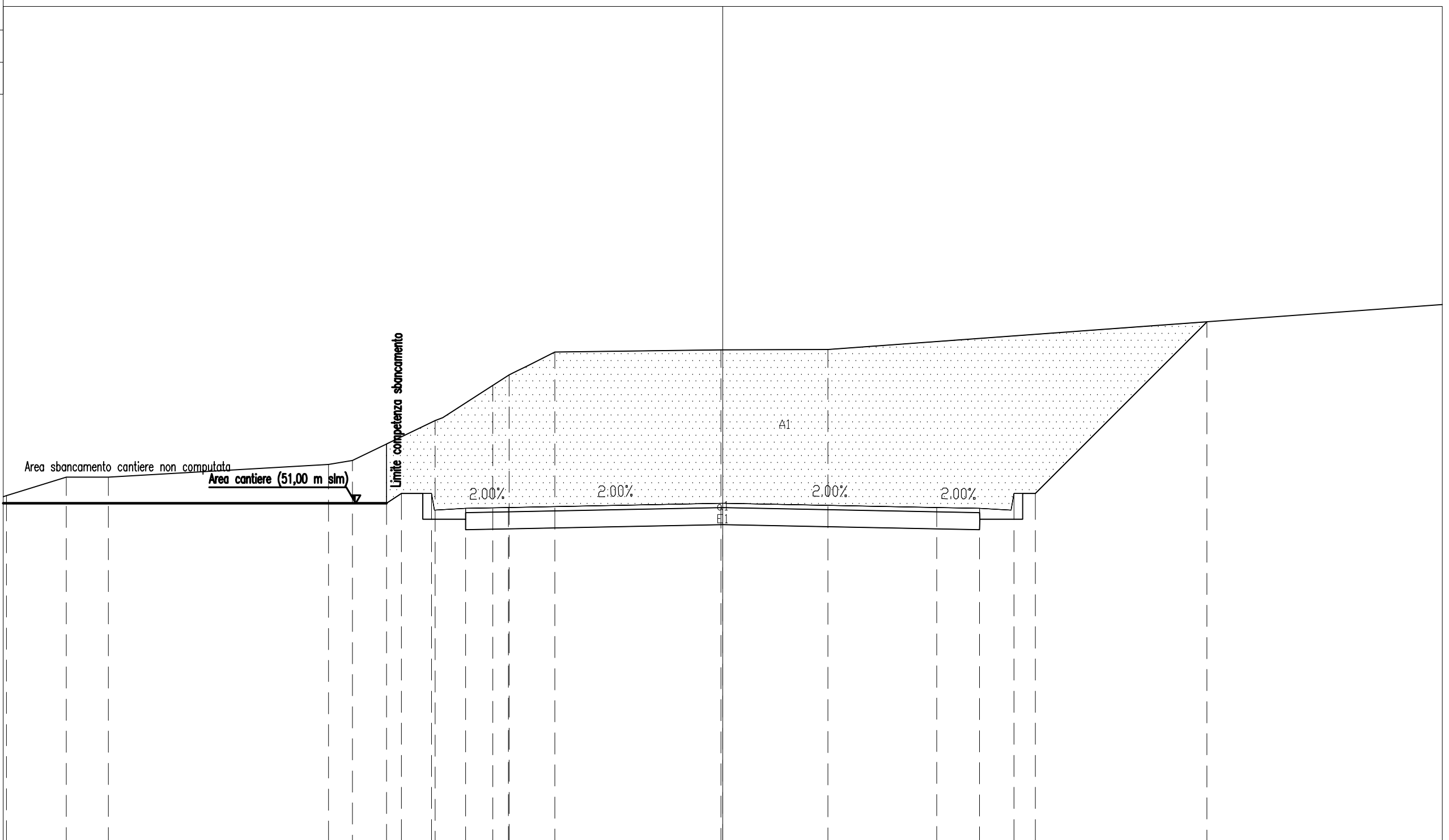

| | | | | | | | | | | | | | | | | | |
|----------------------|-------|-------|-------|------|-------|-------|-------|-------|-------|-------|-------|-------|-------|-------|-------|-------|-------|
| PROGRESSIVE TERRENO | 16.72 | 15.32 | 14.34 | | 9.20 | 8.64 | 6.71 | 5.37 | 4.98 | 3.92 | 0.04 | 2.46 | | | | | |
| PARZIALI TERRENO | 0.67 | 1.40 | 0.98 | 5.14 | 0.56 | 1.93 | 1.34 | 0.39 | 1.06 | 3.88 | 2.50 | 2.46 | | | | 17.54 | |
| QUOTE TERRENO | 51.17 | 51.61 | 51.61 | | 51.91 | 52.00 | 52.93 | 53.75 | 54.00 | 54.53 | 54.58 | 54.59 | | | | | |
| PROGRESSIVE PROGETTO | | | | | | 7.84 | 7.50 | 6.80 | 6.00 | 5.00 | 0.00 | 5.00 | 6.00 | 6.80 | 7.30 | | 11.31 |
| PARZIALI PROGETTO | | | | | 0.34 | 0.70 | 0.80 | 1.00 | | 5.00 | 5.00 | 1.00 | 0.80 | 0.50 | | 4.01 | |
| QUOTE PROGETTO | | | | | 51.00 | 51.23 | 51.23 | 50.88 | 50.90 | | 51.00 | 50.90 | 50.88 | 51.23 | 51.23 | | 55.24 |

PROFILO P-SN1A
 SEZIONE 43.PSN1A
 PROGRESSIVA 837.34

Sbancamento
 A1 52.99 mq.
 Usura
 a1 12.00 ml.

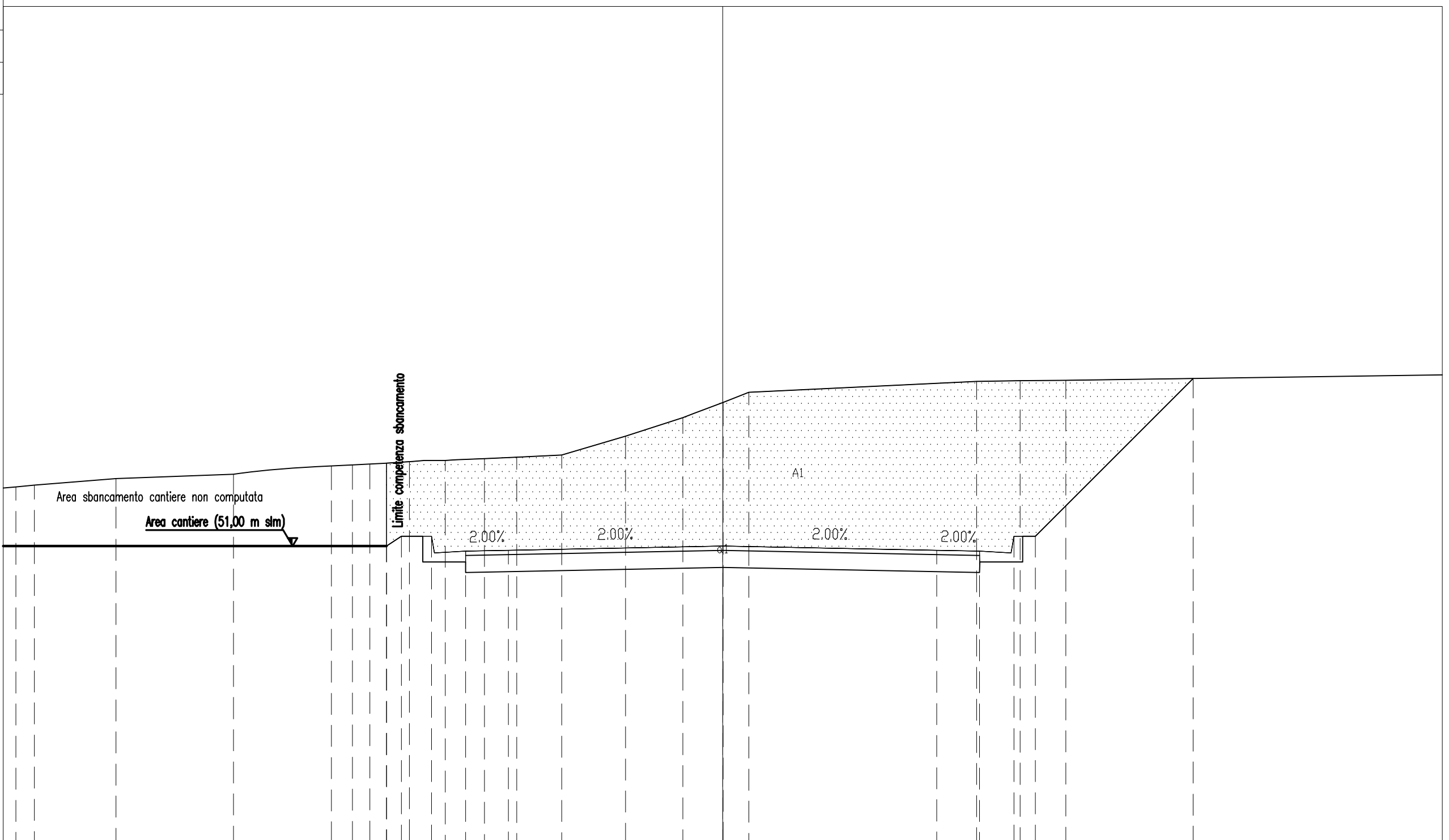

| | | | | | | | | | | | | | | | | | | | | | | |
|----------------------|-------|-------|-------|-------|-------|-------|-------|-------|-------|-------|-------|-------|-------|-------|-------|-------|-------|-------|-------|-------|-------|-------|
| PROGRESSIVE TERRENO | 16.50 | 16.07 | 14.16 | 11.42 | 9.13 | 8.64 | 8.24 | 7.84 | 7.31 | 6.48 | 5.56 | 4.80 | 3.75 | 2.26 | 0.93 | 0.01 | 0.61 | 5.93 | 6.95 | 8.01 | 9.31 | |
| PARZIALI TERRENO | 1.19 | 0.43 | 1.91 | 2.74 | 2.16 | 2.29 | 0.49 | 0.40 | 0.93 | 0.83 | 0.92 | 0.76 | 1.05 | 1.49 | 1.33 | 0.94 | 0.60 | 5.32 | 1.02 | 1.06 | 9.31 | |
| QUOTE TERRENO | 52.38 | 52.43 | 52.57 | 52.68 | 52.87 | 52.89 | 52.91 | 51.00 | 52.97 | 53.00 | 53.04 | 53.07 | 53.13 | 53.56 | 54.00 | 54.36 | 54.59 | 54.85 | 54.86 | 54.87 | | |
| PROGRESSIVE PROGETTO | | | | | | | | 7.84 | 7.50 | 6.80 | 6.00 | 5.00 | | | | 0.00 | 54.36 | 5.00 | 6.00 | 6.80 | 7.30 | 10.99 |
| PARZIALI PROGETTO | | | | | | | 0.34 | 0.70 | 0.80 | 1.00 | | | | 5.00 | | 5.00 | | 1.00 | 0.80 | 0.50 | 3.69 | |
| QUOTE PROGETTO | | | | | | | 51.00 | 51.23 | 51.23 | 50.88 | 50.90 | | | | | 51.00 | 50.90 | 50.88 | 51.23 | 51.23 | 54.91 | |